

POPULAR MECHANICS

MAGAZINE

WRITTEN SO YOU CAN UNDERSTAND IT

REG'D. TRADE MARK GREAT BRITAIN, No. 410428

REG. U.S. PAT. OFF.

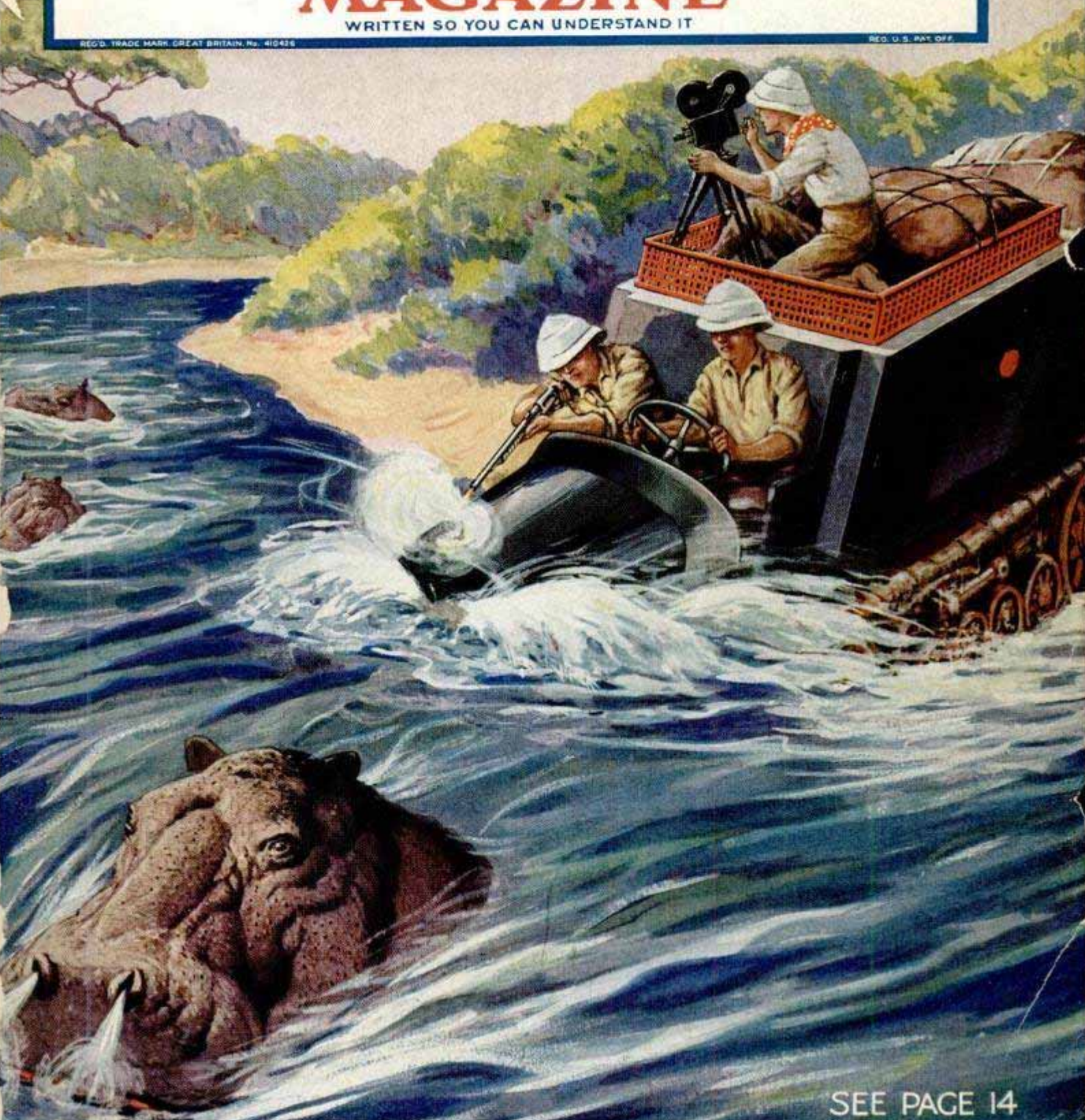

SEE PAGE 14

It takes *only* 8 weeks to get a big job



George W. Smith runs a big Ford Agency and Repair Shop at West Alexandria, Ohio. He says, "I am clearing over \$800 per month."



My method is the shortest successful system ever known for training Big Salary men.
J.H. MCSWEENEY,
President.

Read what these men are doing in the Auto, Tractor and Electrical Business. Here is your big chance to get "on easy street." Come to the great McSweeney Shops on the biggest Special Offer ever made.

Big Firms Need Trained Men

The Auto, Tractor and Electrical Business is on the boom. Thousands of trained men will be needed during the next few months. I get calls every day from Garages, Battery Stations, Auto Repair Shops and other **successful** concerns for McSweeney men. When the big fellows need high-grade men, they know where to come for them. **They want McSweeney-trained men.**

My Training Unusual

Scientific tool training—that's the secret. You do things here according to the latest engineering standards. Thousands of dollars have been spent in modern tools and equipment. That's why my men are at home in the biggest shops in the country. If you want to succeed the way Smith and Collins and the rest have—qualify by the same method.

I'll Pay Your Railroad Fare and Board You

In order to fill the openings that now exist, I am making an offer no one has ever made before—**Free railroad fare, Free board.** But even that is not all. I'll tell you about the rest in my letter.

Send for **FREE** Book

My big illustrated training book tells how others are succeeding. It tells many things you ought to know about Autos and Tractors. Write for it and my **short time** offer NOW. It soon expires.

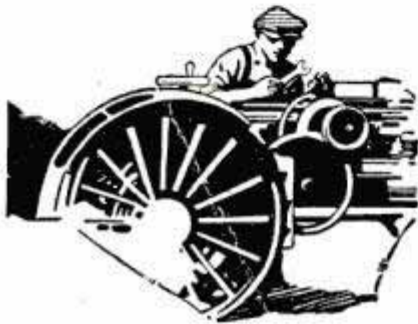

C. E. Gillispie has charge of a fleet of trucks and tractors with the State Highway Commission, due to McSweeney training.



W. W. Peace gets \$250 a month and expenses operating a tractor in the oil fields.



D. M. Collins, Williamsville, West Virginia, writes, "Shortly after finishing McSweeney training, I started in as manager of a garage at \$300 per month."

McSweeney **AUTO TRACTOR AND ELECTRICAL** Shops

CINCINNATI
9th and Walnut

Dept. 146
CHICAGO
517 So. Laflin

CLEVELAND
1815 E. 24th St.

HOME TRAINING FREE. If you cannot come to my shops now, get my Home Training course and come later. Coupon brings full details.



McSweeney Auto, Tractor and Electrical Training Shops,
Dept. 146 (Address shops nearest you)
Cincinnati, O., or Chicago, Ill., or Cleveland, O.

Without any obligation send me your big free book on Autos. Also information regarding special temporary offer.

Name.....
Street.....
City..... State.....

3 Big Training Shops
Cincinnati Chicago Cleveland

For every
Christmas Radio Set
 use only genuine RCA Radiotrons

No matter what set you buy, be sure the dealer puts in genuine Radiotrons:

UV-199	\$2.50
UX-199	\$2.50
UX-120	\$2.50
UV-201-A	\$2.50
UX-201-A	\$2.50
UV-200	\$2.50
UX-200	\$2.50
WD-11	\$2.50
WD-12	\$2.50
WX-12	\$2.50
UX-112	\$6.50
UX-210	\$9.00

Rectrons:

UX-213	\$7.00
UX-216-B	\$7.50

A "UX" or "WX" tube is the same as the corresponding "UV" or "WD" tube, except in the design of the base.

READ all the claims of all the makers of radio sets—and then remember this when you buy—that getting what is claimed for a set depends upon the quality of the *vacuum tube* put into it. You cannot get clearness—you cannot get distance—you cannot get volume—unless the *tubes* get it. That is why it is so important to look at the base of every tube, to be sure it is a *genuine* RCA Radiotron.

A great gift
 for any fan — at \$2.50

A radio fan will appreciate a "spare" Radiotron, just as an autoist appreciates a spare tire. But the Radiotron—a genuine RCA Radiotron—costs only \$2.50. If you note what make of set a man owns, any dealer can tell you which *type* of Radiotron he uses, and you can give him exactly what he would choose for himself.

for owners of Super-Heterodynes
 — the new power tube

Every owner of a Radiola Super-Heterodyne can bring his set right up-to-date with the latest improvement, if you give him the new dry battery power Radiotron UX-120, and the adapter. The adapter costs but \$1.50. And this new tube means great volume with better tone than ever!

RADIO CORPORATION OF AMERICA
 CHICAGO NEW YORK SAN FRANCISCO

RCA-Radiotron

MADE BY THE MAKERS OF RADIOLAS

Radiotron
 UV-201-A,
 standard high-vacuum tube for storage battery sets.

This One

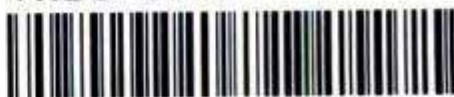

YOUR IVA 0141

And then he knew!



THIS was the second dance in a month, and both times the girls seemed to avoid him. And as he sat alone, hidden by the draperies, he had heard them talk about him. He decided right then what he would do about it!

* * *

A great many men are inclined to have a grimy-looking skin, spotted with blackheads and dull in appearance. Few realize that this hinders their success in life. Pompeian Massage Cream helps you overcome this handicap by giving you a clean, ruddy complexion.

Clears the Skin: Pompeian Massage Cream thoroughly cleanses the pores. It helps clear

up blackheads and pimples by stimulating healthy circulation, and by keeping the skin clean and the pores open.

Easy to Use: After shaving or washing, rub it in gently. Continue rubbing and it rolls out, bringing with it all the dirt and skin impurities. Result—a clean, healthy skin with clear, glowing color.

Special Introductory Offer

1/3 of 60c jar for 10c

For 10c we send a special Trial Jar containing one-third of regular 60c contents. Contains sufficient Pompeian Massage Cream to test thoroughly its wonderful benefits. Positively only one jar to a family on this exceptional offer.

YOUR DRUGGIST HAS IT

There's nothing quite so effective as doing the job yourself. Use Pompeian Massage Cream regularly at home—then you'll get the full benefit.



The Pompeian Co., Cleveland, O., Dept. 74
Gentlemen: I enclose a dime (10c) for 1/3
of a 60c jar of Pompeian Massage Cream.

Name _____

Address _____

City _____ State _____

Popular Mechanics Magazine

200 E. Ontario Street, Chicago, U. S. A.

H. H. WINDSOR, Founder

H. H. WINDSOR, Jr., Editor and Publisher

London: Hachette & Cie.,
16-17 King William Street, Charing Cross, W. C. 2

Paris: Hachette & Cie.,
111 Rue Reaumur

Melbourne: Gordon & Gotch
509-513 Little Collins St.

ISSUED MONTHLY

SUBSCRIPTION:

SINGLE COPY, 25 CENTS

In United States and its possessions, also Canada, Cuba, and Mexico, per year, postpaid - \$2.50

To all other countries in the Postal Union - 3.00

All subscriptions are discontinued at expiration. Please examine the date printed on your wrapper.

Entered as Second Class Matter Sept. 15, 1903, at the Post Office at Chicago, Illinois, under Act of March 3rd, 1879.

Entered as Second Class Matter at the Post Office Department, Canada.

Published monthly by POPULAR MECHANICS CO.

Copyright, 1925, by Popular Mechanics Co.

Copyright in Australia. Copyright in France

Vol. 45

Contents for January, 1926

No. 1

<i>model compressed</i> Africa—through darkest Africa by motor car..... 14	<i>Irish, Saving from breaking</i> Dogs—hotel self-supporting..... 119
Airplanes brakes help planes land in small space..... 12	Dust—explosive power from, to run automobiles..... 112
plane goes thirty miles per gallon..... 96	Education—what home study will do for you..... 105
speed predicted for airplane..... 17	Electric Wiring—insulated wire connector..... 73
wingless predicted..... 109	Elephants—used as teachers to train others..... 30
Alps—iron cross on mountain top..... 17	Evolution—clue to "missing link" found in old skulls..... 10
Amber—supply for pipe stems..... 104	Farmers—farm decreasing yearly..... 113
Animals—ancient monster in living model..... 43	Fences—barbed band on spool helps protect garden..... 46
Archæology—monuments many centuries old..... 32	Fire Apparatus alarm signal..... 4
Arctic Regions—peril of Arctic trips shown..... 50	asbestos fire escape slide..... 24
Astronomy—stars that grow cold..... 25	Fish—and whales labeled to trace movements..... 65
Automobile—old made into tractor..... 58	Flag—of wooden chains carved with knife..... 95
Automobile Racing—autos register time by running over hose..... 95	Flowers metal-plating preserves flowers..... 113
Automobiles—Design—auto with three wheels seats two persons..... 90	orchids found in far north in steamheated valley..... 103
Automobiles—Equipment and Supplies folding luggage rack..... 114	Fuel Gas—generated at home in charcoal burner..... 72
rotating disk cleans windshield..... 32	Gaiters—wool mudguards protect ankles..... 66
wedge-shaped air cushion..... 50	Garage—car parked in attic of hillside house..... 73
Automobiles—Safety Devices—vision shield for auto glass..... 46	Gases—war gas protects plumes..... 18
Aviation fort turned into lighthouse to guard night flyers..... 6	Gasoline—quantity in U. S. per minute..... 103
leaps from boat to airplane..... 91	Germs—raising, to guard your health..... 5
salesroom in airplane..... 103	Glass—substitute for..... 104
Baby Carriages—garage for..... 13	Gold—foil to improve radio..... 120
Bags—folding bag for fishermen..... 66	Golf—golfer tees off from girl's head..... 91
Beds—study ways to improve..... 66	Hats—electric heated hat block..... 104
Biology—length of life increased..... 42	Household Devices..... 110
Birds banding wild..... 92	Houses home owners in U. S..... 95
how high do they fly?..... 90	house built under bungalow to save moving costs..... 23
Blacksmith—shops still busy..... 80	house plans—comfort in story and a half home..... 175
Boots and Shoes—instrument for measuring feet..... 81	rolling house with six rooms for tourists..... 12
Bridges built without nails..... 72	Hygiene—children's "circle of health" relieves city ills..... 80
"islands" in one-way bridge give room for passing over English channel..... 4	Insects—don't sing, music instrumental..... 73
San Francisco bridge..... 120	Insulation (Heat)—dark colored house warmer than white..... 96
Bucket—folding lid for camp bucket..... 65	Insurance—does your auto insurance protect you?..... 59
Camping—folding beds in auto coupe..... 108	Jacks—balloon tire jack for autos..... 25
Carillon—has more bells than chime..... 58	Japan—Tokyo sandwich men announce census..... 113
Cement growth of industry spurred by paving..... 66	Lamp—"candle" that burns kerosene..... 13
tile designs on cement tubs..... 31	Level—with constant bubble..... 80
Check Protectors—worn as rings..... 17	Light mock trial in model court tests light and sound..... 8
Cheese—years to ripen..... 118	test to gauge speed of, within final mile..... 43
Chicago feeding a city of three million..... 75	Lighthouses behind scenes in the lighthouse service..... 9
icebound in sight of city's lights..... 19	lighthouse lens has glasses of thirty shapes..... 50
Clock Dial—flower bed on tells time..... 8	Lions—home-grown lions on California farm..... 83
Coal—mined in U. S..... 49	Macaroni—mirror aid to sun in drying..... 65
Communication—wireless of the ages..... 26	Matches—million, made as one..... 108
Copper—copper taken from water with tin cans..... 109	Mayas—stadium reveals secrets of ancient race..... 44
Cups—white, for bus drivers..... 8	Mental Test—fast makes brain more active..... 4
Cutters electric sheet metal cutter..... 118	Models—model plane run by air..... 24
lever battery post cutter..... 80	Monkeys—do apes possess humor?..... 24
lever shears to cut steel..... 49	Moon—attraction of moon weighed in delicate balances..... 46
Dam—breaks mended with earth filled nets..... 25	Motor Truck—serves as snowplow, sweeper and fire engine..... 10
Decoration and Ornament—trees and leaves of cement..... 102	Motorcycle—with chair seat..... 17
Diamonds—luster of "dizzy" restored with sawdust..... 119	Moving Picture Photography—portraits copied in stone from movie films..... 57
Disabled—blind man builds house..... 90	Mower—lawn trimmer cuts edges..... 90
	Music—where jazz comes from..... 97
	Musical Instrument—harp for jazz music played like guitar..... 10
	Ocean—why sea is blue..... 81

[Continued on Page 4]

[Contents—Continued]

Wire Connector, Insulated, Chevrolet, Conn. 7305

Petroleum—clue to oil wells sought in heat of earth. 23
 Photography—camera hung from tripod to take photos vertically 12
 invisible light photographs in darkest night 1
 photos in cubist style 16
 Postal Service—how foreign mail is guided to proper address 72
 Poverty—yearly cost of each pauper in U. S. 58
 Power Transmission—electric line to link cities of six states 18
 Progress—exhibit showing advance 89
 Radio—getting ready for winter DX 121
 Radio Aerials—masts at huge radio station 109
 Radio Antenna—like roller shade 119
 Radio Apparatus—adjustable resistance unit replaces amplifier rheostats 134
 develops a detector for interference 91
 handy rack for spare tubes 133
 insulator and mounting for inside aerial 125
 making a wireless signal board for code practice 134
 spacing dials from panel 125
 Radio Application—radio to banish danger in flying 51
 Radio Battery—tweezers to keep storage-battery tops dry 134
 Radio Broadcasting—wavelength used by station FL, Eiffel tower 125
 Radio Construction—how to improve incoming signals 133
 Radio Loud Speaker—homemade 124
 Radio Questions and Answers 176
 Radio Receivers—latest superhet 127
 Radio Tubes—sensitive tube for radio movies 32
 Rings—wedding rings of olden days of iron and agate 13
 Rust—college has "tin pan alley" to test galvanized work 66
 Safety Devices and Measures—children on street guarded by gate 88
 electric train-stop system 44
 life belts protect painters 81
 Sand—grains roll many miles before becoming polished 108
 Sandpaper—waterproofed 79
 Science—latest developments in field of 7
 research work by industries 13
 Screwdriver—for auto kit tests spark plugs 49
 Ships—miniature ship complete in detail 14
 Solder and Soldering—long handled dipper 104
 South America—new winter playground 33
 Stage Mechanism—scenic wonders of the theater 67
 Statues—artist's dummy serves as model 120
 giant horses carved in stone for king's memorial 65
 Steam—gigantic condenser 16
 Street Traffic Regulations—tile set in paving blocks to guard traffic 96
 Stroboscope—mechanical eyelids' wink solves mysteries 114
 Submarine—serves as airplane carrier 10
 Sun—loses weight every second 81
 Tank—safety gas tank puncture and fire-proof 8
 Testing—saving our dishes from breaking 47
 Tires—whistling auto tire gauge 88
 Tobacco—leaf coffeepot 18
 Trees—fortunes from stumps 115
 of fantastic shape 112
 tin band around tree trunk keeps cats from birds 18
 Turbine—for Wilson dam 23
 Volcanoes—silent not all dead 31
 Water Supply—dynamite lake bottom to insure 31
 Weather—value of forecasts shown in industries 16
 Windows—rollers hold window sash without weights 66
 Wool—Germany developing artificial wool 72

Foot Scraper—of sheet iron 144
 Furnaces—operating home heating furnace 140
 Humidity Indicator—how to make 144
 Ladders—folding stepladder extension 137
 Lampshade—revolves on stand 139
 Lanterns—washbasin base for lantern 145
 Lathes—driving small wood lathe by foot 155
 Lighting—the fish bowl 156
 Matches—burnt match receiver 155
 Paint—improving roofing 154
 Paint Brushes—treating new 145
 Photography—holder for washing photographic films 137
 retouching fluid applied to negative with oilcan 143
 Plating—nickelplating brass 152
 nickelplating by friction 137
 Refrigerator—concrete window 144
 Screen—making a fireplace screen 138
 Stencil—for marking laundry, of copper 138
 Tin Cans—opening 152
 Tires—locating breaks in casing 139
 Transparencies—making glass 146
 Trough—crankcase makes 139
 Vise—saw vise from old bed rails 146
 Washing Machines—rebuilding cylinder 154
 Windows—hanging window sash on porches 143

SHOP NOTES

Automobiles—Lubrication—oiling spring perch nuts 164
 Automobiles—Repairing—bending Ford bendix set-screw washer 174
 Blocks—metal, hold autos in transit 172
 Building and Construction—kinks for the builder 161, 163, 165, 167
 Cabinets—built-in furniture for the home—Part XIV—sewing cabinet 168
 Crowbar—improving it 159
 Derricks—easily made 173
 Drawing Instruments—repairing broken triangles 162
 Electric Wiring—locating breaks in 172
 Fats and Oils—keeping tractor oil warm in cold weather 174
 First Aid—relief for burning feet 159
 Foundry—flasks from truck wheels 174
 Gauges—leave thin collar on each end of hole when making ring gauges 159
 Glass—washing windows 159
 Lacquer—for silver 160
 Locks—locking cabinet drawers 160
 Mixer—trolley operated concrete mixer 164
 Painting—paint pot hanger 160
 Paints—add turpentine against wrinkles 173
 Pilasters—building brick 159
 Pipes—raising vertical piping 164
 Plumbing—emergency water supply for washroom 160
 Poles—telephone, made from old water pipes 162
 Rust—removing rust from tools 160
 Saw—jigsaw for dollar 157
 Screw Machine—releasing tight collets 173
 Shellac—and graphite replace gaskets 174
 Speedometer—parts, operating small machinery with 166
 Spirals—cutting 166
 Stains—rub kerosene on glass before painting 164
 Stencil—self-inking stamp instantly changeable 162
 Tanks—convenient gasoline drum 166
 Tempering—small articles evenly 172
 Trunks—marking 164

AMATEUR MECHANICS

Alarms—bell signal for service station 145
 Ashes—removing from kitchen stove 146
 Automobiles—Ignition—connecting electric accessories on automobile 147
 Automobiles—Repairing—removing play in Ford fans 152
 Binders—binding pamphlets 151
 Carburetors—cleaning center guide float in 137
 Cement—sidewalks of colored squares 156
 Clocks—how to remedy a common trouble 150
 Clothes Line—homemade reel 151
 Clothing—mend hole in pocket with adhesive tape 139
 Coaster—building a monorail coaster 135
 Desks—writing cabinet for library table 153
 Doors—counterweight on cellar door aids in operating 152
 Electric Batteries—avoiding troubles 156
 Fire—starting furnace with gas 155
 Fishing—saving the dip net 143

No Better Christmas Present
 for \$2.50

than a year's subscription to

Popular Mechanics Magazine

Containing 4500 Pictures and 3600 Articles

Much of it Interests Everybody

Most of it Interests Anybody

All of it Interests Somebody

Order through your Newsdealer or address the Publisher

POPULAR MECHANICS COMPANY

200 East Ontario Street, CHICAGO, ILL.

Railroad Signal 44

DRAKE'S PRACTICAL MECHANICAL BOOKS

THEY WILL RAISE YOUR PAY—

ORDER ON 5-DAY TRIAL

The books listed below will perfect you in your chosen trade—pave the way to the big positions. Written in non-technical language—easy to read and understand. **Every book covers its subject completely.** An entire course of instruction condensed into one volume. Your choice sent postpaid—you benefit 5 days—money refunded in full if not entirely satisfactory. Order direct from this page.

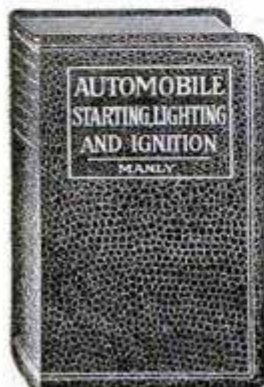

Automobile Books

- Automobile Starting, Lighting and Ignition, by Manly... 700 pp. \$3.00
- Brookes' Automobile Handbook. \$2.00
- Ford Motor Car, Truck and Tractor, by Manly... Cloth \$1.50
- Automobile Battery, Care and Repair, by Manly... Leatherette \$2.00
- Motorecycle Handbook, by Manly \$1.50

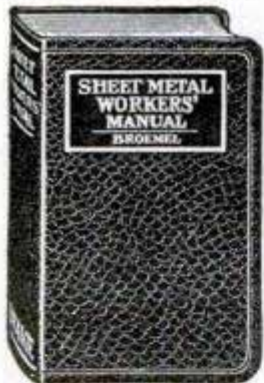

Shop Practice Books

- Sheet Metal Workers' Manual... \$2.00
- Oxy-Acetylene Welding and Cutting... Cloth \$1.25
- Slide Rule and Logarithmic Tables. \$2.00
- Handbook for Millwrights... Cloth \$2.00
- Machine Shop Practice... Cloth \$2.00
- Mechanical Drawing and Machine Design... Cloth \$2.00

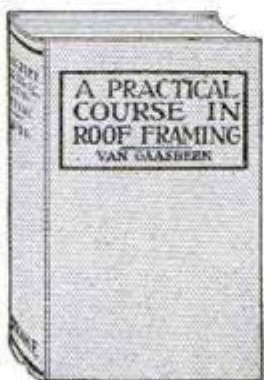

Carpentry Books

- Cloth Binding
- Modern Carpentry, 2 vols. \$3.00
 - The Steel Square, 2 vols. \$3.00
 - Modern Estimator. \$1.50
 - Timber Framing. \$2.00
 - Builder's Architectural Drawing... \$2.00
 - Concretes. \$1.50
 - Practical Bungalows. \$1.00
 - Roof Framing, by Van Gasbeek... \$1.50

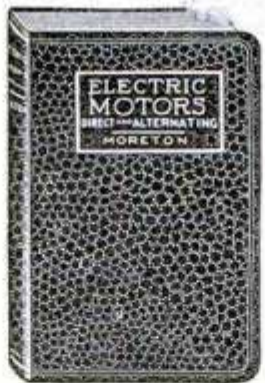

Electrical Books

- Telephony, Including Automatic Switching, by Smith, 450 pp. Leatherette \$2.50
- Practical Applied Electricity. \$2.00
- Wiring Diagrams and Descriptions. \$1.50
- Armature and Magnet Winding... \$1.50
- Electric Motors, D. & A. \$1.50



Painting and Decorating

- Ross Crane Book of Home Furnishing and Decoration... Cloth \$3.00
- House Painting Methods with the Brush and Spray Gun, by Vanderwalker, Cloth... \$2.00
- Interior Wall Decoration, by Vanderwalker... Leatherette \$4.00
- The Mixing of Colors and Paints, by Vanderwalker... Cloth \$2.00
- A Show at Sho' Cards... Cloth \$4.00
- Sign Painting, by Atkinson... Cloth \$4.00
- Strong's Book of Designs, Leatherette \$4.00
- Modern Painter's Cyclopedia. Cloth \$2.00
- Automobile Painting... Cloth \$1.50
- New Hardwood Finishing... Cloth \$1.50

Steam Engineering

- Swingle's Handbook for Steam Engineers and Electricians, Leatherette... \$4.00
- Examination Questions and Answers for Marine and Stationary Engineers, Leatherette... \$2.00
- Steam Boilers... Leatherette \$2.00
- Swingle's Catechism of Steam, Gas and Electrical Engineering, Leatherette \$1.50

Modern Languages

- By Prof. P. S. Allen, U. of Chicago
- French without a Teacher... Cloth \$1.25
 - Spanish without a Teacher... Cloth \$1.25
 - German without a Teacher... Cloth \$1.25
 - Everyday French... \$1.25
 - Everyday Spanish... \$1.25

ORDER DIRECT FROM THIS PAGE — ON OUR MONEY-BACK PLAN

The books listed above are only a few of the many in our catalogue, which you will receive promptly after filling out and mailing us the attached coupon. For quick action order direct from this page—cross name of each book wanted and send in with price quoted. We prepay postage and send books on our money-back plan.

FREDERICK J. DRAKE & CO.
PUBLISHERS

1008 Michigan Ave., Chicago
Drake Books Are For Sale at All Book Stores

FREDERICK J. DRAKE & CO.
1008 Michigan Avenue
Chicago, Ill.

GENTLEMEN:—Please send me free, postage paid, your illustrated catalogue which lists and describes 200 Practical Mechanical Books for Home Study.

My name is

and my address

Mail Coupon For Free Catalogue
Your Guide to Home Study

What Will You be Earning One Year from Today?

A practical plan that is doubling men's salaries

You have said good-bye to Yesterday, with its failures and disappointments. A new Tomorrow lies ahead of you. What are you going to *do* with it?

To the man who gives little thought to his business progress, one day is much like another—filled with routine work—rewarded by routine pay. He has *no right* to expect great things of the future.

But—how different the outlook of the man who is *training* for promotion, and what a difference a mere twelve months can make in his earning power!

Give a thought, for instance, to the experience of Arthur W. Weber, now Assistant Secretary of the Ohio Savings Bank and Trust Company, one of the largest and most influential banks in the state. One of his earlier letters reads as follows:

"Since I have been training, my salary has been increased 150 per cent. This increase is an annual return of 1,107 per cent upon my investment. Not so bad when you consider that most conservative investments net only 6 or 8 per cent. Not only has the course enabled me to increase my earnings, but it has incidentally aided me in jumping from the job of timekeeper in an automobile factory to my present position as assistant auditor of the largest and best bank in Toledo in less than eighteen months."

More recently he writes as follows: "Monthly dividends are being paid me on my investment in LaSalle training in the form of increased salary *at a rate in excess of 125% per month.*"



Skeptics may suggest that the record of Mr. Weber, just cited, is exceptional. And—if Mr. Weber had won his advancement *without* the aid of home-study training, we should be bound to *agree* with the skeptics. For men are rarely promoted to positions they are not qualified to *fill*. When men have *fitted* themselves for advancement, however, such promotions are not exceptional at all.

That his experience could be paralleled many, many times is evidenced by the fact that during only six months' time as many as 1,248 LaSalle members reported definite salary-increases, as a result of training under the LaSalle Problem Method, totalling \$1,399,507. The average increase per man was 89 per cent.

Send for Salary-Doubling Plan—Free

Yesterday is past. Tomorrow is ahead of us. *Let's make the most of it!*

Below this text there's a coupon—just such a coupon as Weber once signed, and hundreds of thousands of others who, thru home-study training, have added greatly to their earning power. Start today toward that better place, that bigger salary, by checking, signing and mailing the coupon NOW.

LASALLE EXTENSION UNIVERSITY

The World's Largest Business Training Institution

LASALLE EXTENSION UNIVERSITY

CLIP AND MAIL

Dept. 164-R

CHICAGO

I shall be glad to have details of your *salary-doubling plan*, together with complete information regarding the opportunities in the business field checked below. Also a copy of "Ten Years' Promotion in One," all without obligation.

- | | | |
|--|---|---|
| <input type="checkbox"/> Business Management: Training for Official, Managerial, Sales and Departmental Executive positions. | <input type="checkbox"/> Traffic Management—Foreign and Domestic: Training for position as Railroad or Industrial Traffic Manager, Rate Expert, Freight Solicitor, etc. | <input type="checkbox"/> Personnel and Employment Management: Training in the position of Personnel Manager, Industrial Relations Manager, Employment Manager, and positions relating to Employee Service. |
| <input type="checkbox"/> Modern Salesmanship: Training for position as Sales Executive, Salesman, Sales Coach or Trainer, Sales Promotion Manager, Manufacturer's Agent, Solicitor, and all positions in retail, wholesale, or specialty selling. | <input type="checkbox"/> Railway Station Management: Training for position of Station Accountant, Cashier and Agent, Division Agent, etc. | <input type="checkbox"/> Modern Business Correspondence and Practice: Training for position as Sales or Collection Correspondent, Sales Promotion Manager, Mail Sales Manager, Secretary, etc. |
| <input type="checkbox"/> Higher Accountancy: Training for position as Auditor, Comptroller, Certified Public Accountant, Cost Accountant, etc. | <input type="checkbox"/> Banking and Finance: Training for executive positions in Banks and Financial Institutions. | <input type="checkbox"/> Commercial Spanish. |
| <input type="checkbox"/> Expert Bookkeeping: Training for position as Head Bookkeeper. | <input type="checkbox"/> Industrial Management: Training for positions in Works Management, Production Control, Industrial Engineering, etc. | <input type="checkbox"/> Business English: Training for Business Correspondents and Copy Writers. |
| <input type="checkbox"/> C. P. A. Coaching for Advanced Accountants. | <input type="checkbox"/> Modern Foremanship and Production Methods: Training for positions in Shop Management, such as that of Superintendent, General Foreman, Foreman, Sub-Foreman, etc. | <input type="checkbox"/> Effective Speaking: Training in the art of forceful, effective speech, for Ministers, Salesmen, Fraternal Leaders, Politicians, Clubmen, etc. |
| <input type="checkbox"/> Law: Training for Bar; LL.B. degree. | | |
| <input type="checkbox"/> Commercial Law: Reading, Reference and Consultation Service for Business Men. | | |



Name..... Present Position.....

Address.....

BUILDERS TRADE GUIDES



4
Vols.
\$6

AUDELS CARPENTERS AND BUILDERS GUIDES—4 VOLS. \$6

Inside Information for Carpenters, Builders, Joiners, Building Mechanics—all Woodworkers. **1600 pages; 3700 diagrams; flexible; pocket size.** Short-cut instructions, new methods, ideas, solutions, plans, systems—money saving suggestions. An easy progressive course for the apprentice. A practical daily helper and Quick Reference for the master worker. A Helping Hand to Easier and Better Work and Better Pay. To get this aid for yourself, simply fill in and mail the FREE COUPON below.

INSIDE TRADE INFORMATION ON:
 How to use steel square; How to file and set saws; How to build furniture; How to use mitre box; How to use chalk line; How to use rules; How to make joints; Carpenters' arithmetic; Mensuration problems; Estimating strength of timbers; How to set girders and sills; How to frame houses and roofs; How to estimate costs; How to build houses, barns, garages, bungalows, etc.; How to read and draw plans; Drawing up specifications; How to excavate; How to use settings 12, 13 and 17 on the steel square; How to build hoists and scaffolds—skylights; How to build stairs; How to put on interior trim; How to hang doors; How to lay floors; How to paint.

"Audels Guides worth four times their price—handy too as I carry them in pocket for reference." **W. J. Bates, Knoxville, Pa.**



4
Vols.
\$6

AUDELS PLUMBERS AND STEAMFITTERS GUIDES—4 VOLS. \$6

A new set—just out! A practical, illustrated, Reference Library and Study-Course for Master Plumbers, Journeymen and Apprentice Steamfitters, Gas Fitters and Helpers, Sheet Metal Workers, Draughtsmen, Master Builders, Engineers and all Building Trade Students. **1670 pages; 3642 diagrams; flexible; pocket size.** Guides explain all the principles, advances and short cuts of the Plumbing and Heating trade. Contains instructions on how to figure and estimate jobs. Use FREE COUPON below to examine, without obligation, this valuable work.

INSIDE TRADE INFORMATION ON:
 Soldering, tinning, joint wiping, bending, beating, pipe—iron—steel, threading, Mathematics, tables, physics, Materials—iron, steel, copper, brass, lead, tin, antimony, Sheet metal—galvanized—plate. Sanitation, syphonage, tanks, Drainage, sewage, purification. Fixtures—bath—kitchen. Pipe fittings, soil pipe, tools. Laying out work. Roughing, screwed fittings, flanges, joints, Pipe bending, examples, Elbows, Heating, ventilation, refrigeration. Water supply, mains, wells, tanks. Gas-fittings. Underwriters. Sheet metal work, problems, methods, Brazing, heating, lead burning. Welding, various welds, methods. Blacksmithing, forges, tools.

"Audels Guides are practical, easy to understand, reliable. Cover the field in plain language." **W. F. Arminger, Annapolis, Md.**



4
Vols.
\$6

AUDELS MASONS AND BUILDERS GUIDES—4 VOLS. \$6

A new, complete, illustrated trade reference library, for Bricklayers, Cement Workers, Plasterers, Tile Setters and Stone Masons, including a practical outline of Steel Construction. **1100 pages; 2067 diagrams; flexible; pocket size.** A practical Trade Assistant explaining modern methods of masonry construction. Easy to understand and apply. A reliable and authentic reference work and study-course for Master Journeyman and Young Mechanic. Use FREE COUPON below and find out for yourself, without obligation, whether this set will benefit you.

INSIDE TRADE INFORMATION ON:
 Bricklaying, tools, materials; Brick designs, patterns, bonds; Setting frames and foundations; Mortars, scaffolds, estimating; Mortars and mortar mixing; Tile setting, mosaic, hollow tile; Straight edge test, troweling; How to figure brick work; Safe loads, piers, chimneys; Boiler settings, anchors, fire stops; Labor tables; Concrete, forms; How to figure concrete work; Stucco—on old and new buildings; Plastering—wood lath—metal; Plasterers agreement; Plastering on various surfaces; Stonemasonry; Cutting, finishing, estimating stone; Derricks, rigging; Steel construction; Fire proof; How to read blue prints.

"Audels Masons Guides are the best books on the subject I have laid brick 12 years and am able to judge." **H. A. Sonnett, Cortice, Pa.**

PRACTICAL ELECTRICITY — 1 VOL. \$4

Audels Handy Book of Practical Electricity is a simplified Ready Reference and Study Course in one pocket size, leather bound volume—for Engineers, Professional Electricians and Students. **1040 pages; 2600 diagrams; flexible red leather bound.** A reliable authority and handy helper for every electrical worker. Contains important and valuable wiring diagrams, calculations, machine sketches, helps on maintenance and repair. Use this FREE COUPON today and find out, without obligation, how this handy book will help you in your daily work.



\$1
PER
MO.

1040
Pages
2600
Diagrams

INSIDE TRADE INFORMATION ON:
 Electro-Therapeutics, X-Rays, Shocks, Welding, Brazing, Radio Hook-ups, Motion Pictures, Telephone, Telegraph, Cranes, Bells, Elevators, Pumps, Tools, Ship Drive, Railways, Vehicles, Automobile Electric Systems, Ignition, Generation, Lighting, Plant Management, Power Plans, Armature Winding, Repairing, A. C. Motors and Apparatus, D. C. Motors and Apparatus, Alternator Construction, Dynamometers, Wiring Diagrams, Sign Flashers, Cable Splicing, Power Wiring, Outside Wiring, Switches, Lighting, Rectifiers, Converters, Transformers, Fuses, Circuit Breakers, Rheostats, Electro Plating, Electrolysis, Storage Batteries, Magnetism, Electrical Energy, Conductors, Insulators, Static, Dynamic, Radio Electricity, Applications, Ready Reference and Index Covering the entire field of Modern Electricity.

Learn More and You Will Earn More!

Know your job and you'll never be without one. The skilled man is always in demand. Knowledge is power. Learn your trade thoroughly by easy reading. This coupon is your opportunity for advancement and better pay. You risk nothing in sending for Audels Guides for free examination. Send it NOW!

FREE EXAMINATION COUPON

THEO. AUDEL & CO.,
 65 W. 23 ST., NEW YORK CITY

Please mail me for free examination the books marked (x) below. If I find them satisfactory, I agree to mail \$1 in 7 days, on each set ordered, and to further mail \$1 monthly on each set until I have paid the purchase price.

4 CARPENTERS GUIDES \$6 4 PLUMBERS GUIDES \$6

4 MASONS GUIDES \$6 1 ELECTRICIANS HANDY BOOK \$4

NAME

ADDRESS

OCCUPATION

EMPLOYED BY

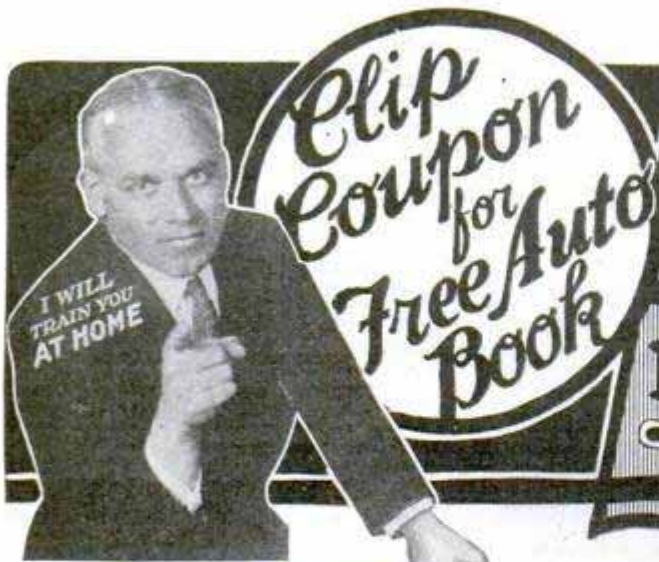

Clip
Coupon
for
Free Auto
Book

BE AN
**AUTO
EXPERT**

- Earn up to
\$10,000
a year -

Go to School
AT HOME
the Cooke
**"JOB-
WAY"**

PROOF!
See What I
Can Do For
YOU!

Send coupon for this amazing **FREE BOOK** right now. See what it has done for others. See what it can do for you! Just think of this! —Walter Mayville, Harold Lester, M. J. Morrision, Herbert Trask, Allen Pomeroy and dozens of others without previous auto experience—**In only a few months** after enrolling—were in business for themselves, making **Big money**. My Free Book tells you all about their wonderful, **QUICK** successes. Send for it.

**Start to
Make Money Quick!**

You don't have to wait to finish to make real money with Cooke "Job-Way" training. Many of my students make money right in the very first few weeks.

\$215 in a Single Week!

Only 15 weeks after enrolling, Ernest B. Tucker, Cotton, Minn., wrote me he was making as much as \$215 in a single week! That's the kind of **QUICK RESULTS** you want! Find out what you can do today!

**Raises His Salary Almost
300% in 7 Short Months**

Cooke "Job-Way" boosted the salary of Gust Alebras, Box 172, Parkerton, Wyo., a foreigner with little education, from \$18 a week to \$50 a week in only 7 months and he gives my training full credit.

GET THE FACTS!

Send for this remarkable **FREE Auto Book**. Get all the facts about this amazing "quick results" Training Method. See what others did. Find out what you can do.

ACT NOW!

**MAIL "JOB-WAY" COUPON
THIS**

**B. W. COOKE, Directing Engineer
CHICAGO MOTOR TRAINING CORPORATION
1916 Sunnyside Avenue, Dept. 116, CHICAGO, ILL.**
Send me **FREE Auto Book** and proof that you will show me the **QUICK WAY** toward a **BIG JOB** and a **RAISE IN PAY**. Also send your **4 Outfits** Offer. It is understood that this obligates me in no way and no salesman is to call on me.

Name
Address



**GET
Results
QUICK**

FREE Auto Book

**The World's
Biggest Business
Needs You!**

If you're earning a cent less than \$50 a week, **clip coupon now**. Get my Free Book. Let me show you how Five Thousand Million Dollars are spent every year for **Auto Upkeep alone**. Let me show you how salaries are raised—doubled—tripled in such **quick time** it's **positively amazing!** Look at this—from \$33 a week to **\$225 IN A SINGLE WEEK** is what Cooke "Job-Way" did for Bernard Rumpel, 365 Edison Place, Glendale, N. Y., **only 10 months after enrolling!** No other business offers you so many wonderful opportunities. No other Training can show such marvelous **QUICK RESULTS**. Get all the facts. Send for my Free Book Today!

**Earn
Up to \$150 a Week!**

Don't sell your time for low pay. Raise your Pay **QUICK**. Be a Big Pay man. My book will show you the way.

Learn Right at Home!

Keep your present job. Get started for Big Pay **QUICK** as an Auto Expert, through Cooke "Job-Way," quickly, easily, right in your own home. Send for my free book: it shows you how successful I've been and how successful I am. Being a practical Directing Engineer, Owner and Head of this Institution, I know what practical money making training **you need** to become a **BIG PAY MAN** and to get **QUICK RESULTS** and **that training I give you**.

**The Only "Job-Way" Training
on Earth!**

My training includes **ALL Electrical work**—Ignition, Starting, Lighting—**All Mechanical** and Welding, Brazing, Vulcanizing—also **Business Course, Salesmanship, Advertising, Buying, How to Keep Simple Books**—also **Auto Magazine**, also **4 Outfits**. Nowhere else I know of, can get you **ALL** this training.

B. W. Cooke is in no way connected with any other person or training of similar name. Nowhere else can you get the original, genuine copyrighted Cooke "JOB-WAY" training. I train you with **Tools** which I give you and **Illustrated JOBS—not books**. Find out how "Job-Way" fits you for Big Pay. Learn what it has done for others, see what it can do for you. Mail coupon to me right now!

Common Schooling All You Need Men between 15 and 60 and with little education quickly and easily finish my training. Many become Garage Owners, Managers, Superintendents, Foremen, Auto Experts, in the class with **BIG PAY executives**. I back you up with the entire resources of this great Institution. Employment service for your whole life. Also **Lifetime Consultation service**. Notice on this page what a few of my students have done—then send for my **Free Auto Book** right away! Address me personally.

**B. W. COOKE DIRECTING
ENGINEER
CHICAGO MOTOR TRAINING CORPORATION
1916 Sunnyside Avenue Dept. 116 CHICAGO**



“The Boss Didn’t Even Know My Name”

“HE SAID my face was more or less familiar and he remembered seeing me around, but he didn’t even know my name until the I. C. S. wrote him that George Jackson had enrolled for a course of home study and was doing fine work.

“Who’s George Jackson?” he asked. Then he looked me up. Told me he was glad to see I was ambitious. Said he’d keep his eye on me.

“He did too. Gave me my chance when Frank Jordan was sent out on the road. I was promoted over older men who had been with the firm for years.

“My spare-time studying helped me to get that job and to keep it after I got it. It certainly was a lucky day for me when I signed that I. C. S. coupon.”

How much longer are you going to wait before you take the step that will bring you advancement and more money?

It takes only a moment to mark and mail this coupon and send it to the

International Correspondence Schools at Scranton. Isn’t it better to do this today than to wait a year or five years and then wish you had? It surely is.

Mail the Coupon for Free Booklet

INTERNATIONAL CORRESPONDENCE SCHOOLS Box 5545-E, Scranton, Penna.

Without cost or obligation, please tell me how I can qualify for the position or in the subject before which I have marked an X:

BUSINESS TRAINING COURSES

- | | |
|--|---|
| <input type="checkbox"/> Business Management | <input type="checkbox"/> Salesmanship |
| <input type="checkbox"/> Industrial Management | <input type="checkbox"/> Advertising |
| <input type="checkbox"/> Personnel Organization | <input type="checkbox"/> Better Letters |
| <input type="checkbox"/> Traffic Management | <input type="checkbox"/> Show Card Lettering |
| <input type="checkbox"/> Business Law | <input type="checkbox"/> Stenography and Typing |
| <input type="checkbox"/> Banking and Banking Law | <input type="checkbox"/> Business English |
| <input type="checkbox"/> Accountancy (including C.P.A.) | <input type="checkbox"/> Civil Service |
| <input type="checkbox"/> Nicholson Cost Accounting | <input type="checkbox"/> Railway Mail Clerk |
| <input type="checkbox"/> Bookkeeping | <input type="checkbox"/> Common School Subjects |
| <input type="checkbox"/> Private Secretary | <input type="checkbox"/> High School Subjects |
| <input type="checkbox"/> Spanish <input type="checkbox"/> French | <input type="checkbox"/> Illustrating <input type="checkbox"/> Cartooning |

TECHNICAL AND INDUSTRIAL COURSES

- | | |
|---|--|
| <input type="checkbox"/> Electrical Engineering | <input type="checkbox"/> Architect |
| <input type="checkbox"/> Electric Lighting | <input type="checkbox"/> Architects’ Blueprints |
| <input type="checkbox"/> Mechanical Engineer | <input type="checkbox"/> Contractor and Builder |
| <input type="checkbox"/> Mechanical Draftsman | <input type="checkbox"/> Architectural Draftsman |
| <input type="checkbox"/> Machine Shop Practices | <input type="checkbox"/> Concrete Builder |
| <input type="checkbox"/> Railroad Positions | <input type="checkbox"/> Structural Engineer |
| <input type="checkbox"/> Gas Engine Operating | <input type="checkbox"/> Chemistry <input type="checkbox"/> Pharmacy |
| <input type="checkbox"/> Civil Engineer | <input type="checkbox"/> Automobile Work |
| <input type="checkbox"/> Surveying and Mapping | <input type="checkbox"/> Airplane Engines |
| <input type="checkbox"/> Metallurgy | <input type="checkbox"/> Navigation |
| <input type="checkbox"/> Steam Engineering | <input type="checkbox"/> Agriculture and Poultry |
| <input type="checkbox"/> Radio | <input type="checkbox"/> Mathematics |

Name..... 3-6-24

Street.....

Address.....

City..... State.....

Occupation.....

Persons residing in Canada should send this coupon to the International Correspondence Schools Canadian, Limited, Montreal, Canada.

The International Correspondence Schools are the oldest and largest correspondence schools in the world



Thousands Have This Priceless Gift —and Never Discover It!

NO sane man would deliberately and knowingly throw away a chance to become an outstanding, influential and important figure occupying a high-salaried job. Yet, without knowing it, thousands of men are neglecting a priceless gift which would bring them influence, position, popularity, power, leadership and money.

Nearly every man has in him the knack of powerful and convincing speech. This magic power is that thing which often rises up within you and demands expression, but is never heard because you lack the confidence in your ability—you get "stage fright."

Now Easy to Become a Powerful Speaker

I don't care what work you are now doing. I don't care what may be your station in life. I don't care how timid and self-conscious you now are when called upon to speak. If you will give me just 15 minutes each day in the privacy of your home I will make you an accomplished and powerful speaker in a few short weeks or it will not cost you a single penny. You need not have a college education nor any previous voice training. By this amazingly easy method you have only a few simple, easy to remember principles to learn. Then you will see how really easy it is to have the power of effective, convincing speech.

YOUR POWER LIES IN KNOWING

How to talk before your club or lodge.
How to address Directors' meetings.
How to make a political speech.
How to tell entertaining stories.
How to make after-dinner speeches.
How to write better letters.
How to converse interestingly.
How to train your memory.
How to enlarge your vocabulary.
How to develop self-confidence.
How to acquire a winning personality.
How to be the master of any situation.

Why Powerful Speakers Are Picked for Important jobs

If you will take particular notice, you will find that the big, important, high-salaried jobs almost invariably go to men who are powerful talkers. Often you will see a man of this type forge ahead in business at an amazingly fast rate, while men of even

greater ability stand tied to one small job. That is the reason you are often astonished to see a man jump over the heads of many superiors into a job among the big leaders. It is the power and ability to speak with force and conviction that flashes men from obscurity and low wages to prominence and high salaries.

An Amazing Book FREE Mail Coupon

If you will fill in and mail the coupon at once, you will receive a remarkable new book called "How to Work Wonders with Words." This book gives you an amazing test by which you can determine for yourself in five minutes whether you are one of the seven men out of every nine who possess the "hidden knack" of powerful speech, but do not know it. Decide for yourself if you are going to allow 15 minutes a day to stand between you and success. Thousands have found this to be the biggest step forward in their lives. If it has played such an important part in the lives of many big men, may it not in yours? Then mail the coupon at once.



NORTH AMERICAN INSTITUTE

3601 Michigan Ave.
Dept. 1351 Chicago, Ill.

NORTH AMERICAN INSTITUTE

Dept. 1351, 3601 Michigan Ave., Chicago, Ill.

Please send me your FREE Test and full information about your amazing new methods of learning Public Speaking. This request places me under no obligation of any kind.

Name.....

Address.....

City..... State.....

It stands to reason: There is no substitute for personal, practical training

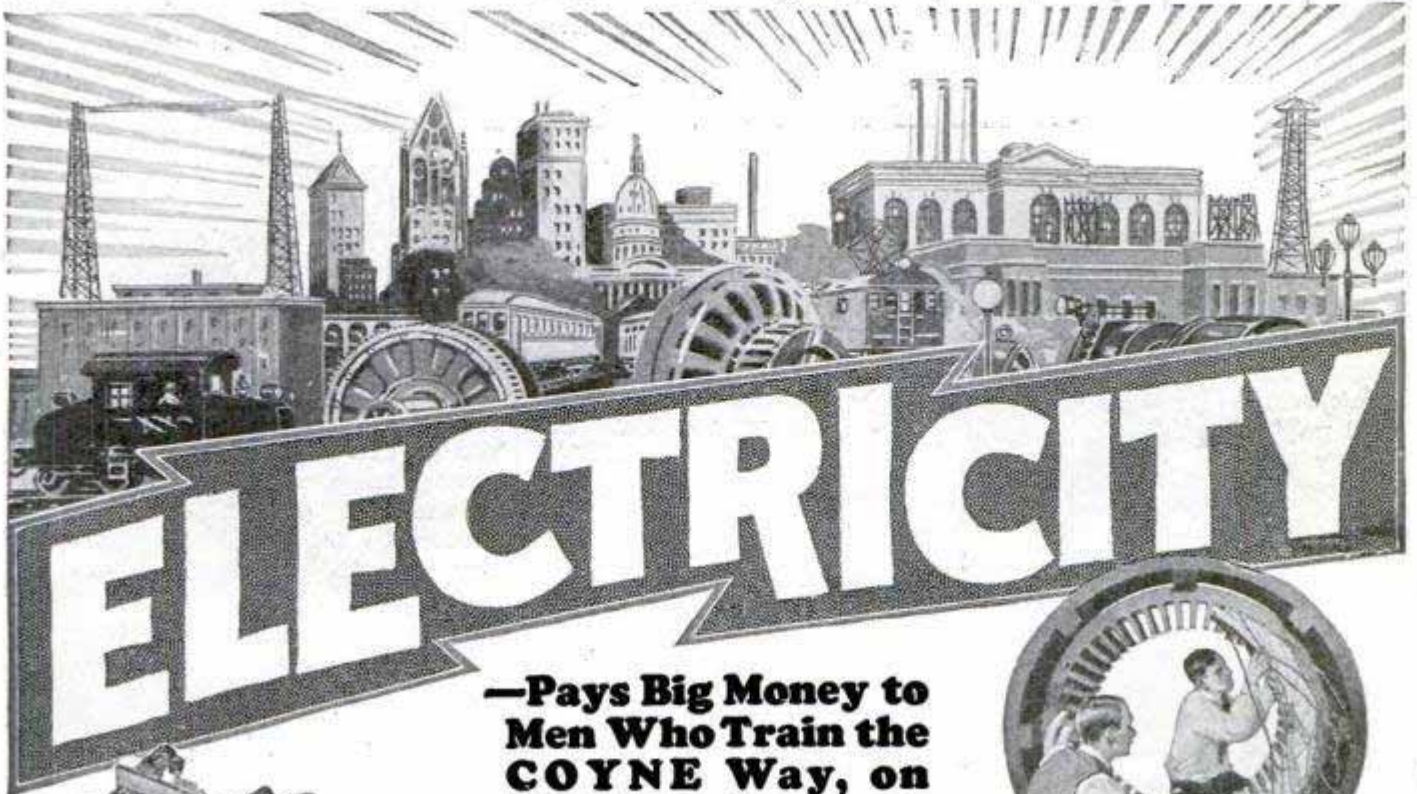

—Pays Big Money to Men Who Train the COYNE Way, on Real Equipment, in Great Shops!

If you are going to train for one of the thousands of BIG-PAY opportunities in the fascinating Electrical Field, why not train on real, gigantic electrical equipment such as you will find in the great Shops of COYNE at Chicago, the electrical center of the world? COYNE training is thorough but easy to understand, because EXPERT instructors guide you at every turn, as you work with your own hands on big, modern apparatus.

Hundreds of COYNE-Trained Men Earn \$60 to \$200 a Week



Students producing "artificial lightning" on Tesla coil in great shops of Coyne

Students operating large switchboard at Coyne

Big Special Offer If You Act NOW!
I'll include with my course, without extra charge, my big Extra Courses in Radio Electricity and Auto, Truck and Tractor Electricity.

I want to send you a copy of my big, attractive Electrical Book. It is 12 x 16 in. size and contains 151 photos of electrical scenes. Tells about dynamos, radios, autos, airplanes, farm lighting and power, etc. Absolutely FREE, Remember.

COYNE

ELECTRICAL SCHOOL

H. C. LEWIS, President Established 1899
1300-10 W. Harrison St., Dept. 1351, Chicago

**Not a Correspondence Course
All Practical, Personal Training**



Student Winding Stator at COYNE

COMPLETE ELECTRICAL TRAINING In 12 Happy Weeks at Coyne

My newly enlarged Electrical Course is the result of 27 years of experience, solving the needs of young men and of the Electrical Field. COYNE has been teaching Electricity in a PRACTICAL way since 1899.

My course is thorough, easy to master, and fits men for BIG Electrical jobs, the HIGH-SALARIED thrilling jobs.



H. C. LEWIS
President, Coyne
Electrical School

We Teach Electricity and Nothing Else

COYNE teaches only ONE thing—ELECTRICITY. We are SPECIALISTS. Our interests are not divided, nor is Electricity a sideline or merely an "additional" subject with us.

You Can Start Any Day of the Year at COYNE
—No Classes or Seasons

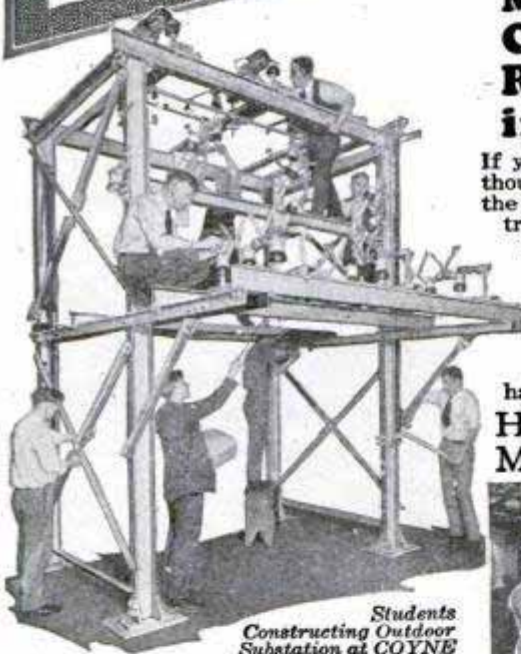

Students Constructing Outdoor Substation at COYNE

Earn While You Learn at COYNE

My well-organized EMPLOYMENT DEPARTMENT helps you to get a job to earn part or all of your expenses while training at COYNE and assists you to a good job on graduation. Furthermore, it stands by you THROUGH LIFE without a penny of extra cost to you.

You Don't Need Advanced Education or Experience

Don't worry if you lack advanced education, knowledge of higher mathematics, or experience. My course is a practical, LEARN-BY-DOING Course. Every COYNE student receives INDIVIDUAL and PERSONAL instruction, on COMPLETE electrical apparatus, under EXPERT INSTRUCTORS, in the COYNE Shops at Chicago.

Men who never before had the slightest knowledge of ELECTRICITY have become REAL ELECTRICAL EXPERTS and stepped into BIG PAY JOBS because of our advanced simplified, practical, methods of training.

SEND COUPON NOW

H. C. LEWIS, President
COYNE ELECTRICAL SCHOOL
1300-10 W. Harrison St.
Dept. 1351, Chicago, Illinois

Dear H. C.—You can just bet I want one of those big, handsome FREE 12x15 books, with 151 actual photographs printed in two colors. Send it quick, before the supply is exhausted. Be sure to tell me all about Special Courses without extra cost.

Name

Address

HOME WORKERS' SERVICES.
DRAFTSMAN—BEGINNER, TO MAKE TRACINGS in spare time. Simple work, good pay. Bring samples. Knight Iron Works, Ard. & Polk.
ARCHITECTURAL DRAFTSMEN—TO HELP evenings during rush. Work may be taken home. Call Elder 2041.

DRAFTSMEN
 Four students can get practical experience; time will select 2 for permanent position. Paying \$60 week to start. Mr. H. H. Mon, Cheney & Hicks, Garland 10 a. m.

WANTED—MALE
Professions and Trades.
ARCHITECTURAL DRAFTSMEN AND DRAWERS
 High class, on bank buildings. Will pay salary to excellent with experience.

DRAFTSMEN
 Excellent position with salary to \$375 per month. Excellent opportunity for advancement.

DRAFTSMEN
 Excellent opportunity for advancement. Salary to \$375 per month.

DRAFTSMEN
 Excellent opportunity for advancement. Salary to \$375 per month.

DRAFTSMEN
 Excellent opportunity for advancement. Salary to \$375 per month.

DRAFTSMEN
 Excellent opportunity for advancement. Salary to \$375 per month.

DRAFTSMEN
 Excellent opportunity for advancement. Salary to \$375 per month.

WANTED—MALE HELP.
Professions and Trades.
DRAFTSMAN—AT ONCE—WHO CAN DO good lettering; Younger man preferred. Experience not necessary. Excellent opportunity in pleasant office. Apply Saturday or Monday morning. Room 546 1st National Bank Bldg.

DRAFTSMAN
\$400 Month
 Excellent opportunity for advancement. Salary to \$400 per month.

KINDRED PRODUCTS CO.
MR. ORRINGTON
DRAFTSMAN—TO DESIGN TOOLS, JIGS, fixtures, punches and dies; good pay, steady position to right man. Call for personal interview. Hill Pump Valve Co., 2307 Archer-av.

DRAFTSMAN—DETAILER, ON HIGH CLASS cabinet work, bank and store fixtures. Conditions: factory location Indianapolis. See MR. DUGAN, Room 1300, G. Carey, to get at him. Call for personal interview. Hill Pump Valve Co., 2307 Archer-av.

DRAFTSMAN—DETAILER, ON HIGH CLASS cabinet work, bank and store fixtures. Conditions: factory location Indianapolis. See MR. DUGAN, Room 1300, G. Carey, to get at him. Call for personal interview. Hill Pump Valve Co., 2307 Archer-av.

DRAFTSMAN—DETAILER, ON HIGH CLASS cabinet work, bank and store fixtures. Conditions: factory location Indianapolis. See MR. DUGAN, Room 1300, G. Carey, to get at him. Call for personal interview. Hill Pump Valve Co., 2307 Archer-av.

DRAFTSMAN—DETAILER, ON HIGH CLASS cabinet work, bank and store fixtures. Conditions: factory location Indianapolis. See MR. DUGAN, Room 1300, G. Carey, to get at him. Call for personal interview. Hill Pump Valve Co., 2307 Archer-av.

DRAFTSMAN—DETAILER, ON HIGH CLASS cabinet work, bank and store fixtures. Conditions: factory location Indianapolis. See MR. DUGAN, Room 1300, G. Carey, to get at him. Call for personal interview. Hill Pump Valve Co., 2307 Archer-av.

WANTED—MALE HELP.
Professions and Trades.
DRAFTSMAN—MACHINE DETAILER AND tracer. \$80 wk. Fisher Bldg.
DRAFTSMAN—FOR ORNAMENTAL AND decorative iron work; must be good detailer; good job for right party. Call Monday on J. GOLDBERG, Atlantic Hotel.

DRAFTSMAN
DETROIT EDISON
 ELECTRICAL MEN WITH POWER HOUSE AND SUBSTATION LAYOUT EXPERIENCE. GOOD OPPORTUNITY AND STEADY EMPLOYMENT. STATE AGE, EXPERIENCE AND SALARY DESIRED. DETROIT EDISON COMPANY DETROIT, MICHIGAN

DRAFTSMEN
BEGINNERS
\$250 Month and Bonus

We want four clean cut young men who have just finished a good drafting course to fill vacancies created in our plant.

Excellent opportunity for advancement. Salary to \$250 per month.

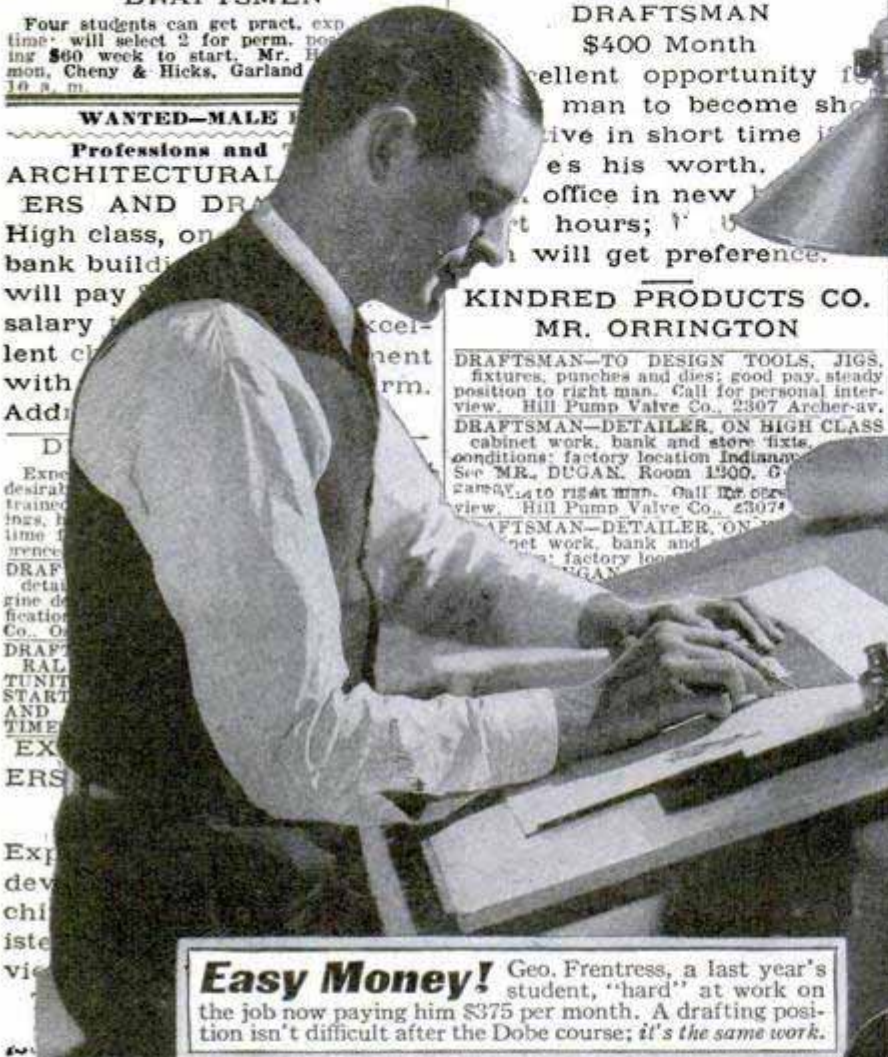

Easy Money! Geo. Frentress, a last year's student, "hard" at work on the job now paying him \$375 per month. A drafting position isn't difficult after the Dobe course; it's the same work.



This is a professional set of instruments I'm offering; the same tools I use myself.

CHOOSE YOUR JOB!

Follow the line of work you like, but *learn the right end.* No work is done—nor even begun—without draftsmen. It's draftsmen all concerns are after. Read the papers!

CHIEF DRAFTSMAN DOBE
 Div. 13-51
 1951 Lawrence Ave.
 Chicago, Ill.



I want your book Successful Draftsmanship while there is still time to consider your special offer of all tools, table and supplies free of any extra charge of any kind.

Name.....Age.....
 Street.....
 P. O.....State.....

DO YOU realize what a big field drafting is? All building, engineering, or manufacturing starts on paper. Single jobs require thousands of drawings. The simplest things you use were drawn before they could be made; the tools you handle; even the pipe you smoke. *Everything you see around you was first a drawing.* Here is your chance to take up drafting. You take my course right at home. I provide all the equipment that's required. We don't use books, but instruments. Drafting is all done with *tools.* So it doesn't call for "talent."

There's big money in drafting. Make no mistake about that! My former students are getting all the way from \$250 a month as juniors, to \$833 a month as chiefs.

SPECIAL OFFER: Until my present classes are filled, I will give all tools and supplies, even including Drafting table—without any additional charges!

Scores of engineering firms and manufacturers recruit their draftsmen from my classes. I haven't enough men now—and a busier season is coming. Therefore, I make this offer to get action; a beautiful set of imported drafting instruments, all rules and tools, and a drafting table, free of any extra expense to those who join-up at once.

Arc
 dus
 \$30
 pos
 sen
 out
 abil

7

DRA
 or
 more
 age.
 Add
 DRA
 chl
 age.
 Add

on
 ply

Int

ING
 STEA
 NUL
 O S
 AN
 SI

Chief Engineer Dunlap



I will make this contract with you

Your name here Wm. C. Campbell
 When you enroll for my home-training in **ELECTRICITY** I agree to give you:

1. Complete training, including Electrical Engineering, Ignition, Radio, etc.
2. Four outfits of standard tools and materials, including a \$10 motor.
3. **I WILL HELP YOU GET A GOOD JOB AND A RAISE IN PAY,**
4. **—or I will refund every cent of your money.**

By *Chief Engineer Dunlap*

Send you 4 Costly Electrical Outfits!



AMERICAN SCHOOL
 — the Million Dollar Educational Institution



Electrical Home-Training

now backed with **FREE JOB SERVICE**

I am pushing thousands of men ahead to success in Electricity by a wonderful new method of home-training. Now we announce a new feature for students and graduates of the American School—a nation-wide Employment Service under the direction of Mr. H. A. Burkart, Job Expert. Burkart is placing men in fine Electrical positions as fast as they qualify. The Electrical business needs more Experts. Go into Electricity and you're sure to find a good job when you're ready for it. **You can get ready with Dunlap**

Job-Method Training:

1.—because it's complete

We guarantee this training is both up-to-date and complete. Without extra charge I give you Electrical Engineering subjects, Electrical Drafting, Ignition, Radio, and many business subjects.

2.—because prepared by 23 noted Engineers

This is no one-man, one-idea school. America's greatest Electrical Engineers helped me prepare this training, and their work vouches for its high-standard and thoroughness.

Instruction prepared by men from:

- | | |
|---------------------------------------|---------------------------|
| 1. General Electric Co. | 7. Western Electric Co. |
| 2. Commonwealth Edison | 8. Underwriters Lab. |
| 3. Crocker-Wheeler Co. | 9. Columbia University |
| 4. Cutler-Hammer Mfg. | 10. Dartmouth College |
| 5. American Telephone & Telegraph Co. | 11. Massachusetts Inst. |
| 6. Westinghouse Electric & Mfg. Co. | 12. Lehigh University |
| | 13. University of Vermont |
| | 14. Armour Institute |
| | 15. University of Kansas |

3

because I train you by the Job-Method

These pictures show how my students learn Electricity by doing actual Electrical jobs with standard materials and tools which I supply without extra cost. **Four costly outfits given!** Students make fast progress by this wonderful Job-Method. Many do similar jobs for pay in their spare time and earn more than enough to pay for this training.

Small Monthly Payments

Our educational standards are high, tuition is within reach of the untrained man who needs this training, and small monthly payments accepted. So you need not face the world without training—let me show you how to get this million dollar No-Profit institution back of you in your fight for success and independence.

Get My JOB AND RAISE Contract—Quick!

Now you can put your time and money into home training with a positive agreement that it will lead to a better job and increased pay. Get the facts about my amazing offer. Find out about the opportunities and jobs waiting for you in Electricity. Act quick and make the next few months the turning point in your life. Coupon brings complete information.

CHIEF ENGINEER DUNLAP, Electrical Division
AMERICAN SCHOOL, Dept. E-174
 Drexel Ave. & 58th St., Chicago

Send JOB and RAISE Contract

To.....
 St. No.....
 City..... State.....

(Mail immediately to Chief Engineer Dunlap, American School, Dept. E-174, Drexel Ave. & 58th St., Chicago)

The third free outfit is a \$10 motor.

The first two free outfits prepare you to do Wiring Jobs like these.

The fourth free outfit is a Radio Set.



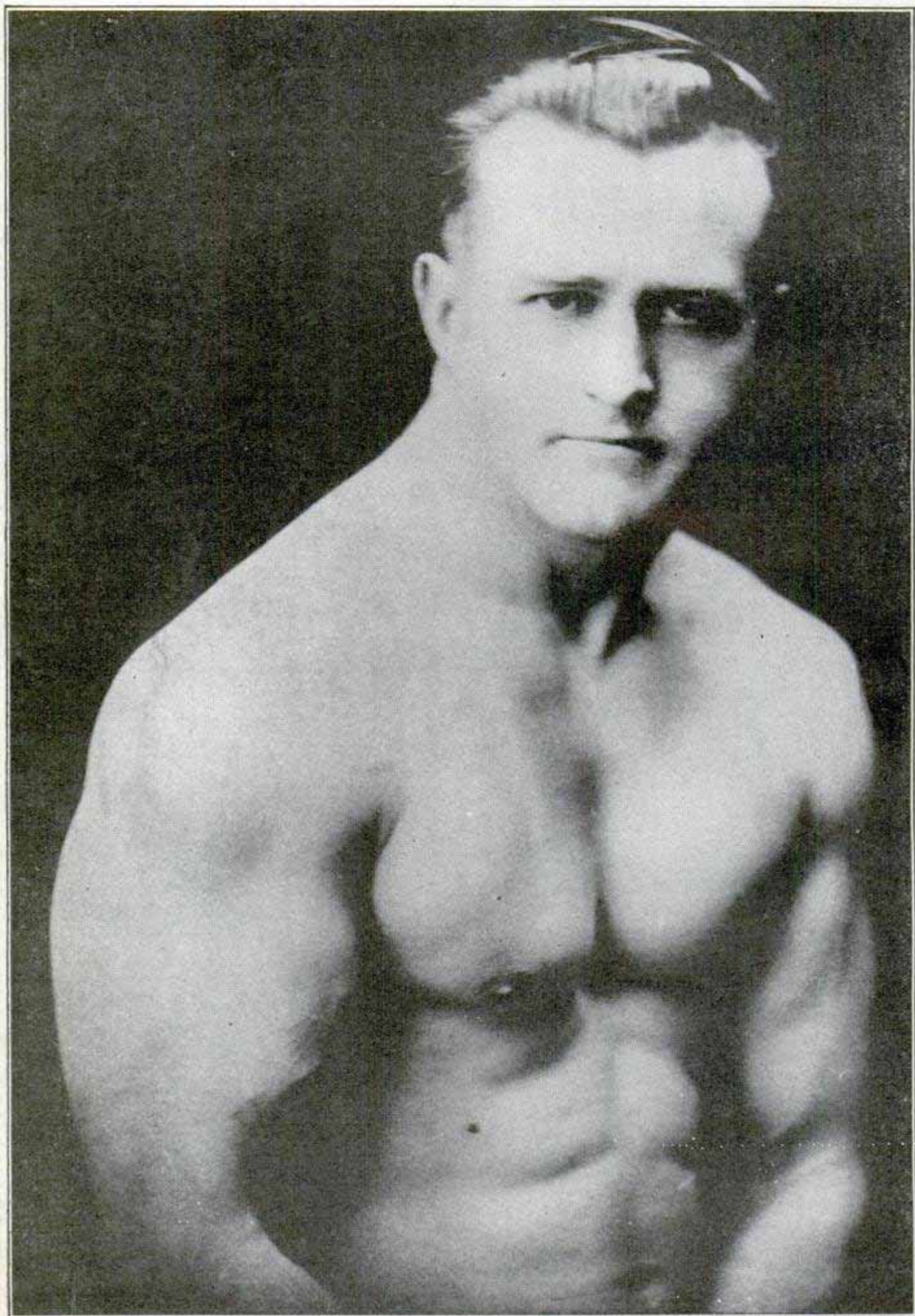

EARLE E. LIEDERMAN, *The Muscle Builder*

Author of "Science of Wrestling," "Muscle Building," "Secrets of Strength," and "Here's Health," etc.

How is your Bone-Oil?

Can you squat down and sit on your heels without hearing a crack in your knees or a stiffness around the joints? Can you bend over slowly without bending your knees and place the open palms on the ground alongside of your feet? Can you place your hands on the wall behind you and gradually let yourself down backwards till your hands touch the ground? If not, your joints are rusty, your tendons are too tight—you need more bone-oil.

What is Bone-Oil?

When you were born, nature gave you a lubricating fluid in and around the socket of every joint. This lubricating fluid continued in an abundant supply as long as you kept active. But when you ceased to exercise, this fluid lessened and the tendons shortened which attached the muscles to your bones. You dried up and stiffened. You became rusty.

When machinery becomes rusty we get the oil can. But you can't squirt Bone-Oil into your joints. What then can you do?

Come to My Repair Shop

As a regular machinist I'm a first class dub—but when it comes to human frame-work, I'm yet to find the one I can't whip into shape. Yes, I know they call me the Musclé Builder, and I'm proud of the fact that my system will build more muscle in a shorter length of time than hitherto has ever been accomplished. I'm the man who guarantees to add one full inch to your arms and two inches to your chest in the first 30 days. Before I'm through, however, I'll at least triple that. Some men have added as much as 8 inches to their chests. In every case I build up the back and literally cover the abdomen with a ripple of real healthy muscle. I clear the brain and brighten the eye.

I add pep and virility to the whole system. But the finest thing about my system is the type of muscle it creates. My pupils are not only enabled to perform remarkable feats of strength, but with it all, they have the suppleness and grace of an aesthetic dancer. I have studied the entire human structure and work around the very joints and cartilages as well. That is why I am now guaranteeing you not only a strong, sturdy, robust body, a virile, muscular body, but actually guarantee to lubricate your joints as well. I guarantee Bone-Oil. Now beat that if you can. And notice I'm not making any idle promises. I guarantee these things. Come on then, let those stiff-kneed, wobbly, half-animated bodies be a thing of the past. Tomorrow you start on the straight and rapid road to real manhood.

You take no chances with me. It's a sure bet, so why hesitate? Snap into it. Let's go.

Send for my free 64 page book

Send For My New
64 Page Book
"Muscular Development"
IT'S FREE

What do you think of that? I don't ask one cent. And it's the peppiest piece of reading you ever laid your eye on. I swear you'll never blink an eyelash till you've turned the last cover. And there are over four dozen full-page photos of myself and some of my prize-winning pupils. This is the finest art gallery of strong men ever assembled. And every last one of them is shouting my praises. Look them over. If you don't get a kick out of this book, you had better roll over—you're dead. All I ask of you is to cover the cost of postage, packing, etc.—ten cents.

Come on then. Take out the old pencil and sign your name and address to the coupon. Snap into it. Do it now. Tomorrow you may forget. Remember, it's something for nothing and no strings attached—no obligation. GRAB IT!

EARLE E. LIEDERMAN

305 Broadway Dept. F-2001 New York City

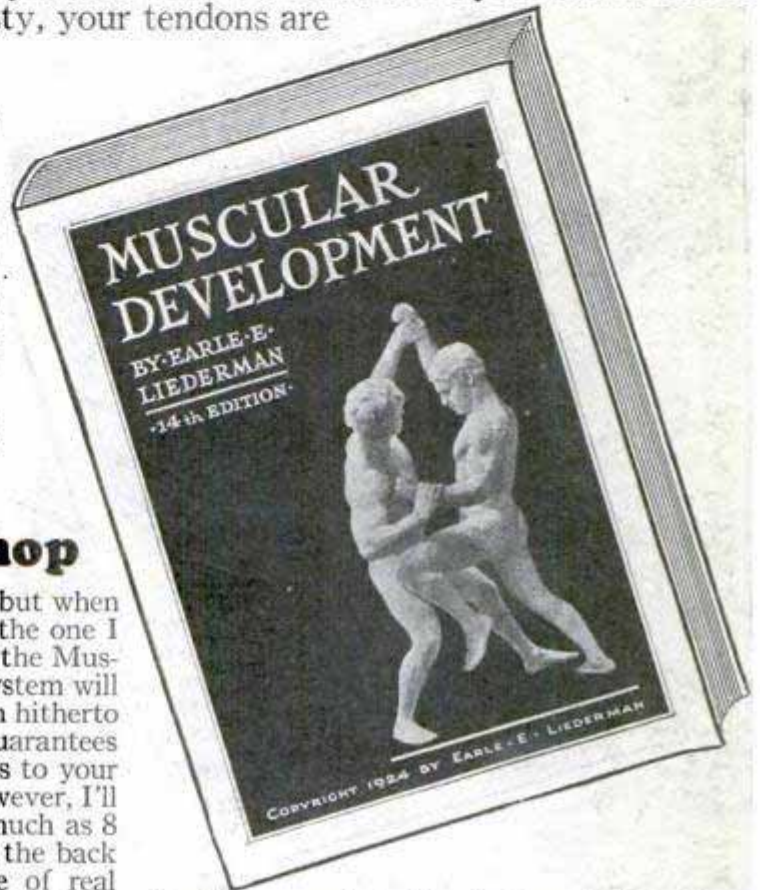

**It
Is
F
R
E
E**

**DON'T
SEND ONE
PENNY
—
YOUR
NAME AND
ADDRESS
ON A
POSTAL
WILL DO**

EARLE E. LIEDERMAN
Dept. F-2001, 305 Broadway, New York City

Dear Sir: Please send me, absolutely free and without any obligation on my part whatever, a copy of your latest book, "Muscular Development." (Please write or print plainly.)

Name

Address

City State

O. C. MILLER
Director of
Extension Work
American
School

Be a real

Draftsman!

Prepare at Home for a well-paid Drafting Job!

Before you put your time and money into any kind of training, make sure there are plenty jobs to be had when you're ready for them. That's why men go into Drafting. 70,000 jobs advertised in 12 months. Big salaries. Fascinating, easy work, short hours, and unlimited opportunities for advancement to executive positions.

Drafting Made EASY for You

NO-PROFIT PRICE

— EASY TERMS

We have developed a new one-step-at-a-time method which makes Drafting principles easy to understand. Even men with only common schooling make rapid progress with this instruction. Right from the very beginning you do actual Drafting room jobs. And by a wonderful new system you learn **without** copying, you see **why** every step is done and so you become a **Draftsman**, not a **tracer**.

This wonderful, more complete, simplified, rapid, up-to-date instruction in Drafting offered at very low tuition easily within reach of the untrained men who need it. Small monthly payments make it easy for you to prepare for a fine Drafting position at a big increase over your present salary.

Real Draftsmen SPECIALIZE!

Training backed with nation-wide Free Job-Service

The big money in Drafting goes to men who specialize in Machine Design, or Electrical Drafting, or Architectural Drafting, or Structural, or Automotive. It isn't enough merely to know general Drafting practice. You must know how to calculate and design and plan original work, to fill the kind of a Drafting position that pays \$60 to \$125 a week. The American School, for 29 years a leading institution teaching Engineering by home-study methods, now includes this specialized training in the complete Drafting course.

The American School now offers its students and graduates, without cost, the services of an efficient Employment Department which keeps in touch with the employers of Draftsmen all over the U. S. We have placed hundreds of men in good Drafting positions.

Look into this opportunity. Get my free book, Job and Raise offer quick! Let me show you how to turn part of your spare time into real training for a real job.

Mail
Coupon
Today!

O. C. MILLER
Director of Extension Work

American School
Dept. D-174
Drexel Ave. & 58th St.,
CHICAGO

O. C. MILLER, Director of Extension Work,
American School, Dept. D-174, Drexel Ave.
& 58th St., Chicago.

Please send me Free Drafting Book, Job and
Raise offer and complete information about pre-
paring for a fine Drafting Job at home in spare time.

Name.....

St. No.....

CIT.....St.....te.....

Complete Professional Outfit Given
These standard quality, full size instru-
ments, board, table, triangles, T-Square,
ink, protractor, etc., given without extra
charge to every student.

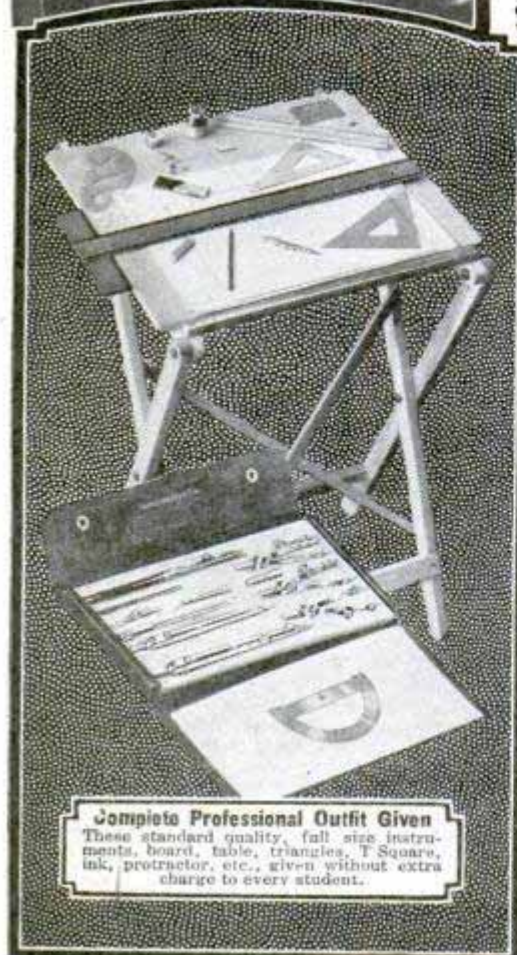

\$554.37 IN ONE WEEK
made by J. Wynn—over \$400 second week.



\$1,000 IN 30 DAYS
made by Hartle, a R. R. Mail Clerk for ten years.



\$13,500 FIRST YEAR
is what A. H. Ward made after taking this sales training.



BECOMES PRESIDENT
Earnings for year will exceed 5 figure mark.

\$5,000 to \$10,000 a Year for Men Who Read This Ad

J. E. GREENSLADE
President of the National Salesmen's Training Association, but called by some "The Man Who Makes Men Rich."

Let Me Make You a Master Salesman! This New Easy Way

I DON'T care what you are now or what you think. The Association of which I am president will take you in short, easy steps and make a Master Salesman of you, put you in the same class with the big pay men who have all the good things of life.

Many have thought that Salesmen were "born." And that idea has kept many men from succeeding. But this Association of Master Salesmen has proved that any man can be taught the rules and principles that make men Master Salesmen. And you know as well as I do that Salesmen top the list of money-makers. They are the producers and you can be one of them.

Easy as A, B, C

If you are as intelligent as the ordinary farmhand, postal clerk or stenographer, you can quickly master the simple A, B, C's of Selling. There are certain ways of approaching a prospect to get his undivided attention, certain ways to stimulate keen interest, certain ways to overcome objection, batter down prejudices, outwit competition and make the prospect act.

You can learn these principles at home in a short period of pleasant, inspiring study. And once you have mastered these secrets of Master Salesmanship, you can take advantage of the employment department of the Association without charge. They will help you select and secure a position as soon as you are qualified and ready.

This is a real opportunity, for during the last year the Association received calls for 43,846 salesmen from the biggest sales organizations in America. And these men are the same as you see above—men who make from \$5,000 to \$10,000 a year in salary and commission.

These are only four out of hundreds of similar records in the Association files.

Our members make good because the Association has specialized for seventeen years in teaching the Art and Science of Salesmanship and teaches the most unusual principles ever laid down for quick success.

The book you see below has been the starting point for thousands of men who are now successful salesmen. This book, "Modern Salesmanship," is now FREE.

Rush the Coupon

If I were asking ten or twenty dollars for this book you might hesitate. But I am not. It is Free. And since it may mean the turning point in your life, when you leave forever behind you the drudgery and low pay of routine work for the fascinating, big pay job of the salesman, it certainly is worth your time and the two cents you will have to spend to get this amazing book and read for yourself the astonishing facts given between its two covers. You have everything to gain and not one cent to lose, so mail the coupon today, sure.



Dept. A-12
N. S. T. A. Building, Chicago, Illinois

J. E. Greenslade, President
NATIONAL SALESMEN'S TRAINING ASS'N
Dept. A-12, N. S. T. A. Building, Chicago, Ill.
Send me FREE your book "Modern Salesmanship," and proof that I can become a Master Salesman.

NOW SENT FREE

The book that has shown thousands the way to amazing salary increases.

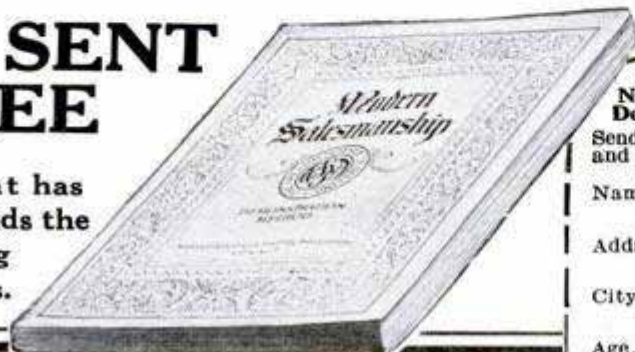

Name.....
Address.....
City.....State.....
Age.....Occupation.....

Pick Your Own Job!

RAILWAY POSTAL CLERK \$1900 to \$2700 a year
POST OFFICE CLERK \$1700 to \$2100 a year Special Clerks at \$2200 and \$2300
CITY MAIL CLERK \$1700 to \$2100 a year
R. F. D. MAIL CARRIER \$1800 plus \$12.24 per mile a year Pay of Rural Mail Carriers, it is estimated, will run from \$2090 to \$2300 a year
CUSTOM HOUSE POSITIONS \$1140 to \$2700 a year
POSTMASTER \$1200 to \$2500 a year and up
INTERNAL REVENUE POSITIONS \$1140 to \$2700 a year
DEPARTMENTAL CLERK \$1140 to \$1500 a year and up to \$2700



I'll Show You How to Get It

Which of these splendid positions do you want? Choose it now, and I will show you how to get it in the easiest, quickest way. I have helped thousands now holding well-paid Government positions, and I can help you, too. For years I was an official member of the Board of Examiners for the 2nd Civil Service District, and I know just how to train you to pass examinations with high rating, so you SURELY QUALIFY for first positions open. I guarantee my coaching brings you an offer of the job you want in one year after receiving your rating—or my instructions cost you nothing.

Stop Worrying About the Future Get one of these splendid Civil Service positions and your worries about work and pay are ended. Pay is from \$1140 to \$2700 to start; work is steady, hours are easy, you get vacations with pay. Work at home, in Washington, or travel. Examinations for some positions coming soon. Get ready now.

FREE Big Book About U. S. Civil Service

If you are an American citizen, 18 years or older, you can get a Government Civil Service position. Find out how you can easily qualify, in your spare time at home, for one of the positions shown in the panel above. Send at once for my handsome 46-page book about the U. S. Civil Service. Get the facts about how I can help you qualify for a steady, good-pay position with the Government. Mail coupon or postal card at once.

**Arthur R. Patterson, Principal
Patterson Civil Service School
61 Wisner Bldg., Rochester, N. Y.**

PATTERSON CIVIL SERVICE SCHOOL
61 Wisner Building, Rochester, New York

Send me your big FREE BOOK and tell me how I can secure a position with the U. S. Government paying from \$1140 to \$2700 a year to start, with excellent chances for advancement. This doesn't cost me a penny.

Name.....
Address.....
City..... State.....

New Way To Earn Money At Home!



Gabriel Andre Petit

Mr. Gabriel Andre Petit, Art Director of Fireside Industries, teaches wonderful, easy way to earn money every day right in your own home, decorating toys, furniture and art novelties. No experience needed. Hundreds of women now earning splendid incomes from this fascinating, well-paid home work. After second lesson Mary A. McLeod made \$150. Mrs. J. S. Davis earned \$195.75. Mrs. O. B. Kennedy sold \$500 in five weeks! Complete outfit of materials given to you when you join.

Send 2c stamp for beautiful Free Book which explains all. Write today.
FIRESIDE INDUSTRIES Dept. 661
ADRIAN, MICHIGAN

Music Lessons

WITH AN ACCREDITED SCHOOL

At Home

A Complete Conservatory Course By Mail

Wonderful home study music lessons under great American and European teachers. Endorsed by Paderewski. Master teachers guide and coach you. Lessons a marvel of simplicity and completeness.

Any Instrument Write telling us course you are interested in—Piano, Harmony, Voice, Public School Music, Violin, Cornet, Mandolin, Guitar, Banjo or Reed Organ—and we will send our FREE CATALOG with details of course you want. Send NOW.

University Extension Conservatory, 234 Siegel-Myers Bldg., Chicago, Ill.

Study AT Home

Become More Efficient

Courses in Mathematics, Chemistry, Psychology, Education, Business and 40 other subjects command either High School or College credit. Start any time.

The University of Chicago
15 Ellis Hall CHICAGO, ILL.

LAW IN YOUR SPARE TIME

Same course by correspondence as given for 15 years at classes of this college. LL. B. DEGREE CONFERRED. 3 year university course prepares for bar exam. Money back guarantee. Low fee, easy terms, includes 1924 12 volume library, lectures, lessons, all expenses. Write for free book.
HAMILTON COLLEGE OF LAW, G-1, 1412 S. Michigan Ave., Chicago

DON'T STAMMER

Master speech. Make friends. Double income. Learn how easy it is. Dime brings information and phonograph record.
153 Stinson, The Lewis Institute, Detroit

Learn How to WRESTLE

In Your Own Home By Mail

Yes, learn to become an expert wrestler right in your own home, by mail, from the greatest wrestlers the world has ever known. Be an athlete, be strong, be healthy. Learn how to throw and handle big men with ease. Learn to defend yourself. Learn from the World's Champions, **Farmer Burns and Frank Gotch Secrets**

Farmer Burns, who taught Frank Gotch—trainer of SEVEN World's Champions, will teach you Scientific Wrestling—Physical Culture—Jiu-Jitsu and Self-Defense. Write today for big wrestling book, illustrated with many fine pictures—shows holds and secret tricks used by champions. Tells how easy it is to learn the marvelous breaks, falls and holds that make you an expert. Send today for this wonderful book. Enclose only 10c to help cover cost of wrapping and postage. Be sure to state age. No obligation.

Farmer Burns, 1771 Ry. Exch. Bldg., Omaha, Neb.

Send Now for Farmer Burns' Book

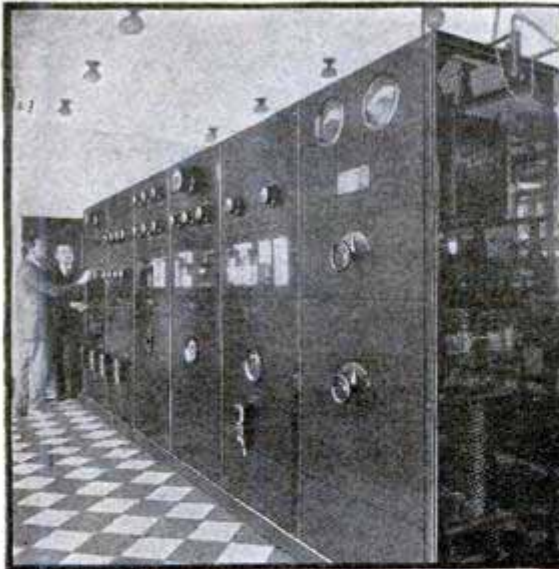

**\$50. to \$250 a week
IN WORK THAT IS
ALMOST ROMANCE**

Be a Radio Expert

Get into the great new Big-Pay Industry—Radio. If you're earning a penny less than \$50 a week, **clip coupon now.** Send for AMAZING FREE BOOK. Be a Radio Expert, and draw down big money for the easiest and most fascinating work in the world. Positions everywhere. Thoroughly-trained men are in big demand. Need for Radio Experts in every community. Short hours. **BIG PAY. Free book gives all the facts.** Astonishing opportunities—thousands of them! Every day N. R. I. trained men are taking good places in the Radio field. Free book tells all about their success. Send for it now!



**Learn Quickly and Easily
AT HOME**

Master Radio Engineers will show you how to qualify quickly and easily at home, for Radio's fine jobs. We **guarantee** to train you successfully. Lack of experience no drawback—common schooling all you need. Our tested, clear methods make it easy for you. Send coupon now for free proof.

**Instruments Given
with Course**

All instruments shown here and many others given to students for practice work while learning. Receiving sets, from simple kind to thousand mile receiver. An **UNEQUALLED OFFER.** Many other big features for limited time only.

**Famous Training
That "Pays for
Itself"**

Spare time earnings are easy in Radio. Increase your income almost from the start through practical knowledge we give you. This is the famous **practical training** that pays its own way.



Operates WMAQ

"Accepted a position with Chicago Daily News—Station WMAQ. My income practically doubled, thanks to your fine course."
KEITH KIMBALL, Chicago.



Gets Big Job

"Just been made Sales Manager of that Radio concern—a big raise in pay. Regret I did not take course sooner."
R. E. JONES, Bay City.

Get this Amazing Book

Most amazing book on Radio ever written—full, interesting facts about this great field and how we prepare you and help you start. You can do what others have done. GET THIS BOOK.

Send Coupon

Send coupon today for special limited offer, including all instruments—you'll get full particulars by return mail.

National Radio Institute

Dept. AT7, Washington, D. C.



ORIGINATORS OF RADIO HOME-STUDY TRAINING

ESTABLISHED 1914



MAIL THIS NOW

**NATIONAL RADIO INSTITUTE
Dept. AT7, Washington, D. C.**

Without obligating me in any way, send me your free book, "Rich Rewards in Radio," and all information about your practical, home-study Radio course.

Name.....

Address.....

Town.....State.....

You get all of these





Automobile Experts in Demand

Study with the same school that helped to train many leading men in the automobile industry

THE best proof of the value of the home-study courses of the International Correspondence Schools is the success of I. C. S. students. This success is especially apparent in the automobile industry.

Jesse G. Vincent, Vice-President of the Packard Motor Car Co., is a former I. C. S. student. So is Walter P. Chrysler, President of the Chrysler Motor Corporation. E. V. ("Eddie") Rickenbacker, Vice-president of the Rickenbacker Motor Car Co.; J. V. Whitbeck, President of the Cleveland Automobile Co.; Hiram Walker, Chief Engineer of the Chandler Motor Car Co., and John Moore, designer of the famous Ansted Motor, are also former I. C. S. students.

The first step they took was to mark and mail an I. C. S. coupon similar to the one printed below. Make your start the same way and make it right now. We'll gladly send you complete information about the I. C. S. Automobile Courses or any other course in which you are interested.

INTERNATIONAL CORRESPONDENCE SCHOOLS

Box 5547-E, Scranton, Penna.

Oldest and largest correspondence schools in the world
Without cost or obligation on my part, please tell me how I can qualify for the position or in the subject before which I have marked an X:

- | | |
|---|--|
| <input type="checkbox"/> Complete Automobile Course | <input type="checkbox"/> Gas Engine Operating |
| <input type="checkbox"/> Automobile Electric Equipment | <input type="checkbox"/> Complete Gas Engine Course |
| <input type="checkbox"/> Electrical Engineering | <input type="checkbox"/> Architect |
| <input type="checkbox"/> Electric Lighting | <input type="checkbox"/> Architects' Blueprints |
| <input type="checkbox"/> Mechanical Engineer | <input type="checkbox"/> Contractor and Builder |
| <input type="checkbox"/> Mechanical Draftsman | <input type="checkbox"/> Architectural Draftsman |
| <input type="checkbox"/> Machine Shop Practice | <input type="checkbox"/> Concrete Builder |
| <input type="checkbox"/> Railroad Positions | <input type="checkbox"/> Structural Engineer |
| <input type="checkbox"/> Civil Engineer | <input type="checkbox"/> Chemistry <input type="checkbox"/> Pharmacy |
| <input type="checkbox"/> Surveying and Mapping | <input type="checkbox"/> Airplane Engines |
| <input type="checkbox"/> Metallurgy <input type="checkbox"/> Mining | <input type="checkbox"/> Agriculture and Poultry |
| <input type="checkbox"/> Steam Engineering <input type="checkbox"/> Radio | <input type="checkbox"/> Mathematics |

BUSINESS TRAINING COURSES

- | | |
|--|---|
| <input type="checkbox"/> Business Management | <input type="checkbox"/> Salesmanship |
| <input type="checkbox"/> Industrial Management | <input type="checkbox"/> Advertising |
| <input type="checkbox"/> Personnel Organization | <input type="checkbox"/> Better Letters |
| <input type="checkbox"/> Traffic Management | <input type="checkbox"/> Show Card Lettering |
| <input type="checkbox"/> Business Law | <input type="checkbox"/> Stenography and Typing |
| <input type="checkbox"/> Banking and Banking Law | <input type="checkbox"/> Business English |
| <input type="checkbox"/> Accountancy (including C.P.A.) | <input type="checkbox"/> Civil Service |
| <input type="checkbox"/> Nicholson Cost Accounting | <input type="checkbox"/> Railway Mail Clerk |
| <input type="checkbox"/> Bookkeeping | <input type="checkbox"/> Common School Subjects |
| <input type="checkbox"/> Private Secretary | <input type="checkbox"/> High School Subjects |
| <input type="checkbox"/> Spanish <input type="checkbox"/> French | <input type="checkbox"/> Illustrating |

Name.....
Street.....
Address.....

City..... State.....

Occupation.....

If you reside in Canada, send this coupon to the International Correspondence Schools Canadian, Limited, Montreal

Be a Popular Favorite- Play the TENOR BANJO

\$18 TENOR BANJO
with case
FREE
When You Enroll

45,000 successful students back up our claim that you can play a piece in 30 minutes by following our printed instructions. Study in leisure time at home. Begin at once.

Picture Lessons Make It Easy

You can't fail to learn—pictures explain every move. You don't have to be able to read notes. We teach you, in our large New York conservatory, by mail.

Play for Fun or Money

Get in on parties. Entertain your friends. Be popular. Play at dances. Earn money in spare time.

Write for Special Offer

\$18 TENOR BANJO, in genuine Seal Grain Fabrikoid Case, **FREE** when you enroll. Write for special offer and guarantee.

FIRST HAWAIIAN CONSERVATORY OF MUSIC, Inc.
9th Floor, Woolworth Building, Dept. 160
New York, N. Y.

Approved as a Correspondence School Under the Laws of the State of New York

Low Prices—
Easy Terms!



LAW

STUDY AT HOME

Become a lawyer. Legally trained men win high positions and big success in business and public life. Be independent. Greater opportunities now than ever before. Big corporations are headed by men with legal training. Earn **\$5,000 to \$10,000 Annually**. We guide you step by step. You can train at home during spare time. Degree of LL.B. conferred. LaSalle students found among practicing attorneys of every state. We furnish all text material, including fourteen-volume Law Library. Low cost, easy terms. Get our valuable 108-page "Law Guide" and "Evidence" books **FREE**. Send for them NOW. LaSalle Extension University, Dept. 164-L, Chicago. The World's Largest Business Training Institution

Learn Advertising at HOME

The highest paid men in the world are advertising men. You can learn easily and quickly at home during your spare time. Bigger opportunities now in advertising than ever before. Tremendous demand for our graduates at big pay.

Send for **FREE Book**. Giving interesting information and vital facts—just what you want to know about advertising. Write today!
PAGE-DAVIS SCHOOL OF ADVERTISING
Dept. 1351 3601 Michigan Ave., Chicago, U. S. A.

MUSIC LESSONS FREE

IN YOUR OWN HOME
You can read Music like this quickly

Write today for our **FREE** booklet. It tells how to learn to play Piano, Organ, Violin, Mandolin, Guitar, Banjo, etc. Beginners or advanced players. Your only expense about 2c per day for music and postage used. **American School of Music**, 51 Lakeside Bldg., Chicago



Wonderful, new device, guides your hand; corrects your writing in few days. Big improvement in three hours. No failures. **Complete outline FREE**. Write C. J. Ozment, D-34, St. Louis, Mo.

LEARN PIANO TUNING AT HOME

With our TUNE-A-PHONE, Action Model, tools, charts and lessons you learn easily and quickly. Earn big money. Estb. 1898. Money-back Guarantee. Diploma given. Low tuition; easy terms.
WRITE TODAY FOR OUR FREE BOOK, "Winning Independence."
Niles Bryant School of Piano Tuning, 40 Bryant Bldg., Augusta, Mich.

Comedies, Dramas, Musical Comedies, Vaudeville Acts, How-to Stagea Play and Revues, Min- Make-up Goods str; Choruses, Songs, Blackface Plays. Everything for Burnt Cork Shows and All Amateur Entertainments. Monologs, Dialogs, Speakers. **CATALOGUE FREE**.
T. S. DENISON & CO., 623 So. Wabash, Dept. 9, CHICAGO

"BECOME A LIGHTNING TRICK CARTOONIST"

MAKE MONEY CHALK TALKING. SEND \$100 FOR SNAPPY PROGRAM OF TRICK DRAWINGS WITH INSTRUCTIONS BY A PROFESSIONAL CARTOONIST. SATISFACTION GUARANTEED. CIRCULAR FREE. BALDA ART SERVICE, Q1, OSHKOSH, WIS.

ELECTRICITY

Complete Study Course and Pocket Library \$10

SHIPPED FREE



A set of **HAWKINS GUIDES** is a good friend to the electrical worker. It tells you how to do any job the right way—without guessing or taking chances.

Hawkins Guides put the facts about modern electrical engineering at your finger tips, making your chances for advancement in the electrical field unlimited.

HAWKINS GUIDES INCREASE YOUR PAY



Electricity is king! It is the great ruling force—transportation, communication, light, heat, power—almost every modern activity is dependent on electricity. Industry is demanding electrical men that know their jobs!

Hawkins Guides teach you all you need to know about electricity in easy, step-by-step lessons. Daily spare time reading of the Guides will greatly increase your value to yourself and your employer in a few weeks. Hundreds of our friends have written us and told us this!

READERS OF HAWKINS GUIDES KNOW HOW



"You can't stump him on an electrical job." "He certainly knows his business." "Certainly have to hand it to him for knowing how." —These are the things employers say about our friends who are readers of Hawkins Guides. No matter what question or problem comes up the Ready Reference Index enables you to give an expert answer at once.

HAWKINS STARTS YOU WHERE OTHERS LEAVE OFF

Don't work any longer at low wages when easy reading of **HAWKINS GUIDES** will give you the money-making knowledge of the expert! Easy daily reading of the Guides will teach you in a few months what it has taken the expert a lifetime to learn!

With **HAWKINS GUIDES** in hand you have a running start to success in the electrical field. You will actually begin where others left off!

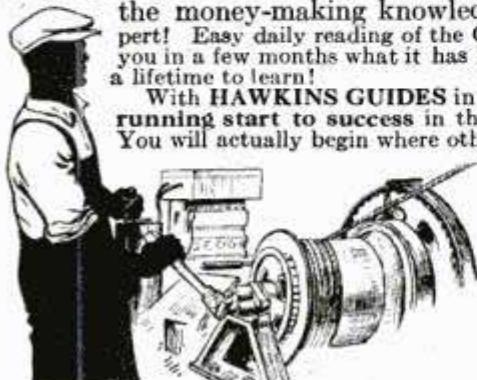

NOW!

This coupon is your golden opportunity. Tear it out—send it now!

FOR EXAMINATION!

REAL ELECTRICAL EDUCATORS

"Hawkins Guides at \$10 are the best investment I have ever made. Am able to take up almost any electrical job and have never gone to an electrical school."—**B. Roessler, Oenaville, Texas.**

AS EASY AS A. B. C.

"Everything in Hawkins Guides is very plain and anybody can read and understand them as easy as A. B. C."—**J. Knight, Tobyhanna, Pa.**

OTHER READERS SAY

"Worth ten times their price." "Helped me to two raises in four months." "Better than a school of instruction." "Studied them when I was laid up and got further ahead than if I had been on the job."

Hawkins Guides Explain These Points So You Can Easily Understand:—

Magnetism—Induction—Experiments—Dynamometers—Electric Machinery—Motors—Armatures—Armature Windings—Installing of Dynamometers—Electrical Instrument Testing—Practical Management of Dynamometers and Motors—Distribution Systems—Wiring—Wiring Diagrams—Sign Flashers—Storage Batteries—Principles of Alternating Currents and Alternators—Alternating Current Motors—Transformers—Converters—Rectifiers—Alternating Current Systems—Circuit Breakers—Measuring Instruments—Switch Boards—Wiring—Power Stations—Installing—Telephone—Telegraph—Wireless—Bells—Lighting—Railways. Also many Modern Practical Applications of Electricity and Ready Reference Index.

Hawkins Guides—10 POCKET SIZE NUMBERS

Each number easy to carry around and read in spare time. Big type and clear diagrams. Easy to study and learn. Durable, flexible binding—gold edges. 3,500 pages—4,700 illustrations. Shipped free for examination. Pay only \$1 a month if satisfied. Price of set, complete, \$10.



EXAMINE GUIDES FREE!

Let the Guides themselves demonstrate their practical value to you—as a study course, reference work and complete electrical library. You are the judge. Simply send this coupon. No obligation unless you are entirely satisfied. Tear out on dotted line—fill in—mail it NOW!

\$1 PER MO.

FREE EXAMINATION COUPON

Theo. Audel & Co., 65 W. 23rd St., New York City

Please send me (postpaid) for my approval **Hawkins Electrical Guides**, 10 numbers (price \$1 each). If satisfactory I will mail you \$1 in 7 days and further mail \$1 monthly until purchase price of \$10 is paid.

Name

Address

Occupation

Employed by

I-T-30

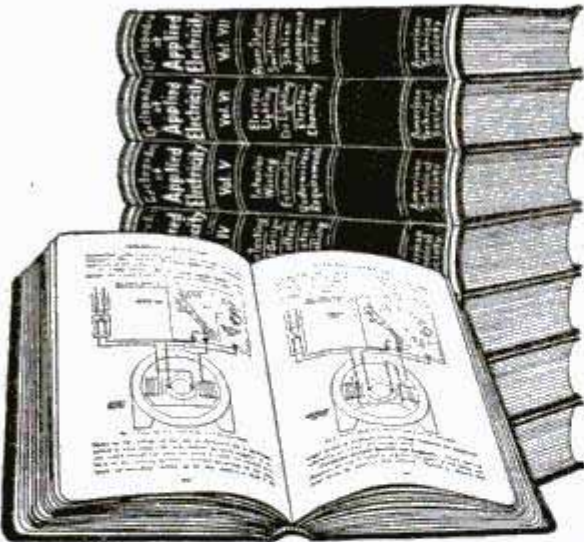

8 BIG BOOKS ON ELECTRICITY

Here is an amazing offer on 8 big electrical books, brimful of interesting and valuable facts and illustrations on electricity; facts that will increase your pay if you learn how to use them. Read all about our

No Money Offer To make it possible for every man with a spark of ambition in his make-up to benefit by this easy way of learning, we have set aside a limited number of complete sets to be sent FREE, without a penny down. Look the books over; read them and see how complete and thoroughly all subjects are treated and yet how plain and easy to understand. Take ten days to do this and then, if you don't realize how helpful and profitable they can be to you, send them back. If, however, your own good judgment proves their value and you see how profitable having them will be, just send us \$2.00 and only \$3.00 per month until the special price of only \$29.80 is paid.

FACTS THAT INCREASE YOUR PAY

Knowing means earning. The man that has specialized knowledge or knows where to get it ALWAYS makes the most money. Here is your opportunity, your chance to get into the Bigger Pay Class. You don't have to read the book through; the jiffy index is complete and simple. You can put your finger on the facts you want to know in a few seconds. Get these books now; don't hesitate—no offer could be more liberal.

MEMBERSHIP FREE In addition to this unusually complete set of 8 full volumes, bound in new flexo covers, we will for a limited time include a certificate of consulting membership in the American Technical Society, which will entitle you to FREE consultation service. Twenty highly paid experts will be ready to help you, entirely without cost to you.

Don't let this opportunity slip by; send for your books NOW. Use the coupon below.

AMERICAN TECHNICAL SOCIETY
Special Dept. E-119, Chicago, Ill.

You may send me the 8 Big Books—APPLIED ELECTRICITY. If I like them I will send you \$2.00 in 10 days after I receive them and \$3.00 per month until only \$29.80 has been paid. Otherwise I will return the books and will not owe you anything.

Name

Address

City State

Reference

ART

We Teach COMMERCIAL ART

Meyer Both Corapany, maintaining the most widely known Commercial Art Studios in the World, offers you a practical training based upon 25 years' success in producing over a quarter million drawings for leading advertisers. This attractive profession equally open to men and women. Home study instruction.

Get Facts Before You Enroll in Any School

Send 4c in stamps for illustrated book telling of the success of our students.

MEYER BOTH COMPANY
Dept. 16
Michigan Ave. at 20th St.
CHICAGO, ILL.

A FILE
NOT A FILE

Stop Forgetting

Make Your Mind an index from which you select facts, figures, names, faces. Develop concentration, self-control; overcome bashfulness, forgetfulness. Write today for FREE memory and concentration test and illustrated booklet, "How to Remember."

PROF. HENRY DICKSON
Dept. 7051 Evanston, Ill.

"STAMMERING

Its Cause and Cure"

You can be quickly cured if you stammer. Send 10 cents, coin or stamps, for 288 page cloth bound book on Stammering and Stuttering. It tells how I cured myself after Stammering and Stuttering for 20 years. **BENJAMIN N. BOGUE**
6929 Begue Building, 1147 N. Ill. St. Indianapolis

TELEGRAPHY

(Morse and Wireless) and RAILWAY ACCOUNTING taught thoroughly. Big salaries; great opportunities. Oldest, largest school. Endorsed by Telegraph, Railway, Radio, and Government officials. Expenses low—opportunities to earn large portion. Catalog free. **DODGE'S INSTITUTE, Jones St., Valparaiso, Ind.**

WANTED—RAILWAY MAIL CLERKS

\$158.00 to \$225.00 a Month for Life

(ALL POSTAL SALARIES JUST RAISED)

Every second week off with full pay—no "lay-offs" because of strikes, poor business, etc.—sure pay—rapid advancement to higher positions. City and country residents stand same chance. Common sense education sufficient—no political influence.

TRAVEL—SEE YOUR COUNTRY

Mail Coupon today—sure. Every day's delay means so much less chance of appointment from the next examinations—so do it at once.

Take this First Step for
a U. S. Government Job

Use Coupon Before You Lose It

COUPON

FRANKLIN INSTITUTE, Dept. L-179, Rochester, N. Y.
Kindly send me, entirely free of charge, (1) A full description of the position checked below; (2) Sample examination questions; (3) A list of U. S. Government Jobs now obtainable; (4) Tell me how I can get the position here checked.

... Railway Mail Clerk (\$1900 to \$2700) ... Customs Positions (\$1140 to \$1860)
 ... Postoffice Clerk (\$1700 to \$2100) ... Internal Revenue (\$1140 to \$1860)
 ... City Mail Carrier (\$1700 to \$2100) ... Rural Mail Carrier (\$2100 to \$3300)
 ... Income Tax Auditors (\$2040 to \$3000)

Name

Address

Easy as A-B-C

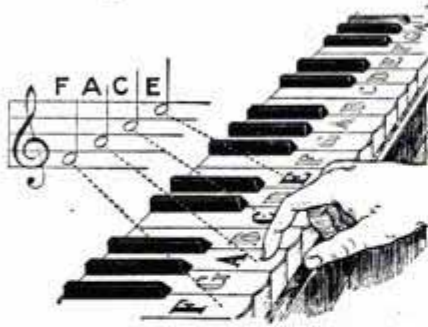

Here's a Queer Way To Learn Music!

No teacher—no monotonous exercises. Just a simple, easy home study method. Takes only a few minutes—costs only a few cents a day. Every step as clear as A-B-C.

WHO would have ever thought that the learning of music could be simplified? Seems almost too good to be true to think of learning to play your favorite instrument without long hours of practice—tedious scales and expensive teachers, doesn't it?

Yet that's exactly how you learn this new way. The only thing that is queer about this amazing method is the fact that it's so different from all ordinary methods.

But although this marvelous home-study method is different and comparatively new, it has already been carefully tested and proved by more than 350,000 people all over the world. Judge from that how satisfactory, reliable and easy it must be.

Musical Talent Not Needed

Even if you have never touched an instrument before you can't go wrong this amazingly easy way. For every step, from beginning to end, is right before your eyes in print and picture. You always know

what to do and how to do it. No guesswork. No delays. If you make a mistake you correct it yourself and continue. It's really fun learning to play this way, you proceed so rapidly. From the start you are playing real tunes perfectly by note. And almost before you realize it you will be able to play anything—the popular "Jazz" or those classical selections for which there is always a big demand at concerts

PROOF!

"I have completed only 20 lessons and can play almost any kind of popular music I wish. My friends are astonished."
TURNER B. BLAKE, Illinois.

"Since finishing the course I have been teaching, playing in churches and at recitals, and receiving a fine salary. I have made money, come into contact with new friends, and greatly increased my popularity."
—RUTH M. PEACOCK, North Carolina.

"Since I have been taking your lessons I've made over \$200 with my violin."
MELVIN FREELAND, N. J.

and home entertainments. Best of all no matter which instrument you choose the cost of learning is just the same in each case, just a few cents a day!

Have Fun—Win New Friends

Just think of all the pleasure you've been missing by not being able to play some musical instrument. Instead of being the center of attraction at parties—you've been unnoticed—out of the social picture. While you've been playing wallflower others have always had something to offer. Now you have a wonderful chance to turn the tables—to treat yourself to some real fun—to surprise your friends! Take some good advice. Learn to play this new easy way. Get your share of a musician's pleasure, popularity, profit. Start Now!

Free Booklet and Demonstration Lesson

If you are in earnest about wanting to join the crowd of entertainers and be a "big hit" at any party—if you really do want to play your favorite instrument, to become a performer whose services will be in demand—fill out and mail the convenient coupon asking for our Free Booklet and Demonstration Lesson. These explain our wonderful method fully and show you how easily and quickly you can learn to play like a professional at little expense. Instruments are supplied when needed—cash or credit. U. S. School of Music, 71 Brunswick Bldg., N. Y. C.

U. S. School of Music,
71 Brunswick Bldg., New York City.

Please send me your free book, "Music Lessons in Your Own Home", with introduction by Dr. Frank Crane, demonstration lesson and particulars of your special offer. I am interested in the following course:

.....

Have you the above instrument?.....

Name.....
(Please Write Plainly)

Address.....

City.....State.....

What Instrument For You?

- | | |
|--------------------------|--------------------------|
| Piano | Cello |
| Organ | Guitar |
| Violin | Ukulele |
| Drums and Traps | Hawaiian Guitar |
| Banjo | Harp |
| Tenor Banjo | Cornet |
| Mandolin | Piccolo |
| Clarinet | Trombone |
| Flute | Saxophone |
| Automatic Finger Control | Harmony and Composition |
| | Sight Singing |
| | Voice and Speech Culture |
| | Piano Accordion |

BOYS

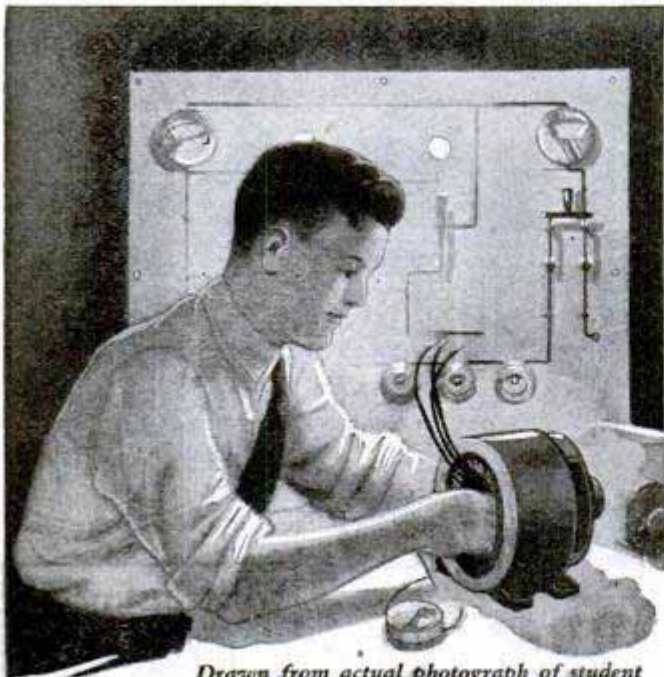

Drawn from actual photograph of student doing spare time electrical work

Learn Electricity Make Big Money

How would you like to earn two or three dollars every evening after school and prepare yourself for a fine big job at the same time? Here's the opportunity of a lifetime for you fellows who like Electricity. Begin right now to prepare yourself for a regular man's size job in this fascinating field. Your chances for a big success are simply wonderful—the pay is big (thousands of men earn \$70 to \$200 a week) and advancement comes swift and sure.

I Will Train You at Home

With my easily earned, spare time Electrical Course I will train you at home like I have trained hundreds of other boys who are now big successful men. It will not interfere with your school work and you can earn more than the small cost of the course doing odd electrical jobs in your spare time. The Course pays for itself. I will show you how to get this work and how to do it. Some of my boy students make \$10 to \$15 a week this way.

Tools, Apparatus and Radio Course —Given Without Extra Charge

Send me the coupon below and I will tell you all about the big outfit of tools, apparatus and instruments and a new Radio Course that I am giving to my students for a limited time. I will send you my big interesting Electrical Book and a sample lesson, too—all Free. You will be tickled with the things I will send you Free. Mail the coupon right now.

L. L. COOKE, Chief Engineer
Chicago Engineering Works
Dept. O-11 CHICAGO

Look What This Boy Is Doing

"Although the School term is coming to a close, and I am pretty busy with my examinations, I manage to keep up with my electrical studies and work.

"I guess I forgot to tell you I am now in business for myself. Am doing fine, but owe it all to you. If it had not been for your Course, I, being under age, could not have secured my license in this town. But I got it, and now have all the work I can do, averaging \$20 to \$30 a week, thru spare time work.

"I went out on a job tonight after school, on which I made \$3 and brought home another on which I made \$2.50—\$5.50, for 4 hours' work and no material furnished by me."

ROGERS SMITH,
1215 Chestnut St.,
Greenville, N. C.

Use This "FREE BOOK" Coupon

L. L. COOKE, Chief Engineer,
Chicago Engineering Works,
Dept. O-11 2150 Lawrence Avenue, Chicago

Send me your Big Outfit Offer, your big Electrical Book, Sample Lesson and particulars of your Electrical Course and Extra Radio Course. This will not obligate me in any way.

Name.....

Address.....
This Coupon only for use of boys 15 years old or more.

Here's the career for YOU



Get into this wonderful, big-paying profession. Hundreds of openings now in Motion Picture Camera Work, Portrait and Commercial Photography. Learn at home. Big money while learning.

Earn Up To **\$250 a Week**



High salaried positions everywhere or open your own studio. "My business averages \$700 to \$1000 a week," writes Michael Gallo. Others doing equally well. Even spare time work pays up to \$75 a week!

CAMERA FREE

to students. Your choice of real Motion Picture Camera taking standard professional film used by all theatres, or 5x7 View Camera, latest model, genuine anastigmat lens.

Send for Book

Tells all about Professional Photography and how to make big money quickly. Also details of Free Camera Offer. Write today. NOW!

New York Institute of Photography
143 West 36th St., New York (Dept. 49)



NOTE:

If you prefer to come to our New York or Chicago Studios for personal instruction, day or evening classes, write for Catalog R-49 to nearest address: 141 West 36th St., New York, or 630 So. Wabash Ave., Chicago, Ill.

LEARN WATCH REPAIRING



You can learn by our modern and original system of instruction every part of the **Watch Repairing Trade** at home as good or better than at a shop. You can earn money while learning and secure a well paying position or start in business after completing our course of instruction. Good watch repairers are always in demand and earn from \$50 to \$75 per week. For particulars apply to the **Wisconsin School of Watch Repairing** 166 Mason St., MILWAUKEE, WIS.



BECOME A LANDSCAPE ARCHITECT

Established 1910.

Dignified, exclusive profession. Little competition. \$5,000 to \$10,000 incomes for experts. Easy to master under our correspondence methods. Assistance extended to students and graduates. Write **AMERICAN LANDSCAPE SCHOOL, 107-NA NEWARK, NEW YORK**



SHORTHAND IN ONE MONTH

Boyd—the Wonderful, New Easy System. Writers hold World's record. 100 to 150 words a minute in 30 days guaranteed. New Principles—dictation first week. Best for Court Reporting and Secretaries. Also Typewriting, Bookkeeping and Commercial Law. Send today for Catalog and Money-Back Guarantee. **CHICAGO HOME STUDY SCHOOLS, 802 Reaper Block, CHICAGO, ILLINOIS**

PIANO JAZZ

By Note or Ear. With or without music. Short Course. Adult beginners taught by mail. No teacher required. Self-Instruction Course for Advanced Pianists. Learn 259 styles of Bass, 684 Syncopated Effects, Blue Harmony, Oriental, Chime, Movie and Café Jazz, Trick Endings, Clever Breaks, Space Fillers, Sax Slurs, Triple Bass, Wicked Harmony, Blue Obligato, and 247 other Subjects, including Ear Playing 133 pages of REAL Jazz, 25,000 words. A Postal brings our FREE Special Offer.

Waterman Piano School, 1826 W. Adams St. Los Angeles, Cal.

How New Method Makes Cartooning Astonishingly Easy to Learn!

Cartoonists earn from \$50 to over \$250 a week! Why don't you make big money in cartooning when new method makes it so easy to learn—at home in spare time?

THOUSANDS who never dreamed they could make cartoons, can now earn big money in this fascinating field. Right at home in your spare time, you can now easily learn to make all kinds of cartoons—comic, sport, political, human interest and animated. You can now earn some of the big money paid for cartoons of every description.

And cartooning *does* pay enormous money! Briggs, Bud Fisher, Fontaine Fox, George McManus, Sid Smith and all the other headliners *earn more than the President*. A single cartoon idea can easily mean a splendid life-salary for you.

The World's Easiest, Pleasantest and Best Paying Profession

How could money be earned more pleasantly? A few hours a day at work that is as enjoyable as play—and there is almost no limit to the money that can be earned!

Never before have the opportunities in cartooning been so many or so varied. Never has there been such a splendid chance to earn big money for cartoons. And regardless of what you are doing at present or how poorly you draw now, you can easily and quickly learn to make cartoons through this new easy method.

New Easy Way to Learn Cartooning

It's fun learning to make cartoons this new way. It's just like a game. You learn at home, yet it is just as if an instructor stood at your elbow. You don't need to know a thing about cartooning. You start with straight lines and curves. Then you learn the little secrets of originating cartoon ideas, the methods of exaggeration, of action and expression—all the little tricks that make cartooning amazingly easy to those who know them. And soon you are making *real* cartoons. Many of our students had cartoons published before they were half thru their courses.

When learning to make cartoons is so easy, why shouldn't you too make big money and enjoy the fun of cartooning. Graduates of this school are to be found in every section of the country. Read in the panel what they are doing and what they say about this training.

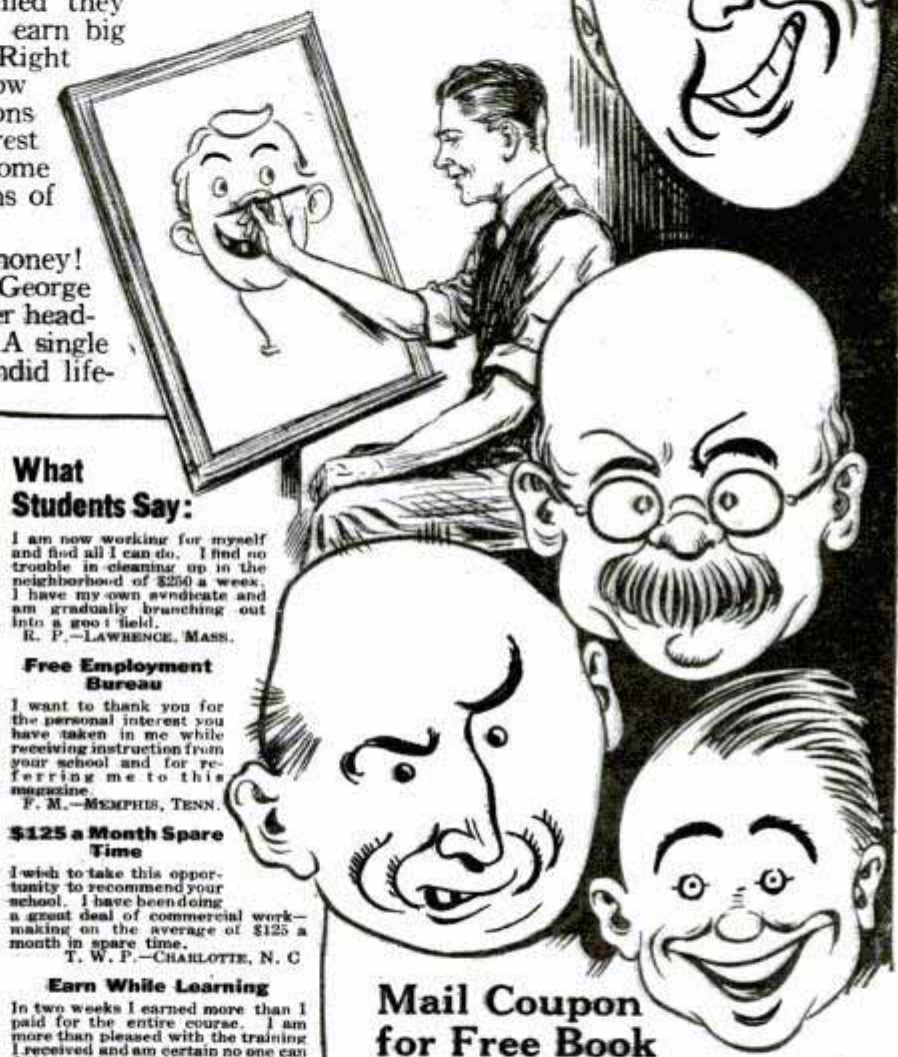

What Students Say:

I am now working for myself and find all I can do. I had no trouble in cleaning up in the neighborhood of \$250 a week. I have my own syndicate and am gradually branching out into a good field.
R. P.—LAWRENCE, MASS.

Free Employment Bureau

I want to thank you for the personal interest you have taken in me while receiving instruction from your school and for referring me to this magazine.
F. M.—MEMPHIS, TENN.

\$125 a Month Spare Time

I wish to take this opportunity to recommend your school. I have been doing a great deal of commercial work—making on the average of \$125 a month in spare time.
T. W. P.—CHARLOTTE, N. C.

Earn While Learning

In two weeks I earned more than I paid for the entire course. I am more than pleased with the training I received and am certain no one can fail to make rapid progress under your instruction.
O. B.—OLD TOWN, ME.

Mail Coupon for Free Book

Learn more about the wonderful opportunities for making money in Cartooning and how this new method makes it easy for you to learn. Read about our students, how they make money while learning, and big salaries after they graduate.

Our handsomely illustrated booklet is crammed full of interesting facts on Cartooning and describes in detail this remarkable method of teaching cartooning. It will be sent to you without obligation. Mail the coupon for this booklet *now*. **Washington School of Cartooning, Room 301-D, 1113-15th St., N. W., Washington, D. C.**

WASHINGTON SCHOOL OF CARTOONING
Room 301-D, 1113-15th St., N. W., Washington, D. C.

Please send me, without obligation, your Free Booklet on Cartooning and full details on your new easy home-study method of teaching Cartooning. **(PLEASE WRITE PLAINLY.)**

Name.....
(State whether Mr., Miss or Mrs.)

Address.....

City..... State.....
(If under 16, please give age.....)

FASCINATING

... and perhaps you, like other ambitious men, due to the lack of money, time and education necessary to master *difficult* mechanical trades, wonder what *you* can get into *quickly* and make the most out of, *now!* Haven't you overlooked the very thing you are looking for?

For *there is* a profession begging for clean-cut, *earnest* men, like yourself! *Look into it!* 60,000 Moler graduates *know* Modern Barbering is easy to learn, inexpensive, *quicker* to earn, *clean* and **FASCINATING!** It pays *better* than you think! **FIND OUT!** Write for catalog B.1.

Address the branch of the **MOLER SYSTEM OF COLLEGES** nearest you

(Street address not needed)

Chicago, Ill.
New York, N. Y.
St. Louis, Mo.
Kansas City, Mo.
Cincinnati, Ohio
Cleveland, Ohio

Detroit, Mich.
Denver, Colo.
New Orleans, La.
Omaha, Nebr.
Milwaukee, Wisc.
Atlanta, Ga.

Memphis, Tenn.
Dallas, Tex.
Houston, Tex.
San Antonio, Tex.
Minneapolis, Minn.
Seattle, Wash.

Los Angeles, Calif.
Salt Lake City, Utah
San Francisco, Calif.
Tacoma, Wash.
Portland, Ore.
Winnipeg, Man., Can.



Play Your Way to Greater Popularity with the fascinating **HAWAIIAN GUITAR**

**Play all the
LATEST HITS
just as the
Hawaiians do**

\$15
HAWAIIAN GUITAR
with Genuine Seal Grain
Fabrikoid Cover

FREE
when you
enroll

Be the most popular member of your set. Get in on all the good times. Play all the new song and dance hits. Entertain your friends—or play professionally. Be in demand everywhere. We will help you.



**Learn Quickly and Easily
in Spare Time at Home**

Even if you don't know one note from another, our method is so simple, plain and easy that you begin a piece your first lesson. In half an hour you can play it! You study in spare time—when you like—as long as you like. And your lessons are always before you to refer to at any time.

**Our Native Hawaiian Instructors
Will Show You How**

You receive expert instruction from such world-famous players as Kolomoku, Kalaluki, Ferera and Seville. They quickly teach you the secrets of this fascinating instrument. And remember—the services of these gifted native masters of the Hawaiian Guitar are obtainable only through this old-established New York Conservatory.

Complete Conservatory Course

You get 52 complete printed lessons. Nothing is omitted. Pictures explain every move. And no matter how little you know about music, no matter if you have never touched a musical instrument, our easy picture method will make you an accomplished player.

New Invention Makes It Easy

Our course includes a marvelous invention which helps you to make rapid progress. You will be astonished how quickly you learn to play this popular musical instrument, the Hawaiian Guitar, just as the Hawaiians do!

Only 4 Motions to Learn

Then you can play any music—popular songs, classical, old-time melodies, native Hawaiian airs—or real jazz—separately or with accompaniment. You'll never be lonesome when you can play the Hawaiian Guitar. By our simple method you learn—and learn quickly. No waiting for class to form—you can begin now.

Our Written Guarantee

Anyone can play the Hawaiian Guitar. We guarantee in writing to teach you. The success of 45,000 students backs up our claim. Like them, you can soon be a full-fledged player, your popularity established and constantly increasing, a professional career ahead of you if you desire. And we coach and advise you after graduation—with no extra expense.

Pay as You Play

We make it easy for you to obtain the many advantages of this big Conservatory. You start with a small first payment—then pay while learning. It comes to only a few cents per lesson. And bear in mind—your only investment is the moderate cost of your lessons—we furnish everything else.

This Sweet Toned Hawaiian Guitar FREE

This sweet-toned Hawaiian Guitar would cost you at least \$15 in any music store without the genuine Seal Grain Fabrikoid Case. We give you the entire outfit free when you enroll, including everything necessary to carry on your studies and play the instrument. We can do this because we make them in huge quantities in our own factory.

**First Hawaiian
Conservatory of Music, Inc.**
9th Fl., Woolworth Bldg.,
Dept. 148 New York

Approved as
a Correspondence School
Under the Laws of the
State of New York



**No
Extras
—We
Furnish
Everything**

Including the Free Hawaiian Guitar, in genuine Seal Grain Fabrikoid Case—picks, steel playing bar and 52 pieces of music.

**Other
Courses**
Famous teachers conduct our courses in Tenor Banjo, Violin, Mandolin, Banjo, Ukulele.

This is the Popularity Coupon—MAIL IT NOW
First Hawaiian Conservatory of Music, Inc., New York, N. Y.
Dept. 148, 9th Floor, Woolworth Bldg., New York, N. Y.
Please mail full information about your 52-lesson Hawaiian Guitar Course. I am not obliged to enroll unless I want to.
Name.....
Address.....
City.....
State.....



The Making of an Unusual Salesman

The Making of an Unusual Salesman

Here are Some of the Records

Big JOBS Now Open

After spending fourteen years as conductor on a railroad, I came in on my passenger run and never went out again. I saw there were wonderful chances in the selling field; so I started in selling real estate. The first month I did not make a sale. I saw I needed something to help me, so I took up LaSalle training Salesmanship. The next month I made \$700 and last month I averaged better than \$67 a day throughout the month.

C. A. THOMAS, California.

My salary was practically doubled a short time ago, but my greatest satisfaction comes from knowing that the amount of business I have written this year is easily five times greater than before.

S. N. WILLIAMS, Kentucky.

With or without previous experience, you may become an unusually successful salesman. Men who sent for this book from one to six months ago have doubled their earnings.

If you are seeking advancement or greater opportunity, get full particulars of the LaSalle salary-doubling plan. The coupon will bring it to you, together with two valuable books—"The Making of an Unusual Salesman" and "Ten Years' Promotion in One," all without obligation.

If a successful career is worth two cents and two minutes of your time, clip and mail the coupon NOW.

LASALLE EXTENSION UNIVERSITY
The World's Largest Business Training Institution
Dept. 164-SR Chicago

I should be glad to receive an outline of your salary-doubling plan, together with a copy of "The Making of an Unusual Salesman," also copy of "Ten Years' Promotion in One," all without obligation.



Modern Salesmanship—
"The Making of an Unusual Salesman"
Other LaSalle Opportunities

The LaSalle plan opens the way to success in every important field of business. Check below the opportunity that appeals to you:

- | | |
|--|--|
| <input type="checkbox"/> Business Management | <input type="checkbox"/> Personnel and Employment Management |
| <input type="checkbox"/> Higher Accountancy | <input type="checkbox"/> Banking and Finance |
| <input type="checkbox"/> Traffic Management | <input type="checkbox"/> Modern Business Correspondence and Practice |
| <input type="checkbox"/> Railway Station Management | <input type="checkbox"/> Expert Bookkeeping |
| <input type="checkbox"/> Law—Degree of LL.B. | <input type="checkbox"/> C. P. A. Coaching |
| <input type="checkbox"/> Commercial Law | <input type="checkbox"/> Business English |
| <input type="checkbox"/> Industrial Management | <input type="checkbox"/> Commercial Spanish |
| <input type="checkbox"/> Modern Foremanship and Production Methods | <input type="checkbox"/> Effective Speaking |

Name.....
Present Position.....
Address.....

Get this FREE Record!

DOUBLE-DISC photograph record of two beautiful Musical Saw solos sent without charge. Hear the marvelous possibilities of this sensational instrument.



Complete Outfit Sent On Trial

No notes to read. No dreary practice. Just three short, simple lessons and you play popular and classical music. I guarantee success; no charge whatsoever if I fail. Thousands of my students are amazing friends, playing in dance and broadcasting orchestras or at lodge and church entertainments. Write for SPECIAL INTRODUCTORY OFFER of Saw, Hammer, Bow and Resin, FREE with Course of Instruction and how you can obtain complete outfit on trial.

MUSSEHL & WESTPHAL
253 West Water St. Fort Atkinson, Wis.

ELECTRICAL ENGINEERING

Course for men of ambition and limited time. Over 4000 men trained. Condensed course in Theoretical and Practical Electrical Engineering including the closely related subjects of Mathematics and Mechanical Drawing taught by experts. Students construct motors, install wiring, test electrical machinery. Course complete

IN ONE YEAR

Prepare for your profession in the most interesting city in the world. Established in 1893. Free catalog.

BLISS ELECTRICAL SCHOOL
231 Takoma Ave. WASHINGTON, D. C.

Learn to Write

BEGIN TODAY
WRITE FOR MY FREE BOOK

are waiting for men and women who can write clearly and legibly. No matter how old you are or what kind of work you do, you can quickly learn to write well by the Tambllyn Method.

Send Today for this free-book showing by word and picture what others have accomplished by spare time practice in a few weeks. YOUR NAME elegantly written on a card if you enclose 2c postage. Address F. W. Tambllyn, 418 Ridge Bldg., Kansas City, Mo.

BIG PAYING POSITIONS

FREE BOOK

LEARN WATCHMAKING

and become independent. We help you secure a position. Easy to learn. Send for FREE CATALOG.

ST. LOUIS WATCHMAKING SCHOOL, Dept. 5, ST. LOUIS, MO.

LEARN MECHANICAL DENTISTRY

Earn \$35 to \$125 a week. Taught by actual practice—day or night. Three months' course. Modern laboratories. No previous training required. Established 30 years. For 36-page catalog, write Dept. 2.

BODEE DENTAL INSTITUTE
NEW YORK 136 W. 52d St. PHILADELPHIA 1305 N. Broad St. BUFFALO 501 Washington St. BROOKLYN 85 Court St.

LEARN PHOTOGRAPHY!

Earn \$200 to \$500 monthly. Or start your own business. Photography and Photo-Engraving taught by largest college of its kind in world. Established 1893. Big demand for graduates. Write for freebook. Illinois College of Photography, Box 416, Effingham, Ill.

Anyone CAN LEARN

No talent or experience necessary. Fascinating work. Pays big money. Complete instruction book tells about: Alphabets, Colors, How to Mix Paints, Show Cards, Window Board and Wall Signs, Ready made letters, Gilding, Tricks of the Trade, also gives 100 Alphabets and Designs. Book bound in flexible int. leather-gold edges, and four half bearing Show Card Pens. Sent postpaid \$3.00. (C.O.D.) 10c ex. Ogilvie Pub. Co., 57 Ross St. Dept. 50, N.Y. City

How to Paint SIGNS and Show Cards

\$3

EARN MONEY IMMEDIATELY— WE FURNISH EQUIPMENT TO START!!

1000 Hotel Positions Open!

Hotels, Restaurants, Clubs, Apartments, Everywhere, Need Trained Men and Women. Over 70,000 High-Class Positions Paying Up to \$10,000 a Year Are Open Each Year in the Hotels of the United States. The Hotel Business is America's Largest Industry in New Construction. Nearly a Billion Dollars Worth of New Hotels, Clubs, and Restaurants Built This Year Will Need Over 70,000 Trained Men and Women.

I Guarantee to Teach You

In my home-study course on hotel work what the leading experts know about the business—men earning from \$5,000 to \$50,000 a year—and at any time there are over 1,000 hotel positions open in this industry.

I Put My Students in Touch With Positions

all over the United States. They are eagerly sought by the biggest and best hotels in the country—my methods are endorsed by leading hotelmen everywhere. Hotels start you at salaries up to \$3,500 a year with your living. If you want a steady, permanent position, with big pay, quick advancement, fine living, free meals and apartment—you can find it in hotel work.

FREE Mail Coupon NOW!

Opportunity Coupon 1000 Hotel Positions Open!

Lewis Hotel Training Schools,
Room N-327, Washington, D. C.

Kindly send me, without obligation, a copy of the free book, "Your Big Opportunity," with details of the Free Registration in your National Employment Bureau.

Name.....

Address.....

City.....State.....

No Previous Experience Needed

You need no previous experience when you take the Lewis Course. We train you by mail in your spare time at home with the Lewis Simplified Study Plan, and put you in touch with big opportunities. All of your training under the personal direction of Clifford Lewis, former U. S. Government Hotel and Restaurant Expert, now Managing Consultant for over 225 Hotels of 50 to more than 600 rooms each, throughout the United States, totaling over 25,000 rooms. **FREE Book Gives Full Details** There are opportunities for you in this big paying hotel industry. Many students have obtained hotel positions paying as high as \$2,500 a year, even before they had finished the course. My **FREE BOOK "Your Big Opportunity"** shows you how you can do as well. The coupon above will bring you by return mail this vitally interesting, illustrated book, which shows how you can become a high-salaried hotel executive; also tells how our students are winning; success with Lewis Training and explains how you obtain Free Registration in our National Employment Bureau and our Money-Back Guarantee.

LEWIS HOTEL TRAINING SCHOOLS
Clifford Lewis, President Room N-327, WASHINGTON, D. C.

PROOF!

Our files are crammed with letters like these which prove that the hotel industry is the field of big opportunity today.

B. VAN HORN, PENNIMAN, VA.: "I have been made manager of this home at a 75 per cent increase in salary."

ALFRED A. MEYER, OAKLAND, CAL.: "I have increased my salary considerably—almost doubled the same in a year's time."

GRACE FORD PUCKETT, OKLAHOMA, OKLA.: "Yesterday at your suggestion I went to Orlando and was engaged as Assistant Manager of Orange Court. My Lewis Training is what accomplished it all."

BE A RAILWAY TRAFFIC INSPECTOR

EARN UP TO \$250.00 Per Mo.
EXPENSES PAID

Hundreds of Successful Graduates!

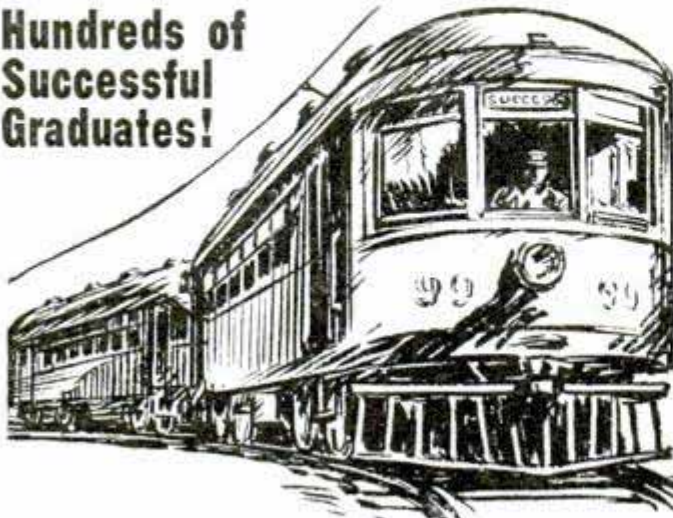

Think of preparing for a position with the knowledge, before you start or spend one cent, that a position will be secured for you, upon graduation, or your money will be refunded!

For over seven years we have helped men become trained Railway Traffic Inspectors and we have placed practically all of them in good, steady positions, after graduation. They start at \$110.00 to \$135.00 per month and advance rapidly with experience up to salaries of \$250.00 a month with expenses paid.



Prepare in Spare Time Only Three Months Required

Preparation is easy and pleasant. Read what Carl W. Lange says: "Any person with a common school education can easily become a traffic inspector by taking your course—and be successful. The recommendations you gave me have placed me in a steady position with one of the largest railway companies in the Central States."

me have placed me in a steady position with one of the largest railway companies in the Central States."

Fascinating Outdoor Work

Another graduate, Daniel M. Mack, says: "I received my diploma on April 15, was on my way to take a position on the evening of April 16, and started to work on April 17. If this is not quick work, I don't know what it is. I found the course complete and also found the school very thorough in its training."



Big Opportunities Ahead

Railways throuout the country want more trained Traffic Inspectors. We must supply them. Investigate now. Get our booklet, our **Guarantee** and comments of satisfied graduates everywhere.

Cost is moderate; easy terms. Mail coupon today.

STANDARD BUSINESS TRAINING INSTITUTE

BUFFALO, N. Y.

Standard Business Training Institute, Buffalo, N. Y.

Send me, entirely free, Booklet No. D-63 giving full particulars about course in Railway Traffic Inspection.

Name

Street

City

Why Miss Half the Fun in Life?



BE POPULAR—Learn to dance well! Arthur Murray, World's greatest dancing teacher, has invented a remarkable new easy method which enables anyone to learn all the newest dances at home—in a few hours—at very little cost! No music or partner needed. *Success positive'y guaranteed!* "350,000 learned dancing by mail."

FREE ILLUSTRATED BOOKLET AND TEST LESSON

To prove I can quickly and easily make you an accomplished dancer, I will send you **FREE** in plain cover, my new illustrated booklet "The Short Cut to Popularity" which describes my method in detail and in addition a Test Lesson from my famous course. To pay the cost of mailing, handling, etc., send 10c. Learn in private—surprise your friends. Act now and be a good dancer soon!

Arthur Murray, Studio 574
3 E. 43rd St. New York, N. Y.

Do You Make Mistakes in English?

Every time you speak or write you show just what you are. Mistakes in English reveal you as a person who lacks education and refinement. Lack of language power prevents you from presenting your thoughts in the strongest possible way. No matter what you do, real command of English will help you to your goal. Stop making mistakes in spelling, punctuation, pronunciation. Increase your vocabulary.



WONDERFUL INVENTION

Only 15 minutes a day with Sherwin Cody's new invention—and you can actually SEE your English improve. It teaches by **HABIT**—makes it easier to do the **RIGHT** way. Wonderful self-correcting lessons include spelling, punctuation, grammar and expression.

FREE BOOK ON ENGLISH AND 15 MINUTE TEST Lack of language power may easily be costing you thousands of dollars every year. See what Mr. Cody can do for you; it costs nothing to find out. Mail a postal card or letter this very minute for free book, "How to Speak and Write Masterly English," and 15 Minute Test, which you can take in your own home. It will prove a revelation to you. **WRITE NOW.** Address **Sherwin Cody School of English, 51 Searle Building, Rochester, N. Y.**

Factory to Rider

Saves \$10 to \$25 on the Ranger Bicycle you select. You can have your choice of **44 Styles**, colors and sizes. Delivered free on approval, *express prepaid*, for **30 DAYS' FREE TRIAL**. Bicycles, \$21.50 up. **\$5 a Month** if desired. Possession and use at once. Parents often advance first payment. Best quality, at factory prices, *express prepaid*. Tires, lamps, wheels and equipment, low prices. Send **No Money**, do business direct with makers. **MEAD CYCLE COMPANY** Write today for free Ranger Catalog, factory prices and marvelous easy payment terms. **DEPT. B-CHICAGO** 109



WANT GOV'T JOB?

All men-women, 18-65, wanting to qualify for Government Positions, \$140-\$300 monthly, local or traveling—Write Mr. Ozment, 111, St. Louis, Mo.

Will You Wear This Suit?



Show it to your friends and neighbors as a sample of our fine quality, hand-tailored, **All-Wool Suits**, guaranteed \$40 values, at amazing low price of \$23.50, take their orders, keep handsome profit for yourself and send orders to us.

Agents Making BIG MONEY

\$3.00 to \$5.00 an hour in spare time, \$75 to \$150 a week for full time. We supply handsome Swatch Line Outfit, large size samples and all latest styles in elegant

Leather Case. Positively finest selling outfit ever furnished salesmen. Write for yours at once, pick out your suit and get started making the Big Money right away. Address Dept. 302.

JAMES OLIVER, Inc., 848 W. Adams St., Chicago
Write name and address below and mail at once.

Name

St. and No. R. F. D. Box

Town State

Can you fix it

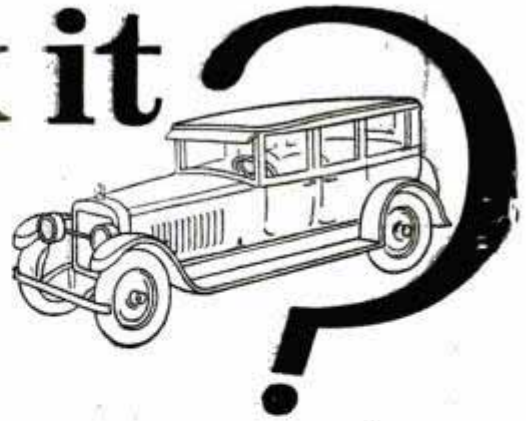

New books have "jiffy index," making all facts instantly available. You find anything you want to know in a moment.

These books tell how

HERE are the most interesting, the most practical books we have ever published on automobile construction, operation and repairs. Brimful of facts, photographs and explanations so easy to understand that anyone can learn how in almost no time.

Over 2000 pages, with diagrams, blueprints and everything else needed to make anyone an authority on automobiles.

Whether you want to qualify as garage owner, auto repair expert or merely wish to know how to keep your own car 100% efficient, you will welcome these books, especially on our

No Money Offer

This plan brings this valuable information within the reach of everyone. You don't send us a single penny. You don't have to pay us anything—just send your name and address and we'll send you the complete set of 5 volumes, specially bound in Flexo covers.

Read them carefully; keep them 10 days; find out anything you want to know, and then if you want to keep them, send only \$2.00 then and \$3.00 per month until the special low price of \$19.80 is paid. There is no further obligation.

American Technical Society Membership Free

This is a great organization for the publishing and spreading of specialized knowledge—we have over a million dollars of resources, enabling us to get the cooperation of the largest automobile manufacturers and dealers, who have furnished us plans and photographs. If you send NOW for this new edition of Automobile Engineering, we will include a Consultation Membership in this great organization.

Eighteen automobile experts will be ready to help you at all times. You can write or wire any time for special information. Answers will be sent to you promptly—without cost.

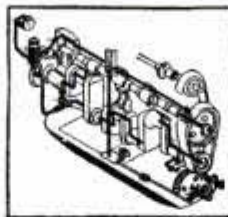

Modern Oiling System

Don't Hesitate

There are no strings to this offer—it means just what it says. Send name and address on the coupon and ALL of the five books—the complete set—will be sent to you for examination.

Remember one fact only which you can find in these books may save you an expensive repair or help you to a better job.

Learn All About Autos

Get these five big books on this liberal offer and learn all the things you want to know about autos.

Carburetors, engines, springs and spring suspension, brakes, 4-wheel drives, lubrication systems—all are fully covered.

These complete and comprehensive auto books are yours if you want them on this easy plan. Send for a set NOW; there's nothing to pay.



You don't have to read the books through; the index enables you to put your finger on the information wanted in a jiffy.

For Free Offer, Use Coupon

American Technical Society,
Spec. Dept. A-119, Chicago, Ill.

I would like to look at the 5 Auto Books described above. Send them on your FREE offer. I will examine them carefully and return them in 10 days unless I like them; in which case I will send you \$2.00 then and \$3.00 per month until the total price of only \$19.80 is paid. You are to also send me Free Consulting Membership Certificate in the American Technical Society.

Name.....

Street.....

City..... State.....

Reference.....



Learn to Play JAZZ by Ear in 90 Days

Be a master of jazz, syncopation, melody. It is easy to learn at home in your spare time. Wonderful Niagara Method shows you how.

By R. C. JAMES

How I used to wish that I could sit down at the piano and pour out the golden syncopation of American melody, like the jazz piano players I had heard. How I used to wish that I could be the popular one in every crowd.

But I could not play a note. I did not know a thing about music.

Niagara Method Shows The Way

Then somewhere—just as you are reading this—I read of the Niagara Method which makes piano playing wonderfully simple. I sent for Director Wright's book "The Niagara Secret." I read the book, and I knew it was right.

I followed Director Wright's principles, and in no time I had caught on to his ideas.

Simple—Easy—Delightful

And the best part of it all is that there is nothing hard about the Niagara Method. In a short time, by following Director Wright's principles and by devoting a part of my spare time to the practical application of his course, I soon learned to play.

No tiresome scales—no arpeggios to learn—no weary hours of practice—no do-re-mi—no meaningless exercises. If you know the Niagara Method, you can sit down and reel off any popular song which the high-priced orchestra leaders play in the cabarets, clubs, hotels, dance halls, or theaters.

Decide to Begin Now

If you have never played a note, or if you do play—no matter how well—you too may become a master of jazz and melody by learning the simple, wonderful Niagara Method.

FREE BOOK



Don't wait another day. Send the coupon now for the "Niagara Secret." This book is yours absolutely FREE. If 10c (coin or stamps) is enclosed you also receive wonderful booklet "How to Entertain at Piano."

Ronald G. Wright, Director
Niagara School of Music,
Dept. 871 Niagara Falls, N. Y.

CLIP THIS COUPON NOW!

NIAGARA SCHOOL OF MUSIC
Dept. 871 Niagara Falls, N. Y.
Without obligation mail me your book "The Niagara Secret." I enclose 10c for book "How to Entertain at Piano."
Name.....
Street.....
City..... State.....

Make Money Taking PICTURES



Get \$100 for Flood Pictures

"I took pictures of a flood and sold them for \$100. I have been able to buy my house and lot from the sale of pictures."

C. M. COLE,
Washington.

\$97 in Two Days!

"I made \$285 in December. Went out two days last week on home portrait, work and made \$97."

A. G. HUGHES,
Kentucky.

Tremendous, big-paying opportunities are open for ambitious men in Modern Photography. This is the picture age. Magazine and newspaper publishers buy thousands of photographs each year. Every manufacturer sends out high priced pictures of his products. Every home wants portraits. Photography is a business running into millions of dollars each year. And there is a great shortage of trained photographers.

EARN \$3,000 TO \$10,000 A YEAR

Hundreds of men are earning big money and establishing their own businesses. Even during spare time, while training, you can make \$75 a week easily—no matter where you live!

AMAZING NEW EASY METHOD

I show you, at home, how to do the kind of work turned out by the big studios in New York and Chicago! I show you how to make big money within 30 days! C. M. Cole bought a home with money he had made when only halfway through his training. So well do I know what I can do for you that I guarantee under bond to return every cent of your tuition if you are not thoroughly satisfied.



PROFESSIONAL VIEW CAMERA FREE!

Write at once for Free Camera Offer—I give you, free, a splendid professional view camera. You will be astonished and delighted. This offer open for short time only—so act quick! No obligation.

INTERNATIONAL STUDIOS, INC., Dept. 1351
3601 Michigan Ave. CHICAGO, U. S. A.



LEARN TO DRAW!

Remarkable book just off the press—"COMMERCIAL ART AND CARTOONING." Explains how to make illustrations for Books, Advertisements, etc. Also tells how to become a successful Cartoonist. NO CORRESPONDENCE COURSE—Everything complete in this book—14 chapters, over 125 illustrations. Tells about Elementary Drawing; Still Life; Pen, Ink, Charcoal and Crayon Work; Wash and Figure Drawing; Cartooning. Bound Flexible, Imitation Leather—Gold top. Worth \$5.00. Sent postpaid for \$2.00 (C. O. D. 17c extra).

OGLIVIE PUB. CO., 57 Rose St., New York, Dept. 133



POST PAID \$2.00

LEARN WATCH REPAIRING

Be a watchmaker—you can learn this profitable trade by correspondence in a few weeks in your own home by the DeSelms Chart System. After you complete the course you will know a watch from A to Z. You will know just what the matter is and how to repair one. When you graduate you will be a practical watchmaker and repairer and competent to fill any position. Positions for our graduates. Ask for our Free Book. It explains our system and terms.

THE DeSELMS WATCH SCHOOL
LOGANSPORT, INDIANA



Clear-Tone TO Clear Your Skin

Your skin can be quickly cleared of Pimples, Blackheads, Acne or any Eruptions on the face or body, Barbers Itch and Eczema, Enlarged Pores, Oily or Shiny Skin. CLEAR-TONE has been Tried, Tested and Proven its merits in over 100,000 test cases.

WRITE TODAY for my FREE Booklet—"A CLEAR-TONE SKIN" telling how I cured myself after being afflicted for fifteen years.

FREE

E. S. GIVENS 128 Chemical Bldg. Kansas City, Mo.

AUDELS ENGINEERS & MECHANICS GUIDES

Salary Increased 100 Percent

"Audels Guides gave me information I was unable to get from much higher priced works. By their use I have increased my salary 100 per cent."

C. Pelsor, Lic. Engineer, Springfield, Mass.

Aid To Getting a License

"My set of Audels Guides are just the books I need as an aid to getting my engineering license. I would not take \$25 for them now or any other time."

R. Anderson, Detroit, Mich.

Guides Great Educators

"I think Audels Guides do more to educate men that want to climb the ladder of success than any other organization or school in the country."

C. P. Luntington, Rawlins, Wyoming.



Here are the correct answers to Engineering and Mechanical Questions—in a handy form. When you are stuck on a job, consult Audels Guides. It will save time, labor and money for you. These authentic guides teach the best engineering practice. Don't guess or take chances.

Study your Job. Study Audels Guides on subjects you are interested in. They prepare you for the job higher up. The engineer and mechanic who reads and thinks as he works puts character into his profession. He is the master of his job. He is the outstanding man who is in demand in these days when power plant and boiler room economy is so important.

Complete Engineering Taught in Practice and Theory in These Practical Pocket-Educators

Audels Guides are 8 handy pocket books—price \$12, payable \$1 a month. These up-to-date educators explain in plain language the theory, practice and rules that have to be known by engineers, mechanics, machinists, firemen, oilers, draughtsmen and engineering students.

Audels Guides are Good Helpful Counselors, worth hundreds of dollars to any mechanic. By learning more you earn more. Read list of subjects covered—all easy to understand and apply. Engineering calculations figured out in simple arithmetic with sketches and examples.

Judge the value for yourself. Examine Guides Free! Send coupon NOW. Make up your mind about keeping these educators after a week's trial.

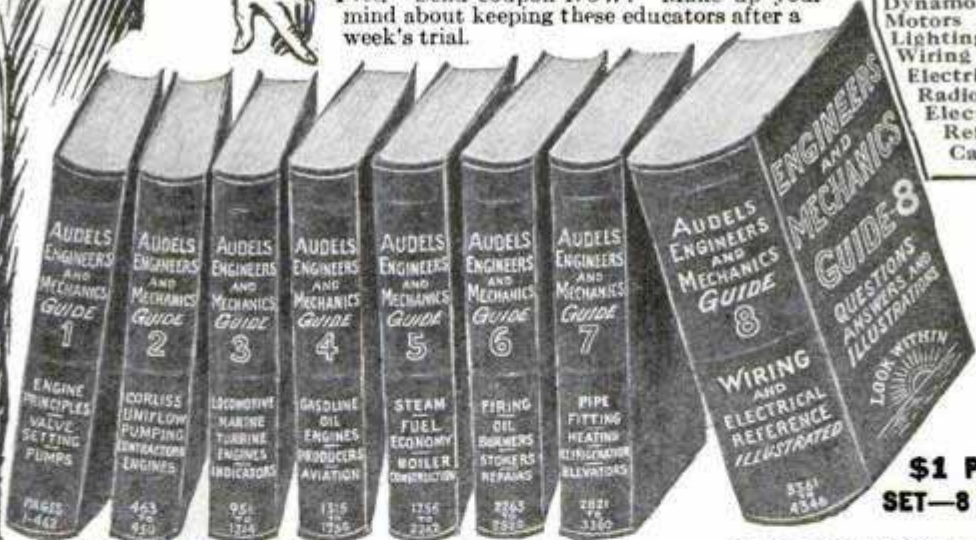

INFORMATION Answers On:

- Engine Principles
- Valve Setting
- Pumps.
- Engines:—
- Corliss Engines
- Uniflow Engines
- Pumping Engines
- Contractors Engines
- Locomotives Engines
- Marine Engines
- Turbine Engines
- Gas and Oil Engines
- Indicators
- Producers
- Aviation
- Steam
- Fuel Economy
- Boiler Construction
- Firing
- Oil Burners
- Stokers
- Boiler Repairs
- Pipe Fitting
- Heating
- Refrigeration
- Elevators
- Dynamos
- Motors
- Lighting
- Wiring
- Electrical Diagrams
- Radio
- Electrical Reference and Calculations

\$1

\$1 PER MONTH SET—8 GUIDES \$12

ANSWERS—In A Handy Form These 8 beautiful books are printed in big type, on strong paper. Flexible covers, gold edges. Easy to carry in pocket for daily reading. Handy to keep on table or shelf for quick reference. 4750 pages, 8754 illustrations. Highly endorsed by engineers everywhere as an Educator and a Helper to Better Pay. Examine the set free! Send no money. Pay nothing to postman. Merely tear out and mail this coupon today!

Our Guarantee

Examine Audels Engineers & Mechanics Guides without charge. If you like this Master Set, keep it. If not, send it back. Pay us only if you are satisfied. No charge if you are not. This is the fair play plan on which we have distributed educational books for nearly 50 years.

NOW!

The foreman, superintendent, chief of today is the man that yesterday STOPPED EVERYTHING until he got this coupon into the mail! Send this coupon now. Learn more so you can earn more!

FREE THEO. AUDEL & CO.
 EXAMINATION COUPON 65 West 23rd St. NEW YORK CITY

Please send me postpaid, for free examination AUDELS ENGINEERS & MECHANICS GUIDES—8 numbers, \$12. If satisfied, I agree to send \$1 in 7 days and \$1 monthly until paid.

Name.....
 Address.....
 Occupation.....
 Employed by.....

**FIND OUT
WHY**

The **COOKE** Trained Man is the **BIG PAY** Man in **ELECTRICITY**

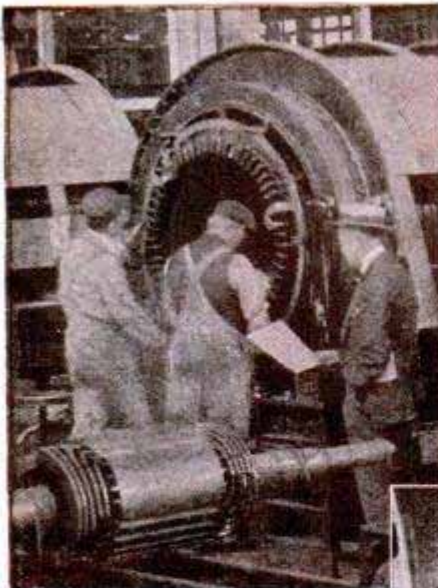

**These Men are
Making Big Money!**

\$90 a Week in Radio

"I am now busy in Radio, and have averaged \$90 a week clear since last February, when I started my own store. My success is due entirely to your training. I wouldn't take \$100,000 for it."

— D. G. Plank, 811 Fourth St., Woodland, Calif.

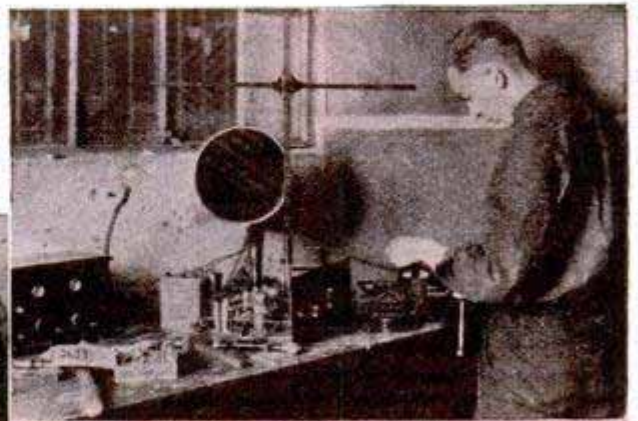

Knew Nothing About Electricity When He Enrolled — Now Makes \$75 to \$150 a Week

"When I enrolled with you I didn't know the first thing about Electricity. But your lessons were so easy I advanced quickly — today I make \$75 to \$150 a week doing electrical work. I am sure glad to be a "Cooke" Trained Man."

— Emile Tokarz, Fort Grande Hotel, R. No. 206, Detroit, Mich.



Jumps from \$20 to \$60 a Week — and Just Started

"I used to work hard in a shop for only \$20 a week. Now I am a graduate of your wonderful school, and making \$55 to \$60 a week. And the beauty of it is that I am just starting. Your Training will make a Big-Pay Man out of anyone who will study your Course and follow your instructions."

— Theo Fedoronko, Trafford, Penna.

Thousands of Cooke Trained Men Earn \$3500 to \$10,000 a year

Be a "Cooke" Trained Man Yourself!

You want to make big money! You want to earn more than a mere \$20 or \$30 a week! Of course you do. Then get into Electricity, the field of big pay and bigger opportunities. I'll train you at home—in your spare time. You work just as you are working now—at your same old job. But you learn Electricity every day,

in an easy,
simple,unfor-
gettable way
—by doing.

And—

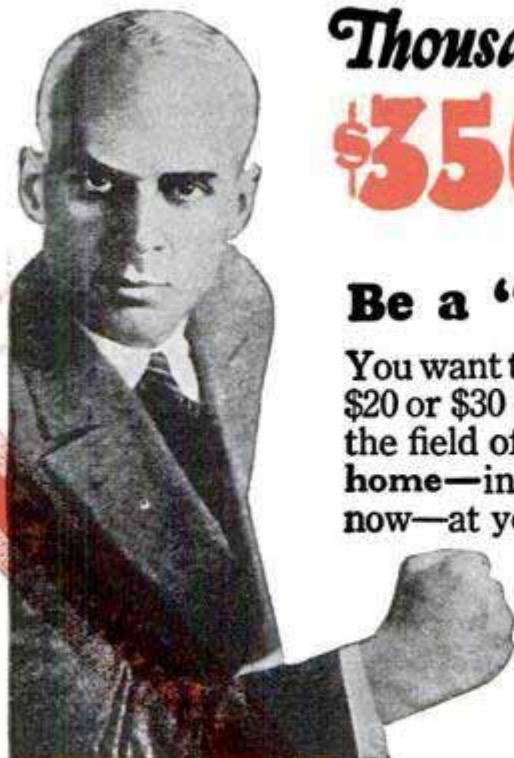

You Earn as You Learn!

That's the way I teach Electricity—so that you can make extra money as you go along. That's why my Course is Practical. That's why my students are successful. That's why the "Cooke trained man is the Big-Pay Man," everywhere, and always. \$40 a week is just an ordinary salary in Electricity. \$70 to \$200 a week is what thousands of Cooke Trained Men are earning.

Money Back if Not Satisfied

That's my Guarantee. And you're to be the judge and jury, all in one. If you're not satisfied you get your money back—every cent of it. And back of me in this Guarantee stands the Chicago Engineering Works, a \$2,000,000 Illinois Corporation.

Nothing Like "Cooke" Training

Don't confuse other Courses with mine. Don't be satisfied with anything but "Cooke" Training, the course with 10,000 boosters. There is nothing like it anywhere. It stands by itself—alone in this field. This is the Training that Electrical men are praising—the Training that Electrical concerns recommend to their employees, that the American Association of Engineers has endorsed 100% after a thorough investigation.

Before you select any Course, find out about "Cooke" Training with its 16 guaranteed features and its long record of proven success.

If You Are Earning Less Than \$70 a Week — Mail Coupon TODAY!

Don't wait a minute! Find out today why "The Cooke Trained Man is the Big-Pay Man" everywhere! Find out how Cooke Training will help you boost your pay! Mail the Coupon for my big book of proof, pictures and Pay-Raising FACTS. Do it NOW!

L. L. Cooke, Chief Engineer

Chicago Engineering Works, Inc.

Dept. 11 2150 Lawrence Ave., Chicago, Ill.

5 BIG OUTFITS to work with

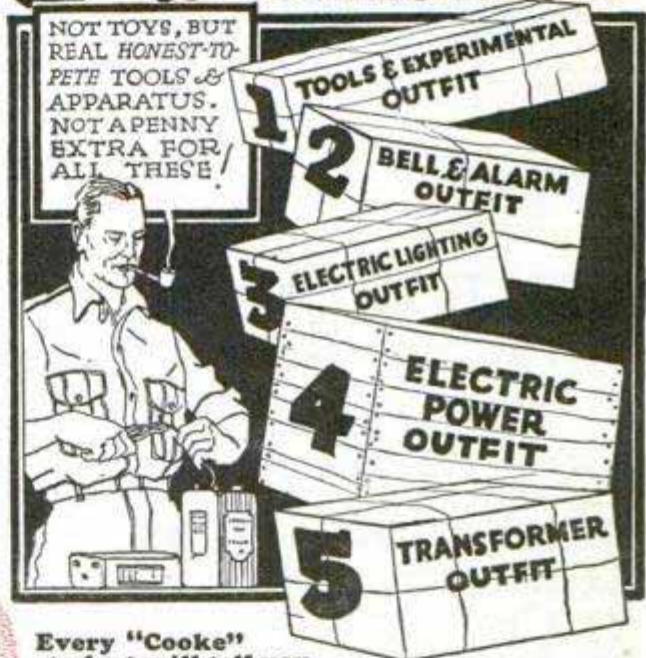

Every "Cooke" student will tell you he doesn't see how I can possibly afford to give so many wonderful and big outfits.

FREE BOOK COUPON

L. L. Cooke, Chief Engineer,
Chicago Engineering Works,
Dept. 11 2150 Lawrence
Avenue, Chicago, Illinois



The
VITAL
FACTS

Mr. Cooke:
I want to know why the "Cooke" trained man is the "Big Pay" man in Electricity. Send me your big FREE Book with other information. This does not obligate me in any way.

Name.....

Address.....

City..... State.....

This Tenor Banjo FREE

WORTH \$18



When You Enroll

This handsome full-size, professional tenor banjo is yours when you enroll. We want to make one thousand new friends this month. We want to present one of these wonderful, delightful instruments as a gift to each of one thousand readers of this magazine—and here's why. Before becoming a professor, and a lover of music, particularly the tenor banjo, Prof. Six yearned and yearned for the possession of a genuine, professional instrument, the same kind used by the big, successful professionals of the world. Now we want you to succeed. We want to help every music-lover that we can, attain success, and this gift offer is made to pave the way for you, and no previous musical knowledge is necessary.

We have another surprise for you! Not only do we start you on the way to popularity, success and fame by supplying you with an instrument that you can compare to any used or displayed in your town, but under personal supervision you will be given, by mail, the benefit of Professor Harry S. Six's twenty-two years' experience as director of Glee and Instrumental clubs of New York University. We don't just send you a lot of printed words and instructions and trust to luck that you will catch on. Our method is different and has proven to be the simplest devised by man—that is why we claim you'll be able to play in thirty minutes. Put us to the test.

Learn in 30 Minutes With My Picture Method

Arthur Brisbane, the highest paid journalist in the world, once said that "a single picture is worth a thousand words." He was right, for it stands to reason, when you take your instrument in hand along with the actual photographs of our professor in action as your guide, it is easy to imitate and do the right thing. But that is not all.



We also furnish as an additional guide, phonographic records of our professor playing the piece you are learning, along with our thorough, printed and illustrated, easy-to-read course.

Doesn't that sound easy? It is easy. If you could sit at our desk and see the letters and telegrams from our pupils you would be convinced that we have perfected the simplest, yet most highly efficient course to insure your mastery of the tenor banjo.

Don't Send a Single Cent

Investigate offer today. Don't put off until tomorrow, because you might forget and miss this wonderful opportunity. It might be the turning point in your career. Don't send a single cent. Just drop a line—use coupon or postal card will do—telling you are interested in receiving full particulars about course and to reserve one regular eighteen dollar, full size professional tenor banjo for you, which is offered as a gift.

Act quickly, because there may not be enough gift banjos to go around for the million or more readers of Popular Mechanics. This does not obligate you in any way. Therefore, do not hesitate—put in your reservation now, this very minute. You will soon join our happy army of enthusiastic finished tenor banjo musicians.

EARN BIG MONEY

Hundreds have started orchestras and are making money.

FREE BANJO COUPON

New York Academy of Music
Studio 11-100 Fifth Ave., New York

Please rush all free information relative to your Tenor Banjo Course and reserve a gift banjo for me. This obligates me in no way whatever.

Name.....

Address.....

City..... State.....

YOU CAN OIL PAINT

TALENT NOT REQUIRED—ANYONE CAN LEARN!

It's amazing how quickly our new method enables men and women to actually oil paint with ease and professional skill—even after the first lesson. Nothing difficult or tiresome to master. You begin to oil paint photos, portraits, landscapes or any art subject at once and earn real money. One student writes she earned the entire cost of the course in less than a week after completing the second lesson. You can do it, too. Our business methods show you how.

EARN \$18.00 TO \$50.00 OR MORE A WEEK AT HOME

Demand for color art work is growing daily. Graduates everywhere tell us they are unable to keep up with orders. Learn more about this fascinating profession. Ask for our free illustrated booklet. It tells all about the course and free working outfit. Remember, no talent is required. You, too, can learn. So write today.

Victorial Art Studios, 2731 N. Clark St., Dept. M.P., Chicago

LEARN RADIO FREE

STUDY IN SPARE TIME AT HOME
Earn a Diploma in Radio Engineering. Free Twin Superdon Set offer if you act now.
Write
AMERICAN RADIO ENGINEERS
Dept. 225, Hearst Sq., Chicago, U. S. A.

FREE

"STRENGTH MAGAZINE"

SEND IN YOUR NAME AND ADDRESS

Get a copy of this Great Health and Body-Beautiful Magazine Free of Charge or Obligation. It is full of interesting and healthful reading matter and is lavishly illustrated with pictures of well-developed men and beautiful, well-formed women. Send NOW. STRENGTH MAGAZINE, 2747 N. Palethorp St., Dept. PM. 1-26, Philadelphia, Pa.



BIG VALUE FOR 10 CTS.

6 songs, words and music; 25 Pictures Pretty Girls; 40 Ways to Make Money; 1 Joke Book; 1 Book on Love; 1 Magic Book; 1 Book Letter Writing; 1 Dream Book and Fortune Teller; 1 Cook Book; 1 Base Ball Book, gives rules for games; 1 Toy Maker Book; Language of Flowers; 1 Morse Telegraph Alphabet; 12 Chemical Experiments; Magic Age Table; Great North Pole Game; 100 Conundrums; 3 Puzzles; 12 Games; 30 Verses for Autograph Albums. All the above by mail for 10 cents, and 2 cents postage.

ROYAL SALES CO., Desk 146, Norwalk, Conn.

A Great Book Free with this pay-raising library

For a short time only we will give every subscriber to the New Library of Machine Shop Practice a copy of French's Engineering Drawing—the greatest book on mechanical drawing ever written. This book makes drawing as plain as day—tells you all about instruments, plans and methods—and prepares you to handle any drawing job you will ever have to do. It comes to you absolutely free with

Machine Shop Practice

9 volumes — 3065 pages — 3608 illustrations
(A combined home study course and reference library)

The New Machine Shop Library is written for practical men. It gives you the best methods for every kind of machine shop work. It explains machine tools and their operation, drawing and design, tool work, gears and grinding, jigs and fixtures, automatic screw machines and their tools and all of the mathematics you will ever have to use. It is plainly written, completely illustrated—the very best kind of help to the machine shop man who wants to advance himself.

Sent FREE



No money down—only 7c a day

FREE EXAMINATION COUPON

McGraw-Hill Book Co., Inc., 370 Seventh Ave., New York

Send me for 10 days' free examination the New Library of Machine Shop Practice. If satisfactory I will send you \$1.50 in 10 days and \$2.00 monthly until the special price of \$19.50 is paid. If not wanted, I will return the books at your expense.

On receipt of my first payment of \$1.50 it is understood that I am to receive, free of charge, a copy of the second edition of French's Engineering Drawing.

Signed.....

Address.....

City and State.....

Position.....

Employer..... P.M. 1-1-26

If you want a job while training, I'll help get you one. Come to my big schools at Chicago, Cleveland, Detroit or Boston



This Dental Laboratory Expert earns \$20 a day!

What's the use of training for the old, overcrowded trades? If you're going to prepare for big-salaried jobs or a profitable business of your own GET INTO THE NEWEST PROFESSION — "Laboratory Dentistry." Biggest opportunity for success of the century, because there are ten times as many jobs as men to fill them, because there are a dozen cities crying for Laboratories for each EXPERT capable of operating one!

Easiest, pleasantest work you ever saw! Your own boss, money and success yours from the very beginning. You can start with a "shoe-string." We prepare you in a few months to run a business of your own, to do any job. Common schooling, ability to use your fingers ALL YOU NEED! Free R. R. Fare to Chicago, Cleveland, Detroit or Boston for a limited time!

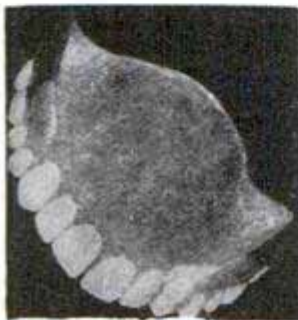

Jobs at \$60 to \$125 a Week!

In a business where there are many times as many jobs as Experts, salaries are high, hours are easy, opportunities are everywhere! McCarrie-trained Graduates always get the preference—Dentists everywhere recognize the high-standing of our graduates. No books here—learn with tools and instruments. Start quick—get ready in a few months for your big opportunity! *Mail Coupon today!*

RUBBER PLATES

Learn to make partial upper or lower plates with soldered, cast or wire clasps, with palatal bars; with lingual bars. McCarrie-trained Students learn to make full rubber plates of every type, including Vulcanite base-plates, butted gums, carved gums, etc.

CROWNS

Here's only a small part of your practical training in Crown-work: Two-piece, seamless, open-face, Richmond, cast-base porcelain, Carmichael, split-pin, carved (swaged) cusp, cast cusp, etc.

BRIDGE WORK

Complete training in both fixed and removable bridge-work. Interchangeable teeth, gold dummy, Sanitary, porcelain dummy jobs—Roach, Gilmore, Bischoff and all forms of cast-clasp work is taught—not with books but in actual Laboratory.

METAL BASE DENTURES

Cast bases of Aluminum, gold, Watt's metal, etc., are included in your training. Both centrifugal and air pressure casting machines are used. Free Catalog contains complete list of subjects in course.

FREE!
R. R. Fare
TO
**Chicago
Cleveland
OR
Detroit**

70,000 DENTISTS NEED LABORATORY WORK!

Only a few hundred Laboratories in all the U. S.—most of them in Chicago and New York. Dentists can't afford to do their own mechanical jobs. They can buy the services of a Laboratory Expert at \$3.00 an hour and sell their own time at \$6 to \$15 an hour. Dentists will encourage you to learn mechanical work, start a "Lab" of your own, give them quicker service than sending to Chicago or New York. Dentists can't wait and keep their patients waiting.

WE HELP YOU OPEN A LABORATORY OF YOUR OWN!

Many of my graduates open a Laboratory of their own. To encourage more men to go into this wonderful profession, we will help you find a good location for your Laboratory, and help you make a success of it. Write for complete information on how you can find yourself in a profitable business of your own after you become a Dental Laboratory Expert.

INTERESTING CATALOG—FREE!

Right this minute there are openings for 150 Dental Laboratory Experts in locations where they can do a business of \$5,000 to \$20,000 a year. But you can't cash in, take advantage of these OPPORTUNITIES until you're trained. Catalog tells you how quickly and easily you can get ready, how hundreds of others have SUCCEEDED! Tells you how you learn in a few months BY DOING ACTUAL LABORATORY JOBS under one of the world's greatest Mechanical Dentists! Brings you FREE R. R. Fare offer and other big inducements. Write for free Catalog today!

EARN while you LEARN!

Day students make all or part cost of course by part-time night work. Night students can find plenty of good jobs to see them thru. We'll help you!

McCarrie School of Mechanical Dentistry

1338 S. Michigan Ave. Dept. 3001-A Chicago, Ill.

McCarrie School of Mechanical Dentistry,

1338 S. Michigan Ave. Dept. 3001-A, Chicago, Ill.

Without obligation, please send me your Free R. R. fare offer and free catalog with complete information about how I may become a Dental Laboratory EXPERT. How you will help me open a Laboratory, how you will help me find a job while I take my training, etc.

Name.....

St. No. or R. F. D.....

City..... State.....

A Better Job Now or—

Earn \$70 A Week and More

Why take small pay from uncertain jobs? Why be knocked around from this to that, and not know whether you are going to have a job tomorrow or not? You can change all that. Learn a good trade. Know autos—how to repair them, and take advantage of the countless opportunities to make money. Pave the way for a business of your own—a business that can make you independent for life. You can do it with a few weeks' training at the Michigan State Automobile School—the great auto-trade school in the heart of the auto industry.

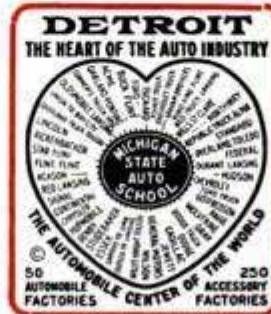

You Can Earn More Money

Skilled auto men are wanted everywhere at good pay. Service managers tell us that **100,000 more trained auto men are needed every year.** They don't get a tenth of that number now. Here is your supreme chance to get out of the rut of poor pay. 18 million cars now, and three or four million more new ones every year. Think of it! Come to Detroit, the heart of this great business. Study autos where they are made.

LEARN IN A FEW WEEKS—START NOW



Levite O. Cyr, Madawaska, Maine, earns \$9.00 to \$10.00 a day as Auto Electrician and expert mechanic. He was a common laborer before taking "Michigan State" Training.

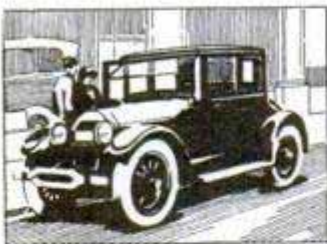

Martin Vander Bie, Holland, Michigan, makes a big success selling cars, and now is partner in a \$150,000 business.



J. R. Navarre, Carrollton, Ohio, formerly day laborer, now earns \$250.00 a month as foreman of Dodge Service Garage.

A thorough training in Detroit at the "Michigan State," fattens your pay envelope if you are working for others, or puts more profit in business for yourself. You can take a full Automotive Course in 12 weeks, or our big Master Course in 30 weeks. Or specialize in any of its money-making branches; you can be an Auto Electrician, a Battery Man, Welder or Machinist. Jobs for all these men are offered to us daily. Free Course in Business, Garage Management and Selling given to all our students. Classes always open.

Work With Real Tools

And learn to use them right. You must have expert training to get the good pay jobs. We train you with tools. You learn from practice, how cars are made and how to repair them. You have head training as well as hand training. The man whose hands only are trained, fails when he hits the hard jobs. There are no hard jobs for Michigan State trained men, for they have the knowledge in their heads to guide the skill in their hands.

Complete Equipment—Expert Instructors

Here you learn on up-to-date, new equipment. All types of cars, engines, axles, transmissions, electrical systems. New Packard Straight Eight with four wheel brakes, Packard Twin Six, New Buick with four wheel brakes, Oakland (four wheel brakes), Cadillac Eight, Reo, Jewett, Oldsmobile, G. M. C. Truck, Hudson, Overland, many others. Each instructor is a master in his line. Their knowledge fits you for success.

L. O. Beyer, Idaho, writes us: "Your training has paid me bigger dividends than any money I ever spent. My business now runs \$22,000 per year."



You get practical shop training at the "Michigan State" in Detroit, the Auto Center. The knowledge we put in your head guides the skill we put in your hands. P. F. Peterson, Chicago, writes, "I'm employed at a service station here in charge of all electrical work, repairing generators and starting motors".

No Experience Required

Whether you have auto experience or not, makes no difference. Green men get this training and start at once in better jobs, soon advance to have their own business, make big money. Men who have experience also say this training puts them way ahead of other men, into the big pay class at once, saves them years of dirty work. In just a few weeks, if you start now, you can be doing work you like and earning this bigger pay!

NO EDUCATION NEEDED EITHER. It just takes common sense, to learn by the practical methods we teach you. R. L. Beck (Pa.), says, "In two years my wages were increased 300%."

MICHIGAN STATE

301 Auto Building Detroit, Michigan

Learn Autos Where Autos Are Made

A Business of your Own!

Trained Auto Men Are Wanted

"Michigan State" graduates are making money in every corner of the world. 20,000 graduates. 700 students here now. Come to Detroit, a fine city. Big business, pleasant climate all year round.

Auto Business Leads

Autos are increasing faster than repair shops or mechanics can keep up with them. The auto industry now leads all industries in value of production. There are more autos than telephones. 269 cars to every service station. This shows as plain as A-B-C where the big chance is today.

**18,000,000
Automobiles in U.S.**

**One Car to Every
6 People**

**269 Cars to Every
Repair Shop**

**Thousands more Trained
Men are Needed**

Send for Photogravure Book

If you want to earn more, cut out the coupon at the bottom of this page and mail it today. We'll tell you how to start. Also send you a handsome new illustrated book about Detroit. You ought to know about this great city, which has jumped to fourth in size in a few years. Read about how our graduates earn up to \$200 a week. They tell you in their own words. Get these facts now, for they may mean a wonderful difference in your own life. Don't wait. Fill in the coupon and mail it now.



John Grahek, Chisholm, Minn., averages \$425.00 a month profit in his small town repair shop.



Ben Koehler, Pulaski, Wis., made \$10,000 his first year in business, with a garage and Ford Agency.

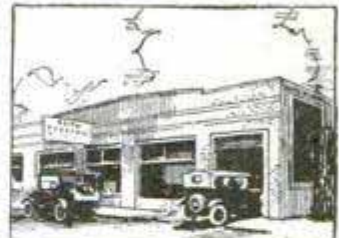

J. I. Moyes, Barnes, Kansas, makes a good salary for himself and saves \$100.00 a month extra, from his Auto Electric Service business.

Read What Factories Say:

THE STUDEBAKER CORPORATION OF AMERICA

"We do not know of a better automobile school than the MICHIGAN STATE."

HUDSON MOTOR CAR COMPANY

DETROIT, MICH. U.S.A.

"This school is thought very highly of by the automobile men of Detroit, and is considered one of the best equipped and most efficient schools in the country. You will make no mistake in attending the M. S. A. S."

DODGE BROTHERS INCORPORATED

DETROIT, U.S.A.

"We believe the Michigan State Automobile School of this city to be an exceptionally high class school, and no doubt a diploma from this school would assist materially in obtaining employment with high class automobile dealers."

PACKARD MOTOR CAR CO., DETROIT

"We do not believe you would make any mistake in attending this school if you wish to become thoroughly experienced in the automobile business."



BUICK MOTOR COMPANY

"We believe the MICHIGAN STATE AUTO SCHOOL, Detroit, would best meet your requirements, as its course in technical training is most thorough and complete in every detail."

Come to Detroit

Of course Detroit is the place to learn autos. Stick this in your memory—the Detroit trained man has an immense advantage over all others. So come here as soon as you can. Come now if possible. But even if you can't come right now, you can start anyway, to get ahead in the world! The great Success-training of this world-famous "Michigan State Automobile School" can be brought to you at home. You can start to learn under our Home Study Plan. (This does not cost anything extra.) It will help you to get a garage job right away. Then plan to come here to School later to finish in thorough "Detroit training."

Earn While You Learn if Necessary

Or come to Detroit and work your way. Some students work evenings to pay their expenses. Others work days and take our evening classes.

Free Management Course

Through our close co-operation with the auto factories in Detroit, we secure one of the leading service managers to train our students in the business end of running a garage. This training is worth \$100 alone. But it costs you nothing extra. It is just another one of the big advantages of Michigan State training. All students get this free Business Course.



A class of 600 students in front of the M. S. A. S. Main Building

AUTOMOBILE SCHOOL

3729 Woodward Avenue Detroit, Michigan

The Factory Endorsed School

Mail Coupon To-day

Michigan State Automobile School 301 Auto Building
DETROIT, MICH.

Send me free and without obligation complete information about Detroit-training to make the most money, also photogravure book on Detroit, "Auto School News", Chart of your courses, and hundreds of your Graduates' letters.

Name.....

St. and No. or R. F. D.....

City..... State.....

I am interested in 12 Weeks' Auto Course.
 30 Weeks' Master Course.
 Home Study Course.



\$95 an Hour!

"Every hour I spent on my I. C. S. Course has been worth \$95 to me! My position, my \$5,000 a year income, my home, my family's happiness—I owe it all to my spare-time training with the International Correspondence Schools!"

Every mail brings letters from some of the thousands of I. C. S. students telling of promotions or increases in salary as the rewards of spare-time study.

What are you doing with the hours after supper? Can you afford to let them slip by unimproved when you can easily make them mean so much? One hour a day spent with the I. C. S. will prepare you for the position you want in the work you like best. Yes, it will! Put it up to us to prove it. Mark and mail this coupon now!

INTERNATIONAL CORRESPONDENCE SCHOOLS
Box 5549-E, Scranton, Penna.

Without cost or obligation, please tell me how I can qualify for the position or in the subject before which I have marked an X:

BUSINESS TRAINING COURSES

- | | |
|--|---|
| <input type="checkbox"/> Business Management | <input type="checkbox"/> Salesmanship |
| <input type="checkbox"/> Industrial Management | <input type="checkbox"/> Advertising |
| <input type="checkbox"/> Personnel Organization | <input type="checkbox"/> Better Letters |
| <input type="checkbox"/> Traffic Management | <input type="checkbox"/> Show Card Lettering |
| <input type="checkbox"/> Business Law | <input type="checkbox"/> Stenography and Typing |
| <input type="checkbox"/> Banking and Banking Law | <input type="checkbox"/> Business English |
| <input type="checkbox"/> Accountancy (including C.P.A.) | <input type="checkbox"/> Civil Service |
| <input type="checkbox"/> Nicholson Cost Accounting | <input type="checkbox"/> Railway Mail Clerk |
| <input type="checkbox"/> Bookkeeping | <input type="checkbox"/> Common School Subjects |
| <input type="checkbox"/> Private Secretary | <input type="checkbox"/> High School Subjects |
| <input type="checkbox"/> Spanish <input type="checkbox"/> French | <input type="checkbox"/> Illustrating <input type="checkbox"/> Cartooning |

TECHNICAL AND INDUSTRIAL COURSES

- | | |
|---|--|
| <input type="checkbox"/> Electrical Engineering | <input type="checkbox"/> Architect |
| <input type="checkbox"/> Electric Lighting | <input type="checkbox"/> Architects' Blue Prints |
| <input type="checkbox"/> Mechanical Engineer | <input type="checkbox"/> Contractor and Builder |
| <input type="checkbox"/> Mechanical Draftsman | <input type="checkbox"/> Architectural Draftsman |
| <input type="checkbox"/> Machine Shop Practice | <input type="checkbox"/> Concrete Builder |
| <input type="checkbox"/> Railroad Positions | <input type="checkbox"/> Structural Engineer |
| <input type="checkbox"/> Gas Engine Operating | <input type="checkbox"/> Chemistry <input type="checkbox"/> Pharmacy |
| <input type="checkbox"/> Civil Engineer | <input type="checkbox"/> Automobile Work |
| <input type="checkbox"/> Surveying and Mapping | <input type="checkbox"/> Airplane Engines |
| <input type="checkbox"/> Metallurgy | <input type="checkbox"/> Navigation |
| <input type="checkbox"/> Steam Engineering | <input type="checkbox"/> Agriculture and Poultry |
| <input type="checkbox"/> Radio | <input type="checkbox"/> Mathematics |

Name.....
Street.....
Address..... 3-6-24
City..... State.....

Occupation.....
Persons residing in Canada should send this coupon to the International Correspondence Schools Canadian, Limited, Montreal, Canada.

I Pay You While You Learn!

Write immediately for my sensational profit-sharing plan. Let me tell you about my offer to pay you for your work while still a student. Individual, personal instruction makes you an Expert quick. My graduates are successful and in demand.



No books, no classes here. All practical work on actual watch jobs.

Be an Expert Watchmaker!

Good jobs everywhere for Experts! In my big Chicago School you can learn watchmaking better in a few months than by the old apprentice system in years! 9 successful Jewelers out of every 10 started as watchmakers—so here is your chance to win money and success in the jewelry business!

\$55 TO \$90 A WEEK!

You never see a Trained watch expert out of a job. Get my training and say goodbye to small pay, unemployment and hard times. I will help you find a spare time job while training and an Expert's job and pay when you graduate. For a limited time I give every student Free courses in Jewelry Repairing, Man's and Engraving.

THOMAS SWEAZEY, Principal,
Chicago School of Watchmaking,
Dep't. 1201
4844 Lincoln Ave., CHICAGO

FREE

Complete watchmaker's outfit given free to every student this month. Write immediately for catalog and profit-sharing offer.

Learn Furcraft

Learn by mail, evenings at home. Make up New Furs and Make Old Furs Like New. Learn Fur Repairing and Cleaning. Learn our secret processes. Learn glazing, ironing and storage. Big demand, big need in every neighborhood. A wonderful uncrowded field. Investigate.



\$3 an Hour!
In Your Spare Time



or a real business now and later a big fur shop. Next month earnings start if you learn now. Men and women equally successful. Tells all about this greatest of Spare Time Money Makers. Big opportunity now in your neighborhood. Be first. Send at once for Free Book and get full details of this money making business. No obligation. Write today.
NORTHWESTERN FUR COMPANY
1771 Sunderland Building, Omaha, Nebr.

Delivered to You Free

for 30 days trial on approval. You can have your choice of 44 Styles, colors and sizes of the famous RANGER Bicycles. Express prepaid. Factory-to-Rider Prices save you \$10 to \$25 on your bicycle.

\$5 a Month if desired. Many boys and girls easily save the small monthly payments. Parents often advance first payment.

best quality, at factory prices, express prepaid. Tires, Lamps, wheels and equipment, low prices. Send No Money, do business direct with makers.

Mead CYCLE COMPANY
DEPT. 109 CHICAGO

Write today for free Ranger Catalog, factory prices and marvelous easy payment terms



CAN YOU DRAW?

"MONEY HUNCHES FOR THOSE WHO DRAW"—just the book you need! Contains practical plans to help artists sell work. Send \$1.00 for copy or stamp for particulars. NOVEL ART STUDIOS (Dept. P1), 7 E. 42nd St., N. Y. C.



BIG NOVELTY BARGAIN! 10c

Throw Your VOICE
Into a trunk, under the bed or anywhere. Lots of fun fooling the Teacher, Policeman or Friends. Barrels of Fun.

THE VENTRILO—
a little instrument—fits in the mouth out of sight, used with above for Bird Calls, etc. Sent with full instructions; anyone can use it. NEVER FAILS. Also a 32-PAGE BOOK ON VENTRILOQUISM. Formula for Secret Writing, 12 Money Making Secrets and the marvelous

NOVELTY X-RAY WONDER
With it you can apparently see the bones in your fingers, lead in pencil, etc.; lots of fun with this outfit. Also 10 Big Magic Tricks Free with every order. All the above Novelties for 10c by prepaid mail for

Ventrilo Company, Dept. 324, Norwalk, Conn.
LARGEST and OLDEST Mail Order House in Connecticut

It stands to reason: There is no substitute for personal, practical training in great shops

Student Winding Stator in the Great Shops of COYNE



Earn While You Learn at COYNE

My well-organized EMPLOYMENT DEPARTMENT helps you to get a job to earn part or all of your expenses while training at COYNE and assists you to a good job on graduation. Furthermore, it stands by you THROUGH LIFE without a penny of extra cost to you.

ELECTRICITY

Start any day of the year at COYNE. No classes, semesters or seasons.

- Pays \$60 to \$200 a Week to Hundreds of COYNE-Trained Men!

SPEND 12 HAPPY WEEKS AT COYNE, THEN STEP INTO THE BIG-PAY CLASS!

We get right down to brass tacks the day you arrive at COYNE, and get you started on the road to Big Pay and Real Independence and Happiness. Our method of training is so fascinating and simple that you will be delighted with it. We don't waste your time on useless theories. Instead, you work on big, wonderful equipment with your own hands, so that you will know Electrical work like a veteran after 12 thrilling, joyous weeks!



H. C. LEWIS, President, Coyne Electrical School

Don't Let Lack of Education or Experience Hold You Back!

COYNE has taught Electricity for 27 years. That's why so many men who never before had the slightest knowledge of Electricity, have become REAL ELECTRICAL EXPERTS at BIG PAY as a result of taking my complete course.

Be Sure to Get the Coupon in the Mail Today!

COYNE

ELECTRICAL SCHOOL

H. C. LEWIS, President

Established 1899

1300-10 W. Harrison St., Dept. 9351, Chicago, Ill.

Not a Correspondence Course; All Practical, Personal Training in Great Shops



At COYNE You Train On Real Equipment

I can't begin to tell you in this limited space of how COYNE Electrical Training has, in hundreds of instances, made big, outstanding successes of men who before had known nothing but failure and despair. I want YOU to enjoy the same glorious success and happiness that other COYNE graduates are enjoying. You can do it if you set your mind and your heart to the task! Make your relatives and friends proud of you!

COYNE SPECIALIZES IN ELECTRICAL TRAINING

I teach only ONE SUBJECT here at COYNE. That subject is ELECTRICITY, and I teach it THOROUGHLY — from A to Z!

My Big FREE BOOK Will Open Your Eyes Wide to the Amazing Opportunities in the Electrical Field!

Don't let another minute pass by without sending the Coupon below for your Absolutely Free Copy of my big, wonderful Electrical Book! The attractiveness and completeness of my book will astonish you, and will show you the true way to Big Pay and Fascinating, Steady Work! I won't charge you a penny for this amazing volume! For a limited time only I am including, with each enrollment, my Special Courses in Radio Electricity and Auto, Truck and Tractor Electricity, without extra cost.

SEND THIS COUPON NOW

H. C. Lewis, President Coyne Electrical School, 1300-10 W. Harrison St., Dept. 9351, Chicago, Illinois.

Dear H. C.—I'm an ambitious fellow and want to lead a happy, successful life. Send me one of the FREE copies of your Big Electrical Book which tells how others have made big money in Electricity. Also tell me about Special Offer of Two Extra Courses.

Name.....

Address.....

Daring

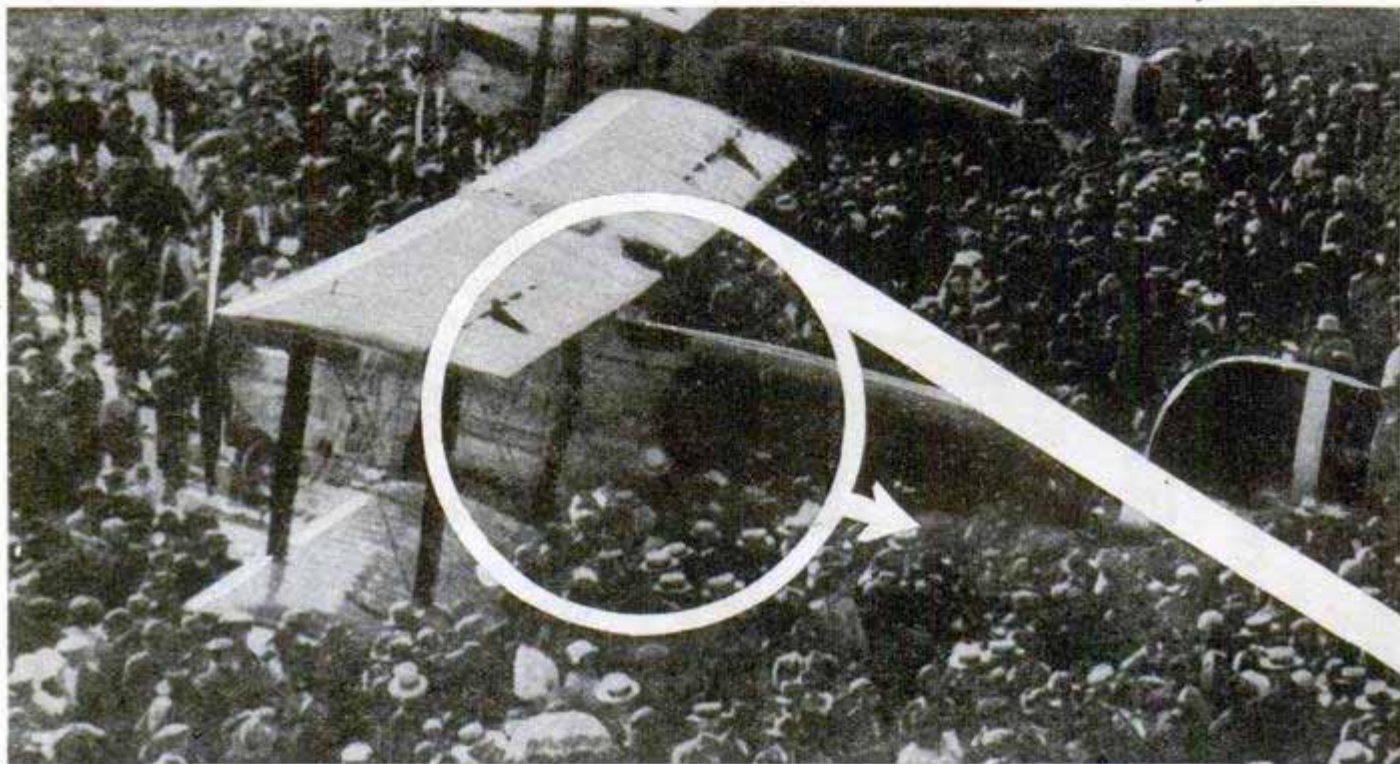

Aviation Experts in Big Demand!

Big Money—Popularity—Thrills! That's What This Fascinating New Profession Offers You! Right Now Aviation Experts Are in Big Demand. Here's an Amazingly Quick, New, Easy Way to Qualify, for One of These Jobs That Will Pay \$4,000—\$10,000 A Year!—Right in Your Own Home in Spare Hours.

BIG, vivid, virile—Aviation offers courageous young men the most astonishing opportunity in America today! Training in this fascinating work pays big rewards in excitement, adventure and popularity, as well as sensational money. Just imagine yourself directing the destinies of air-pilots and being pointed out by your friends as an Aviation Expert!

Never were the opportunities in this thrilling profession greater than at this moment. Aviation is still in its infancy. It stands today where the automobile industry stood 25 years ago. Its de-

velopment will create vast opportunities as surely as the automobile business made millionaires out of Henry Ford, and the Dodge Bros.! The big thing is to get in on the ground floor—right now while the field is new and uncrowded.

Get into this great, thrilling profession now—before the world at large wakes up to its amazing possibilities. Get your share of the tremendous sums that are going to be paid to Aviation Experts within the next few years. The field is opening up bigger every day. Act quickly or this surprising opportunity will slip out of your grasp before you know it.

Young Men Needed in Aviation

Easy To Become An Aviation Expert— \$75-\$400 Weekly

Now—you can quickly train for one of these exciting, highly paid jobs through a new, sure, easy method of basic training. The study of Aviation is almost as fascinating as the actual work itself. That's what makes it so easy to learn. Every Lesson sent you is packed full of vital interest. You get so absorbed that you actually forget you are studying—it doesn't seem like work at all—and once you start, you simply can't get enough of it. You'll hardly be able to wait until you, too, can begin playing your part in America's great conquest of the air.

Students Learn Quickly From Experienced Men

Only an hour of spare time a day will give you the basic training in a surprisingly short time. One student, S. F. McNaughton, Chicago, says: "Your lessons are like a romance, and what is more, after one reading, the student gets a thorough under-

standing. One never tires of reading them." James Powers, of Pennsylvania, writes: "I am indeed surprised that such a valuable course can be had from such practical men at so little cost."

That's the secret of the success of the American-trained student. They learn from practical skilled men who know the flying game from A to Z. These experts guide you carefully through your training, step by step. They select your lessons, blue prints, bulletins, etc. They give you all the inside facts and details that are essential to your success. Every lesson is clearly explained and easy to understand—and they are always glad to answer special questions and help you in every way possible.

Send for Big FREE Book on Aviation

Send the coupon below for new, free book just out "Opportunities in the Airplane Industry." It is vitally interesting, reads like a romance and will tell you things about this amazing profession that you never even dreamed of. This book is so gripping, so brimful of astonishing facts that it could easily sell for a dollar. We are offering a limited number free. Get yours before the edition is exhausted. Write today.



AMERICAN SCHOOL OF AVIATION Dept. 1351, 3601 Michigan Ave., Chicago, Ill.



Aeroplane
Inspector
\$75 a Week

Aeronautical
Engineer
\$300 a Week

Aeronautical
Instructor
\$150 a Week

Aeroplane
Builders
\$200 a Week

Qualify for one of these big pay jobs—the Aviation Industry will be waiting for trained men to fill them.

Aeronautical Instructor	\$60 to \$150 per week
Aeronautical Engineer	\$100 to \$300 per week
Aeronautical Contractor	Unlimited Profits
Aeroplane Repairman	\$60 to \$75 per week
Aeroplane Mechanician	\$40 to \$60 per week
Aeroplane Inspector	\$50 to \$75 per week
Aeroplane Assembly	\$40 to \$65 per week
Aeroplane Builders	\$75 to \$200 per week

These are just a few of the amazing opportunities that aviation will offer to young men of daring and foresight.

MAIL THIS TODAY

American School of Aviation,
Dept. 1351, 3601 Michigan Ave.,
Chicago, Ill.

Without any obligation, please send me Free book "Opportunities in the Airplane Industry," also information about your Course in Practical Aviation.

Name

Address

City..... State.....

Hawaiian Guitar FREE

Worth
\$18

When You Enroll

This Hawaiian Guitar expert and professor wants the opportunity to welcome you as a student so you will quickly learn how to play a Hawaiian Guitar—yes, you will be able to play just like the native Hawaiians. To get you started and help your musical success, which will bring you popularity, you will receive a beautiful Hawaiian Guitar, the same as the one pictured, free when you enroll. Our short cut method of instruction will enable you to play a piece almost from the first lesson. Rush coupon for full particulars today and we will reserve a gift Hawaiian Guitar for you.



Play Quickly

With our short cut method of instruction you will quickly learn how to play Hawaiian Guitar, which will bring you popularity and social success. You learn to play from notes. If you never had any musical training, you will quickly get on, because our nine experts have perfected a course of home instruction which is as simple as learning A, B, C's.

Picture and Phonograph Record Method Easy

We don't depend upon printed lessons only for your success, but we also furnish pictures of our professors playing, diagrams, charts and phonograph records for each lesson. This practically brings our professors from our studio to your own home and enables you to listen to their playing just as if they were actually in front of you. To prove this is easy, we will send you your first lesson free. Rush coupon now.

HAWAIIAN STUDIO No. 521
of New York Academy of Music
100 Fifth Avenue, New York, N. Y.

Please rush your Free book, "How to Learn Hawaiian Guitar," and my first free lesson. Also reserve a gift Hawaiian Guitar for me. This obligates me in no way whatever.

Name

Address

City..... State.....

ELECTRICITY

FREE BOOK
Send for it

LEARN in 12 WEEKS

Prepare for a good paying position in 12 weeks. Salaries from \$10 to \$25 a day not uncommon for Finlay trained men. Finlay Condensed Method, now in 23rd successful year, trains head and hand, combining practical shop work and intensive study. In 12 weeks we teach you HOW and WHY. Thousands of successful men have taken this short road to long pay. You have the same opportunity.

EARN \$10 to \$25 a DAY

Send for Finlay Catalog and full details on 12 weeks' course in Practical Electricity. Thousands of positions open. Enroll any time. Completely equipped shops and laboratories. Faculty of highly trained experts. Certificates awarded. Students assisted to positions. Success is calling you NOW. Write today and get the facts.



FINLAY
ENGINEERING COLLEGE
103 FINLAY BLDG., KANSAS CITY, MO.



FREE PROOF
You Can Make
\$25.00 a Week
In Spare Time

LET us show you how you too can earn big money in spare time making show cards for retail merchants, wholesalers and manufacturers. No talent needed. Tremendous demand. Marvelous new method makes it amazingly simple to learn at home. Act quick for special free offer. Send for Illustrated Free Book for full details. Address post-card now to

Washington Show Card School

Room 301-D

1115—15th St. N. W. WASHINGTON, D. C.

TELEGRAPH—RADIO

\$18 to \$35 a week while training for Radio and Telegraph Operator jobs at \$150 to \$300 per month. Write for particulars.

CHICAGO TELEGRAPH INSTITUTE

Dept. 1501 1338 S. Michigan Avenue, CHICAGO

Learn Watchwork, Jewelrywork and Engraving

A fine trade commanding a good salary, and your services always in demand. Address Horological, Dept. P, Bradley Institute, PEORIA, ILLINOIS, for our latest catalog.

LEARN SPANISH on your phonograph

Learn to speak Spanish as if you were living in Spain. Records fit any phonograph. New Conversational Method evolved in Europe and introduced in America by the I. C. S. School of Languages. Endorsed by the Spanish Embassy.



Write to-day for descriptive literature.

International Correspondence Schools, Box 5551-E, Scranton, Penna.

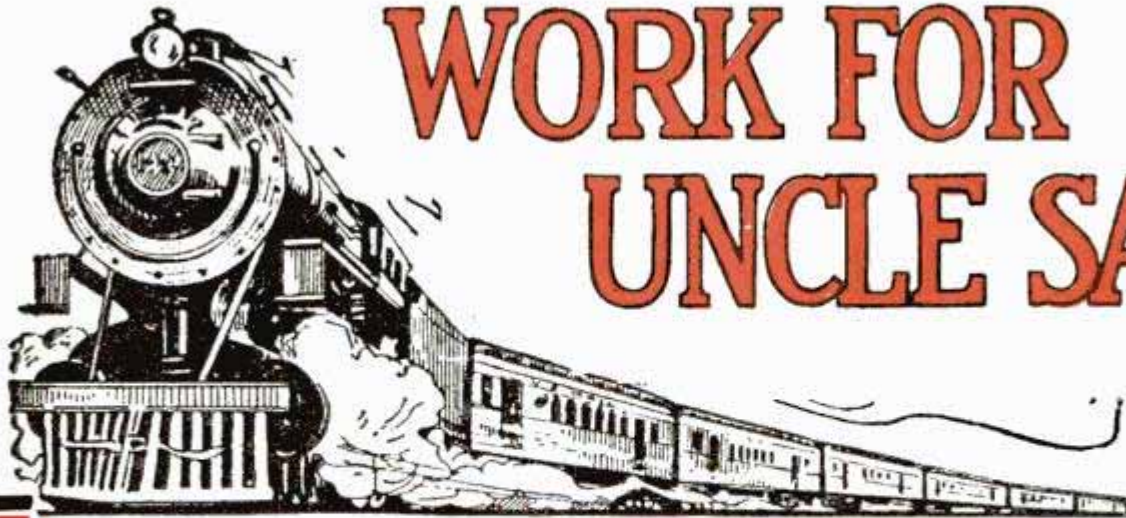

WORK FOR UNCLE SAM

TRAVEL ON GOVERNMENT PAY

Commence \$158 Month

Raise to \$225 Month

Many other U. S. Government Jobs open to Men and Boys 18 up

**Postoffice Clerks
Income Tax Auditors**

**City Mail Carriers
Clerks at Washington, D. C.**

Steady positions. Strikes, poor business conditions, lockouts or politics do not affect them. U. S. Government employees get their pay for full twelve months every year. There is no such thing as "HARD TIMES" in the U. S. Government Service.

RAILWAY POSTAL CLERKS

Railway Postal Clerks now get \$1900 the first year, being paid on the first and fifteenth of each month. \$79.16 each pay day. Their pay is increased to a maximum of \$2700 a year. \$112.50 each pay day. They get extra allowance for hotel expenses when away from home.

PAID VACATIONS

Railway Postal Clerks, like all Government employees, are given a yearly vacation of 15 working days (about 18 days). When on runs they usually work 3 days and have 3 days off duty or in the same proportion. During this off duty and vacation, their pay continues just as though they were working. When they grow old, they are retired with a pension. As Railway Postal Clerks are continually traveling, they have an excellent chance to see the country. They are furnished with a railroad pass.

City Mail Carriers—Post Office Clerks

Clerks and Carriers commence at \$1700 a year and automatically increase \$100 a year to \$2100 with further increase to \$2300. They also have 15 days vacation. Examinations are frequently held in the larger cities. City residence is unnecessary.

What Will You Earn 5 Years From Now?

Compare these conditions with your present or your prospective condition, perhaps changing positions frequently, kicking around from post to pillar, no chance in sight for PERMANENT employment; frequently out of a position and the year's average salary very low. DO YOU EARN \$1900 EVERY YEAR? HAVE YOU ANY ASSURANCE THAT A FEW YEARS FROM NOW YOU WILL GET \$2700 OR MORE A YEAR, EVERY YEAR?

Get Free List of Positions

Fill out the coupon. Tear it off and mail it today—now, at once. DO IT NOW—This investment of two cents for a postage stamp may result in you getting a U. S. Government Job.

**FRANKLIN
INSTITUTE
Dept. L-176
ROCHESTER,
N. Y.**

Kindly send me entirely free of charge (1) a full description of the position checked below; (2) Specimen examination questions; (3) Free copy of illustrated book, "U. S. Government Positions and How to get them"; (4) A list of the U. S. Government Jobs now obtainable.

Railway Postal Clerk (\$1900-\$2700)
Post Office Clerk (\$1700-\$2300)
City Mail Carrier (\$1700-\$2100)
Rural Mail Carrier (\$2100-\$3300)
Clerk at Washington, D. C. (\$1140-\$1860)
Income Tax Auditor (\$2040-\$3000)

Name.....

Address.....

Use This Coupon Before You Mislaid It—Write or Print Plainly

Train for Big Pay in California



Auto Trades Want Young Men

NATIONAL has calls every day for Auto Mechanics, Battery and Ignition Experts, Lathe Workers, Trouble Shooters, Tractor Experts, because the Auto Industry knows National trains men right. National is in the center of a motorist's paradise—1,000,000 cars in California and 500,000 in Los Angeles County. Motoring every day in the year. This means Big Pay and Big opportunity for National-Trained men. We help place students with best automobile concerns in America, through our free employment bureau.

Become a REAL Auto Expert!

The Big Pay goes to the man who is best trained. Do you want to be a half-baked mechanic, or get into the High Pay Class? National has 16,000 graduates, some earning \$75 to \$225 per week. For 21 years National men have stood head and shoulders above self-trained mechanics. Thousands attribute their success to National training methods. Over \$1,000,000 invested in plant and equipment. Competent instructors give you personal, individual guidance in the "job-way" of learning. Within a short time you earn Big Money and gain rapid advancement if you come to National NOW.

Send for Complete Story in Catalog

National's big 84 page illustrated Catalog tells the full story of opportunities for you in the Auto Industry—it tells how National graduates are getting Big Pay—and it gives full details of National Training Course. Mail coupon today for your free copy.

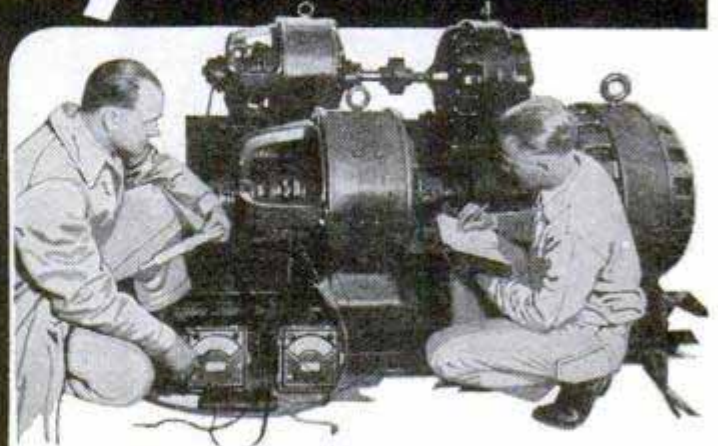

Electricity and Radio Opportunities

YOU can earn Bigger Pay if you train at a recognized school. There are tremendous opportunities everywhere in radio and electricity, for Illuminating Engineers, Commercial Radio Operators, Telephone Engineers, Electrical Draughtsmen, Armature Winders, Dynamo and Powerhouse Experts, Electrical Welders, Automotive Electricians.

In Heart of Hydro-Electrical Development

But you must be trained right to get these Big Pay jobs. Industry has no patience with the man who doesn't know. National is recognized as a leader in training men. This big school, located in the heart of hydro-electrical development, has first call on new jobs, and new opportunities every day. Some of the largest electrical concerns in the world are located in California.

Job-Way Training

No tedious text books at National. You learn by doing. Master instructors give you personal guidance. National's welfare department helps you get part time jobs to pay expenses.

Send for Free Electrical Catalog

National's catalog tells all about Big Pay Opportunities in fascinating electrical industry. Tells how National Graduates are touring the world as radio operators and earning Big Money everywhere. Mail Coupon at once. Don't put it off!

NATIONAL AUTOMOTIVE ELECTRICAL AND RADIO SCHOOL

Dept. 398, 4004 So. Figueroa St., LOS ANGELES, CALIFORNIA

Located in Los Angeles, California—the magic city of movies, beaches, mountains, sunshine and flowers. You can enjoy life in this wonderful city while you train for Big Pay job. Three Great Schools—many acres of floor space. 160-acre Exposition Park Campus across the street.

Mail This Free Book Coupon Right Now!

National Automotive & Electrical School, Dept. 398, 4004 So. Figueroa St., Los Angeles, Cal.
 Send Free Automotive Catalog. Send Free Electrical and Radio Catalog.

Name

Address

City State

Mark choice of book you want





\$30 a Week Six Years Ago Worth \$50,000 Today

Traffic training enabled this man to build a big business for himself

"I want something with a *future*." That's the plea of every ambitious man—and it *ought* to be—

But what's the *secret* of those jobs with a future? Why, simply this: No matter what you tackle, the job will never *lead* to anything unless:

- (1) It gives you opportunity to show results.
- (2) It gives you practical experience which you can *cash*.

It is these two features which make the career of Traffic Manager so fascinating.

Results?—Suppose you were able to save the firm you worked for \$136,000 in a single year—as did the Traffic Manager of a prominent firm making kitchen cabinets.—Wouldn't that *automatically* give your salary a great big boost?

Traffic Management—

A Field of Unlimited Opportunities

Suppose you could use your training as a stepping-stone to financial independence—as did B. F. Stead, a Michigan man—and suppose that within four years you should build up a business with physical assets of \$50,000—Wouldn't you feel that you had made a wise choice in selecting Traffic Management as a career?

But read Stead's letter:

"Words cannot express my appreciation of the LaSalle course in Traffic Management. I knew absolutely nothing about rates, fares, claims, railway accounting, classifications, etc. After graduating, I went into the Accounting Department of one of the largest railroads in the state, and from there I went with one of the largest motor manufacturers in Detroit, taking full charge of all claims, revision and auditing of freight charges. After two years I resigned and went with the largest paper company in the United States. In June, 1921, I resigned my position and went into the motor truck business. I started with an investment of \$1,000. Today I own about \$50,000 worth of equipment, and, to say the least, I have made good. Your course places a man in position to accomplish anything he wishes along the lines of training."

Traffic Management is a field of unlimited opportunities. Whether you want to go higher where you are, get a position elsewhere, or go into busi-

ness for yourself, Traffic Management is a salary-doubling short cut.

Can you make savings for your firm or in your field which would justify doubling your salary? Can you do what thousands of others are doing every day of their lives?

Only 2c and 2 minutes stand between you and the answer to those important questions.

Simply indicate on the coupon the field in which you desire success, and we will send you without cost a book describing the LaSalle salary-doubling plan and the opportunities *in that field*.

Can you afford to turn the page without making this slight effort to insure your business future?

— INQUIRY COUPON —

LASALLE EXTENSION UNIVERSITY

The World's Largest Business Training Institution
Dept. 164-TR Chicago, Illinois

Please send outline of your salary-doubling plan, together with a copy of "Traffic Management," also copy of "Ten Years' Promotion in One," all without obligation.

- Traffic Management—
How Traffic Men Make Money

Other LaSalle Opportunities

The LaSalle plan opens the way to success in every important field of business. Check below the opportunity that appeals to you.

- | | |
|--|--|
| <input type="checkbox"/> Business Management | <input type="checkbox"/> Banking and Finance |
| <input type="checkbox"/> Modern Salesmanship | <input type="checkbox"/> Modern Foremanship and Production Methods |
| <input type="checkbox"/> Higher Accountancy | <input type="checkbox"/> Personnel and Employment Management |
| <input type="checkbox"/> Railway Station Management | <input type="checkbox"/> Expert Bookkeeping |
| <input type="checkbox"/> Law, Degree of LL. B. | <input type="checkbox"/> Business English |
| <input type="checkbox"/> Commercial Law | <input type="checkbox"/> Commercial Spanish |
| <input type="checkbox"/> Industrial Management Efficiency | <input type="checkbox"/> Effective Speaking |
| <input type="checkbox"/> Modern Business Correspondence and Practice | <input type="checkbox"/> C. P. A. Coaching |



Name.....

Present Position.....

Address.....

A resident school—not a correspondence course

Get Out of the Rut! and into the Auto Business!



What Will 1926 Mean to You?

Will it be just another year that slips by without meaning a thing to you? Or will you find real success this year by getting out of the rut and giving yourself a square deal?

What Greer Auto training has done for thousands of men it will do for you. Right now, make the biggest New Year's resolution of your life—that this year shall see you far along on the road of success—thanks to practical training in the Greer Shops. Mail the coupon at the bottom of the page. That is your first step.

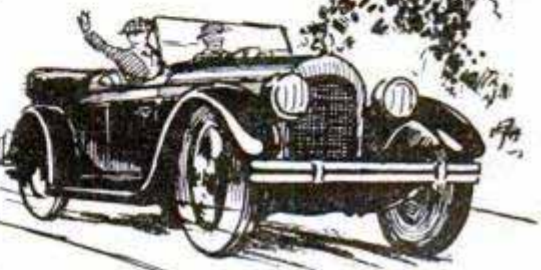

The 7 story home of the Greer Shops

More Men are Needed in the Auto Business than ever before

You couldn't possibly choose a better time to get into the auto trades. With over 20,000,000 cars in operation in the United States, there are not nearly enough men who really know how to keep them in shape. Why don't you be the man who knows and get into the big pay class? Learn the right way and be able to boss the job. You can soon go into business for yourself if you wish and build a good paying business from a small start.

Learn in 12 Weeks or Less

The Greer Shop plan is the practical, sensible way to learn this business thoroughly and quickly. You need not know a tail light from a spark plug, to start with; yet in a very short time you will master the knowledge and the tricks that make you a valuable man. The training you get here will start you into any branch of the auto, truck or tractor business.

24 YEARS' SUCCESS

The Greer shops have been training men practically as long as the automobile business has been in existence. Erwin Greer started this institution in 1902 and has been in active charge ever since. He knows from real experience how to help you get to the top and get the big pay. Although the school has grown tremendously, Mr. Greer keeps up his personal interest in the welfare of every student. In fact, the helpful comradeship of all the instructors is an important feature of the Greer shops.

All equipment is thoroughly up to date. New cars, motors and appliances are constantly added to keep up with the advance of the industry.

Instruction on Real Cars

There are from 75 to 100 customers' cars in the Greer shops at all times. Actual work on their cars, with the help of expert instructors, gives you the real inside knowledge of the business. When you finish this training you will know how and you will know why. That's the reason Greer trained men are always in demand.

Free Employment Service

We help you find the right job, as soon as you have finished training. If you need extra money while learning, we will help arrange a part time job. There are evening classes for men who cannot attend in daytime.

We stand back of you for life with help and advice. You may return at any time to go over any subject, or to learn of new developments in the business.

Send for FREE Book Now

Mail the coupon below without a minute's delay, and we will send you our big free auto book. It contains hundreds of illustrations and much interesting information. You will read what leading automobile manufacturers say about Greer training.

You will find scores of letters from successful auto men who are glad to tell what Greer training has done for them.

Remember that New Year's resolution: that 1926 shall find you getting ahead. There is no time to delay. Now is the time to start so you will finish your training before the big spring season. Take the first step now—fill in this coupon and mail it.

ERWIN GREER, President

GREER COLLEGE — Automotive and Electrical Engineering
Dept. 101, 2024 S. Wabash Ave., Chicago

Please send me your FREE BOOK and offer. It is understood I am not obligated in any way.

Name.....

Address.....

Classified Advertisements

WORLD'S BEST WANT AD MEDIUM

Advertisements in this section, 25 cents per word, each insertion, minimum 10 words, payable in advance.

To be inserted under proper classification in February issue, copy should be in our office December 18th.

ADVERTISING AGENCIES

TO secure agents or salesmen or for selling farms and reaching investors, use classified (want) ads in largest newspapers and magazines. Price list No. 30 sent free. Ankrum Advertising Agency, 20 W. Jackson Blvd., Chicago, Ill. The largest classified advertising agency in the U. S.

ADVERTISE in 24 Big Sunday Newspapers, 24 words \$15.00. Catalog listing 1,000 leading Dailies, Weeklies, Magazines, 4c stamps. Union Advertising, Baltimore Bldg., Chicago.

ADVERTISE in 24 big Sunday Newspapers, 24 words \$15.00. 300 Rural Newspapers 28 words \$10.00. 100 Big weekly newspapers 24 words \$5.00. Service 100%. Consultation Free. National Advertising Service, Richmond Hill, New York.

FREE. Advertising rates. Newspapers, magazines. Guaranteed 100% agents' names \$5.00, 1,000. Pennell, Covington, Ky.

ADVERTISING in all magazines and newspapers at publisher's lowest rates. Rate Book free. Taylor's Advertising Service, Dept. F, Freeport, Ill.

LEGITIMATE Advertising. All Publications, Latin America, United States. Country papers. Catalog free. Owl Agency, Times Building, New York.

INCH Display 100 monthlies \$4; thrice \$8.00. Cope Agency, 233P, Champaign, Ill.

25 WORDS—355 Rural Weeklies, \$14.20. Ad-Meyer Agency, 4112-M Hartford, St. Louis.

FOR ADVERTISERS

ADVERTISING 222 Magazines .08c word. \$6.00 inch, \$45.00 page. Sample 10c. 151 Magazines, 5,000 Newspapers, 28 words \$180.90. Inch, 98 words, \$620.60. 28 words 100 magazines, 100 newspapers, \$5.00. Inch \$12.00. Diamond Advertiser, Norton, Mass.

DINNERWARE for mail order concerns; premium houses; publishers; carried in stock; shipped your customer direct; plans, cuts supplied. Stanford China Co., Sebring, Ohio.

CATALOGUES—Booklets—Folders—Sales Literature—Planned, Written and Printed. Color Printing—High quality Work. Reasonable Prices. All Requirements. George Foster, 314 N. W. 4342 North Robey, Chicago.

YOUR 40-word Classified Advertisement six times with year's subscription to Younk Magazine, One Dollar. Stewart, 157 W. Sta. Barbara, Los Angeles, Calif.

YOUR Advertisement—3 weeks free. 22 leading newspapers. Pay one week regular rate 4c word. Affiliated Newspapers, Bedford Building, Chicago.

I WRITE letters, folders, booklets, complete followup for manufacturers, mail-order dealers. Long experience. Write for details. L. Taylor, Box M44, Freeport, Ill.

ADVERTISE in 300 country newspapers, 28 words \$10. Keator, Hartford Bldg., Chicago.

25 WORDS, 88 magazines, \$1.00; Thrice \$2.00. Inch display \$2.00; Thrice \$3.40. Smith's Service, 1194, Wenatchee, Wash.

SALES PROMOTION

\$50 TO \$50,000 Daily Sales developed during 36 years for clients by my direct-mail plans, copy, campaigns. A \$25,000 annual volume increased ten-fold in twelve months. Another, from an initial expenditure of \$720 developed in four years sales by mail of half million yearly. Ten years Sales Promotion Manager Larkin Co. Submit sales problems for free diagnosis. James C. Johnson, 118A Woodbridge Ave., Buffalo.

OUTLINE your project fully for free expert advice. No obligation. P. Wycross Co., Lansdowne, Penna.

AUTOMOBILE SUPPLIES

MAGNETOS, Starters, Generators, Ignition systems, spark plugs, parts, repairing. Meinert Magneto Co., 1759 E. 21st St., Cleveland, Ohio.

VULCANIZING Auto Tires is a Paying Business on account of new tires advancing. We have Plants near you from \$100 up. We save you 50%. Catalog Free. Instruction Book \$1. Equipment Exchange, 108 East 11. Los Angeles, Calif.

ANTI-FREEZE, Auto Polish, Radiator Cement. Send \$1.00 for three Formulas, full instructions. Appoint Agents. Profits enormous. General Motor Supply Company, Box 102-A, LaCrosse, Wis.

PARTS for any make car at up to 80% discount. Write us advising exact parts you require and get copy of our catalog. We also want local salesman in your territory. Mid-West Auto Parts Company, 628 E. Main St., Louisville, Ky.

BARGAINS on Radiators. All standard makes radiators furnished at bargain prices. State Make and model. We guarantee satisfaction. Independent Radiator Co., 1119 Wabash Ave., Chicago.

EVERY Automobile Owner a Prospect. Standard Size Package. Agent's Sample, 50 Cents. Postpaid. Wolf Auto Supply Co., Kansas City, Mo.

SCIENTIFIC Gas Saver. All autos. One free to introduce. Critchlow, H-124, Wheaton, Ill.

AUTOMOBILES

PATENTS. Time counts in applying for patents. Don't risk delay in protecting your ideas. Send sketch or model for instruction or write for Free book "How to Obtain a Patent" and "Record of Invention" form. No charge for information on how to proceed. Communications strictly confidential. Prompt, careful, efficient service. Clarence A. O'Brien, Registered Patent Attorney, 5899 Security Bank Building (directly across street from Patent Office), Washington, D. C. See pages 142 and 143.

ELECTRICAL equipment of the Ford Car fully explained. Learn how to fix your lights, your ignition, or starter without calling an electrician. This book may save you many mechanic's bills any one of which might be more than the cost of the book. Send No Money. Just write a postal and ask for "The Ford Standard Electrical Equipment." When the postman hands you this profusely illustrated leather-bound book, pay \$1.98 plus the postage. Popular Mechanics Press, 200 E. Ontario St., Room 801, Chicago, Ill.

AUTOMOBILES: 753 Ideas on repairing and improving, in Popular Mechanics three new books: Auto Repairman's Handbook, Auto Owner's Handbook, Auto Tourist's Handbook. Send No Money. Just write a postal. Pay postman the postage and \$1.50. Popular Mechanics Press, Room 801, 200 E. Ontario St., Chicago, Ill.

FORD Chassis made dependable tractor by using Shaw Equipment. Pulls 18" plow, etc. Particulars Free. Shaw Manufacturing Company, Dept. R-4, Galesburg, Kans.

AUTOMOBILE SUPPLIES, ACCESSORIES AND HOUSEHOLD GOODS WANTED

100,000 REPRESENTATIVES Wanted! Sell by mail, through Agents, or Direct! Detailed Information—25c! None free. Surety Service, "Importers and Exporters," Desk A, 551 Harvard St., Rochester, N. Y.

FOR FORD OWNERS

NEW Invention, Radiator Drain Valve, can be opened and closed from dash of car, no need to crawl under car to drain radiator. This device is troubleproof, can be installed in 10 min. Also new Adjustable Bronze Bearing Cap, takes place of Center Main, takes endplay out of Ford Crankshaft. Money promptly returned if not satisfied. Price \$2.50 complete. George Bearing Co., Amarillo, Tex.

66 MILES on 1 Gallon. Wonderful Vapor Humidifier. One free to introduce. Critchlow, J-124, Wheaton, Ill.

HY-POWER Timers for Fords, with the patented sliding shoe makes easy starting in cold weather. Adds 25% power to the Ford motor. Has an average life well over 25,000 miles. Price \$1.50 plus postage. Will give \$10 worth of service. Agents write for proposition. Hy-Power Mfg. Corp'n, Dept. R, Mt. Vernon, N. Y.

DELIVERY Bodies for Ford Model T. Chassis with inclosed Cab. Suitable for Contractors, Groccermen and Farmers. Three styles. Price \$37.50. Write Daniel Zimmerman, Craigville, Ind.

DIRECT Engine Driven Tire Pumps for Ford Cars. Clagett Mfg. Co., Upper Marlbor, Md.

PRONTO Series-Gap Mica Spark Plugs. Guaranteed shoot through oil, especially Ford first cylinders. Owners write special offer. Agents' samples actual cost. Pronto Mfg. Sales Co., Council Bluffs, Iowa.

FORD Owners, Install a set of my quick change 30-minute bands in your car. With full instructions and lined with high-grade treated lining, \$1.80 per set. F. P. Auto Parts Co., 302 Central Ave., Newark, N. J.

FORD propelled speedboat, easily built; blue print and directions, sixty cents. Hubbell, 4B East Ave., Norwalk, Conn.

UNDERSLING with "RKO" Swing Lo Irons. See Red-i-Kut" ad page 150.

ELECTRICAL equipment of the Ford car fully explained in a leather-bound profusely illustrated book. Learn how to fix your lights, ignition, or starter while on the road without calling a mechanic. Save repair bills. Send No Money. Just write a postal for "The Ford Standard Electrical Equipment." When the postman hands you the book, pay \$1.98 and the postage. Money back if not fully satisfied. Popular Mechanics Press, 200 E. Ontario St., Room 801, Chicago, Ill.

MOTORCYCLES, BICYCLES AND SUPPLIES

1923 HARLEY-DAVIDSONS, \$168; 1922, \$118; 1921, \$111; 1920, \$85; 1919, \$65; 1917, \$50; 1916, \$45; 1915, \$40; 1914, \$35. Guaranteed. Money refunded if not satisfied. Circular free. Wisconsin Cycle Sales Co., 725 National Ave., Milwaukee, Wis.

OVERSTOCKED Used Motorcycles, 1923 Indian Chief \$95.00, 1923 Harley Davidson \$95.00, 1923 Henderson DeLuxe \$120.00. Two hundred others; write for free list. Myerow Brothers Co., 15 Berkeley St., Boston, Mass.

USED Harley-Davidson Parts 40% to 80% Discount. Tower Cycle Co., 4305 North Florissant, St. Louis, Mo.

DON'T buy a Bicycle Motor Attachment until you get our prices. Shaw Mfg. Co., Dept. 27, Galesburg, Kans.

AVIATION

CLEAN up Sale—100 H.P. nearly new Gnome Motors as received from Government \$17.50 each. New LeRhone 80 H.P. \$75.00 each. Same nearly new \$35.00. Brand new LeRhone propellers each \$5.00. New Liberty 400 H.P. Propellers each \$5.00. New OX-5 Paragon metal tipped variable pitch each \$5.00. New Zenith OX-5 Carburetors each \$7.50. New T.-M. Scout lower wings each \$25.00. New T.-M. tail group complete each \$50.00. New T.M. Landing gears each \$50.00. Factory rebuilt OX-5's good as new Motors each \$240.00. Fine Canuck Plane OX-5 ready to fly away \$625.00. Nearly new Jennie OX-5 dandy \$750.00. Send 50¢ with order. Balance subject to examination. Anderson Aircraft Co., Anderson, Ind.

PATENTS. Time counts in applying for patents. Don't risk delay in protecting your ideas. Send sketch or model for instructions or write for Free Book "How to Obtain a Patent" and "Record of Invention" form. No charge for information on how to proceed. Communications strictly confidential. Prompt, careful, efficient service. Clarence A. O'Brien, Registered Patent Attorney, 5899 Security Bank Building (directly across street from Patent Office), Washington, D. C. See pages 142 and 143.

AEROPLANE Motors \$3,000.00; complete 165 Horsepower Gnome 9 cylinder engine, weight 292 pounds, air cooled. Immediate delivery \$25.00; cash with order F.O.B. Dayton. 1,100 engines purchased from Air Service. Complete planes \$500 up. Time payments. Nieuport model, 28 wings complete, \$6.00; good condition—bargain for plane builders. Motors ideal for ice sleds, snow sleds, Motor Boats, Wind Wagons. Write for booklet, Marvin A. Northrop, 200 Builders Exchange, Minneapolis, Minn.

HEATH propellers represent the most efficient method of aerial drive. Each propeller individually designed for the particular work to be done, as laid out by America's oldest aeronautical engineers. Propeller catalog 4c; Motorcycle Biplane circular 4c; Ford or Motorcycle sled blueprints \$2.00 each. Resistal goggles \$2.90. Wool Jersey helmets 95c. Heath Airplane Company, Chicago, Ill.

BLUEPRINTS showing detailed specifications converting Ford motor for use with propeller; building high speed Ice Coach; fast Aerodrive boat attachment; speedy Ice Scooter; All only \$2.50 postfree. Propellers, \$5.50 upward. Aircraft Supplies Price list 5c. Ostergaard Aircraft, 4271 North Narragansett, Chicago.

COMPLETE Scale Plans with Building-Flying Instructions for following 3-ft. Model Aeroplanes, 25c each postpaid: JN4D-2; DeHavilland; NC-4; Curtiss Tractor; Bleriot; Nieuport or Taube Monoplanes; Cecil Peoli Racer. Complete 48-page catalog 5c, listing hundreds of parts and supplies for experimenters. Ideal Aeroplane Co., 165½ Spring Street, New York.

FREE to future students! Captain J. A. Yonge's preparatory course on aviation describes the latest aeroplanes, tells you about aviation engines, the Ford and other air lines and a hundred other things necessary to success. It contains a special lesson on learning to fly. Only \$12.50 for ten instructive lessons, complete with diagrams. Gary Flying School, Gary, Ind.

TEN lessons in the air of twenty minutes each will make you a pilot by our advanced method of training. This together with our five weeks' shop course at \$100.00 makes America's oldest aircraft factory the most popular flying school. Work after class hours guaranteed. Heath Airplane Company, Chicago, Ill.

EARN \$3,500 to \$10,000 a year. Learn Airplane Engineering Now at Home. The World Flyers were Airplane Engineers. Write for free catalog. Western Airplane Corporation, Desk K-1, Monadnock Block, Chicago. See our Display ad on page 76, this issue.

AVIATION Fans: Send one dollar for beautiful pair sterling silver wings, mounted on bar pins with safety catch, and identification card issued by National Flyers' Association. Thousands being worn by pilots' aviation mechanics, and aero enthusiasts. Wallace Aero Company, Bettendorf, Iowa.

MOTORS: Curtiss OXX-6 Class A (under Fifty Hours) for Plane, Sea-Sled, Motor boat, etc., \$175.00. All Motor and Plane Spares at Best Prices. Send for Catalogue. Monumental Aircraft Co., 339 N. St. Paul Place, Baltimore, Md.

OPPORTUNITY—Our regular Ground School Aviation Course, same as our student Pilots use, now available by mail. Remit \$5.00, will send complete course in seven lessons by return mail. Great Lakes Airways Inc., Erie, Pa.

THREE-PLACE, Highlift," OX5 Biplane \$1,000. "Highlift" wings (knock-down), \$250. Flying Instruction, \$100. Two-Seater Sportplane Plans, \$5. Propellers, \$10. Aviation Engineering Co., Lawrence, Kans.

THE American School of Aviation announces a new correspondence course in Mechanics of Aviation. A thorough training in Practical Aeronautics. American School of Aviation, Dept. 1861, 3601 Michigan Ave., Chicago, Ill.

SPECIAL Offer, "Airlider," 300 ft. flights guaranteed; 40c postpaid. Big model catalog, airplanes, boats and supplies, 5c postpaid. W. Phipps Company, 367 Wilson Avenue, Brooklyn, N. Y.

PROPELLERS for Aeroplanes, Wind Wagons, Snow and Ice Sleds, Wing Ribs, Correct sizes and tests to build from Dimensions, small airplanes. Crawford Aeroplane Manfr., Long Beach, Calif.

PATENTS: My fee in installments. Free personal advice. Frank T. Fuller, Washington, D. C.

FOR snow sleds and airplanes, 28 H.P. motor weighing 135 pounds, New, \$125. Others to 200 H.P. Propellers \$3 to \$25. Used aviators leather coats, mighty warm \$10. Smith Machinery Co., P. O. Box 153, Houston, Texas.

REMANUFACTURED Curtiss OX 90 H.P. airplane motors. Better than new and fully tested. \$200.00 while they last. Send 2c for our circular. Heath Airplane Company, Chicago, Ill.

LEARN Aviation! Mechanical. Home study. Flying Courses. Aeroplanes for sale. Earn flying tuition. Send 25c for catalog and details. Varney Aircraft Co., Peoria, Ill.

DICTIONARY of Aviation, \$3.90. Languages Publishing Company, 8 West 40th Street, New York.

MODEL Airplane Gasoline Engine. Drawings \$1.00. Ray E. McAdams, Mechanicsburg, Ohio.

BOYS, get a three-foot model aeroplane free. Nothing to sell. Write to Aero Shop, 3050 Huribut Ave., Detroit, Mich.

PATENTS: My fee in installments. Free personal advice. Frank T. Fuller, Washington, D. C.

NEW nine-cylinder Gnome aeroplane engine \$45. Albert Latschaw, Clarion, Mich.

WELDING AND SOLDERING

ALUMINUM Solder—Applied with soldering iron same as soldering brass. Sample 25c. Large bar \$1.00. Modern Machine & Pattern Co., Terre Haute, Ind.

ALUMINUM Solder. Guaranteed to Solder Aluminum Sheet or cast. No flux. Will solder any metal to Aluminum. Send 50c for sample. Gardner Co., Box 267, Lamanda Park, Pasadena, Calif.

BOOKS AND PERIODICALS

"COLORS and Rhythms," About 100 pages. Chromotherapeutics. Marvelous Scientific Knowledge. Illustrations. Deluxe \$2.00; Plain \$1.00. Dept. M. Stevens, 242 Powell, San Francisco, Calif.

FREE—Send for my Newthought, Science, Occult, Mystic and Scientific book literature. Martens Publisher, Burlington, Iowa.

ANSWERS to all mathematical problems likely to occur in the office, store, shop, bank, farm, or factory. Explains and simplifies every principle of arithmetic, mechanics and mensuration. Over 2,000,000 sold. Send No Money. Just write a postal and ask for Ropp's Calculator. When the postman hands you the book, pay \$1.00 and the postage. Popular Mechanics Press, 200 E. Ontario St., Room 801, Chicago, Ill.

HYPNOTISM Amuses, Astounds, Insures health, wealth, happiness. 25 Easy Lessons \$1.00. "Mindreading" (any distance), wonderful, \$5. Success guaranteed. Popular Institute, 1430 Milwaukee, Ave., Chicago.

INDUSTRIAL Alcohol. Wright's book. Full directions for making, fully illustrated. \$2.50. Spon & Chamberlain, 120 P. M. Liberty Street, New York, N. Y.

DRAFTING. Learn Mechanical Drawing. Big demand for men to make accurate drawings to scale. This pocket-size, cloth-covered book starts you at the beginning and leads you by a series of simple lessons to the more difficult assignments that you would get in an architect's or engineer's office. Send No Money. Just write a postal for "A Practical Course in Mechanical Drawing." Pay postman postage and \$1. Popular Mechanics Press, Room 801, 200 E. Ontario St., Chicago, Ill.

SHOP NOTES for 1926 now ready. Get your copy from this announcement. Only a limited edition. Contains all the articles published in the Shop Notes department of Popular Mechanics Magazine during 1925. Send No Money. Just write a postal and we'll send 1925 Shop Notes and Auto Tourist's Handbook. Pay the postman 98 cents when he hands you the two books. Popular Mechanics Press, 200 E. Ontario St., Room 801, Chicago, Ill.

ELECTRICAL Ideas on all phases of practical electricity are to be found in Popular Mechanics new book, "Electrical Kinks." 47 ideas on wiring, 45 on making electrical devices, 19 on lighting, 5 on transformers, 5 on motors, 8 on generators, 11 on switches, 22 on testing, 12 on repairing, 11 on battery manufacture and repair, 5 on telephones, and 9 on electricians tools. 214 articles, 162 pictures. Send No Money. Just write a postal. Pay postman postage and \$1.50. Popular Mechanics Press, Room 801, 200 E. Ontario St., Chicago, Ill.

BOOKS on mail order selling, home work, magic, ventriloquism. Stamp brings list. Morris Specialty Co., 2007 Park St. Louis, Mo.

CURIOUS Books, Unique Novelties, Stunning Pictures. Samples, 10 cents Prepaid. Linds, 214 W. 31th Street, New York.

I BUY and Sell used books. Send dime for list and particulars. Raymond Schenck, Butler, Pa.

10,000 FORMULAS. A real Gold Mine of money-making ideas. Tells how to make almost everything under the sun. You can make and sell cosmetics, mucilage, anti-freeze solutions, battery solutions, beverages, cheese, chewing gum, cleaning preparations, extracts, hair preparations, inks, blueing, leather polish, mirrors, perfumes, polishes, typewriter ribbons, carbon paper, washing powders, liquid soap, and hundreds of other profitable articles. Send No Money, just write a postal for "Henley's 30th Century Book of Formulas." Pay postman postage and \$4. Popular Mechanics Press, 200 E. Ontario St., Room 801, Chicago, Ill.

PICTURES AND POSTCARDS

TRUE-BLUE friends everywhere. Exchange cards, letters, stamps. Movie fans. Hundred listings, dime. Ed Ericson, Elroy, Wis.

JOIN Popular Friendship Club. Exchange postcards, letters, stamps. Enthusiastic members everywhere. Fascinating pastime. Membership two months 10c; six months 25c. Oliver Gandy, Crisfield, Md.

75 BEAUTIFUL Art Pictures and Bathing Beauties 25c (coin). Photo Sales Co., 3242 Richey, Suite 400, Detroit, Mich.

PICTURES, Books and Novelties. Particulars Free. Howard Sales Co., Dept. 15, 1188 Folsom St., San Francisco, Calif.

JOIN Live Postcard Club. Membership lists including Catalog, 10c. Harvey Teeple, Decatur, Ind.

GAMES, ENTERTAINMENTS AND PLAYS

PLAYS, musical comedies and revues, minstrel music, blackface skits, vaudeville acts, monologs, dialogs, recitations, entertainments, musical readings, stage handbooks, make-up goods. Big catalog free. T. S. Denison & Co., 623 So. Wabash, Dept. 11, Chicago.

VENTRILLOQUISM taught almost anyone at home. Small cost. Send 2c stamp today for particulars and proof. George W. Smith, Room 8-51, 125 N. Jefferson Ave., Peoria, Ill.

PLAYS, Minstrels, Musical Comedies, Vaudeville Acts, Monologues, Make-Up, Wigs, Catalogue "D" Free. Banner, 1061 Market St., San Francisco, Calif.

100 LIGHTNING Chalk Talk Stunts \$2.00. Cartoonist, 2925 Euclid, Kansas City, Mo.

NOVELTIES, CURIOS, ETC.

TO introduce our merchandise will send beautiful Sea Shell and price list of ocean curios, sponges, alligators, etc., for 35 cents. Curiosities, St. Petersburg, Fla.

MAGIC TRICKS, BOOKS AND JOKER NOVELTIES

BIG Premium Budget. 12 Popular Songs with Music, 14 Complete Stories, 37 Magic Tricks, 39 Amusing Experiments, 15 Puzzles, 26 Parlor Games, 150 Jokes, Riddles, and Conundrums, 56 Money Making Secrets, 83 Album Verses, Dictionary of Dreams. All for ten cents, postpaid. Benedek Supply House, 2152 LaPorte Avenue, Chicago, Ill.

MAGIC—Tricks, Books and Supplies. For Amateurs as well as the great professionals. Anyone can learn through our instructions. Feature Acts in: Mind Reading, Spiritualism, Rope Ties, etc. Large Illustrated Professional Catalog, 20c. Chicago Magic Co., 140 S. Dearborn St., Dept. B, Chicago, Ill.

A KNOCKOUT! Surprise your friends with a Bootleg Cigar. Useful and Amusing. Sample only 35c; yet you wouldn't take a dollar for it. Why?—Get one—and see. Leland Company, Fruitvale, Calif.

FREE with \$25 order die box. Send 20c for our large catalogue of tricks, wigs, sensational escapes. Oaks Magical Co., Dept. 548 Oshkosh, Wis.

200 KINDS of Iron, Wood and Wire Mechanical Puzzles. Leader with Illustrated Folders 10c. Western Puzzle Works, St. Paul, Minn.

BOOK exposing modern Escapes, Illusions, Mind Reading, Gambling and other Secrets 25c. Catalog Free. Acme Sales Co., 939 W. Exchange, Akron, Ohio.

MAGIC goods, cards, books, novelties, tricks. Catalog free. C. Fenner, 2401 Jefferson, Louisville, Ky.

MAGICAL Novelties. Books. Secrets. Mysteries. Magic. Catalogue Free. Singer, 555 Hancock, Wis.

MIND-READING Trick Cards—Amusing, Mystifying. Set, postpaid, 12c. G. Eisea, Bowling Green, Ohio.

LEARN to entertain with Magic. Catalogue free. Waldmann, 1450 First Ave., New York.

SEVEN Magical Delusions and Catalogs—25c. Gilmagico, Morgan Park, Ill.

250 PARLOR Tricks, Novelties, Catalog 10c! Supreme, 3246 Normal, Chicago.

ESCAPE from any rope tie and mystify your friends. You can easily make \$10 a night giving escape entertainments in Churches, Clubs and country schools. The book, "33 Rope Ties and Chain Releases" tells how to conduct an entire entertainment. It tells how to escape when someone plays a trick on you and ties you more securely than you expected. Tells how to escape from the famous mummy tie in which you are bound from head to foot with 75 feet of strong rope. No knife or other instrument is needed. Send No Money. Just write a postal and ask for "Rope Ties." When the postman hands you this wonder book, pay 98 cents and the postage. Popular Mechanics Press, 200 E. Ontario St., Room 801, Chicago, Ill.

STAMP COLLECTING

WORLDWIDE Packet. Have you a hundred different countries represented in your album. If not here's a packet you want—100 different stamps from 100 different countries. It's Scott Seald Packet No. 329, and only 75c. Also the following, specially selected from the Scott-Seald Packet List of guaranteed genuine, low priced, high value packets. No. 60, 150 all diff., 10; No. 279, 25 diff. Egypt, 30; No. 85, 20 diff. Madagascar, 50; No. 211, Honduras, 46 diff., 50; No. 72, 100 diff. Portuguese Colonies, 50; No. 266 Extra Quality Austria, Czechoslovakia, Hungary, Italy and Switzerland, 75 diff., 50; No. 202, Wurtemberg, 50 diff., 25; No. 181, Iceland, 20 diff., 35; No. 238, Persia, 60 diff., Only \$1.00. The new Scott Free Price List is out with hundreds of packets, set and dime set bargains. Send for it now. Scott Stamp & Coin Co., 33 West 44th Street, New York, N. Y.

ARABS! Bandits! Head-Hunters! Egypt (sphinx); Malay (tiger); Benadir (elephant); Tunis (arab); Turkey (sacred mosque); Belgium (showing battle between angel and "old horns"); Congo (head hunter)—All of these mysterious and remarkable stamps are contained in our Famous Phantom Packet—55 fine varieties (to approval applicants only) for eight cents. Nothing like it; order at once! Pacific Stamp Co., Box 138, Helena, Mont. Extra! Send us, with your order for the Phantom Packet at 8c, the names of three of your friends who collect stamps; and we will give you, free of charge, a scarce set of 11 diff. Albania—bandit land!—cataloguing over \$1.50. Supply limited; write immediately!

BIG Commission to Agents for the Best approval sheets of stamps ever offered. Write for sample outfit. Pioneer Stamp Album with 500 stamp illustrations, 500 mixed stamps over 40 countries, 500 hinges, All for 25c. Bargain Packets, 100 British Colonies 35c.—100 French Colonies 20c.—100 Portuguese Colonies 40c.—100 New Europe 10c.—50 Asiatic 15c.—50 African 25c.—50 Australian 25c.—500 all different 35c.—1,000 all different 95c. Hussman Stamp Co., Dept. P., 620 Olive St., St. Louis, Mo.

THE "Magnificatious" 10c Snap. Contains 111 stamps from Liberia, Iceland, Cape of Good Hope, African Congo, Abyssinia, Hindustan, New South Wales, Mozambique Pictorial, Cochlin with bumper shoot watermark, Beautiful Nyassa, Triangle, Round, Square, Black and Biggest Stamp in the World, Perf. Gauge, Scale, Jumbo Price List. One packet to approval applicants only. Collections Bought. Pavn Stamp Co., 945 Vista Drive, Los Angeles, Calif.

O-O-O-O-H, Boys! What a Thrill! The Fenway "Jungle" Packet!—Contains scarce stamps from jungle and cannibal-land! Included are: Abyssinia, Congo head hunters, Kenya and Uganda, Nyassa camels, Mozambique, Ivory Coast, Upper Volta, Togo, Ubangui, Tanganyika, Fiji Islands (cannibals!) and other savage lands. This wonderful packet from far-away countries to new approval applicants for only ten cents! Fenway Stamp Co., 161 Massachusetts Ave., Boston, Mass.

RARE Stamps from lands cloaked in mystery, hidden at earth's farthest corners. Bargain Offer includes 50 beauties from Uganda, Nyassa, Gold Coast, Kenya, etc. Also 25 Fantastic Wonders from Persia, All 25 different. Many scarce, high values. Also unused Aeroplane Set. All for 15c to approval applicants only giving references (scout number OK). Scarce Hayti stamp catalogued \$1. Free with orders sent now. Reimers, 409 Flatiron Bldg., Fort Worth, Texas.

MYSTIC'S "Mysterious" Packet! Contains stamps from the lands of cannibals, heathens, sun worshippers, and wild savages. Included are Kenya and Uganda, Persia, Africa, Dutch Indies, Gold Coast, Federated Malay States, Eritrea, Nyassa, Travancore, Siam, Congo, etc. This wonderful packet containing 105 all different (mostly unused) for only 8 cents to approval applicants. Mystic Stamp Co., Dept. 8, Camden, New York.

STAMP Collectors Outfit only 25c, includes 32-page book "How to Collect Stamps" Album (illustrated), 100 Hinges, 110 different stamps from Comoro, Guinea, Hejaz, Iraq, Sudan, Zanzibar, etc.; also "free stamps" coupon. For new customers only. Harry Ioor, 801 State Life Bldg., Indianapolis, Ind.

ANCHERS \$\$\$ Outfit—only 12c! Fine triangle stamp; set German stamps with (pre-war) value forty million dollars (interesting!); perforation gauge, mme. scale; small album; 2 approval sheets; airmail set; scarce stamp from smallest republic on earth; newspaper set; packet good stamps from Travancore, Johore, Dutch Indies, etc. Entire outfit for 12c to approval applicants! (Nice pocket stock book, value 25c, with every order!) Ancher Stamp Co., 148 1/2 Clerk St., Jersey City, N. J.

AVOID Duplicates—We send you 2,000 fine different stamps. You pick any 100 for \$2.00, 2nd 100 for \$1.00, 3rd for \$1.75, 4th for \$.50, rest 25c per 100. 50 Diff. Uruguay, \$.70; 25 Diff. Salvador, \$.30; 100 Diff. Persia, \$1.25. Big 8-page U. S. List free; also the finest set list out, listing such countries as Corrientes, Baden, Ionian Is., etc. Stanley Gibbons Inc., 35 Ann Street, New York City.

STAMPS! Big Bargains! 50 diff. Nyassa, Flume triangle, etc., and perf. gauge, only 5c; 15 Uruguay, 12c; 8 Nyassa, beauties, 8c; 25 French Colonies, 10; 50 Br. Colonies, 10c; 40 Africa 12c; 500 diff. foreign 35c; 1,000 diff. foreign \$1.25. All above, cataloguing about \$30 for only \$1.95. My Choice 50% approvals with all orders. List free. L. B. Dyer, Clayton, Mo.

500 DIFFERENT, many unused, from British, French, Italian and Portuguese Colonies, Chile, Flume, Guatemala, Persia, Siam, etc., for only 25c (regular price 50c), to all approval applicants. Big bargain lists free. With small album, package hinges and above packet only 30c. Victoria Stamp Co., London, Canada.

"EXHIBITION" "War Prisoners," "Airmail," "Pictures," "Eagles," "Dues"; six sets unused, different countries, five French, five British, five Portuguese Colonies. Packet Dutch Indies, 100 different foreign, 15c to approval applicants. Deering, 38 Fairmount, Marlborough, Mass.

SNAPS—200 different stamps, 10c; 60 different United States Stamps, 12c. With each order we give free our price list of sets, packets, albums, etc., and our pamphlet which tells "how to make a collection properly." Queen City Stamp Company, Room 36, 604 Race, Cincinnati, Ohio.

AH! Ah! 200 different mint Germany 25c; 200 Austria 25c; 200 different Danzig \$3.00. All stamps of Germany and other new European countries furnished. Highest Prices paid for old U. S. and Confederate stamps, preferably on original envelopes. Victor Weiskopf, 52 Vanderbilt Avenue, New York City.

200—200—200—200 ALL different stamps; 200 hinges; approval sheets to hold 200 stamps; perforation gauge, millimeter scale and ruler; duplicate stamp container—all for only 15c to approval applicants. Edge-wood Stamp Company, Milford, Conn.

1,000 DIFFERENT \$1.00. 2,000 different, catalogue over \$50.00, only \$4.00. Reliant Stamps, 82 Nassau, New York.

FREE—8 Unused Luxemburg Pictorials to approval applicants. Stamp Shop, 515 West 175th, New York.

RARE Tanganyika, Mozambique, Liberia, Nyassa, Ruhr and Aeroplane stamps in our "Wonder 300 Variety Packet" for 25c. Big Price List Free. Mower, 12 Geary Street, San Francisco.

STAMPS, 100 varieties, Africa, Brazil, Peru, Cuba, Mexico, etc., 10c. 50 different U. S. 25c; 1,000 mixed, 40c; 1,000 hinges, 10c. List free. C. Stegman, 5948 Coto Brillante, St. Louis, Mo.

BEST one-cent approvals in America. F. P. Hand, 1117 So. 60th St., Philadelphia, Pa.

200 DIFFERENT unused European. Catalogs \$4.00 Only 30c. 20 different Iceland 30c. 25 Siam 40c. Lists free. Approvals against reference. Miller Company, Chatham, N. Y.

FREE! 12 scarce Azerbaijan to approval applicants. Pennsylvania Stamp Co., Manot, Pa.

25 DIFFERENT Persia, 19c. Iowa Stamp Co., Cedar Rapids, Iowa.

CLASSY Stamp Free to approval applicants. 2c postage. Bond Stamp Co., Lima, Ohio.

STAMPS 1c each. Cheapest and Best. 50 Free for 6c postage. C. H. Hollister, Mukwonago, Wis.

LIBERIA—8 fine varieties, 20c. Lists free. Allison, Angola, Ind.

100 FINE varieties to approval applicants sending 4c postage. R. Sherman, 2823 Sedgwick Ave., New York City.

AGENTS wanted to sell stamps received on our big foreign mail. Send 25c for fine selection. Calculator Co., Grand Rapids, Mich.

100 DIFFERENT South and Central American 45c; 200, \$1.10; 300, \$2.50; 500, \$4.50. Fred Onken, 630 79th Street, Brooklyn.

500 MIXED unused and used foreign stamps 50c. Arcy, Box 483, Muskogee, Okla.

MAGNIFICAROCIOUS Variety Packet Foreign Stamps Free for 2c postage. Gray Stamp Co., Toronto, Can.

1,000 U. S. AND Foreign Stamps 25c. John Nelson, 5952 Division St., Chicago, Ill.

50 DIFF. stamps for Approval Applicants sending 2c postage. Rubin Hoffman, 405 Pennsylvania Ave., Brooklyn, N. Y.

STAMPS on approval 1/4c up. Free premium. References required. Herbert Keigwin, Middletown, N. Y.

\$10.00 CAT. Val., \$1.00 Cash. Richards, Box 36, Shadyside, Ohio.

11 ALBANIA 5c; 16 Armenia 16c; 40 Denmark 12c; 10 Ireland 10c; 20 Norwegian 12c; 23 Epirus 30c; 21 Mozambique 21c; 6 Cape Verde free. Fred Jackson, Montara, Calif.

AIRMAIL—20 different—15c. F. Buffham, Lake Ave., Racine, Wis.

FREE premium to approval applicants furnishing 2c stamp. Joseph Lux, 211 Memminger St., Greenville, S. Car.

FREE—Packet of 25 foreign to approval applicants. Lester E. King, 3776 Isabella Ave., Cincinnati, Ohio.

DANZIG Stamps Free—Wonderful assortment from Danzig with Big Catalogues free for 2c. Midland Stamp Company, Toronto, Canada.

FREE Packet Oriental Stamps, Album, Hinges, Lists, Enclose Return Postage. Oroc, 12 Geary 205, San Francisco, Calif.

500 MIXED U. S. and Foreign stamps 12c. R. H. Carlton, 380 W. So. Temple, Salt Lake, Utah.

GENERAL selections, 60% discount. The Stamp Inn, Middletown, Ohio.

25 DENMARK, 10 Epirus, 5 Ireland, 100 New Europe, 25 Sweden, all for 35c. Oscar G. Harris, East Sullivan, N. H.

FREE—Confederate States \$5 Bill with 100 Different Foreign Stamps for a Dime. B. Nagle, 1101 Marion, Reading, Pa.

STAMP Outfit; 25 different Countries, 7c. Lufbery, Port Orange, Fla.

9 IMPERFORATED United States. Unused Stamps—30c. F. E. DeWick, Brunswick, Me.

PHILIPPINES—Amer. Issues 30%; Spanish 20%. Other Popular Approvals 30%. Aerocovers. Exchange Stamp Company—Stamp Auction Concern—Auburn, Calif.

CURIOSITY Packet, 104 unused in blocks 12c. Big 20-page List, set Air Mails Free. Rueger, 31 Cambridge, Dayton, Ohio.

1,000 MIXED U. S. and Foreign Stamps 25c. Phil. Lundsted, Cane Cottage, Maine.

STAMPS Free—Ask for money-saving approvals. John P. Borresen, Cedar Falls, Ia.

110 NEW Europe All Different, a wonderful collection cataloguing several dollars, free to collectors requesting our Net Approvals. Postage 2 cents. Badger Stamp Co., Milwaukee, Wis.

ZAMBESIA, Zanzibar, Abyssinia, Herzegovina, Travancore stamps, menagerie collection, album, 10c. Liberty, 3974 Arsenal, St. Louis, Mo.

200 DIFFERENT stamps, set triangles, set animal stamps, other sets, U. S. Packet, blank approval book, 40 pages stamp bargains, \$6.00 value for only 25c to applicants, 1,000 Hinges, 9c; 100 U. S., 25c; 500 diff., 45c. Hawkeye Stamp Co., Cedar Rapids, 39, Iowa.

24 VARIETIES Cuban stamps, 10 cents. List of 6,000 low-priced stamps free. Address Chambers Stamp Co., 111F, Nassau St., New York City, N. Y.

STAMPS, 100 all different. Postage 2c. Lists free. P. M. Quaker Stamp Co., Toledo, Ohio.

110 DIFFERENT Stamps, many unused, high values, free to collectors requesting our Net Approvals. Postage 2 cents. Christensen, Milwaukee, Wis.

PACKET of 23 stamps, no two countries alike. Packet hinges. Set of \$1 and \$2 U. S. Rev., all for 5c. P. M. Miami Stamp Co., Toledo, Ohio.

FREE! 25 different United States with 60% discount approvals to reliable parties. Seidenberg, Baroda, Mich.

FREE, "Liberty" packet to approval applicants sending 2 cent stamp. P. Earl Stamp Co., 1811 26th Av. North, Minneapolis, Minn.

25 PRECANCELS—and copy "Badger's Precancel Partner." 4c to approval applicants. Badger's Partner, Brooksville, Fla.

FREE! Loose Leaf Postage Stamp Album at rate of 8 pages each month given with subscription to monthly Journal. Send 2c stamp for prospectus. United Stamp Co., Marquette Bldg., Chicago, Ill.

PENNY Approvals that Satisfy. Neil Gronberg, Box 5441, Philadelphia, Pa.

20 UNUSED stamps free. All different. Postage, 2c. P. M. Fisk Stamp Co., Toledo, Ohio.

FOREIGN Stamp Collection Sent Free. Cornish Co., Schenectady, N. Y.

FREE, Hungary Charity No. 565 to 567 and a surprise packet given to those requesting for my 1, 2 and 3c approvals and also my 50% discount and better. Chas. W. Schmidt, 3227 Benner St., Waukegan, Philadelphia, Pa.

STAMPS sent on approval at 70% discount. Reference required. Emory Renoll, Hanover, Vt.

5 AIRMAIL—20 unused 4c, 1,000 different 98c, 500 different 38c. Both \$1.25. Buckley, 528 Alameda, Dayton, Ohio.

BRITISH Colonies—55 Different 15c. Browne, 90 Kemper, Wollaston, Mass.

105 CHINA, etc., 2c. Album (500 illustrations) 3c. Bullard, Sta. A, Boston.

RARE COINS

GET Profit and Pleasure in collecting Old Coins. Send 10c for Sample Old Coin, together with my Large Illustrated Coin Catalogue. You'll be delighted with it. Send for it right now. B. Max Mehl, Professional Numismatist, Mehl Bldg., Dept. P, Fort Worth, Texas. Largest Rare Coin Firm in U. S.

BARGAINS in United States Commemorative Half Dollars. Alabama 95c; Monroe 99c; Grant \$1.09; Huguonot 99c; Lexington \$1.09; Stone Mountain 99c; Columbian 69c; Isabella Quarters 89c; 25 Large Cents \$1.45; 10 White Cents 39c; 10 2c Bronze pieces 59c; 10 3c Nickels 69c; Eagle Cent and bargain Price List 10c. Arcy, Box 483, Muskogee, Oklahoma.

OLD Money Wanted. We paid \$2,500.00 for one silver dollar to Mr. Manning of Albany, N. Y. We buy all rare coins and pay highest cash premiums. Send 4c for large Coin Circular. May mean much profit to you. Numismatic Bank, Dept. H, Fort Worth, Tex.

\$2 TO \$500 Each Paid for hundreds of Old or Odd Coins. Keep All Old Money. It may be very valuable. Send 10 cents for Illustrated Coin Value Book, 4x6. Get Posted. Guaranteed Prices. We Buy and Sell. Clarke Coin Office, LeRoy, N. Y.

50,000 GERMAN mark 5c. List free. American Exchange, 102 Popejoy, Iowa.

OLD Coins, Large Spring Selling catalogue of coins for sale free. Catalogue quoting prices paid for coins, ten cents. William Hesselein, 101A Tremont Street, Boston, Mass.

10 CONFEDERATE Bills 25c, 20 large foreign bills 25c, Colonial bill 1776 30c. Retail Catalogues free. Nagy, 8P South 18th, Philadelphia.

UNITED States. Two large cents, two-cent piece, and Bargain List, 20 cts, 12 different Foreign 25c. George Coffin, Greenwood Mountain, Me.

40 OLD coins, all different, \$1.00, 100 old coins, all different, \$3.00, Monroe Half-Dollar, Uncirculated, \$1.00, List Free. Claud Denney, Box 315, Dallas, Texas.

SELL by mail European Bonds, Money, Foreign Coins, Profitable Business, Literature free. Giant beginner's outfit \$1.00. Hirschex, 70 Wall St., New York.

CALIFORNIA gold, 3/4 size, 27c; 3/8 size, 53c; three-cent-piece and catalogue, 10c. Norman Shultz, Colorado Springs, Colo.

22 DIFFERENT foreign coins 50c, 20 different foreign notes 50c. Otto Oddehon, Independence, Mo.

SPECIAL—Eagle cent, white cent, 2c piece, 25c. Durso, 25 Mulberry, New York City.

UNITED STATES and Foreign Money, Medals, Catalogue and Villa Bill 10 cents. Alexis Mengelle, Colorado Springs, Colo.

CALIFORNIA gold Quarter 27c, Half 52c, Confederate \$100, 20c; 1776 Colonial bill 50c. A. Wylie, Wheaton, Ill.

FOR BOYS

FUN making things with the Boy Mechanic Library. Four large profusely illustrated books telling how to make almost everything from a sail boat to a toy automobile propelled by a motorcycle engine. Boys of any age can make these things with the crystal-clear illustrations and simple instructions in the Boy Mechanic books. Now \$2 per book or \$7 for the four if ordered at once. Send No Money. Just write a postal saying, "Send the Boy Mechanic Library." When the postman hands you the books, pay \$7 and postage. If you want single books, specify either Book 1, Book 2, Book 3, or Book 4. Popular Mechanics Press, Room 801, 200 E. Ontario St., Chicago, Ill.

AUTOMOBILE—Make your own motor car, toy size, operated with motorcycle engine. Any boy can make it. Costs little aside from engine. Full directions with drawings and dimensions in the Boy Mechanic, Book 3. Send No Money, just write a postal. Pay postman postage and \$2. Popular Mechanics Press, Room 801, 200 E. Ontario St., Chicago, Ill.

CAMERAS AND PHOTO SUPPLIES

KODAK films developed. Rolls or Packs, 5c. Prints any size 3c each. Velox paper used. Special: If order amounts to 50c and cash is included will make one 6x10 Enlargement from your favorite film free. Dalton's Developing Plant, 615 Newnan St., Jacksonville, Fla.

MODERN Photography in all its branches now taught by mail. New Successful Method. Students earning \$300.00 while learning. Big opportunity. Write for particulars and unusual offer open for short time. Dept. 3431, International Studios, Inc., 3601 Michigan Ave., Chicago.

HAVE You a Camera? Write for Free sample of our big magazine, showing how to make better pictures and earn money. American Photography, 116 Camera House, Boston, 17, Mass.

KODAK Films—Special trial offer: your next kodak film developed, 5c—prints, 2c each. Moser & Son, 1917 St. James Ave., Cincinnati.

TRIAL Offer! Roll developed and six prints 25c. Six prints from Negatives 20c. Enlargements from films and tinted in oil colors. 7x9 or 6x10, 75c. Klinkner Film Service, Dversville, Iowa.

KODAKS, 3/4-5/8 \$9; with astigmat lens \$18. Kodaks exchanged. Ray, 296 5th Ave., New York.

PHOTOGRAPHIC equipment and accessories of every description are listed and illustrated in our 228-page catalogue. It will pay you to secure a copy which is issued free, as our prices are low. We also deal in used goods which are sold under the same guarantee as new goods. Ask for our Bargain Book. Central Camera Co., Dent, E-101, 112 S. Wabash Ave., Chicago, Ill.

FILMS Developed. Special Trial Offer. Any Size Kodak film developed 5c, prints 3c each. Trial 6x10 Enlargement in handsome folder 40c. Overnight Service. Roanoke Photo Finishing Co., 209 Bell Ave., Roanoke, Va.

UNEXCELLED Gloss Prints. Trial Offer. Your Kodak Film developed and printed only 10c. F R B Photographers, Dept. "C," 1503 Lincoln Ave., Cincinnati, Ohio.

ROLL and Six Gloss, or Mat, pictures finished 25c. Reprints 3c. Art Studio, Dallas, Texas.

SEND Next Film to Johnson, Box 328, Redwing, Minnesota. Trial order 30c. Price List and Sample Free.

MOTION PICTURES

NEW \$150 Sept spring motor Movie Camera, leather case, 6 magazines, \$39.00. New Movie Projector, motor driven, also shows slides, \$85—Stereopticons and Slides, 5,000 reels Movie Films \$3 and \$5. Ray, 296 5th Ave., New York.

SEND 10c for the latest and greatest Bass Book of Cinema Apparatus; gives full description of all types of instruments as well as the list price. Or, send \$3.00 for a 500-page Cinema Hand Book containing full instructions of the making and taking of films. Bass Camera Company, 105 N. Dearborn St., Chicago, Ill.

\$\$\$ FOR Ideas. Photoplay plots accepted any form; revised, criticized, copyrighted, marketed. Advice free. Universal Scenario Corporation, 206 Security Bldg., Santa Monica and Western, Hollywood, Calif.

FILM—Million Feet for Sale. Cowboy—Drama—Comedy and Feature Specials. Mix—Hart—Chaplin and best Movie Stars. \$3.00 per reel up. Genuine List Free. We Supply the World. Dept. G, Monarch Films, Memphis, Tenn.

\$35.00 PROFIT nightly. Small capital starts you. No experience needed. Our machines are used and endorsed by government institutions. Catalog free. Atlas Moving Picture Company, 482 Morton Bldg., Chicago.

MOVIE films, 1,000 ft. reels. Complete stories, \$2.50 each; shipped anywhere on receipt of remittance with order. Independent Films, 177 Golden Gate Ave., San Francisco, Calif.

FILMS of every kind and character. Comedies—Westerns—Andy Gump Cartoons—Educational and Special Feature Subjects. Rock Bottom Prices. Wonderful Guaranteed List Free. Dixie Film Co., P. O. Box 407, Memphis, Tenn.

NEW and Rebuilt Machines for Big Theatres—Schools—Churches—Traveling Shows. Also Films—Supplies and Complete Theatre Equipments. Bargain List Free. Monarch Theatre Supply Co., Dept. P, Memphis, Tenn.

MAKE money writing photoplays; details free to beginners. No correspondence course. Producers League, 230 Wainwright, St. Louis.

POWERS projector, films, sale or trade. Rector Advertising Service, Marshall, Ill.

SCENERY TO RENT

SETTINGS for Opera, Plays, Minstrels. Plush drops. Address Amelia Grain, Philadelphia.

ARTISTIC Scenery for amateurs. Sale or rent. Easy to hang. Low cost. Enkebold Studios, Omaha, Nebr.

EDUCATIONAL AND INSTRUCTION

MAKE \$66 a Week and Up. Learn Bricklaying at home in spare time by the Job Analysis Method. We can train you in few months. Under our plan you actually work with bricks in back yard, garage, basement, attic, or barn. Course covers all units of construction, corners, angles, jamps, pilasters, etc. Also how to read blue prints and plan complete buildings. Free book, "The Quick Way to Big Pay Everyday," tells everything. Write for copy today. See page 72. The National School of Bricklaying, Dept. M-11, Ninth and G Streets, Washington, D. C.

BARBERING. Course in Modern Scientific Barbering. Learn at Home. Practice on the Family. Become Expert Barber. Complete Instruction Course. Practical. Scientifically Prepared. Worth \$10. Mailed for Only \$2 (Bill) or Money Order. Particulars Free. Foster, Expert Barber, Dept. A, 613 E. 60th St., Chicago, Ill.

YOU can have a business profession of your own and earn big income in service fees. A new system of foot correction; readily learned by anyone at home in a few weeks. Easy terms for training; openings everywhere with all the trade you can attend to. No capital required or goods to buy, no agency or soliciting. Address Stephenson Laboratory, 1 Back Bay, Boston, Mass.

ARTIFICIAL Marble sanitary flooring instructions, ornamental casting, concrete, plaster, papier-mache decorations, garden furniture, statuary, Rubber-moulds. 16 years' instructing the public, particulars and 200 illustrations free. Chris Mahler, Huntington, N. Y.

STUDY Microbiology. Earn \$300.00 a Month. Residential and Extension Course in Bacteriology, Sanitation. Diplomas, Degrees granted. 71 Piece Urinalysis Outfit Free to students. Write for Free Prospectus Today. International College of Microbiology, 7192 West Grand Ave., Chicago.

LEARN bricklaying in School run by 600 building contractors. No apprenticeship or age limit. Good demand for our graduates. Qualifies you to work anywhere. Associated Building Employers, 400 A. B. E. Building, Grand Rapids, Mich.

ELECTRICITY Made Simple; 233 pages, 108 illustrations, cloth. Reduced \$1.25. Ask catalog for home study. F. & B. Co., Hoboken, N. J., Dept. F.

LEARN Show card writing, Sign and House painting. C. B. Potter System of Instruction, 12007 Detroit Ave., Lakewood, Ohio.

WORLD-ROMIC System, Masterkey 5,000 languages. Primers \$1.98. Chinese, French, Spanish—Languages, 8 West 40th, New York.

WRITE for Newspapers. Good Money Paid Writers. Our Course Will Help You. Price \$1.50. John H. White, Shippensburg, Pa.

MARR'S Practical Bookkeeping or Simplified Shorthand, 25c. B605, Nashville, Tenn.

CARTOONING and Commercial Art, 25 lessons, 300 illustrations, 2 clothbound volumes and drawing outfit \$5 postpaid. Catalog Free. Nu-Way Art School, 176 Broadway, Brooklyn, N. Y.

USED educational matter of all kinds. Sold on repurchase basis. Big saving. Money-back guarantee. List free. (Courses bought.) Lee Mountain, Pisgah, Ala.

USED educational matter bought, sold, exchanged. Handling, 799 Broadway, New York.

USED educational matter. Lowest prices; terms. Catalog free. Mention Subject. Economy Educator, 440-A Sansome, San Francisco.

DOUBLE Entry Bookkeeping mastered in 60 hours with 8 keys; guaranteed; diplomas, International Bookkeeping Institute, Dent, 8, Springfield, Mo.

SHORTHAND in four evenings. Arthol course seven dollars. Sent approval. Particulars, Hollefreund's College, Stratford, Ontario, Canada.

RADIO OUTFITS AND SUPPLIES

LONG distance radio \$2.95. Lambert's newest crystal success. No tubes. No batteries. No grief. Always ready. Works 600 miles. Fully guaranteed. We pay postage. Order direct from this add. Leon Lambert, Wichita, Kans.

LOW loss Basket Weave coils and tuners for all radio sets. Send for literature. Davenport Radio Laboratories, Davenport, Iowa.

BUILD your own radio receiver. 150 page book, 75 photos, diagrams, and drawings. 75 cents. Bottum Bros., Tulare, S. Dak.

LONG Distance Crystal Sets \$2.85. Order Direct from This Add. Marko, 3027 Logan, Chicago, Ill.

LOUD Speaking Crystal Set. Broadcastings, heard throughout house. Easily constructed. Book diagram, 25c. Catalog free. Steinmetz Wireless Mfg. Co., Eastend, Pittsburgh, Pa.

RADIO and Electrical Supplies. Send for catalogue. Robert Bedford, Johnstown, N. Y.

TUBES 201A \$1.00, WD12, 199 \$1.35. Guaranteed. Send for money saver. Agents wanted. Kings Radio Sales, 1166 N. Kingshighway, St. Louis, Mo.

ATWATER-KENT 5-tube (new). Bargain. Write Simms, Lake, New York.

TRADE AND TECHNICAL SCHOOLS

MAKE \$65 A Week and Up. Learn bricklaying at home in spare time by the Job Analysis Method. We can train you in few months. Under our plan you actually work with brick in back yard, garage, basement, attic or barn. Course covers all units of construction, corners, angles, jambs, pilasters, etc. Also how to read blue prints and plan complete buildings. Free book, tells everything. Write for copy today, "The Quick Way to Big Pay Everyday." See page 72. The National School of Bricklaying, Dept. M-11, Ninth and G Streets, Washington, D. C.

DOUBLE your earning power. You can quickly become a foreman under my training. I teach you to read blue prints and take charge of work. Trained men are in demand. Write today—tell me your trade—I will show you how to succeed. Carroll Rumsey, 167 Drexel Building, Philadelphia.

TELEGRAPHY—Both Morse and Wireless—taught thoroughly and quickly. Tremendous demand. Big salaries. Wonderful opportunities. Expenses low; chance to earn part. School established fifty years. Catalog free. Dodge's Institute, Fern St., Valparaiso, Ind.

LEARN bricklaying in School run by 600 building contractors. No apprenticeship or age limit. Good demand for our graduates. Qualifies you to work anywhere. Associated Building Employers, 400 A. B. E. Building, Grand Rapids, Mich.

DO you want \$12 to \$20 per day? Learn now Sign Painting—Decorating Paper Hanging—Auto Painting, Show Card Writing. Catalog Free. Chicago Painting School, 148 W. Austin Ave., Chicago.

BUSINESS OPPORTUNITIES

PATENTS. Time counts in applying for patents. Don't risk delay in protecting your ideas. Send sketch or model for instructions or write for Free book, "How to Obtain a Patent" and "Record of Invention" form. No charge for information on how to proceed. Communications strictly confidential. Prompt, careful, efficient service. Clarence A. O'Brien, Registered Patent Attorney, 5899 Security Bank Building (directly across street from Patent Office), Washington, D. C. See pages 142 and 143.

\$5 TO \$15 daily to Introduce New Style Guaranteed Hosiery for men, women, children. No capital or experience required. Premium offer for every new customer. Pay you daily. You simply write orders, we deliver and collect. Samples furnished. 57 styles, 40 colors. Maccohee Textile Company, Card 2581, Cincinnati, Ohio.

MAKE These Big-selling Specialties Yourself! Free Interesting Literature explains how others will sell your goods. Chemist's Lists Guaranteed Reliable Money-making Formulas. All lines. No "Master Formula" Junk. Miller, Chemist, 1706-H Jetton, Tampa, Fla.

PATENTS Procured; Trade Marks Registered—A comprehensive, experienced, prompt service for the protection and development of your ideas. Preliminary advice gladly furnished without charge. Booklet of information and form for disclosing idea free on request. Richard B. Owen, 30-Owen Bldg., Washington, D. C., or 41-B Park Row, New York.

QUICK Profit. Honest, Guaranteed workable Mail Order Plans and complete instructions including detailed working specifications of plans that have made fortunes. Written by a fully competent and reliable authority, under bond. Mail Order Service, Box 93, Omaha, Nebr.

GOOD Steady profits derived from retinning business. Our process gives best results. Rusted ice cream and milk cans must be retinned. Callender, 2529 W. 48th, Chicago.

START mail order business of your own. Particulars free. Demuth Company, Englewood, N. J.

WANT more money? Get these new secrets of success. Remarkable methods give you greater earning power. Quick, positive, sure. Details free. Write today. Natural System Institute, 721P Olive, St. Louis.

MAKE big money. Safe and Lock Expert. Wayne Strong, 3706½ Lan Franco St., Los Angeles, Calif.

ARE you old at forty? See our advertisement on page 146 of this issue. The Electro Thermal Company, 2137 Main St., Steubenville, Ohio.

MAKE \$20 per 100, Stamping names on Keychecks. Send 25c for sample and instructions. J. Keytag Co., Cohoes, N. Y.

MIRRORS Re-Silvered at Home. Costs Less 5 cents per square foot; you charge 75 cents. Immense profits, plating autobarts, reflectors, tableware, stoves. Refinishing metalware, etc. Outfits furnished. Write for information. Sprinkle, Plater 127, Marion, Ind.

1,000 WAYS to make money. Hundreds trade secrets never before given away. Opportunities for big money. Two Dollars. Guy & Schenderline, Box 1213, Great Falls, Mont.

IGNITION shop in Cicero; only two other stations in town; population of 65,000. Selling for half of its yearly income. Act quickly—write F. J. Broz, 5500 W. 25th Street, Cicero.

FIVE different magazines and large premium package 10c. Donato Agency, 299 Willis Ave., New York.

SELL Copyrighted Business Plans by Mail. Enormous Profits. Particulars Free. Jerold Hinds, Monticello, Ill.

GO in Business for Yourself. Operate at home spare time. No canvassing. Very little capital required. Particulars free. Regal Service, 305-J 43rd, Kansas City, Mo.

BIG money made repairing burnt-out Radio Tubes. Instructions \$1.00. Duck Mfg. Co., Freeport, Ill.

VALUABLE mail-order information, etc., free. Write S. A. Van Auken, 34 Riehton, Detroit, Mich.

FREE Advertising rates. Newspapers, magazines. Guaranteed 100% agents' names \$5.00, 1,000. Pennell, Covington, Ky.

FOR territory and machine to manufacture 20,000 Eclipse Rubber Wrapping bands per hour of inner tubes, address C. B. Martin, 1129 Sixth N. W., Canton, Ohio. Small investment required.

BUILD splendid business making chipped glass number and name plates, signs, check-boards. Write for particulars. Simplex Utility Co., 1133 Broadway, New York.

SUCCEED With Your Own Products—Make them yourself. Formulas, Processes, Trade-Secrets. Modern master methods. Catalog free. B. Thaxly Co., Washington, D. C.

GET into the Mail Order Business. We furnish catalogs, merchandise, etc. Write for information. H. Reisman & Co., 551 Lake St., P. Chicago.

MAIL Order News contains latest money-making schemes, opportunities and suggestions showing big profits. Complete instructions how to start profitable Mail Order Business of your own. Everything explained. Sample copy of this big magazine 25c. None Free. Established 23 years. Mail Order News, 360 Bristol Bldg., New York.

GREATEST Plan ever devised to secure Big Mailing Lists, Live Agents, and Stream of Dimes. Complete Plan \$1.00. E. Wood, 81 Ryerson, Paterson, N. J.

15 TESTED Formulas Free. C. Bucknam, 63 Court St., Boston, Mass.

FREE Circular How to Start Business at Home. Neuroh, Box 249, Meadville, Pa.

PROSPECTING for Mail Order Dollars. Complete details of "How to Do It"—free. Walter Anderson, Dept. A, Villa Park, Ill.

100,000 REPRESENTATIVES Wanted! Sell by Mail, through Agents, or Direct! Detailed information—25c! None free. Surety Service, "Importers and Exporters," Desk A, 551 Harvard St., Rochester, N. Y.

START manufacturing. Machinery unnecessary. Progressive manufacturers now using my guaranteed formulas. Catalog Free. Thomas Lav, Chemist, Box 4012, Portland, Oreg.

PUBLISH a Magazine. Big profits. We furnish everything. Sample copy and full particulars 10c. White Mule Magazine, Brazil, N. D.

20,000 MARK German Government Bonds only one dollar; remit money order. Julius Lowitz, 213 S. Clark, Chicago, Ill. Established thirty-one years.

START a mail order business. Reliable, practical plan 25 cents. A winner. Morris Specialty Co., 2007 Park, St. Louis, Mo.

SHAKESPEARE complete, in one beautiful cloth-bound volume. Illustrated. 1227 pages. \$4.00 postpaid. Going fast! News, Holt, Minn.

WHY work for others? Make and sell your own goods. Formulas, toilet articles, perfumes, extracts. Catalog free. Nat'l Scientific Labs., 1904W Broad, Richmond, Va.

ENTER a new business. Earn \$3,000 to \$5,000 yearly in professional fees making and fitting a foot specialty, openings everywhere, with all the trade you can attend to; easily learned by anyone at home in a few weeks, at small expense; no further capital required, no goods to buy, job hunting, soliciting or agency. Address Stephenson Laboratory, (1) Back Bay, Boston, Mass.

SCHEMER, Alliance, Ohio, prints Big profit Schemes, one subscriber making \$25,000 from three; another \$10,000 from one. Try your luck. Three months, 30c; copy 10c.

MAIL Order Business is your opportunity. Brenner's Famous Handbooks teach how to start small, grow big. Sell merchandise, service, ideas; enormous profits. Spare time to begin. Get complete set, 11 books, \$3.00, and be posted. Brenner, 335 Walnut, Philadelphia. Descriptive Catalog and big batch interesting mail order information, 25c. None free.

\$3,000 TO \$6,000 Yearly. Want it? Others are making it. Send check or money order today for our invaluable books "How to Sell Real Estate," \$3.00—and "How to Conduct Real Estate and Insurance Business," \$1.50. Absolute satisfaction guaranteed. Free circulars. Realty Book Co., Dept. 52, Cleveland, Ohio.

UNPATENTED Ideas Can Be Sold. I tell you how and help you make the sale. Free particulars (Copyrighted). Write W. T. Greene, 810 Jenifer Building, Washington, D. C.

INVENTORS—Write for our Guide Book, "How to Get Your Patent" and Evidence of Invention Blank. Send model or sketch of your invention for our free Examination and Instructions. Randolph & Co., Dept. 435, Washington, D. C.

EARN \$10 daily silvering mirrors, plating and refinishing metalware, autos, chandeliers, bedsteads, headlights. Outfits furnished. E. Decie Laboratories, 1133 Broadway, New York.

WE Start You in Business, furnishing everything; men and women, \$30.00 to \$100.00 weekly operating our "New System Specialty Candy Factories" anywhere. Opportunity lifetime; booklet free. W. Hillier Ragdale, Drawer 4, East Orange, N. J.

ATTENTION! You can have a business of your own. Establish and operate New System Real Estate Business, brokerage and insurance agency in your community. Office at home. Earn \$5,000 year. Representatives wanted everywhere. Send stamp free booklet. Hayes Realty Association, Cincinnati, Ohio.

RESPONSIBLE manufacturer wants competent men to manage office and salesmen. \$300 to \$1,500 necessary; will allow expenses to Trenton if you qualify. Address Manager, 536 Forst Richey Bldg., Trenton, N. J.

A WORTHWHILE Mail-Order Business by new methods, quick sure, positive and big, is yours if you want it. Free circular gives latest information. MacRae, Publisher, M805 Oregonian Building, Portland, Ore.

MARBLE mixing instructions, covering wood or cement flooring $\frac{1}{2}$ in. thick, fire-proof, waterproof, low cost, sanitary, all colors. Particulars, 200 illustrations free. Chris. Mahler, Box 122, Huntington, N. Y.

CHEMICAL Expert furnishes Manufacturing Formulas and Processes with complete working directions. Reliable individual service only. No lists. Charges reasonable. Correspondence invited. Dr. Arthur VanHeelden, 508 South Oakley, Chicago.

COST \$5.00, your profit \$104.75. Transferring Decalcomania letters on autos, trunks, bags etc. Send today for outfit or free samples. World Monogram, Dept. 73, Newark, N. J.

MAKE Money at home or on large scale, casting toys and novelties, particulars free. New Specialty Co., 448 E. 79 st., New York.

I MADE \$30 a Week Home. French Breadmaking, 15 years' experience; Free Booklet tells. Ashbrook 67, Marengo, Ohio.

MAKE Money at Home—making toys. We show you how. Send \$1 for complete working drawings and instructions. DeKalb Designing Co., Decatur, Ga.

GET Money in Your Mail. "Lambert's Mail Order Secrets" contains successful methods never before published. \$1.00 post-paid. Particulars free. Leon Lambert, Wichita, Kans.

SIGNS and Showcards Easily painted with Letters Patterns. Large variety of Styles and Sizes. Sample for stamp. John Rahn, A2433 Greenview Ave., Chicago.

LEARN the collection business. Good income, quick results. Interesting booklet, "Skillful Collecting" free. National Collectors Assn., Long St., Newark, Ohio.

FREE Booklet describes 52 plans for making \$20.00 to \$100.00 weekly in home or office business of your own. Downs Co., 2323 Myrtle, St. Paul, Minn.

MAKE toys and novelties at home. Big profits. Instructions and illustrations, 25c. Astrolite Company, Sharpsburg, Pa.

CHEMICAL Expert will furnish Formulas and Trade Secrets. All lines. Lists Free. W. L. Cummings, Ph. D., 228 Gordon Ave., Syracuse, N. Y.

CLAIMS of Every Description Collected. Fidelity Credit Co., 802 East Clay, Richmond, Va.

PATENTBOOK, 139 mechanical movements and illustrations, sent free. Labinere, 3 Parkrow, New York.

GO into the Crispette business. Everybody likes Crispettes. You can make a lot of money. We start you. Write for facts. Long Eakins, 1959 High St., Springfield, Ohio.

\$13,955.00 IN 4 months. Wonderful Vapor Humidifier. All autos. One free to introduce. Critchlow, K-124, Wheaton, Ill.

MONEY-MAKING Opportunities—That big Mail Order and Agents' Monthly that is different—filled with plans, Formulas, and Valuable Money-Making Information. Three Months' trial subscription 25c (silver). Crittenden, 4132 West 21st Street, Chicago.

A MAIL-ORDER business of your own, selling movie patrons all year anywhere; free circulars. Wondo, M. 31 Times Plaza, Brooklyn, N. Y.

BATTERY Shop Equipment and Supplies at Wholesale. Adams-Barr, Columbus, Ohio.

\$50 WEEKLY. Your own Business. Enormous Profits. Mail Order Plan Sample 50c. Suydam, 10748 112th St., Richmond Hill, N. Y.

DOLLARS Yearly in your Backyard. No mushroom dope. Particulars free. Metz, 313 East 89th, New York.

MEN, 5 Home Business plans 25c cash for detailed information. R. Wittman, 1844 Waveland Ave., Chicago, Ill.

CORN Poppers—Money makers. Lowest priced small machines. Northsides Co., 1306 Fifth, Des Moines, Iowa.

START Your Business, Home Evenings. 24 Money-making Plans, 10c. De Luxe Chemical Service, Drawer D, Park Ridge, Ill.

START Candy Kitchen—Big Money. \$15.00 Course \$1.00. De Luxe Candy Shop, "Drawer D," Park Ridge, Ill.

COMPANIES organized. Financing. Write, Box 8-209, 311 Fifth Avenue, New York.

\$50 A WEEK. Mail Order business. Booklet tells how. Sample and plan 25c. Outfit furnished you free. Bradford Co., Dept. B, Shawnee, Okla.

MAIL Order Booklet, where to buy Books, Novelties, Specialties, 10c. Harvey Teeple, Decatur, Ind.

CHILDREN'S furniture anyone can make, six actual size patterns \$1.00. Kiddie Cabinet, 395 West 143rd St., New York.

10,000 FORMULAS. A real Gold Mine of money-making ideas. Tells how to make almost everything under the sun. You can make and sell cosmetics, muckilage, anti-freeze solutions, battery solutions, beverages, cheese, chewing gum, cleaning preparations, extracts, hair preparations, inks, blueing, leather polish, mirrors, perfumes, polishes, typewriter ribbons, carbon paper, washing powders, liquid soap, and hundreds of other profitable articles. Send No Money, just write a postal for "Henley's 20th Century Book of Formulas." Pay postman postage and \$1. Popular Mechanics Press, 209 E. Ontario St., Room 801, Chicago, Ill.

TELEGRAPHY

TELEGRAPHY—Both Morse and Wireless—taught thoroughly and quickly. Tremendous demand. Big salaries. Wonderful opportunities. Expenses low; chance to earn part. School established fifty years. Catalog free. Dodge's Institute, B St., Valparaiso, Ind.

WANTED—BUSINESSES FOR SALE

IF You Want to Sell Your Business for Cash quickly and privately, we take the prospective buyer directly to you at our expense, no matter where located. We specialize in selling out-of-town businesses. If your business is worth \$5,000 or more, write us. The Mutual Security System, 68 W. Washington St., Chicago.

CHEMISTRY

MANUFACTURING Processes, Analysis, Research. Robert Henderson, Consulting Chemist, Madison, Maine.

YOUR chemical problem solved and working process furnished Five Dollars. Write me. W. Stehman Richards, Consulting Chemist, address, Box 2402, Boston, Mass.

TECHNICAL information, analysis, formulas, trade secrets. Jacob Sluyter, Chemist, 313 East Second St., Davenport, Iowa.

MASTER Practical Chemical Analysis by my Chart Method, \$3.00. Your chemical problem solved, \$2.00. Henry Goldblatt, 1502 S. Lawndale Ave., Chicago, Ill.

EXPERIMENTERS laboratory apparatus. Chemicals, Radio. Catalog 5c. Chemical Apparatus Co., 4402 West End, Chicago.

FORMULAS AND TRADE SECRETS

1,000 SHAVES from 12 Blades. No honing, stropping. Secret 25c. Barber, Box 1278, San Francisco.

CONCRETE Waterproofing Processes, making Hard, Light Colored, Dampproof concrete building blocks. Concrete Machine Co., 5 Main St., St. Louis, Mo.

SAWDUST, Chemicals make sanitary flooring. Directions \$2.00. Universal Supply Co., Auburn, N. Y.

WE solve Chemical problems, furnish tested formulas or analyze your samples. Research Laboratories, Washington & Williams St., Roxbury, Mass.

TESTED and Guaranteed formulas. Chemical analysis for duplication. Roxbury Laboratories, 11 Williams St., Roxbury, Mass.

FORMULAS; Beverages, Syrups, extracts, flavors and other manufacturing specialties. Free information. The Formula Co., 1613 Queen Anne Ave., Seattle, Wash.

WONDERFUL money-making formulas 25c. No Stamps. Mazza, VanBuren, Ark.

3,000 VALUABLE Formulas and Recipes, for \$1.00. E. Kephart, Box 34, Station Y, New York City.

SUCCEED With Your Own Products—Make them yourself. Formulas, Processes, Trade-Secrets. Modern master methods. Catalog free. B. Thaxly Co., Washington, D. C.

FORMULAS. Best Chemical Science can devise. Stamp brings big bunch valuable literature describing Guaranteed Reliable Processes for manufacturing all lines. Don't buy till you've seen these valuable lists, 28 years supplying the Best. Miller, Chemist, 1706-F Jetton, Tampa, Fla.

RESILVERING Mirrors—100 Money-making Formulas 20c. Catalog free with order. De Luxe Chemical Service, Drawer D, Park Ridge, Ill.

WHY work for others? Make and sell your own goods. Formulas, toilet articles, perfumes, extracts. Catalog free. Nat'l Scientific Labs., 1904W Broad, Richmond, Va.

500 FORMULAS—, including Luminous Paint—Renewing Dry Batteries—Mechanics' Soap—Gas Tonic—25c. Catalog Free. Ideal Book Shop, 4805-F, North Robey, Chicago.

10,000 FORMULAS; 800 pages; \$3.98. Money refunded if dissatisfied. Ideal Book Shop, 4805-F, North Robey, Chicago.

500 VALUABLE Formulas, 25c. Circular Free. Harvey Teeple, Decatur, Ind.

10,000 FORMULAS. A real Gold Mine of money-making ideas. Tells how to make almost everything under the sun. You can make and sell Cosmetics, muckilage, anti-freeze solutions, battery solutions, beverages, cheese, chewing gum, cleaning preparations, extracts, hair preparations, inks, blueing, leather polish, mirrors, perfumes, polishes, typewriter ribbons, carbon paper, washing powders, liquid soap, and hundreds of other profitable articles. Send No Money, just write a postal and ask for Henley's 20th Century Book of Formulas. When the postman hands you the book, pay the few cents postage and \$1. Money back if you are not delighted. Popular Mechanics Press, 209 E. Ontario St., Room 801, Chicago, Ill.

AGENTS WANTED

NO Dull Times in the Food Business. Selling Federal Pure Food Products is the greatest, surest and safest business in the world today, and here is your opportunity to get into it. You can make \$3,000, \$5,000, \$10,000, or more per year—the only limit is your ability to take care of the business. You will need no experience or money to get into this business. Your \$20.00 starting order sent on trust. We teach you everything you need to know. We furnish you with license. No Dull Times, for the People Must Eat, and our food products are the fastest selling, surest and quickest repeat order goods in the world. Sell on sight in every home where food is used—repeat orders immediately and every week thereafter. A real big business all your own. Every new customer adds a great deal to your weekly income. Your business once established, has a market value just like a store and can be easily sold. The greatest money-making opportunity of your lifetime because you risk absolutely nothing, as we guarantee your sales, and we will not let you fail. Remember! Guaranteed! Best products, biggest sellers, surest repeat orders. No capital or experience is required. We furnish capital and everything necessary for you to become a Federal Distributor. Exclusive territory will be given honest men or women who write at once. Federal Pure Food Company, 2309 Archer Avenue, Dept. A, Chicago, Ill. Largest packers of Pure Food specialties in the world. Reference, any bank, Dun or Bradstreet rating agency, Express or Railway Company in America.

DISTRICT Agents—For Union Made pure wool suits and topcoats retailing at \$23.50, none higher. A remarkable line of 45 beautiful fabrics tailored by a large and well known old established firm, sold only thru our own stores and district agents. A real opportunity for any good man. Big money to start and chance for advancement. We furnish large sale outfit, 9x13 cloth samples. Men over 30 years of age with tailoring or clothing experience preferred. Can use ambitious spare time men in smaller towns. Interested only in serious men who seek a future. Write for free samples and full information. Address M. V. Harvey, Mfr., Box 00, Chicago.

DISTRICT Agents—For Union Made pure wool suits and topcoats retailing at \$23.50, none higher. A remarkable line of 45 beautiful fabrics tailored by a large and well known old established firm, sold only thru our own stores and district agents. A real opportunity for any good man. Big money to start and chance for advancement. We furnish large sale outfit, 9x13 cloth samples. Men over 30 years of age with tailoring or clothing experience preferred. Can use ambitious spare time men in smaller towns. Interested only in serious men who seek a future. Write for free sample and full information. Address M. T. Harvey, Mfr., Box 00, Chicago.

I WANT a Partner-Agent to take care of my business in your town. I furnish everything including the world's finest line of 175 household products, and split the total selling price with you 50-50. Beautiful sample outfit makes selling easy. Toilet Preparations, Food Products, etc. Highest quality—lowest prices—quick sales—permanent repeat business. I pay largest commissions in this line and offer free Chrysler or Hudson Coach besides. Get my amazing offer quick. Address me personally. Sidney F. Mills, Director of Sales, Heathco-Products Co., Dept. AK-1, 117 Duane St., Cincinnati, Ohio.

WHAT Are you seeking? Are you tired of being tied where you realize no increase in your returns from year to year? We want men who really want to build into a good, sound, growing business for themselves. Men of character who will honestly hustle for just and liberal and ever-increasing returns. Men who merit real co-operation from company of world-wide reputation and established integrity. All negotiations confidential—write Business Promotion Manager, 650 N. Meridian St., Indianapolis, U.S.A.

BIG Money Selling "Jiffy Tire & Tube Repair Kit." Contains 3 Self-vulcanizing Tire Shoes; Large Outfit Tube Patch; 3 Puncture sealers, everything complete. Sells to every auto owner and Accessory Dealer. Agents average \$80 to \$100 weekly. We also manufacture Nationally known "Jiffy Tire-Doh." Exclusive territory and free samples. Chicago Tire Patch Co., 347-65 E. 55th St., Chicago, Ill.

FREE—Get This Quick! Chicago's Wonder Shirt line. Sell newest, stylish, snappy, Stylemor Shirts. Amazing values at low prices. Make \$100.00 weekly easy. Complete assortment of large swatches makes selling Stylemor Shirts a cinch. Experience or capital unnecessary. Be your own boss. We will show you how to build a big business of your own. We will deliver and collect. Exclusive territory open. Write today, for big free outfit. Stylemor, 81 W. Van Buren, Chicago, Ill. Dept. 1000.

SALESMEN wanted in exclusive territories by an old established concern, to call on factories, hospitals, schools, department stores, institutions, cemeteries and public buildings. Wonderful advertising co-operation. Proposition will pay from four to ten thousand a year to right man. C. B. Dolge Company, Westport, Conn., Sales Department.

AGENTS—Why Work for Others? Make Fastest selling Auto Supplies yourself: Gas Tablets, Anti-Freeze, Auto Polish, Carbon Remover, Radiator Cement, Magic Windshield Compound, Tire Repairs, Etc. Few dollars buys ten Secret Formulas. Complete instructions and all materials. Mixing easy. No special equipment. Enormous Profits from start. Write for details. General Motor Supply Co., Box 102, LaCrosse, Wis.

AGENTS! Amazing Liquid Thread darns, sox neater, stronger, in one-tenth ordinary time. Mends all fabrics invisibly! Stands washing, boiling, ironing, 50c tube. 32c profit. Men sell 100 daily. Make \$3.20 on every \$5. Amazing money maker. Facts Free. Write New Way Laboratories, Dept. A-100, Mt. Healthy, Ohio.

PENNANTS and Pillows: Colleges, Schools, Clubs Lodges. Students and agents get busy. American Pennant Co., 66 Hancock St., Boston, Mass.

TAKE orders for Shirts and Overalls. Big profits. Work full or spare time. No experience required. Big variety dress shirts with splendid line Union-made work and flannel shirts, overalls, coveralls, work pants, sheep-lined coats, leather coats and vests. Write today for free selling outfit. The Nimrod Shirt Co., Dept. 8, 4922-24-26-28 Lincoln Ave., Chicago.

GIVE Away finest laundry soap Free. You'll make \$10 daily easy by new selling plan. Big repeat business. Write quick. Wolverine Soap Co., 28 Wolverine Bldg., Grand Rapids, Mich.

BIG Money monogramming autos, trunks, bags, etc. Make \$20 to \$25 daily. No experience needed. Samples, information free. Acme Products, 995 Broad, Newark, N. J.

CREATE Mail Order or Local Business. New Simple Plan Gets Money—Easily, Quickly, Steadily, Surely. Particulars Free. Edw. Burke, 733 Nineteen, Oakland, Calif.

REPRESENT National Real Estate Organization in your district. Particulars upon request. Large earnings possible, experience not essential. VLCCo., 987 Union Trust Bldg., Pittsburgh, Pa.

MAKE 18,000 miles without a puncture. Inside Tyres positively prevent punctures and blowouts. Double tire mileage, any tire, old or new. Use over and over again. Low priced. Agents wanted. Write for terms. American Accessories Co., Dept. 378, Cincinnati, Ohio.

\$2.00 EVERY hour you work. Wonderful opportunity to build permanent, profitable repeat business. Demand big for our guaranteed every day household necessities. Sales plans and free premium offers make Sales easy. Million dollar organization. Established 17 years. Write for Samples, particulars. Furst-McNess, Dept. PM, Freeport, Ill.

AGENTS—Can earn \$100.00 and upwards weekly, selling the Gold Medal five-tube Tuned Radio Frequency set at \$25.00. "The Set that stormed the country," built for the home of moderate means. The Farmer, Clerk, Laborer and Lady of the home ought to buy it on sight. Write today for proposition and exclusive territory. Eureka Outlet Corp., Desk PM, 798 Southern Blvd., New York City.

275,000 ARTICLES at Wholesale. Where to buy everything at rock bottom prices. Latest most complete directory published. Postpaid \$1. Circular Free. Harriann Trading Company, Dept. PD, 162 East 23rd Street, New York City.

MAN in each town to plate auto parts, reflectors, bathroom fixtures, refinish beds, mirrors, chandeliers; by new method. No capital or experience required. Simple plan of manufacturing at home starts you in big money-making business. Outfit furnished. Free particulars and proofs. Gun Metal Co., Ave. H, Decatur, Ill.

PATENTS. Time counts in applying for patents. Don't risk delay in protecting your ideas. Send sketch or model for instructions or write for Free book "How to Obtain a Patent" and Record of Invention" form. No charge for information on how to proceed. Communications strictly confidential. Prompt, careful, efficient service. Clarence A. O'Brien, Registered Patent Attorney, 5899 Security Bank Building (directly across street from Patent Office), Washington, D. C. See pages 142 and 143.

WHIRLWIND sellers for agents. Details for stamp. Russell Johnson, Clarkfield, Minn.

25,000 SPECIALTY Agents (or Mail Order Men). Information 20c. F. G. Brigen, 67 Roslyn St., Rochester, N. Y.

FOUNTAIN Pen, Guaranteed, \$1.00—Free with 30—10c bottles. Send \$3. Springfield Perfume Co., Springfield, Mass.

\$1.25 SAMPLE Free to hustlers. Details 10c. Mellberg, 340 Newton North, Minneapolis.

IF We Give You shoes made-to-your measure in any one 60 leathers, 50 different styles, will you keep them, wear them, show them to your friends as sample of our \$10 Made-To-Order shoes to sell at \$6.85? Advise us today. Your complete outfit will go forward absolutely free at once. Dept. 2000, Tailor-Made Shoe System, 45 S. Wells, Chicago.

EASY Money and Quick Sales applying Gold Initials to automobiles. Many buyers waiting. \$1.35 profit on \$1.50 sale. Particulars and samples free. Write quick. Evans Products Company, 32 Gilman St., Hartford, Conn.

BE independent. Make—Sell your own specialties. Immense profits. Catalog dependable Formulas, special selected. Agent's best sellers Free. M. Lusto, 832 East Pershing, Chicago.

AGENTS—\$75 to \$150 Weekly to Introduce "Chieftain," 3 for \$4.95. Guaranteed Tailored Shirts. Samples and full working outfit free. Your Pay Daily. Cincinnati Shirt Company, Secy. 1581, Cincinnati, Ohio.

AGENTS Wanted—Something new—Fyr-Fyter sells easily. Makes a spectacular demonstration; car owners, homes, factories, stores, practically buy on sight. Our men make \$10 to \$50 a day. Exclusive territory to producers. If you wish to establish a business of your own with unlimited possibilities for making big money, write us today. Fyr-Fyter Co., 998 Fyr-Fyter Bldg., Dayton, Ohio.

AGENTS—30% commission. Full line glove silk lingerie and guaranteed hosiery, mill to wearer lowest prices. Get particulars. Wright Hosiery Mills, Philadelphia, Pa.

AGENTS—Shine-Brite Polishing Cloth polishes all metals. Sample free. Knoll Products, Box 532, Kankakee, Ill.

GOLD-LEAP Sign Letters; make and sell; 1,000% profits. Particulars, Johnston Co., Quincy, Ill.

2,000 YEAR calendar, large profits; sample and particulars 25c. Nassau Specialty Co., Hempstead, N. Y.

AGENTS—Men and Women—send for particulars. J. W. Danielski, P. O. Box 2163, Manila, P. I.

BE your own boss. Men and women make big Christmas money selling our men's neckwear; sell on sight; big profits. Tyrite Neckties, 515 Ridge Bldg., Kansas City, Mo.

AGENTS make 500% profit handling auto monograms, sign letters, Novelty signs, etc. Catalog free. Hinton Co., 122 E. 58th St., Chicago, Ill.

SIGN letters for sign men; never tarnish. Samples free. Monroe Sign Corporation, New Haven, Conn.

AGENTS—Sell Handyholder. Other Useful Household Articles. Handyholder Company, 505, Baltimore, Md.

SELL Fine Made-To-Order All Wool Suits at \$31.50. Regular \$55 Values. Over 100 6x9 Cloth Samples. All One Price. Furnished. Hustlers Earn \$100 Weekly. Write W. Z. Gibson, Inc., 161 W. Harrison St., Dept. N-517, Chicago, Ill.

SELL by Mail! Big Profits! Books, Formulas, Novelties, Bargains. Particulars Free! Elfeo, 523 South Dearborn Street, Chicago.

AGENTS—\$100 week; no experience; genuine gold leaf sign letters and script. Consolidated Co., 636 S. Dearborn, Chicago.

BRAND New Household Specialty. Enormous demand, big profits; sure repeater. F. Jordan, Box 614, Seguin, Texas.

PORTRAITS, photo pillow tops, frames, sheet pictures, medallions, merchant's signs, food products, photo jewelry, guaranteed hose, toilet requisites, luminous crucifixes. Catalog 50 specialties free. 30 days' credit. Jas. C. Bailey Co., Sta. C, Chicago.

MAKE \$75-\$100 Weekly. Famous Sun-lite household products; Big Quantity Seller; You risk nothing. Your money back for every unsold item. Amazing offer-free. Summit Specialty, Union City, N. J.

AGENTS—Sell 40 packages Chewing Gum 5 cents package. You Keep \$1.00. Send us \$1.00. Acheson, 2233 West Cary, Richmond, Va.

\$400 TO \$500 a month easily earned selling New Guaranteed Auto Discovery. Nothing else like it. Big demand; sure repeater. Free folder explains; get it today. Boone Specialty Co., Dept. 327a, Boone, Iowa.

COLLECTS Money from the Dead-Beats. Retail \$5.00—Cost \$1.00—Profit \$4.00. "New Method." Every Storekeeper, Doctor buys quickly. Wonderful Money Getter. Federal Association, Hartford, Conn.

AGENTS—90c an hour to advertise and distribute samples to consumer. Write quick for territory and particulars. American Products Co., American Bldg., Cincinnati, Ohio.

WANTED More Agents—To sell Apex Powdered Soap and also Apex Bleacher. Exclusive territories given to proper parties. Our goods sold on a money-back guarantee. Over 75,000 satisfied users boost Apex products. Write for details to Apex Distributing Corp., 545-47 3rd Ave., Pittsburgh, Pa.

REPLATE brass worn-off Automobile parts. Reflectors, Bath Room Fixtures, Worn spoons, Forks, etc., with pure silver. Looks like new. Use U-Kan-Plate Polish. Positively no mercury. \$1.00 half pint Postpaid. Satisfaction Guaranteed. Agents wanted. Dept. A, U-Kan-Plate Co., Philadelphia.

BRING Home the Bacon—selling Stuart's Stain Remover. Removes ink, iron rust, grass and fruit stains. Write for free samples and terms today. C. H. Stuart & Co., 5867 Main, Newark, N. Y.

\$20 DAILY selling Ver-I-Ezy Shoes direct to men or boys in your county. Quick sellers. Low priced. Just take orders; we mail shoes direct. Big cash profit and repeats. Territory protected. Best season now. Write quick, Dept. 229, Easy-Wear Shoe Co., Indianapolis, Ind.

WHY work for others? Make and sell your own goods. Formulas, toilet articles, perfumes, extracts. Catalog free. Nat'l Scientific Lab., 1904W Broad, Richmond, Va.

66 MILES on 1 Gallon. Scientific Gas Saver. All autos. One free to introduce. Critchlow, L-124, Wheaton, Ill.

SELL Radio tubes direct to owners of radio sets. Big profits. Full information on request. Acme Products Co., 901 Broad, Newark, N. J.

AGENT makes \$57 a day driving nails in fire! Amazing discovery heals all punctures—one tire was punctured 857 times without a leak. Send for free Sample Offer. O. S. Nelson, A-3025 Logan Bldg., Mitchell, S. Dak.

RADIO Gas Lighters are biggest 25c sellers in country. Every gas user buys one or more instantly; 300% profit. Enclose \$1.00 sample dozen or \$10 gross, including selling plans. M. Masterlite Co., 110 East 23rd St., New York. (Manufacturers famous Masterlite Pocket Cigar Lighter.)

AGENTS wanted to sell to Retail Stores our fancy signs; three colors, shaded with airbrush, great variety. C. Pohlmann, 929 Second Avenue, New York.

AGENTS: No competition selling specialties, guaranteed to satisfy, only \$3.98. Pay daily. We deliver, collect. Nearly everybody buys. \$10.00—\$25.00 daily easy. True-Fit Optical Co., CW105, 1528 W. Adams St., Chicago.

WHY Buy Other's Goods? Start your own profitable business, making them. Free valuable literature tells how, including Chemist's Interesting Lists Guaranteed Reliable Formulas for Latest Specialties. Miller, Chemist, 1706-K Jetton, Tampa, Fla.

DON'T Buy so-called "Master Formulas" (old recipe-book-stock-formulas). Get this Free, Interesting, Valuable literature describing Latest, Guaranteed, Special Manufacturer's Formulas for all lines latest specialties. Miller, Chemist, 1706 Jetton-G, Tampa, Fla.

AGENTS: \$11.80 Daily in advance! Send for sworn proof! Introducing New Insured Hosiery. 57 styles, 40 colors, guaranteed seven months. No capital or experience required. You simply take orders. We deliver and collect (or you can deliver, suit yourself). Credit given. Pay you daily, monthly bonus besides. 1926 line now ready. We furnish samples. Spare time will do. M. H. Mathews, Card 5861, Cincinnati, Ohio.

IF you want good live agents—fellows who can get the business—ask me how others are doing it. I'll gladly render the necessary assistance. M. L. Rund, Mgr. Classified Advertising, Popular Mechanics Magazine, Chicago.

USE No Liquid, Paste, Powder. New, Prepared Cloth Cleans all metals—Just (1) Rub. Retalls 25c, cost 10c (Dozen in Display Carton). "Sample Free." NuLife Metal, Hartford, Conn.

VEST Pocket Radio. Not a toy. Amazing Xmas seller. Retail \$1.50. Your price \$8.50 dozen. Sample \$1.00. 30-mile tuning. Satisfaction guaranteed. A-Tri-angle Products, 506 W. 45th St., Chicago.

PORTRAIT Agents: Send for prices. Pictures where improvement is necessary a Specialty. Wickersham, 1018 N. Mayfield Ave., Chicago.

ATTABOY—Pung Chow and Joker, Greatest Amusement games ever played on Billiard or Pool Table. Brooks Mfg. Co., 1185 44th Street, Brooklyn, N. Y.

MAKE Real Money Easy selling Type-writers at less than half price. Confidential terms free. Typewriter Sales Co., Ada, Okla.

SUCCEED With Your Own Products—Make them yourself. Formulas, Processes, Trade-Secrets. Modern master methods. Catalog free. B. Thaxly Co., Washington, D. C.

AGENTS for Dud's Gas; cleans stone, brick, tile buildings; wire, prism, frosted, leaded glass; fortunes being made. S. Hamton, 2395 Grand Ave., New York.

AGENTS—Just out. 10 new household specialties; tremendous sellers; 100%—200% profit; \$50 weekly easy. Send for particulars. Honsaker, Masontown, Pa.

AGENTS, Mail Order Men—Beginners. Write today. Wonderful New Plan. Gets Money Easily. Quickly. Steadily. Particulars. Sample Free. Sterling, P. O. Box 539, Kansas City, Mo.

ARTICLE costs 5c, sells quickly for dollar. Particulars free. Baggs, 3239 Archer Ave., Chicago, Ill.

AGENTS—Make a dollar an hour. Sell new kind of sharpeners. Sharpens all knives and tools quickly. Demonstrating sample free. Premier Mfg. Company, Dept. 62, Detroit, Mich.

\$50,000. PICTURE Man Friedman made canvassing. Beginners can make \$100.00 weekly with my sales talk. Experienced men make more. Free book "Profits in Portraits" explains. Samples Free. Picture Man Friedman, Dept. 8-C, 541 W. Lake, Chicago.

AWAY Ahead of Every Thing Else! That's "Zippo" as a seller. Show your sample, talk a minute and pocket your profit. A real Sure-Fire, He-Man Money-Getter that repeats—and say, Boy, it actually sells on a ten second Show-Down. If we didn't know we had a proposition that any man could sell eight out of every ten calls, you can bet your sweet life we wouldn't spend money telling you about it. Karam-Smith, 601 F Street, Ft. Wayne, Ind.

AGENTS—\$90 a Week—\$2 to \$5 an hour spare time. Make this with the celebrated line of Ho-Ro-Co Soaps, perfumes, toilet articles and specialties; over 200 items. Big profit makers. La-Em-Strait Hair Dressing selling like hot cakes. Write for Free Sample Case offer. Ho-Ro-Co Mfg. Co., 781 Ho-Ro-Co Bldg., St. Louis, Mo.

AGENTS, Salesmen—Sell New Thermostatic Automatic Carburetor Control Attachment for Fords. Big profit, full or part time. Burns 95% air. Doubles Mileage. Attached in 2 minutes. No drilling. Does automatically exactly what Ford manual says do by hand. Cadillac now using Thermostatic Carburetor Control under Blanche license. Write today. A. C. Blanche & Co., Dept. 805AX, 602 Lake St., Chicago.

AGENTS: New Selling Plan! \$1.25 premium free to every customer on a \$2.00 sale, consisting of 8-oz. Vanilla, 6-oz. Shampoo 4-oz. Lemon Lotion. A big hit everywhere. Complete details free. Territory going fast. Write today. The C. I. Togstad Company, Dept. 18A, 29 South Clinton St., Chicago, Ill.

\$8.50 TO \$20.00 daily easy. Introducing New Insured Hosiery for men, women, children. 57 styles, 40 colors. Must wear or replaced free. Repeat orders sure. Nyland made \$595 one month. Edwards, \$460.60. Mrs. Boe, \$445.25. Why not you? Even spare time work should pay you \$3 per hour. Your Pay Daily in Advance. We deliver and collect. You spend all your time writing orders. No experience or capital needed. We furnish samples. All grades, colors including silks. No matter what you are now selling, it will pay you to get our offer. Maccabee Textile Company, Card 2561, Cincinnati, Ohio.

DISTRICT Salesman: Must be reliable. Prefer married man, 30 years old or over and permanent resident in his community. Exceptional opportunity for good man. Address Sales Manager, Dept. 101, 844 West Adams Street, Chicago.

ANY man handy with paint brush can start furniture refinishing, job painting, handyman shop on nearly nothing; mostly all profit; experience not needed; winning plan brings customers quickly. John Brace-land, 1457 So. Ninth, Philadelphia, Pa.

NEW Specialty costs 16c. Sells for 50c. Real \$1.00 value. Astonishing profits daily with our 40 Big Profit Sellers. Write quick for new selling plan and Free Agent's Outfit. General Products Co., Dept. 7N, Newark, N. J.

OVER 100% Profit, Self-Lighting Gas and Cigar Lighters. Everybody interested; repeat business. Sell individuals, dealers, subagents. Particulars Free. P. Bernhardt, 148 Chambers St., New York.

\$110 WEEKLY selling finest guaranteed union made to measure men's suits only \$12.50; boys' two-pants suits \$10.95. Six Latest Patterns that sell on sight. Also all-wool overcoats, vests, caps, riding breeches. Big commissions advanced. Free attractive outfit. Double Service Manufacturers, 1327-35 AF, Washington, Chicago.

AGENTS, everywhere, take orders for leather vests, sheep-lined Coats, Raincoats, Lumber Jackets, Sweaters, Shirts, Men's Underwear, Pants. Big Commissions daily; particulars free. Northern Sales Co., Dept. 231, Northern Office Bldg., Chicago.

WE pay \$48 a week, furnish auto and expenses to introduce our Soap and Washing Powder. Bus-Beach Company, Dept. A42, Chippewa Falls, Wis.

AGENTS—100% Obesity Soap guaranteed to reduce fat people. Twenty other brands honestly medicated Soaps. Easy Sellers. Columbia Laboratories, 18 Columbia Heights, Brooklyn, N. Y.

AGENTS: Full or spare time—to sell hand painted scarfs, dollies, pillows. Extremely low priced. A wonderful new process. Our agents are cleaning up. Paintographs practically sell themselves. Write for full particulars of liberal agency offer and circulars describing Paintographs today. Bradford's Paintographs, Inc., St. Joseph, Mich.

300% PROFIT; Sells Like Wildfire. "Solidified Coconut Oil Shampoo". Gross weighs 10 pounds. All shipments prepaid. Distributing Samples Free. Write Quick. Bestever Products Co., 1941-KS Irving Park, Chicago.

TURN your spare time into dollars selling Polmet Polishing Cloth that cleans all metals without liquid, paste or powder. Retail 25c. Our agents say it sells like "hot-cakes." Prove it yourself with free sample sent on request. F. C. Gale Co., 122 Edinboro St., Boston.

HERE'S your chance! Make \$50 to \$100 weekly in our business—honest, clean easy profit. We furnish everything but the elbowgrease and grit. Quarter brings details. Cooperative, 1659 North Ave., Chicago.

SELL Blue Seal Duplicators. Easy, profitable. Copies typewriting, handwrit-ing, drawings, music; five colors. Remit \$3.35 for letter size sample (retails \$4.50). Argus Manufacturing Co., 63 Park Place, New York.

GET into women's shoe game. No investment. Main or side line. Big money. Style-Arch Shoe Co., Dept. B4, Cincinnati, Ohio.

GENERAL Distributors, Agents, Salesmen—Send for our live wire proposition and sample. Exclusive territory to workers. See our display ad on page 170. Wallace Rim Tool Mfg. Co.

LIVE wires, are you looking for big money? Steam-No-More for Rain, Sleet, Steam, etc., on Automobiles, Windows; repeater; send 10c for 25c tube. Grayco, Box 535E, Port Huron, Mich.

MANUFACTURER'S Agents and Salesmen to sell Spray Finishing Equipments to Factories—Public Institutions—Garages—Paint Contractors. Factory established 20 years. Four Factory Branches—National Distribution. Big Financial Rating. Ask any Banker. Paasche Air Brush Co., 1900 Diversey Blvd., Chicago, Ill.

GREATEST Direct Selling Lingerie—Hosiery Plan ever offered agents. Possibilities \$100 up weekly. Placing 100 Men—Women Now. Write Vanizette, 202H Dartmouth, Boston.

GREATEST Sensation of the specialty world. Over 1,000 genuine embossed Display Signs for retail merchants. Write for information. Artistic Signs, 799-E Broadway, New York.

FREE! 25c Chemical Windshield Rain Cloths. Box 265, Station C, Los Angeles, Calif.

KING TUT'S Alive. Electrical Mystery 10c. Box 265, Station C, Los Angeles, Calif.

FREE! Metal Polishing Dryless Cloths. Lowest prices. Sample. No pastes, powders, liquids. Box 265, Station C, Los Angeles, Calif.

SALESMEN and Distributors: Supply Hardware, Clothing, Department Stores, etc. New Patented device needed by all men. Quick repeater. Dignified business. Nelson Manufacturing Company, 35 New Montgomery Street, San Francisco.

MANUFACTURE lamb wool polishers, dusters. Newhall, 85 Court, Brooklyn, N. Y.

NEW Patent Fibre Broom Sweeps. Scrubs, Dusts, Mops. 100% Profit. Free Sample. National Fibre Broom Co., St. Louis, Mo.

IMMEDIATE Profits in advance selling Vitalized Heat Pads, made in the Land of Sunshine. Replace hot water bottles and electric pads. Sell on sight. Write for proposition. Dept. PM, Radiant Mfg. Co., San Antonio, Texas.

BUILD your own Business! Free Valuable Literature explains how you can easily make your own Goods—have others selling them. Miller, Chemist, 1706-A Jetton, Tampa, Fla.

YOU Get Our Knitter Free. Help—Sell 16 doz. Men's All-Wool Socks to friends and stores. Wholesale \$9 doz. or send 75c for salesman's sample. Try-On Knitter, Dept. 323, Lowell, Mass.

WONDERFUL invention. Eliminates phonograph needles. Preserves records. Abolishes scratching. 14,000,000 prospects. \$20 daily. Supply in pocket. Sample on approval if requested. Everplay, Desk B-1, McClurg Bldg., Chicago.

AGENTS, Salesmen—Make real money selling the newest accessory for automobiles. Provides safety in night driving. Three dollars in every sale. Exclusive distribution in your territory. Write quick. Tiffany Mfg. Co., Newark, N. J.

SELL Lawlite Deflector Shields to motorists, garages, etc. Makes any headlight legal. 100% profit collected as sold. Get details immediately. Lawlite Company, Dept. B, 396 Greenwich Street, New York City.

WHY work for others? Make and sell your own goods. Formulas, toilet articles, perfumes, extracts. Catalog free. Nat'l Scientific Lab., 1904W Broad, Richmond, Va.

MAKES Autos Run like on cool, moist night. Wonderful Vapor Humidifier. One free to introduce. Critchlow, M-124, Wheaton, Ill.

AGENTS—\$240 a month. Take orders for well known line of household specialties, food flavors, toilet preparations, etc. Full or spare time. Build a big permanent business. Must satisfy or money back. Write for free sample Outfit and offer. C. H. Stuart & Co., 5567 Main, Newark, N. Y.

BUILD splendid business making chipped glass number and name plates, signs, check-boards. Write for particulars. Simplex Utility Co., 1133 Broadway, New York.

LEARN while earning \$10,000 with fast-selling auto devices on market. Be financially independent. Mashken, Indiana Harbor, Ind.

MARVELOUS New Invention. 400% Profit. Liquid Quick Mend for hosiery and fabrics. Tremendous demand. Over hundred other fast sellers. Local and General Agents. J. E. Johnson Co., Dent, 437, 69 E. South Water St., Chicago.

GET posted—Good prices paid for butterflies, insects. See Sinclair display advertisement, page 72.

SALESMEN: Write your name and address on a card and mail to us. We'll show you sure earnings of \$20.00 a day. Will you risk one minute and a one-cent stamp against \$20.00? Mind you, we say we'll show you. Address Sales Manager, Dept. 782, 850 West Adams St., Chicago.

EVERYBODY buys from Gibraltar representatives all over country taking orders for famous Gibraltar line consisting of shirts, overcoats, raincoats, pants, hosiery, neckwear and other articles. Outfit representing full line Free. Gibraltar Fashion Shop, 724 Roosevelt, Chicago.

DIRECT factory representative to sell changeable letter signs to merchants. Excellent opportunity. Good income assured right men. Address, Maze Manufacturing Co., Norwood Station, Chicago.

SELL high grade Auto Tire Accessories to car owner or dealer. Write for information. Midland Rubber Products Co., 1355 S. Morgan St., Chicago, Ill.

STREETMEN, Big Money, Selling Intensifiers. Reliable Mfg. Co., Utica, N. Y.

AGENTS—Mesco Corn and Callous Remover will build you a steady repeat business. Send today for pocket-size trial outfit. The Moss Co., 265 Searle Bldg., Rochester, N. Y.

MAIL-ORDER Houses and Distributors: We pack French made beauty creams, face powders, perfumes, toilet preparations with your label. Chemist, A2709 Wabash Ave., Chicago.

MR. BRUSH Salesman—Old established New York Brush Manufacturers require the services of men in all territories to sell their extensive line of Sanitary Twisted in Wire Brushes. We pay larger commission than any other Brush House in the country. Write immediately for our proposition. Wire Grip Sanitary Brush Corporation, 15 Mercer St., New York.

65c PROFIT every dollar! Minute demonstration makes sale. Homes, stores, offices, factories, etc. Big repeater. Free sample offer. Mallard Chem. Co., (A) St. Louis, Mo.

AGENTS—Best seller: Jem Rubber Repair for tires and tubes; supersedes vulcanizations at a saving of over 800 per cent; put it on cold. It vulcanizes itself in two minutes, and is guaranteed to last the life of the tire or tube; sells to every auto owner and accessory dealer. For particulars how to make big money and free sample, address Amazon Rubber Co., Philadelphia, Pa., Dept. 505.

YOU Can Earn \$1,000 a month or more with an Everett Agency. Write for proof. Everett Company, Soo, Mich.

SELL something everybody needs. Four out of five buy. \$3.00 profit on \$4.00 sale. Send for outfit. B. Burns, President, 500 Prudential Bldg., Buffalo, N. Y.

FAST Money-Maker. Greatest Polishing Cloth on Market. Big Profits. Sample Free. Wonderful Repeater. Keystone Specialty Company, Dept. B, Altoona, Pa. Established 1906.

MIRRORS Re-Silvered at Home. Costs Less 5 cents per square foot; you charge 75 cents. Immense profits, plating auto-parts, reflectors, tableware, stoves. Refinishing metalware, etc. Outfits furnished. Write for information. Sprinkle, Plater 128, Marion, Ind.

AGENTS—Here's a New One. "Best-ever Powdered Hand Soap." Sells like wildfire. Marvelous Discovery. Removes grease, paint, ink, oil, in fact anything from the hands. Cannot harm skin. 150% Profit. Great Repeater. Agents simply earning money. "Free Samples Get the Business." Write immediately. Bestever Products Co., 1945 E. Irving Park, Chicago.

ONLY one sale a day means \$200 per month! Marvelous new adding machine. Retail \$15.00. Work equals \$30 machine. Adds, subtracts, multiplies, divides, automatically. Computes feet and inches. Speedy, accurate, durable, handsome. Five-year guarantee. Offices, Stores, factories, garages, lumbermen buy one to dozen. A fortune for live agents. Write quick for protected territory and free trial. Lightning Calculator Co., Dept. F, Grand Rapids, Mich.

SELL widely advertised Skat paste soaps, toilet soaps, cleansers, polishes, etc. New allowance and commission plan insures success. Skat Company, Hartford, Conn.

WHY work for others? Make and sell your own goods. Formulas, toilet articles, perfumes, extracts. Catalog free. Nat'l Scientific Lab., 1904W Broad, Richmond, Va.

\$25.00 REWARD for any Corn Great Christopher Positive Corn Cure cannot remove. Good for Warts, Bunions, Moles, Callouses. Price 35c. Sell Reliable Hair Food for Dandruff, Itching Scalp, Falling Hair and Premature Grayness. Absolutely guaranteed to grow hair. Price \$1.00. Agents wanted. Reliable Specialty Corporation, Buffalo, N. Y.

AGENTS make big money selling our household goods. Webster Co., 522 Wrightwood, Chicago, Ill.

\$100 A WEEK: Agents, Crew Managers, sell Extracts, Toilet Articles, other necessities. Guaranteed line. Particulars free. Midwest Drug Co., 191 E. Naghten St., Columbus, Ohio.

\$85 WEEK easily made selling men's women's shoes to wearer. Samples furnished. Territory protected. Write now. Paramount Shoe Co., 627 Himrod Ave., Youngstown, Ohio.

WINDOW Sign Letters. One Thousand for \$9.75 Beautiful design. Perfect cut. Free samples, catalogue. Foll Sign Works, 832 W. 11th Street, Oakland, Calif.

FIBRE Brooms—detachable handles, fine finish. Good profits, repeat sales. The Fibre Broom People, 147 New Jersey Ave., Brooklyn, N. Y.

PROFITS in selling Popular Mechanics Books. Make 100%. Buy books at 50 cents; sell them for twice as much. List of books with descriptions sent free upon request. Write for particulars. Popular Mechanics Press, 200 E. Ontario St., Room 501, Chicago, Ill.

I'VE sold shirts on the coast for over 5 years—must confess that your proposition cannot be equalled anywhere. Others have made similar statements. If you want the best shirt offer ever made write for more details to Supreme Shirt Co., 276-m Fifth Avenue, New York.

AGENTS, men and women. Sell necessities. Every woman a user. Wonderful opportunity to make real money. Colonial Chemical Co., 711 Penn Avenue, Pittsburgh, Pa.

AGENTS—Write for Free Samples. Sell Madison "Better-Made" Shirts for large Manufacturer direct to wearer. No capital or experience required. Many earn \$100 weekly and bonus. Madison Co., 566 Broadway, New York.

SOMETHING new—Presto Rubber Repair for tires, tubes; all rubber goods put on cold, no heat, acid or tools; vulcanizes itself in few minutes. Sells to auto owners and dealers, sample free. Pioneer Products Co., Dept. A, Roebing, N. J.

BIG Money Selling New Household Cleaning Set. Washes and dries windows. Sweeps, scrubs, mops. All complete only \$2.95. Over half profit. Write Harber Brush Works, 132 3rd St., Fairfield, Iowa.

AGENTS—Stamping names on Pocket Key Protectors; sample Check with your name and address, 25c. Stamping Outfits, Emblem Checks, Check Fobs, Name Plates. Hart Mfg. Co., Desk 2, 893 Degraw St., Brooklyn, N. Y.

ORIENTAL Perfumes bring 100% net profit. Good sellers and better repeaters. Bonola Parfumerie, Inc., Woodlawn 10, Chicago.

AGENTS: Big profits. Best and cheapest window letters made. Easily applied. Dilmo brings five samples. Particulars free. Stalbrice Co., 1115 Second Ave., New York.

NEW Marvelous Self-Lighting Pocket Cigar and Gas Lighters. No Friction. Sells on demonstration. Sample 25 cents. Rapid Mfg. Co., 799 Broadway, New York.

EVERYBODY Buys Davis' Nifty Toilet Goods (Assortments). Useful, handsome gifts free to our customers. Over 250 high-quality products. All repeaters. 100% profit. 25 years of success. Write! Davis Products Co., Dept. 56, Chicago.

AGENTS—\$60 to \$200 weekly putting up our Burnished Genuine Gold window letters; scripts. Experience unnecessary. Free samples. Premier Letter Co., 121 N. Francisco, Chicago.

WONDERFUL! Startling! Amazing! Our Ex-Cel Luminous Crucifix and Magical (Luminous) Necklace shine brilliantly in the dark. Sell on first demonstration. Big profits to you. Write for further particulars, or better still, send for sample and territory protection immediately. Crucifix \$1.50, Necklace \$1.00, postpaid. W. G. Hannan Co., Dept. B, 2589 So. State St., Chicago.

AUTO owner tire agent wanted each locality to use and take orders for handmade Mellinger fabric and cord tires; guarantee bond 8,000 and 12,000 miles (no seconds); shipped prepaid on approval; get your tires free; no capital or experience required; make \$100 to \$300 weekly. Write for wholesale prices and sample kit. Address, Mellinger Tire Co., Dept. 399, Kansas City, Mo. or Dept. 300, Philadelphia, Pa.

LIVE Agents Make \$10 Day selling Eureka Strainer and Splash Preventer for every water faucet. Takes on sight. Widely advertised and known. Get details today. A. B. Seed Filter & Mfg. Company, 73 Franklin, New York.

SELF-THREADING Needles, Needle Books, Machine needles, find sales in every home. Fine side lines, easily carried, big profits, sample and catalogues free. Prentice Lee, 145 East 23rd St., New York.

AT Last! Diamond Rival Discovered! Amazing blue white Rajah Gem astounds jewelry world and deceives experts! Beautiful Sample case Free! \$100 weekly! Write Quicks! Rajah Diamond Co., Dept. F-7, Salisbury, N. C.

YOU can be your own boss with our Key-Check outfit. Good for \$5 a day stamping names on pocket key checks, fobs, etc. Sample check with your name and address, 20 cents. Pease Die Works, Dept. M, Winchester, N. H.

WILLIAMS' No-Water Hand Soap. In tubes, has taken Auto owners by storm; washes dirtiest hands perfectly clean without water; easy demonstration makes quick sale. 150% profit. Williams Co., Dept. 265, Montclair, N. J.

WHY work for others? Make and sell your own goods. Formulas, toilet articles, perfumes, extracts. Catalog free. Nat'l Scientific Lab., 1904W Broad, Richmond, Va.

BIG Money and Fast Sales. Every owner buys Gold Initials for his auto. You charge \$1.50; make \$1.35. Ten orders a day easy. Write for particulars and free samples. American Monogram Co., Dept. 40, East Orange, N. J.

AGENTS: Big Money Monogramming by Transfer Method. Catalog Showing Over 50 Styles and Particulars Free. Motorists' Accessories Co., Mansfield, Ohio.

INSTANT Weld. Repairs largest punctures without cement or heat. Lenn's profit one day. \$56. Write quick. Free sample; territory going fast. Tourists' Pride Mfg. Co., Desk T, Minneapolis, Minn.

\$60-\$200 A WEEK. Genuine Gold Letters for store windows. Easily applied. Free samples. Liberal offer to general agents. Metallic Letter Co., 438-D North Clark, Chicago.

AGENTS—Clever Invention! Inkspoon makes every pen a fountain pen. Fast office seller; big profit, demand increasing everywhere. Exclusive territory offered. Sample free. H. Marui Company, Tribune Bldg., New York, N. Y.

POLMET—The Wonderful Polishing Cloth that cleans all metals without liquid, paste or powder. Approved by "Good Housekeeping" and "Modern Priscilla"—sells fast at 2c. Sample free. Gale & Co., Inc., 15 Edinboro St., Boston.

WASH Clothes the new way. Use the Torrent Automatic Washer. You will be delighted. Special offer to one in each locality. Storm Royalty Co., 3610 Enright Ave., St. Louis, Mo.

WE Start You Without a Dollar. Soaps, Extracts, Perfumes, Toilet Goods. Experience unnecessary. Carnation Co., Dept. 201, St. Louis.

GET Our Free Sample Case—Toilet articles, perfumes and specialties. Wonderfully profitable. La Derma Co., Dept. A, St. Louis, Mo.

AGENTS, both sexes, we manufacture and control new household article. Fast seller. Big profits. Exclusive territory. Write Now. Connolly, 123 Liberty St., New York.

AGENTS—Make a dollar an hour. Sell Mendets, a patent patch for instantly mending leaks in all utensils. Sample package free. Collette Mfg. Co., Dept. 404, Amsterdam, N. Y.

AGENTS: 500% profit. "Happy Home Maker Shampoo" builds your own big business. Martin of Indiana made \$75.00 in one day. Missouri man made \$750.00 in one month. Exclusive territory. Geo. A. Schmidt & Co., 236 W. North Ave., Chicago.

WE Pay \$50 a Week and expenses and give a Ford Auto to men to introduce poultry and stock compounds. Imperial Co., D, 23, Parsons, Kans.

EASY, pleasant work for Mechanics. Shop Men, Clerks, during spare hours; will add many dollars to their salaries. Also want persons who can give full time. Big wages assured. Novelty Cutlery Co., 67 Bar St., Canton, Ohio.

AGENTS \$1. Retail \$3. Your Profit \$2. Wonderful, pocket Adding Machine with Magic Writing Pad. Particulars Free. Typewriter Supply, 905 Hersch Bldg., Pittsburgh, Pa.

EASY Money Applying Gold Initials, Monograms on automobiles. Anyone can do it. Simply transferred from paper; takes 5 minutes. Make \$1.50, cost 5c. Samples free. "Ralco," 1043 Washington, Boston, Mass.

\$31.00 PROFIT—with \$1.50 Outfit—Big Money—Easy Work. Selling Gold Monograms for Automobiles, Luggage, Windows, Wagons. No Experience. No License. "Samples Free." NuLife Monograms, Hartford, Conn.

AGENTS: Handle a new necessity. Paint-ographs sell everywhere. Big Christmas demand. Write for Circular and information today. Bradford Company, St. Joseph, Mich.

AGENTS Wanted in Every County in the U. S. A. for Electric Blankets, Bed Warmers, Caps and Warming Pads, Stretching, developing and Gymnasium tables. Wallace Electric Appliances, P. O. Box 147, Oakland, Calif.

LARGE Manufacturer Wants agents. Make \$100 weekly. Outfit free. Sell made-to-measure genuine Cravenette Gabardines, \$14.50. Whitecoats, \$12.50. Reversible Raincoats, \$9.75. Standard Raincoat Co., 131 W. 17th St., New York.

BUSINESS Guide with Free Legal Service Sells everywhere; Wells cleared \$1,185 in 35 days. Write for free outfit. Nichols Co., Naperville, Ill. Dept. 4B.

EVERYBODY uses Extracts. Sell Duo Double Strength Extracts. Complete line of household necessities. Big repeaters. Write today. Duo Co., Dept. E1, Attica, N. Y.

AGENTS make \$100 week placing advertising Cigar Lighters with glass front. Every dealer wants one. Write for free plan. Drake Mfg. Co., Dept. M, Milwaukee, Wis.

MAIL Order Business. Excellent Side Line. No stock to carry. Details Free Hunt Co., Morrisville, Pa.

\$35 A DAY—Easy, selling our fast seller policy, which pays \$20 weekly sick benefit, \$40 weekly Accidental Benefit, \$500 natural death, \$1,000 accidental death, \$2,000 travel accidental death. Lowest premium rates. Biggest commissions. Large renewals. American Peoples Life, 1107, 159 N. State St., Chicago.

FREE Sample—"Rain Shield Winer" Retail \$1.00—cost 25c. Just invented. No Cloth—No Paste—No Attachment. Sold Clear and Rainy Days—(1) Rub keeps Windshield Clear 24 hours. Automobiles buy quickly. Riley made \$198—three days. Experience Unnecessary. Wonderful Sideline. NuLife Corporation, Hartford, Conn.

CALIFORNIA Rosebuds selling like hot cakes. Agents coining money; new stuff. Big profits. Catalog free. Mission Factory PM, 519 No. Halsted, Chicago, Ill.

MANUFACTURE Chipped Glass Numbers; particulars Free. Beveridge, 160-22 Locust Avenue, Jamaica, N. Y.

DUSTLESS Sponge Cloth. New Invention. (1) Rub—Dusts. Cleans and Polishes Automobiles, Furniture, Pianos. Retail \$50c—Costs 15c. "Sample Free." NuLife Corporation, Hartford, Conn.

BIG Profits with Exclusive Territory—\$50 to \$100 weekly easy. More has often been made in one day's work. A hot or cold running water bath equipment for any home at only \$7.50. No plumbing or water works required. Investigate. Send no money. Write today. Sanitary Supply Co., 753 Allen Building, Toledo, Ohio.

CLEAN Up, now till Christmas. Swell Holiday Line. Wonderful Sellers. Big Margin. Hire Sub-agents. Catalog Free. Mission Factory PM, 519 N. Halsted, Chicago.

WHY work for others? Make and sell your own goods. Formulas, toilet articles, perfumes, extracts. Catalog free. Nat'l Scientific Lab., 1904W Broad, Richmond, Va.

\$145.00 WEEKLY. Wonderful Vapor Humidifier. All autos. One free to introduce. Critchlow, N-124, Wheaton.

AN Opportunity never before presented. Representatives wanted in every state in the U. S. A. and Canada, on a direct selling plan. No license required, no competition. Article a household necessity, fully guaranteed. Price within reach of all. Exclusive territory assigned. Particulars: Dundee Mfg. Co., Inc., 157 Summer St., Boston, Mass.

\$3.50 AUTOMATIC Adding Machine. Excellent profits here for workers. No experiment, but old, reliable, meritorious proposition. Year after year seller. Write us. Bassett Company, 1458-P Hollywood Ave., Chicago.

AGENTS—N-R-G Laundry Tablets, the old reliable moneymaker for live agents. Millions sold—200% profit—sales waiting for you. Clothes washed spotlessly clean in 10 minutes without rubbing. Free samples. N-R-G Company, 230 W. Superior, Chicago.

GENUINE Gold Leaf Letters anyone can put on Store windows. Guaranteed to never tarnish. Large Profits. Enormous Demand. Free Samples. Write today. Metallic Letter Co., 438-A North Clark, Chicago.

AGENTS: Our gold-eyed Needle Cases are wonderful sellers; immense profits; \$50 to \$300 weekly; proof and particulars free; sample outfit 15c; factory prices. Paty Needle Co., 231 Davis Square, Somerville, Mass.

MEN or Women Agents, Full or spare time, selling Stationery. Every Man and Woman a customer. Sample outfit Free. Scheffer Stationery Company, 1308 Ewing St., Fort Wayne, Ind.

SELL direct, Shotguns, Rifles, Pistols, Revolvers, from catalog. Stoeger Incorporated, 224 East 42nd Street, New York.

AGENTS—Steady income. Large manufacturer of handkerchiefs and dress goods, etc., wishes representative in each locality. Factory to consumer. Big profits, honest goods. Credit given. Send for particulars. Freeport Mfg. Co., 59 Main St., Brooklyn, N. Y.

\$20 PROFIT daily selling self-threading needles, needlebooks; cost 3-5c each; sell 25c; three samples 25c. Catalog free. Needlebook Specialty Co., 661 Broadway, New York.

AGENTS: \$300—\$500 monthly easy taking orders for Morey Rim Tool. Autoists and trade buy on sight. M. Morey Rim Tool Company, Bittsfield, Mich.

BIG Money—fast sales; everyone buys gold initials for their auto; sell \$1.50, profit \$1.44. Ten orders daily easy. Samples, information free. World Monogram, Dept. 16, Newark, N. J.

FREE Booklet describes 52 plans for making \$20.00 to \$100.00 weekly in home or office business of your own. Downs Co., 2323A Myrtle, St. Paul, Minn.

A BUSINESS of your own. Make and sell chipped glass name and house number plates, checkerboards, signs. Booklet Free. E. Palmer, Dept. 512, Wooster, Ohio.

EARN \$10 daily silvering mirrors, plating and refinishing metalware, autos, chandeliers, bedsteads, headlights. Outfits furnished. E. Decle Laboratories, 1133 Broadway, New York.

CARPENTERS. Popular Mechanics Carpenters' Handbook is filled with ideas for those who like to tinker with tools, and for professional carpenters. 40 articles on saws and sawing, 17 on benches and bench equipment, 23 on doors and door hanging, 18 on lumber, 13 on mitering, 74 on tools and their care, 22 on shop equipment, and many others—366 in all, and 229 illustrations. Send No Money. Just write a postal. Pay postman postage and \$1.50. Popular Mechanics Press, Room 801, 200 E. Ontario St., Chicago, Ill.

NOW that you have read all these offers, read Macochee Company's (Cintl. Ohio) advertisement again.

HIGH GRADE SALESMEN WANTED

WANTED—Tailoring Salesmen, make \$60 to \$125 per week. Biggest merchants in many towns have started with our line. We are the largest made-to-measure tailoring house in the country, furnishing elaborate sample equipments, including 500 all-wool fabrics. You make your own profits from \$8.00 to \$15.00 on each order. Guaranteed absolute satisfaction, perfect fit, best workmanship, or no sale. Write for our line and all accessories to be sent free. Tell us all about yourself. Address N. O. Perry, Sales Manager, Box 483, Chicago, Ill.

BANCROFT-HUNTER Company, Inc., 411 So. Wells St., Chicago, makers of high grade men's all wool clothes selling direct to wearer at \$23.75, are opening sales agencies. Men are wanted who have sold tailoring or something similar. A liberal profit, bonus and co-operative advertising. To qualify must furnish references as to honesty. No investment required—we furnish everything. Write for booklet P entitled "Developing a Sales Agency," which tells everything about the proposition. Address above.

TAILORING Salesmen—Many men in your town pay \$15 to \$20 more than our wholesale prices for the same woollens, workmanship and high-grade, perfect fitting, tailored-to-measure suits and top-coats—all these are live prospects. Complete selling outfit free. 200 choice patterns—all wool; five prices, \$18.50 to \$36.50. Absolute "no-pulling-out" hair cloth fronts. Positive 8-day service. Substantial commissions, bonuses and special prizes. Protected territory. Free advertising. Experience unnecessary. Our sales manual tells you "how." Tell us about yourself, giving two business references for quick action. Wholesale Direct Tailors, Dept. 1203, 83-89 Ellicott St., Buffalo, N. Y.

SALESMEN—Get this big sensational, order-getting shirt outfit free. Sell Stylemor Shirts all year round. It's Chicago's Wonder shirt line. Advanced fall showing of smartest, snappy patterns. Large double swatches, low prices, quick service, makes shirt selling easy. Beilard of Texas made \$46.00 in two days. We deliver and collect. Write today for big free outfit. Stylemor, 81 W. Van Buren, Chicago, Ill. Dept. 1100.

SALESMEN—Make \$6 to \$8 per sale. Double your profits selling the Strand Tailoring Company's two-price all-wool line, \$29.50 and \$34.50 (including your commission) worth \$40 to \$50. Over 100 samples to show. Superb tailoring—perfect fit—guaranteed linings—six day delivery service. Write today for this easy selling double profit line. Strand Tailoring Company, 1325-1341 Dickson St., Dept. 102, Baltimore, Md.

IF You Think in Terms of \$6,000 the First Year write Us Now. Strong line for retail stores. Nationally advertised. Established concern. Best season now starting. Liberal weekly advance to producer. The Continental Co., 1922 Euclid, Cleveland, Ohio. Dept. 200.

SALESMEN—We furnish you a new Ford car immediately and set you up in business. You own both car and business. No capital required. Profits \$50 to \$150 per week easy. Exclusive territory, city or country. Biggest opportunity ever offered hustlers. Territory going fast. Write quick for details. W. & H. Walker, Inc., Dept. 33, Herr's Island, Pittsburgh, Pa.

\$600 PER month and more. Our product sells with a guarantee of sales. We pay 24% commission. Write today. C. V. Champion Co., Danville, Ill.

SALESMEN—Experienced men to sell disinfectants, deodorants, insecticides, sanitary supplies to hospitals, institutions, etc. Commission basis. Ellis Davidson Co., 348 West 52nd, New York.

SALESMEN and Agents: Write for big Money-Making offer selling Suits and Overcoats, Made to Measure; easy sales. Preuss Tailoring Co., 305 5th Ave., New York City.

SALESMEN for new patented padlock; no keys; cannot be picked; excellent future for right man; state experience. Write Defender Lock Co., 68 Cliff Street, New York.

REPRESENTATIVES selling direct to consumers or any ambitious person can obtain information relative to plan which will substantially increase their income. Estru Products Company, 2903 W. Madison, Chicago.

SALESMEN, Salary or commission. Sell cigars direct to consumer at wholesale price. Wonderful opportunity. Send stamped addressed envelope. San Rey Cigar Company, Tampa, Fla.

SALESMEN—Fast Selling Tampa Cigars! \$40 weekly salary and expenses; experience unnecessary. Send stamped addressed envelope for particulars. Gulf Coast Cigar Co., Tampa, Fla.

SALESMEN sell phenomenal advertising specialty. Metcalfe's commission \$72 one sale. Another man made \$120 in 3 hours. Clamps on auto dash with oil change warning. For sample, write Klopp Printing Company, Omaha, Neb.

SELLS for \$9.75. Prints ad on wrapping paper, envelopes, etc. \$4.00 commission. Send 10c for sample work. Automatic Ad-Stamp, Joplin, Mo.

BEST Seller. Jem Rubber Repair for tires and tubes; supersedes vulcanization at saving of over 80%; put it on cold, vulcanizes itself in two minutes, guaranteed to last life of tire or tube; sells to every auto owner and accessory dealer. Get particulars how to make big money and free sample. Amazon Rubber Co., Philadelphia, Pa. Dept. 510.

\$18.00 DAILY representing established manufacturer taking orders Ladies' Home Frocks, Knitted wear, Lingerie, direct to wearer. Outfit free. Counsel Corp., 206 No. Wells, Chicago, Dept. L11.

MEN Wanted—to sell dependable fruit trees, shrubbery, etc. Steady demand. Complete cooperation. Pay check weekly. Write Perry Nurseries, Dept. B, Rochester, N. Y.

BRANCH Manager for National Real Estate organization Profit-sharing basis. Capable salesman can earn \$10,000 annually. VLCCo., 987 Union Trust Bldg., Pittsburgh, Pa.

SALESMEN and Agents (men—women) for the Adding Pencil. It adds, multiplies, counts, checks. Size of fountain pen. Very attractive. Everybody wants one. Clear \$10 to \$20 daily. Write, Adding Pencil Co., Dept. 44, St. Louis, Mo.

NEWEST invention! Sells every office, home, store. Automatically coils telephone and iron cords. Abolishes snarls and kinks. Great time and temper saver. \$25 daily. Samples for test if desired. Neverknot, Dept. 1-1, Metlurg Bldg., Chicago.

HERE'S a big money maker: Masterlite Pocket Cigar Lighter; something new in specialty field; sells instantly upon demonstration to consumers and dealers. Send 50c stamps for sample and selling plans. M. Masterlite Mfg. Co., 110 East 23rd St., New York. (Manufacturers well-known Radio Gas Lighter.)

WHY work for others? Make and sell your own goods. Formulas, toilet articles, perfumes, extracts. Catalog free. Nat'l Scientific Labs., 1904W Broad, Richmond, Va.

GO into business without investing a penny. No rent to pay. No stock to carry. Yet you make bigger profits than regular storekeepers. Write for facts at once. Address Sales Manager, Dept. 701, 850W. Adams St., Chicago.

DISTRICT Salesman: Must be reliable. Prefer married man, 30 years old or over and permanent resident in his community. Exceptional opportunity for good man. Address Sales Manager, Dept. 102, 844 West Adams Street, Chicago.

SALESMEN—Earn \$75 to \$250 weekly selling our All Wool made-to-measure suits \$25 retail, \$4 to \$6 profit on every sale. Six day delivery. United States Fidelity and Guaranty Bond of satisfaction or money refunded. Experience unnecessary. Write today for large free spring samples. Homeland Tailoring Co., Inc., 13 to 27 W. Fayette St., Dept. 105, Baltimore, Md.

GOOD salesman can secure exclusive territory for new patented Key Case. A big seller with big profits. Brand new. An opportunity for real producers to make big money. The Minnesota Specialty Co., 78 E. 3rd St., St. Paul.

SALESMEN Can make \$5.00 a day selling our Calendars, Pencils, Signs, Advertising Novelties, Yardsticks, Whistles, etc. Liberal terms. Sells entire year. Fine side line. Local and traveling agents. Model Calendar Co., Dept. 226, South Bend, Ind.

SIDELINE Salesmen—to sell an instant toothache relief remedy. Sold to Drugists, restaurants, poolrooms. About 40% profit. F. J. Liepold, Adrian, Minn.

\$50 DAILY Selling Salesboards—Make up to \$33 on single sale, selling largest, lowest priced line; no samples to carry; write for 3-color catalogue and full particulars. Lincoln Sales Co., Dept. E, 9 So. Clinton, Chicago.

TAKE orders for coffee, sugar, flour, meats, canned goods, staple groceries; also paints, radio sets, tires, auto and tractor oils. No capital or bond required. We deliver and collect. Permanent business. Big pay. Write at once. Hitchcock-Hill Co., Dept. 50, Chicago.

FOUR \$7.50 sales to merchants net you \$20.00 daily. Sayers Systems, 2803 Sheffield Ave., Chicago, Ill.

SALESMEN—Become Independent. Own Your business, experience unnecessary selling our \$7,500 Accidental Death; \$50 Accident; \$25 Sick Weekly Benefits—\$12.50 Yearly. Other Amounts proportionate. Guaranteed steady income from renewals, \$250,000 Deposited Insurance Department. Universal Policy, Dept. A, Newark, N. J.

\$40.00 SUITS at \$23.50! Think of being able to offer a \$40.00 suit made of the finest quality of pure Virgin Wool; fit, fabric and fashion guaranteed; at the powerfully attractive price of \$23.50! Can you sell such values? You can if the experience of 2,000 other salesmen means anything. And you don't have to know anything about selling clothing. We'll take you, train and equip you to go out and make a success of this work, if you are honest, ambitious and willing to work. If you are, write us. You'll hear from us promptly with the full facts. Address Dept. 700, William C. Bartlett, Inc., 850 West Adams Street, Chicago.

ADVERTISING Salesmen wanted to take orders for Auto Key Purse; new invention; sells to advertisers by thousands; commission 20%; sample by mail 25c. Novelty Cutlery Company, 522 McGregor Ave., Canton, Ohio.

OUR line entirely different; larger commissions. Quality merchandise. Prices right. Coffman Pencil Company, Cedar Rapids, Iowa.

EASILY make \$50 to \$100 weekly extra during your spare time. Season just opening up. Iowa Novelty Company, Box 1061, Cedar Rapids, Iowa.

AUTOMOTIVE Specialty Salesmen. Steady Profits. Results Guaranteed. Adams-Barr, Columbus, Ohio.

MAKE \$100 Weekly in spare time. Sell what the public wants—long-distance radio receiving sets. Two sales weekly pay \$100 profit. No big investment, no canvassing. Sharpe of Colorado made \$955 in one month. Representatives wanted at once. This plan is sweeping the country—write today before your county is gone. Ozarka, Inc., 126-B Austin Ave., Chicago.

EASY to Sell Groceries, Paints, Lubricating Oils, from samples to consumers in towns and country. Prices meet all competition. No capital or experience necessary. Profitable, steady work. Commission advanced. Satisfaction guaranteed; 53 years in business. Write Loverin & Browne Co., Wholesale Grocers, 1775 So. State, Chicago, Ill.

\$60-\$200 A WEEK. Genuine Gold Letters for store windows. Easily applied. Free samples. Liberal offer to general agents. Metallic Letter Co., 438-B North Clark, Chicago.

TRAVELING Salesmen calling on retail stores wanted by large manufacturer to sell unique line of business-boosting articles. Year round, fast selling, main or side line. If not earning \$150 weekly, address Elsasor Works, 222 Charles St., Boonville, N. Y.

CALIFORNIA Rosebuds selling like hot cakes. Agents coining money. Absolutely new. Big profits. Catalog free. Mission Factory SP, 519 No. Halsted, Chicago, Ill.

GET into Business for Yourself. Make storekeeper's profits without storekeeper's troubles. We'll show you how. In fact, we'll put you into business, furnish everything you need, train you, carry stock for you without your investing a penny. We'll work with you until we've made you a success. We have done it for others. We'll do it for you—provided you are honest, ambitious and willing to work hard. If you are, write us. You'll hear from us at once with facts. Address Dept. 105, Goodwear Chicago, Inc., 844 West Adams Street, Chicago.

HELP WANTED

MEN, 18 up, wanting U. S. Mail Service jobs, \$142 to \$225 monthly. Steady. Experience or correspondence course unnecessary. Particulars free. Write P. Bradford, 112 N. 50th St., Philadelphia, Pa.

AGENTS—\$91.50 Weekly and up—Your Pay Daily. Introducing New 12 months Insured Hese for men, women, children. You write orders. We deliver and collect (or goods on credit and you can deliver, suit yourself). No experience or capital needed. Samples furnished. All colors, grades, including silks, lises, wools, heathers. Write Quick, M. H. Mathews, Card 2601, Cincinnati, Ohio.

ARE you old at forty! See our advertisement on page 146 of this issue. The Electro Thermal Company, 2137 Main St., Steubenville, Ohio.

GET posted—Good prices paid for butterflies, insects. See Sinclair display advertisement, page 72.

WHY work for others? Make and sell your own goods. Formulas, toilet articles, perfumes, extracts. Catalog free. Nat'l Scientific Labs., 1904W Broad, Richmond, Va.

U. S. GOVERNMENT wants men. \$1,700—\$1,900 and up at start. Railway Mail clerk examination coming. Let our expert (former Government examiner) prepare you for this and also Rural Carrier, Post Office, Customs, Internal Revenue, and other branches. Write today for free booklet. Dept. 8, Patterson Civil Service School, Rochester, N. Y.

MAN wanted (city or country) old established company will supply capital and start you in your own permanent business selling necessities people must buy every day. Experience unnecessary. Write McConn & Co., Factory M48, Winona, Minn.

LOCOMOTIVE Firemen for railroads nearest their homes—everywhere; beginners \$150—\$250 monthly; promoted, locomotive engineer, \$3,000—\$4,000 yearly. Best paying positions on railroads. Railway Association, Desk M1, Brooklyn, N. Y.

MIRRORS Re-Silvered at Home. Costs Less 5 cents per square foot; you charge 75 cents. Immense profits, plating auto-parts, reflectors, tableware, stoves. Refinishing metalware, etc. Outfits furnished. Write for information. Sprinkle, Plater, 77, Marlon, Ind.

MEN 18 Up. Railway Mail Clerks. \$1,900 year. Sample coaching—free. Franklin Institute, Dept. L-16, Rochester, N. Y.

MEN wanting forest ranger positions. \$1,500—\$2,400 year. Write for free particulars of exams. Mokane, B-21, Denver, Colo.

BUILD splendid business making chipped glass number and name plates, signs, check-boards. Write for particulars. Simplex Utility Co., 1133 Broadway, N. Y.

CALIFORNIA, Mexico, Folders, Brilliant Colors, 18 Noted Scenes, with Villa Dollar, 12c Coin; Lists "Seeing New York" Photos, 2c; Studio, 1130 10th, Sandiego, Calif.

MEN 18 Up. Railway Mail Clerks. Travel—See your country. Commence \$158 month. Steady work. Common education sufficient. Sample coaching lessons free. Write today sure. Franklin Institute, Dept. L-16, Rochester, N. Y.

MEN wanting forest ranger, railway mail clerk and other govt. positions. Write for particulars. Mokane, B-23, Denver, Colo.

BECOME a Landscape Architect. Uncrowded profession of wonderful opportunity for money-making. Easily mastered by mail. Earn while you learn. Write for book. American Landscape School, 56-E, Newark, N. Y.

STEAMSHIP Positions—Europe, Orient. Good pay. Experience unnecessary. No compulsory service. Send stamped addressed envelope for list. Box 30-N, Mount Vernon, N. Y. or Box 336-A, Santa Monica, Calif.

U. S. GOVERNMENT Jobs. \$95—\$250.00 month. Men—women 18 up. Sample coaching free. Write immediately. Franklin Institute, Dept. L-16, Rochester, N. Y.

FIREMEN, Brakemen, Baggage-men. Sleeping car, train porters (colored) \$140—\$200. Experience unnecessary. 810 Railway Bureau, East St. Louis, Ill.

\$115—\$400 MONTHLY paid—Ry. Station—office positions. Free passes, experience unnecessary. Write Baker, Supt., (ART) Star Bldg., St. Louis, Mo.

MEN 18 Up. Railway Mail Clerks. \$1,900 year. Sample coaching—free. Write immediately. Franklin Institute, Dept. L-16, Rochester, N. Y.

SILVERING Mirrors, French plate. Easily learned; immense profits. Plans free. Address, Wear Mirror Works, Dept. 34, Excelsior Springs, Mo.

ALL men-women, 18-60, wanting to qualify for Government Positions. \$140—\$225 monthly, local or traveling, write Mr. Ozment, 101, St. Louis, Mo., immediately.

STORIES, poems, plays, etc., are wanted for publication. Good ideas bring big money. Submit manuscripts or write Literary Bureau, 523, Hannibal, Mo.

EARN \$10 daily silvering mirrors, plating and refinishing metalware, auto, chandeliers, bedsteads, headlights. Outfits furnished. E. Declé Laboratories, 1133 Broadway, New York.

FINGER Print Experts—Excellent paying positions; particulars free. Finger Print Headquarters, 188 East 79th, New York.

INVENTORS desiring to secure patents should write for our book "How to Get Your Patent," tells our terms and methods. Send sketch for our examination and instructions without charge. Randolph & Co., Dept. 418, Washington, D. C.

WANT a U. S. Government Job? \$1,140 to \$3,000 year. Become Railway Mail Clerks. (Travel—See your country). Rural and City Mail Carriers, Post-Office Clerks, Clerks in Government offices. Steady work. Paid vacations. Common education sufficient. Particulars and sample coaching—free. Write immediately. Franklin Institute, Dept. L-3, Rochester, N. Y.

MAKE money writing Photo-plays; details free to beginners. No correspondence course. Producer's League, 230 Wainwright, St. Louis.

WANTED—Boys—Men. Learn Auto Repairing. \$30.00 week. Sample lessons free. Franklin Institute, Dept. L-400, Rochester, N. Y.

INFORMATION

PRACTICAL information on any Mechanical subject. \$1.00. Technical Research Bureau, 377 National Ave., Milwaukee, Wis.

ADVICE on any subject \$1.00. Universal Bureau, 3610 Enright, St. Louis, Mo.

DYKE'S Automobile and Gasoline Engine Encyclopedia. Latest edition contains information on repairing and adjusting every part of all motor cars now in use. Tells how to find out what is wrong and how to fix it. Mechanics everywhere depend upon this compendium to keep them up-to-date. Send No Money. Just write a post card. Pay postman the postage and \$6. Popular Mechanics Press, Room 801, 209 E. Ontario St., Chicago, Ill.

BUSINESS SERVICE

MAKE 'Em Pay—My system will make them pay their bills. Write for the acid test. Literature free. Burleigh L. Horr, Horr Omelia Block, Rhinelander, Wis.

CHARTERS—Delaware; best, cheapest; free forms. Colonial Charter Co., Wilmington, Del. (99)

ONE Inch Display Ad. 355 rural weeklies. \$45.00 Admeyer, 4112D Hartford, St. Louis.

DELAWARE Incorporator. Charters; Fees Small; forms. Chas. G. Guyer, 901 Orange St., Wilmington, Del.

TYPEWRITERS AND SUPPLIES

100 TYPEWRITERS Free. Overstocked. Rent rebuilt Underwood or Remington \$3.00 month. If you pay its value in rental, we give machine free. Particulars free. Pittsburgh Typewriter Exchange, 945 Hersch Bldg., Pittsburgh, Pa.

UNDERWOOD Typewriters—only \$3.00 down. Easy monthly payments. Low prices at less than manufacturers. 10 days' free trial. Rebuilt, all worn parts replaced. Just like a new machine. 5-year guarantee. Write for a big free catalogue C-151. Shiman-Ward Mfg. Co., 1511 Shipman Bldg., Chicago, Ill.

TYPEWRITERS All Makes. Save One-half. Thoroughly rebuilt in our factory to the famous "Young Process." Fully guaranteed. Free trial. We handle all standard makes. Cash or sold on easy terms. Write for catalog. Young Typewriter Co., Dept. 5751, Chicago, Ill.

TYPEWRITERS \$3.00—\$40.00. Motorcycles \$7.00—\$75.00. New victrolas \$10.95. Send cash. Agents wanted. Knight's, 1512 Locust, St. Louis, Mo.

TYPEWRITERS, all standard makes. \$10 up. Fully guaranteed. Free trial. Write for complete illustrated lists. Northwestern Typewriter Exchange, 121 N. Francisco Ave., Chicago.

TYPEWRITERS—Standard Makes; Wonderful Bargains; Guaranteed. Typewriter Rebuilding Co., Ada, Okla.

PRINTING, ENGRAVING AND MULTIGRAPHING

\$5.00 DELIVERED. 500 Watermarked Bond Letterheads, 8½x11, and 250 envelopes, money with order. Job Printing Specialty, National Printing Company, Goshen, Ind.

LETTERHEADS, Statements, Envelopes to suit any business or occupation. Free Samples. Englewood Printing Company, Englewood, Ohio.

QUALITY Printing. Reasonable Prices. Samples free. Riley-Zaur Company, 1517 S. 48th Court, Cicero, Ill.

PRINTING on U. S. postal cards, 50 up. Extraordinarily low prices. Immediate service. Erixpress, Elroy, Wis.

200 HAMMERMILL 8½x11 Letterheads \$1.00, printed, prepaid. King's, Warren, Ill.

500 POSTPAID. Blotters, colored border, 120 lb. enameled. \$3.00; Blotter Cards, \$2.75. Prompt service. J. B. Gray, Printer, 310 E. Second St., Plainfield, N. J.

\$1.00 BARGAINS. Letterheads, envelopes, cards, etc. List free. Q Shop, Roaring Spring, Penna.

QUALITY Printing. Lowest Prices. Send for attractive samples. Quality Printery, Marietta, Ohio.

"NEARGRAVURE" Process Printing—unique—distinctive. Samples stamp. Solidities, Knox, Ind.

5,000 3½x6 FOUR Page Enamel Paper Folders, \$13.75; 10,000, \$21.00; 5,000 5½x8½ Circulars, \$9.50; 5,000 Ad. Slips, \$4.75. Elegant Samples Free. Good's Printery, Harrisonburg, Va.

250 EACH Hammerrill Bond Letterheads, Envelopes, \$3.00. Sample. Midland Press, 543 West Hickory, Kankakee, Ill.

200 PRINTED Business Envelopes \$1.00. Commercial size. With name, business and address. Prompt service. List of 10 Big Dollar Specials Free. P. M. Kendall, Elmhurst, N. Y.

ADVERTISING Pencils, "the kind that you want!" Buy direct; save middleman's profit. Samples free (no agents). Address S. Mustal & Co., 10-12 Lincoln St., Yonkers, N. Y.

500 BOND Letterheads, \$1.75 postpaid. 5,000, \$11.65. Leader Printing Co., Warren, Ill.

250 LETTERHEADS, 250 envelopes, printed, \$3.00. Central Press, Gardner, Kans.

GUMMED Labels, 500 name and address, 2 lines 35c. 3 lines 55c. Catalogue. Eastern Label Co., A. Clintonville, Conn.

1,000 LETTERHEADS, Envelopes, Cards, \$3.00 postpaid; 500, \$2.25. Samples Free. Artservis Press, 68 Houghton, Worcester, Mass.

PRINTING. Lowest prices in America. Samples free. A. Pitz, Amasa, Iowa.

225 BOND letterheads, envelopes, bill-heads, cards, \$1.25 each. Combination, \$4.00. Economic Press, Leonia, N. J.

WE print Stationery, Booklets, Catalogs, Circulars, Samples. Commercial Press, Batavia, Ohio.

250 LETTERHEADS, 250 white envelopes printed and mailed \$3.00. Samples printing free. Sunco, Mohawk, N. Y.

QUALITY Printing! Reasonable Prices! Send for Free Standardized samples and prices. Folders, Circulars, Catalogs our specialty. Ernest Fantus, 525 South Dearborn, Chicago.

1,000 LETTERHEADS or Envelopes. \$3.00. Sent Prepaid. Samples Free. Monitor Press, Morrisville, Pa.

PRINTING OUTFITS AND SUPPLIES

PRINT your own cards, stationery, circulars, paper, etc. Complete outfits \$3.85; Job Presses \$12, \$35; Rotary \$150. Print for others; big profit. All easy, rules sent. Write for catalog presses, type, paper, etc. Press Company, A-11, Meriden, Conn.

PRE-USED Printing Presses, Type supplies. List for 2c stamp. Popular Bargains, Richland, Pa.

PRINTING Outfits—Presses, type supplies, type notetiffs. Send stamp for catalogue. Model Press, York, Penna.

DUPLICATORS AND DEVICES

YOU can make 50 to 100 copies of a letter, notice, etc., at a cost of three cents on a Heyer Quality Duplicator. Write for free trial offer. The Heyer Duplicator Co., 14 S. Wells St., Chicago, Ill.

ADDING MACHINES

FREE Trial. Marvelous new Adding Machine. Adds, Subtracts, Multiplies, Divides, automatically. Work equals \$350.00 machine. Price only \$15.00. Speedy, durable, handsome. Five-year guarantee. Used by largest corporations. Write today for catalog and free trial offer. Lightning Calculator Co., Dept. E, Grand Rapids, Mich.

NEW \$3.50 Automatic Adding Machine. Adds, Subtracts, Multiplies. Absolutely accurate. Capacity \$999,999.99. Fully guaranteed. 75,000 pleased users. Makes adding easy, positive, quick. Eliminates Mistakes. Saves Time. Postpaid \$3.50. Bassett Co., 1453 J. Hollywood Ave., Chicago.

MAILING LISTS

OVER 1,000 miscellaneous names—Doctors, Dentists, Hairdressers, Grocers, many others, \$5.00. J. C. Fuchs, Sterling Place, Longmeadow, Mass.

6,000 ADDRESSES, ranchers, etc., rich Yakima Valley, Wash., \$2.00. Mail Service, Box 917, Seattle, Wash.

NAMES—postcards—cuts. Ben Meyer, 35 West 51st, New York.

GUARANTEED Lists—Buyers, agents, opportunity seekers. \$1.00 thousand; 500, \$2.25. Demuth Company, Englewood, N. J.

FOR SMOKERS

KENTUCKY Sweet Leaf Tobacco. Home grown. Home cured. Mellow with age. Quality first. Satisfaction guaranteed. 5 lb. \$1.25. 10 lb. \$2.50. J. Ernest Choote, Wingo, Ky.

TOBACCO—Send your order for Kentucky "Pinchio Red." Sweet with age. Sent C. O. D. at the following price, plus postage: 10 lbs. Chewing, \$3.00; 10 lbs. Selected Smoking, \$2.00; 10 lbs. Mild Smoking, \$1.50. Vanzant Leaf Tobacco Ass'n, J. W. Sarver, Agt., Vanzant, Ky.

HOMESPUN Chewing and Smoking Tobacco—5 lbs. \$1.25; 10 lbs. \$2.50; 20 lbs. \$4.50. Hickory Ridge Farms, Mayfield, Ky.

FOR MEN

1926 SHOP NOTES now ready. Men in all walks of life find this annual volume worth many dollars. 393 articles, 519 pictures. Short cuts for all kinds of mechanical work. Ideas for farmers, mechanics, carpenters, masons, bricklayers, merchants, gardeners, school teachers, and home owners. Send No Money. Just ask for 1926 Shop Notes on a postal. Special—for a short time, we will give our Auto Tourist's book with 1926 Shop Notes. Sent C.O.D. for 98 cents. Popular Mechanics Press, 200 E. Ontario St., Room 801, Chicago, Ill.

FOR BOYS

BOYS! Look! 250 Feet Fine Film—2,000 Theatre Tickets \$1.50 Postpaid Anywhere. Northern Theatre Supply, Duluth, Minn.

BOATS AND LAUNCHES

"ELEVEN Box Traps": blueprint 30c. Weesho-Uco., 31st Office, Detroit.

FORD propelled speedboat, easily built; blueprint and directions, sixty cents. Marine cooler booklet free to Ford boat owners. C. C. Hubbell, 4B East Ave., Norwalk, Conn.

BUILD your own boat. Do your own concrete work. Two new books tell how to make 21 kinds of boats and 173 articles from concrete. Each book filled with pictures. Send No Money. Just write a postal and say, "Send Popular Mechanics Boat Book and Concrete Handbook." Pay postman postage and \$1. Popular Mechanics Press, Room 801, 200 E. Ontario St., Chicago, Ill.

RAZORS AND BLADES

GILLETTE, or Auto-Strip blades. 10 in pack 90 cents. Gillette style blades. Dozen 45 cents. Wallace Kutz, 132 Chamber St., Phillipsburg, N. J.

DULL Safety razor blades Hollow-Ground better than new. (Patented Process.) Gillettes, Burhans, 45c—all others 35c Dozen. Mail two blades for free trial. John Henry Company, 323 Gloyd, Kansas City, Mo.

LITERARY SERVICE

WE made \$5,000 writing. Let's help you. Guaranteed proposition. Free information. National Press Bureau, Box A1, 242 South Kenilworth, Oak Park, Ill.

FOR THE HOME

GRANDFATHER'S Clock Works. \$5.00. Build your own case; instructions free; make good profits selling your friends. Clock works with chimes for old or new cases. Write for full particulars. Clock Co., Ruffner St., Philadelphia.

LOOMS—Only \$9.90 and up. Big money in weaving Colonial Rugs, carpets, etc., from rags and waste material. Weavers are rushed with orders. Send for free Loom Book; it tells all about home weaving and quotes reduced prices and easy terms on our wonderful new looms. Union Loom Works, 489 Factory St., Boonville, N. Y.

FURNITURE; Make Furniture at Home. Popular Mechanics books tell how to make all pieces. "Mission Furniture and How to Make It, Book 1, Book 2, Book 3." Send No Money. Just write postal. Pay postman postage and \$3. Popular Mechanics Press, Room 801, 200 E. Ontario St., Chicago, Ill.

DIAMONDS, WATCHES AND JEWELRY

OUR New Jewelry and Novelty Catalogue Is Just Out. Marko Bros., 3027 Logan, Chicago, Ill.

NEW Swiss Watches, Extra Cheap. Ralph B. Pile, Somerset, Penna.

WATCH REPAIRING

WATCHES repaired and rebuilt by experts. Will run like new. Wrist watches our specialty. Estimate of cost given first and watch returned prepaid if same is not satisfactory. Write International Watch Service, 5P Fordham Station, New York City.

ANTIQUES, WAR RELICS AND INDIAN GOODS

RELICS from Europe's battlefields. Weapons, medals, etc. Illustrated catalogue 25c (with sample War Photographs). Lieut. Welsh, 1889 Albany Ave., Brooklyn, N. Y.

INDIAN Goods, curios, minerals, coins, stamps, butterflies. 1,000 article catalogue 10c. Indiancraft P. Company, 466 Connecticut St., Buffalo, N. Y.

FOR Sale—Stone Age Relics Axe, Pestle, Celt, Hammer, 12 flints, all \$5.00. Charles Edwards, Springfield, Ind.

OVERSTOCKED: Sell cheap. Mounted Birds. Send for list. The Museum, Springfield, Ind.

SEND 5c for fine, new list Indian relics, antique firearms. F. E. Ellis, Webster Groves, Mo.

PHONOGRAPHS AND SUPPLIES

BUILD your own Phonograph. We furnish everything. Phonograph Parts and Radio catalog sent free. American Phonograph Co., 3752 Belmont, Chicago.

BUILD Your Phonograph. Spring Motors, Electric Motors, Tonearms, Amplifiers, Accessories. Latest Equipment also in Radio Mechanism and Cabinets. Catalog mailed for ten cents. Hoosier Mfg. & Supply Co., 313 Baldwin Block, Indianapolis, Ind.

MUSIC AND MUSICAL INSTRUMENTS

EVERYTHING sold for Bands and orchestra—Saxophones, Banjos, Ukuleles, Drums, Trumpets, Violins, Reeds—All accessories. Salesmen wanted. Jay-Conn's Instruments. Easy Payments. Repairing and Plating. Phonographs Repaired. Write for prices. Sternberg's Music Shoppe, 59 E. Adams St., Chicago.

BAND and Orchestra Instruments—All makes of new and used instruments sold, exchanged and repaired. Standard and popular music sold. Write today for catalog and Free subscription to "Musical Booster" magazine. "Deal with the Professional House." Crawford-Rutan Co., 1051 Grand Ave., Kansas City, Mo.

"MUSIC Composed" to words. Bauer Bros., (formerly of Sousa's Band), Oshkosh, Wis.

VIOLINS. Deep, Mellow, Soulful—on credit. Easy terms for wonderful instrument. Get details today. Gustav F. Henning, 2424 Gaylord St., Denver, Colo.

PIANO Jazz: Teaches Ear Playing, Negro Harmony, Player Piano Effects, Chimes, Blues, Chords, Sweet Harmony. Particulars Write "Piano Bill," Toronto 3, Canada.

YOU can play tunes at once or it will cost nothing. Instant Noteless Player for Ukulele \$3.00. Banjo \$4.00. Guitar \$5.00. Mandolin \$5.00. Shipped C.O.D. Arthur Apex, 510 1/2 E. 5th St., Los Angeles, Calif.

CORNETISTS—Trumpetists—Saxophonists—Clarinetists. Get "Free Printers." Name instrument. Virtuosi School, Concord, Mass.

SAXOPHONE quickly taught by time-saving charts. Nothing like them. Musical training unnecessary. Particulars free. California Music Studios, 950 Dale St., Pasadena, Calif.

I WANT Song Poems. Casper Nathan, 3544 N. Racine, Chicago.

WRITE Songs. Big money and reputation. Write for information. J. Gordon Pub. Co., 201 N. Hoyne Ave., Chicago.

SONG Poem Writers—write Ray Hibbler, D1, 2104 N. Keystone Ave., Chicago.

VIOLINS—Handmade Masterpieces. Easy Terms. Illustrations Free. Kenneth Klurz, Ridgway, Penna.

VIOLINS—Genuine handmade masterpieces. Get details now. John Lehto, 935 14th, San Pedro, Calif.

PATENT ATTORNEYS

"STRONGER Patents at Fair Prices." Drawings, specifications, claims, \$20. Send half fee with description. Prompt, efficient action. American Patents Corporation, Barrister Building, Washington, D. C.

PATENTS—Send for form "Evidence of Conception" to be signed and witnessed. Form, fee schedule, information free. Lancaster and Allwine, Registered Patent Attorneys in United States and Canada, 221 Ouray Bldg., Washington, D. C.

PATENTS, Trade-Marks, Designs. This firm has 27 years' experience and gives expert personal service at reasonable rates. We properly protect your invention. Write for free information and exact cost of procuring patent before proceeding. John B. Thomas & Co., 902 F St., N. W., Washington, D. C.

PATENTS Procured; Trade Marks Registered—A comprehensive, experienced, prompt service for the protection and development of your ideas. Preliminary advice gladly furnished without charge. Booklet of information and form for disclosing idea free on request. Richard B. Owen, 30-Owen Bldg., Washington, D. C., or 41-B Park Row, New York.

ESTABLISHED 1854. Milo D. Stevens Company. Free Booklet, Patents, Trade-Marks, Copyrights. Offices, Monadnock Block, Chicago; Barrister Building, Washington, D. C.

PATENTS and Trade-marks obtained. Prompt service. Write for our new book on patents. Established in 1889. D. Swift & Co., 369 7th St., Washington, D. C.

MILLIONS spent annually for ideas! Hundreds now wanted! Patent yours and profit! Write today for free book—tells how to protect yourself, how to invent, ideas wanted, how we help you sell, etc. American Industries, Inc., 500 Kresge Bldg., Washington, D. C.

PATENTS—Prompt Personal Service. Send for Record of Invention Form. Send sketch or model. References furnished. Write today. Jacobi & Jacobi, Patent Lawyers, 600 Ouray Building, Washington, D. C.

PATENTS: My fee in installments. Free personal advice. Frank T. Fuller, Washington, D. C.

MONROE E. MILLER, Ouray Bldg., Washington, D. C., Patent Lawyer; Mechanical, Electrical Expert. Booklet and Priority Record blank gratis.

COMMERCIALIZE your inventions according to My Cooperative Plan before patenting. Write for booklet. Ralph Burch, Patent Lawyer, Jenifer Building, Washington, D. C.

PATENTS. Time counts in applying for patents. Don't risk delay in protecting your ideas. Send sketch or model for instructions or write for Free Book "How to Obtain a Patent" and "Record of Invention" form. No charge for information on how to proceed. Communications strictly confidential. Prompt, careful, efficient service. Clarence A. O'Brien, Registered Patent Attorney, 5899 Security Bank Building (directly across street from Patent Office), Washington, D. C. See pages 142 and 143.

PATENTS—Write for our Guide Books and "Record of Invention Blank" before disclosing inventions. Send model or sketch of your invention for Free Inspection and Instructions. Terms Reasonable. See advertisement on pages 140 and 141. Victor J. Evans & Co., 934 Ninth, Washington, D. C.

LACEY'S Patent Sense. Valuable book free. See ad page 146.

FRED H. HAYN, M. E., formerly First Assistant, Examiner U. S. Patent Office. 23 years' exp. I. W. Helman Building, Los Angeles, Calif.

UNPATENTED Ideas Can Be Sold. I tell you how and help you make the sale. Free particulars (Copyrighted). Write W. T. Greene, 808 Jenifer Building, Washington, D. C.

PATENTS. Booklet free. Highest references. Best results. Promptness assured. Send model or drawing for preliminary examination. Watson E. Coleman, Patent Lawyer, 644 G Street, Washington, D. C.

PATENTS—Our book "How to Obtain a Patent" sent free upon request. Contains full information about patents, trade-marks and designs. If you will send us a sketch of your invention we will promptly make search of the Patent Office records and advise you as to patentability, our charge for the service being \$5.00. Prompt, efficient service with moderate charge. Over twenty years' experience. Bank and commercial references. Talbert & Talbert, Registered Patent Lawyers, 597 McGill Bldg., Washington, D. C.

"**INVENTORS' Guide**" sent free on request; this book contains illustrations of patented inventions and gives valuable information and advice for all who have original ideas or improvements. Frank Lederjann, Registered Attorney and Engineer, Woolworth Bldg., 1712, New York.

PATENT Book Free. Charles W. Lovett, Patent Attorney, Lynn, Mass.

"**INVENTOR'S Advisor**," the valuable Patent book with 139 mechanical movements and illustrations, sent free upon request, M.M. Labiner, Patent Attorney, 3 Parkrow, New York.

PATENTS. Trade marks, copyrights, Prompt, personal, reliable service. Over 36 years' active practice. Write for terms. Book free. Address E. G. Siggers, N. U. Bldg., 918 F Street, Washington, D. C.

INVENTORS—Write for our Guide Book, "How to Get Your Patent" and Evidence of Invention Blank. Send model or sketch of your invention for our prompt examination and instructions free. Randolph & Co., Dept. 430, Washington, D. C.

INVENTORS: Send sketch or model for advice and exact cost of patent. Ask for our Free book: "How to Obtain a Patent." Tells what every inventor should know. Established twenty-eight years. Highest references. Prompt service. Reasonable charges. Chandler & Chandler, 474 Seventh, Washington, D. C.

MEXICAN Patent Attorney. Patents and Trade-Marks procured for Mexico. References. B. Alcolea, Donceles 80, Mexico, D. F.

PATENTS. Trade-Marks, Copyrights. Very reasonable. Sanders, 7 Band McNally Building, Chicago, Ill.

FOR INVENTORS

PATENTS. If you have an invention which you wish to patent you can write fully and freely to Munn & Co., for advice in regard to the best way of obtaining protection. Please send sketches, or a model of your invention and a description of the device, explaining its operation. All communications are strictly confidential. Our Handbook on Patents is sent free on request. This explains our methods, terms, etc., in regard to Patents, Trade Marks, Foreign Patents, etc. "Scientific American" contains Patent Office Notes, Decisions of Interest to inventors and particulars of recently patented inventions. Munn & Company, Solicitors of Patents, 623 Woolworth Building, New York; 524 Scientific American Bldg., Washington, D. C.; 1313 Tower Bldg., Chicago, Ill.; 666 Hobart Bldg., 582 Market St., San Francisco, Calif.; 521 Van Nuys Building, Los Angeles, Calif.

INVENTORS—Write for our Guide Books and "Record of Invention Blank" before disclosing inventions. Send model or sketch of your invention for our free inspection and instructions. Terms reasonable. See advertisement on pages 140 and 141. Victor J. Evans & Co., 157 Ninth, Washington, D. C.

PATENTS. Time counts in applying for patents. Don't risk delay in protecting your ideas. Send sketch or model for instructions or write for Free Book "How to Obtain a Patent" and "Record of Invention" form. No charge for information on how to proceed. Communications strictly confidential. Prompt, careful, efficient service. Clarence A. O'Brien, Registered Patent Attorney, 5899 Security Bank Building (directly across street from Patent Office), Washington, D. C. See pages 142 and 143.

INVENTORS: The monthly reports we give keep you informed latest developments towards Perpetual Motion. We supply new Standard parts reusable in constructing Perpetual or any other mechanical model. Write for interesting information. Progressive Association, Box M86, Westville, Conn.

PATENTS Wanted by manufacturers; send description and number. Box 126, Dowagiac, Mich.

CASHING In—If you have a practical, useful invention to sell, write promptly. American Patents Corporation, Barrister Building, Washington, D. C.

INVENTORS: Mechanical or Design Patent Specifications, Including One Drawing, Prepared for Your Own Filing, \$25. Send Sketches and \$15 for Prompt Action. C. J. Williams, Mechanical Expert, Pacific Building, San Francisco.

INVENTORS Universal Educator—contains 900 mechanical movements; 50 perpetual motions. Tells how to obtain and sell patents. Suggests new ideas. Explains how to select your attorney and avoid patent sharks. Price (revised edition) \$2.00 postpaid. Albert E. Dieterich, 621 Outray Bldg., Washington, D. C.

PATENTS Procured; Trade Marks Registered—A comprehensive, experienced, prompt service for the protection and development of your ideas. Preliminary advice gladly furnished without charge. Booklet of information and form for disclosing idea free on request. Richard B. Owen, 30-Owen Bldg., Washington, D. C., or 41-R Park Row, New York.

PATENTS: My fee in installments. Free personal advice. Frank T. Fuller, Washington, D. C.

ESTABLISHED Manufacturing and sales company with national distribution can take on additional household articles or specialties. Morgan Mfg. Co., 443 So. Dearborn St., Chicago.

GET our quick action plan for selling your invention! The Plan Bureau, 1929 McCausland Ave., St. Louis, Mo.

LACEY'S Patent Sense. Valuable book free. See ad page 146.

MECHANICAL drawing from sketches. Confidential, neat accurate. Technical Research Bureau, 377 National Ave., Milwaukee, Wis.

HAVE you an invention? If so, write for our free book, "How to Get Your Patent," tells our terms and methods. Send model or sketch for our free examination and instructions. Randolph & Co., Dept. 144, Washington, D. C.

GET your own patents. Legal blanks, complete instructions \$1. Cutting Sons, Campbell, Calif.

UNPATENTED Ideas Can Be Sold. I tell you how and help you make the sale. Free particulars (Copyrighted). Write W. T. Greene, 807 Jenifer Building, Washington, D. C.

PATENTS FOR SALE

INTENSIFIER trouble locator, to be mounted on dash of car. The driver at any time while car is in Motion or Standing Still can locate Ignition trouble. Only thing like it. Can be manufactured Cheap. Quick Seller. Every Car Owner will buy one. R. L. Lyon, 50 Houston St., Atlanta, Ga.

OUTRIGHT or royalty, telegraph contact point. Tested by expert telegraphers with great success. G. I. Shelton, Box 634, Athens, Texas.

WANTED Manufacturer Only Successful Automatic Bottle Refrigerator Yet Invented. Dallas Wright, Ft. Dodge, Iowa.

FOR sale or lease Patent Pending—A simple improvement on scissors consisting of wire cutter and needle puller; a great convenience for every household and especially useful for milliners and costumers. Can be manufactured at no additional cost than ordinary scissors. This improvement gives three uses for one. H. N. James 1311 South Miami Ave., Miami, Fla.

OUTRIGHT or royalty: Auto direction signal device placed on fender, visible from front and both sides. Easily operated and positive in action. F. L. Rose, Box 635, Concord, Calif.

YOU have a worth-while patent, haven't you? Why don't you tell our two million five hundred thousand readers about it? Most of them are specially interested in patents and new inventions. Ask me to tell you how other inventors successfully sold their patents. M. L. Rund, Manager Classified Advertising, Popular Mechanics Magazine, Chicago, Ill.

FOR Sale—Patent on Belt Guide. Practical for any outdoor belt work. Elmer Kilmier, Hiram, Ohio.

FOR Sale. Patented new automobile Turn-Signal for closed cars. All metal. Wm. Schirmann, 193 Hughes Ave., Buffalo, N. Y.

OUTRIGHT or royalty; recently patented, low speed pedal control, for Ford cars and trucks; patent No. 1,560,621. No brokers. J. J. Swanson, Elgin, Nebr.

FOR Sale, Patent, Improved Flour Sifter, Outright or Royalty Basis. Harry Nakagawa, Tanana, Alaska.

JUST Patented! Wonderful Combination Chiropactic Table. Two complete Tables in one. Every Druggless Doctor a Prospect. A fortune can be made from this invention. Hancil Cordrey, Chula Vista, Calif.

PATENT Pending; Propelling Mechanisms for Bicycle. Box 275, Wichita, Kans.

FOR Sale—U. S. and Canadian patents on Auto Wheel Ground Gripper. Assures motorists, truck users, etc., undelayed travel through sandy, muddy roads; easily attached, inexpensive. Address John B. Gravelle, 421 Euclid Ave., Lock Arbour, Asbury Park, N. J.

OUTRIGHT or Royalty—Combination Lock. Simple and efficient. Easily manufactured. Permits of varied construction; suitable for garages, cabinets, drawers, desks, etc., or auto ignition. Bezedcheck, 1850 Graviola Ave., Long Beach, Calif.

FOR sale outright—United States patent number 1,557,796; Canadian patent pending. Dental film support for X-ray machine. W. A. Bonar, Nevada, Mo.

FOR Sale—Patent Burglar Proof Window Lock, open or close any distance; cannot move without damaging window. Apply J. Cushey, 564 Graham Ave., Brooklyn, N. Y.

VALUABLE Patent Pending for sale. Inclosed Cigarette Holder. Smoker will not throw Cigarette butts away on the street. It always tastes fresh and sanitary. Cheap to manufacture; once introduced, quick sale follows. Apply to Jos. K. C. Fat, Hilo, Hawaii.

FOR Sale, controlling device preventing freezing of water pipes and auto radiators. H. W. Haapanen, P. O. Box 86, Sturgis, Ky.

FOR Sale, Patent on Head Light with Automatic dimmer; better road lighting; no blinding glare. Cash or royalty. Carl Cooper, Route 4, Huntington, Ind.

PATENTED Combination "Cigar Holder and Ejector" for sale or royalty. Firmly holds all sizes. For full particulars, Address George D. Martin, Middleport, N. Y.

WRENCH, two in one socket; better than ones that snap on; outright. Palmer, 27 South Orange Ave., Newark, N. J.

FOR Sale. United States and Canadian patents on elevating-pall. Eliminates stooping. A boon in every home. Harrington, Birmingham, Mich.

FOR Sale, Patent No. 1,460,634, automatic draft regulator for steam or hot water. Especially good on hot water. Cheap to manufacture and really dependable. C. H. Abbott, 921 6th St., Astoria, Ore.

SELL your patented or unpatented invention. Write for my Three Plans. Free. Hartley, 44 Central St., Bangor, Me.

ALIMENTARY products washer; Outright or royalty; patent No. 1,550,139; Revolutionizes washing; replaces several men. Best Offer. Secretary A. De Paoli, 129 Gladstone Street, Boston, Mass.

FOR Sale—Patent on Combination Salt and Pepper Shaker. A convenient household article for which the market is unlimited. Will sell patent outright or place on royalty. For further particulars, address Carl G. Nehls, 2517 Mt. Elliott St., Flint, Mich.

FOR Sale. No. 1,554,237. Perfect Scissors Sharpener. Low price. Send for information. Joseph Skarka, 3836 Lawrence Ave., Chicago, Ill.

OUTRIGHT—U. S. and Canadian—Newly patented improvements in non-skidding devices for automobiles. Simple in construction and attachable to any wheel. J. Urbank, 1308 W. 52nd St., Chicago, Ill.

FOR Sale—Patent Miter Box. Patent applied for. The only miter that ordinary Hand Saw can be used. Will cut any arc of circle. Can be carried by mechanic in ordinary tool box. D. G. Dewar, 5608 Forest Ave., Kansas City, Mo.

FOR Sale outright—United States and Canadian patent on Improved Window catch device. Burglar proof and absolutely reliable; easy and cheap to make. Now, Manufacturers, here's your chance to make money. What offers? Sam R. Wallen, Chase, B. C., Canada.

PATENTS—Clevris; Musical Instrument; Tuck Gauge; Sheet Music Turner; Disk Plow Scraper. Talbert & Talbert, McGill Bldg., Washington, D. C.

SURVEYING INSTRUMENTS

LARGEST stock of new and used surveying instruments in the country direct from factory. Satisfaction guaranteed or money refunded. Wissler, 619 N. Broadway, St. Louis.

DRAWING INSTRUMENTS AND SUPPLIES

IMPORTED Drawing Instruments—Slide Rules. Highest Quality—Lowest Prices. Circulars free. Automotive Engineering Co. Box 1062, Indianapolis, Ind.

DRAWING Instruments, all grades; circulars. Preleuthner, 36 West 88, New York.

DRAFTING. Learn Mechanical Drawing. Everyone should learn this fascinating work. Big demand for men who can make accurate drawings to scale. This pocket-size, cloth-covered book starts you at the beginning and leads you by a series of simple lessons to the more difficult assignments that you would get in an architect's or engineer's office. Send No Money. Just write a postal and ask for "A Practical Course in Mechanical Drawing." When the postman hands you the book, pay the few cents postage and the price of the book, \$1. Popular Mechanics Press, Room 801, 200 E. Ontario St., Chicago, Ill.

MODELS AND MODEL SUPPLIES

PATENTS. Time counts in applying for patents. Don't risk delay in protecting your ideas. Send sketch or model for instructions or write for Free book "How to Obtain a Patent" and "Record of Invention" form. No charge for information on how to proceed. Communications strictly confidential. Prompt, careful, efficient service. Clarence A. O'Brien, Registered Patent Attorney, 5899 Security Bank Building (directly across street from Patent Office), Washington, D. C. See pages 142 and 143.

BLUEPRINT Service. Blueprints Made from Your Rough Sketches. Rates Reasonable. "Blueprint Service," 15 Grove St., Downers Grove, Ill.

BLUE Prints of Ships for Modelmakers, send for circular. G. B. Douglas, 165 Summit Ave., Upper Montclair, N. J.

MODEL Steam plant for miniature power boats. Fired by Sterno heat. Absolutely safe and easy to handle. Steel boiler with 12 water tubes will keep 50 lbs. pressure with engine wide open. Send 4c stamp for circular 8. Model Machine Shop, 417 East 71 St., New York City.

ACCURATE Working Drawings Made from Sketches. Rates on Request. Myers, Lalama, and Heintz, Box 546, New Kensington, Pa.

HULIT & Co., General Model Makers, 625 W. Jackson, Chicago, Ill. Specializing in high-grade model work on inventions of merit. Complete Equipment, Experienced Workmen.

DIES, Tools and General Manufacturing. Models and Manufacturing of new inventions or specialty. Logan Machine Co., 126 S. Clinton St., Chicago, Ill.

MODEL Steam Engines, Boilers and Model Pipe line fittings. Model Making Supplies. Send 20c for this year's illustrated catalogue and hand book. Bathe Mfg. Co., Dept. D., 5214 Woodland Ave., Philadelphia.

MODELS, experimental work for inventors. Confidential, reasonable. Technical Research Bureau, 377 National Ave., Milwaukee, Wis.

THE Modelmaker, a magazine for all interested in making-working models. Sample 10 cents. Modelmaker, 122 Liberty St., New York.

SPECIAL machine builders, tool and die makers, inventor's models, production work of all kinds. Dept. L, Quality Hardware & Machine Co., Ravenswood and Thorndale Avenues, Chicago, Ill.

WE make working models for inventors and do experimental work and carry a complete stock of brass gears and model supplies. Send for catalogue. The Pierce Model Works, Tinley Park, Ill.

WE Build Models, design, develop and manufacture articles in large or small quantities. Homeyer Mfg. Co., 1385 E. 17th St., Cleveland, Ohio.

PATTERN Making is a fascinating trade that pays good money. Popular Mechanics has helped many a young man into this trade by supplying the necessary instructions in "Pattern Making," by G. H. Willard, 312 illustrations. Special chapters on moulding and core making. Send No Money. Just write a postal. Pay postman postage and \$1. Popular Mechanics Press, Room 801, 200 E. Ontario St., Chicago, Ill.

MANUFACTURING

METAL-CRAFT — Eventually — Metal-Craft. Competent Engineers, Designers and Producing Organization await your commands on dies, stampings, die-casting, deep pressing, screw-machine and wire products, Plating, Enameling, Burnishing, Assembling, Wrapping and Packing to your specifications. Large completely equipped plant which guarantees prompt, efficient service. It is not the quality of raw materials alone, nor the precision in manufacture, and not just the service rendered that has given Metal-Craft the good reputation they bear—but all of these, as a constant certainty, in combination. Estimates promptly furnished. Metal-Craft Manufacturing Company, Chicago, Box 239-W.

WE design and build special machinery, tools, dies, jigs, and fixtures. Experimental work. Light stamping, quantity production. Reliable Machine Co., 400 West 23rd St., New York City.

WIRE goods made to order. Cooley Mfg. Co., 530 N. Western Ave., Chicago.

METAL Stampings, Dies and Special Machinery. Mail us your drawing or sample for estimate. Send for our free catalogue of Model Supplies. The Pierce Model Works, Tinley Park, Ill.

QUALITY in quantity; small metal specialties, simple or difficult. Large Connecticut factory. Jo Berge Co., Woolworth Bldg., New York.

LIGHT stamping and manufacturing. Aeme Tool Co., Mason City, Iowa.

OUR factory will make your models, manufacture your articles as well as build your tools, dies and fixtures. Standard Die & Specialty Co., 1932 Austin Ave., Chicago, Ill.

MANUFACTURING, Models, Dies, Stampings, Brass Work, one or thousands. Baum's Metal-Specialties, Kansas City, Mo.

PATTERNS, wood and metal. Models, tools and dies. Brass, bronze, aluminum and iron castings. Screw machine work, production work of all kinds. Write Modern Machine & Pattern Co., Terre Haute, Ind.

MACHINERY, TOOLS AND SUPPLIES

THE "Artisan" Lathe! For the Experimenter, Mechanic, Electrician and Repairman. 11" swing over bed; 16" swing over gap; 24" between centers; graduated compound; quick-change gears. An accurate, powerful, compact Lathe, large in capacity but small in price. Write today for free literature. Artisan Manufacturing Co., 831 West 6th St., Cincinnati, Ohio.

NO. 60 Heald Auto Cylinder grinder, \$750.00; No. 2 Cincinnati Milling machine, \$275.00; 24" Hendy Shaper, \$325.00; 16"x8" Bradford Engine lathe, \$300.00; Barnes 20" Drill Press, \$55.00; 24" Woodworker-Planer, \$175.00; 26" Band Saw, \$65.00. Terms to suit on single machine or complete shop. Complete line of machinery and supplies. Cincinnati Machinery & Supply Co., 218 E. Pearl St., Cincinnati, Ohio.

CONCRETE Building Block Machines and Molds. Catalogue free. Concrete Machine Co., 5 N. Main St., St. Louis, Mo.

15x6 SEBASTIAN. Rebuilt, guaranteed, \$150.00. Sebastian Lathe Co., Cincinnati.

ENGINES, MOTORS AND DYNAMOS

GUARANTEED 1/2 hp. 110 volt, 60 cycle, single phase, used motors with pulley at \$7.50, cash with order. We repair, rewind, electric motors and generators, etc. Bargains on electric fans. General Distributing Co., Security Storage Bldg., Duluth, Minn.

BRAND new 1/2 H.P. 110 V Direct Current motors \$4.65. Also bargains in larger motors. Queen City Electric Co., 1736 Grand Ave., Chicago, Ill.

THINKING of Electric Motors? Real Bargains. All sizes, all kinds! both new and rebuilt. Tell us your needs. Motors repaired and exchanged. Send for our price list. Hyre Electric Co., 615 RH South Dearborn Street, Chicago, Ill.

BRAND new 1 KW Westinghouse, 32 volt, 1,150 speed, light and power Generators at \$48.00 each, 25% cash, balance C.O.D. General Distributing Co., Security Storage Bldg., Duluth, Minn.

STEAM Engines, one H.P., \$18.00, 1/2 \$12.00. James Chambers, Bessemer, Ala.

ELECTRICAL

SMALL Used 110 Volt Universal Motors Complete with Cord and Plug. Buy One for Christmas. \$3.00 Delivered. Evert Electric Co., Racine, Wis.

ELECTRICAL Kinks on all phases of practical electricity are to be found in Popular Mechanics new book, "Electrical Kinks." There are 47 ideas on wiring, 45 on making electrical devices, 19 on lighting, 5 on transformers, 5 on motors, 8 on generators, 11 on switches, 22 on testing, 12 on repairing, 11 on battery manufacture and repair, 5 on telephones, and 9 on electrician's tools. 214 articles, 162 pictures. Send no money. Just write a postal asking for "Electrical Kinks." When the postman hands you the book, pay the few cents postage, and \$1.50 for the book. Popular Mechanics Press, Room 801, 200 E. Ontario St., Chicago, Ill.

BENDING MACHINES

THE famous Hossfeld Wrenchless Universal Bender is the last word in bending machines; bends metal, cold or hot, into most any conceivable shape, including Eye-bolts and Automobile Spring Eyes. Bends up to 1" bars or 1 1/4" Pipe cold. Used by the largest corporations, yet so inexpensive that even a farm shop need not be without one. Send for circular. Hossfeld Mfg. Co., Box 344, Winona, Minn.

BLACKSMITHS

BLACKSMITH Notice: Young smith or handy man make more money doing hard jobs easy. In job shop or factory be a Master Machine and Plow Blacksmith and Expert Tool Dresser. With Colored Tempering Charts. All for One Dollar. Samples Free. W. M. Toy, Sidney, Ohio.

FOR SALE—MISCELLANEOUS

BARGAINS — Lowest Prices. Jewelry, Watches, Diamonds, Pearls, Kodaks, Radios. Free Catalog. Acheson, 2235 West Cury, Richmond, Va.

SOCKS. Medium weight cotton—Seamless, Black, Grey, Brown, Six pairs one dollar; also woolen socks, medium weight, four pairs one dollar. Positively Guaranteed. Avon Specialty Co., Avon, N. Y.

PRINTING Presses, Type, Materials. Make easy money printing for self and others. Interesting circulars. Stamp. Watson, 30 Beckman St., New York.

ADDRESSOGRAPHS. Letter Folders, Multigraphs, Envelope Sealers, Duplicators, less than half price. Guaranteed. Pruitt Co., 117 No. Market, Chicago.

SWAP! Buy! Sell! Anything! Anywhere! 20-Word ad and Six Months subscription 50c. International-Opportunity, Brookings, S. Dak.

FOR Sale: Watchmaker's Lathe at a bargain. R. Jaegerman, 5815 Easton Ave., St. Louis, Mo.

BUY—Exchange—Sell! Many of our readers have for sale or exchange the article you are looking for—and lots of them are looking for the very items you want to turn into cash. Get together! Let our two million five hundred thousand readers know your wishes—they'll help you! Send your ad today to M. L. Bund, Manager Classified Advertising, Popular Mechanics Magazine, Chicago.

WANTED—MISCELLANEOUS

MAIL us your Discarded Jewelry, Diamonds, Old Gold, Silver, Platinum, Magneto Points, Gold Crowns, Bridgework. Cash promptly mailed. Your goods returned if offer refused. D. Davis, 1726 Roosevelt Rd., Chicago.

MAIL us your discarded Jewelry, Gold, Crowns and Bridges, Watches, Diamonds, Silver, Platinum, and old False Teeth. Money promptly mailed. Goods returned if offer refused. United States Smelting Works, (The Old Reliable), Dept. 71, Chicago.

CASH sent immediately for gold, silver, platinum, diamonds, watches, bridge-work, crowns, and all valuables. Satisfaction guaranteed. Dept. 50. Buseh Products, 2360 Eighth Ave., New York.

LET'S Swap! Buy! Sell! What's ya got? What's ya want? Wm. Ortman Co., Post Office Box 673, Milwaukee, Wis.

CASH Money for diamonds, old gold, platinum, silver, old watches, gold crowns, bridgework. Cash by return mail. Petersen, 2610 S. Division, Grand Rapids, Mich.

REAL ESTATE, FARM AND ORCHARD LANDS

ATTENTION—"Get acquainted." Cash for your property. Farm, Hotel or Retail Store, no matter where located; confidential service. Hayes' Business Agency, Cincinnati, Ohio.

100 ACRE Farm \$3,500, with Horses, 14 Cattle, \$4,000 Timber, Estimated, valuable wood, farm equipment, crops for winter; homey 5-room stone and brick cottage, good barns, silo, etc. \$3,500 gets it; terms arranged. Details pg. 9 Illus. Catalog. Free. Strout Farm Agency, 255-P, 4th Ave., New York City.

PECAN-Orange-Fig Groves "On the Gulf" Monthly payments. Guaranteed care. Big, quick returns. Suburban Orchards, Dept. M, Biloxi, Miss.

\$5.00 DOWN, \$5.00 monthly; 10 acres unimproved poultry, fruit, stock, woodland; \$100; Ozarks, Fishing, hunting, trapping. Alvin Zimmermann, 1800 N. Fifth, Kansas City, Kans.

SELL your property quickly for cash, no matter where located. Don't pay big commission. Particulars free. Real Estate Salesmen Co., Desk B, Lincoln, Nebr.

SPLENDID Truck and Poultry Farm. \$600 Needed; 12 acres, Crops, Chickens, young cow, pig, hunting dog; implements, milk climate, 1/2 mile shipping station; orchard, grapes, berries; 5-room bungalow, barn, poultry house. Price \$1,450, only \$600 required. Details pg. 18 Illus. Catalog. Free. Strout Farm Agency, 255-P, 4th Ave., New York City.

OREGON homesteads—recently opened—offer exceptional opportunities. Map and details \$1.00. Frank Thompson, Sheridan, Oreg.

DOGS AND PETS

RAISE guinea pigs. Pay better than poultry or rabbits; easy to raise; little space required. We guarantee market. Particulars and booklet how to raise free. Cavies Distributing Co., 3102 Grand Ave., Kansas City, Mo.

FOR Worms in Dogs—Use Carbon Tetrachloride pure. The most effective remedy against Hook and Round Worms, and the safest to use. Also recommended in cases of Running and Barking Fits. In capsules assorted sizes for dogs and puppies, 18 doses, \$1.00. Harrison Chemical Co., Dept. 23, Quincy, Ill.

FOR Sale—blue foxes, red fox, mink, skunks, muskrats, ferrets, opossums, squirrels, rabbits. B. Tippman, Dept. H, Caladonia, Minn.

POLICE Pups. White Collies. Ben Rilly, Gilman, Ill.

FOR Sale, Registered German Police Pups, \$35.00 and up. Write R. S. Lunde, Cooperstown, N. Dak.

GERMAN police pups and grown dogs for sale. Veri-Best Police Dog Kennels, Portland, Ind.

WHITE Scotch Collies, Beautiful, Intelligent, pedigreed. Dept. P, Shomont Kennels, Monticello, Iowa.

RAT Terriers, Newfoundlands, St. Bernards, Police Dogs. We send on approval. Descriptive circular 10c. Fairview Farm, Elmore, Minn.

BEAUTIFUL registered bull pups \$15. Bulldogs. 591 Rockwood, Dallas, Texas.

PERSONAL

EXCHANGE Postcards! Very interesting. Educational, Fascinating, Instructive Pastime. Membership and List. 10c. Popular Exchange, Windsor, N. C.

TOBACCO or Snuff Habit Cured or no pay. \$1.50 if cured. Remedy sent on trial. Superba Co., N3, Baltimore, Md.

SEND 25c and your date of birth for forecast of your vibrations for 1926. Arvel Synclaire, Numerologist, Box 25, Patton, Calif.

DON'T be a tobacco slave. Orsanin positively and quickly overcomes the habit, any form, or money refunded. Investigate. Orsanin Co., Box 503-D, Detroit, Mich.

MISCELLANEOUS

WEEDS—Cut them with cutter bar on Shaw Garden Tractor. Also plows, cultivates and runs belt machinery. Low prices. Immediate delivery. Shaw Manufacturing Company, Department C, Galesburg, Kans.

CUTS anybody can make. Simple, cheap process. \$1. Specimens, particulars. 2c stamp. M. Day, Windfall, Ind.

ARTIFICIAL Eyes. Booklet free. Denver Optic, 559 Barclay, Denver, Colo.

HOMEOPATHIC and Biochemic preparations sent postpaid to all parts of the world. Manual and booklets free. Halsey Bros. Co., 111 N. Wabash Ave., Chicago, Ill. Established 1855.

CAN You Draw? Make money at home. Something new. No canvassing. Sample and particulars 10c. "Straley," 1017 W. Mulberry, Springfield, Ohio.

MEXICAN made pistol holsters, cartridge belts, lariats, sombreros, horse-hair goods; list free. Ingersoll Leather Co., 397 Fannin, Houston, Tex.

FORMS to Cast Lead Soldiers, Indians, Marines, Trappers, Animals. 151 Kinds. Send 10c for Illustrated Catalogue. Henry Schlercke, 1034 72nd St., Brooklyn, N. Y.

ARE You Old at Forty? See our advertisement on page 146 of this issue. The Electro Thermal Company, 2137 Main Street, Steubenville, Ohio.

MIRRORS Re-Silvered at Home. Costs Less 5 cents per square foot; you charge 75 cents. Immense profits, plating autoarts, reflectors, tableware, stoves. Refinishing metalware, etc. Outfits furnished. Write for information. Sprinkle, Plater, 288, Marion, Ind.

GET posted—good prices paid for butterflies, insects. See Sinclair display advertisement, page 72.

VACUUM Cleaners—50-70% discount on slightly used and samples; Eureka, Premier, Ohio, Apex, etc. Guaranteed 3 years. \$15-\$18. Catalog free. Kahn, 1415 Fulton Ave., New York.

MINERAL Treasure under Foot. Find it. Cash fit. Information 10c. Minerals identified \$1.00. Mineral specimens. Radio galena. Buskett, Joplin, Mo.

GIFTS for all. Buy at wholesale price. Send for catalogue, free. I. Geiber Specialty Co., 32 Union Sq., New York, N. Y.

POULTRY Owners—Turn lazy, profitless Hens into hustlers and money-makers! Practical and inexpensive. Free particulars. Address John Englund, Box 267A, Ontonagon, Mich.

ABSOLUTELY THE LAST CHANCE To Get This Great Book FREE

For a short while we have been giving Taylor's great book on TRANSFORMER PRACTICE free with the pay raising Croft Library. Hundreds of men have jumped at this big book bargain—a great bargain, indeed, at a special low price—on small monthly payments. It will pay you to see

The Croft Library of Practical Electricity
A combined reference library and home study course, 8 volumes, 3000 pages, 2100 illustrations, flexible binding \$1.50 in ten days and \$2.00 monthly for nine months, only 7 cents a day.

The man who gets anywhere in any line of endeavor is the man who KNOWS. And generally the more he KNOWS the more he EARNS. For the man who wants to know there is nothing better than these eight volumes packed to the covers with sound, helpful information on every phase of electricity from first principles to central station work.

SEE IT FREE—No Obligation to Purchase
By just filling out and returning the coupon below you will have at no cost to you whatsoever a practical, useful set of books for 10 days' Free Examination. We take all the risk—pay all charges. You assume no obligation—you pay nothing unless you decide to keep the books. Send the coupon NOW and see the books for yourself. When your first payment of \$1.50 is received we will send you your free copy of Taylor's Transformer Practice.

FREE EXAMINATION COUPON

McGraw-Hill Book Co., Inc., 370 Seventh Ave., New York

Send me for 10 days' free examination the Library of Practical Electricity. If satisfactory I will send you \$1.00 in 10 days and \$2.00 monthly until the special price of \$19.50 is paid. If not wanted, I will return the books at your expense.

On receipt of my first payment of \$1.50 it is understood that I am to receive, free of charge, a copy of Taylor's Transformer Practice.

Signed.....
Address.....
City and State.....
Position.....
Employer.....

P. M. 1-1-26

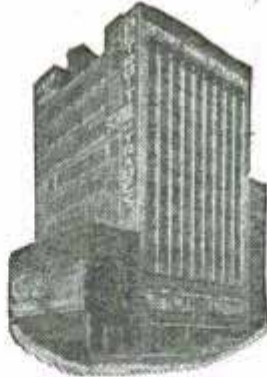

Men Wanted TO COME TO DETROIT AND Learn a Trade AT THE DETROIT SCHOOL OF TRADES

Endorsed by Contractors, Builders and Manufacturers

Come to Detroit. Enroll in our School. Learn one of these high paying trades and your success in life is assured. We teach you on the actual work. You use the tools; not books.

- Bricklaying
- Plastering
- Plumbing
- Carpentry
- Estimating
- and Contracting
- Electrical
- Paper Hanging
- Painting and Decorating
- Sign Painting
- Show Card Writing
- Auto Stripping
- Auto Mechanics
- Auto Trimming
- Metal Finishing
- Auto Painting
- (Duco-Zapon)
- Acetylene Welding

SPECIAL CUSTOM SHOP COURSE

Why work for low wages when you can make from \$9.00 to \$14.00 per day at any of these trades after a short practical training at our School? Reasonable tuition rates.

RETURN COUPON

DETROIT SCHOOL OF TRADES, 217-221 Woodward Ave., Dept. 16-A, Detroit, Mich.

Please send me without obligation on my part full information regarding your School of Trades.

Name.....
Address.....
City and State.....
Trade interested in.....

We have no facilities for negroes

FREE Dollar Book for you!



If you are mechanically inclined,

you don't need any previous experience, just a liking for the work, you can make a real success of your life. I can't turn out men fast enough for the good jobs waiting in the automobile business. I could fill this magazine with letters from Sweeney trained men who have made good. Now is the time to make a decision. The first step is to send for my big free book that gives all the facts and will open your eyes to how other fellows are making real money and are happy in the automobile business. Over 70,000 men date their prosperity from the day they got this wonderful book. It costs me over a dollar apiece to send this book but I will gladly send it to you free.

Yes—You can do as well as these—

Joe Wagner, Moulton, Texas. "Made \$3,300 clear last year. Own up to date garage."

John Anderson, Simpsonville, Ky. "Making twice as much money as I ever made in my life. Head mechanic in a modern garage."

Lynton Harmon, Harrison, Me. "Wouldn't take \$5,000 for what I learned at your school."

H. O. Wending, Altamont, Ill. "In business with another old student, hired two more Sweeney men, have a complete modern garage, sailing fine."

Roy Parker, Jackson, Tenn. "Making \$100 a week clear."

Kenneth White, Princeton, Ind. "Used to think \$3.00 a day was fine before coming to your school. Now making \$1.50 to \$3.00 an hour."

Ernest Moore, Milton, West Va. "From head mechanic to sales manager with Overland Agency. Can always recommend your school."

Frank Roe, Keller, Texas. "Every ambitious fellow has an equal chance."

—and thousands of others.

JOBS PAY \$50 A WEEK AND UP COME RIGHT NOW.

If you are mechanically inclined, if you like to work with tools, you will learn under the "Sweeney System," by actually doing the work, everything about all kinds of automobiles, oxy-acetylene welding, vulcanizing, battery work, electrical work, aviation, building and repairing Radio sets. No experience or education needed. No books are used. You work on most complete gas engine and electrical equipment obtainable. Over \$200,000 invested. \$50,000 Radio Station WHB. You'll get dirty and greasy, but you'll learn by the "Sweeney System" that fits you for big pay jobs at \$50 a week and up, waiting for Sweeney trained men.

SWEENEY SYSTEM OF PRACTICAL INSTRUCTION

There's only one place where you can get this training—it's at the world-famous Sweeney Automotive and Electrical School of Kansas City. There's only one Sweeney School. There's only one "Sweeney System." No other school offers or can give you this training that not only trains you to fill big paying jobs but saves you time and money. This training is making big money for 70,000 Sweeney Graduates. I estimate 20,000 of them own a good paying business.

E. J. SWEENEY, President

LEARN A TRADE
Sweeney
 AUTOMOTIVE & ELECTRICAL SCHOOL
 2131 SWEENEY BLDG. KANSAS CITY, MO.

LISTEN, MEN—

let's go. If you want money, independence, a sure good pay job or business for yourself—travel—see the world—if you want to be somebody and have something—do the work you like, then clip this coupon or send post-card for this book today.

My FREE BOOK

Tells You—

- How to run a garage anywhere.
- How to learn several good trades.
- How to travel and see the world.
- How to fit yourself for prosperity.
- How to get a good mechanical job.
- How to learn to be a chauffeur or truck driver.
- How to learn to repair any make of car.
- How to weld.
- How to learn batteries and auto tires.
- Shows you hundreds of actual photographs of men at work in my big shops. Shows how 70,000 men got their start.
- Shows how easy it is to learn; how much fun you have during recreation hours. Swimming pool, entertainment, band and orchestra, radio broadcasting.
- Answers every question.

WRITE ME TODAY

The first step is to get my free 64-page book. I will gladly send it to you. And I will make you an amazing offer. I will make it easy for any man to learn the auto business. I will send you this valuable book

—send this NOW

free—no cost—no obligation. No colored students accepted. EMORY J. SWEENEY, Pres.

EMORY J. SWEENEY, President
 2131 Sweeney Bldg., Kansas City, Mo.

Please send me your Free 64-page catalog and special offer.

Name.....

P. O.....

State..... Age.....

What Will You Be Doing One Year From Today?

Three hundred and sixty-five days from now—what?

Will you still be struggling along in the same old job at the same old salary—worried about the future—never quite able to make both ends meet—standing still while other men go ahead?

One year from today will you still be putting off your start toward success—thrilled with ambition one moment and then cold the next—delaying, waiting, fiddling away the precious hours that will never come again?

Don't do it, man—don't do it.

There is no greater tragedy in the world than that of a man who stays in the rut all his life, when with just a little effort he could bring large success within his grasp.

Make up your mind today that you're going to train yourself to do some one thing well. Choose the work you like best in the list below, mark an X beside it, mail the coupon to Scranton, and without cost or obligation, at least get the full story of what the I. C. S. can do for you.

INTERNATIONAL CORRESPONDENCE SCHOOLS

Box 5548-E, Scranton, Penna.

Without cost or obligation, please tell me how I can qualify for the position or in the subject before which I have marked an X:

BUSINESS TRAINING COURSES

- | | |
|--|---|
| <input type="checkbox"/> Business Management | <input type="checkbox"/> Salesmanship |
| <input type="checkbox"/> Industrial Management | <input type="checkbox"/> Advertising |
| <input type="checkbox"/> Personnel Organization | <input type="checkbox"/> Better Letters |
| <input type="checkbox"/> Traffic Management | <input type="checkbox"/> Show Card Lettering |
| <input type="checkbox"/> Business Law | <input type="checkbox"/> Stenography and Typing |
| <input type="checkbox"/> Banking and Banking Law | <input type="checkbox"/> Business English |
| <input type="checkbox"/> Accountancy (including C.P.A.) | <input type="checkbox"/> Civil Service |
| <input type="checkbox"/> Nicholson Cost Accounting | <input type="checkbox"/> Railway Mail Clerk |
| <input type="checkbox"/> Bookkeeping | <input type="checkbox"/> Common School Subjects |
| <input type="checkbox"/> Private Secretary | <input type="checkbox"/> High School Subjects |
| <input type="checkbox"/> Spanish <input type="checkbox"/> French | <input type="checkbox"/> Illustrating <input type="checkbox"/> Cartooning |

TECHNICAL AND INDUSTRIAL COURSES

- | | |
|---|--|
| <input type="checkbox"/> Electrical Engineering | <input type="checkbox"/> Architect |
| <input type="checkbox"/> Electric Lighting | <input type="checkbox"/> Architects' Blueprints |
| <input type="checkbox"/> Mechanical Engineer | <input type="checkbox"/> Contractor and Builder |
| <input type="checkbox"/> Mechanical Draftsman | <input type="checkbox"/> Architectural Draftsman |
| <input type="checkbox"/> Machine Shop Practice | <input type="checkbox"/> Concrete Builder |
| <input type="checkbox"/> Railroad Positions | <input type="checkbox"/> Structural Engineer |
| <input type="checkbox"/> Gas Engine Operating | <input type="checkbox"/> Chemistry <input type="checkbox"/> Pharmacy |
| <input type="checkbox"/> Civil Engineer | <input type="checkbox"/> Automobile Work |
| <input type="checkbox"/> Surveying and Mapping | <input type="checkbox"/> Airplane Engines |
| <input type="checkbox"/> Metallurgy | <input type="checkbox"/> Navigation |
| <input type="checkbox"/> Steam Engineering | <input type="checkbox"/> Agriculture and Poultry |
| <input type="checkbox"/> Radio | <input type="checkbox"/> Mathematics |

Name.....
Street.....
Address..... 3-6-24

City..... State.....

Occupation.....

Persons residing in Canada should send this coupon to the International Correspondence Schools Canadian, Limited, Montreal, Canada.



Send For a Master Key

It tells how environment is created. How circumstances may be controlled. How lines of least resistance are formed. Why some persons attract success, power and wealth. Why others seem to fail. It explains the effect of concentration. It explains the Law of Abundance. It tells of a simple but infallible test by which anyone may determine whether he is destined to be a success in life or not. Over a million copies printed during the last ten years. A record of accomplishment seldom equalled. Sent postpaid for only 10c, money refunded if not satisfied.

MASTER KEY SYSTEM
714 N. 9th St. St. Louis, Mo

BUILD YOUR OWN AIRPLANE



Blueprints and Material now ready for Builders

America's smallest, practical Biplane. 100 miles per hr. with 30 H. P. motor.

Send 10c for illustrated catalog.

Lincoln Standard Aircraft Corp., Lincoln, Nebr.

\$100⁰⁰ EARNED BY YOUNG ARTIST IN 2 DAYS



Well-trained artists earn splendid incomes. The Federal home-study Course is a proven result-getter. If you like to draw, send 6c in stamps for 56-page book "Your Future." State your age and present occupation.

FEDERAL SCHOOL OF COM'L DESIGNING
612 Federal Schools Building
Minneapolis, Minn.

ARE YOU SELF-CONSCIOUS? DO YOU STAMMER?

You must overcome Self-Consciousness—Mental Fear—Bashfulness to succeed in the business and social world. Send 10c for amazing booklet, "Road to Poise and Achievement." Tells how thousands have conquered Self-Consciousness in a very short time. SEYMOUR INSTITUTE, 56 W. 45th St., Dept. 22, New York City

Your Choice



\$20⁰⁰

Musical Instruments

FREE TO OUR STUDENTS

Your choice of a Violin, Tenor Banjo, Hawaiian Guitar, Banjo, Cornet, Ukulele, Banjo Ukulele, Guitar, Mandolin or Banjo Mandolin. You will be proud to own any one of these instruments and you can have one absolutely free. A few cents a day for lessons is your only expense. Our system of teaching is so easy that you can play several pieces by note with the first four lessons. We guarantee success or no charge. Instrument and lessons sent on **one week's free trial**. Write for booklet today, no obligation.

CHICAGO CORRESPONDENCE SCHOOL OF MUSIC
Orchard and Willow Streets • Dept. 70 • Chicago, Illinois



Samuel Glassberg



Tremendous Future for Every Man Who Enters Building Business Now. Leading Minneapolis Builder Tells How . . .

"Years ago, when one entered the building business, it was necessary to start at the bottom and work up step by step. My start was to carry the water bucket and be a general helper, at \$3.00 per week. I learned by experience, and it took me many years. Often I have wished I could have had the easy, quick, thorough training offered to boys and men today. The Chicago Tech. School for Builders can teach the fundamentals of building, give every man in 10 months' training what took me about 10 years to learn in the slow, hard school of experience. Today this modern method enables every boy and man to obtain his training during spare time. Opportunities now in the building business are the best ever, growing greater every year. There is an endless opportunity for trained men." So writes Samuel Glassberg, greatest home builder of the northwest, Pres. Glassberg Construction Co., Minneapolis. A self-made man who plans, finances, and builds an average of 75 homes annually, and knows every branch of the building business. He started as a boy. Today he has his own lumber mills, finance company, and employs more than 180 men.



Learn at Home in Spare Time to Earn \$3,000 to \$10,000 a Year

Get into the building business . . . no matter what your job is now. No overcrowding in this tremendous field—room for thousands of new men every day. For building is America's second largest industry. Why buck the competition of crowded industries where only a few men advance to big-pay jobs? Why stay at low wages? In spare time—at home—any man can get his start to become a building expert—and can earn \$65 to \$150 per week.

Clerk or carpenter—office man or bricklayer—salesman or superintendent—it makes no difference. Thousands of specialists—men who can read blue print plans and boss the others—are demanded for the \$6,000,000,000 of buildings that will be erected this year.

Men who are in the building game now know the high wages—\$10 to \$20 a day—paid to foremen, superintendents, and experts in various branches of building.

Building—Plan Reading—Estimating

Even men with ordinary training make real big money in the building field. But trained men win the top—salaries of \$3,000, \$5,000 and \$10,000. Fit yourself for this work. We'll show you the way. You can get into the building business quickly . . . easily. Or if you are in it now . . . and want to advance . . . you can get the training now that you must have for success.

FREE TRIAL LESSON—No Education Necessary

To show you how simple this Builder's Course is we send you a free trial lesson and actual blue print plans. Our book "How to Read Blue Prints" . . . written by a practical building expert, covers the first lesson. You will find this whole course as easy to read and understand as your daily newspaper with everything written in everyday language. You learn from actual blue print plans—from practical building experts. That's why Chicago Tech. School for Builders graduates get ahead so fast—why they are picked for the big jobs. And you don't need any other education.

Earning Less Than \$75 a Week? Then Act Now—Send the Coupon

Send the coupon. It places you under no obligation. Get the facts—today. Find out about this building course—what it has done for others—what it offers you. Builders in your own town or city are making big money. Here's your chance to get into the same big-pay field—or to have a building business of your own. Send the coupon. "How to Read Blue Prints," the Blue Print Plans and a book describing our whole course will be sent to you at once. See for yourself what building means in dollars and cents to you!

Chicago Technical School for BUILDERS

Dept. 177, Chicago Tech. Bldg., 118 E. 26th St., Chicago

From Foreman to Contractor and \$450 a Month

"When I entered as a student I was in charge of a job as a foreman at \$8.00 a day. For the past four months I have been contracting and have averaged \$450.00 a month." Writes R. H. Edney, Asheville, N. C.

Salary Increased From \$1.50 a Day to \$210 a Month

"In 1920, I was a ditchman working for \$1.50 a day. And now my salary is \$210.00 a month. Chicago Tech. Training has taken me out of the ditch and landed me on the top of the building." So writes P. J. Marchand, New Orleans.

FREE Trial Lesson and Blue Print Plans



Qualify for a Good Paying and Permanent Position

- Plan Reading
- Estimating
- Foremanship
- Superintendence
- Building Construction
- Building Management
- Contracting
- Building Homes
- Real Estate and Insurance
- Public Estimating
- Building Inspecting
- Buying and Selling
- Building Material
- Quantity Surveying
- Promoting

Mail This Now!

Chicago Technical School for Builders, Dept. 177, Chicago Tech. Bldg., 118 East 26th St., Chicago, Ill.

Yes, I want to earn more. Send me, without obligation, details of the opportunities in the business of Building, details on how I can increase my earnings, and a copy of your book, "How to Read Blue Prints." (Write or print name plainly, please.)

Name

Address

City

State

Occupation

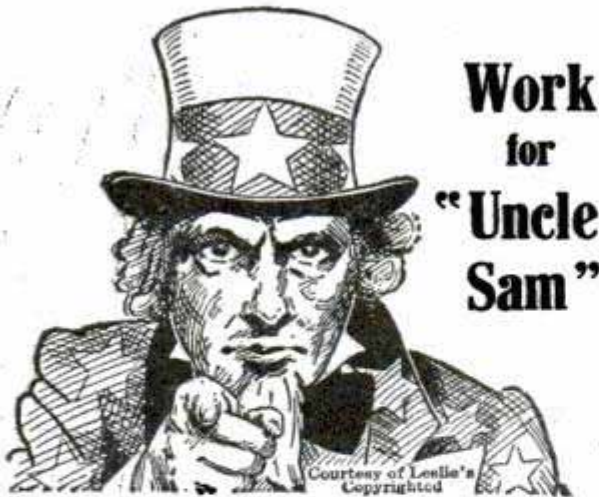

\$1140 to \$3300 a Year PICK YOUR JOB

STEADY POSITIONS

These are steady positions. Strikes, poor business conditions, lockouts or politics will not affect them. U. S. Government employees get their pay for twelve full months every year. There is no such thing as "HARD TIMES" in the U. S. Government Service.

\$1,900 TO \$2,700 A YEAR

Railway Postal Clerks get \$1,900 the first year, being paid on the first and fifteenth of each month. \$78.00 each pay day. Their pay is increased to a maximum of \$2,700 a year. \$112.50 each pay day.

PAID VACATION

Railway Postal Clerks, like all Government employees, are given a yearly vacation of 15 working days (about 18 days). They travel on a pass when on business and see the country. When away from home they get extra allowance for hotel. When they grow old, they are retired with a pension.

CITY MAIL CARRIERS POSTOFFICE CLERKS

Clerks and Carriers now commence at \$1,700 a year and automatically increase \$.00 a year to \$2,100 and \$2,300. They also have 15 days' paid vacation. Examinations are frequently held in the larger cities. City residence is unnecessary.

CLERKS AT WASHINGTON, D. C. (Open to men and women 18 or over)

Salary \$1,140 to \$1,860 a year. Required for pleasant clerical work in the various government departments at Washington, D. C.

IS YOUR JOB STEADY?

Compare these conditions with your present or your prospective condition, perhaps changing positions frequently, kicking around from post to pillar, no chance in sight for PERMANENT employment; frequently out of a position and the year's average salary very low. DO YOU EARN \$1,900 EVERY YEAR? HAVE YOU ANY ASSURANCE THAT A FEW YEARS FROM NOW YOU WILL GET \$2,700 A YEAR?

YOU CAN GET THEM

These positions are not hard to get. Country residents and city residents stand equal chance. Experience is unnecessary, and political influence is not permitted.

GET FREE LIST OF POSITIONS

Men — Boys, 18 up, fill out the following coupon. Tear it off and mail it today — now, at once.

DO IT NOW—This investment of 2 cents for a postage stamp may put thousands of dollars in your bank account.

Name.....

Address.....

USE THIS COUPON BEFORE YOU MISLAY IT

CUT HERE

FRANKLIN INSTITUTE
Dept. L 174,
ROCHESTER, N. Y.

Kindly send me entirely free of charge
(1) a full description of the position checked below; (2) Specimen examination questions and free sample coaching; (3) Free copy of illustrated book, "How To Get a U. S. Government Job"; (4) A list of the U. S. Government Jobs now obtainable; (5) Tell me how I can get the position I have checked.

... Railway Postal Clerk..... (\$1900-\$2700)
... Postoffice Clerk..... (\$1700-\$2300)
... City Mail Carrier..... (\$1700-\$2100)
... Rural Mail Carrier..... (\$2100-\$3300)
... Clerk at Washington, D. C..... (\$1140-\$1860)
... Income Tax Auditor..... (\$2040-\$3000)

LEARN TENOR BANJO

Banjoists! Earn big money through Charles McNeil's famous Home Study Tenor Banjo Course. Same course as used by the Chicago Tenor Banjo Institute in training professionals. Simple as A B C—yet has all technical requirements. Includes phonograph records played by Chas. McNeil, illustrating strokes, breaks, etc. Send for free booklet and full details.

CHAS. McNEIL, Director
CHICAGO TENOR BANJO INSTITUTE
Dept. 1351, 5029 N. Bernard St., Chicago, Ill.

BE AN OFFICER in the U. S. Coast Guard

\$1700 Up to \$7,500 Yearly

\$780 yearly at the U. S. Academy while training. You rank Ensign to Captain in service. Age requirements 18 to 24. Write Dept. S. for information.

COAST GUARD PREPARATORY SCHOOL
4000 Ga. Ave N. W. Washington, D. C.

For
Architects,
Draftsmen,
Carpenters,
Contractors,
Builders
and all
who expect
to build

BRAIN TOOLS

Men who work with their hands know that head-work gets them more money.

Brain tools make the tools in your tool box at least twice as effective, and the best brain tools you can get are good books—not just any books, but books which tell you the things you want to know, and do it instantly.

Carpenters make themselves contractors by learning how to estimate correctly. Contractors are able to handle bigger and more profitable jobs by learning how the big fellows do it, and architects and those who want to enter this highly paid profession earn more money by having facts and figures at their finger tips.

This brand new set of five handsomely bound books covering all phases of architecture, carpentry and building, enable you to get authoritative, specialized information in a moment. No tedious long hours of reading—no hard grinding study but instant reference to the vital facts. You don't waste a minute—the new jiffy index puts before your eyes, without wasted time, the things you want to know.

The most complete work of its kind we have ever published; nothing has been overlooked. Use of tools—building construction, heating, lighting, plumbing, architectural drawing, blueprint reading; in short, the most comprehensive and easily understood work of its kind.

FREE Membership

Send now and we will include with these money making books a membership which entitles you to free consultation privileges with twenty highly paid experts. This alone is invaluable.

These Books Sent FREE

Yes, this is true. We ship them to you without a penny of down payment. When you get them, look them over carefully—note how easy it is to find what you want to know—test the index in any way you want to and then, if after 10 days you agree that you have at hand a veritable mine of invaluable information, send only \$2.00 and keep the books. After that send us only \$3.00 per month until the small total of only \$19.80 is paid. You'll thank the day you sent for your set.

Learning Means Earning

and here you have at hand information gathered from hundreds of experts, all for so small a sum you'll never miss the money. Use these books as others have done and you'll get many times their price in a few months. One job alone may repay you several fold. Send for your set today.

FREE EXAMINATION COUPON

AMERICAN TECHNICAL SOCIETY, Dept. G-119, Chicago, Ill.

You may send me, entirely without obligation, this handsome set of 5 volumes—Architecture, Carpentry and Building. I am to have full ten days in which to look them over and decide if I want to keep them. After which I will either send them back or send \$2.00 down and \$3.00 per month until the special price of only \$19.80 has been paid.

Name.....
City..... State.....
Reference.....

A resident school—not a correspondence course

Amazing News in Electrical Field!

NEW POWER LINE TO SERVE EAST AND WEST

Electric System to Link Illinois with Ohio, Virginias and Kentucky.

Post holes are being dug to-day to connect electric power lines of Chicago with Cleveland, Pittsburgh and other eastern cities and forming the largest unit to date in a proposed interlocking of all power plants in America into a continental electric empire.

Biggest Pool in Chicago.

The Chicago territory to-day contains the largest "electric pool" in the world. The Commonwealth Edison and its affiliated lines are able to develop or have plants under construction to develop more power than is generated in and around Niagara and four times as much as the first development at Muscle Shoals promises.

Beginning at the east, the Calumet Gas and Electric company is building a plant at Michigan City, Ind., to generate 120,000 horse power. Just over the Illinois line in Indiana 100 acres of lake is being filled in and work is started by the same company for a plant to generate more than 2,000,000 horse power; the first unit, well under way, will furnish a tenth of that. In Chicago the Crawford avenue station was put into service last spring with two units operating and producing nearly \$60,000 horse power. Two more units are to be added when needed. The Public Service company of Northern Illinois has a plant at Waukegan producing half as much power as the

122,000-horse power plant is new years ago. The plant is now under construction.

Cash in on these wonderful opportunities by 12 weeks training in the Greer shops. You can finish in time for a fascinating BIG PAY job this spring.

THIS clipping from the Chicago Daily News gives an idea of the strides electricity is making. This is just an example of how fast the world is being electrified. Right now, you have the chance of a lifetime to get into this big, money-making field—this industry that is fast changing every other industry. Fit yourself quickly and efficiently by this practical shop training.

There is no way you can really learn electricity, except by first hand experience with electrical equipment. Here is the place you get just what you need, in shortest possible time. Be ready for the big spring demand for trained men. Be the man who *knows*, so you can rise to the top and get the big pay. Learn how to boss the work of less experienced men. You will soon be able to go into business for yourself if you want to.



This great 7-story building is the home of the Greer shops.

GREER TRAINING is by Actual Practice on Most Up-to-Date Equipment

Our training is conducted by the job sheet plan, the method that has definitely proved to be simplest, easiest and best. Real electrical problems are assigned from the first day. You need know nothing about electricity to start with. Our plan makes everything perfectly clear, step by step. Efficient instructors smooth the way at every turn.

We do not use toys to experiment with, but real, actual working equipment,—the kind you will find when you get out on the job. We have over 30 kinds of motors, so you will be familiar with any kind you ever meet. A real high-line is in operation, an alternating current generator,—in fact everything that could possibly add to the completeness of our training.

Here are some of the positions you can fit yourself to fill:

- Electrical Contractor
- Electrical Estimator
- Maintenance Engineer
- House Wireman
- General Electrical Rep'rman
- Motor & Generator Expert
- Armature & Stator Winder
- Telephone Expert

- Trouble Shooter
- Radio Engineer
- Power & Sub-Station Engineer
- Power & Sub-Station Installer
- Power & Sub-Station Operator
- Boss of Your Own Shop

FREE EMPLOYMENT SERVICE

We are in close touch with the places where trained men are needed. We will help you get started in the right place. If you need to earn extra money while in training, we will help arrange a part time job for you right from the beginning. There are evening classes for men employed in the day time.

THERE IS NO TIME TO LOSE

Don't let this wonderful chance slip away by just waiting. You know that you can't get anything worth while without going after it. You are right up against a big decision, and you know down in your heart what you should do. You owe it to yourself—and to everyone dear to you—to make the most of every opportunity. Here, right now, is your big chance. You can finish your training in time to make your actual start in the business this spring and see quick results.

SEND IN THIS COUPON TODAY

This coupon will bring you full information about the Greer Electrical course and a remarkable offer for immediate acceptance. Fill it in and mail it now, so you won't lose it and miss out on this chance. Address me personally, please, ERWIN GREER, President.

ERWIN GREER, President, Greer College—Electrical Division, Dept. 101-E, 2024 S. Wabash Ave., CHICAGO.

Please send me your FREE BOOK and offer for Electrical Course. It is understood I am not obligated in any way.

Name

Address

Draw a MAN'S Pay



JOB'S WAITING!

WANTED—MALE HELP.

Professions and Trades.

DRAFTSMAN—AT ONCE—WHO CAN DO good drafting. Youngest class preferred. Experience and references. Individual and security in interview office. Apply Saturdays or Monday morning. Room 545 1st National Bank Bldg.

DRAFTSMAN \$400 Month

Excellent opportunity for young man to become shop executive in short time if he proves his worth. Light, clean office in new building; short hours.

KINDRED PRODUCTS CO MR. ORRINGTON

DRAFTSMAN—TO DESIGN TOOLS—JIGS. Estimate, purchase and check good pay, steady position in plant near Cal. for 1000 miles. View. Bill Pump Valve Co. 1207 Broadway. **DRAFTSMAN—DETAILER ON HIGH CLASS** cabinet work. Good pay, steady position. For more information, write to: Fred M. Dobe, Chief Draftsman, 73-51 Lawrence Ave., Chicago.

WANTED—MALE HELP.

Professions and Trades.

DRAFTSMAN—MACHINE DETAILER AND DRIVER. \$500 mth. Fisher Bldg. **DRAFTSMAN—FOR ORNAMENTAL AND** decorative iron work. Must be good detailer. Good job for right party. Call Monday on J. GOLDBERG, Atlantic Hotel.

DRAFTSMAN DETROIT EDISON

ELECTRICAL MEN WITH POWER HOUSE AND SUBSTATION LAYOUT EXPERIENCE. GOOD OPPORTUNITY AND STEADY EMPLOYMENT. STATE AGE EXPERIENCE AND SALARY DESIRED. THE DETROIT EDISON COMPANY DETROIT, MICHIGAN.

DRAFTSMEN BEGINNERS

\$250 Month and Bonus

We want four clean cut young men who have just finished a good drafting course to fill vacancies created by promotions in our drafting department. Men preferred. Ex.



Fred M. Dobe, M.E. Chief Draftsman
He has been drafting and teaching twenty-five years, and has trained a hundred men who are now Chiefs.

This Offer Means Business!

What line do you like? Mechanical? Electrical? Or, it may be Building or Engineering. Automobiles. Radio. They all need draftsmen. Read the Want Ads in any newspaper!

I can fit you to fill any drafting position. To prove it, I'll send one lesson free. Furthermore, I'll furnish every tool. That's how much I need more men; 100 concerns depend on my classes for new blood in their drafting rooms.

It's Easy You don't learn from books. I teach drafting on the board. We do the same work you'll later do for pay! That's why Dobe men make good on any job they take; why they're spoken for weeks ahead of graduation. You can assure your future in any field, in one evening with this free lesson!

My classes will always be open, but the free lesson offer will not! So, whatever you do, don't postpone using this coupon.

This Coupon Good for One Lesson:



A free lesson, to see how easy and interesting drafting really is!

CHIEF DRAFTSMAN DOBE
Div. 73-51, 1951 Lawrence Ave., Chicago:

I want the free drafting lesson, to see how I like it. Send it in time to get all my tools without charge if I decide to learn.

Name.....Age.....

Address.....

Play a Tune in 10 Minutes! or Send It Back

No knowledge of music necessary. No expensive lessons or tiresome practice. Just pick up an "Instant Playing" Ukulele, Tenor Banjo or any stringed instrument you would like to play, press the numbered keys and before you know it you are playing tunes!



Amazing New Invention

Revolutionizes stringed instrument playing. "Instant Playing" Instruments give clearer, truer tones (not mechanical), are easier to finger and take all the work out of learning to play. Famous Vaudeville Star, Trixie Fragonza, writes: "I learned to play a tune in 5 minutes and had never touched a stringed instrument before." John Matine wrote: "Played tunes on the Guitar the same day and am delighted. Anyone can play." Leonard Cleary: "In only a few days I have had my money's worth in fun. It certainly is one fine instrument." Constance Sedler: "I was playing in four minutes."



FREE BOOK

Send this coupon for FREE Book.

Send coupon for Free Book telling all about new "Instant Playing" Instruments and how you can play in 10 minutes. Also Free Catalog of special bargains in musical instruments. No obligation. Send for this Free Book now! Your friends will be astonished at your learning to play so quickly. You will be popular and always sure of a good time. **Send Coupon Today!**

Name.....
Address.....
City..... State.....

FERRY & CO., Dept. 8771
3224 N. Halsted St., Chicago, Ill.

Send me Free Book on "Instant Playing" Instruments and tell me how I can play tunes in 10 minutes. Also Free Bargain Catalog. No obligation.

Big Money in Poultry



Eggs Turn into Dollars FAST!

Make \$1,000 a Year in Spare Time—Easy

Lot's of room for YOU in the poultry business. 85% of the people of this country live in cities. EVERYBODY eats eggs and poultry meat—but only 15% produce them. Why not let the "other fellow" pay YOU the fancy prices? Easy to get started, in back yard, on vacant lot or farm. We GUARANTEE success if you follow our methods. We show you how to feed for eggs, in winter, when eggs are high in price; how to cut feed bills; how to keep flocks healthy; how to tell laying hens, PAY-BIRDS, from loafers. Our course, produced by eighteen famous experts, endorsed by 50 leading agricultural schools—gives you thousands of sure, proved, tested Methods that make PROFITS CERTAIN. FREE book tells what we're doing for others—and what we can do for you.

Others Say:
"You have opened up to me a pleasant and profitable way of gaining an independent living."
Seldon Anderson, R. I.
"When I enrolled for your course, I knew nothing about poultry keeping. I am now successfully operating a commercial poultry farm."
W. J. Warthen, Conn.
"Your course was a splendid investment. I recommend it for both beginners and experienced poultrymen."
Y. W. Ow, Hawaii.



Mail this now

The National Poultry Institute
Washington, D. C. Dept. 401-E

I am interested in your plan on "How to Raise Poultry for Profit." Send me your FREE book, without obligation on my part.

Name.....

Address.....

Learn to Mount Specimens like These



Write for
FREE
Taxidermy
Book!

Mount Birds, Animals and Fish Be a Taxidermist. Learn by Mail

You can now learn quickly, easily and thoroughly right in your own home by mail. Mount all kinds of game—birds, animals, game heads, fish, also taxidermy and furs and make fine robes and rugs. Our wonderful course of 40 lessons teaches you all about taxidermy. The most interesting art you ever studied or can study. Here is the opportunity you have long wanted. Write for free book today. Men, women and boys—all love this wonderful art and all learn quickly. Of untold value to hunters and trappers. Business men, farmers and clerks, all take our lessons and are completely fascinated with this beautiful and easily learned art. If you do nothing else today, send for the free book and investigate.

Make Big Money!

Sell your mounted specimens (if you wish). Big demand and big prices. Mount for your sportsmen friends. The news soon travels that you are a taxidermist and the work pours in. Our students earn big extra money in spare time for guns, traps, books, radio, vacations, etc. One writes "have made over \$900.00 from taxidermy, in spare time, since I joined the school". The most profitable "side line" business in the world.

Learn Field Taxidermy Sportsmen and fishermen, you must know "field taxidermy" to properly care for specimens when you take them, if they are to be correctly mounted later. This is of great importance to all who take hunting and fishing trips. Completely taught in our lessons.

Be a Taxidermy Artist

We now reveal all secrets of taxidermy. We teach latest methods. You become a true artist. You can decorate your home, office or den with nature's finest art—actual game specimens, preserved exactly like life—not mere pictures, but the beautiful game itself. You can become a true taxidermy artist, using spare time only.

Sportsmen—Fishermen if you do not save your finest trophies you miss and lose more than half the pleasure and all the profit. Save your hard-earned elk, deer, wild cat, grouse, duck, bass or trout. All real sportsmen now insist on knowing taxidermy. We can teach you. Our school teaches taxidermy—nothing else. 20 years in business. 75000 graduates in every civilized country. Now is the time to start.

Write for FREE Book

Our beautifully illustrated Taxidermy Book tells you how to learn the art. Send the coupon at once and receive copy by return mail extremely interesting, and shows dozens of photos of mounted game specimens.

FREE This book is absolutely free. No obligation on your part whatever. If you hunt, fish or trap, you need this book. You cannot imagine how interesting and valuable it will be to you, so send right now. Don't delay or you may forget it. Clip the coupon this minute.

Free Book Coupon

Northwestern School of Taxidermy
1771 Elwood Bldg., Omaha, Neb.
Send me absolutely free your illustrated book, "How to Learn Taxidermy." No obligation.

Name
Address



"Be Wise"

Be a BRICKLAYER

Make \$60 to \$90 a week

Learn this **Big Pay Trade** at Home in a **Few Short Months!**



W. P. CISSEL,
Vice President and
Chief Instructor

BRICKLAYING is the best trade in the world for a man of ambition. First, because wages are so high; \$11 and \$14 a day for regular time; and \$20 and \$25 a day for overtime. Secondly, work is steady—because there is a shortage of 38,000 bricklayers.

And now you can learn this big pay trade at home—in spare time—by an amazingly quick, easy method known as "Job-Analysis". In a few short months I teach you MORE than the old time bricklayer learned during his four years apprenticeship. You build walls, panels, pilasters, jambs, piers, arches, corbels, etc., in your own cellar, garage, yard, shed or roof using bricks, mortar and trowel. You perform in your lessons, EVERY job which you will afterwards perform on the wall as a highly paid bricklayer. And you learn quickly and become more skillful than you could by the old time apprentice method because you don't have to "pick it up" as best you can. The pictures, diagrams, blue prints, charts and instructions are so clear that it is just as if I stood back of you, directing every movement; showing you every short cut; training your hands and eyes.

The lessons are easy to understand because of the many

diagrams and illustrations. You just get enough written instructions to make you quick and skillful; everything else is illustrated.

Furthermore: I teach you things the ordinary bricklayer doesn't know. How to read blue prints and plans; how to lay off buildings; how to buy materials; how to estimate; and other information designed to equip you to rise rapidly to Foreman, Superintendent, Estimator, Contractor or Builder—if you are ambitious.

Free Book Explains

Send for free book "The Quick Way to Big Pay Every Day". It tells you why even the ordinary Bricklayer is always sure of steady work at big pay. And why my method equips you to rise rapidly to the higher stations in the building business. Read this free Book. Then decide for yourself. Buy act quick. There is a special, short-time money-saving offer open right now. So mail coupon at once.—W. P. Cissel.

NATIONAL SCHOOL OF BRICKLAYING
Dept. M-10
9th & G Sts., N.W.
Washington, D.C.



Get YOUR FREE COPY

National School of Bricklaying, Dept. M-10
9th & G Sts., N. W., Washington, D. C.

Send free book "The Quick Way to Big Pay Every Day" which explains how to become a bricklayer in only a few short months and how you train me at home—in spare time.
(Write or print name clearly.)

Name.....
Address.....
City and State.....

New Magnetic Discovery Builds Health!



Read Amazing Results Secured with the **Vit-O-Net Magnetic Blanket**

Mrs. J. F. H. of Atlanta, Ga., had been in wheel chair for six years suffering from Arthritis deformans (chronic inflammation of joints). Two doctors said she would never walk again. After taking the Vit-O-Net treatments, she is now taking steps for the first time in six years. She writes: "I am so happy my joy knows no bounds. I suffer very little now. Took steps today and did not hold anything for support. Am very much stronger and sleep fine at night."

How Vit-O-Net Acts Decayed waste remaining in body kills life forces and causes untold human misery. The Vit-O-Net Electro-Magnetic Blanket eliminates more poisonous waste than any other method. The greatest discovery in recent years. Gives you new life—new power. Magnetic warmth soothes and strengthens. Relieves pain. Dissolves congestions responsible for scores of ailments.

Vit-O-Net Electro-Magnetic Blanket

Used by greatest hospitals and physicians for treatment of Rheumatism, Neuritis, Nervousness, Catarrh, Eczema, Blood Pressure, Kidney trouble, etc. Frequently successful after all other methods fail. Helps to restore health. Pays for itself over and over again.
READ THESE—"I can attribute my good health to the help of Vit-O-Net." "Received greater benefit from Vit-O-Net than from treatments costing \$1600.00." "No words can express my love for my blanket." "Would not take \$500.00 for it or do without it for nerves." "I am an entirely new man."
Get Free Health Document—Tells why 90% of diseases are caused by improper elimination. Reveals valuable health secrets you ought to know. Write for your copy today.

Representatives Wanted
Vit-O-Net Mfg. Co. 4105 Ravenswood Ave.
Desk 516, Chicago, Ill.

Seal Rupture With a Quarter

Now you can throw away forever steel bands, chafing leg straps and other heavy makeshift devices. For a well known American scientist has found a new easy way to support rupture assisted by means of a wonderful little invention weighing less than 1-25 of an ounce. Not only do you do away with the objectionable pressure and tight strapping, but you eliminate the "coming down" of rupture—when running, straining, exercising, sneezing, etc.—which too frequently leads to strangulation. So great has been the success of this wonderful device that it is being offered to ruptured people on an absolute guarantee of instant satisfaction or no cost. Simply drop a postcard or letter requesting free literature to **NEW SCIENCE INSTITUTE, 2120 Clay St., STEUBENVILLE, OHIO**



How to Straighten Bow and Knock-kneed Legs!

Improve your personal appearance by using the new patent "Lim-Straitner," Model 18. Corrects bow Bow and Knock-kneed legs safely, quickly and permanently at home. No costly operation or discomfort. Is worn at night. Easy to adjust; its result will save you soon from further humiliation and will improve your personal appearance 100 per cent. Write today for copyrighted Physiological and Anatomical book and experience of others without obligation. Enclose a dime for postage.

M. TRILETY, Specialist Dept. 1308 BINGHAMTON, N. Y.

WHY NOT spend Spring, Summer and Fall, gathering butterflies, insects? I buy hundreds of kinds for collections. Some worth \$1 to \$7 each. Simple outdoor work with my instructions, pictures, price-list. Send 10 cents (not stamps) for my illustrated Prospectus before sending butterflies.
MR. SINCLAIR, DEALER IN INSECTS
Dept. 6, Box 1210, Victoria, B. C., Canada



NO MORE BALD HEADS



WHEN our VACUUM CAP is used a few minutes daily. We accept no pay until you have tried the Cap 60 days and are satisfied. The Vacuum Cap is an appliance that draws the blood to the Hair Roots and starts a new healthy crop of hair. It stops Dandruff, stops the hair from falling out.

Bought by Doctors and men who know that it is the only reasonable HAIR GROWER known to science. No Drugs Used. Write for application blank, testimonials and booklet on "HAIR" sent sealed in plain envelope, FREE.

THE MODERN VACUUM CAP CO.
P-559 BARCLAY, DENVER, COLO.

His Salary Four Times as Big!

The Reason—Higher Accountancy

"At the time of my enrollment for LaSalle training in Higher Accountancy," writes E. B. Risberg, "I was working in the blacksmith shop of the LaCross Well Drill Works—ten hours a day and six days a week. Since that time—and in a period of about four years—I have advanced from an initial position as stock clerk with the Milwaukee branch of a big packing company to my present excellent position with the largest elevator manufacturer in America. Today my salary is more than 400 per cent greater than at the time of my enrollment."

Nothing surprising about Risberg's advancement. The demand for executive accountants and Certified Public Accountants far exceeds the supply. Salaries range from \$3,000 to \$10,000 and better a year. Many LaSalle-trained accountants, now at the head of their own accounting firms, earn up to \$20,000 a year. Read these excerpts from the letters of accountants who have gone forward to success by following the LaSalle *salary-doubling plan*:

"Salary and earnings have increased over 183 per cent."—Frank B. Trisco, Minnesota.

"Accountancy has increased my salary practically 150 per cent in the last three years."—C. T. Thorson, Washington.

"Have been chosen Credit Manager of our Brooklyn store and Consulting Accountant of all our stores

—at a tempting salary even to a Public Accountant. I can frankly say I got all my confidence from my training with LaSalle."—G. S. Hillyer, New York.

You Have the Same Good Opportunity

Is it worth two cents and two minutes of your time to learn in detail of the opportunities that would be yours in the field of Accountancy?



All this information, together with an outline of the steps by which you may quickly fit yourself to take advantage of such opportunities, is clearly set forth in LaSalle's 64-page book, "Accountancy, the Profession that Pays," a book of invaluable assistance to the man who is seriously considering Accountancy as a career.

Get Copy of Plan—Free

The coupon will bring it to you without the slightest obligation, and with it details of the LaSalle *salary-doubling plan*, also the inspiring testimony of men still in their twenties and early thirties who have broken away from the low-pay ranks and today are expert accountants—with incomes ranging from \$3,000 to \$10,000, \$15,000, \$20,000 a year.

Your start toward a bigger salary is as near you as the point of your pencil. For the sake of a brighter future—ACT.

LASALLE EXTENSION UNIVERSITY

The World's Largest Business Training Institution

CLIP AND MAIL

LASALLE EXTENSION UNIVERSITY Dept. 164-HR Chicago

I would welcome an outline of your *salary-doubling plan*, together with a copy of "Accountancy, the Profession that Pays," also copy of "Ten Years' Promotion in One," all without obligation.

Higher Accountancy: Leading to position as Auditor, Comptroller, Certified Public Accountant, Cost Accountant, etc.

Other LaSalle Opportunities: LaSalle opens the way to success in every important field of business. If more interested in one of the fields indicated below, check and mail now.

Business Management: Training for Official, Managerial, Sales and Departmental Executive positions.

Modern Salesmanship: Leading to position as Sales Executive, Salesman, Sales Coach or Trainer, Sales Promotion Manager, Manufacturer's Agent, Solicitor, and all positions in retail, wholesale, or specialty selling.

Traffic Management—Foreign and Domestic: Training for position as Railroad or Industrial Traffic Manager, Rate Expert, Freight Solicitor, etc.

Railway Station Management: Training for position of Station Accountant, Cashier and Agent, Division Agent, etc.

Law: Training for Bar; LL.B. degree.

Commercial Law: Reading, Reference and Consultation Service for Business Men.

Banking and Finance: Training for executive positions in Banks and Financial Institutions.

Modern Business Correspondence and Practice: Training for position as Sales or Collection Correspondent, Sales Promotion Manager, Mail Sales Manager, Secretary, etc.

Expert Bookkeeping: Training for position as Head Bookkeeper

Industrial Management: Training for positions in Works Management, Production Control, Industrial Engineering, etc.

Modern Foremanship and Production Methods.

Personnel and Employment Management.

Business English.

Commercial Spanish.

Effective Speaking.

C. P. A. Coaching for Advanced Accountants.



Name Present Position

Address

LEARN CARTOONING

Successful cartoonists earn big salaries. Many of the most popular cartoonists of today learned to draw in their spare time, at home, through the Landon Course of Cartooning and now earn \$75 to \$200 or more per week.



The Landon Picture Chart Method of teaching ORIGINAL drawing makes cartooning easy to learn. Hundreds of sketches like the above explain every step in creating ORIGINAL heads, figures, animals, etc. Send 6c in stamps today for sample Landon Picture Chart and full explanation of this wonderful course, also long list of successful Landon students and information showing possibilities for you. *Please state your age.*

The Landon School, 738 National Building, Cleveland, Ohio

Former Students Who Are Now Successful Comic Strip Artists

BLOSSER—Now drawing "Freckles and His Friends."
BYRNES—Now drawing "Reg'lar Fellers."
BRANNER—Now drawing "Winnie Winkle."
LOCHER—Now drawing "Cicero Sapp."
TAYLOR—Now drawing "Mom 'n Pop."
EDWINA—Now drawing "'Cap' Stubbs."
CRANE—Now drawing "Washington Tubbs II."
ETHEL HAYS—Now drawing "Flapper Fanny."
PAUL FUNG—Now drawing "Gus & Gussie."
KNICKERBOCKER—Now drawing "This and That."

Learn Watchwork, Jewelrywork and Engraving

A fine trade commanding a good salary, and your services always in demand. Address **Horological, Dept. P, Bradley Institute, PEORIA, ILLINOIS**, for our latest catalog.

MINSTRELS

Musical Comedies and Revues, with full instructions for staging. You can stage your own show with our books. Full line of plays, stage songs, crossfire, monologues, afterpieces, vaudeville acts and make-up. **CATALOGUE FREE.**
T. S. Denison & Co., 623 S. Wabash Ave., Dept. 19, Chicago



FREE—SAXOPHONISTS—FREE

To Saxophonists who send for our Big and Complete Catalogue today we will send in addition **Free of Charge** your choice of either a **Masterbilt Reed Trimmer** or a **Fitsu De Luxe Saxophone Cord** (non-slip). We serve 150,000 Saxophonists. We supply nearly every music shop in America with its Saxophone Music and Accessories. Now, in order to tell other Saxophone fans all about F. & U. music publications, and complete line of supplies, we make this sensational offer. This offer is limited and made only to get our large illustrated catalogue into the homes of every Saxophone player. **Send for your catalogue today.**
FINDER & URBANEK, Dept. 1201-A, 1322 West Congress St., CHICAGO



"THERE'S MONEY IN IT"

AT HOME LEARN TELEGRAPHY AT HOME

MORSE AND WIRELESS

TEACH YOURSELF in half usual time, at trifling cost, with the wonderful Automatic Transmitter, **THE OMNIGRAPH**. Sends unlimited Morse or Continental messages, at any speed, just as an expert operator would. Adopted by U. S. Government, and leading Universities, Colleges and Telegraph Schools. 3 Styles. Catalog free. **OMNIGRAPH MFG. CO., 13-19 Hudson St., NEW YORK**
 If you own a Radio Phone Set—and don't know the code—you are missing most of the fun.

Foot Pains go in 5 minutes if you wear **FAIRYFOOT CUSHIONS**. Must help or no pay. Write to **FOOT REMEDY CO., 22nd St. & Millard Ave., Dept. 28, Chicago, Ill.**



Music Instructor

These books are illustrated and gotten up to make the method of self-teaching so simple that any one without any knowledge of music could learn to play any of the following:

SAXOPHONE	30c	MANDOLIN	30c
ACCORDION	30c	PIANO	30c
BANJO	30c	UKULELE	30c
GUITAR	30c	VIOLIN	30c

The above prices are postpaid. Any above 4 titles, \$1.00 postpaid.
J. C. DORN, 725 S. Dearborn St., Dept. 17, CHICAGO

Information on any book free. Write Popular Mechanics Press, Chicago, Ill.

DON'T WEAR A TRUSS

BE COMFORTABLE—

Wear the Brooks Appliance, the modern scientific invention which gives rupture sufferers immediate relief. It has no obnoxious springs or pads. Automatic Air Cushions bind and draw together the broken parts. No salves or plasters. Durable. Cheap. Sent on trial to prove its worth. Beware of imitations. Look for trade-mark bearing portrait and signature of C. E. Brooks which appears on every Appliance. None other genuine. Full information and booklet sent free in plain, sealed envelope.
BROOKS APPLIANCE CO., 215-B State St., Marshall, Mich.



MR. C. E. BROOKS

Whatever Your Question;—be it the pronunciation of Fascista, the spelling of a puzzling word, the location of Esthonia the meaning of soviet, realtor, vitamin, etc., this Supreme Authority—

WEBSTER'S NEW INTERNATIONAL DICTIONARY

contains an accurate, final answer. 407,000 Words 2700 Pages. 6000 Illustrations. Regular and India-Paper Editions. **G. & C. MERRIAM CO., Springfield, Mass.**
 Write for specimen pages, prices, etc., and FREE Pocket Maps, per Popular Mechanics.



Be a RADIO EXPERT

They Earn \$50. to \$250. a week in Radio—most fascinating work on earth



Learn Quickly And Easily At Home This Practical Way ~ ~ ~ ~

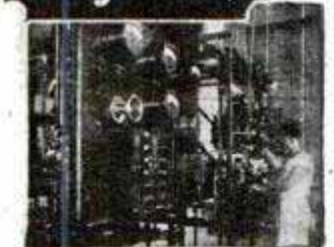

Government Spending Millions on Radio

U. S. Government now spends millions developing, using Radio. Ex-Estimate General Hays said: "Probably the biggest part in the future of the postal service will be played by Radio." Photo above—sending out time signals at Arlington, great Government Radio station at Washington—Radio is fitting new uses, filling new needs never dreamed of before. Radio Experts are in greater demand than ever.

Send Coupon Now

Get out of the low-pay rut, get into the most fascinating, easiest big-pay profession on earth. Free Book tells you how. ACT AT ONCE—SEND FOR BOOK TODAY.

Train At Home For A Big-Pay RADIO JOB

Radio today is urgently in need of trained men—Radio Experts. Astonishing opportunities—thousands of them—have been opened up by enormous strides of the Radio Industry. That's why it's easy to make big money in Radio—\$50 to \$250 a week. Here's a field that is teeming with opportunities and room for expansion—a brand-new, wide-awake, and uncrowded industry. If you're earning a penny less than \$50 a week, clip coupon now for Free Book and proof.

Your Satisfaction Guaranteed

Master Radio Engineers will show you how to qualify, quickly and easily at home, for Radio's fine jobs. We guarantee to train you successfully. You don't risk a penny, for we will gladly return every cent paid in tuition if upon completion of course you aren't absolutely satisfied. Back of this guarantee stands all the resources of National Radio Institute, U. S. Government-recognized and the Originators of Radio Home-Study Training. Established 1914.

Age or Lack of Experience No Drawback

You don't need experience before taking this course, and common schooling is enough. Our tested, practical methods make learning clear and easy—the most natural thing on earth.

Famous Course That "Pays For Itself"

Spare time earnings are easiest in Radio—receiving sets everywhere nowadays. In every neighborhood there are scores of jobs you can turn your hand to in an hour or so after supper. Right at the start of your course we give you practical money-making lessons which teach you how to do this work, then how to get it—so by our practical plan you can make your course PAY ITS OWN WAY while you're studying.

Get All The Facts At Once

Astonishing facts on the marvelous new industry of golden rewards—Radio—the fastest-moving, live-wire line. Free Book puts all the facts before you. No obligation. Send coupon for it now.

NATIONAL RADIO INSTITUTE
Dept. AAT-7 Washington, D. C.

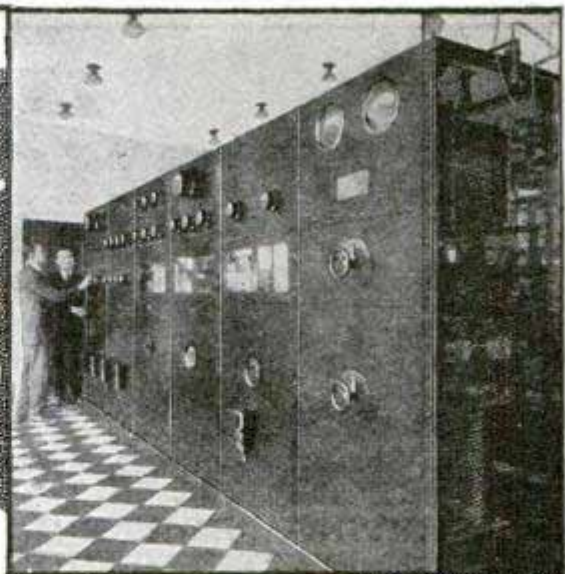

Instruments Given With Course

Receiving sets, from simple kind to thousand mile receiver, included without extra charge in your course. Other apparatus given to help you learn. An UNEQUALLED OFFER. Many other big features for limited time only.

Get This Book

"Rich Rewards in Radio"—most amazing book concerning Radio ever written, will be sent to you promptly when you send the coupon. ACT NOW.

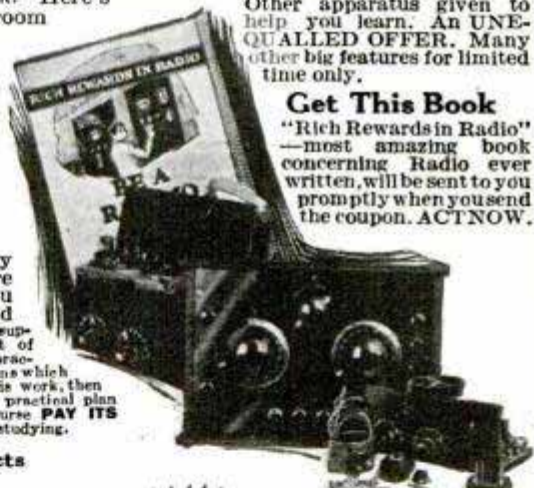

You Can Do What Others Have Done

Why go along at \$15 or \$25 or \$35 a week, when thoroughly-trained Radio Experts earn a hundred or more in the same six days?

What this training has done for hundreds of others, it can do for you. Send coupon at once.



N.R.I. TRAINED MEN ARE SUCCEEDING BIG



Operates WMAQ

"Accepted a position with Chicago Daily News—Station WMAQ. My income practically doubled, thanks to your fine course." Keith Kimball, Chicago, Ill.



Gets Big Job

"Just been made Sales Manager of this Radio concern—a big raise in pay. Regret I did not take course sooner." R. E. Jones, Bay City, Mich.

"Your course so completely covers Radio it is worth \$40 a week more to anyone in the electrical line. Since graduation have averaged \$50 to \$80 a week more." Preston Fowler, Gordon, Neb.



"My charges for consultation now \$2.50 per hour. The course is worth to me at least \$50,000." R. W. Blackhill, Brooklyn, N. Y.

"This N. R. I. Course has been worth \$2500 a year to me. \$3500 in another year. Thanks a million times to your training." Andrew Shurie, Latrobe, Pa.



MAIL THIS COUPON

NATIONAL RADIO INSTITUTE,
Dept. AAT-7, Washington, D. C.

Without obligating me in any way, send your Free Book "Rich Rewards in Radio"—also full information on your practical, home-study Radio course.

Name

Address

Town State

ORIGINATORS OF RADIO HOME-STUDY TRAINING

ESTABLISHED 1914

LEARN THE AUTOMOTIVE TRADE AT THE STEWART AUTOMOBILE SCHOOL

The Stewart Complete Shop Course in **AUTOMOTIVE MECHANICS, STARTING, LIGHTING, IGNITION, BATTERY BUILDING, TIRE VULCANIZING, WELDING AND BRAZING** will enable you to hold a responsible position in the Automotive Industry. You learn by doing the practical work yourself with tools on Passenger Cars, Trucks, and Tractors under skilled Instructors.

During the past sixteen years the Stewart School has successfully trained thousands of men. We can train **YOU**. Get the facts now. **WRITE TODAY FOR LARGE 48 PAGE ILLUSTRATED CATALOGUE FREE. IT GIVES YOU VITAL FACTS AND FIGURES ABOUT THE WONDERFUL OPPORTUNITIES IN THE GREATEST BUSINESS IN AMERICA. SEND FOR IT NOW. IT IS FREE.**

STEWART AUTOMOBILE SCHOOL

Dept. 1951, 225 West 57th St., at B'way NEW YORK



O.K. or Your Money Back



Magazine **Art and Life**

The Picture Magazine of a thousand thrills for those who love **The BODY**

BEAUTIFUL. Mind Intellectual, Soul Intuition. Will add much to your health, wealth, happiness, character, understanding and appreciation of Art, Nature and Life. Different, nothing like it. You must see and read it. Beautiful Roto-print, pictures of birds, animals, scenery, Lense-art photos of the **Human Figure**. Educational, interesting, helpful. Lessons in Art and Photography, Mental and Physical Culture; contests, cash art assignments, etc. For Artists, Photographers, Teachers, Writers, Poets, Movie-fans, Students, **THINKERS**, and all who wish to develop power of Body, Mind and Soul.

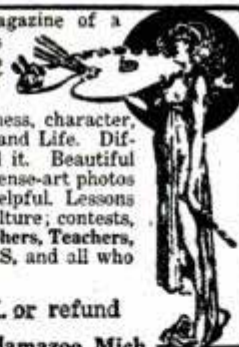

6-SIX-6
Beautiful
Big Back
Issues
For Only
\$1.00
Order Now!
6-SIX-6

CUT THIS OUT

and send with \$2.50 for yearly sub, or \$1 for 4 Mo. Trial Sub. (No free samples.) **You can't lose. O.K. or refund**

ART AND LIFE, Dept. 2605

Kalamazoo, Mich.



Learn



Aviation



Take a **W. A. C. Course in Applied Airplane Engineering**. Many men earn \$2,000 to \$10,000 a year. Big Free outfit of airplane parts. Write for Free catalog.

WESTERN AIRPLANE CORPORATION
Dept. M1, Monadnock Bldg., Chicago, Ill.



Work for "Uncle Sam"

MEN 18 TO 45

City and Rural Mail Carriers

\$141.67 to \$275.00 Month

Many Other U. S. Gov't Jobs Now Obtainable

STEADY WORK. PAID VACATION. COMMON EDUCATION SUFFICIENT. PULL UNNECESSARY.

Coupon
Franklin
Institute
Dept. L315
Rochester, N. Y.
Send me, **WITHOUT CHARGE**, (1) Your Copyrighted Civil Service Book, (2) Tell me how to get a position as City or Rural Mail Carrier at \$141.67 to \$275.00 a month.

Name.....

Address.....

MAIL COUPON—TODAY SURE

How Bad Luck Started Me On a Pleasant and High-Paying Career

Told by Bob Orkins

IT seemed as if the whole world had gone back on me. My wife's prolonged illness, together with the doctor and medicine bills, had placed an unusually heavy burden on my shoulders. Then there was my child to be properly cared for—and not a cent of 'rainy day' savings to fall back on.

"Something had to be done. I was terribly discouraged. More pay was one solution. But I knew just how slim my chances for a raise were when only the week before old Barnett had laid off seven or eight of the boys.

"Even that next Monday morning Bill Newton passed a rumor around that the general manager had ordered another cut in the office force.

"All that week I was on 'pins and needles.' I could not do a tap of work. Some of the fellows kidded one another as to what they would do after receiving the bad news. But in my case it was far from being a joke, and when old Barnett finally told me how sorry he was to have to let me go temporarily, the thought brought back with a chill the situation that faced me.

"The three weeks pay I received would help me over the weeks between jobs. But what about a new position? Here I was in a profession that was so overcrowded that you were always treading on one another's toes. I was desperate! I would take anything for the time being.

"But everywhere I went it was the same old story. 'Just fill out this application, and if anything turns up we will be glad to place you.' I knew what that meant.

"Then one morning, the latter part of that week, I was waiting in the outside office of a large manufacturing plant to see the superintendent. There were several applicants ahead of me. I casually picked up a magazine lying on the table and turned a few pages without the slightest bit of interest. Suddenly something caught my eye. Could what I saw be true?

Enormous Demand for Commercial Artists Earn \$100 a Week In This Fascinating Field No Experience Necessary

"I read on. \$100 a week. Why that was more than three times as much as I had ever earned. And the work was easy and you were your own boss.

"The thought came as a flash of lightning. Why not? I had always liked to fool around with a pencil, but had the idea that artists were 'born' and not made.

"Somehow or other I did not believe commercial art could be learned by mail. But there was nothing to risk—and when I thought of my wife, and the operation the doctor had long ago advised, I did not hesitate one moment.

"I ran out to the nearest newsstand and purchased a copy of the magazine and hurried home. One clip of the shears, a few

words quickly written, a trip to the mail-box—and the first part of my plan was carried out.

"That was a few short months ago. Now I enjoy the good things of life that I have always longed for. There is no worrying about where the next dollar is coming from and I come and go as I please.

"The simplicity of this new home-method was amazing. I started with fundamentals. First straight lines, then curves, then putting the two together. Action, shading, perspective followed in their proper order, until almost before I realized it I was drawing with confidence and selling my work! And now imagine the pleasure of sitting in my own cozy studio and turning out pictures that bring from \$25 to \$100 a piece! No wonder I like to tell this story to everyone."

* * * * *

You, too, can become a commercial artist this easy way. The truly wonderful part of our method is the fact that it makes artists of those who think they cannot draw.

The old "natural ability" myth is exploded. You can learn to draw just as you learned to write. We have proved it time and again with our students, many of whom, with no previous experience, were making money even before finishing their studies!

Cash in on the amazing ever-increasing demand for artists. They are wanted for book and fashion illustrating, advertising, designing and many other fields. Thousands are needed to draw the vast number of political, religious, sport and comic cartoons. Never before have commercial artists had such a wonderful chance to make big money. Glance through the help wanted columns and see for yourself. No field holds such golden promises for the ambitious man or woman. Now indeed is the time to study commercial art.



Laid off and the only kind of work I could do. No wonder I was so discouraged and downhearted.

If I had only known long ago how easy it was to learn to draw and what worthwhile salaries artists received I would have never "slaved" on a low-paying office job.

Send today for the free illustrated booklet. It will tell you more than anything we can possibly say. This booklet will tell you about our school, our students, what they have accomplished through this easy way, and what you can accomplish yourself. It will outline to you all the charm and fun of life as a commercial artist. It will tell you all about the really unusual opportunities calling to you today and how you can answer the call. Everything you want to know about this "work that is play" and how you can get into it, you will find in this book. Send for it today. Just fill in and clip the coupon below and mail it to us now!

WASHINGTON SCHOOL OF ART

Room 301-D, 1115-15th St., N. W., Washington, D. C.

Washington School of Art, Room 301-D,
1115-15th St., N. W., Washington, D. C.

Please send me "Quick Easy Way to Become An Artist"—and tell me about your method of instruction that makes "no talent necessary."

Name.....
(Mr., Mrs. or Miss)

Address.....

City..... State..... Age.....

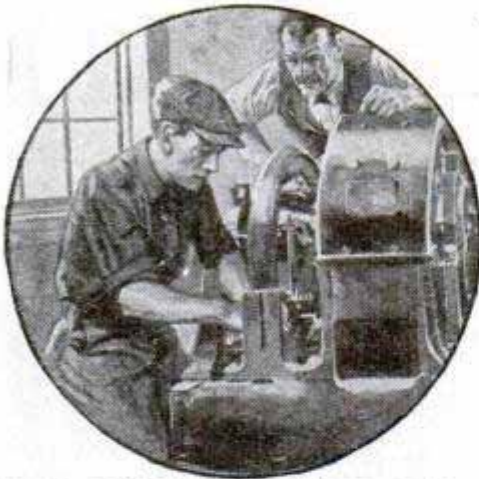

ELECTRICAL EXPERTS IN DEMAND

Good positions await trained men. Salaries of \$12 to \$30 a day not unusual.

THE ELECTRICAL field needs men. It needs them badly. Hardly a week or month passes but what some new use for electricity is discovered. Each new use means new positions—*better positions*—for men who have trained themselves as experts in this wonderfully fascinating work.

Why don't *you* study electricity and prepare for a good position at a good salary?

You can do it right at home in spare time through the International Correspondence Schools. Best electrical home-study courses ever offered. Endorsed by Edison and Steinmetz. Successful students everywhere.

MARK AND MAIL THE COUPON TODAY FOR FREE BOOKLET

INTERNATIONAL CORRESPONDENCE SCHOOLS

BOX 5550-E

SCRANTON, PA.

Explain, without obligating me, how I can qualify for the position, or in the subject, before which I mark X.

- | | |
|--|---|
| <input type="checkbox"/> ELECTRICAL ENGINEER | <input type="checkbox"/> CHEMICAL ENGINEER |
| <input type="checkbox"/> Electrician | <input type="checkbox"/> Pharmacy |
| <input type="checkbox"/> Electric Wiring | <input type="checkbox"/> SALESMANSHIP |
| <input type="checkbox"/> Electric Lighting | <input type="checkbox"/> Show Card and Sign Painting |
| <input type="checkbox"/> Electric Car Running | <input type="checkbox"/> RAILROAD POSITIONS |
| <input type="checkbox"/> Heavy Electric Traction | <input type="checkbox"/> ILLUSTRATOR |
| <input type="checkbox"/> Electrical Draftsman | <input type="checkbox"/> DESIGNER |
| <input type="checkbox"/> Electric Machine Designer | <input type="checkbox"/> BUSINESS MANAGEMENT |
| <input type="checkbox"/> Telegraph Expert | <input type="checkbox"/> Private Secretary |
| <input type="checkbox"/> Practical Telephony | <input type="checkbox"/> Business Correspondent |
| <input type="checkbox"/> MECHANICAL ENGINEER | <input type="checkbox"/> BOOKKEEPER |
| <input type="checkbox"/> Mechanical Draftsman | <input type="checkbox"/> Stenographer and Typist |
| <input type="checkbox"/> Toolmaker | <input type="checkbox"/> Cert. Public Accountant |
| <input type="checkbox"/> Machine Shop Practice | <input type="checkbox"/> Traffic Management |
| <input type="checkbox"/> Gas Engineer | <input type="checkbox"/> Commercial Law |
| <input type="checkbox"/> CIVIL ENGINEER | <input type="checkbox"/> GOOD ENGLISH |
| <input type="checkbox"/> Surveying and Mapping | <input type="checkbox"/> Common School Subjects |
| <input type="checkbox"/> Reading Architects' Blue Prints | <input type="checkbox"/> CIVIL SERVICE |
| <input type="checkbox"/> METALLURGY | <input type="checkbox"/> Railway Mail Clerk |
| <input type="checkbox"/> ARCHITECT | <input type="checkbox"/> STATIONARY ENGINEER |
| <input type="checkbox"/> Architectural Draftsman | <input type="checkbox"/> Textile Overseer or Supt. |
| <input type="checkbox"/> PLUMBING AND HEATING | <input type="checkbox"/> AGRICULTURE <input type="checkbox"/> Spanish |
| <input type="checkbox"/> Sheet Metal Worker | <input type="checkbox"/> Navigator <input type="checkbox"/> Math'm't's |
| <input type="checkbox"/> Automobiles | <input type="checkbox"/> Poultry Raising <input type="checkbox"/> RADIO |

Name _____

Present Occupation _____

Business Address _____

3-6-24

Street and No. _____

City _____

State _____

Canadians may send this coupon to International Correspondence Schools Canadian, Limited, Montreal, Canada



Your Choice

\$20⁰⁰

Musical Instruments

FREE TO OUR STUDENTS

Your choice of a Violin, Tenor Banjo, Hawaiian Guitar, Banjo, Cornet, Ukulele, Banjo Ukulele, Guitar, Mandolin or Banjo Mandolin. You will be proud to own any one of these instruments and you can have one absolutely free. A few cents a day for lessons is your only expense. Our system of teaching is so easy that you can play several pieces by note with the first four lessons. We guarantee success or no charge. Instrument and lessons sent on **one week's free trial**. Write for booklet today, no obligation.

CHICAGO CORRESPONDENCE SCHOOL OF MUSIC
Orchard and Willow Streets • Dept. 69 • Chicago, Illinois

RADIO EXPERTS

EARN BIG MONEY

YOU CAN LEARN AT HOME



FREE!
3 Tube Set

No other profession in the world offers the same big possibilities. Immense salaries await trained men in this fascinating, growing field. Fit yourself to be the radio expert of your own community. Thousands of men also needed in the great radio factories. I will quickly train you at home to be a radio expert. Write for all the facts today; learn how to get a wonderful 3-tube, receiving set free. Remember, we guarantee satisfaction or refund tuition.

WRITE TODAY
A. G. MOHAUPT, Radio Engineer
Radio Association of America
Dept. A-1, 4513 Ravenswood Ave., Chicago

You Can Save \$35⁰⁰



\$4.45 and up

Recover it yourself. Custom tailor made to fit all makes and models. Roof

and quarters sewed together, with rear fasteners, welts and tacks, complete. Anybody can put it on. Give name, year, model number of your car. Catalog FREE. Agents wanted.
LIBERTY TOP & TIRE CO., Dept. L Cincinnati, O.

FREE Electrical Training Book

Mail postcard for amazing FREE book on electricity. Shows you how to earn \$150 to \$600 a month in this immense field. Famous S & H shop-type training fits you quick at home for big jobs. Exclusive system. Lack of experience or education no bar. Write S & H Engineering Co., 1422 W. Monroe St., Dept. A-1, Chicago, Ill.



FREE Book on Deafness

Write today for 168 page FREE book giving full particulars and testimonials from hundreds of grateful users whose hearing has been restored by use of our "little wireless" phones for the ears.

Wilson Common-Sense Ear Drums require no medicine but effectively replace what is lacking or defective in the natural ear drums. They are simple devices, which the wearer easily fits into the ears where they are invisible. Soft, safe and comfortable.

WILSON EAR DRUM CO., Incorporated
275 Todd Building LOUISVILLE, KY.

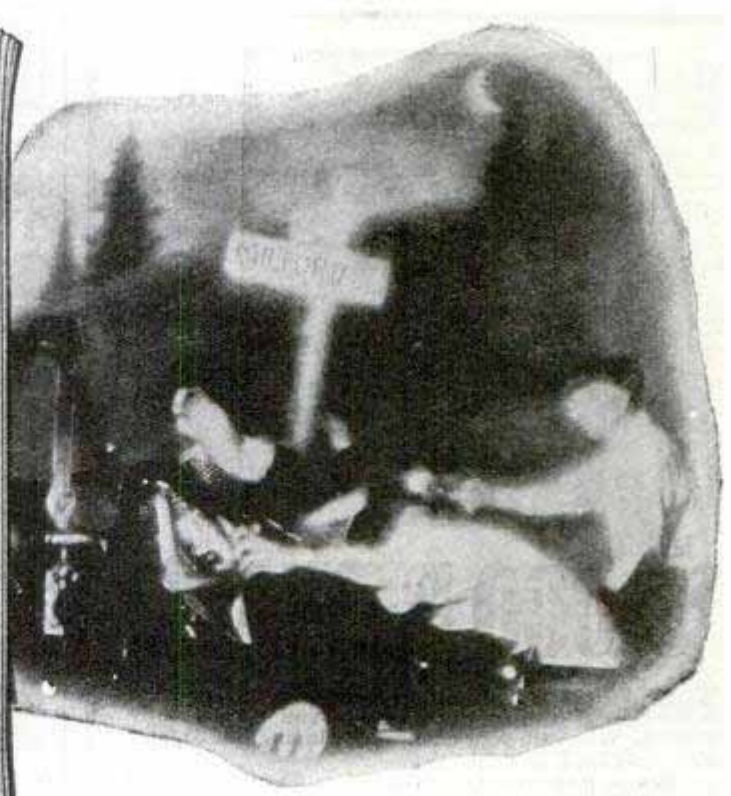

Send for this Free Book!

A FASCINATING BOOK of Detective stories that shows how ordinary boys and men have won nationwide fame, thousands of dollars in rewards, and important official positions by solving finger print mysteries!

"... Shortly before midnight a young couple slipped away from the dance. They sought out a long, low, rakish roadster. With powerful headlights picking out the path, it moved cautiously through the parking space and out onto the high road.

"Early next morning—a farm boy found the girl's dead body crumpled in the wayside ditch. Concealed in the bushes at the side of the road lay the boy's lifeless body, also shot from behind."

Who had committed the murder?

Read the rest of the story on page 15 of our new Finger Print book. Find out how the murderers were traced, tried and convicted, and how a certain finger print expert solved five murder mysteries and secured 97 convictions in less than a year.

Find out how you can become a Finger Print Expert.

Thirteen Thrilling Stories of Mystery and Achievement

Thirteen stories of crime, daring robberies, mysterious murders, thrilling escapes. You'll enjoy "Snowflakes," a great dope story—"The Invisible Finger Print," a blackmail mystery.

In "Foiled," a true account of a great political coup, you'll read of the astounding rise of a young country photographer who saved the Mayor of his city and was later appointed to the most important identification position in the state.

You'll read of men who achieved fame, big rewards and important positions in a short time through the study of finger prints.

Any man who can read and write can become a finger print expert.



PARTIAL LIST

Graduates U. of A. S. Recently appointed Finger Print Experts of these States, Cities and Institutions.

- State of Iowa
- State of Idaho
- St. Paul, Minn.
- Columbus, Ohio
- Detroit, Mich.
- Pittsburgh, Pa.
- Great Falls, Mont.
- Idaho Falls, Idaho
- East Lansing, Mich.
- Schenectady, N. Y.
- Lorain County, Ohio
- El Paso, Texas
- Galveston, Texas
- Houston, Texas
- Lincoln, Nebr.
- Everett, Wash.
- Ogden, Utah
- Butte, Mont.
- Pueblo, Colo.
- Albany County Penitentiary, N. Y.
- Wilkes Barre, Pa.
- Livingston, Mont.
- Alhambra, Calif.
- Tulsa, Okla.
- Havana, Cuba

Finger Print Experts Needed!

More and more the detection of crime resolves itself into a problem of identification. Trained men are needed every month to fill the new positions that are created. Records show that University of Applied Science graduates get first choice at the big positions. Listed below are some of the city and state bureaus to which U. of A. S. men have been appointed.

You can learn finger print identification in a few months in your spare time—at home.

Send the Coupon!

This book cannot be bought at any newsstand or bookstore—but it will be sent to you FREE if you write to us at once. Thirty-two pages, illustrated in color with weird crime pictures. This book explains your opportunities in the finger print world—shows how you can get your training in a few months—tells how you can get a professional finger print outfit free. Write for this book today.

University of Applied Science
1920 Sunnyside Ave., Dept. 13-51 Chicago, Ill.

University of Applied Science, Dept. 13-51
1920 Sunnyside Avenue, Chicago, Ill.

Please send me free your 32-page illustrated book "Finger Prints." I understand that there is absolutely no obligation. Also tell me how I can become a finger print expert by studying a few months in spare time—and how I can get a professional finger print outfit free.

Name.....

Address.....

City..... State.....



\$5,000 REWARD

THIS MAN is real. So is the reward. It was paid him, and will be paid you—if you really want it. What are your chances of winning this \$5,000? *You can't lose!* Listen:

I'LL DO BETTER than make you \$5,000; I'll make you a five-thousand dollar man. In other words, a draftsman. In record time. Without one hour's drudgery. For I teach drafting on a drafting board. With instruments, not books. I give you the actual, brass-tack knowledge that makes you a practical, all-round draftsman. Dobe trained men get the first call with the biggest concerns in the U. S. They say so right in their ads.

YOU MAY START at \$250 a month; but you needn't stay long at that figure! Dobe men are drawing \$500, \$600, and \$833 a month—and that's ten thousand a year. I have more calls for draftsmen now than present classes will graduate in a month. So, here's a very special inducement for action:

I'LL GIVE YOU all the tools—everything you'll ever need for drafting—even the table. I'll send them at once, without any extra charge whatever. The day this big outfit arrives, you are ready for business. Only one condition to this offer: you must accept it promptly. Don't let the cost of my course stop you; every month you stay at your present pay may be costing you twice what I ask for teaching drafting. Besides, you can pay me as you go along; keep the job you have until you are a finished draftsman. The main thing is to get started.

EVERY JOB calls for blueprints. Every workman must understand drawings. It's as easy to learn how to make them as to read them. And the man who can make them makes the money! What interests you most; building, engineering, electricity, automotives, mechanics? They all begin with drafting! No work can start without the draftsman. Don't you see that the draftsman comes first in every line?

DO YOU REALIZE how easy it is to learn drafting? Mechanical drawings have nothing to do with art, or artists. They are made by rule. One line at a time. And every line or curve is made with tools; you couldn't draw them crooked if you tried! Nothing you'll ever be paid for doing is any easier to do. And few lines pay as well! My book tells all about this wonderful field, and I will send you a copy free. If you are interested, clip the coupon now—while my free tool offer is open!

CHIEF DRAFTSMAN DOBE, Div. 83-51
1951 Lawrence Avenue, Chicago

Send me FREE and POSTPAID Successful Draftsman-ship Book and material telling all about your home course, terms, and free tools offer.

Name.....Age.....

St. or No.....

P. O.....

YOU Can Be a Dental Laboratory Expert

Make Up to \$150 A Week This Expert Is Stivison Trained



He Can Earn More in one day than the average Mechanic does in a week. He got it the same way you will get it if you select the

Stivison Way

Personal Instruction to Each Student In One Big School for Mechanical Dentists. Students are taught on Patients' work that is actually used. **Only Modern Methods Taught.** Thousands of dentists need Laboratory Experts.

Stivison Trained Graduates Always in Demand

Jobs Hunt You. Every Dentist does Laboratory Work that he would gladly have done by an expert and pay Big Prices.

Real Dentist's Tools are furnished and Instructions given by Real Dentists on work that Dentists need.

Our attractive Illustrated Catalog tells of many others who are earning big money and how easy you may be able to get into the Big Pay Class. If you live in Maine or California, it costs no more for you than it does for one living in Mo. or Kas., because WE PAY YOUR R. R. FARE TO KANSAS CITY. WE FURTHER ASSIST YOU in paying your TUITION by allowing You to Earn While You Learn. Bear in mind, the Catalog is Free and no man ever got in the Big Pay Class by wondering what he should do. Decide now and write for this "Short Cut to Success" today.

STIVISON DENTAL INSTITUTE

501 McMillen Bldg.

Kansas City, Mo.

FREE AIR RUNS AUTO

An amazing invention makes it possible actually to run your auto on FREE Air! It makes practically any car give double its mileage on a gallon due simply to the introduction of free air. Many go 37 to 57 and even 60 miles on a gallon of gas.

OWNER MAKES \$120 A DAY

A car owner, J. M. James, made \$120 in one day telling his friends about this astounding device. Vernon Gaines made \$94 in one day—J. W. Cronk \$51 in an hour. The demand is enormous. You can make \$250 to \$500 a month in full or spare time. And now the inventor will send you a sample at his own risk. Write today to J. A. Stransky, A-10, Stransky Building, Pukwana, South Dakota.



Bow Legs and Knock Knees Unsightly!

Send for booklet showing photos of men with and without THE PERFECT LEG FORMS.

PERFECT SALES CO. 140 N. Mayfield Ave. Dept. 5, Chicago, Ill.



A PERFECT LOOKING NOSE

Can Easily Be Yours

Trados Model No. 25 corrects now ill-shaped noses quickly, painlessly, permanently and comfortably at home (excepting cases caused by improper bone structure). It is the only adjustable, safe and guaranteed patent device that will actually give you a perfect looking nose. Over 90,000 satisfied users. For years recommended by physicians. 16 years of experience in manufacturing Nose Shapers is at your service. **Model 25 Junior** for children. Write for testimonials and free booklet, which tells you how to obtain a perfect looking nose.

M. TRILETY, Pioneer Noseshaping Specialist
Dept. 2476 Binghamton, N. Y.

Wanted: Men—Women!

Make \$5,000 to \$15,000 a year as Real Estate Specialists. I made \$100,000 in less than 5 years. Learn the secret of my success. Use my scientific system. Start at home in your spare time. No capital or experience needed. Write for free book and positive proof of big success.

MEN—Women—listen!

No matter **who** you are, **where** you are or **what** your daily task may be, here is a money-making business opportunity meriting your immediate attention.

It is an opportunity to get started in one of the biggest profit-making professions there is. And you can start right at home—in your spare time—without capital or previous experience—and build up a permanent, independent business of your own.

Real estate is a business of wonderful possibilities. It is a business in which up-and-doing men and women are making \$5,000—\$10,000—\$15,000—a year.

I started in the real estate business with no experience and less than \$5 capital, and in less than five years I made over one hundred thousand dollars.

And I have started others in the business—men and women—from 19 to 65—taught them my successful system—gave them my counsel and advice—helped them make money my way.

And what I have done for others, I will do for you—provided you are in earnest in your desire to get ahead.

To learn the secret of my success—to learn how I started others—to learn how you can use my system to break away from the rut of routine work and establish yourself in a high-class business—sign and mail the Request Blank at the bottom of this page. You will then receive—without cost or obligation—my new, illustrated book, "How to Become a Real Estate Specialist," which contains my **history and your opportunity**. American Business Builders, Dept. 44-A, 18 East 18th St., New York.

Get Your Share Of These Big Profits



\$420 in One Deal

"Have been laboring in a shop, day in and day out, just like in prison, not knowing there was a way out until I received your System. Am selling a property already—valued at \$10,500, and am getting 4% out of it."—J. W. Y., Chicago, Ill.



Money in the Bank

"Have been helped a great deal by your System. I have now a new car, two new type writers, a stenographer and a dandy office and money in the bank, all through my own efforts and without any capital to start with."—Mrs. P. M., Westport, Conn.

No Other Business Offers Such Rich Rewards

THERE is no other business in the world, that I ever heard of, that offers you all the advantages and opportunities that real estate does. Here are a few of them:

(1) Real estate is the biggest thing there is. More than half the wealth of the nation is invested in it.

(2) It is an easy business to learn. It does not take years of study like medicine, law, dentistry, pharmacy, architecture, engineering, etc.

(3) You can get started with little or no capital. I started with less than five dollars. Others have started with small sums and made big money.

(4) The real estate business is as permanent as the earth itself. It is not affected by changes in style, by human whims or caprices.

(5) Real estate is a pleasant business—no hard, laborious work requiring unusual health or strength.

(6) It is a business open to young and old of both sexes.

(7) It pays bigger money than anything else I know of. Experienced men sometimes make \$1,000—\$5,000—in single deals—more than the average man makes in a year of hard work.

(8) There is practically no limit to the business. It is said that there are at least ten million properties for sale or exchange at all times.

(9) It is a great small-town business. One user of my system said he made more than \$1,000 a month last year in a town of only 3,000 people.

If you want to get into a business having all these advantages and opportunities, write at once for my free book "How to Become a Real Estate Specialist."

Mail This Request Blank For Free Book

The time to act is now—**TODAY**—before it is too late. So, sign and mail the Request Blank at once and get your copy of my new, free book. It opens the way to one of the biggest and best money-making, business-building opportunities you ever heard of.

AMERICAN BUSINESS BUILDERS, INC.,

Dept. 44-A, 18 East 18th St., New York.

Send me—without cost or obligation—your new, illustrated book, "How to Become a Real Estate Specialist."

Name

Address



Choose as Your Profession Electrical Engineering

Electricity offers a brilliant future to the young man who is about to choose his career. Never before has there been such wonderful opportunity in this great field. Big paying positions in electrical work the world over are open to trained men—men who possess specialized, practical knowledge. Come to the School of Engineering of Milwaukee—one of the largest and best equipped electrical schools in America. Here you are trained in both theory and practice by a faculty of experts. You learn in large, finely equipped laboratories. If you have 14 high school credits or equivalent, you can become an Electrical Engineer with a Bachelor of Science degree in three years. If you lack these credits they can be made up at School of Engineering in a short, intensive Junior E. E. course.

**B.S. Degree
In 3 Years**

A Complete, Practical, Electrical Education

Learn by the thorough approved scientific methods which our twenty years of specializing enable us to give you. In addition to Electrical Engineering, the following complete courses are given: **A. C. and D. C. Armature Winding—Electric Light, Heat, Power Wiring and Testing—Practical Electricity—Drafting—Electrotechnics—Commercial Electrical Engineering—Junior Electrical Engineering and Automotive Electricity.**

Earn While You Learn

By our special system you may earn part of your way while learning. Our Employment Department will help secure you a position to which you may devote a part of each day, spending the remainder at the school. This plan both solves the students' financial problems and provides splendid experience at the same time. Low tuition fee. Board and room reasonable. Daily Broadcasting WSOE. School Orchestra. Fraternities.

**Winter Term
Begins Jan. 4th**

Write for FREE Catalog

Write today for our free, illustrated catalog. Read about this wonderful institution and the great opportunities that lie before you. Find out about our specialized method of training and the details of our "Earn While You Learn" plan.

SCHOOL of ENGINEERING of Milwaukee

Founded 1905 Dept. P.M.-126 415 Marshall St. Milwaukee, Wis.
SCHOOL OF ENGINEERING OF MILWAUKEE
Dept. P. M. 126. 415-17 Marshall Street, Milwaukee, Wis.

Without obligating me in any way, please mail free 72-page illustrated book, "Electricity and the One Best Way to Learn It," and particulars regarding the course I have marked with an X.

- **Electrical Engineering.**
- **Electrotechnics.**
- **Commercial Electrical Engineering.**
- **Junior Electrical Engineering.**
- **Automotive Electricity.**
- **Radio Sales, Service and Broadcasting.**
- **Armature Winding.**
- **Light, Heat, Power Wiring and Testing.**
- **Practical Electricity.**
- **Home Laboratory Service.**
- **I am interested in your "Earn While You Learn" Plan.**

Name..... Age.....
Address.....
City..... State.....
Education.....

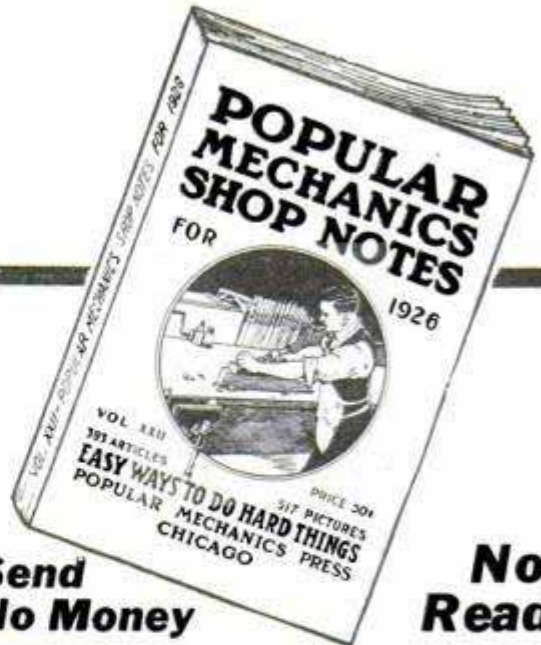

**Send
No Money**

**Now
Ready**

Shop Notes

**393
Articles**

**FOR
1926**

**517
Pictures**

This announcement has been eagerly awaited by thousands because they have learned that each yearly issue of Shop Notes contains dozens of short cuts that save time and money. Every article is written by some man who has tried the idea and found it worth money. The variety of subjects covered is one reason why so many folks buy Shop Notes each year. In many ways the 1926 issue surpasses previous numbers. The following brief list will give you an idea of the variety of subjects covered.

SOME OF THE SUBJECTS

- | | | |
|--------------------------|-----------------------------|----------------------------------|
| Auto repair tools | Machine shop practice | Printer's aids |
| Farm equipment | Well drilling discoveries | Dairy equipment |
| Service station ideas | Garage equipment | Electrical equipment |
| Shop tools | Poultry raising helps | Machinist's tools |
| Blueprinter's helps | Sheet metal worker's helps | Contractor's aids |
| Merchant's shortcuts | Concrete working ideas | Small-shop machines |
| Paint formulas | Special grading attachments | Tool boxes |
| Ice harvester | Tree protectors | Boat repair suggestions |
| Builder's equipment | Carpenter's shortcuts | Photographic discoveries |
| Emergency heating plants | Painter's equipment | Auto trailer |
| House-moving suggestions | Home-made bench saw | Welding equipment |
| Making magnetic chuck | Draftman's secrets | Overcoming dredging difficulties |
| Storage battery kinks | Store room time-savers | Septic tank |
| Merchandise display | Electrician's methods | Using twist drills |
| | Lathe fixtures | Pulley and gear speeds and sizes |

5,510 Ideas on All Shop Work

There are now 14 volumes of Shop Notes available. And this unrivaled library of shop helps may be had for a special price of \$6.50. If you do not have the back numbers of Shop Notes, you should purchase the entire library. The following are now available:

- 1908, 1912, 1913, 1914, 1916, 1917, 1919
- 1920, 1921, 1922, 1923, 1924, 1925, 1926

Amateur's Guide PROFESSIONAL'S HANDBOOK

Both amateurs and professionals find Shop Notes of wonderful value. The articles are so clearly written and so thoroughly illustrated that even a boy can follow them. Teachers of Manual Training should have the complete library.

SEND NO MONEY

Don't send a penny. Just fill in the coupon with your name and complete address, indicate whether you want the whole library or the special offer of 1926 Shop Notes and Lathe Handbook for 98 cents. When the books are delivered to you, pay the few cents postage and deposit price of books with postman.

SPECIAL OFFER COUPON

POPULAR MECHANICS PRESS,
200 E. Ontario St., Room 712, Chicago, Ill.

Send me, as per your special offer, the following books. I will pay postage and the price of books when they arrive. My money will be refunded if I am not satisfied. (Check what you want.)

- 1926 Shop Notes and Lathe Handbook, 98 cents
- Complete Shop Notes Library (14 vols.) \$6.50

Name.....
City..... State.....
Street and No.....

He thought he could throw me—

Dear Tom: You know how Ted Brown has always been saying he could throw me with one hand tied behind him, if he wanted to. Well, yesterday, he grabbed hold of me and we had it out. Gee, I wish you'd been there. You know how much bigger Ted is than I. He thought he had me licked dead easy—

but

I wriggled around and got a hold on him that I'd learned from the Farmer Burns School of Wrestling. The next second—KERFLOP, and I had Mister Ted Brown on the ground, yelling for me to quit. It's a cinch to handle a fellow half as big again as you are if you know the secret holds. If I were you I'd write to Burns School for their free book about wrestling. So long—FRED.

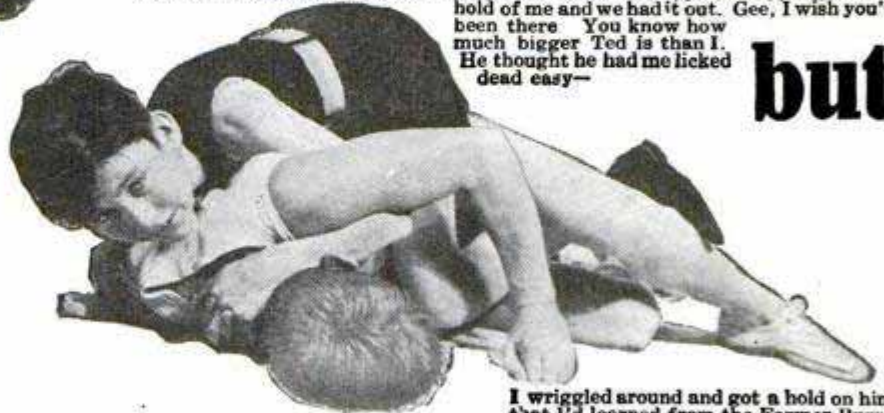

Learn Wrestling Secrets from Worlds Champions Farmer Burns and Frank Gotch

Learn the marvelous holds, breaks, blocks and tricks that will enable you to handle big, strong men with ease. The renowned FARMER BURNS—"father of scientific wrestling"—and FRANK GOTCH the world's champion, have prepared a series of lessons in which they reveal the inside secrets of training that will make YOU, too, an expert wrestler. All the great secrets of self-defense and jui-jutsu illustrated by printed word and picture. The lessons teach you how to become a great athlete, and secret knowledge enabling you to throw boys and men larger and stronger than yourself.

Send for FREE Book

Our FREE ILLUSTRATED BOOK tells you all about the advantages in health, vigor and respect that being able to wrestle brings one. It tells you how to learn to become a skilled wrestler in your spare time. Brim full of interesting information about wrestling. Also lots of pictures. INVESTIGATE. Write today for this free book. No obligations. Tear out and mail coupon NOW!

Farmer Burns School 1771 Railway Exchange Bldg. Omaha, Neb.

Farmer Burns School
1771 Railway Exchange Bldg., Omaha, Neb.
Please send me at once without obligation your FREE illustrated booklet on Scientific Wrestling, Physical Culture, Self-Defense, and How to Win.

Name.....

Address.....

Age.....

DO YOU LIKE TO DRAW?

It's Easy To Learn When Shown In The Right Way

Some of the cleverest cartoonists and comic artists in America today learned how to draw quickly—by following CARTOONIST EVANS' SIMPLE AND EASY METHOD. This school is recommended by foremost cartoonists because they know the students are handled right. If you like to draw, send 6c in stamps for portfolio of cartoons and full details. The course is NOT EXPENSIVE.

The W. L. Evans School of Cartooning 821 Leader Building CLEVELAND, OHIO



PATENTS

Booklet Free Highest References
Promptness Assured Best Results

Send drawing or model for preliminary examination of Patent Office records.

ALL BUSINESS GIVEN PROMPT AND PROPER ATTENTION

Listed Patent Lawyer in the latest editions of the Rand-McNally Directory of Bankers and Attorneys, of Chicago, Ill.; The Baggott & Ryall Directory of Attorneys, New York City; The Lawyers Guaranteed Directory, Detroit, Michigan; The Lawyers and Bankers Quarterly, published by the Legal Directory Publishing Company of St. Louis, Mo.; the American Lawyers Annual, Cleveland, Ohio.

WATSON E. COLEMAN,
REGISTERED PATENT LAWYER

644 G Street, N. W., Opp. U. S. Pat. Office
WASHINGTON, D. C.



High School Course in Two Years!

You Want to Earn Big Money!

And you will not be satisfied unless you earn steady promotion. But are you prepared for the job ahead of you? Do you measure up to the standard that insures success? For a more responsible position a fairly good education is necessary. To write a sensible business letter, to prepare estimates, to figure cost and to compute interest, you must have a certain amount of preparation. All this you must be able to do before you will earn promotion. Many business houses hire no men whose general knowledge is not equal to a high school course. Why? Because big business refuses to burden itself with men who are barred from promotion by the lack of elementary education.

Can You Qualify for a Better Position

We have a plan whereby you can. We can give you a complete but simplified high school course in two years, giving you all the essentials that form the foundation of practical business. It will prepare you to hold your own where competition is keen and exacting. Do not doubt your ability, but make up your mind to it and you will soon have the requirements that will bring you success and big money. YOU CAN DO IT.

Let us show you how to get on the road to success. It will not cost you a single working hour. Write today. It costs you nothing but a stamp.

American School

Dept. H-174, Drexel Ave. and 58th St., Chicago

American School

Dept. H-174, Drexel Ave. and 58th St., Chicago

Send me full information on the subject checked and how you will help me win success.

- | | |
|-----------------------------|---------------------------|
|Architect |Business Law |
|Building Contractor |Lawyer |
|Automobile Engineer |Machine Shop Practice |
|Automobile Repairman |Mechanical Engineer |
|Civil Engineer |Shop Superintendent |
|Structural Engineer |Employment Manager |
|Business Manager |Steam Engineer |
|Cert. Public Accountant |Foremanship |
|Accountant and Auditor |Sanitary Engineer |
|Bookkeeper |Surveyor (& Mapping) |
|Draftsman and Designer |Telephone Engineer |
|Electrical Engineer |Telegraph Engineer |
|Electric Light & Power |High School Graduate |
|General Education |Wireless Radio |
|Vocational Guidance |Undecided |

Name.....
Address.....

Mathematics Made Easy by ROPP'S CALCULATOR AND SHORT-CUT ARITHMETIC

Shows the Answer as Quickly as a Watch shows the Time to all Problems likely to occur in the Office, Store, Shop, Bank, Farm, or Factory. Over 2,000,000 Sold

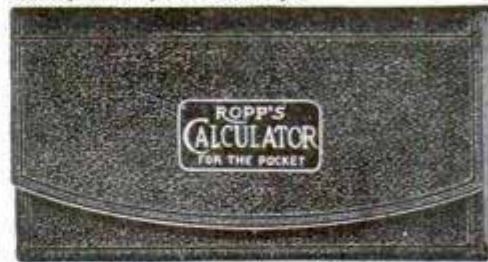

Explains and simplifies every principle in Arithmetic, Mechanics, and Mensuration.

PRICES POSTPAID
Desk Size...\$1.50
Leatherette, Pocket Size...\$1.00
Pocket Size, Cloth...\$0.50
Pocket Size, Paper...\$0.35

Popular Mechanics Press, Room 208, 200 E. Ontario St., Chicago

Helpful IDEAS for Home Owners

In these two practical books, you will get 502 ideas that will be helpful in making your home a better place to live in—a home to be proud of. The ideas are for the making, improving and repairing of the devices needed about and in the home. The books are:

1. Home Mechanic's Handbook No. 1
2. Concrete Handbook No. 1

These books tell how to make most everything, from door stops to a refrigerator, and from a concrete sidewalk to a lawn fountain.

Send No Money Simply write a postal and ask that Popular Mechanics two Homeowner's books be sent C.O.D. When the postman delivers the books to you, hand him \$1.00 plus the few cents postage.

\$1 TWO BOOKS FOR

POPULAR MECHANICS PRESS

Popular Mechanics Bldg. Room 712 Chicago, Ill.

366 SHORT CUTS FOR CARPENTRY WORK

Popular Mechanics New Carpenter's Handbook is filled with illustrated short cuts and improved methods for doing all sorts of carpentry work and odd jobs. Each idea was discovered by a practical man in the course of his work. Each idea is practical, a time-saver, a money-saver. The 229 Pictures are so clear that in many cases, the picture itself explains the short cut. This new book is a book for professional carpenters, for amateurs, and for boys. It is destined to be just as popular as the many other handbooks published in recent months. This new book is beautifully bound in golden brown cloth, is a handy size, and sells for the remarkably low price of \$1.50.

Send No Money Simply write a postal saying that you want Popular Mechanics New Carpenter's Handbook. It will be sent C. O. D. and you may pay the postman the price of the book and the few cents postage when he delivers the book to you. If you live outside the U. S. or if you are not at home when the postman delivers your mail, send \$1.50 with your order.

POPULAR MECHANICS PRESS

Room 712, Popular Mechanics Bldg., 200 E. Ontario Street, Chicago, Ill.

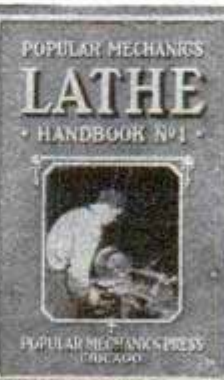

259 Discoveries For Lathe Operators

This book contains the experiences of 106 successful operators in the U. S. and in the principal foreign manufacturing countries. 83 articles tell how to make special lathe tools and attachments. 33 on gauges and indicators. 23 on special devices for holding work. 9 special lathe centers. 29 on how to do unusual jobs, 28 on boring and drilling. 11 on thread cutting.

212 Illustrations The pictures make it easy for a beginner. Every article is written so anyone can understand it, and every kink has been thoroughly tested.

Send No Money Just write a postal. Popular Mechanics Lathe Handbook and Drilling and Thread Cutting Handbook will be sent C. O. D. Pay postage and 98c for the 2 books.

POPULAR MECHANICS PRESS
Room 101, Popular Mechanics Building, Chicago, Ill.

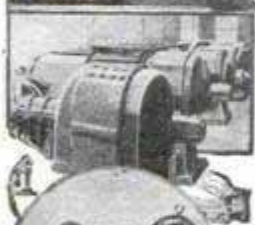

LEARN BY DOING

Every phase of all branches of

ELECTRICITY

taught by

Actual Practice

In America's foremost institution for trade training

No Books Used

Individual Instruction Start Any Day

Write for **FREE 64-page catalog**

THE NEW YORK ELECTRICAL SCHOOL

44 West 17th St., New York City

Science Discovers the Secret of CARUSO'S Wonderful Voice

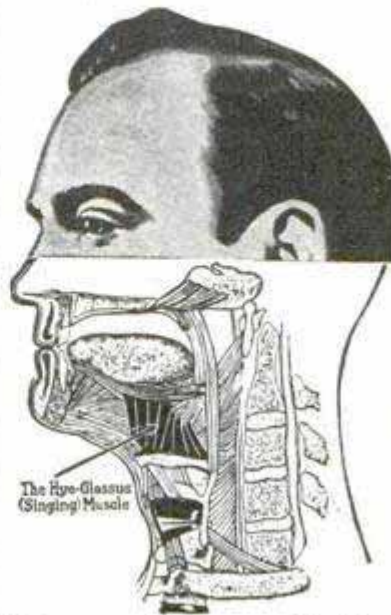

Why is it that the humble peasant boy of Italy became the greatest singer of all time? This diagram of his throat will show you. Caruso's marvelous voice was due to a superb development of his Hyo-Glossus muscle. Your Hyo-Glossus muscle can be developed, too! A good voice can be made better—a weak voice become strong—a lost voice restored—stammering and stuttering cured. Science will help you.

Your voice can be improved 100%

A few very fortunate persons—like the late Caruso—are born with the ability to sing well. But even Caruso had to develop his Hyo-Glossus muscle before his voice was perfect. You can develop a beautiful singing or speaking voice if your Hyo-Glossus muscle is strengthened by correct training. Professor Feuchtinger, A. M.—famous in the music centers of Europe for his success in training famous Opera Singers—discovered the secret of the Hyo-Glossus muscle. He devoted years of his life to scientific research and finally perfected a system of voice training that will develop your Hyo-Glossus muscle by simple, silent exercises right in your own home. The Perfect Voice Institute guarantees that Professor Feuchtinger's method will improve your voice 100%. You are to be your own judge—if your voice is not improved 100% in your own opinion, we will refund your money.

Grand Opera Stars His Students

Hundreds of famous singers have studied Physical Voice Culture. Over 10,000 happy pupils have received the benefits of his wonderful training. You do not know the possibilities of your voice. If you want to sing—but lack the proper training because you have not the time nor means to study—here is your chance. You can now train your voice at a very small cost in the privacy of your own home.

If you want to improve your speaking voice—if you stammer or stutter—Professor Feuchtinger will help you.

Inspiring New Book FREE!

You will do yourself a great and lasting good, by studying the new book "Physical Voice Culture." It may be the first step in your career. Do not delay. Mail the coupon today.

Free Trial

In Your Own Home



FREE Instruction with Every Instrument

Deagan Xylorimba

Become a crack Xylorimba player right in your own home. Easiest instrument to play. Learn in a few hours with our 14 free complete lessons. Earn \$80.00 to \$200.00 a week. Deagan Instruments are world-renowned—used extensively in leading dance, theatre and concert orchestras.

FREE LESSONS—A YEAR TO PAY!

Our free trial, easy payment plan makes it easy to learn at home. Send coupon below for illustrated literature and details of our special free trial offer.

Send Coupon Today!

J. C. DEAGAN, Inc., Dept. 1351, 1770 Berteau Ave., Chicago, Ill.

Dear Sirs: Without obligation, please send me literature and information regarding your free trial Deagan Xylorimba,

Name.....
 Address.....
 City..... State.....

Perfect Voice Institute

1922 Sunnyside Ave. Studio 13-51 CHICAGO

Perfect Voice Institute

1922 Sunnyside Ave. Studio 13-51 CHICAGO

Please send me **FREE** your new book "Physical Voice Culture." I have put X opposite the subject that interests me most. I assume no obligations whatever.

.....Singing.....Speaking.....Stammering.....Weak Voice

Name.....

Address.....

.....Age.....



SHOW CARD LETTERING

Learn at Home

HERE is the very course you need if you want to get a good paying position as a Show Card Letterer or Sign Letterer, or have a business of your own. This course is complete and practical and especially arranged to meet the needs of the student who studies at home. It was written by E. L. Koller, Principal of the School of Art of the International Correspondence Schools, member of the American Federation of Arts, and The National Society of Craftsmen.

Mr. Koller has had twenty years' teaching experience, and his success in helping other men and women is an indication of what he can do for you.

H. L. Wood, a clerk, made more than \$700 "on the side" before he had completed his course and also won \$125 in prizes. Harry William Lord writes that he has more than doubled his salary as a result of studying this I. C. S. course in spare time. William Whitman, a former wagon builder, now has a sign painting business of his own and is earning nearly three times as much as he did before enrolling with the International Correspondence Schools.

There is no doubt that Show Card Lettering and Sign Lettering offer a real opportunity to ambitious men and women. Just mark and mail the coupon and we'll gladly send you a booklet telling all about the I. C. S. course in Show Card Lettering, or any other subject in which you are interested.

INTERNATIONAL CORRESPONDENCE SCHOOLS
Box 5546-E, Scranton, Penna.

The oldest and largest correspondence schools in the world

Without cost or obligation on my part, please tell me how I can qualify for the position or in the subject before which I have marked an X:

SHOW CARD LETTERING

- | | |
|---|---|
| <input type="checkbox"/> Business Management | <input type="checkbox"/> Salesmanship |
| <input type="checkbox"/> Industrial Management | <input type="checkbox"/> Advertising |
| <input type="checkbox"/> Personnel Organization | <input type="checkbox"/> Better Letters |
| <input type="checkbox"/> Traffic Management | <input type="checkbox"/> French |
| <input type="checkbox"/> Business Law | <input type="checkbox"/> Stenography and Typing |
| <input type="checkbox"/> Banking and Banking Law | <input type="checkbox"/> Business English |
| <input type="checkbox"/> Accountancy (Including C.P.A.) | <input type="checkbox"/> Civil Service |
| <input type="checkbox"/> Nicholson Cost Accounting | <input type="checkbox"/> Railway Mail Clerk |
| <input type="checkbox"/> Bookkeeping | <input type="checkbox"/> Common School Subjects |
| <input type="checkbox"/> Private Secretary | <input type="checkbox"/> High School Subjects |
| <input type="checkbox"/> Spanish | <input type="checkbox"/> Illustrating |

TECHNICAL AND INDUSTRIAL COURSES

- | | |
|---|--|
| <input type="checkbox"/> Electrical Engineering | <input type="checkbox"/> Architect |
| <input type="checkbox"/> Electric Lighting | <input type="checkbox"/> Architects' Blueprints |
| <input type="checkbox"/> Mechanical Engineer | <input type="checkbox"/> Contractor and Builder |
| <input type="checkbox"/> Mechanical Draftsman | <input type="checkbox"/> Architectural Draftsman |
| <input type="checkbox"/> Machine Shop Practice | <input type="checkbox"/> Concrete Builder |
| <input type="checkbox"/> Railroad Positions | <input type="checkbox"/> Structural Engineer |
| <input type="checkbox"/> Gas Engine Operating | <input type="checkbox"/> Chemistry <input type="checkbox"/> Pharmacy |
| <input type="checkbox"/> Civil Engineer | <input type="checkbox"/> Automobile Work |
| <input type="checkbox"/> Surveying and Mapping | <input type="checkbox"/> Airplane Engines |
| <input type="checkbox"/> Metallurgy <input type="checkbox"/> Mining | <input type="checkbox"/> Agriculture and Poultry |
| <input type="checkbox"/> Steam Engineering <input type="checkbox"/> Radio | <input type="checkbox"/> Mathematics |

Name.....
Street Address.....
City..... State.....

All About Ford Electrical Equipment

Diagrams, descriptions, trouble shooting ideas, and complete instructions for repairing and keeping in order the electrical equipment on Ford cars — this is contained in a valuable book we now offer at the special price of \$1.98. Many of the illustrations are photographs plainly marked so that you cannot mistake the directions.

Battery, Ignition, Starting, Lighting

All these are thoroughly treated. The explanations are so simple that even a boy can quickly learn all of the fine points about Ford electrical systems. Don't pay big garage bills. Fix it yourself. Don't be delayed on your trip. Carry this book with you and find your trouble quickly. Electrical troubles are about the most difficult for an amateur to find, yet their correction is very simple when you know how. Order today "The Ford Standard Electrical Equipment." The book is a handy size and is attractively bound in leather.

Send No Money Just write a postal and say that you want "The Ford Standard Electrical Equipment." When the postman hands you the book, pay him \$1.98 and the postage.
POPULAR MECHANICS PRESS, 200 E. Ontario St., Room 712, CHICAGO, ILL.

OUTDOOR SPORTS THE YEAR 'ROUND

Popular Mechanics New Useful Book—Outdoor sports appeal to us all. But the fun is double when you make your own devices. There are 226 clearly written and concise articles telling how to make equipment for new and popular sports of many kinds in the new Outdoor Sports book. There are clever devices for such sports as:

- | | | | |
|------------------|--------------|----------------------|--------------|
| Swimming | Trapping | Photography | Kite flying |
| Camping | Tobogganing | Tennis | Summer games |
| Football | Baseball | Outdoor winter games | Nutting |
| Swinging | Fishing | Skating | Pushmobiling |
| Trolley coasting | Golf | Boating | Racing |
| Roller skating | Boat sailing | Toy making | Skiing |

It is easy to make the devices described because there are 317 helpful illustrations. The articles are clear enough for boys, yet interesting enough for any man.

Send No Money Just write your name and address on a postal card and say that you want Outdoor Sports the Year 'Round. When the postman hands you the book, give him \$1.50 plus the few cents postage. That is all. If you live outside the U. S. or if you are not at home when the postman delivers the mail, then send \$1.50 with your order. Address your postal to

POPULAR MECHANICS PRESS Room 712, Popular Mechanics Bldg. 200 E. Ontario St., Chicago

Books on all subjects are sold by Popular Mechanics Press, 200 East Ontario Street, Chicago, Illinois.

EVERYBODY'S HANDBOOK of Electrical Kinks

This is a brand new book similar to Popular Mechanics other "kink" books. It is made up of 214 ideas and short cuts for doing electrical work of all kinds. It is a book for amateurs as well as professional electricians. If you are interested in wiring, electric lighting, the making of electrical devices, experimenting, repair work, battery manufacture and repair, or telephones, you will find many helpful articles in this book. If you are interested in radio, you should have this book to learn some of the short cuts used by electricians in wiring and making apparatus.

THE BOOK CONTAINS

- | | |
|--|--|
| 47 ideas on wiring | 11 ideas on switches |
| 45 ideas for making electrical devices | 6 ideas on installation |
| 19 ideas on electric light's | 22 ideas on testing |
| 5 ideas on transformers | 12 ideas on repairing |
| 5 ideas on motors | 11 ideas on battery manufacture and repair |
| 8 ideas on generators | 5 ideas on telephones |

There are 162 Pictures to make the ideas clear. Boys can follow the directions as well as men. If you understand the simple fundamental principles of electricity, this book will be a wonderful help to you.

Send No Money Just write your name and address on a postal card and say that you want the New book of Electrical Kinks. When the postman hands you the book, hand him \$1.50 and the few cents postage. If you live outside the U. S. or do not expect to be at home when the postman calls, send the \$1.50 with your order. Address

POPULAR MECHANICS PRESS Room 712 Popular Mechanics Bldg. 200 E. Ontario St., Chicago

Home Mechanics 329 ideas for repairing, improving and making devices needed about the home. Simple directions and illuminating illustrations. Only 50 cents. Write POPULAR MECHANICS PRESS, Popular Mechanics Bldg., Rm. 701, Chicago, Ill.

LEARN *to* FLY

1000 Ambitious Young Men WANTED



Opportunities in Flying

Aviation Mechanics—
\$50-\$125 Week
Riggers—\$50-\$75 Week
Flyers—\$125-\$225 Week
Taxi Service—\$100-\$300 Week
Aerial Photo Pilot—\$200-\$250
Week
Special Messenger Service—
\$125-\$200 Week
Aerial Advertising—\$225-\$500
Week
Crop Dusting—\$125-\$200
Week
Crop Survey—\$125-\$225 Week

**You Fly
by Flying**

Sweeney System

of Practical Airplane Mechan-
ics opens up a world
of opportunities for young
men. *You Learn by Doing!*

THIS photograph shows Instructors Wimer and Spencer working with students. The Sweeney System first prepares a student by intensive practical work on motors, building, recovering wings, rigging and all details of construction, repairing and handling. This is called ground school work. Instructor Spencer, an overseas flyer, tells you that it took about 4000 mechanics and assistants to keep several hundred flyers in the air at his field in France. To show you the quality of the men who teach you look at Spencer and Wimer for instance. Spencer was an army pilot and has been teaching and doing commercial flying since 1917. Wimer is a college man, went overseas, was with the 1st Air Park, was an observer, spent over 200 hours in the air and since the war has been with two big aircraft corporations.

THE SWEENEY SYSTEM

is divided into two parts. **FIRST:** You are thoroughly taught in the ground school. This fits you as an aviation mechanic. You can build your own plane and do anything required in aviation mechanics and construction and repairing when you have finished this work. You are thoroughly taught motors, etc., and work with thousands of dollars worth of new material, including all types of engines, Liberty 12s, Sturdevants, Gnomes, Hall Scott fours and sixes, etc.

SECONDLY: after completing this work if you want to be a pilot you take ten hours of flying. Now when you understand that two to seven hours is all the average man needs to learn expert flying you will appreciate what ten hours in the air under skilled men will do for you.

SEND THIS NOW

EMORY J. SWEENEY, President
2131A Sweeney Bldg., KANSAS CITY, MO.

Please send me full information about your Aviation Course.

Name

P. O.

State.....Age.....

Skilled Airplane Mechanics Wanted

Now after years of preparation, aided by the best flyers in the world, I have perfected the system of teaching whereby in a short time you become a skilled mechanic, and also if you wish, a skilled pilot. The mechanical and repair work end of aviation, as well as airplane construction, is thoroughly taught you!

All the resources, skill, experience and reputation of the great Million Dollar Sweeney School insure that the Sweeney aviation course is the simplest, most efficient, most practical system in the world.

LEARN TO FLY! Aviation is no longer a mystery—no longer a hazard; no, it is a business growing greater and more important; you can qualify as a mechanic, or an engineer, or repair man, or builder; five men on the ground are needed for one man in the air, but if you want to become a pilot you easily master the work and can go into postal, government, or commercial work. Flyers are in demand, earning big money at fairs taking up passengers, etc. \$5 for a 10 minute flight is pretty fine pay! The building of the new million dollar Fokker plant here means liberal high paid employment for hundreds of aviation mechanics.

SEND NAME TODAY for full details of this aviation mechanical course and photographs of planes and equipment actually used; also full information as to the commercial end of flying and opportunities for young men.

SWEENEY SCHOOL OF AVIATION

LEARN A TRADE—
Sweeney
SCHOOL OF AVIATION
2131A SWEENEY BLDG, KANSAS CITY, MO.

20 Violet Ray Treatments FREE



Violet Rays Give Health Vigor Beauty

Ailments

successfully treated with Violet Rays:

- Rheumatism
- Neuritis
- Paralysis
- Catarrh
- Nervousness
- Skin Disease
- Hay Fever
- Headache
- Colds
- Constipation
- Sprains
- Asthma
- Deafness
- Eczema
- Eye Troubles
- Falling Hair
- Goitre
- Insomnia

Quick Results! No Medicine!

If you suffer from any of the ailments listed, let us send you a complete Violet Ray Outfit. Give yourself 20 Violet Ray Treatments, for which doctors would rightfully charge \$5 each. Then you'll know Violet Rays can help you.

With Violet Rays thousands have conquered pain, disease, nervous troubles. Violet Rays give quick relief and permanent results by scientifically and painlessly removing the basic causes of pain and sickness.

Dr. L. H. Leight, Millerton, N. Y., writes: "I am having wonderful success in treating neuritis and all stomach cases. I have given over 2,000 treatments with your outfit."

Try This Complete Outfit in Your Home



Identical with outfits doctors have bought from us for years and used successfully in treating ailments named. Saves the user doctor bills, delays, medicines, — relieves suffering.

Send for FREE Book

Explains how Violet Rays (discovery of world-famed scientist, Nikola Tesla) work and heal—what doctors and plain folks accomplish with them. Shows charts of human body, explaining where pains start and how to banish them. Send for FREE copy today and details of FREE TRIAL offer.—Vi-Rex Company, 211 South Peoria Street, Chicago.

For special free advice state your ailments!

Mail Coupon—Send No Money

VI-REX COMPANY, Dept. 21
211 South Peoria Street, Chicago

Please send me without cost or obligation your free book describing your VI-REX Violet Ray outfits and details of your FREE TRIAL OFFER.

Name

Address

City State

Attch



Everybody is helped— everybody should help!

TUBERCULOSIS in this country is a threat against your health and that of your family. There are more than a million cases in this country today.

The germs from a single case of tuberculosis can infect whole families. No one is immune. The only sure escape is to stamp out the dread disease entirely. It can be stamped out. The organized work of the tuberculosis crusade has already cut the tuberculosis death rate in half. This work is financed by the sale of Christmas Seals.

Everybody is helped by this great work—and everybody should help in it. Let every member of your family stamp all Christmas parcels, letters and greeting cards with these able little warriors against disease. Everybody, everywhere, buy Christmas Seals—and buy as many as you can.



Stamp Out Tuberculosis with this Christmas Seal

THE NATIONAL, STATE, AND LOCAL TUBERCULOSIS ASSOCIATIONS OF THE UNITED STATES

Building Draftsmen WANTED



\$9,000 in Four Months
 "I have made \$9000 in four months on nine buildings" writes, Wm. J. Petrusek, Chicago, Ill.

\$210 Per Month
 "I am making \$210 per month as Architectural Draftsman. Thanks to Chicago Tech." Geo. E. Shafner, Haley, Tenn.

\$6,000,000,000 in Building Train at Home for Big Money in This Fertile Field

Six Billion Dollars in one year! Think of it! Today Building is probably America's greatest and most profitable industry. Here is a field whose future is insured by the normal growth in population and the industrial expansion of our country. There is a big building shortage now and many competent observers predict that our largest cities will be practically rebuilt in the next ten years due to ever higher standards of living. Six Billion

Dollars spent each year in building means fortunes for thousands who have the vision to grasp the opportunity open now to get in on the ground floor.

Get Into Big Pay This Easy Way

Architectural or Building Draftsmen are needed everywhere. Get out of the low or moderate pay job. Step into a *real* job. You can do it with training in Architectural Drafting. Salaries are big because of the tremendous demand and the shortage of trained Building Draftsmen. Work is steady and you have a splendid chance to go into business for yourself. This is the opportunity offered to you by this old established school of Architecture and Building Construction. Step out of the \$40 a week class. Learn how to earn \$50 to \$100 a week—and later \$5,000 to \$10,000 a year as chief or superintendent.

This \$25.00 Drawing Outfit Sent without extra cost. Good for a lifetime. Mail the coupon and learn how to secure this valuable outfit.

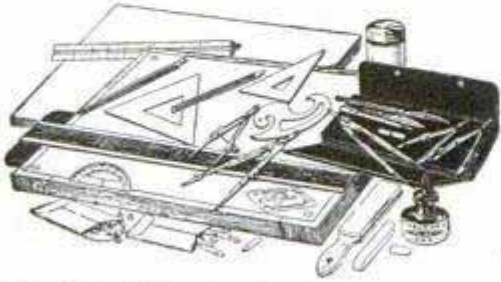

Train at Home—Earn as You Learn

No need to quit your present job. Keep your present income and prepare for a bigger one. Our simple "Practice Plan Method" will qualify you quickly in your spare time. Into it has gone over 25 years of experience and the best knowledge of our large staff of architects and builders. It is simple, complete, resultful. Practical, successful builders guide you Lessons in plain English. A common schooling is all you need. Get the facts now—today.

FREE TRIAL LESSON AND BLUE PRINTS

Just to show you how easy it is to learn Architectural Drafting by our method, we will send you a Trial Lesson and Blue Prints Free. Test yourself and see how you like the work. Send no money—just the coupon. Get this Free Lesson now with our Big Book of Opportunity also free. Make your first step today—it costs you nothing.



MAIL COUPON TODAY.

Chicago Tech. College, Dept. 130, Chicago Tech. Bldg., 118 East 26th St., Chicago, Ill.
 Send me, without obligation, your Free Trial Lesson, Blue Prints and Book of Opportunity. I want to know how to become a Building Draftsman.

CHICAGO TECHNICAL COLLEGE
 Dept. 130, Chicago Technical Building
 118 East 26th Street CHICAGO, ILLINOIS

NAME.....
 ADDRESS.....
 CITY OR TOWN..... STATE.....
 Architectural Drafting Electrical Drafting
 Machine Drafting Structural Drafting

BANISH WEAKNESS

YOU CAN BE STRONG



STRONGFORT
BUILDER OF MEN

Don't be a weakling another day. You can become strong. You need not go on shuffling, shambling through life like a cur dog with his tail between his legs. You needn't be laughed at by men and shunned by women. Don't stand the gaff; you can be a vigorous, powerful fellow with rolling muscles, a grip like iron and a punch that will make the bullies sit up and take notice. Of course you feel hopeless about your condition if you are all run down, fagged out and devitalized. You haven't ambition enough left to do anything or get anywhere. But don't be discouraged.

I CAN HELP YOU

I have put thousands on their feet after they had been dragged down so deep they thought they never could be real men again. I gave them stamina, pep, vigor, energy, ambition. I built them up inch by inch—internally and externally—by my original methods—until they were robust, powerful fellows who commanded attention everywhere—some of my pupils becoming famous athletes and strong men, devoting themselves to physical instruction and exhibitions of feats of strength. I have hundreds, yes, thousands of testimonial letters proving that by my unique system I have worked wonders with men's bodies—first by restoring them to health, then developing them into wonderful specimens of muscular strength.

STRONGFORTISM

SCIENCE OF HEALTH AND STRENGTH

It was through the methods I used in developing my own body until I won the world's record as the finest specimen of muscular development and championships in feats of great strength, in Europe and in the United States, that I constructed the science of Strongfortism. It is through it that I reclaim wrecked and weak men, make them into new beings and give them a body and arms of which they can boast. I require you to use no apparatus. No drugs or medicines are prescribed.

You can banish your weakness. You can be a man to be feared in physical combat. There is no doubt about it. I can prove it if you'll just sit down and tell me frankly that you are willing to guide by what I tell you.

Send for My Book

The experience and research of a lifetime are contained in my wonderfully instructive book, "Promotion and Conservation of Health, Strength and Mental Energy." It will tell you frankly how you can make yourself over into a vigorous specimen of vital manhood with 100% pep, power and personality. It will show you how to be true to the best that is within you. It is absolutely free. Just check the subjects on the free consultation coupon on which you want special confidential information and send to me with a 10c piece to help pay postage, etc. It is a man-builder—a success-maker and a lifesaver. Send for my book right now—TODAY.

LIONEL STRONGFORT

Physical and Health Specialist Over 25 Years

Dept. 97 Newark, New Jersey, U. S. A.

FREE CONSULTATION COUPON

Mr. Lionel Strongfort, Dept. 97, Newark, N. J.
Please send me absolutely free, your book on the Promotion and Conservation of Health, Strength and Mental Energy. I enclose a ten cent piece (1 dime) to help cover postage and have marked (x) before the subjects in which I am most interested.

- | | | |
|---------------|-----------------|---------------------|
| .. Colds | .. Increased | .. Weak Eyes |
| .. Catarrh | .. Height | .. Weak Heart |
| .. Asthma | .. Pimples | .. Poor Circulation |
| .. Hay Fever | .. Insomnia | .. Round |
| .. Headache | .. Short Wind | .. Shoulders |
| .. Thinness | .. Constipation | .. Lung Troubles |
| .. Rupture | .. Indigestion | .. Muscular |
| .. Lumbago | .. Nervousness | .. Development |
| .. Flat Chest | .. Rheumatism | .. Great Strength |

Name.....
Age..... Occupation.....
Street.....
City..... State.....

\$1500 - \$3000 Year For You

SALESMEN WANTED Men, 17 up. Thousands wanted immediately by BIG SUCCESSFUL HOUSES. Travel—See your country at BIG PAY. Common education sufficient. Experience unnecessary.

FULL PARTICULARS—FREE

Write immediately for full particulars, free sample training in Selling and Free Book, "How To Be a Big Paid Salesman."

FRANKLIN INSTITUTE, Dept. L703, ROCHESTER, N. Y.

WANT WORK AT HOME?

Earn \$18 to \$60 a week **RETOUCHING** photos. Men or women. No selling or canvassing. We teach you and furnish **WORKING OUTFIT** given with each enrollment. Limited offer. **Write today.**
Aircraft Studios, Dept. 59, 3900 Sheridan Rd., Chicago

Earn \$100 a Week Profits in Advance

Sell Gibson extra fine men's made-to-order all-wool suits at \$31.50, direct to wearer. Regular \$55 values. **Biggest commissions paid in advance.** We deliver and collect. 6x9 cloth samples (over 100 styles — all one price) and complete outfit in handsome carrying case, furnished to ambitious men who are willing to hustle and earn \$100 weekly. Write today.



W. Z. GIBSON, Inc., 161 W. Harrison St., Dept. N-516, Chicago

BOW LEGS?

OUR GARTER (Pat'd)
Makes Trousers Hang Straight
If Legs Bend In or Out. Self Adjustable.
Free Booklet — Plain Sealed Envelope
THE T. GARTER CO., Dept. 2, New London, New Hampshire

TRY YOUR LUCK WITH THE LUCKY SAW

FREE TRIAL Follow the directions—the now famous "LUCKY SAW" answers your questions, solves problems, brings you "good luck" says Lucky Joe, the Old Carpenter, who wore one many years. Wear this beautiful charm (or pocket piece) on 30 days free trial. If you like it, keep it. Money refunded if it fails to bring good luck. **Amaze and entertain friends** with this mysterious novelty. All the rage with society, theatrical, racing people in New York. Men and women everywhere, delight-ed! Be first to have one. Brilliant rolled gold. We send **Four 25c Cash Certificates** if you rush order. Send \$1 now for Lucky Saw and the full directions for use to: **THE LUCKY JOE CO., 152 West 42d St., New York, N.Y., Department A.**

Don't Wear A Truss

FREE TRIAL **NO MORE STEEL OR RUBBER BANDS**

PLAPAO-CERATE

YOU know by your own experience the truss is a mere make-shift—a false prop against a collapsing wall, and is undermining your health. Why, then, continue to wear them? **STUART'S PLAPAO-PADS** are entirely different—being medicine applicators, made self-adhesive purposely to prevent slipping, and to hold the distended muscles securely in place. No metal parts; no straps, buckles or springs attached; no "digging-in" or grinding pressure. Soft as Velvet—Flexible—Easy to Apply—Inexpensive. Continuous day and night treatment at home. No bothersome taking off every night, no delay from work. Hundreds have testified under oath that **Plapao-Pads** positively and permanently cured their Rupture—some, most aggravated cases.

FREE TO THE RUPTURED
TRIAL OF PLAPAO and interesting, instructive 48-page book on Rupture, both **Absolutely FREE.** Nothing to pay—now or ever nothing to be returned. Write today, 'tis madness to defer. Address,
PLAPAO LABORATORIES, Block 1762 St. Louis, Missouri.

SOFT AS VELVET—EASY TO APPLY **EQUALLY GOOD FOR YOUNG AND OLD**



It's easy to learn Electricity by the Job-Method. You learn by doing actual Electrical jobs with standard tools and materials. I supply four costly outfits for doing the jobs.



It's easy to learn Radio by actually assembling and wiring the Radio Set send you.

22 Engineers men from Westinghouse, General Electric, Western Electric, Underwriters Laboratories, and the great Universities and Electrical corporations, have joined in building a complete, rapid, and simplified home-training in Electricity. By a new Job-Method you are prepared quickly for a good Electrical position.



Here a student is doing a house-wiring job—installing a ceiling fixture.



Student winding the commutator on the motor I send with 4 Free outfits.



10,000 MEN WANTED!
Men Who Like Electrical Work
 will be given an unusual opportunity. They must be over 18 years of age. Must now be employed in some legitimate work. Must have had at least 8th grade schooling and be able to give two character references. The Electrical field has hardly been scratched, and in view of the rapid changes now taking place and the new discoveries being made, a man must be trained in fundamental Electrical principles if he expects to be anything more than a common laborer in the Electrical field. The men selected for this opportunity will be trained at home in actual work by the present positions. Their training will be planned to enable them to qualify for a good position and increased pay in the shortest possible time. As soon as they are ready for it, an efficient Employment Service, operating nationally, will help them find a satisfactory job position. Any applicant accepted under this offer who is not satisfied with either the training or the small amount charged for his training. If you wish to share in this opportunity—If you have reached a point where you realize the absolute necessity and value of practical training—and if your wishbone has not switched places with your backbone, then write me immediately for full information.

CHIEF ENGINEER DUNLAP AMERICAN SCHOOL CHICAGO
 Dept. E-174-A, Drexel Ave. & 58th St., Chicago



One of these outfits is a \$10 motor. Same type as the big fellows in a power plant. You wire the commutator and the field, assemble it, change the voltage from battery to power current, make it run, change it over into a generator



After you know how to do these jobs, you can direct the work of others.



I give you Electrical Drafting, Ignition, Radio, Electrical Engineering subjects, training in the business end of Electricity. I prepare you for a well-paid Electrical job and help you find it when you are ready for it.

SEND JOB and RAISE offer!
CHIEF ENGINEER DUNLAP
 Dept. E-174-A, Drexel Ave. & 58th St., Chicago

Please send complete information about the offer to prepare me for a well-paid position in Electricity.

Name.....
 Address.....
 City.....
 State.....

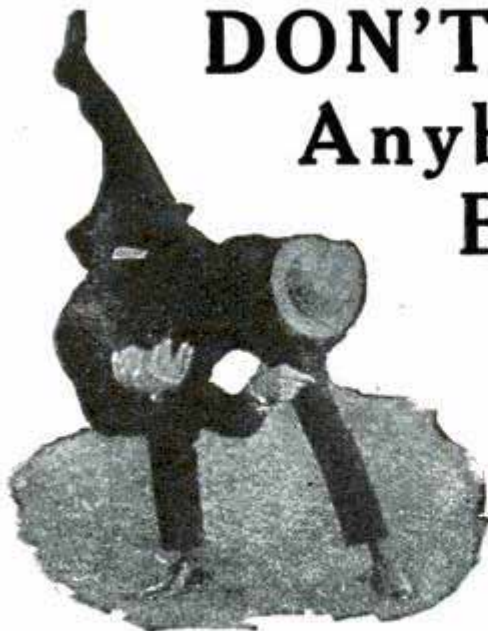

DON'T Let Anybody Bully You

LEARN SCIENTIFIC TRICKS OF PHYSICAL MASTERY

Don't pick scraps, but when you're right don't "back water." And don't worry about a man that's bigger and stronger than you are. By a few simple tricks you can have any assailant at your mercy quick as a flash. At last the astounding secrets of self-defense, used by the New York Police, are revealed in the marvelous, officially recognized system—

Sgt. Wallander's Course

All Complete In

PHYSICAL TRAINING MANUAL

By Sgt. A. W. WALLANDER, Commander Physical Training

NEW YORK POLICE ACADEMY

This volume is a complete course in physical culture. Scores of gripping action photos showing just how to throw a bigger man and overpower him—how you disarm a hold-up thug—how to build up muscle—how to keep in fighting trim. Hundreds of health hints, too; care of the feet, prevention of colds, correct posture, how to walk without fatigue. This is the genuine book used by the New York Police Dept., now available to YOU for the first time!

Easy to Learn Let Sgt. Wallander give you his great secrets. A few hours of easy reading will make you master of these closely-guarded detective tricks. You'll hardly believe that such valuable knowledge could be learned so easily.

ALL YOURS IN WORLD'S MOST AMAZING COURSE

SEND NO MONEY.—In Physical Culture and Police circles this volume is world-famous. You're lucky that you can get in on this short-time offer. Send immediately for your copy. You'll be a new man. You can learn how to be a great athlete. Don't delay. Don't send money now. Just send the coupon today. When volume arrives, pay the postman \$1.97, plus few cents postage. If you are not satisfied return volume and get money back.

\$1.97
Plus
Post-
age

SIEBEL PRESS, 34-Z W. 20th St., New York.

Please send me Sgt. Wallander's *Physical Mastery Course* as contained in the "Physical Training Manual." Upon arrival I will pay the postman \$1.97 plus a few cents carrying charges. It is understood that if I am not satisfied with this book, I will return it and my money will be refunded.

Name.....

Address.....

City.....

State.....

(\$2.25 U. S. Cash with order in all other countries)

ELECTRICITY



My first job after leaving school took 2 hours and I received \$65.00 for the inspection. I worked up to over \$600.00 a month and expect to clear \$10,000 the first year.
Paul A. Carson.



B.S. Degree, 3 yrs.

Actual experiments in our shops teach you all branches of electricity.

You Learn by Doing

No matter what your education or age, you'll find a place at S. O. E. and a course to meet your needs. Send for Free Catalog. 3 mos. D. G. and A. C. Armature winding; auto electricity or radio courses at your fast advancement. Learn practical electricity in 6 mos.; junior electrical engineering, commercial electrical engineering or electro-technician in 12 mos. Step in the limelight of success. Send for **BIG, FREE ILLUSTRATED CATALOG TODAY.**

SCHOOL of ENGINEERING of Milwaukee

Dept. PM-A 126-415 Marshall St., Milwaukee, Wis.

LEARN Painting Paper Hanging and Decorating

\$100 PER WEEK AND UP EASILY EARNED

A few weeks' training at this Big School will place you in the BIG MONEY CLASS.

BIG OPPORTUNITY FOR AMBITIOUS MEN

Send for our Big Free Catalog

CHICAGO PAINTING SCHOOL Dept. 412, 148 West Anstin Ave., CHICAGO

LEARN PHOTOGRAPHY! Earn While Learning. Qualify in a short time. Start your own business. Genuine professional 8x10 camera FREE. Write immediately for information on the guaranteed success course of study.
UNIVERSAL INSTITUTE 620 MONADNOCK BLDG. CHICAGO, ILL.

MEN See Our Classified
Ad on Page 59
A Real Opening—For Real Men
BANCROFT-HUNTER CO., Inc. CHICAGO

Clear Your Skin

If you suffer from pimples, acne, blackheads, oily skin, or eruptions, simply send me your name and address, and I will tell you about a simple home remedy that often cures pimples in one day after everything else has failed. No obligation—just send your name.

W. H. WARREN, 451 Gateway Sta., KANSAS CITY, MO.

Let us recommend the best books to study on any subject. Popular Mechanics Press, Chicago, Illinois.

Heat Without Coal

At last the ideal way to heat your home, without coal or wood, has been discovered. This is a new invention called the "Heat Fountain" which converts any stove, heater, range or furnace into a gas heater. It combines ordinary kerosene (coal oil) with air to have a perfect heating gas. No piping—no changes to your present heating plant necessary. Simply slip this little device into any stove or furnace and you have instant heat, any degree desired, at a turn of a valve. Already 200,000 homes, many of them in Canada and Alaska, have found this wonderful device the most dependable for heating even in sub-zero weather. Find out now how you can be done forever with soot, ashes, dirt, smoke and drudgery of coal and wood—the worry of coal shortages, strikes and exorbitant prices. Find out how you can use this new invention in your home on 30 days' trial. Simply write for free book "The New Way to Heat Homes" and full details of our offer. Send name and address to

OLIVER OIL BURNER CORPORATION
Dept. A-134 10 Chestnut St., ST. LOUIS, MO.

From \$35 a week as a
Garage Hand to
\$5000 a
Year
as a
Draftsman



Is He Smarter than YOU?

Do you want a man's size pay envelope? So did this man. Are you a little shy on book learning? This chap never finished eighth grade at school. *But he looked the field over and chose the line nineteen out of twenty Help Wanted ads called for.* He learned the line that's always in demand. He wrote to me in February. *By the middle of May he was a draftsman.* Today, my mail brought his photo and the statement, "I've been made Assistant to the Chief Draftsman at \$400 a month!"

Six Months

is ample time for anyone to learn draftsmanship. It's longer than this man studied at home under me! And you need no "talent" for drafting. This student was a garage hand when he started my course! Smart? Yes.

Smart enough to pick the liveliest line in all industry.

This Coupon Started Him

Get the Better Things of Life



Your Own Home
Would you rather have a correspondence school "diploma"—or a draftsman's salary that will buy a HOME?



Your Own Car
An "automotive expert" can repair a car—but a draftsman can OWN one.



Leisure
A draftsman has leisure hours and the money to enjoy them!

Let Ambition Guide You

—but don't let it run away. There are many, many "schools" that teach most anything. Shoot for the line that is practical—profitable. Get the knowledge every industry needs and is willing to pay for.

You Need Only the Will to Start

We have everything required to put you in the high-pay class—everything *but your name and address.* If you clip the coupon *now and mail it*—we'll make the next move—by next mail!

REMEMBER, it's supply and demand that regulates everyone's pay. What good is any trade in which there is a waiting list instead of work? Or a head crammed with knowledge for which there is no actual, cash demand? But in drafting, you don't see signs "NO HELP WANTED!" Every industry is clamoring for draftsmen; read the want ads in any newspaper.

JOBS WAITING all over U. S. Every industry uses blueprints by the thousands, as you know. The biggest concerns recruit their draftsmen from our offices. We haven't students enough to go 'round right now—and next Spring the shortage will be worse. Therefore, to induce action I'll furnish tools without extra charge. So clip coupon NOW.



Train at Home Under My Supervision

—and I'll have you right in the business of drafting—the first hour. There are no books. No theories. We put the tools in your hands, tell you what they're for, illustrate how they're used—and you begin to draft. I will have you so interested inside of a week—and so sure of yourself in a month or two—but you'll have to clip the coupon and get the introductory material to see what a pleasant and profitable course is waiting for you!

You Suffer if You Wait MAIL THIS COUPON NOW

FREE

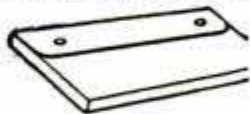

CHIEF DRAFTSMAN DOBE
Div. 93-51, 1951 Lawrence Avenue, Chicago, Illinois
WITHOUT OBLIGATING ME send full information about the way you teach practical draftsmanship, your new, enlarged BOOK, and free tool offer.

Name.....Age.....

Address.....

P. O..... State.....



A Young Canadian Worthy of the Name

"THE men who made Canada did more than hew a wilderness into a great land of unlimited opportunity; they bequeathed to us a heritage of dauntlessness and achievement. We have in us the blood of conquerors—of men who won mightily. That blood is either stagnant—sadly deteriorated—or it impels one to strive toward better things.

"Joe, here, is one of the strivers. During his spare time he learned all he could of such special knowledge as we require and use in this business. Now he *knows* just the things he must know to hold down the position to which I have promoted him. I'm telling you this because there are *other* good positions here for men who know. Boys, it's up to you. You've only to fit yourselves for those positions and they are yours."

Joe's success was gained through vocational training acquired from the International Correspondence Schools. How about yourself? An I. C. S. Course—there are 300—is easy to learn. Let us tell you all about this wonderful method. Just mark and mail the coupon.

INTERNATIONAL CORRESPONDENCE SCHOOLS
Box 1891, Scranton, Penna.

Without cost or obligation, please tell me how I can qualify for the position or in the subject *before* which I have marked an X:

BUSINESS TRAINING COURSES

- | | |
|--|---|
| <input type="checkbox"/> Business Management | <input type="checkbox"/> Salesmanship |
| <input type="checkbox"/> Industrial Management | <input type="checkbox"/> Advertising |
| <input type="checkbox"/> Personnel Organization | <input type="checkbox"/> Better Letters |
| <input type="checkbox"/> Traffic Management | <input type="checkbox"/> Show Card Lettering |
| <input type="checkbox"/> Business Law | <input type="checkbox"/> Stenography and Typing |
| <input type="checkbox"/> Banking and Banking Law | <input type="checkbox"/> Business English |
| <input type="checkbox"/> Accountancy (including C.P.A.) | <input type="checkbox"/> Civil Service |
| <input type="checkbox"/> Nicholson Cost Accounting | <input type="checkbox"/> Railway Mail Clerk |
| <input type="checkbox"/> Bookkeeping | <input type="checkbox"/> Common School Subjects |
| <input type="checkbox"/> Private Secretary | <input type="checkbox"/> High School Subjects |
| <input type="checkbox"/> Spanish <input type="checkbox"/> French | <input type="checkbox"/> Illustrating <input type="checkbox"/> Cartooning |

TECHNICAL AND INDUSTRIAL COURSES

- | | |
|---|--|
| <input type="checkbox"/> Electrical Engineering | <input type="checkbox"/> Architect |
| <input type="checkbox"/> Electric Lighting | <input type="checkbox"/> Architects' Blue Prints |
| <input type="checkbox"/> Mechanical Engineer | <input type="checkbox"/> Contractor and Builder |
| <input type="checkbox"/> Mechanical Draftsman | <input type="checkbox"/> Architectural Draftsman |
| <input type="checkbox"/> Machine Shop Practice | <input type="checkbox"/> Concrete Builder |
| <input type="checkbox"/> Railroad Positions | <input type="checkbox"/> Structural Engineer |
| <input type="checkbox"/> Gas Engine Operating | <input type="checkbox"/> Chemistry <input type="checkbox"/> Pharmacy |
| <input type="checkbox"/> Civil Engineer | <input type="checkbox"/> Automobile Work |
| <input type="checkbox"/> Surveying and Mapping | <input type="checkbox"/> Airplane Engines |
| <input type="checkbox"/> Metallurgy | <input type="checkbox"/> Navigation |
| <input type="checkbox"/> Steam Engineering | <input type="checkbox"/> Agriculture and Poultry |
| <input type="checkbox"/> Radio | <input type="checkbox"/> Mathematics |

Name.....
 Street.....
 Address..... 3-6-24
 City..... State.....

Occupation.....
 Persons residing in Canada should send this coupon to the International Correspondence Schools Canadian, Limited, Montreal, Canada.

It's Fun to Make Things

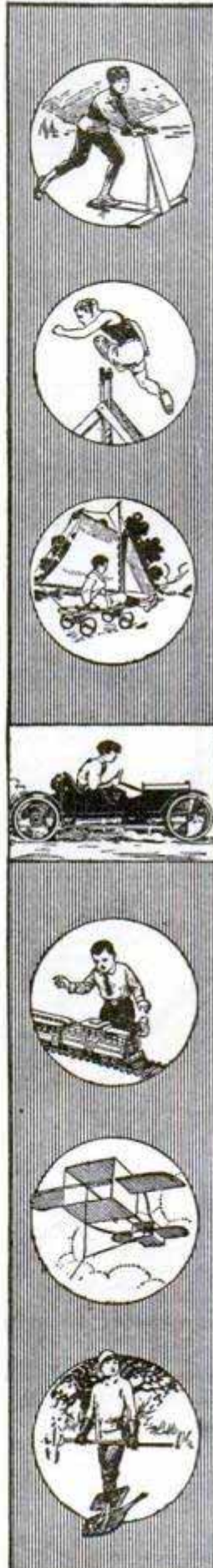

Let the other boys wonder how you can make so many interesting things. Make your own motor sled. Make your own radio. Make your own skis and snowshoes. You can learn how to make almost anything that any boy could want by following the pictures and the simple directions in

The Boy Mechanic Library

And just think of it, there are nearly 4,000 separate articles in the four beautiful volumes! Some of the most fascinating subjects are listed below.

How to Make Things

- | | |
|-------------------|-----------------------|
| Boats | China painting |
| Winter sports | Decorative metal work |
| Camping | Furniture making |
| Ice boats | Farming |
| Water sports | Poultry |
| Toboggans | Models |
| Tents | Laboratory helps |
| Skis | Household helps |
| Indian snowshoes | Wood working |
| Skating | Electrical devices |
| Gymnasium | Photography |
| Wind wagons | Music |
| Motor sleds | Outdoor games |
| Radio | Stoves |
| Magic | Furnaces |
| Trapping | Wireless |
| Pets | Tricks |
| Leather work | Puzzles |
| Carpentry | Hoops |
| Painting | Flowers |
| Toys | Hunting |
| Fishing | Kites |
| Fruit growing | Metal working tools |
| Entertainments | Secret locks |
| Automobile | Swings |
| House decorations | Sleds |
| Drafting | Power devices |

Learn how to make things to sell. Learn how to make things to enjoy yourself. Buy the complete library, including Book 1, Book 2, Book 3 and Book 4.

Send No Money

Simply sign your name and address to the attached coupon and mail it at once. When the postman delivers the books to your door, pay him the price of the books and the few cents postage. That is all.

POPULAR MECHANICS PRESS
 Popular Mechanics Building
 Room 1777 CHICAGO, ILL.

Mail the Coupon Today!

POPULAR MECHANICS PRESS
 Popular Mechanics Building
 Room 1777, Chicago, Ill.

Please send me at once C. O. D. The Boy Mechanic Library comprising Book 1, Book 2, Book 3, and Book 4. I will pay postman \$7 and the few cents postage.

Name.....
 City.....
 State.....
 St. No. or R. F. D.....

If you want individual books at \$2 each, check the numbers of the books you want: 1 2 3 4

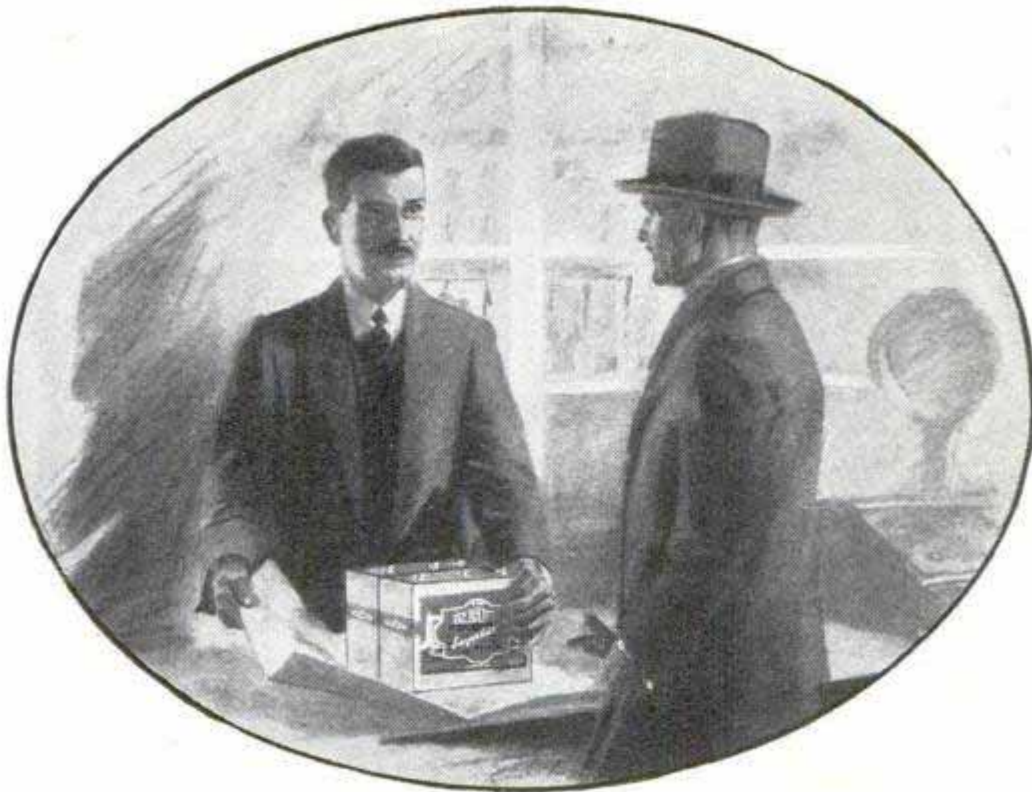

“These Eveready Batteries are the correct size for your set. With average use they will last you a year or longer”

“You have been one of the many who use ‘B’ batteries that are too small in capacity for their receivers. That makes you buy ‘B’ batteries twice as often as necessary. Fit the right size Evereadys to your set and add a ‘C’ battery,* if you haven’t one, and you’ll get maximum service at minimum cost.”

The life of your Eveready “B” Battery depends on its capacity in relation to your set and how much you listen in. We know, through investigation, that the average year-round use of a set is two hours a day. Taking that average we have proved over and over on

*NOTE: In addition to the increased life which an Eveready “C” Battery gives to your “B” batteries, it will add a quality of reception unobtainable without it.

sets of one to three tubes the No. 772 Eveready “B” Battery used with a “C” battery will last a year or longer. On sets of four and five tubes the larger heavy duty Eveready Batteries used with a “C” battery will last eight months or more.

The secret of “B” battery satisfaction and economy is—

With sets of from 1 to 3 tubes, use Eveready No. 772.

With sets of 4 or more tubes, use either of the heavy duty batteries No. 770 or the even longer lived Eveready Layerbilt No. 486.

We have prepared a new booklet, “Choosing and Using the Right Radio Batteries,” which we will be glad to send you upon request. This booklet also tells about the proper battery equipment for use with the new power tubes.

Manufactured and guaranteed by
NATIONAL CARBON CO., INC.
 New York San Francisco
 Canadian National Carbon Co.,
 Limited, Toronto, Ontario



LEFT—Eveready Layerbilt “B” Battery No. 486, 45 volts, for maximum economy on four, five or more tubes.



RIGHT—Eveready DryCell Radio “A” Battery, 1½ volts. The battery built especially for dry cell tubes.

EVEREADY
Radio Batteries
—they last longer

EVEREADY HOUR
EVERY TUESDAY AT 9 P. M.
Eastern Standard Time

For real radio enjoyment, tune in the “Eveready Group.” Broadcast through stations—

WEAF—New York	WCAE—Pittsburgh
WJAR—Providence	WSAI—Cincinnati
WEET—Boston	WWJ—Detroit
WTAG—Worcester	WOC—Davenport
WFI—Philadelphia	WCCO—Minneapolis
WGR—Buffalo	WCCO—St. Paul
	KSD—St. Louis

679

Comt. Charles W. Seiger, Union League Club
Port + Taylor, San Francisco, Calif.



Unique among the World's Roads, California's Redwood Highway Is Lined for More Than 100 Miles by Forests of Giant Sequoia Trees, Ranging from 100 to 350 Feet in Height and Many of Them Old When the Children of Israel Were Being Led to the Promised Land; Roy Chapman Andrews, the Discoverer of the Dinosaur Eggs, Has Just Found Petrified Redwoods in the Gobi, Indicating That They Came from Mongolia

Popular Mechanics Magazine

REGISTERED IN U. S. PATENT OFFICE

WRITTEN SO YOU CAN UNDERSTAND IT

Vol. 45

JANUARY, 1926

No. 1

714

Corp.
Arc.
Chicago

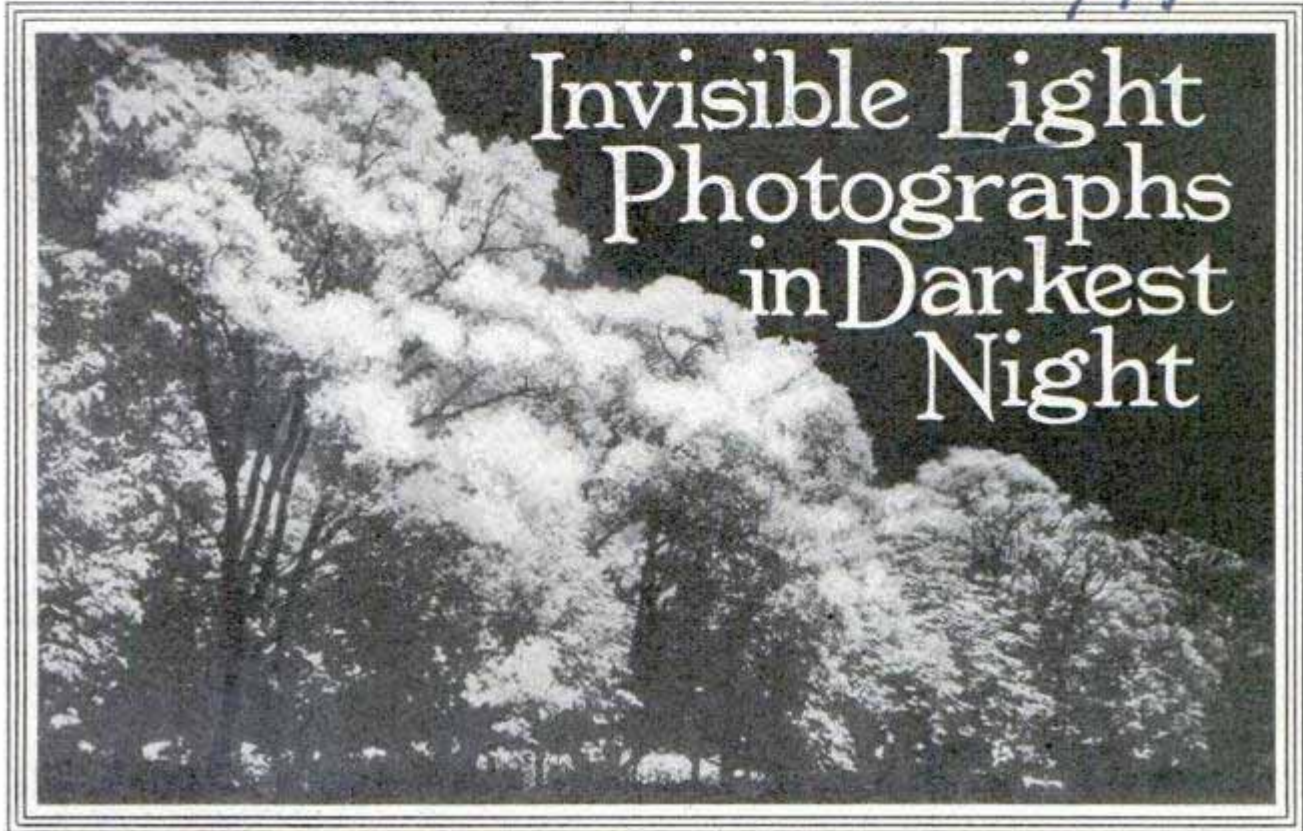

Invisible Light Photographs in Darkest Night

Beautiful Snow Effects Are Obtained by Professor Wood in Photographing Green Trees and Grass by Invisible Infra-Red Rays, Which Lie outside the Visible Spectrum

Pictures by Unseen Rays and of Unseen Objects One Hundred and Fifty Miles Away Achieved by Quartz Lamp and Lens

INVESTIGATION of an announcement from Tokyo recently that Jusei Sugiye, a Japanese scientist, had succeeded in taking photographs in the dark by an invisible light revealed one of the wartime secrets of the U. S. navy which helped guide the ship convoys across the ocean at night without visible lights, which would have betrayed them to submarines.

The same invisible light used by the Japanese scientist was employed in war time to enable the ships to keep their places in line and Dr. Harvey Brace Lemon, of the University of Chicago, who recalled the war stunt, has duplicated in his laboratory the Japanese achievement.

The invisible light is obtained by passing the rays through a black glass impervious to all but the ultraviolet portion, which cannot be seen by the eye. Lights, sheltered behind this black glass, on the

stern of each convoy ship were invisible, but the next ship in line could see it by focusing on it a telescope in which was fixed a small fluorescent screen, like the screen used to make X-ray pictures visible.

Ordinary glass will not pass ultraviolet rays—which is the reason sun cures must be taken in the open air, or behind a window of quartz. To take pictures by the invisible light, it is necessary not only to have the special black glass, but the light behind it must be inclosed in a quartz tube in order that the ultraviolet rays may escape.

In the experiments made by Dr. Lemon a small mercury-vapor lamp in a quartz globe was used, the lamp being mounted in a wooden box, with a sheet of the black glass in front. A subject posing before it for a photograph becomes visible because his eyeballs, fingernails and teeth become fluorescent, shining in the

Equip ment from Scaertner
1201 W. Rightwood
Chicago

Industrial Experiment Station

dark, and in some cases even the skin and hair show similar activity.

The eyes have a peculiar sensation of receiving a bright light, though none is visible, and if the head is lowered to take the eyes out of the ultraviolet beam, the sensation disappears so suddenly that it feels as though a nerve has been severed.

Even the fairest skin, devoid of freckles, photographs covered with dozens of them, for every place where the pigment of the skin has a latent tendency to freckle, if exposed too long to the sun, the concentrated invisible rays pick out the difference and imprint it on the photographic plate.

Camera plates are so sensitive to the rays that they easily become fogged from exposure. In absolute darkness, with the camera at one side and behind the light source to protect the plate, a second's exposure is sufficient for a picture. Pointed at the light source, the black glass becomes transparent to the camera, though not to the human eye, and the plate records a picture of the hidden apparatus within the light box.

Fluorescent liquids glow in the dark as they pick up the invisible rays. Water with a small amount of esculin dissolved in it remains clear and pure to the naked eye, but exposed under the ultraviolet rays, it flares with a brilliant ultramarine, only to turn again to clear water when

taken away. The invisible light can be used not only to take pictures in the dark, but will photograph invisible objects miles away. At Lick observatory, in California, Prof. Wright has succeeded in taking pictures of redwood trees on the Sierra mountainsides 150 miles away, every detail of the trees showing clearly. A quartz lens, heavily coated with silver, to keep out all visible light, was used in a camera made of apparatus used to photograph distant stars. With the same lens, it is possible to send up an airplane and hide it in a cloud, so that it becomes invisible to the people on the ground, and yet take pictures showing every detail of the ground, since the invisible rays pass through the cloud without interruption.

Remarkable rainy-day and fog effects can be produced in out-of-door photography with the ultraviolet rays. Prof. Lemon has been experimenting for several years with them.

Another experimenter, Prof. Wood of Johns Hopkins university, is working at the other end of the spectrum, photographing by the infra-red rays, which are below the band of visible reds. Pictures of green trees and grass taken by this light turn out wonderful snow effects, the greens photographing white.

The study of the invisible rays at either end of the visible spectrum, whose colors unite to form white light, is still in its in-

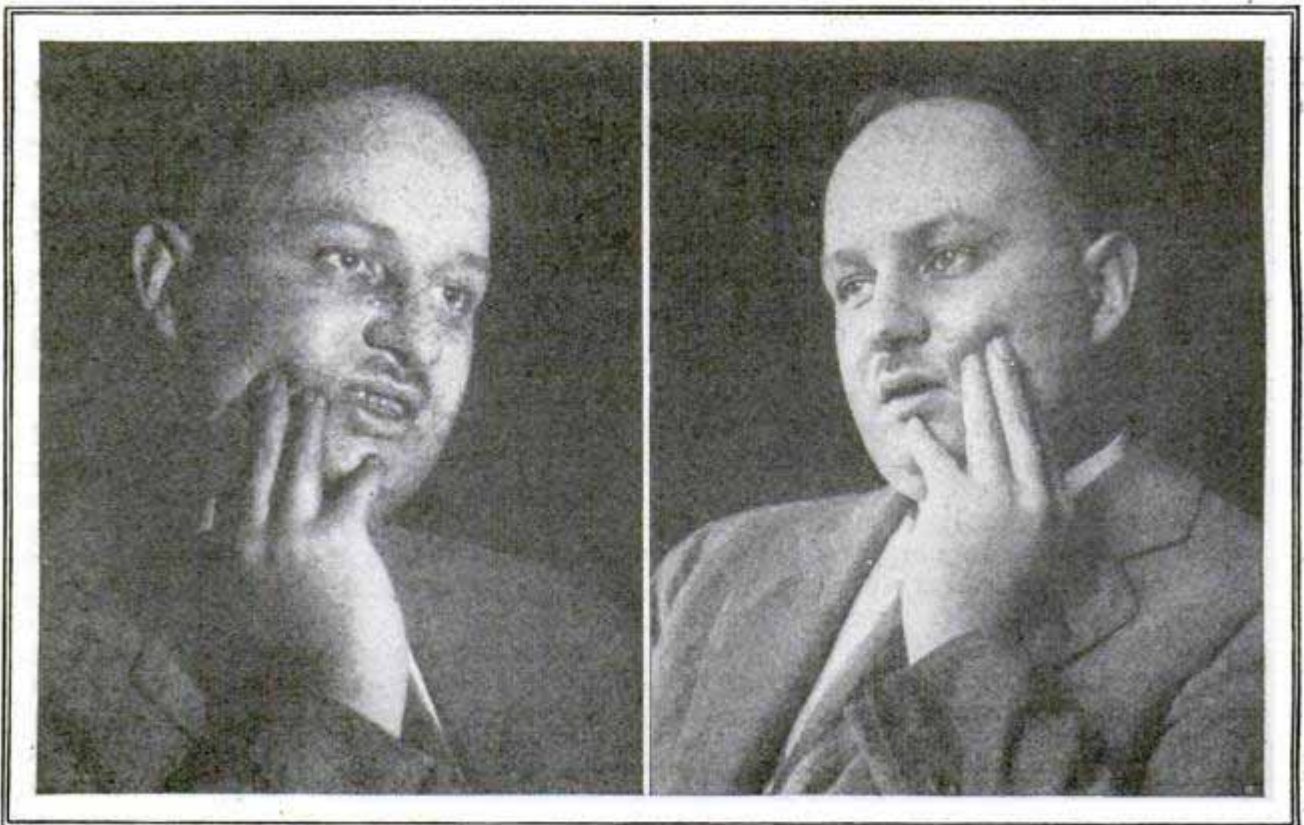

Eyeballs and Teeth Become Fluorescent under the Ultraviolet Ray, and Invisible Freckles Appear; Picture Taken in the Dark by Invisible Light, at Left, and in Ordinary Light, at Right

fancy, though the last missing band of wavelengths has finally been measured. With new chemical combinations for their plates and better equipment, research workers are constantly extending the field of photography into things the eye cannot otherwise see.

Investigation of invisible light has received considerable impetus within the past few months by the discovery of a process for producing crystal quartz cheaply and in quantities, and by revelation of the healing power the rays possess. Because of the relative cheapness of quartz produced by the new process, entire windows of the material have been made possible, the first being installed at Johns Hopkins. Experimenters in recent months have discovered that the ultraviolet rays will cure such diseases as rickets, common particularly among children in crowded tenement districts where little sunlight penetrates. Experiments on chickens showed that fowls confined in hothouses under ordinary window glass failed to attain their growth, sickened and eventually died of rickets, marked by failure of the bones to develop. Other chickens exposed for only



Mercury Lamp in Quartz Globe and Black Glass, Which Passes Only Ultraviolet Rays, Above; Water with a Small Amount of Esculin, at Bottom, Remains Clear as Crystal, but Becomes Fluorescent under the Rays, Center



a few minutes daily to ultraviolet rays thrived.

In the hands of an inexperienced person the rays, however, are a source of danger. Only a few minutes' exposure is sufficient to produce a bad case of sunburn, while the

eyes may be injured unless protected by goggles. The special black glass used in laboratory experiments is designed to pass rays on the borderland of visibility, to lessen the danger of burns and the bad effect on the eyes.

Beyond possible use in war time, in photographing enemy troop concentrations without their knowledge, no use has yet been found for photography by ultraviolet rays, but the reaction of pigment in the skin to the invisible light may some day make it valuable in the study of skin disease. Even now it is a good test of the origin of one's teeth, since only your own become fluorescent under the rays. Fillings, crowns and false teeth remain dark and loom up as gaps in the finished picture.



PITCH OF FIRE-ALARM SIGNAL TELLS LOCATION OF BLAZE



One of the Triangle Fire-Alarm Signals That Tell Location of Blaze by Their Pitch

Volunteer firemen in a Maryland town determine the approximate location of a blaze by the pitch of the alarm, the clang of a triangle, beaten by an iron rod. There are four such signal instruments, each in a different section of the village, and each varies in pitch by several notes. A little practice and a fairly acute sense of hearing and music, enable the volunteers to rush the hose cart and other apparatus to the scene of the fire with the least possible delay.

FAST MAKES BRAIN MORE ACTIVE

Prolonged fasting retards mental ability and alertness, but the brain's efficiency suddenly increases, often above normal, when eating is resumed, tests conducted at the University of Chicago show. Three subjects were chosen for the experiments. One of them went without eating for thirty-three days, one for seventeen

and the other for ten. Hands were steadier and the brain keener after the fast than before. Seven tests were given, such as reading clippings from a magazine backward; naming 1,200 mixed colors; writing the letters "ab" for twenty minutes; reading various kinds of type in a dark room under a standard light; testing the steadiness of the arms, and standing at attention for a given length of time. The tests were made during the fast, at its conclusion and from twenty-three to thirty-three days thereafter. The subjects kept diaries in which they recorded their sensations and experiences. Most of their dreams were about food.

SHIP CANAL BETWEEN BRIDGES ACROSS ENGLISH CHANNEL

Suggested by a Swiss engineer as a substitute for a tunnel, a bridge over the English channel would be constructed in the form of two parallel jetties with a canal for ships between them. It is estimated that the work would cost \$350,000,000. Spans near each end would be erected to permit the passage of boats, and the breakwaters protecting these points could be used by lighters for loading and discharging cargoes. Each jetty is to provide a double railroad track with a motor highway above.

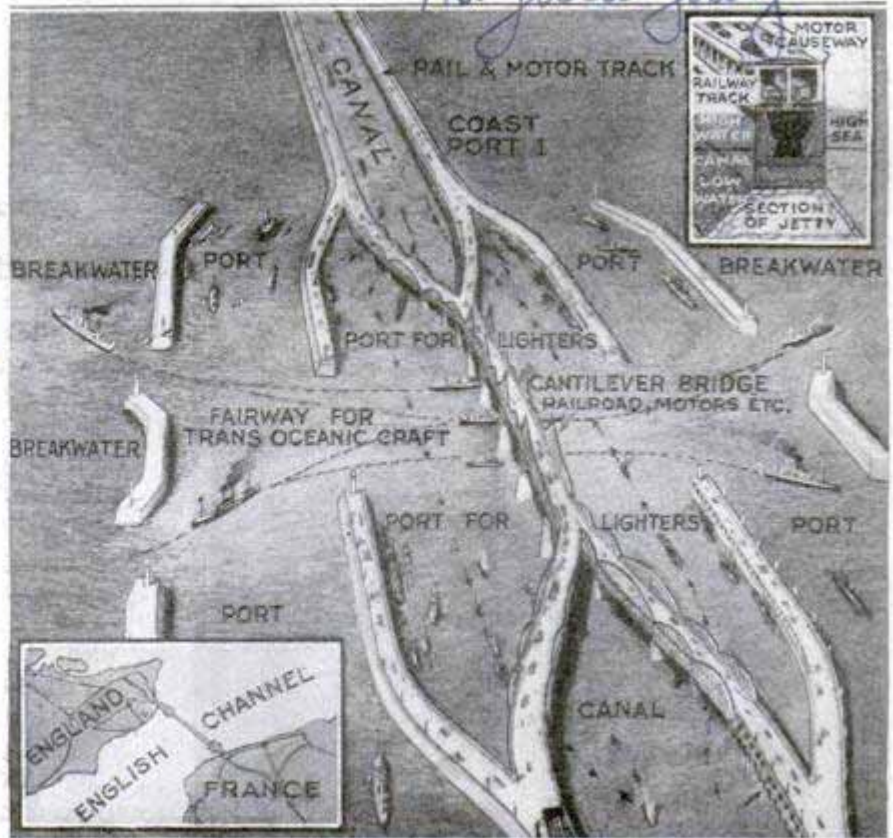

Drawing of Suggested Jetties over English Channel, Showing Canal for Ships, Spans, and the Protected Areas for Ports

*Cont. Ethair Vincent Wilcox
Takoma Park, Washington, D.C.*

North Beach

M. Jules Jaeger

G.A. Islage

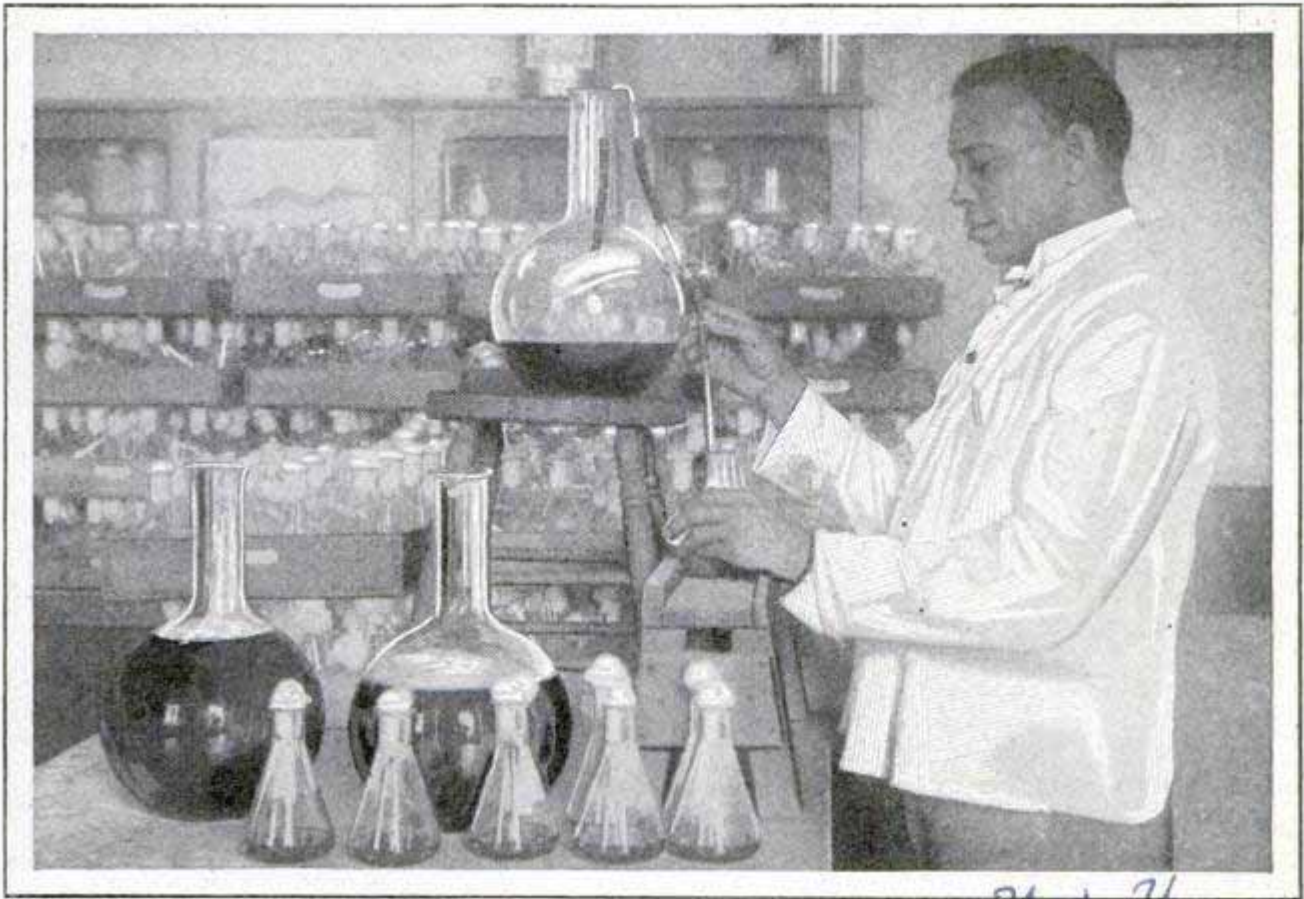

In a Germ-Culture Laboratory: the "Chef" Is Preparing Beef Tea to Feed His Hungry Charges Which Are Being Raised for Experiments and for Helpful Vaccines

Raising Germs to Guard Your Health

Disease-Preventing "Bugs" Are Pampered with Many Luxuries and Have Special Chefs to Cook for Them

GERMS are popularly regarded as harmful, but science rates them so highly that thousands of dollars are spent annually to raise certain varieties for the preparation of vaccines and serums, to save human lives and for experimental purposes. An institute in London keeps about 2,000 kinds on hand for sale. Millions of germs may be purchased for a few cents, depending upon the species. They are shipped to all parts of the world to supply physicians and hospitals.

Some laboratories devoted to germ culture employ special "chefs" to prepare food for the organisms, many of which are so tiny that 500,000 or more may be contained in a single drop. Their diet consists of animal and vegetable gelatin, glucose and beef tea, either with or without sugar. When the germs are properly developed, they are washed off the substance in which they have been raised, thoroughly shaken and counted. This is done with the aid of a microscope by placing them on a ruled glass divided into

small squares. By counting the number of germs in one of the sections and multiplying the result by the number of squares in the total area, the correct number is closely estimated. This is important, for the number of germs determines the strength of the vaccine, which is administered in carefully measured amounts to insure beneficial effect of the treatment.

Before the germs are ready for use, they must be killed. This is accomplished by heating them to about 180 degrees Fahrenheit for thirty minutes. They are then placed in a salt solution and made ready for the shipping containers. Administered as a vaccine, the dead germs stimulate the white corpuscles of the blood to combat the disease germs, preventing their multiplying in the system. This is what occurs in the treatments for preventing typhoid fever, pneumonia, boils, whooping cough and other diseases for which vaccines are available. The preparations are of little aid, in fact may

203
6

be positively harmful, doctors declare, if given after the disease has been contracted, for the reason that the white cor-

phoid fever, for instance, only since 1904 in this country. During the Spanish-American war, before the typhoid-fever

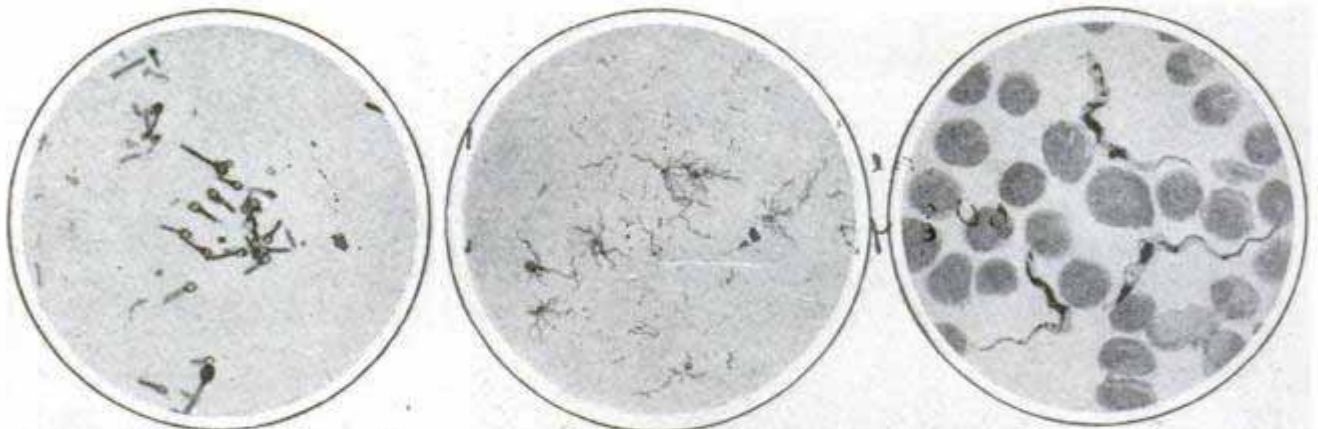

Left to Right, Lockjaw, Typhoid Fever and African Sleeping-Sickness Bacilli, Each Magnified 1,000 Diameters

puscles already are working to fight the enemy and need no artificial stimulation.

A serum is not made directly from germs, but from the blood of a horse or other animal to which a vaccine has been administered. It acts as a poison and is intended to combat the disease germ directly as in lockjaw and diphtheria.

Preparing food for the germs requires the utmost care in order that foreign microbes may not contaminate the vaccine. It is thoroughly sterilized, weighed and measured and kept at an even temperature in bottles sealed with cotton. Often the kind of food on which the germ thrives gives a clue to its identity.

As a check against mistakes and before a germ is admitted to "recognized standing" in the scientific world, four tests have been applied. First of all, the germ must be found, it must then be reproduced by culture in some medium, inoculation must show that it really produces the disease it is supposed to cause, and after that, the germ must be recovered from an animal or person suffering from the disease. By this cycle of tests, the nature of the germ is established and it can be raised with a certain degree of assurance that it will produce the expected results. Many germs under cultivation in laboratories have not yet passed these tests. Among these are the influenza germ and that which causes small-pox.

Evidence of the effectiveness of these beneficial microbes in saving human lives is plentiful, but figures gathered by Dr. C. C. Pierce, director of the third district of the United States public health service, from army records are cited as proof of the value of the use of such means of combating disease, a method which has been practiced in the fight against ty-

vaccine was used, one man out of every six of the 175,000 called to the colors contracted the disease, and there were 1,580 deaths. In the World War, with nearly 4,000,000 men in the service, only one out of every 3,800 contracted typhoid, and there were but 213 deaths from it.

Some of the varieties of germs under cultivation are so delicate that they must be kept at constant temperatures day and night. Some thrive best on food in which egg is a chief ingredient and others manifest a taste for alcoholic substances.

Journal Beacon
FORT TURNED INTO LIGHTHOUSE TO GUIDE NIGHT FLYERS

Inland lighthouses, like those that direct ocean vessels from points of vantage near the shores, have been established in France to guide night traffic by air. They supplement landing field signals and are intended to prevent such accidents as occurred in this country not long ago when Pilot Charles H. Ames of the mail service crashed into a mountain top in Pennsylvania. Two beacons already have been erected, one at Paris, and the other at Dijon, the crossroads of the air lanes. In the latter city, the lamps, of 1,000,000-candlepower, capable of throwing their rays more than 200 miles on clear nights, have been installed in the tower of an old fortress which stands on the summit of a hill. Reserve motors and transformers have been placed in the lower part of the structure, and the light is reached by winding stairs to the top of the tower. The lamps are fixed upon two revolving platforms and can be adjusted to give either two or four shafts of light. Sometimes the beams appear to sweep the horizon like the huge arms of a horizontal windmill.

L'illustration

Kansas City Star 10/15/25

Latest Developments in Field of Science

John D. Hammond Jr. Worcester, Mass.

New York City

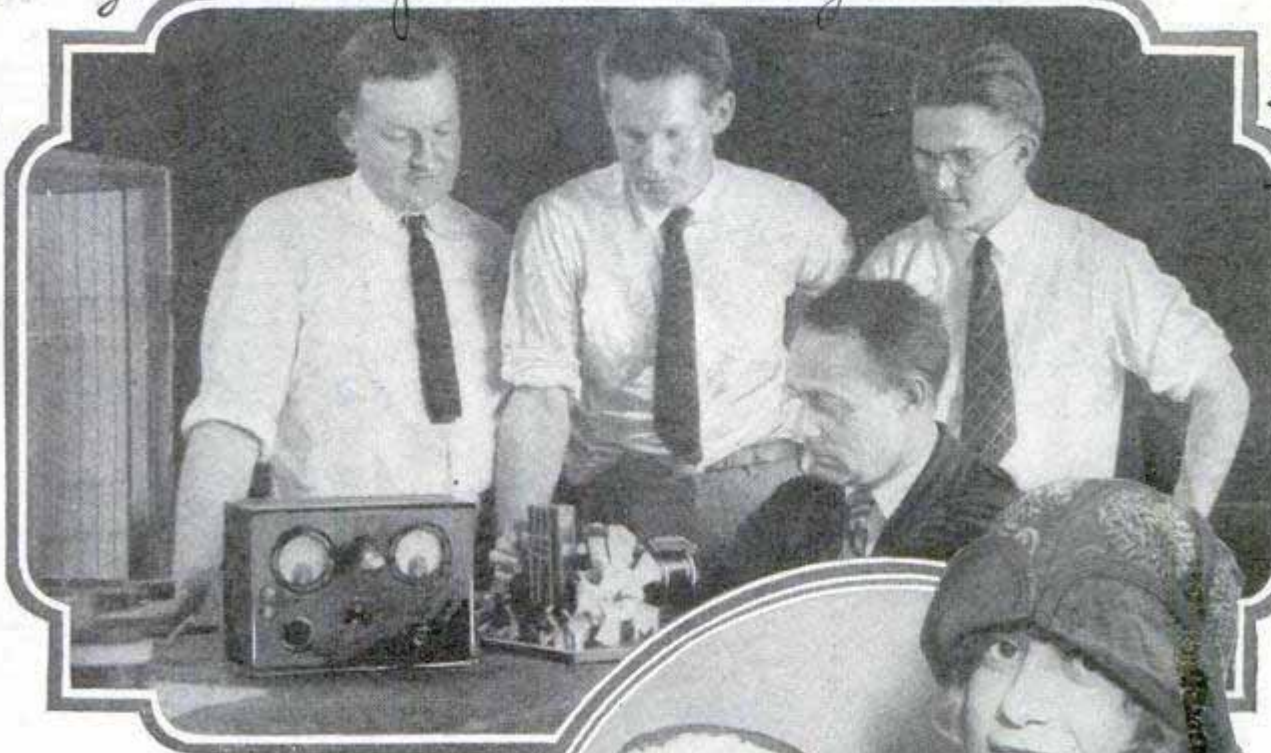

Wide World 258-252

Multiple System of Radio Transmission Promises New Usefulness for Wireless; Eight Telegraphic Code Messages Were Broadcast Simultaneously on This One Transmitter and All Were Registered on a Single Receiving Set; the Process Involves a Short Carrier Wave at 30,000,000 Vibrations per Second on Which Are Impressed Several "Modulatory Waves"



Blvd de Co-1, 50 E. 42nd St. New York City



"Snow" with Temperature of 110 Degrees below Zero Frozen from Liquid Carbon Dioxide, and at Left, Safety Mask Which Protects Eyes, Mouth, Nose and Ears in One Unit

Examining Specimens of Pure Metallic Thorium, Sought for a Century and Now Produced by a New Method; the Substance Is Prepared in the Form of Rods, Wires, Filaments or Powder and Is Expected Greatly to Improve X-Ray Appliances and Radio Tubes



165 Broadway, New York

Mr. J. W. Marden, Westinghouse Lamp Co. Research Laboratories

TIME IS TOLD BY FLOWER-BED PLANTED ON CLOCK DIAL

719

One of the sights at Interlaken, Switzerland, is a flower-bed clock. The blossoms have been planted over the dial of a



Flower Clock at Interlaken, Switzerland; Works Are Below the Dial and Turn Real Hands over the Blossom Numbers

real timepiece, which is tipped up so that passers-by can see the position of the hands. Numbers of the hours are plainly visible against a dark background, and the orbit of the tiny second hand is divided into four sections, each indicating a quarter of a minute. The clock is in a sanitarium garden where it may be consulted by doctors and patients.

WHITE CUFFS FOR BUS DRIVERS AID NIGHT SIGNALING

So that their hand signals may be seen more easily both by day and night, the

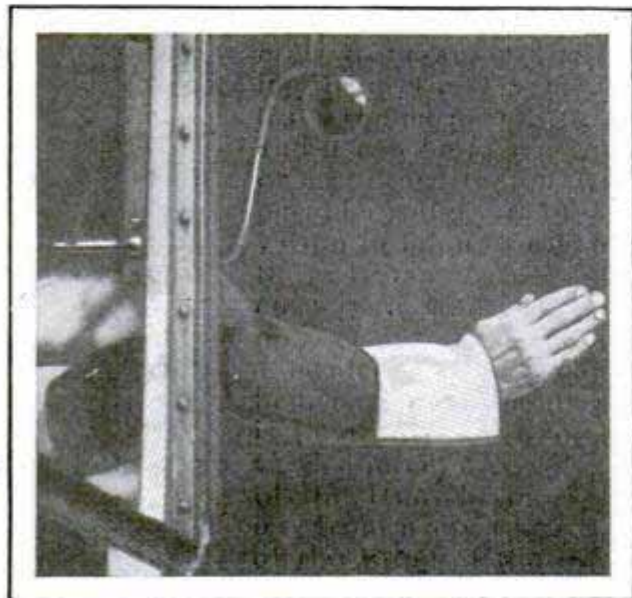

Cuff Attracts Attention to Arm Signals

uniforms worn by London bus drivers are being fitted with broad white armlets that extend from the wrist nearly to the elbow. They are particularly plain at night when light is directed upon them, giving ample warning to drivers behind to prepare for the turn or stop of the bus.

SAFETY GAS TANK PUNCTURE AND FIRE-PROOF

702

Although penetrated by explosive and incendiary bullets, a gasoline tank for an airplane did not catch fire or even leak after tests in Vienna. It was of the usual metal type, but was lined with a secret composition something like the material placed inside automobile tires to prevent punctures. A special mechanism inside the container eliminated the effects of the explosive projectiles. Flaming bullets were instantly coated with the lining material on piercing the tank. This extinguished the blaze and also prevented phosphorus-coated bullets from leaving a deposit. After twenty rounds of ammunition had been fired into the tank without any bad results, it was placed in the airplane which then made an hour's flight, using only gasoline from the apparently perforated tank. No leak, fire or other trouble occurred.

no other data reported from Vienna

Auckland news 10/8/25

MOCK TRIAL IN MODEL COURT TESTS LIGHT AND SOUND

642

Before the wheels of justice were started in a St. Louis court, a jury of judges, lawyers and building experts sought the best ventilation, light and acoustical properties for the courtroom by staging a mock trial. Theater trappings were borrowed and an area, the size of the room as it would be when finished, was walled off. A court stenographer, clerk and volunteer jury were arranged in their usual locations. As the trial proceeded, if the judge's desk seemed improperly placed, it was moved; witnesses and stenographers were shifted and the jury box was changed to afford its occupants the best opportunity to hear. Results of the tests were incorporated in a model plan for all the courtrooms in the building.

Stilling Business



Putting New Super-structure on the Cape Charles Lightship, a Floating Steamer Guardian

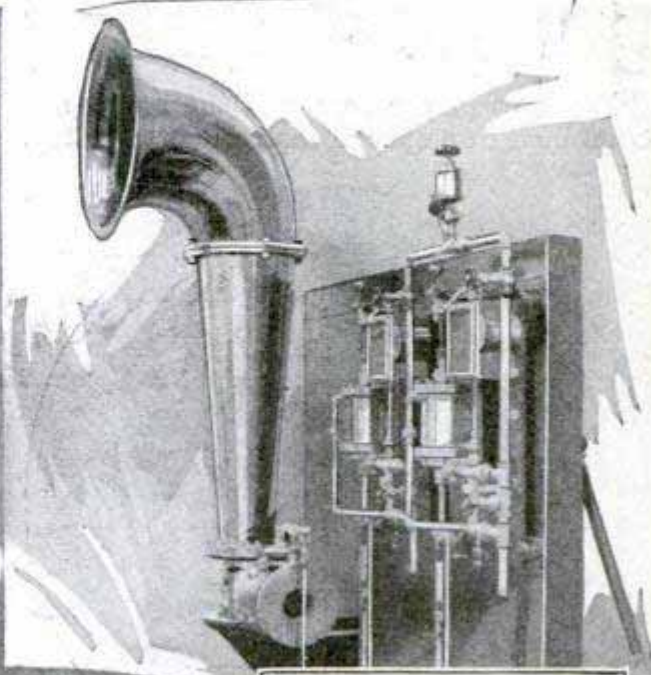

Operated by Compressed Air, This Siren Bellows Fog and Storm Warnings

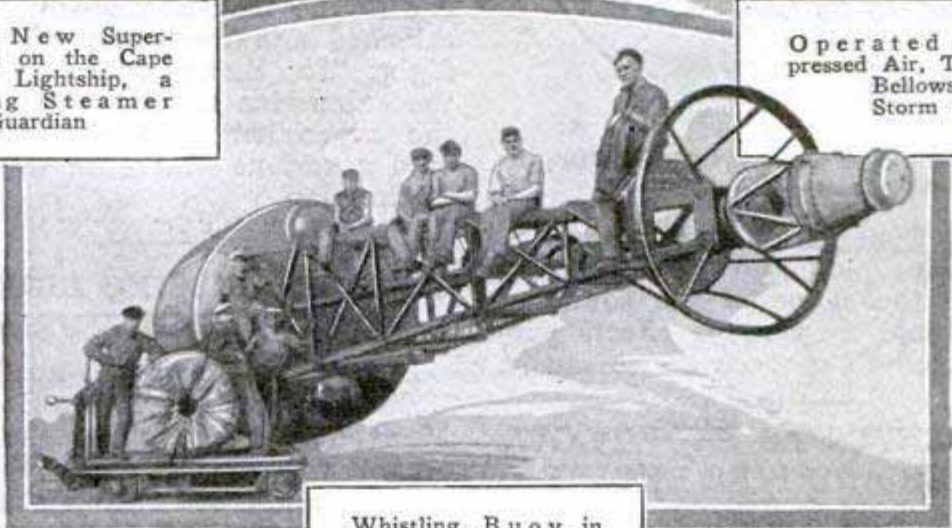

Whistling Buoy in "Drydock" for Repairs; It Weighs Twenty-Two Tons and Stands Thirty-One Feet Out of the Water

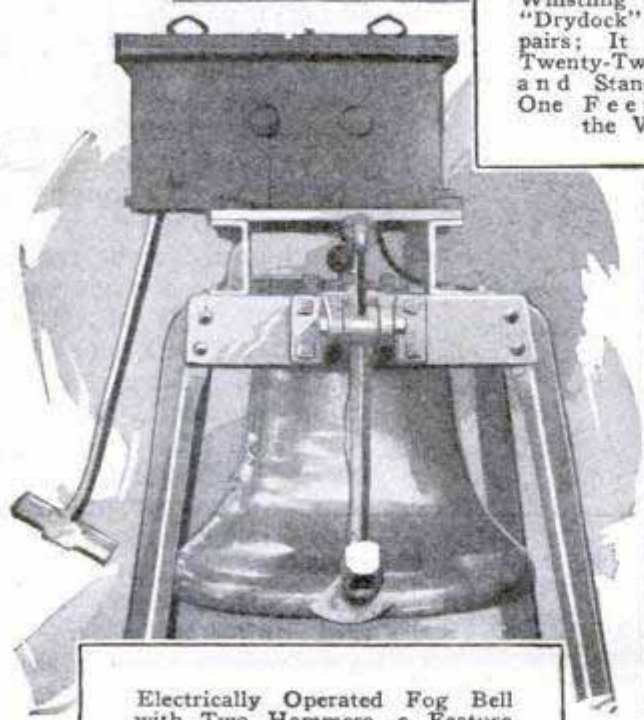

Electrically Operated Fog Bell with Two Hammers, a Feature of Up-to-Date Lighthouses

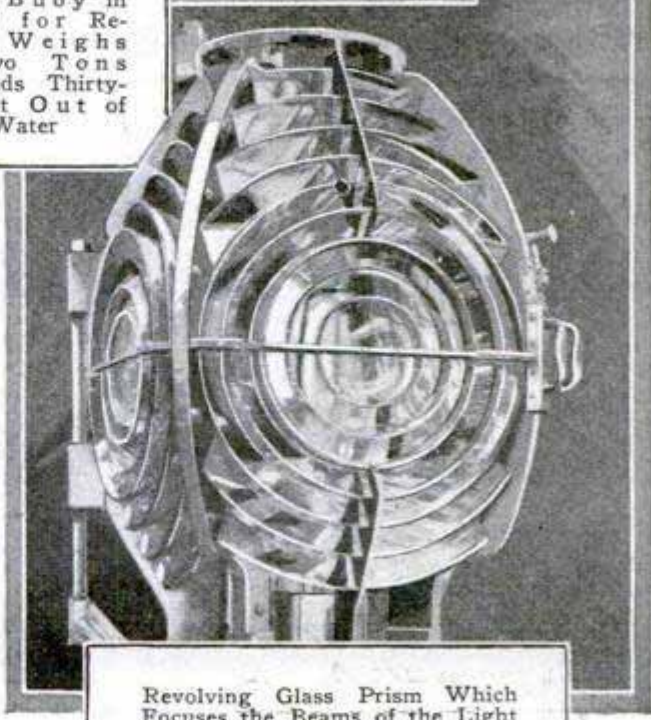

Revolving Glass Prism Which Focuses the Beams of the Light for Distant Visibility

*Mr. John W. Deane
Bureau of Navigation
Navy Dept. Washington*

**SPECIAL HARP FOR JAZZ MUSIC
PLAYED LIKE GUITAR**

692

Features of the harp and the guitar are combined in a special instrument that has



Playing the Six-Stringed Jazz-Band Harp-Guitar; Its Size Commends It for Orchestra Use

appeared in London for jazz bands. It is played with pick and steel, has six strings, and the shape of the sounding chamber is said to produce effects particularly suited to modern dance music.

no data

**TRUCK SERVES AS SNOWPLOW,
SWEEPER AND FIRE ENGINE**

691

Principles of the snowplow, the street sweeper, sprinkler and fire extinguisher

*Motor
winning*



Combination Truck in Action; Plow for Scraping Snow or Dirt in Front, Street Flushers at Sides, Operated by Powerful Pumps

German - no data

have been combined in a motor truck introduced in Germany. The shovel is carried on a frame in front and can be adjusted to various heights and angles, while water for cleansing the pavements and sidewalks is forced out through vents from a large supply tank. Hose connections are provided, when the truck is to be used for fighting blazes.

**PLANE CARRIED ON SUBMARINE
IN CIRCULAR TANK**

629

Submarines may carry their own airplanes to help direct torpedo fire as a result of naval experiments. A circular tank, similar to those used in transporting oil was installed on the deck of the submarine "S-1," and a hydroplane, with its wings removed, stowed into it. When the "sub" had risen to the surface, the end of the tank was removed, the wings attached and the plane made ready for flight. The limited space on the deck of the submarine added to the difficulty of the experiment, but this is not considered a serious hindrance to the success of the plan.

**CLUE TO "MISSING LINK" FOUND
IN SKULLS CENTURIES OLD**

73

Discovery of mammal skulls, probably 10,000,000 years old, in the Gobi desert of Mongolia, may help link the life of the present with that of the remote past, scientists believe, and further strengthens the theory that that part of Asia was the cradle of existence. The bones belonged to animals about the size of rats that lived at the supposed transition period between reptiles and mammals. Although no human bones were found, extensive traces of man were unearthed in the form of implements, drawings and weapons. The expedition, sponsored by the American Museum of Natural History, also found a huge petrified forest in Asia that probably was the ancestor of the California redwoods, and obtained what is considered conclusive evidence that Mongolia is the oldest continuously dry land in the world.

*Headed by Roy
Chapman Andrews*

u d
Submarine Serves as Airplane Carrier

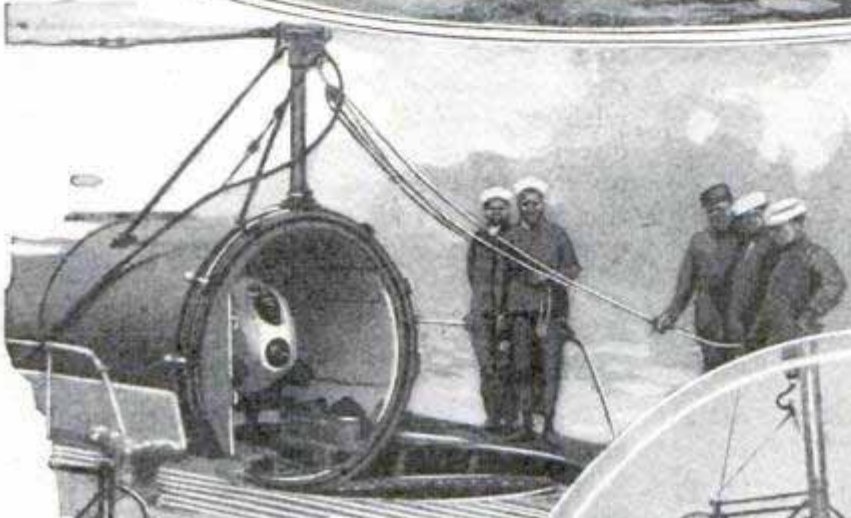

Seaplane on Submarine Deck Ready for Flight, and View of Storage Tank with End Removed to Show Nose of Plane Tucked Away After Wings Were Taken Off

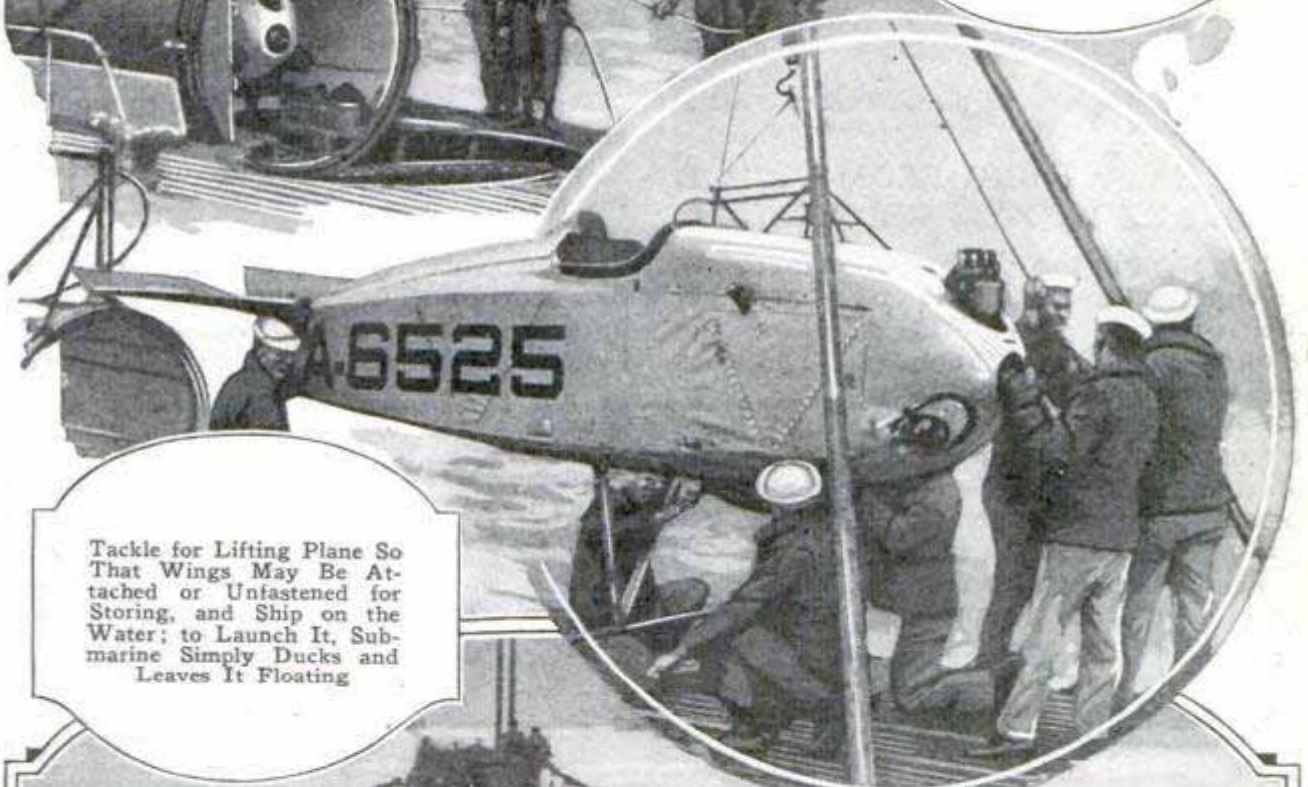

Tackle for Lifting Plane So That Wings May Be Attached or Unfastened for Storing, and Ship on the Water; to Launch It, Submarine Simply Ducks and Leaves It Floating



67
 12
 District National Bank Bldg
 Washington, D.C.
 M. Fairchild, Fairchild
 Airplane Mfg. Co. Ltd.
 Farmingdale, L.I.
 BRAKES HELP STOP AIRPLANES
 TO LAND IN SMALL SPACE



Forester Taking a Close-Up Aerial View with Aid of Special Tripod to Show Vegetation

CAMERA IS HUNG FROM TRIPOD TO TAKE PHOTOS VERTICALLY

Foresters in the Crater national reserve in Oregon use a portable tripod arrangement in taking pictures to show the ground conditions of the area. The camera is suspended from a pole supported by the tripod and is hung in such a way that the lens points directly downward. The height of the pole is easily adjusted and, with the distance known, the camera can be focused accurately. Exposures are made by pressing the bulb to avoid jarring the instrument. The resulting photographs are virtually close-up aerial views and give detailed analysis of vegetation, soil conditions and growth of young trees far more completely than would be possible in pictures taken at an angle, foresters declare. The area included in the exposure can also be determined.

Constructed as part of the wings and operated by a lever from the cockpit, brakes for airplanes have been devised to permit the ship to land in small fields. Wind-tunnel tests indicate that the attachments reduce the speed in landing by twelve per cent. They are similar to the ailerons and the handle is like that of the emergency brake on an automobile. Aviators predict that they will increase the usefulness of the airplane, as there are few styles at present that can be landed safely within restricted areas. The brakes were designed especially for a monoplane to be used in aerial photography. It will carry five passengers, has a camera cabin with darkroom, and tanks for water, for developing and washing the pictures while on flights, are installed in the wing. If the brakes prove effective, landings for quick delivery of photos can be made.

ROLLING HOME WITH SIX ROOMS RELIEVES HOUSE SHORTAGE

Portable houses equipped with modern conveniences have appeared in Nice, where the annual influx of tourists taxes the hotels. The homes are designed like cars, occupy but small space and contain a living room, dining room, bathroom, two bedrooms and kitchen. They are easily hauled and, when in use, are anchored by stout supports on the sides and ends.

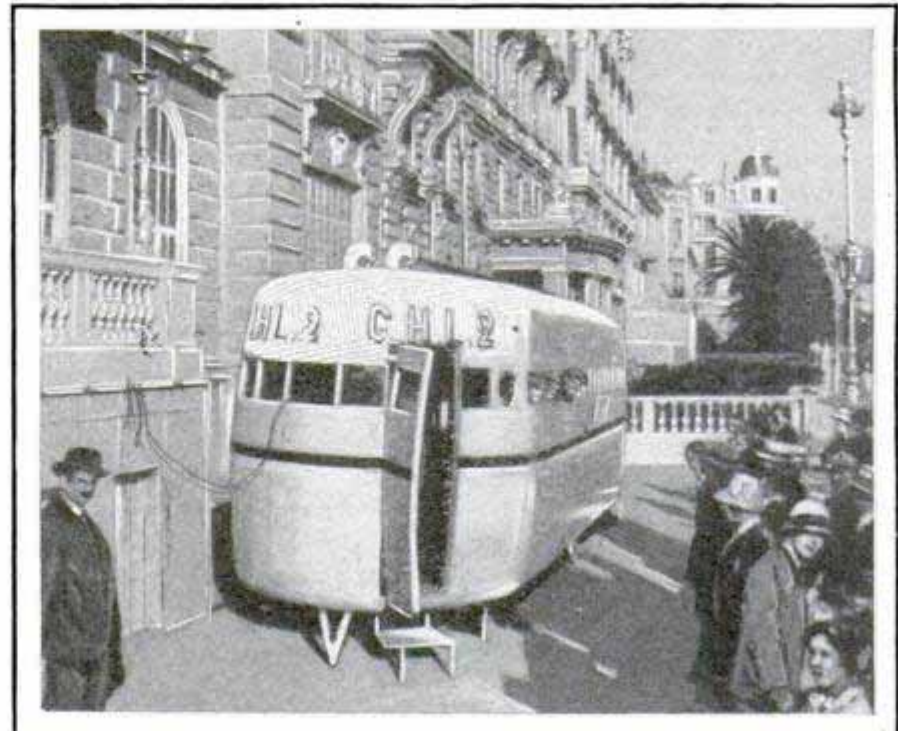

All the Comforts of a Hotel on the Sidewalk; Rolling Six-Room Home for Tourists Visiting Nice

Saken in the Promenade

**WEDDING RINGS OF OLDEN DAYS
MADE OF AGATE AND IRON**

While sentiment has demanded that wedding rings should be made of the most precious and durable of metals, wives of the ancient Romans sometimes wore bands of iron as a token of ownership or fidelity, and some of the earliest rings were of agate. Since platinum has superseded gold in value, rings of this metal are common. Gold rings were worn by the Egyptians as early as 2000 B.C., but they had no matrimonial significance. The symbols indicated orthodoxy in the households of the early Christians, and finger rings were first used as seals to identify papers. In America, rings were not always popular. The Puritans believed that they were too suggestive of charms.

**CANDLE THAT BURNS KEROSENE
SERVES AS VAPORIZER**

Resembling a candle set in a metal holder, a small lamp that burns kerosene, gives practically the same illumination as a tallow taper without the bother of frequent renewals and untidy wax. The upright portion is a cylinder containing a wick and a chamber for the fuel. The height of the flame is regulated by means of knobs on the side of the chimney base, and if needed, a small basin of disinfectant may be placed above the light on a special holder so that its vapor will purify the air. The shades are decorated with a number of patterns and colors and some are equipped with a tiny heat "motor" so that they revolve when the lamp is lighted. The glow is sufficient for a sick-room night light.

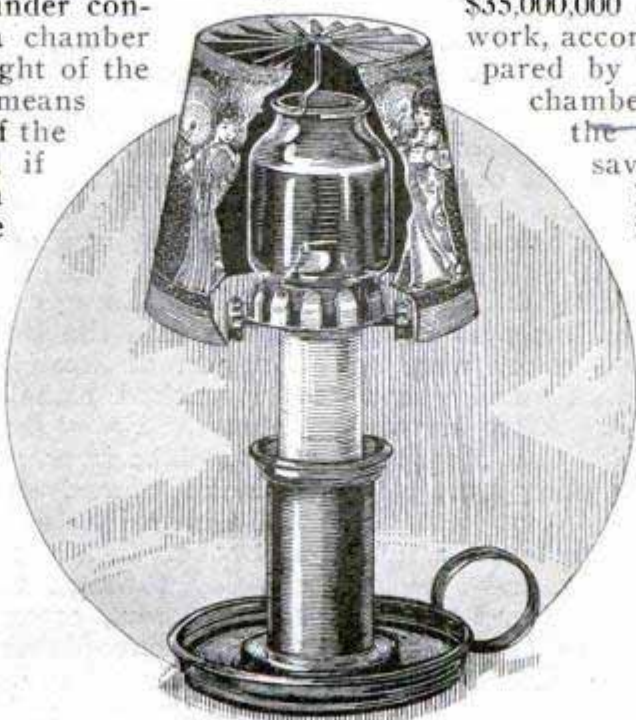

Candle Lamp with Revolving Decorated Shade; Pan of Disinfectant May Be Set on Chimney

**GARAGE FOR BABY-CARRIAGES
SERVES CITY FAMILIES**

Forty-three families in a model tenement in New York have a common garage for their baby carriages. It is a low,



One Solution of the Small-Apartment Problem; Community Baby-Carriage Garage, Readily Accessible in Court and on Street Level

waterproof shed, with padlocked doors, in a convenient court and spares the mothers the trouble of taking the vehicles to their apartments. Each family contributes five cents a week toward the rent and maintenance of the garage.

**RESEARCH WORK BY INDUSTRIES
SAVES HALF BILLION YEARLY**

American manufacturers spend nearly \$35,000,000 each year in research work, according to estimates prepared by the United States chamber of commerce, but the investment is said to save \$500,000,000 annually in the conduct of industry. Many of the large trade associations spend more than \$20,000 each every year to find out how to improve their business. A canners' organization is reported to have an annual budget of \$120,000 for this purpose, and a building-material association spends \$100,000 for work of this kind including laboratory experiments.

Agents - Plitag; Portland, Ore. Sydney, N.S.W. Montreal, Winnipeg, London, Wellington, N.Z.

*Aladdin Industries
601 W. Lake, Chicago*

*new York Times
4/1/25*

*Hudson Esquido
new York*

686

693

660

712

661

L. A. Illustration, Sept. 26, 1925
P. 305



Arrival of the Motor Cavalcade on the Shores of the Indian Ocean after Crossing Africa from the Mediterranean Coast; This Section Reached a Kenya Colony Port

Auto Travel

Through Darkest Africa by Motor Car

French Expedition, in Eight Machines with Caterpillar Treads for Rear Wheels, Links Ends of the Continent in 12,000-Mile Dash

LINKING Algeria and Morocco, on the Mediterranean shores, with Cape Town, at the southern tip of the continent, and Daressalam and other towns of the Indian ocean, a French expedition of seventeen explorers, has come out of the jungles after taking motor cars where they had never been seen before.

The equipment included eight specially designed automobiles, with standard front wheels and balloon tires, but with caterpillar tread in the rear. They were so loaded that each two cars formed a separate self-sustaining unit. After starting from Colomb-Bechar, on the Morocco-Algeria frontier, and traveling more than 5,000 miles together, two cars left the others at Kampala, on Lake Victoria, near the headwaters of the Nile, and traveled eastward along part of the route Stanley took when he was hunting Livingstone. They crossed Uganda and Kenya colony, and finally reached the Indian ocean at Tanga and Mombasa.

The other six continued south across

Lake Victoria to Mwanza and then on to Tabora, in the Tanganyika territory, where the party split in three parts. One pair of cars went east, 400 miles or more, to Daressalam, on the Indian ocean and another south to Lake Nyasa, down the west side of the lake, rounded its lower end, and by way of Zomba continued on to Mozambique on the Indian ocean.

The remaining unit branched west from Tabora into the Belgian Congo, through a region of steaming equatorial jungles and reached Kabala, a Belgian military outpost. From there they followed up the Ludlaba river, moving south to Elizabethville, named after the Belgian queen, and eventually reached northern Rhodesia at Broken Hill. From there on the journey lay through the British section of south Africa, crossing the lands of the once warlike Matabele by way of Bulawayo, their old capital, and into the Transvaal to Pretoria and Johannesburg. From the old Boer towns the route led southwest to Kimberley and to Cape Town.

661

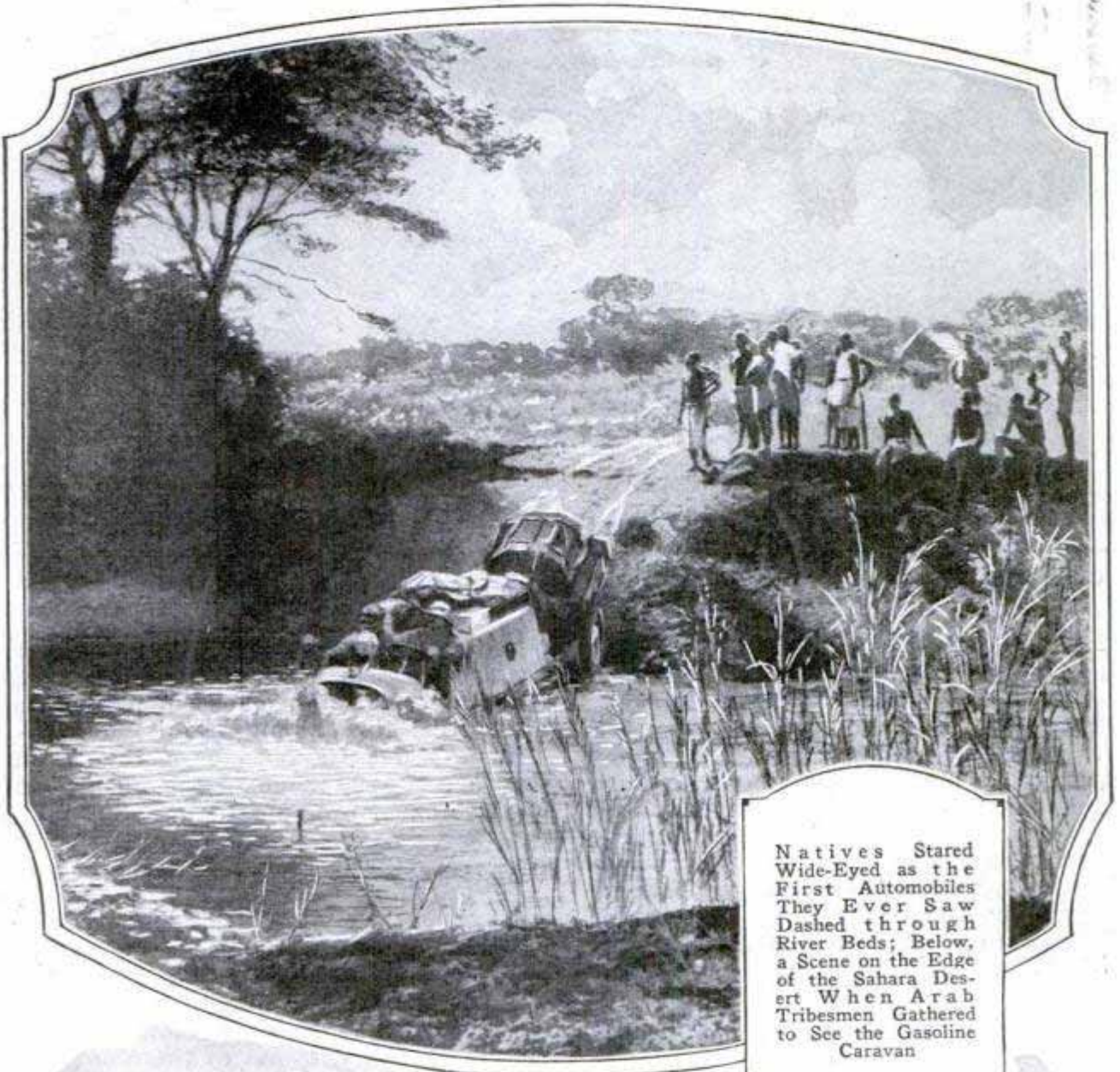

Natives Stared Wide-Eyed as the First Automobiles They Ever Saw Dashed through River Beds; Below, a Scene on the Edge of the Sahara Desert When Arab Tribesmen Gathered to See the Gasoline Caravan

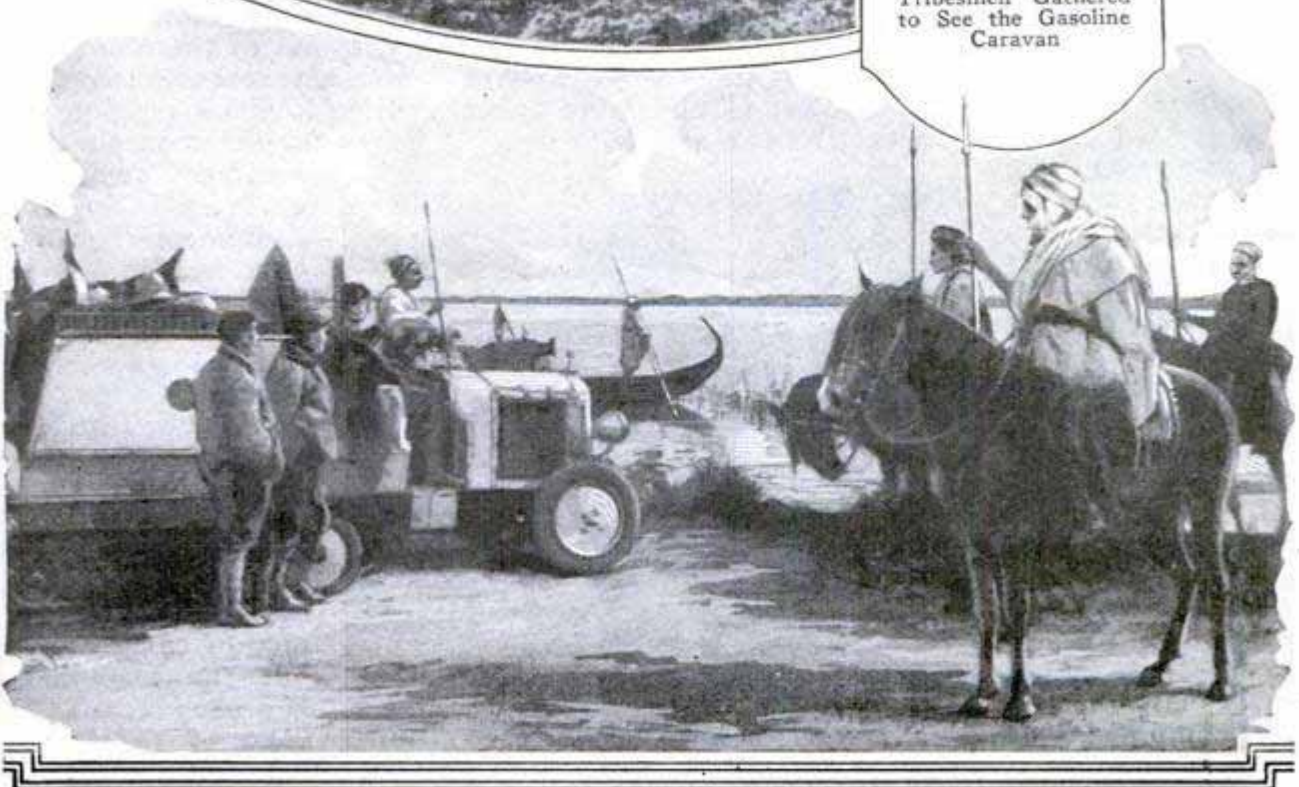

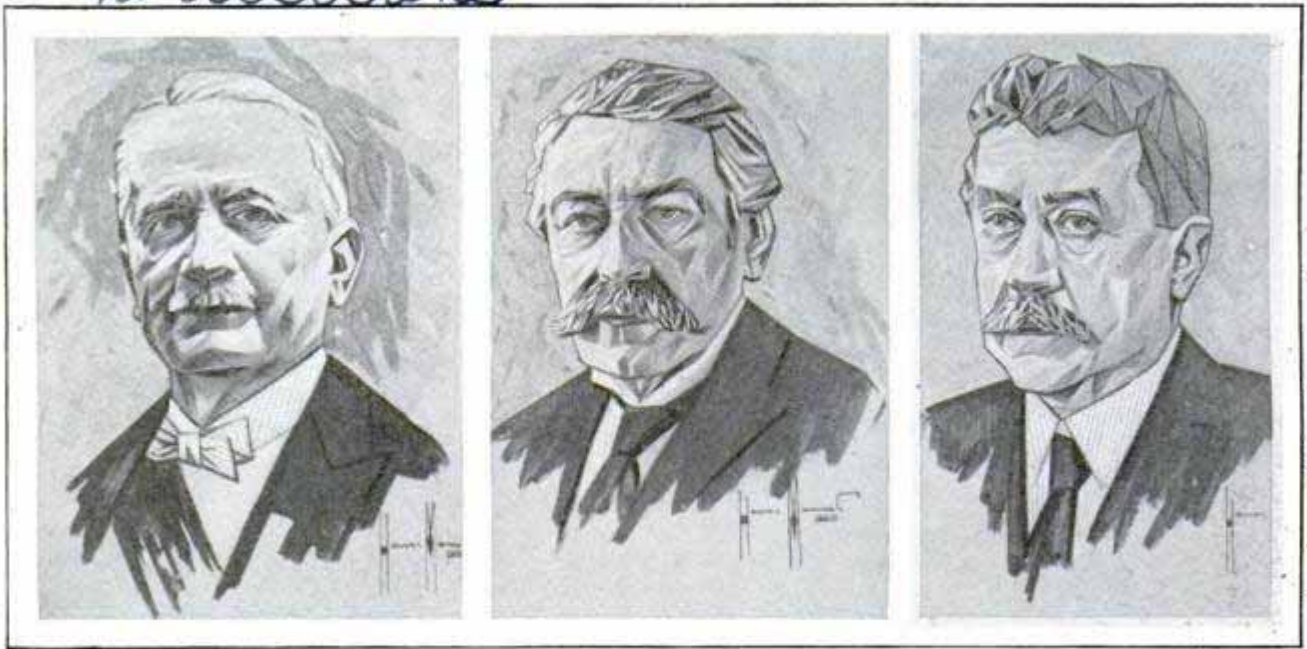

Cubist Photographs like Cartoons, Emphasizing the Traits of Three Prominent Men of France; from Left to Right, President Doumergue, Aristide Briand and M. Painleve

699 PHOTOS TAKEN IN CUBIST STYLE REVEAL CHARACTER

By a process of photographing the various planes of the face, and reproducing them in a composite portrait, a French artist takes pictures resembling cubist paintings. The method accentuates the features in such a way that the characteristics of the subject are emphasized. The finished picture has the appearance of a carefully arranged pattern of lights and shadows in geometrical shapes.

GIGANTIC STEAM CONDENSER WEIGHS MILLION POUNDS

The size of a large eastern power plant is illustrated by a single detail such as the condenser unit to convert exhaust steam from the turbines into water. It is nearly thirty feet high, weighs almost 1,000,000 pounds and contains more than fifty-one miles of tubes. When its two pumps are operated simultaneously, they have a joint capacity of 144,000,000 gallons of water every twenty-four hours, nearly half that of the combined waterworks and pumping stations of the

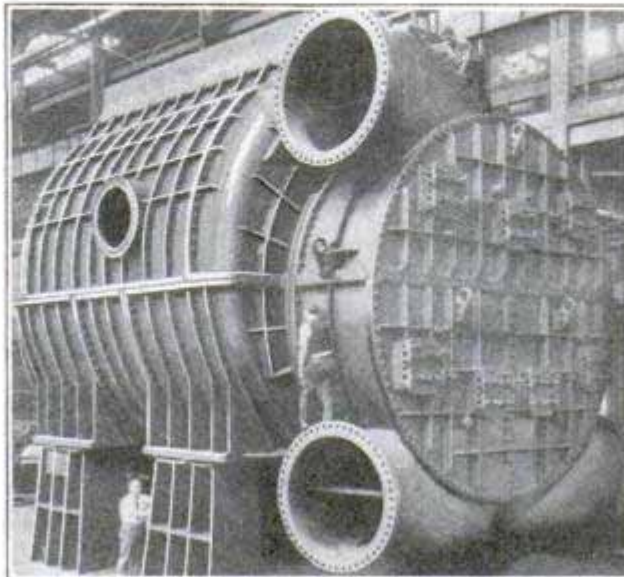

Huge Steam Condenser Weighs Nearly Million Pounds and Has Over Fifty-One Miles of Tubes

city of Philadelphia. The main condenser has a cooling surface of 70,000 square feet. After the unit had been assembled, it was dismantled for shipping to its destination. Twelve condensers of this giant type are contemplated in the final plans of the huge power plant.

698 VALUE OF WEATHER FORECASTS SHOWN IN INDUSTRIES

Timely warnings of approaching storms or cold sent to the public from the weather bureaus, annually save thousands of dollars to shippers and manufacturers. An example of the benefit of the service was seen recently when a large concern, using 27,000,000 gallons of lake water a day, shut down in time to prevent serious damage to its equipment because of a sudden fall in the lake level. Changes in weather conditions were noted by the observers who informed the company officials that a fall of a foot or more was likely between noon and evening. The prediction came true, but the machinery had been stopped in view of the warning and no harm resulted.

Westinghouse Electric & Mfg. Co.
 1925
 Philadelph. P. A. 51

Nov. 1925
 Machinery

Phila - Philadelphia Electric Co.

**SPEED OF SIX MILES A MINUTE
PREDICTED FOR AIRPLANE**

613

**IRON CROSS TEN FEET HIGH
MARKS MOUNTAIN TOP**

588

After attaining a speed of 302.3 miles an hour, an unofficial world's record up to that time, with a 2,200-pound Curtiss racer, Lieut. Alford Williams, U. S. N., declared that he believed he could better that rate by nearly fifty miles. The tremendous momentum was gained by diving from a height of 3,000 feet and then "flattening out" on a straight course. A drop of 9,000 feet would permit the six-mile-a-minute pace, Lieut. Williams believes. The racing plane measured twenty-two feet from wing tip to tip, by nineteen feet eight and one-half inches long and eight feet one inch tall. The material in the wing-type radiators is thinner than the average sheet of paper, and water circulates at the rate of seventy-five gallons a minute. The propeller is of duraluminum. It is not damaged by rain, hail or tall grass and can be bent without breaking. To test the strength of the wings before the flight, bags of shot equaling the weight of fifteen automobiles were piled upon them, both when the plane was in a flying position and upside down. The cockpit is so sheltered that it would be impossible for the pilot to free himself, but a pull on a wire automatically opens it and allows the aviator to leap out.



Defiant of Winter Storms, Iron Cross, Guyed to Rocks, Caps Alpine Mountain Crest

**MOTORCYCLE WITH CHAIR SEAT
RESTS RIDER'S BACK**

522

Motorcycles with chair seats have appeared in London, affording the rider greater comfort in a support for the back and in a broad cushion. The outfit is, in effect, a two-wheeled automobile with a windshield, headlight and broad mudguard in front. The frame is built low and is supported, when at rest, by a drop brace under the seat.

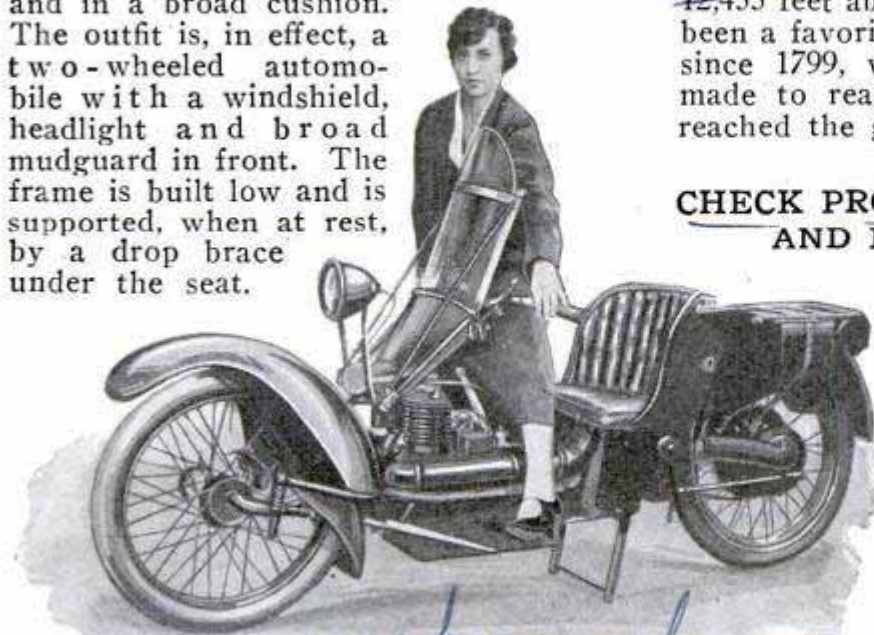

© Keystone View Co.

Comforts of the Automobile Are Enjoyed in This Motorcycle with High-Backed Seat and Windshield.

**CHECK PROTECTOR FITS FINGER
AND IS WORN AS RING**

560

Worn as a finger ring, a check protector devised by an English business man has sharp, milled edges that puncture the paper in any desired direction. It is designed as a substitute for more costly outfits, and is used by laying the check flat, clenching the fist and drawing it across the slip. The ring, being loose-fitting, turns on the finger as a wheel.

Handwritten notes on the right margin:
L. W. H. H. - George
% George H. - Halden
Highfield Ave. Tapton Union Road, Chesterfield, Eng.

maker unknown

at London motorcycle

105 W. Franklin St

542

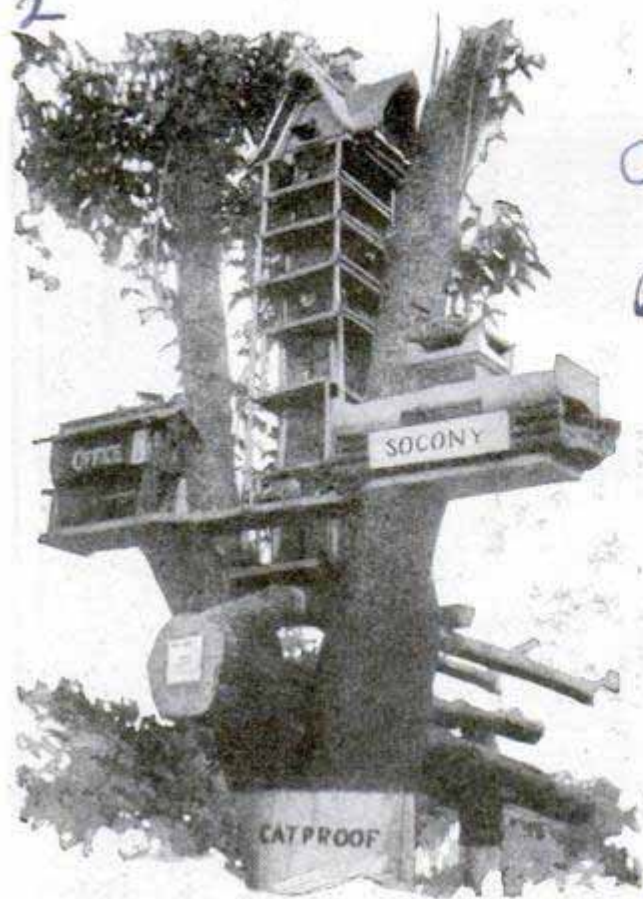

Bird "Apartment House" Made Secure from Cats by Tin Sheeting Wrapped around Tree Trunk

TIN BAND AROUND TREE TRUNK KEEPS CATS FROM BIRDS

642

Cats cannot reach birds in a commodious "apartment house" an eastern man has built for them, as the supporting tree is bound with a band of tin, presenting a surface too slippery for the marauders to climb. The house has room for many inmates, and besides the usual nesting places, has a replica of a garage and a filling station to make it up-to-date. The birds apparently know that cats cannot reach them in these shelters and flock to the house in great numbers each season.

DEADLY WAR GAS PROTECTS PLUMES

464

Poison gas was used to guard a case of costly plumes of the bird of paradise and other rare fowls shipped to a museum in Baltimore, Md. A sign on the outside warned, "to open this

case is to court death." Thus anyone bent on stealing the valuable contents would have only himself to blame if he came to grief by tampering with the package.

Baltimore, Md

ELECTRIC-POWER LINE TO LINK CITIES OF SIX STATES

630

A 182,000-volt transmission line between South Bend and Michigan City, Ind., will link Chicago with cities in Ohio, Indiana, Pennsylvania, West Virginia and Kentucky, enabling centers to borrow power from each other in emergency, as well as providing a means of interchange between plants in the same city during peak hours. The line is expected to be opened next March. It is considered one of the largest links in the proposed interlocking of power plants throughout the nation. The cables are strung on steel towers nearly 100 feet high, and the erection of two huge generating plants, one of 120,000 and the other of 2,000,000-horsepower capacity, is included in the project.

*Calumet & Hecla Co
American Locomotive Co*

TOBACCO-LEAF COFFEEPOT IS FAIR ATTRACTION

567

Among the exhibits at a Georgia fair was a realistic coffeepot woven of large tobacco leaves, the product of one of the counties of the state. Held at an angle as though liquid were being poured from it, the display attracted much attention.

Model of Coffeepot Woven from Broad Tobacco Leaves as Exhibit for Georgia Fair



Southeastern Fair



Jagged Piles of Ice Repel the Supply Tug and Make Landing on the Water Cribs a Difficult Task, While Often the Floes Block the Lake for Miles and Render Aid Impossible

Icebound in Sight of City's Lights

Keepers of City's ^{Supply} Water Cribs Frequently Storm-Bound for Month or More in Plain View of Teeming Millions Ashore

STORM-BOUND for day after day, with food supplies running short while, three miles away, millions of people are going about their daily business, is a frequent winter experience of the men who man the water cribs in Lake Michigan, off Chicago's lake front. By night, when thousands of lights gleam along Michigan avenue they can pick out the brilliantly lighted hotels and restaurants, where hundreds are dining, and watch the endless procession of moving automobiles whose occupants are bound from home to dinner, from dinner to theater, and then on to a midnight supper.

The water cribs are the intake pipes of the city's water system, connected with shore by huge tunnels driven through the solid rock far below the lake bed. A powerful tug, formerly in the navy's sea-going fleet, acts as tender and carries sup-

plies to the crib crews, but every winter there are recurring periods, when the ice floes are piled so deep off the harbor mouth that the boat cannot buck its way through.

When that happens, the crib keepers cut down rations and tighten their belts, for only a rising thermometer, accompanied by a shift of the wind from northeast to west or southwest can bring relief, and nobody knows when that will happen. Thirty and forty-day periods icebound on the cribs have happened, and two to three-week spells are quite common.

Ordinarily the crib keepers are relieved every week, getting a week ashore after each week at the water gates. In good weather, when such reliefs are possible, the tender tug gets around to each crib every couple of days bringing fresh meat and vegetables, newspapers and other sup-

2523

plies to them. The upper end of Lake Michigan does not freeze over its entire expanse even in very cold weather, because the water remains warmer than the atmosphere. But along the shores, and at times for several miles out, ice forms in periods of calm, and breaks off to go cruising about the lake when the wind shifts and kicks up a storm. In the harbors and more protected spots, ice of six to ten inches' thickness is common, while one to two inches may stretch for several miles off shore. As winter progresses, the ice floes, fed by the repeated breaking loose of shore ice, assume prodigious proportions. Piled up by shifting winds, the ice



Barrels of Fresh Meat Are Hauled Ashore by the Hungry Crib Keepers

field may reach a depth of several feet and cover an area of a hundred or more square miles.

When the winter northeasters blow, the ice field is driven down on the Chicago shore and piles up for several miles out in the lake. A few years ago a steamer was icebound for two weeks six miles off Chicago's loop district, and the grinding ice wedged under

it so much that the boat was lifted bodily a half dozen feet above the lake level. Coast guards with a lifeboat mounted on sled runners, and an airplane from a meat-packing plant delivered supplies to the unlucky seamen and averted a famine.

Life on the cribs during such winter weather is one round of hard work. The center of each crib—of which there are five—is a

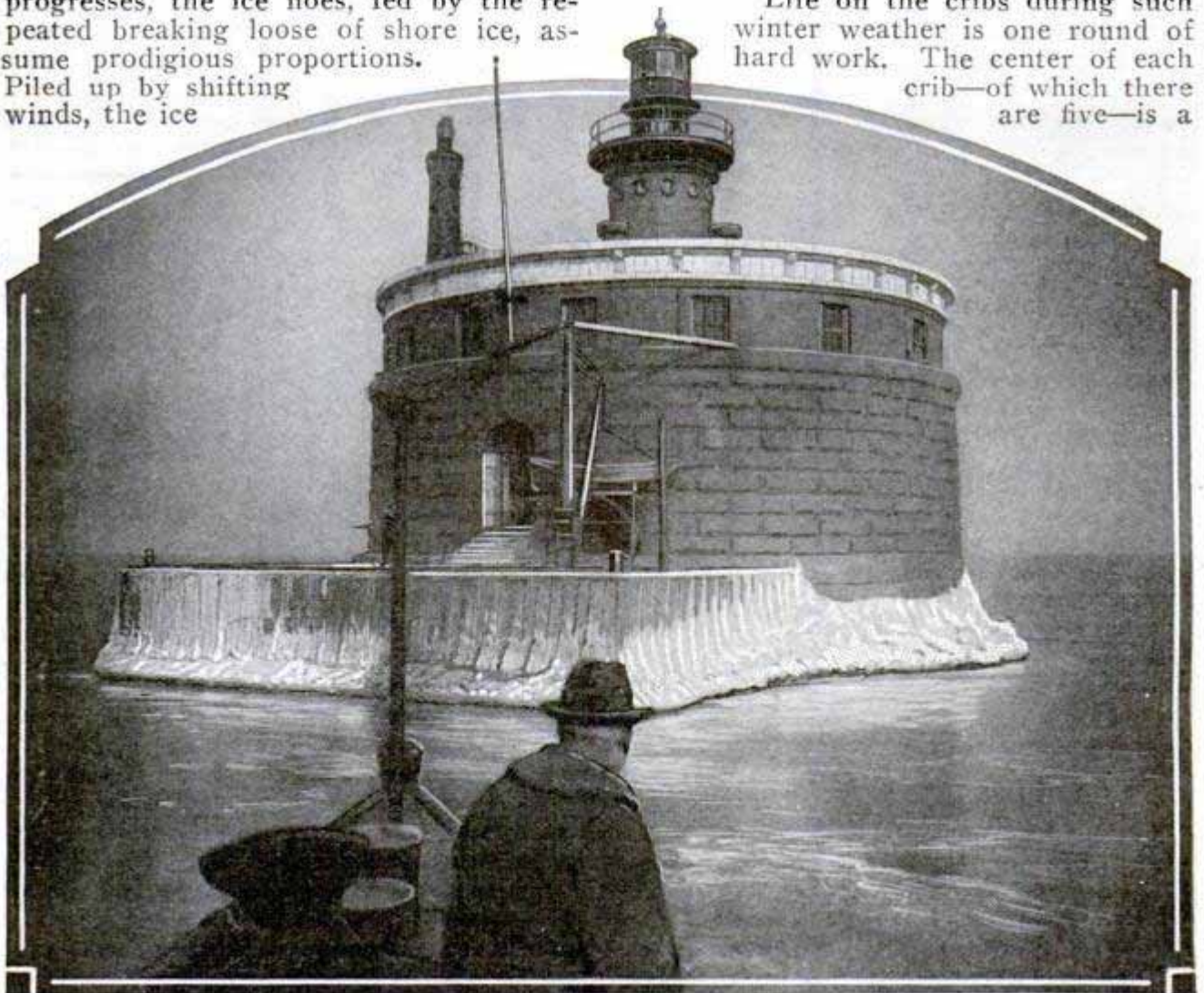

One of the Stone-Walled Cribs in Winter; Often the Northwest Gales Will Send Tons of Green Water High over the Roof, Frequently Breaking the Windows Forty Feet above the Lake

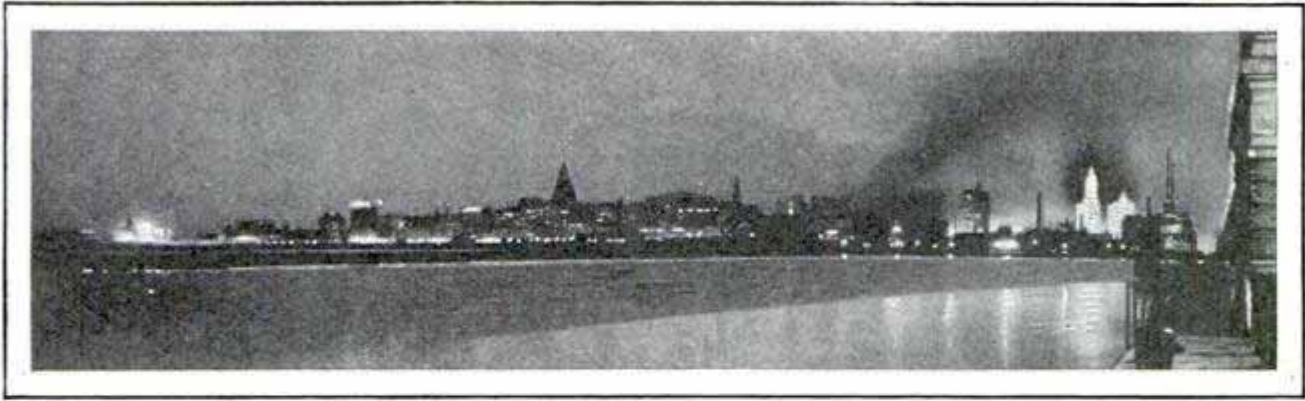

Copyright, Underwood & Underwood

The Lonely Crib Keeper on a Clear Winter's Night Can See the Lights of the City Where Teeming Millions Are Living in Comfort at Home, Free to Go Where They Please

huge circular well, with thick stone walls. In the middle of the well the intake pipe from the tunnel to shore rises almost to the lake level. In the outer walls a series of portholes admit the water to the well, and it then flows down the intake. The well room is surrounded by a two-story circular house, with living quarters on the upper floor, forty feet or more above the water line. Despite their height, great green seas frequently break over the coping of the lookout balconies and go crashing through the rooms.

Three men man each crib in summer, when the only work to be done is cleaning the intake screens every couple of hours. But in winter, when ice constantly threatens to close the portholes and intake, the crew is increased to eight, two working on each six-hour shift.

Heavy surface ice which forms over the well pool presents no danger, but the bugaboo of the crib keeper is anchor ice, which at first is of the consistency of taffy and clings to everything.

Under certain temperature conditions water will freeze to any obstruction, even though the current is considerable. When that happens, the portholes, intake pipe and every part of the underwater structure begin piling up with ice. A string dropped into the well pool and pulled up

will be covered by a coating of ice. Then there is nothing to do but rout out the entire crew and set to work with pike poles and dynamite to break and blast away the ice. Dynamite broken into third-of-a-stick lengths is lowered four or five feet below the surface and exploded by electricity, the small charge being sufficient to break the ice loose without damaging the thick stone foundation.

One of the crib keepers, a couple of years ago, devised an "anchor-ice detector." While the other crib crews were standing constant watch day and night, the fortunate possessors of the detector turned in and slept soundly until an electric bell rang over the chief's bed and informed him ice was forming. Rival cribs sent delegations over to get the plan of the new invention. All they could

see was a tightly closed wooden dynamite box resting on the platform grating above the well, with two wires leading to the living quarters, and a string hanging down into the water. Offers were

made to buy a detector at any reasonable price—

and declined. Surreptitious lifting of the box indicated it contained an amazingly heavy collection of machinery. Finally it was opened, and found to contain two small strips of brass and a quantity of paving bricks. The brass strips

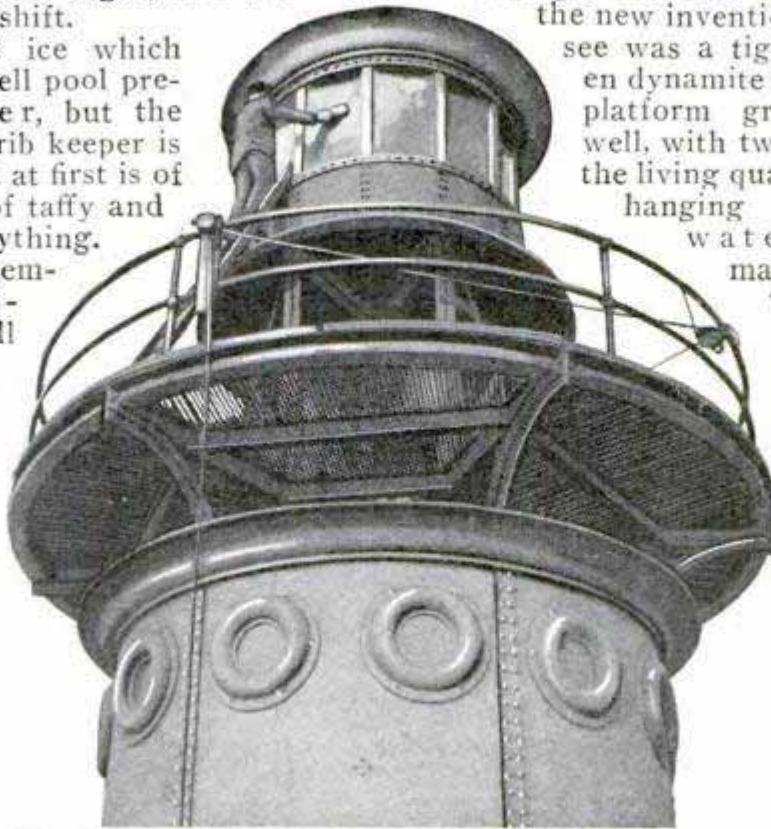

Lighthouses on the Cribs Must Be Kept Efficient to Serve as a Warning to Shipping

formed a switch, from which the string, weighted at the lower end with a few links of chain, depended. The weight was just sufficient to almost close the switch and complete the electrical circuit through dry batteries and bell in the chief's room. When anchor ice formed on the cord, the added weight closed the circuit.

Life on the cribs has brightened considerably since the invention of radio. Previous to that, communication with shore was confined to the telephone, reserved for official business, and the uncertain visits of the tug. Two years ago the city purchased a fine radio set for each crib, and now, day and night, the air keeps the men amused and in touch with events on land. A Chicago broadcasting station sends out news bulletins every half hour, so there is no longer any waiting for the tug to bring out the accumulated newspapers of past days.

The city feeds its "desert islanders" well. An enormously big ice box, placed out on the cold balcony, is kept filled in winter with all kinds of meats and fowls. A sample day's luncheon included two

kinds of meat, peas, potatoes, salmon and boiled-egg salad, bread and butter, pie and coffee—and second or even third helpings are permissible. One of the noticeable facts on the cribs is that only the cook and his helper are kept thin by their work.

All refuse from the cribs is burned in incinerators instead of going down a sewer. The waste water from the kitchen sink and bathroom, which can't be burned, passes through a chemical plant for treatment, and a city health officer makes frequent visits to take samples and see that the treated water is absolutely free from dirt and germs.

Tending the city's water gates is only a part of the crib men's work. Each crib is surmounted by a lighthouse with a fog bell, since they are obstructions to navigation, erected under war department permits, and subject to inspection by the lighthouse tender. The lights must be kept clean, the acetylene-gas supply working, and at the least trace of fog, the clockwork, which strikes the fog bell at ten-second intervals, must be put in motion.

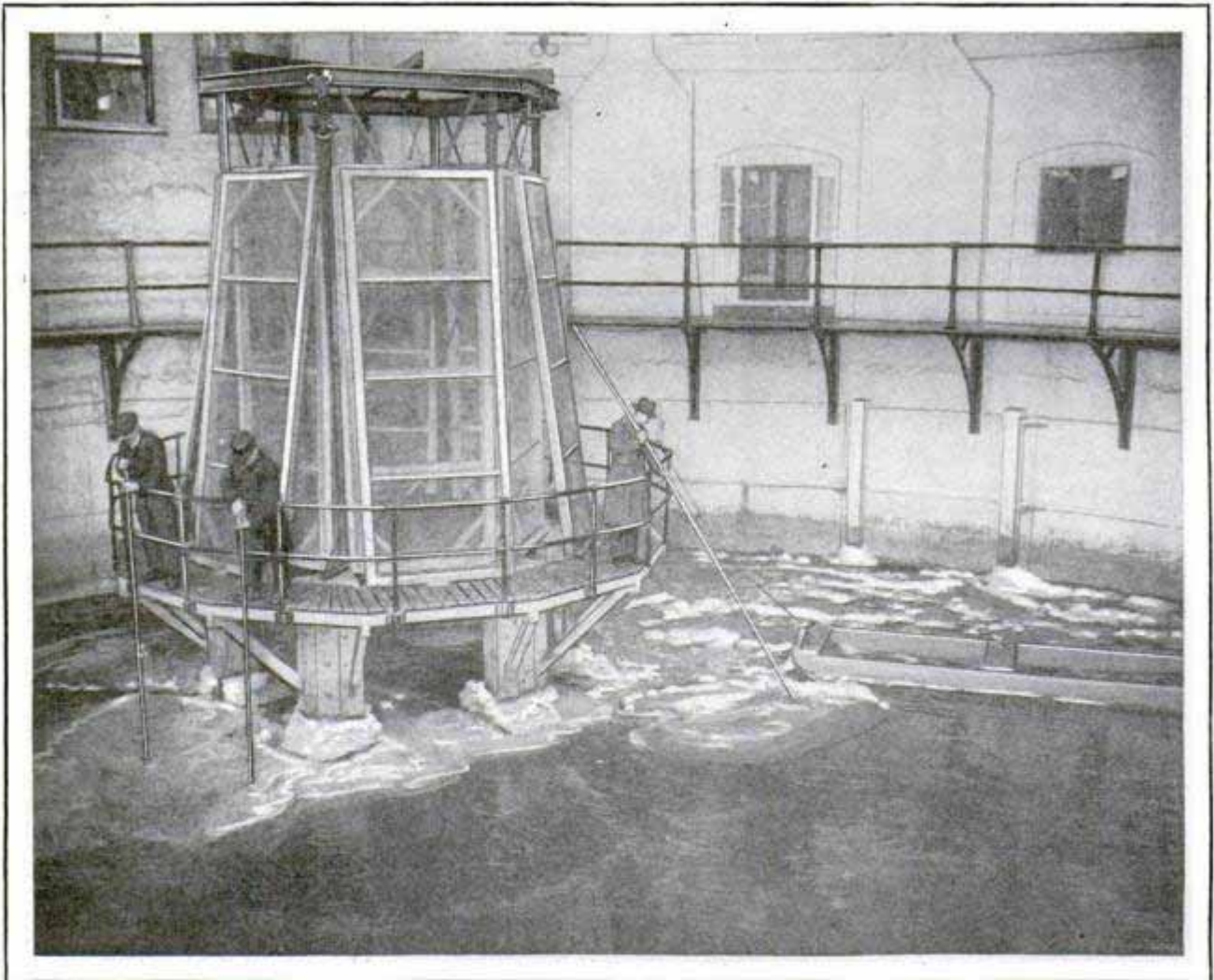

When Ice Begins to Form around the Intake of the Tunnel Leading to the Water Works, the Entire Crew Must Turn Out with Pike Poles and Dynamite to Keep the Opening Free

Cont. no. 3720 S. Park Ave Los Angeles, Calif
POPULAR MECHANICS 23
596

HOUSE BUILT UNDER BUNGALOW TO SAVE MOVING COSTS

Instead of wrecking or moving a bungalow which stood upon his lot, a Los Angeles builder raised the structure on high "stilts" of wooden

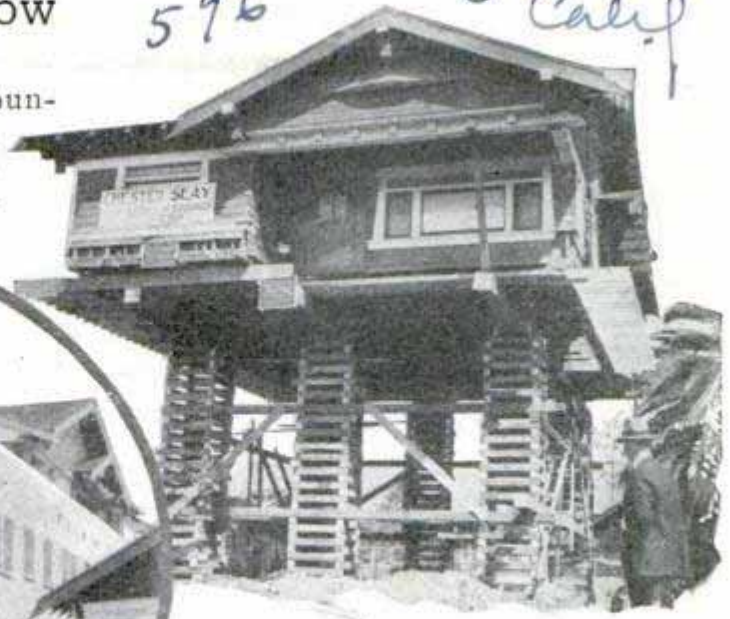

Bungalow on Props and on Rear of Roof of Apartment House Built under It

blocks and constructed an apartment house around and under it. The bungalow was incorporated into the larger unit as part of the top floor and could scarcely be distinguished from the rest of the finished house. Uniformity and harmony were achieved by modeling the front part of the apartment's upper story after the pattern of the original bungalow.

635

CLUE TO OIL WELLS SOUGHT IN HEAT OF EARTH

Oil fields and other valuable mineral deposits may be discovered by measurements of the heat in deep wells, according to a government geologist. Tests of the method have shown, he declares, that there is a direct relation between the temperature and the shape of the folds or strata associated with deposits of oil. By taking two or more such measurements, a clue might be gained as to the location of oil-bearing soils in a given area, it is suggested, saving the expense of useless drilling, as small holes large enough for taking the temperatures could

be made with diamond drills at much less cost than that involved in boring a well.

BIG TURBINE FOR WILSON DAM OCCUPIES ENTIRE CAR

620

The magnitude of Muscle Shoals, an engineering dream that is fast becoming a completed reality, is emphasized in such parts of the equipment as the big turbine rotors or water wheels for the generator units at Wilson dam. A single one of these makes a capacity load for a freight car. The rotor is so shaped that water pours into it in radial fashion from all sides, exerting a twisting effect upon the shaft and a final "kick" on the sloping ends of the blades or vanes before it plunges back into the river. A 30,000-horsepower unit of the plant, placed in service last fall, rendered valuable aid to surrounding country because of the unusual drought.

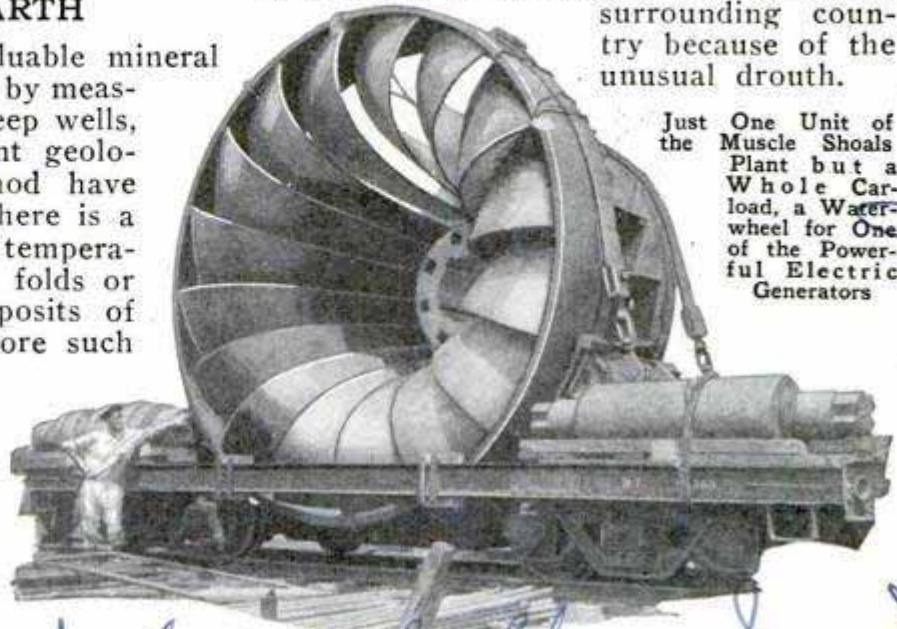

Just One Unit of the Muscle Shoals Plant but a Whole Carload, a Water-wheel for One of the Powerful Electric Generators

Statement by W. S. Thom Jr.

Cont. William Benjamin Wood, Principal Surveyor, was Spoke

Mitau, Italy.

no data
572

ASBESTOS FIRE-ESCAPE SLIDE OFFERS QUICK EXIT



Demonstrating Use of Asbestos Chute as Means of Escape from Burning Building

Safe and speedy means of exit from a burning building is provided in a canvas-reinforced chute of asbestos. One end is attached to a reel that may be placed near a window or other opening, and the other is held on the ground. The refugee leaps into it and slides quickly to the bottom. The strip is trough-shaped and is strong enough to support heavy weights.

DO APES POSSESS SENSE OF HUMOR?

That chimpanzees have many characteristics like those of human beings has been further established by Prof. Wolfgang Kohler, a German scientist, who spent several years studying the animals in a secluded jungle home on an island off the coast of Africa. He captured nine apes when they were young, gradually tamed them,

and then watched their behavior almost daily to see how they would solve problems set for them. One young chimpanzee indicated what appeared to be a sense of humor. While eating its bread ration, fowls gathered and devoured the crumbs. After that, the ape kept out of reach behind the bars and when a hen tried to peck at the bread, the animal pulled it away in apparent glee. If food was placed beyond the cages, the apes learned to "fish" for it with sticks or with crude hooks they devised from straw, grass blades or rags. One tried to use an old straw hat, doubling and redoubling it when the material proved too pliable to serve as a stick. They also learned to pile up boxes and reach for their food when it was suspended from the top of the cage. The apes grew to know and love their keeper, and on one occasion, displayed their gratitude for being let in out of the rain by affectionately patting and embracing him.

MODEL PLANE IS RUN BY AIR FOR SIXTY SECONDS

592

Driven by compressed air released against the propeller from a storage tank, a model seaplane constructed by an Englishman, can make a continuous flight of sixty seconds' duration. Air is injected by a hand pump to a pressure of about 180 pounds. The model has a wing span of eight feet, weighs four and one-half pounds and is fitted with floats.



Filling Storage Tank of Air-Driven Model Seaplane

© Henry Miller

House Engineer London U.S. with fields Eng. on Welsh Harp, Hedon Eng. W.D. G. Pantley Co Model Aero + repairing tram road

J. A. O'Neil 10/3/25

Demonstrates at Model-Aeroplanes Club

594

Hananghu dam / Hanan shu
ana

DAM BREAKS ARE MENDED WITH EARTH-FILLED NETS

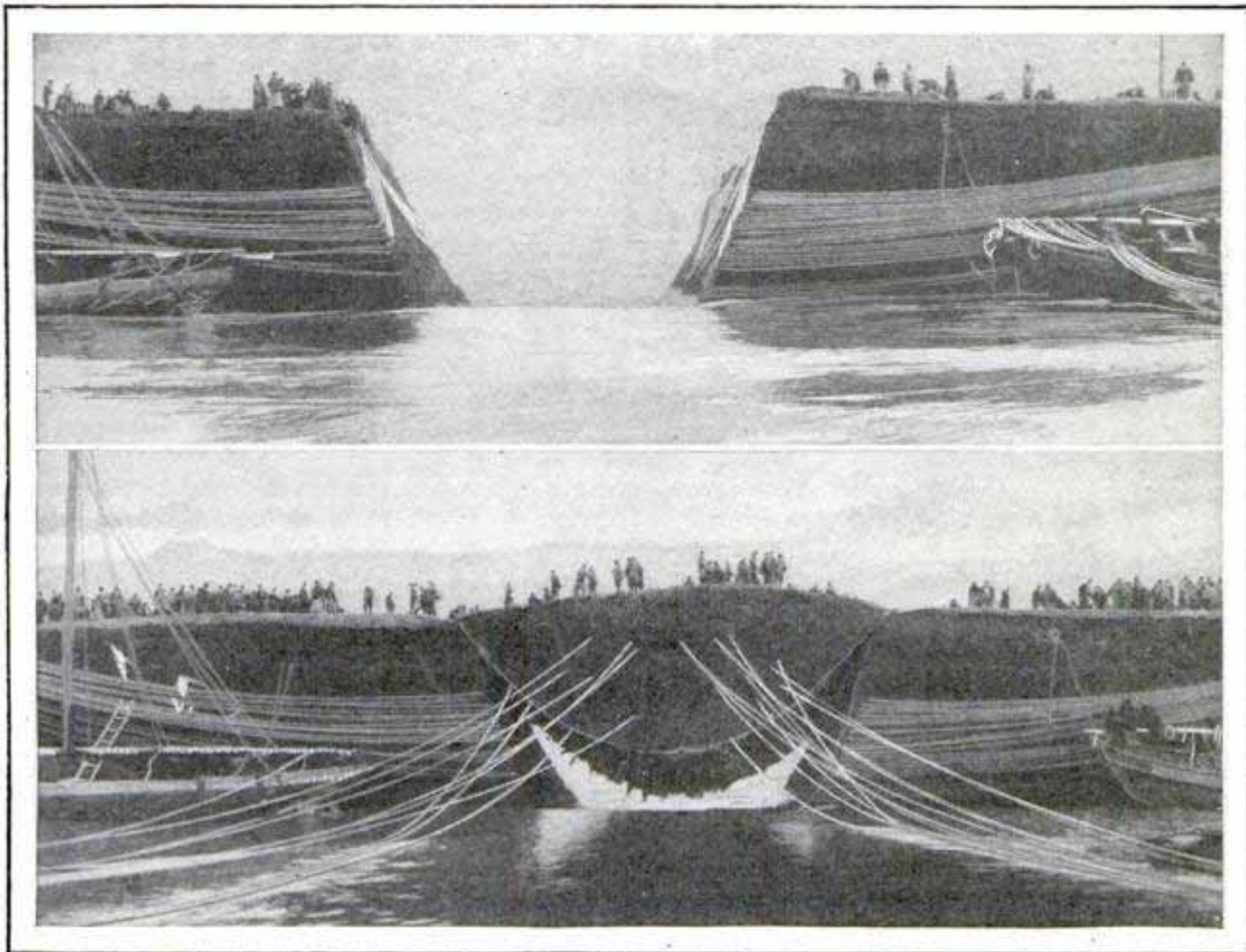

How the Chinese Repair a River Dam: Upper Photograph Shows the Break and Workmen Preparing the Net; Below, the "Plug" Is Settling of Its Own Weight

When breaks occur in a dam in China, nets of hempen rope are filled with earth and lowered into the cavity, quickly stopping the leaks. Washouts are not uncommon, and the natives co-operate when repairs are necessary, doing, in a few hours, work that ordinarily would require the attention of skilled engineers. 605

MYSTERIES OF SKY INCREASED BY STARS THAT GROW COLD

Scientists are able to weigh the sun, moon and stars, and measure the distances of bodies the light from which takes centuries to reach the earth, but the sky is still full of puzzles and one of them is the problem of the dark stars or those that have grown cold and are plunging through space at tremendous rates of speed. In 1901, a blazing star was discovered in the constellation of Perseus. It was not a new body, but probably the result of a collision between two dark stars or the passage of one through a vast cloud of gas or dust, one of the mysterious areas that are found in the heavens. A Dutch

scientist, three years ago, found one of these clouds which was 140,000,000,000,000 miles long and twice that distance from the solar system.

BALLOON-TIRE JACK FOR AUTOS GIVES TREAD CLEARANCE

For use in adjusting balloon tires, the screws of an automobile jack are telescoped to give extra clearance needed when raising the car. Since more space is necessary between the rims and the ground for replacing the wider tires than is needed by ordinary treads, the jack is designed with a full extension of seventeen and a half inches.



Ind Post 9/13/24

1903
Chicago
Wm. E. P. Pugh
400 State Lake
105
3
Intr. Co

2363
26

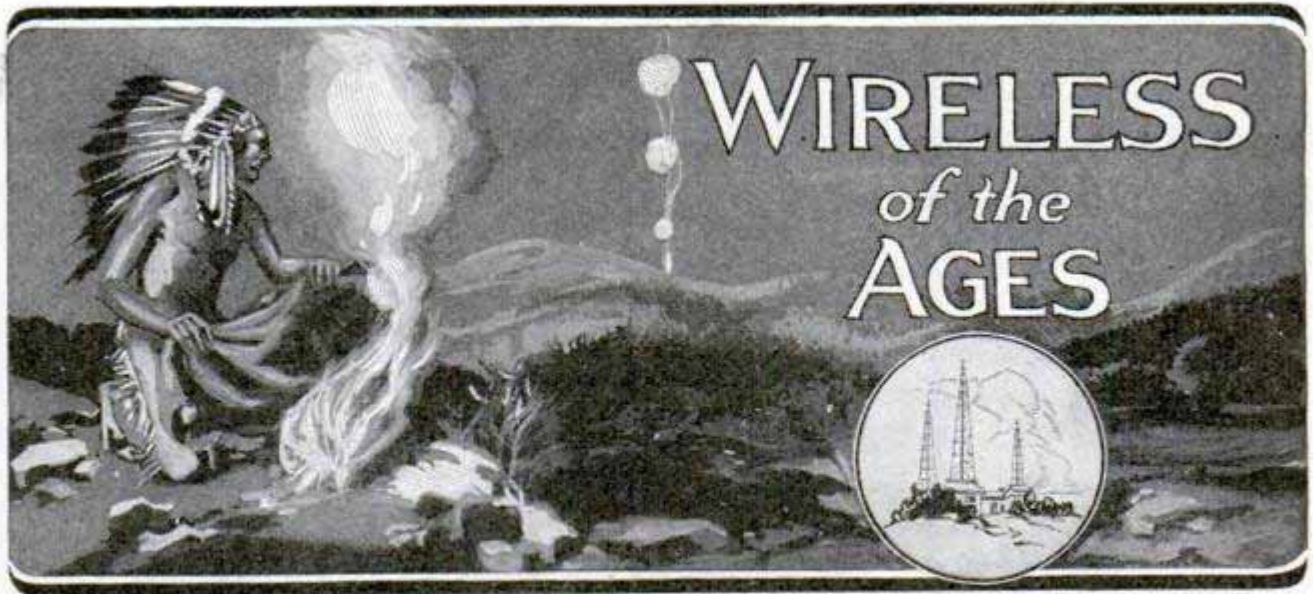

Man's Search for Long-Distance Communication Dating Back Some Twenty-One Centuries, Has Climax in Radio Newspaper

By J. EARLE MILLER

WITH powerful broadcasting stations sending out the news of the world at half-hour intervals to all who care to tune in, a dream more than twenty-one hundred years old has at last been realized.

The radio service given by American newspapers is the last step in the search for some quick and easy means of communicating intelligence over vast distances to many people, a search that started two hundred years before the Christian era.

Even as late as Civil War days, it took a relay of pony-express riders, galloping at top speed, nine days to bring the news to San Francisco when Fort Sumter was attacked. Today one part of the world can know what the other parts were doing half an hour ago.

Yet with the dream realized there still persists one of man's first wireless systems, so old that its origin is lost in antiquity, but probably antedating any white man's civilization.

With radio mes-

sages circling the earth; voice and music being broadcast from continent to continent, and even pictures flashing through 3,000 miles of air, this last of the pre-electric wireless systems—the talking drum—is making its final stand in the heart of Africa, in the jungles of South America, and on the islands of the South Pacific.

In those last outposts of civilization they still roll through the night with their code messages—one of the most efficient "wireless systems" ever developed until Marconi tamed the Hertzian waves.

In the heart of Africa, scores of miles beyond the last white settlement, it is probable that the Wills-Firpo fight of many months ago is still celebrated in song and story, and it is equally probable that the natives knew the outcome within a few hours after the final blow.

When Jeffries was beaten by Johnson in 1910, Thomas Cameron Taylor, a white explorer, was in the heart of the "ju-ju country" in darkest Africa,

SPEEDING THOUGHT

MORE progress in fast communication has been made during the past twenty-five years than in the preceding twenty-five centuries.

Smoke by day and fire by night were first used for transmission of information.

Carrier pigeons have been used for hundreds of years.

Germany equipped the letter carriers with stilts in the sixteenth century to increase their speed.

Among the savage nations, drums are still used to transmit messages over wide areas.

In the United States, stagecoach and pony express furnished the fastest means of communication by letter before the advent of the railroad; but it was not until the invention of the telegraph and later of the telephone and radio that instantaneous communication was established.

The first long-distance message over the telephone was in 1876, from Boston to Cambridge, a distance of two miles. In 1922, the first telephone conversation across the Atlantic ocean took place. In 1924, President Coolidge, sitting in the White House and without raising his voice above an ordinary conversational tone, was heard all over the United States, Canada and parts of Europe.

hundreds of miles from the coast and 180 miles from the nearest telegraph line. But within twelve hours after the end of the fight he knew that Johnson had become world's champion. The native drum telegraph was at work.

To a port on the coast, the fight result had come in the summary of the world's news telegraphed by a press association. It was discussed in the presence of the native servants. In a twinkling the news was over the town. In a dirty compound back among the hills behind the settlement a drum begins to beat—a drum fashioned from a hollowed-out log, with a skin stretched across it. Far away a second drum takes up the tale. A neighbor is "listening in." The sender pauses until the first repeater has ceased his re-broadcast, and then takes up the tale again. Bit by bit the story goes on, a long and exultant tale. For hundreds of miles over deep jungles and hidden creeks the rolling drums carry the story.

But the native drum is only the last survivor of more than 2,000 years of wireless experimentation. The Greek runners who carried the news of

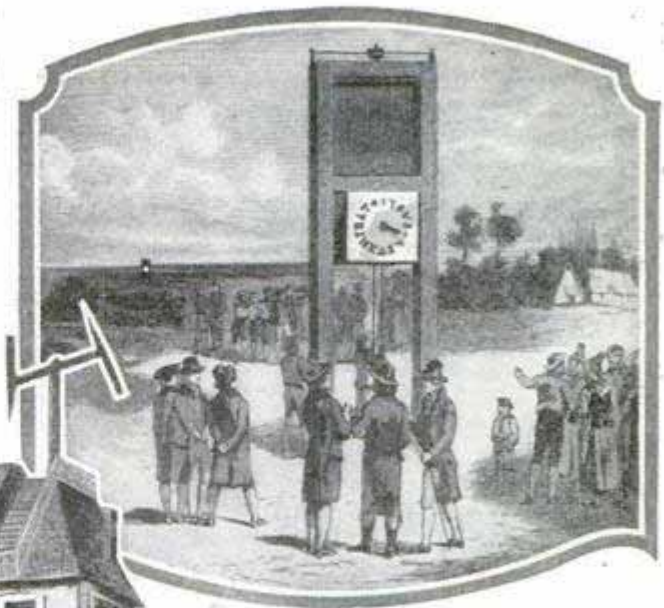

Above, Claude Chappe Demonstrating His Clock Semaphore Telegraph in 1791; Semaphore Tower of Napoleon's Army, Center, and the Control Wheel Which Operated the Signal Hands of the Semaphore

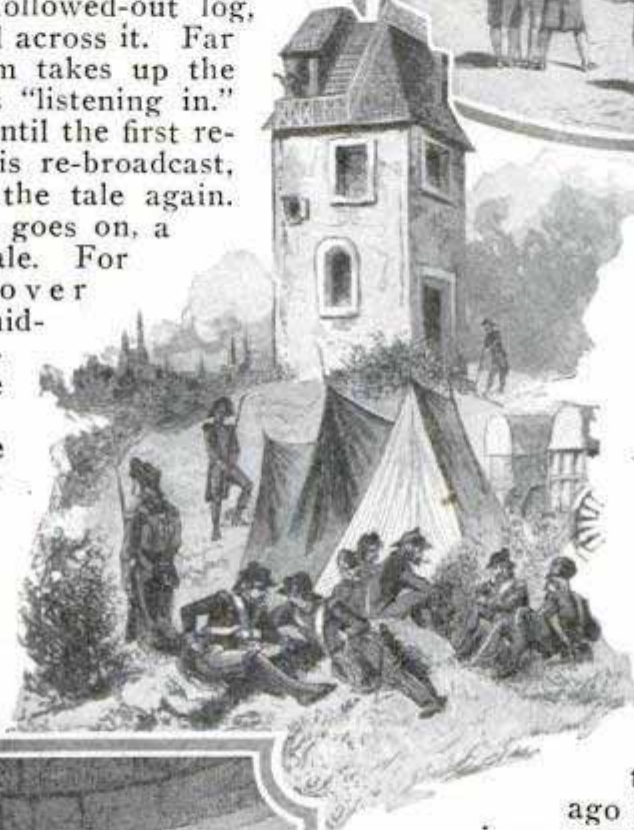

wars and battle were one of the first developments. Then came the primitive signal torches—limited in their application because only prearranged intelligence could be transmitted. Polybius, the Greek historian and inventor, records

their drawbacks as long ago as 208 B.C. and tells of

improvements made by himself and others. Aeneas, the tactician, was the first to add an improvement. He proposed the use of two jars of equal size, fitted with loose cork floats, in which were stuck long reeds marked in narrow rings, with a message written on each ring. Every conceivable message was included. In use, the sender signaled with a torch to the distant receiving station, where a second torch acknowledged the fact that the listener was "standing by." Both then opened taps in the bottoms of their jars and let the water flow out until the sender raised his torch as a signal that the ring with the proper message had just descended to the top level of the jar. The taps were then closed and the message read, after which the jars were refilled with water. The system, however, was imperfect. Word that an army had attacked or a fleet arrived could be telegraphed, but the message could not tell

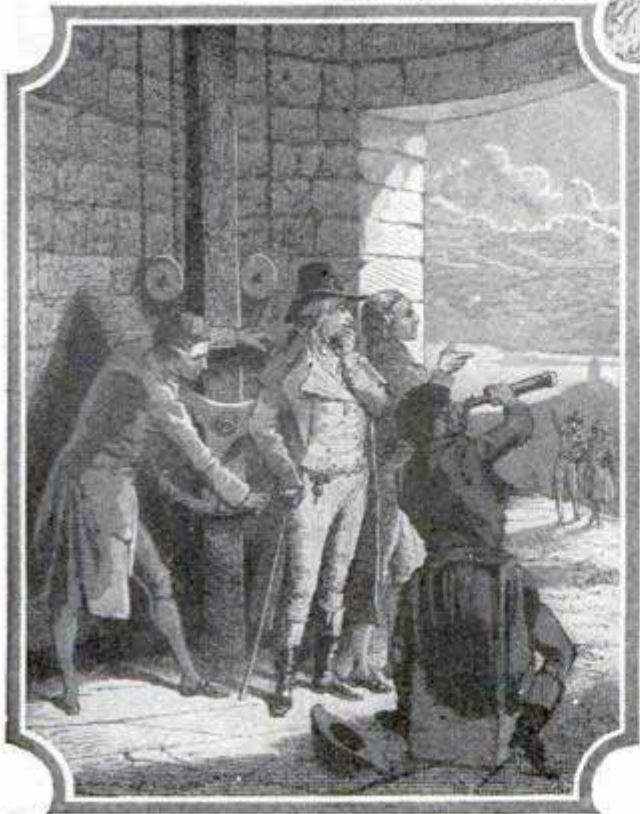

how many men were in the army or the number of vessels in the fleet.

Cleoxenus and Democlitus tried to improve on Aeneas' system, and Polybius himself finally brought it to what he claimed was perfection. He divided the Greek alphabet into four groups of five letters and one of four letters. The sending and receiving stations had the groups written on five tablets, a group to each.

He then raised torches behind the right-hand barricade to show the number of the letter on that tablet, and thus slowly spelled out his message.

The Greeks tried various improvements on the Polybius system, but all were far from satisfactory because of the limitations of distance and also the lack of speed in transmitting.

Development continued apace in widely separated parts of the world. By the time the first white men reached America the Indians had perfected a very serviceable smoke-column telegraph, the smoke being alternately obscured by a smothering blanket and allowed to rise.

The Romans had signal towers where smoke columns were displayed by day and fire torches in iron braziers by night. Old prints show the torch towers,

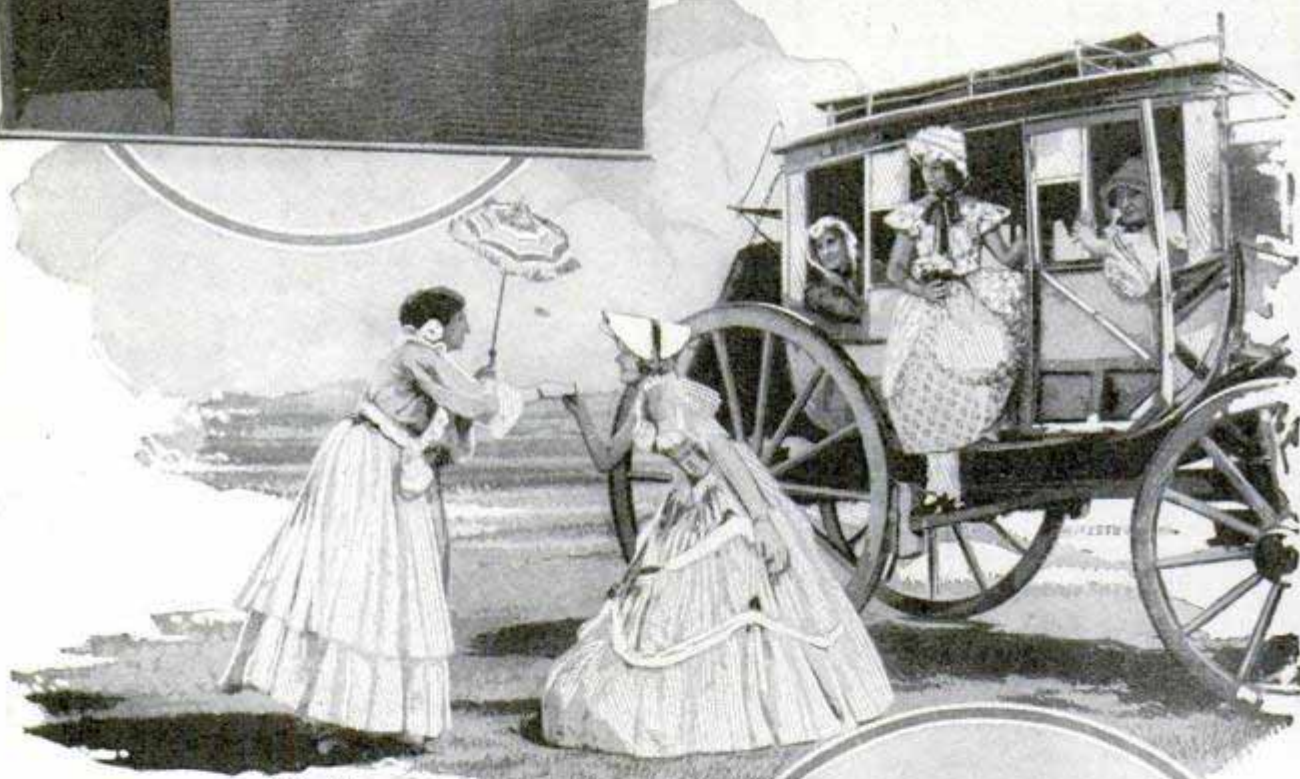
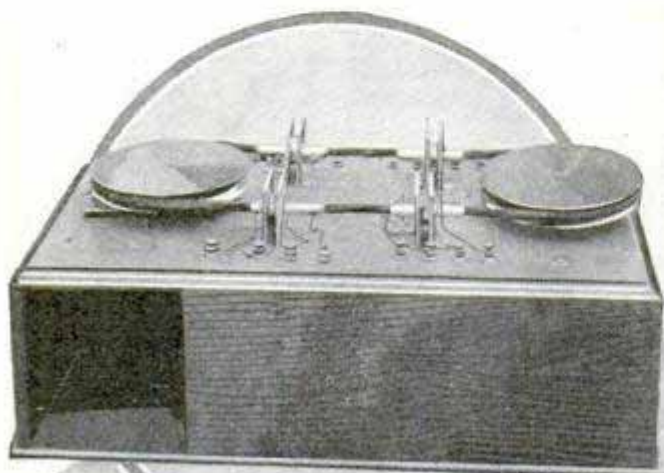

© U. & U.

The First "Wireless" System to Bridge the American Continent Was the Pony Express Rider, Followed by the Stagecoach; Above and Below, Parts of the Original Marconi Apparatus Which Bridged the Atlantic in 1901

The rest of the equipment at each station consisted of a supply of torches, two fences as high as a man and ten feet long, and a device he calls a "steno-scope," consisting of two long tubes, or funnels, through one of which the "listener" could watch torches raised behind the sender's right-hand fence, while through the other he could see the left-hand barricade.

The sender raised torches from behind the left-hand fence to show the number of the tablet he was using, one if the first tablet, two if the second group, and so on.

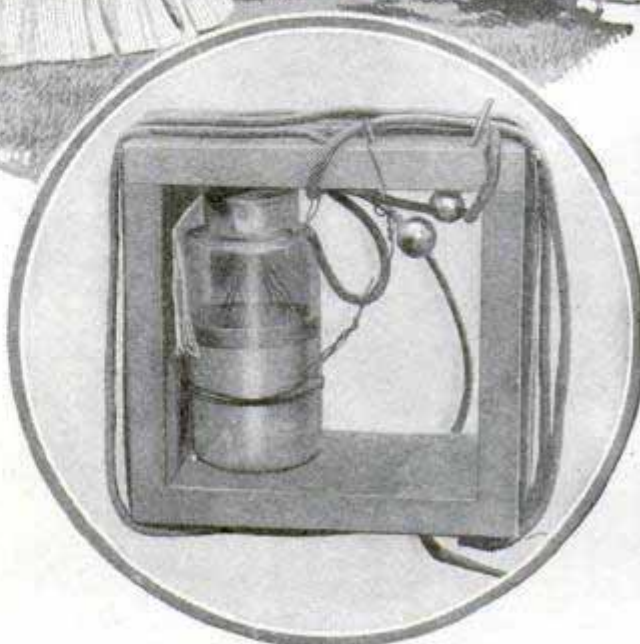



Courtesy The Marconi Co., London

Against a Painted Background of Newfoundland Scenery, G. S. Kemp, at Right, Marconi's Assistant in the Historic 1901 Experiment, Reconstructs the Original Apparatus at Wembley Exposition

strongly fortified and protected by wicker fences, behind which fierce dogs prowled to give warning of the attack.

France came to the front with a semaphore system, the two arms being controlled by ropes and wheels inside a tower. A French inventor, Claude Chappe, in 1791, produced an "aerial telegraph" which worked over a distance of nine and one-half miles. A dial like a clock, with letters instead of figures, had a single revolving hand, worked by rods and gears. The dial was painted white and the figures and hand were black, so they could be seen at great distances. It is noteworthy that Chappe proposed to operate the dials by electricity, with a sys-

tem of condensers between the stations, but was never able to make his dream work.

While France in the Middle Ages already was experimenting with semaphore systems, England had beacon fires on every hilltop. Drake got word of the coming of the Spanish Armada in this way, and the news was flashed entirely around England and Scotland. With the development of better cannon, noise displaced smoke and fire, and signal guns grew common.



The African Wireless, a Ceremonial Drummer at the Court of the King of Ugandi

Up to that time the "wireless" had been used principally for war purposes, to warn of attack and report victory or defeat, but later it gradually was applied to peaceful pursuits. The curfew bell and the morning and evening signal gun, telling of sunrise and sunset,

Wasmund
Sept. 1925

still survive. The electrical telegraph got its first war tryout in the Franco-Prussian and Crimean wars. It was not "wireless," but it did get messages across long distances, provided the enemy or a chance shell did not break the wire circuit.

The wire telegraph never quite displaced other "wireless" systems, since it always had the drawback of needing wires, which took time to erect, and were always subject to interruption. The heliograph, a system of sun flashing, remained in use with armies until the World War, and semaphore flags and blinker lights are still used by the world's navies.

The heliograph was a true "wireless" system, with the drawback that its operation was confined to days when the sun shone. Two adjustable mirrors, mounted on a crossarm fastened to a tripod, were used, the one to reflect the sun's rays on the other, which was aimed in the direction in which the signal was to be sent. Before this mirror another tripod, bearing a shutter operated by a lever, was placed. The lever could be worked like an ordinary telegraph key, sending messages in Morse code by passing dots and dashes of sunlight. In the clear air of the southwest, the system has been used over distances of more than seventy miles.

The pre-electric wireless of ships at sea included not only the international code flags, but semaphore flags which could be used in code combinations corresponding to the telegraph code. At night electric blinker lights on the yard arms of warships flash out Morse code messages to other vessels of the fleet.

But wherever civilization has touched, the wireless, and particularly the new short-wave apparatus, is replacing the older systems.

ELEPHANTS USED AS TEACHERS TO TRAIN OTHERS TO WORK

628 Imported Indian elephants are employed as teachers for their African cousins in a training school for the latter at Api in the Belgian Congo. In the earlier days of the school, which was founded about twenty-five years ago, grown-up animals were taken as pupils, but they were dangerous, difficult to catch and resisted the efforts of the human instructors who sought to train them for useful work. The method now in vogue is to capture the elephants when young and give them educated Indian beasts as individual teachers. Each new scholar is tied by a rope to the leg of its mentor and, willing or not, must follow. In a short time, the pupil learns, by example, how to pull a cart, roll tree trunks and carry burdens. The camp at Api now has forty-two African elephants in training. They not only pay for their schooling by their work but become as good teachers as the Indian animals. The African buffalo is also being trained successfully, and a second school is to be established in the same neighborhood. It is known that the ancient Romans and Carthaginians used to train elephants in warfare, hence it is believed that they must have known how to tame them, but the method seems to have been forgotten for some 2,000 years.



Courtesy The Marconi Co., London
Senator Marconi Sitting before His Instruments in the Cabin on a Newfoundland Hilltop Where He First Heard the Letter "S" Sent through the Ether from His English Broadcasting Station

*Utah Explosives Engineer
 From the "Explosives Engineer"
 POPULAR MECHANICS
 by W. J. Koeh.*

DYNAMITE LAKE BOTTOM TO INSURE WATER SUPPLY



Courtesy the Explosives Engineer

Taken an Instant After the Charge Was Fired, Tons of Water and Dirt Thrown into Air as 400 Pounds of Dynamite Were Exploded to Deepen Lake Channel

Utah Lake

Four hundred pounds of dynamite were used effectively near Salt Lake City, Utah, to deepen a lake channel leading to a pumping plant that supplies irrigation ditches and copper mills near by. The shots were placed under the water in two rows of holes, forty inches apart and about two and one-half feet deep at intervals of eighteen inches. All the sticks were fired simultaneously by electricity. Soundings showed that the blast had cleared a passage about five feet deep and twelve feet wide. The water was from a foot and a half to two feet deep.

the past century, there have been several small eruptions from Mount Rainier.

**TILE DESIGNS ON CEMENT TUBS
 BRIGHTEN PLANT DISPLAY**

Patterns in polished, colored tiles have been worked into cement tubs for holding shrubbery by a western firm. The decorations relieve the drab concrete and since the tiles are of scrap and left-over pieces, practically no added expense is involved, save that of arranging the designs. The tubs are heavy and have wide, flat bottoms.

**VOLCANOES SILENT FOR AGES
 NOT ALL DEAD**

Although the snow-capped volcanic cones on the Pacific coast long have been inactive, not all of them are regarded as scientifically "dead," and some scholars believe that further eruptions from these "sleeping volcanoes" are not impossible. In the northwest, Mount Rainier and Mount Baker, in Washington, and Mount Hood, in Oregon, with Mount Shasta and Lassen peak farther south in California, form a chain of peaks all of which, it is believed, were once in violent eruption. Since 1914, Mount Lassen has been the scene of minor disturbances, and during



Plant Tubs of Cement, Made Attractive by Tile Designs

*Philta Inquirer
 10/14/15*

*Used by Metropolitan Building Co. Seattle, Wash.
 Cobb Bldg.*



Sensitive Tube to Help Radio Movies; It Emits Electric Impulses When Light Strikes It

**RADIO TUBE IS SO SENSITIVE
 A SHADOW HOWLS**

Successful transmission of motion pictures by radio over distances far greater than have been attempted in experiments up to the present time, is promised in the development of a new photo-electric tube, one of the most sensitive units known to science. It sends out electric currents and radio impulses when light falls upon it. Already, its properties have been used in steering ships, controlling railroad trains automatically and recording light from the stars.

**MYSTERY SEEN IN MONUMENTS
 MANY CENTURIES OLD**

Lake dwellers in Switzerland, 10,000 years ago, built their houses on piles just as the seashore cottager in America does today, recent explorations have disclosed. The supports were discovered at Lake Neuchatel, extending slightly above the water which had preserved the wooden columns from decay. Stone hearths and pots, in which were cherry pits and strawberry seeds, were found on the lake bottom near the piles. Bits of fish netting, materials used for clothing and ruins of a canoe or light skiff, shed additional light on the picture of a lake dweller's life as it was lived about a hundred centuries ago. Records of an earlier civilization were found in southern France in the form of crude weapons and instruments possibly belonging to a period 100,000 years ago. In Brittany, monuments like those of the Druids at Stonehenge, present a mystery.

They are from 50,000 to 100,000 years old and while some of them are tombstones, the majority are not, their true significance being a matter of conjecture. Another prehistoric mystery is seen in the famous cave at Altamira, in Spain. It contains one of the finest art galleries of primitive man and was hidden for centuries until a little girl playing in the cave, saw the queer carvings and called her father. Years later, scientists vouched for their genuineness. The men who carved the figures must have had artificial light, they were highly skilled but gave evidence of ancient superstitions, in that they omitted the human body in their designs, using only the likenesses of animals.

**ROTATING DISK ON WINDSHIELD
 626 REPLACES WIPER**

As a substitute for the squeegee type of windshield wiper, a motor-driven glass disk that throws off mist and rain permits uninterrupted vision, is silent and requires but little current. It may be placed either in front or behind the windshield, and is mounted on a ball-bearing shaft which is supported by an aluminum bracket carrying the motor. The screen whirls rap-

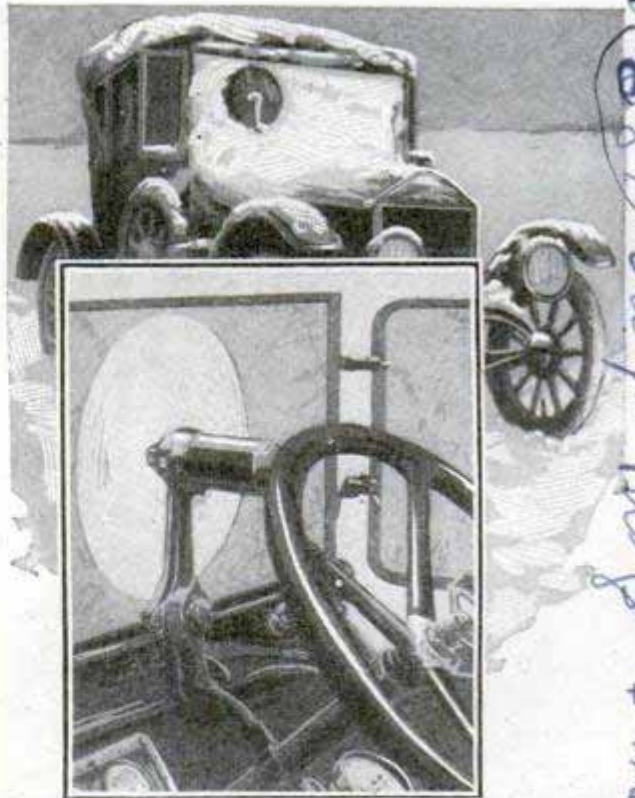

Revolving Disk for Windshield, Its Bracket and Motor, and How It Acts as a Wiper

idly, and has the additional advantage that it leaves no streaks. It has been used successfully on the bridges of large ocean liners to permit taking bearings in stormy weather.

*Bradwing Hallwell,
 Dept. of Anthropology*

University of Pennsylvania

*Autos... New York
 183 Vanech St. Quincy, Chicago
 483 22 W. Quincy, Chicago*

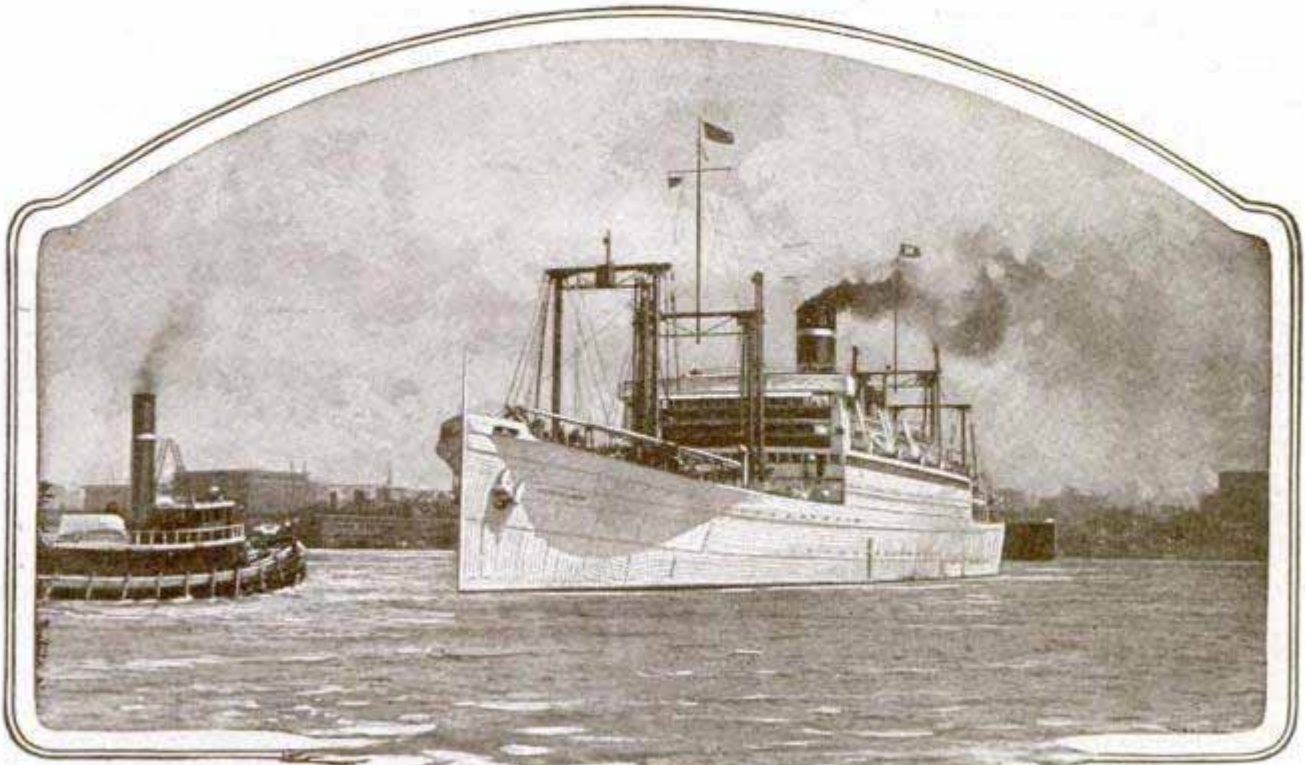

U.S.S. "American Legion" Arriving in New York from South American Ports

South America New Winter Playground

U. S. Liners and Panama Canal Make Continent Mecca for Tourists and Draw American Capital for Development

LURED by summer weather when it is winter in the northern hemisphere, Americans are turning to South America both as a tourist resort and to invest capital in the development of the vast potential resources of that continent. With four government-owned liners, operated by a private company for the United States shipping board, serving the east coast, and the Panama canal bringing the west coast days nearer New York, South American travel has been made as comfortable as going to Europe.

There has always been a close bond of sympathy between the two continents. Simon Bolivar, the liberator of Peru, Ecuador, Bolivia, Colombia and Venezuela, formed his ideas of republican government on a visit to the United States, and after he had driven the Spanish out, the Monroe doctrine made South American independence certain.

Accustomed to think of the frequently revolution-torn republics of Latin America as unimportant nations, most Americans underestimate their size and potentialities. Colombia and Venezuela, the nearest to the United States, are no farther from Florida than Kansas City is from New York, and the first covers as much territory as Texas, California and New York combined, while the second could swallow all of France and Germany. Yet with extraordinary resources of timber, petroleum, metals and agricultural lands, they still are in the infancy of economic development.

Brazil, which occupies just half of South America, is as big as the continental United States, Spain and Italy combined, while Argentina, if set down on North America, would cover all the states east of the Mississippi and part of the first tier west of the river. Chile, on the west coast, is almost as big as California, Oregon and Washington, and Bolivia and Peru are twice as large.

The Panama canal and the fast service of the government ship lines have made it possible to reach Rio de Janeiro in eleven days from New York, go on to Santos, the coffee capital of the world, Montevideo, and Buenos Aires, the Paris of South America, cross the Andes by one of the world's highest railroads, visit Santiago and Valparaiso, sail up the west coast to Antofagasta, Iquique, Arica, Callao, Lima, visiting the ancient Inca ruins on the way, then on to the canal, through it, and back to New York.

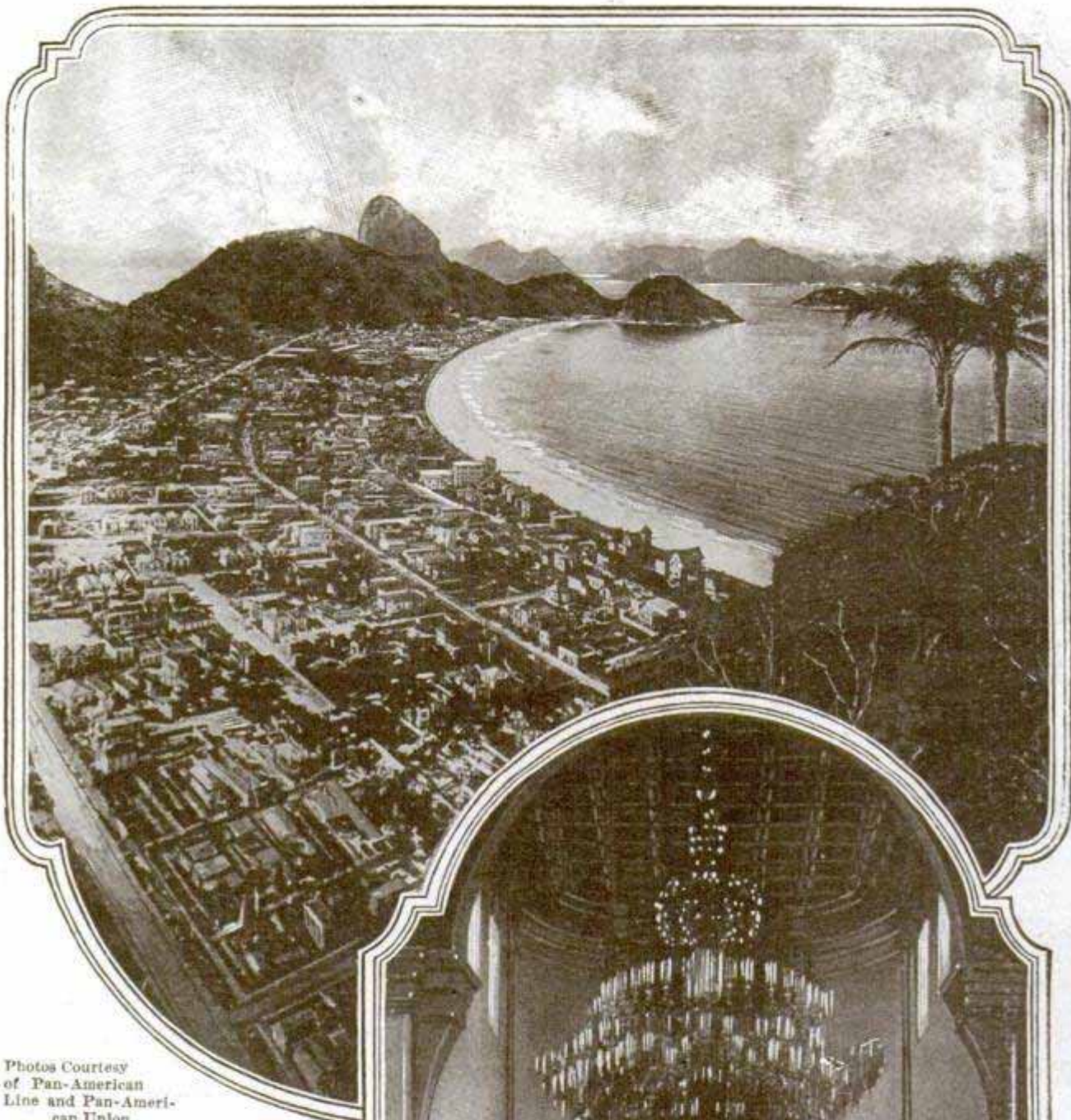

Photos Courtesy
of Pan-American
Line and Pan-Ameri-
can Union

The Magnificent Crescent Harbor of Rio de Janeiro, Above, Dotted with Island Peaks and the Famous Sugar Loaf Mountain in the Background; at Right, the Tomb of Simon Bolivar, "El Libertador" in the Panteon Nacional at Caracas, Venezuela; Bolivar, Who Created More Free Countries Than Any Man in History, Drove the Spaniards from What Is Now Colombia, Bolivia, Ecuador, Peru and Venezuela, and Was at One Time President of Colombia, President for Life of Peru and "Perpetual Protector" of Bolivia, Which Had Been Named in His Honor and Whose Constitution He Wrote; He Obtained His Idea for Freeing His Native Land on a Visit to the United States

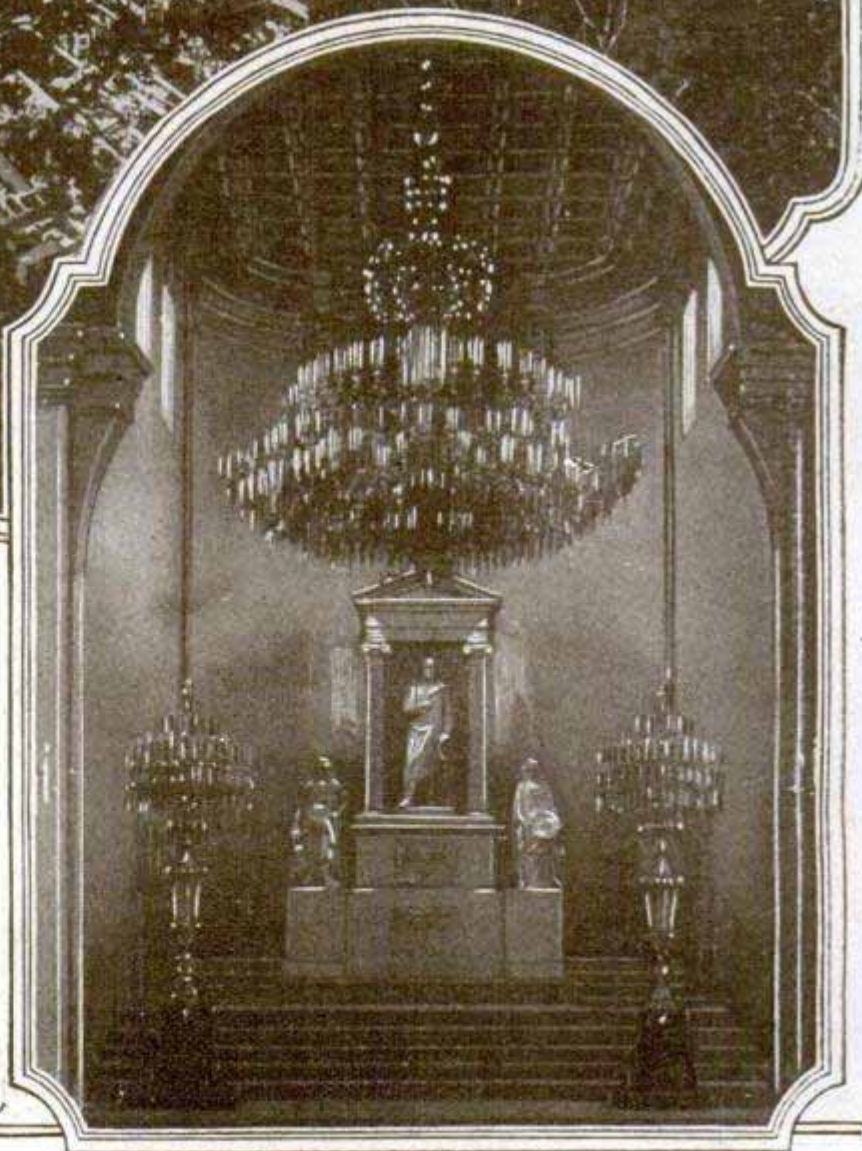

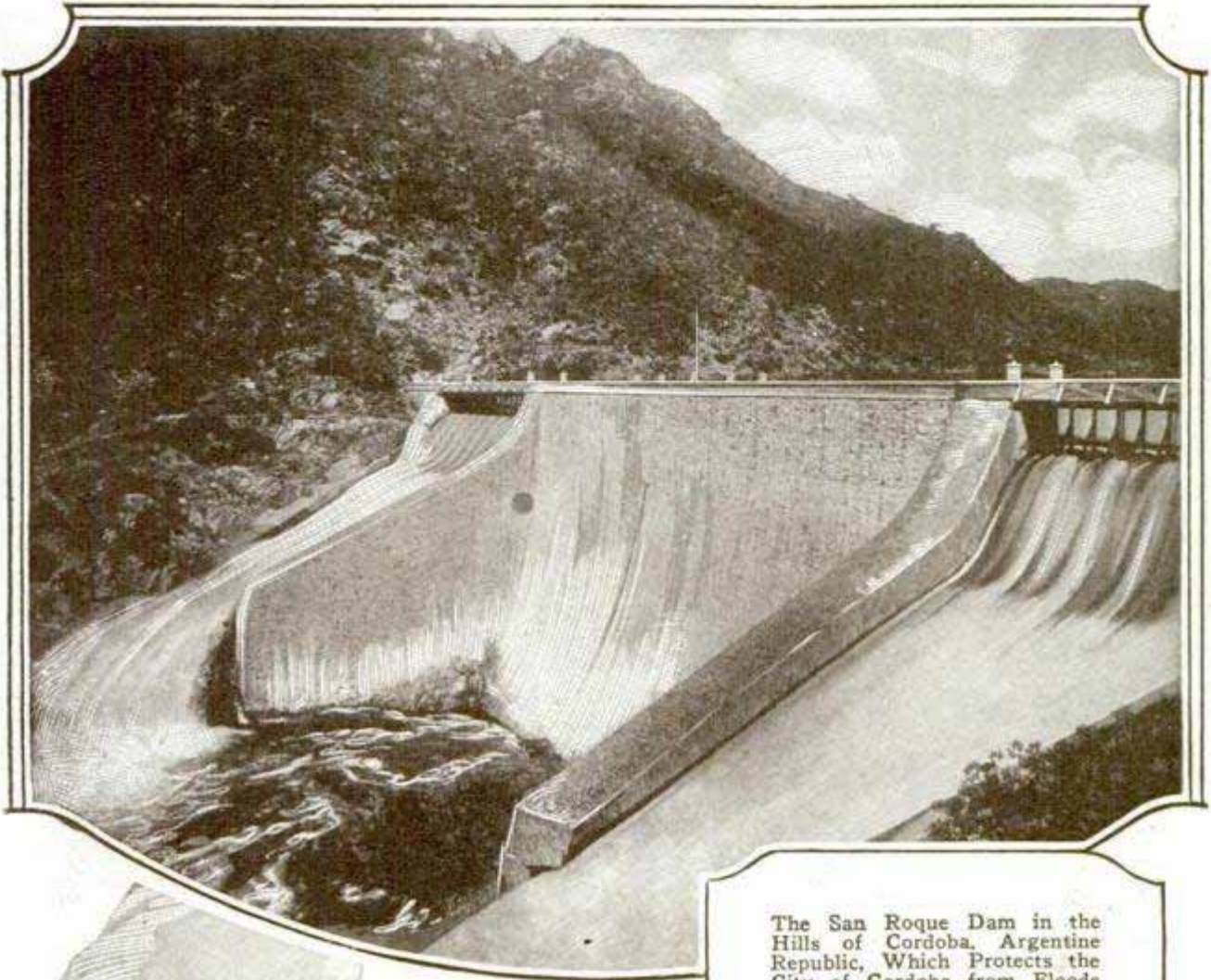

The San Roque Dam in the Hills of Cordoba, Argentine Republic, Which Protects the City of Cordoba from Floods and Likewise Generates Power to Light the Provincial Capital; Below Is the Great Granite Grandstand of the Buenos Aires Race Track, One of the Most Famous Race Courses in the World and the Scene of Extravagant Fashion Displays during the Season in the Argentine Capital, Noted as the Paris of the New World

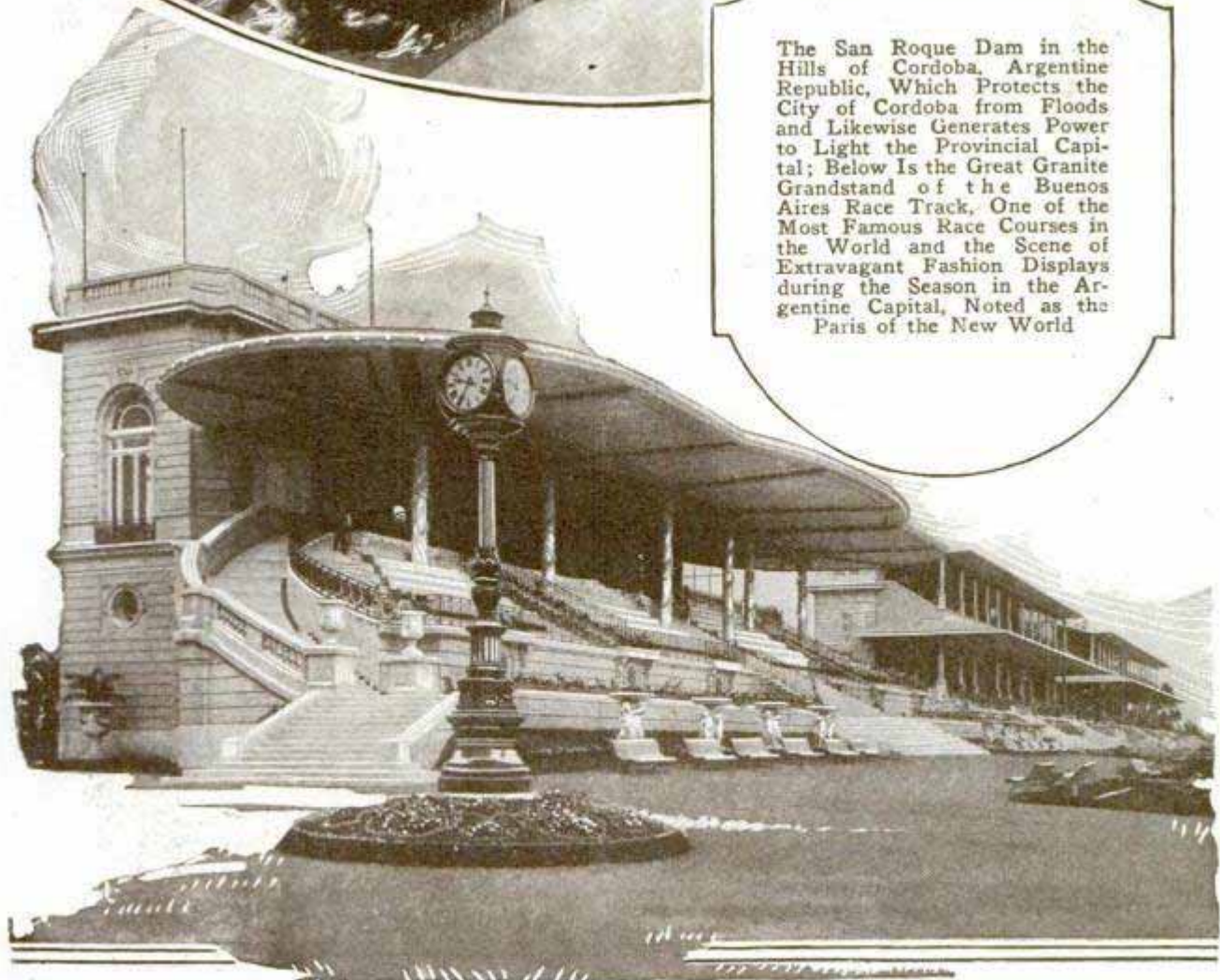

504

Bird's-Eye View of Panama Canal Zone

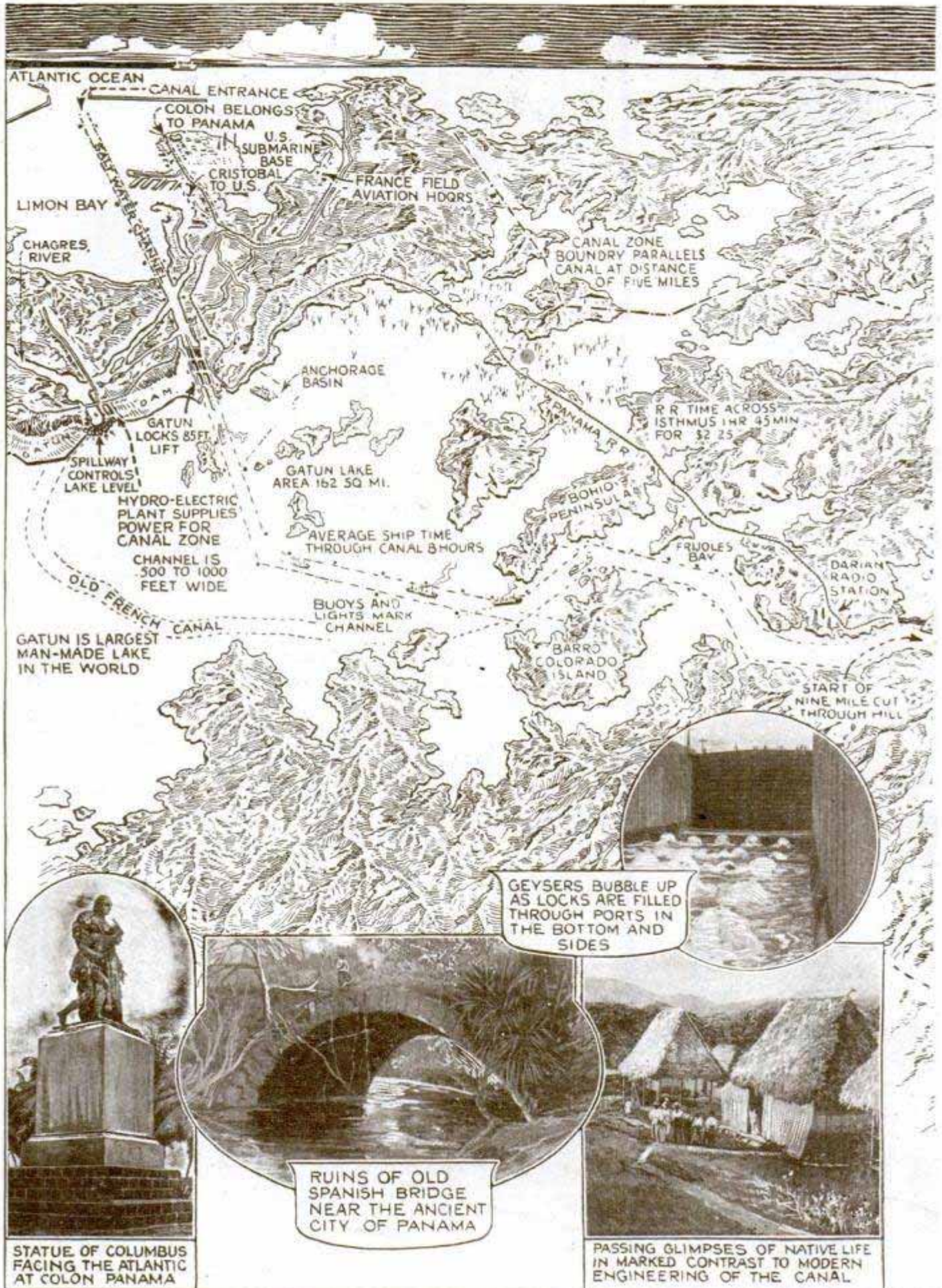

604

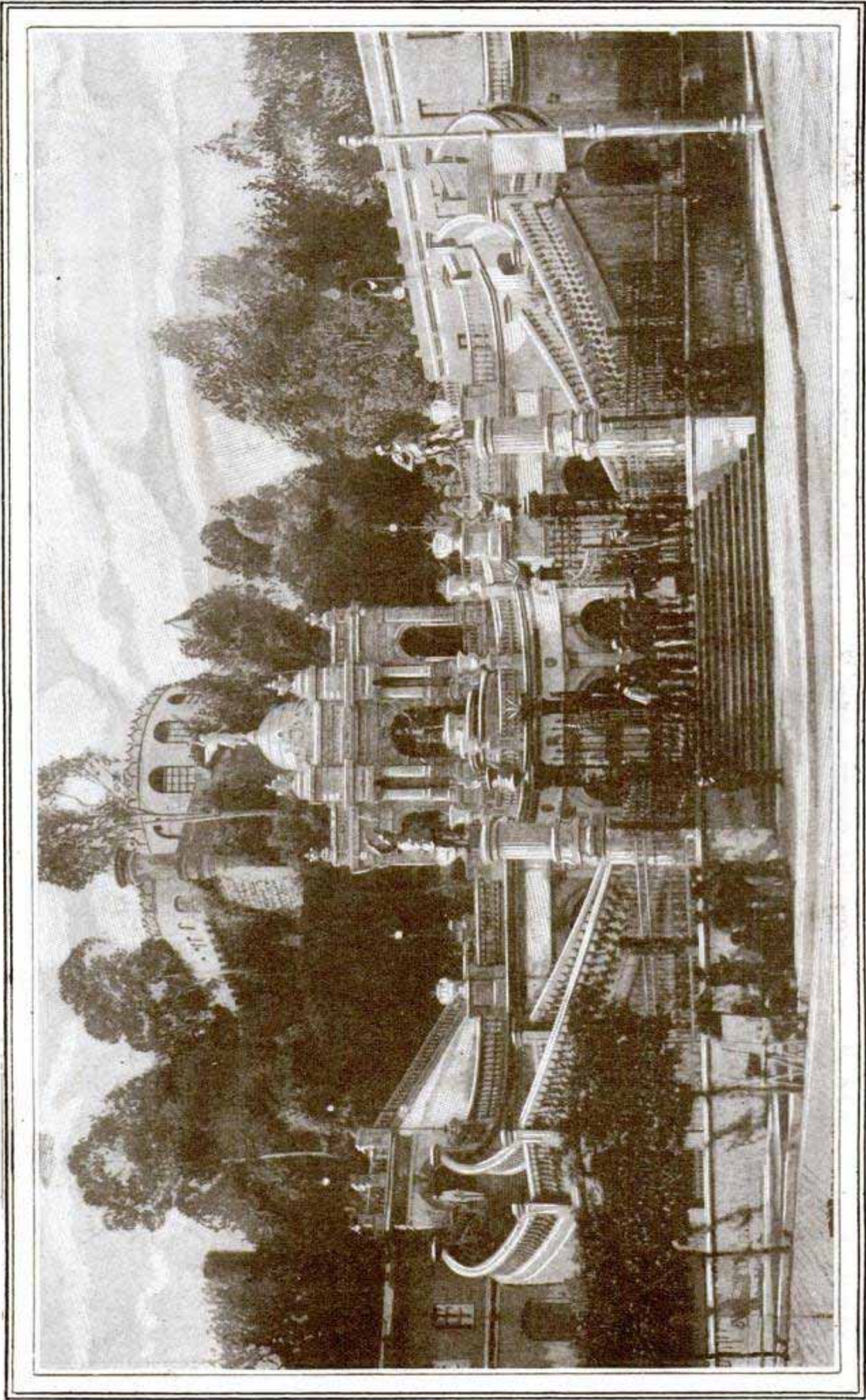

The Famous Hanging Gardens of Santa Lucia Hill Is One of the Noted Show Spots in Santiago, Chile; the Cities of Latin America Are Filled with Magnificent Public Buildings, Statues and Parks, Showing the Effect of Spanish, Italian and French Influences



Every Traveler Crossing the Equator for the First Time Is Called before the Court of King Neptune and Initiated into the Ancient Order of "Freemen of the Seas"; the Sailors Are Lathered with Flour Paste, Shaved with a Wooden Razor and Then Dumped into a Water Tank, but the Passengers Are More Leniently Treated; Even Sand Piles for the Little Tots Are Provided on the Government Owned Ships.

504

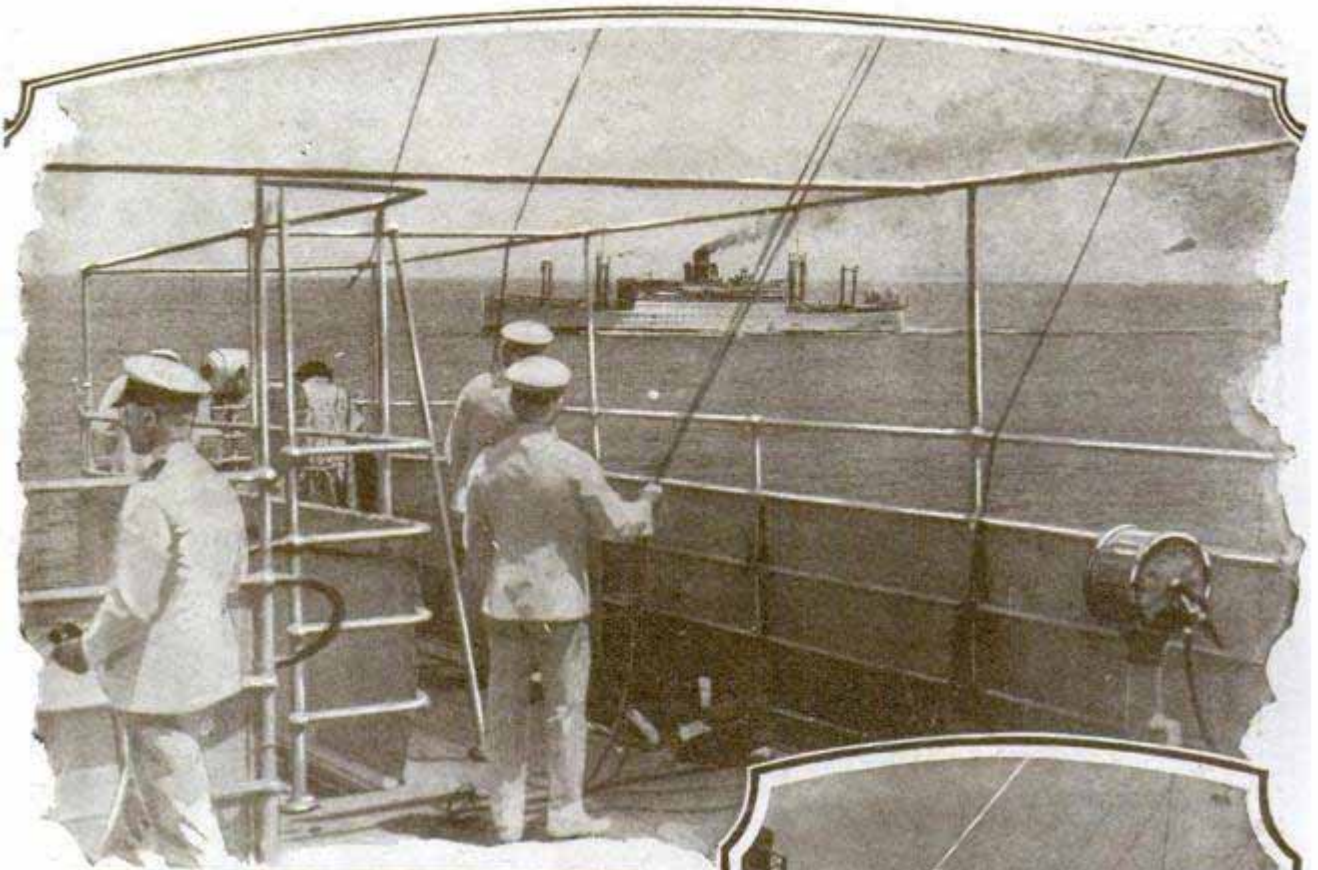

Two of the Shipping-Board Liners Passing near the Equator, Above, and a Carro of Coffee Being Taken on Board the S.S. "Southern Cross," Plying between New York and the East-Coast Ports of South America

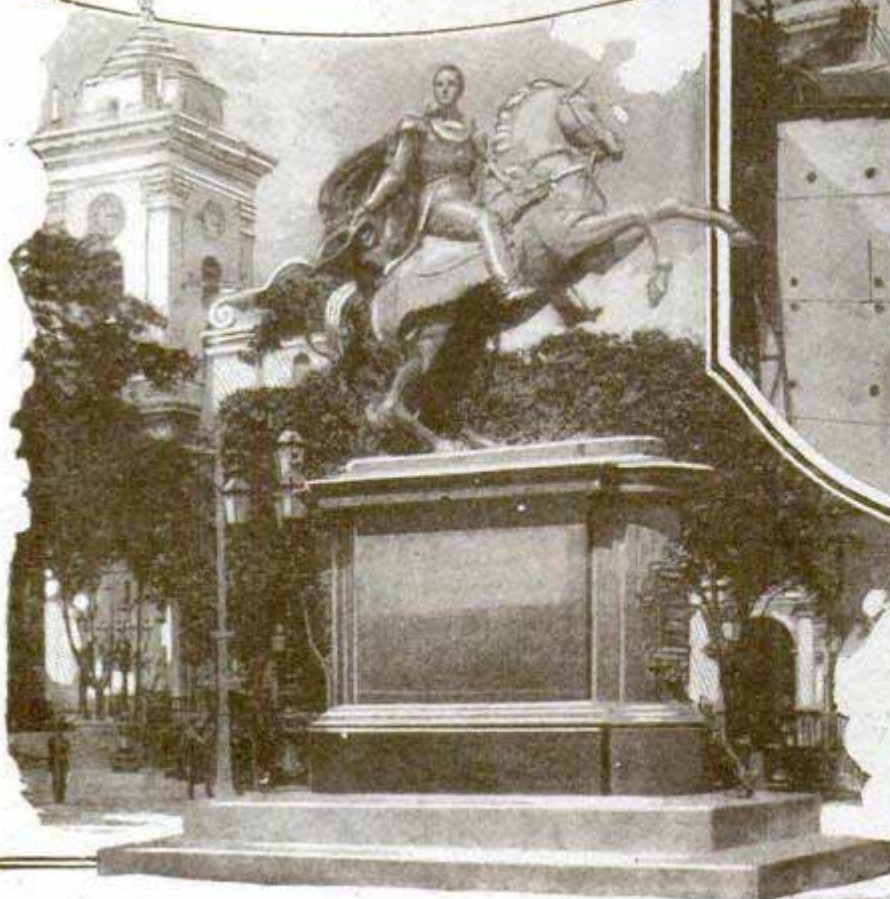
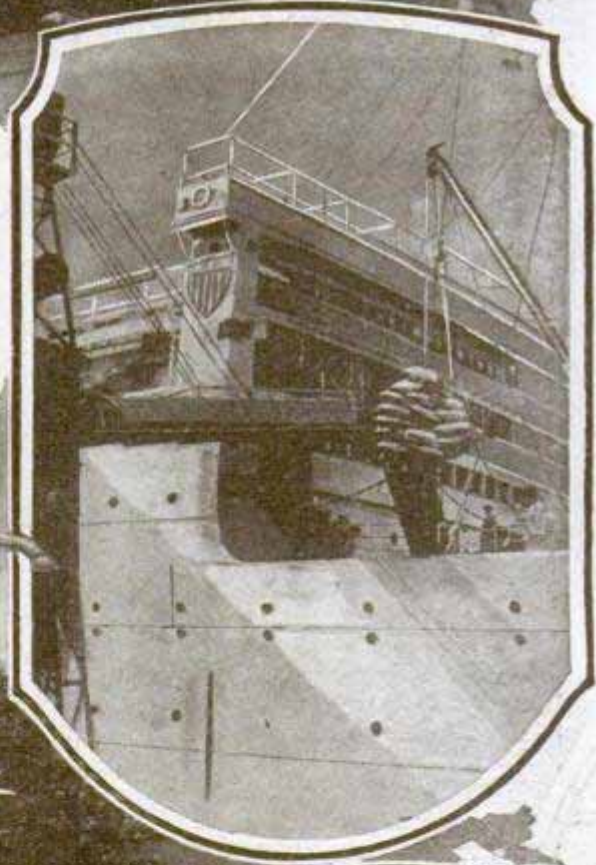

Statue of Simon Bolivar at Caracas, Venezuela; Similar Honor Has Been Paid the Liberator of Five South American Countries by Erecting a Statue of Him in Central Park, New York City

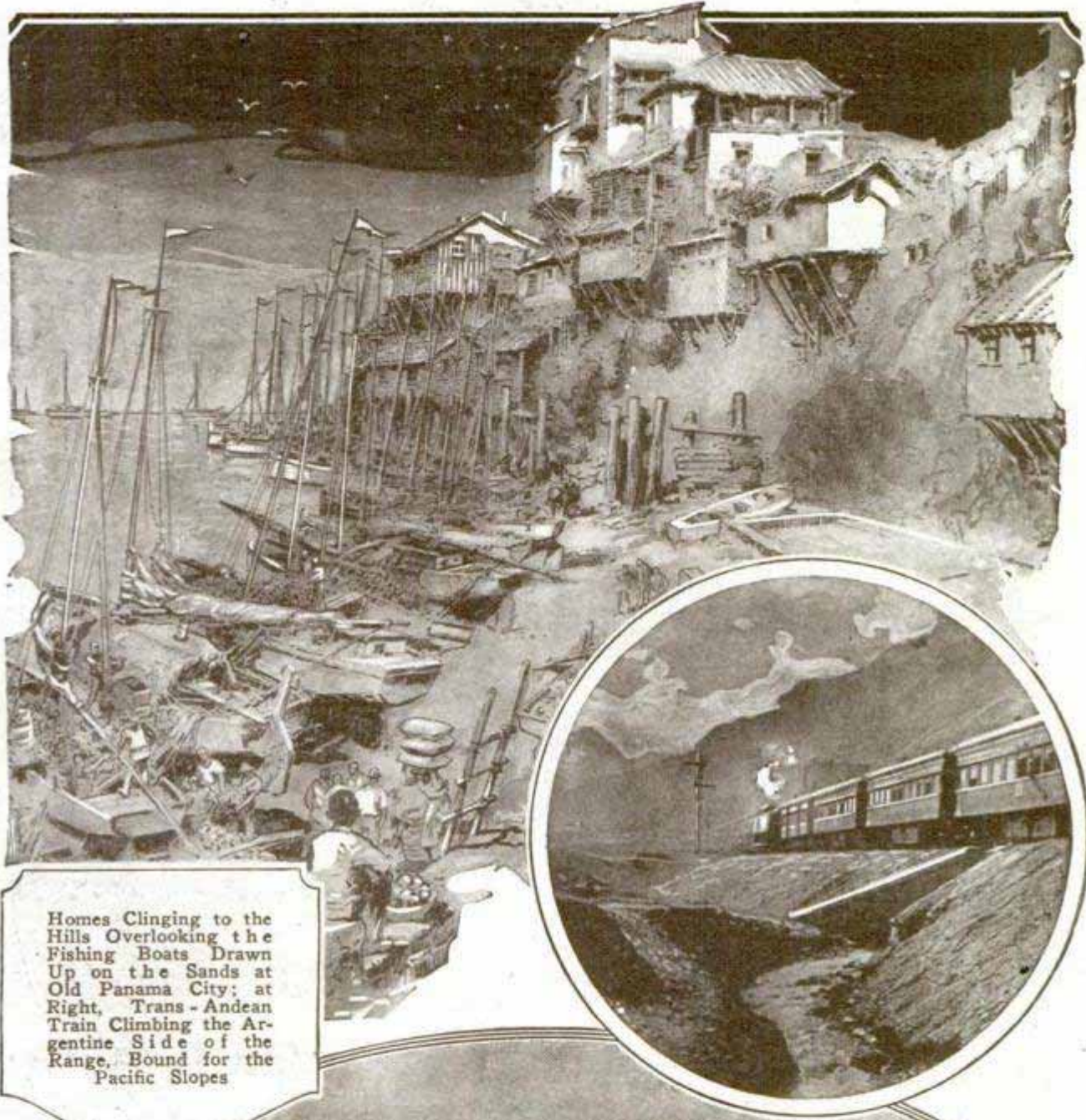

Homes Clinging to the Hills Overlooking the Fishing Boats Drawn Up on the Sands at Old Panama City; at Right, Trans-Andean Train Climbing the Argentine Side of the Range, Bound for the Pacific Slopes



The "Casa Rosada," or Pink House Which Is the Home of the Argentine President

504

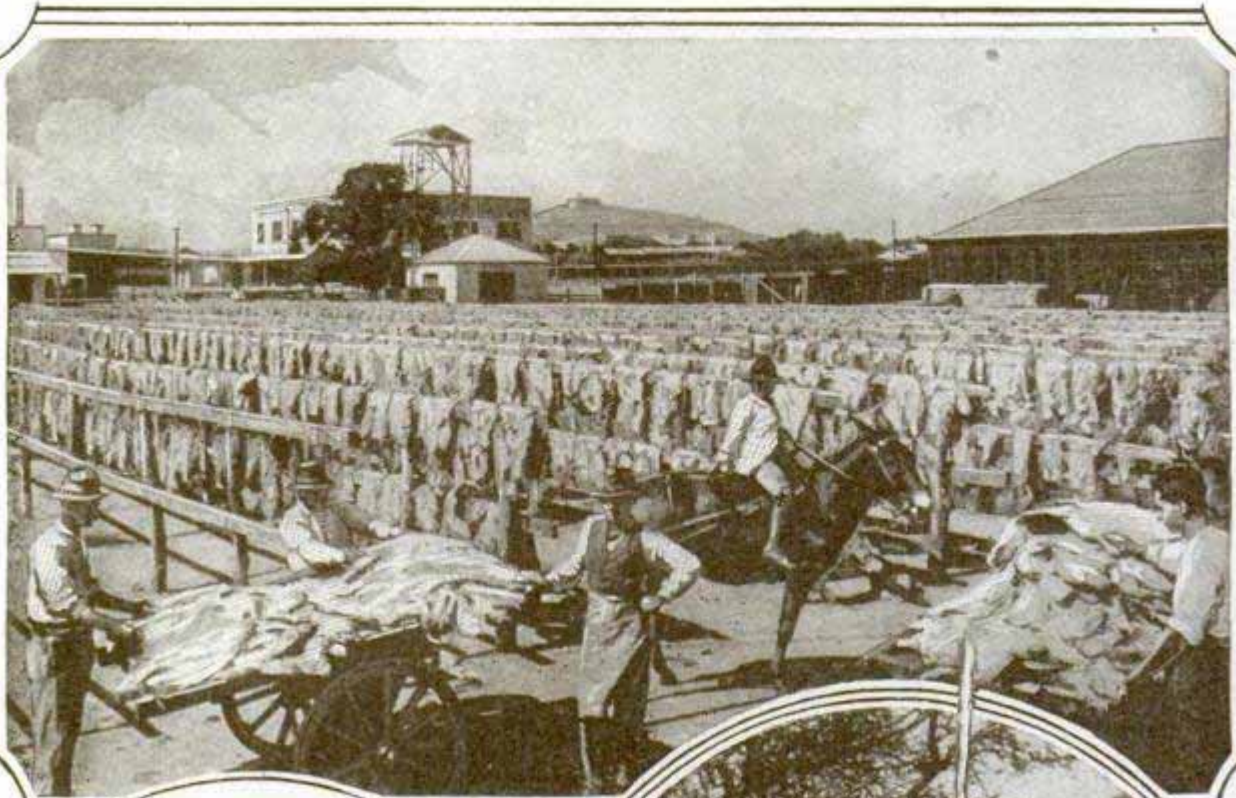

Jerked Beef Is Prepared and Hides Dried on Open-Air Racks under the Sun in Montevideo, Uruguay; Above Is One of the Large Plants from Which Meat and Hides Are Shipped to All Parts of the World; at Right, an Indian Family in El Gran Chaco, Tropical Territory in Northern Argentina

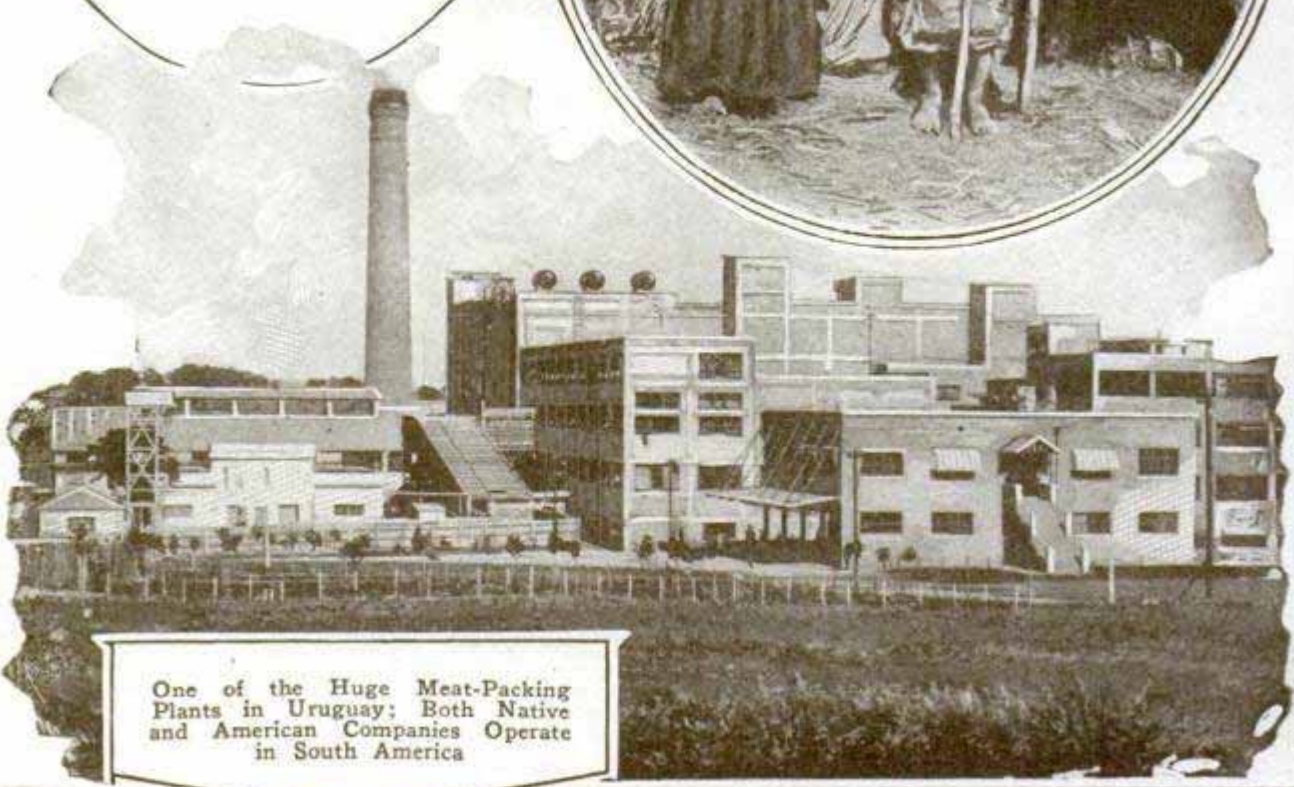

One of the Huge Meat-Packing Plants in Uruguay; Both Native and American Companies Operate in South America

ANCIENT MONSTER LIVES AGAIN IN MOVING MODEL

Equipped with a system of gears operated by motors, a huge moving model of a brontosaurus, a reptile that, scientists say, roamed this continent 10,000,000 years ago, has been built for the American Museum of Natural History in New York City. It is nearly forty-nine feet long and weighs two tons. The body is nine feet high, the head is sixteen feet above the ground when up and the tail fifteen. Both touch the ground when lowered. The neck has five different motions, each leg four, the head three, the tail four and the stomach three. These are obtained by means of speed-reduction gears run by ten motors installed on a table inside the model and controlled from one switchboard, and the motions may be reversed if desired. The body is of rattan, put together with springs to give flexibility. The head and neck are controlled by heavy steel tubing operated through a series of gears and flexible shafts. The covering required 150 yards of heavy quilting with a composition worked over it: The head and feet are made of papier-mache, and the coloring of the animal is executed in green, brown and gray. The monster is modeled after the skeleton of one found in Wyoming some years ago.

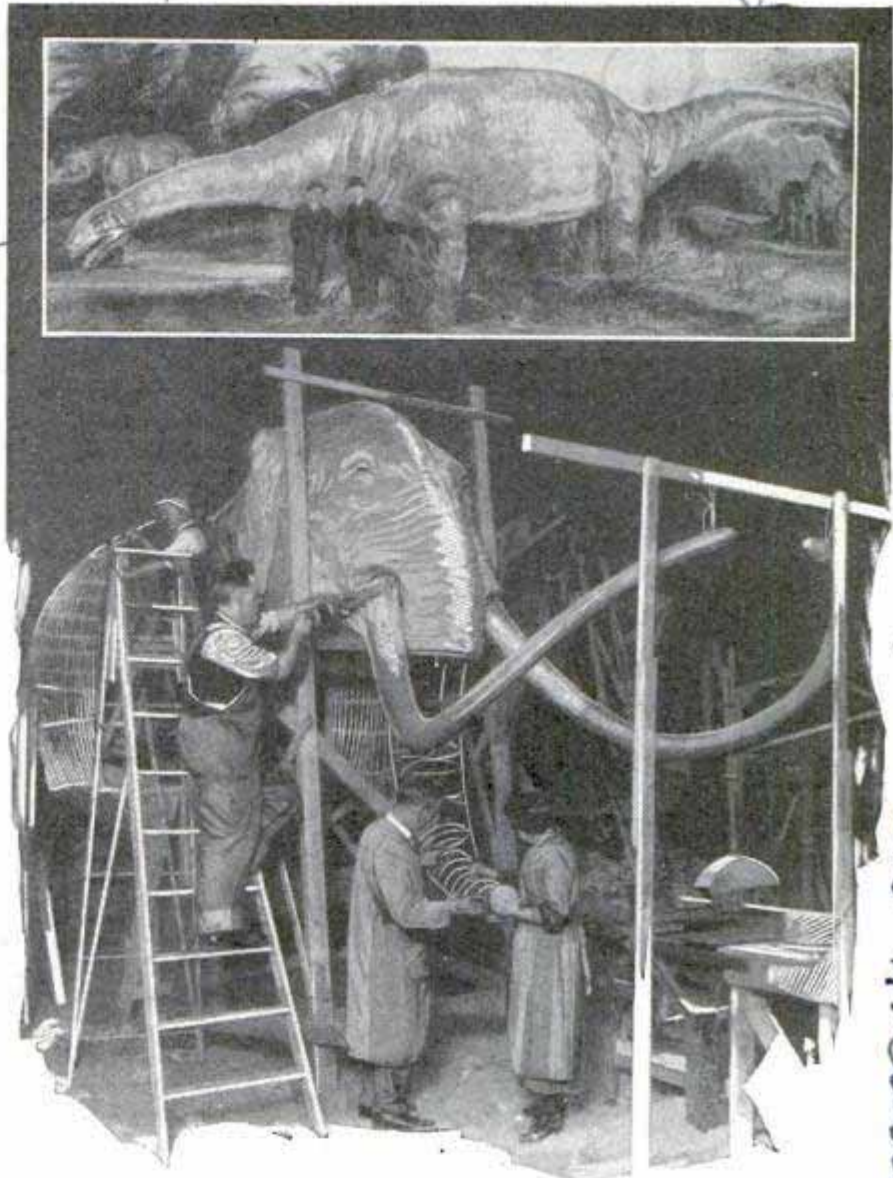

Upper Photo Shows the Completed Model of the Brontosaurus; Below, Workers Are Constructing Flexible Framework for Replica of Mammoth

TEST TO GAUGE SPEED OF LIGHT WITHIN FINAL MILE

By reflecting beams between two specially constructed mirrors 100 miles apart, Prof. Albert A. Michelson of the University of Chicago, hopes to measure the speed of light to within at least five miles or perhaps even one mile of its actual rate. His tests already have shown that its approximate velocity is 186,300 miles a second. These data were gathered by projecting a powerful light through a mirror

which was spinning at the rate of about 30,000 revolutions a minute, to a reflecting apparatus twenty-two miles away. The experiments were conducted between Mount Wilson and Mount San Antonio in California. The further tests, planned for this summer, are to be done with more refined instruments. The revolving mirror to be used will have a capacity of three times that of the former. The present estimate of the speed of light is believed to be correct within twenty miles. One of the practical uses of an accurate figure for the velocity is in measuring the distances between points. Knowing the speed of light, it is possible to figure distances with an error of less than one part in a million, an accuracy which no engineering instrument can attain.

Our Bureau of Information will answer all questions regarding articles appearing in this magazine.

because anticipated by most of those leaving machine Co, 215 N. Cortis St. Chicago

636

10/3/25 P. 620-1

575 STADIUM REVEALS SECRETS OF ANCIENT RACE

Further wonders of the ancient Maya civilization in Central America have been disclosed by the excavation of a stone citadel, occupying nearly eight acres at Lubaandum in southwestern British Honduras. It is pear-shaped, nearly fifty feet high, and its summit is covered by great terraced pyramids and cement-floored plazas. The northern half of the structure is devoted to an amphitheater, where, it is believed, allegorical dramas were presented to the accompaniment of weird music for the entertainment of as many as 10,000 persons at one time. Banks of seats, similar to those of a stadium, commanded a full view of the central court. The pyramids are flat-topped, unlike those found in other Maya ruins, and show no signs of ever having supported temples or palaces, giving further indication that the

citadel was devoted to a special purpose. Graves were discovered on some of the elevations, containing relics similar to those unearthed in burial places outside the stadium, and the bones, in no case, indicated an age of more than three or four centuries while, in some instances, the burials had occurred less than 100 years ago. Objects found included spears and javelin heads of flint, ax heads, hammers, beads, mirrors of iron, pottery, grinding stones, shell trumpets and whistles. Near the surface of one of the diggings, a figurine showing a man in medieval European dress was picked up, indicating that the manufacture of these articles must have continued after the Spanish conquest, when the Mayas were driven into the forests, killed or forced into slavery by their captors.

638

ELECTRIC TRAIN-STOP SYSTEM TO PREVENT COLLISIONS

Air brakes are applied automatically and the locomotive must be halted before they can be released by an electric train-stop system now being installed on an

eastern railroad. It consists, roughly, of two main units, an inductor, set in the roadbed close to the track and connected to the block-signal system, and a receiver which is attached to the locomotive tender. In case the block is obstructed or caution is necessary, the inductor is so affected by the signal that approach of the receiver actuates a mechanism which applies the brakes without the engineer's aid.

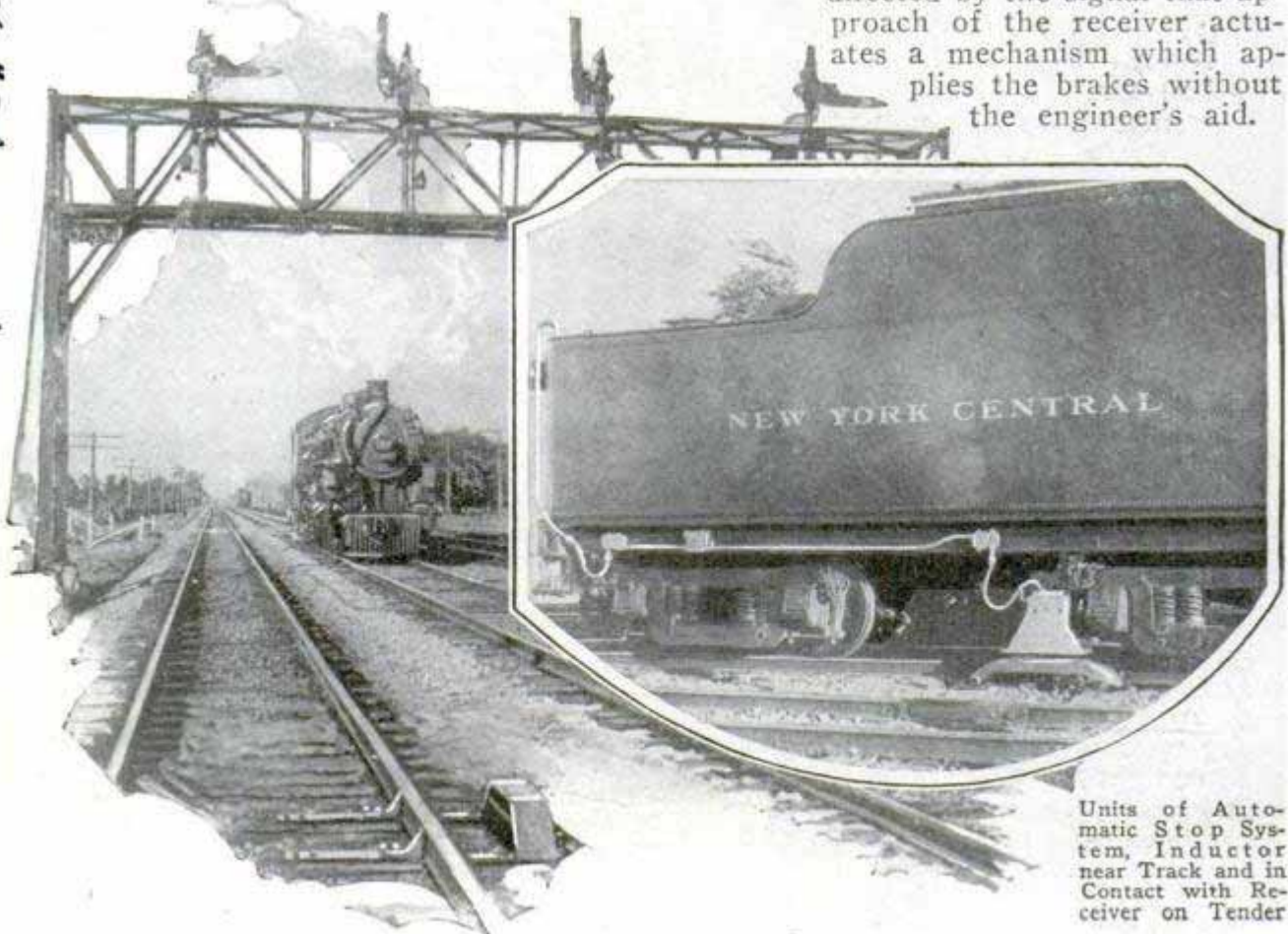

Units of Automatic Stop System, Inductor near Track and in Contact with Receiver on Tender

new York Central RR
 466
 Lettington Ave
 new York

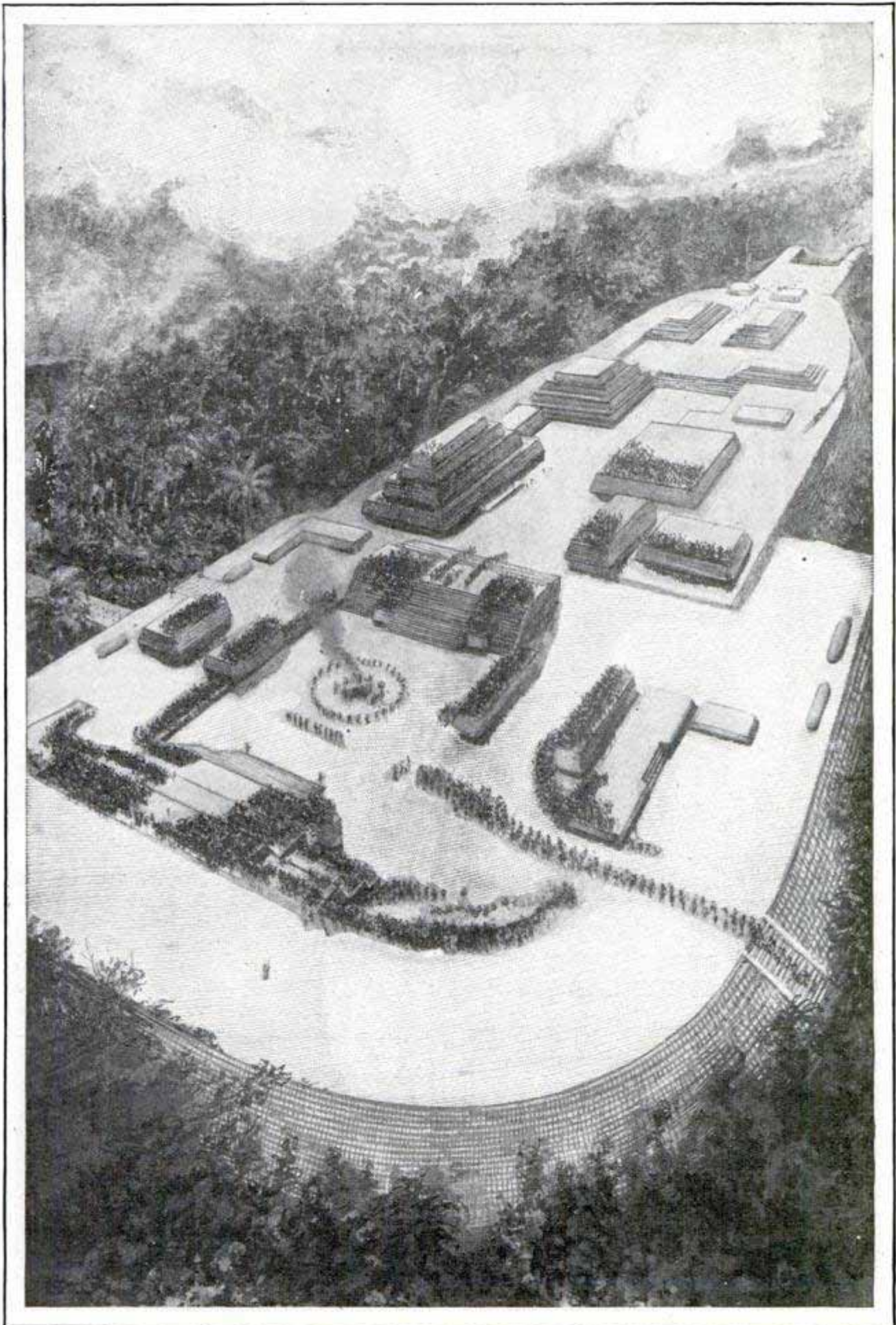

Courtesy Illustrated London News

Largest Prehistoric Building on the American Continent, a Reconstruction Drawing of a Ceremony in a Maya Citadel, the Remains of Which Have Been Cleared from Forest in British Honduras

*Myr. Onw... Wuppermann to m. v. 1.1
Schlebusch - manufacturer near Cologne, Germany*

BARBED BAND ON SPOOL HELPS TO PROTECT GARDEN

502

As a substitute for barbed wire, bands of metal bristling with points are tacked to the top of rails or between the fence

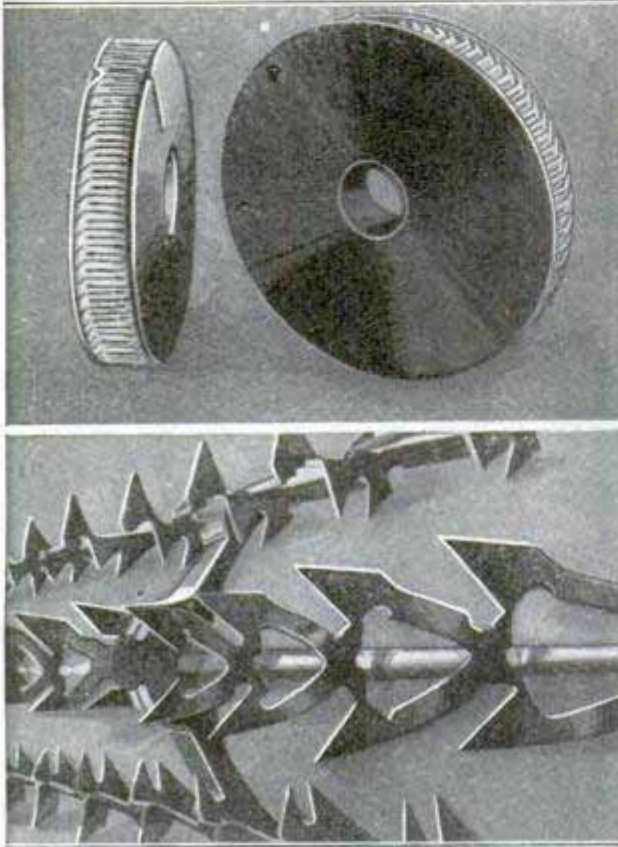

Bands Flat on Spools and Unwound, Showing How Barbs Extend When Strand Is Stretched

posts to protect the yard or garden. The lengths are neatly coiled on spools for convenient handling, and the points are not exposed until the strand is stretched out. The material weighs less than ordinary wire.

ATTRACTION OF MOON-WEIGHED IN DELICATE BALANCES

Sensitive balances devised by Prof. Ralph C. Hartsough of Columbia university are so delicate that they will react to one 280-billionth part of an ounce. They register the effect produced in a fraction of a second by the changing position of the moon or the attraction which gravitation exerts on an object weighing only one twenty-nine-thousandth part of an ounce. Gold-surfaced mirrors, each a half inch square and held by a beam consisting of a quartz thread as fine as gossamer, correspond to the scales in the balances. The weight is attached to the underside of one of the mirrors. It is constantly being affected by the changing relative positions of the sun, moon and

earth, and is counterbalanced by 150 twists in the quartz thread which exerts a constant pull. Changes in weight are recorded by the shifting of a shadow produced by the displacement of waves of light from a mercury lamp and reflected upon the mirrors. The shadows become narrower or wider according to the relative position of the mirrors. The balances are being used to locate oil deposits. Oil, being lighter than other parts of the earth's crust, causes a decrease in gravitation. Surveys are made over an area at 1,000-foot intervals. Wherever the scales show a relatively slighter attraction, a test boring is made for oil. The instrument also provides a test for the validity of the Einstein theory, which holds that impulses of gravitation have the same speed as light. If this is true, the moon should exert its pull one and one-third seconds after it passes a given spot, the time it takes light to get to the earth from the satellite. The scales are adjusted to measure any changes in gravitation that take place in a fifth of a second because of the moon. Because of the vibrations due to street cars and other traffic, delicate tests such as this cannot be made except in secluded spots. The scales are said to be 100 times more sensitive than the most delicate instrument known before their invention. They weigh fifteen pounds and although they must be protected from changes in temperature, are fairly sturdy.

597 **VISION SHIELD FOR AUTO GLASS PREVENTS FORMING OF FROST**

Held to the automobile window by rubber vacuum cups, a strip of transparent material now on the market, keeps frost or mist from forming on the glass. It is easily removed or attached, can be cut in neat shapes and is said to be effective even in the coldest weather.

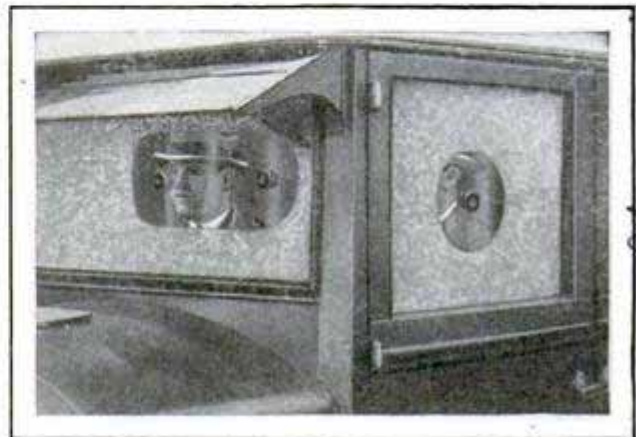

Peepholes through the Frost; How the Shields on Auto Glass Aid the Driver

Hedden Co. Milwaukee

New York City 6341

Access

dealer in Chicago

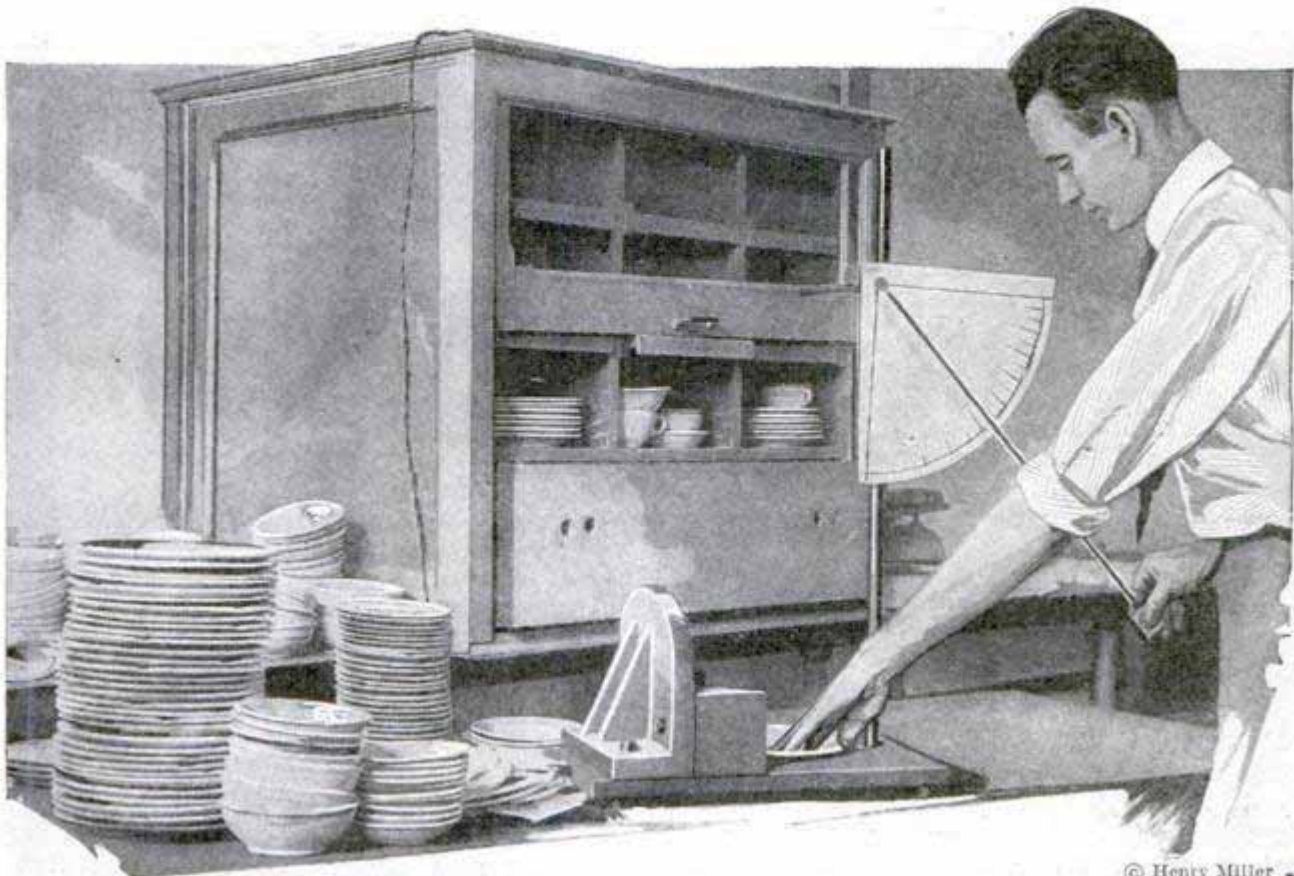

© Henry Miller

This Man Is Paid to Nick Dishes. The Weight Is Drawn Back, Then Allowed to Strike against Plate; the Force of the Blow Is Indicated on Dial

319-18th St.
N.W.
Washington
D.C.

Saving Our Dishes from Breaking

Government Scientists Shatter Cups and Saucers to Test Strength and Durability of Crockery

By UTHAI VINCENT WILCOX

DID you ever drop a dish and it failed to bounce—just went to pieces before your eyes? Did you ever nick the best plate or the favorite tea cup? Did you ever have one of your dishes accidentally fall to the hard, unyielding tile floor at the soda fountain—and everyone craned to look your way? If any of these experiences were ever yours, you have fervently wished that some one would invent some unbreakable crockery. "Oh, if only china could stand a little hard usage," you moan.

But think of the hotel managers and the restaurant keepers! They, too, would like to have some of the unbreakable kind of crockery. Yes, indeed they would, when they pay untold thousands of dollars a year because dishes will break. It is a fact that one eastern hostelry of international repute spends more than \$60,000 annually for new dishes and glassware to replace those broken in handling. A leading Chicago hotel has to count in the

budget \$35,000 to replace chinaware alone. Restaurant keepers regularly charge for a twenty-per-cent dish breakage each year. And that charge must be paid for by the patron of the restaurant, hotel, and eating house where crockery is used.

So, breaking dishes becomes something of a national problem touching the pocketbook of every man and the budget of every housewife. If it were possible to tabulate the dish-breakage losses throughout the United States, the total would look like interest on what Europe still owes us. Everytime we eat in a restaurant, or a hotel, or at home we share in the sum total. But cheer up. This is to bring you good news and not to add to your resentment at the high cost of living. It is a fact, thanks to a group of scientists who labor for us at the bureau of standards, that dishes are now growing up—they get older in service and stand harder knocks without collapsing. These scientists have made machines that subject the dishes

to the same usage that you do or the amateur or professional dishwasher and waiter. They have just stopped short of using heavy artillery and high explosives. All of which, incidentally, gives a conception of rough usage that science gives to crockery with the expectation of helping users and manufacturers to obtain cups, saucers, and plates, and all the rest, that will not break except the heavens fall.

One dish-breaking outfit made by Uncle Sam's men consists of a heavy weight against which the plate is held. The investigator-of-the-truth-about-dishes draws back a steel ball attached to a pendulum arm, letting it fall against the plate. If the plate doesn't break with the first hit, he tries it again and again, all the time increasing the distance that the steel ball has to travel as measured off on a graduated scale.

The strength figures indicated on the scale are noted down, and as the plates break at this figure or at that, it all goes into the record. The plate that can stand the most is the plate that wins, and by such a process are better plates made. The same steel shot is also used on the plates to find out how much they will stand before nicking. It's something like hitting the faucet over the sink with the plates, cups and saucers when washing the

of them stand it. According to these scientists, the tumblers and glasses that stand such treatment have strength enough to survive a four-foot drop to a concrete floor.

Other tests include sudden heat and cold. Extremes of each are given to simulate conditions to which these culinary articles are subjected in the commercial restaurants or hotels where mechanical dish-washing machines play havoc. Boiling tests are given to glassware in order to find the kind that will endure the most.

But the dishes that grace the dining table are not the only victims of this pounding and hammering and sliding and chipping and dropping and heating—window glass comes in for its share. How much will your window pane stand if Dick bats his ball against it? This may not be the way the problem is stated in the scientific papers of the bureau, but that is what it amounts to. How much storm pressure will your window stand on a wild, gusty night when the whole house shivers in the blast and the thunder reverberates even beneath the blankets?

In the government laboratory wind pressure is simulated by water pressure, which is so regulated that it duplicates the vagaries of the wind. Hammers and steel balls test for the sudden breakage as when the rock goes astray from the urchin's hand.

To do this, a piece of the window glass is placed on the testing machine lying flat. A saddle is suspended over the unsupported central portion of the glass. This saddle is connected with a swinging arm similar to the ordinary scale arm. A standardized bucket is placed on the far end of this arm so that it will catch all

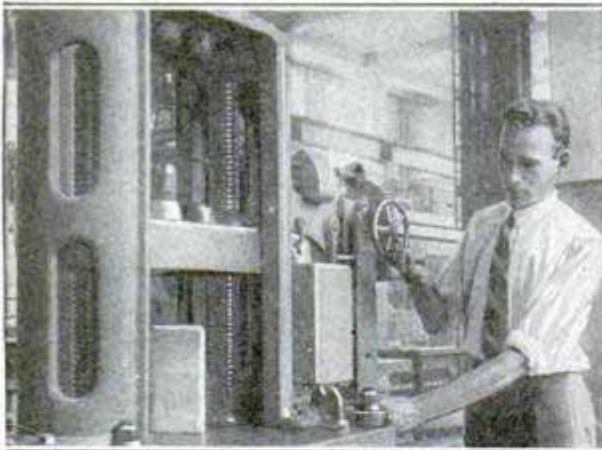

From Top to Bottom. Rack That Exerts 100,000 Pounds' Pressure on Dish; Another View of the Breaker in Use and Kiln for Heat and Cracking Tests

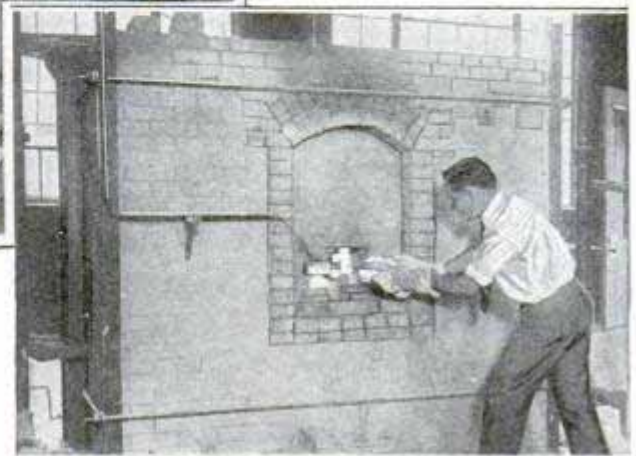

dishes for Friend Wife.

The tumbler tester helps the alibi—"the bottom just dropped out; honestly it did!" The glass is placed so that its bottom is exposed. The iron ball attached to the pendulum is then drawn back the graduated distances and released. The weight rams into the bottom of the glass. And some

LEVER SHEARS TO CUT STEEL
REDUCE WORK AND COST 555

Steel sheets or bars up to a quarter of an inch in thickness are cut smoothly or slit with little difficulty in lever shears a

Metal Shears in Operation; Slight Pull Exerts Great Leverage on Blade



Letter rec'd 12/11 7/25

the shot that flow from an adjoining shot tower when the gate is opened. The shot pouring on the bucket that rests on the scale beam, which, in turn, is fastened to the saddle, exert a constantly increasing strain on the glass. At last, when this machine has poured out more shot than the glass can stand, it breaks, and in so doing pulls a trigger that stops the flow of shot. The weight of the shot in the bucket gives the transverse strength of the glass.

These and other tests are studied intensively by architects and engineers, and as a result, your house, your store, your office windows are made to withstand the necessary strain.

Such tests by cold and calculating science have established one fact that is interesting to buyers of crockery, glass and china, and that is that the made-in-America ware has come through with better marks than the imported dishes. These demon dish destroyers have found that, as a rule, the homespun plates, cups and saucers are more durable than the best of the foreign brands.

American hotels have been interested, because it will save a large bill of lading from European sources, which in turn will make cheaper eating.

SCREWDRIVER FOR AUTO KIT TESTS SPARK PLUGS

A tester for spark plugs and a screwdriver have been combined in one useful implement for the auto tool case. In trying the plugs, the flash, if visible at all, is

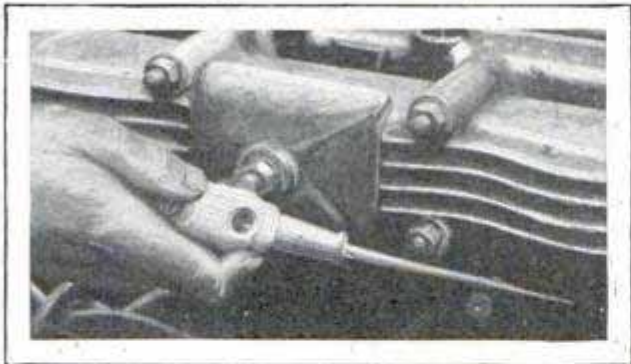

Opening in Side of Screwdriver Exposes Visible Flash in Making Spark-Plug Tests

seen through an opening in the side of the handle, which is so arranged that the user is protected from shocks likely to be suffered if he were working with an ordinary screwdriver.

According to estimates, about one per cent of the bituminous and twenty-five per cent of the anthracite-coal resources of this country have been mined.

western inventor has patented. The jaws are so hinged that the blades do not get out of alinement, assuring clean, straight edges both in cutting and in slitting. Great leverage is applied from the handle with but a slight pull.

LENGTH OF LIFE IS INCREASED TWENTY-ONE YEARS

Largely through the aid of efficient hospitals, the average length of human life in this country has been increased twenty-one years in the past generation, according to a Chicago physician. He predicts that another twenty-one years will be added in the next half century so that it will be "unnecessary if not negligent for anyone to die before he is seventy-five years of age." One of the aims of the American Hospital association is to provide homes for patients who are recovering so that beds will be available in the hospitals for acute cases. Grading of nurse education is also being developed as one of the institution's most important activities, and it is said that the hospitals of America have more young women students than the universities and colleges.

Mr. S. S. Silmore

Louisville Ky. Before American Hospital Association Annual Convention

Acme Products Co., Parkersville, Pa.

Acme

658

622

50
data from above

GLASSES IN LIGHTHOUSE LENS OF THIRTY DIFFERENT SHAPES

663

Capable of intensifying light more than 1,000,000 times, the lens for one of Uncle Sam's light houses on the Atlantic coast contains

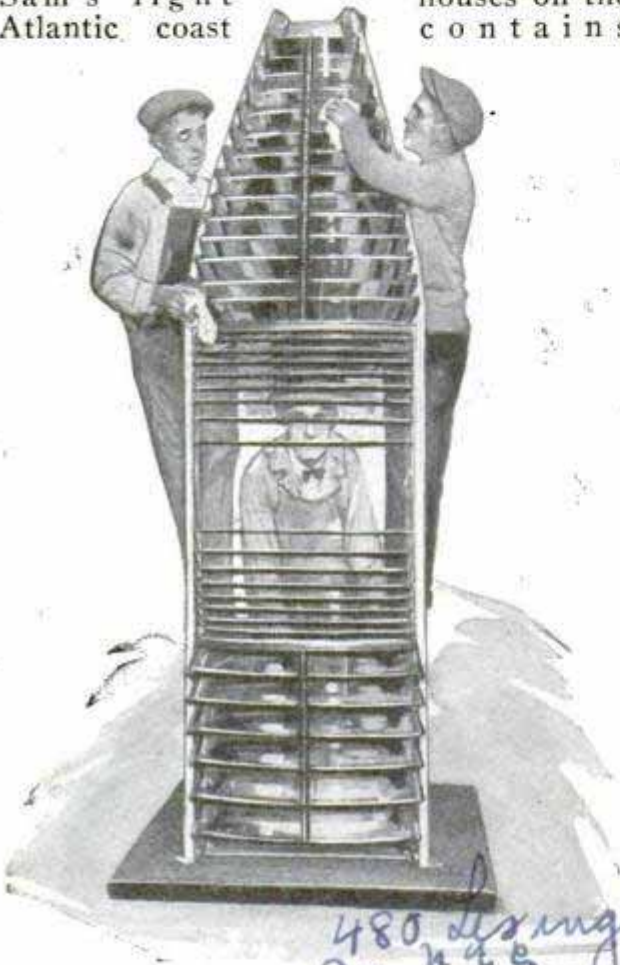

480 Lexington Ave N.Y.C.

© Kadel & Herbert

Polishing the Huge Glass Lighthouse Lens; Pieces Are Set to Intensify and Focus the Rays

no further data

glasses of thirty different shapes. They are so arranged that the beams are reflected and focused so efficiently that radiance from the oil lamp, which is the light source, is visible for several miles.

PERIL OF ARCTIC TRIPS SHOWN IN BIG TOLL OF SHIPS

619

The successful return of MacMillan and Amundsen from their latest expeditions to the north, recalls that many earlier explorers gave their lives to Arctic adventure and that a long line of sturdy ships has surrendered to the ice. Less than two years ago, William Nutting and three companions set out from Norway to follow the Viking trail to America in their little ship, the "Leif Erickson." They disappeared after leaving the coast of Greenland. Earlier centuries had their Arctic expeditions. In 1500, Gaspar Corteal, a Portuguese explorer, ventured in-

Kansas City Times

to Hudson strait in a small craft and was never heard from again. His brother and a number of companions who organized a searching expedition, likewise were lost. Four hundred years before there was a map of the Arctic, Sir Hugh Willoughby sailed into the north, later to be found dead with his crew and the ship frozen fast in the ice. Sir Martin Frobisher's search for the northwest passage in 1590 met with partial disaster when one of his three ships foundered in a gale. Bering made many expeditions during the middle part of the eighteenth century, but was finally wrecked on the island that now bears his name, and died, there, legend says, of a broken heart. After a successful voyage into northern seas with Peary, in 1893, and a relief expedition a year later, the "Falcon," commanded by Capt. Henry Bartlett, a skilled navigator, was lost with all her crew. The first "mariner of the air" to be claimed by the Arctic was Salomon August Andree, who, with two companions, left Spitzbergen in 1897 in a balloon fitted with sails and trailing ropes. They hoped to reach the pole and return, but a few of the buoys dropped from the basket as a means of tracing the expedition and a message brought by a carrier pigeon, were all that came back of the ill-fated venture. In May, 1845, Sir John Franklin, with 129 men and the "Erebus" and the "Terror," set out to find a northwest passage. Neither the ships nor any of the men returned. Thirty relief expeditions, over as many years, were sent in search of them, although a message found fourteen years after the men had sailed, stated that the ships had been crushed in the ice.

WEDGE-SHAPED AIR CUSHION ADDS TO AUTO COMFORT



Motor drivers are spared fatigue on long journeys by using an inflated, wedge-shaped cushion that may be adapted as a seat, as a back rest or as a buffer or pillow for the head, neck and shoulders. It also

places a short person nearer the steering wheel. It is made of a rubberized material in various colors, and when deflated occupies but little space. Blown up it is sixteen, and one-half by eighteen inches.

Airrubber Corp.

Chicago, Illinois

587



The Air-Mail Pilot's Headphones Are Built Right into His Helmet, So That When He Puts It On, He Is Ready to Tune In on the Radio Receiver in the Corner of the Cockpit

Aeronautics Radio to Banish Chief Danger in Flying

Air-Mail Experimental Laboratory Perfecting Wireless Guiding Beacon and Altitude Finder to Protect Flyers in Fogs

IN a tiny shack hardly twelve feet square, set down at the edge of a cornfield on the Illinois prairie a few miles from the Mississippi river, two revolutionary inventions are being perfected to remove the worst dangers which confront airmen.

One of the devices is a radio beacon, or compass, which will enable a pilot to fly straight from one point to another through the thickest fog or the darkest night. The other is a radio altitude finder, or altimeter, which will keep him at a safe height above the ground, free from the danger of crashing through fog or darkness into some mountainside.

The prairie laboratory is the experimental field of the United States air-mail service. On one side of the rutted country road, in a small clearing reclaimed from the surrounding cornfields, is the tiny experimental laboratory and the tall wooden lattice masts of the radio department. Across the way, at the edge of a meadow big enough for a plane to land and start, are a two-ship hangar, offices and shop. The place, at the edge of Monmouth, is many miles south of the trans-continental air-mail route, so that work can be carried on without any interruption from the planes that day and night

flash through the sky. In this out of the way spot, southwest of Chicago, most of the development work for the air mail is carried on. A measured test course stretches away to the south for the testing of new planes, both those built in the air-mail shops at Maywood field, Chicago, and new designs submitted by manufacturers. Three new types were tested a few months ago and models picked to replace the DeHavillands, which have been standard since the service started. In the radio laboratory, however, the most work is being done. The wireless beacon, originated by the bureau of standards, improved by the army signal and aviation sections at McCook field, is being perfected for standard air-mail and commercial flying. Like the beacon lights which stretch from New York to the Rockies along the night-mail routes, the radio apparatus of the air-mail service will be at the disposal of every commercial flyer, as well as mail or service pilots.

The radio beacon has already been tested successfully over distances of more than 200 miles on long wavelengths, well above the usual commercial range, and tests are now being made on sixty meters, with the idea that the shorter waves will



and then delivered by special messenger. The service, it is believed, would be specially useful to banks and lawyers, as it would be proof of genuineness, a point that is not true of telegrams.

The idea of a radio beacon to guide airplanes from point to point originated in Germany as far back as 1907, and was used with varying success to direct the Zeppelins in their raids on London, but

not only eliminate much of the static interference, but, by using less power, will make the stations cheaper to build.

Photo-Diagram of How the Radio Beacon Works; the Code Signals Sent Out on Each of the Triangular Aerials Interlock in One Zone to Form a Continuous Guiding Signal

With the present equipment, each station would cost about \$6,000, and it would take some fifteen or sixteen to span the continent on the New York-San Francisco mail route alone. The altitude finder, based on apparatus designed for the air mail by C. Francis Jenkins, inventor of the radio movies and a process for transmitting photographs by wireless, is still in the experimental stage, but already shows promise of success.

In addition to its other work, the experimental division also is testing the Jenkins picture transmitter with the idea of handling the air-mail orders between stations by sending a facsimile of the written sheet instead of trusting to the dots and dashes of wireless code. Eventually the picture system may be available to mail patrons as an additional way of transmitting a letter, faster by far than either train or airplane. In six minutes an exact facsimile of a letter, signature and all, could be transmitted from coast to coast

in its present form it is purely an American development. It is based on the fact, which every owner of a radio-receiving loop has learned, that the loop antenna has a directional effect and receives its strongest signals when pointed straight toward the transmitting station, while, when turned at right angles to the sending point, it fails to pick up the broadcast at all.

The same properties of receiving loops hold good when the sending station uses an antenna of this form, but in the radio beacon the air mail uses not one loop but two. They are of triangular shape, supported from a single wooden mast about seventy feet high, with the base wire eight feet above the ground, and 250 feet long.

The two loops are erected at right angles to each other. An automatic sending device transmits the letter "N," a dash and a dot in wireless code, on one loop, and sends out the letter "A," a dot and a dash, or just the reverse, on the other loop. An aviator with a receiving set, if he were in line with either loop, would receive only the signal transmitted by it, but halfway between the two, he would pick up both signals with equal intensity, while on either side of the halfway point, the farthest signal would gradually fade away, while that from the nearer loop grew stronger as he approached it.

The sending arrangement is such that when the flyer is in the equal-intensity zone, the two signals interlock. A wireless dash is twice as long as a dot, and a space equals a dot. What the aviator hears in the equal-signal zone is first the dash of

The interlock of the signals, however, turns all that into one long dash, a considerably magnified letter "T."

As long as the pilot, at five-second intervals, hears a steady "zzzzzzzzzzzz" in his phones, he knows he is right in the wireless beam and on his true course. But if that steady sound breaks up into separate signals, one half loud and the other faint, he is off to one side. If he is to the right, while flying toward the Monmouth beacon, there will be a loud "zzzz" for the dash of the "N," then a fainter "zz" as the dot of the "A" comes in, followed by a loud "zz" and a fainter "zzzz." If he is to the left of his course the signals will be reversed, the first faint, the second loud, and so on.

Pilot Burnside, of the test division, made a round trip from Maywood to Monmouth, a distance of 175 miles each way, on a day when visibility was so low he could not see a mile to either side, yet arrived safely at each landing field by simply listening to the beacon. The waves, of course, spread as they leave the aerials, with the result that the equal-intensity zone is two degrees wide. At the edge of the Monmouth landing from the antenna, the beam has broadened while at Maywood, 175 miles away, it is

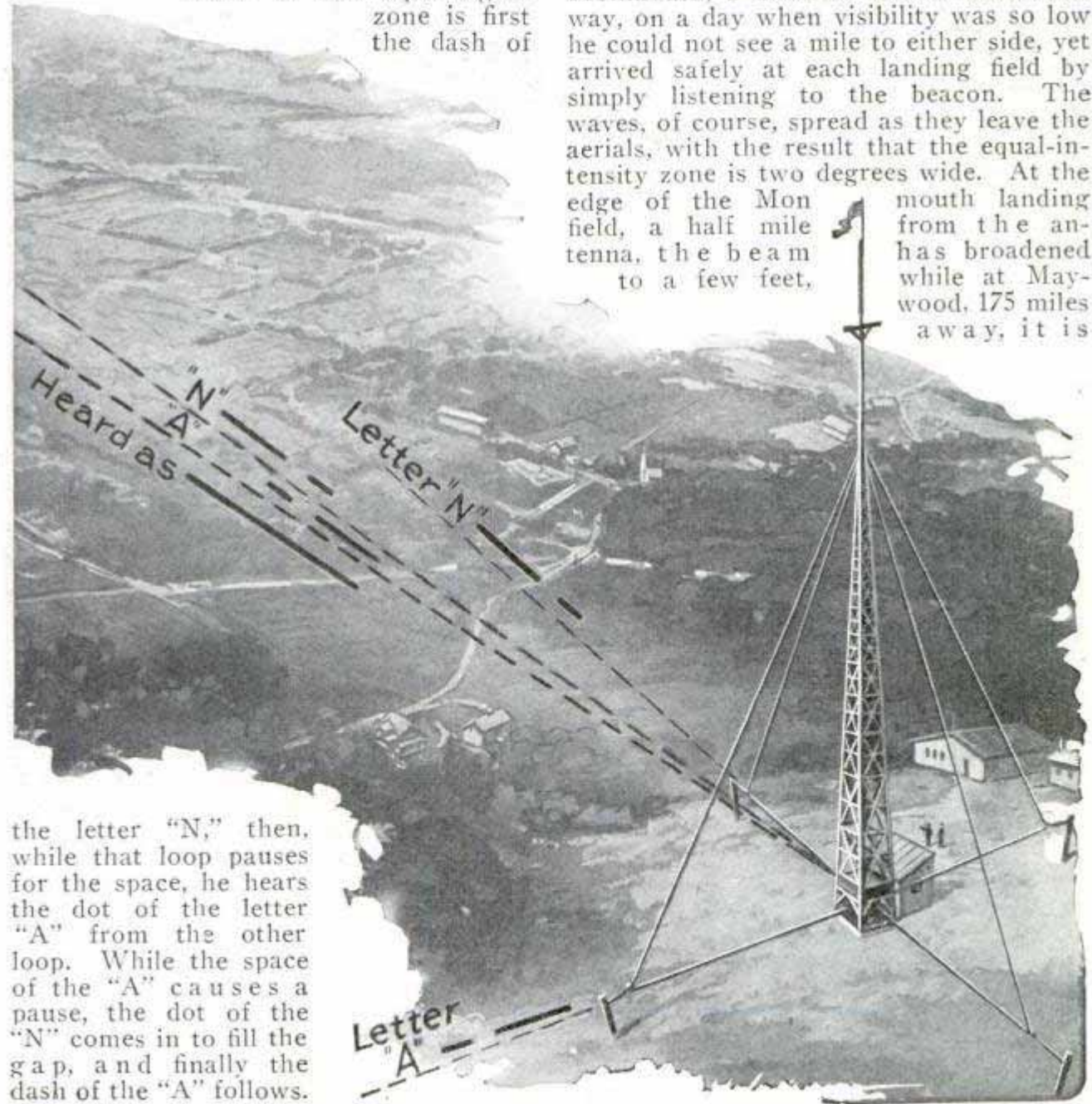

the letter "N," then, while that loop pauses for the space, he hears the dot of the letter "A" from the other loop. While the space of the "A" causes a pause, the dot of the "N" comes in to fill the gap, and finally the dash of the "A" follows.



about five miles wide, hence easily located by a pilot flying toward that field.

While, if both aerals contain exactly the same amount of wire of the same resistance and the same amount of current is used to send the signals in each, the equal-signal zone will be halfway between them, the zone can be changed at will by increasing the current in either aerial. No three of the air-mail fields are in a direct line, and after a pilot has flown from one to another in one beacon zone, it is necessary

Radio Altitude Receiver and Sender and How Signal Reflected from Earth Lights Lamp at Certain Height

to shift the beacon to guide him on to the third. The shift is accomplished accurately with a device called a goniometer, which can be set instantly for any point on the compass after it is once calibrated.

The transmitting set used is a standard radio telephone, so that the operator in charge can cut in at any time to transmit weather reports, orders or other information to the pilots. At present, the pilot will have no way of talking back, but a light sending set to be carried in the planes is also be-

5711

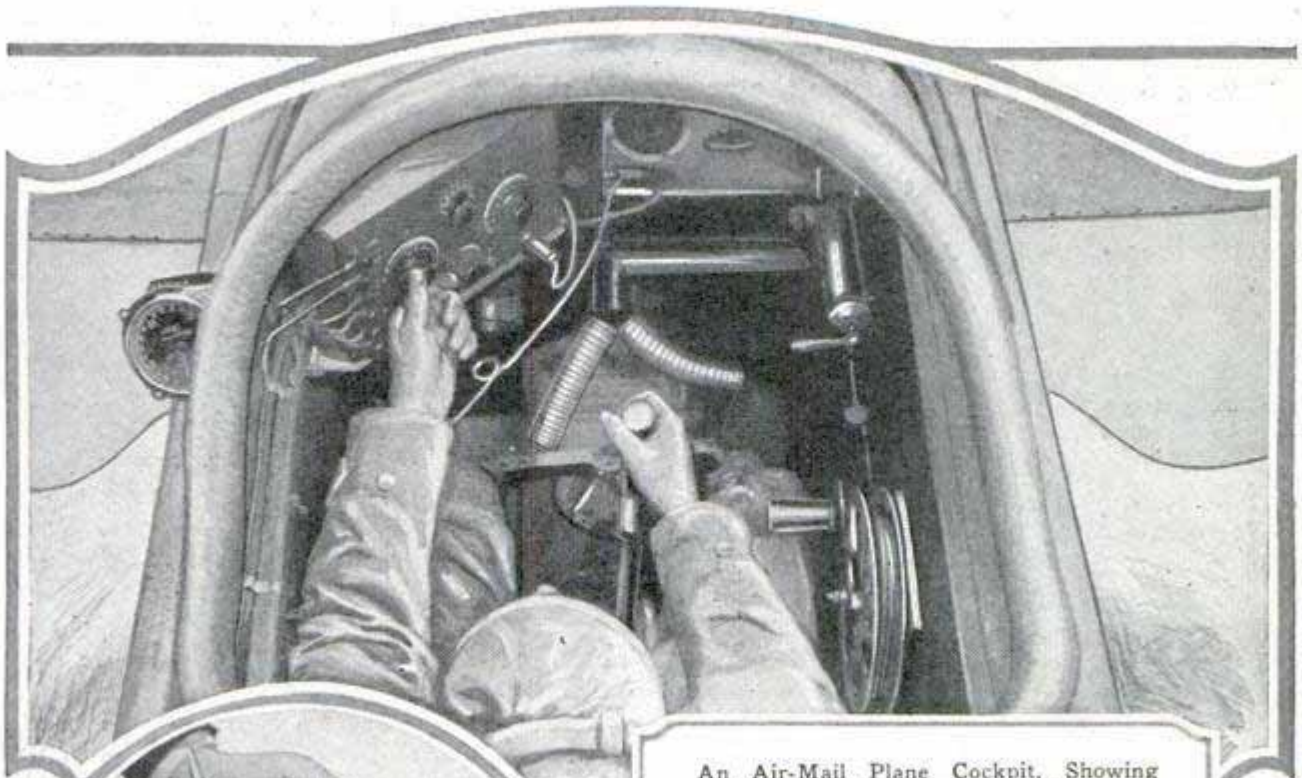

An Air-Mail Plane Cockpit, Showing the Corner Receiving Set, Where It Does Not Obstruct the Instrument Board, and, Right, the Aerial Reel, Both Out of the Way of the "Joystick" in the Pilot's Hand

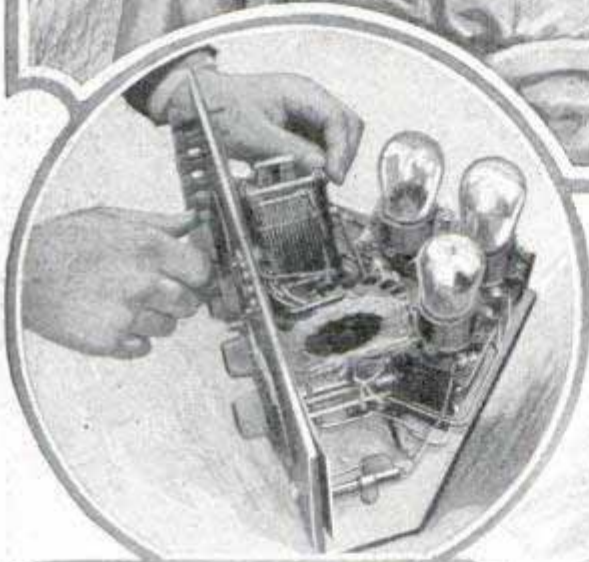

The Beacon Receiver Is Built Triangular to Fit in the Corner of Cockpit, Giving Unusual Grouping of the Tubes



With the Goniometer, at the Left, It Is Possible to Direct the Radio Beacon to Any Point Desired by Merely Shifting the Revolving Pointer; the Queer Apparatus in the Foreground, Driven by the Small Motor, Carries Notched Disks Which Automatically Send Out at Five-Second Intervals the Dots and Dashes Which Interlock to Guide the Plane; Above Is a Big Rectifier, Which Changes Alternating Current to Direct Current



ing developed at Monmouth. The radio altitude finder, being developed on the Jenkins idea, is even simpler than the beacon. It consists of a very small transmitting set, using only two ordinary radio-receiving tubes, and a small three-tube receiver. The pilot has only to turn on the sending current, which transmits an electrical wave to the ground, from which it is reflected back to the plane. A sensitive instrument on the receiving-set panel will measure the strength of the return signal, but instead of being calibrated in milliamperes, the instrument dial will show feet, since the strength of the returning signal will vary in accordance with the height of the airplane above the earth. The scale will read backward, the higher the plane flies the weaker the current returning.

Experiments are also being made in using a tiny electric-light globe filled with neon gas to give a visible signal. With it, the receiving apparatus will be set for any desired height above the ground at which the pilot wishes to fly. When the plane reaches that altitude, the light will come on, and remain on so long as he keeps his height. If the plane passes over a hill the light will go out, and the same will be true when a valley is reached. The wireless wave sent out from the ship does not follow a straight line to the ground, but describes a letter "S," and coming back, travels a reversed S-route, so that the two waves together form a figure "8." With the receiving apparatus set for a certain altitude, the two S-shaped curves will meet at that point, and be in phase, lighting the lamp. As they will not meet in phase at any other point, it follows that the light will glow only when the pilot is flying at his predetermined level.

The signal corps and air service at McCook field are developing a similar light arrangement for use in the radio beacon, giving a visible check on what the

pilot hears in his phones. Three small lights will be used, red, green and white. If the plane strays to the left of its course, the red light will burn; if to the right, the green will come on, while when the ship is in the interlocking beacon course, the white light will record the fact.

The beacon, post-office officials believe, would have averted many accidents in the past, notably the tragedy which cost the life of Pilot Ames only a few weeks ago. Leaving New York with the night mail, he became lost in the fog, and eventually crashed into a mountainside while trying to land beside one of the airway lights only six miles from his landing field at Bellefont, Pa. Had he been flying by radio compass, the interlocking signals would have guided him direct to the field. Some idea of the difficult terrain over which the night-mail flyers wing their way may be gained from the fact that, though Ames fell within six miles of his field, it took searchers ten days to locate the ship, the pilot being found dead at his controls. He had been struck on the head by a bit of flying wreckage.

The altitude finder would likewise have saved him from crashing into the mountainside by warning that the ground was sloping upward nearer and nearer to the mail plane. There have been several previous accidents in which flyers crashed into mountainsides, the most notable being the wrecking of the flagship of the round-the-world flight, piloted by Major Martin, on an Alaskan mountain.

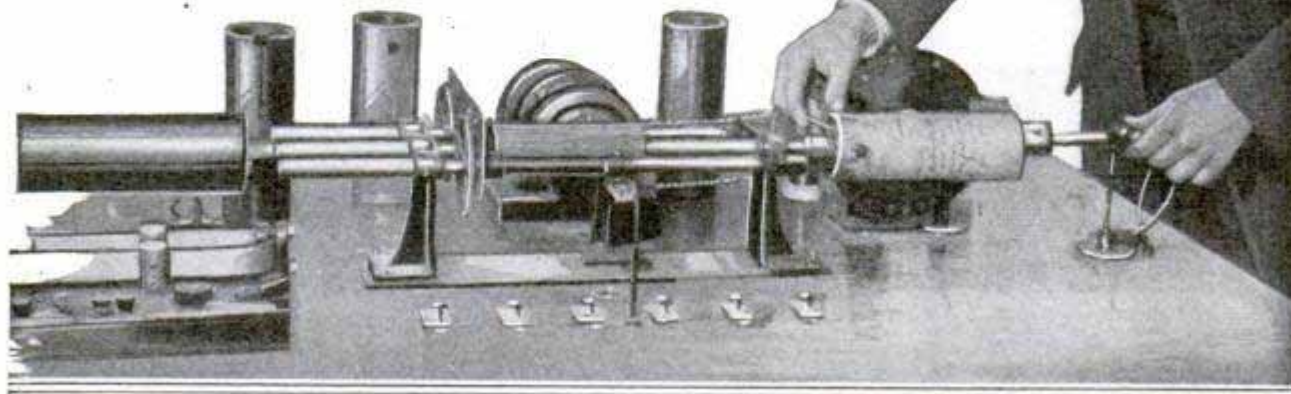

Radio-Picture Apparatus Used to Transmit Written Orders, Instead of Code; Some Day the Post Office May Send a Picture of Extra-Special Delivery Letters in This Way

PORTRAITS COPIED IN STONE FROM MOVIE FILMS

minute, the entire time that the model is needed. The film is developed and projected up-

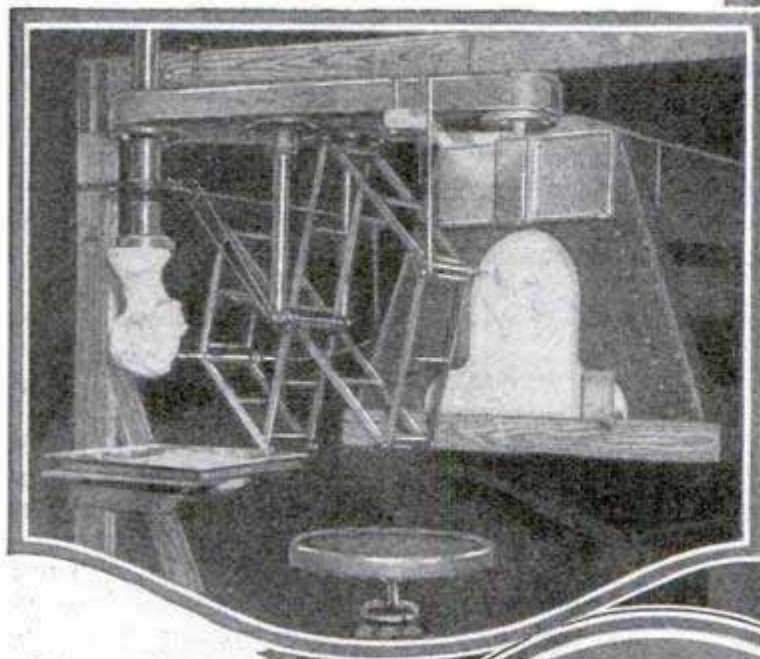

An unsatisfactory photograph of his little daughter, gave a Chicago man the idea for a carving apparatus with which he produces portrait busts directly from motion pictures of the model, who is required to pose but twenty-five seconds. The photograph's fault lay in poor lighting, parts of the face were in deep shadow, others too prominent.

The Copying Frame, the Artist at Work, and Daughter Holding a Bust of Herself

But in these masklike lines were the high lights and shadows a sculptor so carefully studies. The father, a mechanical engineer with a sense of the artistic, realized that a series of such pictures, taken from many angles, would give sufficient data for a bust. He therefore worked out his process, which consists in two main steps, taking the pictures and reproducing them in the desired material, stone, plaster of paris, marble or other substance. A pivot holder for a motion-picture camera is so adjusted that the instrument can be revolved completely around the model who sits in the center of the camera's orbit. Four hundred exposures are taken during only one rotation, which requires less than half a

on a small screen in the copying frame, an adaptation of the pantograph. Only one picture is exposed at a time, and each is exactly life-size. As the operator traces the lines and depressions in each exposure, a little motor-driven cutter attached to the other end of a

swinging arm which supports the copying instrument, reproduces the image of the film in a block of the material of which the bust is to be made. A turn of a crank exposes a new picture and at the same time shifts the bust so that the lines cut upon it will conform to the planes exposed on the fresh view. By the time a complete revolution has been made, the block has assumed what is virtually an exact copy of the camera's record. A particular advantage of the process, it is claimed, is that busts of children may be made with little difficulty, a feat that often the most skillful sculptors are unable to achieve because the young models will not hold still and it is hard to produce a life-like expression.

W. H. Englemann, 834 E. 51st St

CARILLON DIFFERS FROM CHIME IN NUMBER OF BELLS

664

Highest and lowest notes on a set of chimes have a difference of little more than an octave and an average of ten bells composes the installation, while a carillon must have a range of at least two octaves, a minimum of twenty-three bells. It attains a maximum compass of four octaves and a half, or fifty-three bells, as is the case with the carillon in the Park Avenue Baptist church in New York City. Many different melodies as well as harmonies or chords to accompany them are rendered by the carillon, and mastery of the instrument is difficult. In Belgium, there is a national school for instructing "carillon-neurs," the art being taught with as great thoroughness as other music branches.

wheelbase of fifty inches and a tread of about thirty-six inches. The rear axle and housing were shortened and oxy-acetylene-welded to make a jackshaft which was fitted with a pinion on each side, to mesh with the driver gears on the traction wheels. The tractor turns in a fifteen-foot circle, has a speed of two to two and one-half miles an hour, and besides handling plows, can drag a seven-foot or nine-foot harrow or three thirty-one-inch lawn mowers.

657

YEARLY COST OF EACH PAUPER THREE HUNDRED DOLLARS

Maintenance of a pauper in the United States averages \$334.64 a year, and each has 2.14 acres of land cultivated for his support, figures from states of the union show. The value of buildings and equipment devoted to their care is \$1,118.96 per person. Wide differences were discovered between the states. For instance, in Nevada the cost each year per capita of inmates in almshouses is \$865.10, while in Alabama it is only \$187.53. Property investment per person cared for in the charitable institutions and on the poor farms of South Dakota is \$5,600, and but \$415.63 in Mississippi. A reason for the high expense in certain localities was seen in a large number of small establishments with less than twenty-five inmates each.

OLD AUTO MADE INTO TRACTOR WITH BINDER WHEELS

Home made

By cutting down the chassis of an old automobile and making other alterations, the car was remodeled into a serviceable tractor that pulled one sixteen-inch or two twelve-inch plows with little difficulty and did other duties about the farm. Practically the entire outfit was constructed from what ordinarily would have been

*Shaw Mfg. Co.,
Ipswich, Mass.
and all necessary parts*



Saved from the Scrap Heap and Harnessed to Useful Farm Tasks; an Old Auto as Remodeled into Tractor

consigned to the scrap heap. The traction wheels were taken from an old binder, the lugs being removed and replaced with ones of two-inch angle steel. The chassis was cut down to a

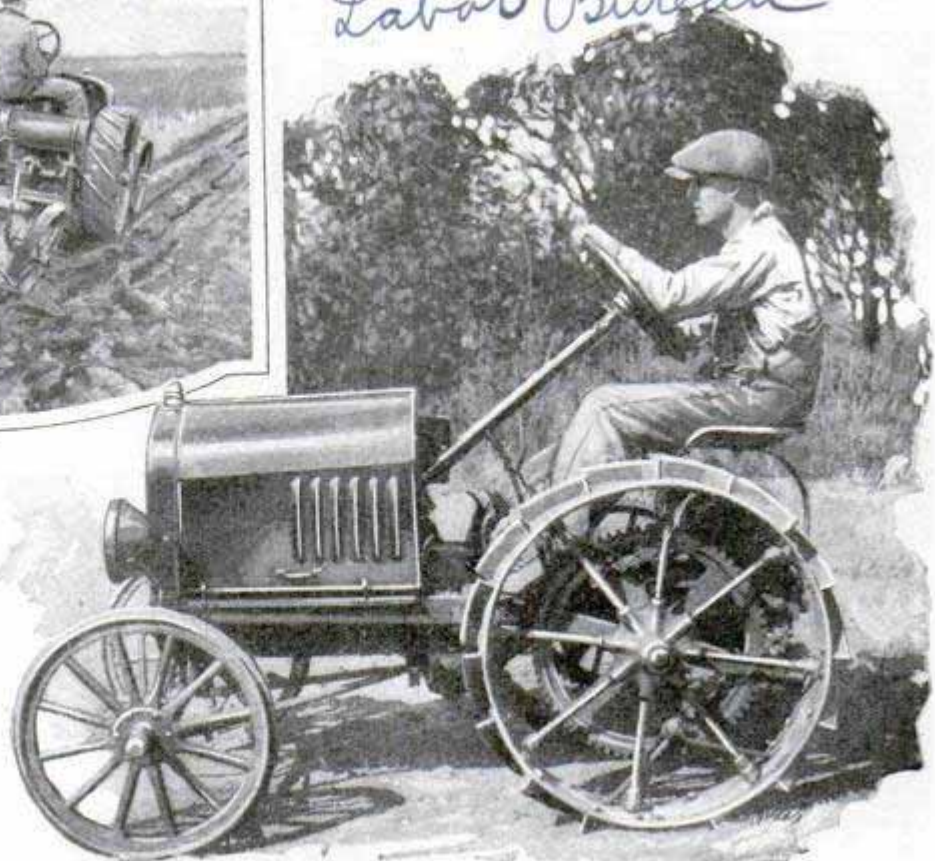

Labor Bureau



Unwary Owners Who Do Not Read Their Policies and Understand What They Cover, Often Lose for Failure to Obey Rules

AN autoist, hurrying down a narrow street, speeded up to pass a street car so he could turn into the track to go around a parked car. His effort to save a minute wasn't a success. With his car turned into the tracks at an angle of forty-five degrees, the street car caught its left side and shoved the right into the parked machine. Traffic was tied up for more than half an hour while the mess was unscrambled. The loss in time to those delayed, and the disruption of street-car service probably cost considerably more than both automobiles were worth. But that's another story—this one is about insurance.

Both the automobile owners had full coverage, and so their grief was somewhat allayed—until they tried to collect. After the wreckage had been removed from the right of way, the man who had lost a half hour and the use of his car by trying to save a minute caught a taxicab and hurried to the office. Pressing business occupied most of the morning, but about noon he remembered to notify his insurance agent. He explained the accident and the insurance office was very sympathetic, but very sorry. He was advised to read his policy again, and note particularly a clause which provided that, after an accident, the owner should remain with the wreckage until the insurance adjuster or garage man arrived.

The insurance company was properly sorrowful for his predicament, but he had left his car unguarded for hours, and that nullified its contract and he could collect nothing. And, as if that wasn't enough, the insurance company likewise pointed out he had violated another clause of his contract with it by not reporting the accident promptly.

The other fellow, the innocent victim

of the accident, whose car was standing still at the curb with no one in it, and who couldn't possibly in any way have been responsible for the accident or have avoided it, knew all about reporting accidents and guarding the wreckage to prevent pilfering of usable parts, which is the thing the insurance company seeks to guard against by inserting that clause.

He took the names and addresses of all the possible witnesses, got the story of the street-car motorman and the license number of the offending car, and then hopped into the nearest store, and, with one eye on the wreckage, called his insurance agent. The latter listened to his story and then explained he was very sorry, but the insurance issued by his company didn't cover the situation. The insured car, he explained, was standing still at the curb and his company's policies only covered damage incurred in accidents occurring while the car was in motion.

The only protection for the auto owner is to read and reread his policy until he knows every clause by heart, and, what is more important, understands the real meaning of the legal verbiage in which that meaning is guised. The insurance company tells you to read your policy, and prints that advice on it. If the insured fails to carry it out, the company is justified in disclaiming responsibility when you break the specific terms of your contract. Yet how many owners know what those terms are?

Suppose you are driving along the street; your attention is attracted by something in a store window; you look away for an instant, and ram the car ahead or brush a pedestrian aside with a fender. Do you get out and apologize for your carelessness or do you bawl out the other fellow for being in your way?

254

When You Brush a Pedestrian with Your Fender, Do You Stop to Get His Name and Report the Affair to Your Insurance Company? He May Sue You Months or Years from Now; If You Knock Down a Cyclist, Do You Know How to Make a Settlement?



damages without a fight, if there is any chance of winning that fight, and when you accept the responsibility, you have made it impossible for the company to fight.

You may have only brushed the pedestrian with a fender—not even knocking him down—and decided he wasn't damaged, so went right along without getting his name or reporting the facts to your insurance company. But he caught your license number, and a day or two, or a week or a year or several years later, he

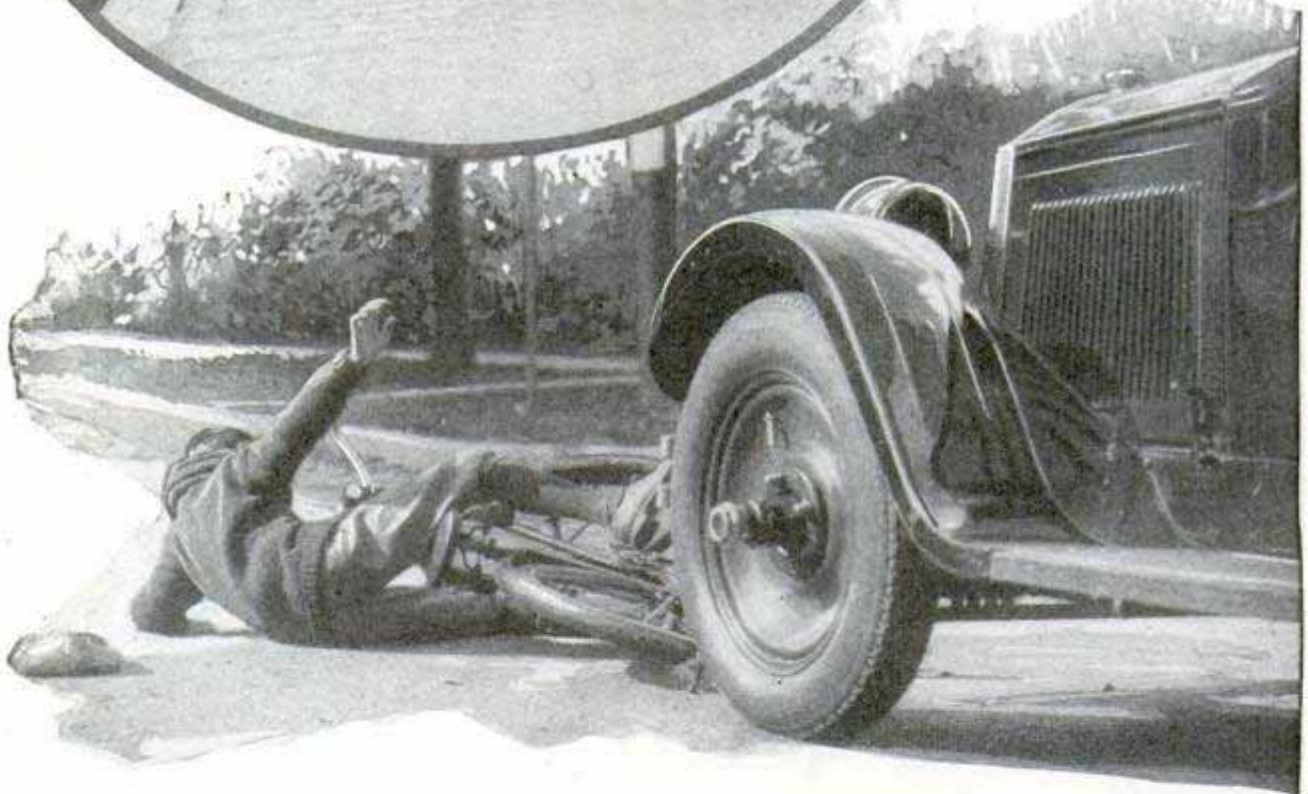

The first is the polite thing to do, but if you do it and he comes back with a suit for damages, you might as well kiss the money goodby, for your insurance company very probably will not stand behind you. You have violated another term of your contract, which says you must accept no liability for any accident, and when you apologized you implied you were responsible. The insurance company naturally does not want to pay any

may go to the hospital, claim he was injured by your car, get medical treatment, and then sue you for \$50,000 or \$100,000 damages. If he does, you haven't a leg to stand on with your insurance company. You didn't take the pedestrian's name and you didn't report the accident to your insurance agent promptly, as required. The company washes its hands of you, and you can face the jury alone. Suppose the pedestrian you hit is an eleven-year-old

boy playing in the street. He isn't injured much, outside of a strained back, and in a few days he recovers from that. You are very sorry for having hurt him, and gladly pay the doctor's bills and a bit besides, and, being a careful person, ask his mother, who is present, to sign a release from all damages.

Let ten years pass, and you have forgotten all about the affair until one day you are served with a summons in a damage suit for \$100,000. The eleven-year-old boy of ten years ago has just turned twenty-one; from some cause has become hopelessly paralyzed, and, under the advice of a doctor or lawyer, has decided that the slight injury a decade before is responsible for his condition.

Being a careful person, you put the release from all damages in your safe-deposit box and you bring it out and take it to your attorney. He investigates the case and then explains that in your state only the father can sign such a release for a minor child, and, as the father was away from home when you gave the lad a cash present and got his mother to sign the release, the paper is of no value.

You go into court. The boy, just on the threshold of manhood, is there with his physicians who will testify that he is a hopeless invalid for life. His potential earning power as a healthy man for the expectancy, or probable length of life, which insurance actuaries would credit him with, would amount to such huge figures that a sympathetic jury may not feel his claim for \$100,000 is at all too high.

Perhaps this case doesn't fit you—yet. You are insured, and if you hit a boy tomorrow, the insurance company, you say, will protect you. It will, up to the limit of your policy, but is that policy written to provide \$5,000 damages for injury to one person and \$10,000 for injury to two, or is it for some higher figure? And how far will \$5,000 or \$10,000 go in paying off a judgment for \$100,000?

You may have one of the bigger damage policies, paying \$100,000 for death or injury of one person and up to \$300,000



Spare Tires and Other Removable Equipment Are Not Ordinarily Covered by Insurance, But May Be if the Thief Tried to Steal the Car Too

for death or injury of two, and in that case you are fully protected, if—and note this carefully—the company which insured you is alive and paying damages ten years from now. Is your insurance in an old and established company which has a reasonable expectancy of being alive a decade from now, or did you shop around for the cheapest rates you could get, and buy a policy in some struggling concern which may have a run of hard luck because of too many damage claims and go into the hands of the receiver?

You can get good insurance that will cover every possible situation, if you pay for it, and get it in a company which writes policies with fairly reasonable clauses and avoids the jokers. The insurance you buy can be varied to suit your purse and your needs, and if you understand insurance you can save enough on some items to get extra protection on others. Suppose you store your car in a fireproof garage, where attendants are forbidden to smoke, that you always stop your engine before filling the gasoline tank, and that the make is a good one, with a well protected electrical system which has a good reputation for not catching fire. Under those circumstances you

254

might take a chance and dispense with fire insurance, or cut it to a minimum.

You may be able to save on theft insurance. Do you make a habit of leaving your car on the street for any length of time, and at the same place, where thieves can become accustomed to your movements? Is it a make popular with thieves: are you absent-minded and apt to leave it unlocked; if you have a private garage, is it likely to tempt thieves, and if you store your car in a public garage, is the owner a responsible person? All those things affect the amount of theft insurance you will need.

Collision and property-damage insurance will depend upon your carefulness as a driver, your nervousness and quickness to react to an emergency, whether other members of the family drive your car, whether you drive in congested districts, whether you have bumpers and a stop-light, the weight of your car, and whether, in an accident, it is more apt to inflict than suffer damage.

Liability coverage is something every one needs, and with the verdicts awarded in damage suits during the last few years showing a constant tendency to rise, the motorist cannot be too well protected.

When you buy a policy be sure whether it reads "insure" or "indemnify," for there is quite a difference. In a liability policy the company agrees to insure or indemnify you against loss by reason of the liability imposed on you for bodily injury or death of a person or persons. That is the approximate legal phraseology. It means that the company agrees to reimburse you

after judgment has been taken and the money collected from you. Obviously, the company cannot legally promise to pay you before the loss has been sustained.

But some companies will let you pay the judgment, and if you can't pay, they refuse to settle, since you have suffered no loss, as yet. But the judgment remains hanging over your head ready to be levied on any future property you may acquire. Other, and responsible companies, voluntarily pay legal claims out of their coffers without forcing policy holders to sustain the loss first. It is important to be sure which kind of company you hold a policy in. If it is the first, you may have an accident and then find your home taken away from you to pay the judgment, after which the insurance company will reimburse you.

If you have a standard policy, it may include, and you may have failed to note, a clause relieving the company from liability while your car is towing or propelling any trailer or other vehicle. If you have a touring trailer or are in the habit of helping unfortunate motorists by giving them a tow, be sure the policy is amended in writing to cover the point.

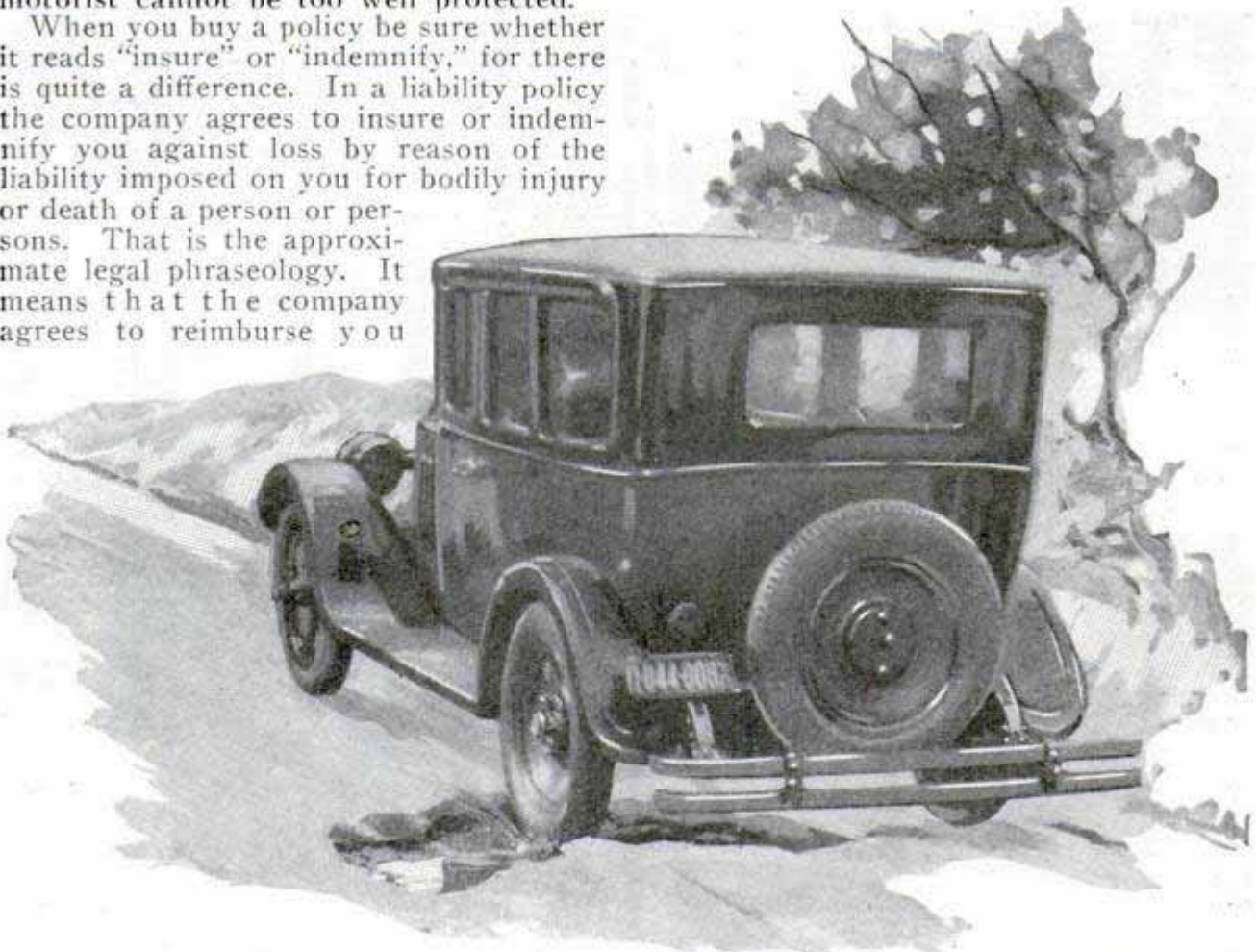

Collision Insurance, if You Have No Deductability Clause, Will Cover Damage Done to a Spring When Your Car Strikes a Bump or Drops into a Rut, But Costs Considerably More

254

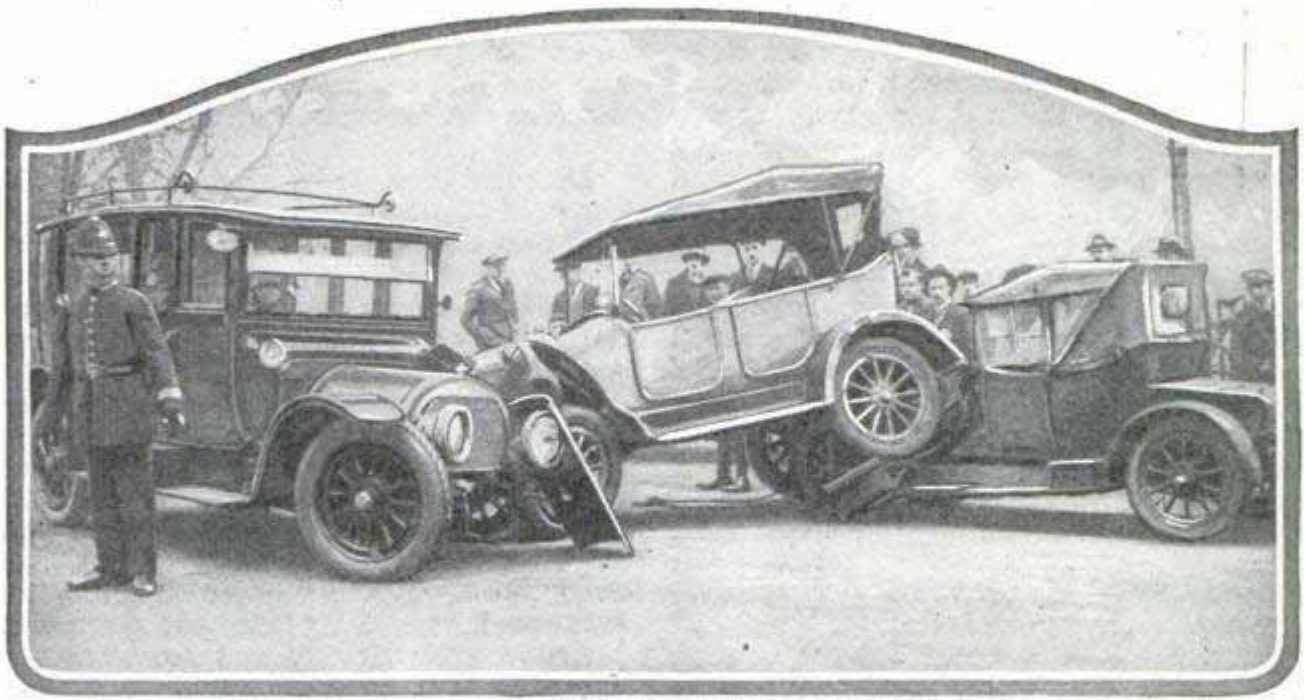

A Triple Crash in London; Either One of the Cars at the Right Might Be to Blame, a Nice Point in Fixing Damages; Fire Insurance Is Needed Often, But Is Cheap and Protects You against Accidents like That Below

If other members of the family or friends drive your car, you should be sure the policy covers any damage they may do to property or other persons. Most policies stipulate that the company's liability shall apply to you first, and then, if there is any balance of the liability left, it will apply toward judgments against your friend who was driving the car at the time of an accident. In other words, if you had \$10,000 liability coverage and a jury rendered a joint verdict against the friend who was driving and you as owner of the car, and that verdict was for \$8,000 each, your insurance company would pay your share, and apply the \$2,000 remaining to your friend's share.

There is an interesting legal point involved here. If your friend drove the car at your request, he is acting as your agent and you are responsible for any damage he does. If he asked permission to drive the car, then he alone is responsible. But if your policy covers not only your liability but that of family and friends, then your insurance company will protect him up to the limit of the policy.

If your chauffeur or a garage employe takes your car out without your knowledge and has an accident, then your policy does not protect him, but does safeguard you.

On the other hand, if you send the car to the garage for repairs, and during the

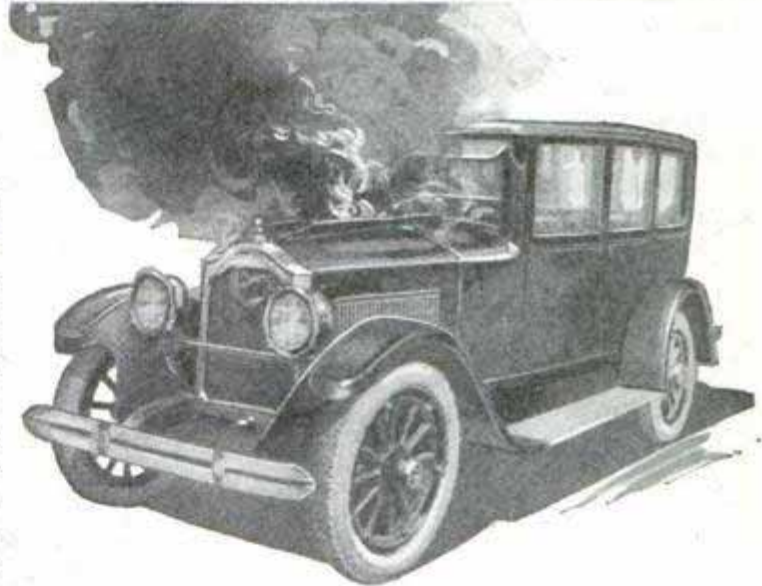

course of the work it is taken out by a garage mechanic for testing on the road, and he has an accident, the injured person has a good chance of getting a verdict against you, particularly if you have money and the garage employe or owner has not. In this case your insurance policy will be absolutely worthless unless you have made sure that it does not contain a clause disclaiming liability in event of any accident incurred while demonstrating or testing the car.

There are even jokers in the theft policies. In large cities, it is common in standard policies to class spare tires, spotlights, motometers and other easily removed accessories with the tools and repair equipment, and refuse to insure them against theft, unless they are stolen along with the entire car.

But suppose a thief tries to steal your car, pushes it around the corner, is un-

able to get it started, and then steals the spare tire. You present a damage claim for loss of the tire, but the insurance company may deny it, on the ground that you still have the car. Unless you get the thief and have him admit he tried to steal the entire car, there is not much chance of collecting.

Few autoists know that their insurance policy will cover injuries sustained by members of their own families, suffered while the insured is driving the car. Yet a jury in a New Jersey court recently awarded a verdict of \$800 to a girl whose nose had been broken while she was riding in the automobile driven by her father. To fix the liability of the insurance company, the girl brought suit, naming her father as defendant and charged him with reckless driving. The jurors decided she had proven her case and awarded the verdict, which was against the father, but came under his insurance policy, so the insurance company had to pay.

In a similar case in New York, a mother, as next friend to their minor child, brought suit against her husband, alleging that the father told the boy to wait for him on the running board of the car, and then returned, jumped in and started

to drive off, forgetting about the boy, who was thrown to the street and injured. The suit was just a friendly one simply to determine the amount the insurance company should pay.

In both these cases the owner of the car carried adequate insurance, but there is always the possibility that an uninsured autoist may some day face the same situation, have a jury decide against him, and have to pay the indemnity out of his own pocket.

Damages awarded by juries, as has been pointed out, show a constant tendency to increase. Death cases where \$5,000 to \$10,000 insurance once offered adequate protection, now are settled with verdicts for anywhere from \$15,000 to \$50,000, or even more. When you buy liability insurance, it is well to learn the temper of juries in your vicinity and see what size damages have been awarded.

This is only a bare outline of some of the things that may happen to you if you don't read your auto-insurance policy, and read it until you understand every phrase. There are plenty more, and if you ask a friend who has had an accident, he probably can tell you some of them from personal and sad experience.

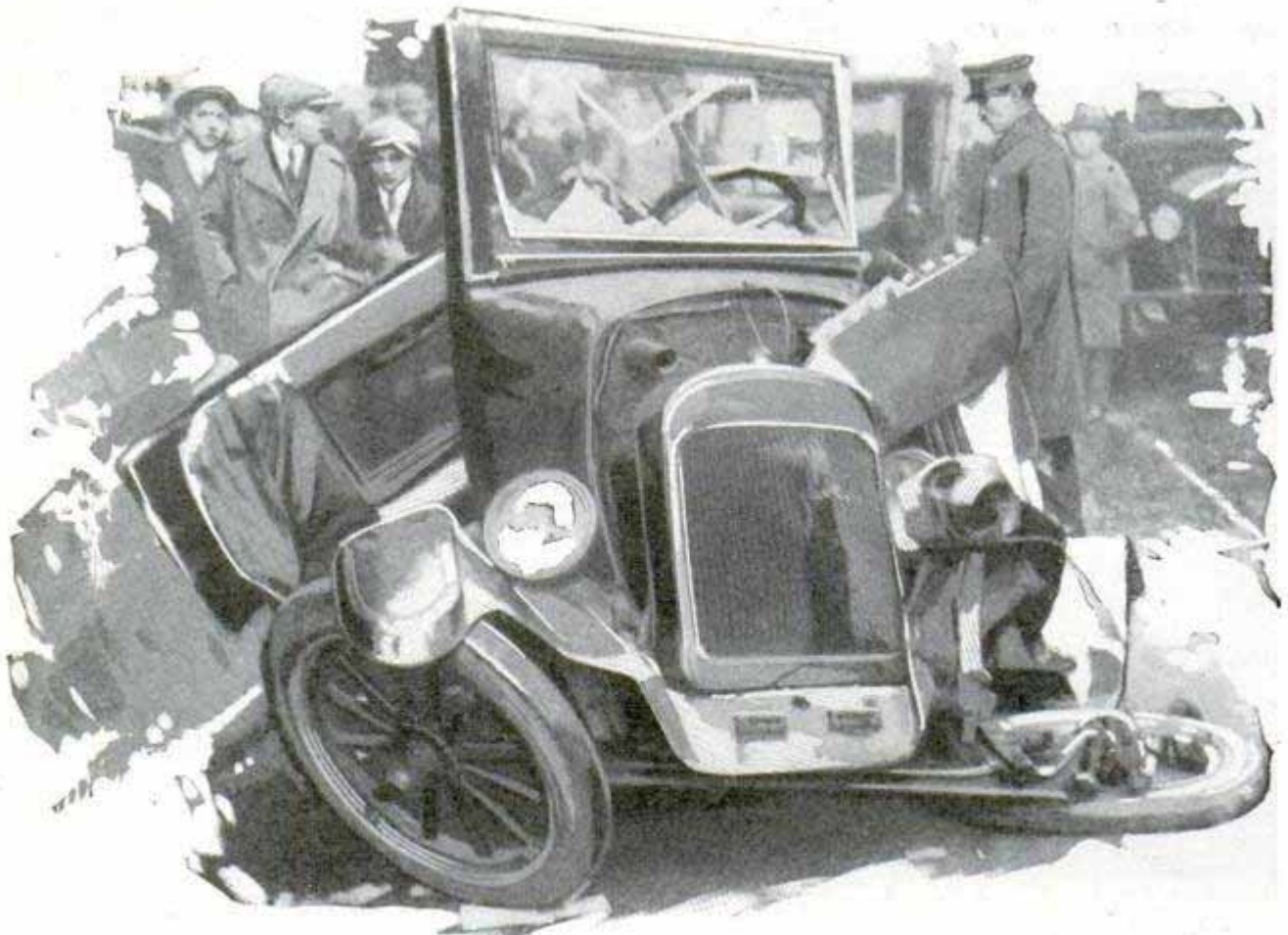

If You Drive in Heavy Traffic, Are a Poor Driver, or Are among Other Poor Drivers, the More Accident Insurance You Carry the Better; a Street Car or Truck May Do This to You Any Day

FISH AND WHALES ARE LABELED TO TRACE MOVEMENTS 683

To find out how long whales live, how far they travel, and other facts concerning them, small identification darts are fired into the thick layer of blubber on the back of the monsters with a specially designed crossbow. Each dart has a label attached, and hunters, finding one of the tagged whales, report the legend on the marker, a record of which is kept at the British colonial office. This plan of identifying creatures of the sea is also applied to salmon, mackerel and haddock. The fish are caught in a trawl net, and the best specimens are labeled with two disks, held together by silver wire, which is threaded either through the back fin or the hard lap covering the gill. The disks are marked with letters and numbers, and for the capture of each fish and the report of its marker, a reward is paid. By this means, it was found that one young plaice covered 210 miles in eight months, another 175 miles in three months. A salmon labeled in the spring of 1919 was three feet long and weighed thirteen pounds. Recaptured the next autumn, it had doubled in weight and had grown six inches in length. Even crabs travel long distances. One was found 100 miles from the place where it had been tagged.

FOLDING LID FOR CAMP BUCKET FITS IN GRIP 623

Fastened with strong spring clips and fitted with a screen strainer on one side, a folding top for the camp bucket can be carried inside the grip or tucked away in almost any small space. It is made of galvanized steel and is adaptable to many uses, as on a minnow pail, a lid for the cooking pot—the screen permits easy draining—or a cover for the water bucket. One side of the top can be raised to permit the use of a cup or dipper, and the screen holds back sticks and refuse in case the container is used for filling the automobile radiator.

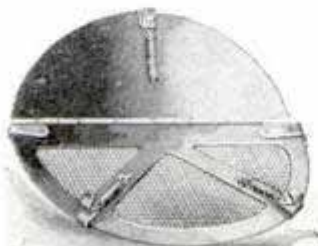

Wallace Hardware Co.

GIANT HORSES CARVED IN STONE FOR KING'S MEMORIAL 652

Details of the monument in honor of King Victor Emanuel II in Rome include the figures of enormous horses which

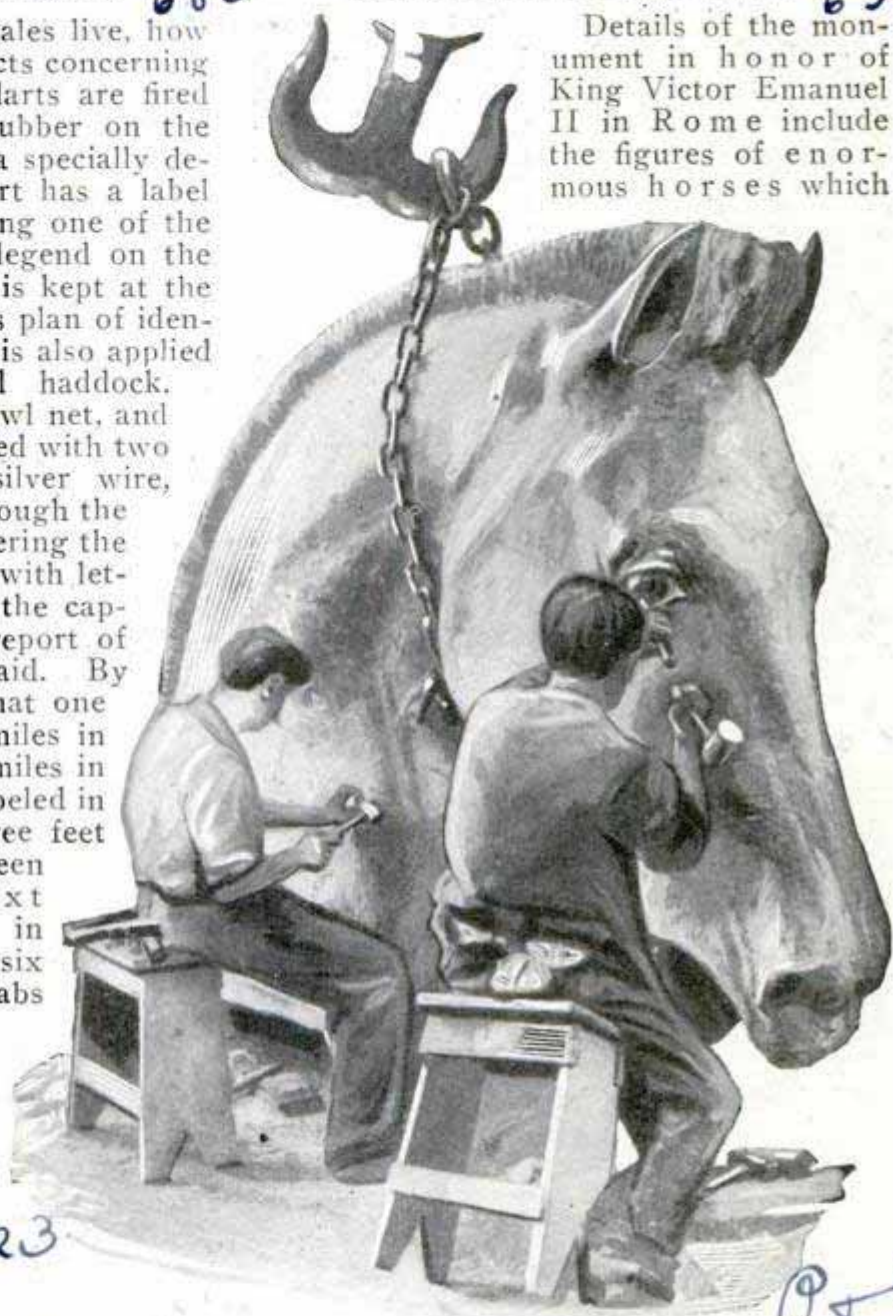

Carving Horse's Head, One of the Details of Huge Monument to King Victor Emanuel II in Rome

were carved in sections and put in place with tackle because their huge size forbade shaping them as a single unit. Although the replicas are not intended for close scrutiny, they are accurately and carefully fashioned.

MIRRORS AID TO SUN IN DRYING AND COLORING MACARONI 685

By using mirrors to supplement the sun in drying macaroni, manufacturers of the product have found the color to be more satisfactorily preserved, since the deep yellow tint is not bleached so easily, and the flavor also is said to be improved. The process is quicker than sun-bleaching.

Pub. George H. Holden, Eng. Highfield & Newington, London. Westwood, Chesterfield, Eng.

ROLLERS HOLD WINDOW SASH WITHOUT WEIGHTS AND CORD

COLLEGE HAS "TIN-PAN ALLEY" TO TEST GALVANIZED WORK

365
Compressed Air
Holder Co 1830 Tribune
Tower, Chicago

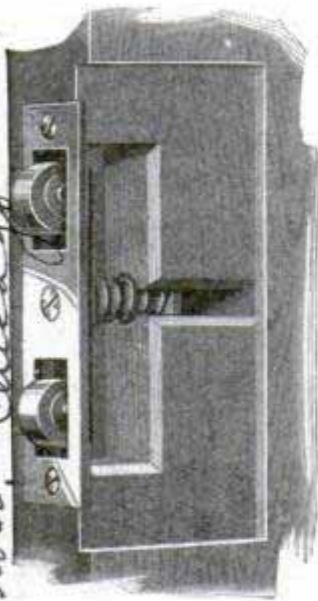

624
Windows are held at any desired level by a pair of rollers attached to an adjustable tension spring. They are set in the side of the sash and simplify installation, since no space is needed for weights and cord, and the frames can be placed against a brick wall if desired. The tension of the spring may be adjusted so that

Steel articles that have been coated with zinc, cadmium, lead, nickel and other metals through different galvanizing processes are to be left out in the open for an indefinite period, possibly thirty years, at Pennsylvania state college, to test the ability of the objects to resist corrosion. The experiment ground has been called "Tin-Pan Alley" and the "Acre of Metal." A wide variety of specimens has been selected for the time and weather test, including drinking cups and sheet roofing

it will hold a heavy window as securely as a lighter one.

Holder - 85¢
Sash & Holder - 1-25

FOLDING BAG FOR FISHERMEN FITS IN SUITCASE

578
Fishermen are spared the trouble of extra luggage by a folding creel that fits flat when collapsed, so that it can be carried in a suitcase, is easily strapped to the saddle or may be tucked under the automobile seat cushion. It is made of water-proof duck which has been treated to prevent mildewing. is bound with leather and rubber-lined. There are no rods to adjust, ventilating holes are provided, and a pocket for bait is arranged in the top.



There are no rods to adjust, ventilating holes are provided, and a pocket for bait is arranged in the top.

GROWTH OF CEMENT INDUSTRY SPURRED BY PAVING

607
The United States now produces more Portland cement than all the rest of the world combined, government figures show, and the rapid growth of the industry is seen in the increase of shipments. In 1914, the total amount was 86,437,956 barrels, while the estimated shipments for last year were 145,747,000 barrels. Nearly twenty-five per cent of this total was consumed in paving and road building. In eight years, the demand for cement for road purposes alone has increased more than 400 per cent.

Los Angeles Calif
Sunnymore Mfg Co. Inc
700 S. Los Angeles St.

WAYS TO IMPROVE BEDS SOUGHT BY STUDYING SLEEPERS

682
While twelve young men students at two eastern schools slept in specially prepared cots, scientists each night studied their movements to learn the effects produced by different types of beds and bedding, and the relation between fatigue or various mental conditions and sleep. A recording apparatus was attached to each bunk for registering the degree and time of movement of its occupant, to indicate periods when there was not complete relaxation. Another instrument gauged the mental alertness of the subjects, their degree of tiredness or efficiency. The experiments are to be conducted over a long period, possibly for several years, to obtain facts from which reliable conclusions may be drawn, so that better conditions for sleep may be achieved.

WOOL MUDGUARDS FOR ANKLES PROTECT AGAINST SPLASHES

639
To shield the stockings from mud splashed by automobiles in wet weather, women are wearing gaiterlike protectors of wool. They fit tightly about the ankles, are easily removed or put on, prevent damage to fabrics, and afford comfort in cold weather.



no data

Dr. H. M. Johnson
Mellon Institute
University of Pittsburgh
Pittsburgh, Pa

Los Angeles Calif
Sunnymore Mfg Co. Inc
700 S. Los Angeles St.
University of Pittsburgh
Pittsburgh, Pa



By HAROLD T. WILKINS, *4, Crowhurst Road, Brixton S.W. 9, London, Eng.*

ELIMINATING massive scenery which cost more than \$20,000 for a single set, a new electrical effect achieved by the Paris opera has made possible a far more realistic scene, with no equipment beyond a simple white sheet, made transparent by glycerin, and a battery of light projectors. The first scenery-less scene attempted showed the rush of the messengers of Odin in Wagner's "The Ride of the Valkyries."

The success of the experiment added another credit for the stage electrician, who is fast becoming the most important man back stage. The old equipment of footlights and an occasional spotlight has been replaced by huge installations, such as that at Drury Lane theater, London, which uses between seven and eight thousand lamps, ranging from individual colored globes to huge searchlights and

manmoth "sun" arcs, consuming one hundred amperes each.

The master electrician who controls the enormous back-stage switchboard and achieves the lighting effects that make modern spectacular dramas possible must not only know his lights, but know the play as well as the man who wrote it. An opera-house electrician is required to know every note of the score of every opera produced just as well as the director of the orchestra. With his own copy before him on the music rack, the electrician plays the opera through in lighting effects, moving the multitude of switches in accordance with his penciled notes on the sheets of music.

The old-fashioned equipment for the valkyries' ride in the Wagner opera required several tons of properties, including a tremendous assemblage of tower-

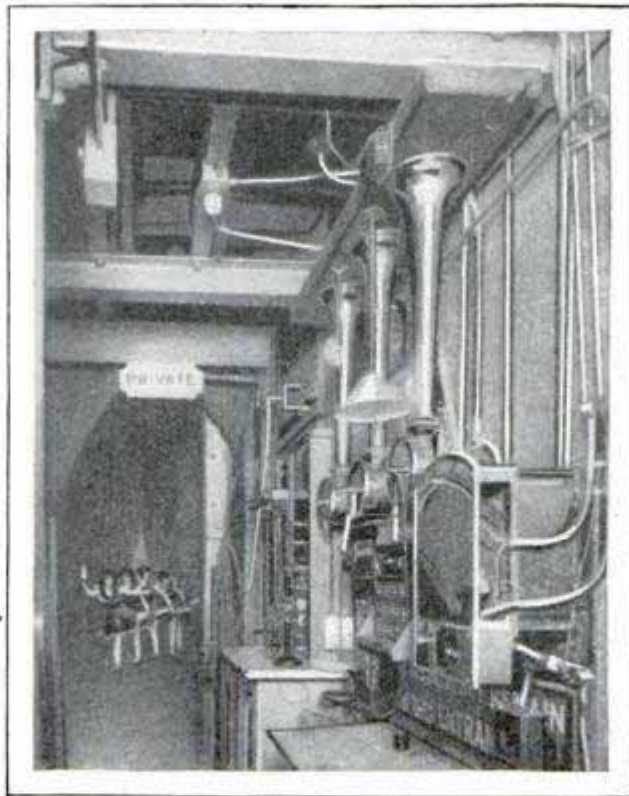

What the Stage Manager Sees from His Corner—a Glimpse of a Rehearsal

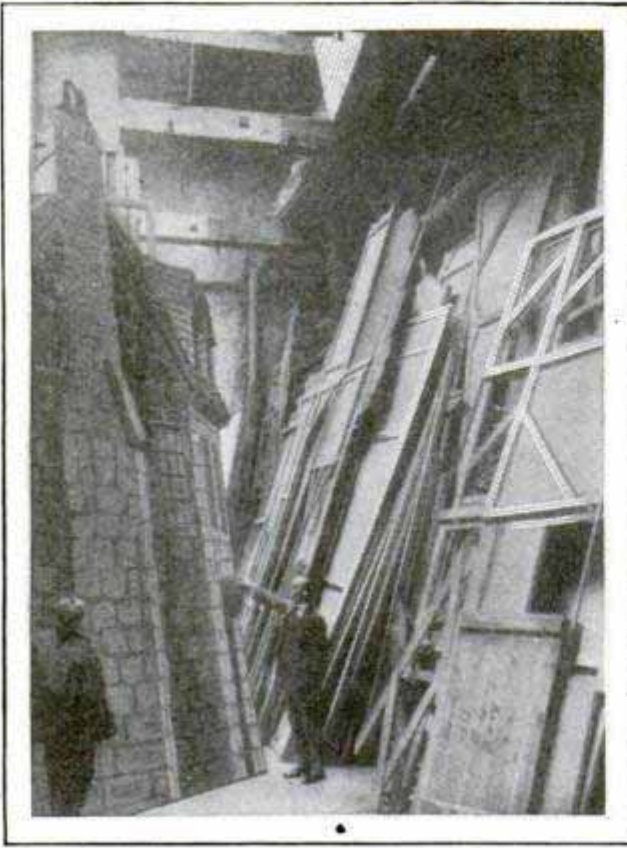

In the Scenery Studio Where a Wide Range of Settings Are Constructed and Painted

ing mountains and fantastic properties, with the movable specters mounted on iron rails. As played by electricity, the scene uses a few glass slides, three projectors and the white curtain at the back of the stage. The singers on the stage are illuminated by spotlights in the wings, instead of footlights, so their shadows will not be cast on the transparent back drop. The valkyries themselves are painted on one set of glass slides, the background on

another and the sky on a third. Sky and background move across the transparent sheet in opposite directions, while the valkyries, appearing very small near one corner, grow larger and larger as the projecting focus is changed, and at the same time move toward the center of the sheet, until they appear to fairly leap out of it. The projectors are located behind the scene, throwing the light through it, just the reverse of movie projection.

The stage effects used in a spectacular production such as those featured at Drury Lane consume an enormous amount of electricity. A single scene from "Decameron Nights," one of the big spectacles, used 184 big 500-candlepower lights just to illuminate the set, in addition to all the special lights which produced various effects. Back stage there are two huge switchboards, one in a fixed balcony, where the master electrician presides, and the other movable so that it can be placed at any desired point in the wings. Each battery of lights is controlled by a separate switch, with twelve positions, giving as many gradations from full light down through various shades of dimness until the current is shut off.

In the Boccaccio presentation of Damascus splendor, a huge company of crusading knights in glittering armor, swords at their sides and with the cross of the crusades blazoned on each breast, gather with tonsured monks in the vast nave of a Gothic cathedral setting. They face the high altar and, to the tones of a huge organ, chant the solemn Gregorian music of the Middle Ages. As the chant dies away the artificial sunbeams, pouring down in



Property Room and Some of the Craftsmen Who Construct Materials for Special Scenes; Their "Stock" Ranges from Frescoes for Egyptian Tombs to Children's Gocarts

100

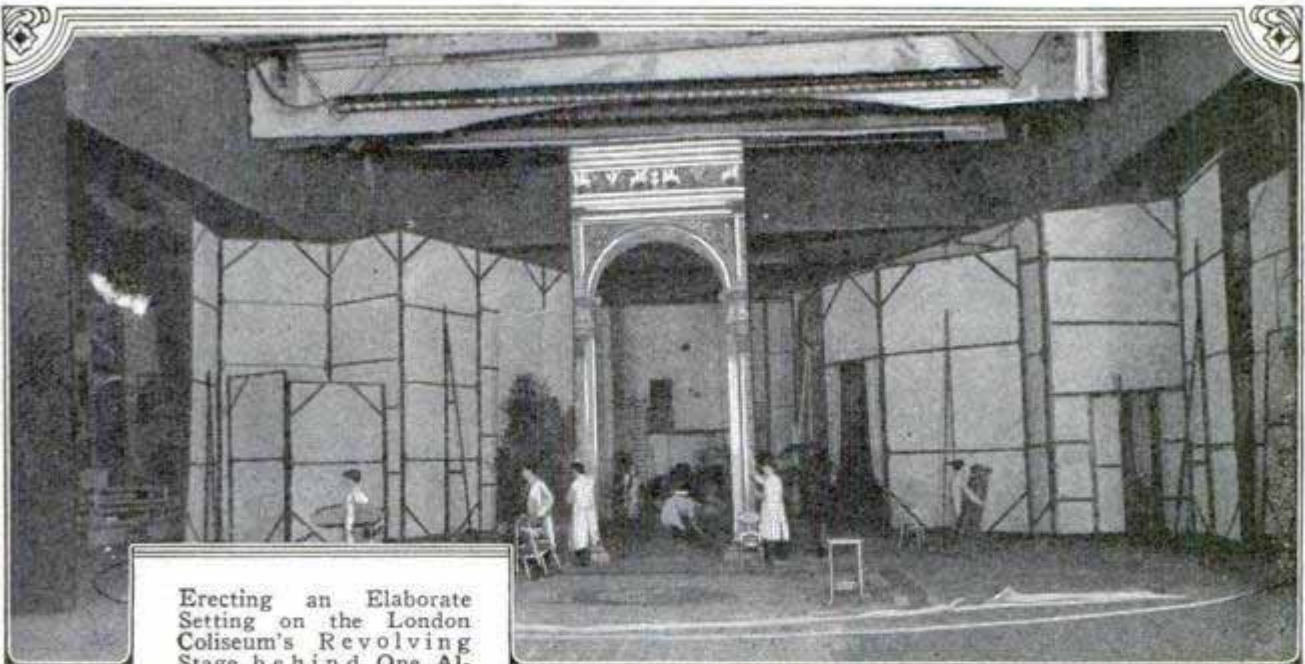

Erecting an Elaborate Setting on the London Coliseum's Revolving Stage behind One Already Set

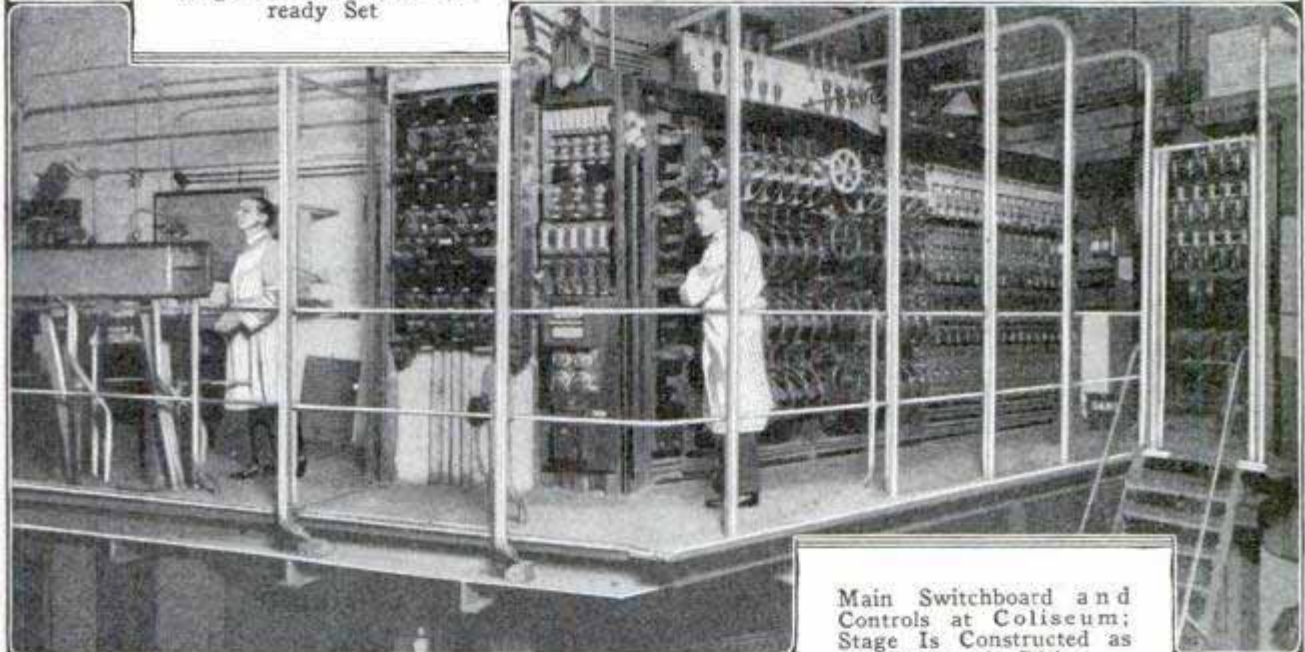

Main Switchboard and Controls at Coliseum; Stage Is Constructed as Concentric Disks

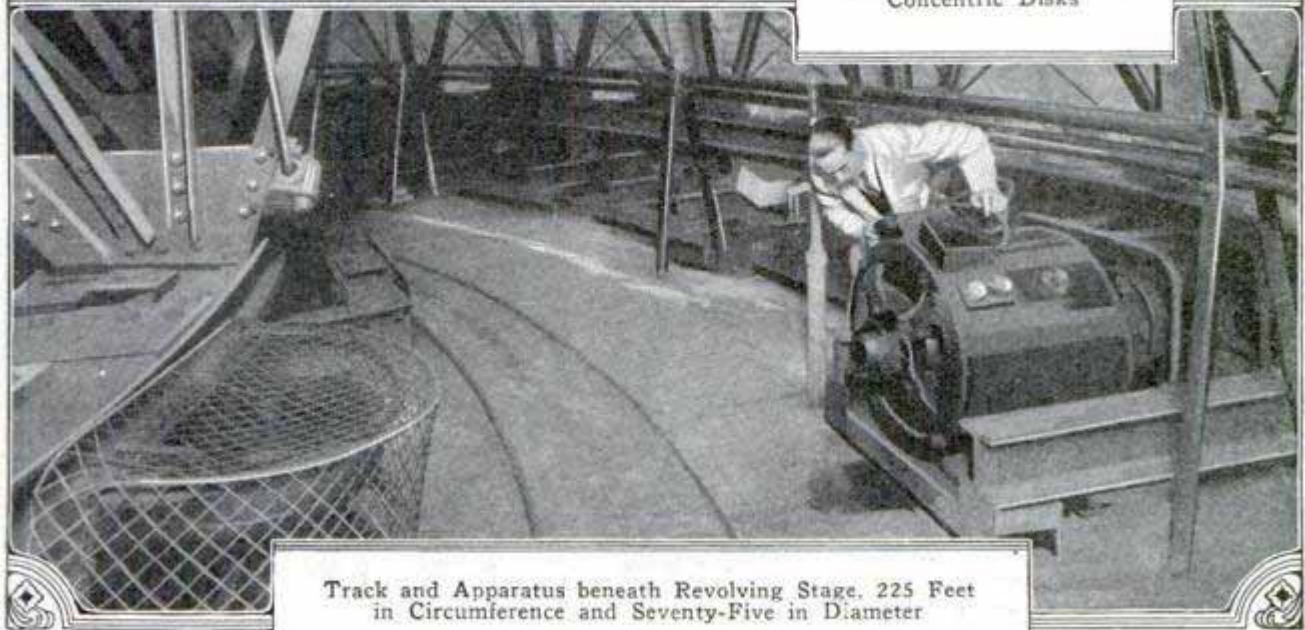

Track and Apparatus beneath Revolving Stage, 225 Feet in Circumference and Seventy-Five in Diameter

dancing streams through stained-glass windows, pale and the knights file out, bound for the gates of Jerusalem. The picture slowly dissolves as the lights in the cathedral grow faint.

Again the curtain rises and the audience is transported to the Bridge of Sighs, watching through the colonnades as the gondoliers dreamily glide down the canals of Venice, singing their boating songs. Again the magic carpet of lighting changes, and the spectators see the hanging gardens of Damascus, then enter the palace of the Soldan, with its baroque splendors of Oriental light and color, picturesque eastern mobs and be vies of dancing girls in voluptuous seraglios. The climax comes when the whole company descends, in front of the audience, a staircase leading down behind the footlights, the Soldan of Egypt resting on the shoulders of his attendants, and behind him Saladin, Prince of Damascus.

Back stage, in wings and galleries rising nearly 100 feet above the stage, and below the scene in hidden pits, a small army of unseen workers have carried the scenes through. Even the descending staircase, where none had been before, was manufactured in a twinkling by engineers so far removed from the stage that they were directed by flashing electric lights and could only see the stairs take form by watching their gauges which reflected the movement.

Hanging from the walls of the wings, and stretching across stage far above the proscenium arch are row on row of lighting bridges, lined with big lights and banks of small ones. Huge panorama lights, with seven ranges of colors and thirty-six 2,000-candlepower sun arcs, which can be slowly dimmed or strengthened, give realistic sunrise or sunset effects. Ten banks, each containing 260 forty-watt globes, with three color circuits, sweep waves of color across the actors and scenery as desired. Down from the high lighting galleries in the wings an even dozen white lights, of 24,000 candlepower, cast brilliant light over the stage. Another battery of these 2,000-candlepower globes is spread along the front of the stage, just before the footlights, to paint out shadows which may be cast by the lights from above.

On either side of the stage, five horizon lights, also of 2,000-candlepower each, chase the shadows from the tops of towering scenery, or sweep across the stage level. And if even more and whiter light is desired, there are batteries of oxygen tanks and gas containers ready to illuminate groups of big limelights, capable of throwing the mountain peaks or castle turrets of spectacular scenes into high relief.

The color lighting of iridescent costumes is controlled by a group of high-power arc lamps and an extra battery of twenty-four limelights. On either side the

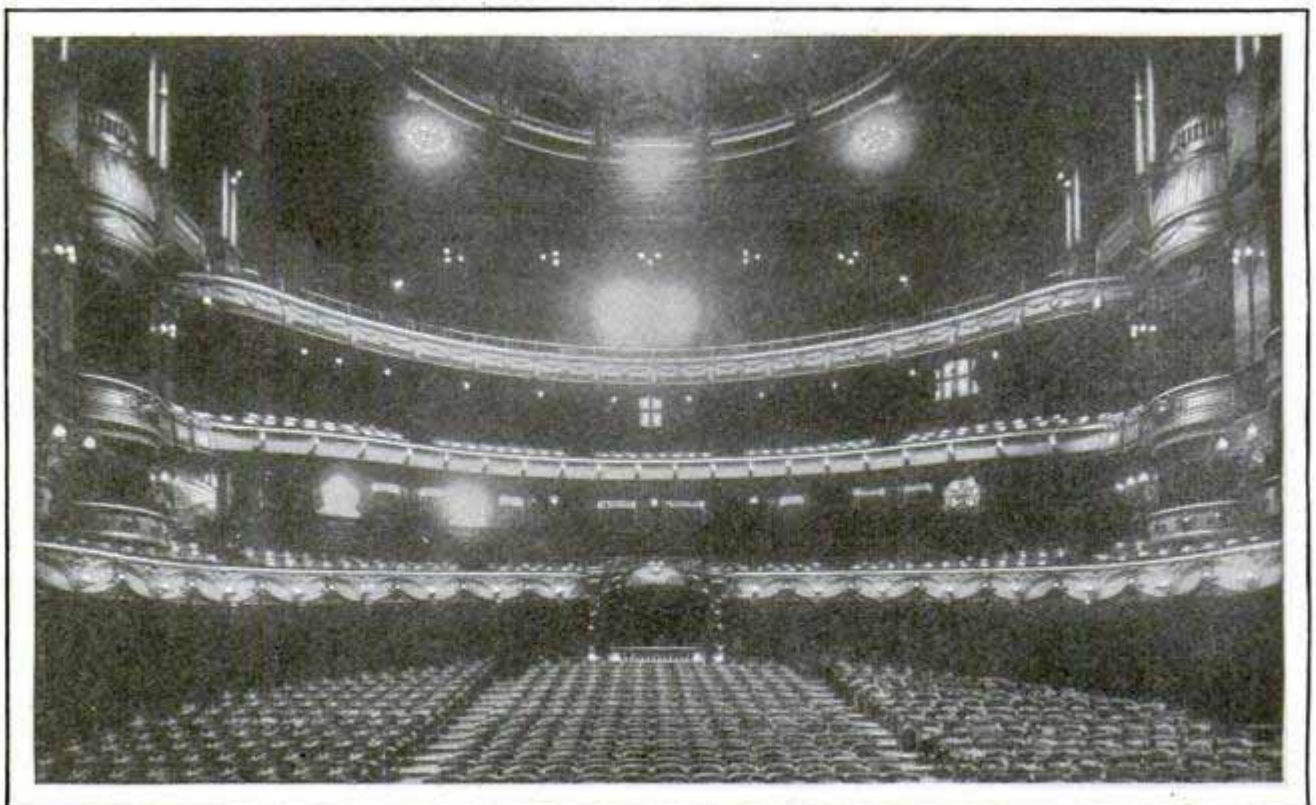

Interior of the London Coliseum; with Its Tiers of Luxurious Seats and Artistic Lighting, the Modern Theater Auditorium Is Planned to Harmonize with Its Stage

100

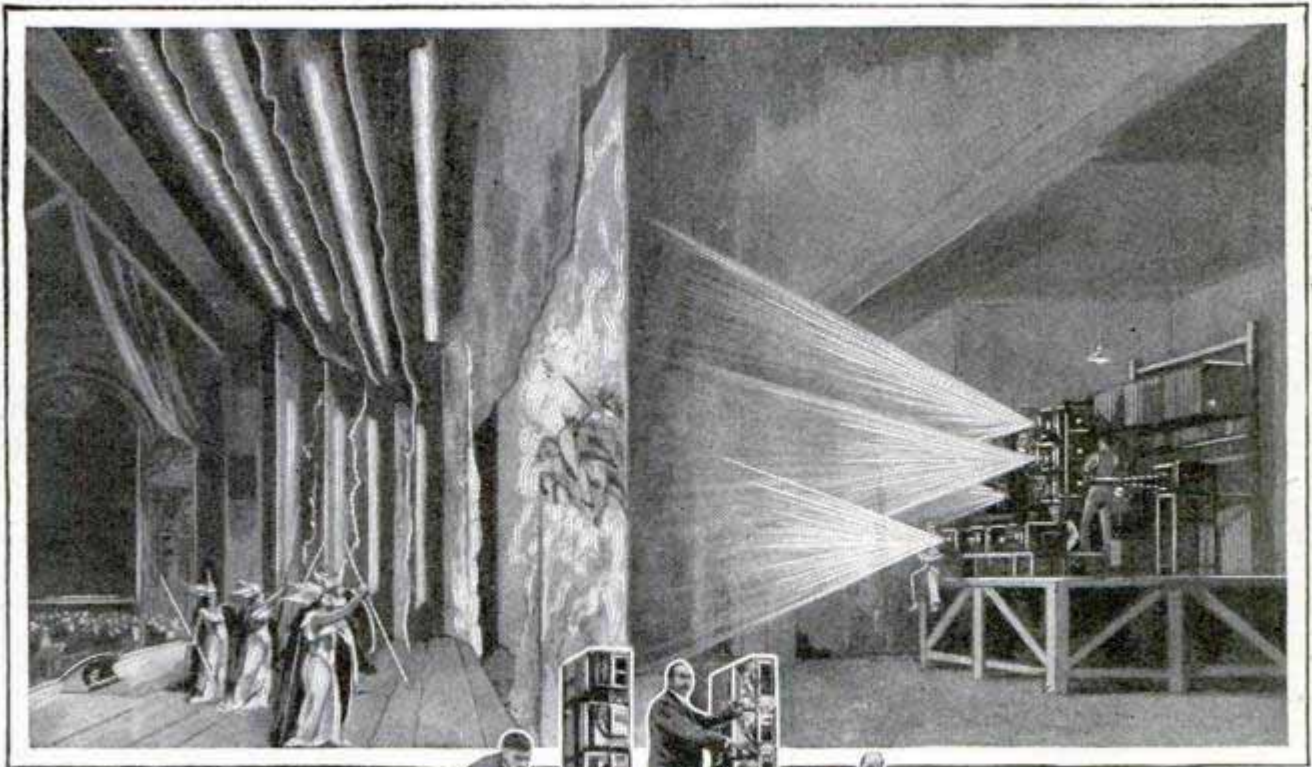

stage, a group of fifty-six big globes in three circuits of five colors bathes the performers in streams of blue, yellow, pink, amber and white light, the gelatin color screens which produce the effects being controlled by automatic apparatus.

With the entire outfit working, the stage electrician can eliminate most of the hanging cloths and painted friezes used in the past to represent sky and clouds, along with the lights which formerly illuminated them. The illusion of sky and horizon, cloud and tempest, rain and sunshine is created entirely by cleverly focused lenses and white and colored lights, combined with photographic projection apparatus.

Even more unusual than the lighting arrangements, however, is the group of bridges which can be turned into a stairway, if desired, or used to produce a shipwreck at sea, a train wreck on land, or any other spectacular effect involving disappearance. Six sections of the floor are movable, two controlled by hydraulic lifts, two by electric motors, and two by handwheels and counterbalances.

In one Drury Lane spectacle, an ocean liner on the stage battled a terrific tempest. The ship rose and fell and rolled

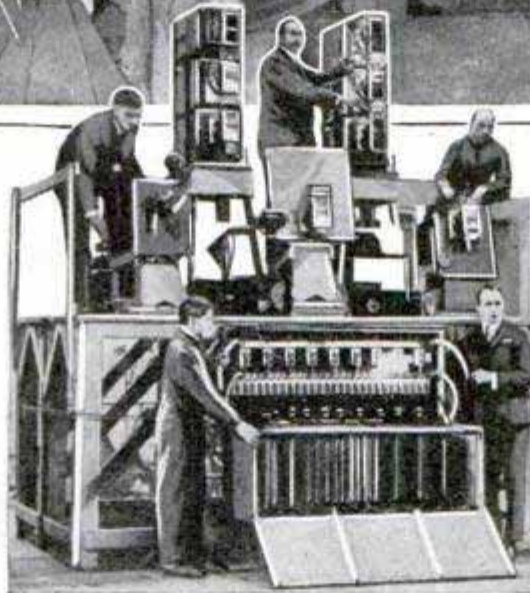

Courtesy Eugene Frey, Paris
Projector and Screen That Replace a Complicated Set in an Opera Act

from side to side in the storm, while rain fell in torrents. Suddenly there was an explosion and blinding clouds of steam shot up, hiding the helmsman from view, then the stricken ship, with boilers presumably blown up, sank below the stage. The illusion was produced by mounting the ship on one of the hydraulic lift bridges, with a ball and socket joint by

which it could be pitched and rolled in the seas. At a signal flashed by the electrician to the theater boiler room, the engineer opened a valve and shot a jet of steam through a flexible connection to the scenery on the stage, while at the same time a flash pan of powder was exploded. Then the hydraulic bridge was slowly lowered, carrying the ship with it.

In another production, a locomotive dashed onto the stage, a real whistle shrieked with real steam supplied by the same flexible tube, and the engine dashed over a parapet wall and plunged into the pit, a mass of smoking wreckage.

Like the vast batteries of lights, the bridges and other mechanical effects are all directed from the chief electrician's gallery. Watching the stage from his high vantage point, he sends each bridge operator his cue at the right moment.

*Smith Leas Engineering Co., Dayton, Ohio.
Moraine City, Ohio.
649
Leas Research Co., Moraine City, Ohio.*



South American Suspension Bridge, Five Hundred Feet Long, Is Tied Together Wholly with Knots, No Nails Being Used

BRIDGE BUILT WITHOUT NAILS IS TIED WITH KNOTS

With a span of 522 feet, a suspension bridge over the Rio Uribante near San Cristobal, Venezuela, contains no nails, bolts, screws or rivets, but is held together entirely by a special system of tying the natives use. The superstructure is of wood and is hung by long cables from uprights on either side of the stream. Besides being strong and durable, the bridge has a neat appearance, rivaling that of steel structures of similar types.

FUEL GAS GENERATED AT HOME IN CHARCOAL BURNER

Gas for cooking, heating water or warming the house may be generated at home in a small plant that uses charcoal. The apparatus requires no attention except to fill the hopper with a sack of fuel once each day and remove a small quantity of ash. Gas is derived from air and water vapor passed over the glowing charcoal by a small electric suction fan. It is not stored but is used as made and the supply is easily regulated by adjusting the burners.

Germany is developing an artificial wool which is produced from pine wood.

HOW FOREIGN MAIL IS GUIDED TO PROPER ADDRESS

Due to the skill of handwriting and language experts of the post office department, only a small percentage of the thousands of letters annually received from foreign countries fail to reach their destinations. A day's mail at the Washington office, for instance, will include missives written in Pali from Baluchistan; in Hindustani from Burma, or in Senegalese from the Orange Free States.

One from Perak, Federated Malay States, written by an Eurasian, falls upon the clerk's desk. The address extends from the upper left-hand corner diagonally to the lower right-hand corner. To the layman, it is a puzzle, but the translator ponders a moment, then writes the English equivalent of the strange characters below the foreign address for the guidance of the postman. One of the important duties of these special clerks is re-addressing mail directed to places in countries that no longer exist, such as Prague and Trieste. Constantly changing boundaries in such regions as the Balkan states and others, demand that the post-office workers keep abreast with the times. Where boundaries are still in doubt, the mail is sent to the most probable distribution point. By long experience, these expert clerks acquire an extensive knowledge of towns, cities and streets the world over. Without consulting a directory, they know that a letter addressed to Ovid is probably meant for New York, although the state is not specified, and that Ponchatoula is in Louisiana, and so forth.

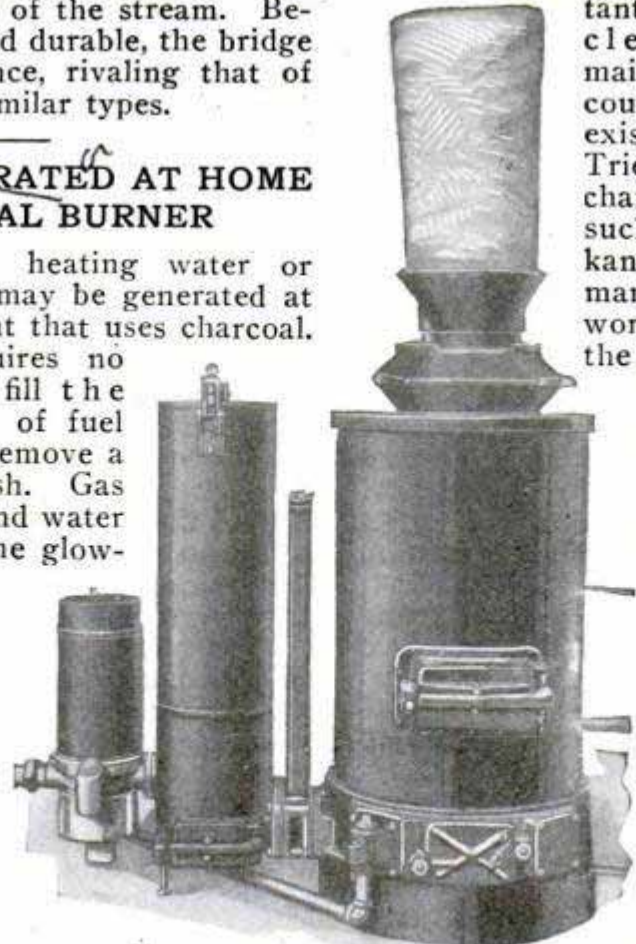

Home Gas Generator Complete; Inverted Bag of Charcoal Fuel on Hopper of Main Unit

(L. W. H. Smith)

Box 384, Berkeley Calif.

CAR IS PARKED IN THE ATTIC OF HILLSIDE HOUSE 658

Built on the slope of a steep hillside, a house in a Pacific coast city is so arranged that the garage is in the attic and is reached by a roadway at the rear of

produce the ringing music frequently heard on summer evenings. An individual insect is difficult to locate, for the sound seems to shift and eludes the listener, but the cricket, when found, proves to

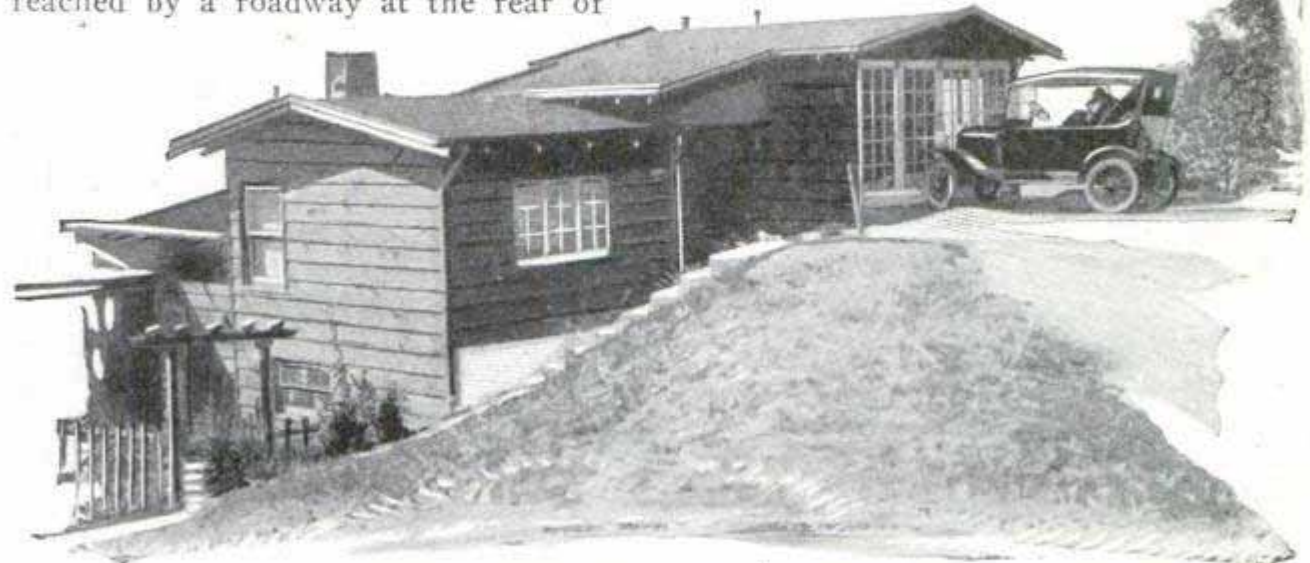

Auto at Door of Attic Garage, Which Is Built as Part of House on Steep Hillside; Steps Lead Down to First Floor of Dwelling

the dwelling. The plan saved the cost of an extra building, which could have been erected only at considerable expense because of the location. 668

INSECTS DON'T SING, MUSIC IS OF INSTRUMENTAL TYPE

While the sounds made by various insects are familiar to almost everyone, not many know just how the tones are produced, and even scientists are perplexed as to the reason for their choruses. In a recent report from the Smithsonian Institution, it was pointed out that insects do not really sing at all, that is, produce tones by vocal cords. Their music originates from special organs most of which correspond to drums. The vibrations are set up by two general methods, by rubbing and by muscles attached to the vibratory surface. One species of grasshopper plays on two "fiddles" at a time; the strings are its front wings and the bows its hind legs. The katydid produces its peculiar sound by rubbing the file-like surface of its left wing over a ridge or scraper on its right, although the tone and volume of the notes are due in part to the vibration of the membrane on its wings. The musical organs of the cricket are like those of the katydid, except that the parts are equally developed on each wing. Their method of playing is generally the reverse of that of the katydid, the right wing being kept on top of the left. Tree crickets

be a slim-legged pale-green creature with hazy wings over its back. To produce the song, these are raised and rubbed together so rapidly that their outlines become almost invisible. The cicadas, popularly but inaccurately known as the locusts, have an oval membrane like the head of a drum, set into the solid rim of the body wall just back of the base of each wing. These membranes are set in vibration by muscles, and the sound is due to a cavity in the insect's abdomen.

INSULATED-WIRE CONNECTOR REPLACES TORCH AND TAPE 2338

Insulated wires can be joined quickly and easily with a connector that requires no wrapping tape, torch or solder. It consists of an inner socket into which the wires to be connected are inserted after being twisted together. A screw is then placed in the jacket to hold the wires in place and a fiber cover slipped over it and the rest of the connector to provide insulation. The device is made in only one size and has a capacity of from two to eight stranded wires. It is handy for emergency jobs about the house.

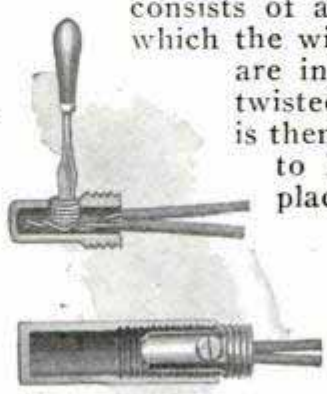

A. S. Snodgrass, U. S. Bureau of Entomology

The Station Mfg. Co. New Haven, Conn.

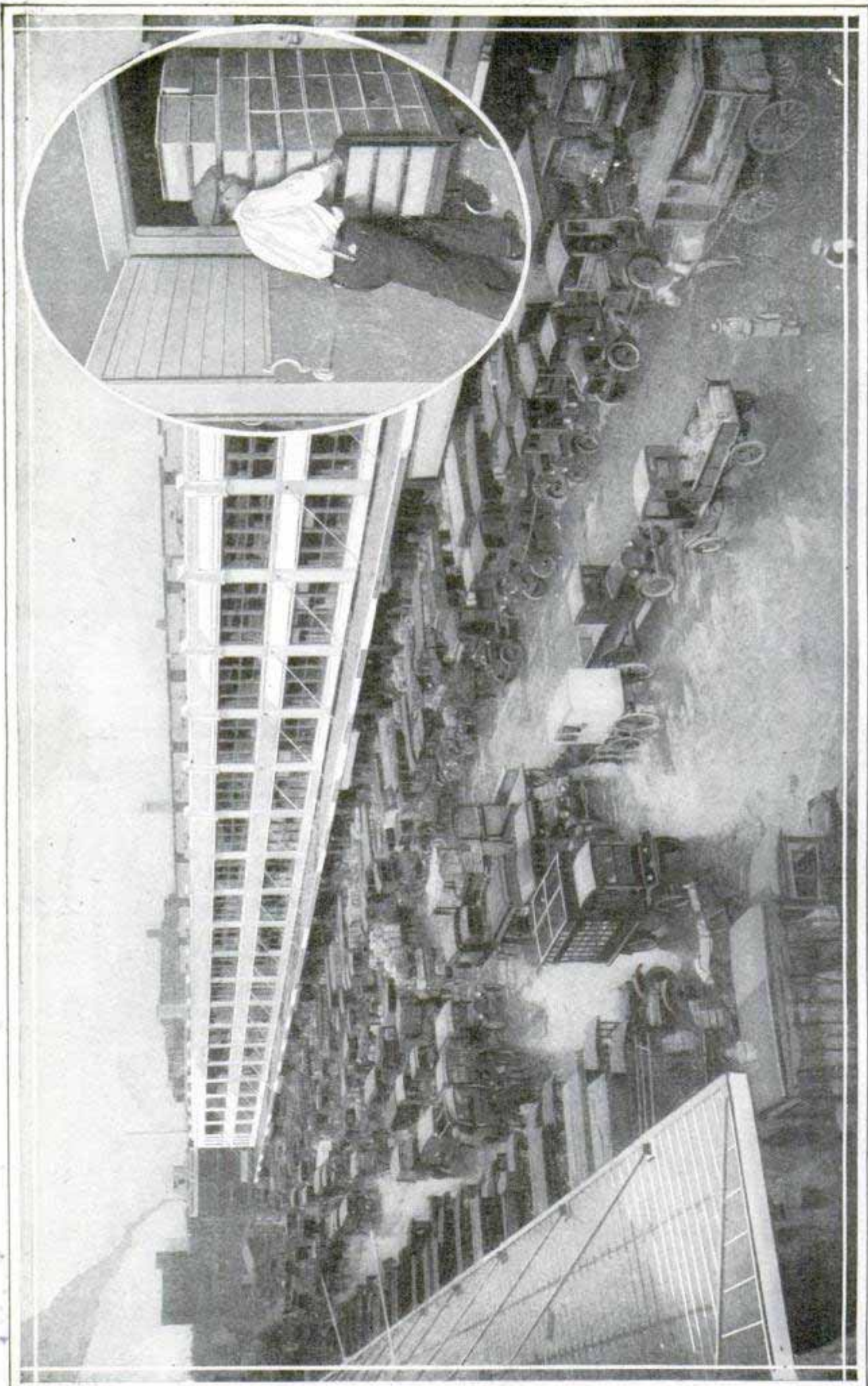

One of the Six Blocks in the New South Water Market, Where Chicago Produce Dealers Handle All the Perishable Food Supplies for a Great City; Insert, Wheeling California Fruit into the Refrigeration Room of One of the Cement-and-Tile Store Units



Feeding a City of Three Million People

Every State Contributes the Fruit and Vegetables, Poultry, Butter, Eggs and Cheese Handled in World's Biggest Produce Market

HOW much garlic will it take to satisfy the appetite of the garlic eaters in a city of 3,000,000 people? The produce merchants of South Water street, who still retain the name of Chicago's historic market center though they have recently moved into a new \$17,000,000 home some miles away, can tell you after one glance at their annual records.

The answer is twenty-seven carloads, or at least it was in 1924, and if you ask, they will give the additional information that California contributed twenty-four carloads, Louisiana two and Illinois one.

Twenty-seven huge railroad cars filled with the

odorous bulb is enough to stagger the imagination, but that item was only a drop in the bucket in a produce-distributing center that handles a hundred thousand carloads of fruits and vegetables every year, along with 88,464,594 pounds of dressed poultry, 258,061,395 pounds of butter, 130,022,710 pounds of cheese and 4,679,295 cases of eggs.

The grand total is what Chicago ate in one year, and includes the perishable foods only, as South Water street does not deal in canned foods, nor does it handle any meat except poultry.

To clear the way for a new double-decked boulevard, and to get out of a



Sunny Italy Is Well Represented among the Commission Men, Particularly Those Handling Fruits

506
row of ramshackle old buildings that dated from just after the Chicago fire, the 166 produce dealers of this, the world's biggest produce market, built themselves their new seventeen-million-dollar home, which covers six city blocks and has railroad connections at the back-doors, eliminating a tremendous amount of unnecessary trucking.

Every store unit is fireproof and sanitary, made so by concrete-and-tile construction. They are equipped with vast refrigerating plants for the perishable goods, and heated rooms for the delicate fresh fruits and vegetables brought from southern states in winter. The streets between the buildings are wide, to



Samples of All the Smaller Vegetables and Table Delicacies Are on Display While the Dealer Exhibits a Box of Fresh Mushrooms; Insert, Stacking Western Grapes on the Sidewalk

handle the press of trucks and wagons which call each day from thousands of grocery stores and fruit dealers.

As famous in its way as Wall street or LaSalle street in the financial world, this unique food center started more than a hundred years ago with a trading post on the banks of the Chicago river, where the settlers exchanged their goods for supplies, principally game, brought in by friendly Indians. Until the move a short time ago to its new home, the entire pro-

duce business of the city had centered ever since in the street along the river.

From a trading post for Indians it grew until, in recent years, the annual turnover has reached half a billion dollars, putting it second to "Packingtown" among the city's industries.

In the early days the commission men of the street dealt in everything from hay and hides to vegetables and flour, and in winter, when there were no fresh fruits and vegetables arriving from warmer



Poultry Is Plucked and Dressed in Wholesale Quantities for Each Day's Market

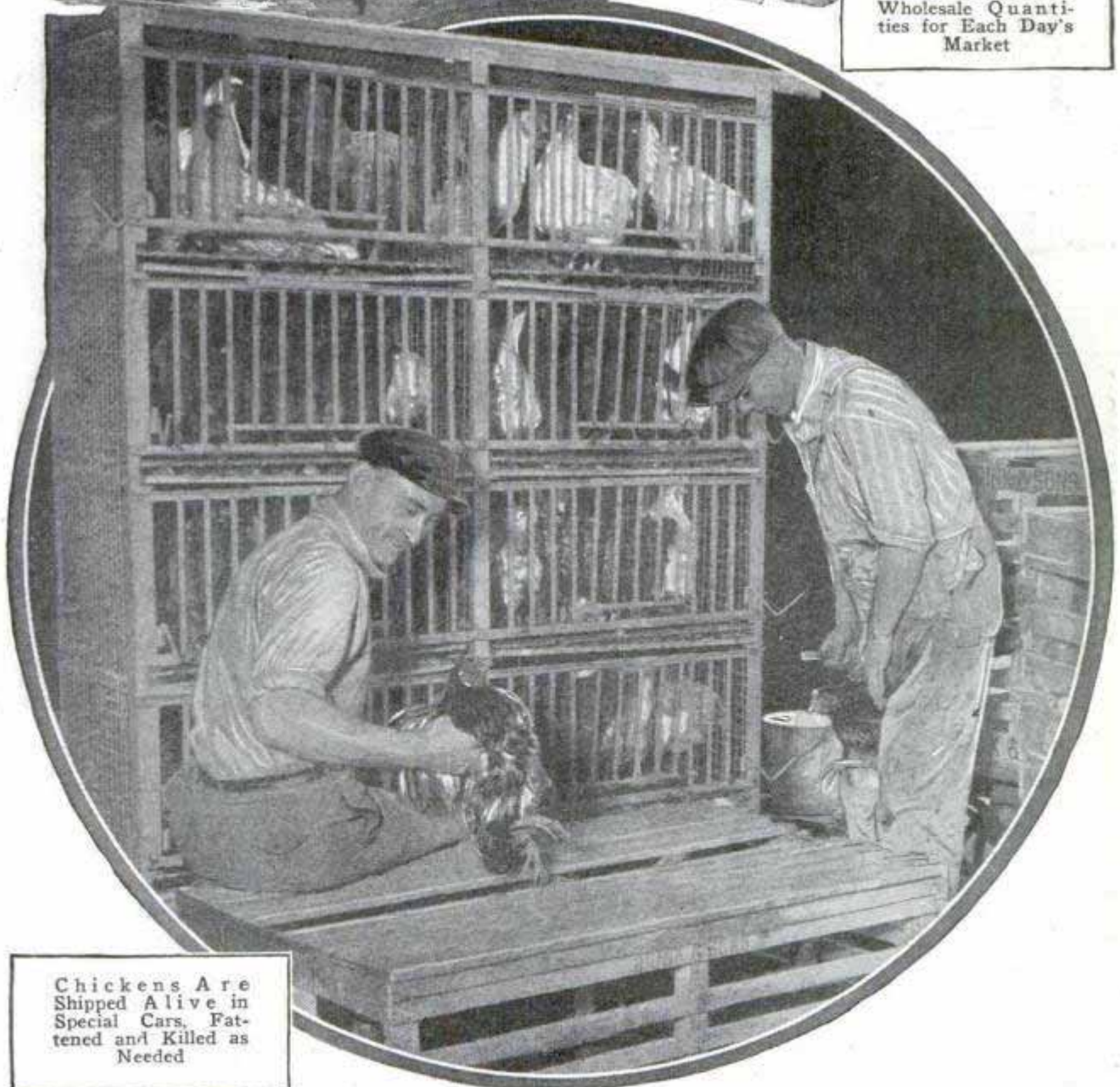

Chickens Are Shipped Alive in Special Cars. Fattened and Killed as Needed

climes, as they do now, the street turned to meat, and invited the farmers for miles around to kill their hogs and send them in.

The versatile dealer in everything disappeared long ago, and in recent years each of the 166 commission houses has specialized in its own lines. The grocer's buyer gets his cases of oranges and lemons from California and grapefruit from Florida at one store, moves on and gets a supply of dressed poultry, butter and eggs from another, stops at a third for some cheese, and calls at a vegetable house for artichokes, asparagus, beans, brussels sprouts, cauliflower, carrots, cucumbers and other supplies. Another firm will contribute cantaloupes and perhaps some fresh fruits or berries in season, and so on, until the day's supplies for the store have been collected. Less than a hundred dollars will cover the cost of a

each year goes back to the farmers scattered through every one of the forty-eight states. Some of the items come from only one or two states, and others from several. California is the sole source of the thirty-three carloads of apricots, required to satisfy the city's annual appetite, while thirty-seven states, ranging from New England on the east to Montana, Idaho and Wyoming on the west, contribute toward the more than 130,000,000 pounds of cheese. California, again, sent a thousand and one carloads of lemons in 1924, but with four cars of potatoes was only one of thirty-five states contributing toward the 22,356 carloads consumed. Wisconsin alone supplied more than 7,000 of those cars, and Minnesota ran second with nearly 5,000 carloads.

Washington led the apple-growing states, contributing more than 3,600 of the



In Fair Weather the Entire Store Fronts Roll Back

wagonload for the average grocer, but the total purchases of the thousands of city stores in a year will exceed \$500,000,000.

The vast sum this single city spends for food



Sidewalks, under the Canopy, Are Clogged with Boxes

9,242 cars received. Three states sent 177 carloads of asparagus, while California again stood alone as contributor of ninety cars of artichokes. The progress of the

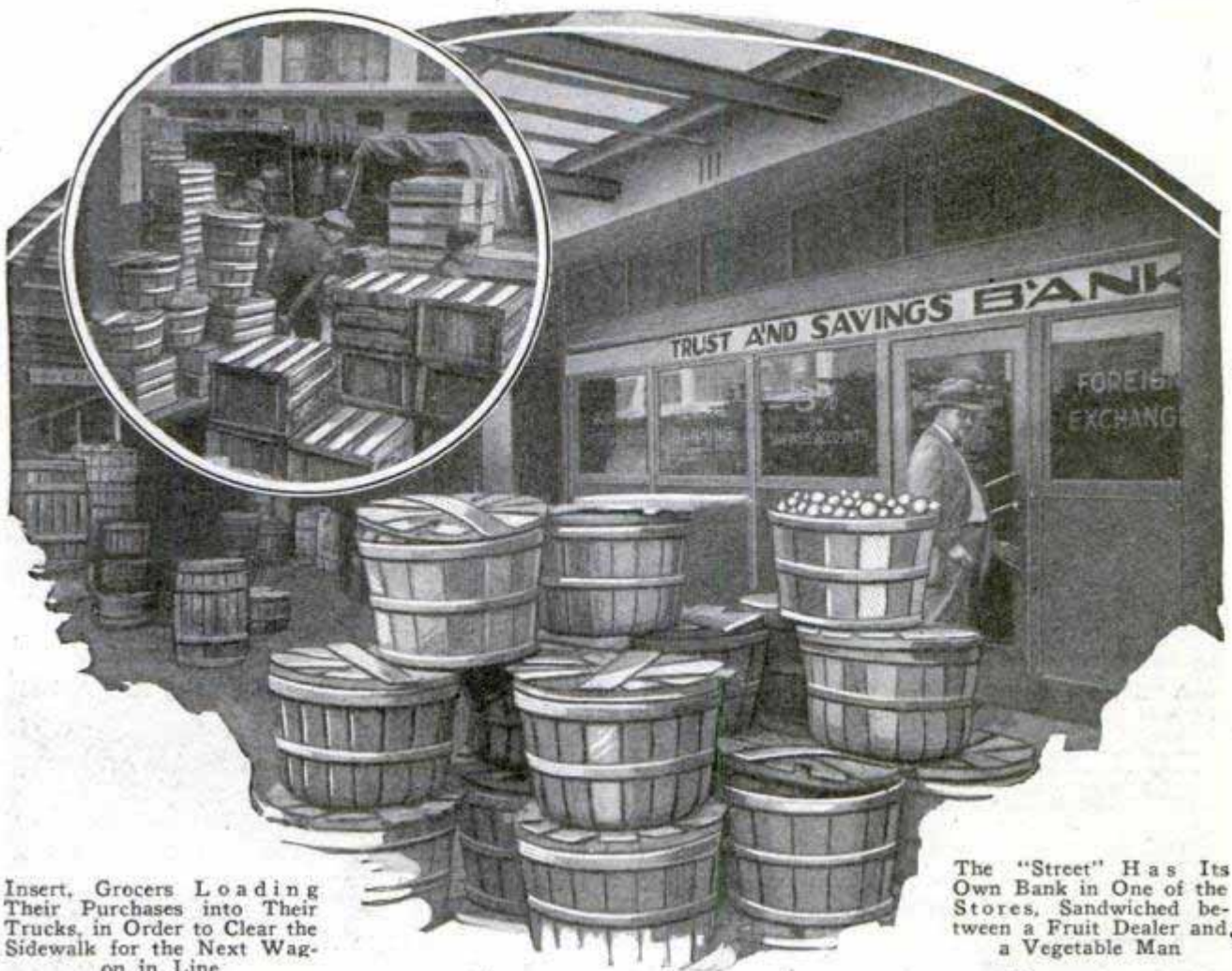

Insert, Grocers Loading Their Purchases into Their Trucks, in Order to Clear the Sidewalk for the Next Wagon in Line

The "Street" Has Its Own Bank in One of the Stores, Sandwiched between a Fruit Dealer and a Vegetable Man

seasons can be watched by the arriving cars of some of the year-around staples. Florida, Mississippi, Alabama, Louisiana, Texas and California send in the first beans of the year; then, as spring advances, Arkansas and North Carolina arrivals appear, to be followed by Illinois, Missouri and Maryland. These eleven states raised 109 cars of wax and green beans for the people of Chicago in 1924.

The summer berry crop is spread over much of the middle west, and stretches into other sections. Wisconsin and Michigan contributed twenty-six cars of blueberries, while Michigan, Arkansas, Tennessee and North Carolina gave twenty-eight cars of blackberries. Two states sold twelve carloads of currants to South Water street; twenty-three states sent 2,675 cars of peaches; some of the same sections supplied 1,574 cars of pears, and others, including many in the south, grew 2,356 cars of strawberries for this one city.

The street handles just fifty-seven varieties of produce, starting with the "A" of apples and ending at "W" with 3,100 carloads of watermelons. A study of the complete list, by states, is a lesson in the geographical distribution of American

agriculture. Where do the gooseberries for gooseberry pie come from? A glance at the list shows Michigan was the sole state of origin of the fourteen carloads used in one year. The figures, however, do not show how many pies fourteen cars of berries would make, but the answer, in the words of one gooseberry dealer, is "plenty."

Some states contribute to more than half of the fifty-seven different kinds of food. Illinois alone supplies portions of the supplies of thirty-three different articles, New York produces twenty-three, and California, which leads because of its citrus and other fruits, contributes forty different articles.

WATERPROOF SANDPAPER

Waterproof sandpaper, now on the market, permits use of the abrasive under damp or even wet conditions, and prevents raising dust when cleaning painted, varnished or enameled surfaces. Both sides have been treated and the gritty material does not readily come off so that the paper is said to last ten times as long as the ordinary product.

Manning Abrasive Co., Troy, N.Y.

Compressed Air - Aug 1920

653

Ozarkham House, St. Leonard

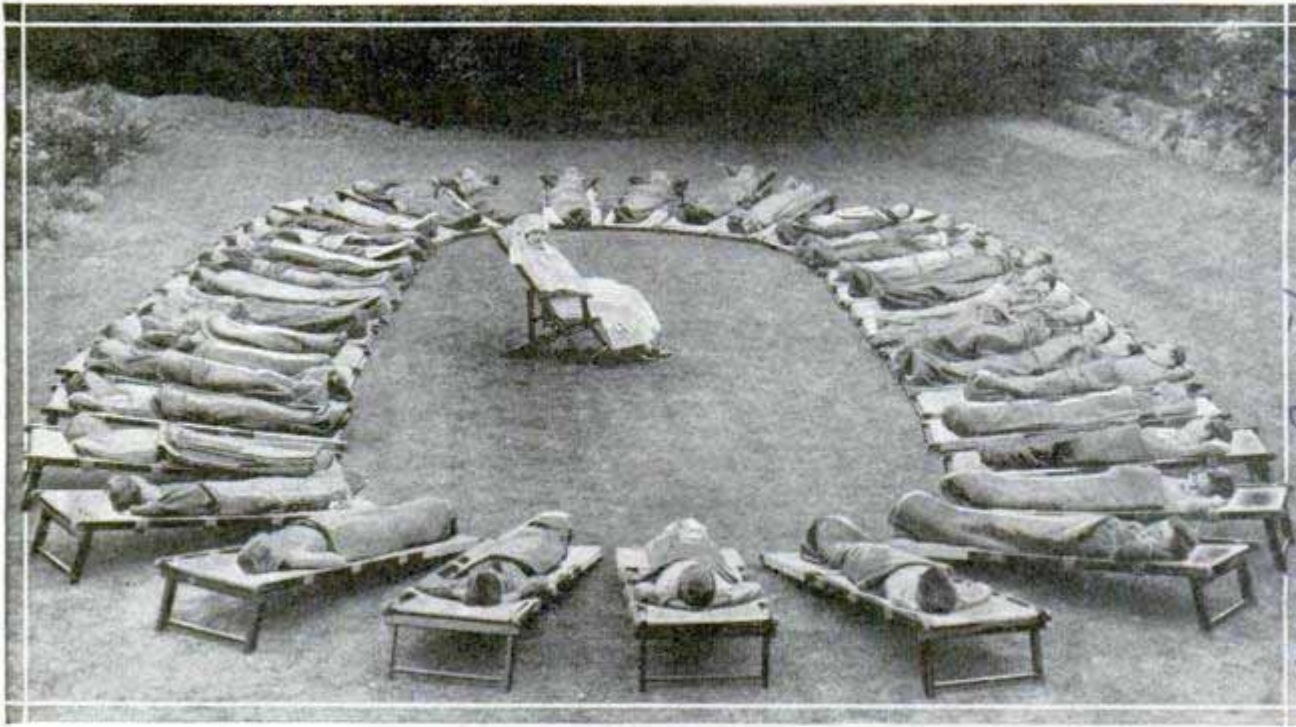

A "Circle of Health" to Cure Lung and Throat Ills; Children Taking Fresh-Air Treatment Enjoy Rest Periods on Special Cots That Protect Them from Dampness

Battery Equipment div.
Cleveland, Ohio.

**CHILDREN'S CIRCLE OF HEALTH
—RELIEVES CITY ILLS**

Fresh-air treatment has been found beneficial to London children who are exposed to its fog-laden atmosphere, and one of the aids to the health authorities is a special type of cot upon which the patients can recline out of doors while resting and, at the same time, be protected from cold and dampness. The beds are easily set up or taken down, strong and comfortable, and prevent exposure to moist grass or earth. By arranging a number of the cots in a circle, a single nurse can watch over many children at a time. They are taught uniform methods of reclining and the best positions to assume, as an additional aid to health.

681

**BLACKSMITH SHOPS STILL BUSY
DESPITE THE AUTOMOBILE**

Although the clang of the anvil has been dulled by the exhaust of the motor, blacksmiths in this and foreign countries still do a thriving business. There are 175,000 men in the occupation in the United States today, according to statistics gathered on the industry. The total yearly output of horseshoes is estimated at 1,250,000 hundred-pound kegs. A peak year was registered in 1918, when the product was valued at \$12,000,000, due largely to the demand occasioned by the World War. Approximately 17,000,000 mules and horses are employed in agricul-

tural work in the United States and many of these need the blacksmith's attention. The industry has been known for more than 2,500 years and the methods of horseshoeing have not changed greatly since the days of the early settlers and of Longfellow's "Village Smithy."

434

**LEVER BATTERY-POST CUTTER
LEAVES STRAIGHT EDGE**



Fitted with long arms and toggle action so that strong leverage may be developed, a battery-post cutter shaves off the lead flush with the hood plate. It has interchangeable knives and after the cutting is done, leaves a straight, smooth edge.

609

**LEVEL WITH CONSTANT BUBBLE
—AIDS ACCURATE SURVEYS**

Changes in temperature, affecting the length of the air bubble in the spirit level on a surveying instrument, sometimes interfere with accurate observations. This difficulty is reported to have been overcome in a level with a tube so shaped that only the cross-sectional area of the bubble is affected, the length remaining unaltered.

From Laundry League
Miss
Chicago Evening Post
4/2/25

Part of mtg Co
Prospect av.
2819
Reliable

Chicago Evening Post
4/2/25
E. R. Watts & Son, Inc
101 Camberwell Road

WHY SEA IS BLUE ⁶⁰⁴

Small particles of salt in the sea explain why the ocean often appears to be a deeper shade of blue than fresh water, according to one theory. The color deepens according to the depth of the water and the amount of salt. For instance, the Mediterranean, noted for its beauty, is rich in the mineral and the Pacific ocean sometimes appears dark enough to be called indigo. Stretches of white sand below shallows near shores cause the blue to change to different shades of green or gray, and myriads of minute organisms in some parts of the seas affect their color. Blue is the fundamental color of water, although it cannot be detected in small quantities of the liquid. The sky's color is believed to be due to minute particles of dust in the air and the way in which the sunlight is reflected by them.

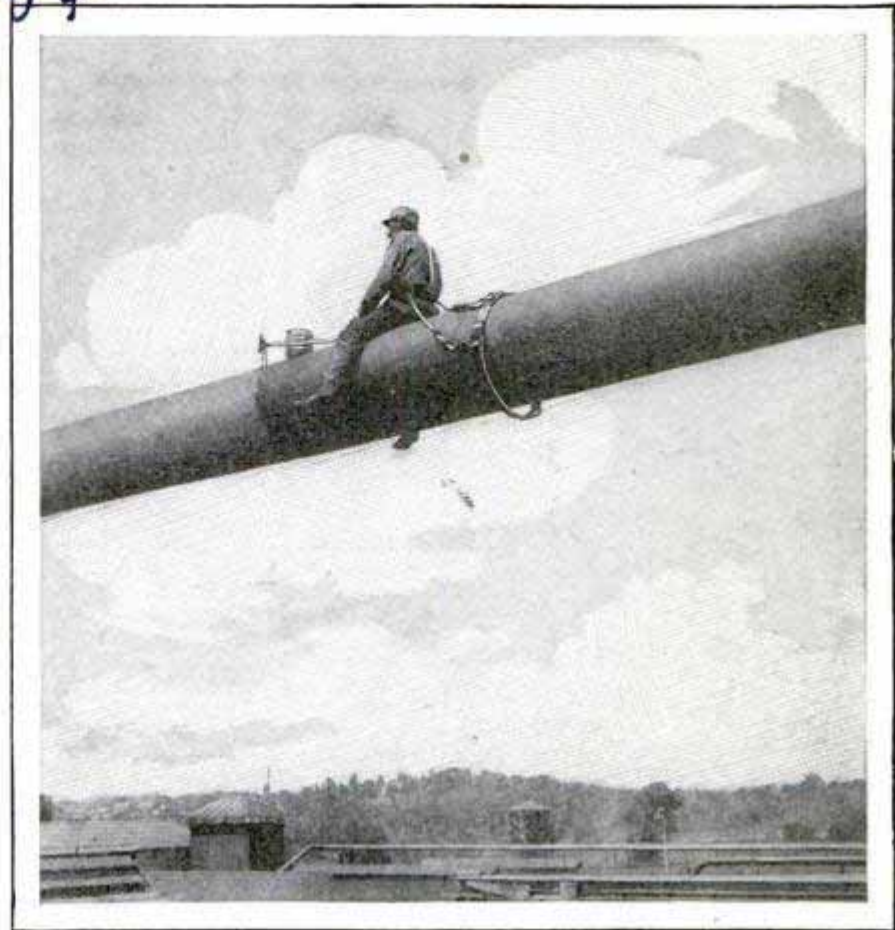

Sliding Ring Anchor to Which Worker's Belt Is Buckled as Safety Precaution While Painting Pipe

SHOE FITTER MEASURES FOOT AND STAMPS SIZE ON CARD ⁵¹⁹

Measurements of the foot are taken quickly and accurately on a shoe-fitting apparatus to help the salesman pick out

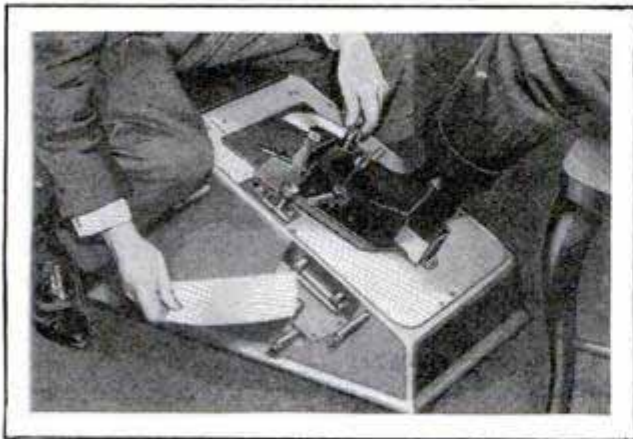

Instrument Records Dimensions of Foot on Blank

the right size for the customer without the bother of a number of trials. On a card inserted below the rest for the foot, numbers are automatically stamped, indicating the dimensions of the sole.

Used in shops in

LIFE BELTS PROTECT PAINTERS FROM SERIOUS FALLS ⁵⁷⁰

Painters and other workmen at a large manufacturing plant who are required to climb to perilous positions, are guarded by specially constructed life belts about the waist and attached to the structure on which they are engaged. In painting a large horizontal pipe, the life lines were connected to a ring encircling the conduit, so that it could be moved along as the work progressed. Even the paint pail had its "life line" to prevent danger to those below. Similar equipment was used by men on a scaffold to provide a safeguard if the rope falls should break.

SUN LOSES FOUR MILLION TONS IN WEIGHT EVERY SECOND ⁵³⁶

According to estimates made by Sir Oliver Lodge, the sun loses 4,000,000 tons in weight every time the clock ticks. The scientist declares that this should occasion no alarm, however, for the sun can go on reducing at this rate for hundreds of years and still furnish the earth heat and light. The loss is represented in burning gases, the nature of which is to be studied further when an eclipse occurs.

Talk before British

4 86

Charles Esay, Esays Lion Farm
near El Monte, Calif.
POPULAR MECHANICS.



The Gay Lion Farm and a Porcelain Statue of "Numa," Which Guards the Entrance; in Center Is a Group of Sixteen of the Fully Grown and Trained Beasts in a Corner of the Wire-Net Inclosed Yard in Which They Live, Instead of Being Caged in Separate Homes; Below, Mrs. Charles Gay and Three of the Cubs; Notice the Kittenlike Posture of the One Lying On Its Back; There Is a Growing Demand for Small Lion Cubs among People Who Want Unusual Pets





Mr. and Mrs. Charles Gay and a Group of Their Lion Cubs

Home-Grown Lions on California Farm

Eighty Animals, Raised on Goat's Milk and Trained without Whips, Gambol in Movies as Playmates of Actors

By FRED GILMAN JOPP

A FIVE-ACRE lion farm, with an annual profit per acre from each year's crop that would astonish more prosaic farmers, has, in the last six years, grown up as one of America's strangest business ventures.

Starting with a lion and two lionesses a half dozen years ago, Charles Gay, the world's only lion farmer, has run his shoe-string into a \$100,000 plant, a stock of eighty animals in addition to many which have been sold outright, and a business that pays a comfortable small fortune every year. A few years ago, he landed in Los Angeles with his wife, and ten dollars in his pocket, his only other asset a decade as an animal trainer in the Bostock troupe in Europe.

Today his lions are performing regularly in most of the movie studios of Hollywood, or in the imitation African jungle which he has planted on his farm. Each lion used in a picture draws a salary of \$50 a day. In addition to this income, surplus stock is sold each year

to zoos, circuses and stage performers, while hundreds of visitors daily pay admission to the farm to see more lions than eight or ten large zoos could boast.

The success of the Gay lions as performers is due to his unique training methods. The animals are as tame as kittens, even when full-grown and, under Gay's direction, can be handled by the most inexperienced movie actor without danger. They have never known a whip, prodding iron or blank cartridge, so are without fear of man. In their training, Gay uses a little switch, twelve inches long, and when he enters a cage full of the beasts there are no attendants outside with other weapons to protect him.

In addition to the professional market, there is a growing demand for cubs as pets. A cub at birth is valued at \$350, so the pet market alone offers a good income for a farm which produces scores of cubs every year. Gay estimates the entire lion market of the United States can absorb 200 animals a year, and it is his ambition

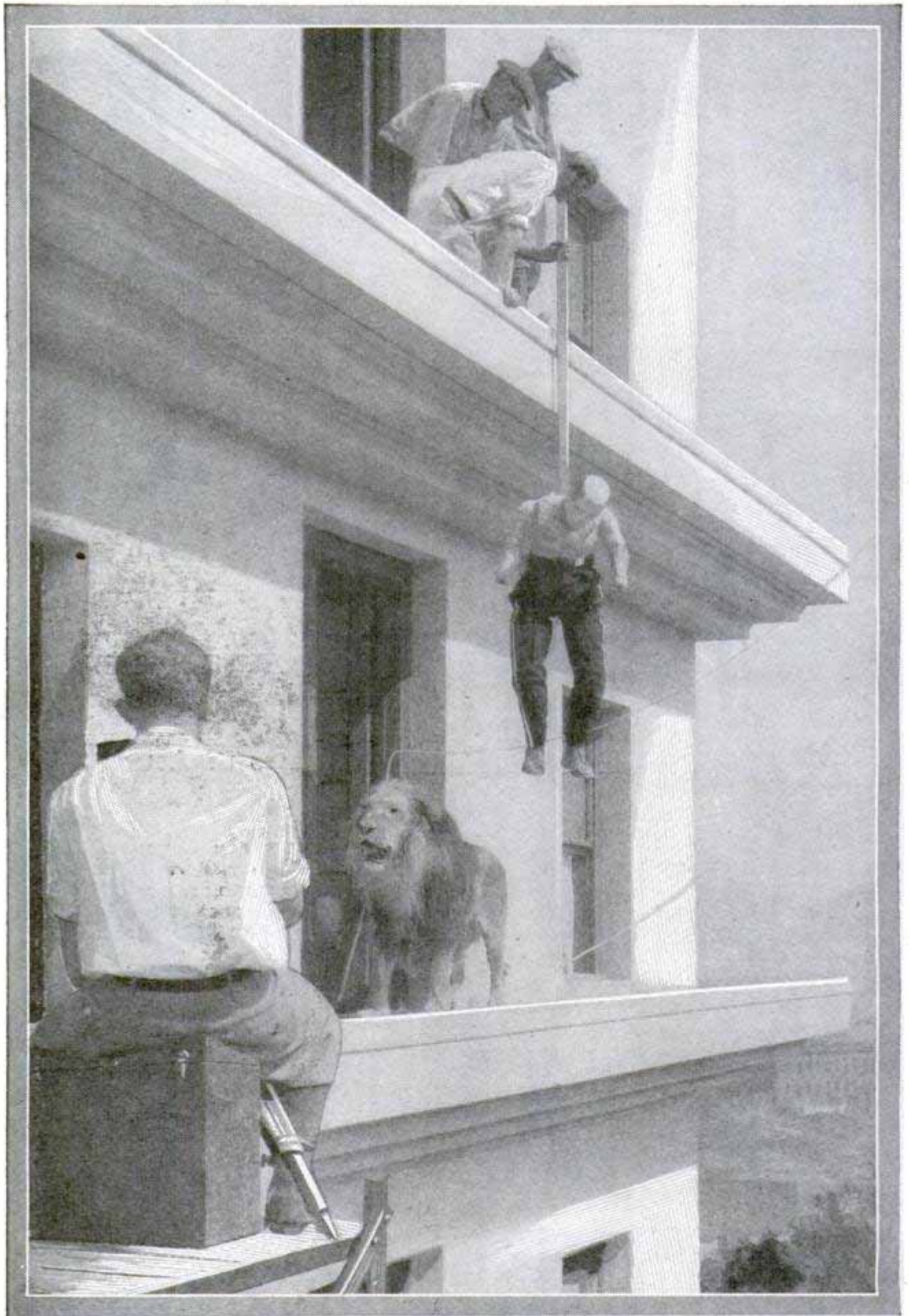

Playing "Opposite" the Studio Dummy, the Well-Trained Lion Actor, like His Human Companions of the Screen, Faces the Camera for a Close-Up, Unmindful of the Perils of a High Cornice

to supply it with tame farm-raised pets, eliminating the importation of half-savage beasts trapped in Africa. Full-grown and trained lions bring from \$30,000 to \$50,000, and a trained lioness, lacking the noble head and vast mane of her mate, not quite so much. "Numa," king of the Gay lions, is valued at \$50,000 and is much in demand with photographers and painters as the most perfect lion in America.

There are no iron-barred cages on the lion farm. Instead, all the animals live in the open, roaming around in large screened inclosures. Heavy posts support the strongest wire netting, the bottom edge of which runs underground and is turned in for several feet to discourage digging out. Bordering the arenas, low stucco houses, divided into individual compartments, one for each lion, provide shelter. One arena is given over to the fully grown and trained animals, a second to the "high-school gang" of half-grown beasts, and a third is alive with a squirming, rollicking mass of cubs.

Each animal, from birth, has his own name, and for Mr. and Mrs. Gay his own peculiarities. "Numa"

Gay Taking a Ride on a Full-Grown Lion and an Actor Supporting Part of "Numa's" 600 Pounds



and some of the other patriarchs of the group are aloof, calm, sedate and dignified. "Pluto" and "Vanredi," the friendliest of the lot, are lively and playful. "Pluto," with his big paws well padded, is an expert at wrestling and boxing with his trainer. At three years of

Gay Putting Two of His Big Performers through Their Paces in Drill

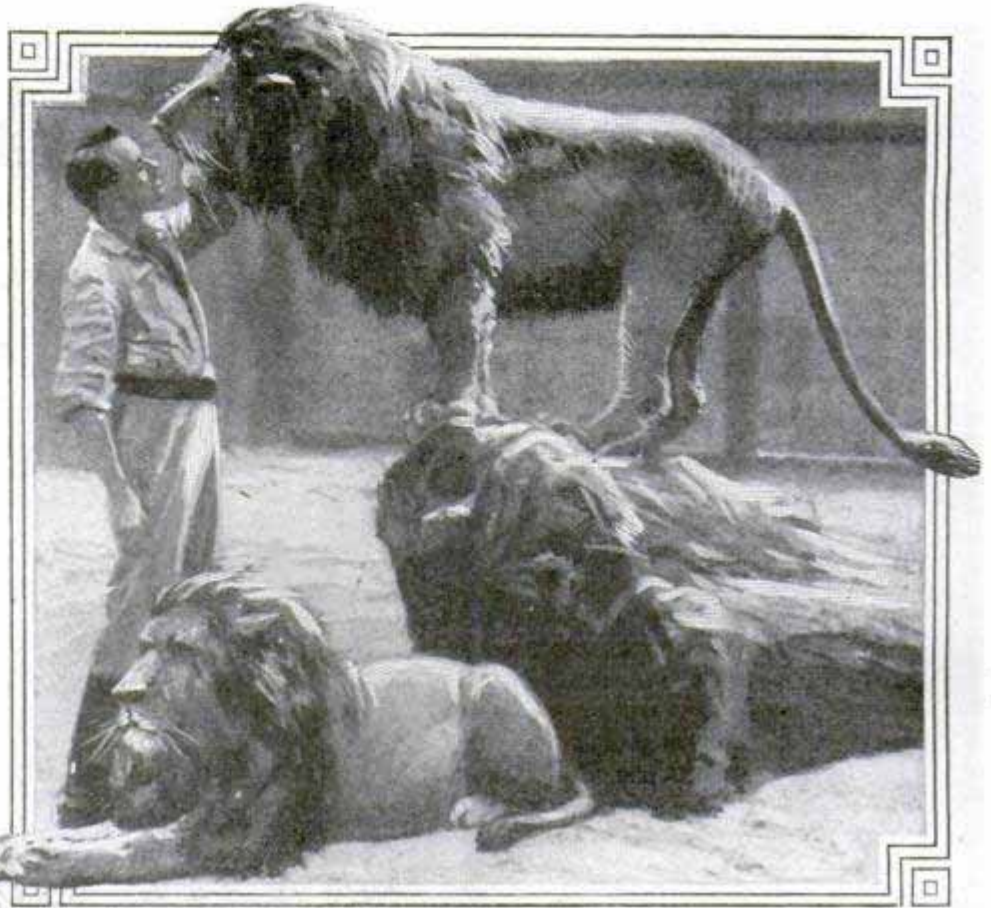

age he weighed 400 pounds and stood eight feet tall when he reared up on his hind feet. "Vanredi" is a purring, affectionate, but terribly lazy female; "Rosie," one of her sisters, is famous as the mother of quadruplets, something almost unknown in lion circles.

The cubs of the nursery class look like house cats and are as playful as any kitten. They are Mrs. Gay's special charge. At birth, they are removed from their mothers, for a lioness in captivity is helpless, apparently losing all instinct of what to do for her cubs. Mrs. Gay puts them in warm boxes in the sun and feeds them goat's milk

Another Argument against Wearing Trains, at Least When Lions Are Around

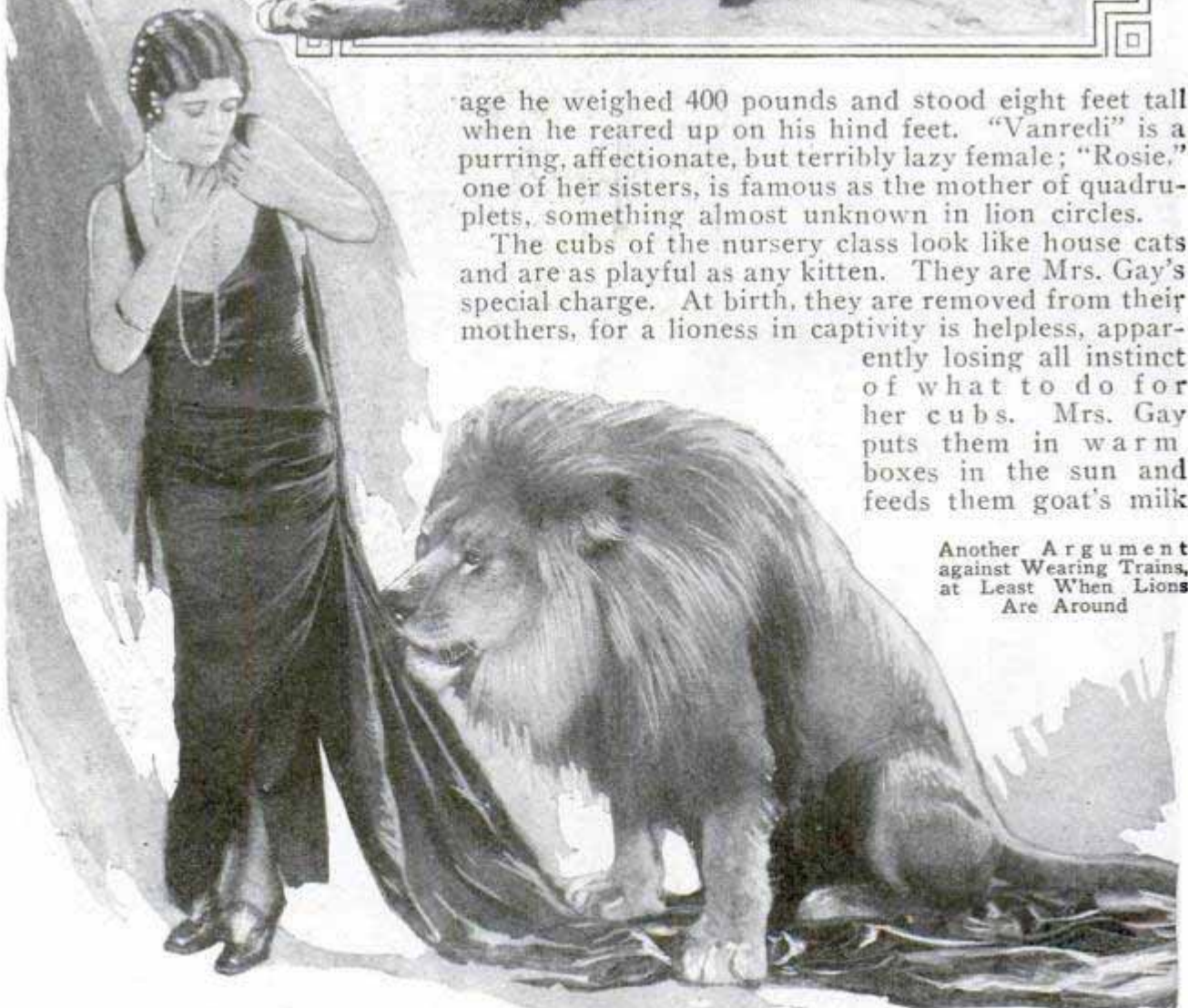

from a bottle three times a day. Later fresh eggs are added to the diet at frequent intervals.

As soon as the cubs are big enough to be weaned, they are turned over to Gay in the high-school arena and go on a meat diet, getting one meal a day.

Feeding a farm crowded with lions is an expensive task. A full-grown beast gets fifteen pounds of horse meat daily, which means that a new animal must be butchered each afternoon. The meat is served warm and fresh, whereas zoos and circuses with fewer animals are forced to use chilled beef, and store it in a warm place for several hours before feeding in order to remove the chill.

On the movie lot the animals are constantly surrounded by crowds of players, who pet them without fear. However, this foreign petting is the owner's chief worry, for, like a dog, a



"Caesar," a Baby Lion, Visits the Doctor to Have a Splinter Removed from Its Paw

lion will stand just so much handling and no more. As soon as the beast shows signs of growing tired of performing, he goes back into his transfer cage and is returned to the farm for the day. They are never handled for two hours before and after eating.

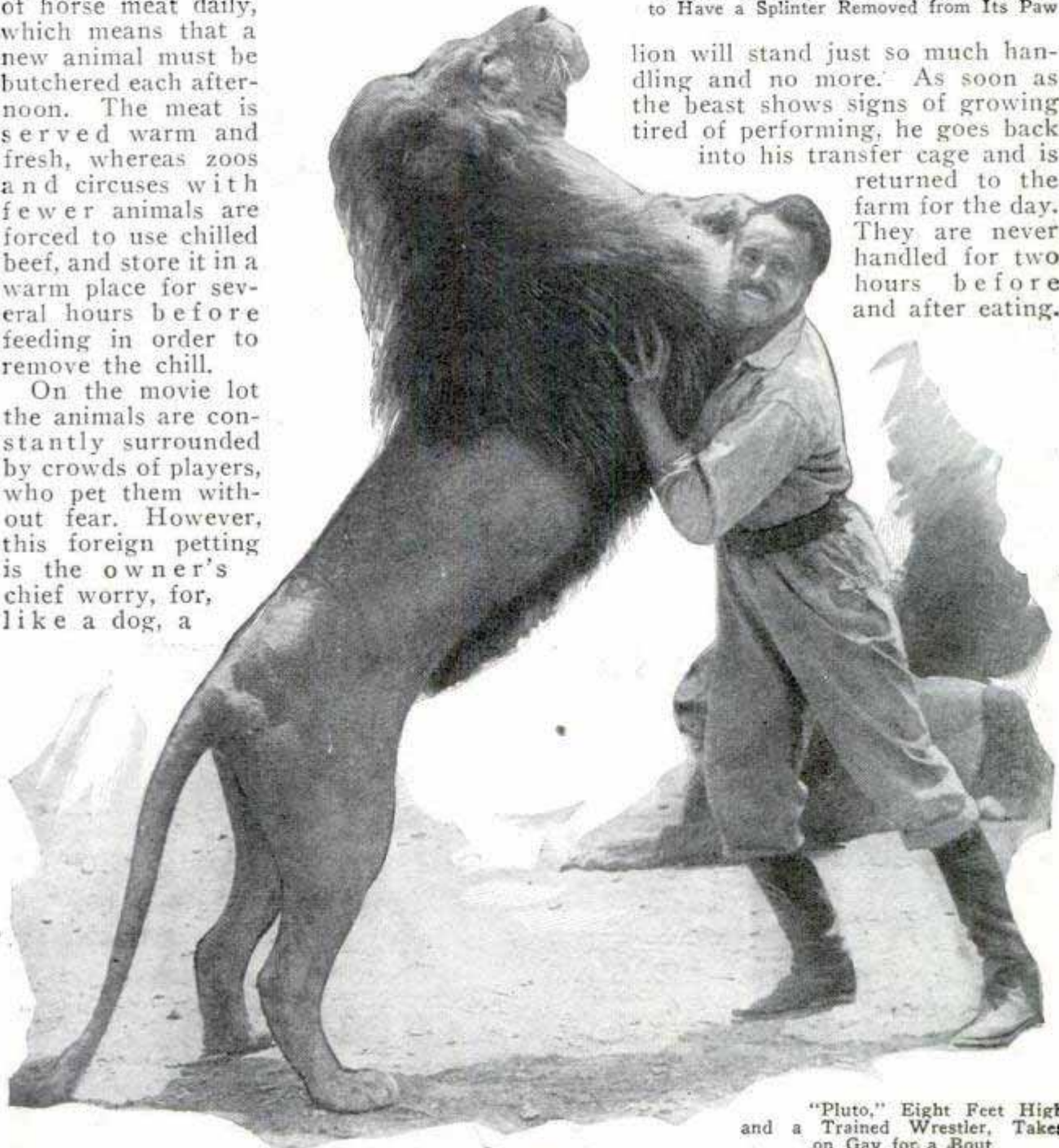

"Pluto," Eight Feet High and a Trained Wrestler, Takes on Gay for a Bout

CHILDREN GUARDED ON STREETS BY LOWERING SAFETY GATE

AMERICAN RUSH IS CRAWL CITY SURVEY SHOWS

Children have the right of way at times, while going to and from a school in

The pace of American cities is more of a crawl than a rush, if travel conditions in Washington, D. C., are typical of those in other centers. On the basis of 90,000 replies to a transportation-survey questionnaire, it was found that the pedestrian whose daily trips between his home and office are two miles or less, averages 3.7 miles an hour; street-car riders, 4.1 miles; motorbus patrons, 4.5 miles, and an automobile passenger, 5.7 miles. On journeys of two to six miles, 7.2 miles an hour was the average for street-car patrons, 7.5 miles for bus passengers,



Striped Crossing Gate, like Those at Railroads, Is Lowered to Halt Autos, Insuring School Children's Safety

Evanston, Ill., for automobiles are halted by gates similar to those used at railway crossings, permitting the pupils to reach the other side in safety. Juvenile traffic officers formerly were stationed at the intersections, but their signals were little heeded by motorists.

while 10.6 miles an hour was made by the private-automobile user. The survey also showed that the regular rider who uses the street car and pays in tokens at less than the cash fare, pays the companies 2.44 cents for each mile traveled; regular bus patrons 3.66 cents per passenger-mile, and the taxi rate is 23.9 cents for each passenger-mile. On the basis of an average load of 1.9 passengers, the cost of driving a private automobile is estimated at 5.85 cents per passenger-mile. Data relative to the amount of street space required showed that the private auto, on the basis of an average load, takes up forty-six square feet for each passenger as against ten square feet for each passenger on the street cars. In rush hours, the automobile requires fifty-one square feet

WHISTLING AUTO-TIRE GAUGE PREVENTS OVERINFLATION

Danger of overinflating auto tires is practically eliminated by using an automatic air gauge now on the market. Before attaching it, the motorist adjusts a thumbscrew indicator to the pressure desired. The instrument is then connected by inserting the tire valve into an opening in one side of the gauge and the hose into an aperture on the other side. When the required pressure is reached, the supply is automatically cut off from the tire and passes out through an "exhaust" valve while a little whistle blows to inform the user that the tire is properly inflated. The gauge is less than four inches long and is manufactured in two styles, one for balloon and the other for the ordinary high-pressure tires.

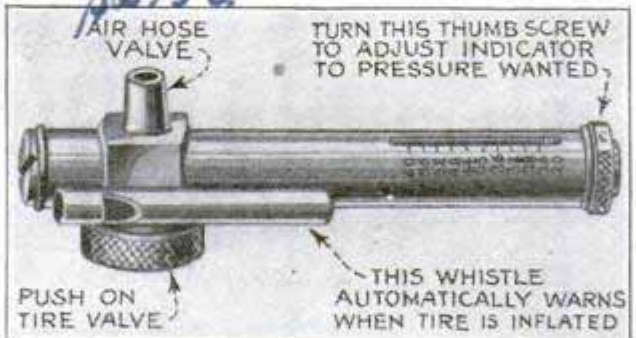

Safety Tire-Gauge Which Prevents Overinflation by Automatically Shutting Off Excess Air

of space to each occupant, as compared to seven for each street-car passenger. This difference is caused by the fact that autos carry fewer passengers during the busy hours, on the average, than the street cars. Although automobile owners were given previous warning that the count was to be taken, it was found that of the 85,000 registered cars, 18,000 were parked on the streets overnight.

Chicago agents Mr. Lloyd 1003 Riverside
or Mr. Shaner

625
no patent number
Dynamer Motor Products Co.,
1526
Lincoln St.
Evanston, Ill.

Public Attention
Compared to
Columbia

640

Policeman
Elmer Reiter

may. Wm. B. R.
Correll,

614

552 Exhibited by Consolidated Gas Co., New York City
 How We Have Advanced Shown at Exhibit

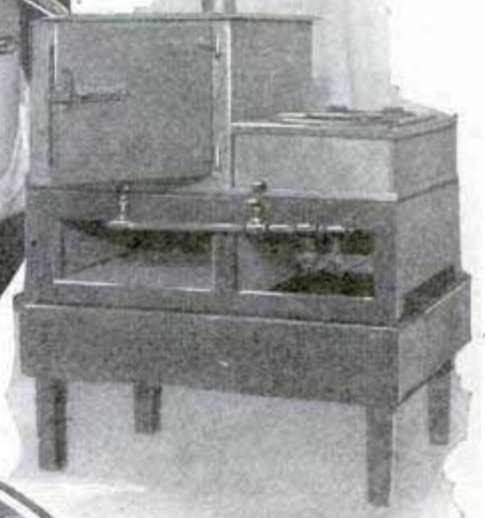
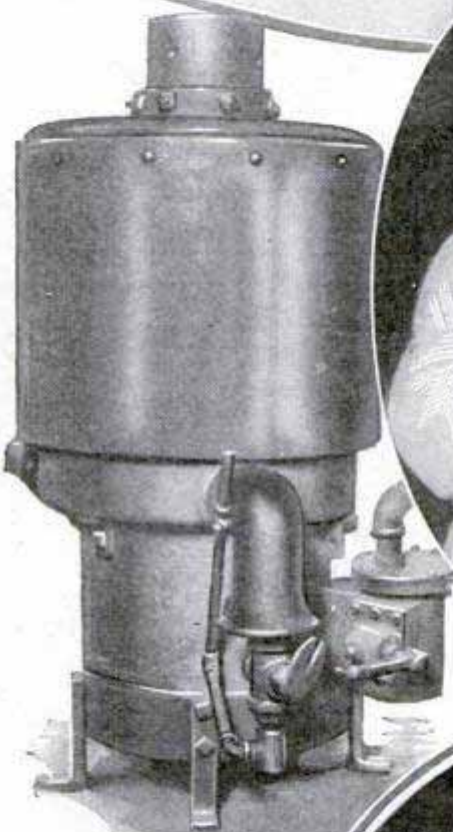
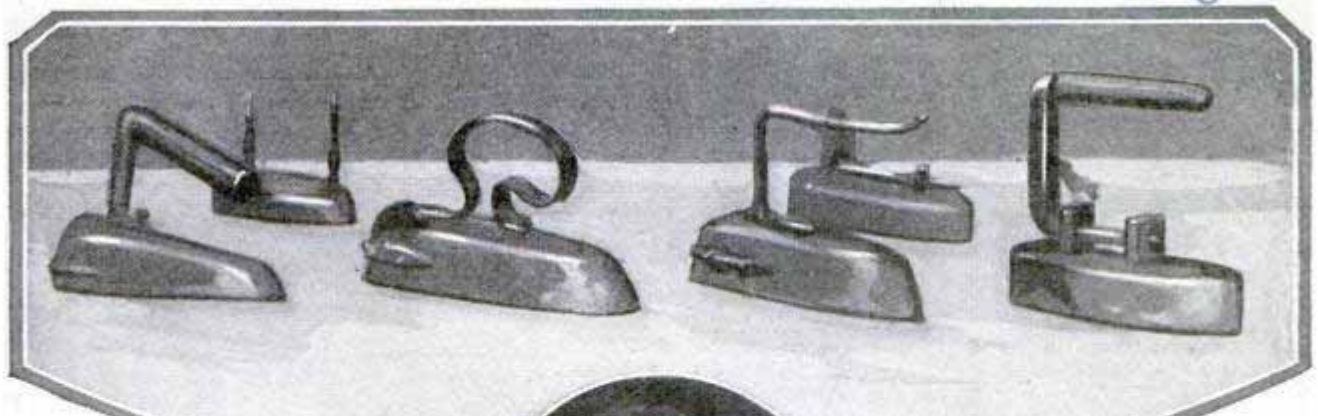

A Story of Progress Written in Iron — Household Appliances That Show Man's Endless Search for Comfort; Flatirons Above Are Typical of Those of the Fifteenth Century, and in the Center, the Young Woman Is Holding an Iron Found in the Ruins of Pompeii; It Was Intended for Use with Delicate Apparel

At Left of Center Is an Early Model of Automatic, Instantaneous Water Heater, the Fore-runner of the Efficient Equipment of Today; Above, the Oldest Known Gas Range with Its Crude Oven and Burners, and at Left, Fireplace, Pots, Andirons and Other Accessories That Have Been in Service in the Same Family for 150 Years

**LAWN TRIMMER CUTS EDGES
 SAVING USE OF SHEARS**

530 Owners of lawns are spared the task of trimming edges with shears or sickles by

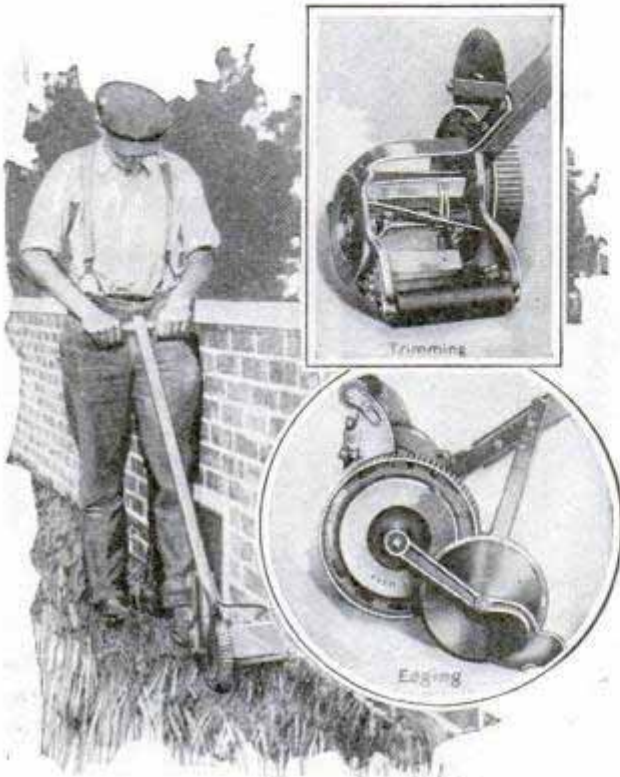

Trimmer in Side and Rear Views and in Use Flush against a Wall

a mower that is like the ordinary kind cut in two. It can be run close against the sides of buildings, and not only cuts the grass, but slices the sod, evens up margins and cleans edges with a sharp disk that can be raised out of the way while cutting. Below the disk, is a little plowshare to throw material aside. The trimmer is similar to a full-size mower, having a four-knife cylinder.

HOW HIGH DO BIRDS FLY?

By applying methods of the astronomer, a German scientist has established reliable figures as to the height at which migrating birds fly. Formerly, many bird students believed that such elevations as 35,000 feet were not uncommon, but it is now practically acknowledged that the average height is only about 350 feet. The observer watches until he sees a flock of birds in flight across the face of the full moon. If he recognizes the species and knows their size, it is a simple matter of calculation to estimate closely their height by using the moon as a sort of scale. He has discovered thrushes flying at about 600 feet, starlings at 2,400 feet and lapwings at 2,200. The greatest height ob-

served was 4,900 feet, but in this case the birds could not be identified. Assuming an average for their actual size, their apparent size as seen against a moon crater, gave the data for calculating the height.

**BLIND MAN, GUIDED BY FINGERS,
 BUILDS OWN HOUSE**

Although handicapped by blindness, Francis A. Burdett of Wayne, N. J., sixty-three years old, has built his own two-story house. His sensitive fingers served as his eyes to help him measure boards and timbers and fit them into place. The home is the second he has constructed. Three years ago he built a two-room bungalow, doing all the work himself and completing it in two months. He was a watchmaker by profession when an accident caused his blindness. He taught himself how to make crates and boxes and later applied his skill to home building.

**AUTO WITH THREE WHEELS
 SEATS TWO PERSONS**

Among the many types of small cars used in Europe, a three-wheeled auto with an all-aluminum body introduced in Berlin, carries two persons, one seated behind the other. Windshield, top, and adjustable headlight like those of the ordinary automobile are included in the equipment. The body is narrow, to decrease

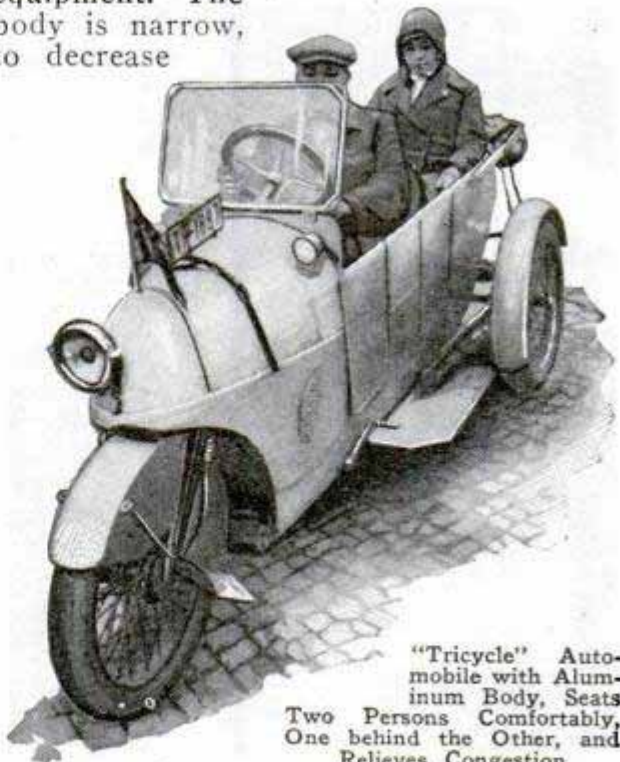

"Tricycle" Automobile with Aluminum Body, Seats Two Persons Comfortably, One behind the Other, and Relieves Congestion

the amount of wind resistance, and a wide mudguard behind the front wheel protects the sides of the car.

no data. p.s.a.

White, Pmb, Ledger
 10/4/25

1 Cosmos, May 1925



© Henry Miller News Service

Stunt Man Leaping from Boat to Ladder of Airplane Going Eighty Miles an Hour; Later He Tried to Drop Back upon the Boat with a Parachute but Missed

538
LEAPS FROM BOAT TO AIRPLANE AT EIGHTY MILES AN HOUR

Teamwork and skill were required for the successful leap of a daring "stunt man" from a fast motorboat to an airplane. The boat was going sixty miles an hour when the plane, flying twenty miles an hour faster and with a ladder dangling, swooped down so the climber could catch on. The connection was made without mishap, and when the plane had ascended 1,800 feet, the man on the ladder attempted to leap back to the boat with a parachute. His calculations and those of the aviator and the hydroplane operator were so nearly correct that he missed his objective by but a few feet.

419
EXPERT GOLFER TEES OFF FROM GIRL'S HEAD

Standing 273 feet above the street on the twenty-fourth-floor level of a Chicago office building, a professional golfer made a drive of 781 yards. Besides this

stunt
 stunt, the player demonstrated his skill by driving woolen balls from a cardboard tee placed on the foreheads of assistants, one of whom was a girl.

528

RADIO DEVELOPS A DETECTIVE TO LOCATE INTERFERENCE

The radio industry has given birth to a special kind of detective, a sleuth not concerned with evidence relating to crimes but to causes of interference, such as doorbells, battery chargers, X-ray and violet-ray machines and leaky power lines. His equipment consists of nothing more than a coil or loop antenna that revolves, and a radio-receiving set of a portable, rugged type. With his outfit conveniently installed in an automobile, he can make wide surveys about his neighborhood, seeking the source of the trouble. Once it is located, correction is sought by cooperation between the owner or owners of the disturbing elements and the radio users.



© Harris & Ewing
 Seeking Source of Interference, a Radio Detective on the Job with His Equipment

Jack Redmond, 24th floor

Frank S. D. Winters, Westchester National Bank, 24th floor, Washington, D.C.

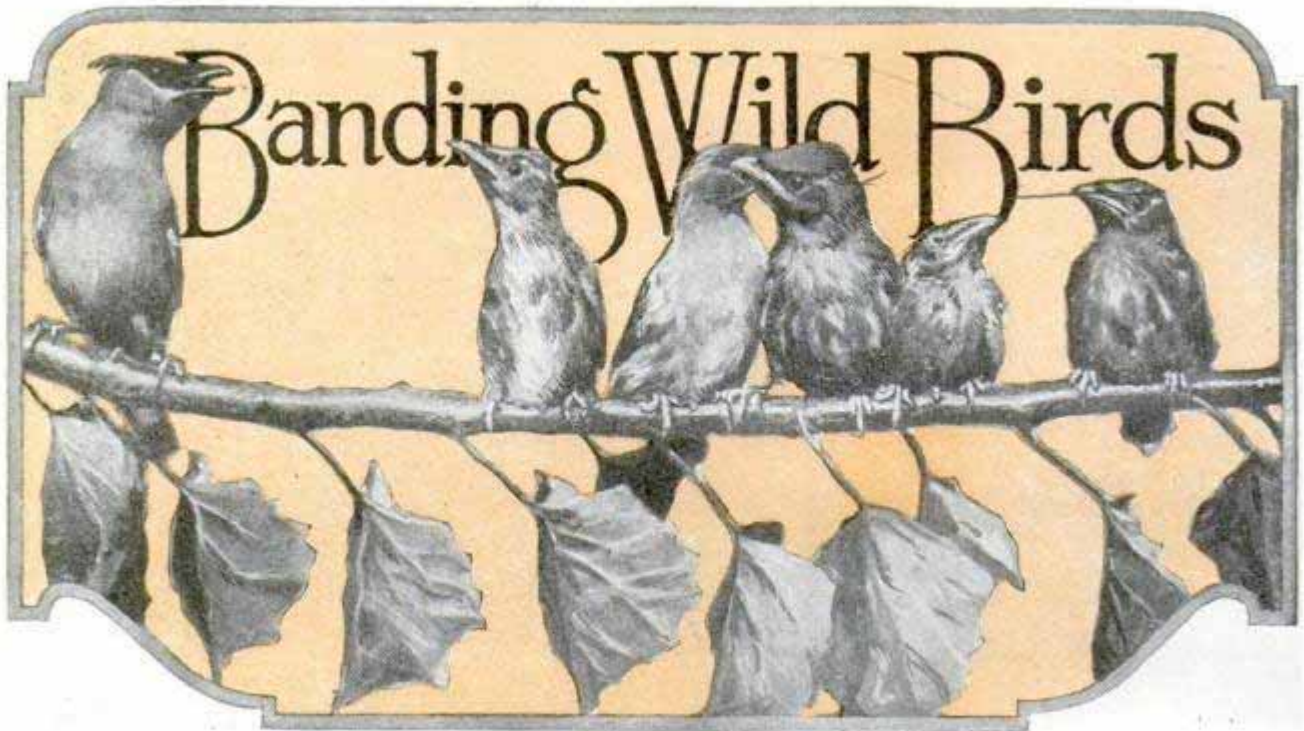

More than 100,000 Already Have Been Tagged with Leg Labels Then Released to Trace Their Travels

By HARLAN H. EDWARDS, *Altadena, Calif.*

MANY interesting and hitherto unknown facts about the life, habits and travels of wild birds are being established by means of bird banding. This work, authorized by federal and state permits, is being carried on throughout the United States and Canada in co-operation with the biological survey.

Birds are captured for banding purposes in various kinds of traps, all of which, however, effect the harmless imprisonment of the bird until it can be removed. It is then examined, and a tiny aluminum band, or bracelet, placed loosely on one leg, after which it is released. Each of these little bands bears a serial number, which is registered in Washington together with a description of the bird. Every time a bird so numbered is retaken, a record is made, thus adding another chapter to its known history. Although this work has gone on for comparatively few years, over 100,000 birds already have been banded and the number is increasing by leaps and bounds.

Places where trapping and banding operations are carried on soon seem to become known to the birds as sanctuaries, so that the population rapidly increases, as compared to the surrounding territory. In this way, time and energy spent in this work by bird lovers are amply repaid. By banding, one can keep almost daily record of many of the birds inhabiting the local-

ity, while during migration, one may discover the day an individual bird comes and the day it moves on.

The birds display no fear of the trap. They often seem to regard it as a special feeding table and some birds form the "trap habit," entering it several times a day. In fact, one station in Georgia reported a brown thrasher as spending most of every day in the trap, while a cardinal became such a nuisance by getting into the trap and keeping other birds away that finally it was found necessary to move it to another location.

Many interesting instances might be given of the actions of the wild birds while being banded. In spring, they often sing their song immediately upon being released. One worker reported a bird as regularly singing while held in his hand. Some birds grasp one's hand with their beak, others with their claws, and some "play possum," but with their eyes open.

This tendency of the birds to remain motionless in the hand, although entirely unrestrained, is of interest. If one releases birds by very gently opening the hand, many of them remain deliberately until they have entirely recovered from their first little scare, before taking wing. Sometimes they stay until the hand grows tired.

There are many things to be learned from the data obtained by banding, the evidence gathered becoming more and



Grosbeak and Myrtle Warbler Family Above; Center, Calaveras Warbler "Playing Possum"; Below, Blackbird at Nest and Golden-Winged Warbler



516

more valuable as the number of birds banded and recovered increases. It has been proved that certain species of birds return yearly to the same locality for nesting and for the winter seasons. Migrating birds stop at the same feeding places en route year after year. By additional returns, answers to the following questions are expected to be obtained. How long do birds live? Do migrating birds travel each day or linger at places en route where feed is good and the weather suitable? Do they move on ahead of or after storms? How far do birds wander in their daily feeding? If birds do return to the same nesting place year after year, will they use the same nest and have the same mate? After the young birds leave the nest, do they stay in the same locality? Do birds raise a second brood in the same nest or near by? Do young birds return to the same place another season? What are the routes and speed of migration of the various birds?

Definite data bearing on these questions are already being obtained. Each year adds to the number of banded birds which are at large, and also produces multiplying records of birds which have returned to stations at which they were first banded. Reports are being constantly received con-

cerning banded game birds which have been killed at various points, all, when analyzed, of interest.

By ascertaining migration routes, especially of game birds, preserves can be established at various points to afford the birds protection while traveling to and from their nesting grounds in the far north country. That some action must be taken in the near future to prevent extinction of our game birds is becoming more apparent, as can be attested by the increasing scarcity of birds at various hunting grounds. Some birds, once abundant, the passenger pigeon, Eskimo curlew, etc., are already extinct. Others, the prairie chicken, whooping crane, trumpeter swan, and some of the ducks and geese, are so reduced in numbers that their extinction seems imminent.

Among the many interesting migration records already established are those of a number of ducks banded at Browning, Ill., while in migration. From the bands returned, many of the birds traveled as far north as central Manitoba and Saskatchewan, others as far south as the Texas and Louisiana coast, while a few stragglers got as far east as the Atlantic ocean. Among the longest recorded distances traveled was that of a common tern which



Flock of Fulmar Petrel Following a Whaling Vessel for Scraps; by Leg Band Tracers, Much Is Being Learned of Birds More Difficult to Study

5/16
 was banded at Eastern Egg Rock, Me., July 8, 1913, and was found in August, 1917, on the Niger river delta, West Africa. Another, banded at Brigantine island, N. J., in 1920, was found two years later in Paria bay, Trinidad, off the coast of Venezuela. A blue-winged teal, banded Sept. 24, 1920, at Lake Scugog, Ontario, was found Dec. 9, 1920, in the Caroni swamp, near Port of Spain, Trinidad. Black-headed gulls, banded at Rossiten in northern Germany, were recovered at the island of Barbados, W. I., and off the coast of Vera Cruz, Mexico. Perhaps the reader may be the one to find a bird bearing a tiny aluminum band on one leg, on which a number is stamped together with the abbreviations "Bi. Surv." and on the back, "Washington, D. C." This bird may have been banded in some far-off place and its recovery forms a valuable link in the chain of evidence being gathered. If such a bird is found or taken either alive or dead, the fact should be reported at once to the United States biological survey, Washington, D. C. If the bird is dead, the band and identifying parts of the bird should also be sent, together with the date and place where found, and the name and address of the person who found it. If the bird is captured unharmed, jot down the band number carefully before releasing it, and send the data with a description of the bird.



Flag of Poplar-Wood Chains and Its Carver; Links Are Colored on Both Sides and Supported by Rod

U. S. FLAG OF WOODEN CHAINS
 CARVED WITH KNIFE

540
 Chains of poplar-wood links, carved with a pocketknife and colored, have been

formed into a United States flag by an Indiana craftsman who spent several years' spare time on the task. It is three feet wide and five feet long, and is tinted on both sides so that it is reversible. The chains are supported at the top on a strong metal bar.

Clyde Jansey
Lipton, Ind

RACING AUTOS REGISTER TIME
 BY RUNNING OVER HOSE

579
 To insure greater accuracy in timing racing automobiles, a western inventor has developed a simple outfit which eliminates the human factor. It consists of a water-filled length of hose laid across the track with a plunger and lever connected to a stop watch at one end. When the car runs over the hose, water forced against the plunger actuates the lever and starts the watch. Returning from a lap around the track, the auto stops the timepiece as it recrosses the hose. The equipment has been found especially useful for timing cars in qualifying rounds to determine positions in a race. The automobile shown in the accompanying illustration is equipped with a special type of supercharger which makes 24,000 revolutions per minute when the motor's speed is 4,000 revolutions per minute.

Bydros. J. Miller Corp
Laurel Motors
Anderson, Ind.

585
 FOURTEEN MILLION OWN HOMES
 IN U. S., SURVEY SHOWS

Although America has been called the most extravagant country in the world, home making is one of its biggest industries, a building association's survey shows. Construction of residences constituted sixty per cent of the year's \$6,000,000,000 building program, and it is estimated that 14,000,000 American families are homeowners. Approximately \$3,000,000,000 a year is spent for automobiles, with almost as much for tobacco.



When Auto Runs over Hose, Plunger Starts or Halts Stop Watch on Stand

Indiana Limestone
Quarrymen's Association

584

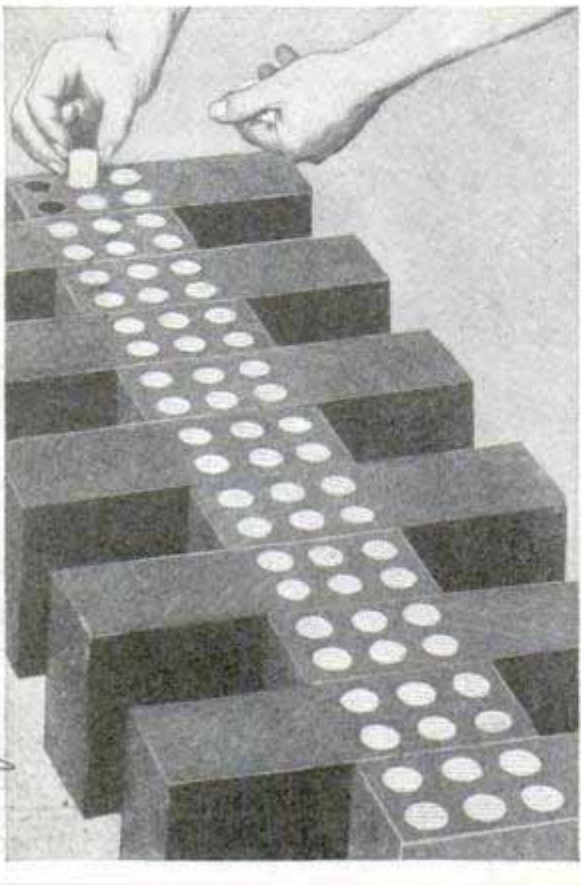

White Tile Markers for Traffic Lines and How They Are Inserted in Wooden Blocks

TILE SET IN PAVING BLOCKS TO GUIDE TRAFFIC

Permanent lines for the guidance of traffic are provided by round pieces of white tile set in holes bored in wooden paving blocks. Although they appear as rows of white dots when seen at close range, from a distance they give the effect of a solid line. They do not wear away as does paint, so need little renewal, are easily cleaned and do not readily become dislodged.

DARK-COLORED HOUSE WARMER THAN WHITE

That the interior temperature of a house during the summer months depends to a marked extent upon the color of the outside surface, has been proved by a series of experiments. It was shown that darker colors are as much as ten

degrees warmer than lighter ones, and that most unpainted buildings will be warmer in summer than those painted white or a light tint. The tests were made with metal containers and both wood and iron panels, all painted in different colors. They were exposed on the roof of the laboratory on a day when the official air temperature was eighty-two degrees Fahrenheit. Thermometers were inserted in the ends of the specimens and regular readings taken. Wide differences were noted. For instance, the unpainted metal container showed a temperature of 102 degrees, but the black one registered 114. The interior of the white wood panel was only 104 degrees but the thermometer went to 130 in the black one. The white iron panel was twenty degrees cooler than the one without any paint. The tests were held to indicate the importance of planning color schemes for new houses, as a difference of a few degrees often represents the difference between comfort and misery.

PLANE GOES THIRTY-FIVE MILES ON GALLON OF GASOLINE

Weighing only 320 pounds, a small airplane that won the speed and efficiency tests at Mitchell field, flew thirty-five miles on one gallon of gasoline. It is estimated that it could make a trip from Chicago to New York at an expenditure of only about \$5 for gasoline and oil. The wing spread is sixteen feet and the length fourteen feet three inches. The plane can attain a speed of eighty-five miles an hour.

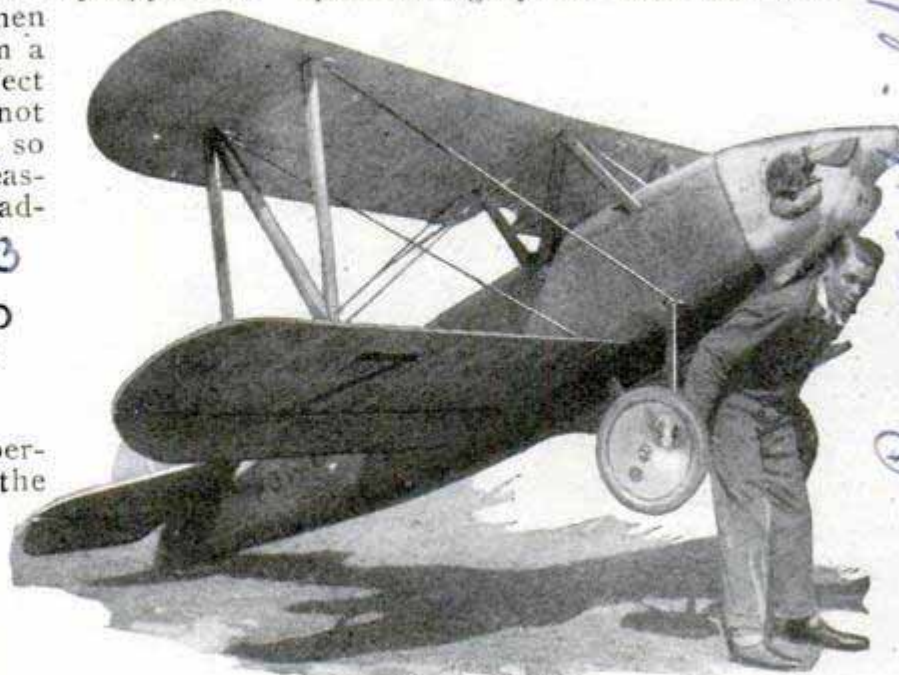

One Man Can Lift Tiny Airplane, as It Weighs Only 320 Pounds, But It Can Fly Eighty-Five Miles an Hour

Whitchell, London no other information.

silver

581

584

markers

603

Powell flight plane

American Builder

10/1925

Ed. O. Jerry block.

361

Syncopated Music, with the Variations Introduced by Jazz, Depends for Many Effects on the Wind Instruments



Where Jazz Comes From

Distinctive American Form of Music, an Accidental Discovery by Four Boys, Now Being Adopted into Classical Forms

By EARL CHAPIN MAY, *Sharow, Conn*

AT a national convention of music industries, a piano manufacturer attacked jazz as "a series of animal howls—a yowling of jungle creatures." About the same time, several thousand lovers of music assembled to hear Eric Delamarter, internationally famous as organist, conductor and composer, interpret his complete jazz symphony with the aid of one of the largest pipe organs in the world and eighty-five members of the Philadelphia Symphony orchestra.

The debate on the question, "Resolved: That jazz is a distinctive American form of true music," waxes more violent with its increasing popularity. The violence of the debate is equaled only by the argument over its origin. As a matter of fact, the question of where jazz originated finds a parallel in that classically moot query, "Which came first, the egg or the hen?" Even the origin of the word "jazz" is in doubt, and few agree on what style or type of music shall be justly called jazz. But several years of study and practical experience lead to the conclusion that jazz is the offspring of syncopation, plus a multitude of non-musical notes and a wealth of effects by the traps and the drums, and other similar

instruments that are sounded by beating. Syncopation is the stressing or accenting of the afterbeat in music. It antedates music because the first drum corps in the wilds of Africa went in strong for syncopation. The savage who evolved a drum, by stretching dried skin across the end of a hollow log, made "drum talk" by accenting the afterbeat. The Kaffir coal miners of the Rand rally around their syncopating drum corps to this day. You'll find syncopation among the Peruvian drummers of the Andes, the Siberian drummers with their bone drumsticks, and the Tibetans who drum upon human skulls.

John Sebastian Bach, "father of modern music," was using syncopation in his "Well Tempered Clavichord" and other compositions before 1750. Ludwig Van Beethoven wrote syncopation into the Scherzo movement of his Opus 18, Number 6, before 1800. When our south imported slaves, it also imported syncopation from Africa. When the dives of the old Barbary Coast of San Francisco introduced us to the one-step and fox trot they adopted a syncopation, developed in Buenos Aires, Argentina, which came from the tribal dances of Brazil. But the



Charlie Chaplin, a Southpaw, Leading an Orchestra in One of His Own Compositions

effects by which modern jazz is identified originated in our own southland and its negroes. We first came to recognize them in the negro blues. W. C. Handy, an Alabama negro, put the blues on our musical map. Handy was proprietor and manager of a dance orchestra. One night,

more than thirty years ago, he was filling an engagement at the little town of Cleveland, Miss. Three local negroes applied for permission to interpolate a selection. This permission granted, the trio, equipped with mandolin, guitar and bass viol, played, over and over again, a mournful, primitive strain of twelve instead of the orthodox sixteen measures.

There were just three changes of harmony in this unfinished symphony, but it made a hit, partly because the guitar and mandolin players slid their fingers along the frets and produced the effects we now hear in the Hawaiian steel-stringed guitar and ukulele and partly because the bass-viol player "wolfed" his tones. White folks present showered money upon the local negroes.

Handy sat up and took notice. He studied the new type of music, which had a melody something like the negro spirituals, but encouraged encores because it left the impression that there was something more to come. One result of Handy's study was the composition which has won fame as "The Memphis Blues." It was a song without words at first, but it went big. Then Handy wrote some verses for it, referring to a Memphis election campaign. They were not so good. George Norton, a white man, contributed a new set of verses, which became permanently attached to the Handy melody,



© Keystone

A Band of Original Syncopators, the Kaffir Drum Corps Gets Jazzy Results by Accenting the Afterbeat



Chaplin Directing the Phonograph Recording of His Own Compositions, Above, and a Jazz-Band Member with a Few of His Rhythmic Reeds



praising the hospitality of Memphis and the skill of Handy's orchestra.

"The Memphis Blues" traveled from coast to coast. There was an outbreak of blues in every musical quarter. The rag-time craze followed. But jazz was still unborn. It remained for four New Orleans white boys to add that word to the world's vocabulary.

Nearly twenty years ago, this quartet of youngsters did the usual kid tricks in the Crescent City. They followed the street bands. They imitated them on mouth organs and "kazoos." Presently, and somewhat blindly, the boy named La-Rocca found himself the leader of the band of four, and also the cornetist. By the same undefined process, the youth named Edwards began to master the seven positions of the slide trombone. Young Shields became "one of those grinning fools who suck a stick," in other words, a clarinetist. And young Scar-

boro became intrigued by the manifold possibilities of the traps and instruments of percussion, so often now referred to as the "battery."

Without an hour of professional instruction and in total ignorance of notes as written, the boys announced themselves as the Dixieland band. The announcement made no immediate sensation in New Orleans. The band's services were not in instant demand. In fact, the four boys knocked at the door of opportunity for months before they finally forced themselves into a job at a local dance. The remuneration was six dollars or one dollar and a half for each budding musician. Other jobs followed. Then fate beckoned them to a popular grill.

The Dixieland band made good because, in their ignorance of written music and innocence of technique, the boys committed many atrocities in the name of the muse. The violinist wolfed his tones, which no good musician should do. The trombonist blatted and sounded many a flat and sharp where accidentals should not have been heard. The cornetist achieved blue notes by blowing on his cornet when the water key was open. The trap drummer indulged in many a raucous noise with the aid of cuckoo calls, horse neighs, nose blows, and other devilish devices. But they made a hit and their fame spread to far-off

Chicago. Down from Chicago, in 1914, came a restaurateur named James. James came, heard and was conquered. He offered the four New Orleans boys the princely sum of twenty-five dollars per week a piece and all expenses to play in his Chicago restaurant. The offer was accepted with alacrity. Mr. James was given no time in which to change his mind.

Half scared and half thrilled, the four members of the Dixieland band opened their Chicago engagement in the Boosters' club. They were a riot. Police reserves were called out to keep the mobs of patrons at bay. And then one night, while the boys were catching their several breaths after an unusually enlivening blue number, somebody in the restaurant—it has never been decided just who did it—shouted, "Jazz 'er up, boys."

Now there are thousands of jazz orchestras in this country. Almost every town of 5,000 has one or more. Few vaudeville programs are complete without a jazz number. Many a student in our institutions of higher learning is completing his education by playing



Rehearsing a Jazz Selection and Working Out the Parts for the Other Instruments; the First Jazz Band Never Rehearsed, Because None of the Members Knew or Could Read Music

361

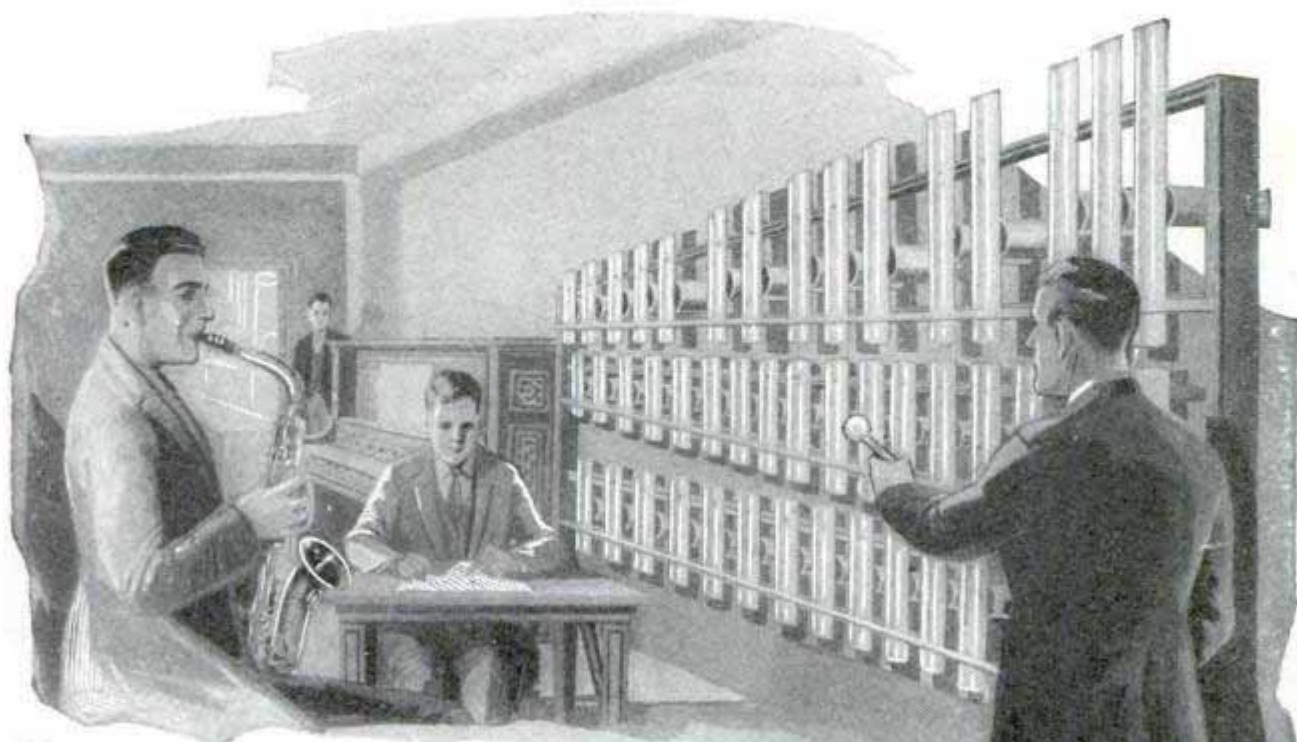

Courtesy The H. N. White Co.

Huge Group of Musical Testing Bells, with a Range of Three Full Octaves, Used to Test Pitch of New Instruments

jazz engagements during the summer. From a quartet of cornet, clarinet, trombone and drums, the modern jazz orchestra has grown into a mighty force for the perpetuating of the reign of reeds and rhythm. First the piano was added. Then came the moaning, wailing saxophone. Then the oboe arrived, and finally all the wood wind instruments and the wealth of imitations to which the trick trap drummer is so much addicted.

The old simple syncopated melodies, such as Irving Berlin's "Alexander's Ragtime Band," have been succeeded by Vincent Lopez and his jazz version of "The Covered Wagon." Our distinguished pianist and composer, Edward Burlingame, has brought out a "Jazz Study" for two pianos. The brilliant Texan, Harold Morris, has composed his "Second Sonata" in which are incorporated many negro tunes. Powell's "Negro Rhapsody," Whithoner's "Times Square" and Carpenter's "Krazy Kat" are among the current contributions to the literature of American jazz.

So many of our jazz orchestras invaded foreign fields that the French government made a determined, although not wholly effectual, effort to bar them, for they were cutting French musicians out of long-held jobs. But the jazz orchestras, augmented by helicon basses and a terrifying assortment of marimbas, chimes, bells, xylophones and whatnots, are sounding the dominant notes in American

music. It is nothing for a boy still in high school to be bitten by the jazz orchestra bug and to invest \$400 in various bird calls, animal imitations and instruments of percussion, while the professionals go much farther.

I once spent an evening with Ross Gorman, of the Paul Whiteman organization, inventorying his stock in trade. Ross is primarily a saxophonist. But all jazz artists must specialize in effects. Ross was getting his with equipment valued at \$3,540.

One trap drummer of my acquaintance has more than \$1,000 invested in his imitations and percussion instruments. But it pays them well. Ross makes about \$400 a week although that is small change compared to Vincent Lopez and his weekly income of \$5,000.

And there is a bit of a joke on those who raise an outcry at the increase in jazz music and orchestras. Some jazz players may make the sounds of jungle beasts. But the interesting phase of the whole situation is that while most of our popular jazz tunes are transcriptions from some classic melody, many of our modern master musicians, especially those who live and move and have their being in cul-

tured Europe, are accepting these jazz tunes as typically American and are giving them what these master musicians regard as classical transcriptions.

So you see there is something to the parallel questions of where did jazz come from and whether the egg or the hen came first. Probably jazz did come from the jungle by very easy stages. But having come from the jungle via Beethoven, Handy, Berlin, and the boys from New Orleans, it is becoming refined by those who sit in the seats of the musically mighty.

Jazz teaches us to keep time to a tune. It also familiarizes us, in theater, dance hall, cabaret or restaurant, with the melodic themes of Rachmaninoff's "Prelude in C," Dvorak's "New World Symphony," Schubert's "Serenade," Handel's "Messiah," Beethoven's "Moonlight Sonata," the Hungarian rhapsodies of Liszt and even Chopin's "Funeral March" and Mendelssohn's "Spring Song."

The works of Oscar Strauss have been metamorphosed for the dance hall. Wagner's "Evening Star" from Tannhauser has its jazz version. "Yes, We Have No Bananas" was, note for note, parts of three other pieces, the "Hallelujah" chorus, "I Dreamt That I Dwelt in Marble Halls," to say nothing of that song of our youth, "Aunt Dinah's Quilting Party." Melodious Nevin, trifles from Delibes,

Chaminade, Moszkowski, Grieg, Schumann, Puccini and Brahms are revamped into super-syncopated jazz tunes and interpreted for our tapping feet by trombone, saxophone, helicon and drums.

"Home, Sweet Home," "Massa's in the Cold, Cold Ground" and "Carry Me Back to Old Virginny" are jazzed in many a supper show palace. Even Rubinstein's "Melody in F" and the wedding march from "Lohengrin" do duty as fox trots.

But, barring the shock this gives the musically expert, I see no harm in it. Melody is the basis of all true music, and if the jazz orchestras familiarize the great American public with melody, much good must come from it.

589
**TREES AND LEAVES OF CEMENT
FORM GARDEN DECORATIONS**

The possibilities of cement in the decorative arts were further illustrated at a London exhibit featured by grotesque replicas of trees molded from the material. The so-called cubist influence was apparent in the designs. The broad, sharp-angled leaves, resembling big shingles, were set at varied positions to give the effect of branches, and the trunks were four-square columns set close together. Advantages of the "property trees" are that they can be placed where natural ones would not grow and that they blend with certain bizarre architecture.

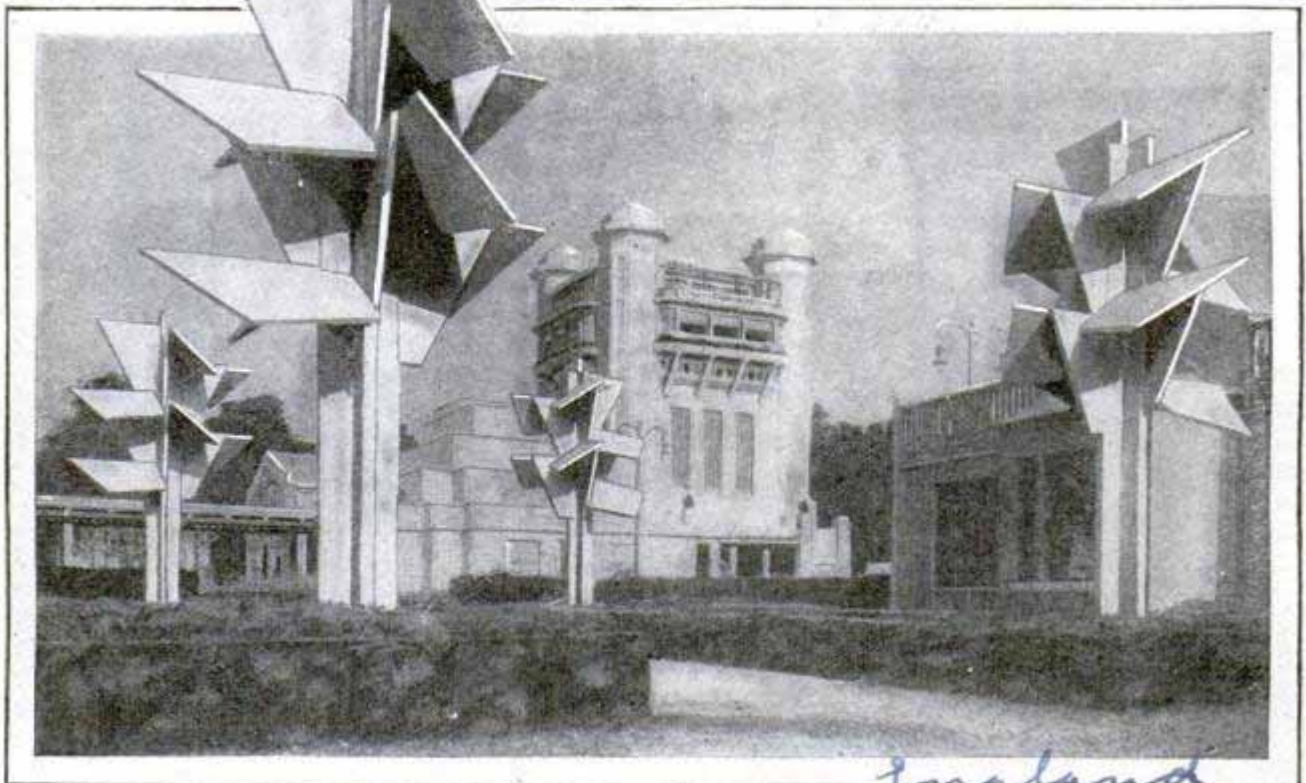

When Cement Workers Turn Artists: Fantastic Trees Shown at London Exhibit to Illustrate the Possibilities of the Material for Garden and Exterior Decoration; Buildings Also Were of Strange Design

Mallet Stevens in the Garden of the East...

650 Remington-Burnelli

Designer - Vincent J. Burnelli

SALESROOM IN AIRPLANE HOLDS AUTO AND DESKS

Universal Use

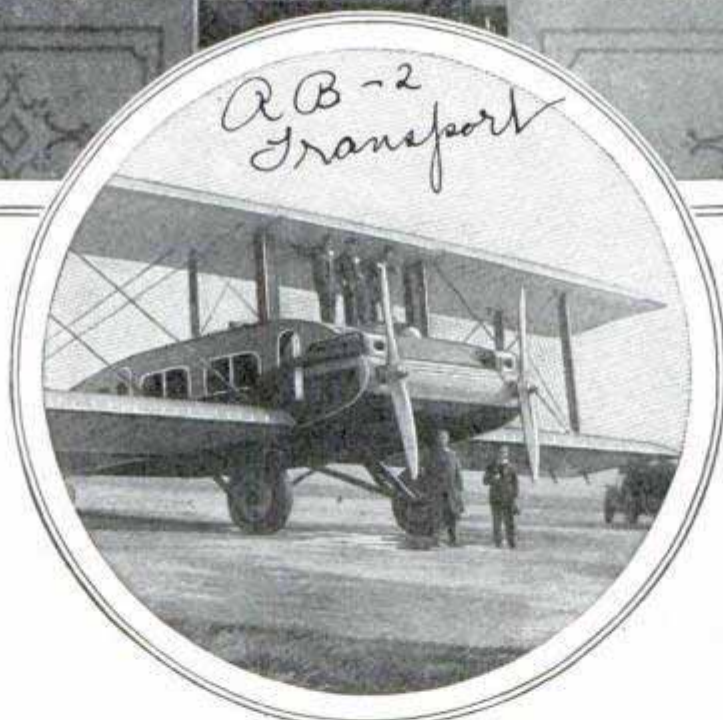
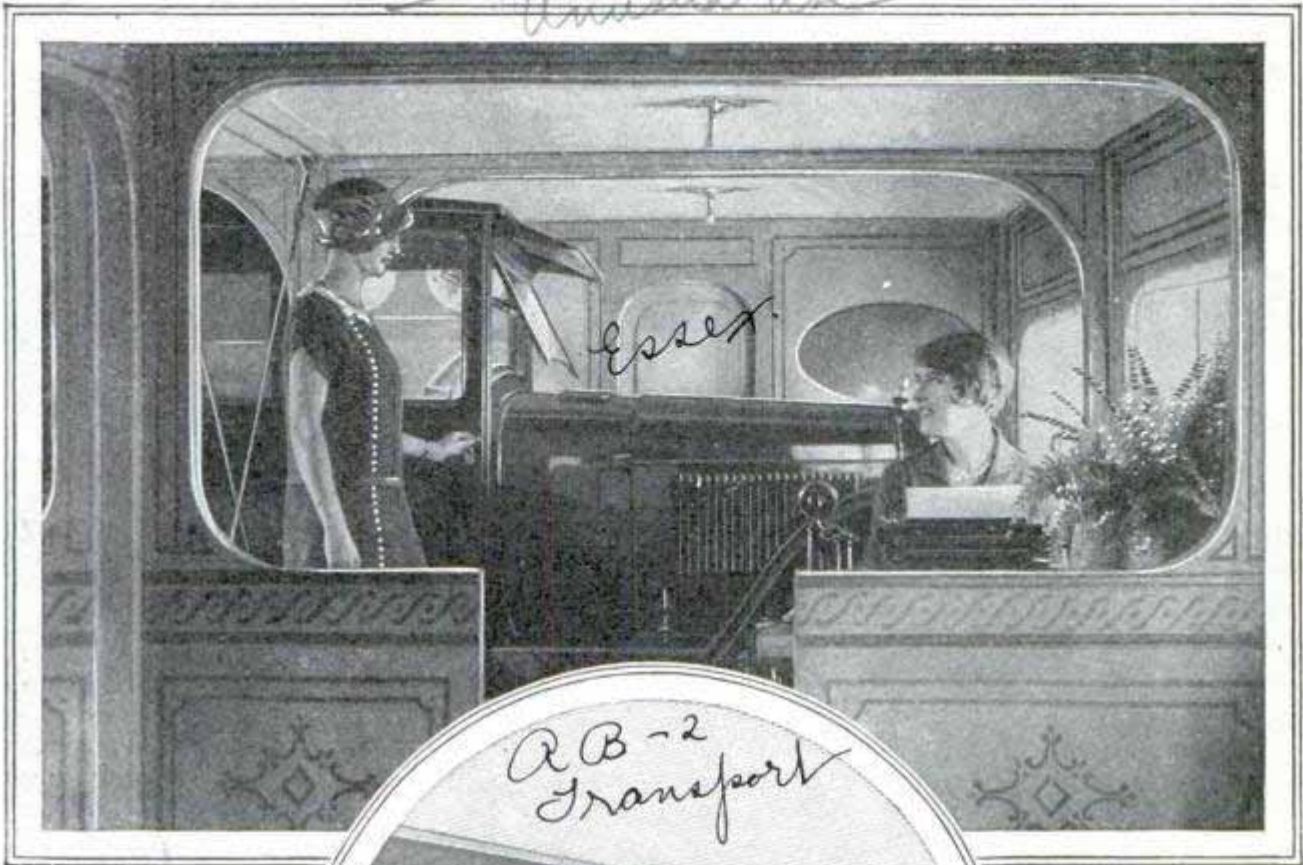

Interior of Salesroom, Housed in Airplane, with Sample Auto and Office Workers, and Exterior of the Ship

Has the day of the "flying office" arrived? A step in that direction has been achieved in a monster airplane with a wing spread of eighty-seven feet. Its fuselage was fitted up as an automobile salesroom, containing a sample car and office equipment, in addition to sufficient accommodations for the necessary personnel.

650

ORCHIDS FOUND IN FAR NORTH IN STEAM-HEATED VALLEY

Legends of a "tropical valley" in the extreme northern part of British Columbia, where orchids and wild honeysuckles grow in rich profusion near mountains capped with ice, have been verified by official reports from Maj. E. B. Hart, who was commissioned to make a survey of the province. His findings, now on file in the

archives at Victoria, not only substantiate the tales of Indians and trappers who described the valley and its 300,000 acres of good land, but explain the apparent mystery of its mild temperature. Hot springs, extending along the course of the rivers Liard and Toad, literally steam-heat the valley so that even in winter, the depth of snow is not over six inches, while less favored areas are blanketed to a depth of three or four feet. In season, upon bottom lands, are found luxuriant pine grasses, pea vine and lupins with an occasional orchid, while scattered growths of poplars attain a diameter of fifteen inches. Maj. Hart attributes the springs to weak spots in the earth's crust.

☐ Approximately 21,666 gallons of gasoline are produced in the United States every minute.

Remington-Burnelli Aircraft Corp., Hartford, Conn.

Col. Francis Lichie, Esq.
 Director of the Dept. of the Interior
 Ottawa, Canada

Chicago
ELECTRIC-HEATED HAT BLOCK PREVENTS SCORCHING

Danger of scorching hats when shaping them is practically eliminated in an electrically heated block with a red safety



Electric Hat Block. Showing Control Switch and Safety Light That Signals Too High Temperature

light that flashes when the danger point is reached. The block has a two-heat control switch to maintain an even working temperature. is warmed quickly and is adapted to hats of different sizes.

ONLY TENTH OF AMBER SUPPLY FIT FOR PIPE STEMS

Combing the beaches of the Baltic sea as their ancestors did 3,000 years ago, fishermen every fall search for precious bits of amber washed up by the waves and tangled in the seaweed. The material is petrified rosin from prehistoric forests and about half of the world's annual supply of 250,000 pounds is found here. Although there are many imitations, the demand for real amber is still great, and the introduction of substitutes has not changed the methods of the fishermen. They must brave rough weather, for the bits are washed in most plentifully only when the winds are strong and blow from the direction of the submarine deposits. Weeds likely to contain amber are dragged in with forklike rakes, and pieces that may be dropped to the sea floor, are caught in nets attached to the end of long

poles. The workers wear mufflers to protect themselves against the cold, and dash in upon the beach every few moments to warm themselves at fires which the women have built. If the weather is unusually severe, the fishermen link themselves together with rope like Alpine climbers. Catches of twenty to thirty bushels of amber within three or four hours were known in the eighteenth century when the supply was more plentiful. Such a haul was valued at more than \$4,000. Like diamond miners, amber fishermen are lured by chance and dream of finding large pieces such as the thirteen and one-half pound lump picked up in 1803 by a stroller along the beach. It is now in a museum in Berlin and is valued at \$10,000. Out of every 100 bushels gathered today, only about one is fit for carving into pipe stems and other articles. Some bits imprison rare leaves or insects and these are in great demand among scientists. Associated with legends, and a rival of spices in building up trade routes and spreading civilization, amber was regarded by the ancients as a mysterious substance because of its magnetic properties when rubbed. The Greeks gave it the name "electron."

LONG-HANDLED SOLDER DIPPER PREVENTS BURNS



For soldering or tinning joints overhead or in other difficult positions, a dipper with a swinging cup that always remains upright, prevents dangerous burns that often occur from spilling, and eliminates waste. The solder requires but one heating for fifty to seventy-five joints, it is claimed, as sufficient warmth to keep it

liquid is retained in the cup. Longer handles may be substituted for the regular one, if desired, so that a stepladder is unnecessary.

As a substitute for glass, a transparent sheeting material now on the market has been adapted to crystals for watches. The disks will not break, are held in place by a patented bevel and can be trimmed to fit with scissors or a file.

4307 Cottage Lane Chicago
new York Times 10/26/25
Identify Swiss Remmick

189
Paul W. Koch & Co. Chicago
19 E. Wills St. Chicago

E. D. de Pont de
Washington

International Correspondence
School, Scranton, Pa

349

POPULAR MECHANICS

Chicago Technical College, 118 E. 26th St Chicago
La Salle Extension University - Chicago
4101 S. Michigan - Chicago

105



What Home Study will do for You

The Campus, with Two Main Buildings, of One of the Large Correspondence Schools, Which Has Educated Hundreds of Thousands of Students in Their Spare Hours at Home

By DR. FRANK CRANE,

50 W. 47th St. New York

BENJAMIN FRANKLIN said, "Investment in knowledge always pays the best interest."

A comparatively rich man once said, "The way to have money is to spend less time skimping pennies on small salaries and more time on preparing yourself for high-salaried positions. If you make yourself worth enough, more money will come."

Good health and a trained mind are the two legs that raise a man above the crowd. He should form sane habits of living for the sake of his health and then devote himself to improving his mind.

Inventive genius is one of the things that is no respecter of persons. The poor man who cannot afford a university training may possess it. He needs the tools of knowledge to liberate it. The easier access to advanced learning through home-study courses has placed these tools within the grasp of all.

It is interesting to note that few of the men who have given us our great revolutionary inventions have been men of favored circumstances.



Instructors' Room in a Correspondence School, Where the Lesson Papers of the Students Come for Correction; Faculties in These Colleges Are Often Larger Than in Many Universities



Part of the Mailing Department in a Correspondence School, Where Lessons and the Corrected Papers Are Distributed into Regional Sacks to Speed Up Post Office Delivery

The little hunchback immigrant, Steinmetz, arrived in the steerage in the late eighties. He was penniless and his first job paid less than that offered a ditch digger.

Henry Ford, when a mechanic in Detroit, built his own modest little house at night after work, while his wife held a lantern.

The man who gave us the telephone was in dire poverty even after a company had been formed to advance its use. It is said that on the early books of the treasurer of the company can be seen such items as "Lent Alex. Bell fifty cents."

In 1869, when Edison came to New York, he did not have a cent. He had left his books in Boston as part payment of his debts. It is said that his first meal in New York consisted of tea which he begged from a professional tea taster whom he saw at work.

Real genius lies oftentimes in those who cannot afford attendance at an institution



A Corner of the Reference Library of One Big Mail School, Where Complete Collections of Books on All the Subjects Taught Are Available for the Use of the Instructors

of higher learning. Home study opens the door for those who are willing to apply themselves.

No such course will do it all. The result depends ultimately upon the man. But it will help him direct his energies.

Like prohibition, evolution and the Ford automobile, correspondence schools have been made the butt of countless jokes.

The result is that some people lose sight of the significance of the work they are doing.

About twenty-five years ago, they began to assume prominence. During the years since, they have been one of the big influences in the tremendous and beneficial attempts to "popularize" knowledge. They have helped take the mystery out of technical subjects. They have sought to bring knowledge within the grasp of the common man.

Real progress comes when the mass of the people are being educated instead of a few. In the thirteenth century the Renaissance gave the world a handful of super-scholars, but left the masses in poverty and ignorance.

The past quarter of a century has been one of putting spearmint in the intellectual chewing gum. The result is that the average amount of education is being raised.

Coincident with this rapid expansion of popularized education, there has been a period of unparalleled fruitfulness in mechanical inventions. The almost unbelievable progress along the lines of aviation and radio are examples.

There can be little doubt that this increased activity is largely due to the wider spread of scientific knowledge to the common man.

It is when a man stops studying that he ceases to grow.

Everyone should go to college if possible. However, for many reasons, a college education is impossible to many.

Thwarted in his ambition for a college education, a young man can do one of two



A Section of the Students' Service Department in One School, Where Records of the Lessons Mailed and Received, with All Other Work Done by Each Pupil, Are Kept on File

things. He can give up or he can study at home. If one has the will power to study at home, the struggle in itself is a developer of character.

To take yourself by the scruff of the neck and make yourself get down to work after dinner in the evening instead of listening to the latest jazz music over the radio, means that you are gaining self-control, which is one of the ends of all education.

"The science of education," Charles P. Steinmetz, the electrical genius, once said, "is the science of helping people find out what they want to know."

Too often the fight for success is likened to a football game or a prize fight, where you smash your way through the opposition of others.

In truth it is oftener like traveling a lonely road.

In the "Americanization of Edward Bok," the former editor tells of his surprise at this discovery. He says:

"The path to success is wide open. The competition is negligible. There is no jostling. In fact, to travel in it is lonely."

This is what the man who studies at home must remember.

There are few sudden spectacular conflicts to wrestle with. There is only the steady grind of making yourself fit for bigger things. There is the constant internal struggle resisting the desire for a

"good time" when there is work to do. There is the strain of keeping to the lonely path of self-control and hewing to the line of a determination.

This is the road to achievement and it is the biggest test of a man's real worth.

The big problem is to get ahead within yourself and not to get ahead of someone outside of yourself. That will take care of itself.

Price - \$37.50 including springs mattress and installation

Price Built in Coupe Bed Co. Los Angeles Calif. 5031 S Vermont Ave.

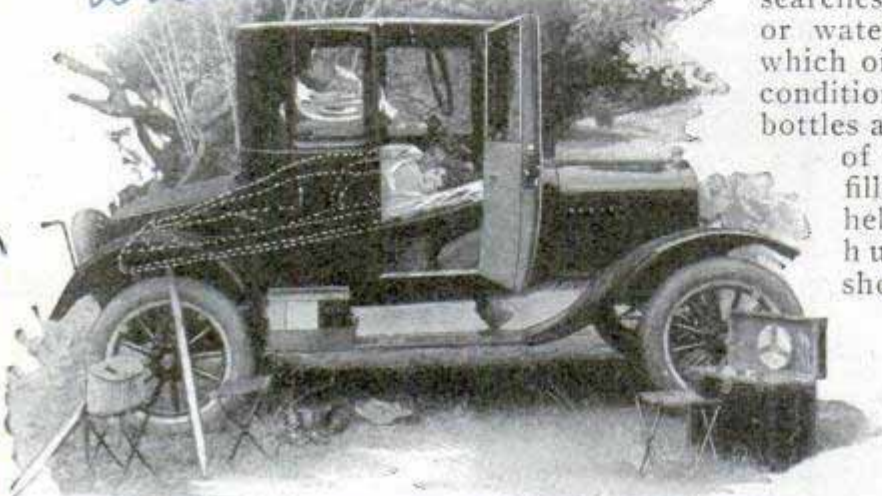

Dotted Lines Indicate How the Double Bed Extends to Rear of the Coupe; Bed for Child Above

FOLDING BEDS IN AUTO COUPE HOLD THREE PERSONS

Occupying but little space when folded up, a bed big enough for two persons fits inside the auto coupe which needs little remodeling for the installation. In addition, sleeping space is provided for a child across the seat back. The springs of the larger bed are suspended only at the ends, increasing comfort, and the mattress is an inch longer than the standard size. It extends the full width of the coupe and back into the rear part of the body. When not in use, the beds are concealed and can be put down or made up in less than two minutes, the manufacturers assert.

SAND GRAINS ROLL MANY MILES BEFORE BECOMING POLISHED

For most sand grains, a journey equivalent to two trips from the center of the continent to the ocean is necessary before they acquire a round, smooth shape. They wear away much more quickly when carried by water than when borne in the air. These are among the results of a western professor's three years' study of sand to discover the origin of oil-bearing

deposits. Prospectors, he believes, will be greatly aided in further searches, if they know whether wind or water laid down the strata in which oil is found. To study actual conditions, grains were placed in bottles and rotated on drums. Some of the containers were partly filled with water and others held only the sand. In a few hundred hours, the sand showed practically the same effects that result from hundreds of years of natural weathering.

MILLION MATCHES MADE AS ONE

Quantity production is imperative in match manufacturing, and to meet the enormous demand, special machinery has been devised to save time and labor. For instance, the heads are formed successively by passing the sticks, mounted on an endless belt, through three chemical solutions. A million matches are treated as a unit in this way. A cutter that prepares the wooden splints for dipping has a capacity of 40,000 a minute.

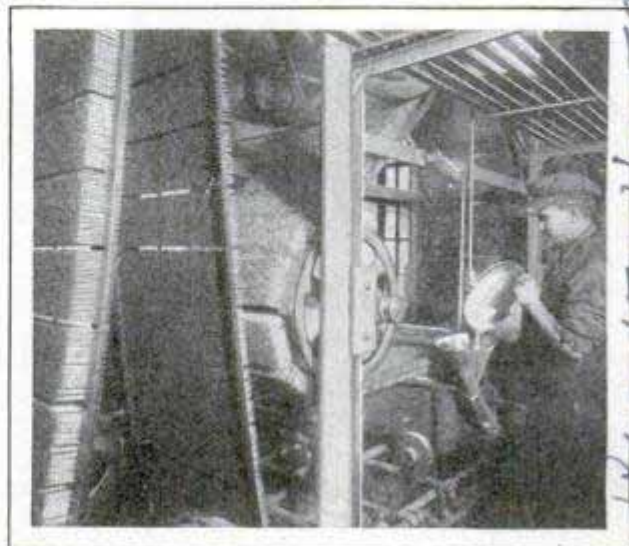

As Matches Attached to Endless Belt Pass through Chemical Baths, the Heads Are Formed

Esustans G. Anderson, University of Oklahoma

no data

Raymond H. Brown, N.Y.C. 91-7th Ave

**MASTS AT HUGE RADIO STATION
EIGHT HUNDRED FEET HIGH**

584

Twelve 800-foot masts, weighing 300 tons each, are required to support the

"winged projectiles," mostly engine and propeller, and with wings of the minimum

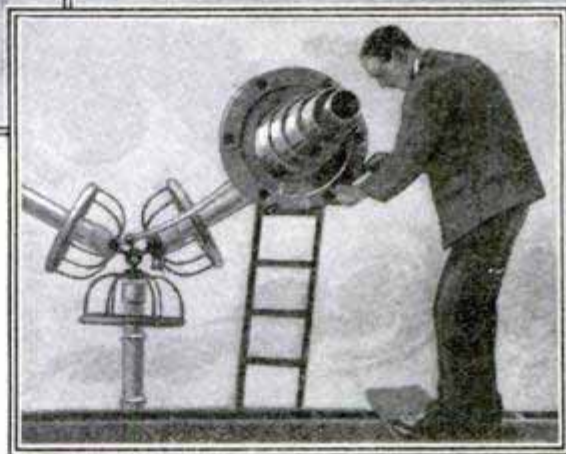
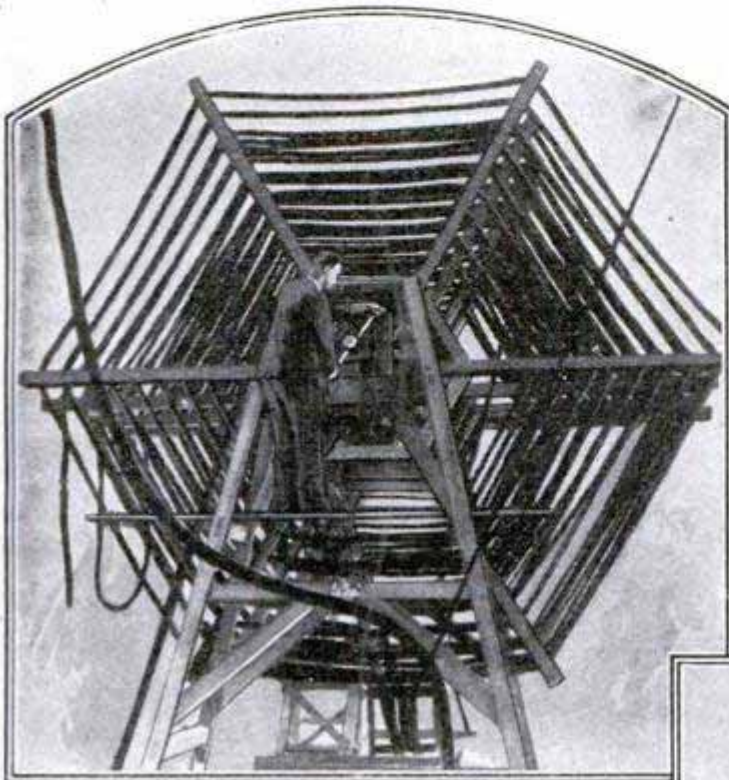

Inductance Frame, Huge Insulators and Lead-In of Powerful Wireless Station at Rugby, England

aerials at the huge British government broadcasting station at Rugby, Eng. The size of insulators, inductance frames and other parts is in keeping with the proportions of the rest of the equipment, as shown by the accompanying illustrations. The aerial system is one and one-half miles long and one-half mile wide. Not far away, at Daventry, is another large station with two 500-foot towers placed 800 feet apart. They are anchored on top of a hill 600 feet above sea level, so, from the standpoint of altitude, are the highest in England. Both are expected to be important units in the British empire scheme of international communication by radio.

574

**WINGLESS PLANES PREDICTED
AS RESULT OF ARMY TESTS**

Motors that can propel airplanes without the lifting power of the wing surfaces have been developed, army tests disclose. Using a Curtiss D-12 racer, Lieut. Russel Maughan flew edgewise, maintaining a straight course at 225 miles an hour, the body alone being sufficient to support the weight. Pursuit airplanes of the future, army officials predict, will be literally

length and surface required for taking off, steering and banking.

606

**COPPER TAKEN FROM WATER
WITH AID OF TIN CANS**

Nearly 100,000 pounds of copper are salvaged annually from the water of a mine by running the liquid through heaps of old tin cans and scrap iron. The process first produces iron sulphate, due to the action of the water in eating away the iron. From this, a sludge is formed which, when dried, assays fifty per cent pure copper. Each 1,000 gallons of water yields five and one-half pounds of metal. The mine flow is pumped through steel pipes lined with wood into long troughs, where most of the copper is deposited. In six months, 155 tons of tin cans and forty-seven tons of scrap iron were consumed by the process.

Copper Queen Co
Bisbee
Prin

Kansas City Post
10/5/25

3/8

Time and Money-Saving Tools



Faucets Can Be Mended without Tools by Using This Split-Pin Washer That Is Pushed in Place



With Baby Safely Seated, Mother Can Drive Car in Comfort

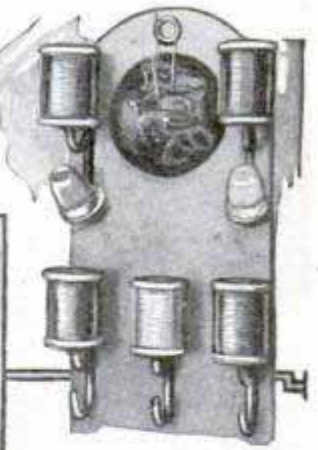

Holder for Sewing Articles Fits against Wall



Portable Electric Boiler to Sterilize Water



Cleaning Windows' Outer Surface from Inside in Safety

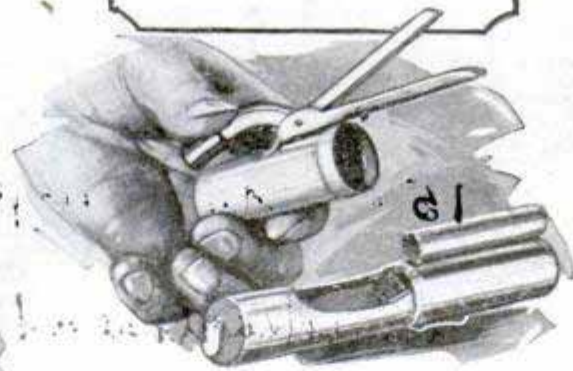

Fitting into a Case Less Than Four and One-Half Inches Long, a Pocket Curler Is Always Ready; at Left Is a French Floor-Waxer Intended to Give Even Pressure on Every Spot

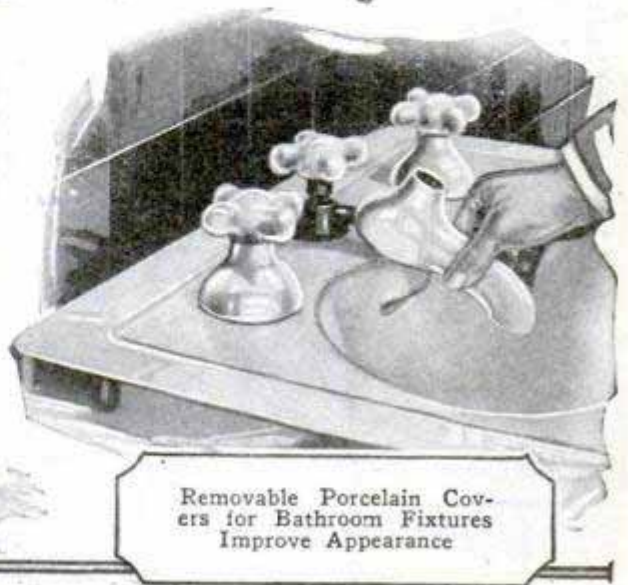

Removable Porcelain Covers for Bathroom Fixtures Improve Appearance

for Woman's Workshop in Home

F
S



"Gear-Shift" Meat
Grinder Changes
from Coarse to
Fine Knife by
Pressing Lever

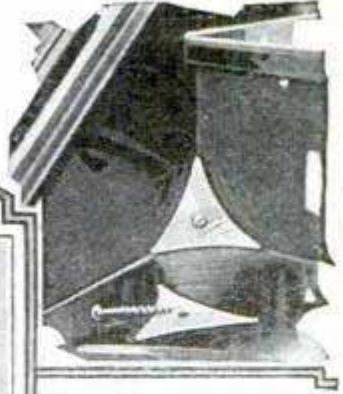

Metal Shields to
Keep Dust Out
of Corners Are
Easily Installed
and Save Work



Electric Water Heater and
Radiator in Wall Add Lux-
ury to Bathroom

F
I
e



Pail for Many Uses
Fits inside White-
Enamel Swing-Top
Holder



Sealing Tape to
Keep Juice in
Pies

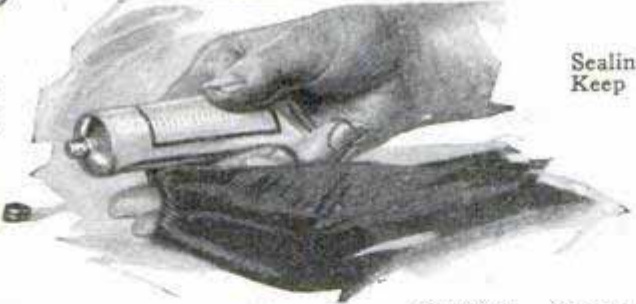

Patching Compound
for Use Instead of
Sewing and Darning
Withstands Launder-
ing Processes

*



Lighter Pastry
Dough and
Quicker Work
Are Possible
with Double
Rolling Pin



Mop Wringer
That Does Not
Splash and Saves
Stooping

2



Heavy Canvas Bag Will Not
Tear When Crushing Ice

559

Picture Service
519-63 POPULAR MECHANICS
Washington D.C.

TREES OF FANTASTIC SHAPES REVEAL TRIMMER'S ART

Years of labor and patient care are represented in the trees of an Iowa farm-

menace to health in manufacturing plants, into a cheap fuel for producing power is being made by the bureau of chemistry. It would replace coal, gasoline and oil, saving the country millions of dollars an-



Copyright, Henry Miller News Service

Iowa Farmer's Yard of Oddly Trimmed Trees; All Are Thriving in Spite of Repeated Cuttings, and Some of the Designs Are Being Changed by Gradual Pruning

er's front yard. They have been trained and trimmed into fantastic shapes like weathervanes, spirals, animals and other forms, and in spite of repeated cuttings, have flourished. They are set far enough apart to permit a clear view of each from the road.

EXPLOSIVE POWER FROM DUST 521 TO RUN AUTOMOBILES

An attempt to convert waste dust, now a serious potential fire hazard and a

nually, scientists predict. According to Dr. C. A. Brown, chief of the bureau, there are many products from which inflammable dust, suitable for fuel purposes, could be derived. These include various kinds of chemicals, metals, wood, leather, cork, grain, rubber, sugar, cocoa and cinnamon. Carbon in these substances combines with oxygen, producing the combustion.

The hazard of grain dust in elevators is well known, and to prevent accidents and explosions, elaborate precautions in the form of construction and in methods of handling the grain are taken. At a recent exhibit in New York, chemists from the bureau made use of this elevator problem to demonstrate the principles of dust explosions and show how they may be able to harness the power to run machinery. Into the miniature shaft of a model elevator, was poured a teaspoonful of corn starch or sugar. A piece of paper was clamped over the top of the shaft. Then air was pumped into the small passage, stirring up the powdered substance which had been carefully dried and finely pulverized for the demonstration. By means of an

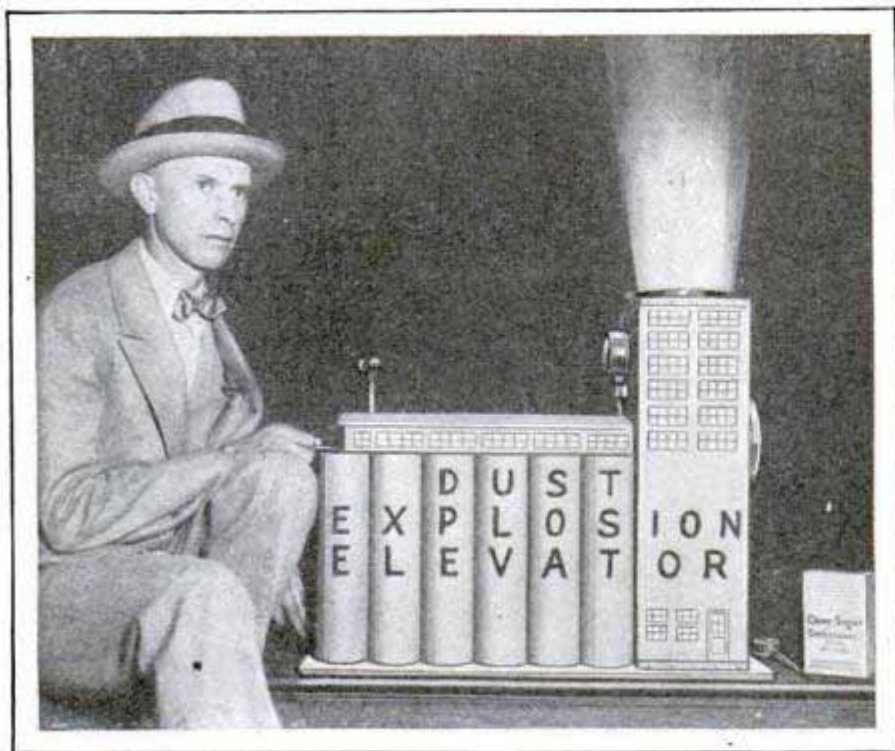

Illustrating the Explosive Power of Sugar; Model Elevator Photographed the Instant an Electric Spark Ignited Dust

W. A. Noel, Engineer

electric spark, the combination of dust and air was ignited, the carbon in the floating particles uniting with the oxygen in the air and producing a miniature explosion of such force that the paper and its hoop were blown to the ceiling. The test not only showed the un-harnessed power lying in inflammable dust, but demonstrated what occurs when a real elevator "explodes," frequently with loss of life and heavy damage.

The most powerful of all fuel dusts is said to be that of aluminum.

METAL PLATING PRESERVES FLOWERS 541

A process of plating flowers and foliage with metal to preserve their original appearance is being used by an associate of the late Dr. Charles P. Steinmetz. He predicts that roses he has treated with silver in this way, will be found in a perfect state of preservation when the plating is removed ten years hence. Besides the roses, he has prepared golden-maple leaves and copperized bunches of ivy. The method involves an electro-chemical treatment and the scientist asserts that it can be adapted to furs. By a special heating process, he expects to deposit metal on the hairs without destroying their softness. Silver-fox fur, for instance, could be imitated in cheaper varieties, by this coating, it is claimed.



Coating Cut Flowers and Leaves with Metal

TOKYO HIRES SANDWICH MEN TO ANNOUNCE CENSUS 566

When the census is to be taken in Tokyo, squads of sandwich men, bearing



Tokyo Sandwich Men with Their Signs Announcing a Census Taking, Ready for Trip through City

placards announcing the event, are sent into various districts of the city to prepare the population for the arrival of the statistic clerks. This form of advertising, it has been found, reaches more persons than printed notices in the papers.

NUMBER OF FARMS DECREASES FIFTEEN THOUSAND YEARLY 587

In the past five years, the number of farms in the United States has decreased 75,735, or more than 15,000 yearly, according to the department of commerce. The total is placed at 6,372,608. The decline was not general, some sections reporting increases, as in Texas where a gain of 30,387 farms was shown over the 1920 figures. The greatest decrease was found in Georgia where the total dropped from 310,732 in 1920 to 249,098 in 1925. Illinois had 225,645 farms last year, a decline of 11,536 as compared to 1920, while Wisconsin reported an increase of 3,838 over the previous census.

Names and addresses of manufacturers of articles described in this magazine will be supplied by our Bureau of Information.

Handwritten note: 1 no. Dr. Maas 401 W Broadway

Power 10/13/25

569 Third St
Oakland, Calif

495

'MECHANICAL EYELIDS' WINK SOLVES MYSTERIES

569

Perfection in England of a portable binocular stroboscope, or mechanical eyelids, as compact and easily carried as a pair of field glasses, has made it possible for the eye to see things which heretofore it has been too slow to catch. The stroboscope is a device in which a shutter can be opened and closed at any desired rate, so that moving or vibrating objects seen through it can be made to appear as though they were standing still. If the human eye could wink fast enough it could look at a revolving flywheel, and by winking in tune with the movement of the spokes, see them as clearly as though the wheel were stopped. The new portable stroboscope is expected to prove of value in the study of vibration in machinery, since it will allow direct observation of the smallest movement, without setting up complicated apparatus in order to enlarge the vibratory effect so that it will be made visible to the naked eye.

494

MINIATURE SHIP IS COMPLETE IN EVERY DETAIL

Details of the S. S. "Greater Detroit" are faithfully reproduced, even to carpets, interior decorations and furnishings, in a model of wood and metal completed at a cost of \$10,000. Seven men worked on it at intervals for eight months. The replica is built on a scale of three-sixteenths of an inch to the foot. It is so arranged that it can be laid open in order that interiors of the state rooms and holds, and the working parts, even to the smallest details, may readily be inspected.

Chicago agent

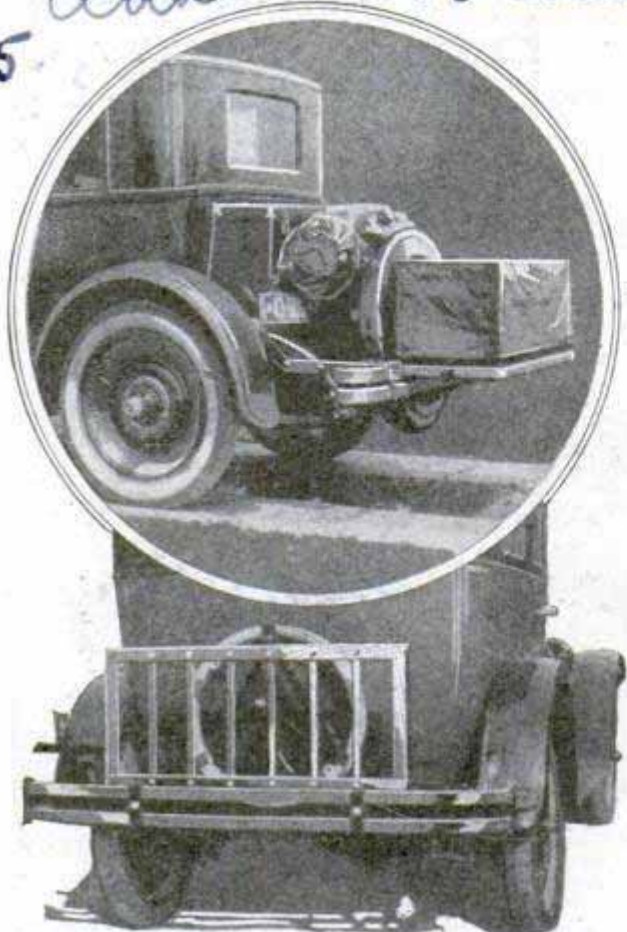

Luggage Carrier Extended and Folded over Spare-Tire Rim as Extra Bumper

49

FOLDING AUTO LUGGAGE RACK SERVES AS EXTRA BUMPER

Extending beyond the spare tire to afford extra space, an auto luggage carrier of heavy nicked steel, may be folded up when not in use, and in that position serves as an auxiliary bumper. It is high enough to protect the back of the car and the extra tire and, fitting flat when drawn up, does not interfere with cars behind.

For Detroit + Cleveland Navigation Co

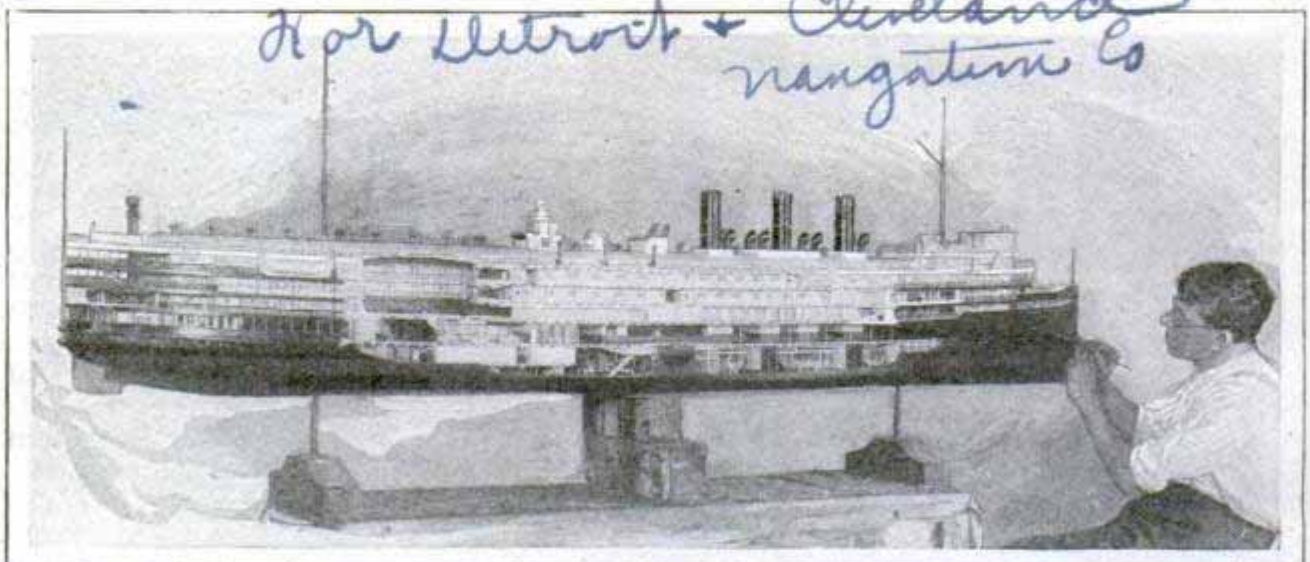

Putting Finishing Touches on Elaborate \$10,000 Model of Lake Steamer "Greater Detroit"; It Permits Inspection of Engine and State Rooms and Is Copied after Original, Even to Carpeting

made by Horace E. W. Ancher, New York

Fortunes from Tree Stumps

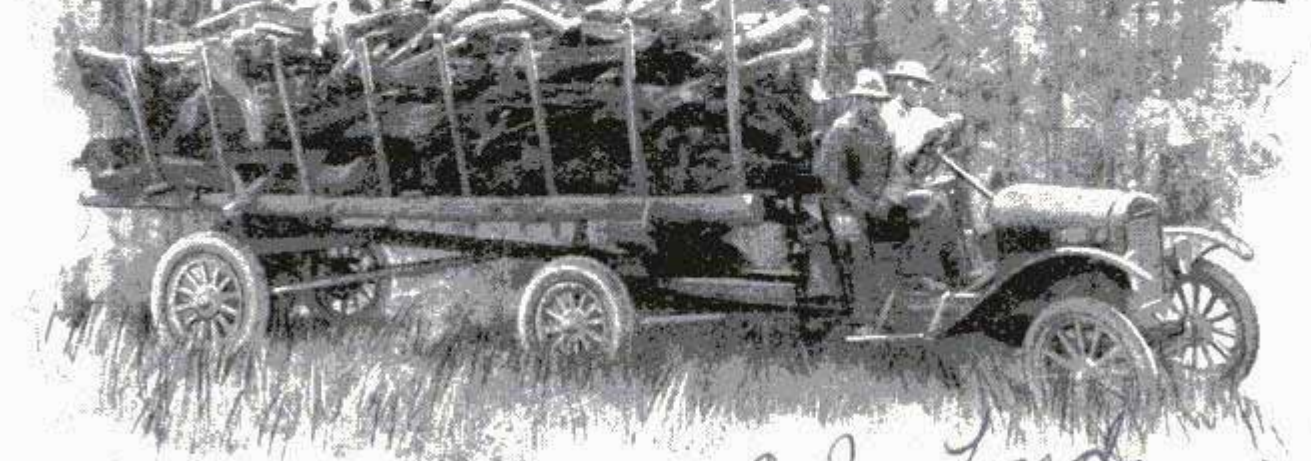

Norman C. McLeod
917 St. Paul St.

EXTRACTING a fortune from the dead stumps of long-gone pine trees in the millions of acres of cut-over land in the southern states has been made possible by the inventive genius of two men who have developed a process for recovering turpentine and rosin and put it into practice in two southern states.

Using the waste material which the loggers left behind, and which has prevented farmers from taking up the former forest land, they not only are able to recover two valuable chemical products, for which there is a wide market, but prepare the ground itself for agriculture.

Dynamite and modern industrial chemistry have made both things possible.

Less than a century ago, the southern states boasted the world's greatest supply of turpentine and rosin, both used chiefly then for shipbuilding. North Carolina alone was able at one time to produce nearly enough of the pine products to glut the entire world's market. Her forests were so rich that every North Carolinian was said to have his heels covered with pine tar every time he took a walk, a saying from which the residents of the state are still called "tar heels." Today North Carolina produces but a fraction of one per cent of the available supply.

The English settlers had begun tapping the trees in the time of Sir Walter Raleigh to get "naval stores," the old name which still clings to turpentine, rosin and pine tar, though the ships of the world no longer use any appreciable

amount of either. Turpentine and rosin gathering are carried on much the same as maple-sugar collecting, except that the trees may be tapped throughout most of the year. From V-shaped slashes the gum exudes and oozes into collecting pans, and then is sent to the distillery to be mixed with water and distilled. The lighter turpentine passes off into storage vats and the gummy rosin is left behind.

The turpentine business remained good until the need for southern-pine lumber became keenly felt after the forests of the Great Lakes region gave out. In recent years, a large part of the south has been stripped of marketable pine timber, and the turpentine industry suffered as a result.

It remained for Homer T. Yaryan, a Toledo scientist, who had invented a process of continuous evaporation for chemical plants, to conceive of recovering the turpentine and rosin left in the stumps, dead limbs and fallen trees left behind by the lumberjacks. He decided the valuable material could be salvaged from the wood by shredding the stumps and then cooking them in live steam. In co-operation with Joseph E. Lockwood he developed the process.

Success was made possible because the turpentine gums are driven to the heart of the stump or log as the outer portion decays. Protected by the rosin, the heart will remain sound for untold years.

Yaryan and Lockwood built their first plant in Mississippi, and it proved such

Baltimore, Md.

1431 Nicholas Blvd
Baltimore, Md.

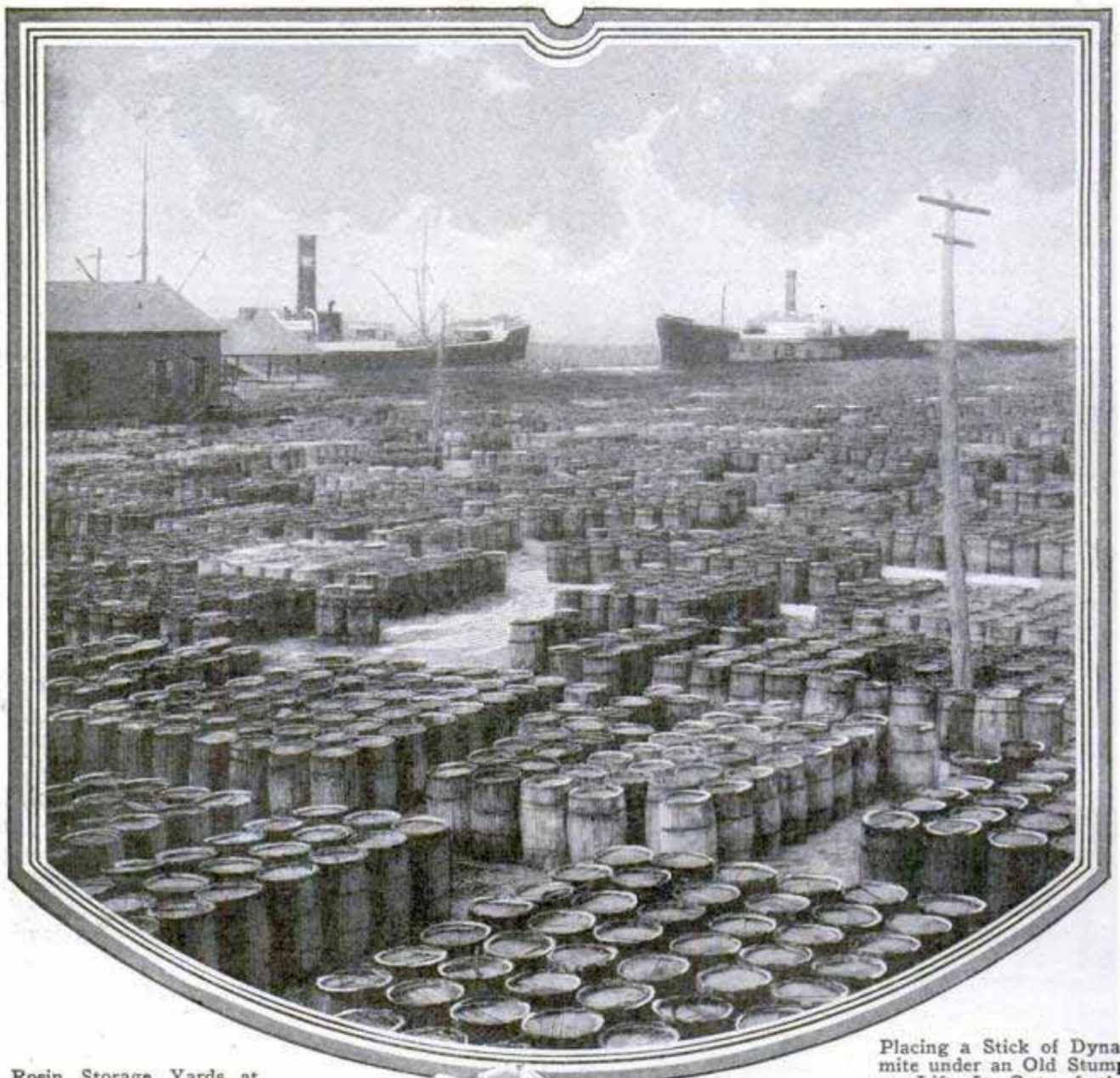

Rosin Storage Yards at Savannah, Ga., Above, Where the Recovered Material from Old Stumps Is Gathered for Shipment to Market by Sea

Placing a Stick of Dynamite under an Old Stump to Lift It Out of the Ground; Each Stump Is Blown with a Separate Fuse



a success that a larger and improved outfit was established in Georgia. Their survey indicates there are at least 15,000,000 acres of cut-over land on which to draw for material.

The old stumps are removed by blasting. An electric auger, getting its current

nishes, and has a place in medicine and in making prepared drugs. It goes into shoe polish, as well as floor and furniture polishes, in which it acts as a solvent for the waxes. Patent leather could not be made without it, nor could synthetic camphor. It is used as a solvent in the rubber industry and is the raw material for "isoprene," from which artificial rubber is made.

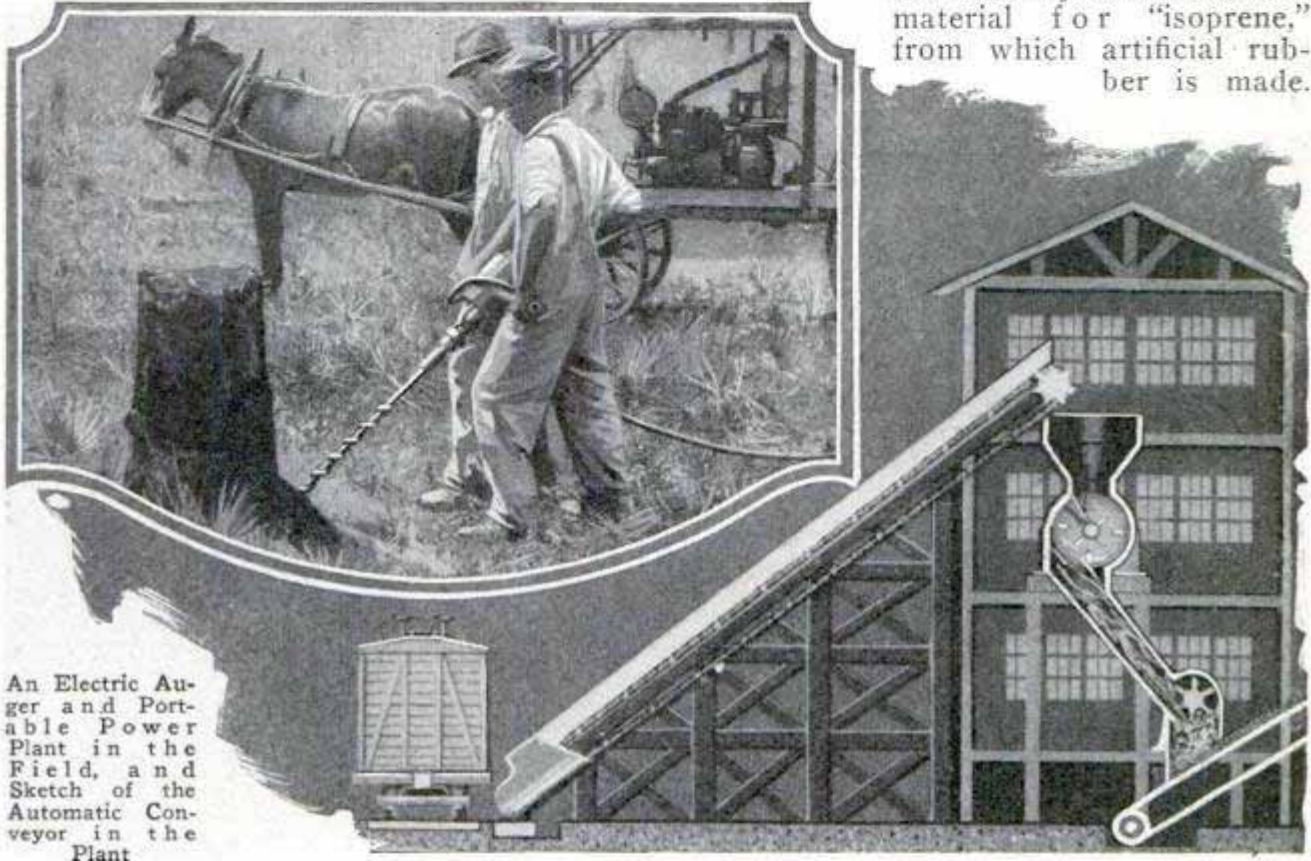

An Electric Auger and Portable Power Plant in the Field, and Sketch of the Automatic Conveyor in the Plant

from a gasoline-driven generator, mounted on a horse-drawn truck, bores the holes in the stumps. A stick of dynamite is slipped in, a fuse attached and lighted, and the stump and a large section of its roots sprayed over the landscape. The debris is gathered together, loaded on railroad cars and transported to the distillery, where an automatic conveyor lifts it to the hoppers of huge lumber-mill "hogs," massive grinders designed to reduce lumber refuse to the size of matchsticks.

The shredded material is then placed in air-tight cooking vats and subjected to high-temperature steam, which cooks out the gum and prepares it for eventual separation into turpentine and rosin.

Despite the virtual disappearance of the old-time wooden sailing ships, whose hulls and cordage required vast amounts of naval stores, the market for the recovered product is better than ever, thanks to modern industrial chemistry. Nothing has been found to take the place of turpentine in many essential industries. It is used for thinning paints and var-

It prevents colors "bleeding" when calico and print goods are stamped and goes into fireworks, wood stains, printing inks, crayons and many other articles.

Rosin, the other product recovered from the waste of the stumps, is a vital element in making laundry soaps and soap powders, sealing wax, axle grease, paint driers, ceramic enamels, cheap linoleum and oilcloth, medicinal plasters, ointments, foundry cores, sticky flypaper, shrapnel-shell filling and in scores of widely varying manufacturing processes.

Besides the two chief ingredients of stumps, the distilling process also yields quantities of pine oil, which is used in the concentration of low-grade gold ore by the flotation process, and in disinfectants and other articles.

Although still young, and operating in only two localities, the pine-stump recovery industry this year used more than 2,000,000 pounds of dynamite to remove the stumps from the ground. The age of the stump is no detriment, since the older and more rotten the exterior, which is discarded, the richer the heart will be.

395

No stumps cut less than ten years ago are used. By concentrating on the rich heart-wood from a portion of each stump, the same amount of gum is recovered as if the entire stump had been distilled when new, and yet only a fraction of the original amount of wood

qualities are dependent wholly on the method in which the cheese is cured and seasoned. As in the maturing of French wines, the cheeses bear data, giving the whole "pedigree" from start to finish, and the exact location of each cheese in the storage vaults is

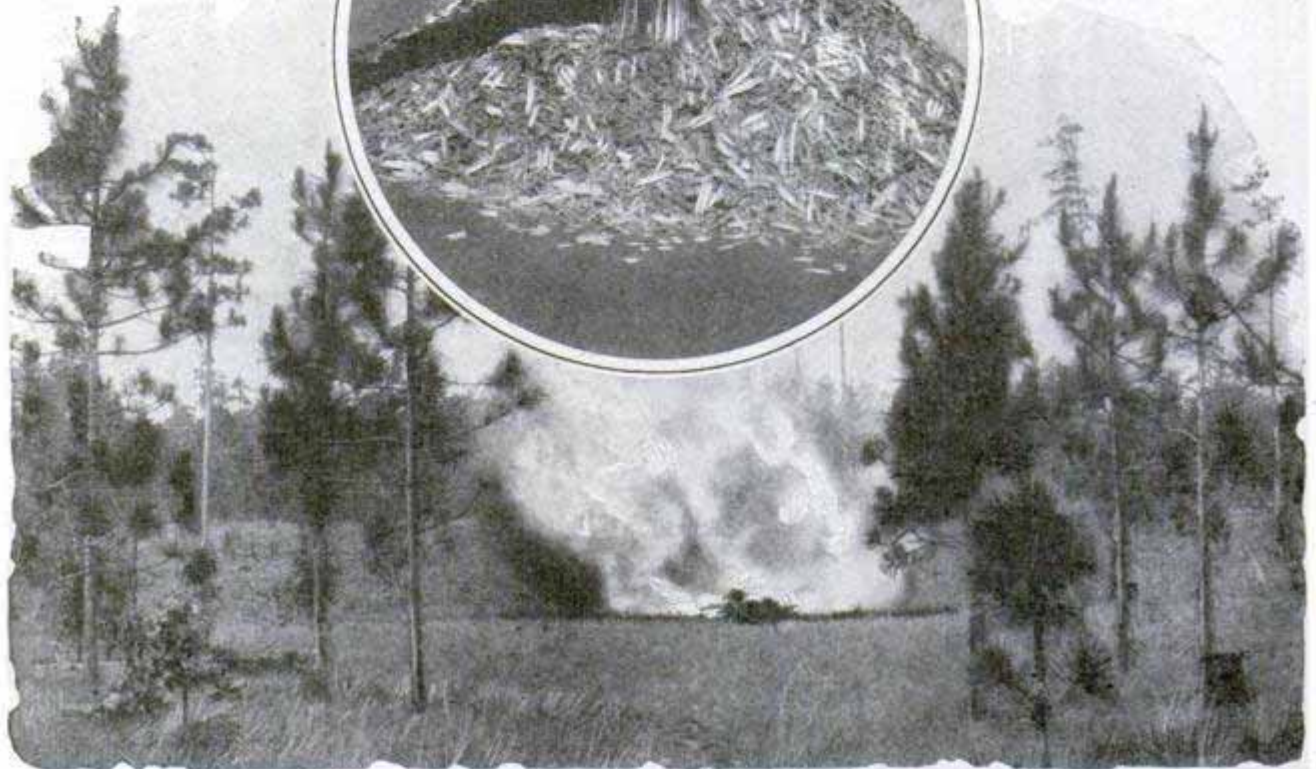

Fine Chips of Pine after Passing through the Shredder, Above, and a Close-Up of a Dynamite Blast Showing a Stump Being Removed from a Field of Second-Growth Pine Timber

must be shredded and cooked. How many million gallons of turpentine and pounds of rosin can be extracted from all the cut-over pine forests of the south has never been estimated, but the forestry department of the state of Louisiana estimates that the stumps in that state alone would yield 340,000,000 gallons of turpentine, in addition to a vast amount of rosin.

The 23,000 square miles of stump land available in the south is equal to the combined area of New Hampshire, Vermont and Connecticut.

YEARS TO RIPEN CHEESE

Various experiments have been tried and adopted in the manufacture of almost 200 different kinds of cheese, but to gain the delicate flavor of the best Italian grades, no less than four years must be allowed for seasoning. There is nothing in the milk or in the preparation of these varieties that gives them their peculiar flavor and mellowness, it is said. These

charted on a map kept constantly under lock and key.

ELECTRIC SHEET-METAL CUTTER RUNS FROM LIGHT SOCKET

515 Weighing only thirty-eight pounds, an electric sheet-metal cutter is said to leave



no burr on the material and, when adjusted so that the work can be rested on a bench, may be operated by only one man. On sixteen-gauge steel, it has a speed of fifteen feet per

minute, and curves or irregular shapes are cut as easily as straight lines, the manufacturers assert. The action is secured through an eccentric on which the motor-driven cutter is fastened. The knives are removable for sharpening.

embases. It Holden, Eng
Highfield Upper Tipton Eng
West Road, Chesterfield, Eng

561

The Hunshears Co. Inc.
New York

*Highfield View
Japan View Road
Chesterfield Eng*

Roads

LUSTER OF "DIZZY" DIAMONDS RESTORED WITH SAWDUST

562.

Like human beings, diamonds get "dizzy" and lose their brightness, an English gem expert declares. He restores their luster by rubbing them well with Cologne water and then throwing them into fine hardwood sawdust while still damp. They are whirled in a rubber-lined mechanical shaker until dry and their natural brilliance is practically restored. Plain gold ornaments, such as brooches, fob chains and trinkets which have become shop-soiled, also appear new after passing through the process and then being rubbed with chamois leather.

"ISLANDS" IN ONE-WAY BRIDGE GIVE ROOM FOR PASSING

Annual 534

To save money in the building of a 1,578-foot bridge across the Wairoa river, on the North Island, New Zealand, the structure was erected with only a twelve-foot roadway, sufficient for one-way traffic. Two wider spaces, with eighteen-foot roadways and each 120 feet long, were provided a third of the way from each end, to take care of passing vehicles. Foot passengers were provided with eight bays into which they can detour at the approach of vehicles. As the river is navigable, it was necessary to provide a bascule draw in the channel, with twelve-horsepower engines to operate each leaf.

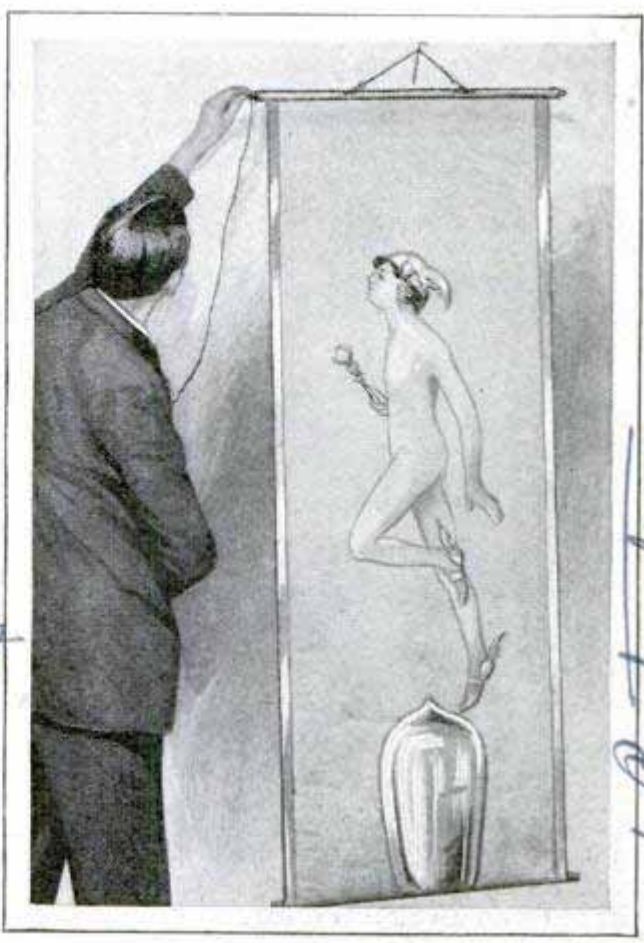

573

Figured Copper-Screen Radio Antenna That Rolls Up

ANTENNA LIKE ROLLER SHADE SERVES AS PICTURE OR MAP

Wound on a roller like a window shade, a radio antenna consisting of a thin sheet of copper foil between two layers of special insulating material, may be decorated with a picture or a map. The lead-in is attached to a terminal at one end of the top roller. The antenna is quickly arranged for service, occupies but little space when stored away and eliminates conspicuous wires.

*The invention of Patentless
The Great Russell St. London
U.S. England*

454.



At the Center of the Bridge Are the Lifts, the Detours Are a Third of the Way from Each End

Marysville

CA dog hotel which boasts 120 "guests" is being operated by a California land-development company. The residents of the two-story hotel are required, however, to furnish their own food. The dogs were imported to run down and kill jackrabbits, which are then cooked and served them for food.

Enter Basin Co

San Francisco in foreground -

Alameda and Berkeley in distance

distance

SAN FRANCISCO BRIDGE TO COST SIXTY-FIVE MILLION

520

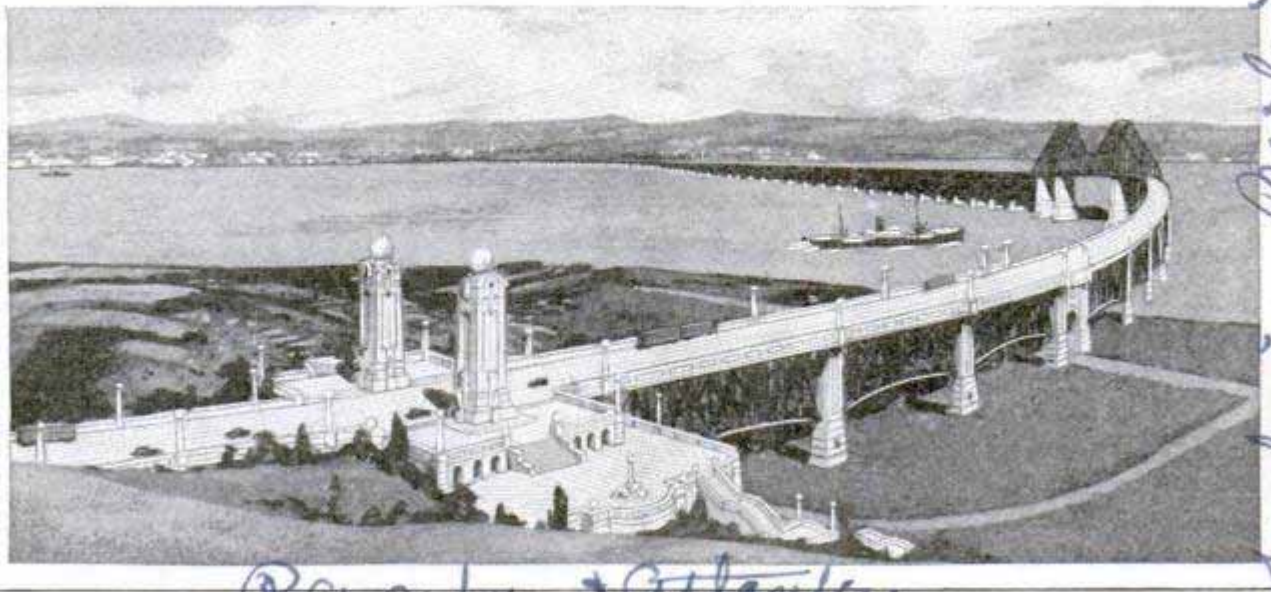

Pacific + Atlantic

Architect's Drawing of Bridge to Connect San Francisco and Oakland; Spans on Each Side Will Permit Passage of Ships and Ornate Columns Will Mark Approaches

Plans for a bridge, costing \$65,000,000, to connect San Francisco with Oakland have been submitted. Besides traffic space for automobiles and pedestrians, the structure will provide room for street-car tracks, and spans near each end of the long viaduct will be constructed to permit the passage of ships. Artistic approaches with stairways and ornamental columns are included in the architect's drawings.

can be arranged in lifelike positions. Head and features have been accurately molded and figure can be costumed as desired. It also serves as a support to steady a live model, when used, in various poses.

GOLD FOIL, CLEAR AS GLASS, TO IMPROVE RADIO

Gold and nickel foil, but a fraction of the thickness of the thinnest leaf made by hammering, has been produced by a German scientist. The layers are said to be as translucent as glass. Photographs, taken through a covering of the foil over the camera lens, could hardly be distinguished from those made in the usual way. It is expected that the filaments will be especially valuable in studying various phases of radioactivity and forms of energy due to the radiation of gaseous matter. Though but a millionth part of a centimeter in thickness, the centimeter being about three-eighths of an inch, a few of the strips together carried sufficient electric current to light several electric bulbs, and the films could be swung rapidly back and forth without tearing. Practical adaptation of the discovery is expected to improve radio, telephones, phonographs, and other appliances that require delicate membranes or conducting surfaces, by bettering tone quality and increasing the range of the instruments. The process was discovered by chance while the scientists was investigating chemical rays. It is being kept secret, but is based upon a kind of galvanic precipitation of the various metals.

DUMMY IN ARTIST'S STUDIO SERVES AS MODEL

Saving the expense of hiring a person to pose, a flexible dummy an artist uses



Harrison Fisher Adjusting Dummy Model He Uses in Studio to Aid in Portrait Painting

Harrison Fisher

Berlin, Germany, Technics, physics and natural & unstable

Dr. Carl Muller

Getting Ready for Winter DX

By JOHN R. SMYTHE

WINTERTIME brings the distant stations closer, and the cold clear evenings bring back old friends that have been buried under the summer static, if—and it is a big IF—the set is in proper condition for the best reception. Inspecting the radio set is just as important as automobile inspection. It is sometimes put off until increasingly poor results make it absolutely necessary. Good results depend on first-class equipment kept in working order, and a little attention to these details pays in increased range, better volume, and longer service from the instrument.

Since the set was last overhauled, the vacuum tubes have been burning some 500 or 600 hours. The batteries, especially the B-batteries, have been delivering current over a long period and are most likely run down; noises in the set that probably have been attributed to static are coming from these old batteries, and loss of volume usually can be traced to the same source. If this is the case,

otherwise, as these are a common source of trouble unless the work has been done very carefully. Many times, too much flux has been used and this has run in behind the terminal, forming a high-resistance path, or if the wrong kind of flux has been used, corrosion takes place. Remove the terminal nut and clean with a cloth moistened with alcohol and placed over the end of a screwdriver. Replace the nut and tighten firmly. The terminals on the coils, transformers and tube sockets should all be gone over in this manner. Turn the set over and examine the connections; see that each connecting wire is tightly soldered, and that no wire has been bent so as to touch another; each loose joint here should be carefully soldered. Broken joints can be accurately located by operating the set temporarily. Connect the batteries and place the tubes in the sockets; the broken connections

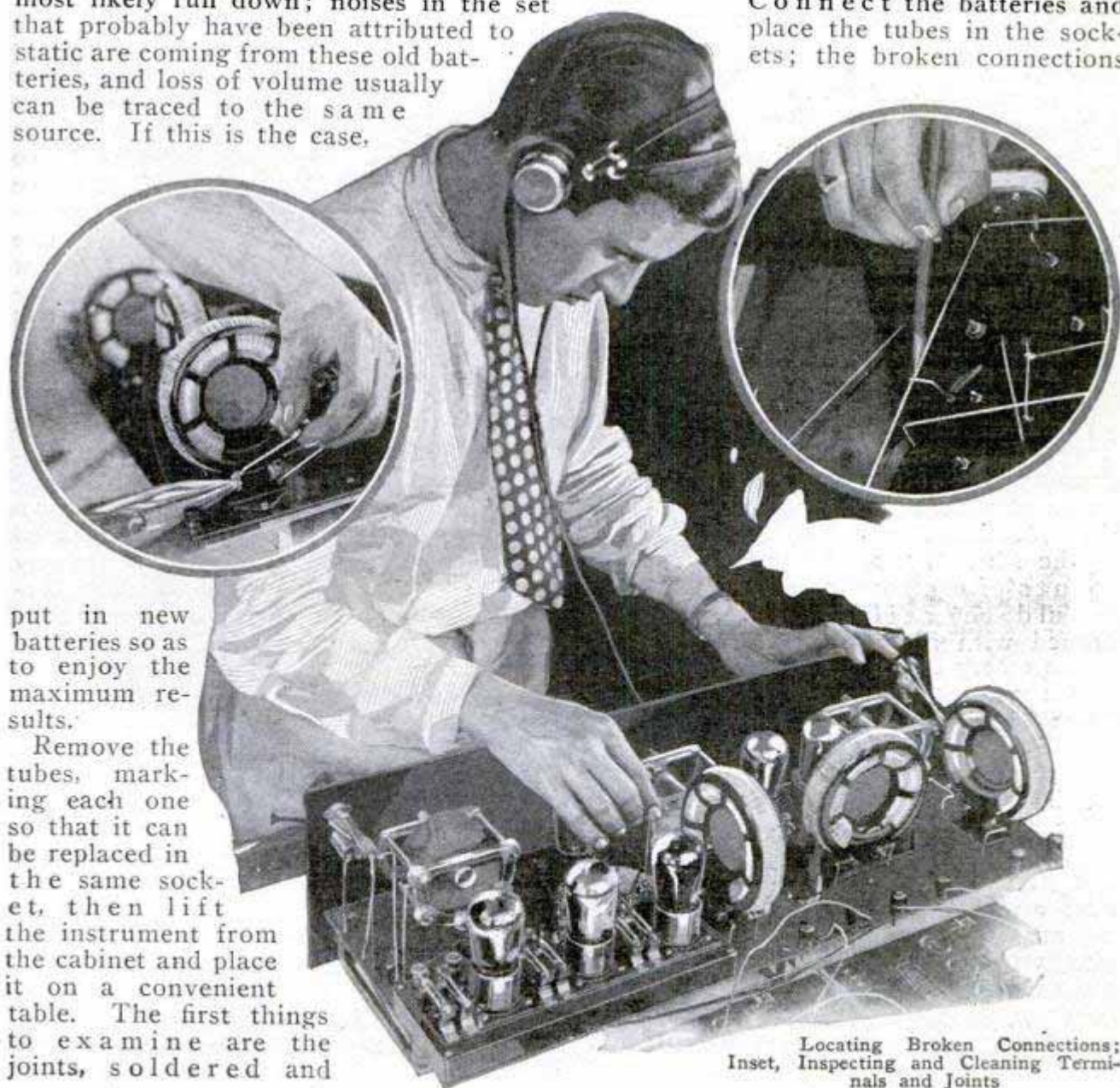

put in new batteries so as to enjoy the maximum results.

Remove the tubes, marking each one so that it can be replaced in the same socket, then lift the instrument from the cabinet and place it on a convenient table. The first things to examine are the joints, soldered and

Locating Broken Connections; Inset, Inspecting and Cleaning Terminals and Joints

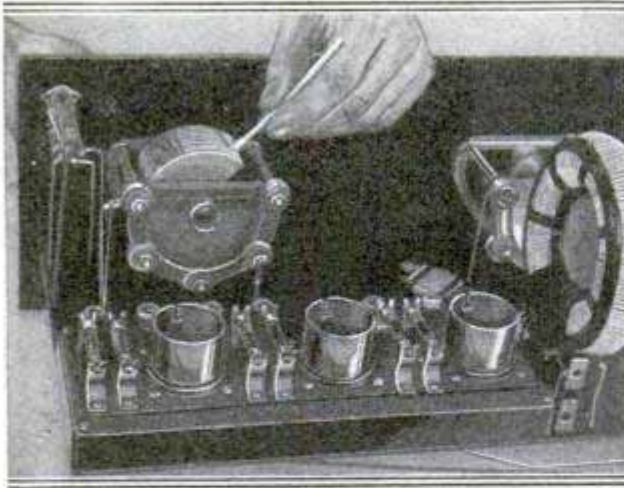

A Pipe Cleaner Provides the Best Cleaner for Variable-Condenser Plates

can then be located while the set is in actual use by tapping or moving each joint in turn and listening for noises in the headphones.

Dust and dirt are also enemies of good reception as they permit moisture to accumulate and introduce leakage causing troublesome noises. This is especially true in the variable condensers, where dust will gather between the plates; it can be easily removed with a pipe cleaner, used in the manner shown in the photo. If these instruments are of the type provided with wiping connections on the shaft, the points of contact should be well cleaned with a bit of fine emery cloth. If the connections are of the pigtail or flexible type, make sure that they are not broken and that they make good contact. Go over all binding posts and see that they are tight. The rheostats are very important to good operation; examine the terminal connections, and, if corroded, remove the leads, place lugs under the terminals and resolder the connections. Another important point is the contact of

the wiping arm on the resistance winding of the rheostat. If this arm does not make good contact at all points on the wire, poor results are certain; if not, remove the setscrew, bend the arm slightly and replace on the shaft.

Phone and loud-speaker cords in average service should be renewed once a year as the constant twisting of these cords breaks the fine tinsel conductor and causes noises. They are not expensive and are easily replaced.

Good tubes are all-important; if they have been in use for some time, they should be tested. Some will be found much better than others, and the poor ones can usually be rejuvenated, if they are of the standard type, such as the UV-201A or C-301A; this also applies to the UV-199 and the C-299 types. A good tube has an average life of about 1,000

hours, but when excessive filament voltage is applied, the strain is pushed beyond safe limits, and the tube becomes sluggish or paralyzed. No change can be noted by ocular inspection; the tube still lights, but it fails to produce the results obtained before.

Another important point that should not be neglected is examination of the tube prongs. Each should be cleaned with fine emery cloth to make certain of a good electrical contact with the spring clips in the socket. Inspect also the end of each prong, to make sure that the soldered tip is secure. Before placing the tubes back in the sockets, see that the spring

clips in the sockets are tight; if loose, the socket may have to be removed and the screws holding these springs tightened with a screwdriver. After you have gone over the set thoroughly, turn your attention to the aerial and ground.

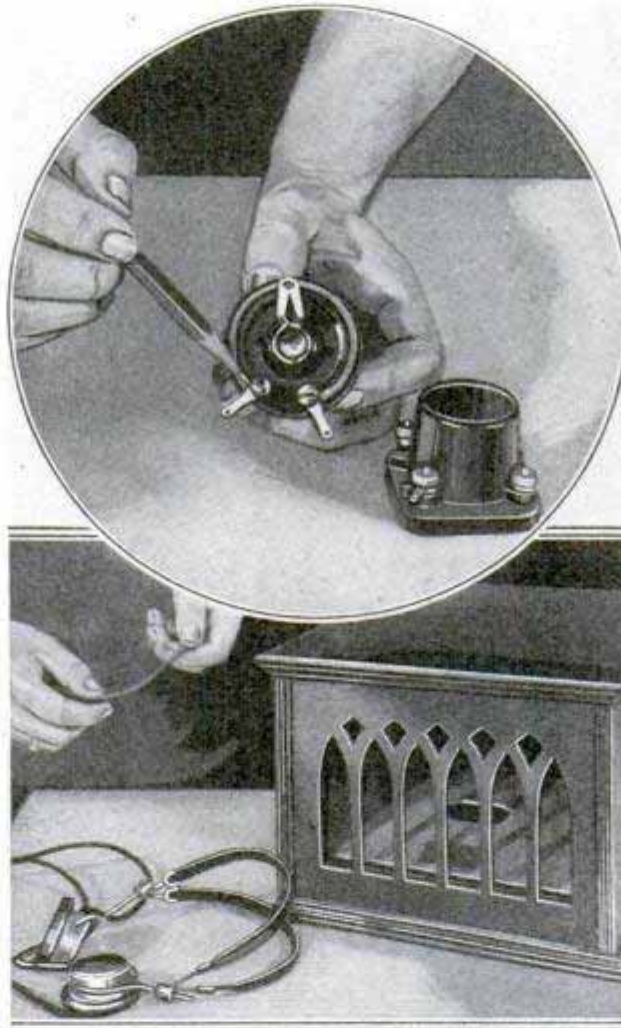

Lugs on Rheostats and Sockets Must Be Tight and Clean; Below, Inspecting Phone and Speaker Cords

No set will work well on a poor aerial and inefficient ground. The superheterodyne and other types of receivers using loop aerials are practically free from trouble of this nature, unless there is a loose connection, but with the outdoor type of aerial conditions are different. Summer storms may have rendered the aerial ineffective; it may be touching the building, the wire may be broken; lead-in wires may have rubbed against the building, damaging the insulation and causing shorts, especially during damp weather. If the aerial was installed temporarily, it may be that the connections were made without soldering and corrosion has taken place. Solder the connections at the insulators and at the point where the lead-in wire is connected to the main wire. It is best to make a new joint, first carefully scraping all corrosion from the wire. After the joint has been soldered, wrap it with electrical friction tape. This will insure a good electrical connection that will not be affected by the weather. If the aerial has sagged, this slack should be taken up, as a swinging aerial will give poor results and increase the chances for shorts against the building. Inspect the lead-in to the set and see that it is well insulated and in good condition. No. 14 weather-proofed copper wire makes a very good lead-in and should run as directly as possible to the point where it is taken into the building.

The best ground is obtained on a cold-water pipe, the pipe being filed bright and the wire securely fastened to it by means of a ground clamp. Even if this was done when the set was first installed, it is a good idea to remove the clamp and brighten it on the inside with emery cloth, polishing also the contact surface on the pipe before

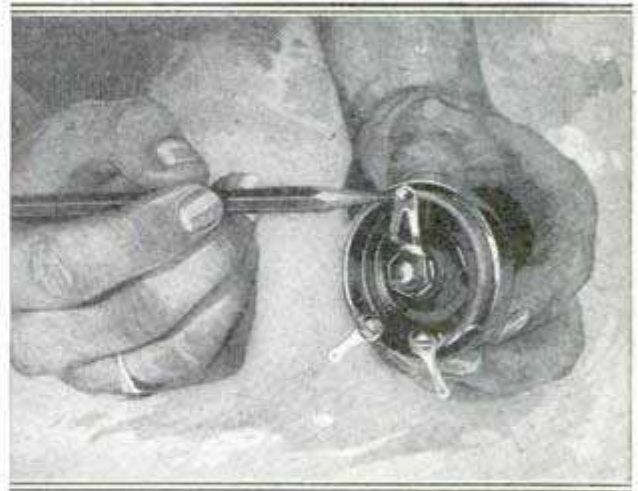

The Wiping Arm on the Rheostat Must Make Good Contact with the Winding

replacing the clamp. If a water-pipe is not handy, a good ground can be obtained by driving a length of pipe into

the soil outside of the building; select a damp spot at a point near the window closest to the set, and fasten the clamp to this pipe. Iron rod can be used if pipe is not available. More elaborate grounds can be obtained by burying metal sheets, or if the aerial is of the overhead type and it is possible to use a counterpoise consisting of several wires strung below the aerial, even better results can be obtained. An approved lightning arrester should be used with all types of outside aerials, and it is necessary to use well-insulated wire run through porcelain-tube insulators where the wire enters the building, continuing this wire to

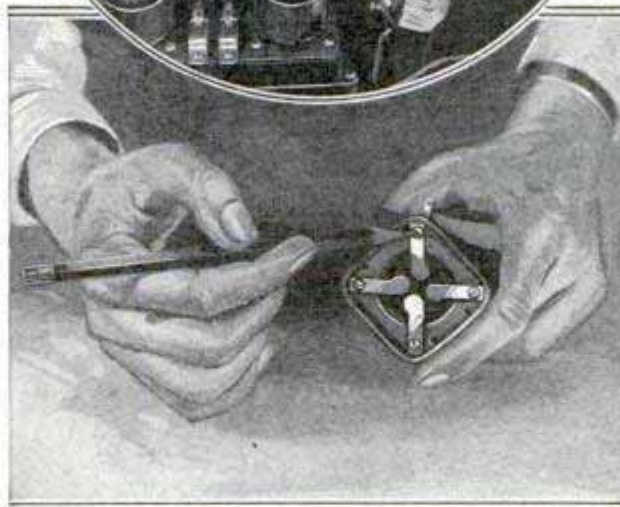

Above, Inspect Tubes for Loose Prongs; Below, See That the Socket Contacts Are Tight

the set. Do not run outside aerials near high-tension wires. If such wires are near the building, run the aerial at right angles to them in all cases. Many humming noises and crackling sounds are attributed to the set which are really caused

by induction from near-by high-tension lines that are paralleling the aerial. If there are other aerial wires on the building, do not run your aerial close to

this is important and will always give better satisfaction in the long run. A well-installed aerial and ground need little attention and pay big dividends in good results.

These things take little longer to do than the time required to tell



Take the Slack Out of the Antenna, and See That the Lead-In Is in Good Condition; Inserts, Soldering and Taping Aerial Joints

them. Keep as far away as possible, and at right angles, if there is room, above or below them. Use good materials;

about them, and the fan who has done them can go ahead with his "DXing" assured that his only enemy will be static.

Finishing a Homemade Loud Speaker

Although it may be very efficient, the average homemade speaker is a bit unfinished in appearance. If made of metal, cardboard or wood it can be very attractively finished by using either the clipped-wool or the blistered effect so often seen. The latter is a little easier to keep clean.

To make the blistered effect, a glue and whiting "dope" is used. This dope is made in the following way: First mix 10 parts of finest gilders' whiting with cold water until a thick cream is formed; to this, add

6 parts of liquid glue. In another container, white damar turpentine varnish, 1 part, is mixed with 4 parts of raw linseed oil. The two parts are then mixed and cooked 10 minutes in a double cooker. When cool, the mixture should have the consistency of very soft butter. Pour this into a wide-mouthed jar and use the following day. This dope is the old foundation for polychrome work and works better after standing for a day.

The speaker should first be given a thorough application of shellac; uncovered spots will not hold the polychrome dope.

The dope, if of the right consistency, will flow from the brush. If it is too thick, add water drop by drop, and if it is too thin, set the jar, with the lid off, in hot water to evaporate some liquid.

Spread the dope over the speaker with a spatula or broad soft brush. It is best to do one side at a time, as it is a pretty sticky job. Go over the inside surface with a tapping motion. This must be done until the surface assumes a blistered effect. The coating should be allowed to dry for two or three days and the outside is then treated. After drying another three days, the whole surface is given a coat of shellac. For the final finish the speaker may be given two or three coats of colored varnish or of flat paint, to match the interior of the room.

The clipped-wool finish is a little easier and more quickly done. The speaker is first given a coat of shellac and, when dry, is given a rather heavy coat of turpentine damar varnish on the inside. This is a very sticky job. While still very wet, sift on the varnish sign painters' flock. Apply the flock until the surface is evenly covered. This will give a velvety surface that is very good. When perfectly dry, finish the outside of the trumpet in the same manner. If the soft finish is not wanted, a semi-glossy effect can be had by painting over with a thin varnish, after the varnish holding the flock has dried. Do not attempt to hurry the work.

Spacing Dials from Panel

A simple form for spacing the dial from the panel when assembling the set, aids the builder to maintain an equal distance between the dial and panel, at all points. This gauge is made from heavy cardboard and should be large enough to extend about $\frac{1}{2}$ in. beyond the edge of the dial. A slot is then cut to fit around the shaft of the condenser, coupler or variometer, as the case may be. Place the gauge on the shaft next to the panel, and then fit the dial against the form and tighten the setscrew. Then pull out the cardboard. By using this method all dials will be correctly spaced, and will not rub against the panel when rotated.—H. Ray Eaton, Pittsfield, Mass.

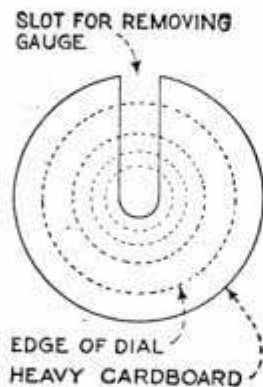

Simple Insulator and Mounting for Inside Aerial

An easily made and efficient insulator for the indoor antenna is shown in the illustration. A short length of ebonite or



Simple Indoor Aerial Supported by Ebonite Rods; Lower Right, Detail of Construction

bakelite rod is filed flat at the ends; next, holes are drilled through its center and slanting slots sawed from the outside to the holes on what will be the inside when mounted, as shown in the detail. The edges of the slots are rounded so that the wire will not bend at sharp angles.

As distance pieces between the wall and the rod, porcelain insulators of the common commercial type are used. The latter should be long enough to keep the wire several inches from the wall, the mounting screws passing through the ends of the ebonite rod and the insulators. A triangular aerial, as shown in the illustration, uses a minimum number of insulators, and gives the greatest length of aerial wire. In addition, such an aerial is non-directional, and receives equally well from all directions. The aerial should be kept about one foot below the ceiling, or even more if it can be arranged.—C. A. Oldroyd, Barrow-in-Furness, Eng.

Ⓞ A wavelength of only 6 ft. has been used by station FL, Eiffel tower, France, successfully over a distance of two miles. The antenna current used did not exceed 30 milliamperes. It was found that these short wavelengths were free from static disturbances.

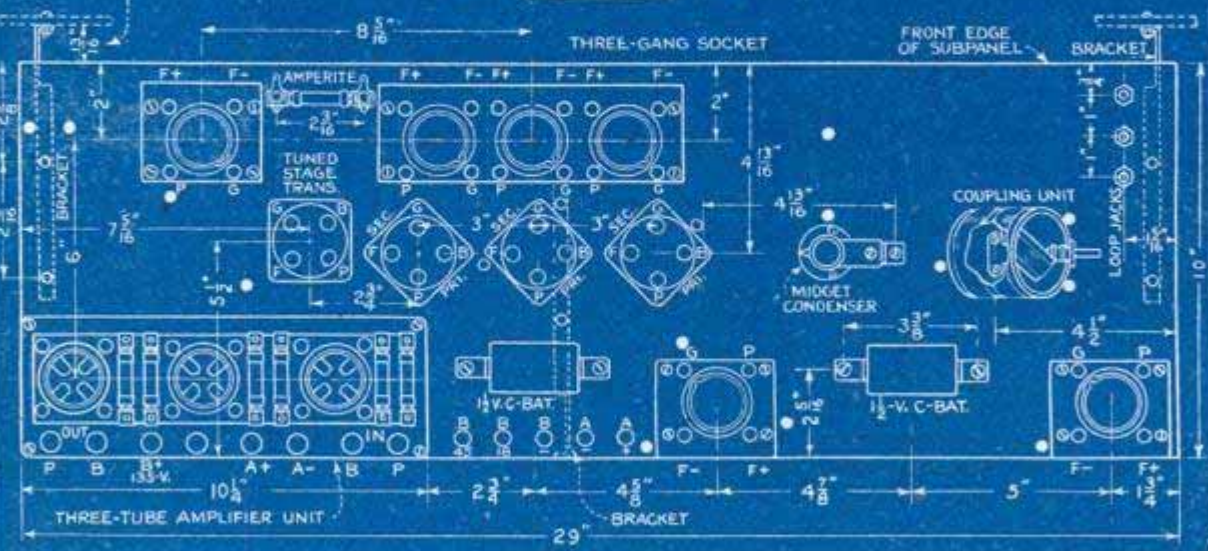
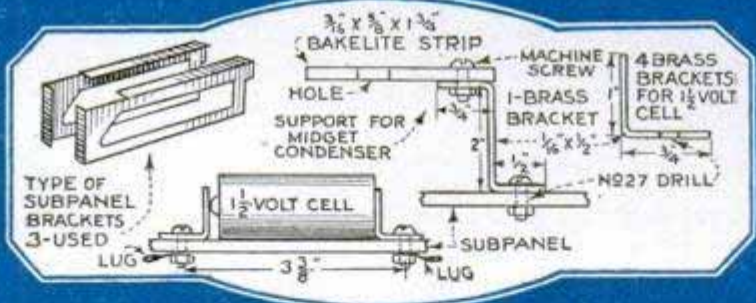
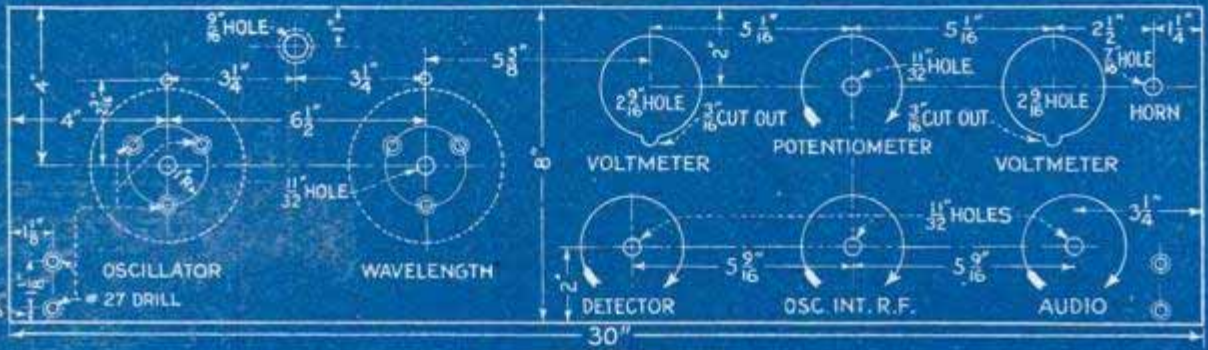
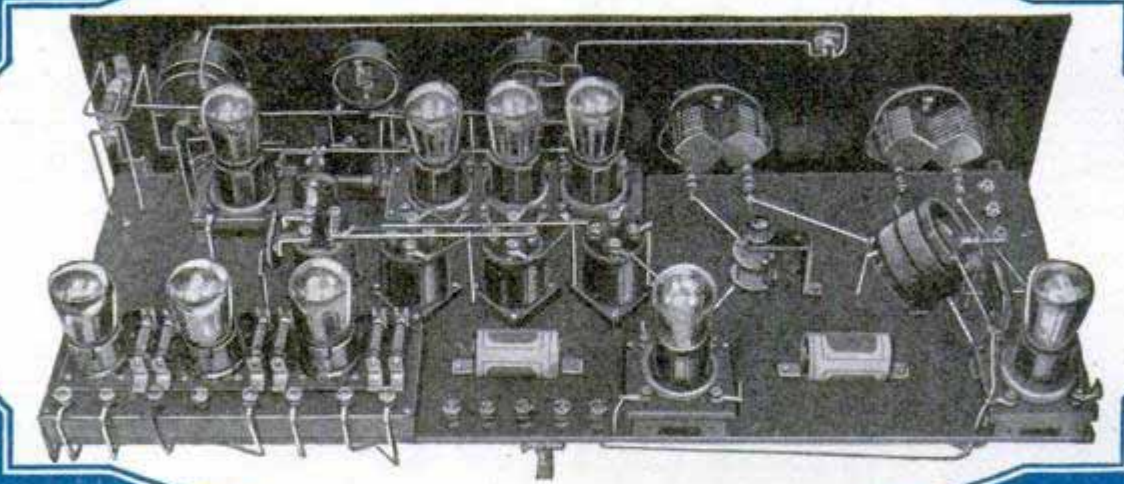

Above, Rear View of the Completed Set, Ready for the Cabinet; Below, Front and Subpanel Layouts and Details of Brackets



Great Range, Ease in Tuning and Simplicity of Construction
Also Feature 1926 Model Set

By F. L. BRITTIN

THE instrument described in this article is a further development of the well-known Popular Mechanics' Superheterodyne Eight, which has given real satisfaction to thousands of fans both in this country and abroad. Practically all the parts are the same, but the circuit has been greatly improved, and a resistance-coupled amplifier replaces the a.f. transformers, resulting in even better tonal qualities. The new model sets a standard for volume, range, tone and selectivity that will be difficult to surpass for some time, and gives the broadcast listener a new conception of what receivers should be.

Simplicity of design makes the new set especially interesting to those with limited experience. The front panel and sub-panel are larger than in the former set, providing ample room for the instruments, which are so arranged that shielding is unnecessary. Before attempting to build the instrument, look over the diagrams carefully and provide all parts just as specified in the material list; take time to do good work and follow the instructions in the order they are given.

The layout for the subpanel is given at the bottom of the opposite page. Place this panel on the table and arrange the instruments in the positions shown in the diagram, with all terminals exactly as indicated; then, holding each instrument firmly in place on the panel, point off each mounting hole with an icepick or other sharp instrument, and before removing the sockets and other instruments from the panel, point off the holes indicated by the white dots. These holes are required for running the leads below the subpanel and only the most important points are indicated, as the other holes can be drilled later, as required. Point off the holes for the mounting brackets and other instruments carefully. All holes in this panel then can be drilled with a No. 27 drill except the three holes for the loop jacks

where $\frac{3}{8}$ -in. holes are required. The sub-panel brackets are a standard type that can be obtained from any dealer; these raise the subpanel 2 in. and permit easy wiring under it, resulting in short direct leads. Three brackets are used, one at each end and one reversed and mounted in the center of the panel at the rear. The flat ends of the two end brackets, in which screw holes will be noted, are mounted toward the front and extend $\frac{13}{16}$ in. beyond the panel; each of these brackets is $\frac{5}{8}$ in. from each end of the panel. The center bracket at the rear is mounted with the flat end flush with the rear edge of the panel. Round-head brass machine screws, 6-32 by $\frac{1}{2}$ in., are used to mount the brackets, as well as for most of the other instruments; screws $1\frac{1}{2}$ in. long will be necessary for the tube sockets and the amplifier unit.

The bracket for mounting the midget condenser is shown in detail in the diagram, also the four small brackets used for mounting the $1\frac{1}{2}$ -volt dry cells; these brackets are all made from a $10\frac{1}{4}$ -in. strip of $\frac{1}{16}$ -in. brass $\frac{1}{2}$ in. wide. The brackets for the $1\frac{1}{2}$ -volt cells are mounted $3\frac{3}{8}$ in. apart and are bent so as to hold the cell tightly in place and make good contact on the cell base and the brass positive terminal at the opposite end. Refer now to the large wiring diagram, and mark these brackets positive and negative in their proper order, so that there will be no error later. The amperite unit, mounted between the second detector and the three-gang socket, is an automatic filament control for the second detector tube, and eliminates a rheostat at this point. The .00025-mfd. condenser is mounted on the metal brackets supplied with the tuned-stage transformer and placed across the secondary terminals; a similar bracket is supplied for the .0005-mfd. grid condenser, which also carries the gridleak in clips; this bracket is mounted on the grid terminal. The A and B-battery binding

POPULAR MECHANICS SUPERHETERODYNE 1926 MODEL

NO. 2 A-LEAD TAKEN FROM FRONT END OF BRACKET

VOLTMETER
0-7.5V, 0-150 V.
A B

POTENTIOMETER

VOLTMETER
0-5 VOLTS,
THREE-TAP TYPE

PANEL LIGHT

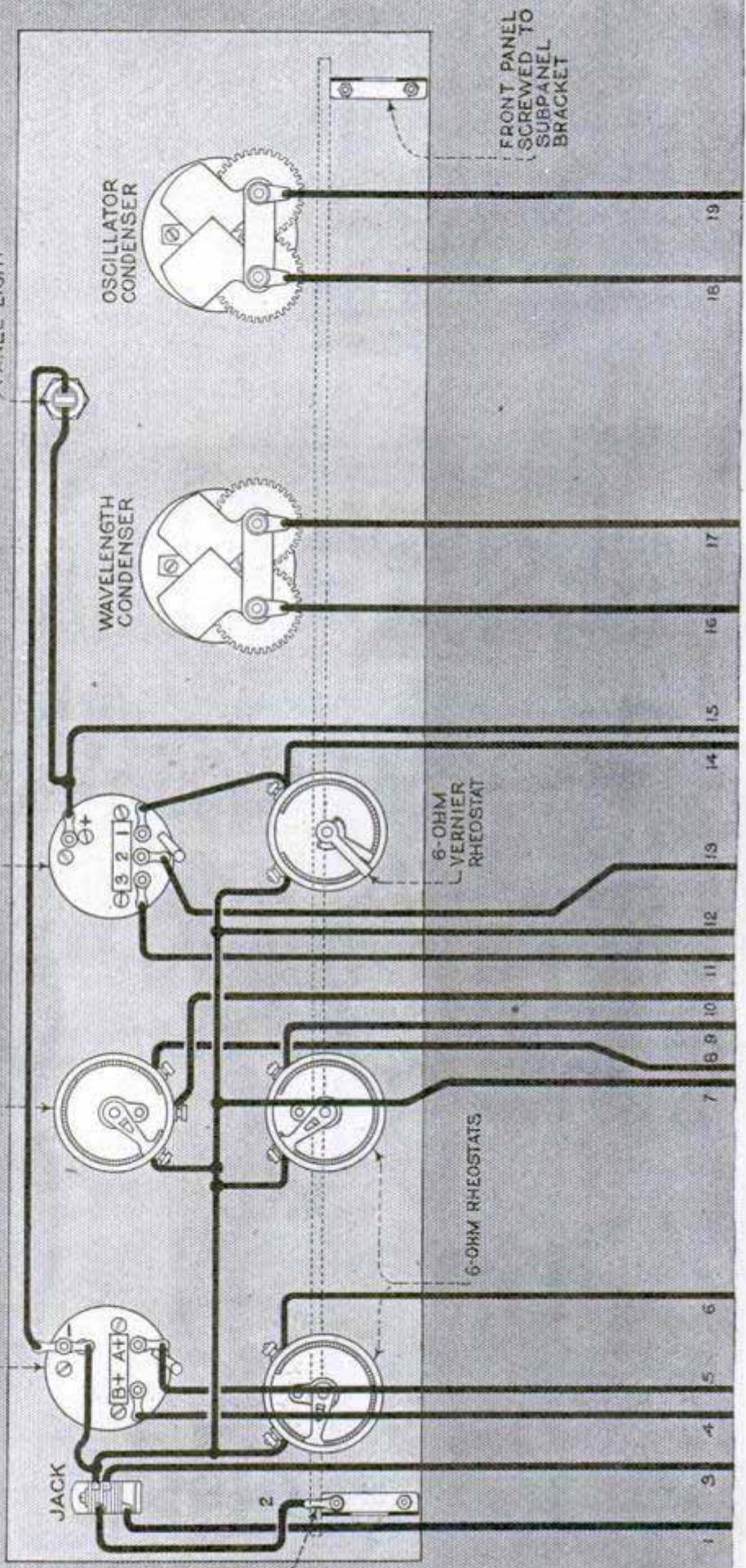

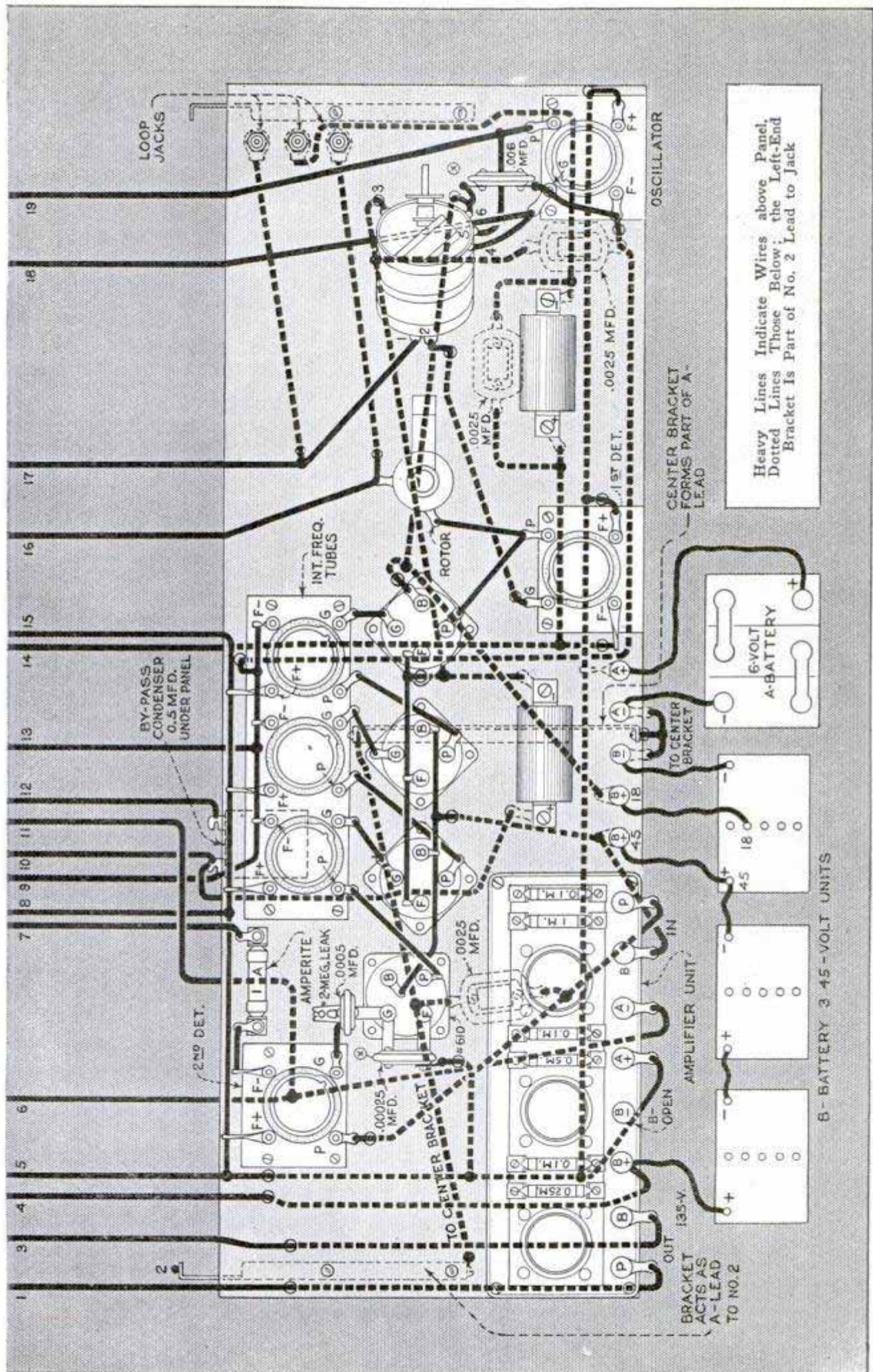

Heavy Lines Indicate Wires above Panel,
 Dotted Lines Those Below; the Left-End
 Bracket Is Part of No. 2 Lead to Jack

CENTER BRACKET
 FORMS PART OF A-
 LEAD

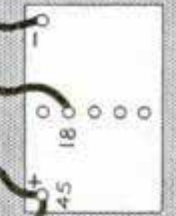
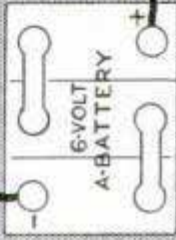

B - BATTERY 3 45-VOLT UNITS

posts are mounted on the subpanel in the order shown. Mark the 18 and 45-volt B-posts for identification; the other posts can be had with engraved tops. The three-tube amplifier unit is complete and greatly simplifies the wiring; the terminals are plainly marked so there is little chance for error.

All dimensions for the front panel are

plainly shown. This panel should be laid out with care, and it is best to prepare a cardboard template the exact size of the panel. Clamp this to the panel with two or more C-clamps and point off the holes to be drilled carefully, marking the panel deeply so that the drill will not creep and throw the hole out of line. Countersink the holes marked with double circles. For the larger holes, it may be necessary to take the panel to a machine shop, especially for the voltmeter holes.

The front of the panel is shown in the template so it is necessary to refer to the double-page wiring diagram for the rear view of this panel with the instruments mounted in their respective positions. The dotted line indicates the height of the subpanel when the front panel is mounted on the brackets, there being sufficient space between the two panels to clear the rheostats.

The panel light is placed above and between the condensers, serving as a reminder that the

Front View of
Completed
Instrument

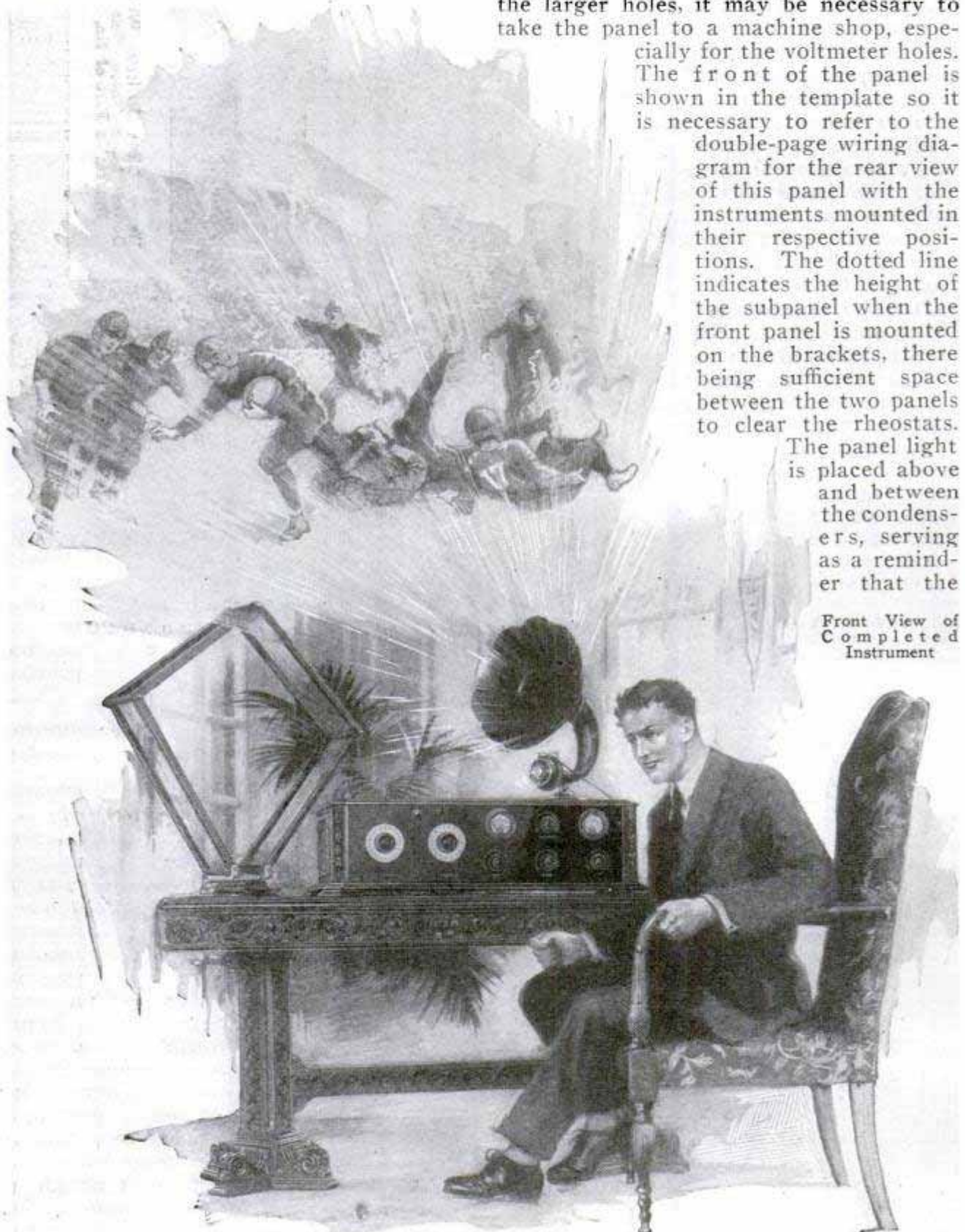

tubes are lighted and also as a tuning light for the dials, which is useful at times. The horn jack shown in the upper left-hand corner is detailed in one of the illustrations, and each spring in it is numbered to correspond with the circuit wires to avoid error. This jack functions both as a horn jack and a filament switch: plugging in the horn places the set in operation, and to shut the set off, the plug must be withdrawn, which is a further check on the operator to remind him not to leave the set turned on, needlessly using the batteries when the set is left alone.

This, of course, puts all the tubes in use at once, but volume can be controlled with vernier detector rheostat, if a UV-200 or C-300 tube is used for the first detector, or practically the same result can be had by detuning, if a UV-201A or C-301A tube is used. All other tubes are of the A-type. For those who prefer to operate the set at times with a minimum number of tubes, a simple switching device that can easily be mounted on the front panel will be described in an early issue. The set is now ready for wiring.

The wiring diagram is as simple as it is possible to make it, and all wires are shown in their exact positions both above and below the subpanel, the panels being separated to show the wiring more clearly. The wires are numbered so that each lead can be easily traced from page to page; the black lines indicate the wires above the subpanel and the dotted lines show the position of the wires below. Wire No. 4, running from the B-positive 135-volt terminal on the amplifier unit to the B-positive terminal on the A and B-battery voltmeter, is a flexible rubber-covered lead, No. 14 round tinned-copper busbar wire being used for the remainder of the circuit. Very little spaghetti insulation is used; only a few short lengths are necessary under the subpanel where wires are likely to be shorted if moved out of place. Soldering lugs are used under every termi-

nal where a wire is to be connected. The lugs are fastened to the small fixed condensers with short brass machine screws. Lugs are very important; do not fail to employ them, and use solid wire solder

and a very small amount of flux paste, carefully wiping the flux off so that it will not run under the terminal when the iron is applied. Note how the wires are run from the instruments on the subpanel down through holes and continuing to their respective terminals. Do not change the direction of these leads under the panel; they are so placed as to avoid forming loops in the circuit, which would

cause detrimental effects in the set. Several by-pass condensers are mounted below the subpanel, and are indicated by the dotted lines; these condensers are clearly shown in the under-panel photo. Note that the .5-mfd. by-pass condenser is mounted on the underside at the front by means of two short brass machine screws, the soldering terminals extending just beyond the edge of the panel. Now, mount the front panel on the subpanel brackets, place a soldering lug under the nut at the point marked for wire No. 2. This is for the A-negative lead, of which the left-end bracket and the center bracket are a part. Soldering lugs are mounted on the ends of the brackets with short brass machine screws, and the dotted line clearly shows the lead connecting the brackets. The A-negative and B-negative binding posts are connected to each other and then to a lug mounted on the rear end of the center bracket. The 2-in. space below the subpanel provides ample room for all wires without crowding, and leads crossing each other can be well separated. Note the lead running from the negative of the 1½-volt cell to the center loop jack; the center loop lead will be plugged into this jack when the set is hooked up for operation. The A and B-batteries and their connections are so clearly shown that little explanation is

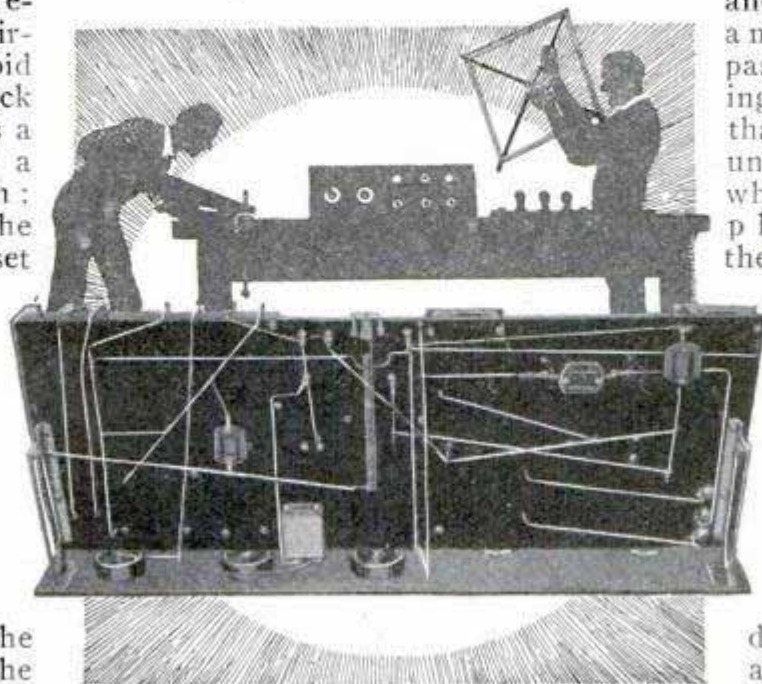

View of Underside of Panel; Note the Position of the Condensers

necessary. The B-batteries should be of the large 45-volt type, and are connected in series to obtain a total of 135 volts for



Side View of Jack, with Springs Numbered to Correspond to Diagram

the amplifier unit, the 18 and 45-volt taps being taken from the first 45-volt unit as shown. Note that the B-negative post on the amplifier unit has no connection. The loop may be of any good make, but must be provided with a center lead. Flexible, well-insulated leads not over 3 ft. long—shorter if possible—are connected to the loop. These leads terminate in small plugs of the cord-tip type, and are plugged into the loop jacks, the center lead to the center jack. Plug in the horn and place one tube successively in each socket, after connecting the batteries, turning up the rheostats to see that the filament circuit is correctly wired. Facing the set, the audio rheostat is the one on the extreme right; it controls the filament voltage for the amplifier tubes only. This voltage can be checked by point 3 on the three-tap voltmeter. The second detector tube is automatically controlled by the amperite, and the center rheostat is for the oscillator tube and three intermediate-frequency tubes in the three-gang socket; this voltage is checked on point 2 of the voltmeter. The first detector tube is controlled by the vernier rheostat and is checked at point 1 on the voltmeter. After testing the filament circuit, place

all of the tubes in the sockets, and the set is ready for operation.

Operating a superheterodyne receiver correctly, so as to obtain maximum results, requires a little practice. This is true of any highly developed instrument—the experienced operator has the advantage; however, the operation of the instrument is so simple that anyone can soon tune in stations at surprising distances with good tone and volume. Set the rotor of the coupling unit at an angle of about 45° , and the set can be adjusted under operating conditions. Set the pointer knobs of all rheostats so that the rheostat is at the off position when turned to the extreme left. A small setscrew in the knob is then tightened on the shaft, and the pointer on the potentiometer knob is fastened in the same manner. To tune in a station, first set the potentiometer about one quarter of the way up from the lower-left side, then turn up the rheostats slowly, keeping the pointers at approximately the same position, and continue until you hear a soft hum from the tubes. Second, set the wavelength condenser at any given point, say 30° , and rotate the dial of the oscillator condenser very slowly 10 to 15° on each side of the 30° mark; if a click or whistle, indicating the presence of waves from a station, is heard, but the words or music is not clear, turn up the detector rheostat slightly, or shift the potentiometer either forward or back, to clear the signal. The potentiometer will have a certain setting where all stations come in best, this point always being found to the left of center. The rheostats will also have a more or less fixed setting that will give the best results, and the tuning is then almost entirely confined to the condenser dials. Third, if nothing is picked up at the first setting of the condensers, move the wavelength condenser up 10° , and again rotate the oscillator dial slowly as before on either side of the 40° mark, continuing this process until a station is picked up. Shift the position of the loop from time to time, as this will often enable stations to be picked up that otherwise would not be heard. When a distant station is picked up and tuned in to best advantage, set the little midget condenser to the point where the signals come in with the best volume and clarity; also make any slight adjustment of the coupling unit rotor that may be necessary to get the loosest coupling without approaching the breaking-over point too closely.

These last-mentioned adjustments need only be made once, and best results are

obtained if they are left alone after the proper setting is once determined.

Place the set in a cabinet or console having a depth of 12 in. measured from

lighter flexible well-insulated leads for the B-batteries.

A complete set of large blueprints, including full-size panel and subpanel drill-

MATERIAL LIST

- | | |
|--|--|
| 1 bakelite or formica panel, 3-16 by 8 by 30 in. | 1 No. 855 Chelton midget condenser, low-loss. |
| 1 bakelite or formica subpanel, 3-16 by 10 by 29 in. | 1 Daven super-amplifier unit complete (three-stage). |
| 1 bakelite strip, 3-16 by $\frac{5}{8}$ by 1 $\frac{3}{4}$ in. | 1 No. 55 Jewell voltmeter, 0 to 8 volts only, three-tap type. |
| 1 brass strip, 1-16 by $\frac{1}{2}$ in., 10 $\frac{1}{4}$ in. long. | 1 No. 55 Jewell voltmeter, A and B-type, 0 to 7.5; 0 to 150 volts. |
| 3 Benjamin subpanel brackets. | 1 loop aerial, three-tap, (box-type preferred). |
| 3 No. 600 Remler intermediate-frequency transformers. | 1 panel light. |
| 1 No. 610 Remler tuned-stage transformer. | 1 2-meg. gridleak, cartridge type. |
| 1 No. 620 Remler coupling unit. | 1 Sangamo condenser, .0005 mfd., with gridleak clips. |
| 2 No. 631 Remler .0005-mfd. capacity unit, complete with dials. | 3 Sangamo condensers, .0025 mfd. |
| 1 three-gang, shock-absorber type socket unit, standard base. | 1 Sangamo condenser, .006 mfd. |
| 3 single shock-absorber type sockets, standard base. | 1 Sangamo condenser, .00025 mfd. |
| 2 6-ohm rheostats, plain, one-hole mounting. | 1 Dubilier by-pass condenser, 0.5 mfd. |
| 1 6-ohm rheostat, vernier, one-hole mounting. | 2 1 $\frac{1}{2}$ -volt dry cells (large size). |
| 1 400-ohm potentiometer, one-hole mounting. | 5 binding posts with engraved tops. |
| 1 filament-control jack. 1 1-A amperite. | 3 cord-tip jacks and plugs. |

the front panel to the rear partition, drilling holes through the rear of the cabinet for the loop and battery leads; bore the holes for the leads about 1 in. apart. Use heavy, flexible rubber-covered auto-ignition wire for the A-battery leads, and

ing templates, instrument layout, and wiring diagram, as well as a schematic diagram of the circuit, may be obtained from the Radio department, Popular Mechanics Magazine, 200 E. Ontario st., Chicago, for 75 cents. Specify blueprint No. 104.

Handy Rack for Spare Tubes

Many good radio tubes have been ruined for lack of a safe place to keep them, and the simply constructed rack described herewith is therefore a worthwhile addition to the experimenter's equipment, and should be used even if the tubes are removed from a set for a few moments only. Anyone can make the rack at very little cost. Three pieces of hardwood, $\frac{1}{4}$ in. thick, 12 in. long and 3 in. wide, are required for the shelves. The position of these is shown in the drawing. The lower shelf serves as a support for the tube base, while the two upper ones are perforated to hold the bulbs snugly in an upright position. The holes in the top shelf are $1\frac{1}{16}$ in. in diameter, and those in the one

below, $1\frac{7}{16}$ in. in diameter. Be sure the holes are spaced properly so that they will line up when the rack is assembled.

The two endpieces are of $\frac{1}{2}$ -in. stock; these should be 4 in. wide and 5 in. high at the highest point, the rounded top improving the appearance of the rack. These pieces may be grooved to take the shelves, which are then glued and tacked in place with small brads, or the shelves

may be tacked directly to the ends, if preferred. After the rack is assembled, it should be sanded and varnished. It is a good plan to screw the rack to the table.—C. A. Reberger, Roselle Park, N. J.

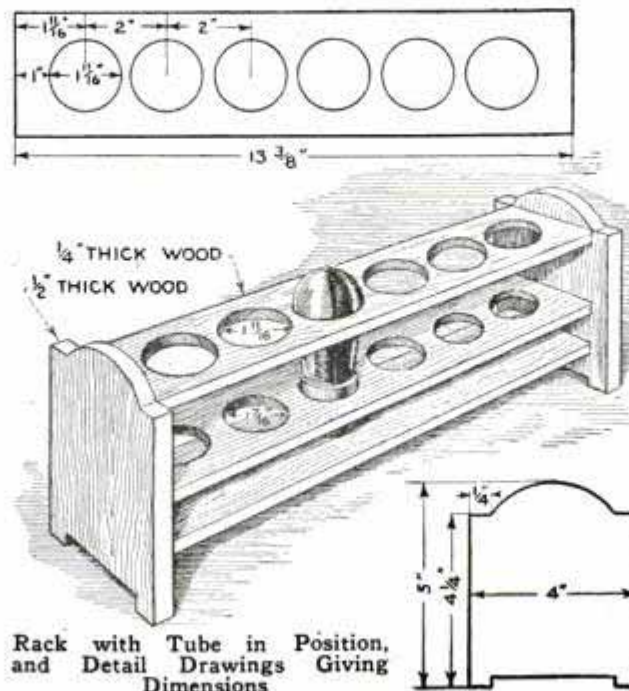

ⓄThe tone of incoming signals can be improved considerably by shunting the primary of the first audio-frequency amplifying transformer with a fixed condenser of .001 mfd. capacity.

Making a Wireless Signal Board for Code Practice

A radio-signal board for the beginner who is learning the code will prove a great help. With it, the necessity for listening

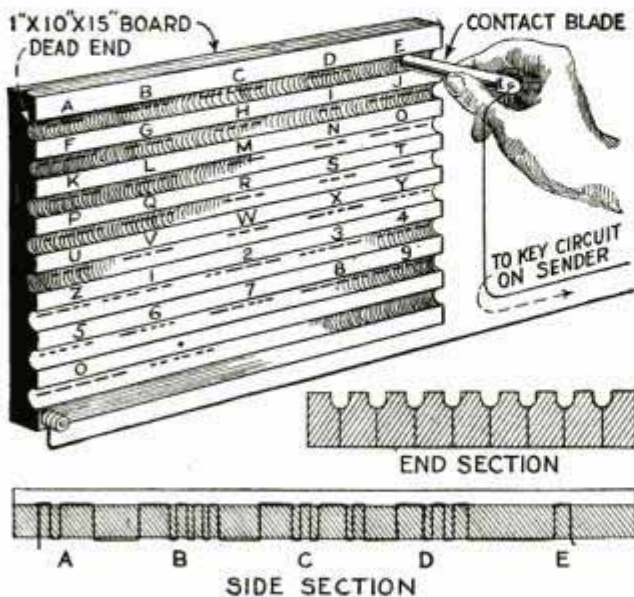

Wireless Code Board Which Transmits Signals Automatically; the Construction Is Clearly Shown

in is eliminated, and the speed can be regulated to suit the operator. A device of this type was used years ago by telegraph operators, and the one described is a simplified form of this, which will meet the need of the radio amateur. It can be used instead of a key for sending messages if desired, or connected to a buzzer for code practice.

Use a board, 15 in. long, 10 in. wide and 1 in. thick, preferably of oak or ash. Lay off eight parallel grooves, the long way of the board, with a round-nose gouge. The end section given in the illustration shows the relative depth of these grooves. The spaces between them should be a little wider than the grooves themselves. The wireless signals are made up of dots and dashes, so the idea is to arrange long and short metal contacts in the grooves to correspond with the individual code signals. This is done by threading soft copper wire through the board as indicated. For this purpose, mark off the dots and dashes in the grooves. Five characters to a line will be about right; then mark the character itself in ink above the groove. Thus A, B, C, D and E will be written along the top of the board, and the corresponding characters will be drawn in pencil in the groove below them.

Now, with a small drill, bore vertically through the wood at the ends of each dash and dot, being careful to keep the holes apart through their entire depth. The board is now ready for wiring. Starting at A, push the end of the wire up through the first hole from the bottom and down through the second. This makes a short line or dot. Then push the wire up again in the next hole and down through the following. This makes a dash, and with the previous dot forms the code signal for the letter "A." Continue this threading process throughout the entire board, pulling the wire taut at all times and flattening it in the grooves with a dull tool. The end of the wire should come out at the lower left-hand corner of the board where it is fastened to a binding post. The end started at A should be left open, or dead. Remember to use one continuous wire throughout.

Connect the binding post to one side of the key or buzzer, and the other wire from the circuit to a dull-edged piece of metal, called the contact blade, which should slide freely in the grooves. It should also be insulated for part of its length to form a finger hold for the operator. With the circuit ready for sending, simply draw the blade slowly across the contacts under the letter to be transmitted. Its longer or shorter contact with the wire in the groove means a dot or a dash, automatically sending the letters.

Adjustable Resistance Unit Replaces Amplifier Rheostats

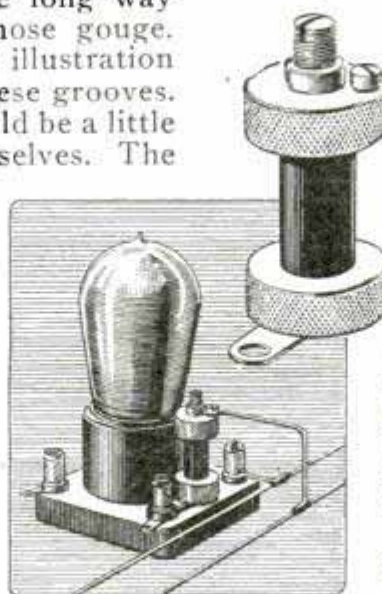

A simple adjustable resistance unit that can be used instead of rheostats mounted on the panel is now available. It simplifies the operation of the set by eliminating panel-controlled rheostats, and being mounted upright on the filament post of the tube socket, as shown in the illustration, takes very little space. The upper view shows the unit in detail. The adjustment can be instantly changed to suit any tube, the resistance ranging from .2 to 35 ohms.

Ⓞ A pair of electrician's tweezers are a convenience in keeping the tops of storage batteries dry, when used with cotton batting and weak ammonia. They are especially useful when cleaning under the lugs of B-batteries.

623-R.
Victory Blvd.
Shelton, Conn.
10 11
The Control



Building a Monorail Coaster

By L. B. ROBBINS

HERE is a winter coasting device that is a sort of combination ski and bicycle. It is used for running down long, smooth snow-covered hills and will afford much fun for the lover of speed.

The body of the coaster is made by cleating together several smooth, matched spruce boards, 7 ft. long. Their width is immaterial but the total width should be about 30 in. First put on the two back cleats, one on each side, with screws. Place these at right angles to the edges and 24 in. from one end. Let these two cleats project beyond the top edge about 3 in.

Now, 30 in. ahead of these cleats, saw a vertical notch down through the top board, for a depth of about 6 in., and make it 1 in. wide. This is for the handlebar post. Then screw two cleats over the boards at this point so as to completely

cover the notch. Be sure to draw the boards well together before cleating and to countersink the screw heads. Then saw the rear ends of the boards off at an

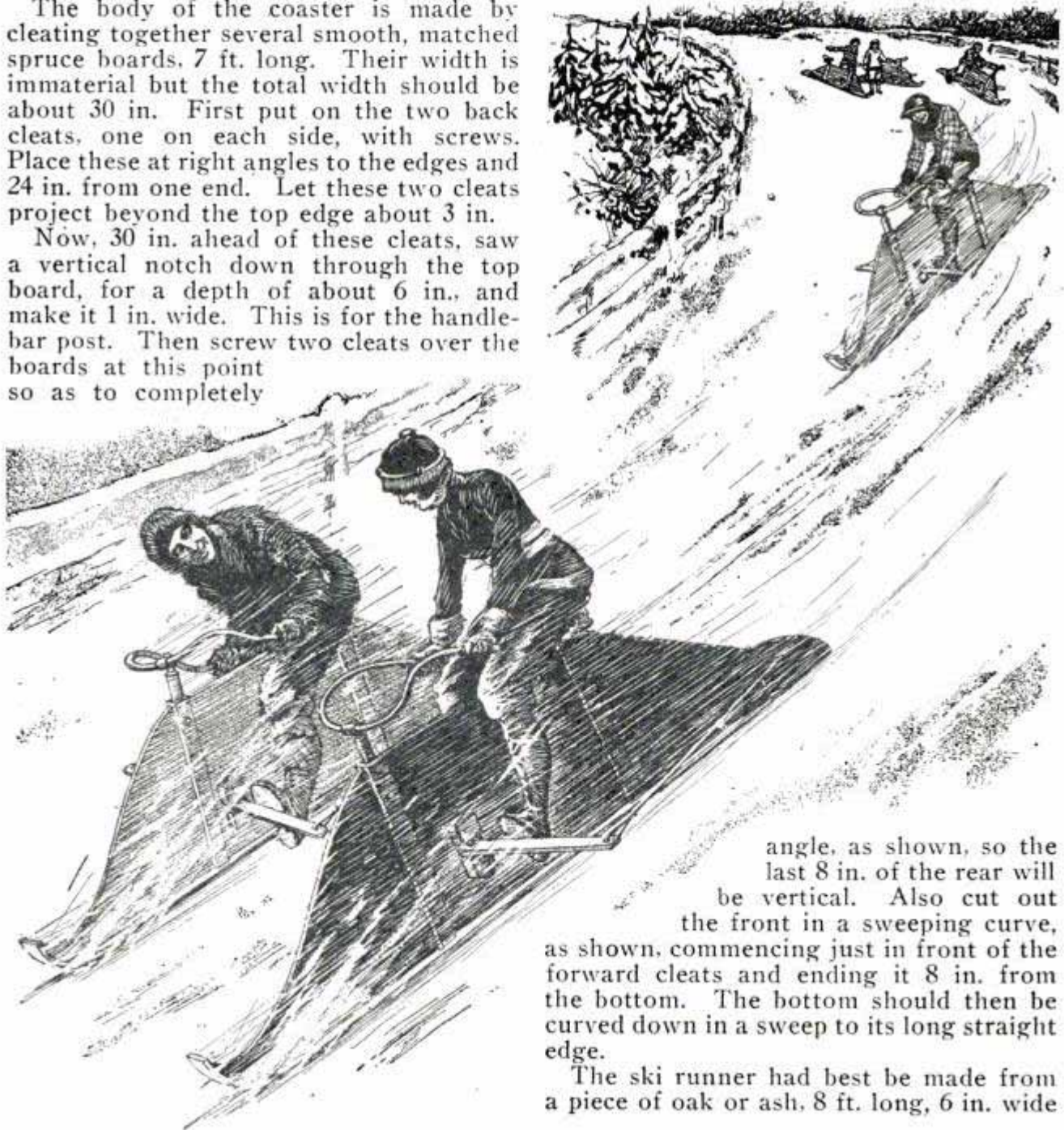

angle, as shown, so the last 8 in. of the rear will be vertical. Also cut out the front in a sweeping curve, as shown, commencing just in front of the forward cleats and ending it 8 in. from the bottom. The bottom should then be curved down in a sweep to its long straight edge.

The ski runner had best be made from a piece of oak or ash, 8 ft. long, 6 in. wide

and $\frac{1}{2}$ in. thick. Fasten it to the bottom edge of the body with brass screws, countersinking the heads only slightly. The back end should be flush with rear of the body, but the front end should project up and beyond the point. This curve is

hole in the steering bar. Be sure to have the 11-in. end of the bar on the blocked side of the body.

The rudder is cut out of a piece of hardwood, 12 in. long and 6 in. wide, to the shape shown in the detail. Sharpen

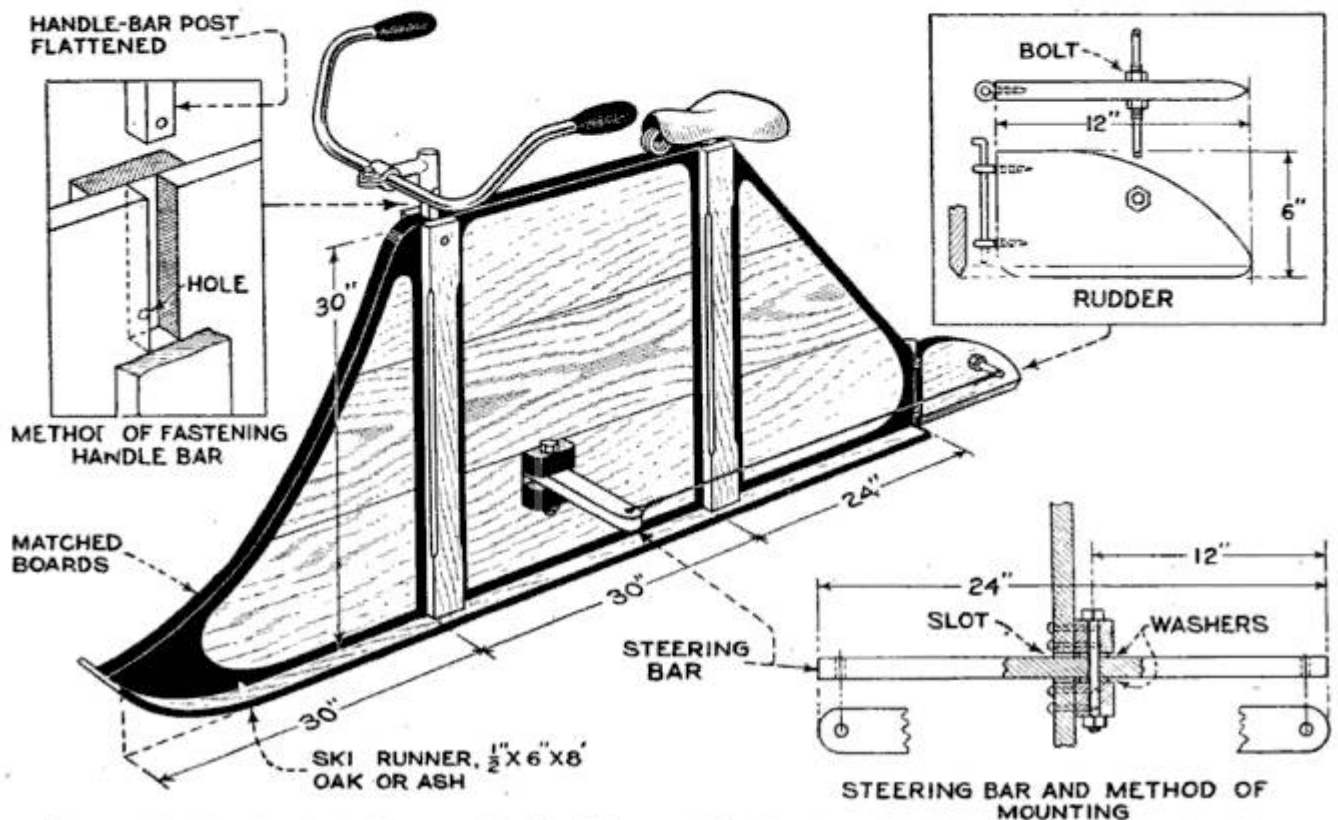

Construction Details of the Coaster; the Handlebars and Saddle of an Old Bicycle Are Used and a Foot-Steering Arrangement Is Provided

easily obtained if the wood is steamed or soaked in boiling water before attempting to fasten in place. Sandpaper the runner smooth and oil with linseed oil.

The handlebars can be taken from an old bicycle. Flatten the post so it will fit down in the notch in the body and drill a hole through it and corresponding holes through the cleats for a retaining bolt, to hold it steady. The seat may also be an old bicycle saddle and can be bolted to the top between the two rear cleats, as shown. The saddle type used will determine how this should be done.

Then comes the steering arrangement. This consists of an iron bar 24 in. long, 2 in. wide and stiff enough to stand your weight. Have a pivot hole drilled 11 in. from one end and a small hole in each end for the steering cables. Cut a horizontal slot in the body, 10 in. from the bottom, and at a point between the cleats convenient to the feet when sitting in the saddle. Bolt two hardwood blocks above and below this slot and drill a hole down through them. This is a pivot hole for a long bolt, which should be driven down through the blocks and through the pivot

the bottom edge and fasten a long bolt through the middle, near the top edge. Drive a pair of heavy screweyes into the vertical edge of the rudder to fit close to another pair in the end of the body. A steel pin, run through the screweyes, allows the rudder to swing from side to side. Drill a hole in each end of the bolt and connect them to the ends of the steering bar, as shown. Use small steel wire and line the rudder up so it will be exactly in line with the runner when the bar is at right angles to the body.

Give the entire body two or three coats of bright-colored paint, to protect it from moisture and give a sporty appearance.

Starting from the crest of a long hill, this monorail coaster is ridden exactly like a bicycle except that the steering is done with the feet on the steering bar. A slight movement either way moves the rudder and changes the course of the coaster. Be careful of attempting to take too sharp curves however. The best speed can be realized by wearing a hard-packed path down the slope by several descents and following this track as closely as possible in all later trips.

Nickelplating by Friction

In nickelplating iron, a thin coating of copper can first be produced on it by rubbing on a solution of 20 parts of sulphate of copper, 5 parts of sulphuric acid and 100 parts of water. After the copper plate has been formed rub over it, with a rag, a solution of 3 parts tin, 6 parts nickel and 1 part iron in 100 parts of hydrochloric acid and 3 parts of sulphuric acid. If finally the object is rubbed with a rag that has been dipped in finely pulverized zinc, a nickel deposit will be made on the copper. The thickness of the nickel deposit can be increased by repeating the two last operations. A silver coating can be produced by dissolving freshly precipitated chloride of silver in a solution of hyposulphite of soda, 1.1 parts to 10 parts of water, and adding to this solution 180 parts spirits of sal ammoniac and then stirring in 800 parts of finely washed chalk. This mixture is applied and rubbed until it dries on the object being silvered, and the result is a brilliant deposit of pure silver.

Holder for Washing Photographic Films

Photographic films can be effectively washed in the sink by means of the simple device shown in the illustration. A short

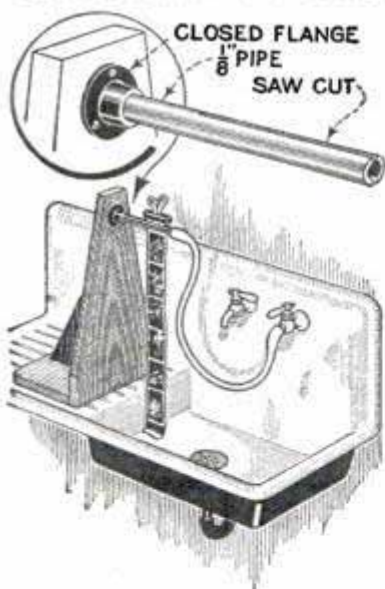

length of $\frac{1}{8}$ -in. pipe, threaded at one end, a $\frac{1}{8}$ -in. pipe flange and a section of rubber hose are the only materials needed. With the hacksaw, cut a slot, lengthwise through the pipe, about 1 in. greater than the width of the largest film to be

washed, as shown in the detail. Screw the pipe into the flange and fasten this to a wooden standard which should be high enough to permit the film to hang down into the sink without touching the bottom. The film is held with a clip. A length of rubber tubing is slipped onto the water faucet and over the end of the pipe and the water is then allowed to run slowly. It will flow down both sides of the film and clean it thoroughly.—Harold Nowell Whitmore, Cleveland, Ohio.

Folding Stepladder Extension

A stepladder that can be opened up so that it becomes almost twice as long, is a convenient part of the household equip-

Dual - Purpose
Ladder Can Be
Used Outdoors as
Well as Indoors

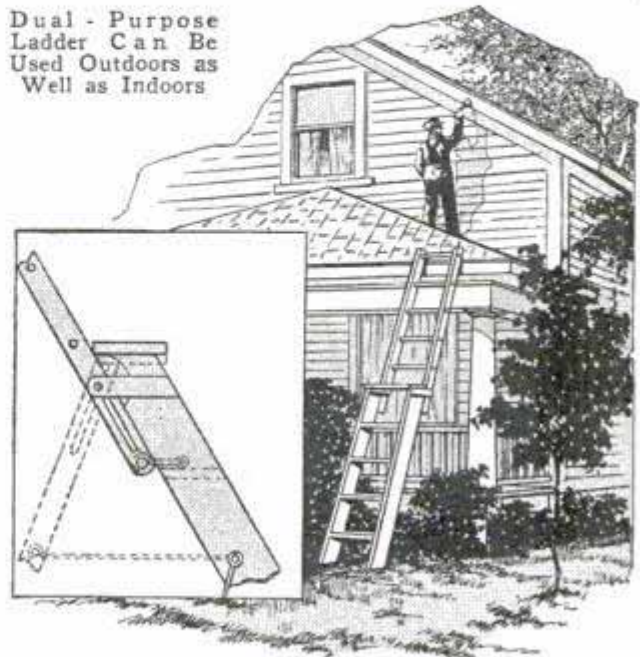

ment. As shown in the drawing, half of the ladder is part of an ordinary stepladder, and the second half is simply a short ladder of the usual type. The two sections are joined by means of two metal straps with a rung between them on which the top ladder slides in slots cut in the rails. A hook attached to the lower half is swung out to slip over the bottom rung of the upper half to hold it rigid when extended.—A. C. Cole, Chicago, Ill.

Cleaning Center-Guide Float in Carburetor

Many carburetors are fitted with hollow metal floats having a tube through the center. The inlet needle works in this tube and any roughness or dirt here will cause trouble by too high or too low a fuel level. A good method of cleaning out the inside of the tube is to remove the float and draw a rag soaked in metal polish through it. Repeat this several times and then draw a dry rag through the tube. If the opening is still rough, roll up a piece of very fine sandpaper or emery cloth, insert it in the tube and pull this back and forth until the surface is smooth. Finish by using metal polish on a rag. The inlet needle should also be treated with metal polish. Care should be taken when using sandpaper in the tube through the float, as any holes made here would allow the float to fill with gasoline.—E. T. Gundersen, Jr., Humboldt, Iowa.

Making a Fireplace Screen

Sparks from fireplaces sometimes set houses afire and frequently cause other

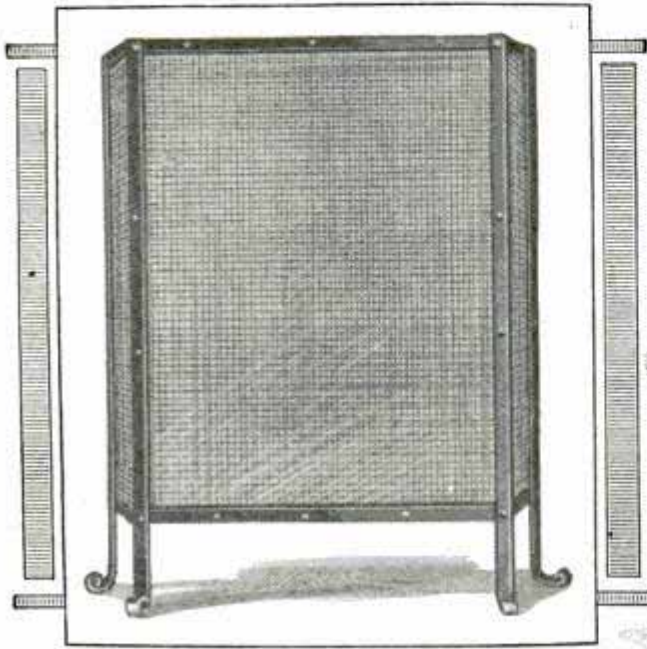

Fireplace Screen Made from Strips of Flat Metal, Sheet Metal and Copper Screen

accidents. This danger could be greatly reduced if fireplaces were protected with screens. These can be purchased or made at home; the one shown in the photo and illustration is simple in construction and can readily be made by anyone who is handy with tools. The frame is made of $\frac{3}{16}$ by $\frac{3}{4}$ -in. bar iron, which can be obtained from a blacksmith or a hardware dealer. With a hacksaw, cut off four lengths for legs, making each leg 4 in. longer than the height required for the frame. Form a foot on one end of each, as shown. This can be done by heating the iron, then clamping it in a vise and bending and hammering it into shape. The legs must, of course, be uniform in shape and dimensions. Drill $\frac{1}{4}$ -in. holes in each to receive stove bolts with which crosspieces are attached, the length of which is determined by the width of the fireplace. If there is a projecting hood above the opening the screen should be bent to conform to its shape as shown in the lower right-hand detail. In any case it should be bent approximately to the form shown, making the front legs project forward at least 4 in. beyond the rear ones so that the screen will stand securely. Cut strips of 24 or 26-gauge sheet iron about $\frac{3}{4}$ in. wide. With tin snips one edge of these strips is cut to form points, as shown. Bend these points up at right angles and attach the strips to

the crosspieces and to the end legs as indicated. It is then an easy matter to attach some copper screen by slipping it over these points and then bending the points over. Be sure that the screen is drawn up straight and true. It is held stretched and smooth by $\frac{1}{2}$ by $\frac{1}{8}$ -in. iron bars, cut to fit over the strips of sheet metal holding the screen, holes being drilled through the bars to fit over the stove bolts. The projecting edges of the screen are carefully trimmed off and the rough edges and corners of the metal

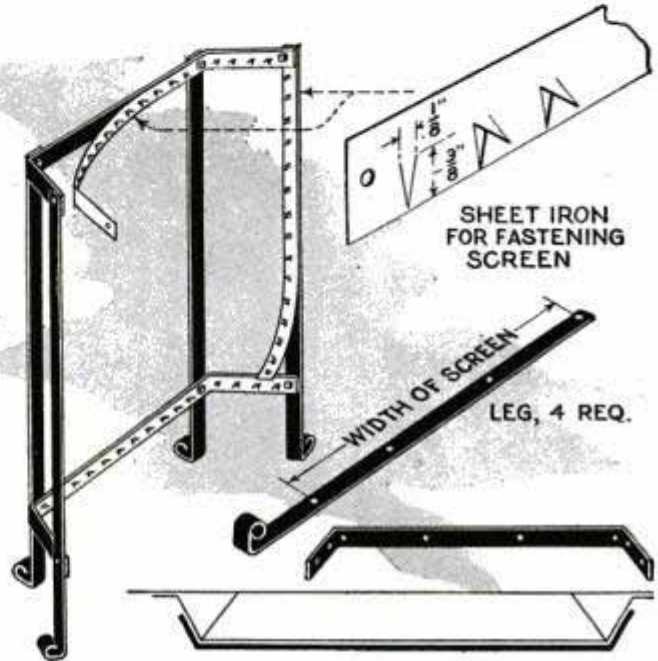

FIREPLACE HOOD

strips filed down.—Howard E. Good, Waterville, Ohio.

Copper Stencil for Marking Laundry

A stencil suitable for marking laundry may be easily made as follows: Obtain a small sheet of very thin sheet copper, about 1 in. wide, and 4 in. long. Dip this in a vessel containing some melted beeswax so that both sides will be evenly covered with a thin coat when it cools. The design, name, monogram or figure that is wanted in the stencil should now be drawn upon a piece of thin white paper, the reverse side of the paper blackened with graphite, and then laid on the stencil plate with the design in the center of the plate, whereupon the design is lightly traced with a blunt point on the thin wax coating. After the paper is removed, trace the design on the wax surface with a pointed instrument, but not completely, the lines being broken at more or less regular intervals, to form holders so that, after etching, the design cannot fall out.

Next lay the stencil in a shallow dish and pour a small quantity of fresh nitric acid over it. Keep the air bubbles removed from the surface of the sheet by means of a piece of soft feather or brush. The design will be eaten out in a very short time where the wax has been removed, and this may be readily observed by holding the stencil plate up to the light. The acid should then be rinsed off with water, and the wax removed by heating and wiping it off with a cloth. The stencil may be given a final cleaning in a dish of benzine or gasoline, which will remove any remaining wax.

Novelty Lampshade Revolves on Stand

A lampshade turned by the heat from the bulb can readily be made for the type of electric lamp in which the bulb is mounted upright at the top of a supporting base. Remove the regular shade and replace it with a special shade made of fairly transparent parchment or colored bond paper. This shade may be made either cylindrical or square. The top of the shade is of cardboard, and is cut so that it has small blades or fans like those of a windmill wheel. The center has a dent punched in it to rest upon the small tip of the bulb. Thus mounted, there is almost no friction and the rising heat from the lamp through the fan blades of the top causes the shade to revolve slowly. Figures can be cut from black paper and pasted to the shade or

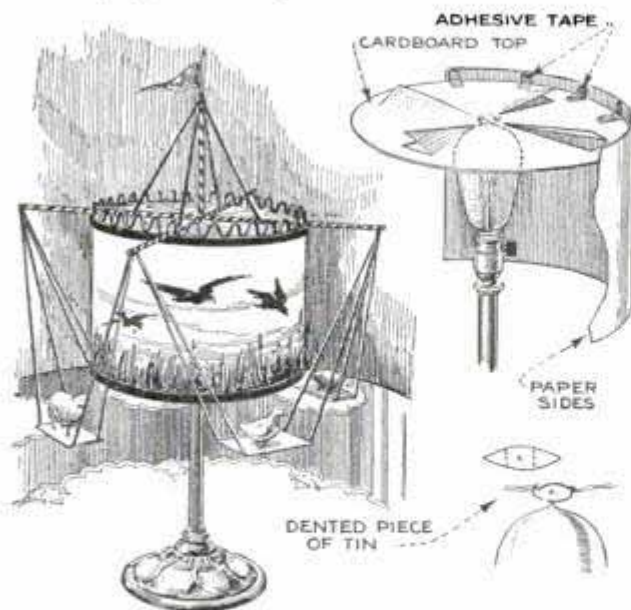

Novel Parchment Lampshade Which Is Rotated by Rising Heat from the Lamp

other light ornamentation of the kind shown may be added and will make it quite attractive.

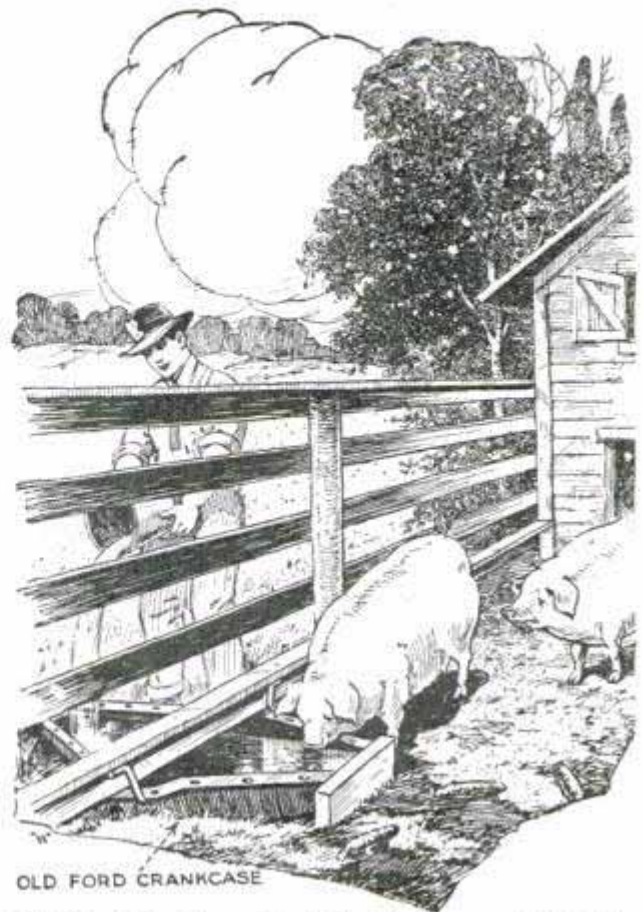

Old Ford Crankcase Used for Feeding and Watering Hogs

Crankcase Makes Hog Trough

Instead of throwing away an old discarded Ford crankcase, one farmer made use of it as a trough for watering and feeding his hogs. A small hole is dug in the ground under the fence to receive the crankcase, the narrow end of which projects outside of the hog yard. This arrangement enables the farmer to pour the slops into the crankcase without spattering it on his clothes or having the pigs rub their snouts against his shoes.

Locating Breaks in Tire Casing

Breaks on the inside of tire casing that are large enough to wear the inner tube, are sometimes difficult to find when the tire is removed from the wheel. It is a good plan to roll the casing by hand on the floor, bearing down on it heavily. This gives the effect of a tire about half down, and causes breaks on the interior to show up plainly inside of the flattened portion. This is a good method to use with small tires, but larger tires are usually too stiff to be flattened in this way.—E. T. Gunderson, Jr., Humboldt, Ia.

☐ When you have a hole in your pocket turn the pocket inside out and cover the hole with adhesive tape.

Operating Heating

Home Plant Will Repay by Reducing Cost



Feed the Coal Properly to the Firebox if Best Results Are to Be Obtained

TO keep the cost of heating the home low, while at the same time keeping the house comfortable, demands that the operator understand his plant. Simply filling the firebox with coal and removing the ashes whenever they accumulate, is not enough. Every owner should learn to regulate his heater so that it will follow the changes in outside temperature, and so that the fuel will be burned efficiently.

The thing that is most neglected about the average plant is the proper use of the



The Feed-Door Damper, Which Supplies Air above the Fire, to Aid in Combustion



There Are Two Draft Dampers in This Ash-pit Door, for Better Regulation

fire. The feed-door damper, which is usually a small slide in the door leading to the firebox, is more important than is usually supposed; cold air may be admitted through it directly over the fire, and if it is opened wide, it acts as a check. If properly regulated, it admits just enough air to supplement that admitted through the draft damper, and is a great aid in inducing perfect combustion of the coal. The smoke-pipe damper is not always fitted, but with a chimney having a strong draft, it is of great assistance, as it provides better control of the draft than the check damper can alone, especially in windy weather or at night. It should always be fitted between the furnace and

the Home Furnace

Study of Its Little Ways of Heating House

the check damper, never between the check damper and the chimney flue, as it is sometimes found. Soft-coal furnaces are fitted with another damper, known as the hot-blast damper, connecting with an air chamber for admitting hot air above the fire.

When starting the fire, place some light material in the firepot and a little heavier wood on top; then open the draft damper wide, close the check and feed-door dampers and set the smoke-pipe damper so that the wood burns well, but not too fast. When it is burning briskly, throw on some

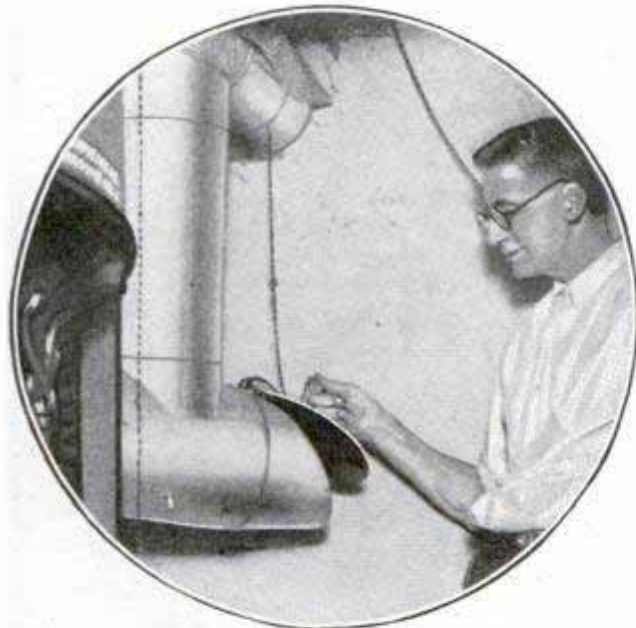

The Check Damper in the Smoke Pipe, Which Reduces the Draft in the Chimney

coal, spreading it well over the burning wood. Do not throw on too much at one time, and see that the fire continues to burn well. If blue flames spring up all over the surface of the coal when the feed door is opened, open the feed-door damper to admit enough air to burn off the gases arising from the top of the coal. When the blue flames disappear, close the feed-door damper and allow the fire to burn until the desired temperature of the house has been reached. The draft damper should then be closed and the check damper opened until the fire seems to "stand still"; it may be found necessary to let the draft damper stand open slightly, in fact, it will usually be found

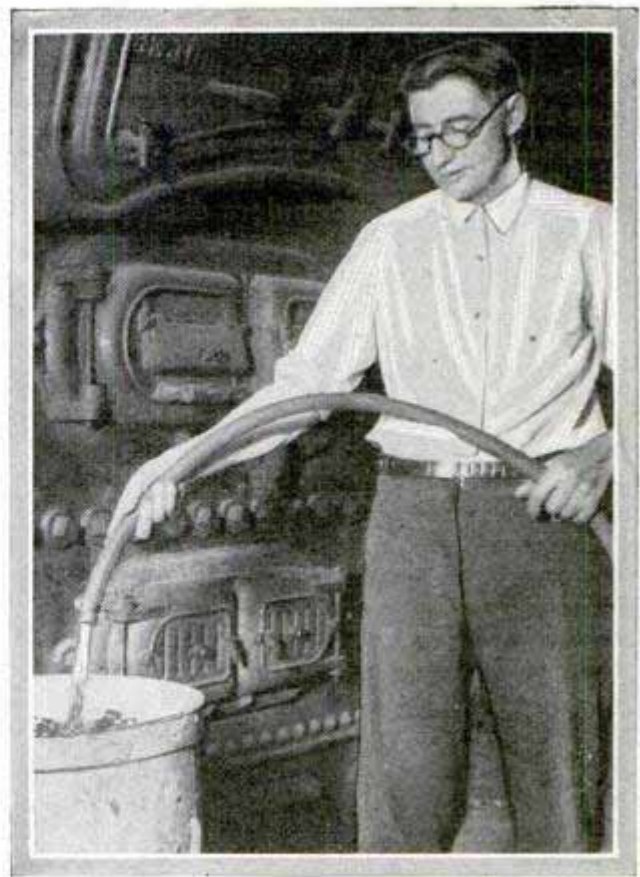

Sprinkle the Ashes before Removal from the Basement, but Not too Much

necessary to experiment with the check and draft dampers until the position is found for each that will hold the fire at the desired point. It is usual to have the check damper connected by means of a chain to a regulator on the floor above, so that the fire can be checked or increased without the necessity of going down to the furnace, and, while this is a convenience, an occasional trip should be made downstairs so that the condition of the fire can be observed and proper attention paid to it.



Keep the Ashpit Free from Ashes and Clinkers to Permit the Air to Get to the Fire

When banking the fire for the night, close the check damper and open the draft damper, and allow them to remain in this position until the blue flames over the banking coal or cinders disappear, indicating that the coal is not giving off any more unconsumed gases, then open the check and feed-door dampers and close the draft damper. It may be found advisable to close the smoke-pipe damper entirely, but this is also a matter for experiment, as it depends on the installation, the chimney and the weather. Different grades of coal affect the damper regulation also, as some coals require more air for complete combustion than others. The only way to learn to regulate the dampers is by trial and error, but the process is well worth while, as it will

result in increased economy of operation. A fire should not be shaken down more than three times a day, and twice will usually be found sufficient, in the morning and at night. Care should be taken not to shake it too much, and live coals should not be shaken through the grate. In mild weather an accumulation of ashes can be allowed to lie on the grate. The ashpit is so designed that enough air can pass through it to enable the coal to be burned completely, but this effect cannot be obtained if the ashes are allowed to accumulate in the ashpit until they choke it. Clean out the ashes immediately after shaking, and avoid not only the hindrance to combustion, but also the danger of burned and warped grate bars. Also, the fire should not be shaken until it has had time to catch; after throwing on fresh coal in the morning, open the draft damper and close the check damper, opening

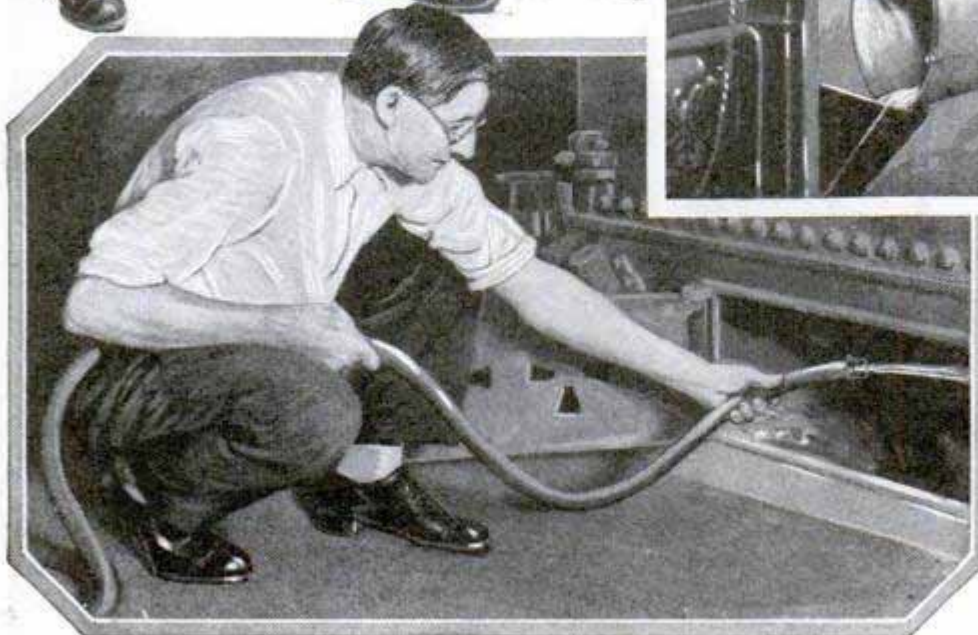
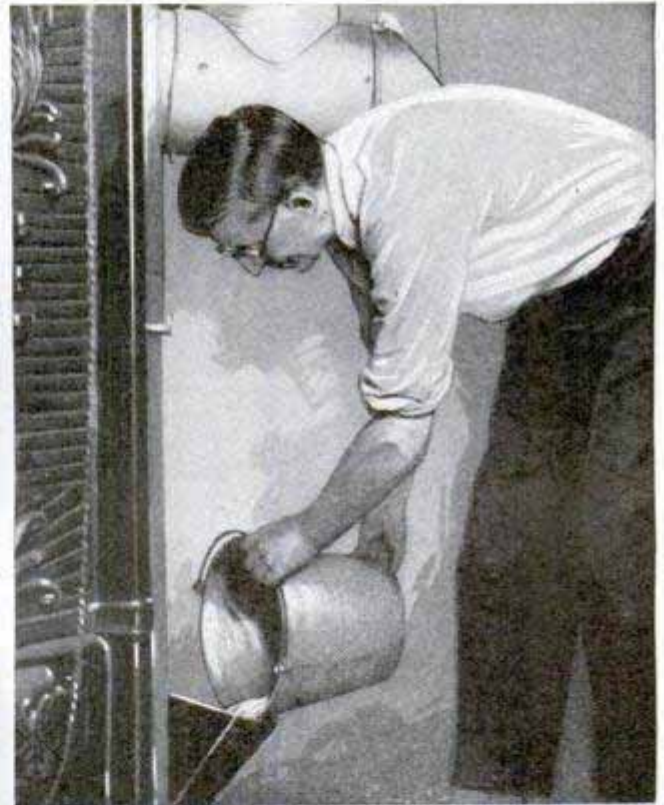

Upper Left, Shake Lightly; Upper Right, Don't Neglect the Water Pan; Below, Sprinkle Ashes in Pit before Removal

also the smoke-pipe damper until the fire is glowing, then shake with a light, quick movement. Do not turn the grate completely over unless it is necessary to re-

move a large clinker. When the first bright cinder is seen to fall through the grate, stop shaking and remove the ashes, sprinkling them a little—not too much—before removing them. A small watering pot kept near the furnace is good for sprinkling the ashes, but the spray nozzle on the hose will answer.

The fire should not be poked unless it is necessary to break up a mass of caking coal to prevent it from fusing over the grate. With large pieces of this character, it is best to pry them to the top of the fire, where they can be broken up and removed through the fire door, rather than to overturn the fire in the attempt to dislodge them through the grate. There must be a good fire on top of the mass before this is attempted, however, or else the fire may have to be coaxed with wood. If there is a good bed of live coals in the fire before the mass is pried to the top, the addition of fresh coal is all that is necessary.

Before removing the ashes to the alley, it is well to sprinkle them a little again to keep down the dust as much as possible.

A factor in the cost of heating a house that is little considered is the humidity of the heated air. Most furnaces are fitted with a water pan, but this is usually set so low down in the body of the furnace that it is not of much account. The home mechanic can improve it by moving it up in the furnace so that it is well within the warm-air space, and with its bottom at least 2 in. above the top of the combustion chamber. A supply pipe with a ball stopcock and an overflow tube makes it easy to keep the pan filled with water.

In an article published in the April, 1925, issue of this magazine the proper method of feeding the coal to the fire was explained, and the reader is referred to this article for full information on the subject.

Retouching fluid can be applied to the negative one drop at a time by using a small oilcan and keeping the opening closed by means of a glass-headed pin.

Hanging Window Sash on Porches

It is a great asset to have the porches inclosed during the winter months. In many cases sash are provided and take

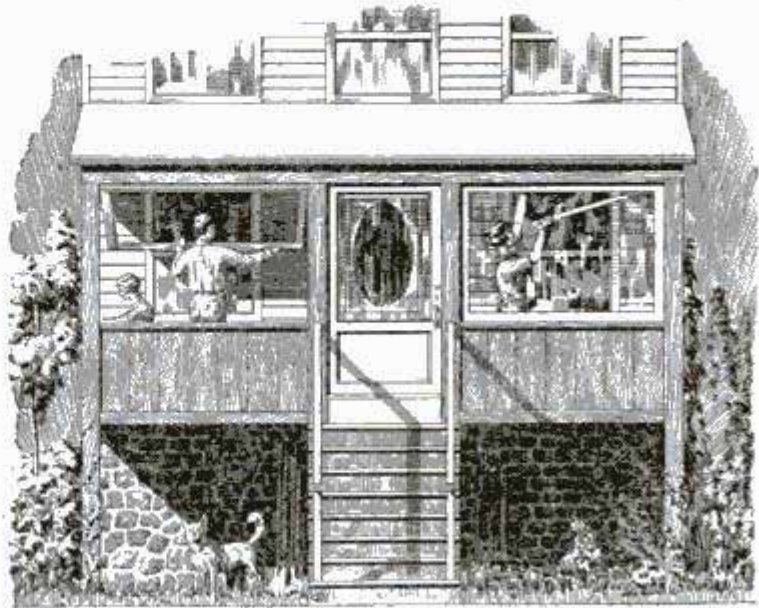

Convenient Method of Hinging Porch Sash Which Permits Hanging Them Up against the Ceiling

the place of the screens which are used in summer. Changing them means considerable work, however, and while stored away, the glass may be broken. To overcome these objections, I had sash made that were hinged at the top, so that they could be raised inward and fastened securely to the porch ceiling with hooks. The screens were fastened on the outside of the porch so that they did not interfere with the sash if it was desired to let them down. When real cold weather starts, the screens are, of course, removed.—Mrs. E. O. Swope, Danville, Pa.

Saving the Dip Net

Where dip nets are used in streams with rocky or gravel beds, the part that surrounds the wire frame soon becomes worn and frayed. One expert fisherman protected his net by splitting an old inner tube and stitching one half of it over the wire frame, as shown in the drawing. When the rubber begins to show wear, it can easily be replaced.—Dale R. Van Horn, Walton, Nebraska.

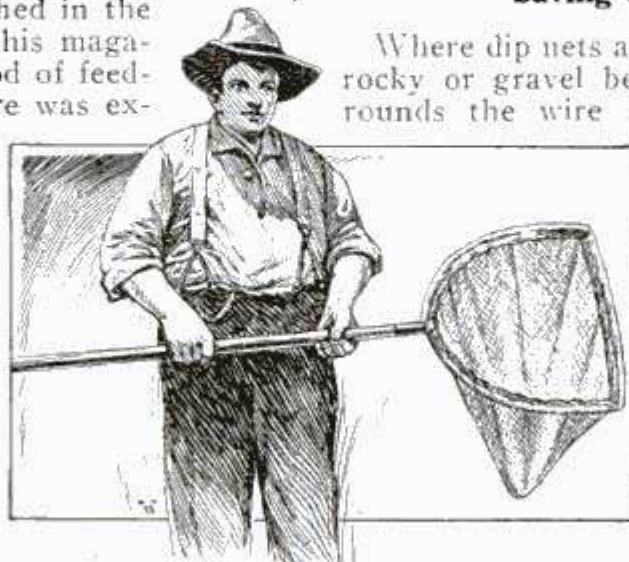

Strip from Inner Tube Saves Net from Wear

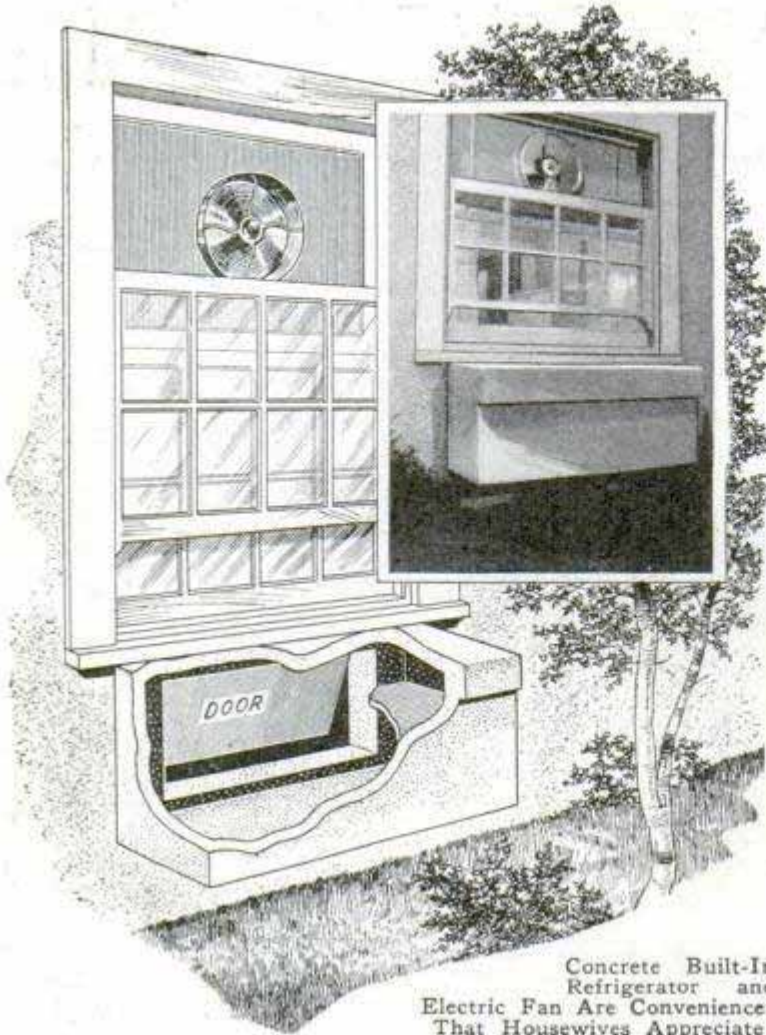

Concrete Built-In Refrigerator and Electric Fan Are Conveniences That Housewives Appreciate

Concrete Window Refrigerator

Made of concrete, the refrigerator shown in the drawing is a considerable improvement upon the wooden window box, which is quite common. It is built as part of the wall of the house and opens into the kitchen. There is a drop door, the inside of which is heavily padded with heat-resistant material to prevent the heat from the kitchen from getting through to the food. Inside of the box there is the usual shelving. Built as thick as it is, this window box not only serves to keep things cool without freezing during the winter but also helps keep out the heat in summer. If desired, ice can be used.—Felix J. Koch, Cincinnati, Ohio.

How to Make a Humidity Indicator

A simple weather indicator that may be used in determining the condition of the atmosphere is made as follows: Dress a small figure, in the form of a doll, with a piece of cloth, previously dipped in the following solution: Chloride of cobalt, 30 parts by weight; sodium chloride, 15 parts; gum arabic, $7\frac{1}{2}$ parts; calcium chloride, $4\frac{1}{2}$ parts and water, 400 parts. This cloth

will change color as the amount of moisture in the atmosphere changes, the change being due to the cobalt salt, which, in dry air is lavender blue. As the moisture in the atmosphere increases, the color changes first to bluish red, then light red and finally pink, according to the amount of moisture. With a decrease in moisture, the colors change in the reverse order, and the blue color returns when the air becomes dry.

Sheet-Iron Foot Scraper

If one wishes to depart from the conventional style of foot scraper, here is an idea that may be of value. The scraper can be cut out of sheet iron with a cold chisel, the pattern resembling an animal or bird. In the drawing, one scraper is made in the shape of a dog, the other resembling an owl or parrot. In making them, be sure to use heavy sheet iron, especially if the pattern calls for some of the metal to be cut away at the base. The outline can be drawn on the metal with chalk and then cut out with the chisel. It does not matter if the outline is ragged or a bit irregular, as it can be filed smooth later. As the scrapers are set in concrete blocks, part of the sheet metal underneath the design is allowed to remain so that it can be anchored in the concrete.



Ornamental Foot Scrapers Resembling Animals and Birds Improve the Appearance of the Doorstep

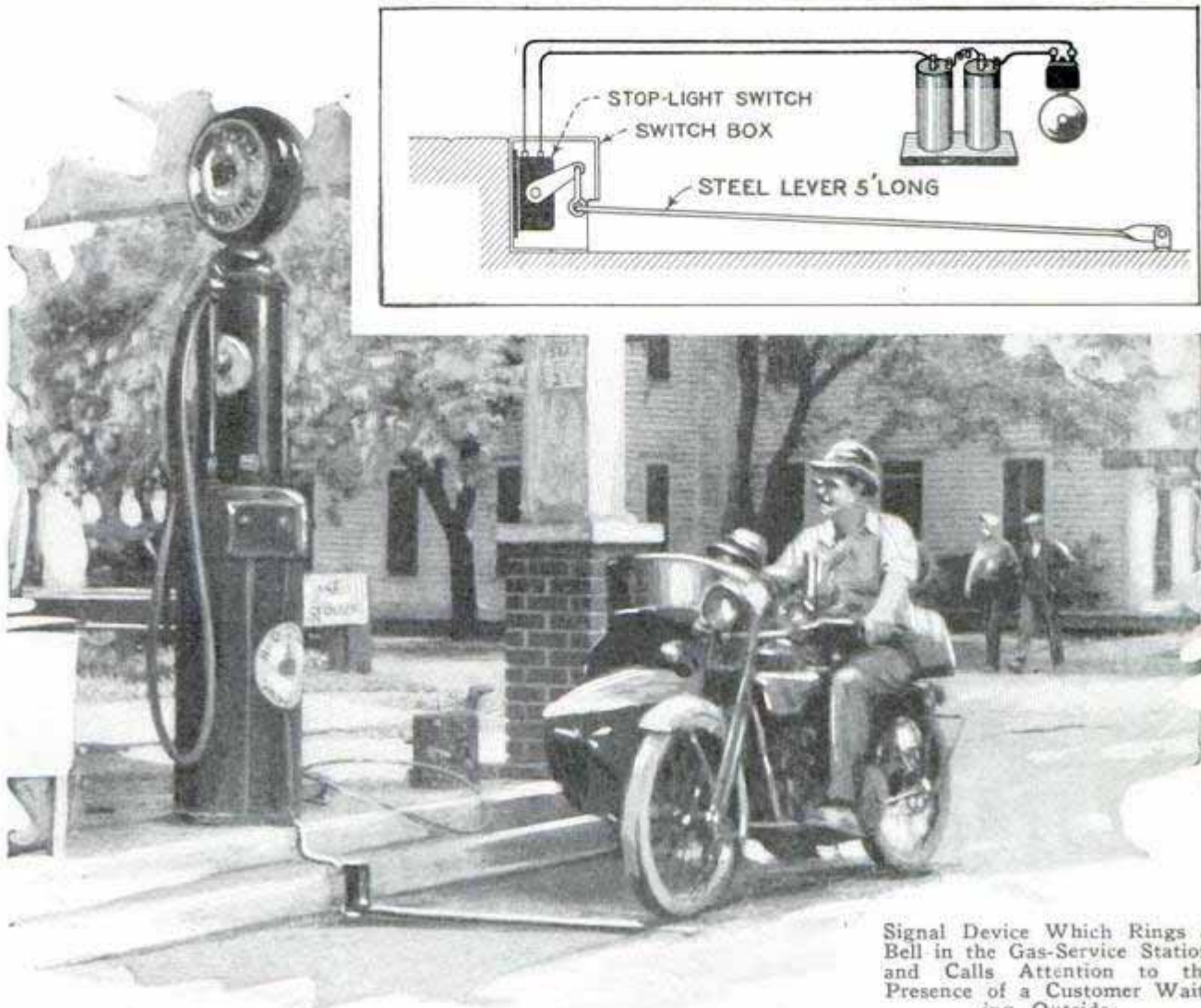

Signal Device Which Rings a Bell in the Gas-Service Station and Calls Attention to the Presence of a Customer Waiting Outside

Bell Signal for Service Station

As a signal to call his attention to the presence of a customer, the owner of a gas-service station installed the bell-ringing device shown in the photo. The insert shows the arrangement and wiring diagram. A steel lever about 5 ft. long is laid in the auto track so that the car must ride over it. When this takes place, a switch is closed for an instant and causes a bell to ring, which may be located at any convenient place in the station.—C. O. Cole, Wichita, Kans.

Treating New Paintbrushes

Failure of good paintbrushes to render service usually is due to improper treatment before dipping them into the paint. They should be thoroughly cleaned before they are used. Work them against the hand or a board until all dust and loose hairs are worked out. Then place the brush in clean water and let it remain there until the hairs are well saturated. Finally, shake out all the water and allow the brush to dry. When so treated,

new brushes will last longer and will work better.—L. H. Georger, Buffalo, N. Y.

Wash-Basin Base for Lamp Prevents Fire

Dangerous fires have been caused by ordinary lanterns accidentally knocked over.

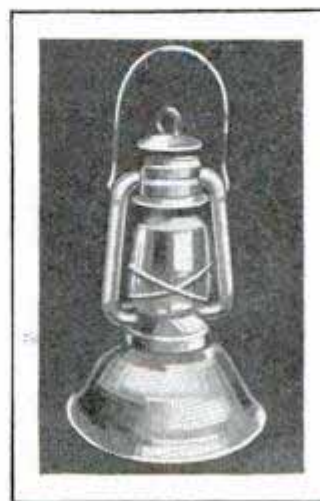

To eliminate this hazard, one farmer mounted his lanterns on ordinary tin wash pans. These provide such a wide base that there is practically no danger of the lantern upsetting. The edges of the lantern base are soldered to the bottom of the wash pan. When soldering, the oil should, of course, be removed.—L. M. Jordan, Vredenburgh, Ala.

Removing Ashes from Kitchen Stove

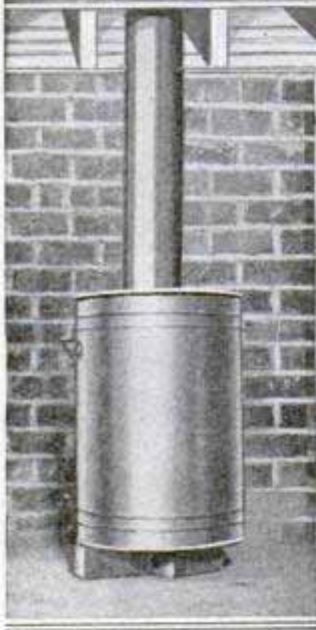
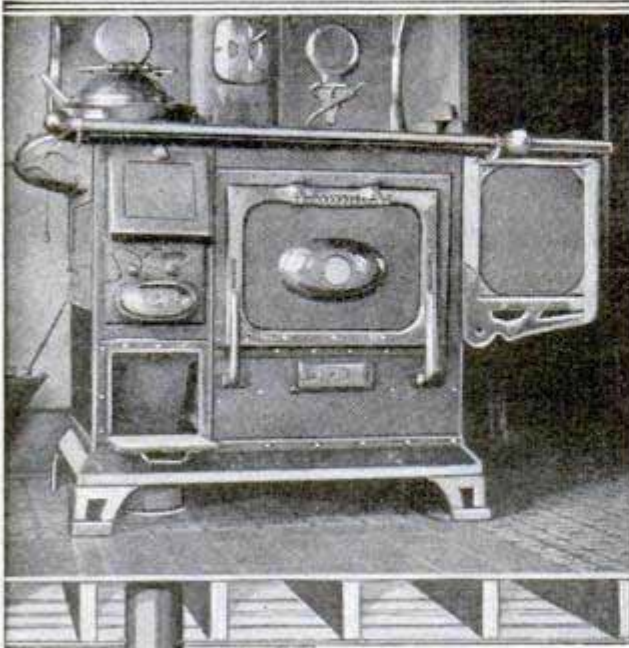

Ashes from Kitchen Range Fall Directly into a Large Ash Can Located in the Basement

Removing ashes from the kitchen stove is usually quite a bother, and the ash chute shown in the photo, therefore, will be found a great convenience, as the ashes fall into a can located in the basement under the stove.

The ordinary ash pan is removed, and a stovepipe brought up from the basement, as indicated. A galvanized-iron hopper with sloping sides and a short circular pipe at the bottom takes its place. The short pipe fits in the top of the stovepipe leading to the ash can.

Making Glass Transparencies

A great number of the amateur photographers have made glass transparencies by contact printing, using regular photo plates instead of paper. Few have gone farther than this, either framing or just binding the transparency so that it can be hung up in some location where the light shows through it. A better way is to make the transparency in the usual way and use a clear glass for a backing, placing a sheet of thin, colored tissue paper between the two glasses and then binding

the glasses with gummed tape. In this way different effects can be obtained by using the same view with colored tissue papers, or by placing bright-colored tin foil between the two glasses. When using the tinfoil plan, there will be no transparency from side to side of the photo but from the front only and the picture can be placed in any location where there is light on its surface. The bright foil underneath will bring out the picture clearly.

Saw Vise from Old Bed Rails

An old bed rail, picked up in the junk yard, can be made into a serviceable saw vise by the home mechanic. The horizontal bars, which form the jaws of the vise, are cut 14 in. long, and notched in the center to admit the vertical members. The two sets of bars are drilled and tapped, the holes being countersunk on the inside of the jaws. Draw up the screws tightly, saw off the parts projecting outside of the jaws, and rivet over to prevent loosening. The vertical bars should not exceed 16 in. in length. The fulcrum bar, bolted to both vertical bars, should keep them $\frac{1}{2}$ in. apart. Drill a $1\frac{1}{32}$ -in. hole in the lower end of the outer vertical bar and tap for a $\frac{1}{2}$ by 2-in. capscREW. This, when forced against the opposite bar, brings the jaws together firmly. The fulcrum bar should not be over 10 in. below the jaws. Attach the vise to the workbench with one or preferably two short pieces fixed to the inner vertical bar, as shown.

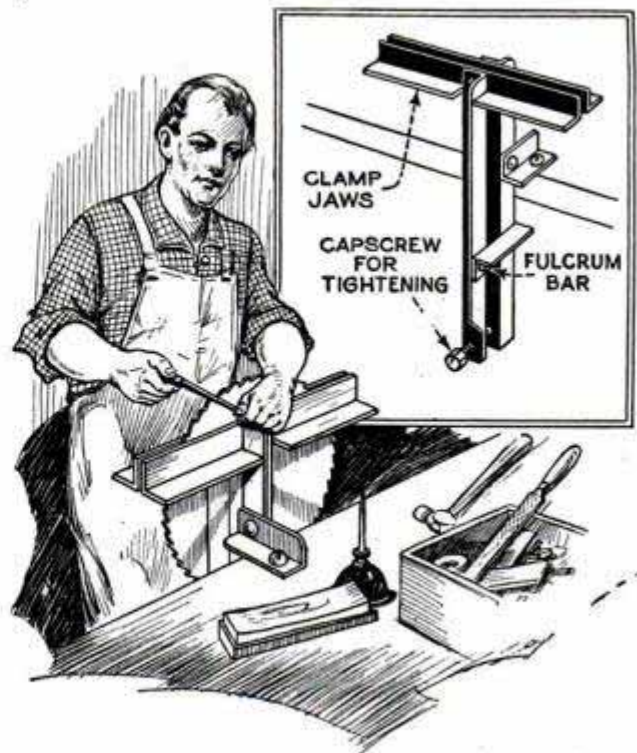

Useful Saw Vise for the Home Mechanic Made from Old Bed Rails

CONNECTING ELECTRIC ACCESSORIES on the AUTOMOBILE

"WHERE'S J. J.?" asked Bill Smith, alighting from his car at the door of John Jackson's garage. "In the shop," replied Hank, J. J.'s gas and oil attendant and general handy man, as he unlocked the gasoline pump. "Anything I can do for you? You must be in a hurry this morning, you're around so early." "No," replied Bill, "I just want J. J. to wire up my spotlight. You know I've got to go over to Centerville tonight, and J. J. didn't have a spotlight in the house last night, so I bought one over at the hardware store, and they didn't know how to wire it." "You've been driving a car for five years, Bill. Why didn't you wire it up yourself?" broke in a voice behind them, as J. J. strolled out of the garage. "it's an easy job." "Maybe it is, John, but I don't know how to do it," replied Bill. "Well, gimme the works, and I'll show you how it's done, and then when you buy a cigar lighter or some other gadget in another town, where they haven't a good-natured garageman to wire it for you, you can do the job yourself.

"Connecting a spotlight, hand warmer or any other kind of electrical device on the car is extremely simple," said J. J., as he started to work. "Most accessories of this kind have switches of their own, the spotlight usually having a switch in the handle, while a cigar lighter makes its circuit when it is pulled from the socket. Practically all cars nowadays have the single-wire or grounded wiring system, and this also makes the wiring of accessories a simple matter. The first thing to do, of course, is to decide on the position of the accessory, and mount it. Convenience is the thing to be consulted usually in this, and in the case of a cigar lighter, the best position is the one on the dash nearest the driver. It might seem a little discourteous not to mount the lighter nearest the position of the other fellow in the seat, but he has nothing else to do but reach over



Connecting Accessories to the Ford Manifold Terminal Block

and grab it, while the driver has to attend to business, and can't afford to let much else interfere with that.

"Some drivers prefer their spotlight on their own side, where they can adjust it while driving, and others mount it on the right side of the windshield, and adjust it to the side of the road, then let it alone. On the right side, it annoys approaching drivers somewhat less than when on the left, but, on the other hand, it cannot then be used to read signposts or house numbers. For my own part, I prefer it mounted down below the headlights, on the front of the car, and directed on the right-hand edge of the road. In this position it gives the maximum light where it is most wanted, and it cannot glare into an approaching driver's eyes. For reading signs, and that sort of thing, I have another spot mounted on the windshield frame. However, it's all a matter of choice.

"Having mounted the device, one of the wires is connected to the frame. The proper way to do this is to remove the nut and washer from a convenient bolt on the frame—and the bolt too, if possible—clean off the rust and paint from the frame member around the bolt and brighten it with a file or emery cloth, polish the un-

derside of the washer with the emery cloth also, skin the wire and brighten it, loop it around the bolt—so—then place the washer back with the bright side against the wire, replace the nut and tighten it. (See Fig. 2.) This makes a good clean connection, and one that won't give you any trouble for a long time. A light coat of shellac over the joint is an additional precaution against corrosion, but care should be taken not to put on such a coat that the shellac will creep between the wire and the frame or washer and ruin the connection. Now the other wire can be connected, and it will usually be found convenient to connect it to one side of the ammeter. There are two terminals on the ammeter, and if the wire is connected to one terminal, the current consumed by the accessory will register on the instrument; if connected to the other, it won't. Whether it registers or not is largely a matter of choice; I prefer it to register, in the case of a spotlight. If it is a heater that is being attached, like a hand warmer or a carburetor heater, it is better that the current doesn't pass through the ammeter, as it usually is somewhat heavy, and might injure it. Switch on your spotlight. Now we'll try the end of the wire on this terminal. Doesn't show any reading? All right, we'll try it on the other. It shows now, doesn't it? There, she's tight. That's

all there is to it. If it doesn't register when connected to one terminal, try the other. What if you don't know which is the 'on' position of the accessory switch? Oh, that's easy, just wire temporarily direct to the battery terminals and try the switch both ways; that'll soon show which is the right position.

"I remember that the first car I had to put a spotlight on had no ammeter. I was kind o' green at this electrical game at the time, and it stuck me. My boss showed me how to do it, though, and it's just as simple as this job. He first found the 'on' position of the switch, in the way I just mentioned, and turned it on. Then he turned the lighting and ignition switch on the instrument board off, and connected one wire from the spotlight to the frame, just like this. Then he started touching the bared end of the other wire to the terminals on the back of the lighting switch until he found one where the spot would light up, and that was the one he connected it to. If you ever run into a car like that, however, be sure that the accessory switch is turned on, or you'll be likely to hunt a long time for the right terminal.

"A stoplight or parking light may sometimes more conveniently be connected to one side of the starting switch (Fig. 1), but be sure to connect it on the battery side of the switch, where the battery wire is connected to the ammeter. In this case, of course, the current taken by the light is not registered on the ammeter.

"There is another way to connect a spotlight that has some advantages. The spot is usually trained on the right-hand side of the road, and in many cases is not used when the bright lights are on, the driver turn-

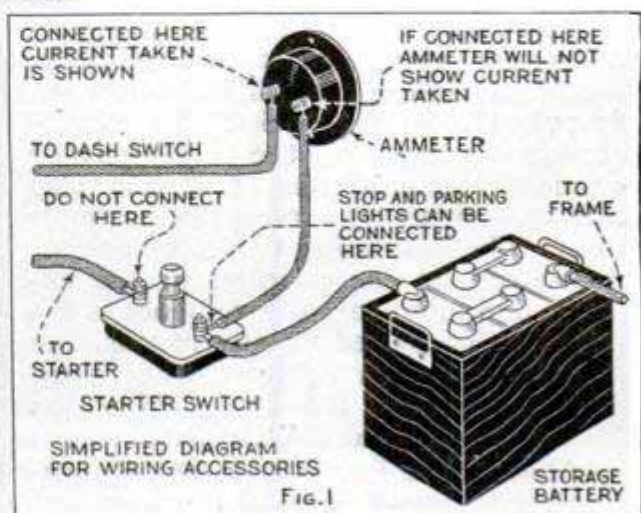

Here Is a Simplified Diagram of the Wiring Involved in Connecting Accessories on the Car

ing on the spotlight when he switches from bright to dim on meeting another car. This means two motions. If the spotlight wire is connected to the terminal on the back of the lighting switch that supplies current for the dim lights or for the small side lights, the act of switching from bright to dim will turn on the spot at the same time. On the Ford, this connection may be made at the connection block or manifold at the front of the dash. On the older type, the connection block has five terminals, and the spotlight is connected to the second one from the left—the one carrying the yellow wire—if the light is to be connected to the battery at all times. (See Fig. 3, A.) If you want it on with the dim lights only, connect it to the terminal on the extreme right (B, Fig. 3); this terminal carries a yellow wire—if you can make out the color. On the newer Fords the block has six terminals, and the third from the left, carrying the yellow wires, gives a direct battery connection. The one on the right as before, (but now carrying black wires) connects the light to the dim circuit.

"Suppose you forget which terminal is which? That's easy! In this case, the lighting switch is turned to the 'dim' position, and the end of the wire touched to the terminals on the block, in turn, until one is found that will light the spot. To make sure that it is the right one, switch to 'bright' and see if the spotlight goes out. If it does, it's OK; if not, you'll have to try again, as you may have hit the horn terminal, or some other one.

"Connecting stoplights? Well, there are a number of ways to do this job, but the simplest way for the average owner is to connect one wire, from the stoplight switch, to

one side of the starting switch and the other wire to one of the terminals on the stoplight socket. The other socket terminal is grounded to the frame. If you want to have an indicator that will show whether the stoplight is working or not, and I would advise having this, for a stoplight that isn't working is worse than none at all, then you can install another dash-light socket carrying a 2-cp. bulb, on the instrument board. Run one wire from the ammeter terminal to one on the dash socket, and another wire from the socket to the stoplight switch, then to the light, which is grounded to the frame as usual. This is the simplest way, although by no means the best. You can color the dash bulb red so that it will show up strongly whenever the light is operated.

"When you get a stoplight, examine the switch thoroughly and see that it is well made, for the switch is usually the weakest part of the installation, and most of the stoplights that are not working have inoperative switches. Look at the switch occasionally after it is installed and see that it stays in good condition—an ounce of prevention is worth a pound of cure, you know, and this applies to all the electrical accessories. I will tell you more some other time about the other ways to install stoplights.

"Most accessories are connected by

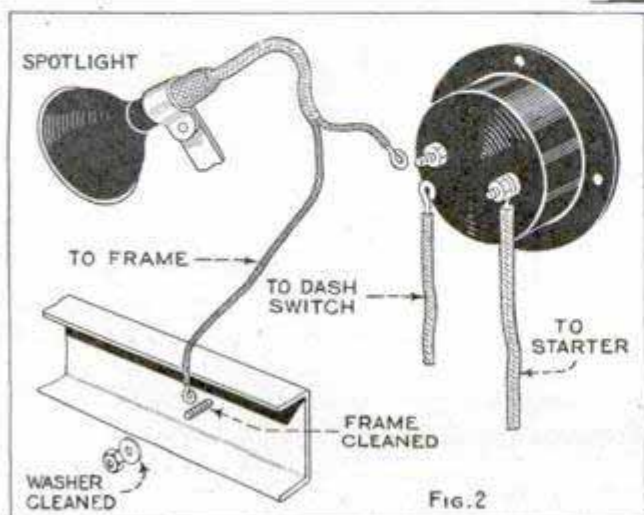

The Ends of All Wires Should Be Bared and Scraped Clean, and All Frame Contacts Polished

means of flexible cords, and these will kink and fray, leading eventually to breaks and short circuits. See that the wires are stapled to the body or fastened to the frame firmly. Wires leading inside the car can be sewed to the upholstery, and this is usually the neatest way to fasten them. Under the car, they can be

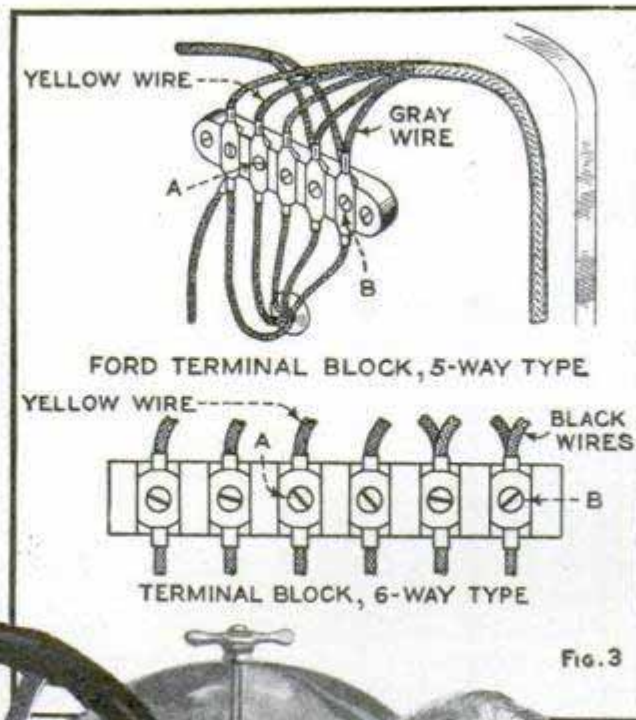

tubing over it wherever it touches the frame of the sheet-metal body, so as to prevent rattles that may prove difficult to find some time in the future.

"There you are, Bill, all set. No, no trouble at all, only next time let me sell you the accessory as well as install it for you. Sure! I hadn't any spotlight

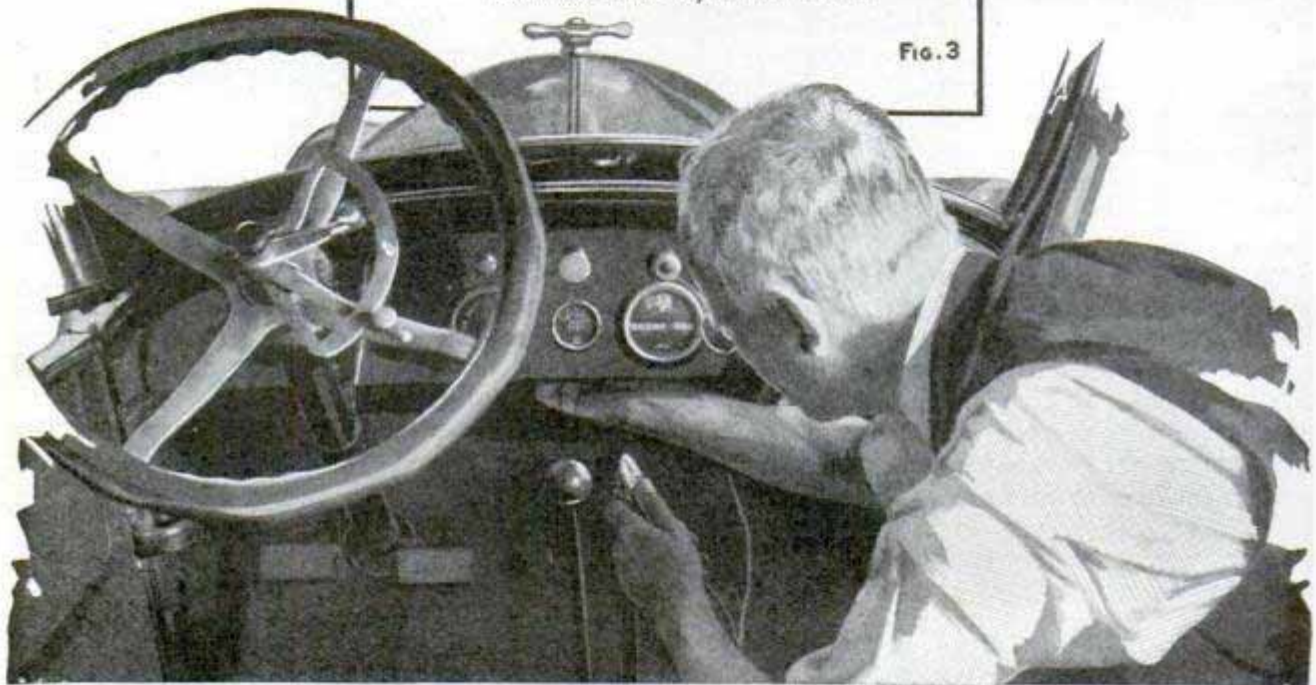

Testing on the Ammeter Terminals before Tightening; Above, Connections for the Ford System

stapled to the floorboards. If armored wire is used, slip a short length of rubber

yesterday but I'll have them in this afternoon. So long!"

How to Remedy a Common Clock Trouble

The minute hand of a clock sometimes catches against or under the hour hand, which gradually brings the clock to a standstill. If the hands are released, the clock will run till the hands catch again, but it will strike wrong because the minute hand has dragged the hour hand out of position. An hour hand has a round hole in it and fits on a round section of the spindle; it may be turned forward or backward without injury to the works. But a minute hand has a square hole in it and fits on a square section of the spindle; this hand, therefore, may be moved for-

ward harmlessly, but it is risky to try to force it backward. There is a simple way to remedy this trouble. First turn the minute hand straight up, pointing to twelve. Stop the clock. Pull out the pin that is in the spindle in front of the hands. Remove the minute hand. If it is crooked, bending toward the hour hand, it should be straightened, but before attempting to straighten or to bend a clock hand be sure to heat it. Some clock hands are hard and brittle and will break if one tries to change their shape when cold. It is seldom necessary to alter the hour hand, for hour hands are usually perfectly straight, but if bent, it is best to straighten this hand also, using the same precautions

against breakage. Push the butt of the hour hand in until it is flush with the shoulder on the spindle. Then replace the minute hand, point upward. Next, insert a pin in the hole in the spindle in front of the hands. Such a key should project at least $\frac{1}{8}$ in., at both ends, outside of the spindle. If the pin that has been in use is not long enough, whittle a new one out of a piece of hardwood. Lastly, pack the space between the pin and the minute hand by wrapping the spindle with a string. Continue wrapping until the roll of cord reaches nearly to the ends of the pin. Then tie a hard knot and clip off the ends of the string. Such packing, carefully done, holds the minute hand firmly against the shoulder of the spindle and tilts the point of it outward, away from the hour hand. The erratic striking must then be corrected. To do this, start the pendulum and wait till the clock strikes two or more. Count the strokes. While holding the minute hand at twelve, and stopping the clock, turn the hour hand to the hour that was struck. If the repaired clock is found to be behind correct time, move the minute hand forward slowly, always pausing for the clock to strike, till the hands point right. If the repaired clock is ahead of correct time, do not start it till the governing timepiece catches up. Then put the pendulum to swinging. If there's nothing wrong with the works, regular winding thereafter will keep the clock going and it will strike right.—Dr. H. D. Ribble, Blacksburg, Va.

Homemade Clothes-Line Reel

This clothes-line reel is attached to one corner of the house and is always ready for use. The sides are made of wood, cut to the shape shown in the photo; the top and bottom are pieces of sheet metal, and

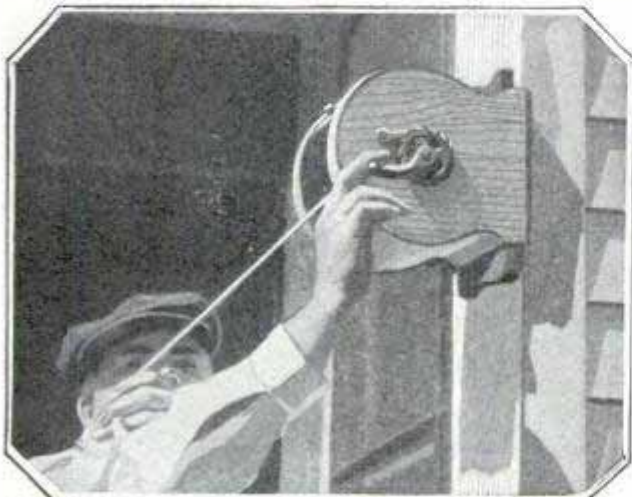

Novel Homemade Clothes-Line Reel Is Attached to Corner of the House

a sliding sheet-metal door is provided in front to protect the line against the elements when not in use. The reel is operated by a crank in connection with a pawl and ratchet to keep the line taut.

Binding Pamphlets

Having some pamphlets which I wanted to keep for reference and therefore desired to bind in some inexpensive way, I

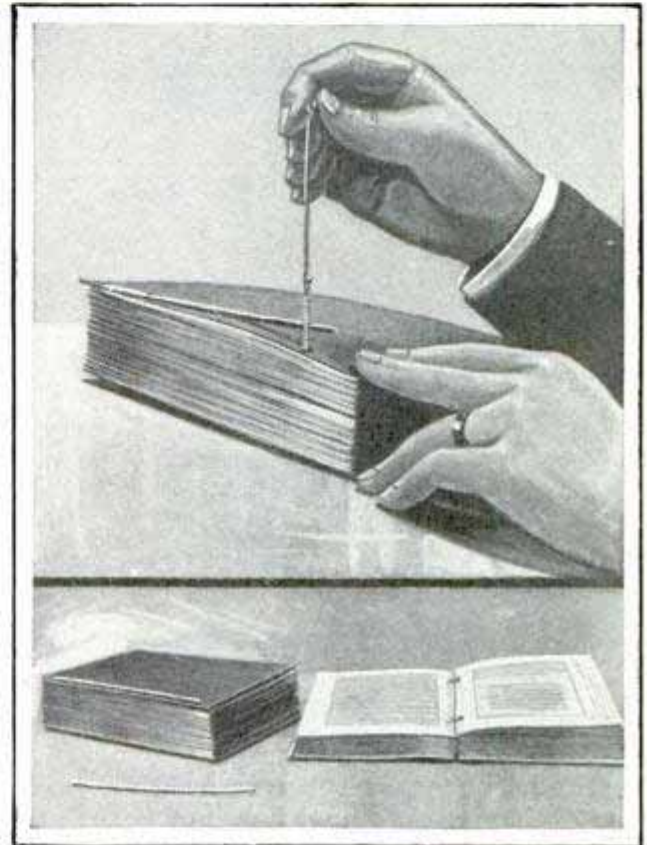

Cheap and Satisfactory Method of Binding Pamphlets and Magazines

devised the method shown in the photo, and found it entirely satisfactory.

Two holes were punched through the pamphlets and through two pieces of red "leatherboard," which were used as covers, so that all of the holes registered. For each binder two pieces of $\frac{1}{16}$ -in. piano wire, 1 in. shorter than the pamphlets, and two steel coil springs of $\frac{1}{8}$ -in. diameter, about 1 in. long and looped at both ends, were obtained. The springs were slipped through the holes in the assembled covers and pamphlets and the wire rods threaded through the spring loops at top and bottom. When the thickness of the pile exceeded the length of the springs, a hook was used to pull them up, after which the rod was again slipped through the top loop. In this way the pamphlets were held together tightly and could be handled like a book.—Leslie H. Phinney, Springfield, Mass.

Opening Tin Cans

If the point of the opener is inserted just below the beading of the can top, with its heel at the left of the vertical seam,



Cutting Tin Cans through the Side Is Easy and Permits All the Food to Be Removed

it can be run around the can with much less effort than is required in cutting through the top. Besides, by using this method, the extra force needed to make the flat blade follow a curved path is eliminated. Opened in this way, the can is emptied readily and completely, while a top-opened can usually leaves a jagged edge that retains some of the food and is much more likely to cause injuries than the comparatively clean edge produced by side cutting.—Chester Lynndelle, Trenton, N. J.

Removing Play in Ford Fan

The new style Ford fans often develop end play due to excessive wear. As the front end of such fans is closed, the fan would have to be taken off and the blades removed from the pulley before the shaft could be turned in to remedy the play in the usual way. A better method of taking up this play is to remove the cotter pin from the locknut at the rear end of the fan shaft and loosen the lock about one full turn. Then place a cotter pin through the nut and the fan shaft, but do not spread the ends. Next, turn the locknut with a wrench and the fan shaft will turn with

it. Turn the shaft in until only a very slight end play can be felt. Then remove the cotter pin through the locknut and tighten it. Replace the cotter pin through the locknut and spread the ends. The locknut on such fans must be kept tight and the cotter pin in place, or the fan will eventually turn the shaft in so tightly that the fan will stop.—E. T. Gunderson, Humboldt, Iowa.

Nickelplating Brass

Some time ago I had some brass boat parts which I desired to nickelplate. A friend of mine told me how it could be done without using an electric current. The following is his method: Dissolve 8 oz. of sal ammoniac and 8 oz. of double nickel salts in 1 gal. of water, then heat the solution nearly to the boiling point. Now put in your brass or copper articles together with some scrap aluminum, taking care that the aluminum touches the articles to be nickeled. In a short time a nickel deposit will be found on the brass. Although this deposit is not as heavy as that obtained by electroplating, it may be lightly buffed and will be satisfactory in many cases.—Ralph Hanenkratt, Albany, N. Y.

Counterweight on Cellar Door Aids in Operating

Cellar doors of the type shown in the photo are more or less difficult to handle

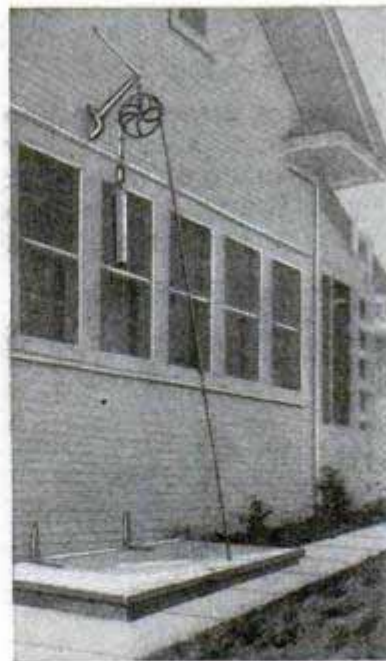

and there is always danger of their falling down, which may cause a serious accident when one is ascending or descending the steps. A counterweight eliminates this risk entirely. Simply attach a pulley to the side of the house and run a length of sash cord over it, fastening one end

of the cord to the cellar door and the other to a suitable counterweight. A 2-in. pipe filled with concrete will serve nicely for this purpose.

Ammonium chloride
nickel ammonium sulfate

Writing Cabinet for the Library Table

By GEO. H. CAPPEL

AN attractive and roomy writing cabinet, which is set on the library table and will easily hold all writing materials, paste, etc., can be made by anyone handy with tools and careful to follow instructions. Ordinary wallboard may be used for the back, front or writing door, and for the end panels, while cypress is used for the top, base and edges.

The cabinet is $19\frac{1}{2}$ in. long, $12\frac{1}{2}$ in. wide at the base and 9 in. at the top, and is $10\frac{3}{4}$ in. high. This is about the most convenient size for the ordinary library table. The sides, back and front are made first. The wood is glued to the wallboard and then tacked on the inside so that no nails will be exposed. The base is then put on. The curved lines are first penciled off carefully and then cut out with a scrollsaw. The bottom, which also may be of wallboard, is next put in place; it is held by wooden cleats,

can be obtained at any hardware store. If desired, a lock may be used. The inside is partitioned off to suit the user. Thin stock is used for this purpose. Pieces of felt or rubber-head tacks are used on the bottom of the cabinet and on the door, where it rests on the table when open.

All the woodwork is stained with asphalt thinned with gasoline, rubbed off with a cloth, followed up with two applications of shellac, applying the second coat after the first has dried thoroughly. It is finished with wax, which will give a neat appearance. The panels or exposed parts of the wallboard are papered with wall paper, to match that of the

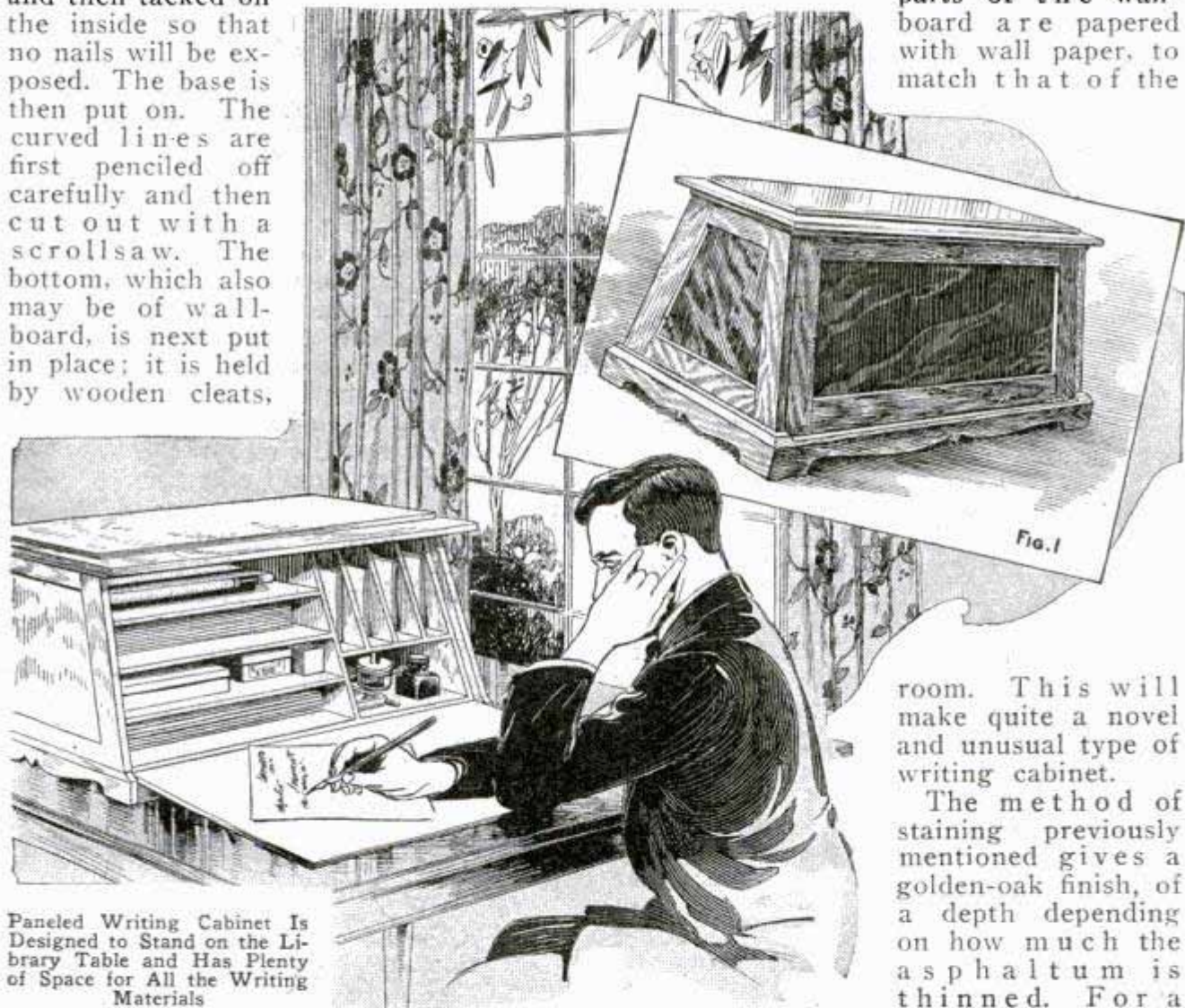

Paneled Writing Cabinet Is Designed to Stand on the Library Table and Has Plenty of Space for All the Writing Materials

nailed inside of the sides, back and front. The top is a nicely grained piece of cypress, nailed to the back and end with headless nails, which are sunk with a nail set and the holes filled with putty or wood filler. The door is then fitted in place; it is hinged to the base with two or three small nickel hinges and a catch, which

room. This will make quite a novel and unusual type of writing cabinet. The method of staining previously mentioned gives a golden-oak finish, of a depth depending on how much the asphaltum is thinned. For a fumed or mission-oak finish, use wood dye or a similar penetrating stain, smoothing the rough surface, after staining, with fine sandpaper and finishing with wax as before. Varying shades of oak, walnut and mahogany can be obtained in the wood dyes, so that the cabinet can be finished to suit the furniture in the room.

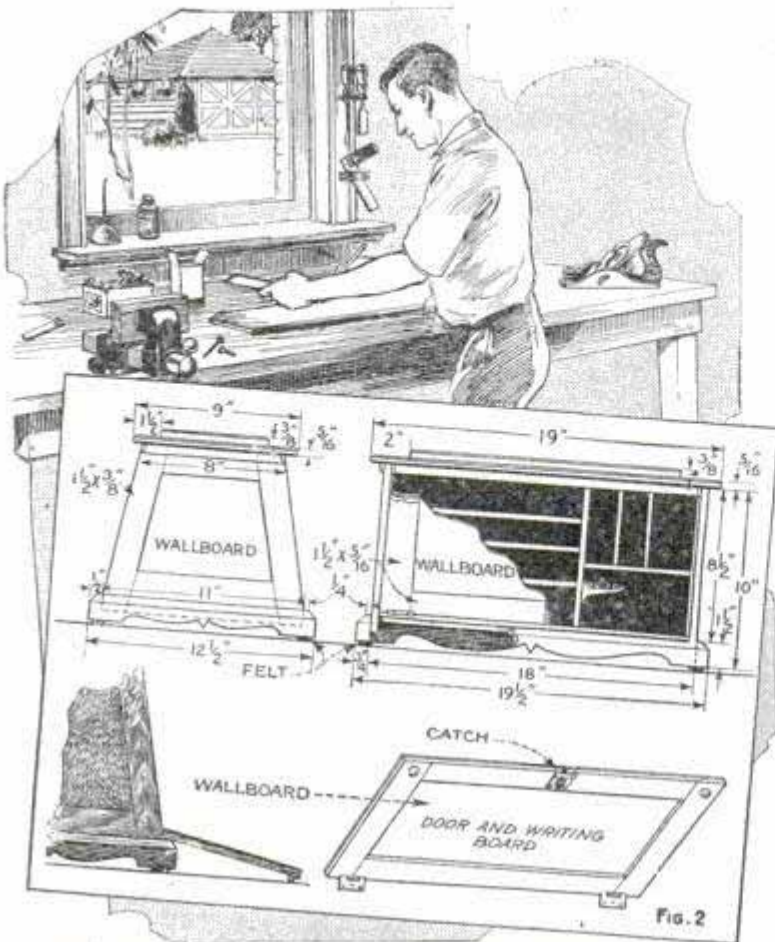

Anyone Handy with Tools Can Build This Writing Cabinet. It Is Made of Cypress and Wallboard

Where prepared dyes and stains cannot easily be obtained, the amateur can make his own. Mahogany stain may be made by dissolving Bismarck brown in alcohol. Mission-oak finish may be obtained by exposing the wood for a day or two to the fumes of strong ammonia (28 per cent) in a tightly closed box. If the wood is moistened with water just before exposure, the resulting stain will be darker than if fumed dry. The surface must be sandpapered after fuming and before waxing or oiling.

If a varnished finish is desired, the surface should be filled, using a good paste filler, applied, after staining, in the manner specified by the maker. The filler must be well rubbed off, when dry, with fine shavings or cotton waste, rubbing across the grain. After sandpapering, the wood is ready for the varnish.

Improving Roofing Paint

Tar or asphalt roofing paint makes a lasting and very cheap covering for a tin roof even though it is badly pitted with rust. A great objection to many of these preparations, however, is the fact that they are black and absorb so much heat as to make the house perceptibly warmer.

In recent tests of black and white paints as applied to oil tanks, it was found that the latter rose in temperature only 19 to 22° and lost only 9 per cent of their naphtha content as compared to a temperature increase of 54° in tanks covered with black paint. Obviously similar conditions hold true where the roof of a house is coated white or black. A cheap and effective method of overcoming the objection to the use of asphalt paint is to dust its surface with beach sand or finely powdered stone of some light color. The paint will soften when the sun shines on it so that the stone or sand will stick.

Rebuilding Washing-Machine Cylinder

The revolving cylinder in our electric washing machine began to wear out. The perforated metal covering around the cylinder was breaking from hole to hole, which let the clothes work through and tear. However, the two ends, the wooden crosspieces and the lid were still in good condition, as was the rest of the machine. A new cylinder would cost \$28, so I decided to rebuild the old one myself. After carefully removing the worn-out coverings from the ends where they were rimmed together, I sawed ten pieces of 1 by 3-in. cypress to the shape shown in the detail. These pieces were placed from one crosspiece to another entirely around the ends as shown by the dotted lines, and were fastened to the metal ends with cop-

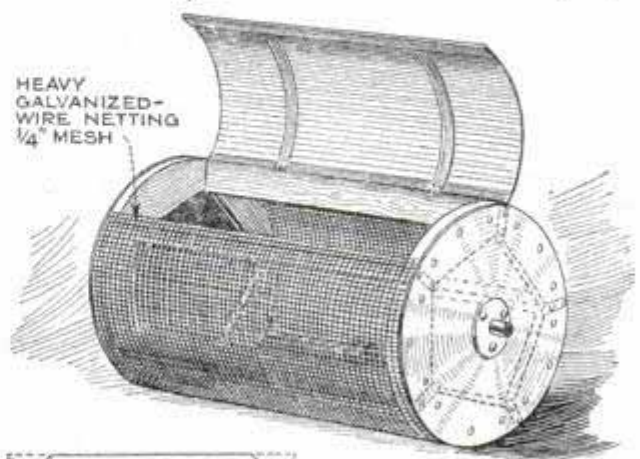

CUT FROM 1"X3" CYPRESS
Galvanized Wire Mesh Used to Repair a Washing-Machine Cylinder

per screws. This braced the crosspieces and also served as a base to fasten the edges of $\frac{1}{4}$ -in. galvanized-iron mesh. I used the 24-in. width and as the cylinder was 22 in. long, this permitted overlapping the mesh about an inch to fit inside of the edge of the cylinder. Starting at the crosspieces where the lid is hinged, I fastened the mesh by using $\frac{3}{16}$ -in. round-head bolts, $3\frac{3}{4}$ in. long, placing the heads inside of the cylinder so that they would be drawn slightly into the wood when tightened up and would leave no sharp edges to tear the clothes. I lapped the ends of the mesh about an inch to get a better hold. A strip of sheet brass was placed between the wood and the mesh. The bolts were then tightened after placing a washer under the nut. The sheet brass was turned over the nuts, after cutting off the ends of the bolts, and screwed down to cover the rough edge of the mesh. The mesh was then drawn around the cylinder, putting in a few temporary screws to hold it in place. It was fastened to the other side of the lid opening on the crosspiece in the same way as before. Putting this netting on was a rather tedious task but it has proved entirely satisfactory.—S. E. Schofield, Indianapolis, Ind.

Burnt Match Receiver

During fire-prevention week, the children in our schools were required to contrive some novelty that would aid the purpose. Our eight-year-old lad noticed how a dangerous fire had once started in our kitchen by dropping a still blazing match into a receptacle near the stove. So he decided to prevent a recurrence. Taking an empty tin can, he pierced the bottom with a large nail, pressed the oval lid in place at the top and then placed the can in an inverted position near the stove. The burnt matches are dropped into the container through the holes, and when full, the can is emptied. The matches seldom continue to burn after they are dropped into the can and if they do, the flame soon goes out.—Rev. Lewis F. Freyberg, Zanesville, Ohio.



Driving Small Wood Lathe by Foot

The treadle attachment on a wood lathe shown in the illustration has been used successfully for two years. The attachment consists of

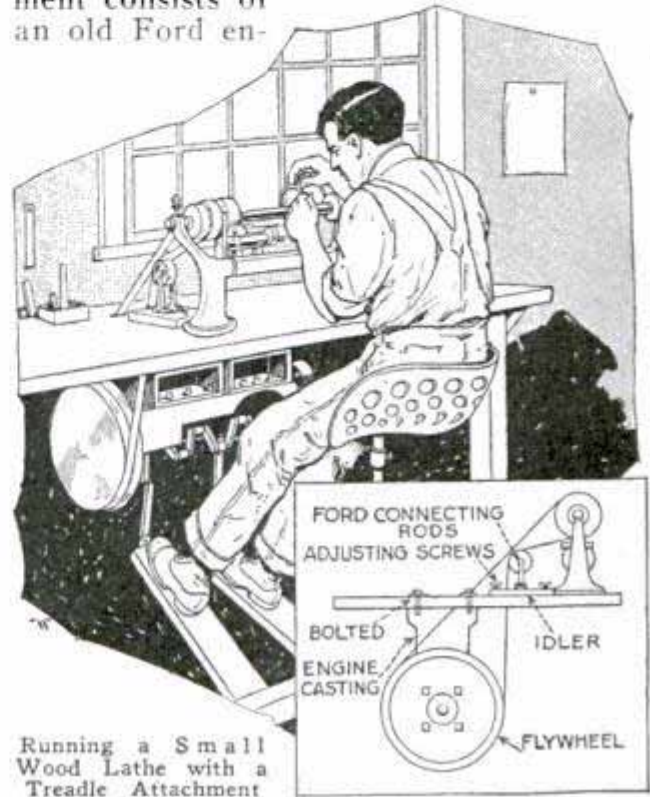

Running a Small Wood Lathe with a Treadle Attachment

gine block with the crankshaft, two connecting rods and a Chevrolet flywheel. The flywheel was turned down and holes drilled in it so that it would fit on the end of the crankshaft, and the face crowned to keep the belt on. An idler pulley is fastened to the bench top to permit adjustment of the belt. Two connecting rods are used to support the idler pulley and these are fastened to a block of 1-in. wood, which has slots cut in it and is held to the bench top with screws and wingnuts. The pedals are hinged to a crosspiece under the bench and are connected to the crankshaft.—J. P. Kincaid, Durant, Okla.

Starting Furnace Fire with Gas

For starting a furnace fire quickly, one man bent a 2-ft. length of $\frac{1}{4}$ -in. gas pipe to a 45° angle and attached to it a length of rubber hose, which he connected to the nearest gas fixture. When the furnace fire is desired no kindling is used, but this improvised gas burner is held under the grate and in a few minutes the coals will glow. This method is perfectly safe and eliminates chopping of kindling, which is more or less difficult to get in large cities.—Mrs. V. S. Martin, Detroit, Michigan.

Lighting the Fish Bowl

An illuminated fish bowl, which is attractive in the den or parlor, can easily be constructed in the home workshop. The

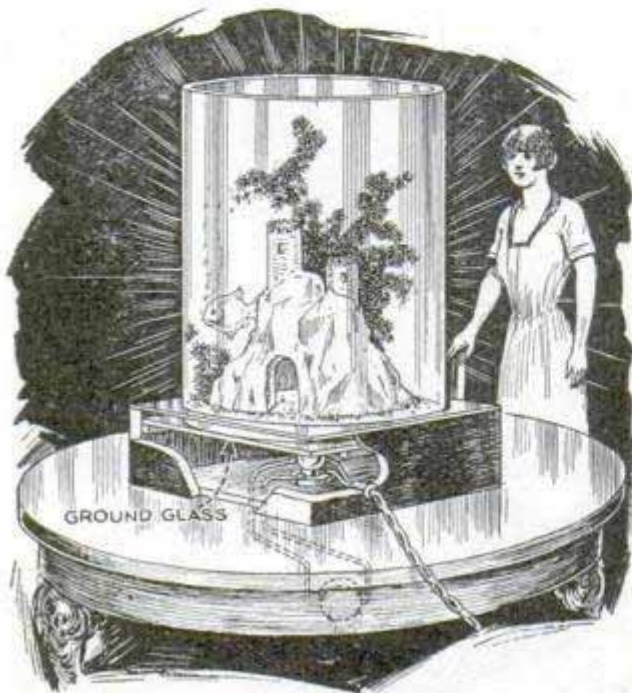

Electrically Illuminated Fish Bowl Adds to the Appearance of the Parlor

stand shown is 12 in. square by 4 in. high, but the size will, of course, have to be varied according to the size of the bowl, which in this case is a cylindrical jar. If a wood-turning lathe is available, the stand may be turned round, although a square stand is the easiest to make. A square of cardboard with a circle cut out equal to the diameter of the bottom of the bowl is inserted under the ground glass, to prevent the light from escaping around the sides of the bowl. Illumination is provided by a 6-volt lamp which can be run on a bell circuit obtained by the use of a bell-ringing transformer.

The stand may be stained or varnished to harmonize with the furniture, and be made as elaborate as desired. Two small holes should be drilled in the rear to permit heated air to escape.—R. B. Clifton, Denver, Colo.

Avoiding Battery Trouble

Regular use of a good hydrometer is the only way to know whether or not a storage battery is getting a proper charge. The heaviness of the acid is the only true indicator of the condition of the battery and the hydrometer measures this. Never leave a battery in a discharged condition and, whether in use or not, don't leave it without attention for a long period of time. When not in use, a fully charged battery will become one-third discharged in a month or so. Neither should a battery be overcharged. The gassing produced if this is done disintegrates the active material in the plates. Keep the battery well charged in winter. This may necessitate increasing the charging rate over the summer normal. A fully charged battery cannot freeze. Keep the hold-down bolts tight, or the box will be damaged and the terminals are likely to be loosened, due to shaking of the battery which allows acid to creep up around them. Also, sediment will settle between the plates and cause an internal short circuit. Never add anything but distilled water to the electrolyte; boiled water won't do. And never fill the battery with "trick" solutions.—A. C. Cole, Chicago, Ill.

Sidewalks of Colored Squares

Quite a novel departure in the construction of cement sidewalks is shown in the photo. The pavement is made up of large colored squares. The colors are mixed in the cement in separate batches, which should be worked up carefully. Wooden frames of 2 by 4-in. lumber are used as forms, and tar paper is placed between adjacent squares to keep the colors from running together. It is not necessary to use colored cement for the entire thick-



Large Squares of Different-Colored Cement Make an Unusually Attractive Sidewalk

ness of each block; the base can be made of ordinary concrete and a $\frac{3}{4}$ -in. thickness of cement applied on top. Ground colors for cement work can be purchased at any paint store.—M. A. Ayers, San Francisco, Calif.

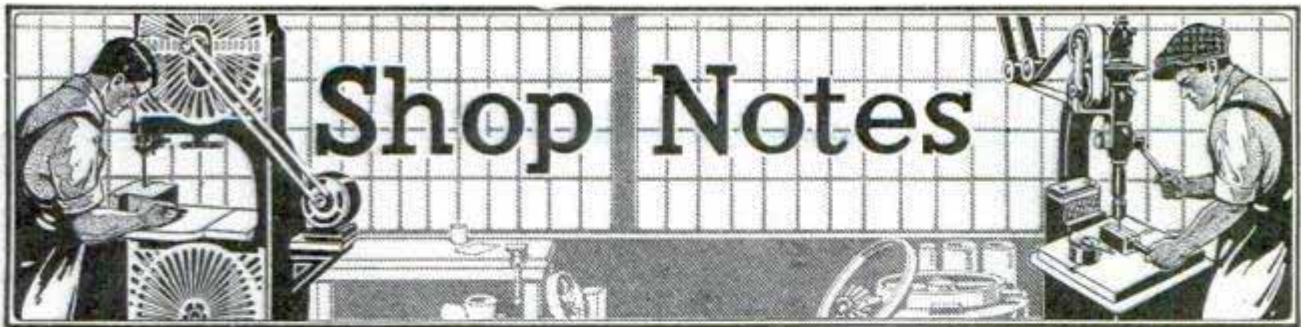

All Shop Notes published in 1925, in book form—Fifty Cents—from our Book Department

A Jigsaw for a Dollar

By M. ORDAHL

WANTING a jigsaw for his shop, but not having the wherewithal at the moment to buy one, a mechanic set out to improvise one. After thinking the matter of a suitable mechanism over for some time, he decided that the easiest

thing from which to make it was an old sewing machine. Half an hour's search of the secondhand stores in the neighborhood resulted in his parting with a dollar and acquiring an old head, the insides of which were all present and in good order.

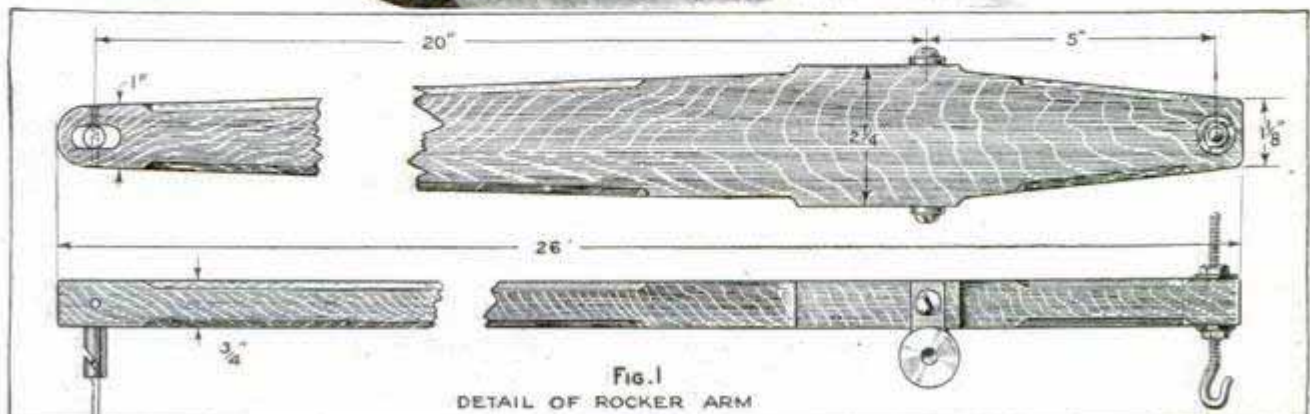
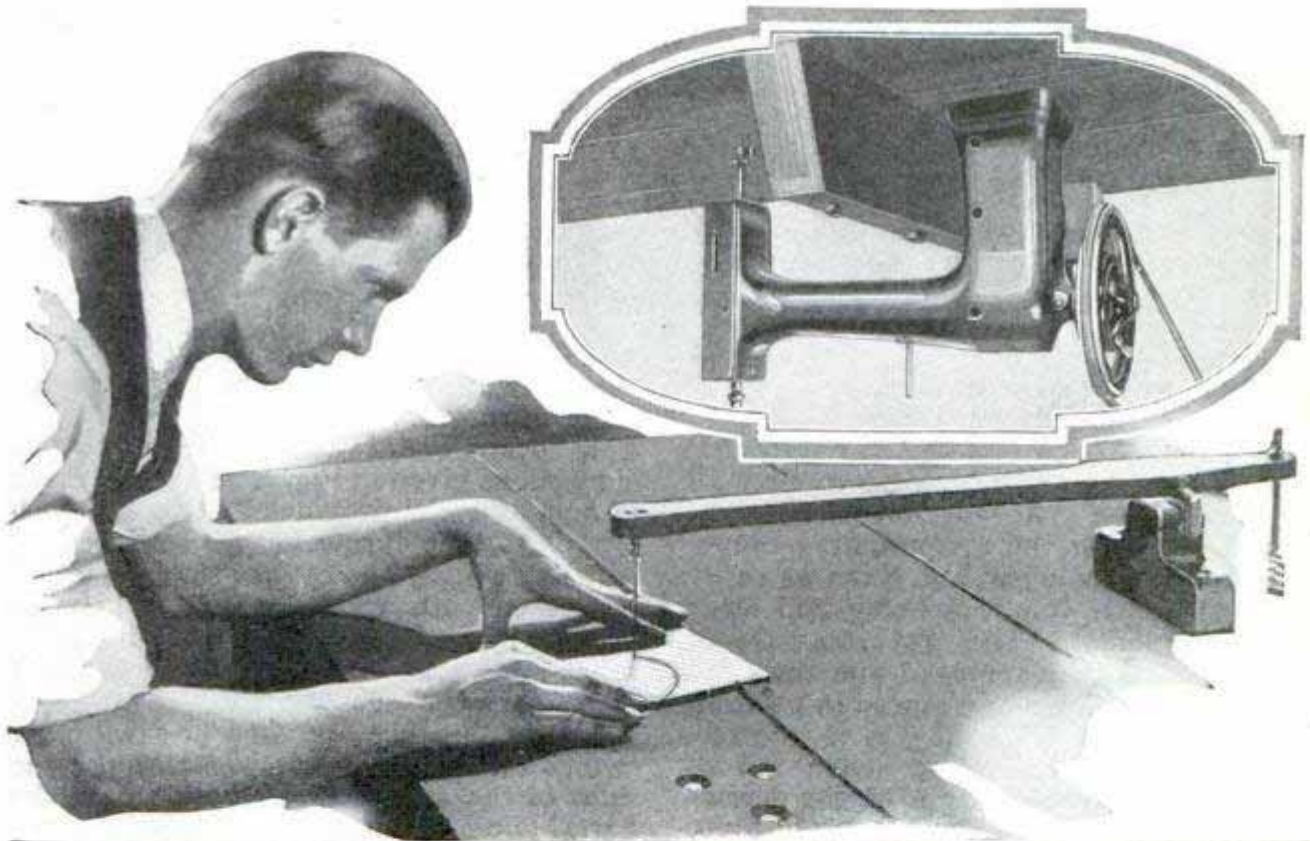

A Jigsaw Made from an Old Sewing-Machine Head; Insert, the Head in Position under the Bench; Below, the Rocker Arm

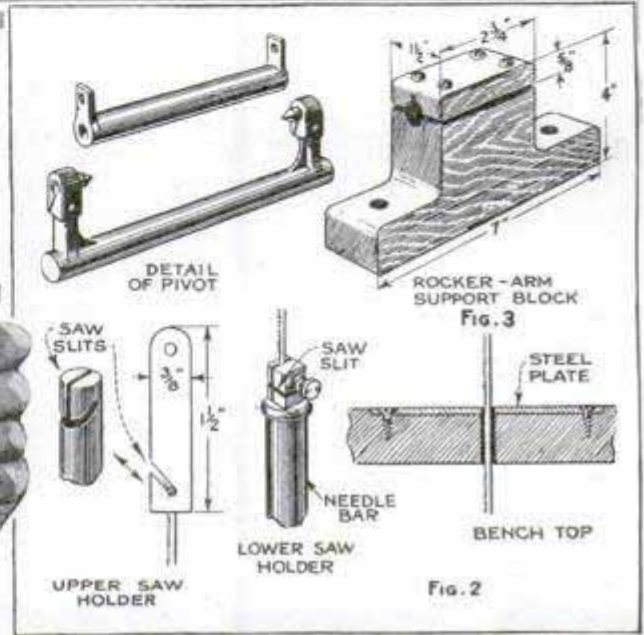
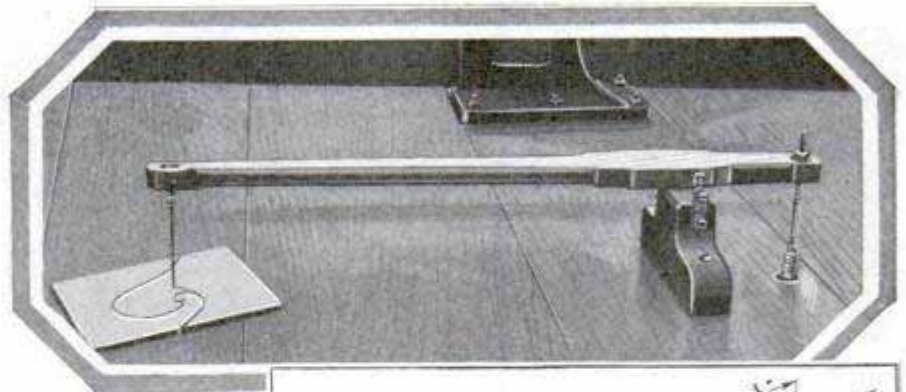
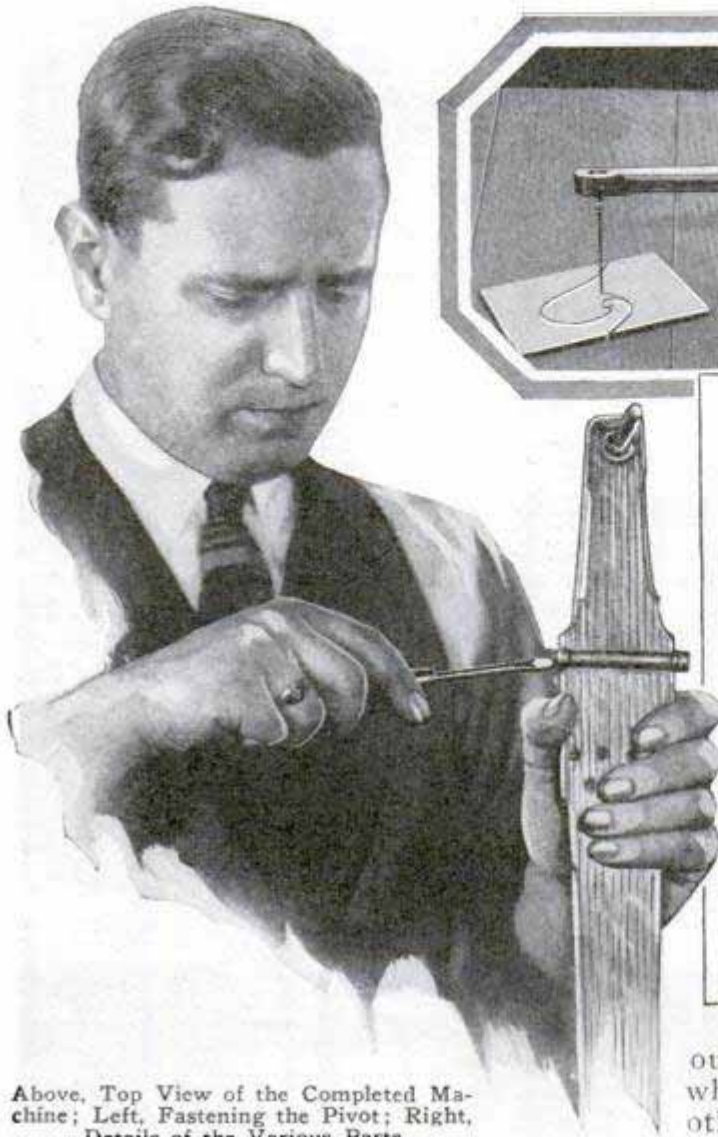

Above, Top View of the Completed Machine; Left, Fastening the Pivot; Right, Details of the Various Parts

The first thing done was to remove all the mechanism that was not directly involved in giving the reciprocating movement to the needle bar, and this was easily done, the parts removed being laid aside for the moment. The cast-iron base of the head was then removed and the head turned upside down and placed in position under the bench where it was to be used. Holes were drilled in the bench top to correspond to the position of the screws that formerly held the base, the old holes in the head tapped out to fit $\frac{1}{4}$ -in. capscrews, and the head fastened in place. The heads of the capscrews were counterbored into the bench top so as not to interfere with the work, and a small hole was drilled in the top of the bench in line with the end of the needle bar.

As the saw was to be driven from a small motor mounted on the base of the bench, the flywheel was removed from the sewing machine and grooved for a $\frac{1}{4}$ -in. round belt. There was plenty of stock for this. Incidentally, the wheel had a small clutch that was used when winding bobbins, and this worked in very nicely, as, by throwing

out the clutch, the jigsaw would "free-wheel" while the motor was in use for other purposes.

A rocker arm was next made to the dimensions given in Fig. 1. This was made of oak, and was provided at one end with a hook for the spring, made from a $\frac{1}{4}$ -in. bolt. The other end of the arm was slotted and fitted with a saw holder. This was made from a short piece of $\frac{3}{8}$ -in. cold-rolled steel, slit with the hacksaw to admit the end of the jigsaw blade and to catch the blade pins (see Fig. 2). The saw holder swings on a brass pin, driven through the sides of the arm. Upon looking over the parts taken from the underside of the sewing-machine head, a pivot and pivoted shaft were found, which, with a few minutes' work, were adapted to form a pivot for the rocker arm. One of the parts had two lugs that were cut off to length, drilled for small wood screws and fastened to the rocker arm. The other part had two adjusting-screw centers and was fitted into a support block, made as shown in Fig. 3. This, in turn, was bolted to the top of the bench and the arm slipped into place and adjusted by means of the pivot screws. Directly below the hook on the rear end of the arm, a hole was bored in the bench, and a spring (taken from an old bed

spring) hooked on, passed through the hole and held in place by means of a short piece of $\frac{1}{4}$ -in. rod through the end.

It was only found necessary to cut a cross slit in the end of the needle bar in the head to adapt it to holding the saws. The top of the bench was recessed to take a sheet-steel plate, through which the saw passed, and the saw was complete.

The motor driving the saw has a speed of 1,750 r. p. m. The grooved wheel on the saw is approximately $5\frac{1}{2}$ in. in diameter, and a 3-in. pulley on the motor will run the saw at a satisfactory speed.

Washing Auto Windows

For washing automobile windows that have become covered with oil, dirt or dust, the following formula will be found excellent: 1 gal. water, $\frac{1}{2}$ cup alcohol, $\frac{1}{2}$ cup ammonia, and 1 tablespoon salt. The water, of course, serves its usual function as a cleanser, the alcohol aids in drying and saves a lot of rubbing, and the ammonia and salt cut the grease and fix the luster on the glass. This is splendid for general window washing also, and to give a high luster to fine cut glass.

Improving the Crowbar

Crowbars of the usual type can be greatly improved by providing a handle at one end, as shown in the photo. This prevents blistering of the hands and the bar can be manipulated more conveniently. To make this handle, one end of the bar is split with a hacksaw and the halves rounded to form the sides and handle. A short piece of pipe is slipped over the ends just before they are bent together.



Non-Blistering Handle on Crowbar Increases Ease of Manipulation

A $5\frac{1}{2}$ -ft. bar has been found most convenient for farm work, and for chopping through ice, frozen ground, etc.

Building Tapering Brick Pilasters

Building tapering brick pilasters seemed a difficult job, but proved quite easy with the aid of the guides shown in the photo. Two lengths of 1 by 3-in. stock were



cut to the required height. These were braced by smaller crosspieces, and wires were used to hold the sides together. The pilasters were then built up inside. This method proved timesaving and enabled the builder to make all the pilasters alike. —E. J. Veronda, South Pasadena, Calif.

Relief for "Burning" Feet

Workmen in machine shops and garages will find relief from "burning" or "scalding" feet, if they cut an inner sole for their shoes from ordinary cork gasket or packing material. After cutting the cork to fit, it is securely fastened in the shoes by shellacking the bottom side of the cork and applying a light coat along the middle of the sole. If the size of the shoe permits, make these inner soles of two thicknesses of cork.

When making ring gauges, always leave a thin collar on each end of the hole, so that any bell-mouthing in lapping can be ground off.

Paint-Pot Hanger

Nearly all paint-pot hangers are arranged for use on a ladder, or to attach to some place on the wall which is suited

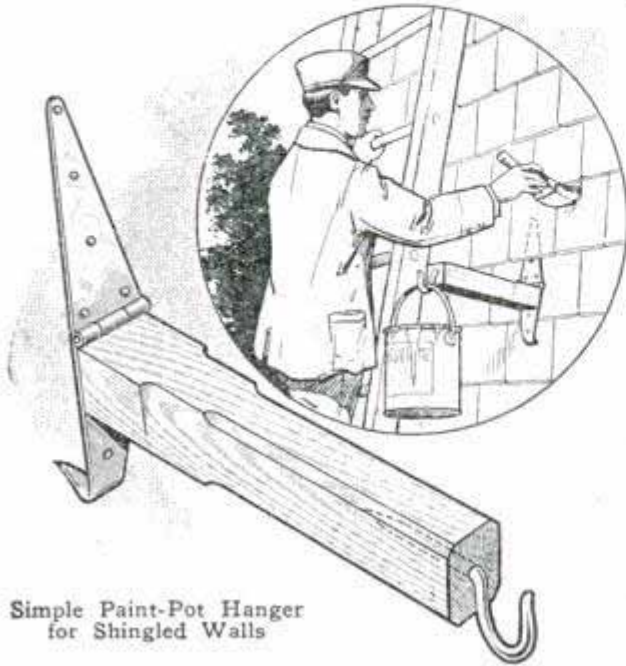

Simple Paint-Pot Hanger
for Shingled Walls

for the purpose. The one shown in the illustration is designed for use when painting a shingled house. It consists of a piece of hardwood, 6 or 8 in. long, with a hook in one end, from which the pot is suspended, and a long strap hinge screwed to the other, as shown. The upper end of the hinge is left in normal condition, but the lower end should be filed down to a sharp point and bent away from the stick at right angles. The method of using this hanger is evident from the illustration. The weight of the paint pot will force the pointed end of the hinge into the wood.—L. B. Robbins, Harwich, Massachusetts.

Emergency Water Supply for Washroom

A break in the water pipe supplying the men's washroom made some repair necessary as it was near quitting time and scores of men would demand water for cleaning up. As the break could not be fixed at once, the pipe was uncoupled and plugged on the washroom side of the break with a hardwood plug and a garden hose attached to one of the faucets in the washroom and run to a sprinkling hydrant outside. Then, by opening this particular faucet and turning on the hydrant, water was forced backward into the faucet under high pressure and a fair pressure was obtained at each faucet in the washroom.—Harold E. Benson, Boulder, Colorado.

Removing Rust from Tools

Many of the so-called rust removers actually remove the rust from objects but also the finished surface of the metal itself. A derusting process has just been evolved in which acids and alkalis are eliminated, a simple chemical substance being used in a water solution. The substance is ammonium citrate. A tablespoonful of this to $\frac{1}{2}$ pt. of water works very well. The chemical is inexpensive, non-corrosive and gives off no fumes; in fact, it is a very agreeable substance to work with. The tools, instruments, etc., are immersed in the solution overnight. In the morning, the rust will be found to have disappeared, the solution being brown, due to the formation of ferric citrate. But the solution can be used until depleted. The articles are then rinsed in water and oiled. If desired, they can be left overnight in a solution of potassium chromate, then rinsed and dried.

Locking Cabinet Drawers

Cabinet drawers without locks can be made safe by using the method shown in the illustration. The locking device consists of a $\frac{3}{8}$ -in. iron rod,

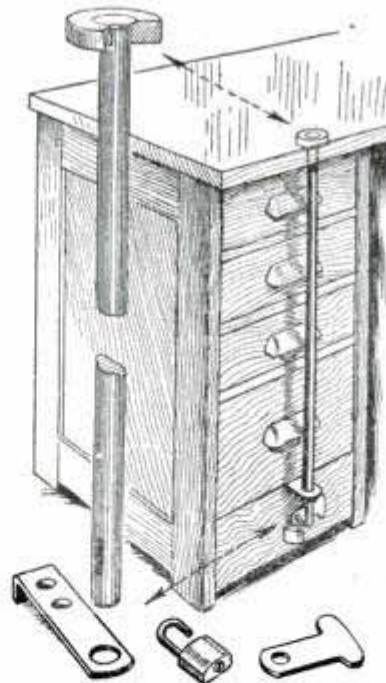

long enough to pass in front of the drawers, with a collar 1 in. in diameter pressed onto the top end. A $\frac{3}{16}$ -in. hole is bored through the top of the cabinet and counter-bored about $\frac{1}{4}$ in. deep so that the collar will be flush with the top when the rod is passed through. The

lower end of the rod is slotted to take a sheet-metal latch drilled for insertion of a lock, and is held in a perforated strap countersunk into and screwed to the base, as indicated.—R. L. Hill, Saginaw, Mich.

☐ Transparent celluloid, dissolved in acetone, makes a good lacquer for silver.

KINKS FOR THE BUILDER



Easily Made Desk for Foreman on Job

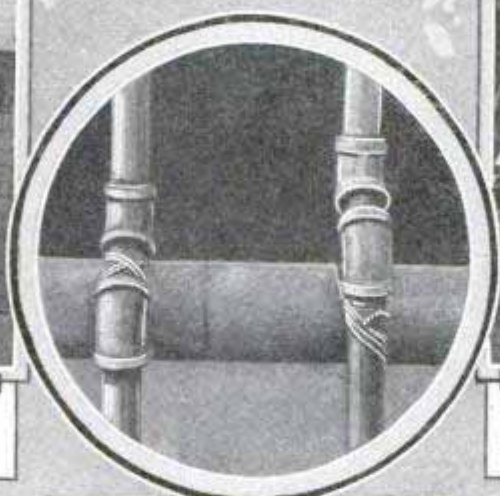

Pipes Wired in This Way Don't Vibrate

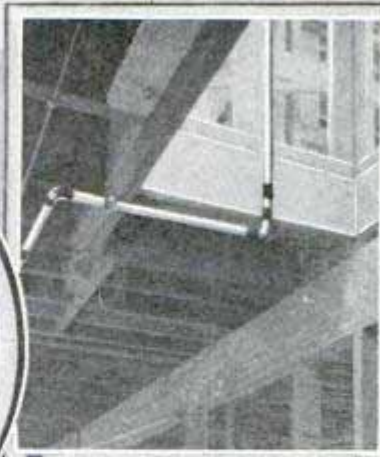

Taping Speaking-Tube Joints Prevents Leakage



Portable Street Barricades



Pipe Drains Porch Floor

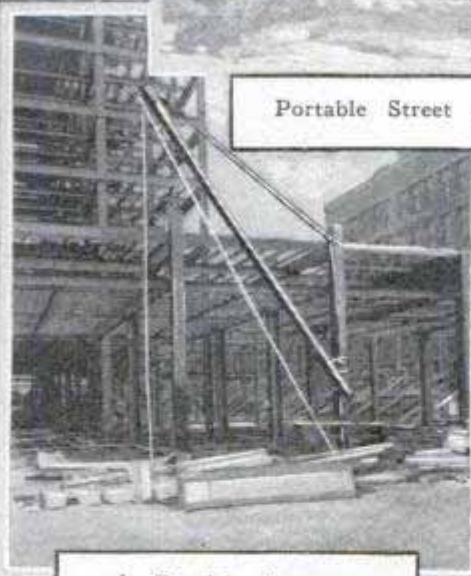

A Derrick Swung from the Steel Column of a Building under Construction Is Handy for Many Jobs



Simple Wood Vise Attached to Strut for Filing Circular Saws

A Self-Inking Stamp That Can Be Changed Instantly

One day when I had about 50 envelopes that I wished to print with a return ad-

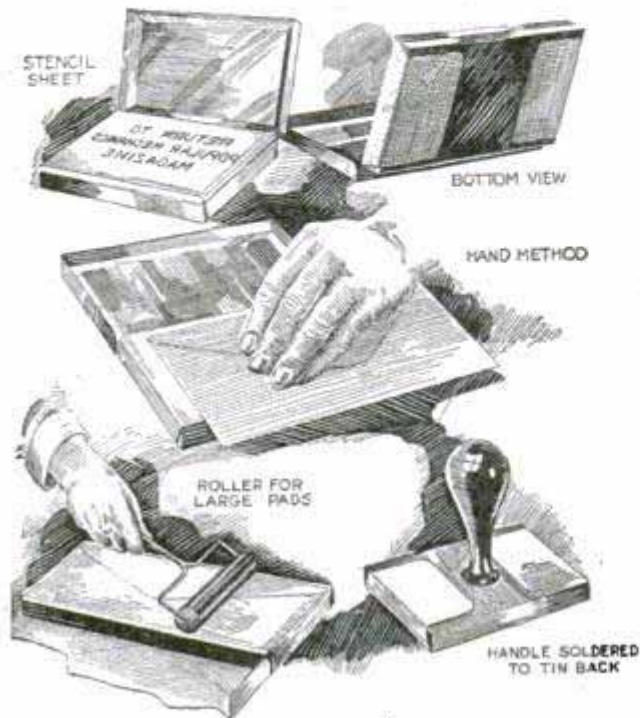

Self-Inking Stamp Made from a Mimeograph-Paper Stencil and an Ordinary Pad

dress, I found a stencil was in place on my mimeograph. Not wanting to remove it for so short a run, I devised the stamp shown in the illustration. It is self-inking, and the lettering can be changed at any time at a cost of about one cent for each new wording. Although I made the stamp to supplement my mimeograph in marking small articles, such as envelopes, bills, receipts, cards, etc., its use is not limited to owners of mimeographs. It will be found most serviceable to all who have numerous small items to be stamped or printed, but do not care to have a great number of rubber stamps made. Stencil sheets may be purchased for 14 cents and less, depending on size. The 14-cent sheet will make ten to fifteen pieces the size of a stamp pad. The typewriting or drawing is done on the stencil before separating it from the backing sheet. Then the backing sheet is torn off, and the stencil cut to the proper size to fit the pad. Sufficient margin is allowed to fold the sheet over the pad; the sheet is stretched tightly over the latter and the ends glued to the bottom. Pads may be bought in the 5 and 10-cent stores. Impressions are made by pressing the paper on the pad firmly. For some purposes, it is expedient to solder a handle to the back of the pad holder, as shown in the drawing,

permitting the device to be used as an ordinary stamp. When very large pads are used, the impression should be made with a small roller.—Lucius Winchester, Norwalk, Conn.

Repairing Broken Triangles

Triangles are easily broken and the draftsman's habits in handling them do not help the situation materially. Fanning ink lines and other practices soon ruin them. Also, in leaning on them, they are sometimes cracked, making it difficult to pick them up when in a flat position. Cracked triangles can be repaired in a very simple and effective manner. Make a solution of 3 parts of alcohol and 4 parts of ether, mixed together well, and apply it to the broken edges, and when more or less warm, press them together, keeping the triangle on a flat surface and using thumbtacks as bracing. Allow the joint to dry for 24 to 36 hours. The triangle will then be as good as new.—L. H. Georger, Buffalo, N. Y.

Telephone Poles Made from Old Water Pipes



The owner of a telephone system found that old, discarded water pipes make good strong telephone poles, which are of special advantage as frequent fires, kindled along the road to clear the brush, will not harm them. The sections of pipe are 25 ft. long and have a piece of round timber driven into the upper end and to

this piece the crossarms are bolted. It is necessary to paint these pipes occasionally to prevent deterioration due to rust and if this is done, they will last practically indefinitely.—L. M. Jordan, Vredenburgh, Alabama.

KINKS FOR THE BUILDER



Wire Lath at Joint Prevents Cracks in Finished Plaster

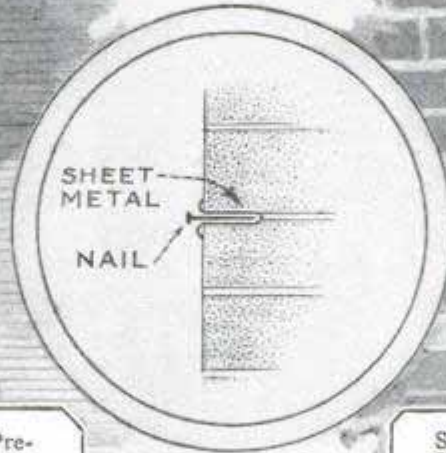

Sheet-Metal Bracket Holds Nails in a Brick Wall

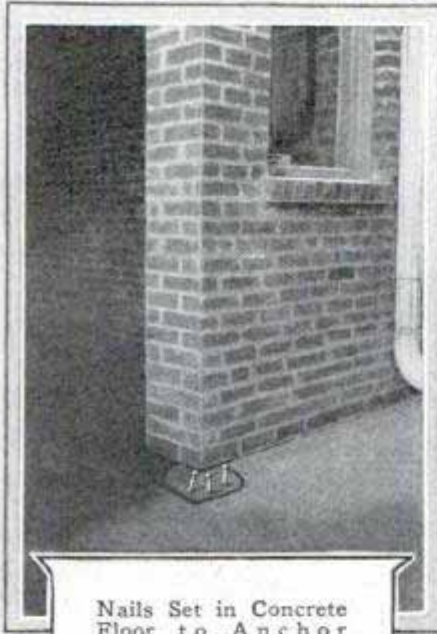

Nails Set in Concrete Floor to Anchor Bumping Post

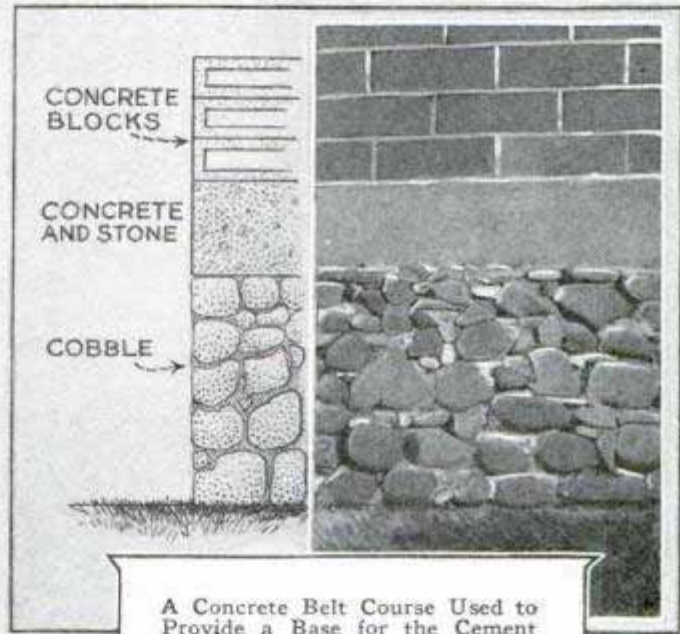

A Concrete Belt Course Used to Provide a Base for the Cement Blocks

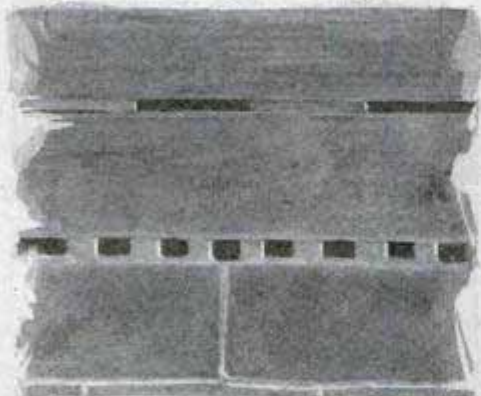

Joist Bedded in Concrete to Make It Firm on Cement Blocks



Beveled Sill of Basement Window Admits More Light and Makes Neat Job; Finished with Cement

Trolley-Operated Concrete Mixer

A novel concrete mixer is being used in San Francisco for paving the street-car tracks. The machine is equipped with

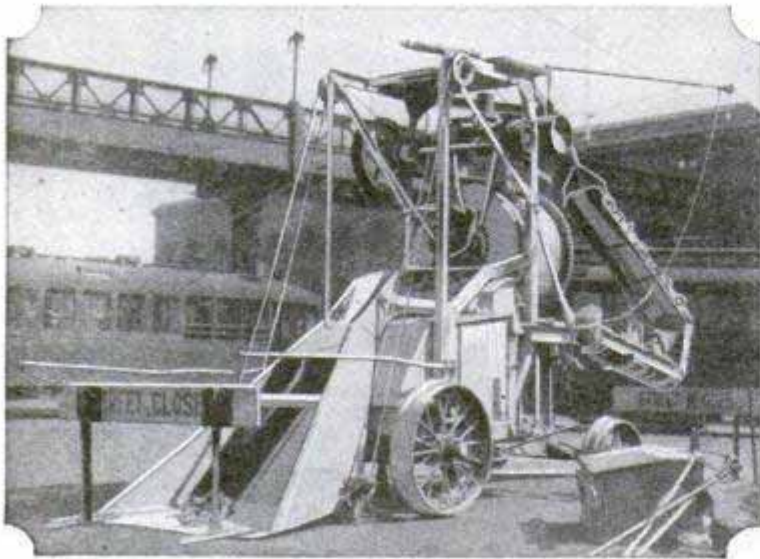

Novel Concrete Mixer That Runs on Street-Car Tracks and Uses Trolley Current

flanged wheels, a trolley pole and a motor, which also runs the mixing drum. A swinging spout, about 10 ft. in length, is suspended ahead of the mixer. The outfit is run on one of the tracks while pouring the paving base for the other. As it is used only at night, the mixer is run off the tracks and parked during the day.

Oiling Spring-Perch Nuts

Late-model Ford cars are fitted with conical nuts on the front-spring perches, which keep the front ends of the radius rod to the axle. When tightening these nuts, they often stop between openings for cotter pins and it is difficult to draw them to the next one. As it is hardly practical to grind off the conical end of the nuts to allow them to be turned on farther, they should be backed off several turns and oil applied to the ends. The oil reduces the friction and usually allows the nut to be turned to the next opening for the cotter pin without trouble.—E. T. Gunderson, Humboldt, Iowa.

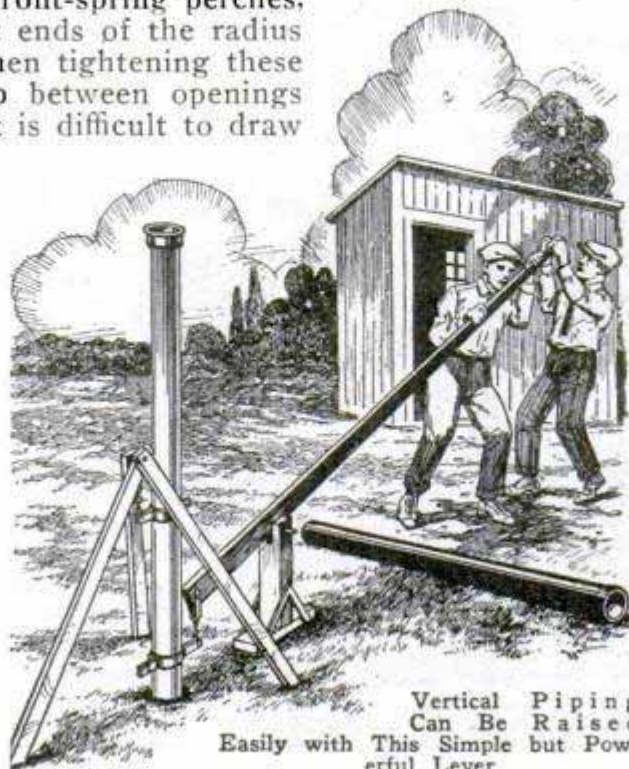

Vertical Piping Can Be Raised Easily with This Simple but Powerful Lever

Marking Trunks

Hunting for a particular trunk among a whole carload of them, or in a baggage room, means a loss of time when one is in a hurry. To avoid this, paint a wide stripe of any bright color all around the trunk on the sides and also across the top and bottom. This makes it visible at all times, no matter in what position the trunk is placed, and it can be picked out of a lot of similar-looking trunks at a glance. The stripe should be painted neatly and be from 3 to 5 in. wide.—H. R. Wallin, Galveston, Tex.

Raising Vertical Piping

For raising heavy vertical pipe, such as pump piping, columns to high water tanks, etc., the device shown in the illustration has been found very effective. It consists of a tripod of 3 by 4-in. wood with a 1-in. bolt through the top from which a short chain is hung. Attached to the end of this chain is a clamp made of two pieces of $\frac{1}{2}$ by $1\frac{1}{2}$ -in. strap iron, bent to the shape indicated and held in place by two bolts, to one of which the chain is attached. A lever fulcrumed on a stand, as shown, has a similar chain and clamp attached to its short end. In use, the clamps are fastened around the piping with a sliding fit, so that, when the long lever arm is pressed down, the lower

clamp locks the piping and raises it several inches, while the upper clamp grips and holds it when the lever is raised for a new purchase. Pipe may be lowered with the same device by raising the clamps with the hands as the strokes are made and riding the lever upward. The device is also an efficient post puller.—L. M. Jordan, Vredenburgh, Ala.

☞ Before painting window sash, rub a cloth soaked in kerosene over the glass.

KINKS FOR THE BUILDER

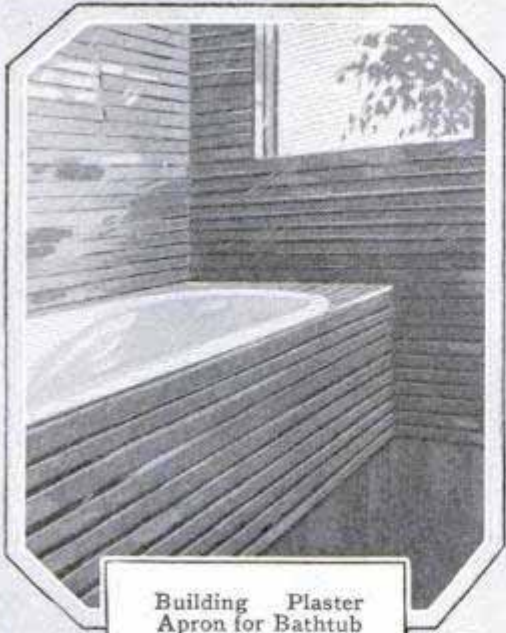

Building Plaster Apron for Bathtub

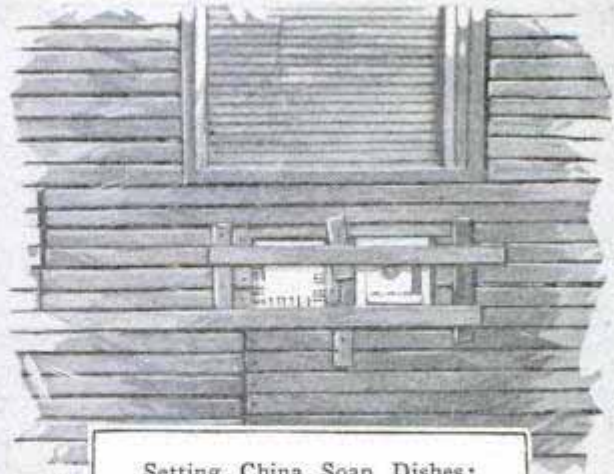

Setting China Soap Dishes;
Copper Nails Hold Mortar

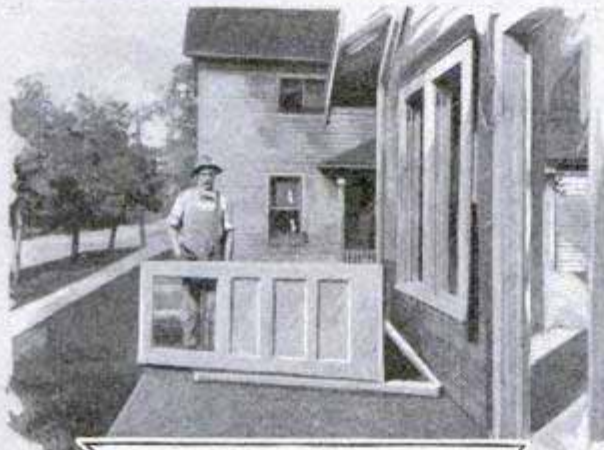

Wood Jack for Holding
Doors While Planing Edges

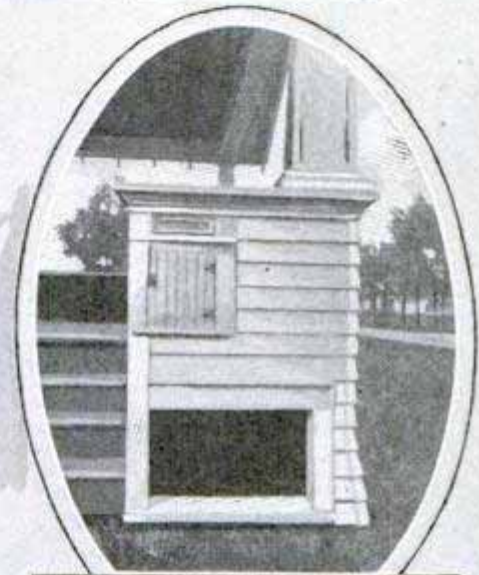

Handy Package Receivers
Built in Front-Porch Wall

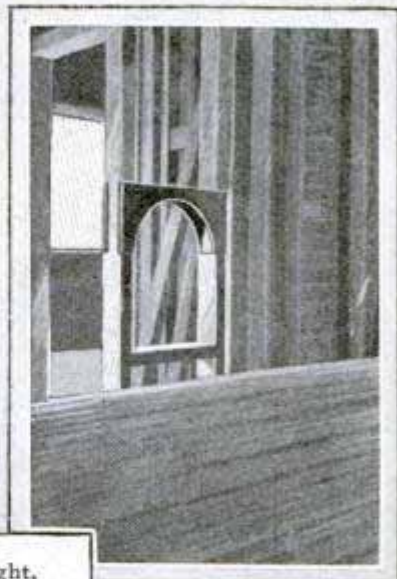
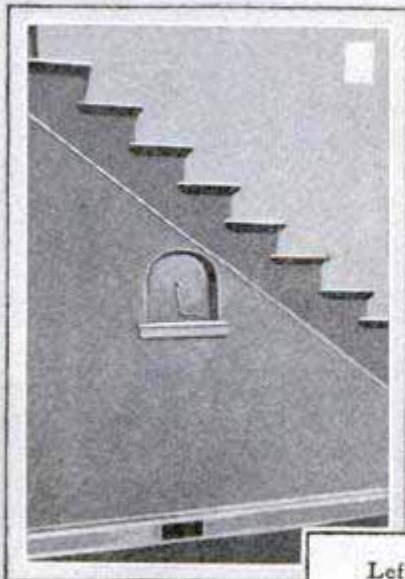

Left, a Telephone Niche, and Right,
the Method of Framing It

Convenient Gasoline Drum

A farmer who believes in having everything convenient, built a substantial platform just outside of his garage for a 50-

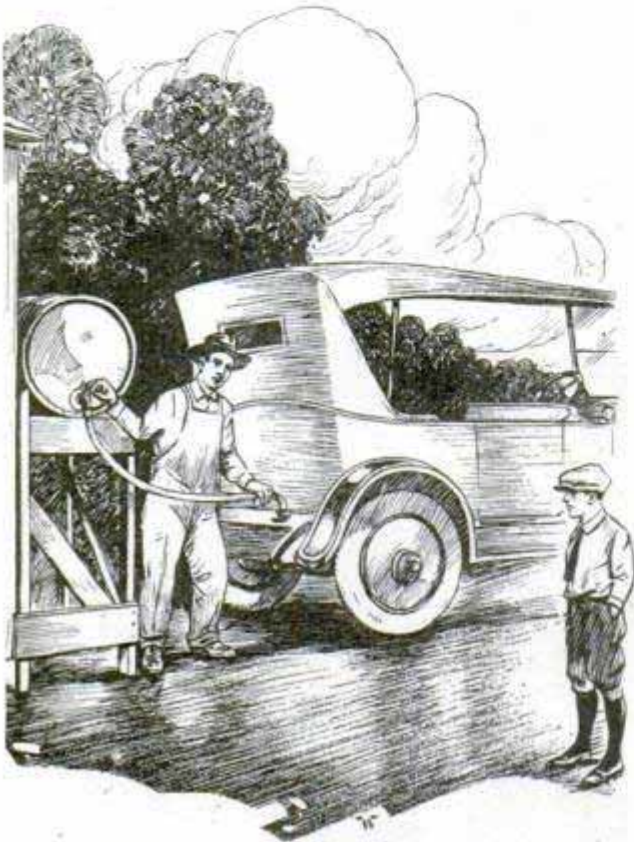

Elevated Gasoline Tank near Garage Facilitates Filling of Auto Tank

gal. gasoline drum and attached a 5-ft. length of hose to the faucet. The free end is fitted with a small tin cylinder in which is set a strainer of cloth, screen and chamois, to keep out foreign matter.

Operating Small Machinery with Speedometer Parts

When operating small machinery such as laboratory equipment or moving window displays, it is sometimes desired to have the source of power at a distance, to provide a speed reduction or to transmit power at an angle. Where the power under consideration is small, an old speedometer swivel joint and flex-

ible shaft, which can be purchased for a small sum at an auto-wrecking house, will often solve the problem. The gear reduction in these swivel joints is $2\frac{1}{2}$ to 1, and they need no attention as they are grease-packed. The spur-gear wheel is made of fiber and is easily converted into a grooved pulley. The flexible shaft is perfectly satisfactory for transmitting small power, and can be bent in any direction and located where it is impossible to place motors or belts. Another inexpensive ready-made gear reduction is to be found in the small emery grinding wheels which clamp to a bench or table and are crank-operated. They are generally accurately made and can be converted into a speed-changing device with little trouble.

Cutting Spirals

Cutting a spiral or, more correctly, a helix, usually calls for expensive machinery. To do such a job accurately without this equipment is practically impossible, but if the spirals need not be absolutely accurate they can be cut by simpler methods. In the photo is shown a method of cutting a spirally grooved roller in a shop where the only machine that could handle such a large piece was a planer. The roller was mounted on centers and was free to turn about them, subject to the control of a spiraling arm, which was setscrewed into the roller shaft and carried on its end a small roller that traveled up and down on a stationary bar as the whole rig, except the bar, was reciprocated by the motion of the planer bed. A spring set in the far side of the swivel arm kept the roller tight against the bar all the time. After each cut was made, the setscrew was loosened and the roller turned an amount equal to the spacing between the spiral teeth, and then the arm was tightened for another cut. The cutting was done by a

tool ground to shape and fed directly downward into the roll. Spirals made in this way answer nicely on such pieces as feed rollers on wood working machines, leather feed rolls and for grinding. — D. Hampson, Middletown, N. Y.

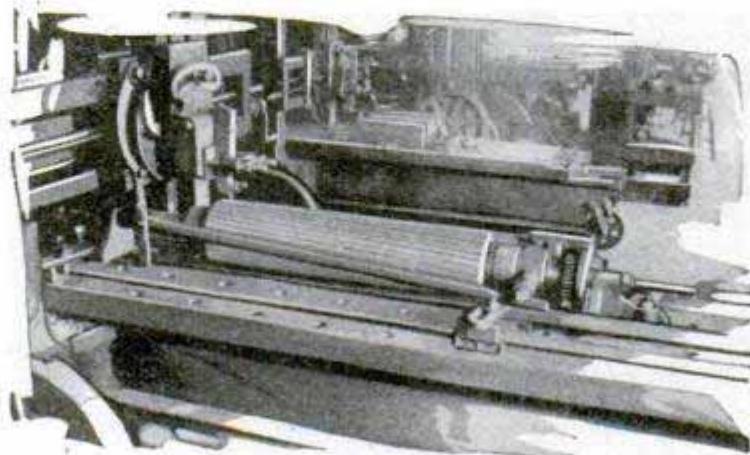

Cutting a Spirally Grooved Roller in a Planer without the Use of Expensive Machinery

KINKS FOR THE BUILDER

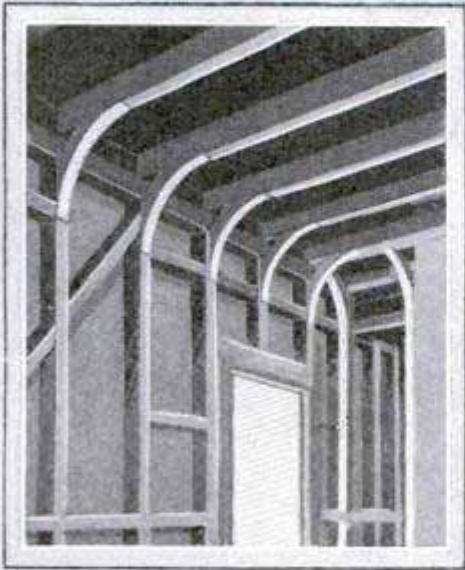

Simple Framing for a Cove Ceiling

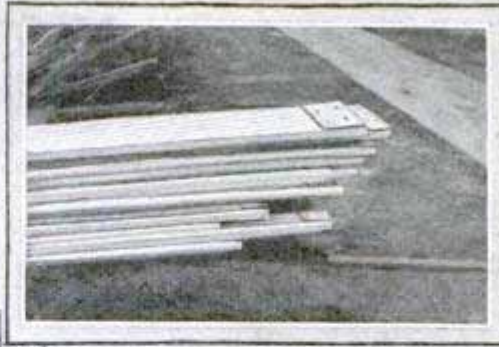

Shingles Nailed to Planks Prevent End-Splitting



Glass Supported on Blocks Is Less Likely to Crack

Useful Roller for Handling Long Timbers



Old Nail Kegs Make Pier Forms

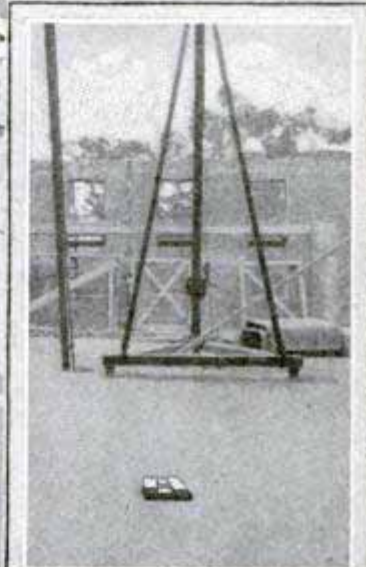

Wood Protector for Projecting Pipe



Stovepipes Set in Forms and Filled with Sand Provide Openings in Concrete Floor



Preventing Cable from Cutting Tree

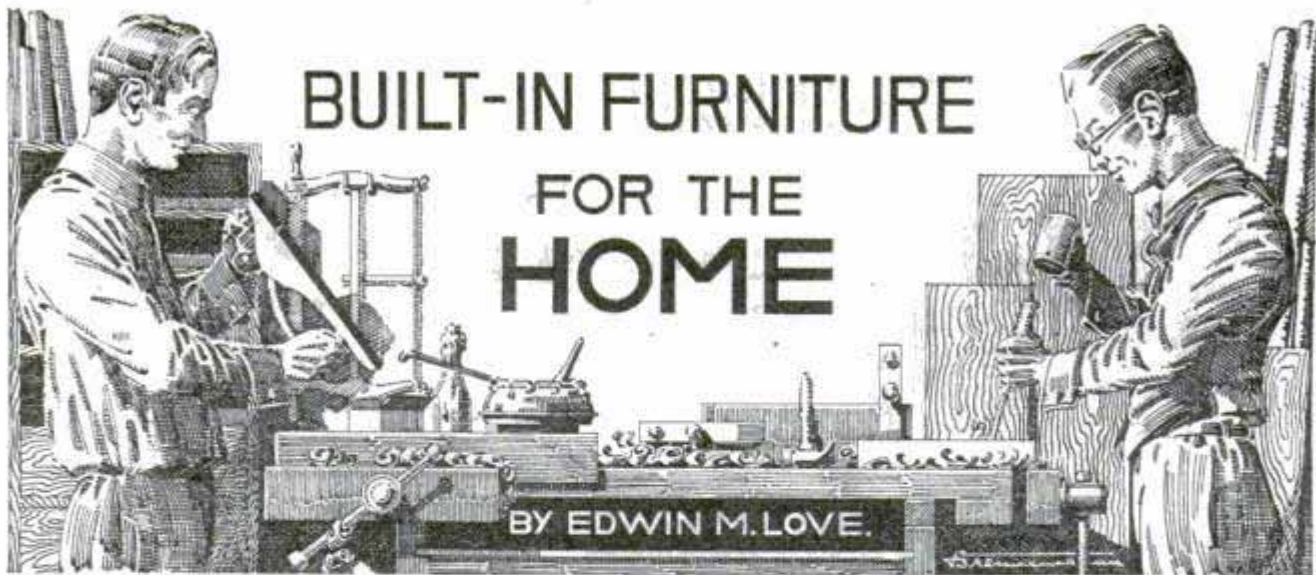

Part XIV—Sewing Cabinet

ASIDE from the novelty of being built into the wall, the sewing cabinet illustrated herewith has numerous worthwhile features to recommend it. The door opens to a horizontal position, and can be used as a cutting table. Six drawers, hinged to open out completely, and a bin nearly 1 ft. square, also hinged, besides shelves, furnish ample storage space, while the partitioned drawer for buttons, the pivoted spool rack, and a work basket built to fit snugly in the remaining space, take care of sewing equipment.

As this piece fits between four studs without any being cut, it is built in three separate sections before being assembled with the casing. All are built of 1 by 5-in. stock, sized to a width of $4\frac{1}{2}$ in. For the six side jambs, cut stock 2 ft. 2 in. long, and rabbet each end on the face side to a depth of $\frac{3}{8}$ in. and a width of 1 in., leaving a face side length of 2 ft. Lay out one and use it as a measure for all others. The six top and bottom jambs are exactly $12\frac{3}{4}$ in. long.

Select a pair of side jambs for the left-hand compartment. Measure up from the bottom shoulders, $4\frac{1}{4}$ in., locating the upper edges of $\frac{3}{8}$ -in. dados cut $\frac{1}{4}$ in. deep. The tops of the next pair are $3\frac{1}{2}$ in. above these. The bottoms of the $\frac{3}{4}$ -in. gains for the heavy shelf are $3\frac{1}{2}$ in. above the top of the one just cut.

Make the three shelves 5 in. wide and $12\frac{1}{2}$ in. long, and assemble this section of the cabinet. Nail the outer corners both directions with four-penny finish nails. Sight along the side jambs to be sure that they have not been bulged outward by the shelves, and nail through into the thick middle shelf. Now notch the projecting $\frac{3}{4}$ in. of the shelves by squaring lines flush with the inside faces of the jambs and sawing to the jambs, the waste wood being

chipped out with a chisel. Square up the box and tack a diagonal brace across the back.

Build the center section in the same way, this time placing the top of a $\frac{3}{8}$ -in. shelf 11 in. above the lower jamb, a second shelf $6\frac{1}{2}$ in. above this, and a third, $3\frac{1}{2}$ in. above the second. In the center of each jamb, $1\frac{1}{4}$ in. above the lower shelf, bore a $\frac{3}{8}$ -in. hole for a pivot bearing of the spool rack. Cut from the front of the lowest shelf a semicircular segment having a radius of $1\frac{1}{2}$ in., to give finger room for removing the work basket from its recess.

The section at the right consists merely of the jambs, as it is filled with the six pivoted drawers without recourse to rails or shelves:

Assemble the three sections by tacking on the casing muntins of 1 by 5-in. stock, sized to a width of 4 in. and cut to 2 ft. in length. The edges are flush with the inside faces of the jambs. Cut the upper and lower casings of 1 by 4-in. stock, mitering the ends, and nail them solidly to the head jambs of the sections with six-penny finish nails. Fit the side casings and nail them in place. Now lay the cabinet, face down, on the bench or floor, place smooth blocks under the miters of the casings, and drive two $\frac{1}{2}$ -in. corrugated fasteners into each. Remove the braces from the back and cover the sections with $\frac{3}{8}$ -in. three-ply pine or fir panel veneer, cut 1 ft. $11\frac{1}{2}$ in. by 2 ft. $1\frac{1}{2}$ in., one for each section, nailing them on with shingle nails or six-penny finish nails.

For the spool rack, make a rectangle of $\frac{3}{8}$ by 5-in. stock, $4\frac{1}{2}$ by $11\frac{7}{8}$ in. in size, and gauge on the face side a pencil line 1 in. from each edge. Centering on these lines, bore six holes $\frac{3}{16}$ in. in diameter, spacing them 2 in. apart; the end ones being $1\frac{1}{16}$

the inside, so that, after assembly of the door a second sheet of panel veneer may be fitted over the first to make the inside flush. Work a $\frac{3}{4}$ -in. cove on the outside of the door, as shown. Hang it with three

cabinet is to be placed, locate a studding space 3 ft. from the floor and chip off plaster to the edge of a stud. Four feet from this point expose another stud. Level a line between the two, 2 ft. $4\frac{3}{4}$ in. from the

MATERIAL LIST

- | | |
|--|--|
| 1 piece, $1\frac{1}{8}$ by 3 in. by 8 ft., pine or fir, S4S, sanded. | 1 piece, $\frac{3}{8}$ by 5 in. by 12 ft., pine or fir, S4S, sanded. |
| 1 piece, $1\frac{1}{8}$ by 4 in. by 4 ft., pine or fir, S4S, sanded. | 1 piece, $\frac{3}{8}$ by 5 in. by 8 ft., pine or fir, S4S, sanded. |
| 1 piece, 1 by 5 in. by 14 ft., pine or fir, S4S, sanded. | 1 piece, $\frac{3}{8}$ by 4 in. by 6 ft., pine or fir, S4S, sanded. |
| 1 piece, 1 by 5 in. by 12 ft., pine or fir, S4S, sanded. | 1 piece, $\frac{3}{8}$ by 20 in. by 7 ft., three-ply pine or fir panel veneer. |
| 1 piece, 1 by 4 in. by 14 ft., pine or fir, S4S, sanded. | 1 piece, $\frac{3}{8}$ by 16 in. by 7 ft., three-ply pine or fir panel veneer. |
| 1 piece, $\frac{3}{8}$ by 12 in. by 4 ft., pine or fir, S4S, sanded. | $9\frac{1}{2}$ pair, $\frac{1}{4}$ by $\frac{3}{4}$ -in. hinges. 1 desk chain. |
| | $1\frac{1}{2}$ pair, $2\frac{1}{2}$ by $2\frac{1}{4}$ -in. loose-pin butts. |

Cost of materials, about \$12. Time to build, about 20 hours.

$2\frac{1}{2}$ by $2\frac{1}{2}$ -in. loose-pin butts, choosing a kind that can be closed backward to a right angle. Countersink the holes on the backs and put on wrong side out, which will bring the pin underneath the door, thus offering little hindrance to the opening of the lower drawer. Put a desk chain on the left end of the door.

Having chosen the place where the

floor, and another 2 ft. $2\frac{1}{2}$ in. above that. Plumb lines down the inside edges of the studs and remove the lath and plaster from the inclosed rectangle by cutting the

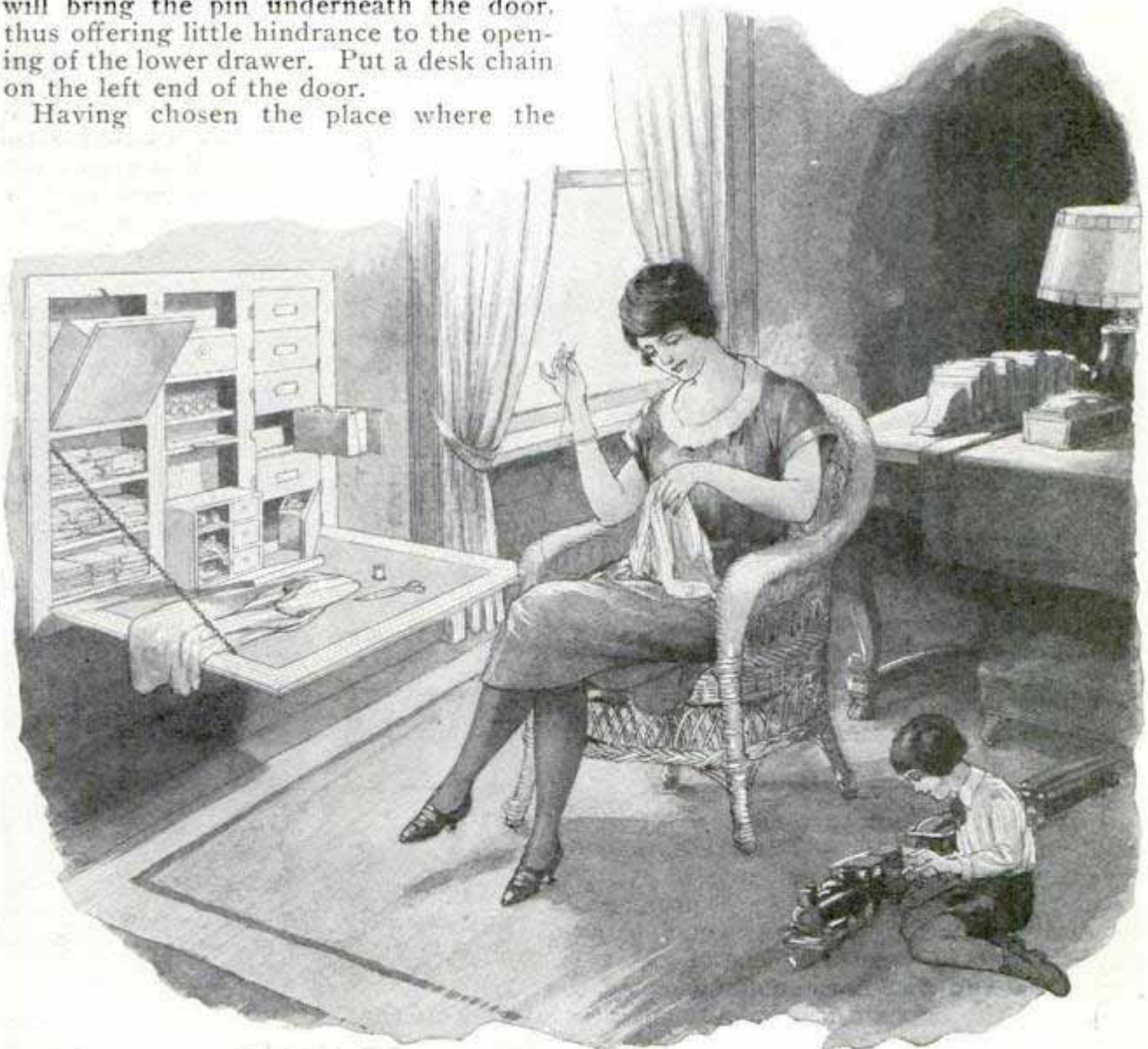

Here Is a Sewing Cabinet That Will Appeal to Every Home-Owning Housewife; It Provides a Place for Everything Used in Sewing and Mending

plaster with a cold chisel and laths with a compass saw. Set the cabinet in place, leveling carefully. Then nail the casings to the studding with eight-penny finish nails. If the plaster keys interfere with the cabinet going back to place, carefully break them off.

Removing the casing muntins, wedge the jambs, and nail through into the studding. Then nail the muntins permanently in place. Cut the curved depressions opposite each drawer and the bin for finger holds, and sand the cabinet preparatory to finishing. It is useless to putty nail holes or joints before the priming coat or stain is applied, since the dry wood will absorb the oil from the putty and loosen it.

Metal "Blocks" Hold Autos in Transit

A well-known automobile factory is now using a pressed-steel blocking brace

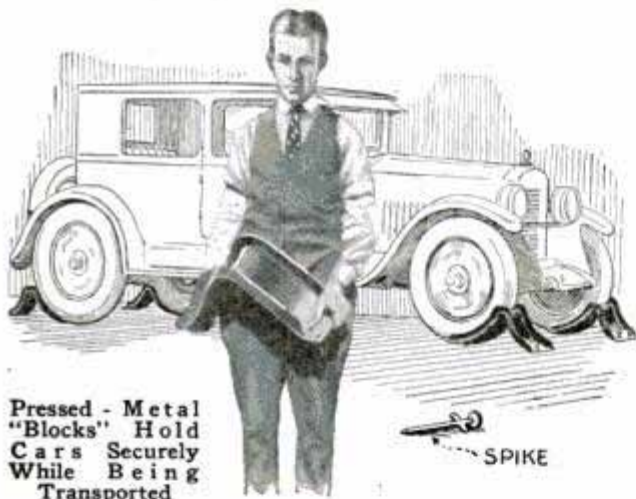

Pressed - Metal "Blocks" Hold Cars Securely While Being Transported

in loading autos on freight cars for shipment. Stronger than the old-time wooden blocks, these are easier to apply and remove, hold securely, and may be used over and over. A special type of spike is used, having a 1/2-in. shoulder under the head, which permits easy withdrawal and at the same time assures a secure hold. —Richard C. Tarr, Gloucester, Mass.

Tempering Small Articles Evenly

It is quite difficult to temper a lot of small springs or other small articles and have the temper equal in all parts of each piece. The following process will produce the desired effect: Obtain a small cup which is pressed from one piece of metal, or a pieced cup with hard-soldered seams. Partly fill the cup with some animal or fish oil. Petroleum products are not good on account of their volatility. The articles

are heated to the usual color and plunged into the cup, which is to have sufficient oil in it to cover them. After being thus hardened, the cup with the oil and the articles is held over the fire until the oil takes fire and burns. After the temper has been drawn sufficiently, the cup is removed from the heat and a cover placed over it to quench the flames. When cool, the articles are removed. They will be found evenly tempered.

In tempering springs, I usually allow the oil to burn about six minutes before quenching. As the oil can be heated to only a certain temperature, the articles receive a perfectly even heat. If the oil is burned off from the article while it is only smeared with oil, some parts will be heated more than others. If a spring is made of piano wire, it will be greatly stiffened and improved by heating it to an even blue after it is formed. The reason for this is that when the wire is coiled the metal is full of strains which the heat removes. —J. H. Beebee, Rochester, N. Y.

Locating Breaks in Electric Wiring

Many feet of valuable extension cord are wasted, and often an entire cord thrown away because of the difficulty of locating breaks in the wires concealed by the insulation. A simple method of locating these breaks is to connect the terminals at one end of the cord to the high-tension terminals of a Ford spark coil and short-circuit the other ends of the cord. If the battery terminals of the coil are then connected to three or four dry cells, arranged in series, as shown in the drawing, a hot spark will jump across the break in the wire, and its location can easily be detected by the noise and by the

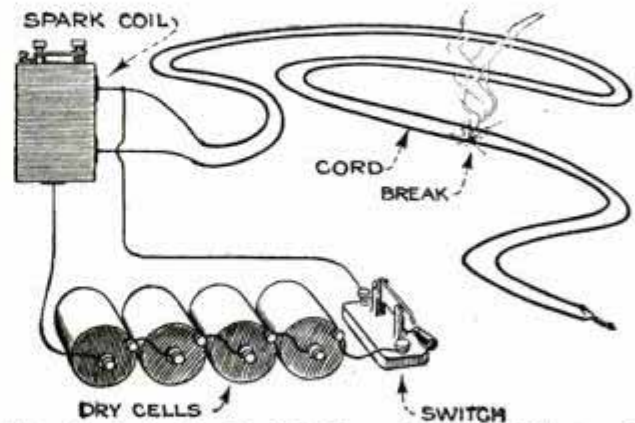

The Break in the Cord Is Located by the Noise and the Burning of the Insulation

burning of the insulation which will appear near the spot.—A. F. Gettelman, Madison, Wis.

Easily Made Derrick

Farmers and others often need some means of raising heavy weights, such as logs, timbers, stones, pipe and machinery onto a wagon or truck. This can very easily be done by constructing a derrick



Simple Improved Derrick for Farm Use Which Makes It Possible to Lift Objects of Considerable Weight

of the kind shown, which is both inexpensive and portable. One end of a sound log or 6 by 6-in. timber, about 15 ft. long, is sharpened and base supports nailed on as shown. At the other end a short cross-arm is attached with bolts or nails. To raise a heavy object, the sharpened end of the log is placed in the ground, and a hitch is taken around the crossarm with a rope, which is fastened to the weight, and should be long enough to reach to the ground when the pole is raised. Lifting power is supplied by a truck, horse or a group of men. When the weight is raised to the proper height, it can easily be pulled onto a wagon.—A. Bereskin, Winnipeg, Can.

Releasing Tight Collets

Spring collets that stick are a common trouble on handscrew machines. This may be the result of several causes; the rod being used may be old and rough, or it may be bent or a shade too large for the collet. When a rod fails to come forward as the clutch is released, the best thing to do is to tap it lightly on the end projecting through the collet; this loosens the latter and allows the rod to feed forward to the stop in the turret. Sometimes this is a frequent occurrence, and many operators keep a hammer handy for tapping the rod back when it sticks. The drawing illustrates a better way. The stop itself has a $\frac{5}{8}$ -in. cold-rolled stock tapped at each end for $\frac{1}{4}$ -in. studs, which

carry another piece of $\frac{5}{8}$ -in. stock on their outer ends. A hole is drilled and

tapped in the center of the outer piece for a $\frac{1}{4}$ -in. screw. When a rod refuses to feed forward to the stop, the position of the latter being controlled by a stop on the machine, the device is dropped to a horizontal position where a pin driven through the stop holds it. The end of the rod is then tapped by bringing the turret forward, and as the collet releases it, the device is lifted back to the position indicated by the dotted lines, leaving the end of the stop free to locate the rod as usual. A device of this type enables the operator to keep up the regular swing of

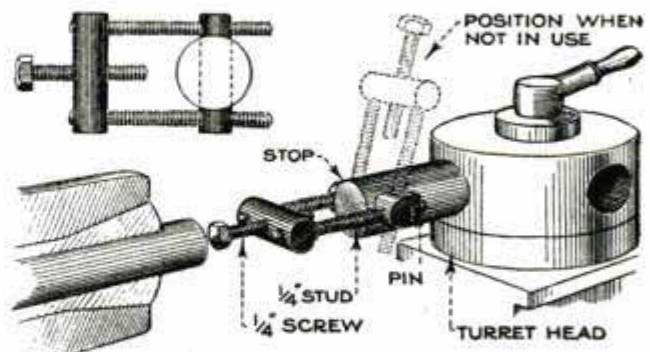

Attachment for Handscrew Machine for Releasing Stock That Sticks in the Collet

the turret, which is impossible when he must stop and pick up a hammer.

Oil paint has a tendency to wrinkle up on exposure to extreme cold but this may be prevented by adding a little turpentine to the paint.

Foundry Flasks from Truck Wheels

A foundry in the middle west received an order for some 24-in. wheels and gears but had no flasks suited to the job. As the order was likely to be repeated, it was

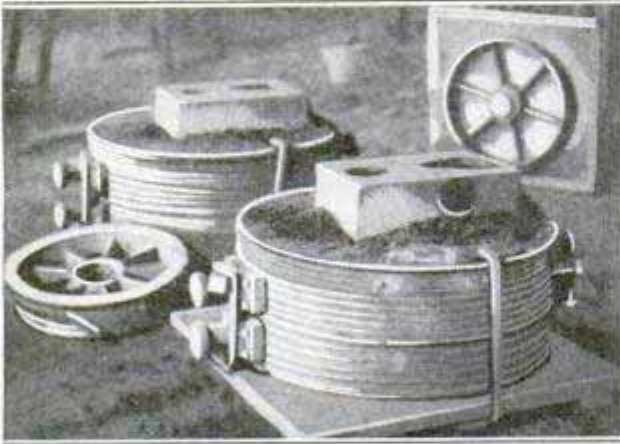

Old Automobile Rims Used as Flasks in Foundry

decided to make flasks specially adapted to that work alone. The ordinary round flask made of cast iron was rejected as it was too heavy. In the yard there were some old truck tires with the inside steel rim left on, and someone conceived the idea of stripping the rubber off and using these steel rings, as they were as near the diameter and width as could be desired. The old rubber was cut through with a metal band saw and was peeled from the rim. For ease in handling, particularly in turning over to dress the mold, a pair of iron trunnions were attached to each ring. The plan was so successful that later more of the flasks were made in another size for other work. Naturally the cost of the flasks was extremely low.—Donald A. Hampson, Middletown, N. Y.

Bending Ford Bendix Setscrew Washer

It is rather difficult to bend up the lip on the lock washer under the bendix-head setscrew on Ford-starter motors when replacing them. If a punch and hammer are used, the shaft turns at each blow and greatly lessens the effect, and an ordinary pair of pliers will not compress with enough force to bend the washers. A simple method is to grasp the partly bent lip on the washer and the screw head in a pair of pliers and turn the bendix until the pliers rest against the frame of the car. Now hammer on the opposite jaw of the pliers until the washer is bent, keeping a strong grip on the plier handles.

Shellac and Graphite Replace Gaskets

Powdered graphite and ordinary orange shellac, when mixed to the consistency of putty, form a solid sealing gasket, which resists heat and holds pressure. This mixture is also of use for small cracks in the water system around radiators, or various places where slight leakage occurs. If used to seal slight crevices, it should be made quite thin and worked into the crack with a putty knife.

Keeping Tractor Oil Warm in Cold Weather

Lubrication of tractors during cold weather presents the problem of keeping the oil thin. A good method of doing this is to arrange a tight-fitting box over the exhaust pipe, so that quite a bit of heat will be retained in the box. The oilcans are kept in it, and freely running oil will then be had in the coldest weather. For drying wet mittens and gloves this box is also a great convenience.—G. G. McVicker, North bend, Nebr.



Keeping Lubricating Oil Thin during Cold Winter Weather in a Box Built over the Exhaust Pipe

House Plans

Maximum Comfort in Story-and-a-Half Home

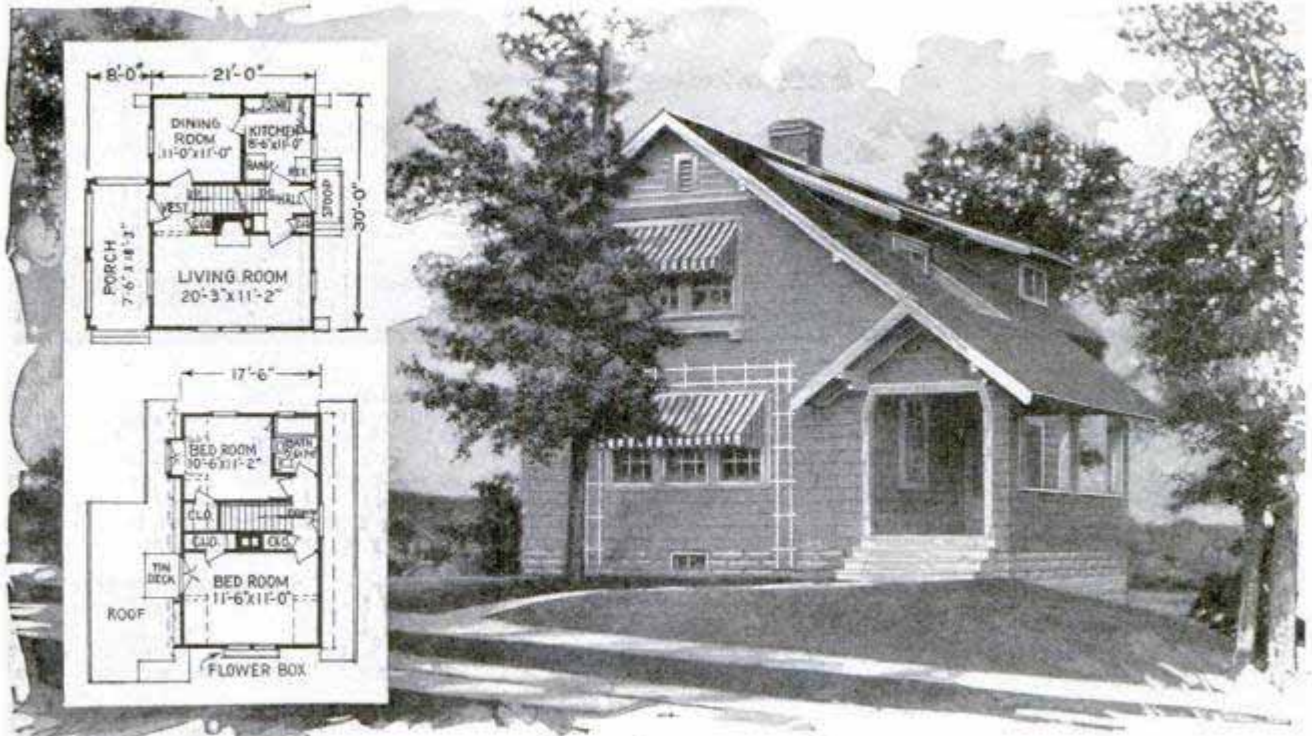

Plan No. 5A1

Copyright, Architects' Small House Service Bureau

THIS is a one-and-a-half-story home, planned to meet the most exacting modern requirements and to provide comfort, convenience and a pleasing exterior at reasonable building outlay. There are five main rooms, bathroom, six closets, basement with heater room, and large light laundry.

The living room is everything that its name implies. It is a large, light room, with windows on three sides and a fireplace for winter comfort. It has the unusual advantage of opening both from the front and side hall. Notice, in fact, how easy it is to get from one part to another of this home.

Among the conveniences are the coat closet in the front hall; the broom closet and the general utility closet in the side entry. On the second floor there is a shelved linen closet. The kitchen is planned so all the fixtures are within easy reach. The ice box, though in the kitchen, is iced from outside. Both bedrooms have windows on two sides, and each has its own large closet. The bathroom is over the kitchen, an economical plumbing arrangement, as one stack can be used for both kitchen and bathroom.

The plan shown is drawn for lots facing east or south, while in the house pictured

it has been reversed, making it suitable for lots facing north or west.

Home Builders' Questions

Q. Can anything be saved by doing without a general contractor and letting separate contracts for the different kinds of work? **A.** On paper it may seem less expensive to build with separate contracts. Practically in order to save anything, one must be sufficiently skillful in purchasing materials and in handling labor to offset the corresponding skill of the general contractor. Generally speaking, the hazard is not worth taking. A good contractor can build your house, put everything into it that you want, get it built better than you could, and then, after adding his profit, turn it over to you for less than you could by handling the subcontracts yourself.

Q. Is it necessary to have a set of specifications, if I have a complete set of plans? **A.** Yes. The plans show what is to be done. The specifications tell how it is to be done. The final cost of your house built without specifications may be much more than it would have been if you had had good specifications.

Q. What is the best way to turn a corner with a soldier brick course? **A.** Lay bricks at the corner flat.

Q. What is the cause of rust running down the kitchen wall from the hole where the vent pipe from the gas range comes through the plaster? **A.** This is caused by the warm air from the gas range coming into contact with the cold walls of the pipe which condenses the moisture from this warm air. The difficulty can be overcome if a drip is run from the bend of the pipe so that the water of condensation drips onto the basement floor. It is very difficult to overcome this condition in an old house without unreasonable expense.

Q. Is it safe to build an eight-inch brick wall to a height of ten or twelve feet? **A.** An eight-inch brick wall laid of good bricks and in good mortar is a substantial wall in the height you mention.

QUESTIONS regarding home building addressed to this magazine will be answered by the Architects' Small House Service Bureau of the United States, Inc., controlled by the American Institute of Architects and indorsed by the department of commerce, United States government. Blueprints, specifications and material lists for the house shown above may be obtained at a nominal cost. Inclose self-addressed, stamped envelope for reply. If further information is desired send five cents and stamped envelope for a 24-page booklet explaining how the small home bureau functions and showing twelve sample plans.

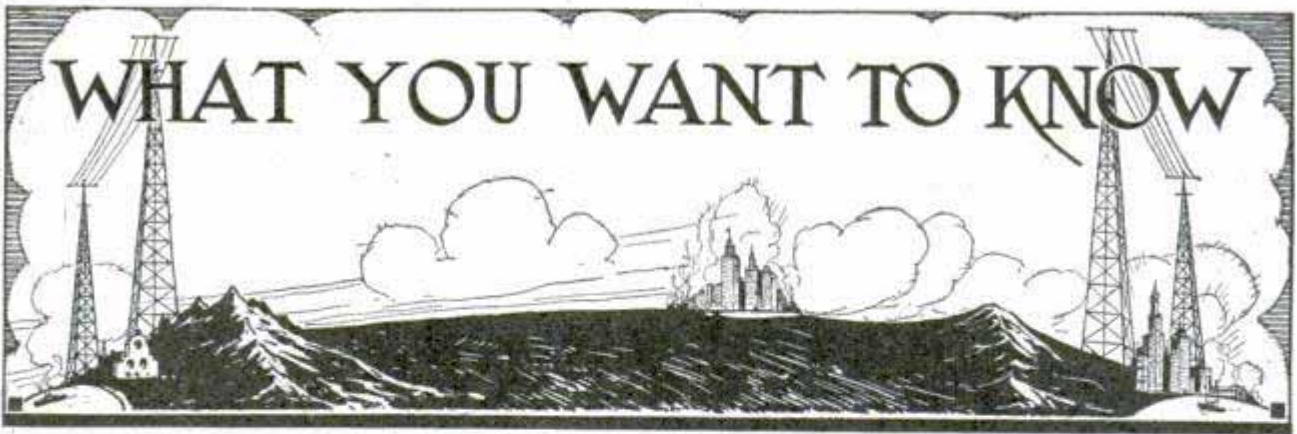

WHAT YOU WANT TO KNOW

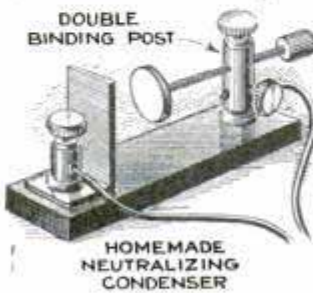

Fig. 1

Q. I am building a five-tube tuned r.f. set and would like to make my own neutralizing condensers. Can you suggest some simple means of doing this? **A.** A simple condenser of this type is shown in Fig. 1. A small brass strip is bent at an angle, as shown, and secured to the subpanel by means of a brass machine screw and binding post. The adjustable unit consists of a small

copper disk, about the size of a penny, soldered to the end of a threaded brass rod or long machine screw. The upper hole in the double binding post is threaded to take this rod, and a hard-rubber or composition binding post head makes a good knob. Mount this unit on the subpanel at a convenient distance from the stationary unit.

Q. Please send me a schematic diagram of a simple one-tube set showing a wavetrap drawn in the circuit. **A.** The diagram for the circuit, including a wavetrap, is given in Fig. 2. There are several methods of using the trap, but the method shown is in common use, and adds greatly to the selectivity of the set.

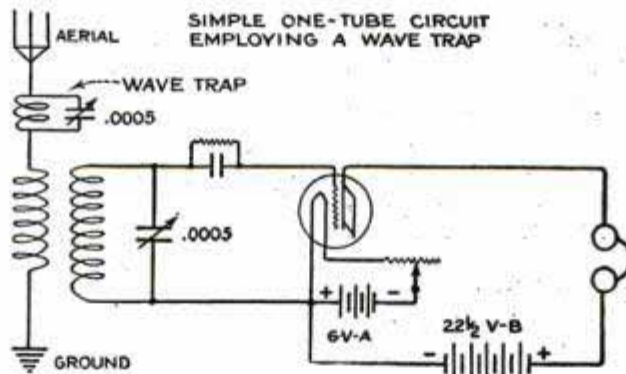

Fig. 2

possible to get a good ground in such soil. A simple counterpoise substitute can be made by stringing one or two wires under the aerial a few feet above the ground. A lead is taken from the counterpoise in the same manner as from the aerial and goes to the ground post on the set. The counterpoise acts as a capacitance giving a condenser effect between the two, and makes a very effective substitute.

Q. What is the best type of wire to use for an aerial? **A.** Copper wire should be used; if this can be obtained in the enameled form it would be ideal as corrosion would be prevented. Use either No. 14 or 12 gauge wire, or standard antenna wire of the stranded type.

Q. I live in an apartment house and there are several aerials on the roof. One of them parallels my aerial and is about two feet away; will this interfere with my set? **A.** There will be no interference unless either your set or your neighbor's is of the regenerative type; then, there will be interference due to the radiation qualities of this type of circuit.

Q. What amperage should a fresh dry cell have? There seems to be a difference of opinion among the dealers here. **A.** Some makes of No. 6 dry cells test 30 amp., others from 17 to 22. A pamphlet can be obtained from the manufacturer specifying the amperage. Some of the

high-resistance types will test low, although they may be fresh and in first-class condition. If a voltmeter is connected across the socket terminals of the set, and the rheostats turned up to the best operating point, the voltage reading should be up to the specified voltage for the tubes. If less, renew the batteries. The tubes should be run against voltage rather than against amperage.

Q. What are the approximate points on the dial where I can find the different wavelengths of the stations as they are listed? **A.** In most receivers the short-wave stations come in on the lower end of the dial. A receiver covering a range of 200 to 600 meters would tune in the 200-meter station at 0 on the dial, and 600-meter stations at about 100. At 50 on the dial, you could expect to find stations ranging around 300 meters.

Q. What ratio is best for the average two-step amplifier? I have several a.f. transformers of different ratios and want to use the best possible combination. **A.** For good results two 3 1/2-to-1 ratio a.f. transformers work to the best advantage in the average set.

Q. What is the proper size of grid condenser to use with a three-circuit receiver? **A.** The grid condenser may be either .0005 or .00025 mfd. The latter capacity is commonly used in manufactured sets. Tubes vary, however, and it is best to try both values.

Q. I am having difficulty in getting a good ground. The soil here is very dry and sandy; please suggest some type of substitute ground. **A.** It is almost im-

possible to get a good ground in such soil. A simple counterpoise substitute can be made by stringing one or two wires under the aerial a few feet above the ground. A lead is taken from the counterpoise in the same manner as from the aerial and goes to the ground post on the set. The counterpoise acts as a capacitance giving a condenser effect between the two, and makes a very effective substitute.



Fig. 3

IN accordance with the editorial policy of this magazine never to accept compensation in any form for what appears in our reading pages, and also to avoid all appearance of doing so, we are obliged to omit the name of the maker or the seller of any article described. This information, however, is kept on file and will be furnished free, by addressing Bureau of Information, Popular Mechanics Magazine, Chicago. [Editor.]



Making it easy to do good sawing

YOU make good sawing easy for yourself—or hard—when you buy your saw. For with a saw that chatters, hacks, or binds, easy sawing is impossible.

Smooth, fast, true cutting—this is the beginning of good finished work, the secret of easy sawing.

That is the kind of sawing the Disston Saw has been doing for eighty-five years. Henry Disston, training his own workmen, developing his own steel, first made it possible.

Disston Steel keen, edge-holding, tempered and sharpened for true, fast cutting. Disston craftsmen-

ship, that balances and tapers a saw in ways that are all its own. These make the easy-cutting Disston, "The Saw Most Carpenters Use."

To saw easily, to saw well, look for the saw that *cuts*. Your own dealer has it—the Disston Saw.

Ask Disston

Tell us what work you are doing, in wood, metal, stone, ivory, rubber, leather, cloth, fibre or other materials. We will tell you how to saw it better and easier. Disston issues many free books to aid saw users.

HENRY DISSTON & SONS, INC.
Philadelphia, U. S. A.

DISSTON

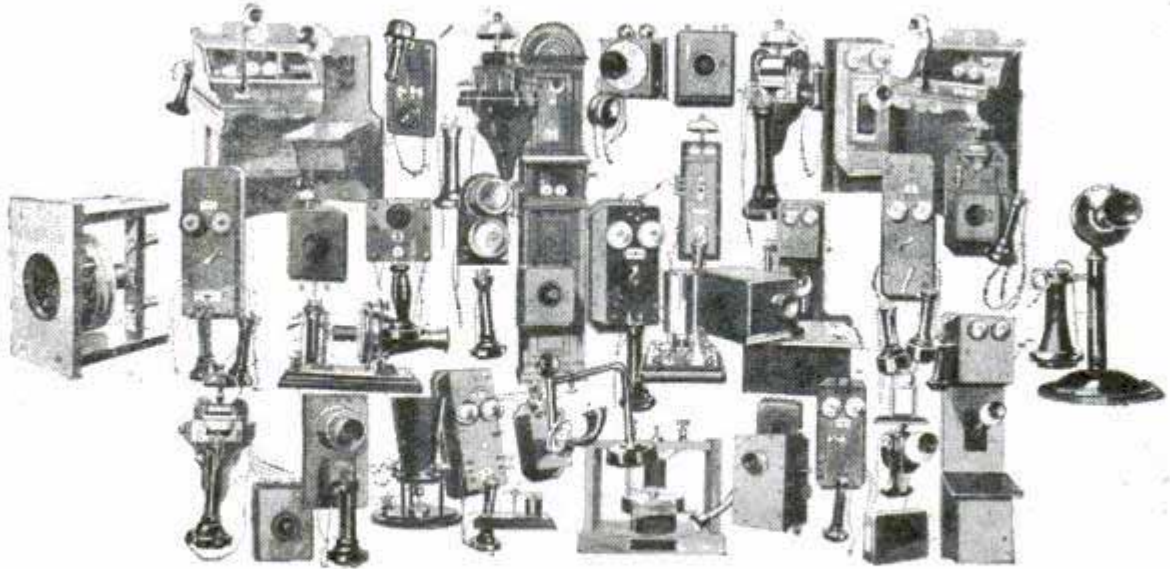

An Account of Stewardship

FIFTY years ago Dr. Alexander Graham Bell was busy upon a new invention—the telephone. The first sentence had not been heard; the patent had not been filed; the demonstration of the telephone at the Centennial Exposition had not been made. All these noteworthy events were to occur later in the year 1876. But already, at the beginning of the year, the basic principle of the new art had been discovered and Bell's experiments were approaching a successful issue.

The inventor of the telephone lived to see the telephone in daily use by millions all over the world and to see thousands of inventions and developments from his original discovery.

If he had lived to this semi-centennial year, he would have seen over 16,000,000 telephones linked by 40,000,000 miles of wire spanning the American continent and bringing the whole nation within intimate talking distance. He would have seen in the Bell System, which bears his name, perhaps the largest industrial organization in the world with nearly \$3,000,000,000 worth of public-serving property, owned chiefly by an army of customers and employees.

He would have seen developed from the product of his brain a new art, binding together the thoughts and actions of a nation for the welfare of all the people.

AMERICAN TELEPHONE AND TELEGRAPH COMPANY
AND ASSOCIATED COMPANIES

BELL  **SYSTEM**

IN ITS SEMI-CENTENNIAL YEAR THE BELL SYSTEM LOOKS FORWARD
TO CONTINUED PROGRESS IN TELEPHONE COMMUNICATION

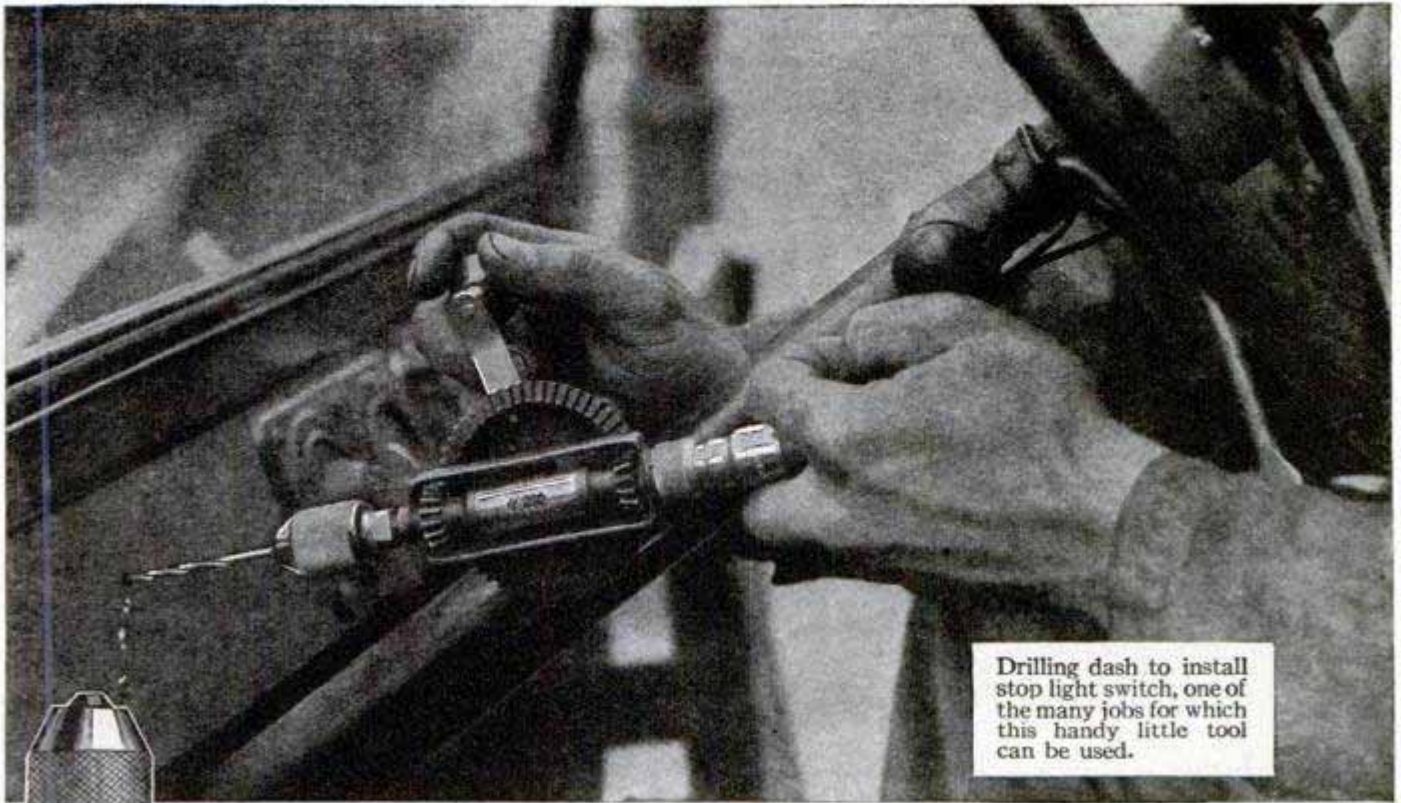

Drilling dash to install stop light switch, one of the many jobs for which this handy little tool can be used.

A Midget in Size A Giant in Service

"Yankee" Hand Drill No. 1530 is so small you can carry it in your pocket, yet it has all the famous ratchet adjustments of the big "Yankee" Breast Drills and Hand Drills.

It works in places impossible for other drills, by means of five ratchet adjustments (controlled by a finger touch).

In a cramped place, where you can not give the crank a full turn, you set the shifter

at DOUBLE Ratchet, and by turning the crank only an inch to and fro, you keep the bit cutting into the work.

Only a "Yankee" Drill can do this, for no other has the famous "Yankee" DOUBLE Ratchet.

"Yankee" Hand Drill No. 1530 is only 10½ inches long and weighs but 1¼ pounds. 3-jaw chuck holds round drills up to 3/16 inch.

For large drilling jobs use "Yankee" Ratchet Breast Drill No. 1555, 3-jaw. Holds round drills up to ½ inch.

Some other "Yankee" Tools

Ratchet Bit Brace
Automatic Feed Bench Drills
Vises, with Removable Base

Ratchet Screw-drivers
Ratchet Tap Wrenches

Dealers Everywhere Sell "Yankee" Tools

"Yankee" on the tool you buy means the utmost in quality, efficiency and durability

NORTH BROS. MFG. CO., Philadelphia, U. S. A.

"YANKEE" TOOLS

Make Better mechanics

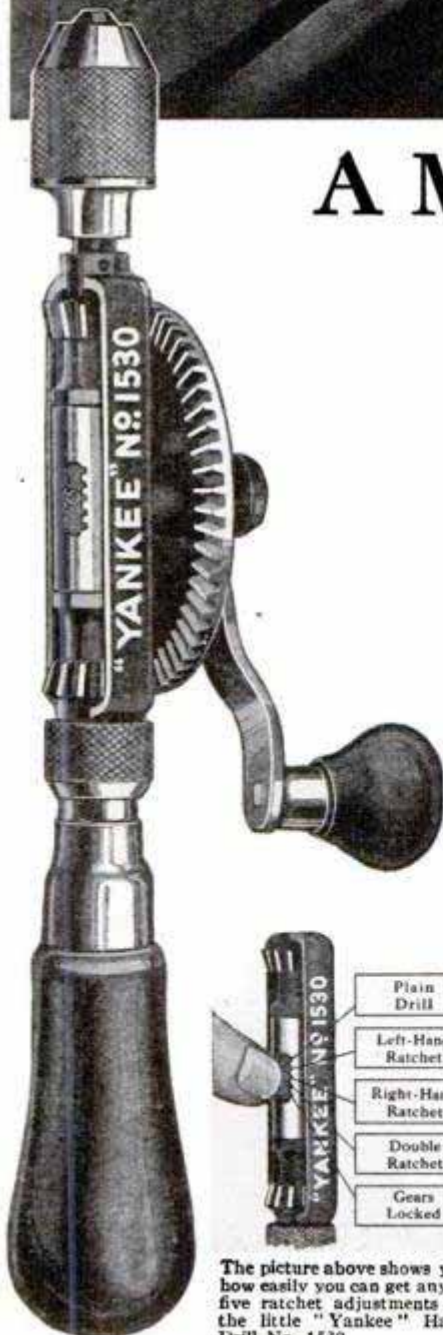

The picture above shows you how easily you can get any of five ratchet adjustments on the little "Yankee" Hand Drill No. 1530.

Isn't it worth it?

IN THE PAST twenty years, Fatima has been more widely imitated probably, than any other cigarette—yet today it is as distinctive as ever, in richness of taste, in mildness, in delicacy of aroma. A few cents more, yes—but you get the *real thing*. That's the difference



WHAT A WHALE OF A DIFFERENCE JUST A FEW CENTS MAKE

WURLITZER

TRADE MARK REGISTERED
THE WORLDS LARGEST MUSIC HOUSE



Try Any Wurlitzer Instrument in Your Own Home

EXAMINE IT, show it to your friends, play it as much as you wish. A week's free trial — no obligation to buy. We make this liberal offer because we want you to see for yourself this superior quality of Wurlitzer instruments, the result of 200 years' experience. Noted musicians praise them for unusual tone quality, artistic workmanship and ease of playing. They are used in the finest bands and orchestras throughout the country.

Easy Payments

If you decide to buy, payments are arranged in small monthly sums. A few cents a day pays for your instrument. Special offers on complete musical outfits.

SEND FOR New Catalog

The greatest musical catalog ever published! Over 3,000 articles—every known instrument described and illustrated; many of them shown in full colors. Gives you lowest prices and all details of Free Trial, Easy Payment plan. All sent FREE—no obligation. Send coupon below.

Clip
and
Mail

THE RUDOLPH WURLITZER CO., Dept. 1771

120 W. 42nd St., New York 117 E. 4th St., Cincinnati
329 S. Wabash Ave., Chicago 250 Stockton St., San Francisco
Send me, absolutely free, new illustrated catalog, with prices and details of Free Trial Easy Payment plan. No obligation.

Name _____

Address _____

City _____ State _____

Instrument _____

(State instrument in which you are interested)

When y-o-u buy
Brown & Sharpe Tools
 on *Utility* alone

you are buying
 for the same reason
 that all classes of mechanics
 prefer these fine *Quality* tools
 the world over----because
 the tools profit the user.



Brown & Sharpe
Mfg. Co.
 Providence, R.I., U.S. A.

— Whether toolmaker, mechanic,
 machine operator or motor ser-
 vice man, there are tools in
 the complete Brown & Sharpe
 line for every need—tools
 necessary for the best work.

If you haven't a copy of our Small Tool Catalog, just
 ask for one at a good tool store—or we'll send a
 copy direct. It will profit you to keep a copy at hand.

“Standard of the Mechanical World”

What I would do if I wanted more money—By J. Matheson Bell

FIRST of all I'd make up my mind definitely that I was going to get it.

I don't believe any man living can get things worth while without *firmly believing* that he can. Determination will conquer failure anytime, anywhere.



"Busted" and Blue

I'll work harder on my present job to make the boss feel that he owes me more.

But I won't stop there.

I'll put my spare time to work.

I'll quit losing money by making my evenings pay.

I wouldn't give up my present job but I'd make more money by working longer hours.

I'd find something that could be sold evenings, either in my home or some one else's home.

That something would have to be a little out of the ordinary because it would have to be of special interest in the evening.

That would be the time of day when both the man and his wife are at home so I'd find something that would be of interest to both of them.



Decides to Work Harder

I feel sure that such an article would have to be something for the home, something they would both use and enjoy.

So far so good, but what will that something be.

Piano?

Fine, but come to think of it I can't even play one myself so that's out.

Automobile—

Sounds better, guess I could learn how, but seems to me that everybody I know has one. At any rate the auto sounds good—let's see if there is anything better.

Phonograph—

Doesn't sound near so good as the auto.

Vacuum Sweeper—



How Can I Make More?

Not so much interest to the man and I don't see just how I'd show up dust at night.

Radio—

Why, the Sam Hill didn't I think of that before, but let's see if it will do—let's see what its good points are as well as its bad ones.

True—I don't know anything about radio, but I have lots of friends who have learned something about it, so I think I could. What sounds good to me is, that I can demonstrate in the home in the evening, the very time of the day for me, and that's just when all the music is being broadcasted.

I'll have competition. I expect it. I'll have to know just what my demonstration will do that the other fellow's won't, so let's see what would make the biggest appeal.



Thinks Hard!

Of course, they would be impressed with music from our nearby stations but I feel sure that if I bring in great distances they will be more impressed. It will have to bring in music loud enough so they can sit away back in the room and enjoy it. It must have volume.

They may be satisfied with music from nearby stations, but they'll ask me for distance, so I must be able to get "by" our powerful nearby station. The radio I want must be selective so I can tune out our nearby station if I desire.

I can picture myself in some prospect's home with a radio that will do that, but I wonder if that is enough—maybe my competitor will be there also—maybe he can do all those things as well as I can.

Then where am I?

I've got it—I'll tell you what my radio must do—I want one that my prospect can do all the tuning, so that he will get the thrill of bringing in the music from a distance *clear and loud* and with a tone that will please.

After all he is the one who is going to operate it, so why wouldn't it be better and best if all he had to do was sell himself. I'll admit I'm not much of a salesman, so if I find a radio that



Gets An Idea—

will sell itself then I'll not only whip competition but I'll do it easily.

Best of all, I'll make that extra money I want.

Who knows, I may be so successful at it that I can give up my present job and give it all my time—Geethat sounds

too good to be true, but other men have done it so why can't I—I can and I will.

But what radio can I sell that will do what I want and yet sell at a reasonable price—I don't want one so high that my people can't buy—but it must be a good one.

Then when I do sell it, they will want me to fix anything that goes wrong so somebody must teach me how to service radio—that's something I can't afford to overlook.

Where is such a radio?

Where is a manufacturer who will teach me how to sell and how to demonstrate—where I can learn this business, both selling and servicing radio—there must be someone.



There is—Ozarka Incorporated of Chicago—the sign of the long distance

goose—they have a 64-page book "The Ozarka Plan" which they will send me if I tell them about myself and mention the name of my county. Where is my pen and some paper? I'm going to make more money and I'm going to start *right now* by writing for this book.

There is—Ozarka Incorporated of Chicago—the sign of the long distance

goose—they have a 64-page book "The Ozarka Plan" which they will send me if I tell them about myself and mention the name of my county. Where

is my pen and some paper? I'm going to make more money and I'm going to start *right now* by writing for this book.

I am greatly interested in the FREE Book, Ozarka Plan No. 100, telling how I can establish myself in the radio business and increase my present income.

OZARKA



INCORPORATED

120 Austin Avenue P
Chicago, Illinois

120 Austin Avenue P
Chicago, Illinois

Name.....

Address.....City.....

County.....State.....

Use
This
Coupon!

10-25

Start the New Year Right!

*Get the New Supplement
to the Starrett Catalog*



You're going to need new tools this coming year. NOW is the time to start planning.

Send for this Supplement to the Starrett Catalog. You will find it invaluable in making your selection of the tools best suited for your individual requirements.

Many fine, new Precision Tools are described in this Supplement to the regular Starrett Catalog. Illustrations—uses completely described—prices—the newest additions to the Starrett Line—it tells the whole story.

Write for it TODAY. Mailed promptly at our expense. Ask for Catalog No. 23 "AP" and Supplement.

THE L. S. STARRETT CO.

*World's Greatest Toolmakers
Manufacturers of Hacksaws Unexcelled
Steel Tapes—Standard for Accuracy
ATHOL, MASS.*



Starrett Tools

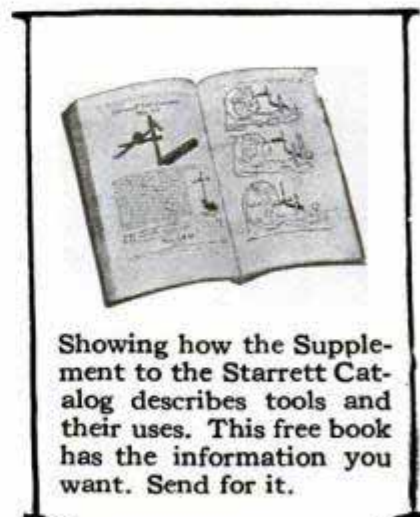

Showing how the Supplement to the Starrett Catalog describes tools and their uses. This free book has the information you want. Send for it.

Look *sent on*

Adjusted to the Second
Adjusted to Temperature
Adjusted to Isochronism
Adjusted to Positions
21 Ruby and Sapphire Jewels
25 Year Gold Strata Case
Your choice of Dials
(Including Montgomery R. R. Dial)
New Ideas in Thin Cases

Approval

The 21 Jewel
Santa Fe Special

We will send this famous watch, express prepaid, for you to examine, to inspect, to admire, to approve without one penny advance payment. Examine the watch and be convinced it's the best watch buy you ever saw. Just a small payment down, the balance in easy MONTHLY payments. You use the watch while paying for it.

Save 1/3 to 1/2 of Your Money

By purchasing this Famous Santa Fe Special Watch. Not only are you saving money from the present day prices of watches, but you can still secure the "Santa Fe Special" Watch, at the same low prices and terms that have made our watches famous.

Ladies' Wrist Watches

Artistic, dependable ladies' wrist watches—perfect timepieces, beautiful hand engraved cases in white or green gold. Send for New Watch Book and see the new shapes and designs. Sent on approval and sold on payments.

Write for "Santa Fe" Watch Book

Clip the coupon, fill out and receive the FREE WATCH BOOK just off the press. All the newest watch case designs in white or green gold, fancy shapes and thin models are shown. Read our easy payment offer. Wear the watch 30 days FREE. Watch sent for your examination and approval without a penny down. Nothing to risk. See the watch before you buy.

*Write for New Book Today and Select Your Watch.
Mail Coupon.*

SANTA FE WATCH COMPANY

16 Thomas Building, Topeka, Kansas
(Home of the Great Santa Fe Railway)

JUST OUT!

Send for our New Watch Book—Just off the press. It will post you about watch styles and values. Send for it today—It's FREE.

FREE BOOK COUPON

Santa Fe Watch Company,
16 Thomas Building,
Topeka, Kansas.

Please send prepaid and without obligation your New Watch Book Free, explaining your "NoMoney Down" Offer on the Santa Fe Special Watch.

Name

Address

State



*Men in every walk of life
now wear Strap Watches*



Slide Caliper Rule

A useful tool for close measurements. For especially fine adjustments, the final movement of the thumb slide is made by turning the knurled adjusting

nut. Reversing the slide, the tool can be used as a stop rule. Removing the slide provides a narrow hook rule. The tempered steel rule is 6 inches long, $\frac{3}{8}$ inch wide, $\frac{1}{20}$ inch thick, with either No. 10 or

metric graduation. Packed one in a pasteboard box, weight 2 ounces. Price \$3.50. Slide Caliper Rule, No. 1771, without the fine screw adjustment. Price \$2.50.

Save money, time, trouble

THE amount of effort and expense involved in repairs and replacements around the house—the car—the radio—often depends on the accuracy of your measurements.

Hair-line precision on close work, a snug fit for all parts you buy—such as gaskets, petcocks, washers, bolts, nuts, screws, keys, and pins—absolute accu-

racy of every measurement for which a caliper slide rule and a trammel rule can be used, is insured by these two vest-pocket-size tools.

These good tools will be mailed guaranteed, postage-paid, to any point in the United States on receipt of the price. Goodell-Pratt Company, Greenfield, Mass., U. S. A.

Trammel Rule

A compact, handy trammel for all measurements within the capacity of the steel rule which forms the beam. The hardened steel points can be set directly

from the graduations on the steel rule. When describing circles the point at the left, with the flat top, is used as the center, and the point at the right the scriber. The tempered steel

rule is 6 inches long, $\frac{3}{8}$ inch wide and $\frac{1}{20}$ inch thick, with either No. 10 or metric graduation. Packed one in a pasteboard box, weight $1\frac{1}{2}$ ounces. Price \$2.50.

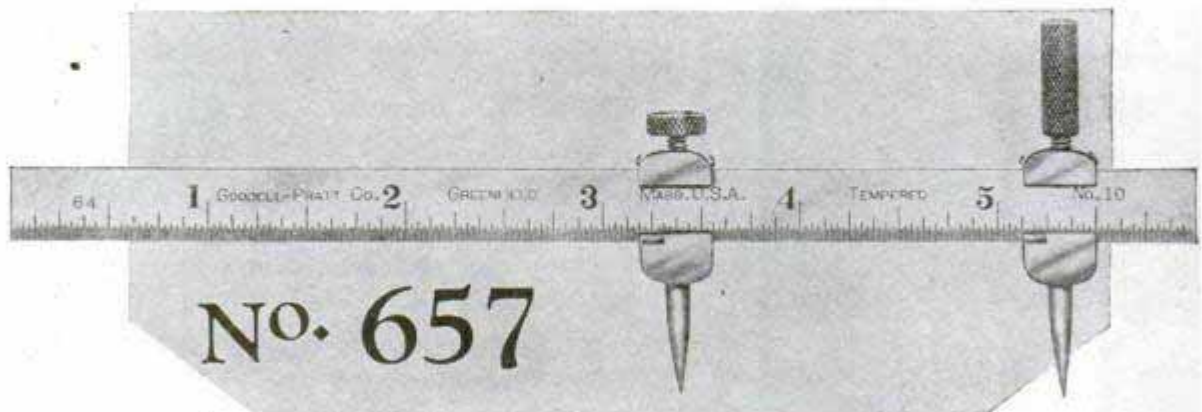

GOODELL-PRATT

1500 GOOD TOOLS

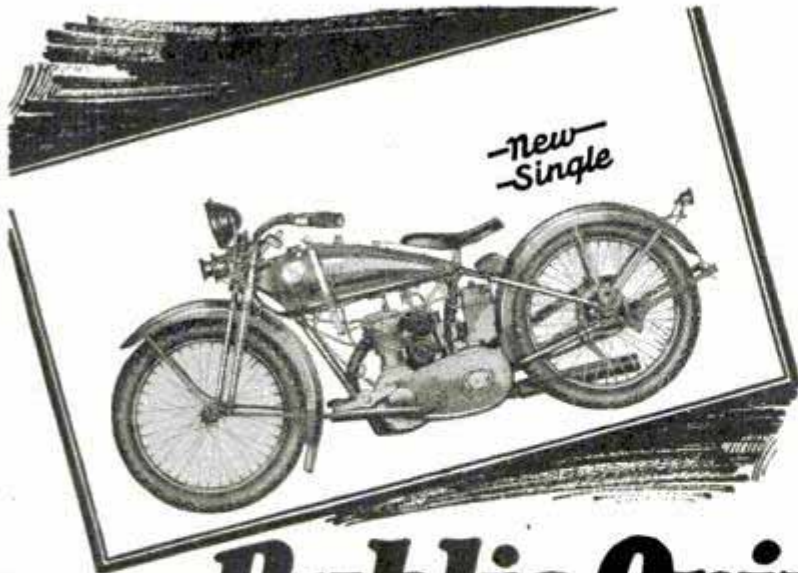

Public Opinion Built the "Single"

THIS new type of motorcycle represents the ideas of hundreds of men like yourself.

Low price — cheap upkeep — easy to ride. People have been waiting for these features in a motorcycle —and the Harley-Davidson Single is the answer.

It travels 70 to 80 miles on every gallon of gasoline—800 miles per gallon of oil—10 to 12,000 miles on a pair of inexpensive tires. Comfortably!

No trick to ride it—you learn in a city block. Ample power for any road or hill—amazing, but safely balanced speed. Easy to park and garage.

Your type of motorcycle! You can pay-as-you-ride!

See the "Single" at the Harley-Davidson dealer's. And mail the coupon.

HARLEY-DAVIDSON MOTOR COMPANY
Dept. P, MILWAUKEE, WISCONSIN



SEE
and RIDE

Money-making sales opportunities in open territories. Ask how others have made big successes selling Harley-Davidsons.

Mail the Coupon

See our other ad on Page 158

The New HARLEY-DAVIDSON Single

HARLEY-DAVIDSON MOTOR CO.
Dept. P, Milwaukee, Wis.

Send me FREE, interesting literature showing your 1926 improved "Single".

Name.....

Address.....

ASK . ANY . . RADIO . . ENGINEER

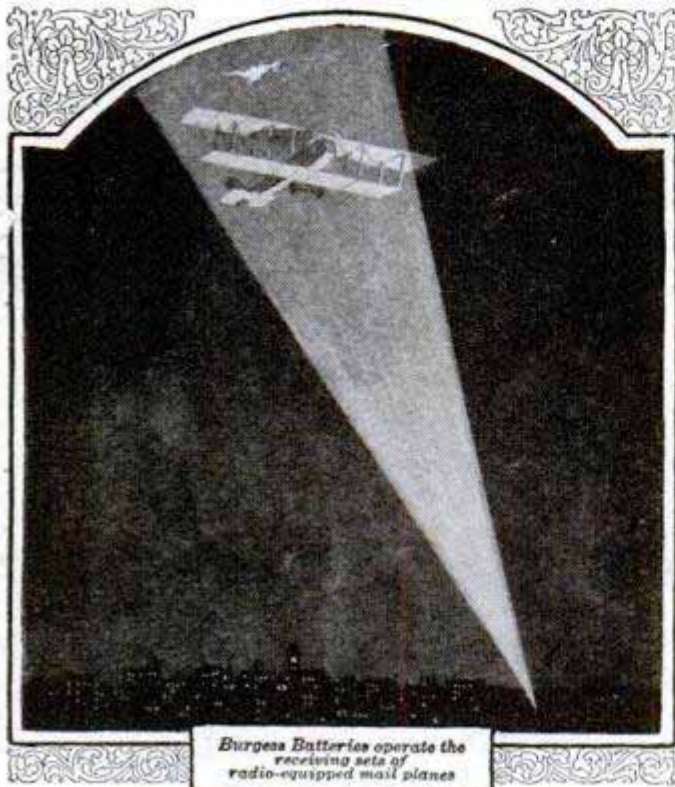

Burgess Batteries operate the receiving sets of radio-equipped mail planes

An every night adventure of Burgess Radio Batteries

ONE of the reasons why you should always buy Burgess Radio Batteries is that the batteries used by air-mail pilots—battleships—explorers—and the majority of recognized radio engineers—are evolved in the Burgess Laboratories and manufactured in the Burgess factory.

These batteries are identical with the batteries sold by your dealer and thousands of other good dealers everywhere.

BURGESS BATTERY COMPANY
GENERAL SALES OFFICE: CHICAGO

Canadian Factories and Offices: Niagara Falls and Winnipeg



BURGESS RADIO BATTERIES



Collapsible LOOP AERIALS

Popular Prices—Remarkable Results

No better loops at any price. Quantity production keeps prices low. Handsome, convenient and efficient.
LINCOLN 4-POINT TAPPED LOOP . . . \$8.00
 Built for any circuit where it is desired to vary the inductance of the loop. Exceptionally fine for Superhets.
LINCOLN CENTER-TAPPED LOOP . . . \$6.50
 For any set employing radio frequency amplification. For certain Superhets requiring a center tap. If your dealer cannot supply you, order direct, giving your dealer's name. Write for illustrated catalog **PM.**
LINCOLN RADIO CORPORATION, 224 N. Wells St., Chicago

RADIO DEALERS WANTED!

If you are the type of dealer who hustles after business, who isn't content to wait for trade to come in but who takes sets out to demonstrate, can talk and sell quality merchandise, and knows Radio values, we have a big proposition for you. Are you that dealer?

50% DISCOUNT TO DEALERS

We manufacture a complete line of high grade receivers and sell to dealers at 50% discount. We are distributors for more than 225 Nationally advertised lines. Write today for amazing offers, new 112-page catalog and regular monthly catalogs quoting below-the-market prices on latest merchandise—all free. Everything in Radio for less.

AMERICAN RADIO MFG. CO.
1416-18 McGee St. Dept. O, Kansas City, Mo.

SOLDERALL
METAL IN PASTE FORM

The only convenient metal solder

Every Electrical Connection needs Solderall for perfect reception

25¢

The **SOLDERALL CO., NEWARK, N.J.**

LATEST WHOLESALE RADIO CATALOG Simply Send Name

FREE TODAY for big 64-page book explaining liberal proposition paying agents \$60 to \$100 a week and how to get latest radio goods at Wholesale. Live dealers and agents wanted.

STANDARD RADIO CO., 1402 Walnut St., Kansas City, Mo.

Radio

The LIFELONG ONLY 4.95

CRYSTAL VARIOMETER RECEIVER

Now you can have this genuine variometer tuned crystal receiver for only \$4.95 ready to hook up to any electric light socket. We guarantee, by following factory instructions, that you can listen in on stations from 1 to 50 miles away and hear perfectly. Why wait when you can have this amazing set now for only \$4.95? or \$6.70 complete with ear phones. **Send No Money.** Just pay postman small C. O. D. Charges after approving this amazing Radio. Take no chances but mail your order for the famous **LIFELONG** Radio today on an absolute guarantee of success.

THE LIFELONG RADIO COMPANY
1757 Coit Avenue E Cleveland, Ohio

Copyright 1925
Shipman-Ward Mfg. Co.

Save on the price, and get a FIVE year guarantee
—
All tools, cover, etc., included



A Genuine Underwood

\$3 and it's yours

Own a Typewriter!

Act NOW, and Get a FREE Trial of this ACE of Writing Machines!



Speak up, if you want one! Underwood typewriters are so popular this lot we're completing now won't be long in selling! Rebuilt from top to bottom—*every single worn part replaced*. New typewriters are guaranteed for a year; we guarantee this one *five* years! That's our Better-Than-New Guarantee. And we guarantee a big saving!

You can learn to write on this standard keyboard Underwood in a day. In a week, you'll feel lost without it! The free trial will *prove* it. Our rebuilt plan gives you the *best* machine and a *big* saving!

Don't send a cent, but do get our

special offer—valuable book on typewriting—*free*.

Pay Like Rent

Three dollars puts this Underwood in your home—small monthly payments soon make it yours for good if you want to keep it—but send no money now. Just get our offer. Clip and mail coupon. There's no excuse now for not owning a typewriter—and the finest make! We include all tools, cover, etc., all complete, all ready to write. Write us now. Deal direct; we are the largest factory of the kind.

Get our catalog free; quotes lowest prices and most liberal terms in exist-

ence. We'll send a manual free, too; it contains valuable instruction for learning rapid typing, useful pointers for all who use a typewriter.

FREE NEW BIG BOOK ON TYPEWRITERS

SHIPMAN-WARD MFG. CO.
2121 Shipman Bldg., Chicago

Please send FREE, full offer, catalog, typing manual, and outline your free course in Touch Typewriting.

Name
St. or RFD.....
P. O.



for distance
install a
Beldenamel Aerial

THE Beldenamel Aerial is not a trick aerial. It is a scientific achievement, endorsed by leading radio engineers.

Beldenamel Aerials are made of stranded copper. Each strand is coated with baked Beldenamel to protect the copper surface from corrosion. A Beldenamel Aerial cannot deteriorate. The signal strength and volume are constant, winter after winter, in spite of smoke and fumes in the atmosphere. No bare copper aerial can accomplish this result. For distance and volume, install a Beldenamel Aerial, today!

Sold by all
Leading
Radio
Dealers and
Jobbers



Belden

Send for Free Illustrated Booklet

Belden Manufacturing Company
2306-H So. Western Ave., Chicago

Please send me your latest illustrated booklet, free, describing Belden Radio Products and their use in radio work.

Name.....

Address.....

EFFICIENCY

That Meets the Requirements of Eminent Radio Engineers

Apex Vernier Dials are more than mere "knobs." In reality they are instruments endowed with an ultra degree of efficiency. Their rich elegance of finish lends a touch of striking attractiveness to any set. Precision of production and of operation makes a good set a better set—providing a greater range of selectivity—positiveness of control—and utmost simplicity of tuning in most difficult stations. Ratio 12 to 1. Clockwise or counter clockwise. No back lash. Royal Brass Finish 4-inch \$1.50—3 1/4-inch \$1.25. Satin Silver Finish 4-inch \$1.75—3 1/4-inch \$1.50. DeLuxe Gold (24K) Finish 4-inch \$2.50—3 1/4-inch \$1.85. Your dealer has them. If not, order direct.

APEX Rheostat Dials

are as essential to successful operation and pleasing appearance as are Apex Vernier Dials. Royal Brass Finish—60c. Satin Silver Finish—70c. DeLuxe Gold (24K)—80c.

APEX ELECTRIC MFG. CO.

Dept. 101

1410 W. 59th St. CHICAGO

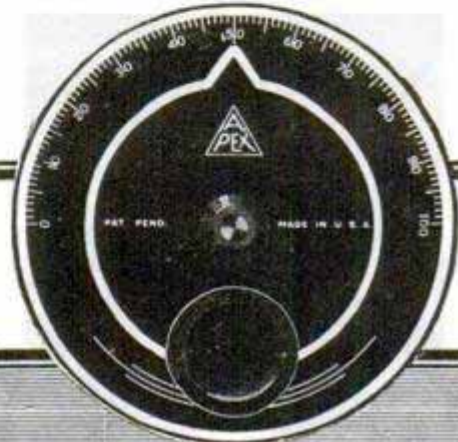

COAST TO COAST RADIO—Low Price



IMPERIAL 5 Tube Set

Latest, most advanced type 5 tube tuned radio frequency receiver. Greater range, power, selectivity and perfect tone. Why pay more when you can't get more than the new IMPERIAL gives you? Write at once for full particulars of this new, better radio receiver and low prices.
SIMPLEX CO., 2835 S. Michigan, Dept. 22, Chicago

Como Duplex Transformers

"The World's Standard for Push Pull Amplification"

Use them in your set and you will realize why they are continually specified by leading Radio Engineers. The fact that they are widely copied is proof of their superiority. "Take no chances—use Como."

\$12.50 per matched pair at leading dealers. Send for literature.

Como Apparatus Corp., Manchester, New Hampshire

**Save 20 to 50%
FREE RADIO CATALOG**



Get the lowest rock-bottom prices on radio parts, sets, kits. New free Radio Catalog and Guide brimful of standard, reliable, guaranteed goods. Over 100 latest hook-ups and illustrations. Be sure to get this thrifty book before you buy. It puts money in your pocket. Saves you as much as half on a set. Also please include name of radio fan. Send letter or postal NOW.

THE BARAWIK COMPANY

103-168 S. Canal St., Chicago, U. S. A.

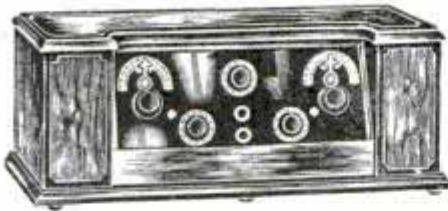

Crosley Super-Trirdyn Special

The improved Super-Trirdyn panel is assembled in a new solid mahogany cabinet finished in duotone. This cabinet with its striking lines and simple detail decoration is of ample size to house all dry batteries required for dry cell tube operation..... **\$60.00**

Performance That Has No Peer In Any Field of RADIO

Since the announcement of the present new Crosley models, Crosley sales have been leaping to sensational figures, literally taxing the production facilities of all Crosley plants.

This new leadership in sales is based on Crosley's new leadership in value; and this latter resolves itself into two simple propositions:

Crosley sets consistently deliver a performance that has no peer in any field of radio—and this matchless performance is offered at the lower prices that only the economies of tremendous production make possible!

On this page are shown four of the new Crosleys—the two famous Super-Trirdyns and the two Special De Luxe models. Not only do they offer an effective beauty and accurate workmanship, but they provide a performance that cannot be surpassed in the \$23.50—\$60 price range or many dollars above it!

Make your own comparison on the basis of selectivity, distance, clarity, and volume. Place the competing receivers side by side with lead-ins from the same antenna, and put them through their paces.

Forget the radical difference in price. Reach your conclusion solely on results. Then and only then will you understand why thousands upon thousands of radio buyers are singling these Crosleys out of the entire field—unwilling to pay more because a greater investment cannot provide greater enjoyment.

See the complete Crosley line at the nearest Crosley dealer's. Address Dept. 15 for his name and our illustrated catalogue.

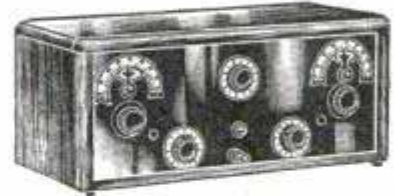

Crosley Super-Trirdyn Regular

Incorporating the famous Trirdyn hook-up, this set brings in stations sharp, clear, and mellow on the Must-cone. The cabinet is of oil rubbed solid mahogany, exquisitely simple in design and beautifully finished. For sheer performance under all conditions the Super-Trirdyn **\$45.00** cannot be surpassed.....



Crosley 3-Tube 52 S. D.

In this improved model are introduced radical refinements that increase its general efficiency. Refinement of parts and improvements in design have made it a truly remarkable value, considering its nominal price. Genuine Armstrong regeneration with the double circuit to reduce radiation to a minimum. Beautifully proportioned with attractive sloping panel. Cabinet holds all necessary dry cells. A genuine long range radio, easy to tune, easy to enjoy, and **\$32.50** easy to pay for.....

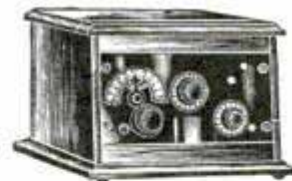

Crosley 2-Tube 51 S. D.

This superb long range set combines Armstrong regeneration and one stage of audio frequency amplification. The handsome mahogany finished cabinet, with sloping panel, holds all required dry batteries. Improvements include new worm type tleklie, new vernier plate condenser, and a double circuit to minimize radiation. Unusual selectivity and distance, extreme accuracy **\$23.50** of control.....

CROSLEY · RADIO

B E T T E R · C O S T S L E S S

THE CROSLEY RADIO CORPORATION, CINCINNATI, OHIO

Cable Address: Listenin-Cincinnati

Owning and operating WLW, first remote control super-power broadcasting station

Crosley manufactures receiving sets which are licensed under Armstrong U. S. patent No. 1,113,149 and priced from \$9.75 to \$60.00 without accessories. None of the prices quoted include batteries, tubes, headphones, etc. Add 10% to all prices west of the Rocky Mountains.

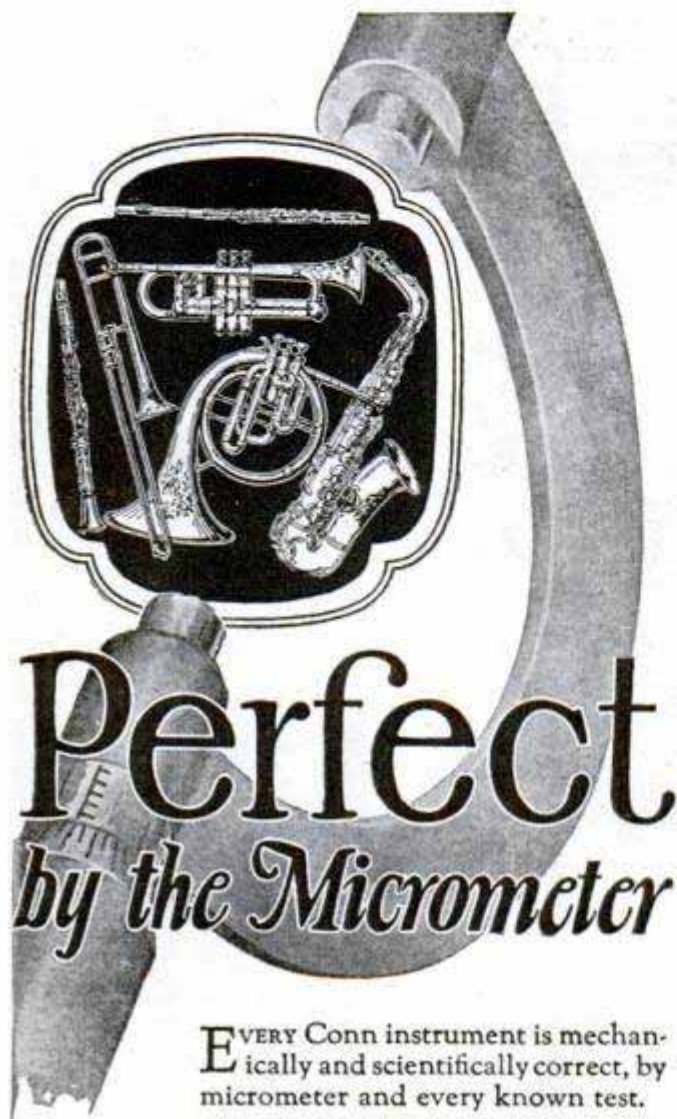

Perfect by the Micrometer

EVERY Conn instrument is mechanically and scientifically correct, by micrometer and every known test.

The famous hydraulic expansion process, originated and patented by Conn, assures ease of blowing, perfect pitch, that sweet yet brilliant tone which sets Conns apart from all others as supreme in quality.

World's foremost artists use Conns—the Conn you buy is exactly the same quality as theirs.

Free Trial, Easy Payments. Conn is the only maker of every instrument for band. Send coupon for "Success in Music and How to Win It," and details of trial offer; mention instrument.

Dealers and Agents Everywhere



Isham Jones, famous saxophone star, uses and endorses Conn instruments.



C. G. CONN, Ltd.
131 Conn Bldg., Elkhart, Ind.

Gentlemen: Please send Free Book and details of trial offer on.....
(Instrument)

Name

St. or R. F. D.

City, State

County.....

Use Pencil Please



FANSTEEL Balkite Radio Power Units

the ideal radio
power supply

Simple—Noiseless—Permanent

Balkite Battery Charger for "A" batteries. Balkite Trickle Charger converts your "A" battery into a power unit that operates from the light socket. Balkite "B" replaces "B" batteries and operates from the light socket.

Fansteel Products Co., Inc., North Chicago, Ill.

All Balkite Radio Power Units are Tested and Listed as Standard by the Underwriters' Laboratories

CLASS 25¢ PINS

BUY DIRECT FROM THE MAKER
CATALOG FREE

Either pin shown made with any 3 letters and 2 figures 1 or 2 colors enamel. Silver plate 25¢ ea. \$2.50 doz. Sterling silver, 40¢ ea. \$4.00 doz.

BASTIAN BROS. CO.
3490 630 Bastian Bldg., Rochester, N. Y. 2534

CHRISTMAS GIFT!

MAKE MOVIES YOURSELF

There's a wonderful thrill in taking your own motion pictures of interesting things where you live, of unusual scenes when you travel, of events everywhere.

VICAM Movie Camera

COMPLETE OUTFIT FOR TAKING AND SHOWING takes high-grade, standard size pictures. Wonderful features—close-ups, stills, portraits, swift action. Can be loaded in daylight. Pictures can be projected on wall or sheet.

\$37 Including 2 Magazines

WRITE FOR INTERESTING CATALOG
Send 10c in stamps for illustrated catalog describing marvelous Vicam Products.

Vicam Photo Appliance Corporation
1224 Belmont Ave. Philadelphia, Pa.

Make \$60 to \$100 A WEEK

**New 300 Candle Power Lamp—
Burns 96% Air**

Introduce wonderful patented invention. Burns only 4% fuel—cheap kerosene or gasoline. Uses less than wick lamps. Greatest advancement in lighting of the age. Table lamps, wall lamps, hanging lamps, lanterns. Powerful, brilliant, soft, restful white light—like daylight. Brighter than a score of wick lamps. No Smoke—No Soot—No Odor.

FREE Outfit Offer Easy to earn big Money. No experience—no capital required. Work all or spare time. Simply take orders. We deliver and collect—pay you big commission same day. Vivian of Minn. made \$400 in 39 days. Green of N. Y. made \$33 in one day. Hundreds making \$10 to \$40 a day. Get territory quick. Big season now on. Write today for **Free** catalog and special agents offer.

THE AKRON LAMP COMPANY
101 Lamp Building Akron, Ohio

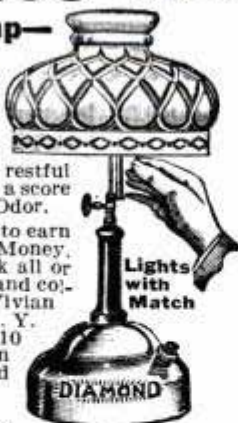

Agents: \$2 an Hour

Wonderful new selling plan for prepared cake flour. Jiffy cake contains eggs, milk, sugar, shortening, baking powder and flavoring—all ready to bake. We have plan that sells it in every home. Repeat business. Steady income.

\$50 to \$100 a Week

Write now and we will tell you how to make \$2,000 cash and a free automobile in six months. 350 High quality, low price Zanol Products. All fast sellers. No capital or experience required. Write today for territory, free auto offer and details of our new selling plan.

American Products Co., 4954 American Bldg., Cincinnati, Ohio

I WANT 350 AGENTS

To complete my selling organization for VE-PO-AD, the amazing new vest pocket adding machine. Sells on sight. 100% profit for you in every sale. Many of my men

MAKE OVER \$200 WEEKLY

Everyone who uses figures is your prospect. Exclusive territories. A real money-making opportunity for live agents. Write me today for full details. Sample machines furnished FREE.

C. M. CLEARY, Sales Manager, Reliable Adding Machine Corp.
Dept. 41 104 W. Washington St., Chicago, Ill.



AGENTS!!! 300 to 500% PROFIT

Goods have Fine Appearance, Good Quality. Sells easy, and agents make big money. Write today for FREE CATALOGUE AND SAMPLES.

National Soap Company
512 W. Huron St., Dept. D-5, Chicago

THIS WONDERFUL INVENTION



converts any ordinary cook stove into a gas stove. OXO-GAS is made from kerosene and air. Cheaper, cleaner and more efficient than coal. Responsible distributors wanted.

GLORIA LIGHT CO.
111-N. May St. Chicago, Ill.

30 Days' Free Trial

Select from 44 Styles, colors and sizes, famous **Ranger** bicycles. Delivered free on approval, express prepaid, at **Factory Prices**. You can easily save \$10 to \$25 on your bicycle. Prices \$21.50 and up. \$5 a Month on any Ranger if desired. Parents often advance first deposit. Boys and girls can easily earn small monthly payments. Pay as you ride.

Tires Lamps, wheels and equipment, low prices. **Send No Money, do business direct with makers.**

Mead CYCLE COMPANY
DEPT. 109 CHICAGO

Write today for free Ranger Catalog, factory prices and marvelous easy payment terms



LOFTIS BROS. & CO. EST'D 1858



The Best Christmas Gift of All—A Diamond Ring

Buy of **LOFTIS**, the Direct Importer. Our Diamonds are exquisitely beautiful, high-grade, **QUALITY** gems, Blue White, of dazzling brilliancy—the finest offerings of the European Diamond markets. Personally selected by our expert Diamond buyers.

We invite comparison of quality and prices

Send for Catalog

Over 2,000 illustrations of Diamond-set Jewelry, Watches, Wrist Watches, Pearls, Mesh Bags, Silverware, etc. Sent prepaid for you

FREE EXAMINATION

TERMS: Goods delivered on first payment of one-tenth of purchase price; balance in equal amounts, payable weekly, semi-monthly or monthly, at your convenience.

Satisfaction Guaranteed or Money Refunded

Cash or Credit

WRIST WATCH

No. 49—Solid 18-k White Gold, 17 Jewels, \$35. Delivered on first payment of \$3.50, then

\$1.00
A Week



17-Jewel Elgin

Guaranteed 25 Years
No. 15—Green Gold, engraved. Assorted patterns. 12 Size, gilt dial, \$30. Delivered on first payment of \$3.00, then

\$1.00
A Week

LOFTIS BROS. & CO. EST'D 1858

NATIONAL JEWELERS

DEPT. H894
108 N. State St., Chicago, Ill.
Stores in Leading Cities



No. 34
5 Blue White Diamonds, 4 Sapphires, Platinum, \$300. Only \$30 down, then
\$7.50
A Week



No. 33
Blue White Diamond, Solid 18-k White Gold, \$75. Only \$7.50 down, then
\$1.75
A Week



No. 12
Blue White Diamond, Solid 18-k White Gold, \$50. Terms, \$5 down, then
\$1.25
A Week



No. 35
Blue White Diamond, Solid 18-k White Gold, \$97.50. Pay \$5.75 down, then
\$1.00
A Week



No. 27
Dazzling, Blue White Diamond, Solid 18-k White Gold, Price \$100. Pay \$10 down, then
\$2.50
A Week

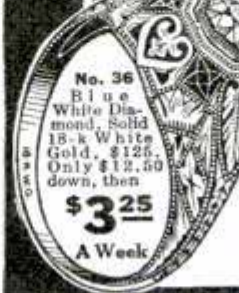

No. 36
Blue White Diamond, Solid 18-k White Gold, \$125. Only \$12.50 down, then
\$3.25
A Week

Send for Christmas Catalog today

Radio Fans

Listen in on W. H. T. every Tuesday night from 7 to 7:30; every Friday night from 10 to 10:30, central standard time. Loftis Bros. & Co.'s hour of music.



Build and Fly Your Own 3-ft. Model Aeroplanes!

It's the most interesting fun you ever had. Shows you how big machines are built, because these are true models of real 'planes. You can fly your model too, right from the ground, under its own power. Any bright boy can build one. Ideal Scale Drawings and Building-Flying Instructions show exactly how to do it; and Ideal Model Aeroplane Construction Outfits contain everything needed. Get your outfit now and build a model Aeroplane for Christmas!



This is the Well Known JN4D-2 Training Plane Complete Construction Outfit \$7.

(West of Denver, Colo. and in Canada, add 50c to these prices.)



This is the Famous DeHAVILLAND Mail Plane Complete Construction Outfit \$7.50

These are perfect 3 ft. models of the popular aeroplanes, and have parts and fittings like big ones. Guaranteed to rise from the ground and fly in the air under their own power when correctly constructed. Complete Construction Outfits contain everything required to build the Model with plans, drawings, charts and full instructions.

Ask Your Local Dealer for These Ideal Model Aeroplane Construction Outfits or we will supply them postpaid, upon receipt of prices listed.

Plans and Instructions for Ideal Model Aeroplanes, each 25c

Scale Drawings and Building-Flying Directions; BUT NO MATERIALS; for 3 ft. Models of any one of these Aeroplanes: Curtiss JN4D-2; DeHavilland Mail Plane; NC-4 Naval Seaplane; Bleriot, Nieuport or Taube Monoplanes; Cecil Peoli Racer—25c each postpaid. (7 for \$1.50 postpaid.)

Catalog Ideal Model Aeroplanes, Parts, Supplies and Flying Toys, 5c postpaid.

IDEAL AEROPLANE & SUPPLY CO., 408 W. Broadway, New York

Palmolive Shaving Cream

"5 New Delights for Men"

Amaze Your Friends With Chemical Tricks

The Boy's Handbook of Chemistry
Price 15 Cents

Write secret letters with invisible ink; pour blue, brown and black liquid from a glass of water; make a magic pitcher of bluing; make your own magic writing paper, your own ink and dyes. It's all easy if you have Chemcraft Junior—the pocket Chemical outfit. Get yours now. Order right away and get a FREE Copy of The Boy's Handbook of Chemistry; 100 pages of experiments, formulae, interesting chemical information, money-making suggestions and catalog of supplies.

CHEMRAFT JUNIOR CHEMICAL OUTFIT
PRICE 25 CENTS

Porter Chemical Co.
113 Washington St.
Hagerstown, Md.

BOTH 25c POSTPAID



TO SELL MY HIGH GRADE LINE OF GENERAL Made to Measure Clothes—famous for years. Now selling direct from factory at almost half price. Quick easy money for you. Sell on sight at \$23.50.

\$4.00 Profit for You

All wool fabrics—big variety—latest styles. Perfect fit and satisfaction guaranteed. Commissions in advance. I have men making \$150 weekly full time. \$20 to \$60 a week part time. Rush name for new convenient-to-carry sales kit.

Tom Rudge, Sales Manager
General Tailoring Co., 529 South Franklin Street Dept. 41 CHICAGO

SEND NO MONEY 2 Genuine Diamonds 4/100 Each

Cut Stones, No Chips
SOLID GOLD \$25

Terms if desired (6 mos. to Pay)
Outside U. S. cash with order
14 kt. White gold top. Gold Emblem (any Lodge) or any Initial (Old English), yellow or white gold, Inlaid in Genuine

HOPE RUBY

Also, in Black Onyx



New No. 6132

Send size of finger and ring This Reg. Trade Mark will be sent for inspection. Guarantees you genuine diamonds.
Send for Free Catalog **D F C M S M** Any Letter
BUFFALO JEWELRY MFG. CO., "THE MAIL ORDER HOUSE" Dept. P 501 Washington St. BUFFALO, N. Y.

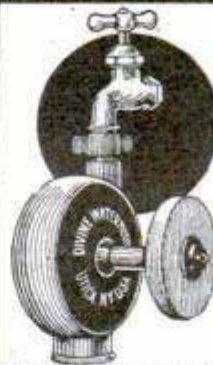

DIVINE RED DEVIL Water Motors

Simple—strong—durable. Wonderful little workers for all sorts of household and shop uses. Thousands in use. For all light power purposes. Attaches to faucet.

Two sizes: 4"—\$4.25
6"—\$6.75

The higher the water pressure the more work they do.
Send today for catalogue.
Divine Water Motor Company
Utica, N. Y.



THIS CLEAR, POWERFUL 6 POWER VEST POCKET TELESCOPE with glove leather case \$2

Only 3 3/4 in. long! Easily slips in vest pocket, yet powerful, precise, adjustable to either eye, six full magnifications, and brings distant objects close without objectionable "trembling" of higher power glasses. Nothing cheap in appearance or action. Guaranteed satisfactory by us and by maker, or money back at once. Handsome black baked-in enamel finish. Fine flint glass lenses by Wollensak. Check, money order or C.O.D. \$2.00 prepaid, including fine limp leather case.

BOSTON SPORTING GOODS CO. Dept. P, 80 Boylston St. BOSTON, MASS.

Beautiful HOUSES \$900 and BUNGALOWS

CAN BE BUILT FOR AND UP

This and many others in my new book, Building Plans for Modern Homes, will save you hundreds of dollars. One of the most complete and comprehensive books of plans ever published by any architect. New edition just off the press. Nearly 600 floor plans and photographs of Colonial houses, bungalows, etc., costing from \$200 up; gives sizes and cost to build. Sent postpaid for \$3.00.



FREDERICK H. COWING ARCHITECT
101 Tremont St., BOSTON, MASS.

Save Coal!



— and get much more heat too! Here is a device, installed on furnace door, giving balmy warmth on coldest days, the—

CROWN FUELSAVER

Guaranteed to save 20% of fuel. Entirely automatic. Easily installed. Used on any heating plant. Endorsed by hundreds of users.

LIVE DISTRIBUTORS WANTED

Count the homes in your locality—every one means a profit. Substantial, permanent income assured. **WRITE TODAY** for complete sales plan.

C. F. S. Co., 41 No. 10th St., Richmond, Ind.

Sole Canadian Distributor: 33 St. Vincent St., Montreal, Can.

Self-Filler DE LUXE Style Pen

"INDEPENDENT"

All the best features of a Fountain. Lasts longer. Writes smoother. Improves handwriting. Eliminates inkage. **GUARANTEED.**

\$2.00

By Mail

14 Kt. White Gold Point. Chased Rubber Holder. Lever Filler. Pocket Clip.

Your Name in Gold Inlay, 25c.

Write for Pen Catalog. Agents Wanted.

J. C. Ulrich & Co., 161 Washington St., New York
Known the World Over for 40 Years.

Easy to Fill Walls with Pictures & Decorations

MOORE PUSH-PINS

Glass Heads — Steel Points

Moore Push-less Hangers
Securely Hold Heavy Articles

10c pkts. Everywhere

MOORE PUSH-PIN CO., Philadelphia, Pa.

DOES YOUR BOAT LEAK?

Send for our Booklets, "How to make Your Boat Leakproof," and "Marine Glue—What to Use and How to Use It."

JEFFERY'S MARINE GLUES IN ALL THE VARIOUS GRADES

Any old boat so long as the frames are in fair condition can be made watertight by following the instructions in the above booklets.

For sale by all Yacht, Boat and Canoe Supply Houses; Hardware, Paint and Oil and Sporting Goods Dealers.

L. W. FERDINAND & CO.

156 Kneeland Street Boston, Mass., U. S. A.

WHITE FLAME

BURNERS make your old kerosene lamps and lanterns give a brilliant white light better than electricity or gas. Doubles your light. Saves oil. **NO MANTLE TO BREAK.** Guaranteed Safe and Reliable. Delights every user. Send now for complete sample postpaid 50 cents, stamps or coin. 3 for \$1.25. Money Back if Not Satisfactory. Live Representatives Wanted. Exclusive Territory.

WHITE FLAME LIGHT CO., 68 Clark Bldg., Grand Rapids, Mich.

AGENTS 500% PROFIT

GENUINE GOLD LEAF LETTERS

S guaranteed to never tarnish. Anyone can put them on stores and office windows. Enormous demand, large profits. Paul Clark says: Smallest day \$28.70. R. L. Reel made \$920 in two months. Write today for free sample and liberal offer to general agents.

METALLIC LETTER CO., 433-B N. Clark St., CHICAGO

National Handball Champion wins on Keds!

Trademark Reg. U.S. Pat. Off.



THE National A. A. U. Handball Championship was added recently to the list of championships won on Keds! Also the New York State Handball Championship.

Champion players in all lines today wear Keds because Keds give longer wear and better service.

Keds soles are full of life—built to absorb jolts—remarkably tough. The uppers are of durable canvas—strong enough to protect against twists—yet light and comfortable. A special Feltex innersole absorbs perspiration—keeps the feet cool.

And remember—Keds are made only by the United States Rubber Company. Every real Keds shoe has the name Keds on it.

Our Keds Hand-book of Sports is full of interesting information—on games, sports and dozens of other subjects. Sent free if you address Dept. 970, 1790 Broadway, New York City

United States Rubber Company

They are not Keds unless the name Keds is on the shoe.



"COMET"
the special Keds basketball shoe. It gives a sure grip

\$351.00
Cleared
in one day
(Aug. 1925)
by W. H. Adams
Dayton, Ohio

V. A. Marini, Santa Cruz, Cal. (Nov. 1924) reports \$11,275 sales in 3 months. J. Gordon of New Jersey says \$4000 profit in two months. Alexander of Penn. \$3000 profit in four months. Ira Shook, Flint \$365 in one day. Bram, bought one outfit then 10 more within a year. Patillo, Ocala, writes: "Crispettes all you claim and then some." John W. Culp, South Carolina, writes, "Everything going lovely. Wrappers lying all over. It's a good old world after all." Perrin, \$380 in 1 day. Mrs. Lane, Pittsburgh, 8000 packages in

one day. J. R. Bert, Ala. "only thing I ever bought that equaled advertisement."



WE'LL START YOU IN BUSINESS

Furnish secret formulas, raw material, and equipment. Very little capital required; no experience needed.

Build Paying Business of Your Own

No limit to the sale of Crispettes. Everybody likes them. It's a delicious food confection made with or without sugar. Write me for facts about a business that will make you independent. Start now, in your own town.

Profits \$1,000 a Month Easily Possible

Send postal for illustrated book of facts. In contains enthusiastic letters from others—shows their places of business, tells how and when to start, and all information needed. Free. Write now!

LONG-EAKINS COMPANY

128 High Street Springfield, Ohio



I Made \$21.00
In Five Hours

—Writes Peter Werner, III, Sell Madison "Better-Made" Shirts for Large Manufacturer Direct to wearer. No capital or experience needed. Many earn \$100.00 weekly and bonns.

Write for Free Samples

MADISON SHIRT MILLS, 562 Broadway, New York

Do Your PRINTING

Cards, stationery, circulars, labels, paper. Complete Outfits \$8.85 up, Rotary Jobber, \$150. Card Cutters \$3 Save Money. Print for others, big profit. Easy with rules sent. Write for catalog presses, type, paper, cards ink, etc. **THE PRESS CO., L-37, MERIDEN, CONN.**



"If I hadn't been all through it myself, I wouldn't have the assurance to say to you 'cheer up.'"

ERICKSON.

Those who wear them say:
ERICKSON LEGS are Wonderful

because they do not chafe, overheat or draw end of stump.



If you have had a recent amputation send for new booklet on TEST LEGS for beginners.
E. H. ERICKSON CO.
 38-A Washington Av. N.
MINNEAPOLIS - MINN.

SAVE YOUR BODY

Conserve Your Health and Efficiency First

"I would not part with it for \$10,000"

Sowrites an enthusiastic, grateful customer. "Worth more than a farm," says another. In like manner testify over 100,000 people who have worn it.

The Natural Body Brace

Overcomes **WEAKNESS** and **ORGANIC AILMENTS** of **WOMEN** and **MEN**. Develops erect, graceful figure. Brings restful relief, comfort, ability to do things, health, strength.



For Boys and Girls Also

Wear it 30 Days Free at Our Expense

Does away with the strain and pain of standing and walking; replaces and supports misplaced internal organs; reduces enlarged abdomen; straightens and strengthens the back; corrects stooping shoulders; develops lungs, chest and bust; relieves backache; curvatures, nervousness, ruptures, constipation, after effects of Flu. Comfortable, easy to wear.

Keep Yourself Fit Write today for illustrated booklet, measurement blank, etc., and read our very liberal proposition.

HOWARD C. RASH, Pres., Natural Body Brace Co.
 223 Rash Building - SALINA, KANSAS

REDDING & COMPANY

(Est. 1859) 9 West 23 St., N. Y. C.

Masonic Books, Monitors, Bibles, Jewelry, and Lodge Supplies



Send for catalogue 3 of Books and Jewelry; catalogue 4 of Lodge Supplies. No obligations. Mail orders promptly filled.

MOTORCYCLES

LESS THAN HALF COST



Ace, Indian, Cleveland, Harley-Davidson, Henderson Motorcycles and Sidecars, new, used and rebuilt. **Rider Agents Wanted.** Write for FREE trial offer, agent's free outfit and big bargain bulletin. **New American Bicycles** in different styles and colors. Write for illustrated catalog giving our money saving prices.



AMERICAN MOTOR CYCLE CO.
 2047 W. Chicago Ave., Dept. 129, Chicago

DENINGER WILL TRUST YOU

\$40 SEND 10c INSTAMPS FOR CATALOGUES
BIG MONEY SAVING FOR YOU

Used and rebuilt motorcycles \$25 to \$100, used bicycles \$9.50, tandems \$20. All machines fully guaranteed. New bicycles and motorcycles at factory prices, save dealers' profits. Motorcycle and automobile tires \$3. Complete line frames, engines, supplies.

DENINGER PRICE CUTTER, ROCHESTER, N. Y.

PAY AS YOU RIDE

STOP FORD CRANKSHAFT END-PLAY!

C-A ADJUSTABLE BEARING corrects and prevents end-play without removing motor. Eliminates many troubles. Easy to install—simply drop pan. Only \$3.75. Ask your dealer or sent prepaid by **ADJUSTABLE BEARING CO.** Dept. P **BRAZIL, IND.**



INSTALL YOUR OWN
FREE PLANS
HOT WATER HEATING PLANT
CUT-TO-FIT GUARANTEED



Complete Hot Water Plants ready for shipment. Outfits as low as \$200.

PLUMBING and HEATING

→ SAVE HALF ←

By our New Easy Method and Lowest Wholesale Prices.

Mail the coupon for our FREE Bargain

Catalog. Gives illustrations, complete descriptions, sizes and wholesale prices on Heating Outfits of all kinds, Water Supply Systems, Complete Bathroom Outfits and Plumbing Supplies, Fittings, Pipes, etc. All at wholesale. Send today for your copy.



50 Years and Million Dollar Plants

behind our bonded guarantee. Every Hardin-Lavin System is figured to eliminate long runs of piping, to save valuable time and unnecessary materials and expensive labor. We furnish Heating Plants or Plumbing Outfits cut-to-fit at the factory for the exact job and we thread and mark all the larger pipes. Any Handy Man with our simplified plan and new easy method can do the installing.

MAIL COUPON TODAY

We have saved economical buyers hundreds of thousands of dollars. Everything you get from us is guaranteed highest quality, Grade A merchandise with new, exclusive features.

HARDIN-LAVIN CO.

ESTABLISHED 1876

When in Chicago Visit Our New Plant at
 107-17 West Pershing Rd., CHICAGO

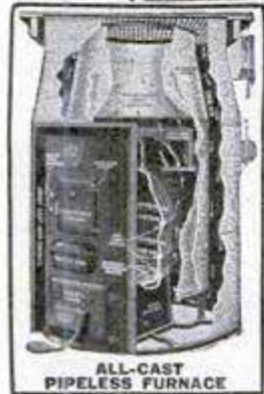

HARDIN-LAVIN COMPANY.

107-17 West Pershing Rd., Chicago, Ill.

Gentlemen: Please send me your FREE BARGAIN CATALOG with special wholesale prices. I am interested in:

- Water Supply System
- H. W. Htg. Plant
- Stm. Htg. Plant
- Pipeless Furnace
- Warm Air Furnace
- Bathroom Outfit

NAME.....
 ADDRESS.....
 P. O.....STATE.....

Makes Pumping Up Tires Unnecessary



Line up with big money. The Hughes "Airlox" Valve Cap is a proven success. Air-tight. Eliminates all troubles due to under-inflation; lasts life of tire. Positive necessity to auto owners. Doubles tire mileage. Tested and approved by leading auto manufacturers. \$100 a week for hustlers. Unlimited demand. No competition.

FREE SAMPLES TO AGENTS
 to use and introduce in exclusive territories. Immense uncrowded field. Don't hesitate. Write today for facts and FREE SAMPLES.

AIRLOX RUBBER CO.
 2512-14 W. Monroe St., Dept. 805U Chicago, Ill.

AMAZING NEW ADDING PENCIL \$3.

ADDS, MULTIPLIES, COUNTS, CHECKS

TOTAL SHOWS HERE



Adds as accurately as a \$100 machine. Convenient, rapid and useful. Carry like pencil or pen. Simply press pencil point on numbers; addition entirely automatic, instantaneous; total shows constantly. To clear, just twirl top. No larger than fountain pen. Not only adds, multiplies and counts with astonishing ease, but permits accurate checking. A remarkable time saver--infallible action. Adds as you write. **Guaranteed for 5 years.**

ORDER YOURS NOW - We send Adding Pencil prepaid. On arrival pay postman only \$3.00, or if you prefer, send \$3.00 with order. In either case Adding Pencil is guaranteed to remain in perfect mechanical working order five years or we replace it free of charge. Send Now!

AGENTS
 BIG money maker for agents. Everybody is interested. Write for our proposition.

The Adding Pencil Co.
 1201 Arcade Bldg. St. Louis, Mo.

SHAW MOTOR ATTACHMENT
MAKES YOUR BIKE A MOTORCYCLE!

A high grade 2 1/2 H. P. motor attachment quickly clamped on any bike frame. Speed 4 to 40 miles an hour. 90 to 125 miles per gallon of gas.

Special Low Price Now! Write today for Complete Description and Special Low Prices on SHAW Motor Attachments and the SHAW Complete Motorbicycle.



SHAW MANUFACTURING COMPANY
 Dept. 37 Galesburg, Kansas

AUTO BODIES—RADIO SETS

SEND FOR THE INTERNATIONAL CATALOG, our net price list. Full line of RADIO SETS; and auto bodies for Fords at Wholesale Prices. Save big money by buying Direct from Factory.

INTERNATIONAL BODY WORKS. 914 W. Ohio St., Dept. 7. CHICAGO, ILL.

Hand Forged Razor Steel Blades, No. 57

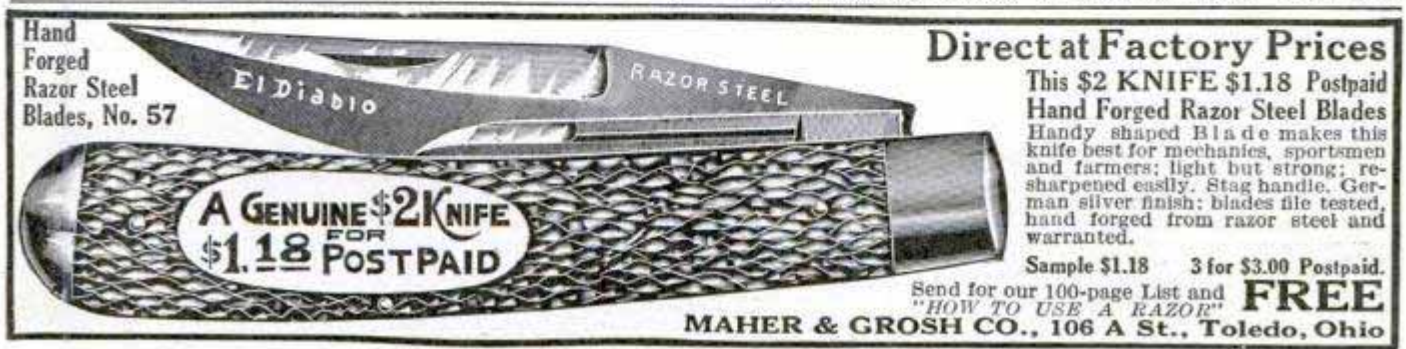

Direct at Factory Prices

This \$2 KNIFE \$1.18 Postpaid
 Hand Forged Razor Steel Blades
 Handy shaped Blade makes this knife best for mechanics, sportsmen and farmers; light but strong; re-sharpened easily. Stag handle. German silver finish; blades file tested, hand forged from razor steel and warranted.

A GENUINE \$2 KNIFE FOR \$1.18 POSTPAID

Sample \$1.18 3 for \$3.00 Postpaid.
 Send for our 100-page List and "HOW TO USE A RAZOR" **FREE**

MAHER & GROSH CO., 106 A St., Toledo, Ohio

\$5 DOWN Buys Any Latest Model WITTE Engine

Now, more than ever, the need for economical, dependable power is felt by the producer who is faced with ever-increasing labor costs. **WITTE Throttling Governor ENGINES** answer this important question perfectly—now an economical, dependable power plant is within the reach of everyone.

Today the WITTE ENGINE sells at the lowest price in history. Into this WITTE has gone the ripe experience of more than 42 years of engine building—over 100,000 users all over the world have placed upon it their stamp of approval. You, too, can put a WITTE on your place, secure in the knowledge that represents the



Standard of Power

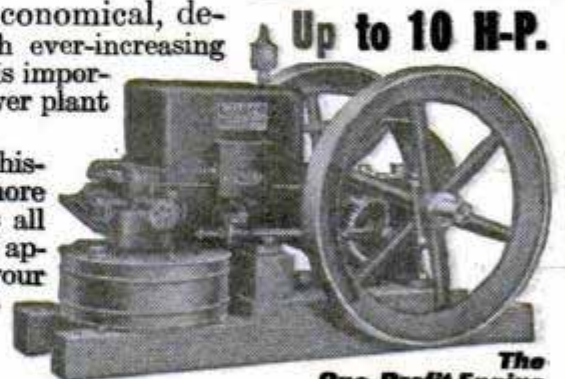

Up to 10 H.P.

The One-Profit Engine

The WITTE Throttling Governor

the original and leader of the throttling-governor type. An even steady speed with a big surplus of power for the heavy loads. The minimum in fuel consumption—the WITTE ENGINE burns kerosene, gasoline, gas-oil, distillate or gas at a fuel cost of less than 2c an hour per H.P. Simple, trouble-proof and guaranteed for a lifetime of hard work. Completely equipped with WICO Magneto, speed and power regulator and throttling governor.

The WICO Magneto

—the most perfect system of high tension ignition known. Makes starting easy, even at 40 below zero—sure performance in any climate or temperature. Not affected by rain, hail, snow or sleet. The perfect replacement for old-style battery-equipped engine.

Makes all Jobs Easy and Cheap—No need to do the hard, back-breaking work—no need to pay high prices for poor labor—you can show \$1,000.00 more profit every year you have a WITTE working on your place. Investigate now!

All Sizes, 2 to 25 H.P. Easy Terms. Scrap the Old One—Pay a Little Down on the New Witte!

Ask for Our Big FREE ENGINE BOOK or if interested, ask for our Log and Tree Saw, 3-in-1 Saw Rig or Pump catalog.—ED. H. WITTE.

WITTE ENGINE WORKS
(FOUNDED IN 1870)

1744 WITTE BLDG., KANSAS CITY, MO.
1744 EMPIRE BLDG., PITTSBURGH, PA.
1744 WITTE BLDG., SAN FRANCISCO, CALIF.



CALCULATIONS

in Office, School, Store and Shop can be instantly made with the Midget Slide Rule. It gives the answer to any problem involving fractions, mixed numbers, decimals, whole numbers, roots, powers, Logs, and Trig. Functions. Thousands of these rules are used by Accountants, Engineers, Clerks, Students, etc. It is the most versatile calculator ever invented. If you have any figuring to do, order a Midget Slide Rule on trial. Made of aluminum with figures on white celluloid. Size 4". Price with Instruction Book, \$1.50. Leather Case, 50c extra. Catalogue Free. Sent C. O. D. if desired. Your money back if you are not satisfied.

GILSON SLIDE RULE CO., Niles, Mich.



PILLIOD Tool Cases Excel

Machinists, Tool Makers and Carpenters find them most satisfactory in construction, appearance, service and price. Immediate shipment. Booklet describing 20 styles on request.

THE PILLIOD LUMBER CO.
Dept. 1 Swanton, Ohio



Books on all subjects are sold by Popular Mechanics Press, 200 East Ontario Street, Chicago, Illinois.



The New Sypher

More for the money than ever built before. Length over all, 30 in. Between centers, 14 in. Swing over bed, 7 3/4 in., includes counter shaft. Bronze taper bearings. Weight \$60 60 pounds. Absolutely accurate. Time payments if desired. Write today for circular.

The Sypher Mfg. Co. Dept. D Toledo, Ohio

Makes Old Ford a Tractor

We furnish everything for converting Ford Auto Chassis with Engine into a handy Farm Tractor. Just right for truck growers, small farms, nurseries, etc. Pulls 16" Plow, Discs, Seeds, Cultivates; Runs Belt Machinery. We also build Garden Tractors.

Handles Easily Turns in 15' Circle



Write for Free Particulars.

SHAW MFG. CO.,

Dept. F Galesburg, Kansas

WADE BENCH LATHE

AMATEUR MECHANICS, REPAIR SHOPS, INVENTORS, STUDENTS

A real machine tool for the home work bench—capacity 4" dia. x 12" length. For Metal—Wood—Composition Materials—Turning—Facing—Boring—Drilling—Winding—Thread Cutting. Accurate—Strong—Quiet—Compact. Slide-rest has travel entire length of bed. Leadscrew inside b.d. No. 1 Lathe, plain headstock, \$28.00. No. 2 Lathe, back-geared headstock, \$58.00. Complete line of accessories at equally low prices. Write for free catalog—just out.

THE GEROLD CO., Dept. P-18, 120 Liberty St., New York

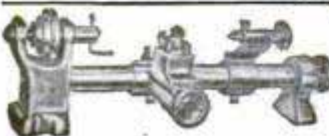

Yes—A Pair of Brand New, Shining, Nickeled, Hardened Steel SKATES Attached to Strong, Comfortable, Smart, Athletic SHOES



For only **\$5⁵⁰** Pre-paid

Skates are a clean cut, snappy design from the famous Winslow Skate Mfg. Co., made in the most up-to-date style for hockey and all round skating, and firmly attached to strong calf-skin athletic shoes with just the right medium high heel and the firm ankle support strap necessary to make skating easier and more comfortable. The lacing extends way down to the end of the toes, enabling you to adjust shoes perfectly for the snug support combined with comfort. This skate-shoe outfit will make your skating far, far better than the old clamp-on skates. If you have never worn shoe-skates, you'll be surprised to see how much better you get along. Check, money order, or C. O. D. Money back if not thoroughly satisfied. Shoes and skates complete for less than the price of ordinary shoes—a real buy! Men's and boys' shoe sizes from 3½ to 11½. Women's and girls' sizes from 3½ to 8½. Sporting goods catalog free.

IVER JOHNSON SPORTING GOODS CO.
10 Cornhill, Boston, Mass.

TURN WASTED TIME INTO MONEY!

Every Purchaser Finds Numerous Uses for the **Torit Acetylene Torch No. 13**

Uses Acetylene only. No oxygen or air pressure is required. Tips suck in air. Simply connect to Presto auto tank, light gas, and the outfit is put to work.

Beats anything you ever tried for soldering, heating or light brazing.

Outfit consists of 4 tips for different kinds of work, soldering copper, 5 feet tubing, tank connection, and full instructions.

ST. PAUL WELDING & MFG. CO., 177 W. 3rd St., St. Paul, Minn.



\$7.50

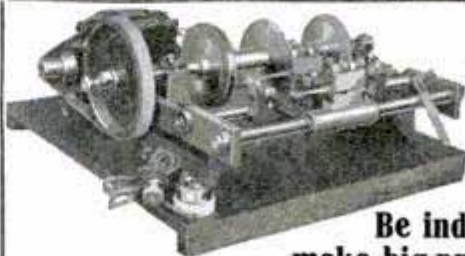

Don't Be a Slave

Be independent and make big profits with the

BEISSER KEY MACHINE

You can start a business of your own, no experience necessary. Only machine that will make first keys without taking lock apart. Makes a dozen duplicate keys per minute.

Write Today for Full Particulars

BEISSER KEY MACHINE CO.

407 Fort Street, East

Detroit, Michigan



Tool Cases for Toolmakers and Machinists
Are shown in our New 1926 Catalog. Write today for a copy. Thirty sizes and styles shown. One to suit your needs.

H. Gerstner & Sons

425 Columbia St., Dayton, O.

BURN YOUR NAME ON TOOLS

WITH THE ARKOGRAF

PROTECT YOUR TOOLS FROM THEFT
Write with electricity any name or design on the hardest and finest tools and instruments, or any metal, like writing on paper with pen or pencil. Complete Outfit \$3.50—Prepaid Anywhere. Interesting illustrated circular free. Write today. Agents wanted.

ARKOGRAF PEN CO., 1171 E. Stark St., Portland, Oregon



FOR HIS CHRISTMAS

Bartlett DROP-FORGED Compound Lever Snips \$2.70 to \$9.50

Made of high-grade Crucible Tool Steel, accurately tempered. Cuts metal up to 18 gauge easily. 7-in. size just right for household use. 7-inch stamped, \$2.70. 8-inch, forged, \$4.00. 10-inch forged, \$6.00. 12-in., \$8.00. 14-in., \$9.50.

Your dealer has them or can get them from his jobber. If he will not we will ship prepaid in U. S. at above prices.

FOLDER ON REQUEST

Bartlett Mfg. Co., 420 E. Lafayette Ave., Detroit, Mich.



A CONVENIENT OUTFIT OF CRESCENT Wood Working Machines
consists of No. 12 Saw Table with Tilting Top, 4" Bench Jointer, 20" Band Saw, each with individual motors. Prices Very Low, Quality Very High. Send today for circulars of Band Saws, Saw Tables, Shapers, Jointers, Variety Wood Worker, Planers, Planers and Matchers, Disk Grinders, Cut Off Table, Swing Saws, Routers, Hollow Chisel Mortiser, Tenoner, Universal Wood Workers.

The Crescent Machine Co. 93 Columbia Street LEETONIA, OHIO

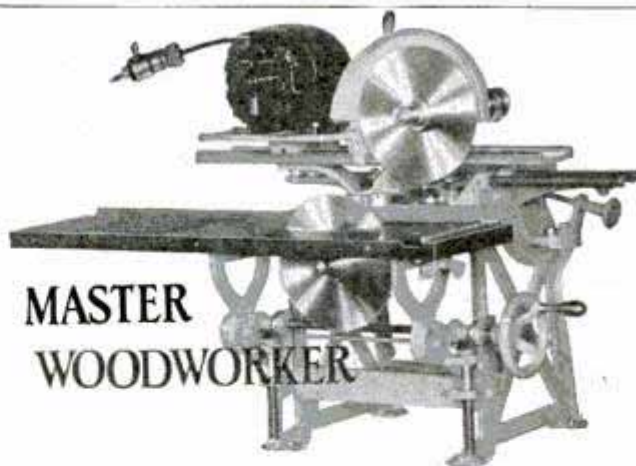

MASTER WOODWORKER

Complete Woodworking Shop—Small Cost—Easy Payments

A great opportunity for you to get a complete woodworking machine for home use, factory or construction use.

The "Master" is 12 machines in one. It does cross cutting, ripping, jointing, boring, sanding, dadoing, planing, plowing, mitering, rabbeting, molding, band sawing, mortising, tenoning, grinding, matching and stair routing.

Wonderfully speedy and accurate—sturdy and reliable. Lasts a life time—runs from a lamp socket.

Model No. 10 illustrated, rips 1" stock, cross cuts 2" stock. Three larger models for heavier work.

Costs little—sold on easy payments.

MASTER WOODWORKER MFG. CO.
612 BRUSH ST., DETROIT, MICH.

Send for big descriptive book



“ATKINS” The Best Gift for Real Men

Give “him” an ATKINS No. 400 Lifetime Saw this Christmas.

The moment he sees the big blue box with its beautiful saw of “Silver Steel”, he will appreciate your gift. Through years of use he will treasure it because it **MUST** hold its edge longer and cut faster and easier than any saw he ever knew.

YOUR dealer can show you genuine ATKINS Saws. Remember—look for the ATKINS name on the blade! Write for new folder “The Saw in the Home”—sent free.

E. C. ATKINS & CO.

Established 1857

*Leading Manufacturers of Saws, Saw Tools,
Saw Specialties and Machine Knives.*

Dept. P, INDIANAPOLIS, U. S. A.

ATKINS SILVER STEEL SAWS

A WONDERFUL BUSINESS WITH FOLEY SAW TOOLS

Listen to what Chas. Fuller of Lima, Ohio, says about Foley Saw Tools: “I have developed a wonderful and profitable business with Foley Saw Tools. I get 50c per saw for filing and \$1.25 per saw for recutting new teeth, and would not continue business without Foley Tools again.”

You can do the same. With a Foley Filer you can sharpen a saw perfectly in 5 minutes. Expert filers make big money. Get into business for yourself.

Write for Free
Circular
about Foley
Saw Tools

**FOLEY
SAW TOOL
COMPANY**

914 E. Lake St.
Minneapolis,
Minn.

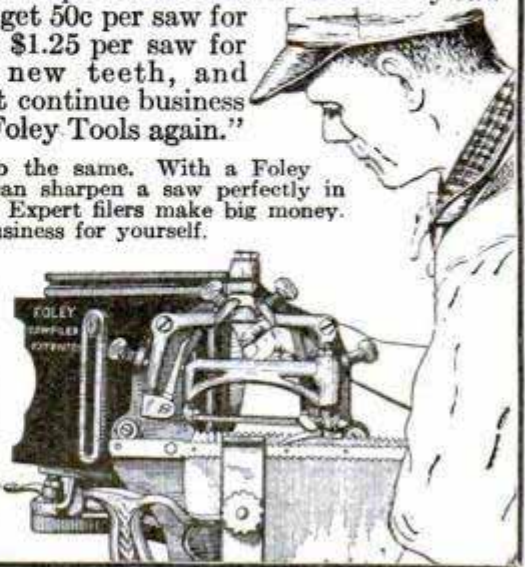

NOW, ONLY
\$4.00
DOWN

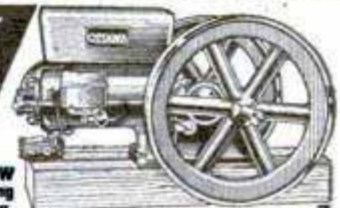

Put This MARVELOUS NEW
ENGINE with Easy Starting
Device To Work For You.

Increase Your Profits \$1000.00

Get my new FREE Book and ridiculously low prices—any size, 1½ H-P. up—Stationary, Saw Rig. Guaranteed to satisfy or your money returned. Built to stand hardest use. 30 days FREE trial. Send postcard for my new Free Book before you choose any engine. Write today. Harry Overman, Pres.

OTTAWA MFG. CO., Dept. 531-E King St., Ottawa, Kansas.
531-E Magee Bldg., Pittsburgh, Pa.

CUT WINTER FUEL THE EASY WAY



The farmers best helper for 40 years. Thousands save money and backaches every year. YOU CAN TOO. Send for free catalog showing low prices. Address Dept. 115.
FOLDING SAWING MACHINE CO., 2633 S. State St., CHICAGO, ILL.

SIMONDS

pronounced SI-MONDS

HACK SAW BLADES

Write for your FREE copy of **Hacksaw-ology**
SIMONDS SAW & STEEL CO., FITCHBURG, MASS.

Send 35c for an All-Work File to
FAYETTE R. PLUMB, Inc.
4823 James St. PHILADELPHIA



The Famous **KON-VER-TER SLIDE RULE**

Instantly adds, subtracts, divides, multiplies, converts fractions or decimals of an inch. Gives sines, co-sines, versed sines, co-versed sines, tangents, co-tangents, secants, co-secants of angles directly. Gives square roots, squares, cube roots, cubes and fifth roots and powers of all numbers. Logarithms, co-logarithms, anti-logarithms. Instructions with rule. De-Luxe Model \$3. Cash or C. O. D.

NEW ENGLAND NOVELTY CO.
Dept. A. WAKEFIELD, MASS.

9 times in 10 you'll use these Crescent Tools

The owner of a car or motorcycle with Crescent Wrenches, Pliers, or Screwdriver in his kit finds that these tools are always his first thought when there are nuts to tighten or general adjustments to make. Your hardware or accessory dealer has them.

CRESCENT TOOL COMPANY
210 Harrison St., Jamestown, N. Y.
Originators of the Crescent Wrench

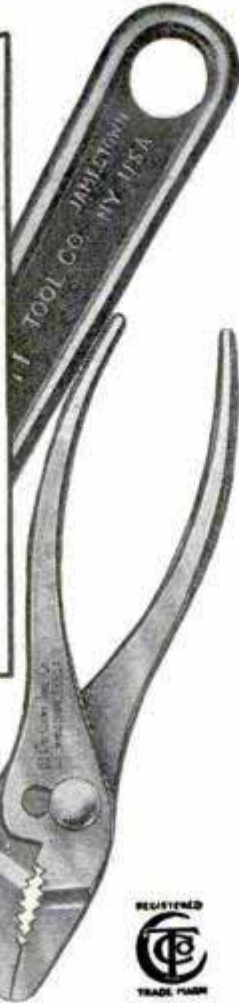

Lighting Fixtures READY TO HANG

(Direct from the Manufacturer)
Completely wired, including glassware. Send for New Catalogue No. 27. Just reduced prices. Special proposition to DEALERS.

ERIE FIXTURE SUPPLY CO.
STA. A ERIE, PA.



WHAT EVERY MASON WANTS

We have Masonic books and lodge supplies for Blue Lodge, Chapter, Commandery, Scottish Rite, and Shrine.

Our Rituals are Used the World Over. Send for free catalog of books and rituals for Masons, Odd Fellows, Knights of Pythias, Knights of Columbus, Elks, etc.

EZRA A. COOK, Publisher, Inc.
1350 N. Clark St., Dept. M. Chicago, Ill.



Buchstein's Fibre Limb

is soothing to your stump—strong, cool, neat, light. Easy payments. Braces for all deformities.

D. BUCHSTEIN CO.
610 3rd Ave., So., MINNEAPOLIS, MINN.

Re-New Your Furs



By new Plan of "Furcraft" any woman can now repair her own furs at home. Save money and have your furs in best of condition at all times. Also make extra money doing this work for neighbors. Learn the secrets of Furcraft. Learn by mail, evenings at home, to Re-new, Repair and Make up all kinds of fur garments. Big need for this service in every neighborhood. \$3 an hour in your spare time or a real business now and a fur shop later. We teach you secret processes. Earnings start in 30 days. Uncrowded field.

FREE BOOK Send now for illustrated free book giving details about Furcraft. No obligation.
NORTHWESTERN FUR CO., 9771 Sunderland Bldg., Omaha, Neb.



He clipped the Coupon. It Put Him Across Why not You?

Other fellows had left him in the social background. Girls avoided him. He was missing all the modern fun. Then one day he read an advertisement. It held out a promise of popularity if he would only learn to play a

BUESCHER *True Tone* **SAXOPHONE**

He knew that it was the right idea, but he thought he was musically dumb. "Still, the ad said it was easy." He mailed the coupon, and later sent for a Saxophone for 6 days free trial. Before the end of that period he was playing easy tunes. That was three months ago, and today he's the sheik of his set. He's making nice side-money too playing with a local dance orchestra. You can learn to play a Buescher - 3 lessons free give you a quick easy start. You can pick it up yourself and later get a teacher if you wish to make it your profession.

Try It Six Days FREE

Try a Buescher, any instrument you may choose, in your own home. Six Days FREE. If you like the instrument and decide to keep it, pay a little each month. Play as you pay. Get the details of this wonderful plan. Send the coupon for free literature.

BUESCHER BAND INSTRUMENT CO.

Everything in Band and Orchestra Instruments
1355 Buescher Block Elkhart, Ind. 297

free



This 64 page book tells about the various models, with pictures of professionals using them. Send for a copy of this wonderful

SAXOPHONE BOOK

Clip the Coupon NOW!

Mail BUESCHER BAND INSTRUMENT CO.
1355 Buescher Block, Elkhart, Indiana
Gentlemen: Without obligation to me, send your beautiful book "The Story of the Saxophone" Check here If you prefer other literature describing other band or orchestra instruments, check below.
Cornet Trumpet Trombone Tuba

Mention any other
Write plainly, Name, Address, Town and State in Margin Below

These Masters Of The Ring Say:

April 29, 1925.

My Dear Mr. Liederman:

You are to be congratulated for the wonderful benefits you are offering to the world.

I have met a number of your students and each and every one of them has the highest words of praise for your course. After investigating your system myself I join them.

If anyone is run-down and wants to better himself physically and develop his muscles and strength, he should not hesitate in becoming your pupil.

You have my best wishes always for everlasting success.

Yours very truly,

(Signed) **GENE TUNNEY.**



Greb

Dear Liederman:

March 2nd, 1925.

In my travels throughout the country, I have met a great number of your students. Sometimes this has been in gymnasiums, and on other occasions during my training periods. I have continually heard nothing but boosts for you and your system and naturally this caused me to investigate your methods.

I am sure I am safe in saying that your system is one that cannot be beaten. Your original exercises are bound to bring results to anyone who will follow your instructions. As the World's Middleweight Champion, I think I know the proper training method when I see it, for I always keep myself in splendid condition. I do not hesitate in recommending your course wherever I go and the next time I am in New York, I shall call on you. In the meantime, if you have written any new books since I last saw you, I will be pleased to have you send me an autograph copy. With kind regards and wishing you continued success in your wonderful work, I am sincerely yours, (Signed) **HARRY GREB.**

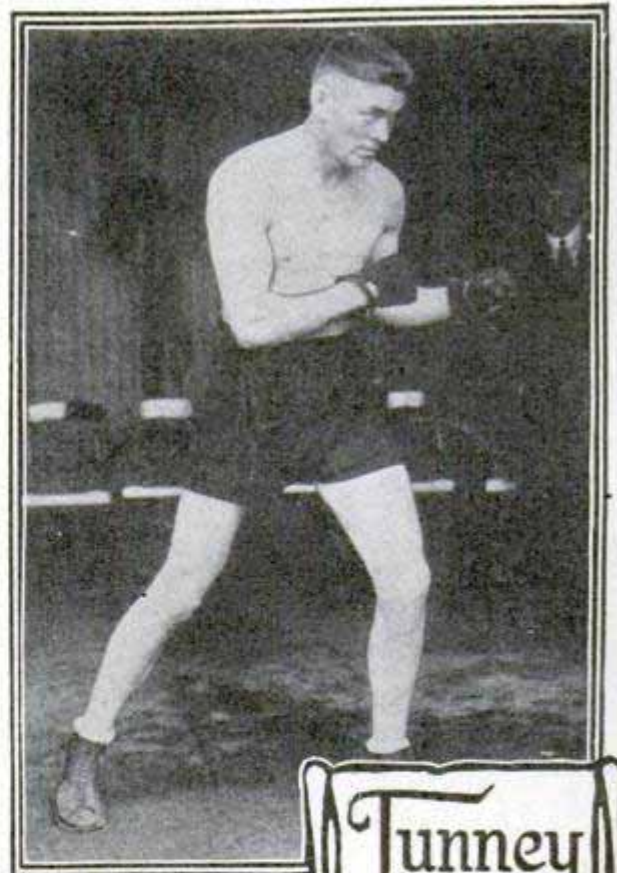

Tunney

When these "Masters of the Ring," who have had years upon years of experience with training, recommend a system to follow, as they do the Earle Liederman system, the final word has been spoken. What further proof would you want?

Do You REALLY Want Muscle?

LET you and me be on the level with each other. I can't cure small-pox, erysipelas, housemaid's knee or any other of those things. I'm not a doctor and never claimed to be. I admit I've cheated many a doctor out of a nice fat fee by preventing numerous things, but all I have to offer is muscle. And another thing. I don't give any dancing lessons or calisthenics. I build muscle—yes, big, beefy muscle.

Now where do you come in? Do you really want a big, virile and powerful body? Are you sincere about it? Are you willing to work for it? If you're not, don't bother reading any further. You've lost your desire for life—you're through. But—if you really want muscle—let's slam into this thing and get going.

GET THIS

If I offered you a cool thousand dollars on a gold platter, would you take it? Only a crazy man would refuse it. Well, I'm offering you something a blame sight better—something that money alone could not buy. I'm going to make you one of the strongest, healthiest, sturdiest, liveliest, ripsportingest real He go-getter of a man that ever lived. Just to start things going I'm going to add one full inch to your arms inside of 30 days—yes, and two inches to your chest in the same length of time. Sounds good—what? You ain't heard nothing yet. That's only the starter. Now come the real works.

A MAN'S MAN

I'm going to cover you with muscle from your ears to your toes. I'll broaden your shoulders. I'll deepen your chest. I'll triple your lung capacity so that every breath will shoot your blood full of red corpuscles. I'll pack muscle up your spine and down over your stomach. I'll strengthen every vital organ within you. I'll clear your brain. I'll pep up your spine. I'll fill you so full of life, animation and power, you'll feel like tackling a wild cat. You'll stretch out your big, powerful body and crave for bigger things to do. You'll feel as though you had the world by the tail. Nothing will seem too big for you to tackle.

Sounds pretty fine, what? You're durn tootin, it does. And the best of it is, it's true. I don't just promise these things. I GUARANTEE THEM. Do you doubt me now? Well, come on and make me prove it. That's my meat. I don't ask you to take any chances. Well, what are we waiting for? Let's ride.

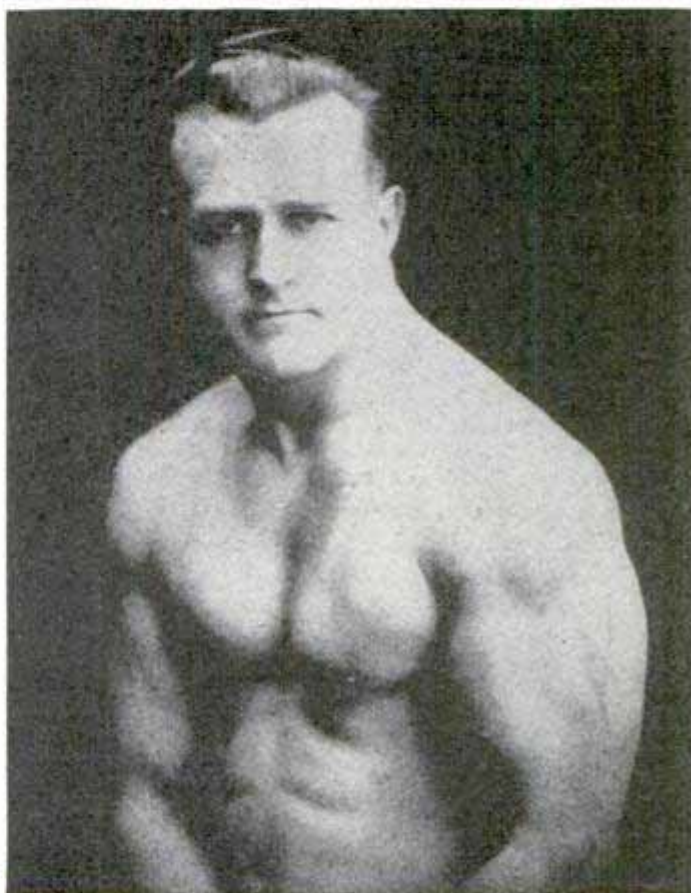

EARLE E. LIEDERMAN, The Muscle Builder
 Author of "Science of Wrestling," "Muscle Building,"
 "Secrets of Strength," and "Here's Health," etc.

Send For My New 64 Page Book "Muscular Development"

IT IS FREE

It's a wow—I want you to have it with my compliments. No obligations. Just read it. It will inspire you. It will thrill you. It's the best half hour's reading you ever had. Contains forty-eight full page photographs of myself and some of my prize-winning pupils I have trained. See what I've done for every kind of a man you can think of. Doctors, lawyers, merchants, mechanics, etc. Read how I make weak men strong, strong men stronger. Look over the art gallery. You'll never give it away. I swear you won't. No strings attached to it. Here's your chance for a free ride. Don't hesitate. Do it now before you forget. Take out your pen or pencil—fill in your name and address and shoot it to the mail box.

EARLE E. LIEDERMAN

305 Broadway Dept. 2001 New York City

It Is F R E E	DON'T SEND ONE PENNY	EARLE E. LIEDERMAN Dept. 2001, 305 Broadway, New York City. Dear Sir: Please send me without any obligation on my part whatever, a copy of your latest book, "Muscular Development." This is absolutely free and does not obligate me in any way. Name..... Address..... City..... State..... (Please write or print plainly)
	YOUR NAME AND ADDRESS	
	ON A POSTAL WILL DO	

PATENTS TRADE-MARKS AND COPYRIGHTS

Have You An Idea?

Our Offer: FOR THE PROTECTION OF YOUR INVENTION YOUR FIRST STEP

Before disclosing an invention the inventor should write for our blank form

"RECORD OF INVENTION"

This should be signed and witnessed and returned to us together with model or sketch and description of the invention for **INSPECTION and INSTRUCTIONS**

No Charge for the Above Information

**Our Four Books Mailed
Free to Inventors**

Our Illustrated Guide BOOK

HowtoObtain a Patent

Contains full instructions regarding U. S. Patents. Our Methods, Terms, and 100 Mechanical Movements illustrated and described.

Our Trade Mark Book

Shows value and necessity of Trade Mark Protection. Information regarding *Trade Marks and unfair competition in trade.*

Our Foreign Book

We have Direct Agencies in Foreign Countries, and secure Foreign Patents in shortest time and lowest cost.

Progress of Invention

Description of World's Most Pressing Problems by Leading Scientists and Inventors.

We Regard a Satisfied Client as our best advertisement, and furnish anyone, upon request, lists of clients in any state for whom we have secured patents.

*Highest References—Prompt Attention
—Reasonable Terms*

VICTOR J. EVANS & CO.

PATENT ATTORNEYS

Main Offices: 956 9th St., N. W., Washington, D. C.

Opposite U. S. Patent Office

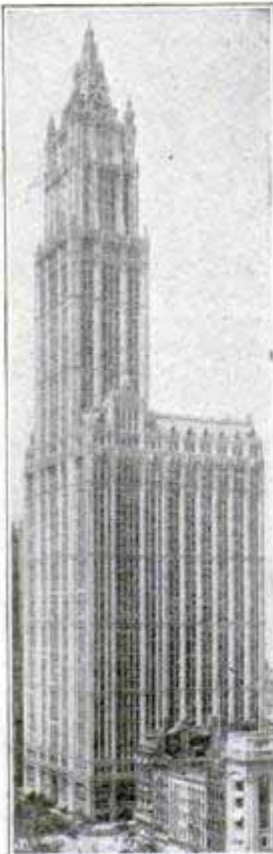

Our New York Office
Suits 1007 Woolworth Bldg.



Our Philadelphia Office
Suits 714-15 Liberty Bldg.



Our Washington Office
Victor Building



PATENTS TRADE-MARKS AND COPYRIGHTS

IMPORTANT

TO HAVE YOUR CASE MADE SPECIAL AND AVOID DELAY YOU SHOULD HAVE YOUR CASE MADE SPECIAL IN OUR OFFICE to secure protection, save correspondence and secure early filing date in Patent Office. To secure special preparation of your case send \$25.00 on account with model or sketch and description of invention.

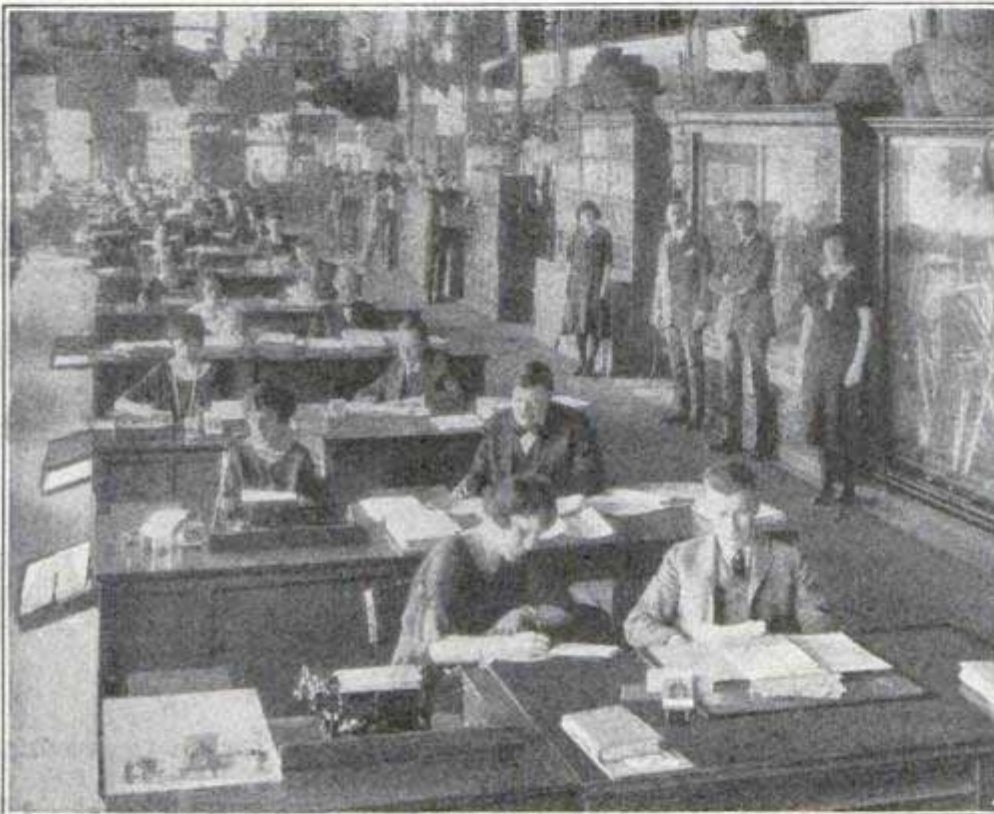

MAIN OFFICE, VICTOR J. EVANS & CO.—VICTOR BUILDING, WASHINGTON, D. C.

Our Lawyers Practice in all U. S. Courts and defend Clients in Suits involving Patents, Trademarks and Copyrights

All Communications and Data Strictly Confidential. Interference and Infringement Suits Prosecuted

OUR ORGANIZATION OFFERS **PERSONAL SERVICE** By Experienced Patent Lawyers, Solicitors and Draftsmen

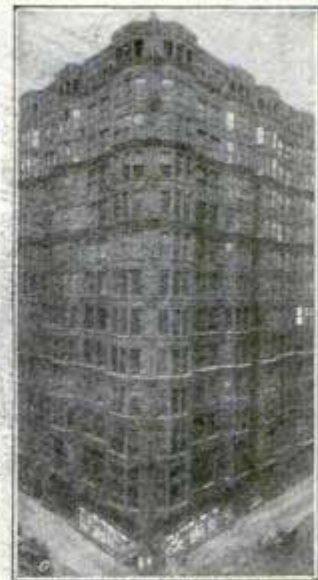

Our Chicago Office Suite 1114 Tacoma Building



Our Pittsburgh Office Suite 514 Empire Building



Our San Francisco Office Suite 1010 Hobart Building

**FREE
COUPON**

**VICTOR J. EVANS & CO.
PATENT ATTORNEYS**

NEW YORK OFFICES
1007 Woolworth Bldg.

CHICAGO OFFICES
1114 Tacoma Bldg.

PHILADELPHIA OFFICES
714-715 Liberty Bldg.

PITTSBURGH OFFICES
514 Empire Bldg.

SAN FRANCISCO OFFICES
Hobart Bldg.

MAIN OFFICES: 956 9th Street, N. W., WASHINGTON, D. C.

Gentlemen: Please send me *Free of Charge* your books as described on preceding page.

Name

Address



IPA INVENTORS.

**JUST
ACROSS
STREET
FROM
U. S. PAT.
OFFICE.**

At the right is a view of my drafting and specification offices where a large staff of experienced experts are in my constant employ. All drawings and specifications are prepared under my personal supervision.



PROTECT YOUR IDEAS **Take the First Step Today**

If you have a useful, practical, novel idea for any new article or for an improvement on an old one, you should communicate with a competent Registered Patent Attorney AT ONCE. Every year thousands of applications for patents are filed in the U. S. Patent Office. Frequently two or more applications are made for the same or substantially the same idea (even though the inventors may live in different sections of the country and be entirely unknown to one another). In such a case, the burden of proof rests upon the last application filed. Delays of even a few days in filing the application sometimes mean the loss of a patent. So lose no time. Get in touch with me at once by mailing the coupon on the opposite page.

Prompt, Careful, Efficient Service

This large, experienced organization devotes its entire time and attention to patent and trademark cases. Our offices are directly across the street from the U. S. Patent Office. We understand the technicalities of patent law. We know the rules and requirements of the Patent Office. We can proceed in the quickest, safest and best ways in preparing an application for a patent covering your idea. Our success has been built on the strength of careful, efficient, satisfactory service to inventors and trademark owners located in every state in the Union.

Clip this Coupon *and* Mail

TENTS

Write for these FREE BOOKS!

**NO CHARGE
for Information**

**On How to
Proceed!**



The books shown here contain valuable information relating to patent procedure that every inventor should have. And with them I will also send you my "Record of Invention" form, on which you can sketch your idea and establish its date before a witness. Such evidence may later prove valuable to you. Simply mail the coupon and I will send you the books, and the "Record of Invention" form, together with detailed information on how to proceed and the costs involved. Do this NOW. No need to lose a minute's time. The coupon will bring you complete information entirely without charge or obligation.

STRICT SECRECY PRESERVED

All communications, sketches, drawings, etc., are held in strictest confidence in strong, steel, fireproof files, which are accessible only to authorized members of my staff. Feel free to write me fully and frankly. Your case will have my personal attention. It is probable that I can help you. Highest references. But **FIRST**—clip the coupon and get my free books. Do **THAT** right now.

**FREE
COUPON**

**CLARENCE
A. O'BRIEN**

*Registered
Patent Attorney*

7099 Security Savings and
Commercial Bank Bldg.,
Washington, D. C.

Clarence A. O'Brien

Registered Patent Attorney

Member of Bar of: Supreme Court of the United States; Court of Appeals, District of Columbia; Supreme Court, District of Columbia; United States Court of Claims.

**Practice confined exclusively to Patents,
Trademarks and Copyrights**

Please send me your free books, "How to Obtain a Patent," and "Invention and Industry," together with your "Record of Invention" form without any cost or obligation on my part.

Name

Address

It Now!

(Important: Write or Print name clearly)

PATENTS

TRADE MARKS • DESIGNS • FOREIGN PATENTS

MUNN & CO. PATENT ATTORNEYS

Associated since 1846 with the Scientific American

672 WOOLWORTH BUILDING
New York City

523 SCIENTIFIC AMERICAN BLDG.
Washington, D. C.

1312 TOWER BUILDING
Chicago, Ill.

665 HOBART BUILDING
San Francisco, Cal.

520 VAN NUYS BUILDING
Los Angeles, Cal.

Books and Information on Patents and Trade Marks by Request. Associates in All Foreign Countries.



PATENTS

Send us sketch or model for advice and exact cost of patent. Our book "How to Obtain a Patent" sent free. It tells how to apply for Patents, Trade Marks, Foreign Patents, Copyrights, etc.; gives information on Patent Procedure; tells what every inventor should know. Thousands of Inventors, who are our clients, are our reference.

CHANDLEE & CHANDLEE, 25 Years' Experience
473 7th St. Washington, D. C.

Have You An Invention?

If so the WORLD PROGRESS will send you upon request sample copy Free containing SUGGESTIONS TO INVENTORS as to Inventions Needed. We invite manufacturers to address us regarding inventions they want.

Subscription for one year 60 cents

WORLD PROGRESS PUB. CO., Inc.
Room 203 Victor Bldg. WASHINGTON, D. C.

PATENTS

C. L. PARKER

Formerly Member Examining
Corps, U. S. Patent Office

PATENT LAWYER

MCGILL BLDG.
WASHINGTON, D. C.

Patents, Trade Marks, Copyrights, Patent Litigation

Pamphlet of instructions sent upon request



GEARS ALL KINDS SMALL

The most accurate made and prices reasonable. We carry a complete line of gears in stock for immediate shipment. Can also quote on special gears of all kinds. Send us your inquiries.

WRITE FOR CATALOGUE.

CHICAGO STOCK GEAR WORKS
105-109 S. Jefferson St., CHICAGO

PATENTS

**Booklet Free Highest References
Promptness Assured Best Results**

Send drawing or model for preliminary examination of Patent Office records.

ALL BUSINESS GIVEN PROMPT AND PROPER ATTENTION

Listed Patent Lawyer in the latest editions of the Rand-McNally Directory of Bankers and Attorneys, of Chicago, Ill.; The Baggott & Ryall Directory of Attorneys, New York City; The Lawyers Guaranteed Directory, Detroit, Michigan; The Lawyers and Bankers Quarterly, published by the Legal Directory Publishing Company of St. Louis, Mo.; the American Lawyers Annual, Cleveland, Ohio.

WATSON E. COLEMAN,
REGISTERED PATENT LAWYER

644 G Street, N. W., Opp. U. S. Pat. Office
WASHINGTON, D. C.

PATENTS

To the Man with an Idea

I offer a comprehensive, experienced, efficient service for his prompt, legal protection and the development of his proposition.

Send sketch, or model and description, for advice as to cost, search through prior United States patents, etc. Preliminary advice gladly furnished without charge.

My experience and familiarity with various arts frequently enable me to accurately advise clients as to probable patentability before they go to any expense.

Booklet of valuable information and form for properly disclosing your idea free on request. Write today.

Richard B. Owen, Patent Lawyer
9-303 Owen Bldg., Washington, D.C.
41-E Park Row, New York City

TRADE-MARKS
REGISTERED

U.S. PATENTS



SEND FOR THIS FORM

DON'T LOSE YOUR RIGHTS
TO PATENT PROTECTION

Before disclosing your invention to anyone send for blank form "EVIDENCE OF CONCEPTION" to be signed and witnessed. A sample form together with printed instructions will show you just how to work up your evidence and establish the same before filing application for patent. As registered patent attorneys we represent hundreds of inventors all over the United States and Canada in the advancement of inventions. Our schedule of fees will be found reasonable. The form "Evidence of Conception," sample, instructions relating to obtaining of patents and schedule of fees sent upon request. Ask for them—a post card will do.



Registered Patent Attorneys In U. S. and Canada.
480 Ouray Bldg., WASHINGTON, D. C.
Originators of forms "Evidence of Conception."

How to Invent

Edison says invention is a science and should be taught as a profession

One Idea May Win You a Fortune



Raymond Francis Yates

Thousands of inventions are needed today. Just one little idea can bring you fortune and fame. The world is waiting for new inventions in engineering, chemistry, household articles, radio and other fields—and will pay big money for even the simplest idea. Little things like the tin bottle cap, the crimped hair-pin, the rubber on the end of a pencil brought their inventors hundreds of thousands of dollars. Couldn't you make some equally simple invention? Haven't you ideas that could be turned into money? Invention isn't a matter of blind luck—it isn't a question of guesswork. Invention is based on certain principles, just as any other profession. It follows a definite course of procedure step by step from the origination of the first idea to its final development on a commercial scale.

Learn at Home in Spare Time

Hitherto, every inventor had to work out these principles of invention for himself. For every successful inventor knows and uses these principles. He knows WHAT TO INVENT and HOW TO INVENT. But now you can learn in a few months what it took Raymond Francis Yates and 15 other great inventors years to acquire. Fifteen famous inventors have now revealed, for the first time, the secrets of invention. They explain how to originate ideas, how to develop and perfect your ideas, how to patent your inventions, and how to sell them to your best advantage. In short, they make it amazingly easy for you to become an inventor, simply by learning the whole wonderful science of invention, step by step, from beginning to end. It requires just fascinating moments of your spare time at home.

First Course of Its Kind

This is the first course in practical invention that has ever been devised. Now you can take Edison's advice and actually learn HOW TO INVENT—how to make invention a profession! In simple, easy-to-understand language, you are told how successful inventors work; you learn how to use the secrets of invention that convert a simple little idea into money.

FREE New Book on Inventive Science

A wonderful new book has just come from the press that tells all about the Science of Invention; that shows how great inventors work, how little ideas have made fortunes; how you, too, can easily learn the secrets of successful invention. This fascinating book will be sent free to all those who are genuinely interested. Send for this book today, as only a limited number are available for free distribution. Write your name and address on the coupon below, or send a post card NOW! There is no cost or obligation.

BUREAU OF INVENTIVE SCIENCE
Dept. 31, Wisner Bldg. ROCHESTER, N. Y.

BUREAU OF INVENTIVE SCIENCE
Dept. 31, Wisner Building, Rochester, N. Y.

Please send me your free book, "The Science of Invention."

Name.....
Address.....
City..... State.....



"Been on a vacation Bill?"

"No, Jim — I've stopped smoking. Gained six pounds in a week. You know how I used to smoke—a package of cigarettes and a cigar or two a day—it sure had some hold on me. But I'm cured—

took a scientific home tobacco treatment—fixed me up in two weeks.

"Wasn't hard on me at all—noticed improvement the first day—I feel like a new man. It didn't interfere with my work—didn't leave any druggish after-effects—the money I saved in the last two weeks has paid for the treatment alone.

"Why don't you take it! It has cured men like you and me for over forty years—it is a doctor's individual prescription that sure fixes you up. Just send the coupon for full information NOW. No obligation. All correspondence is strictly confidential."



"A Doctor's Prescription"

The Keeley Institute, Dwight, Ill.

Please send me, without any obligation on my part, your free booklet which will tell me how to rid myself of the tobacco habit.

Name

Town

Street..... State..... PM-1

PATENTS

Trade Marks, Copyrights, Patent Litigation Handbook with illustrations, 100 mechanical movements. Sent free on request.

ALBERT E. DIETERICH formerly member examining corps U. S. Patent Office **PATENT LAWYER and SOLICITOR**

621-A, Ouray Bldg. 27 Years' Experience Washington, D. C.

PATENTS Personal Prompt Service Send for Record of Invention Form.

JACOBI & JACOBI, Patent Lawyers, 601 Ouray Building WASHINGTON, D. C.

INVENTORS who derive largest profits know and heed certain simple but vital facts before applying for Patents. Our book *Patent-Sense* gives those facts; sent free. Write **LACEY & LACEY, 646 F St., Washington, D. C. Established 1889.**

A Test Every Man Past 40 Should Make

Medical authorities agree that 65% of all men past middle age (many much younger) are afflicted with a disorder of the prostate gland. Aches in feet, legs and back, frequent nightly risings, sciatic pains, are some of the signs—and now a well-known American scientist has written a remarkably interesting Free Book that tells of other symptoms and just what they mean. No longer should a man approaching or past the prime of life be content to regard these pains and conditions as inevitable signs of approaching age. Already more than 20,000 men have used the amazing method described in this book to restore their youthful health and vigor—and to restore the prostate gland to its proper functioning. Send immediately for this book. If you will mail your request to the Electro Thermal Company, 2153 Main Street, Steubenville, Ohio—the concern that is distributing this book for the author—it will be sent to you absolutely free, without obligation. Simply send name and address. But don't delay, for the edition of this book is limited. Western Office, Dept. 21-U, 711 Van Nuys Building, Los Angeles, California.

DEAFNESS IS MISERY GOOD HEARING A JOY



Millions of people know that, but Multitudes of persons with defective hearing and Head Noises are again enjoying conversation, go to Theatre and Church because they use Leonard Invisible Antiseptic Ear Drums, which are Tiny Megaphones fitting in the Ear entirely out of sight. No wires, no batteries, no head piece. They are Unseen Comforts and inexpensive. Write for booklet and sworn statement of the inventor who was himself deaf.

A. O. LEONARD, Inc., Suite 161 70 5th Ave., New York

FREE 1000 Illustrations ELECTRIC CATALOG!



Write today for your copy. Save 50% direct from Manufacturer. No Middleman's Profit. OUR SPECIAL: 8 Room Electric Set, ready to hang, \$24.50—Other bargains.



UNITED LIGHTING FIXTURE CO. 83 Flatbush Ave. Dept. P, Brooklyn, N. Y.

PLUMBING-HEATING



YOU SAVE HALF

Send for BIG FREE BOOK of Guaranteed Plumbing and Heating. Everything cut-to-fit. 50 yrs. in business. Thousands of customers. "You saved me \$400.00," says Mr. Edw. Borkosky of N. J. Write today. **HARDIN-LAVIN CO., 107-17C. W. Pershing Rd., CHICAGO**



BLUE BOOK ON PATENTS AND PRIORITY RECORD BLANK GRATIS.

MONROE E. MILLER, PATENT LAWYER 411-2 Ouray Building, WASHINGTON, D. C. ELECTRICAL AND MECHANICAL EXPERT

INVENTORS PROTECT YOUR IDEAS

Send for our Guide Book, **HOW TO GET A PATENT**, and Evidence of Invention Blank, sent Free on request. Tells our terms, methods, etc. Send model or sketch and description of your invention for **INSPECTION and INSTRUCTIONS FREE. TERMS REASONABLE. BEST REFERENCES.**

RANDOLPH & CO. 300 Victor Bldg., WASHINGTON, D. C.

NAME

STREET

CITY..... STATE.....

Buy Direct From Mill!

You can buy at **wholesale prices** just the home you want, and save \$200 to \$2,000. Materials shipped direct from mill to your station.

Ready-Cut Enables You to Do Own Building

Studs, joists, rafters and sheathing cut and fitted at mill. Plans so easy to follow and material so accurately cut, many buyers put up houses themselves. Save in both labor and lumber.

200 Home Plans Free!

Highest Quality Guaranteed

Everything top quality, backed by guarantee of "Satisfaction or Money Back." 200,000 customers.

Free Estimates on Any Job

We carry largest stocks of lumber, millwork and building material in the country. Send us your bills and we will figure them free.

Garages \$89 Up

Build it yourself. Material Ready-Cut. Easy to put up.

Four Mills

We ship from one nearest you. Safe arrival guaranteed.

Gordon-VanTine Co.

ESTABLISHED 1865

Satisfaction Guaranteed or Money Back
662 Case Street DAVENPORT, IOWA

Send for Book Today!

Shows photos, floor-plans, descriptions, 3 to 9 room town and country homes, bungalows, cottages, Colonial, color illustrations, full specifications; describes our famous Ready-Cut system. 132 pages. Clip coupon or mail post-card for Book today.



GORDON-VAN TINE CO.,
662 Case St., Davenport, Iowa.

I expect to

() Build a.....

() Repair a.....
Please send proper catalog.

Name.....

Address.....

FREE Diagram, Templates, Instructions for building Calcaterra's 5 tube Tuned RADIO FREQUENCY Set for \$55

Write KELLOGG SWITCHBOARD & SUPPLY CO., Chicago, Illinois:

SARGENT PLANES

See them at your hardware store.

Write for booklet.

SARGENT & CO., 49 Water Street, New Haven, Conn.

60 Days Trial, Money back if not pleased

New Unbreakable Fountain Pen

Agents Sample Only **67c**

Regular Retail Price \$1.25

Writes Like a \$7 Pen

Beautiful Red, Green Black or Purple

Guaranteed for 2 Years

Ladies or Gents Style

FREE

Ideal Xmas Gift

Packed in Beautiful Holly Box

Latest Improved Point

New and unusual Mail Order Distributing Plans and Large Wholesale Specialty Catalog showing best sellers from all parts of the world. Money refunded if not pleased.

Mark Check and Fill Out at Once

F. SPORS & CO., 350 Main St., Le Sueur Center, Minn.

- Send Sample C. O. D. 67c, plus few cents postage and C. O. D.
- Send 12 Pens Assorted Colors C. O. D. \$6.42, plus postage and C. O. D.
- Send Catalogue, no obligation on my part.

Name.....

Address.....



\$1 Brings your Choice of these 3 Big Specials

Buy From Us and Save Money

Simply pin a dollar bill to this ad, put it in an envelope with your name and address and Mail It Today. Your choice of these exceptional values will come Prepaid for a 15 Day Trial. If you can duplicate your purchase for less money anywhere, send it back and your dollar will be returned. If satisfied pay balance in ten equal monthly payments.

No Red Tape—Prompt Delivery
Transactions Confidential
Rush Your Dollar Today



- A10** Beautifully hand-carved 18K White Gold Ladies Ring. 3 Genuine sparkling, blue-white Diamonds. Price \$42.50 \$1.00 Down; \$4.15 a Month
- A11** Rectangular style 14K Solid White Gold Wrist Watch set with 4 Genuine, brilliant, Blue-white Diamonds, 4 blue sapphires. Guaranteed 16 Jeweled Movement. Price \$42.50 \$1.00 Down; \$4.15 a Month.
- A12** Gent's 12 size 17 jewel Guaranteed Elgin Watch. 14K Gold Filled Engraved Case guaranteed for 25 yrs. Complete with gold filled Knife and Chain. Price \$37.50. \$1.00 Down; \$3.65 a Mo.

A12 FREE

A complete Booklet with over 3,000 other big bargains in Diamonds, Watches and Jewelry.

Send for it. 10 Months to Pay on Everything.

AUTHORIZED CAPITAL \$1,000,000.

L.W. SWEET INC.

Dept. 66-V 1660 BROADWAY, NEW YORK

The man who studies gets ahead. Popular Mechanics Press will advise you what books to read to advance in your trade. 200 East Ontario Street, Chicago, Illinois.

Different from all others—the NEW BENJAMIN



AIR RIFLE

Made on a different principle from all other Air-Rifles.

The Benjamin is really a strong air-pump used to compress the air in the air chamber to any degree of power desired. From one to six strokes of the pump give all the force necessary. Each additional stroke gives increased power. The Benjamin works on the same principle as all air-drills and air-hammers—with this difference:

You control the shooting force as you desire. Look at this block of hardwood. It shows how Benjamin power is regulated as you wish.

You can't have accidents with a Benjamin. It's safe, always, because you control the power. The Benjamin never loses shooting force, and has no springs to get out of order or shake your aim. Write us for an interesting folder about this wonderful air-gun.

If your dealer does not handle same, send direct to factory.

(PRICE \$5)
POSTPAID

BENJAMIN AIR-RIFLE & MFG. CO., 615 N. Broadway, St. Louis, Mo.

Ask your dealer for demonstration.

Pacific-Coast Representatives
THAYER & BOWER
Los Angeles Calif., and San Francisco Calif.



FOUND MONEY! \$12 a Day Easy

Let us prove how easy it is to make big money selling our beautiful dress goods, silks and wash fabrics. Low prices. Big commissions. No capital or experience needed.

We Show You How

Just write and say you want to be our agent. Big sample book furnished with complete selling instructions. Wonderful opportunity. Write at once.

THE NATIONAL IMPORTING COMPANY
Dept. A-6, 573 Broadway New York City



\$35 Complete Outfit as illustrated
Delivery Paid East of the Mississippi

\$38 Delivery Paid West of Miss.

Saw Table Can be purchased with 6-inch motor for \$22.50 Delivery paid East of Mississippi. \$24.50 Delivery paid West of Mississippi.

Motor This heavy duty motor can be furnished separately for \$12.90 Delivery paid East of Mississippi. \$13.90 Delivery paid West of Mississippi. Complete with Cord, Plug and flat or grooved Pulley. Guaranteed 60% Overload. Special Prices on Quantities of 10 or Over.

PAUL J. DEVITT, 1101-1107 So. 2nd St., Phila., Pa.

MECHANICS BENCH SAW

With this saw you can make your own repairs in shop, home, farm or garage. Makes a clean edge on the toughest wood—no planing necessary. Rips, cross-cuts, bevells, miters, mortises, tenons, or grooves. Attach to any lamp socket. Weight only 61 lbs. Will cut up to 1 1/4" All metal. Saw size 6 in. Table 10x13, base 7x11, height 7 in. Table tilts for beveling 5 degrees left 10 degrees right.

WRITE FOR OUR NET PRICE BUILDERS' HARDWARE CATALOG



Musical Popularity

Ability to play a musical instrument always wins popularity. But that is only one of many advantages that come to those who play Hohner Harmonicas.

Hohner Harmonicas win popularity, admiration and friendship. They stimulate interest in good music, develop a sense of accuracy and rhythm, lay the foundation for musical education and supply clean, wholesome entertainment for the player and his audience as well.

Anyone can learn to play a Hohner Harmonica with the aid of the Free Instruction Book. Ask your dealer for one today; if he is out of copies write M. Hohner, Inc., Dept. 181, 114 East 16th Street, New York City.

"That Musical Pal of Mine"



TIRES WITH 500 NAIL HOLES LEAK NO AIR

Car Owners Amazed

AGENTS With the startling performance of Milburn Air Filled Puncture-Proof Tubes. Over 1,000,000 sold. Costs no more than the ordinary tube and doubles tire mileage. Backed by refund guarantee. Wanted everywhere. Big demand. No competition. Free Tube Plan starts you. Write us quick.

C. K. Milburn, President
MILBURN PUNCTURE-PROOF TUBE CO., Inc.
4650 Shields Ave., Chicago, Ill.

You-and This New Machine Can Earn \$500 a Month

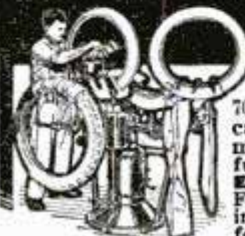

Operate a Tire Repair Shop
70,000,000 Tires in use. America's greatest opportunity for men with small capital. We furnish everything—\$100 and up. Easy payments. We train you FREE right at home. Start making money at once. Write today for Free Book of Opportunity.

Haywood Tire Equipment Co., 1344 S. Oakley, Chicago

Great *New* Invention

for seekers of

Health Power Beauty



Elco Health Generators at last are ready for you! If you want more health—greater power to enjoy the pleasures and delights about you, or if more beauty is your desire—write! Ask for the book on these inventions which has just been prepared. It will be sent to you without cost. It tells you how Elco Health Generators aid you in leaving the lethargy and hopelessness of bad health and weakness behind forever. Re-vitalize yourself. Bring back energy. Be wholly alive. Write today!

10 Days Free Trial—Write for FREE BOOK



These great new inventions generate *High Frequency Violet Ray, Mechanical Vibration, Medical Electricity and Ozone.* Combined or separate.

They operate on the electric light in your home or on their own motive power at less than 50 cents per year. Elco Health Generators are positively the only instruments which can give you in one outfit Electricity, Violet Ray—Vibration and Ozone—the four greatest curative agents. Send coupon below. Get the Free Book NOW!



For All These:

- | | |
|-------------|-----------------|
| Rheumatism | Asthma |
| Gout | Hay Fever |
| Lumbago | Sore Throat |
| Neuralgia | Catarrh |
| Sciatica | Deafness |
| Headache | Insomnia |
| Neuritis | Pain |
| Nervousness | Development |
| Circulation | Skin Disease |
| Weakness | Pimples |
| Paralysis | Scalp Disorders |
| Eye Trouble | Obesity |

MAIL the COUPON for FREE Book!

Do not put this paper down without sending the coupon. Don't go on as you are with pains and with almost no life and energy. You owe it to yourself to be a better man or woman. You were put here to enjoy life—not just to drag through it. So do not rest another day until you have put your name on the coupon here. That will bring the whole story of these great new inventions. Do it today—now.

Health Power Beauty

Lindstrom & Company

30 West Lake Street. Dept. 13-51, Chicago, Ill.
Please send me your free book, "Health—Power—Beauty" and full information on your 10-day Free Trial Offer.

Name

Address

Make Your Tires PUNCTURE-PROOF
 IN ONE MINUTE
Agents AND DISTRIBUTERS
 580 NAIL & SPIKE PUNCTURES WITH NO AIR LOSS
25¢ PER TIRE
 IN FORD SIZES
Wanted

GALACITE * will repair a puncture in ONE MINUTE without taking the tire off the wheel or rim; and in addition it will make the tire Puncture Proof for life. GALACITE seals instantly and permanently, punctures, leaks, porous places and leaky valves. No more flat tires, no more getting out and changing tires in a hot sun. No soiled clothes. A scientific laboratory product. Tested in every part of the United States. Backed by a MONEY BACK GUARANTEE to do everything we claim. Guaranteed not to injure tube, valve or tire; on the contrary it preserves and lengthens the life of tube and tire, often

INCREASING TIRE MILEAGE FROM 10,000 TO 12,000 MILES
 Take a hammer and drive as many nails into a tire as you wish, 50-100-500, it makes no difference. GALACITE seals the punctures permanently, as soon as they are made. We guarantee it for one year, but it will last indefinitely.

CAR OWNER AGENTS WANTED
EARN \$5,000 TO \$10,000 A YEAR

TREMENDOUS PROFITS. Agents and Distributors everywhere to demonstrate and sell to car owners, garages, filling stations. Work all or spare time in your own home town or traveling. GALACITE sells itself. Every customer becomes so enthusiastic that he helps you sell his friends. A revolutionary invention that will make you independent. You can also manufacture and sell GALACITE PUNCTURE PROOF INNER TUBES.

ACT QUICK SEND NO MONEY. Just your name and address will bring complete particulars by return mail. Get this information right now. Test it out. Get started while the field is still uncrowded.
C. F. JOHNSON & CO. Dept. 955, 19 W. Jackson Blvd. CHICAGO, ILLINOIS, U. S. A.
 *Galacite Trade Mark Reg. Copyright 1925

AGENTS NEW SPARK PLUG
Visible Flash



Just Out—Amazing Invention—Beacon Lite Spark Plugs. You see the flash of each explosion in the cylinders. Tells which are firing right. Greatest improvement in spark plugs since gas engines were invented. Wonderful gas savers. Agents coining money.

\$90 A WEEK
 Easy to make with new sure-fire plans. Sells on sight to every auto owner. Phillips, Ont., writes "Sold 2 dozen today, 3 dozen yesterday. Rush 10 dozen." Write for special Free Demonstrator Offer and FREE deal to introduce these wonder spark plugs in your territory. Write quick—today.

CENTRAL PETROLEUM COMPANY
 1021 Century Building Cleveland, Ohio

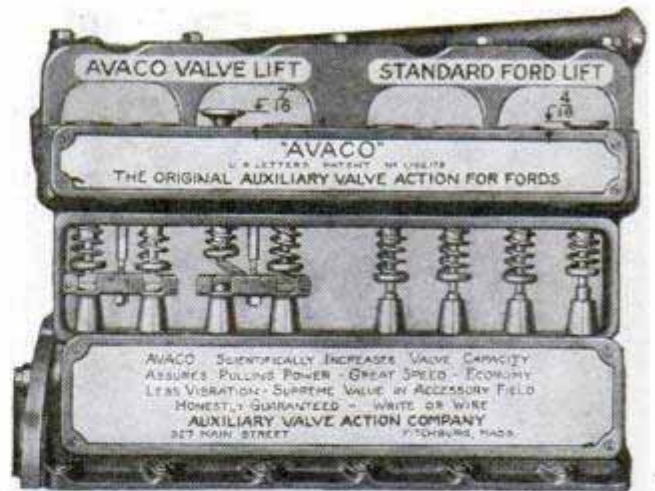

Tire AGENTS WANTED

Use and Introduce **MELLINGER CORD TIRES**

15,000 MILES GUARANTEED

Lowest Wholesale Prices in America. Shipped prepaid on approval. Make big money all or part time. No capital or experience. Sample sections furnished.

YOUR TIRES FREE! Simply send name today for valuable FREE BOOK; tells how thousands have gone into big business. SPECIAL AGENTS' OFFER. Wholesale Prices and FREE SAMPLE KIT. Write nearest address.

MELLINGER TIRE & RUBBER CO.
 PHILADELPHIA, PA. Dept. 1915 KANSAS CITY, MO.



ATKINSON AUTOMATIC TIMER

\$75 to \$100 Weekly



Every Ford Needs One

New Invention that will make starting easy. Smoother running at all speeds. Short Proof—Kick Proof. Agents or Salesmen can earn big money. Sells for \$3.00. Write for free folder and confidential prices. Start quick before your territory is taken.

ATKINSON AUTOMATIC TIMER CO., CYNTHIANA, KY.

MOTORCYCLES

Price \$10 and up purchased through our Co-Operative Plan for as low as \$1.00 down and \$1.00 per week

Indians Harley-Davidsons Ace Henderson and Clevelands

Motorcycles shipped to all parts of the world

WALKER-INDIAN CO., 188 Mass. Ave., BOSTON

MOTORCYCLES



RELIABLE STANDARD MAKES that you can **DEPEND** on. Enjoy the glorious experience of going wherever you like—whenver you like. The price is within your means—15% to 50% less than others. These machines are slightly used, thoroughly overhauled or rebuilt. Send for catalogues.
MYEROW BROS.,
 15 Berkeley St. Boston, Mass.



Make Your FORD a Closed Car

Limo weather-proof sections change your 1923-24-25 Ford Touring or Roadster into classy limousine-style closed car in a jiffy. Doors open from outside. Sliding front panels for ventilation. Three-ply double covered veneer frames. Color matches your top; quickly in-stalled. Guaranteed. Low priced. Write for prices.

BUOB & SCHEU P80 Webster Street, Cincinnati, O.

MAKE YOUR Ford INTO THIS Sport Car—Save \$50 to \$150 with Red-i-Kut Life-Size Patterns \$5.00

Famous sure-fit **RED-I-KUT** life-size patterns and picture instructions show how you can easily convert your Ford into this **Fast, Saucy, Sport Car** as thousands have done, with easily obtained materials. No need to lay up the car. Rear seat folds making 4-passenger car. **Look at Wilfred Eno's.** Eno says: "It took me 5 Sundays to build it and I sure am proud to hear them say, 'He built that snappy sport car.' I never cut any steel or did any woodwork before but one can't go wrong with Kuempel patterns. St. Louis, Mo."



The Lark life-size patterns for each part of the body so you can't go wrong, picture instructions and **CONICAL DISK WHEEL PATTERNS.** Only \$3.00 delivered. \$4 extra brings patterns for **Jiffy Top and Gouss** windshield. 22 gages **RKO Steel** for Lark \$10 complete. Extreme West \$13. Order now while we can make good delivery, and really enjoy these wonderful days in your Lark. **Keen, Classy, Up-to-the-minute.** You can build it. Over 11,000 in use. Don't hesitate. "Swing Lo" Underling Irons, no frame cutting kind, \$6.59. Only \$4.99 when ordered with Lark patterns. Send 5c coin for new manual of other distinctive sport body patterns from \$4.80 up—"RKO" Steel "Swing-Lo" Irons. Tons and Windshields. **ORDER RIGHT NOW.**
KUEMPEL CO., 66 Kuempel Bldg., Guttenberg, Iowa

Easy-to-Understand Instructions

The "Lark" Class—Snap



21 Jewel ~ Extra thin STUDEBAKER

The Insured Watch

Sold direct from the factory at a saving of 50%.



SENT FOR

\$1.00
DOWN!

Only \$1.00! The balance in easy monthly payments. You get the famous Studebaker 21 Jewel Watch—insured for a lifetime; 8 adjustments, including heat, cold, isochronism and 5 positions—choice of 60 new Art Beauty Cases in green gold, white gold or yellow gold effects. Latest thin models.

Chain Free! For a limited time we are offering a beautiful Chain FREE!

Write For FREE Book
Send today for wonderful Studebaker Book of Advance

Watch Styles and our \$1.00 Down Offer—FREE!

STUDEBAKER WATCH CO.
Dept. E12 South Bend, Indiana
Canadian Address: Windsor, Ontario

GRIPSTIK

OUTGRIPS A PLIER AND OUTSTICKS A WRENCH

EASY MONEY FOR AGENTS
SELLS ON SIGHT

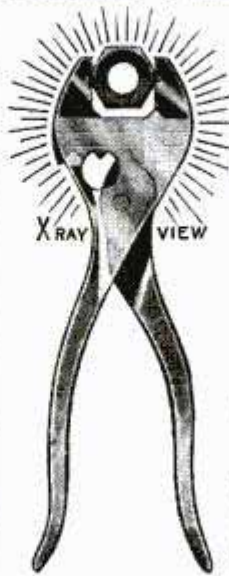

We make these tools for men who know their stuff. They are machined from the finest steel, built like an automatic pistol and finished like a micrometer. The lightest, handiest, most powerful tools ever made. They never slip. Every man wants one for his car, and they sell for a song.

MECHANICS
Sell Three and Get One FREE
AGENTS

Some Choice Territory Still Open

Large commission and the most attractive monthly bonus proposition you ever saw. Write TODAY—DON'T DELAY.

THE GRIPSTIK CO.
DOVER, OHIO

THE GRIPSTIK CO., 715 Main Street, Dover, Ohio

Gentlemen: Please send us your proposition.

Name..... } Agent
 Address..... } Mechanic
 City..... State.....

Play this Jazzy Sax Without Practice

Any one can play this Big Imported Jazzy Sax right away. No knowledge of music required, no lessons. Play by numbers instead of notes. All instructions and 87 songs free! Be popular at parties, dances, picnics, entertainments. Made of metal, handsome polished finish. Over 20 in. long; weighs 2 lbs. Looks like regular saxophone.

Play Jazz Right Away

Surprise your friends. Beautiful clear, ringing tones and delightful harmony. V. D. Beauty writes: "Played tunes in 15 minutes. Delighted."



FREE

Big Book of

ONLY \$5.98
87 SONGS

Big Book of 87 Songs. Popular music, Jazz tunes, old time favorites, and full directions absolutely FREE with each Jazzy Sax on our special limited offer. But you must get your order in at once.

Send No Money

Send just your name. When Sax and big Free Book of 87 Songs arrive pay postman only \$5.98 plus a few pennies postage. Satisfaction guaranteed or money refunded. Don't delay, act now!
FERRY & CO., 3224 N. Halsted, Dept. 9771, CHICAGO

PRICES REDUCED

Only **\$3**
Down



A Year to Pay

Yes, lowest prices on

UNDERWOOD, REMINGTON, L. C. SMITH, ROYAL, and all standard makes on easiest terms ever offered. Re-manufactured like new by the famous "Young Process" to give a lifetime of service.

10 Days Trial Our liberal "direct from factory plan" saves half. You actually use the typewriter 10 days without obligation to buy. Let us prove we have the greatest typewriter bargains ever offered. You actually save from \$40 to \$50.

Big Illustrated Catalog FREE
This interesting valuable book explains fully how "Young Process of Re-Manufacturing" guarantees you highest quality, perfect service and satisfaction. Rush coupon today to
YOUNG TYPEWRITER CO., (Est. 1911)

SEND COUPON NOW

Young Typewriter Co., Dept. 1101, 654 W. Randolph St., Chicago

Send me Free book and Special Reduced Prices. This does not obligate me in any way.

Name.....
 Address.....
 City..... State.....

SHOW IT—and IT'S SOLD



Razor Blade Paring Knife

The fastest selling home necessity ever offered. Sells for 25c. Your price \$1.50 dozen, prepaid. Guaranteed

MORGAN MANUFACTURING CO. 443 S. Dearborn Street Dept. G CHICAGO

\$6

CASH WITH ORDER

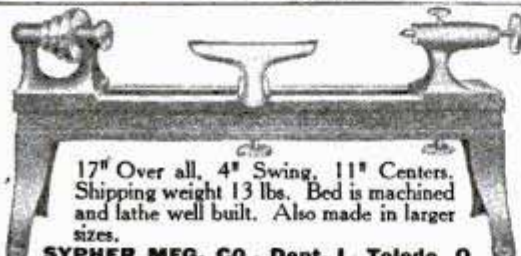

17" Over all, 4" Swing, 11" Centers. Shipping weight 13 lbs. Bed is machined and lathe well built. Also made in larger sizes.

SYPHER MFG. CO., Dept. L, Toledo, O.



Mechanics Radio Men

Get this Flexible and Portable Shaft Outfit of a thousand Uses

This Flexible Shaft Outfit is indispensable for home, garage and shop use. It's an important repair tool for autos, trucks, tractors and stationary engines. It has lots of pep behind it. It's portable. You take the tool to the work, instead of the work to the shop.

A precision instrument primarily designed for hard service. Supplied with 2 adjustable chucks taking drills and tool shanks from the smallest to 3/4 inch diameter, giving the Flexible Shaft a wide range of uses. All parts are standard and easily interchangeable.

Consists of a ball-bearing coupling to connect to any motor, 3 feet of flexible shafting, and a ball-bearing Hand Piece or chuck holder. Will operate emery and buffing wheels, reamer and auger bits, metal drills, files, burrs and many other appliances. Simply place the tool in the chuck, tighten the chuck in the hand piece and the outfit is put to work.

A FEW USES

The following gives you an idea of the many uses of the Flexible Shaft Outfit: grinding and sharpening knives and cutlery; buffing and polishing; drilling and reaming holes in metal, wood, Bakelite or composition; filing and scraping; die cutting; mold making; carving; engraving; silvering; rectifying dies and punches; cleaning solder joints, etc.

A good 1/8 or 1/4 horse power motor for operating is easily obtainable. For drilling, be sure motor turns counter clockwise looking at exposed end of shaft. In ordering, state size of motor shaft.

Special Offer

Our Flexible Shaft Outfit regularly sells for \$40. As a special introductory offer from our factory to you, send \$5 with order, and pay postman \$20, plus postage on arrival. Satisfaction guaranteed or money back. Order direct from this advertisement.

THE S. S. WHITE DENTAL MFG. CO.
(Industrial Division)
152 West 42nd Street, NEW YORK, N. Y.

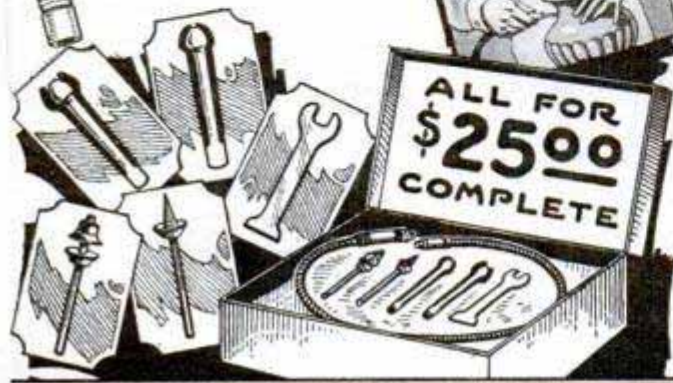

"The Best Transformer We Ever Tested"



says a leading Laboratory

Entire new conception in design—no excess iron—greatly increased copper "turns"—scientific distribution.

2.2 to 1, \$5.00
4.7 to 1, 5.75

Better audio amplification than you can secure in any other way—and without paying a premium.

Silent Socket

Only successful remedy for microphonic noises. Better than spring sockets—it absorbs vibrations. Put one on your detector and you won't know your set. Including Universal Socket..... **\$1.25**

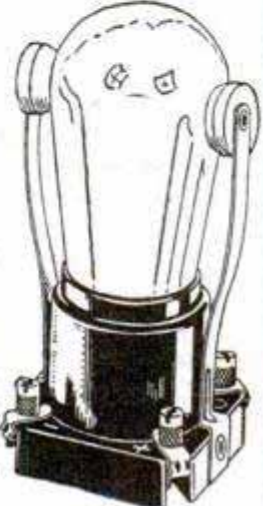

BREMER-TULLY Mfg. Co.
532 S. CANAL ST. CHICAGO, ILLINOIS

PACKARD

Prepaid in U. S.

\$725

FOREIGN \$9.50



Weight 12 lbs. **SIZE: 26 in. by 10 1/2 in.**

Lifting power of great strength operated by crank, holds up to 200 lbs. Tailboard has snap catches and chute. "Stop" and "Go" signals, nicked Headlights and Hubs. Balloon tire wheels. Rubber tires \$70 per set extra. Fully guaranteed. Catalog of other trucks and moviegraphs upon request.

Libbey & Nichols, Dept. O, 100 Boylston St., Boston, Mass.

DIAMONDS

Here at 60% of Market Price

This snappy accurately cut diamond 7/8 less 3/32 ct. at \$52.50 among bargains in recent list. Many other big values in our lists. Buy here! Prices based on loan values, not market values. This 75 year old diamond banking firm has thousands of unpaid loans and other bargains. Many from big cash deals direct with European Diamond Cutters. Must sell NOW to get back our cash.

Why Pay Full Prices
Any diamond sent for absolutely free examination at our risk. No obligation. No cost to you.

Send for Latest List

Describes Diamond Bargains in detail, gives guaranteed loan values. Explains unlimited exchange privilege. Write for list today. **Send NOW!**
JOS. DeROY & SONS 1940 DeRoy Building
Only Opposite Post Office Pittsburgh, Pa



LEPAGE'S mends for keeps



COMPARED to the value of the article mended, the cost of the glue you use is practically nothing. Then while you are about it, why not use the best glue—LePage's? Have the satisfaction of knowing that the article is mended *for keeps* and that it won't come apart in a little while and have to be mended over again. Insist on LePage's.

LEPAGE'S GLUE

MOVIES—Believe the Bible



See What It Teaches
We sell wonderful religious movie films and real movie machines—so you can show movies at home. Some movie machines as low as \$3.75—others higher. Also fine assortment of comedy, western and feature films with an exchange service for home users.

Write for Big Free Catalog
PARAMOUNT MFG. COMPANY Dept. MB
Boston, Mass.

NEW MARVELOUS ONE - MINUTE CAMERA

Takes and finishes pictures inside the camera in one minute. Agents wanted. Exclusive Territory. Make money selling these wonderful cameras or taking photos or both. Six different models. Photos 4x6, 3 1/4 x 5 1/2, 3 1/4 x 4 1/2, 2 1/2 x 3 1/2, 2x3 and 1 3/4 x 2 1/4 inches. No experience necessary. Any one can operate these cameras. Write today for special offer.
CROWN MINUTE CAMERA COMPANY. Dept. 940. NORWALK, CONN.

THIS GREEN LINE TOOL CASE

KEEPS TOOLS SAFE
—ALL IN ONE PLACE

ONLY
\$4.95

Good tools deserve good care. Green Line is complete with 6 different types and sizes for machinists, carpenters, radio installers and set builders, pattern makers, electricians, garage and repair men, etc.

General Tool case pictured is light, sturdy, handy, especially adapted for Home or Shop use. Weighs only 7 1/2 lbs. yet measures 8" x 8" x 20". Made of cypress, covered with olive green metal with brass corners, bolts and lock, large tray and strong handle. If your dealer can't supply you, sent direct, prepaid upon receipt of price \$4.95, West of Rockies \$5.45. Order at once or send for catalog of complete line.

GREEN-CASE, Inc., (Tool Case Division), Racine, Wis.

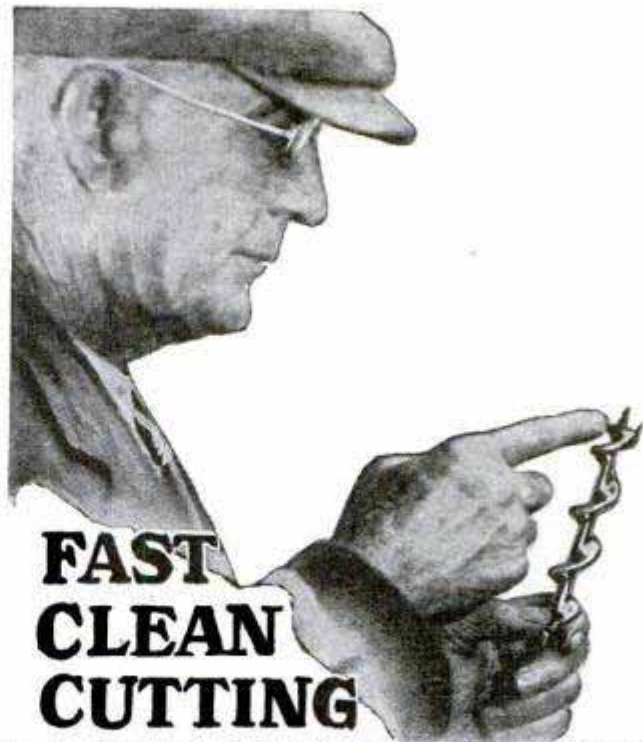

FAST CLEAN CUTTING TOUGH AUGER BITS

An old carpenter very aptly summed up the reasons for his preference for Irwin Auger Bits. He said, "They cut fast, they cut clean clear through, and they are the toughest, best edge holding, wear resisting bits I ever used." What more could be asked of any Auger Bit?

Every man should have a complete set of Irwin Auger Bits. The time they save and the convenience of having the right bit for every job soon repays the small cost.

Ask your hardware dealer to show you Irwin Auger Bits in sets.



Illustration shows the Carpenter Set and Borecase

- Irwin Home Set, 6 bits and case . . . \$3.50
- Irwin Handy Set, 10 bits and case . . . 5.50
- Irwin Carpenter Set, 13 bits and case . . . 7.25

THE IRWIN AUGER BIT CO., Wilmington, Ohio

Hardware dealers everywhere sell genuine Irwin Auger Bits. The Irwin mark shown below is stamped on the shank of every Genuine Irwin Bit.



The IRWIN Bit

REG. U.S. PAT. OFF.

DIAMONDS

WATCHES & JEWELRY

12 MONTHS TO PAY

Send No Money Pay The Post Man



No. 39 - \$61
\$1 Deposit - \$5 a Month

This exquisite diamond ring is considered extremely handsome. The best quality genuine blue white diamond is full of fiery brilliance and sparkling colors. It makes a wonderful engagement ring or friendship ring. Your friends will think you paid \$100.00 for it. Everyone will admire it. The gift case is free. Write for Catalog.

18 KARAT

\$1 Down: \$5 A Month

Great big cluster of seven sparkling, brilliant blue white, specially selected diamonds set in solid platinum in this handsomely engraved 18 kt. solid white gold ring. Two triangular, dark blue sapphires give the proper touch of style. It looks like a 2 carat solitaire worth \$1,000.00.



No. CS2
\$61

FREE Every purchaser who answers this advertisement will receive a valuable premium. The premium list will be sent as soon as we receive coupon.

No. 8 \$22 \$1 DEPOSIT \$1.75 A MONTH
ELGIN OR WALTHAM

Man's full 12 size, open faced model, fancy engraved watch with your choice of either of the world-famous Elgin or Waltham movements. They are cased in this handsome gold filled case which will wear like solid gold. The Waltham and Elgin movements are positively guaranteed both by the factory and ourselves. They are accurate time keepers. **FREE:** We will give away, absolutely free, a handsome gold filled chain and knife to match. They come in a fine gift case, and make an unexcelled present.

STERLING DIAMOND & WATCH CO., Inc.
 1540 Broadway Dept. P-2085 New York

TEAR OUT & MAIL

STERLING DIAMOND & WATCH CO., Inc.
 1540 Broadway, Dept. P-2085 New York, N. Y.

Please send it to me by parcel post C. O. D. and I will pay the small deposit to the mailman when he hands me the package.

I enclose \$..... as a deposit. Please mail the article to me direct to my home.

Don't send the ring or watch, but mail a copy of your big free catalog to me, which shows thousands of diamond, watch and jewelry bargains for me to select from.

Name

Local Address

City and State

EDWARDS

WILL SAVE YOU MONEY ON

METAL ROOFS

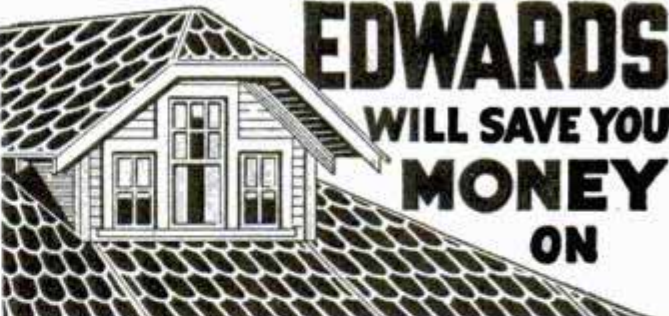

We own our own steel mills, roll our own sheets, make them into high-grade REO METAL SHINGLES, Sidings, Ceilings and Roofings of every type and style for every kind of building. We control every operation from the raw material to the finished roof and we sell direct from our factories to the user. Not a dollar to divide with anybody but the customer! You get better value for less money.

OUTLAST THREE ORDINARY ROOFS

EDWARDS METAL ROOFS are weather-proof, lightning-proof, fire-proof! The galvanizing bends with the metal. No tools required.

LOW-COST ALL-METAL GARAGES



Any size. Any style. Portable. Ready to erect. Complete with frames, doors, sash and hardware. Ornamental, durable, economical. Blue-prints and complete instructions **FREE**. Write today. Get our low prices and Free Samples. Ask for Roofing Book No. 150 or for Garage Book No.

THE EDWARDS MFG. CO.
 100-150 Butler St. Cincinnati, O.

FREE
 Samples & Roofing Book

\$25000 A WEEK!

Made with the new and improved "Krispy" Potato Chip Outfit.

Potato Chips the lunch of the hour. Everybody is eating them. One stand in small building sells \$100 worth in a week. Think of it! Grocers, druggists, pool rooms, cigar stands, tourists' counters, parks—all sell thousands of packages. Supply them. Get the big profits. Chips easily, quickly made at home. No experience necessary. Write today. Get in a big profit fast growing business now.

SERVICE & EQUIPMENT CO., 905 Hoag St., Toledo, Ohio

THE WOTEN, GASOLINE ENGINE

2 CYCLE, 3-PORT

Aircooled and Watercooled. One-Half H. P. in five pounds. Handiest little engine ever made. Ideal wherever power is needed. Complete line of small gasoline and steam engines, dynamos, motors, batteries, battery chargers, etc. **CATALOGUE FREE.**

DYNAMIC MANUFACTURING CO.
 First Nat'l Bank Bldg., Dept. 6 Chicago



Make Your Tool Kit Complete

Polly

10 WRENCHES IN ONE

No tool kit is complete without an assortment of wrenches. The "Polly" affords complete equipment with fewer wrenches at less cost. Entirely new principle, instant adjustment. Jaws cannot change adjustment while using. Light weight, more convenient handle; strongest wrench made. 6 in. 85c; 9 in. \$1.25; 12 in. \$1.75 or complete set, in kit, \$2.85. From your dealer, or sent prepaid on receipt of price.

GELLMAN MFG. CO.
 Dept. 15 Rock Island, Ill.



Pat. Appl. 17, 1921

"Saws 25 Cords In 5 Hours"

Any hustler can make big money with the one-profit WITTE Saw RIG—Ed. Davis sawed 25 cords in 5 hours—another user sawed 40 loads of pole wood in 3 hours. Hundreds of owners make \$3,000 to \$5,000 a year. Sold on Easy Payments.

**5 H-P.
3-in-1
Saw
Rig**

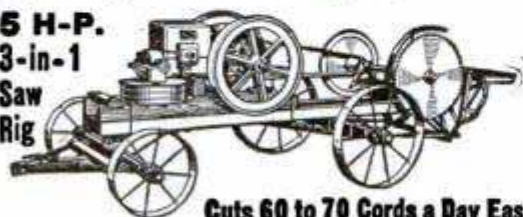

Cuts 60 to 70 Cords a Day Easy

A real all purpose outfit for farmers and men who make wood sawing a regular business. When not sawing you can fill silos, grind feed, shell corn, thrash and do other work. Easy to start at 40 below zero. Completely equipped with WICO Magneto, speed and power regulator, throttling governor and 2 fly wheels.

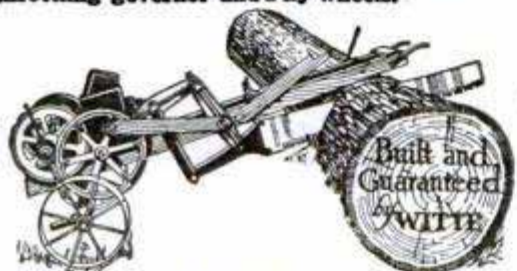

WITTE LOG & TREE Saw

Cuts down trees and saws them up FAST—one man cuts 10 to 15 cords a day—makes ties. The WITTE is easy to run and trouble-proof. Thousands in use. Powerful engine runs other farm machinery. Uses all low priced fuels.

EASY Pay only a few dollars down and take a year for the balance of low price.
PAYMENTS—MAKE YOUR OWN TERMS.

FREE Write today for full description and low price—no obligation. Or if interested, ask for our Engineer Pump catalogs.

WITTE ENGINE WORKS

Kansas City, Mo. Pittsburgh, Pa.
6746 Witte Bldg. 6746 Empire Bldg.
6746 Witte Bldg., San Francisco, Calif.

UTAH LOUDSPEAKER

Ours is the strongest guarantee! Use it 10 days. If not the finest you ever heard, return it and get your money. Dealers Everywhere.
Utah Radio Products Co. Dept. 50, 1427 S. Michigan Ave. CHICAGO, ILLINOIS

SPORT BODIES for FORD and CHEV. 490 at \$34.50 UP

Life-size paper patterns—You can build your own body at small cost.



\$8 UNDER SLUNG PARTS Per Set \$6.75

We are manufacturers and our quantity production enables us to quote exceptional low prices. Our unique shipping methods save you 73% in FREIGHT CHARGES. Send at once for free particulars on Central Bodies. Our Book: "HOW TO BUILD A FORD RACER" sent anywhere on receipt of 25c in cash or stamps. WRITE TODAY!
Central Auto Supply Co. Dept. 120, Louisville, Ky.



The Bridge to Amplification Without Distortion

Daven engineers were pioneers. They blazed the way for others to follow. They designed and built the first Resistance Coupled Amplifier offered the public. They found resistance coupling in an experimental stage. They perfected it.

Daven Resistance Units, Amplifier Kits and Super-Amplifiers are accepted by the foremost authorities in Radio as standard. The Daven Super-Amplifier is for use in any known set or circuit.

A New Tube By Daven

To meet the exacting requirements of Resistance Coupled Amplification the Daven Radio Corporation has created a new product, the DAVEN HIGH MU VACUUM TUBE, Type MU-20. It is designed for one specific purpose only—to increase the amplification of the Daven Resistance Coupled Amplifier so as to exceed that of ordinary audio frequency coupling. The Daven High Mu is a 6 volt, 1/4 ampere tube with an amplification constant of 20. Daven Power Tube Type Mu-6 is recommended for the last or output stage of any set.

Resistor Manual

Manufacturers of high grade sets are turning to Resistance Coupled Amplification. The authority is *The Resistor Manual*. At your dealer's, 25c; or by mail, 30c.

Daven products are sold only by good dealers

"The Sign of Merit"

DAVEN RADIO CORPORATION

Resistor Specialists

NEWARK Reg. U. S. Pat. Off. NEW JERSEY

CLIP THIS COUPON



DAVEN RADIO CORPORATION
165 Summit St., Newark, N. J.

Please send me the following on Resistance Coupled Amplification.

CHECK ONE
... Resistor Manual. 30c is enclosed.
... Complete Catalog (free).

Name.....

Address.....

For Dealers: Send your letterhead or card and we will have our nearest distributor communicate with you.

THE BIG LITTLE THINGS OF RADIO

LUMINOUS PAINT

Make Your Watches, Clocks, Etc., Visible by Night

The very latest discovery in the scientific world. Hitherto, practically unobtainable except at an exorbitant price, we have at last succeeded in producing this remarkable LUMINOUS PAINT, which, applied to the surface of any article, emits rays of white light, rendering it perfectly visible in the dark. THE DARKER THE NIGHT, THE MORE BRILLIANT IT SHINES. Quite simple to use. Anyone—you can do it. A little applied to the dial of your watch or clock will enable you to tell the time by night. You can coat the push buttons or switch plates of your electric lights, match boxes, and innumerable other articles; make your own Luminous Cigarettes, Luminous Rosaries, etc. Small bottles, price 25c. Larger sizes, 50c and \$1 postpaid.

JOHNSON SMITH & CO. Dept. 471, RACINE, WIS.

Serpent's Eggs

Box contains 12 eggs. When lit with a match, each one gradually hatches, itself into a snake several feet long, which curls and twists about in a most life-like manner. Price per box, 10c postpaid, 3 for 25c.

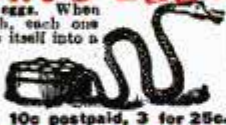

CIGARETTE MAKER



Roll your own and save money. Makes them better and quicker besides saving more than half. Use your favorite brand of tobacco. Neat, useful and handy. Pocket size, weighs 1/2 oz. Made entirely of metal, nickel-plated. Price 25c postpaid.

MIDGET BIBLE

GREAT CURIOSITY
Smallest Bible in the World. Size of a postage stamp. 200 Pages. Said to bring good luck to the owner. A genuine work of art. Must be seen to be appreciated. Make good money selling them to friends, church acquaintances, etc. PRICE 15c each, 3 for 40c, 12 for \$1.35, 100 for \$7.50. Also obtainable in Leather Binding, with gold edges. Price 50c each, 3 for \$1.25, \$4.50 per doz. Magnifying Glass for use with Midget Bible, 15c.



STAGE MONEY



With a bunch of these bills, it is easy for each person of limited means to appear prosperous by flashing a roll of these bills at the proper time and peeling off a genuine bill or two from the outside of the roll, the effect created will be found to be all that can be desired. Prices, postpaid: 49 Bills 20c, 125 for 50c, or \$3.50 thousand postpaid.

Wonderful X-Ray Tube

A wonderful little instrument producing optical illusions both surprising and startling. With it you can see what is apparently the bones of your fingers, the level in a lead pencil, the interior opening in a pipe stem, and many other similar illusions. A mystery that no one has been able to satisfactorily explain. Price 10c, 3 for 25c, 1 dozen 75c. Johnson Smith & Co.



Good Luck Ring

Quaint and Novel Design

A VERY striking and uncommon ring. Silver finish, skull and crossbones design, with two brilliant, flashing gems sparkling out of the eyes. Said by many to bring Good Luck to the wearer, hence its name, Good Luck Ring. Very unique ring that you will take a pride in wearing. ONLY 25 CENTS.

Exploding Cigarettes



JUST LIKE ORDINARY CIGARETTES. BUT SUCH REAL STARTLERS! The box contains ten genuine cigarettes of excellent quality. They appear so real, but when each cigarette is about one-third smoked, the victim gets a very great surprise as it goes off with a loud BANG! A great mirth provoker yet entirely harmless. Price 25c per box.

Popular Watch Charms

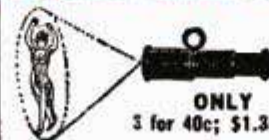

Very pretty little curiosities and decidedly novel. Fitted with Magnifying Lenses that enlarge the pictures to a very surprising degree; in fact, it seems almost incredible that a clear picture could be possible in such a small compass, and how sharp and distinct they show up when you look through. Come in assorted views—Astronauts, views of Panama Canal, Lord's Prayer in type, etc.

Mystic Skeleton

A jointed figure of a skeleton 14 in. in height, will dance to music and perform various gyrations and movements while the operator may be some distance from it.



NEW BOOK ON ROPE SPLICING

Useful Knots, Hitches, Splices, etc.

A most practical handbook giving complete and simple directions for making all the most useful knots, hitches, rigging, splices, etc. Over 100 illustrations. All about wire rope attachments, lashing, blocks, tackles, etc. 27 Heraldic Knots illustrated. Of great value to mechanics, riggers, campers, boatmen. Price 20c ppd.

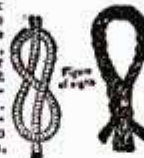

MAGIC FLUTE

Wonderfully Sweet Toned and Musical



The Magic Flute, or Humanations, is a unique and novel musical instrument that is played with nose and mouth combined. There is just a little knack in playing it which, when once acquired after a little practice will enable you to produce very sweet music that somewhat resembles a flute. There is no fingering, and once you have mastered it you can play all kinds of music with facility and ease. When played as an accompaniment to a piano or any other musical instrument, the effect is as charming as it is surprising.

BLANK CARTRIDGE PISTOL

Protection against Burglars, Tramps & Dogs

Prices 50c \$1.00



Well made and effective; modeled on latest type of Revolver; appearance alone is enough to scare a burglar. When loaded it may be as effective as a real revolver without danger to life. It takes standard .22 Cal. Blank Cartridges obtainable everywhere. Price 50c, superior quality, \$1.00 postpaid. Blank Cartridges, by express, 50c per 100 Holster (Cowboy type) for Blank Cartridge Pistol, 50c Johnson Smith & Co., Dept. 471, Racine, Wis.

Post-paid

BOYS! BOYS! BOYS! THROW YOUR VOICE



Into a trunk, under the bed or anywhere. Lots of fun fooling the teacher, policeman or friends.

THE VENTRILO
a little instrument, fits in the mouth out of sight, used with above for Bird Calls, etc. Anyone can use it.

Never Fails. A 32 page book on Ventriloquism, the Ventrillo, ALL FOR 10 CENTS

K.K.K.



Everything about the Ku Klux Klan told in a clear, fearless manner. Book tells all—How it started and was oppressed in 1871—The New Ku Klux Klan—How Organized—How Members are Enrolled—Oath of the Klan—Questions for Candidates—Creed—Objects of the Order—Obedience—Fidelity—Pledge of Loyalty—Ku Klux Klan and the Masons—The Jews—The Masons—Real K. of C. Oath—The Negro Ku Klux Klan, etc., etc. Latest and most complete book on the Klan published. Price 25c, Postpaid. Stamps or Coins

LOOK 35¢ LOOK

Wonderful instrument. Greatest thing yet. Nine separate articles in one. Everybody delighted with it. Odd, curious and interesting. Lots of pleasure as well as very useful. It is a double Microscope for examining the wonders of nature. It is also an Opera Glass, a Stereoscope, a Burning Lens, a Reading Glass, a Telescope, a Compass, a Pocket Mirror, and a Laryngoscope—for examining eye, ear, nose and throat. It is worth all the cost to locate even one painful cinder in the eye. Folds flat and fits the pocket. Something great—you need one. Don't miss it. Sent by mail, postpaid. Only 35c or 3 for \$1.00



25 CENTS BABY TANK



Goes backward or forward by steam power. Nothing to wind. What makes it go is a mystery. It crawls along, overcoming obstacles just like the larger Tanks. Performs dozens of most amazing stunts. Runs ten times longer than most mechanical toys. Hand-screwed. Runs on oil and vasoline. Packed in natural colors. 25c postpaid.

Female SEX Male Sex Indicator



Hold the MAGIC INDICATOR over a man's hand—instantly it moves in a straight line, backward and forward. Hold it over a woman's hand and it describes a complete and continuous circle. The same action can be obtained over a letter written by a man or woman, etc. It is fascinating; ha! ha! We have never been able to figure out how it's done—but we've never seen it fail. Many novel and entertaining feats may be performed with the Sex Indicator. For example, similar results can be obtained with animals, cats, dogs, rabbits, over birds, chickens, canaries, etc. Also used to predetermine the sex of chickens and birds, etc., in fact it is sold as a patented egg tester in Europe. Price 25c, or 3 for 85c, ppd.

Address orders for all goods on this and opposite pages to

JOHNSON SMITH & CO.

Dept. 471 RACINE, WIS.
A DeLuxe Edition of our new 1925 CATALOG mailed on receipt of 25c. Handsome cloth binding. Only book of its kind. 420 pages of all the latest tricks in magic, the newest novelties, puzzles, games, sporting goods, interesting books, curiosities in seeds and plants, etc., unobtainable elsewhere. Remit by Money-Order, Check, Coin, Stamps, etc. Stamps of foreign countries also accepted.



THE TEDDY CAMERA



Takes and Finishes an Excellent Photograph on a Card 3 1/2 x 2 in One Minute

It is the newest method of photography in which skill and experience are not necessary. Not a plate nor a film camera, but a camera that produces the complete picture. Does not use either plates, film, or dark-room. All the troubles of picture-taking in the ordinary manner are swept away. It eliminates all the fuss and trouble and, above all, there is No Waiting, for you actually see the finished picture in One Minute. You merely place the cards in the camera, press the shutter, drop the card into the automatic developing tank attached to the camera, and in One Minute you have a Completed Picture all finished and ready to show. It is so simple and easy that any child who can use its hands can take good pictures. The camera weighs little more than half a pound, and measures about 4 1/2 x 3 1/4 inches, easy to

\$2.50

carry about and always ready to take and finish a picture in one minute. The Lens is of high grade, universal focus, needs no adjustment, and takes clear and brilliant pictures at any distance. The Shutter works perfectly and responds to very slight pressure. It loads in broad daylight. The Developing Tank is attached to the Camera and holds a single solution that develops, tones and fixes the picture in one minute with absolute certainty and with no care or attention on the part of the operator; it cannot be over-developed. Produces a picture 3 1/2 x 2 inches. Send today and have the never-fading pleasure of making excellent pictures of your family, friends or neighbors, your house or your domestic pets. Price of Camera Complete with Developer and Package of Cards, ONLY \$2.50. Extra packages Sensitized Cards 15 cents per package; extra Developing Solution 25 cents. All prices are postpaid to any address in the world.

Every Boy His Own Toy Maker

Greatest boys' book written. Tells how to make a Pinhole Camera, a Canoe, model Railroad, a Telephone, Boomerang, Telegraph Instrument, Box Kite, Talking Machine, Microscope, Electric Motor, Electric Door Bell, Water Wheel, Paddle Raft, a pair of Skis, a Dog Sled, Bird House, Rabbit Yard, etc. 64 pages, 150 illustrations. PRICE, 10c postpaid; 3 for 25c.



INVISIBLE INK

The most confidential messages can be written with this ink, for the writing Makes No Mark. Cannot be seen unless you know the secret. Invaluable for many reasons. Keep your postals and other private memorandums away from prying eyes. Great fun for playing practical jokes. Only 15c a Bottle; 3 for 40c.



JAPANESE ROSE BUSHES

The Wonder of the World Japanese Rose Bushes bloom all the year round. Just think of it. Six weeks after planting the seed, the plants will be in full bloom. It may not seem possible, but we positively guarantee it to be so. They will bloom every ten weeks, Summer or Winter, and when three years old the bush will be a mass of roses, bearing from five hundred to a thousand roses on each bush. The flowers are in three shades—white, pink, and crimson. The plants will do well both in and out doors. We guarantee at least three bushes to grow from each packet of seed. Price, 10c packet, 3 pkts. for 25c postpaid.



Novelty Badges



Kissing Permit 10c. Garter Inspector 10c. Two very novel metal badges, nickel plated, that you can wear, giving you fun out of all proportion to their trifling cost. 10c, each badge, 3 for 25c, or 75c per doz. p.p.d.

False Mustache

Here you are, boys! Just the thing for a little harmless masquerading. On and off in a twinkling. Lots of fun putting one on in a crowd of friends. The sudden transformation is astonishing. Fine for private theatricals, minstrel shows, charades, tableaux, etc. Changes your appearance beyond recognition. PRICE 10c, 3 for 25c postpaid.



Microphone Transmitter Button



You can easily make a highly sensitive telephonic by using this Transmitter Button to collect the sound waves. You can build your own outfit without buying expensive equipment. It is simple and inexpensive. You can install an outfit in your home and hear conversations being held all over the house. You can connect up different rooms of a hotel. This outfit is used by secret service operatives during the war. It is being used on the stage. It is ultra-sensitive and as the greatest invention in microphones. You can point the button almost anywhere—card board boxes, stove pipes, stiff rulers, on the wall behind a picture frame, etc. Button is so light and small it cannot be detected. Persons can be overheard without suspecting it. You can listen in on conversations in another room. A deaf person in the audience can hear the speaker. Connected to phonograph, piano or other musical instrument, music can be heard hundreds of feet away. Button may be used to renew telephone transmitters, often makes an old line "talk" when nothing else will. The ideal microphone for radio use; carries heavy current and is extremely sensitive. Amplifies radio signals. Countless other similar uses will suggest themselves. Experimenters find the Button useful for hundreds of experiments along the lines of telephones, amplifiers, loud speakers, etc. Many fascinating stunts may be devised, such as holding the button against the throat or chest to reproduce speech without sound waves. \$5.00 is given to anyone who sends in a new suggestion for the use of the Button. Send the manufacturer's card and it suitable for use in their literature. PRICE \$1.00 POSTPAID ANYWHERE.



MAGICIAN'S OUTFIT

Apparatus and Directions for a Number of Mysterious Tricks Enough for an Entire Evening's Entertainment ANYONE CAN DO THEM 75c



It is great fun mystifying your friends. Get this Conjuror's Cabinet, and you will be the cleverest fellow in your district. It contains the apparatus for seven illustrate tricks, including: The Disappearing Rose, that, when placed on the lapel of your coat, vanishes from sight at will; the Magic Vase and Ball Trick in Wooden Ball is placed inside, and upon replacing the lid has disappeared and is found in someone else's pocket; The Magic Nails with which you can apparently cut your fingers almost in two; the Wonderful Card Trick is done in an envelope, and when the open an entirely different card altogether is found; The Disappearing Coin Box a coin is placed in the little wooden barrel, and, when opened again, is found to have vanished entirely, or can be made to change into a coin of another design; The Famous Dissolving Penny Trick; The Glass Goblet and Vanishing Gum Trick in which a coin is dropped into a glass of water, and, when the water is poured out the coin has vanished. With the tricks described above we send full printed instructions for performing each trick, so that anyone can readily perform all the tricks to the great amusement of their friends or the public. Any boy of ordinary intelligence, with this Cabinet of Tricks in his possession, can give a parlor entertainment not inferior to some regular magicians. Besides the tricks contained in the Cabinet, there are many other feats and illusions fully explained with full printed instructions, for which you can easily make or procure the necessary apparatus. This unexcelled Cabinet of Tricks for ONLY 75 CENTS POSTPAID TO ANY ADDRESS.

Great Fire Eater

Most Sensational Trick of the Day! With the Fire Eater in his possession any person can become a perfect salamander, apparently breathing fire and ejecting thousands of brilliant sparks from his mouth, to the horror and consternation of all beholders. Harmless fun for all times, seasons and places. If you wish to produce a decided sensation in your neighborhood don't fail to procure one. We send the Fire Eater with all the materials, in a handsome box, the cover of which is highly ornamented with illustrations in various colors. Price of all complete only 30 cents, postpaid.



SQUIRT ROSE

25c A REAL STARTLER. This is the most popular of all squirt tricks. The flower in your coat looks so fresh and sweet that everyone is tempted to inhale the delightful perfume. Then is the moment to press the bulb. Bewildered! Don't they jump? There is a very long rubber tube that easily reaches to the pocket of your coat or trousers, and the bulb is large enough to make a dozen shots with one loading. PRICE 25c each, or 3 for 65c postpaid.



PISTOL, OPERA & FIELD GLASS

PRICE POSTPAID, \$1.00 It is made in the shape of and looks like a regular Automatic Pistol. No one is likely to stop and ask you whether it is real or not. This is likely to prove itself very handy in an emergency. On pressing the trigger it opens up, as shown in the illustration at the right, revealing nine most useful articles: Opera and Field Glass, Telescope, Mirror, Magnifying Glass and Burning Lens, Reading Glass, Sun Dial, Sun Compass, etc. In the handle of the revolver there is a place for various pocket necessities, such as First Aid Articles, Buttons, Pins, etc. The Pistol is of sheet metal, hard finish, that can be carried comfortably in pocket. PRICE \$1.00.



It is made in the shape of and looks like a regular Automatic Pistol. No one is likely to stop and ask you whether it is real or not. This is likely to prove itself very handy in an emergency. On pressing the trigger it opens up, as shown in the illustration at the right, revealing nine most useful articles: Opera and Field Glass, Telescope, Mirror, Magnifying Glass and Burning Lens, Reading Glass, Sun Dial, Sun Compass, etc. In the handle of the revolver there is a place for various pocket necessities, such as First Aid Articles, Buttons, Pins, etc. The Pistol is of sheet metal, hard finish, that can be carried comfortably in pocket. PRICE \$1.00.

SURPRISE MATCHES

More fun than fighting with your wife. Look just like ordinary matches. Put up in boxes just like regular Safety Matches. As the victim tries to light one he gets quite a surprise. PRICE 10c per box, 3 boxes for 25c postpaid, 12 for 75 cents.



GOLD TEETH

You know how fashionable it is to have gold crowns—if you can afford it. These gold-finished shells fasten over your real teeth and look like very wealthy fillings. Can be slipped on and off in an instant. Get some and surprise your friends. PRICE 5 Cents Each, 3 for 15c, or 50c for 1 doz. postpaid.

SEEBACKSCOPE

By merely placing this clever instrument to your eye, you can see what is going on behind your back, and sometimes you see very interesting things when no one thinks you are looking. Why it is just like having eyes at the back of your head. PRICE ONLY 25 Cents Postpaid. 3 for 50 cents.



The "Little Giant" Typewriter

A First Class Writing Machine For \$1.50 A perfect little typewriter for \$1.50. There are the thousands of persons who would like to use a typewriter but whose needs and business do not warrant the expense attached to the purchase and use of a fifty or seventy-five dollar machine. To such persons we confidently recommend our Little Giant. It is strongly made, but simple in construction, so that anyone can quickly learn to operate it, and write as rapidly as they would with pen and ink. The letters of the alphabet most frequently used are so grouped as to enable one to write rapidly, the numerals 1 to 10, and the punctuation marks being together. With this machine you can send your best girl typewritten love letters, address envelopes, make out bills, and do almost any kind of work not requiring a large, expensive machine. With each typewriter we send a tube of ink and full printed instructions for using the machine. Price complete \$1.50 by mail postpaid to any address in the world.



You Can Share in Motorcycle Profits



THE demand for motorcycles is constantly growing. People who can't afford a car can afford a Harley-Davidson New Single. And people with cars are more and more buying this personal mount for quick running around. The New Single provides the world's lowest cost motor transportation—goes three times as far as the most economical car on a gallon of gasoline!

There are lots of fellows right in your community who are simply waiting for someone to sell them a motorcycle. Be that someone! Our "Pay-as-You-Ride" plan and national advertising make sales easy.

Mail the Coupon!

We need a few more live, responsible dealers in unassigned territory. Write or wire quick if you are interested.

Harley-Davidson The Motorcycle

Harley-Davidson Motor Co., Dept. P, Milwaukee, Wis.

Tell me how I can get into the profitable motorcycle business with your help. Also send free literature describing and illustrating the New Single.

Name _____
Address _____

See our other Ad on Page 123



CLASS RINGS & PINS

Largest Catalog Issued—FREE

Samples loaned class officers. Prices \$.20 to \$8.00 each. No order for class, society, club emblems too large or too small. Special designs made on request.



METAL ARTS CO., Inc. 7705 South Ave., Rochester, N. Y.

Sell Women's Shoes



Make Plenty Money—Steady Year Round Trade

Women buy from 2 to 8 pairs shoes (average 4) per year. In every house, in every block, in your town, women are anxious to buy Style-Arch Shoes at factory prices. Make plenty money—year round income—taking orders. We deliver, we fit, we collect. You get your pay, in cash, right on the spot. 27 Paris-influenced styles, leathers, colors. Arch-support feature powerful selling point. Holds up sagging arches. Relieves agonizing foot pains. Additional representatives being appointed. Choice territory still open. Make application today.

SUCCESSFUL PIONEER HOUSE.

STYLE-ARCH SHOE CO., Dept. B-2, Cincinnati, Ohio

Preferred by Experts Best for Handy Men

Trying to nurse along an old style Blotorch on present-day, low-grade fuels is a discouraging task. You'll appreciate the ready performance and hot flame of the Turner No. 45. The Turner patented Superheating Burner Baffle and heater plug was specially designed to gasify present-day gasoline or kerosene.



TURNER BLOTORCH

Safe as a Candle

Absolutely safe; it can't explode. The patented Automatic Safety Valve prevents bursting pressure. The patented Twin Needle Control obviates enlarged orifice, a trouble that often renders the ordinary blotorch useless. The patented, seamless, solderless, leakproof Brass Tank has but one opening and that above fuel line—no leaks from soldered connections. The Pistol Grip fits any hand comfortably. Only a Turner has these features. Fearlessly Guaranteed.

No. 45 — 1 Quart

\$8.25

Postpaid

Order from your dealer or write us direct. \$8.25 postpaid.

THE TURNER BRASSWORKS

Industry Ave. Sycamore, Ill.

The World's Largest, Exclusive Manufacturers of Blotorches, Firepots and Brazers

ALUMINUM SOLDER

SOLDERS ALUMINUM of any description. NO ACIDS OR FLUX NECESSARY. For home, shop and garage use. Your tool kit is not complete without HAMILTON LEAD CO. ALUMINUM SOLDER. (Name on every bar.) Send 25c for 2 six inch bars, or \$1.00 for 9 bars; postpaid.

HAMILTON LEAD CO., HAMILTON, OHIO

PLUMBING-HEATING

YOU SAVE HALF
Send for BIG FREE BOOK of Guaranteed Plumbing and Heating. Everything cut-to-fit. 50 yrs. in business. Thousands of customers. "You saved me \$400.00," says Mr. Edw. Borkosky of N. J. Write today.
HARDIN-LAVIN CO., 107-17C. W. Parshing Rd., CHICAGO

SOFT SNAP FOR AGENTS

GLAROFF Kills Headlight Glare
Our representatives making from \$12 a day up to \$8000 yearly. Simple new device protects driver from glare of headlights and sun. Write for Special Free Offer.
GLAROFF MFG. CO. 805A Reed St., Sioux Falls, S. D.

SEND ONLY 10¢ NO MORE TO PAY

We Will Send You a Full Cut, ONE CARAT
Corodite Diamond
NO C. O. D.—NOTHING TO BUY OR SELL
NO STRINGS ATTACHED TO THIS OFFER
We make this remarkable offer so that every lover of beautiful jewelry can have the opportunity of comparing a Corodite Gem side by side with a Genuine Diamond. We want you to see with your own eyes the fiery flashing beauty of this gorgeous gem. CORODITE DIAMONDS are double polished and have the true diamond (82 facets) cut. So closely do they resemble the genuine that even lifetime experts are astonished. The illustrations above show how beautiful a CORODITE looks when mounted in a ring. Send your name and address and 10c in coin or stamps to help cover cost of handling. Yours Today. Your Corodite will come Fully Prepaid by return mail.

E. RICHWINE CO. Dept. C-4 19W. Jackson Blvd. CHICAGO, U. S. A.

Fastest Cutting

Saws Fifteen Cords a Day!



Men—
Let Me Send You My
Greatest LOG SAW Offer!

ONLY
\$39



It's easier now than ever before to own this fastest-cutting, easiest-moved, most powerful Log Saw. Now, you can make big money sawing firewood, stave-bolts, ice, shingle timber, etc. Write today for full details of this most wonderful offer. Know how easy it is to make big money sawing fifteen cords of wood a day with no hard work.

350 Saw Cuts a Minute—

nearly six each second. Just think of it—now you have a log—in a few seconds it's all sawed up into lengths you can use—without any hard work! The OTTAWA has balanced crank shaft, power force feed, friction clutch.

Make BIG MONEY—

Wood selling at \$3 a cord brings owner \$45 a day. Saw your own wood—go into the wood business. Don't let the lack of ready money stop you. Remember, we sell on very easy terms. More in use than all others combined.

Puts the OTTAWA Working for YOU!

"I average \$20 profit a day with my OTTAWA."—J. Schill, New York. "My OTTAWA has earned \$700 for me."—S. Graham, Wisconsin. "I can make more money with the OTTAWA than by farming."—D. Godt, Missouri.

OTTAWA 4.H.P. LOG SAW

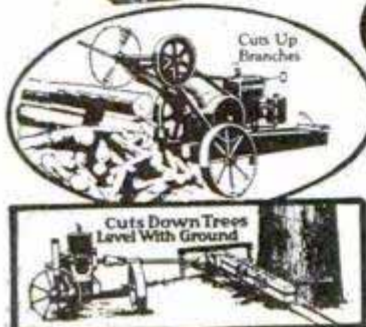

30 Days to Try—one whole month to use the OTTAWA at your own sawing. Shipped on trial only—backed by 10-year guarantee. Prove to yourself how easy you can saw 15 cords or more a day—at a cost of 1 1/2¢ a cord.

To Save You Freight—and get your machine to you a few days after you order, I ship from: Ottawa, Kan.; Pittsburgh, Pa.; St. Paul, Minn.; Albany, N. Y.; Memphis, Tenn.; Indianapolis, Ind.; Pueblo, Colo.; Ft. Worth, Texas; Portland, Ore.; San Francisco, Cal.

Send me your name and address on postcard today, so I can send you my wonderful new edition of the "Wood Sawing Encyclopedia." Educational, instructive. Be sure to investigate—will help you to make big money.
HARRY OVERMAN, Pres. OTTAWA MFG. CO.
1742-P Wood St., Ottawa, Kans. Room 1742-P, Magee Bldg., Pittsburgh, Pa.

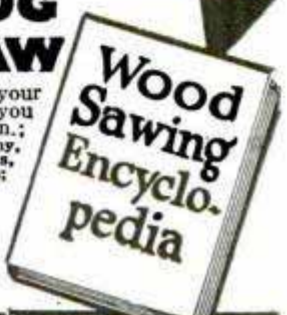

Going to Build Remodel or Repair?

DON'T think of building a new home or repairing an old one without a copy of our free woodwork catalog.

To those who contemplate building or remodeling, this book is a valuable work of reference. In it are found the latest ideas and most advanced styles for everything in millwork. It illustrates and describes windows and sash of all kinds, including porch and storm sash, doors, frames, mouldings, screens, porchwork, stairwork, hardwood flooring, interior finish, cabinet work—in fact, practically everything in manufactured millwork. Every article in the book shows a low money-saving price direct to you.

FREE ESTIMATES

Send us your lumber and millwork bills for a free estimate. Let us quote prices on your material and tell you the exact amount of freight. Then compare our prices with others. This service costs you nothing and places you under no obligation whatever.



CHICAGO MILLWORK SUPPLY CO., 1444 W. 37th St., Chicago, Ill.
PLEASE SEND ME YOUR FREE BOOK

Name _____ St. No. _____
Town _____
State _____
Occupation _____

Book is Free



FREE
10 DAYS
TRIAL

We will send you the world's only ball bearing, long wearing L. C. Smith Typewriter with absolutely no obligation to you whatsoever. After 10 days' trial, if you are not satisfied it is the greatest value and finest typewriter you ever saw, just send it back. If you keep it, you pay only \$3.00 down and monthly payments so small you'll never miss them. Same Free Trial and Terms from our authorized dealer agents.

Our special prices are lowest ever made on the genuine Ball Bearing Silent L. C. Smith—late style models—up-to-date, full size, perfect machines—every modern convenience—absolutely finest quality rebuilt and guaranteed for 5 years. No other typewriter at anywhere near our price will give as many years of perfect service. We are largest exclusive dealers in L. C. Smith Typewriters in the world. The easiest running and longest wearing typewriter ever built. Anyone can easily operate it with our free course of instructions. Over half a million sold.

Free to You Now! Complete course of lessons and valuable equipment if you mail coupon NOW.
SMITH TYPEWRITER SALES CORP., 111-360 East Grand Avenue, Chicago, Ills.

MAIL THIS COUPON NOW

Smith Typewriter Sales Corp., 111-360 E. Grand Ave., Chicago

Without obligation of any kind, you may send me your free booklet, and special 10 day free trial offer on a genuine L. C. Smith. Your new low prices, including Instruction Book, free course of lessons on Touch Typewriting, Tools, etc.

Name.....
Address.....
City.....State.....

Earn as Much as \$40.00 a Day

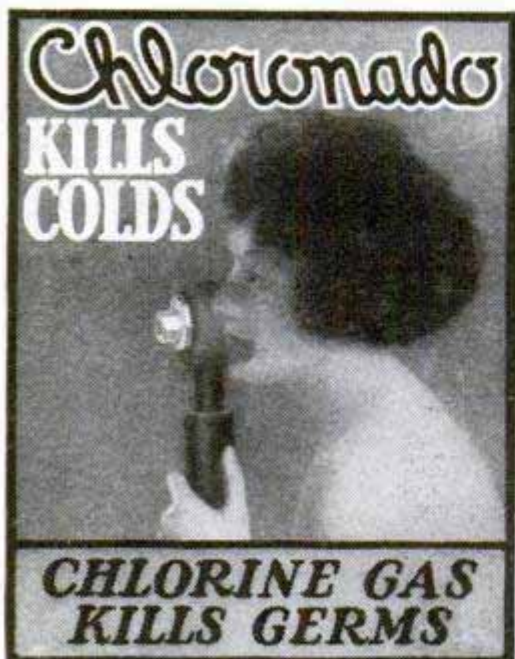

With Chloronado

Here's the opportunity of a lifetime to build a highly profitable business.

Chlorine Gas—the treatment developed by U. S. Army Physicians—for colds, catarrh, hay fever, bronchitis, influenza and many other respiratory diseases can now be had by everyone in their own homes.

The same gas treatment used by President Coolidge and thousands of prominent people with remarkable results.

A Money-Making Offer to Men and Women

Chloronado salesmen can easily earn \$5,000 or better—distributors \$10,000 to \$15,000. Everyone is interested in preventing disease—everyone is a prospect for Chloronado.

There is still some choice territory open to wide-awake salesmen and distributors. Enter your application in NOW—

Get the cream of the business in your locality by being the first to offer this amazing device. Live leads furnished to salesmen—National advertising and circularizing campaigns—every possible help and co-operation to aid you in building a permanent, profitable business. Write or wire for full details.

Chloronado Needed Everywhere

Chloronado is the first scientific Chlorine Gas Generator for the home. Thousands now in use. Millions need this aid to the prevention of colds and other chronic respiratory ailments.

A Very Interesting Proposition to State Distributors

CHLORONADO LABORATORIES CO. 439 E. Fort St. Detroit, Mich.



MASTER TOOL AT LAST!

Wire Cutter, Wire Stripper, and Cleaner, Screw Driver, Counter Sinker on Radio Panels, Spanner, Metal Ruler, etc., etc. Necessary to every radio fan, mechanic, electrician, autoist, etc. Beautiful leather case with each Master Tool. **DIFFERENT USES REALLY UNLIMITED.** Wrench, Insulation and SPECIAL INTRODUCTORY OFFER—Send only 50¢ for your MASTER TOOL. Money Back Without Question, If You Are Not Delighted. ROSS MERCHAND, CORPORATION, P. O. Box 10, Station I, New York

Rider Agents Wanted

Select from the 44 Styles, colors and sizes of Ranger Bicycles. Ride and exhibit sample Ranger and make money. Delivered free, express prepaid, on Approval. Factory-to-Rider bicycles \$21.50 up, \$5 a Month on any Ranger if desired. Boys and girls easily save the small monthly payments. Parents often advance first payment. best quality, at factory prices, express prepaid. Lamps, wheels and equipment, low prices. Send No Money, do business direct with makers.



Mead CYCLE COMPANY
DEPT. B-109 CHICAGO

Write today for free Ranger Catalog, factory prices and marvelous easy payment terms

Interlox MASTER SLIDE RULE

Takes inside as well as outside measurements accurately

The quick acting and durable rule. Slides out; no folding. Any length 2 to 8 feet, 20¢ per lineal foot. If not at dealers, sent postpaid. Dealers and Agents: request attractive proposition. Master Rule Mfg. Co., 813 East 136th St., New York

Buy Now Pay Later Making It Easy to Build Things!

Men everywhere are finding it easy to build things in wood with Boice-Crane Bench Machines. New 64-page illustrated booklet explains how to perform many woodworking operations. Contains latest information on the complete line of Boice-Crane Circular Saws, Jig Saws, Band Saws, Mortisers, Jointers, Lathes and Drills. Write today for booklet, prices and E-Z Pay Plan.



Handisaw Model 2

Does ripping, mitering, grooving, sanding, grinding and drilling with ease and accuracy. Table 10"x13". Saw 7" diameter cuts 2 1/4" stock. Dadoes 1/8"x3/4" deep. Cuts mouldings.

14" Band Saw

Table 12"x14" tilts 45 degrees. Saws 7" stock. Use blades 3/16" to 1/2" wide. Bronze bearings. All Boice machines driven by 1/4 to 1/2 H.P. Motor attached to light socket. Machines sold with or without motor.

8" Bench Lathe

Does turning, drilling, sawing, sanding, grinding and jig sawing in wood or soft metal. Swings 8". Capacity between centers, 20". Metal-working model fitted with compound slide rest.

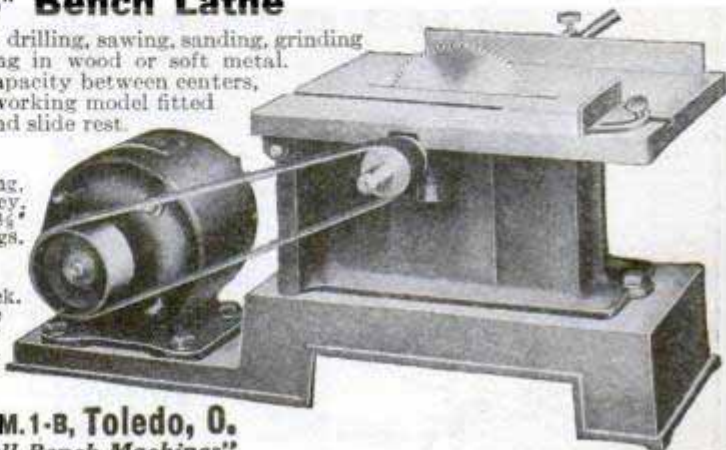

W. B. & J. E. Boice, Dept. P. M. 1-B, Toledo, O.
"World's Largest Makers of Small Bench Machines"

The ROTOR Successor to the Motor

Runs by atmospheric pressure. Develops 1/50 H. P. Educational and practical. No Pressure. No Explosions. No Danger.

A Modern Toy for the Modern Boy

The little model we are now offering the boys of America bids fair to develop into the greatest labor saving machine of the twentieth century.

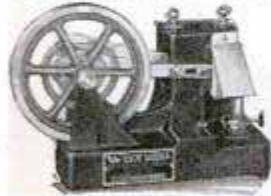

Introductory Price, \$6.00, post prepaid anywhere in United States

THE ROTOR CORPORATION OF AMERICA
Dayton, Ohio

FULL TIME OR SPARE TIME THE WALTON SYSTEM

will put you in a position to make money, full or spare time, with a dignified high grade line, without any investment. Selling experience desirable, but not necessary.

We are wholesale tailors, making a fine line of made to measure customized clothes, retailing for \$27.50, covered by the strongest money back guarantee ever put out by a tailoring house. WALTON SYSTEM clothes are the equal of any suit in retail stores selling to \$45.00. This is possible only because we sell "direct to customer" and save them the dealers' profit, so why shouldn't it be easy to sell men, clothes made to their measure, choice of a big variety of patterns, with a saving of \$12.50 to \$7.50.

The most attractive line of woollens you ever saw, 80 patterns all one price suits, \$27.50. Liberal commission, bonuses and complete selling equipment. Write for booklet "AN INDEPENDENT BUSINESS WITHOUT CAPITAL," which tells you everything.

Louis A. Walton Co., Inc., 413 So. Wells St., Desk P. M., Chicago

KARAS HARMONIK TRANSFORMERS KARAS ORTHOMETRIC CONDENSERS

The highest quality parts possible to produce.

KARAS ELECTRIC CO., 4047 N. Rockwell Street, CHICAGO

The Traffic Cop of the Air



Add a Ferbend Wave Trap to your Radio Set and "Police" your reception. Regulate traffic. Guaranteed to tune out any interfering station. Widely imitated but never equalled. The original and only successful WAVE TRAP. Now in its fourth year. Sent Postpaid upon receipt of \$8.50 or C.O.D.

FERBEND
Wave Trap



plus postage. Send for Free Booklet
FERBEND ELECTRIC CO.
415 W. Superior St. Chicago

Big Money!

AGENTS ~ Salesmen-Distributors

Wanted to use and introduce this famous automatic attachment for Fords. No experience needed. Sell to Ford Owners, Fleet Owners, Dealers, etc. 250,000 already in use. Get Plan that starts you without capital in a business of your own, and makes from \$250 to \$2000 a month profit. Thousands of others making big, permanent money with us. Makes Fords run on 94% air—start easy in coldest weather—increases mileage per gal. of gas 50% to 100%—prevents carbon and crank case oil dilution. Installed in 5 minutes without tools.



Blancke Thermostatic Carburetor Control
For Ford Cars and Trucks

CADILLAC NOW USES AS STANDARD EQUIPMENT thermostatic carburetor control under Blancke license. This convincing proof, together with money-saving features, National Advertising, etc., enables you to sell Blancke Controls on sight. Write today—NOW, for big profit plan.
A. C. Blancke & Co., 602 W. Lake St., Dept. 805-A, Chicago, Ill.

At Last! Soldering Iron and Blow Torch In One!

Saves Time, Trouble and Money!

For every handy man! Pays for itself in one job! Enables you to do easily a lot of work that would otherwise require a plumber or tinsmith. Needs no pump or pressure system. Needs no stove or charcoal pot, or separate blow torch. No fussing! No trouble!



No need to waste time constantly reheating your iron. Ready for use in a jiffy—stays ready for an hour—and you can regulate it for exactly the right amount of heat!

Burns for an hour at less than 1/4 cent for gasoline and can be used where nothing else would be available! Just remove copper point and you have an ideal BLOW TORCH for burning off old paint, tempering tools, thawing frozen pipes, etc., etc. Send the coupon below!

Why pay out good money to tinsmiths and plumbers for jobs you can easily do yourself with the Justrite! Send for one on Free Trial TODAY!

For Every
Householder,
Farmer,
Auto Owner,
Mechanic,
Tinsmith,
Radio Fan,
Plumber,
Electrician,
Dentist,
Jeweler,
Painter,
Printer,
Garage,
Repair Shop.

Agents!

Get our extremely liberal offer to agents. Sales come fast, you'll be amazed. Just show people how this wonderful tool works. As soon as they see how much time and trouble it saves, they want it! Nine times out of ten a demonstration means a sale. Send post card for special Agents' Offer.

5 Days' Trial

Send No Money No C. O. D.

The Justrite will be sent you prepaid for 5 days' trial—without your sending us one penny and without any C. O. D. See for yourself what a wonderful time saver and labor saver it is. If, at the end of 5 days you decide to keep it, send us only \$3.00. If not satisfied, after 5 days' trial, just return it. That's all! But send coupon today!

Mail for 5 Days' Trial. Send No Money. No C. O. D.

JUSTRITE MFG. CO., Dept. 13-51
2071 Southport Ave., Chicago

Please send me by parcel post, prepaid, one Justrite Soldering Iron and Blow Torch, packed complete with sal ammonia and solder, ready for use. After 5 days' trial I will either send you \$3.00 or promptly return the tool.

Name.....

Address.....

WRITE FOR THIS

LADIES SOLID GOLD
DIAMOND RING

Diamond and Sapphire Flexibel Bracelet \$15.50



Fine full cut blue white diamond of rare brilliancy set in 14 K. white gold ring beautifully carved and pierced. **\$9.50** Direct to you.

116 Page Catalog Free

When you buy from K. Burns & Son you buy direct from the importer and cutter, saving yourself 30 to 40 %.



14K. Solid White Gold Aquamarine Ring Very Newest



Ladies' and Gents' Diamond Rings

Fine full cut blue white diamonds of rare brilliancy set in 18K. white gold rings beautifully carved and pierced. Satisfaction guaranteed or money back.

14K. Solid Gold Wrist Watch

Oval or Rectangular Style

\$9



Jewel adjusted. Guaranteed dependable timekeeper. Platinum finished dial. Beautifully engraved design. Blue sapphire crown.

Diamond & Sapphire Platinum Top Bracelet

Handsomely pierced lace work design. 14K. solid white gold, platinum faced. Two oblong shape synthetic blue sapphires and a full cut genuine blue white diamond.

\$15.50 SPECIAL \$9

Elgin or Waltham Gold Guaranteed 25 Year Jewelled Adjusted Watches Green or White Gold



SEND NO MONEY—FREE EXAMINATION

Let us send you any one of these magnificent diamond rings, or any other item illustrated. Absolutely free examination. No red tape, no obligation to buy. Compare; try to match our values for at least 40% more, if you can, or don't keep it. Not one penny of risk to you. We pay all charges.

Write today for our free catalog

K. BURNS & SON

641 Broad Street Dept. P75 NEWARK, N. J.

\$15 a Day Making Doughnuts

This machine makes 500 dozen Doughnuts per day. \$15 to \$40 daily profit. No experience needed. Put dough in hopper—turn crank—out drop delicious golden doughnuts. Machine in store window attracts crowds. You rake in money fast. Pay for machine first week. Big money wholesaling to grocers, restaurants, etc. Mrs. Humphrey, Iowa, averages 140 doz. per day (\$758 per month). Henderson, Illinois, averages 100 doz. per day. (profit \$20 daily). This machine also makes delicious potato chips. Write for FREE details.

BUTLER & BUTLER, Dept. 12, 5945 Chicago Ave. Chicago, Ill.

9 Made \$368 BONUS LAST MONTH

"In just one month my bonus on old sales, which had already paid me my regular profit, totaled \$368.50," writes K. D. Ralph. We have originated a startling new sales plan which brings you profits while you sleep. Nothing like it ever heard of before.

AMAZING EXTRA PROFITS

Often you can make one simple, little sale that will go on working for you, paying you sensational extra profits without extra work on your part. Our men report sales of from 19 to 23 in one day. One boy sold nine in three hours. We can't explain our plan here—others might copy it. But just write and we will send full details confidentially. No experience needed. Ideal for spare time work.

RHODES MANUFACTURING CO.

Dept. A-370 Pendleton & Cozens Ave. St. Louis, Mo.

Make Your Roofs Last a Lifetime!

Positively that! The wonderful Seal-Tite method renews, preserves, and makes your old, wornout roofs watertight. One application lasts 10 years. Write today for this great money-saving roofing offer.



Not a Paint

NO Money Asked

We send you everything you need to stop all roof leaks without asking you to send a single penny. No C. O. D. No notes. Pay four months later if our material proves to be exactly as represented.

Write! Don't put off another day finding out all about this wonderful way of solving all your roof problems. We'll make you an offer so liberal, so clear, so surprisingly unprecedented that you simply MUST take advantage of it at once. Don't wait for rain to remind you that your roof leaks. Write TODAY!

Monarch Paint Co. Established 1903 Dept. 13-51 Cleveland, O.

ALL-AMERICAN
TRADE MARK

Experienced set builders do not experiment when they want results. They use ALL-AMERICAN parts because of their

Reliability

For consistent, year-after-year performance, look for the ALL-AMERICAN name-plate and the guarantee serial number on parts you buy.

Pioneers in the Radio Industry

LOOK! Big Soldering Outfit

Complete with Everything

Send No Money ~ Send Coupon ~

Special Low Price

THIS IS THE OUTFIT —
 If soldering is troublesome or complicated to you it is because you have never used real professional tools. With this big complete outfit you can do

real expert soldering equal to any! Radio and electrical connections, mending leaky pots, pans, water pipes and auto radiators. There are hundreds of jobs you can do around the house, shop and office. This big set will save many times its price on your first two jobs. Just think how often you have badly needed a good soldering outfit. Every mechanic has. And every lover of good tools should own one. Formerly the price of a professional outfit like this has kept most folks from buying one. But now you need wait no longer. Here is everything you need: One "genuine" **JIFFY BLOW TORCH** (Self Blowing), **A BIG HEAVY DUTY PROFESSIONAL SOLDERING IRON RACK**, **One Collapsible, Adjustable ALL-STEEL SOLDERING IRON RACK**, **A BIG BOTTLE OF GENUINE JIFFY FLUX** (for soldering all metals), **PROFESSIONAL SOLDER** (enough for 50 jobs), **one combination JOINT CLEANER and WIRE SCRAPER** and complete instructions **HOW TO DO PROFICIENT SOLDERING**. There! Everything complete. No extra tools or accessories needed. Nothing more to buy. **A real \$5.00 Value**. It is almost unbelievable, but the **BIG BARGAIN PRICE is only \$2.50**. You, no doubt, wonder how such tools can be offered at such a **SMALL PRICE**. Read on!

THIS GRIP-IT SCREW-DRIVER (8 in. overall) IS
Free!
 (Worth 75c in Any Hardware Store)

I AM FREE

Yes — absolutely free. Because when your friends see yours they will want one, too. You can readily see where it pays us to introduce the **NEW GRIP-IT Screw-Driver** in this manner. Just the thing for handy men, electricians, mechanics — **EVERYBODY**. Heavy, sturdy, made to last. It grips the screw as shown in circle. Won't let go until you release lock with thumb. Can be used with one hand only. Drives screws in tight places where an ordinary screw driver won't work!



Thousands of these **NEW GRIP-IT Screw-Drivers** will be sold to people who see them in use. You can make big money selling to friends. In one garage having ten mechanics one of our salesmen sold ten **Screw-Drivers**. They sell like that everywhere—100%. Write for our money making plan.

Drives wood or machine screws. Can also be used as regular screw-driver.



Above is an actual photograph of the complete set (reduced many times because of limited space). The **Blow Torch** furnished is guaranteed to be a genuine "**Jiffy**"—the torch you have heard repairmen praise so highly. It is self-blowing, develops an intense blue-hot flame in but a few seconds and burns for hours—without attention—on one filling of fuel. Cheap to operate. Efficient to use. Guaranteed to be **ABSOLUTELY SAFE!**

Radio Fans!

You can build the most complicated sets quickly and easily. You can startle your friends and make your work in demand everywhere. Why is one set of the same design better than another? Why has one greater volume, distance and selectivity? **Look into any high-grade factory-built set and you will discover the answer.** You will see only good, solid "loss proof" connections. Radio engineers know the value of professional soldering. They know where the greatest chance of loss lies. Some fellows don't realize this, and that's why so many poor sets are built. You can start **RIGHT NOW** to build sets better than those of any of your friends. Good workmanship is all you need—and that means "**professional**" soldering. Get **BIG COMPLETE SOLDERING OUTFIT** at once!

Just mail the coupon — that's all!

Absolutely FREE

To each of the first 500 persons who mail the coupon below we will send one genuine **GRIP-IT SCREW-DRIVER** **ABSOLUTELY FREE**. This newly invented tool sells for 75c at leading hardware stores. We have a good reason for **GIVING IT TO YOU FREE**. Read the description and reason in the center of this page.

How We Can Do It!

Good soldering tools have to be made to withstand all kinds of heavy abuse as well as intense heat. For this reason copper, steel and brass are largely used. During the slump in the stock markets last spring we purchased large quantities of these necessary materials at ridiculously low costs. And now when prices are up sky-high, we have the material we bought then. Our big factories are working night and day, and the result is we can offer a bargain that can not be beat anywhere.

ONLY 500 SETS WITH FREE OFFER

DON'T WAIT! DON'T DELAY! Be one of the lucky ones. Send the coupon right **NOW** and get the screw-driver **FREE!**

SEND NO MONEY

Apex Stamping Company, Riverdale, Illinois

RUSH me the **BIG COMPLETE SOLDERING OUTFIT** and (if this is one of the first 500 coupons you receive) **INCLUDE THE GRIP-IT SCREW-DRIVER ABSOLUTELY FREE**. I agree to pay postman \$2.50 plus a few cents postage, upon arrival. There are no further obligations on my part.

Name.....
 Address.....
 City..... State.....
 (PM-Jan)

GENUINE *Sent for* DIAMOND RINGS **\$2.00**

\$2.00 Brings the Most Sensational Price Smashing Diamond Ring Offer Ever Made

Each of these rings is set with guaranteed, perfect cut, blue-white, fiery diamond of first quality; mountings are of 18 kt. white gold, hand engraved in the latest designs.



No. 5
First quality, blue-white diamond set in 18 K white gold disc, 3 4 ct. size, 18 K white gold mounting.
Price **\$79.50**

Ten Days Free Trial

Simply send \$2.00 and your choice comes to you all charges paid. If for any reason whatsoever you are not satisfied at the end of ten days, return the diamond ring to us and your deposit will be refunded. A legal bond as to quality and value accompanies each ring. After trial pay balance in 12 monthly payments.

NO RED TAPE—NO DELAY

FREE BOOK OF GEMS

Most complete jewelry catalog ever published of diamonds, watches and jewelry—newest designs at lowest prices. A full year to pay for everything you order from our \$2,000,000 stock.
Established 1895
Address Dept. 1518



No. 10
Dinner ring set with five large diamonds and four French blue sapphires in 18 Kt. solid white gold ring. Price **\$67.50**



No. 15 Perfect cut, diamond center, four French blue sapphires; 18 K white gold ring. Price **\$42.50**

ROYAL

DIAMOND & WATCH CO.
170 BROADWAY NEW YORK

I Averaged \$20.77 profit PER DAY for 217 Days



Any MAN can sell them

Approved by Underwriters

says L. D. Payne, Frank DePries made over \$325 profit in one day. Siddell and Viles sold over \$25,000 in 2 years. G. Howard earned \$100 in one day. F. E. Mendenhall worked half time and made \$100 a week. W. E. Findlay ran up his commissions in a few months from \$100 to over \$500 per month. Every Home, Auto Owner, Store and Factory a Live Prospect—Keeton, Howard, and others, never sold Fire Extinguishers before. Our special training course starts you on road to success first day. If now employed, we can show you how to make big money during spare time. **No Experience Necessary.** Get our new Sales Plan—find out how to make real money. Territory going fast—write today!

THE FYR-FYTER CO., 134 Fyr-Fyter Bldg., Dayton, O.

Save 1/3 to 1/2 AT FACTORY PRICES



Combination Ranges \$59.80 up

This new FREE book Quotes you lowest factory prices on Quality heating stoves, furnaces, porcelain enamel combination ranges, coal and wood ranges and gas stoves. 200 styles and sizes. Cash or easy terms—**as low as \$3.00 monthly.** 30 days FREE trial; 360 days approval test. 24 hour shipments. 560,000 pleased Kalamazoo customers. Make a \$25 to \$75 saving by sending postal for FREE book today.

Kalamazoo Stove Co., Mfrs.
391 Rochester Ave.
Kalamazoo, Mich.

"A Kalamazoo Direct to You"

Trade Mark Registered

PATTERN-MAKING for Those Who Should Know

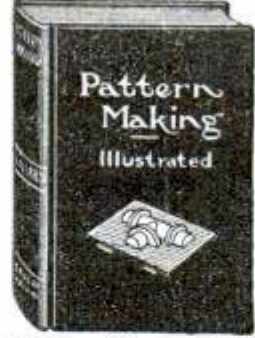

Pattern Making Illustrated

Compiled by G. H. WILLARD, a pattern maker of many years' experience, for those who wish to increase their pay—or those who wish to enter this well-paying occupation. Filled to the covers with helpful shop-kinks and actual working information. Practical instructions written in plain language, which anyone can easily read and understand. Learn at home—in your spare time. Bound in cloth, 224 pages, 312 illustrations, diagrams and working drawings, etc.

Tells About Pattern making as a trade—The Tools—Woods—Joints—4 chapters on Turning—2 chapters on the Circular Saw—2 chapters on Machine Tools—3 chapters on Simple Tools—Crooked Patterns—2 chapters on Large Pattern Work—Cross-Head Guide patterns—Sweep work—Pipe work—Stove pattern work—Molding—Machine Work—Molding Pattern Work.

CORE MAKING AND MOLDING

Part II explains the simple and complicated problems in core making and molding which every good pattern maker should know. **Tells about—**Core making, simple and complex—principles in Molding—Loam Patterns—Loam Molds. Everyone following this trade or intending to enter it should have this remarkable book. The price is so low that anyone can afford to buy it. Those who have it, wouldn't be without it.

SEND NO MONEY Just write a postal. Pay postman postage and \$1 when he hands you book.

POPULAR MECHANICS PRESS
200 E. Ontario St., CHICAGO

Poultry Miller's American Guide

—Tells all about chickens—care, feeding and raising for profit. Also describes IDEAL INCUBATORS, Hot Water and Electric—IDEAL BROODERS—Coal and Oil Burning—Baby chicks, Eggs for Hatching. Special LOW PRICES

FREE

J. W. MILLER CO., Box 12, Rockford, Ill.



BETTER HEAT EASIER COOKING CHEAPER THAN COAL OR WOOD

If you're interested in cheap fuel and more efficient heat, write for free folder on the **HOME ECONOMY OIL-GAS BURNER**

Turns low cost kerosene or furnace oil into gas. Simple new principle burner that cannot clog with carbon. A control valve makes it the most efficient on the market. Can be installed by anyone. Fits any stove or furnace. Simple in operation. Objectionable noises eliminated. Entirely different from others. Gravity outfits for stoves or ranges, \$20. Pressure outfits for furnaces, \$35.

Wonderful opportunity for agents and distributors.

HOME ECONOMY BURNERS, Inc.,
600-604 Keith Theatre Bldg., SYRACUSE, N. Y.



HEAT

MADE FIRST—MADE BETTER—BUILDS MOST

"I have been a Meccano Fan since I got my first set"
Jackie Coogan

Having a choice of all construction toys, Jackie selected Meccano, the original and "The Daddy of them all". More than once Jackie has been known to dash off between pictures to finish a Meccano model which he has designed himself.

You, too, can share in this Meccano fun. You can build towers, cranes, bridges—anything you can think of. It's as easy as building with blocks.

Made First—Made Better Builds Most

Meccano has such a great variety of parts—that's why it will build more models than any other toy. The parts are all made of shining steel and solid brass, and fit together perfectly. Other toys have copied some of these parts, but only Meccano has them all. Don't be fooled—to build *right* you must have the genuine

MECCANO

Engineering for Boys

In every Meccano outfit is a big book full of pictures of models. The fun begins as soon as you open your set. You can have a new toy every day for years without building the same one twice.

Yes, Jackie is enthusiastic about Meccano, and you fellows will be, too, when you get your outfit. Ask Dad to give you Meccano, and then—Oh Boy!

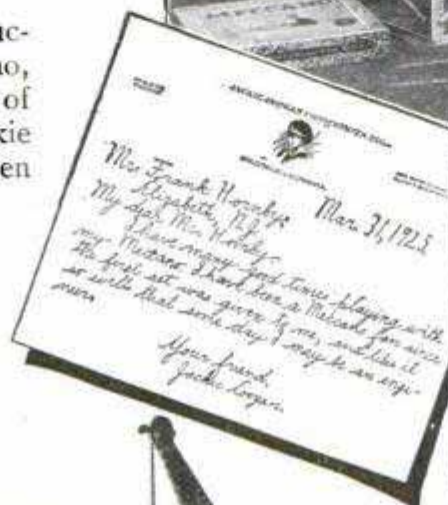
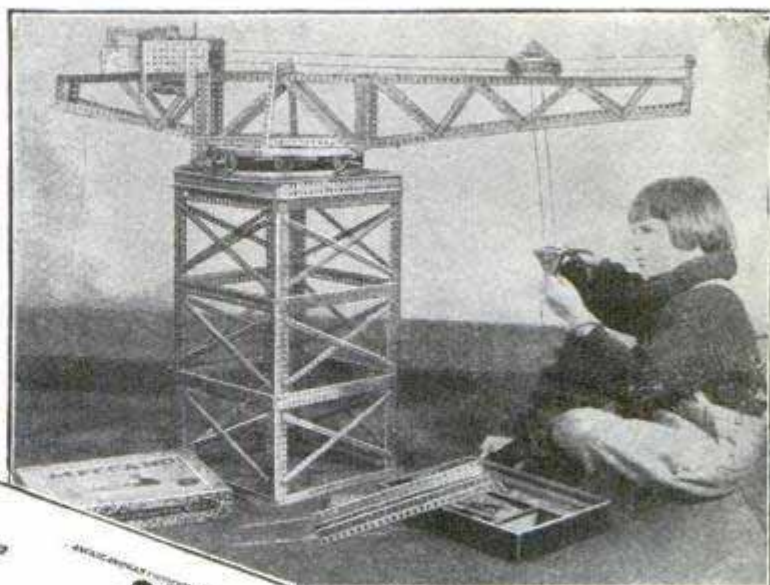

Meccano outfits are for sale by most toy stores. If your dealer cannot supply you, write us.

Some Exclusive Meccano Features

Only in Meccano can you get these parts

- 1 Heavy Perforated Steel Strips with smooth edges
- 2 Sturdy Angle Girders
- 3 Nuts and Bolts brass to prevent rust
- 4 Brass Wheels with solid brass hubs
- 5 Large Braced Girders
- 6 Solid Brass Gears the teeth are cut, not stamped
- 7 Curved Strips
- 8 Patented Cranks and Couplings
- 9 Triple-throw Eccentric
- 10 Powerful Geared Motors

Other toy parts may look like Meccano, but place them side by side and judge for yourself

Meccano Price List

No. 00	Meccano Outfit.....	\$1.00
No. 0	Meccano Outfit.....	2.00
No. 1	Meccano Outfit.....	3.00
No. 1x	(has Electric Motor).....	5.00
No. 2	Meccano Outfit.....	6.00
	and up to \$45.00	

Send for these two FREE Books



"The Magic Carpet"—that carries you to the wonderland of Meccano joy and model-building. Full of beautiful pictures.

"The Jackie Coogan Book"—an interesting story of Jackie's visit to the Meccano Headquarters and what he saw there.

Send us your name and address, together with the names and addresses of three of your chums, and the two books will be sent to you absolutely free. Put No. 36 after your own name for reference.

Meccano Company, Inc., Div. H-1, Elizabeth, N. J.
 In Canada—Meccano Ltd., 45 Colborne St., Toronto

AS EASY AS BUILDING WITH BLOCKS

Big 3-ft. Telescope

Makes people and objects miles away seem close. Brings new pleasures to home, farm, camp, travel, sport. See moon and stars as never before. New Ferry "Wonder" telescope has 5 sections—opens out over 3 ft. long, measures 12 inches closed. Big, strong and powerful, yet light, compact, easy to carry. Fully brass bound. Brass safety caps at each end to keep out dust. Powerful lenses.

Only
\$1.85

5 Sections
8-Power Lenses

Free!

YES, ABSOLUTELY FREE! Handsome leatherette covered Carrying Case, light, strong, complete with strap. Protects from dust and damage. Handy for farmers, auto tourists and hikers.

Thousands Delighted!
"I am delighted with the 'Wonder' telescope. Today I have been watching submarines 3 miles off the coast."—Philip Brush. "I can see across the Mississippi 3 miles and see people fishing."—M. L. Thorn. "I am nearly 80 years old, and if I could not get another would not take \$10 for it."—A. R. Walker. "I can tell time on the church clock 5 miles away."—Edward Foster. "Could tell color of aeroplane 4 miles away."—Mrs. L. M. Yarbrough.

Send No Money

Sign and mail coupon below and Ferry Wonder 3-ft. Telescope with free Carrying Case will come by return mail. Pay postman special bargain price of \$1.85 plus few cents postage. Satisfaction guaranteed or your money back. Send coupon today!

Ferry & Co., 3224 N. Halsted St., Dept. 1771, Chicago

Send me 3-ft. Ferry Wonder Telescope and Free Carrying Case. I will pay postman \$1.85 plus postage on arrival. If I am not satisfied, you will refund my money.

Name

Address

City.....State.....

BIG BARGAIN CATALOG SENT FREE



Practical Tools for Practical Men



Equipped with back-gear head or plain head as shown. Arranged for wood turning, metal turning or both. A practical machine for skilled mechanic or amateur: for shop or home. Made with same precision and quality materials as large lathes. Has 6" swing; 12" or 18" between centers; speed 180 to 1750 R. P. M. Quantity production explains its low cost.

Baby Grand Drills and Grinders



Both are thoroughly practical tools of high quality. Drill capacity 0" to 3/8" drills. Wide speed range. Comes equipped with chuck as shown. Grinder wheels 4" dia.; 1/2" face. Comes complete as shown.



Write today for prices and complete information on Baby Grand Tools.

The Watson Mfg. Co.

101 Watson Bldg.

Toledo, Ohio

Free trial to Motorists

Free

Amazing New Auto Invention—the Marvelous WESCO—a Boom to Motorists!

Makes Autos Run 60 Miles to a Gallon of Gasoline!

I don't care what mileage you are making—how many so-called gas savers you have used, I positively guarantee that unless WESCO cuts your gas bills—half or less, removes all carbon, increases power and pep and eliminates spark plug trouble it will not only cost you nothing but I'll gladly pay you for your trouble. Just send name, make and model of car and say "I want to try WESCO at your risk."

WESCO, 175 May Bldg., Sioux Falls, S. D.

Starts Cold Motor

INSTANTLY; new QUICK-START electric-heat primer, for FORDS and others. Principle adopted by Lincoln, Packard, Chrysler. Three devices in one. **GREATEST GAS SAVER YET INVENTED** Prevents carbon. Saves battery; saves oil. **AGENTS:** Quick-selling year-round article. Bigger margin of profit for you. Special **FREE Deal.** Write **W.W. KUTSCHE,** Inventor, Dearborn, Michigan.



Cabinet size, 30" long, 14" wide, 30" high
Price \$18.00

RADIO CABINETS Save Money

For your old set, or if you build a new one, buy one of these exquisite two-toned walnut console radio cabinets. Makes your old radio up to date. Just the cabinet for the Popular Mechanics circuit illustrated in November issue.

Biggest Bargain Ever Offered

These cabinets are made of selected gumwood, with 5-ply walnut veneer doors and top. Doors open to compartments for all batteries, wires, etc. Order direct from this ad. Send deposit of 25%—balance C.O.D. Satisfaction guaranteed.

ORDER NOW!

LOEB EQUIPMENT SUPPLY CO.

618 W. Lake St., Dept. A, Chicago



Cabinet size, 36" high, 30" long, 14" wide. Panel sizes, 7" x 15" to 7" x 26"
Price \$21.50

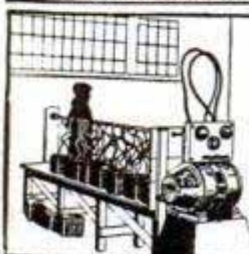

\$150 to \$300 PROFIT MONTHLY EASY WITH ONE DAY BATTERY CHARGING

Why not have a moneymaking One Day Battery Charging business of your own? Over 12,000 shops are making \$150 to \$300 every month selling One Day Charging. Every car needs it, especially in winter. Just \$35 cash completely equips your shop for HB One Day Charging. Small monthly payments on balance. 30 days' free trial in your shop on moneyback guarantee. No experience needed to operate an HB. Try its moneymaking possibilities in your shop at our risk. Write for free Bulletin 126.

HOBART BROS. CO. Box M 126, TROY, OHIO

ONLY \$16.50 MONTHLY—PAID BY INCREASED PROFITS

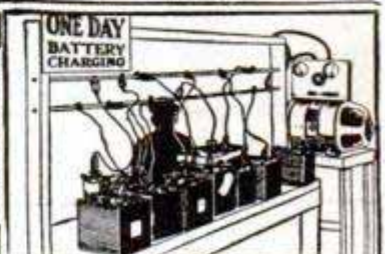

10 Days Free Trial

*The
Speed
Shop*
(Model
260)



In
Your
Own
Home

Six Complete Motor Driven Tools

The SpeedWay Shop Model 260 is a compact metal and woodworking outfit for mechanics, experimenters, householders, farmers and shop men. The power unit is our powerful back-gear'd electric motor.

A Complete Shop

Attaches to **any** lamp socket. All of the 23 items listed below are packed under pressed steel case with the lathe bolted to platform 25 in. x 6 in.

- | | | |
|-----------------|-------------------------|--------------------------------------|
| 1. Lathe Bed | 9. Gouge Chisel | 17. 4-in. Wire Brush |
| 2. Tool Rest | 10. Universal Wrench | 18. Tool Case |
| 3. Tail Stock | 11. Base 25 in. x 6 in. | 19. Drill Handle |
| 4. Centers | 12. Saw Table | 20. Drill Bits |
| 5. Chuck | 13. 5-in. Circular Saw | 21. Nut and Washer |
| 6. Spur Center | 14. 2-in. Wheel | 22. Steel Cover |
| 7. Face Plate | 15. Arbor and Flanges | 23. The Well Known
SpeedWay Motor |
| 8. Parting Tool | 16. Cloth Buffer | |

All of best material and superior workmanship.

Free Job Sheets

We furnish free, Job Sheets explaining just how to make Furniture, Birdhouse, Toys, Trellis, etc. You can do Radio jobs; polish auto and golf clubs; and endless other things.

We want you to read what others say about SpeedWay Shop Model 260. We want to show you how it will profit you. Send the coupon TODAY. Every tool in the "Shop" is high grade, for regular work. A money maker for the small job man. Get full particulars. Send coupon TODAY.

ELECTRO-MAGNETIC TOOL COMPANY

1830 South 52nd Avenue Dept. 1351 Cicero, Illinois [Adjoining Chicago]

Only \$10.00 Down

Five minutes after receipt you can have the chips flying. Pay as you enjoy it. Use the SpeedWay Shop for pleasure or profit. This wonderful outfit gives you the following tools, all motor driven—

Saw, Lathe, Grinder, Buffer, Cleaner, Stationary or Portable Drill. Tools quickly interchangeable.

SEND COUPON TODAY

Electro Magnetic Tool Co.,

Dept. 1351

1830 South 52nd Ave., Cicero, Ill.

Dear Sirs: Please send me full particulars about 10-day free trial on SpeedWay Shop Model 260.

Name.....

Address.....

City..... State.....

\$43⁴⁸ POSTPAID
Kit RK 9215
Range 3500 Miles

4-Tube ROBERTS

Superior to most other sets
REGARDLESS OF
NUMBER OF TUBES!

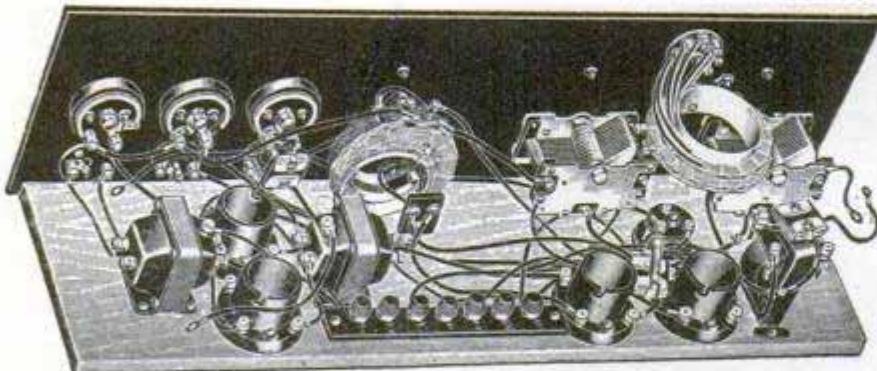

SEE WHAT YOU GET—BEST QUALITY

All parts highest grade—advertised, well-known, reliable, dependable—fully guaranteed by manufacturers and ourselves. Look at those brands. You cannot get a better kit!

Fine 7x24x8 mahogany finish cabinet, drilled and engraved Bakelite-Dilecto panel, five-ply (laminated) baseboard, Sickles' Roberts' coils, 2 Hammarlund low loss variable condensers, 3 E-Z Tone vernier dials, Thordarson transformer, pair Modern push-pull transformers, 3 Patent rheostats, 4 Bell Bakelite low loss sockets, Jones Improved single-circuit jack, Jones Improved double-circuit jack, Cutler-Hammer inductance switch, Smilcer filament switch, Electrad grid leak, Hilco grid condenser and mounting, 2 Hilco fixed condensers, Amplex grid-densifier, 7 Aristocrat binding posts, binding post strip, complete set "No-Sod-er" connecting wires, hardware, blueprint and instruction sheets. You can assemble in only three hours or so. Satisfaction positively guaranteed or money back.

List price, \$64.69; our regular catalog price, \$48.56—Special price to Jan. 31, only \$43.48. ORDER DIRECT FROM THIS AD—ON APPROVAL—NO MONEY IN ADVANCE—SHIPPED SUBJECT TO EXAMINATION WHEN REQUESTED—WE PAY TRANSPORTATION—24-HOUR SHIPMENT—SATISFACTION OR MONEY BACK (Foreign customers will please remit with order and include enough for transportation and insurance which we don't pay.)

Send for **BIG CATALOG—68 Pages—FREE**

Filled with big bargains in Kits, Parts and Accessories. Send today!

RADIO SPECIALTY COMPANY, Kit Div. 1631, 245W, Greenwich Street, NEW YORK

STOP! See This! To get you started dealing with us, we have slashed the prices on this most popular kit. But your order will have to be sent by January 31 when our regular catalog price will again be in effect.

Combines principles of Reflex, Neutralization, Tuned Radio Frequency, Regeneration (without blooping), and Push-Pull Amplification. Smooth-working—easily tuned—non-howling—non-reradiative—non-squealing. Guaranteed absolutely to give entire satisfaction.

See what Doubleday, Page & Co., through Mr. Arthur H. Lynch, Editor of their magazine, "Radio Broadcast," say about the Radio Broadcast's sensational 4-Tube Knock-Out Set developed by Walter Van B. Roberts: "Tube for tube, dollar for dollar, result for result, we will stack it up against any receiver for home construction ever described by any radio publication and gamble that it comes out winner. It is the best we have ever seen—and we have seen and operated almost every type made and used during the past twelve years. It has pulled in forty-six stations on a loud speaker with two tubes, using an indoor antenna. Its signals have been heard through the air more than a quarter mile. It is not merely the best four-tube receiver, but the best by a very good margin."

CUSTOMERS PRAISE IT!

Special Features Great volume—Utmost clearness.—Sweetness of tone.—Highly selective.—Cheap to build.—Easy to operate.—Receives great distance.—Does not radiate or cause squealing in your neighbors' receivers.—Low cost of upkeep. The best 4-Tube set for home construction ever produced.

Our New Method of Wiring—Perfectly Simple
—No Radio Knowledge Needed

"No-Sod-er"
MAKES SET-BUILDING EASY

No solder—No bare wires—No poor connections—No dissatisfaction. No tools needed except a common screw-driver and common pliers. All connections are made by the use of our flexible, insulated eyeletted connecting wire in place of bus bar or wire, and solder. And in a fraction of the time usually required when using the old fashioned way. And when the job is done it is neat and connections are tight.



**now we'll
have clear
music**



MAGNATRONS in your set will give sweet purity of tone—clear and complete rendition of all the wealth of overtones. Music and speech come from the loudspeaker of the Magnatron equipped set with rich fidelity and generous volume, recreating in your home the actual performance itself, whether it be ten or a thousand miles away.

Magnatrons are the product of the oldest exclusive makers of vacuum tubes. That, in a large measure, explains their excellence.

There's a Magnatron for every purpose. The DC-201A, the DC-199 (large or small base), the DC-120 (for super volume), and the Rex (for B eliminators) all list for only \$2.50 each.

Write for your FREE copy of "Pot Pourri"
—a snappy review of mirth and
music to Dept. P.M.

CONNEWY ELECTRIC LABS.,
Magnatron Bldg.,
HOBOKEN, N. J.

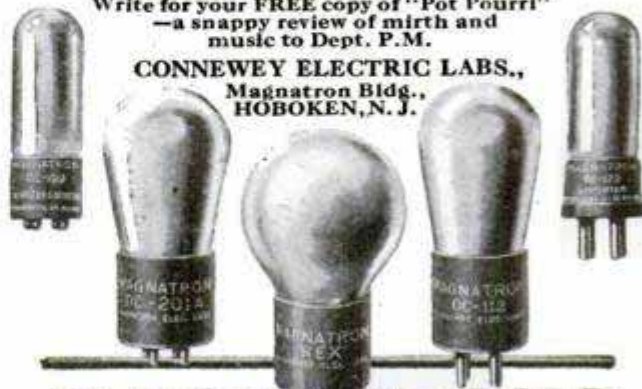

MAGNATRONS

Complete factory stock for Pacific Coast carried at Pacific Radio Labs.,
256 S. Los Angeles St., LOS ANGELES, CAL.

"I MAKE \$25.00 A DAY SURFACING FLOORS"



"I am making \$25 a day and have made as high as \$40 a day with my American Universal Floor Surfacing Machine. I get plenty of work to keep my American Universal busy all the time."

WITH THIS MACHINE

Start in a small way and make big money. That's what Don Arnold did and thousands of others have done. Like you they read an advertisement just like this and accepted the wonderful opportunity to get behind an electrically driven American Universal Floor Surfacing Machine and build up a big profitable business of their own.

They are men from factories, stores, and offices, young and old alike, who were looking for a future and an opportunity to make real money. They are now making from \$25 to \$40 a day with one American Universal Floor Surfacing Machine, which does the work of six men and earns six men's pay. All started with just one machine, but many are now operating six or more machines and have become floor surfacing contractors on a large scale.

Every New Floor Must Be Surfaced Every Old Floor Needs Resurfacing

There is surfacing work to be done in every new and old business or residence in your vicinity. If you are willing to don a pair of overalls you can make from \$25 to \$40 a day every working day in the year—Winter and Summer, month in and month out.

NO EXPERIENCE NECESSARY

Any intelligent man can learn to operate the electrically driven American Universal Floor Surfacing Machine in a very short time. It actually does in a day the work of six men scraping by hand and does much better work than can be done by hand.

Write now for particulars. Let us tell you how you can become an American Floor Surfacing Machine contractor. You can secure this information absolutely free without any obligation on your part.

THE AMERICAN FLOOR SURFACING MACHINE COMPANY
523 So. St. Clair St. Toledo, Ohio



Let the American Scroll Saw SOLVE YOUR SAW PROBLEMS

You will like its sturdy mechanical construction. It will saw wood, fibre, bakelite 1 in. and metal 1/4 in. thick. Sold also without motor. We carry a complete line of bench woodworking machinery.

For details write to

DELTA SPECIALTY CO.
Dept. No. A-110
858 Third St., Milwaukee, Wis.

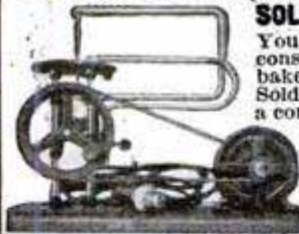

Bodies of Rare Beauty for Fords

At Factory Prices!

\$22.75 and Up

Write for Circular A-2 showing this Model and others.
SPORT BODY WORKS
AURORA, ILL.

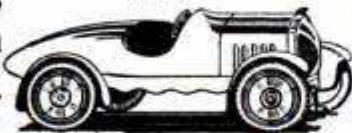

This model in grey prime, \$39.50

REMINGTON PORTABLE TYPEWRITER

Dealers and Branches Everywhere

SUCCEED With Your Own Products Make them yourself. Formulas, Processes. Trade-Secrets. Modern master methods.
CATALOG FREE

W. THAXLY CO. Washington, D. C.

Watch for announcement of Ives wonderful electric reversing locomotive.

Ives Manufacturing Corp.
Holland Ave., Bridgeport, Conn.

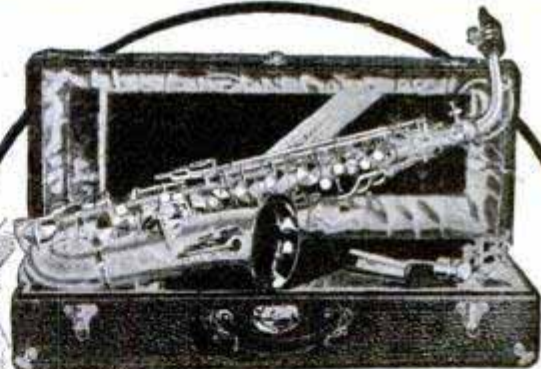

"KING" Saxophones

Built Acoustically Correct

KING Saxophones and Band Instruments are built to the most exacting standards in the industry. Every instrument is true to pitch, easy to play and has a beautiful quality of tone.

Free Trial—Easy Payments

You can have 10 days free trial to prove to your own satisfaction that a "King" is all that is claimed—and easy payments are extended in purchasing. Other instruments are accepted as part payment.

Send for Catalog. The New King Catalog will tell you how "Kings" are built, explain the various exclusive features which make "Kings" the finest instruments you can obtain.

THE H. N. WHITE CO.
5211-71 Superior Ave. Cleveland, Ohio



THE H. N. WHITE CO.
5211-71 Superior Ave., Cleveland, Ohio

Kindly send me free without obligation your latest catalog on _____ (Instrument)

Name _____
Address _____
City _____ State _____

Fat Men

This new self-massaging belt not only makes you look thinner INSTANTLY—but quickly takes off rolls of excess fat.

DIET is weakening—drugs are dangerous—strenuous reducing exercises are liable to strain your heart. The only safe method of reducing is massage. This method sets up a vigorous circulation that seems to melt away surplus fat. The Weil Reducing Belt, made of special reducing rubber, produces exactly the same results as a skilled masseur, only quicker and cheaper.

Every move you make causes the Weil Belt to gently massage your abdomen. Results are rapid because this belt works for you every second.

FAT REPLACED BY NORMAL TISSUE

From 4 to 6 inches of flabby fat usually vanishes in a few weeks. Only solid, normal tissue remains. The Weil Reducing Belt is endorsed by physicians because it not only takes off fat, but corrects stomach disorders, constipation, backache, shortness of breath and puts sagging internal organs back in place.

Special 10-Day Trial Offer

Send no money. Write for detailed description and testimonials from delighted users. If you write at once, you will receive a special 10-day trial offer. The Weil Company, 91 Hill Street, New Haven, Conn.

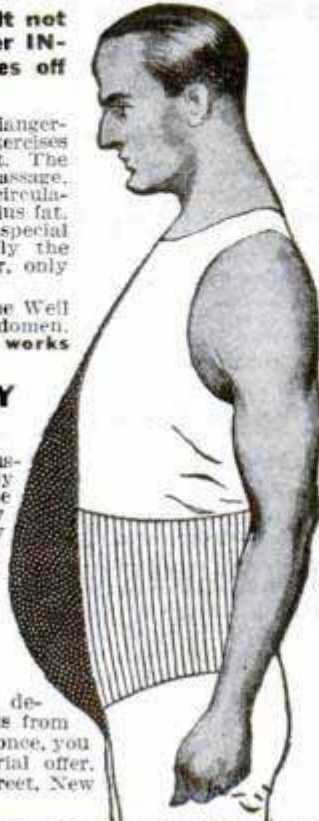

THE WEIL COMPANY, 91 Hill St., New Haven, Conn.

Gentlemen: Please send me complete description of the Weil Scientific Reducing Belt, and also your Special 10-Day Trial Offer.

Name

Address

City..... State.....

PAY NOTHING NOW



Just Send Us Your Name And We'll Send You This Ring Set With Full Cut 1 Ct. Blue-White Deelite Diamond

All we want is your name and address and we make immediate shipment of this beautiful ring.

\$1 Per Month

NO REFERENCES. WE TRUST YOU. 9 MONTHS TO PAY. For a genuine diamond of the same cut, size and flash you would ordinarily be required to pay upwards of \$150.00. For our Deelite Diamond pay only \$2.00, making only our first payment to postman when he delivers package and pay the balance \$1.00 per month. Rush your name and address. An absolute guarantee with each ring.

A. G. DEELITE CO., 530 Broadway, New York



12-Cell—24-Volt Storage 'B' Battery

Positively given free with each purchase of a WORLD "A" Storage Battery. You must send this ad with your order.

Send Your Order in Today

FREE!



WORLD Batteries are famous for their guaranteed quality and service. Backed by years of successful manufacture and thousands of satisfied users. Equipped with Solid Rubber Case, an insurance against acid and leakage. You save 50 per cent and get a 2-Year Guarantee Bond in Writing

WORLD Battery owners "tell their friends." That's our best proof of performance. Send your order in today.

- Solid Rubber Case Radio Batteries**
- 6-Volt, 100-Amperes.....\$11.25
 - 6-Volt, 120-Amperes.....13.25
 - 6-Volt, 140-Amperes.....14.00
- Solid Rubber Case Auto Batteries**
- 6-Volt, 11-Plate.....\$11.25
 - 6-Volt, 13-Plate.....13.25
 - 12-Volt, 7-Plate.....16.00

Send No Money Just state battery wanted and we will ship day order is received, by Express C. O. D., subject to your examination on arrival. **FREE "B" Battery** included. **Extra Offer:** 5 per cent discount for cash in full with order. Buy now and get a guaranteed battery at 50 per cent saving to you.

WORLD BATTERY COMPANY
1219 S. Wabash Ave., Dept. 6, Chicago, Ill.

World

For AUTO and STORAGE BATTERIES RADIO

Approved and Listed as Standard by Leading Authorities

Including Radio News Laboratories, Popular Science Institute of Standards, Popular Radio Laboratories, Radio Broadcast Laboratories, Radio in the home, and Lefm., Inc.

RADIO long distance COMPLETE sets

THESE are the finest long distance sets at the lowest prices in history. Wonderful new circuit that brings amazing results. **SATISFACTION GUARANTEED.** Everything furnished with complete sets. There's a set for every pocket-book.

- 5 TUBE SET**—100 Amp. Storage "A" Battery, rubber covered "A" Battery Cable; "B" Battery, 90 V. 5 Tubes, Loud Speaker, Loud Speaker Plug, Antenna..... **\$95.95**
- 3 TUBE SET**—3 Dry Cells; "B" Battery, 90 V.; 3 Tubes, Loud Speaker, Head Phones, Antenna..... **\$49.95**
- 2 Tube Set**—2 Dry Cells; "B" Battery, 45 V.; 2 Tubes, Head Phones, Antenna..... **\$29.95**
- 1 Tube Set**—1 Dry Cell; "B" Battery, 22½ V.; 1 Tube, Head Phones, Antenna..... **\$18.95**

Sets also sold without accessories. Full line radio accessories and partly assembled kits. Console models and kits for installing radios in phonographs. Write for free catalog. Don't buy until you see us.

THE MELLODYNE RADIO COMPANY
Department M-1 CINCINNATI, OHIO

Write for free catalog today



TUBE REJUVENATOR

Safe—Economical—Guaranteed Connect to any electric light socket. For the price of one good tube you can use this Tube rejuvenator to put added life into all your tubes for years. Full instructions with each set. **GUARANTEED TO SATISFY YOU OR YOUR MONEY BACK.**

SEND NO MONEY—Pay Your Postman Only (plus postage.) **\$2.98**

THE HOUSE OF BANKS, 4430 Malden Ave. B. Chicago

\$4.50 LIST PRICE WALLACE COMBINATION JACK and RIM TOOL

Just the tool for all motorists, garage owners. All-in-one Ball Bearing. Fits all split rims. Will fit any style and size. If your dealer can not supply you send your order direct to us. Representatives wanted everywhere. WALLACE RIM TOOL & MFG. CO. Dept. P. M., 24 S. Clinton St., Chicago



ONLY **\$37.50** Prepaid

Get this KISMET 5-Tube Set at FACTORY PRICE!

An amazing bargain! This latest Kismet Receiver gives you a 5-tube T.R.F. circuit, wonderful for distance and volume. Genuine Bakelite insulation. New type straight line condensers. Beautiful sloping panel; two-tone walnut finish cabinet with battery compartments. A precision instrument in a masterpiece of cabinet-craft! You risk nothing!

Every set guaranteed free from mechanical defects—money refunded if set does not work. Sent to you prepaid, \$37.50. Send for complete Radio Catalogue. VAN-ASHE RADIO CO., 208 N. 10th ST., ST. LOUIS, MO.

Swear Off Tobacco



Tobacco Tells on Nervous System



Tobacco Ruins Digestion

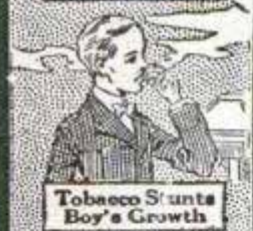

Tobacco Stunts Boy's Growth



Tobacco Robs Man of Vitality



Tobacco Steals from You the Pleasures, Comforts, Luxuries of Life

Tobacco Habit Banished Let Us Help You

Quick Results

Trying to quit the tobacco habit unaided is often a losing fight against heavy odds, and may mean a serious shock to your nervous system. So don't try it! Make the tobacco habit quit you. It will quit you if you will just take **Tobacco Redeemer** according to directions.

It doesn't make a particle of difference whether you've been a user of tobacco for a single month or 50 years, or how much you use, or in what form you use it. Whether you smoke cigars, cigarettes, pipe, chew plug or fine cut or use snuff—**Tobacco Redeemer** will positively remove all craving for tobacco in any form in a few days. Your tobacco craving will usually begin to decrease after the very first dose—there's no long waiting for results.

Tobacco Redeemer contains no habit-forming drugs of any kind and is marvelously quick, scientific and thoroughly reliable.

Not a Substitute

Tobacco Redeemer is in no sense a substitute for tobacco, but is a radical, efficient treatment. After finishing the treatment you have absolutely no desire to use tobacco again or to continue the use of the remedy. It helps to quiet the nerves, and will make you feel better in every way. If you really want to quit the tobacco habit—get rid of it so completely that when you see others using it, it will not awaken the slightest desire in you—you should at once begin a course of **Tobacco Redeemer** treatment for the habit.

Results Absolutely Guaranteed

A single trial will convince the most skeptical. Our legal, binding, money-back guarantee goes with each full treatment. If **Tobacco Redeemer** fails to banish the tobacco habit when taken according to the plain and easy directions, your money will be cheerfully refunded upon demand.

Let Us Send You Convincing Proof

If you are a slave of the tobacco habit and want to find a sure, quick way of quitting "for keeps" you owe it to yourself and to your family to mail the coupon below or send your name and address on a postal and receive our free booklet on the deadly effect of tobacco on the human system, and positive proof that **Tobacco Redeemer** will quickly free you from the habit.

Newell Pharmacal Company
Dept. 300, Clayton Station, St. Louis, Mo.



Free Book Coupon

NEWELL PHARMACAL CO.,

Dept. 300, Clayton Station, St. Louis, Mo.

Please send, without obligating me in any way, your free booklet regarding the tobacco habit and proof that **Tobacco Redeemer** will positively free me from the tobacco habit or my money will be refunded.

Name.....

Street and No.....

Town..... State.....

Make FURNITURE at Home

You Can Do It in Spare Time—It's Easy

THE simple designs in furniture are, after all, the most attractive.

And the best of the easily-made styles have been gathered into "Popular Mechanics Furniture-Making Books." These books are filled with pictures that show you how the finished piece looks, and how to lay out, saw, and put together the various parts. You are also told how to finish your furniture in the most attractive ways. Nowhere else will you find instructions more clear. Nowhere else will you find such a marvelous assortment of simple designs to select from. Think of it! 142 different designs, including all the pieces of furniture and the different styles of lamps you need to make your home a pleasant place to live.

142 Pieces

Complete
Instructions
and Designs

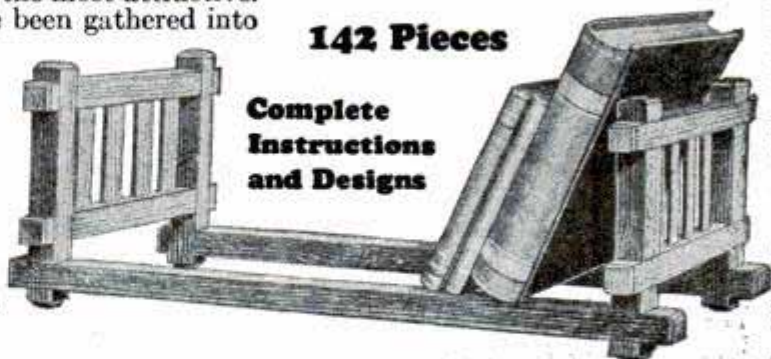

Popular Mechanics Furniture-Making Books

Tell How to Make These 142 Pieces of Furniture and Lamps

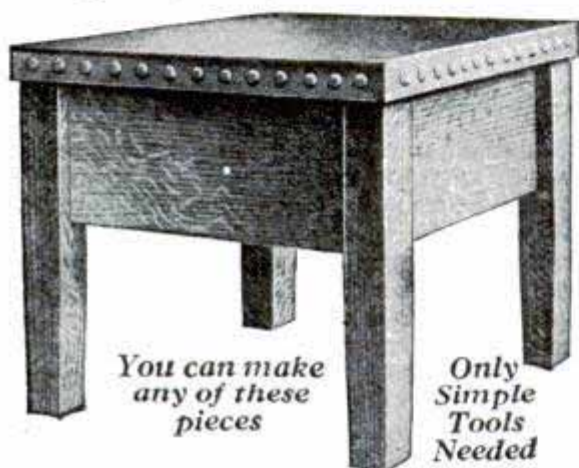

You can make
any of these
pieces

Only
Simple
Tools
Needed

Settee
The tanning of oak
How to make black wax
40 styles of chairs, beginning with
the Egyptian style made 300
years before Christ
Pinno bench
A shaving stand
A waste paper basket
A cellorette pedestal
A princess dresser
A sideboard
A window seat
A plant stand
A bedside medicine stand
A hall chair
A side chair
An arm chair
A book case
A lamp stand
Extension dining table
An oak-bound cedar chest

A dresser for child's playroom
Arts and crafts oil lamp
China closet
An oak bedstead
A footstool
A library set in pyro-carving
A grille with pedestals to match
A lady's writing desk
A telephone stand and stool
An oak medicine cabinet
Home-made mission chair
A lamp stand and shade
A porch chair
A tabouret
A Morris chair
A mission book rack
A substantial library table
A mission candlestick
A low-back mission chair
A magazine stand
A lawn swing
A portable table
A combination billiard table and
davenport

Easily made book shelves
A blacking case tabouret
A Roman chair
A roll top desk
A pyrographer's table
A piano bench
A library table
A princess dresser
A sewing box
A fern stand
A wardrobe
An oak table
A book trough
An oak serving table
An umbrella stand
A chafing-dish buffet
A writing desk
A music rack and book stand
A dictionary and magazine stand
A leather back arm chair
A wall shelf
A pedestal
A magazine rack
A hall tree

One-light portable lamp
Two-light portable lamp
Four-light chandelier
Dining-room dome
Reading lamp
Fazor or den lantern
Lantern
One-light portable
Shade for droplight
Four-light chandelier
One-light bracket
Piano lamp
Newel post lamp
Electric candle sconce
One-light brackets
Droplights
Reading lamp No. 1
Reading lamp No. 2
Square dining-room dome
Mission chandelier
Des's light
Droplight No. 3
Chandelier
Hexagonal library lamp
Hexagonal dome
Lamp No. 1
Lamp No. 2
Lamp No. 3
Lamp No. 4
Conventional patterns
The butterfly design
The pyramid design
An oak buffet
Oak stain
A pine oak hall clock
A rocking chair

A curved back arm chair
A plate rack
A tool for marking dowel holes
A magazine table
A waste paper basket
A writing desk
A couch with cushions
Shade for dining room
How to bend wood
A smoking stand
A china closet
A leather-covered footstool
Arts-craft mantel clock
A music stand
Wall case with mirror
A table for the den
A hurlap-covered seat
A quarter-sawn oak settee
A screen
A mission book rack
A round extension table
An arm dining chair
A hall bench
A sewing table
A side chair
Another pinno bench
Another screen
A folding card table
A magazine stand
A tabouret
A porch swing
A foot warmer
Plate rack
A mission sideboard

IDEAL BOOKS For Manual Training Courses

Men and boys, alike, find these books to be marvels of simplicity and fascination. Boys just starting manual training courses, will find in these books instructions and designs that will make their work both interesting and profitable, for the pieces so clearly described may be readily sold at a good profit.

33 Lamps to Choose From



Save Half the Cost
of Furnishing
Your Home

It's Fun to Make Things.
It's Profitable to Make
Furniture and Lamps

This valuable set known as "Popular Mechanics Furniture-Making Books," includes the five volumes of which thousands have been sold:

1. Mission Furniture and How to Make It, Book 1
2. Mission Furniture and How to Make It, Book 2
3. Mission Furniture and How to Make It, Book 3
4. Lamps and Shades in Metal and Art Glass
5. Arts-Crafts Lamps and How to Make Them

Send No
Money

Don't send a penny (if you live in the U. S.). We want you to have these valuable books in your hands before you make any deposit. When the postman hands them to you, pay the postage, and deposit \$4.95 for the five books. If you are not delighted with your purchase, we will promptly refund the entire purchase price. Nothing could be fairer than that. Just write a postal and say, "Send me the Popular Mechanics Furniture Making Books." Single books, \$1 each.

POPULAR MECHANICS PRESS
Room 14, 200 East Ontario St., Chicago

Save Money on New or Used Auto Parts!

15 years of progress has made our stock of new and used accessories and replacement parts the largest in the world. We can furnish you with anything from a Cotter-Pin to a complete Power Plant.

FREE! CATALOG
of Parts Both

NEW AND USED

The most complete catalog ever issued. Chock full of bargains. Save 30% to 80% on your purchases. Buy from Warshawsky. Every item guaranteed to be just as represented.

WRITE TODAY SURE!

Big Illustrated
Radio Catalog
FREE

A FEW SPECIAL BARGAINS IN NEW REPLACEMENT PARTS
Prices quoted are F. O. B. Chicago

- Ford Cylinder Heads, New \$3.75
- Ford Cylinder Blocks, New, Complete with rings, wrist pins, pistons, bushings. \$20.00
- Ford Counter Balance Crank Shafts, A \$19.00 value. \$12.50
- Ford Triple Seal Pistons, New, Up to .005 oversize. Complete with wrist pins and bushings. Per set \$5.00
- Ford Gas Savers, New, 2-in. manifold, \$3.50 value \$1.00
- Ford Water Pump, New \$2.50
- Genuine Chevrolet Pistons, New, Up to .005 oversize \$1.00
- Nu-Life Ring Expanders, New 5c
- Miles Piston Rings, New 40c
- All sizes. A \$1.25 value....

WARSHAWSKY & CO.

"World's Largest Car Wreckers and Replacement Parts House."

No Branches 1915 So. State St., Dept. P. M. 1 Chicago, Ill.

"The Old Razor was O.K. after all"

Just needed Barbasol to produce a quick, clean, cool and silky shave. No brush. No rub-in. The modern way. Try it—three times—according to directions. 35c and 65c tubes. Send coupon and 10c for trial tube.



The Barbasol Co.
Indianapolis Ind.

I enclose 10c; please send trial tube.

Name.....

Address.....

P.M.-1-26

For Modern Shaving

For Your Boat



Elto

Ole Evinrude's New Quick Detachable ROWBOAT MOTOR

Easily carried. Quickly attached to any boat (without tools). Drives boat any speed, 2 to 10 miles per hour. No rowing, no work, no bother.

Fast—Light—Powerful Easy to Carry

Has 12 exclusive features, all described in our new Free Catalog. Write for it today.

Elto Outboard Motor Co.
Manufacturer's Home Bldg.
Dept. AA
Milwaukee, Wis.

(14)

Elto—The Motor that Starts with a Touch

NO JOKE TO BE DEAF

—EVERY DEAF PERSON KNOWS THAT



I make myself hear, after being deaf for 25 years, with these Artificial Ear Drums. I wear them day and night. They stop head noises and ringing ears. They are perfectly comfortable. No one sees them. Write me and I will tell you a true story how I got deaf and how I make you hear. Address



Medicated Ear Drum

GEO. P. WAY, Artificial Ear Drum Co. (Inc.)
80 Hoffman Bldg., 2539 Woodward, Detroit, Mich.

Clear-Tone

FOR

PIMPLES

Your skin can be quickly cleared of Pimples, Blackheads, Acne or any Eruptions on the face or body, Barbers Itch and Eczema, Enlarged Pores, Oily or Shiny Skin.

CLEAR-TONE has been Tried, Tested and Proven its merits in over 100,000 test cases.

FREE

WRITE TODAY for my FREE Booklet — "A CLEAR-TONE SKIN" telling how I cured myself after being afflicted for fifteen years.

E. S. GIVENS 129 Chemical Bldg. Kansas City, Mo.

It's a Plier, It's a Wrench, It's a Whole Tool Kit



"Red Devil" Giant-Grip No. 444, no bigger than an ordinary plier and just as well balanced, has solved many of the plier and wrench troubles. Lays parallel on all sizes of nuts up to 3/4". Moves the most stubborn nuts or bolts, even when they are rusted. It does its work without damage. Nothing to get out of order.

SMITH & HEMENWAY CO., INC.

Mfrs. of "Red Devil" Tools, 122 Coit St., Irvington, N.J.

Ask your dealer for "Red Devil" No. 444, 7 1/2", or send us \$1.25 and we'll send it to you postpaid. Mechanic's tool booklet free.

Crippled Children and Young Adults



Infantile Paralysis
Ura Hilliard
Rosebud, Texas
Treated 5 1/2 Mos.

For 30 years the McLain Orthopedic Sanitarium has been devoted to the treatment of crippled children and young adults. No plaster paris is used and no surgical operations are performed requiring chloroform or any general anaesthetic. Facilities provide for immediate reception of patients. Parents may retain full charge of children and give them their personal care and attention during treatment, if they so desire.

Write for Free Books

"Deformities and Paralysis" and "Book of References" which show and tell of the facilities the McLain Sanitarium has for treating Club Feet, Infantile Paralysis, Spinal Diseases and Deformities, Hip and Knee Disease, Wry Neck, etc. JR621



CLUB FEET
Edward King,
948 Humphrey,
Oak Park, Illinois

McLain Orthopedic Sanitarium
902 K Aubert Ave. St. Louis, Mo., U. S. A.

Reduce Motor Speed WITH IXL

FREE BOOK Every inventor and experimenter should know about IXL Speed Reducers. Most efficient, compact and safe device for reducing motor speeds. May be built into machines where speed reduction is required, or used in shop transmission in place of belts, chains and open gearing. Large variety of sizes and reductions.

Send for your copy of our big FREE book today.

We Make Cut Gears of all kinds, Micarta Pinions, Micarta Timing Gears, Flexible Couplings, Speed Reducers, Special Machinery

FOOTE BROS. GEAR & MACHINE CO
230-240 N. Curtis St., Chicago, Ill.

Gentlemen: Please send me a copy of your free Speed Reducer Book.

Name.....
Address.....
City..... State..... 177-D

MOTORS large quantity brand new universal 110 volts standard very well constructed. General Electric about 1/70 H. P. 1080 R. P. M. orig. cost \$16.00 **\$6** Robbins & Myers " 1/30 H. P. 3000 R. P. M. " " \$14.00 Edison used, about 1/40 H. P. 600 to 1800, controlled by governor. **SATISFACTION GUARANTEED OR MONEY REFUNDED** WEXLER ELECTRIC MOTOR CO. 196 Centre Street, New York

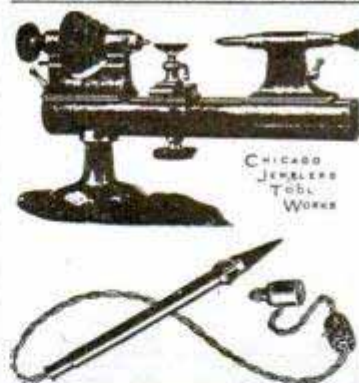

Watch and Instrument Makers **Precision Lathe**
OVER 3000 IN USE
For experimenters, laboratories, etc., complete with Collets and Attachments; all standard parts, fully guaranteed. Shipped subject to examination and approval **\$48.50**
Burn your name or initials into your tools, dies or any metal by electricity. Complete outfit, works from any lamp socket **\$3.00**
CHICAGO JEWELERS TOOL WORKS
10 So. Wabash Ave. Chicago

40 Years OF BIG VALUE Lathes

15" Lathe as low as **\$250.00**

Write for Catalog **SEBASTIAN LATHE CO.**
107 Culvert Street CINCINNATI, O., U. S. A.

Gold Seal SEBASTIAN LATHES GUARANTEED CORRECT TRADE MARK

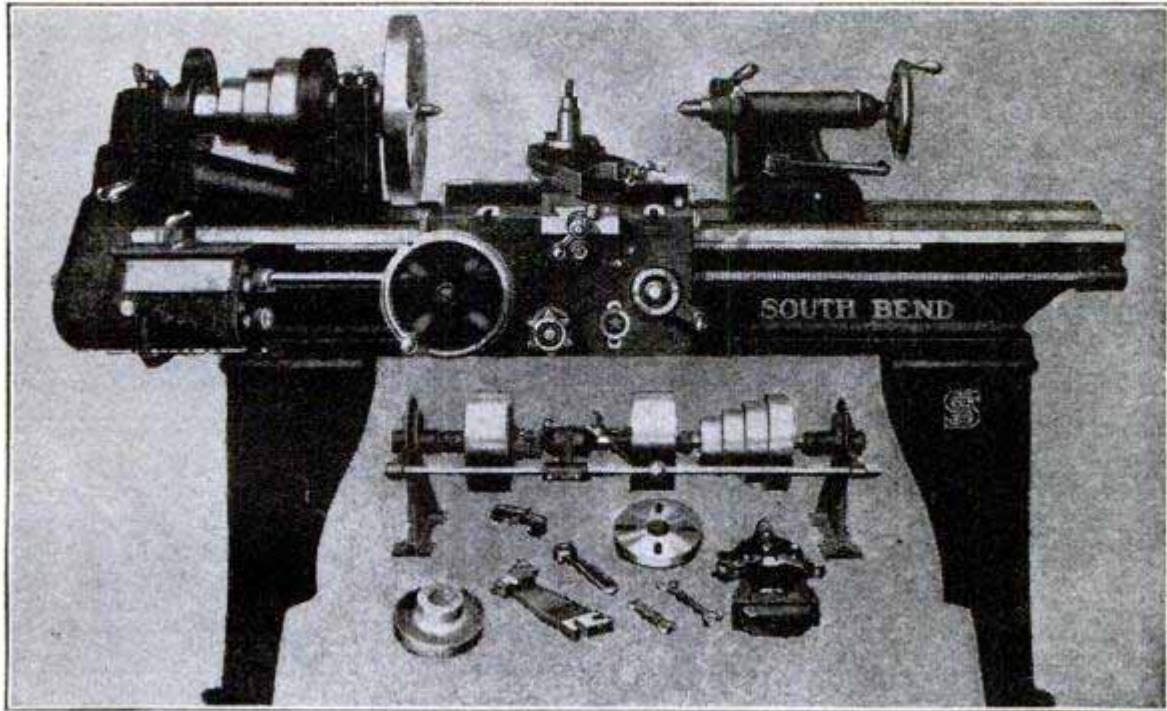

15" x 6' South Bend Quick Change Gear Lathe, \$431.00
WRITE FOR OUR EASY PAYMENT PLAN

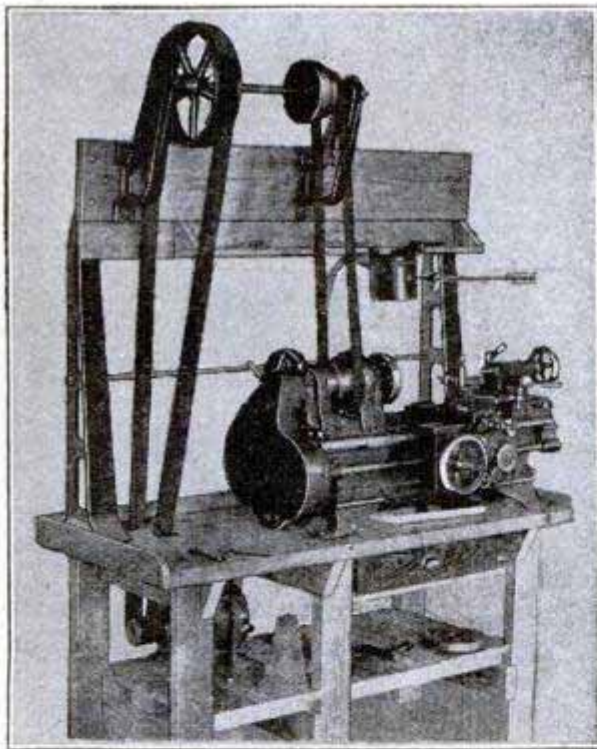

11" x 3½' Bench Lathe Unit
 Complete with D. C. Motor, \$323.50
WRITE FOR OUR EASY PAYMENT PLAN

EASY PAYMENT PLAN

Our Easy Payment Plan allows you to install a South Bend Lathe in your shop, by making one payment with the order; the balance to be paid month by month, the amount depending upon the size of the Lathe.

South Bend Lathes are made in all sizes from 9" swing to 24" swing inclusive and in bed lengths from 2½' to 16' inclusive.

Write today for Catalog No. 82 which describes the Easy Payment Plan. Mention size of lathe desired.

SOUTH BEND LATHE WORKS
 805 East Madison Street
 SOUTH BEND, IND., U. S. A.

— 33,000 IN USE —

SOUTH BEND LATHES

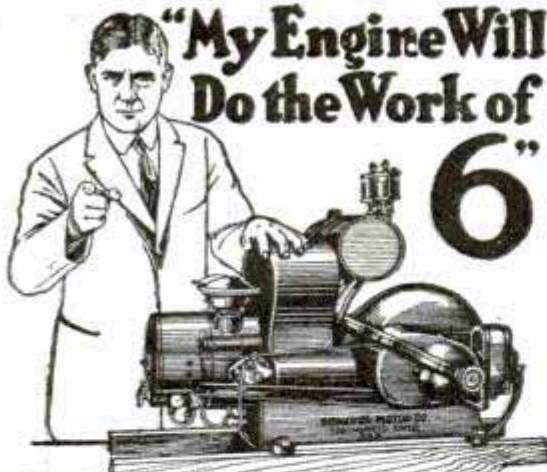

"My Engine Will Do the Work of 6"

Try This Remarkable Engine

FREE The Edwards Farm Engine sells direct to you at low factory price. No other engine like it. 1 1/2 to 6 H. P. in one engine. Change power while running. Efficient at all powers.

Fits Every Farm Job

Pumps, saws, grinds, cuts ensilage, runs spray rig, concrete mixer, washer—anything up to 6 H. P. Portable. Burns kerosene or gasoline. No cranking. All moving parts enclosed. Work it anywhere without fastening down. Endorsed by thousands of users.

Clarence Rutledge, of Ontario, says: "Have given my Edwards four years' steady work and like it fine. Runs 28-inch wood saw, 8-inch grinder, ensilage cutter and does all chores. Have had ten other engines. The Edwards beats them all." Write now for full description of Edwards Engine, low factory price and details of free trial offer.



For Special FREE TRIAL Mail Coupon Now

EDWARDS MOTOR CO.
318 Main Street, Springfield, Ohio
Without obligation, send complete description of engine, also free trial offer.

Name _____
Address _____



68 BREEDS Valuable New Poultry Book Free—100 Pages. Fine Pure-bred Northern raised chickens, ducks, geese, turkeys, eggs, chicks also incubators at lowest prices. My 44th year.
W. A. Weber, Box 82 Mankato, Minn.



RAISE BELGIAN HARES

NEW ZEALAND REDS—Chinchillas—Flemish Giants
MAKE BIG MONEY—We supply stock and pay you following prices for all you raise: Belgian Hares \$2 each—New Zealands \$3 each—Chinchillas \$4 each—Flemish Giants \$5 each. 32-page illustrated book, catalog and contract, also copy of Fur Farming magazine, tells how to raise skunk, mink, fox, etc., for big profits, all for 10c. Address

OUTDOOR ENTERPRISE CO., Box 25, Holmes Park, Mo.

TYCOS Incubator Thermometer



is the accepted standard among experienced poultry men. They know. Price 75c. Postage 5c. Write now for free booklet "TYCOS Incubator Facts Worth Knowing."

Taylor Instrument Companies Rochester, NY, USA

Ultra-Violet Rays Pass Thru



Flex-O-Glass

1/8 Cost of Glass

AND BETTER

New Wonder Material

makes hens lay all winter. Make scratch shed quickly and cheaply. Give poultry soft sunlight full of Ultra-Violet rays that glass stops. Gather eggs all winter. Also use for enclosing screened porches thru winter, storm doors, windows, hotbeds, cold-frames, greenhouses, garages, barns, etc., at 1/8 former cost. Flex-O-Glass has a special cloth base coated with a newly discovered preparation. Lets healthful Ultra-Violet rays thru. Is absolutely waterproof, airtight, unbreakable, transparent. Cut with shears and tack on.

PRICES—Postage prepaid: (roll 35 1/4 in. wide) 1 yard 50c, 5 yds. at 40c, 10 yds. at 35c, 25 yds. at 33c, 100 yds. at 32c per yd. **SPECIAL OFFER—**15 yds. for \$5 (covers scratch shed 9x15 ft. for 100 hens). Add 3c per yard outside U. S. Use FLEX-O-GLASS 10 days; if then not satisfied that it is better than glass send it back and we will refund your money. Order direct from factory today. Free book on request.



Flex-O-Glass Mfg. Co., Dept. 94
1451 N. Cicero Ave. CHICAGO, ILL.



American Poultry Journal

OLDEST, LARGEST AND BEST

3 Months Free All ONE, TWO or FIVE year subscriptions received before Dec. 31st will be entered to commence with the January issue, and the Oct., Nov, and Dec. issues of this year will be mailed FREE. Order today and get them.

1 YEAR 75c. 2 YEARS \$1 5 YEARS \$2.00

Averages over 100 pages per issue. Tells how to feed, house and breed; how to secure high egg production; how to hatch and rear poultry successfully.

4 months trial subscription 25c
American Poultry Journal, 14-523 Plymouth Ct., Chicago

Do Your Own Hatching

Trust your hatching to **"SUCCESSFUL"** Incubators and Brooders

Used by the big money-makers who stay in business year after year. Poultry Lessons free to every buyer. Eastern customers will be served quickly from our Eastern Warehouse.

Catalog Free.
Des Moines Incubator Co 689 Second Street, Des Moines, Iowa



33 Years Making Good

Poultry and Pigeons For Profits

Foy's big Book. Contains many colored plates, encyclopedia of poultry information. Low prices on fowls, eggs, baby chicks and incubators. Written by a man who knows. Mailed FREE.

Frank Foy & Sons, Box 18 Clinton, Iowa



64 BREEDS Chickens, ducks, geese and turkeys. Pure-bred, high quality, hardy and most profitable. Fowls, eggs, incubators, brooders; lowest prices. America's great plant. At it 33 yrs. Fine new 100 page book and catalog free.
R.F. Neubert Co., Box 908, Mankato, Minn.

PLANS for Poultry Houses

All styles, 150 illustrations; secret of getting winter eggs, and copy of "The Full Egg Basket." Send 25 cents.
INDIAN POULTRY JOURNAL, Dept. 74 Indianapolis, Ind.



SQUAB BOOK FREE!

Pigeons Printed in Natural Colors

Make money breeding squabs. Sold by millions. Start small, grow big. Start now. Read how our customers sell squabs for \$12 a dozen. We have been established for 25 years. Better look into this. Let us send now, at no cost to you, our big, illustrated free book telling how to make money breeding squabs. We sell Racing Homers also. Write
Plymouth Rock Squab Co. 634 H. St. Melrose Highlands, Mass.

TOSTWICH THE GREATEST PROFIT-MAKER

The Tostwich brings amazingly big profits and sales wherever installed—a patented process—makes sandwiches taste 100% better than ever before. Full information without obligation to you—write today.
THE TOSTWICH CORPORATION
Dept. 1771, 646 No. Michigan Ave., Chicago.

Cal. 30

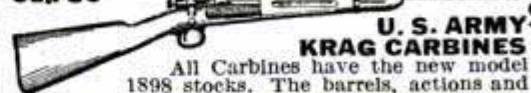

U. S. ARMY Krag Carbines

All Carbines have the new model 1898 stocks. The barrels, actions and parts are either new or have been refinished by the Government and equal to new

Krag Rifles..... \$12.50 Krag Sporting Rifles.. \$14.00
Sprgfd. 45 Shot Guns 4.50 Sprgfd. 45 Carbines... 3.50

and other arms. SEND 10c FOR NEW CATALOG.
W. STOKES KIRK, 1627-PM, North 10th St., Phila., Pa.

\$15

BE YOUR OWN FIXER WITH SMOOTH-ON No. 1

—and save your repair money for bigger things

Cracked heating boilers, radiators, water pipes, tanks, leaky ovens, furnaces, stove pipes, loose handles, leaky automobile radiators, hose connections, gas tanks, cracked water jackets and gear cases, loose nuts, grease

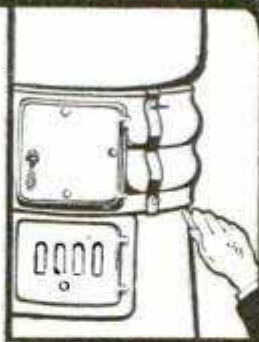

cups and hub caps are usually a snap to repair with Smooth-On No. 1—and with a saving of anywhere from 25c to \$25 each time.

Get a 7-oz., 1-lb. or 5 lb. can of Smooth-On (from any live supply store) and you'll find that for the few cents spent, you'll save many dollars.



Write for
FREE BOOK

The repair booklet which we send free if you mention this magazine, will help you to get good results.

SMOOTH-ON MFG. CO., Dept. 37
574 Communipaw Ave., Jersey City, N. J.

FARAWAY RADIO



\$63⁵⁰

Gets Stations Far and Near, Loud and Clear
FARAWAY RAD O
AGAIN to the FRONT

Amazing new set at an exceptional price. Most advanced set on the market today—designed exclusively for the new tubes. Use 8 get stations from New York to Frisco—loud and clear. Operate with either dry cell or storage battery. **SATISFACT ON GUARANTEED.** Don't pay \$100 to \$150. Write for our money-saving plan and literature.

2-Tube Set—\$22.50 5-Tube Set—\$63.50

Dealers: Biggest possibilities you ever heard of. Write for plan and territory quickly.

The Faraway Radio Co., Dept. T2, 125-27 E. 3rd St., Cincinnati, O.

CORONA FOUR

With standard office keyboard—an office typewriter in portable form.

Write for literature

Corona Typewriter Co., Inc.
112 Main St. Groton, N. Y.



try this on your coldest radiator



AIRID Air Valves make cold radiators hot. Attach easily to any steam radiator without tools—need no adjusting—never leak—make no noise. Sold at heating and plumbing stores. Only \$1.60.

AIRID AIR VALVES make cold radiators HOT

AMERICAN RADIATOR COMPANY

1812 Elmwood Ave., Buffalo, N. Y.
Send me a trial Airid (one only). Guaranteed 5 years. (This will be mailed C. O. D., or enclose check or money order for \$1.60.)

Name

Address

SALESMEN WANTED To Sell Catholic Art Calendar For 1927 Full or part time Big Profits

One of our salesmen made \$3900.00 in ten months. Do not overlook this opportunity.

Be convinced. Write for special proposition.

EXTENSION PRESS CALENDAR DEPARTMENT, Dept. C, 25 E. Lake St., Chicago, Ill.

\$150 to \$300 PROFIT MONTHLY FROM HB ONE DAY BATTERY CHARGING

Over 12,000 shops are making great big profits every month from One Day Battery Charging. Every car needs One Day Battery service—why not have this money making business coming to you? Only \$35 cash puts an HB One Day Charging outfit in your shop, complete ready to operate. Easy terms on balance, quickly paid by you. Increased earnings. No experience needed, outfit runs itself. 30 days' free trial in your shop on absolute moneyback guarantee. Prove for yourself in your shop at our risk that HB One Day Charging will pay you \$150 to \$300 monthly. Write for free Bulletin 28.

HOBART BROS. CO. Box M-1 TROY, OHIO

MAKE YOURS THE BUSY SHOP WITH HB ONE DAY BATTERY CHARGING

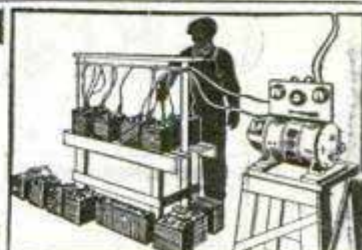

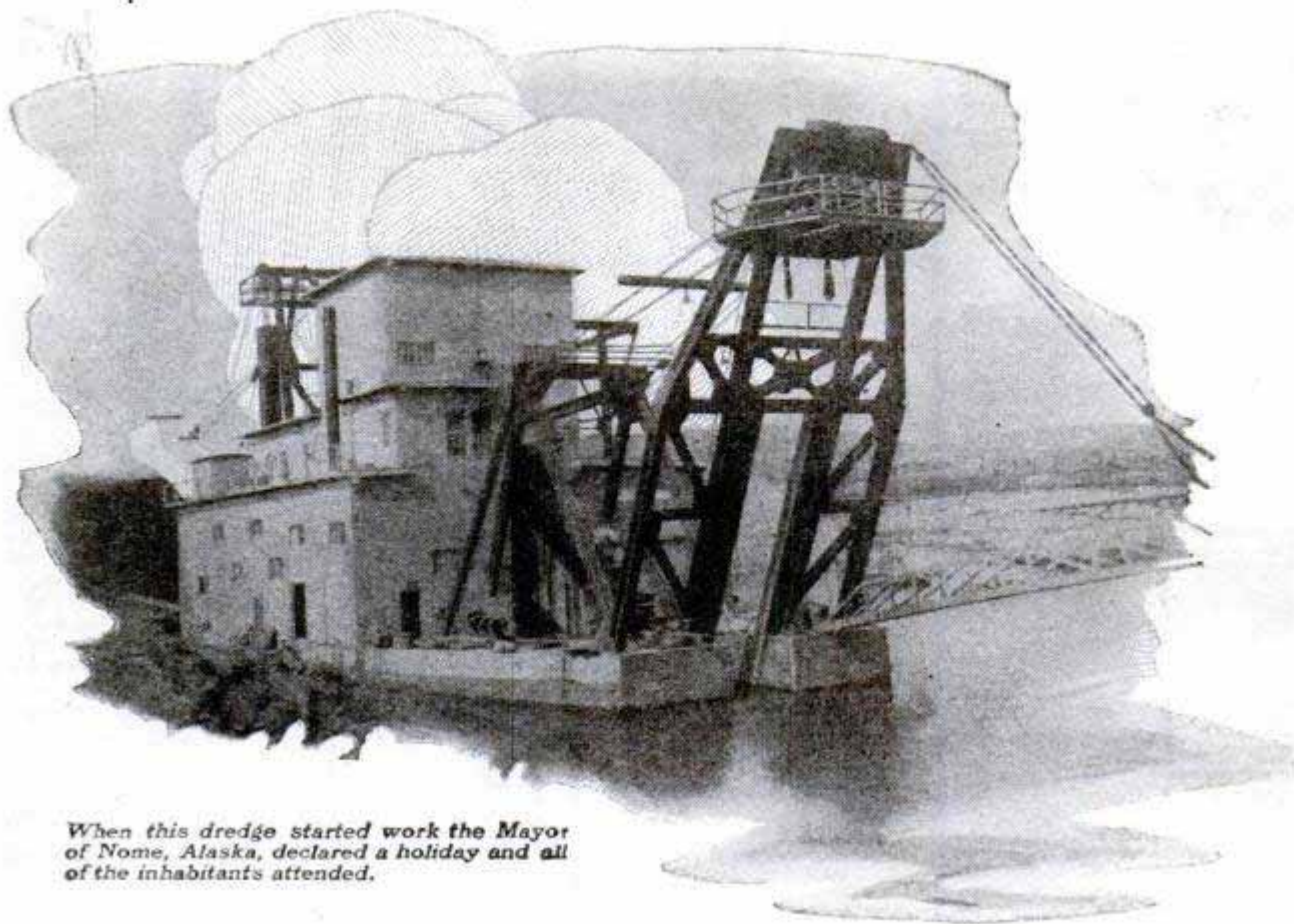

When this dredge started work the Mayor of Nome, Alaska, declared a holiday and all of the inhabitants attended.

The "Forty-Niner" of '26



General Electric supplied all electrical equipment for two such dredges now operating at Nome. A Diesel-electric power plant, four miles distant, furnishes the energy for a total of 592 h.p. in electric motors for each dredge. To cope with winter conditions G-E cable was chosen to carry the power to the dredges.

Massive electric dredges now mine Alaskan gold. At almost incredible temperatures they dig 60 feet deep and scoop out 200,000 cubic yards a month. From the Arctic regions to the Equator, G-E equipment is called upon to perform many hard tasks once done by hand but now better done by electricity.

GENERALELECTRIC

Select FROST-RADIO Parts and Accessories for Your Popular Mechanics' Circuit

Sold by the best dealers everywhere

WHEN you go to your dealer's to select parts for your Popular Mechanics' Circuit, be sure that you obtain genuine **FROST-RADIO** apparatus wherever specified. You will then be certain to get the maximum efficiency and best possible results from this wonderful circuit.

Every Part Guaranteed

FROST-RADIO parts and accessories are guaranteed by the name of the manufacturer. You must receive full value in quality and service for the price paid, otherwise your dealer is authorized to refund your money. **FROST-RADIO** Apparatus is built up to a high standard of quality and not down to a price, yet it is the most fairly priced line on the market today.

Prices slightly higher on Pacific Coast.

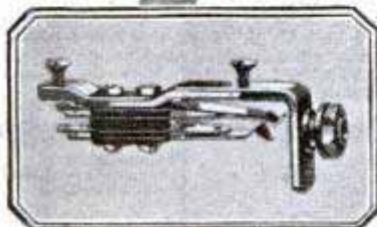

FROST-RADIO
Pan-Tab Jacks:
65c to 90c

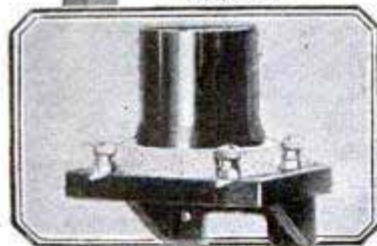

FROST-RADIO
Bakelite Cushion
Sockets: \$1.25

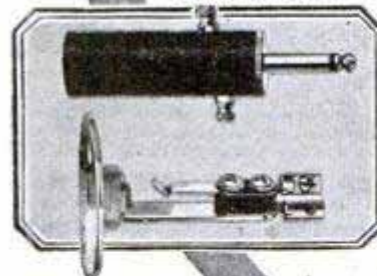

FROST-RADIO
Loop Plug and
Jack: \$1.50.

48-page Book
Free on Request

We want every reader of Popular Mechanics to send for this FREE catalog of **FROST-RADIO**, describing and illustrating our complete line. See your dealer for the merchandise, but write us for the catalog. Address Dept. 14F438.

HERBERT H. FROST, Inc.

314-324 W. Superior St., Chicago
New York Cleveland
Kansas City Los Angeles
Export Office:
314 W. Superior Street, Chicago

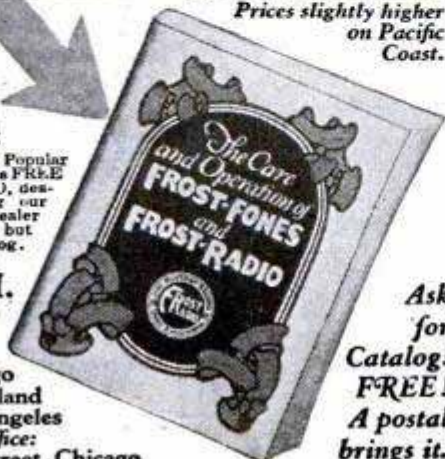

Ask for Catalog! **FREE!** A postal brings it.

OLD MONEY WANTED

We Paid \$200 to J. D. Martin of Virginia FOR JUST ONE COPPER CENT

"Please accept my thanks for your check for \$200.00 in payment for the copper cent I sent you. I appreciate the interest you have given this transaction. It is a pleasure to do business with a firm that handles matters as you do.—**JULIAN D. MARTIN**, Virginia

Post yourself! It Pays! We paid Mr. Manning New York \$2500 for a single silver dollar, Mrs. G. F. Adams, \$740 for some old coins. W. F. Wilharm, Pennsylvania, \$13,500 for his rare coins. In the last 20 years we have paid hundreds of others handsome premiums.

All Kinds of Old Coins, Medals, Bills and Stamps Wanted

\$1.00 to \$1,000 paid for certain old cents, nickels, dimes, quarters, etc. Right now we'll pay \$50 for 1913 Liberty Head nickels (not Buffalo) \$100 for 1894 dimes, "S" Mint. \$8.00 for 1853 quarters, no arrows. \$10 for 1866 quarters, no motto. \$200 each for 1884 and 1885 Silver Trade Dollars. 10 cents each for 1912 "S" Mint nickels, etc.

Big Cash Premiums for Hundreds of Coins Now Circulating

There are literally thousands of old coins and bills that we want at once and for which we will pay big cash premiums. Many of these coins are now passing from hand to hand in circulation. Today or tomorrow a valuable coin may come into your possession. Watch Your Change. Know what to look for.

You'll Open Your Eyes When You Read Our Big Illustrated Coin Folder Send 4 cents. We will send at once our highly illustrated and interesting Coin Folder. WRITE TODAY for this eye-opening, valuable wealth of information on profits that have been made from old money. No obligation on your part. You have nothing to lose—everything to gain



Send this COUPON NOW

Numismatic Company of Texas, Dept. 220, Fort Worth, Texas

Please send me your large Illustrated Coin Folder for which I enclose 4 cents.

Name

Address

City.....State.....



Nestler Process is simplicity itself as demonstrated by the inventor, Emil Nestler, rubber expert and engineer. One step of 7 which comprise process here shown.

New Tires from Old

Amazing New Patented Process Fuses or Welds New, Tough, Durable Rubber Tread onto Worn Tires

CONCEIVE that of all methods present or past, the Nestler Rubber Fusing Process alone produces a positive joint such as by fusing or welding between new and old rubber! The first and only practical and successful method of re-rubbing a tread worn tire is here at last—a simple, fast, inexpensive process that makes tires new again and cuts tire costs in half.

Think of the opportunity for this service right in your community! Right now the opportunity is exceptional on account of present tire costs. And all indications point to still higher prices for years to come due to an impending rubber famine. The result is a tremendously increased demand for Nestler Service.

Each year since 1917 thousands of worn tires have been successfully Nestlerized by ourselves and those licensed by us under the basic Nestler Patent. We are now prepared to issue to men who qualify, a limited number of additional licenses. License rights will include protected territories and full cooperation from this company. Previous experience is unnecessary since licensees will receive thorough training without charge. We have demonstrated that any person of average intelligence can learn to operate the Nestler Process and the simplified Nestler Equipment in a few weeks' time. Investment for necessary Equipment only from about \$1000 upward, depending on production required for territory. Terms may be arranged.

The 34 million tires worn out annually, constitute a limitless opportunity for business and profit. With aggressiveness and the application of sound business methods, a Nestler Rubber Fusing Station yielding \$10,000, to \$20,000, or more yearly profits can easily be created.

The Nestler Plan tells how it can be done. It gives facts and figures in addition to a full description of the Nestler Rubber Fusing Process, Nestler Equipment and the way they work together. Choice territories are now going fast. If the bare outline of this proposition as given above is interesting to you, you are urged to write without delay.

Nestler Rubber Fusing Co., Inc.
Dept. DP—245 W. 55th Street
New York, N. Y.

It's Fun to Make Things

Let the other boys wonder how you can make so many interesting things. Make your own motor sled. Make your own radio. Make your own skis and snowshoes. You can learn how to make almost anything that any boy could want by following the pictures and the simple directions in

The Boy Mechanic Library

And just think of it, there are nearly 4,000 separate articles in the four beautiful volumes! Some of the most fascinating subjects are listed below.

How to Make Things

- | | |
|-------------------|-----------------------|
| Boats | China painting |
| Winter sports | Decorative metal work |
| Camping | Furniture making |
| Ice boats | Farming |
| Water sports | Poultry |
| Toboggans | Models |
| Tents | Laboratory helps |
| Skis | Household helps |
| Indian snowshoes | Wood working |
| Skating | Electrical devices |
| Gymnasium | Photography |
| Wind wagons | Music |
| Motor sleds | Outdoor games |
| Radio | Stoves |
| Magic | Furnaces |
| Trapping | Wireless |
| Pets | Tricks |
| Leather work | Puzzles |
| Carpentry | Circle |
| Painting | Flowers |
| Toys | Hunting |
| Fishing | Kites |
| Fruit growing | Metal working tools |
| Entertainments | Secret locks |
| Automobile | Swings |
| House decorations | Seats |
| Drafting | Power devices |

Learn how to make things to sell. Learn how to make things to enjoy yourself. Buy the complete library, including Book 1, Book 2, Book 3 and Book 4.

Send No Money

Simply sign your name and address to the attached coupon and mail it at once. When the postman delivers the books to your door, pay him the price of the books and the few cents postage. That is all.

POPULAR MECHANICS PRESS
Popular Mechanics Building
Room 1777 CHICAGO, ILL.

Mail the Coupon Today!

POPULAR MECHANICS PRESS
Popular Mechanics Building
Room 1777, Chicago, Ill.

Please send me at once C. O. D. The Boy Mechanic Library comprising Book 1; Book 2, Book 3, and Book 4. I will pay postman \$7 and the few cents postage.

Name

City.....

State.....

St. No. or R. F. D.

If you want individual books at \$2 each, check the numbers of the books you want: 1 2 3 4

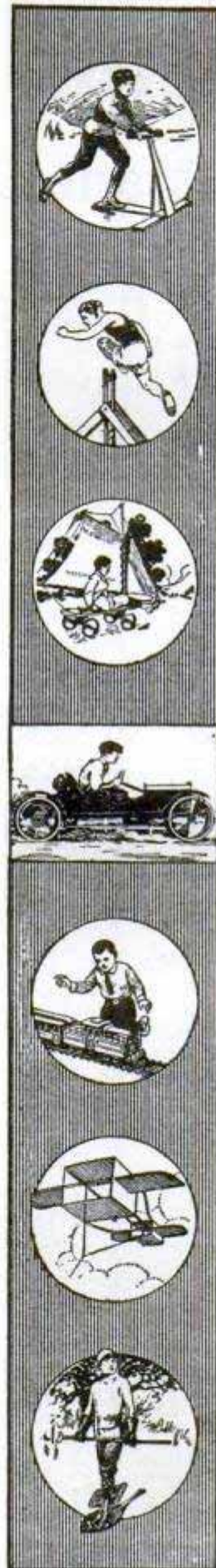



Tested Parts

All parts offered in our catalog including those combined in knock-down KITS have been carefully tested and approved by our graduate Radio Engineers. Satisfactory results are guaranteed.



Panels for Kits

A completely drilled and engraved panel is included with each of our kits. Makes set building easy and sure. No other concern gives this FREE service.

Just Out!

Our Latest 1926

FREE RADIO CATALOG

BEFORE you build be sure to consult our latest 100 page radio catalog. A dependable guide for set-builders. Knock-down sets and kits for all the latest circuits. No finer or more complete assortment to be found anywhere. Latest designed parts—Acme, All-American, Bremer-Tully, Carter, Freshman, Frost, General Instrument, Walbert, etc. And the prices — *every one quoted means a big saving for you!*

Write for your FREE copy today!



Blueprints

Complete BLUE-PRINTS and easy-to-understand INSTRUCTION BOOK included with each of our KITS. No technical knowledge required to build your own set.

Save Money

Our enormous buying power permits us to pay spot cash and get rock-bottom prices. Be sure to see our catalog before you buy — save money. Write for your free copy today.

CHICAGO SALVAGE

509 South State Street

Dept. P M 6

STOCK STORES

CHICAGO, U. S. A.

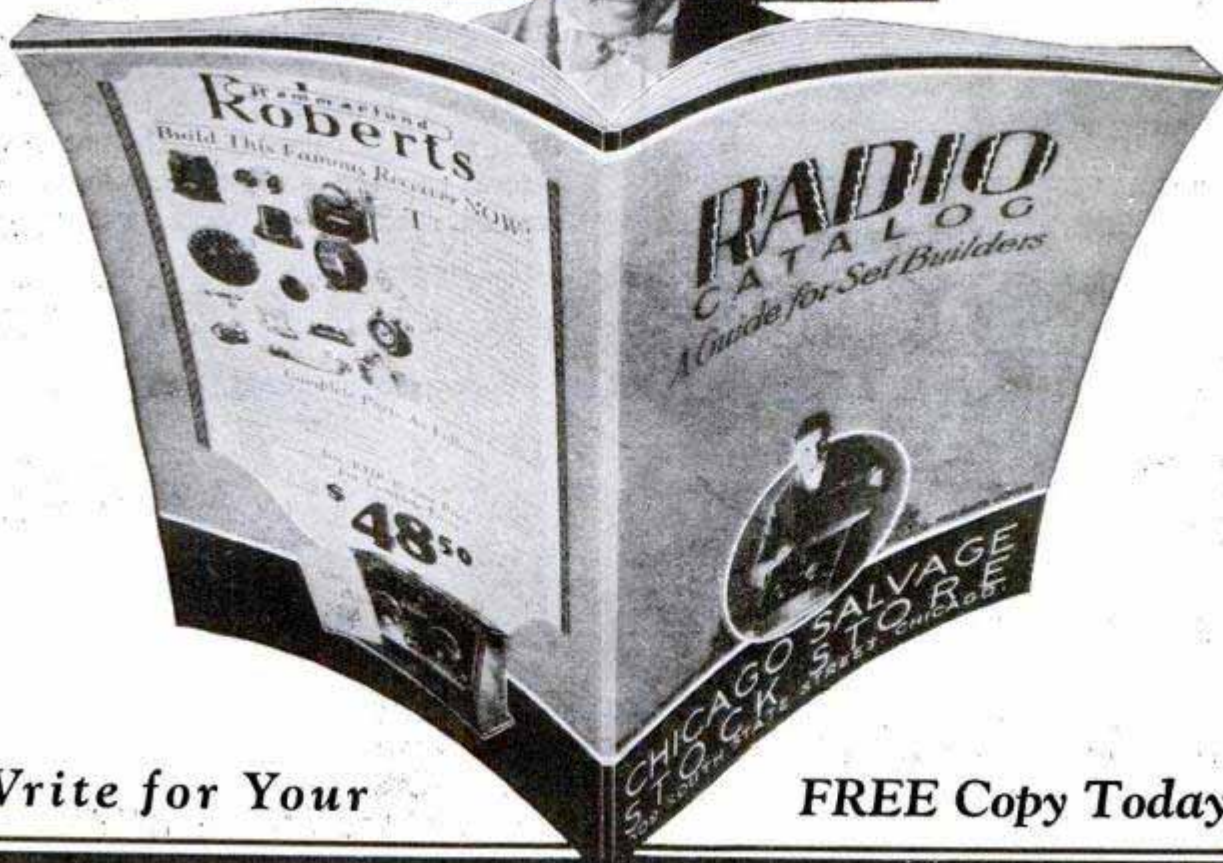

Write for Your

FREE Copy Today!



*Adjusted to Temperature
Adjusted to Isochronism
Adjusted to Positions
Adjusted to the Second
21 Ruby and Sapphire Jewels*



WONDERFUL QUALITY AND STYLE

Whether you want a lady's watch so small and dainty it becomes a piece of jewelry, or whether you want a watch made strong, sturdy and dust-proof for

miners, loggers and cement mill workers, you will find it in the new Burlington catalogue—and at a remarkably low price, considering QUALITY.

21 JEWEL BURLINGTON

Yes, every Burlington watch for men has 21 jewels. The Burlington quality is exactly the same in the heavy service watch as it is in the very thin aristocratic model. Superior quality distinguishes the Burlington. We are proud of this distinction. Every owner is equally proud of it.

Burlington Watch Co. Dept. 13-51
19th and Marshall Blvd., Chicago, Ill.
Canada: 62 Albert St., Winnipeg

Please send me your new watch catalogue and prices, also your special \$1.00 down offer.

Name

Address

SPECIAL OFFER

Burlington quality has made it possible for us to sell you a high-grade watch for \$1.00 down and the balance in small monthly payments. Do not buy before you see our new catalog and read our special offer. Write for it today.



FORDS START INSTANTLY IN A CLASS BY ITSELF.

A WONDERFUL INVENTION

AT ZERO

NO MORE STARTING TROUBLE
MOTOR RUNS BETTER
SAVES BATTERY & STARTER
AMAZING PICK-UP
MORE POWER
MORE MILES

Millions of Ford owners need this marvelous device—the results are amazing. Just think—more power—more miles—and most important, the Instant Starting Feature in any weather—Any one of these is important but when such a wonderful device accomplishes them all it really is sensational—The Super acts as a positive automatic primer. The first turn-over of the motor—“off she goes”—acts independent of the driver—nothing to push—nothing to pull—wonderful in its effect on the motor while running—eliminates carbon—phenomenal power going up hills—saves half the gasoline—users say it doubles the mileage—some claim as high as 60 miles on a gallon—others say 45 and 50 miles on a gallon.

Good News for Ford Owners

READ WHAT THESE USERS SAY

DOES ALL WE CLAIM
Received your Super. It certainly has lived up to your claims not only in mileage but in starting and pepping up the motor.
JAMES FARRELL, Conn.

SAYS IT'S WONDERFUL
I was very much surprised how quick the Super starts the motor and how saving they are in gasoline and on the battery and starter, it's wonderful.
J. COOPER, Ind.

SOLD 4 IN 30 MINUTES
I was out this morning and took orders for 4 in about thirty minutes.
ALEXANDER CULVER, R. I.

54 MILES ON A GALLON
Received the Super Saturday, attached it and emptied my gas tank. I then put in one gallon of gas and to my surprise rode 54 miles before the tank went dry.
ED. RANDERSON, Wis.

SELLS ITSELF
Please ship this order of Supers at once as I am all out and parties are waiting for them, they sell like hot cakes, don't need to do much talking, they sell themselves.
W. S. SHEPPERD, Ill.

SOLD 12 IN 2 HOURS
I was out two hours today and sold 12 Supers.
ARTHUR SEVERSON, No. Dak.

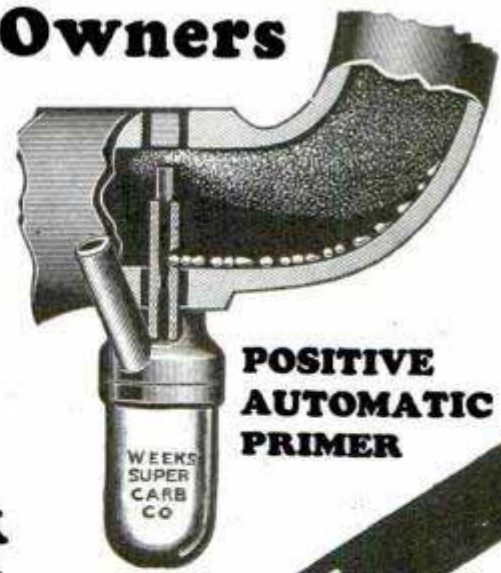

POSITIVE AUTOMATIC PRIMER

\$60⁰⁰ to \$150⁰⁰ per Week

No matter what you may have sold before or whether or not you ever sold anything before—here is the chance of a life time—no previous selling experience is necessary—in fact it isn't necessary that you own a Ford—your future lies in your desire to sell—because the Super will sell itself if you give it the opportunity.

AGENTS WANTED EVERYWHERE

The Super takes hold in a locality like wild fire—therefore we want distributors everywhere to take orders and deliver and to look after the repeat business that is bound to follow—A Trial of the Super convinces the most doubtful person—Be the first in your locality.

Weeks Super Carburetor Co.
426-1610 Eleventh Street,
MILWAUKEE, WIS.

MAIL TODAY
WEEKS SUPER CARBURETOR COMPANY,
426-1610 Eleventh St., Milwaukee, Wis.
Gentlemen:—Kindly mail me full free information about your wonderful invention.
Name
St. or R. F. D.
Town
County
State

Be Your Own Boss

If you're tired of working for someone else—here's your opportunity to get into business for yourself. Be the Johnson Floor Expert in your community. We'll help you get started.

Earn \$15 to \$25 a Day

There's a bigger demand every day for floor maintenance service in homes, business and professional offices, stores, schools, clubs, hotels and public buildings. In just a short time you can have a business of your own that will pay you \$15 to \$25 a day. And all you need to start is a

JOHNSON'S WAX *Electric floor Polisher*

It's the machine that insures success, independence—a business of your own. Light and easy to operate. Runs from any light socket. Simple and sturdy in construction. Nothing to get out of order. Polishes floors ten times faster and better than any other method. Gets under davenport, buffets, beds, desks and other low pieces without moving the furniture.

Investment Less Than \$50

Think of it! For less than \$50 you can have a profitable business of your own, with a high-class clientele. No more lay-offs. No more dull seasons. You'll be giving orders instead of taking them. You'll be a recognized successful business man. Mail coupon today for full information on the Johnson Floor Service Plan.

Don't Delay—Act Now

Don't put off mailing this coupon. It will mean the comforts and luxuries of life. A bank account. A home of your own. Safe years ahead.

Fill
Out
and
Mail This
Coupon

S. C. JOHNSON & SON
Dept. P. A. 1, Racine, Wis.
"The Floor Finishing Authorities"
Please tell me how I can earn \$15 to \$25 a day giving Johnson Floor Service.

NAME.....

ADDRESS.....

CITY..... STATE.....

Send for this RADIO BOOK FREE

64 illustrated pages contain-
ing thousands of bargains in ra-
dio sets, semi-finished sets and radio kits
of all styles, sizes and approved circuits.
5-tube sets as low as \$29.50. Beautiful
models of the very latest designs and types.
Elaborate console models with loud speakers built right in
cabinets of genuine mahogany and walnut. All sets guaranteed.
Coast to coast receiving range. Also contains everything in radio
supplies, including batteries, chargers, loud speakers, transformers, con-
densers, rheostats and any other parts you may want for improving your
set or building a new one. Guaranteed saving to you of $\frac{1}{3}$ to $\frac{1}{2}$.



1926 Catalog of RADIO BARGAINS Save $\frac{1}{3}$ to $\frac{1}{2}$

AMERICAN RADYNOLA 5 TUBE SET

\$29.50
FOR SET ONLY



The Biggest 5-Tube Value on the Market

Positively the world's greatest 5-tube radio bargain. Reg-
ular \$75.00 value. Our large quantity production enables us
to sell this set for only \$29.50, fully built and wired in beau-
tiful mahogany cabinet of latest design with sloping Bakelite
panel of Satin finish, handsomely etched and engraved as ill-
ustrated. Constructed of the finest low-loss condensers,
coils and sockets. Bakelite baseboard panel and **\$29.50**
dials. Price for set only
Transportation charges extra. Shipping wt. 25 lbs.

This set with all accessories, including the famous
American Bell loud speaker with adjustable unit, 2-45 volt
"B" batteries, one guaranteed 100 Ampere Hour, storage "A"
battery, cable for battery connection, 5-201 A tubes, aerial
and ground equipment and everything complete
ready to set up and operate. Nothing else to buy. Price **\$59.75**
Transportation charges extra. Shipping wt. 100 lbs.

ORDER FROM THIS PAGE—SAVE ABOUT ONE-HALF

Columbia Grand 5-Tube Console Set



\$57.95

Beautiful Walnut Cabinet in
two-toned effect. Two door
panels inlaid with highest grade
burled walnut. Cabinet is 38
inches high. Top measures
19x37 inches. Equipped with
high-grade built-in loud
speaker with adjustable unit.
Large roomy interior for hold-
ing all batteries, books, etc.
5-tube tuned radio frequency
receiver. Coast to coast. Very
selective. Has latest type, low-
loss condensers, coils and
sockets. Bakelite baseboard,
sockets and dial knobs. Dials
beautifully etched in gold on
walnut finish bakelite panel.
Price for set only, fully built
and wired—\$57.95.
Transportation charges extra.
Shipped by freight or express.

This set with all accessories, which includes 2-45 volt "B" batteries, one guar-
anteed 100 ampere hour storage "A" battery, 5-201A tubes, multicolored cord
for easy battery connection, aerial and ground equipment, instructions for setting
up and operating—everything complete, nothing else to buy. **\$84.95**
Transportation charges extra. Shipped by freight or express.

SEMI-FINISHED 8-TUBE SUPER-HETERODYNE



\$43.75

World's Fam-
ous 8-tube
super-Hetero-
dyne. Fully
mounted on
panel and base-
board. Comes
completely assembled ready to wire and
operate. We have testimonials from thou-
sands of builders of this set. Some have
received foreign stations on loop aerial. Un-
surpassed in volume and tone quality. Low-
loss straight line frequency condensers, ver-
nier dials, finest quality rheostats. Matched
Columbia long wave transformers. Re-
quires only three screws for attaching panel
and baseboard and set is ready to operate.
7x30 panel. Price of set only **\$43.75**

Requires following accessories to complete
this set: 7x30 cabinet, 8-201 A tubes for
storage battery operation or No. 199 tubes for dry
cell operation, 100 Ampere hour storage battery,
2-45V "B" batteries, loud speaker, center tapped
loop aerial. All these items are listed in our catalog
at a tremendous saving.

Complete Parts for
Best 45 Kilocycle
Super-Heterodyne
Genuine Remler Parts

\$49.50

Complete Parts for
Genuine Popular
Mechanics 8 Tube Super-
Heterodyne

\$89.50

Semi-Finished 5-Tube Radio Frequency Set



\$18.75

This special offer is astound-
ing the radio world. Coast to
coast reception on loud
speaker. Low loss condensers
and sockets. Highest quality
transformers. Bakelite rheo-
stats. All wiring completed
under Bakelite baseboard. 7x18
panel—fits into any stand-

ard 7x18 cabinet. Complete instructions for operation. Guaranteed saving to you of
\$50.00. Price of set all mounted, **\$18.75**. Cabinet of same model as American
Radynola pictured above \$5.85 extra.

You must have our catalog no matter what set or kit you want. Our
line is complete and includes all popular sets, such as Super-Heterodyne,
Neurodyne, Ultradyn, Reinartz, Regenerative, Radio Frequency,
Browning-Drake, Super-Heterodyne Reflex and all other latest cir-
cuits. Kits, sets and parts manufactured by all well known manufac-
turers such as Frost, Howard, Baldwin, Brandes, Western Electric,
Columbia and others.

Our semi-finished sets come with all parts mounted on panel and
baseboard ready for wiring. Do not fail to send for our catalog. Remem-
ber—we are the largest exclusive radio mail order dealers in the world
and carry the best of everything in radio. We save you $\frac{1}{3}$ to $\frac{1}{2}$ on
the following kits. Detailed descriptions appear in our catalog.

Catalog includes
list of broadcast-
ing stations,
general radio in-
formation and
facts about our
free service divi-
sion. Write for it
today.

NEURODYNE
Genuine licensed Neurodyne
kit of parts, come fully assembled
on the panel and baseboard with
complete instructions, **\$29.75**
ready to wire. Price.

COCKADAY
3-tube Cockaday kit of
parts, fully assembled on
panel and baseboard,
ready to wire. **\$15.85**
Price.

**FOUR TUBE BROWNING-
DRAKE and also PRESS-
LEY and REMLER SUPER-
HETERODYNE**
At Bargain Prices.

HARKNESS
2-tube reflex kit of parts,
fully assembled on panel and
baseboard, ready to wire.
Complete in-
structions. Price. **\$16.95**

RANDOLPH RADIO CORPORATION
159 N. Union Ave. Dept. 228 Chicago, Illinois