

OCTOBER

Loops, and How to Use Them

N.S.E.
25 CENTS

POPULAR MECHANICS

MAGAZINE

WRITTEN SO YOU CAN UNDERSTAND IT

REG. TRADE MARK GREAT BRITAIN No. 410428

REG. U. S. PAT. OFF.



SEE PAGE 542

Livingston

Right in your hand!



Opportunity-Independence-Money

A McSweeney trained man can go anywhere and make big money—the practical experience that the McSweeney Graduate Shops give you—no one can take away from you. The training is a key to success anywhere—because McSweeney trained men are in demand anywhere there are automobiles—and automobiles are everywhere.

YOU, TOO, CAN MAKE BIG MONEY

Down in Tennessee, Walter Creekmore makes as high as \$20.00 a day. Fred Pendley was made chief mechanic in a Tennessee shop working on Packards and Cadillacs. George Smith is making \$800.00 a month in Ohio.



J. H. McSweeney,
President,
Dept. 143
McSweeney Auto-
motive and Electrical
Training Shops,
1815 E. 24th St.,
CLEVELAND, O.
8th and Walnut Sts.,
CINCINNATI, O.
517-521 South Luffin St.,
CHICAGO, ILL.

Dear Mac: Send me full details of your SPECIAL tuition offer and your FREE 65-page book.

Name.....
Address.....

SPECIAL
Tuition offer
includes Board
and Railroad
fare.

MAIL THIS
COUPON
for my
FREE BOOK
"Mac"

TWO MONTHS' TRAINING

A little thing to do—A big thing to accomplish

The McSweeney Graduate Shops give you an experience in two short months, that would be difficult for you to get in a lifetime, merely working some place.

The McSweeney system is not a course in book study, but a period of intensive but easy training. It is an actual experience in the McSweeney shops, where equipment is modern and complete with automobiles, trucks, tractors and stationary engines.

SEND FOR FREE BOOK

All the information, all the detail, of the McSweeney training plan, is contained in a handsome illustrated book, that is yours for the asking. It tells how McSweeney-trained men are earning big money. A few minutes now, while you think of it, and a 2c stamp will bring to you, this interesting story, and show you how you can travel anywhere, make big money, and be independent.

If you have the desire to succeed—if you have the slightest ambition—you can not afford not to investigate McSweeney methods. Don't put it off. Follow your impulse and send in this coupon right away. Give McSweeney the chance to lay this key to bigger things right in the palm of your hand.

M'SWEENEY AUTO
and TRACTOR
GRADUATE SHOPS

Cincinnati . . . Chicago
Cleveland

Write the nearest one



It's a *genuine* UV-201-A
only when it bears
the name Radiotron
and the RCA mark

WD-11, WD-12, UV-199, UV-200, and UV-201-A are the type names of Radiotrons. They belong to Radiotrons only. To be sure you are buying the genuine, look for the name Radiotron and the RCA mark on the base. Then you are sure of quality.

Radio Corporation of America

Chicago

New York

San Francisco



Radiotron

REG. U.S. PAT. OFF.

AN RCA PRODUCT



LUDO-Z2Y-X1HK

Balkite

Radio Power Units

the ideal power supply for any radio set

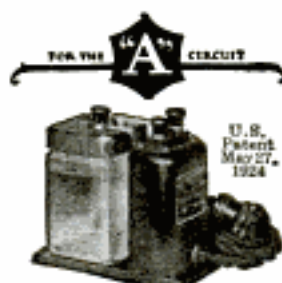

Balkite
Trickle Charger

Charges both 4 and 6 volt Radio "A" batteries. Will furnish more current than is used by 6 dry cell or 2 storage battery tubes, if used only while the set is in operation. If allowed to "trickle" charge continuously will also furnish enough current for 8 storage battery tubes. Size 5 1/2 in. long, 2 1/4 in. wide, 5 in. high. Operates from 110-120 AC 60 cycle current.

Manufacturers are offering switches which turn on Balkite "B" and turn off the charger when you turn on your set. This makes the current supply for both circuits automatic.

Price \$10
West of Rockies, \$10.50
In Canada, \$15



Balkite
Battery Charger

The most popular battery charger on the market. It can be used while the radio set is in operation. Charging rate 2.5 amperes. Operates from 110-120 AC 60 cycle current. Special model for 50 cycles.

Price \$19.50
West of Rockies, \$20
In Canada, \$27.50

Balkite Radio Power Units are the ideal power supply for any radio set. They simplify and improve radio reception. They reduce the amount of attention you must give your set. With their use your current supply is always exactly what is required for each circuit.

For the "A" circuit there are the Balkite Chargers. Because of its obvious advantages the Balkite Battery Charger is the most popular charger on the market.

For sets of smaller "A" current requirements there is the Balkite Trickle Charger. With a low capacity storage battery it enables owners of sets now using dry cells to make a most economical installation.

For the "B" circuit there is Balkite "B." It eliminates "B" batteries entirely and supplies plate current from the light socket. It fits any set of 5 tubes or less. For sets of six tubes or more there is Balkite "B" II.

Noiseless—No bulbs—Permanent

All Balkite Radio Power Units are entirely noiseless in operation. They have no moving parts, no bulbs, and nothing to adjust, break or get out of order. Each is a permanent piece of equipment with nothing to wear out or replace. They require no other attention than the infrequent addition of water. They require no changes or additions to your set.

Manufactured by
FANSTEEL PRODUCTS COMPANY, Inc.
North Chicago, Illinois

FANSTEEL
Balkite
Radio Power Units



Balkite "B"

Eliminates "B" batteries. Supplies plate current from the light socket. Operates with either storage battery or dry cell tubes. Keeps "B" circuit always operating at maximum efficiency. Requires no attention other than adding water about once a year.

Will serve any set of 5 tubes or less. Occupies about same space as 45 volt dry "B" battery. Operates from 110-120 AC 60 cycle current.

Price \$35
In Canada, \$49.50



Balkite "B" II

Same as the new Balkite "B" but will fit any set including those of 10 tubes or more. Operates from 110-120 AC 60 cycle current. Special model for 50 cycles.

Price \$55
In Canada, \$75

The Gould Unipower is equipped with a special Balkite Radio Power Unit

Popular Mechanics Magazine

200 E. Ontario Street, Chicago, U. S. A.

H. H. WINDSOR, Founder

H. H. WINDSOR, Jr., Editor and Publisher

London: Hachette & Co.,
15-17 King William Street, Charing Cross, W. C. 2

Paris: Hachette & Co.,
111 Rue Reaumur

Melbourne: Gordon & Gotch
509-513 Little Collins St.

ISSUED MONTHLY

SUBSCRIPTION:

SINGLE COPY, 25 CENTS

In United States and its possessions, also Canada, Cuba, and Mexico, per year, postpaid . . . \$2.50

To all other countries in the Postal Union . . . 3.00

All subscriptions are discontinued at expiration. Please examine the date printed on your wrapper.

Entered as Second Class Matter Sept. 15, 1903, at the Post Office at Chicago, Illinois, under Act of March 3rd, 1879.

Entered as Second Class Matter at the Post Office Department, Canada.

Published monthly by POPULAR MECHANICS CO.

Copyright, 1925, by Popular Mechanics Co.

Copyright in America. Copyright in France

Vol. 44

Contents for October, 1925

No. 4

Accidents—most dangerous ages	564	Gardens Tools and Appliances—lawn edging tool	640
Africa—with pygmy cannibals in the Congo	575	Gas Masks— for ^{for} army animals	647
Agriculture—triple farm labor capacity with machines	625	Germicides—antiseptic fluid kills germs	607
Airplanes		Ghosts—haunted houses often mean loose water pipes	576
auto as starter for planes	625	Glass	
ten-ton plane for long sea trips	555	hand cutter for glass tubes	573
Art—gallery modeled in sand	637	romance of	619
Athletics—walking race on treadmills	629	Gold—detachable club grip	642
Automobile Driving		Granary—concrete corncrib	624
higher speeds on good roads urged	574	Hail—stories of big hailstones supported by records	552
women motor drivers equal men	554	Hair—electric drier for the hair	607
Automobile Touring—free shade for motorists	541	Hammer—changed to hatchet	586
Automobiles—horn code signals	564	Handicraft—art and utility combined in	592
Automobiles—Equipment and Supplies		Hawaii—to form a continent	646
camp outfit combines four articles in one	628	Heating Plants	
car seat made into table	586	air heater on furnace grate	376
door silencer protects windows	572	does your fireplace smoke?	643
fan-shaped glare protector	561	Horses	
home comforts in auto bed	609	cow ponies killed to save food for sheep	617
steering post registry card	634	snow-white, rare	591
Automobiles—Fuel—magnet fuel pump	624	Household Devices	638
Automobiles—Lighting—removable dash lamp	647	Houses—how to lower your building cost	703
Biology		Insects—fighting	567
weight lost in sleep shown by scale	532	Insulation (Electricity)—insulators bigger than a man	544
world's most wonderful power plant <i>heart</i>	635	Jewelry—of rubber, latest fad	647
Birds		Lakes—greatest artificial lake	609
as weather prophets	600	Lead—process for tempering	561
world's bird population	630	Life Saving Apparatus—sunburn collar and buoy com- bined	648
Botany—some plants work overtime under light	582	Light	
Bottle Openers—rubber-lined bottle cork	607	portable light meter	565
Box—five years old as packing case	629	weighing a sunbeam	555
Bridges		Locomotive—high pressure, has greater power	542
models for engineers	566	Lumber and Lumbering—900-foot log rafts	533
toll bridge to cross Florida bay	512	Man—trail of prehistoric man found in rocks	539
Butter—made from tallow	512	Manual Training—where students are paid for going to school	545
Cabinet—made by Coolidge	554	Maps	
Cameras—movie camera cranked by motor	630	dashboard map on roller used with one hand	641
Cancer—germ seen through camera	529	world map of aluminum	553
Carts—dog team taxi for children	610	Merry-Go-Round—and swing combined	576
Caves—Whipple cave in Nevada	541	Models	
Clips—fastened to shoe tops keep rubbers on	628	from wax models to giant liners	556
Clock—on auto radiator visible in dark	542	show navy's growth	504
Clothes Line—tightener for	533	Morocco—desert tribesmen discount science of modern warfare	562
Compressed Air—hot air as a polisher	634	Mountain Climbing—trip to top of Mt. Logan	640
Concrete—wire roller for	609	Music—marble music shrine	600
Cowboys—gaining in number	641	Musical Instruments—queer harps made to answer need of modern music	636
Crime—armored bank teller's cages to foil bandits	574	Occupations—how folks earn their living	647
Distance—timing echo from plane to estimate height	602	Oysters—hatching, in incubators	631
Dogs		Palestine—lost bible city of Capernaum uncovered	602
memorial planned for husky that bore serum to Alaska	542	Paper Money—durable dollar bill sought	586
talk with their tails	531	Parachute—five jumpers race from single balloon	565
Doors—opened and closed by electric motor	640	Pearls—honey bath for "sick"	533
Drills		Pests—ladybugs war on orchard pests	544
coiling drill for concrete	634	Petroleum—oil well digs own grave	648
combined with lathe for radio builder	635	Piano—pianist weights wrists to strengthen hands	617
Dust—from volcano in air three years	607	Pictures—lighted color rolls tell stories for children	541
Eiffel Tower—light, as ad for auto factory	602	Pillows—air-filled cushion headrest	564
Electric Railroads—elevated train controlled by cable	601	Pipe—built of wooden staves	593
Electricity—girls taught electric terms to aid house- work	639	Pipe (Tobacco)—hundred pounds of briar for one pipe	601
Fire Apparatus—fire mask with glass front	572	Police—six-wheeled bus for riots	634
Fish		Population—farm population declines	609
hunting tigers of the sea	547	Porpoise—seen as leather source	572
mystery in habits of fish to be solved by tags	610		
Forests and Forestry—life of a forest ranger	611		

Stoveplace, 643
Furnace Air Heater on grate

[Continued on Page 4]

Copyrighted material 576

Lighted Color Rolls 5 1/2" x 7" x 1/2" deep on school desks 5-95

Postal Service—dead-letter mysteries solved	535	Automobiles—Lighting	
Poultry—chicken and egg crop of U. S.	544	improving ground for "tulite" bulbs	669
Precious Stones—most emeralds mined in Columbia	574	tail light shock absorber	666
Prisons—prisoners share profits of flax mill	593	Boots and Shoes—ventilating the feet	674
Radio—five tools in one	662	Boxes	
Radio Aerial—building a radio mast	649	how to make inlaid glove box	670
Radio Apparatus		neat thread cabinet	675
automobile radiator makes good ground	653	Carpet Sweeper—bumper on	677
good phone plug	662	Chairs—making woven chair seats	680
tool chest made from cash box	658	Clothing—renewing worn shirts	682
Radio Construction		Cooking Utensils—mending	675
condenser improves quality of reception	653	Corn—auto drives sheller	682
eliminating hand capacity	653	Desk—improvised typewriter	680
jig for drilling for switch points	662	Electricity	
low-loss instrument for short and long waves	655	electric don'ts	666
workbench for radio fan	651	handing lighting current safely	682
Radio Loops—how to select and use them	659	Eraser—doubling life of typewriter	681
Radio Loud Speakers		Fish—novel trap	668
building loud speaker in standard cabinet	652	Flies—using vacuum cleaner as fly catcher	677
felt diaphragm modulates tones	658	Garage—paint from auto blocks	665
Radio Phones—reverse polarity	653	Glass—phonograph needles make glazier's points	682
Radio Questions and Answers	704	Jack—fits different wagons	675
Railroad Stations—\$6,000,000 depot covers three acres	608	Laundry	
Railroads—United States—dining cars	603	clothes drying cabinet fits over radiator	681
Razor—self-sharpening safety	636	folding holder for clothesline	665
Rollers—foot-propelled lawn	601	Paint—to paint monograms on leather	669
Rubber—melt auto tires for rubber roads	634	Paper Weights—unusual	669
Safety Devices and Measures		Pests	
tail lamp for saddle horses	625	destroying caterpillars on grape vines	665
wire masks protect girls in factories	585	simple bug chaser	675
Salt—beds a thousand feet thick	531	Photography	
Sandblast—electric sander is portable	648	intensifying or reducing negatives	674
Savings and Savings Banks—dime bank like fountain pen	616	lino-fronted easel for	667
Saws and Sawing Rigs—portable saw, electrically driven	574	Poultry—nests easily cleaned	677
Scooter—combined scooter bicycle for sidewalks	554	Saws and Sawing Rigs—sawbuck holds cordwood immovable	668
Screen—tool tacks and stretches screens	630	Seats—improvised porch seat	659
Screwdriver—grip on, blade holds nuts in place	553	Shaving—shelf for lavatory	666
Sculpture—art of vegetable sculptor	531	Sink—methods of cleaning	643
Sea—Neptune's drug store	565	Swing—safety device for baby	676
Searchlight—giant, visible over two hundred miles	573	Toys	
Smoke Nuisances—cinder in eye inspires invention	541	noddling doggie, how to make	678
Smokers' Stands, etc.—ash tray extinguishes cigaret	610	wind-propelled toy wagon	667
Snakes—old snake yarns refuted	617	Weeds—killing chemically	664
Solder and Soldering—swivel end soldering iron	637	Wood—making large shrunken tubs and tanks watertight	681
Steamships—cost to operate steamer "Majestic"	636	Wood Finishing—silver-gray	676
Steel—history of steel traced	585		
Stencil—curved	602		
Street Railroads—vestibuled street car train	544		
Street Traffic Regulations—triple crossing in San Diego, Calif.	585		
Suffrage—movies detect dead "voters"	586		
Suitcase—has three sections	585		
Sun—harnessing	587		
Sunflower—diet for cattle	624		
Telephone			
queer phone problems met	531		
rubber base for telephone	616		
Theater—under earth for miners	648		
Thermostat—for auto motor	555		
Tires—tire cord loom placed in museum	600		
Toys—building blocks like books	561		
Track—motor-driven track shifter	642		
Transportation			
oil engine for river traffic	561		
unchanged joy riders	626		
Treasure Trove—nightly treasure hunt at bathing beach	573		
Typewriters—fountain pen type cleaner	531		
U. S. Naval Academy—Four Years at Annapolis—Third Year	577		
Ventilation—man-made hurricane to free tunnel of gas	554		
Voice—teachers pick singers without hearing voice	610		
Watch Case—on auto dash records driving time	616		
Watches—why timepiece is a watch	607		
Water			
frozen so quickly an explosion results	532		
harder than steel	573		
Water Supply—town to be turned into lake	572		
Woman			
in industry increase	628		
useful inventions by women	640		
Wood—cure for woodpecker holes not found	593		
Workshop—full workshop in single tool	616		
Wrench—self-adjusting	593		

SHOP NOTES

Automobile-Repairing	
outside oil line on Ford motor makes quick repair	702
remedying worn Ford hubs	684
Bolts—inserting in awkward place	696
Built-In Furniture for the Home—Part XI—built-in writing desk	697
Bushings—taking up play in brass	685
Clover—divider for cutting sweet	701
Compressed Air—old boiler used as tank	694
Concrete—avoid crumbly material in	692
Counters—double purpose	692
Drills—brass drift block on drill press	685
Emery Cloth—clip holds on file	700
Fences—painting wire	695
Files—and how to use them	688
Gas—riding manholes of gas	702
Matches—method of removing and preventing scratch marks	692
Milk—bucket support holds pail	686
Motor Trucks—short truck makes sharp turns	685
Nails—removing from painted work	693
Packing (Machine)—lead for high pressure packing	686
Pipe—cutting at angles	685
Poultry—hook for suspending fowl	693
Rot—creosoting poles set in ground	692
Saws and Sawing Rigs—guard prevents kick-back on saw	701
Screws—storing small screws, bolts and nuts	700
Scribing shafts	694
Solder and Soldering	
aluminum	696
making soldering iron heater	683
Staining—walnut stain for cypress	685
Stains	
removing, caused by fire	686
to prevent coal tar stains on paint	701
Steam Boilers—finding boiler efficiency	694
Taps—tapping holes in small steel rod	701
Tires—tool for expanding tire	693
Twine—cutting equal lengths of	696
Typewriter—pipe cleaner for inaccessible parts	693
Wire—novel straightener	684

AMATEUR MECHANICS

Automobile—experts advise warming engine as soon as possible	679
Automobiles—Fuel—making gravity feed efficient	676

DRAKE'S PRACTICAL MECHANICAL BOOKS

THEY WILL RAISE YOUR PAY—

ORDER ON 5-DAY TRIAL

The books listed below will perfect you in your chosen trade—pave the way to the big positions. Written in non-technical language—easy to read and understand. *Every book covers its subject completely. An entire course of instruction condensed into one volume.* Your choice sent postpaid—you benefit 5 days—money refunded in full if not entirely satisfactory. Order direct from this page.

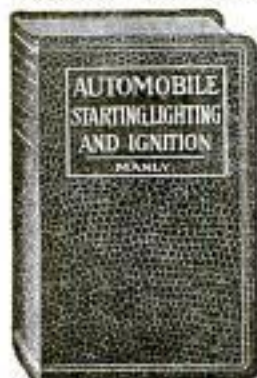

Automobile Books

- Automobile Starting, Lighting and Ignition, by Manly... 700 pp. \$3.00
 Automobile Handbook, \$2.00
 Motor Car, Truck and Motor, by Manly... Cloth \$1.50
 Automobile Battery, Care and Repair, by Manly... Leatherette \$2.00
 Motorcycle Handbook, by Manly \$1.50



Shop Practice Books

- Sheet Metal Workers' Manual... \$2.00
 Oxy-Acetylene Welding and Cutting... Cloth \$1.25
 Slide Rule and Logarithmic Tables... \$2.00
 Handbook for Millwrights... Cloth \$2.00
 Machine Shop Practice... Cloth \$2.00
 Mechanical Drawing and Machine Design... Cloth \$2.00

ORDER DIRECT FROM THIS PAGE—ON OUR MONEY-BACK PLAN

The books listed above are only a few of the many in our catalogue, which you will receive promptly after filling out and mailing us the attached coupon. For quick action order direct from this page—cross name of each book wanted and send in with price quoted. We prepay postage and send books on our money-back plan.

FREDERICK J. DRAKE & CO.

PUBLISHERS

1008 Michigan Ave., Chicago
 Drake Books Are For Sale at All Book Stores

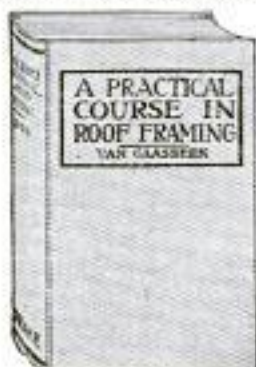

Carpentry Books

Cloth Binding

- Modern Carpentry, 2 vols. \$3.00
 The Steel Square, 2 vols. \$3.00
 Modern Estimator... \$1.50
 Timber Framing... \$2.00
 Builder's Architectural Drawing... \$2.00
 Concrete... \$1.50
 Practical Bungalows... \$1.00
 Roof Framing, by Van Gasbeek... \$1.50

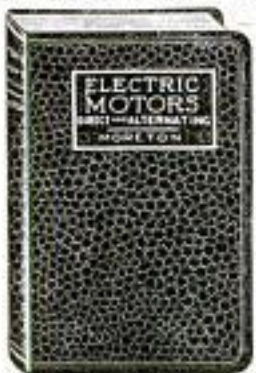

Electrical Books

- Telephony, including Automatic Switching, by Smith, 450 pp. Leatherette \$2.50
 Practical Applied Electricity... \$2.00
 Wiring Diagrams and Descriptions... \$1.50
 Armature and Magnet Winding... \$1.50
 Electric Motors, D. & A. \$1.50



Painting and Decorating

- Ross Crane Book of Home Furnishing and Decoration... Cloth \$3.00
 House Painting Methods with the Brush and Spray Gun, by Vanderwalker... Cloth \$2.00
 Interior Wall Decoration, by Vanderwalker... Leatherette \$4.00
 The Mixing of Colors and Paints, by Vanderwalker... Cloth \$2.00
 A Show at 5th' Cards... Cloth \$4.00
 Sign Painting, by Atkinson... Cloth \$4.00
 Strong's Book of Designs, Leatherette \$4.00
 Modern Painter's Cyclopaedia... Cloth \$2.00
 Automobile Painting... Cloth \$1.50
 New Hardwood Finishing... Cloth \$1.50

Steam Engineering

- Swingle's Handbook for Steam Engineers and Electricians, Leatherette... \$4.00
 Examination Questions and Answers for Marine and Stationary Engineers, Leatherette... \$2.00
 Steam Boilers... Leatherette \$2.00
 Swingle's Catechism of Steam, Gas and Electrical Engineering, Leatherette \$1.50

Modern Languages

- By Prof. P. S. Allen, U. of Chicago
 French without a Teacher... Cloth \$1.25
 Spanish without a Teacher... Cloth \$1.25
 German without a Teacher... Cloth \$1.25
 Everyday French... \$1.25
 Everyday Spanish... \$1.25

FREDERICK J. DRAKE & CO.
 1008 Michigan Avenue
 Chicago, Ill.

GENTLEMEN:—Please send me free, postage paid, your illustrated catalogue which lists and describes 200 Practical Mechanical Books for Home Study.

My name is

and my address

Mail Coupon For Free Catalogue
 Your Guide to Home Study

Home-Study Business Training —Does It Pay?



F. H. LANDWEHR, Sec'y
Electric Auto-Lite Company



The Electric Auto-Lite Company, Toledo



C. O. MINIGER, Pres.
Electric Auto-Lite Company
Sixteen members of the
Electric Auto-Lite Co. are
enrolled for home-study
training with LaSalle Extension
University. LaSalle-
trained men and women—
in positions of responsibility—
are to be found in every
large business organization in
America.



TOLEDO

**"It Increased My Income
in a Very Substantial Way"**

—So writes F. H. Landwehr, Secretary of
the Electric Auto-Lite Company, Toledo



"We want men who can
think beyond their jobs"

"We want men in our organization who have the capacity to think beyond their jobs. To my notion, LaSalle Extension University offers an excellent opportunity to the man who wants to get ahead."

(Signed) C. O. MINIGER, Pres.
Electric Auto-Lite Company.

"My training has proved
a wonderful investment"

"At the time I enrolled with LaSalle, I felt that I could not afford it; but the results obtained have proved it a wonderful investment. Your training has made it possible for me to increase my income approximately 700 per cent."

(Signed)
F. H. LANDWEHR, Sec'y
Electric Auto-Lite Company.

F. H. Landwehr could still be a clerk in a small-pay position—and probably *would* be, if he had not made a certain decision . . .

He did not come to this decision all at once. He will tell you that he practically lost five or six good years.

But when he *did* realize that his future was absolutely in his own hands—that the right kind of home-study business training would quickly speed his progress toward the responsible executive position he desired to fill—he ACTED.

Today he is Secretary of the great Electric Auto-Lite Company of Toledo. His earnings have doubled—trebled—quadrupled—till today he is making several times as much as he was making as a clerk. Ahead of him lies a splendid future.

And he dates his start toward this greater success from the day when he clipped and mailed a LaSalle coupon.

Send for Salary-Doubling Plan

Have you ever traveled a road when the night was inky black, arrived at a cross-roads, and wondered which way to turn?

In that predicament, have you ever flashed your spot-light on a sign and suddenly seen

the name of your destination in big clear letters and a hand pointing out the road which would take you there?

Thousands and thousands of men have arrived at just such a cross-roads in their business experience—have suddenly caught the vision of a successful career in the training offered by LaSalle and have followed that brighter path to the goal of their desires.

For example—during only six months' time as many as 1,248 LaSalle members reported definite salary-increases, as a result of their training, totaling \$1,399,507, an average increase per man of 89 per cent.

What would it be worth to you to increase your earnings 89 per cent—within a comparatively few months?

LaSalle offers you a salary-doubling plan which has added millions of dollars to the earning power of its members. LaSalle will send you a booklet describing this plan without obligation. Whether you adopt the plan or not, the basic information this booklet will place in your hands is of very real and definite value. And—it's FREE.

Balance the two minutes that it takes to fill out the coupon against the rewards of a successful career—then clip and mail the coupon NOW.

LASALLE EXTENSION UNIVERSITY

The World's Largest Business Training Institution

CLIP AND MAIL

LASALLE EXTENSION UNIVERSITY

Dept. 1064-R

Chicago

I shall be glad to have details of your salary-doubling plan, together with complete information regarding the opportunities in the business field I have checked below. Also a copy of "Ten Years' Promotion in One," all without obligation.

- | | | | |
|---|---|--|--|
| <input type="checkbox"/> Business Management: Training for Official, Managerial, Sales and Departmental Executive positions. | <input type="checkbox"/> Law: Training for Bar; LL. B. Degree. | <input type="checkbox"/> Industrial Management: Factory Management; Training for positions in Works Management, Production Control, Industrial Engineering, etc. | <input type="checkbox"/> Modern Business Correspondence and Practice: Training for position as Sales or Collection Correspondent, Sales Promotion Manager, Mail Sales Manager, Secretary, etc. |
| <input type="checkbox"/> Modern Salesmanship: Training for position as Sales Executive, Salesman, Sales Coach or Trainer, Sales Promotion Manager, Manufacturer's Agent, Solicitor, and all positions in retail, wholesale, or specialty selling. | <input type="checkbox"/> Traffic Management—Foreign and Domestic: Training for position as Railroad or Industrial Traffic Manager, Rate Expert, Freight Solicitor, etc. | <input type="checkbox"/> Modern Foremanship and Production Methods: Training for positions in Shop Management, such as that of Superintendent, General Foreman, Foreman, Sub-Foreman, etc. | <input type="checkbox"/> Business English: Training for Business Correspondents and Copy Writers. |
| <input type="checkbox"/> Higher Accountancy: Training for position as Auditor, Comptroller, Certified Public Accountant, Cost Accountant, etc. | <input type="checkbox"/> Railway Station Management: Training for position of Station Accountant, Cashier and Agent, Division Agent, etc. | <input type="checkbox"/> Personnel and Employment Management: Training in the position of Personnel Manager, Industrial Relations Manager, Employment Manager, and positions relating to Employee Service. | <input type="checkbox"/> Commercial Spanish: Training for position as Foreign Correspondent with Spanish-speaking countries. |
| <input type="checkbox"/> Expert Bookkeeping: Training for position as Head Bookkeeper. | <input type="checkbox"/> Banking and Finance: Training for executive positions in Banks and Financial Institutions. | | <input type="checkbox"/> Effective Speaking: Training in the art of forceful, effective speech, for Ministers, Salesmen, Fraternal Leaders, Politicians, Clahmen, etc. |

NAME _____ PRESENT POSITION _____ ADDRESS _____



CARPENTERS

LET THIS NEW AUDEL SET SOLVE YOUR PROBLEMS

KNOW your job and you'll never be without one. The man who takes pride in his personal skill is the man that is always in demand. The skilled carpenter's work is the easiest because he knows the practical short cuts and modern methods. His pay is higher because he does more and better work with less effort. *Audel's Carpenters' & Builders' Guides* gives you a Helping Hand into the Master Class. A complete Carpenter's and Builder's Course for study and ready reference.

Helping Hand Is Extended to You

Carpenters everywhere are using AUDEL'S CARPENTERS' & BUILDERS' GUIDES as a helping hand to easier work, better work and better pay. To get this assistance for yourself you need only use the coupon below without risk. Find out for yourself whether they will be a valuable daily assistant in your work. If you find that the hundreds of charts, tables, diagrams, specifications and instructions will help you, keep the books, sending \$1 a month for 6 months.

Strong, flexible covers—easy to carry in the pocket. Clear white paper. A handsome set of practical, helpful books that every carpenter will be proud to own.

4 HANDY POCKET SIZE GUIDES
BIG TYPE—EASY TO READ AND LEARN
1500 PAGES—3700 EXAMPLES

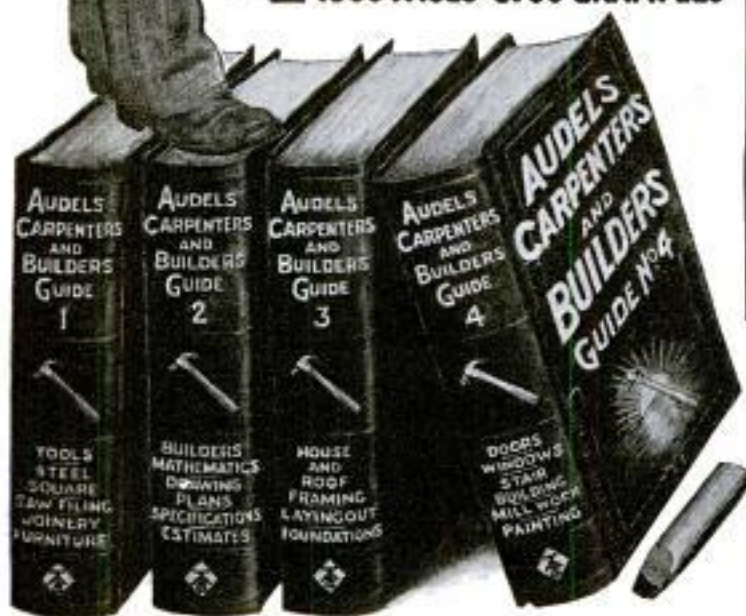

Condensed Contents of Audel's New Guides

Guide No. 1—431 Pages 1200 ILLUSTRATIONS

Use of tools, different woods, nails and screws, filing saws, chalk line, plumb and level, rules and scales, mitre boxes, steel square, laying-out work, joints and joinery, how to build work bench and furniture.

Guide No. 2—455 Pages 400 ILLUSTRATIONS

Carpenters' Arithmetic, how to build houses, barns, garages, bungalows; reading plans, drawing up specifications, estimating cost, proportioning beams, estimating strength of timbers, mensuration, geometry, trigonometry.

Guide No. 3—255 Pages 400 ILLUSTRATIONS

Excavating foundations, how to build concrete forms, framing houses, setting girders and sills, framing joists, well holes, how to lath, types of roofs, tangents, skylights, and scaffolding and hoisting.

Guide No. 4—448 Pages 400 ILLUSTRATIONS

Shingling, how to lay roofs, hang doors, frame windows; building stairs; cornice work, exterior and interior trim, laying floors, putting on siding, painting, and first aid to the injured.

Use This Free Coupon Now!

Take this step now into the Skilled Carpenter Class. Don't keep on doing hard or unnecessary work that you don't have to do. Learn the short cuts and easier modern methods. Be a Master Worker. Let these Practical Guides give you a helping hand into the class where you belong.

**FREE
EXAMINATION
COUPON**

THEO. AUDEL & CO.
65 W. 23rd St., New York City

Please submit me for approval and free examination: **AUDEL'S CARPENTERS' AND BUILDERS' GUIDES**. Ship at once, prepaid, the 4 numbers. If satisfactory I agree to send you \$1 within five days and to further mail you \$1 monthly until \$5 is paid.

Name

Address

Occupation

Employed by

DON'T be a low-pay man. Don't be a Job-Hunter. Change quick from Empty Pockets to **STUFFED POCKETS**. YOU TOO, have a right to enjoy **BIG MONEY**—there is a fast way to do it. I'll show you a **QUICK** way—so quick that it is positively amazing—just a few happy, easy weeks. My Auto Book tells this romantic story of **QUICK RESULTS**. It's **FREE** to you. Send for it **NOW**—That Coupon brings it.

B. W. COOKE

Directing Engineer
CHICAGO



I WILL
TRAIN YOU
AT HOME

Get
RESULTS
Quick
The B.W.
"COOKE-
WAY!"

Be an **AUTO
EXPERT**

Earn up to **\$150** a week

You want **RAISES IN PAY**—Well then, take the **QUICKEST** way to them. **QUICK RAISES** are what you want. Clip Coupon—Get my free Book. Student after student reports \$100 a month extra, some even over \$200 a month EXTRA, spare time money, long before graduation—right in the early weeks of this famous "JOB-WAY" Auto Training. Did you ever hear of training that can show such quick and big results? Right at your home. I train you for a fine Big-Pay Auto Business of Your Own or the splendid Auto Experts' positions paying up to \$150 a week.

Get Into the **AUTO BUSINESS**

The World's Biggest Business

Think of it—18,000,000 cars on the roads today—5 Thousand Million Dollars spent every year for upkeep alone! Wonderful opportunities to make **Big Money** and **Quick Money** in this gigantic Auto Industry. Get B. W. Cooke "Job-Way" Training. Be your own boss—go into business where up to \$10,000 or \$15,000 a year can easily be made! Remember with Cooke "Job-Way" training you **don't have to wait**. Hundreds of my students start right in collecting and spending Big Extra Money in the very first few weeks of their training! Read what John F. Plow did.

\$30 a Week More Pay

—Right in the First Few Weeks of My Training!

22 year old John F. Plow, Box 370, Ironwood, Mich.—still in the earliest part of his training—writes that he has averaged \$30 a week EXTRA MONEY over his regular pay. But Mr. Plow is only one of hundreds. Think of it—how would you like a fine quick \$30 a week raise! That's the kind of opportunity Cooke "Job-Way" offers you! Mr. Plow says: "I can't get away without thanking you for it. Your course is ONE in a million and I'll back up my statement with anybody."



\$300 in a Week!

Speaking of Pay Raises—look at this! Joseph Woronecki, 186 Allick St., Hartford, Conn., was making only \$21 a week when he wrote me. Just four months later he wrote that he made \$300 in one week in his own garage! That's an example of how quick my training gets amazing results. Find out what it can do for you. Get my Free Book today!

Big Pay Jobs Open

More trained Auto Men needed today than ever before! See how I back you up with the entire Resources of this Institution—how I give you Consultation Service—Employment Service for your whole life! Not a penny extra charge. See how the demand for B. W. Cooke "Job-Way" trained men grows bigger and bigger every year. Send for my Free Auto Book quick!

Get the PROOF!

If you want a quick boost in Pay—if you want to make up to \$150 a week—send for my Free Auto Book right now! You don't need previous Auto Experience to MASTER Automotive Work the B. W. Cooke "JOB-WAY" Cannon schooling all you need. I'll show you how so many men between the ages of 15 and 60—from all walks in life—become Garage Owners, Managers, Superintendents, Foremen, Auto Executives. Get ALL the Facts! Clip Coupon Now!

LEARN THE COOKE
AT HOME JOB-WAY

Keep your **JOB! STAY HOME!** Earn all your present job pays you, PLUS the big extra money which comes to so many of my students so quickly. Get started this quick way to Big Pay as an Auto Expert through Cooke "JOB-WAY"—RIGHT IN YOUR OWN HOME. Being a practical Directing Engineer, Owner, and Head of this Institution I know what practical, money-making training you need to be a Big Pay Man—and what training you need to bring you **QUICK BIG MONEY**—that training I give you!

The Only "JOB-WAY" Training on Earth

My training includes all Electrical Work—Ignition, Starting, Lighting—All Mechanical End—Welding, Reaming, Vulcanizing—also Business Course, Salesmanship, Advertising, Buying, How to Keep Single Books—also Automotive Magazine, also 4 Outfits. Nowhere else I know of can you get ALL this training. Find out how B. W. Cooke "Job-Way" fits you for Big Pay and Quick Raises. Learn what it has done for others. See what it can do for you. MAIL COUPON RIGHT NOW!

4 BIG OUTFITS
INCLUDED
FREE
of extra cost

Tools, Tool Bag, Test Bench, Radio Receiving Set—all equipment included. Also 293 Wiring Diagram Charts. Write quick.

B-W-COOKE

Directing Engineer

CHICAGO MOTOR TRAINING CORPORATION
1916-1926 Sunnyside Ave. Dept. 716-A Chicago, Ill.



**AUTO
FACTS**

FREE
AUTO
BOOK

THIS QUICK!

CHICAGO MOTOR
TRAINING
CORPORATION
1916-1926 Sunnyside Ave.
Dept. 716-A, Chicago, Ill.

MAIL
**B. W.
COOKE,**
Directing Engineer

Send me your Free Book "AUTO FACTS" and "PROOF" that you'll show me the way to a QUICK RAISE and BIG PAY as an Auto Expert, also send your 4 Outfits offer. It is understood that this obligates me in no way, and that no salesman will call on me.

Name

Address



The Tired Old Man who may some day be you!

HE'S a kindly, well-meaning old fellow, but somehow a failure. Seems as if he never could quite make the grade.

Too frequently now you will find him scanning the Help Wanted columns of the newspapers, searching for something—for anything—to do. You feel a tinge of pity as you pass him by, and breathe a hope that you will never come to *that*.

Yet that broken man of fifty or fifty-five was once as young as you. At twenty or twenty-five, he viewed the future with confident eyes, and dreamed his dream of success even as you are dreaming yours today. But he simply dreamed.

And the months went by and the years, and slowly, but surely, the dream faded out. Too late he realized, if he realized at all, that he had failed, not because an unkind nature had given him less than his share of ability—but because he had never learned to do any one thing well.

Today he marches as a humble, foot-sore soldier in the great Army of the Unprepared. He isn't a trained salesman—he isn't a trained architect—he isn't a trained accountant—he isn't a trained anything. *He does not have anything to do because he does not know how to do anything!*

Take care, young man—take care lest some day that tired old man be you!

Prepare yourself now for the great day that is Tomorrow. Plan your future as carefully as an architect would plan a building of value beyond price. Train yourself to do some one thing surprisingly well. For then, and then only, will the years find you rising instead of falling.

There is no better way to prepare for advancement in any line of business than to study at home in spare time through the International Corre-

spondence Schools. Such a course will lift you out of the ranks of the untrained and bring you to your goal of success far quicker than if you try to make the journey alone.

The coupon beckons—the same familiar coupon that has brought success to so many other men in just your circumstances.

Isn't it better to send it in today than to wait a year or five years and then *wish* you had?

INTERNATIONAL CORRESPONDENCE SCHOOLS

Box 5531-E, Scranton, Penna.

Without cost or obligation, please tell me how I can qualify for the position or in the subject before which I have marked an X:

BUSINESS TRAINING COURSES

- | | |
|--|---|
| <input type="checkbox"/> Business Management | <input type="checkbox"/> Salesmanship |
| <input type="checkbox"/> Industrial Management | <input type="checkbox"/> Advertising |
| <input type="checkbox"/> Personnel Organization | <input type="checkbox"/> Better Letters |
| <input type="checkbox"/> Traffic Management | <input type="checkbox"/> Show Card Lettering |
| <input type="checkbox"/> Business Law | <input type="checkbox"/> Stenography and Typing |
| <input type="checkbox"/> Banking and Banking Law | <input type="checkbox"/> Business English |
| <input type="checkbox"/> Accountancy (including C.P.A.) | <input type="checkbox"/> Civil Service |
| <input type="checkbox"/> Nicholson Cost Accounting | <input type="checkbox"/> Railway Mail Clerk |
| <input type="checkbox"/> Bookkeeping | <input type="checkbox"/> Common School Subjects |
| <input type="checkbox"/> Private Secretary | <input type="checkbox"/> High School Subjects |
| <input type="checkbox"/> Spanish <input type="checkbox"/> French | <input type="checkbox"/> Illustrating <input type="checkbox"/> Cartooning |

TECHNICAL AND INDUSTRIAL COURSES

- | | |
|---|--|
| <input type="checkbox"/> Electrical Engineering | <input type="checkbox"/> Architect |
| <input type="checkbox"/> Electric Lighting | <input type="checkbox"/> Architects' Blue Prints |
| <input type="checkbox"/> Mechanical Engineer | <input type="checkbox"/> Contractor and Builder |
| <input type="checkbox"/> Mechanical Draftsman | <input type="checkbox"/> Architectural Draftsman |
| <input type="checkbox"/> Machine Shop Practice | <input type="checkbox"/> Concrete Builder |
| <input type="checkbox"/> Railroad Positions | <input type="checkbox"/> Structural Engineer |
| <input type="checkbox"/> Gas Engine Operating | <input type="checkbox"/> Chemistry <input type="checkbox"/> Pharmacy |
| <input type="checkbox"/> Civil Engineer | <input type="checkbox"/> Automobile Work |
| <input type="checkbox"/> Surveying and Mapping | <input type="checkbox"/> Airplane Engines |
| <input type="checkbox"/> Metallurgy | <input type="checkbox"/> Navigation |
| <input type="checkbox"/> Steam Engineering | <input type="checkbox"/> Agriculture and Poultry |
| <input type="checkbox"/> Radio | <input type="checkbox"/> Mathematics |

Name.....

Street.....

Address..... 3-6-24

City..... State.....

Occupation.....

Persons residing in Canada should send this coupon to the International Correspondence Schools Canadian, Limited, Montreal, Canada.

**The International Correspondence Schools are the oldest and largest
correspondence schools in the world**



Wide World Photo

Sudden New Demand for Daring Young Men!

AVIATION in America is on the threshold of an amazing new development. For in the past few months gigantic commercial air lines have been established. The biggest capital and business forces in the world are behind this enterprise. Even in the beginning, thousands of young men are needed. For those who can qualify there will be highly paid jobs which will lead quickly and surely to advancement and success.

Big Opportunities Await the Trained Man

Look over the fields of work which are open to the young man today. You will find that Aviation is the ONE FIELD that is not overcrowded—the ONE FIELD in which there is plenty of room at the top. Think of it! Only 21 years ago Orville and Wilbur Wright made the world's first airplane flight. Now airplanes fly around the world. Yes, Aviation offers the same wonderful opportunities today that the automobile and motion picture industries did 15 and 20 years ago. Men who got in on the ground floor of those industries made fortunes before others woke up.

Easy to Become an Aviation Expert—\$50 to \$100 a Week

You can qualify now quickly for one of these exciting highly paid jobs through a new, sure, easy method of training. The study of Aviation is almost as interesting as the work itself. Every lesson is fascinating and packed full of interest. That's why Aviation is so easy to learn—you don't have to force

yourself to study. Only one hour of spare time a day will give you the basic training in an amazingly short time.

One student, S. F. McNaughton, Chicago, says: "Your lessons are like a romance, and what is more, after one reading, the student gets a thorough understanding. One never tires of reading them." James Powers, Pa., another student, says: "I am indeed surprised that such a valuable course can be had from such practical men for so little cost."

Men who have had actual experience in Aviation give you personal attention and guide you carefully through your training. They select the lessons, lectures, blueprints and bulletins. They tell you the things that are essential to your success. Every lesson is easy to read and quickly understood.

PREPARE FOR ONE OF THESE POSITIONS

Aeronautical Instructor
\$60 to \$150 per week
Aeronautical Engineer
\$100 to \$300 per week
Aeronautical Contractor
Enormous Profits
Aeroplane Repairman
\$60 to \$75 per week
Aeroplane Mechanician
\$40 to \$60 per week
Aeroplane Inspector
\$50 to \$70 per week
Aeroplane Salesman
\$5,000 per week and up
Aeroplane Assembler
\$40 to \$65 per week
Aeroplane Builder
\$75 to \$200 per week



Big Book on Aviation FREE

Send coupon below for New Free Book, just out, "Opportunities in the Airplane Industry." It is interesting and instructive and will show you many things about Aviation which you never knew before. Only a limited number offered—get yours before the edition is exhausted.

AMERICAN SCHOOL OF AVIATION Dept. 1357, 3601 Michigan Ave., Chicago, Ill.

American School of Aviation,
3601 Michigan Ave., Dept. 1357, Chicago, Ill.

Without any obligation, send me your Free Book, "Opportunities in the Airplane Industry," also information about your Course in Practical Aeronautics.

Name.....

Street.....

City..... State.....

Come Out of the Fog And Be Happy!



ELECTRICITY

—Will Close the Big Gap Between Your PRESENT and Your FUTURE!

Does your present job offer you a FUTURE? If so, how long must you wait for that future? Five?—ten?—fifteen?—perhaps twenty years? TOO LONG to wait for an uncertainty! GET WHAT YOU EARN—now! Dredging through the years in hopes that mere chance will provide a big future for you is like wandering in a fog with little prospect of reaching your destination.

The Electrical Field offers Thrills Galore, Wonderful Experiences, and SALARIES that any ho-man can brag about! This is the Electrical Age and your day of opportunity. COME OUT OF THE FOG AND BE HAPPY—in the Electrical Field!

**HUNDREDS OF COYNE-TRAINED MEN
EARN \$60 TO \$200 A WEEK**

REMEMBER, THERE IS
NO SUBSTITUTE FOR
PRACTICAL TRAINING
IN GREAT SHOPS

**Earn While You Learn
at COYNE**

My Employment Department helps you get a job to earn part or all of your expenses and assists you to a good job upon graduation.

Read My Big
SPECIAL OFFER

COMPLETE ELECTRICAL TRAINING

in 12 Happy Weeks at COYNE

My newly enlarged and unusual course of instruction in Electricity is the result of 27 years of experience, solving the needs of young men and of the Electrical Field.

My course is absolutely thorough, easy to master, covers every single phase and factor of the subject and fits men for BIG Electrical jobs, HIGH-SALARIED, thrilling jobs.

R. R. FARE TO CHICAGO AND 2 BIG SPECIAL COURSES Without Extra Cost if You Act Now

Without a penny of additional cost to you, I'll include, in your tuition, your RAILROAD FARE TO CHICAGO from any point in the United States, also EXTRA Special Courses in RADIO ELECTRICITY and AUTO, TRUCK and TRACTOR ELECTRICITY—IF YOU ACT PROMPTLY! This unusual offer will soon be withdrawn. Send the Coupon TODAY!

Don't Fail to Send at Once for
My Big FREE BOOK and
Special Offer of R. R. Fare and
Two Big Courses

It will pay you to grab a pencil now and hustle with the Coupon to the nearest mail box or post office without delay. My big FREE Book will certainly please you. ACT AT ONCE!

Tune in on Coyne Radio Station WGES

COYNE

ELECTRICAL SCHOOL

H. C. LEWIS, President Established 1899
1300-10 W. Harrison St., Dept. 1357, Chicago

**You Don't Need Advanced
Education or Experience**

Don't worry if you lack advanced education, knowledge of higher mathematics, or experience. My course is a practical, LEARN-BY-DOING Course. Every COYNE student receives INDIVIDUAL and PERSONAL instruction, on COMPLETE electrical apparatus, under EXPERT INSTRUCTORS, in the COYNE Shops at Chicago.



H. C. LEWIS, President
COYNE Electrical School

SEND COUPON NOW

H. C. LEWIS, President
COYNE ELECTRICAL SCHOOL
1300-10 W. Harrison St.
Dept. 1357, Chicago, Illinois

Dear H. C.—You can just bet I want one of those big, handsome FREE 12x15 books, with 151 actual photographs of electrical operations and shop scenes, printed in two colors. Send it quick, before the supply is exhausted. Be sure to tell me all about Special Offer of Railroad Fare and 2 Extra Courses.

Name.....
Address.....



Learn Electricity

by the

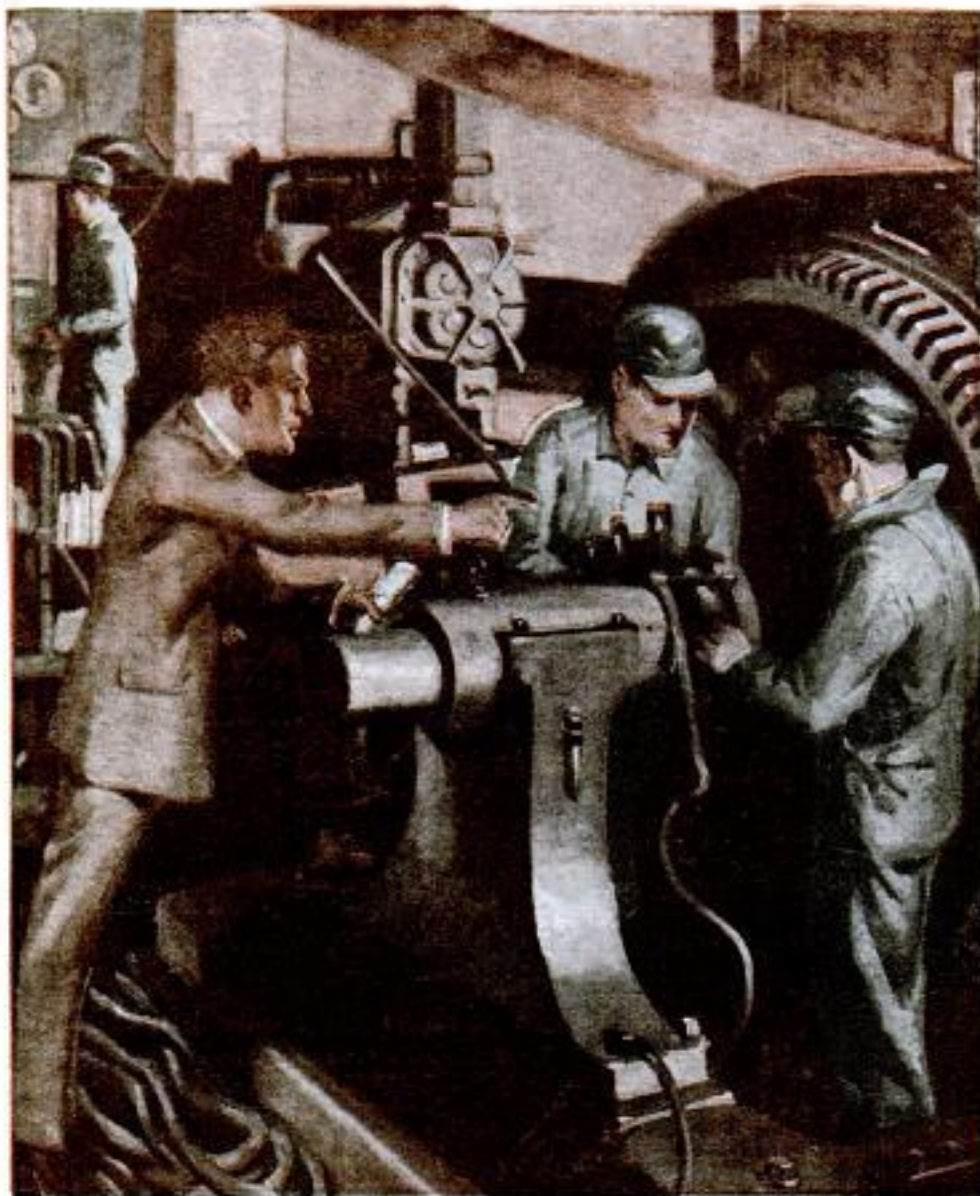

The American School

is chartered under the laws of Massachusetts, as an educational institution NOT FOR PROFIT. Established 79 years. Over 200 Executives, Engineers, and Educators have prepared the texts used in these wonderful home-study courses.

DUNLAP Job-Method Training

Dunlap Home-Training in Electricity is divided in two parts. The first, "Applied Electricity," 53 lessons and "Jobs," covers all the ground usually found in Electrical home-training. In the second part, containing 51 lessons and jobs, you get Electrical Engineering subjects. It is this second part which prepares you to step out of the mechanic class into the big-pay class of Electrical Experts who boss the important jobs in the Electrical Industry.

Get my amazing GUARANTEE

When you put your time and money into home-training you want to know in advance **WHETHER IT WILL EQUIP YOU TO FILL A BETTER JOB AT BIGGER PAY.** The American School answers these questions in plain English. You owe it to yourself, before you enroll for home-training, to get my **MONEY-BACK GUARANTEE.** Coupon brings it.

Electrical Experts Wanted!

\$60 to \$250 A WEEK!

FREE Job-Service for Students and Graduates

We have supplied thousands of jobs FREE, not only to graduates, but to STUDENTS also. This JOB-SERVICE keeps in touch with the great Electrical employers all over America. The day you enroll, this Job-Service department registers you, finds out what kind of job you want, where you want to work, etc. When the AMERICAN SCHOOL backs you for a fine BIG-PAY job, you are pretty sure to get it, and make good in it.



Go into Electricity—The Business of

At Home Job-Method

**I train you for a fine Electrical
JOB and a BIG RAISE in PAY!**

If you are now earning less than \$40 a week, if you want to become an ELECTRICAL EXPERT, if you want to step quickly into the class of men who earn \$60 to \$250 a week—write me at once! This million-dollar training school guarantees you COMPLETE, thorough training, and guarantees to back you from one position to another until you are a success! My training is easy to understand, rapid, practical, because you learn by doing actual Electrical jobs with all this standard material, tools and equipment which I send you without one penny of extra cost!

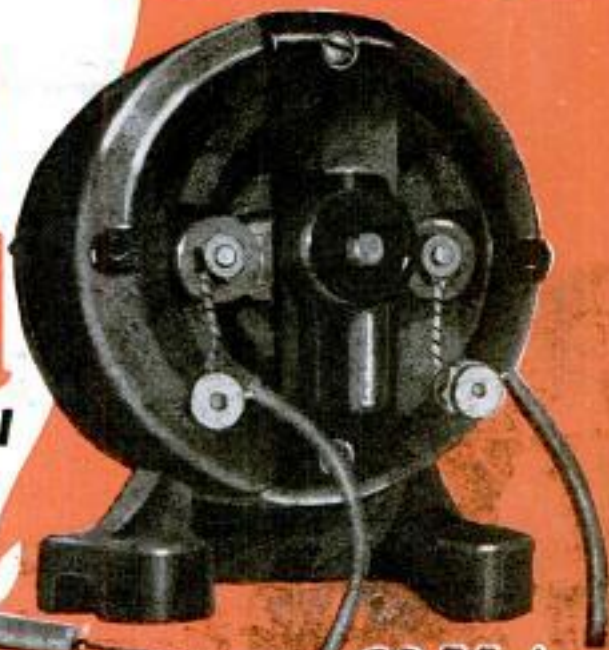

**\$10 Motor
4 Big Outfits
GIVEN!**



**Dunlap-
training has
increased men's
pay 50% to 500%**

I have hundreds of letters which prove my training has doubled and trebled the pay of my students and graduates. You only need common schooling to go through with this—the ability to read and write simple English. If you haven't a high-school education, I will give you the mathematics you need later, without extra cost. My training includes Radio, Auto Electricity, Electrical Drafting, Business training, and Electrical Engineering subjects, all for one small price and on terms within reach of the fellow who needs this training.

Write Me Today! Get my catalog, my wonderful new guarantee, my sensational offers—quick! Get the facts about your opportunities in Electricity when you are Dunlap-trained, when you have the backing of the American School. Get the facts about my training. Get the real facts about my job-service. Mail coupon today!

CHIEF ENGINEER DUNLAP, Electrical Division
AMERICAN SCHOOL, Dept. E-774, Drexel Av. & 58th St., Chicago

a Million Opportunities!

**Training built
by 23 Noted Engineers**

This is no one-man, one-idea school. 22 famous Engineers and Executives of the world's greatest Electrical corporations and leading Universities helped Chief Engineer Dunlap make this training complete and up-to-date:

- | | |
|--|---|
| 1. General Electric Co. | 8. Underwriters Laboratories, Inc. |
| 2. Commonwealth Edison Co. | 9. Columbia University |
| 3. Crocker-Wheeler Co. | 10. Dartmouth College |
| 4. Cutler-Hammer Mfg. Co. | 11. Massachusetts Institute of Technology |
| 5. American Telephone & Telegraph Co. | 12. Lehigh University |
| 6. Westinghouse Electric & Mfg. Co. | 13. University of Vermont |
| 7. Western Electric Co. | 14. Armour Inst. of Tech. |
| 15. University of Kansas and many others | |

Nearly 100 items included in 4 BIG Motor, Radio, and Electrical Outfits given to you without one penny of extra charge. Not a "premium," not something "FREE" to induce you to enroll. But costly, standard, full-size tools, materials, and equipment. All necessary a part of your instruction as the lessons and job-sheets. The sub-size motor of the same type as the big-fellows in a power plant. Not a toy, but a regular power-motor. Runs on Alternating or Direct Current, or 32 Volt form electric systems. Comes to you knock-down. It's part of your job to wind the armature and assemble it. That's the way you learn every branch of Electricity by the Dunlap Job-Method.

MAIL COUPON FOR SENSATIONAL OFFERS!

CHIEF ENGINEER DUNLAP
AMERICAN SCHOOL, Dept. E-774
Drexel and 58th, CHICAGO

I want to be an Electrical Expert. Please rush guarantee, job-service facts, complete information, and money-saving offers.

Name

Street No.

City..... State.....

Draftsmen Wanted!

My Employment Manager calls it to my attention that in the last three months, 2427 concerns have advertised for Draftsmen.

— Fred W. Dobe

ARCHITECTURAL DRAFTSMAN—Thoroughly competent draftsman and designer for large apartment house work in Philadelphia; at least one year's work to start immediately; salary \$75 to \$85 per week. In reply state briefly experience, age and soonest date available.

I Will Train You At Home For These Positions Paying Up To \$4420 a Year

Where are all the men to come from to fill these jobs? Only trained men are wanted. There's no demand for men who want to learn "on the job." If you want to get into this highly paid trade, you have got to learn it before you enter.

Have YOU the time to lay off work and go to day school? Why should you? Not at all necessary.

You can learn drafting at home in your spare time. I have trained hundreds of men who were in the same position you are in—men who are making good at high salaries. I know what other Chief Draftsmen demand in the way of experience and skill. I have spent years developing a practical course of training that teaches these things in the shortest possible time. The slight cost of my course is within easy reach of everyone. In fact, I have a plan that enables you to earn the entire cost of your course, without interfering with your studies or your job.

No Extra Charge for Drafting Outfit

As soon as you decide to take my training, I send you a complete Drafting Outfit, just like the one I use myself. It comes as part of your course. No extra charge. Everything is just what you need, both for your course, and your BIG JOB later: The "Chief's Own" Drafting Table, fine set of drafting instruments, 24-inch T square, triangles, French Curve, drafting board, rule, pencils, ink, paper, thumb tacks. These are all necessary in my course, because I teach practical work. That's the way to learn drafting.

**Chief Draftsman Dobe, 1951 Lawrence Ave.
Div. 13-57 Chicago, Ill.**

Send me your Great Special Offer open now to ambitious men. Also your book, "Successful Draftsmanship." No obligation on my part.

Name..... Age.....

Address.....

Post Office..... State.....

Write Quick! for Great Special Offer

Let me tell you of the most exceptional opportunity now open. If you have ambition and determination, I show you the road to big success, high salary, and all the good things that go with it. Men with money don't need my help. It's the men who want to *make money* I want to help. Write me today. Let's figure together on your future. Just use the coupon. I'll understand.

**Chief Draftsman Dobe, Div. 13-57
1951 Lawrence Avenue - - Chicago, Illinois**

MUSHY MUSCLES!

When you looked in the mirror this morning, did an imitation of a real man stare you in the face? Chest hollow as a bent mud-guard? Shoulders stooped like a tired old hack horse? Arms like ropes with knots on the end? Neck scrawny as an old crow's? Legs thin as pipe-stems? Muscles soft and flabby? How can you expect to amount to anything if your body is like something the cat dragged in? Mushy muscles—

THEY ARE MY MEAT

as thousands upon thousands of my pupils will tell you. I take them as they come, weak and flabby. Then I start working! I make your muscles hard as steel. I make your chest big and deep. I give you legs and arms that fill your clothes. Your friends won't know you. I fill you with pep and ambition. When you wake up in the morning, you spring out of bed full of fire and pep. "Bring on your wildcats!" is the way you feel. You are ready for a full day's work. You just thrill with vitality.

I AM THE MUSCLE-BUILDER

That's what they call me. Why? Because I take the mush out of muscles! When you think of muscle, think of me! I build strong bodies. Just any kind of exercise won't do. A lot of other fellows thought they could do it themselves. They soon found they were wrong. This is my job. I've studied it. I've watched my pupils develop. I know it's good. In fact, I don't promise results; I guarantee them! In thirty days I will put one full inch of muscle on your arm. I will put two inches on your chest at the same time. But that's just a starter to show what I can do. I'll put muscle up and down your back. I'll build a wall of armor around your bread-basket that will stop a battering ram! I'll strengthen every muscle in and around your vital organs! I'll make a he-man, up-and-at-'em-fellow out of you! Sounds good, eh? You're darn right it's good. It's wonderful! Remember, I guarantee it. Come o.n. Let's get going right now. Don't lose a minute.

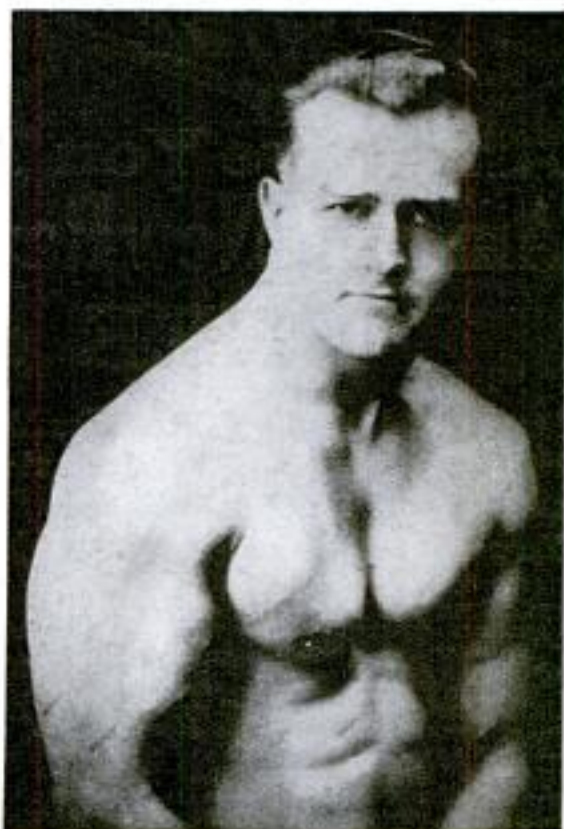

EARLE E. LIEDERMAN
The Muscle Builder

Author of "Science of Wrestling and Jiu Jitsu", "Muscle Building", "Secrets of Strength", "Here's Health", etc.

Send For My New
64 Page Book
"Muscular Development"
It Is FREE

It contains forty-eight full-page photographs of myself and some of the many prize-winning pupils I have trained. Many of these are leaders in their business professions today. I have not only given them a body to be proud of, but made them better doctors, lawyers, merchants, etc. Some of these came to me as pitiful weaklings, imploring me to help them. Look them over now and you will marvel at their present physiques. This book will prove an impetus and a real inspiration to you. It will thrill you through and through. This will not cost you one penny. I want you to have it with my compliments. It is yours to keep. This will not obligate you at all, but for the sake of your future happiness and health do not put it off. Send today—right now before you turn this page.

EARLE E. LIEDERMAN
Dept. 2010, 305 Broadway, NEW YORK CITY

**It
Is
F
R
E
E**

**DON'T
SEND ONE
PENNY
—
YOUR
NAME AND
ADDRESS
ON A
POSTAL
WILL DO**

EARLE E. LIEDERMAN
Dept. 2010, 305 Broadway, New York City.

Dear Sir: Please send me, absolutely FREE and without any obligation on my part whatever, a copy of your latest book "Muscular Development."

Name

Street

City State

(Please write or print plainly)

I'll Keep You in Razor Blades For Life!

And Give You This Amazing New Razor FREE

Most Revolutionary Offer Ever Made in the History of Shaving! Sensational New Invention Guarantees You 365 Cool, Slick Shaves a Year—And You Never Need Buy a New Blade Again!

THIS amazing new invention marks such a radical advance in new shaving comfort and economy that it deserves to be called much more than a stropper. KRISS-KROSS is a super-stropper—a blade rejuvenator! Almost literally, it makes a new blade out of an old one every day—makes hundreds of keen, quick shaves blossom where only one grew before.

KRISS-KROSS strops your blade diagonally—just like a barber does. Never before has anyone captured the secret of successfully reproducing this stroke **automatically**. Eight "lucky leather grooves" do the trick in 11 seconds with a precision it takes a master barber years to attain.

Seven other unique mechanical features. Stropps from heavy to light with uncanny ingenuity. Adjustable, automatic pressure—jig flies up to tell you when blade has reached maximum keenness. Blade reverses automatically every two seconds. KRISS-KROSS prolongs life of any-make blade, **single or double edge**, for weeks, months and years. No more bother about remembering to buy new blades! No more "raking" with dull ones! Keen, velvet-smooth shaves **forever**. Think of the economy!

Sensational Limited Time Offer

Now for my smashing offer! To introduce KRISS-KROSS stropper I am giving with it **free** for a limited time, a new kind of razor built on unique new principle. Gives you a diagonal **sliding** stroke instead of old style **pulling** stroke. Zips right through the toughest beard. Instantly adjustable for either side of face. A twist of the wrist converts it into either "T" style or horizontal, like old straight-edge razor. This razor, with **5 free blades**, completes the outfit with which I guarantee to keep you in razor blades for life.

Rhodes
KRISS KROSS
Stropper

KRISS-KROSS is the only razor that is instantly adjustable. Can be made straight, T-shape or diagonal in a jiffy. Finest thing you ever saw for neck shaves, straightening sides and trimming the moustache.

Sold only through authorized representatives

Here's the plan—proof that my promise "goes all the way." Use the blades and keep renewing them with KRISS-KROSS super-stropper. If any one of them goes back on you for any reason (except rusting or nicking) return all 5 and I'll recondition or replace them with new ones. Sounds impossible? Not at all. I know what amazing things KRISS-KROSS can do—that's how I can afford to make this daring introductory offer.

Send for Full Details

Write for free information on this astonishing new invention. KRISS-KROSS is never sold through stores. You deal direct with me or my authorized representative. Send for illustrated description and full details of this limited 30 day offer. It's even more remarkable than I can tell you in this limited space. No obligation! Just clip and mail coupon today!



AGENTS

This amazing new invention is hanging up surprising sales records all over the country. Once a man sees KRISS-KROSS—fits its sturdy nickel-plated smoothness into the palm of his hand and tests its astonishing ingenuity—you can't make him hand it back. It's one of those things that makes every shaver say to himself, "I'll buy it or bust!" Agents say that its uncanny power to sell itself is absolutely without parallel in the direct selling field.

K. D. Ralph made \$412 in 30 days. W. G. Ferrell, Pa., made \$10 in 10 minutes. W. W. Shugarts boosted Ferrell's sale and made \$12 in ten minutes. Other men take in \$20 to \$60 on fair days with almost no effort.

This is the most astonishing chance to cash in that you ever heard of. Find out what other agents say of KRISS-KROSS—why it is the big money-maker of all time.

WONDERFUL SALES PLAN—Absolutely Unique and Different. You make no deliveries—no collections. A veritable bonanza for men either with or without experience. Check the agent's square in the request blank below and send it to me without delay, or, better still, drop me a line. Act at once.

M. H. Rhodes, President.

RHODES MANUFACTURING CO., Inc.
P-370 Pendleton & Couzens Ave., St. Louis, Mo.
World's Largest Manufacturers of Mechanical Stroppers

Rhodes Manufacturing Co., Inc.,
P-370 Pendleton and Couzens Ave., St. Louis, Mo.

Please send me full details of your big special offer to keep me in Razor Blades for LIFE. Also send me full description of KRISS-KROSS stropper and Free Razor Kit.

Name.....

Address.....

City..... State.....

Check this space if you are interested in becoming an authorized KRISS-KROSS representative.



J. E. GREENSLADE
President of the National Salesmen's Training Association, but called by some "The Man Who Makes Men Rich."



FARMHAND MAKES \$1,000
Berry did that in first month after complete his training.



\$1,000 IN 30 DAYS
made by Hartle, a R. R. Mail Clerk for ten years.



\$13,500 FIRST YEAR
is what A. H. Ward made after taking this sales training.



More Than \$10,000
and elected president as a result of N.S.T.A. training.
CHAS. V. CHAMPION

\$5,000 to \$10,000 a Year
for Men Who Read This Ad

Let Me Make You a Master Salesman!

This New Easy Way

I DON'T care what you are now or what you think. The Association of which I am president will take you in short, easy steps and make a Master Salesman of you, put you in the same class with the big pay men who have all the good things of life.

Many have thought that Salesmen were "born." And that idea has kept many men from succeeding. But this Association of Master Salesmen has proved that any man can be taught the rules and principles that make men Master Salesmen. And you know as well as I do that Salesmen top the list of money-makers. They are the producers and you can be one of them.

Easy as A. B. C.

If you are as intelligent as the ordinary farmhand, postal clerk or stenographer, you can quickly master the simple A. B. C.'s of Selling. There are certain ways of approaching a prospect to get his undivided attention, certain ways to stimulate keen interest, certain ways to overcome objection, batter down prejudices, outwit competition and make the prospect act.

You can learn these principles at home in a short period of pleasant, inspiring study. And once you have mastered these secrets of Master Salesmanship, you can take advantage of the employment department of the Association without charge. They will help you select and secure a position as soon as you are qualified and ready.

This is a real opportunity, for during the last year the Association received calls for 43,846 salesmen from the biggest sales organizations in America. And these men are the same as you see above—men who make from \$5,000 to \$10,000 a year in salary and commission.

These are only four out of hundreds of similar records in the Association files.

Our members make good because the Association has specialized for seventeen years in teaching the Art and Science of Salesmanship and teaches the most unusual principles ever laid down for quick success.

The book you see below has been the starting point for thousands of men who are now successful salesmen. This book, "Modern Salesmanship," is now FREE and it will be sent to every man who fills out and returns the coupon below.

Rush the Coupon

If I were asking ten or twenty dollars for this book you might hesitate. But I am not. It is Free. And since it may mean the turning point in your life, when you leave forever behind you the drudgery and low pay of routine work for the fascinating, big pay job of the salesman, it certainly is worth your time and the two cents you will have to spend to get this amazing book and read for yourself the astonishing facts given between its two covers. You have everything to gain and not one cent to lose, so mail the coupon today, sure.

National Salesmen's Training Association

Dept. R-12
N. S. T. A. Building, Chicago, Illinois

J. E. Greenslade, President
NATIONAL SALESMEN'S TRAINING ASS'N
Dept. R-12, N. S. T. A. Building, Chicago, Ill.
Send me FREE your book, "Modern Salesmanship," and proof that I can become a Master Salesman.

Name.....
Address.....
City..... State.....
Age..... Occupation.....

SENT FREE

The book that has shown thousands the way to amazing salary increases.



NATIONAL SALESMEN'S TRAINING ASSOCIATION

thousands the way to amazing salary increases.

"I aint" "He don't"
 "It's me!" "You was?"
 "Can't hardly"



What Are YOUR Mistakes in English

IF some one you met for the first time made the mistakes in English shown above, what would you think of him? Would he inspire your respect? Would you be inclined to make a friend of him? Would you care to introduce him to others as a close friend of yours?

These errors are easy for you to see. Perhaps, however, you make other mistakes which offend other people as much as these would offend you. How do you know that you do not mispronounce certain words; are you always sure that the things you say and write are grammatically perfect? To you they may seem correct; but others may know they are wrong.

Unfortunately people will not correct you when you make mistakes; all they do is to make a mental reservation about you. "He is ignorant and uncultured," they think. So you really have no way of telling when your English offends others.

FREE Book on English and 15-Minute Test

Sherwin Cody, perhaps the foremost teacher of English in the country, has prepared a simple 15-minute English test which you can take in your own home. This test, with the answers which will also be sent, tells you at once just where you stand. You can discover at a glance whether you make even slight errors. Give yourself this test. If you are efficient in English, it will give you greater confidence; if you are deficient, you surely want to know it, so that you can correct your mistakes.

Mr. Cody's remarkable new invention, the 100% Self-Correcting Method, has already improved the English of more than 41,000 people. No useless rules, no tedious copying, no hard study. Only 15 minutes a day required. You learn by creating the HABIT of using correct English. Nothing like Mr. Cody's method has ever been used before!

You do not want others to judge you unfairly. Write today for this test—it is free. We will also gladly mail you our new free book, "How to Speak and Write Masterly English." Merely mail the coupon or a postal card.

Sherwin Cody School of English

510 Searle Building

Rochester, N. Y.

SHERWIN CODY SCHOOL OF ENGLISH

510 Searle Building, Rochester, N. Y.

Please send me your Free Book "How to Speak and Write Masterly English," and also Mr. Cody's 15-minute Test of my English.

Name

Address

City State

Make Money Taking PICTURES



Get \$100 for Flood Pictures

"I took pictures of a flood and sold them for \$100. I have been able to buy my house and lot from the sale of pictures."

C. M. COLE,
Washington.

\$97 in Two Days!

"I made \$285 in December. Went out two days last week on home portrait work and made \$97."

A. G. HUGHES,
Kentucky.

Tremendous, big-paying opportunities are open for ambitious men in Modern Photography. This is the picture age. Magazine and newspaper publishers buy thousands of photographs each year. Every manufacturer sends out high priced pictures of his products. Every home wants portraits. Photography is a business running into millions of dollars each year. And there is a great shortage of trained photographers.

EARN \$3,000 TO \$10,000 A YEAR

Hundreds of men are earning big money and establishing their own businesses. Even during spare time, while training, you can make \$75 a week easily—no matter where you live!

AMAZING NEW EASY METHOD

I show you, at home, how to do the kind of work turned out by the big studios in New York and Chicago! I show you how to make big money within 30 days! C. M. Cole bought a home with money he had made when only half way through his training. So well do I know what I can do for you that I guarantee under bond to return every cent of your tuition if you are not thoroughly satisfied.



PROFESSIONAL FREE! VIEW CAMERA FREE!

Write at once for Free Camera Offer—I give you, free, a splendid professional view camera. You will be astonished and delighted. This offer open for short time only—so act quick! No obligation.

INTERNATIONAL STUDIOS, INC., Dept. 1357
 3601 Michigan Ave. CHICAGO, U. S. A.

PIANO JAZZ

By Note or Ear. With or without music. Short Course. Adult beginners taught by mail. No teacher required. Self-Instruction Course for Advanced Pianists. Learn 259 styles of Bass, 684 Syncopated Effects, Blue Harmony, Oriental, Chime, Movie and Cafe Jazz, Trick Endings, Clever Breaks, Space Fillers, Sax Slurs, Triple Bass, Wicked Harmony, Blue Obligato, and 247 other Subjects, including Ear Playing. 133 pages of REAL Jazz, 25,000 words. A Postal brings our FREE Special Offer.

Waterman Piano School, 1826 W. Adams St. Los Angeles, Cal.



"BECOME A LIGHTNING TRICK CARTOONIST"

MAKE MONEY CHALK TALKING. SEND \$1.00 FOR SHARPLY PROGRAM OF TRICK DRAWINGS WITH INSTRUCTIONS BY A PROFESSIONAL CARTOONIST. SATISFACTION GUARANTEED. CIRCULAR FREE. BALDA ART SERVICE, Q4 OSHKOSH, WIS.

STAMMER

If you stammer attend no institute until you get my large FREE book "STAMMERING, Its Origin and The Advanced Natural Method of Treatment." Ask for special tuition rate. Established 22 years. Write today.

MILLARD INSTITUTE OF NORMAL SPEECH
 2317 Millard Building MILWAUKEE, WISCONSIN

Learn to Write

BEGIN TODAY
 WRITE FOR MY FREE BOOK

Send Today for this free book showing how by word and picture what others have accomplished by spare time practice in a few weeks.

YOUR NAME elegantly written on a card if you enclose 2c postage. Address

F. W. Tamblyn, 418 Ridge Bldg., Kansas City, Mo.

BIG PAYING POSITIONS
 are waiting for men and women who can write clearly and legibly. No matter how old you are, or what kind of work you do, you can quickly learn to write well by the Tamblyn Method.

FREE BOOK

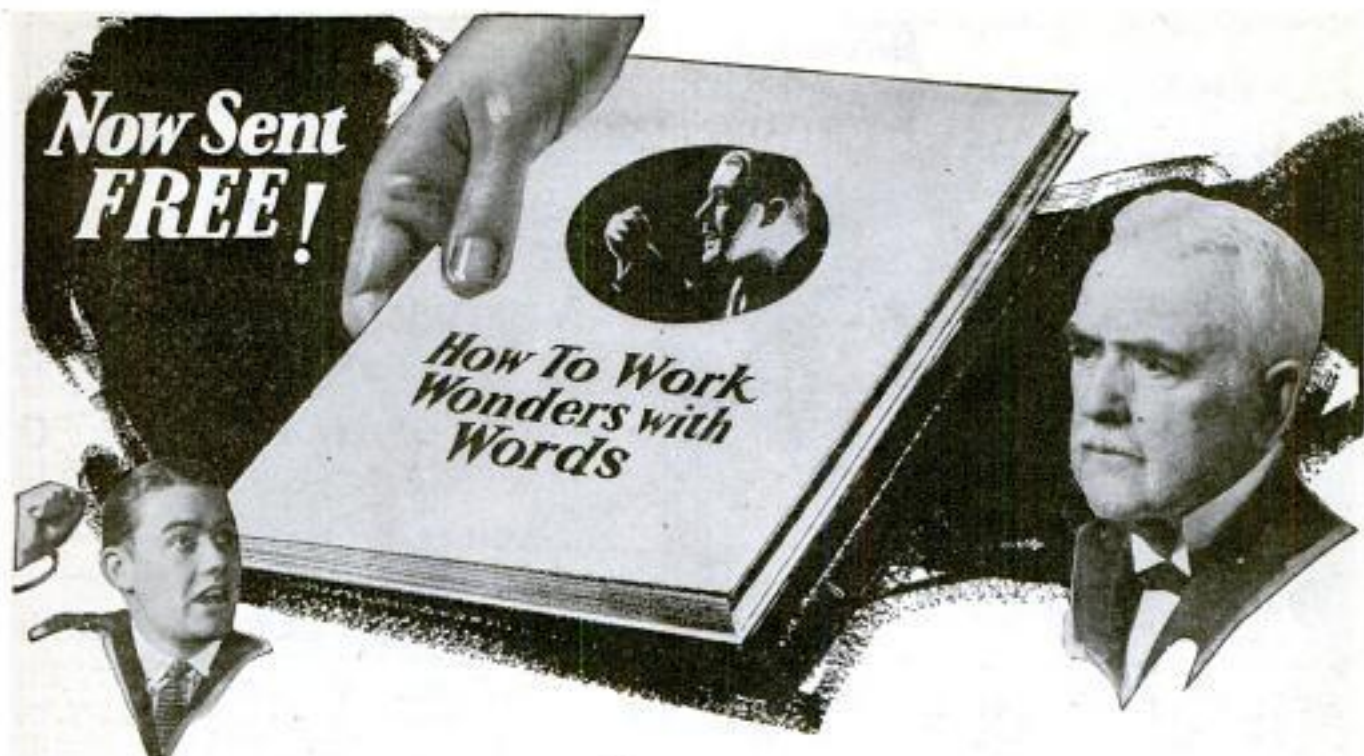

Not Only Men Who Have Made Millions Send for this Astonishing Book ~but Thousands of Others!

Many successful business men have sent for this amazing book NOW MAILED FREE. Such men as Walter C. Ford, of the Ford Manufacturing Company; C. F. Bourgeois, President of Robischon and Peckham Company; H. B. McNeal, President of the Telephony Publishing Company; and many other prominent, prosperous business executives, are unstinting in their praise of it. But don't think it is only for big men. Thousands of young men have found in this book the key to advancement in salary and position, popularity, standing, power and real success.

Today business demands for the big, important, high-salaried jobs, men who can dominate others. It is the power of forceful, convincing speech that causes one man to jump from obscurity to the presidency of a great corporation. Another from a small, unimportant territory to the sales manager's desk. Another from the rank and file of political workers to a post of national prominence as a campaign speaker. A timid, self-conscious man to change almost overnight into a popular and much-applauded after-dinner speaker.

EITHER YOU BECOME A POWERFUL SPEAKER—OR YOUR TRAINING IS FREE

You are shown how to conquer stage fright, self-consciousness, timidity, bashfulness and fear—those things which keep you silent when men of lesser ability get what they want by the sheer power of convincing speech. You are told how to bring out and develop your priceless "hidden knack"—which will win for you advancement in position and salary, popularity, standing, power and real success. This simple, easy, sure and quick training is guaranteed to do this—or it will not cost you a single penny.

ONLY 15 MINUTES A DAY REQUIRED

There is no mystery about the power to work wonders with words. It makes no difference how embarrassed or self-conscious you now are when called upon to speak. Certain principles will show you how to rise head and shoulders above the mass and make yourself the dominating figure in any gathering. How to rise to any occasion and demand what you want with

force, vigor and conviction. Give only fifteen minutes a day in the privacy of your own home and you can accomplish all this in a few short weeks.

MAKE THIS FREE TEST

If you will fill in and mail the coupon at once you will receive this remarkable new book, "How to Work Wonders with Words," which gives you an amazing test by which you can determine for yourself in five minutes whether you are one of the seven men out of every nine who possess the "hidden knack" of powerful speech, but do not know it. Decide for yourself if you are going to allow fifteen minutes a day to stand between you and success. Thousands have found this to be the biggest forward step of their lives. If it has played such an important part in the lives of many big men, may it not in yours?

NORTH AMERICAN INSTITUTE

Dept. 1357, 2601 S. Michigan Ave., Chicago, Illinois

NORTH AMERICAN INSTITUTE, Inc.
Dept. 1357, 2601 S. Michigan Ave., Chicago, Ill.

Please send me FREE and without obligation my copy of your famous book, "How to Work Wonders with Words."

Name.....

Address.....

City.....State.....

WHAT 15 MINUTES A DAY WILL SHOW YOU

- How to address business meetings
- How to propose and respond to toasts
- How to make a political speech
- How to tell entertaining stories
- How to write better letters
- How to enlarge your vocabulary
- How to develop self-confidence
- How to acquire a winning personality
- How to strengthen your will power
- How to be the master of any situation

\$100 for One Good Commercial Drawing



Become An Artist This Quick Easy Way

Thousands who never dreamed they could draw can now easily become artists. **You** too—without any previous training—and no matter how little apparent talent you have—can now easily learn Illustrating, Designing and Cartooning through this amazingly easy method.

You learn at home, yet your work receives the personal attention and criticism of one of America's most successful artists. Many students actually sell enough work during their training to pay for it many times over.

Big Money in Commercial Art

Millions of dollars are being spent this year on advertising and story illustrations, commercial designs, and cartoons. And even more will be spent next year. Commercial art is a **tremendous** field—and a field where very big money is gladly paid anyone who can produce good art work. Advertisers, magazines, newspapers, printing houses, business concerns all need trained artists. Competent artists easily earn from \$50 to far over \$300 a week. And now you can easily enter this "world's most fascinating, best paid business."

Mail Coupon for Free Book

A new handsomely illustrated book has just been printed, which gives all the most up-to-date information on the thousands of wonderful opportunities in Commercial Art and shows how this startling short-cut method easily enables you to enter this field. It tells about our students—their success—what they say—actual reproductions of their work—how they made big money while studying. This attractive book will be sent without cost or obligation. Send for it. Mail coupon now. **Washington School of Art, Room 3010-C, 1115-15th St., N. W., Washington, D. C.**

WASHINGTON SCHOOL OF ART
Room 3010-C, 1115-15th St., N. W., Washington, D. C.

Please send me without cost or obligation your new book on art, "Quick Way to Become an Artist," and details of your special offer.

Name.....
Please write plainly Mr., Mrs. or Miss.

Address.....

City..... State.....

**QUIT WISHING
AND WAITING
EARN**

\$3500 to \$5000 a Yr.

**LEARN
MECHANICAL DENTISTRY**

*Three Months'
Training
Will Qualify
You for
Success.*

*2600 More
Dental Mechanics
Needed Now
and Demand
Is Increasing.*

YOU LEARN BY DOING

We train each student individually—no classes whatever—using the tools of the trade and you learn on regular dental work. But we do not make the **serious mistake of depending on practical work alone.** You are given definite theoretical training as well.

FREE PARTIAL SCHOLARSHIPS

Send today for Free Catalog No. 2, outlining Scholarship Offer, how students "Learn by Doing" actual work through practical, individual instruction, day or evening sessions, and how you can "Earn while Learning."

BODEE DENTAL INSTITUTE

Established 30 years.

New York	Philadelphia
130 W. 60th St.	1205 N. Broad St.
Buffalo	Brooklyn
501 Washington St.	85 Court St.

ELECTRICAL ENGINEERING

Course for men of ambition and limited time. Over 4000 men trained. Condensed course in Theoretical and Practical Electrical Engineering including the closely related subjects of Mathematics and Mechanical Drawing taught by experts. Students construct motors, install wiring, test electrical machinery. Course complete.

IN ONE YEAR

Prepare for your profession in the most interesting city in the world. Established in 1893. Free catalog.

BLISS ELECTRICAL SCHOOL
220 Takoma Ave. WASHINGTON, D. C.

MUSIC LESSONS FREE

IN YOUR OWN HOME

You can read Music like this quickly

Piano, Organ, Violin, Mandolin, Guitar, Banjo, etc. Beginners or advanced players. One lesson weekly. Illustrations make everything plain. Only expense about 20c per day to cover cost of postage and music used. Write for **FREE** booklet which explains everything in full.

AMERICAN SCHOOL OF MUSIC, 51 Lakeside Building, CHICAGO

LEARN WATCHMAKING

and become independent. We help you secure a position. Easy to learn. Send for **FREE CATALOG.**

ST. LOUIS WATCHMAKING SCHOOL, Dept. 5, ST. LOUIS, MO.

BENNY LEONARD'S

**HOME COURSE OF MUSCLE
AND BODY BUILDING**

123 WEST 31st STREET, Dept. 11-0, NEW YORK CITY

Write for **FREE** Booklet

PLUMBERS & STEAM FITTERS

INFORMATION

In handy form on:—
Mathematics—symbols, arithmetic, mensuration, tables.

Physics—specific gravity, pressure, expansion, hydraulics.

Materials—iron, steel, copper, brass, lead, antimony, bismuth, zinc, asphaltum, sheet metal.

Pipe—wrought iron, steel, welded, threads, tests, tubes.

Tools—square, level, plumb bob, pipe threading, torches, fire pots.

Soldering—soft, tinning.

Joint Wiping—preparing joint, wiping, judging solder.

Bending—hot and cold.

Beating—lead flashing, gutter corners, etc.

Sanitation—cold water supply, syphonage, circulation.

House Drainage—sewer, drain, stacks, traps, venting.

Sewage Disposal—purification, cesspools, septic tanks, disposal.

Fixtures—bath, lavatory, shower, urinal, kitchen, tanks.

Pipe Fittings—hubs, splints, laying length, cast soil fittings.

Roughing In—layout for work.

Accessories—valves, cocks, floats, tubing, thread fitting.

Soil Pipe—joints, packing, caulking, wrought pipe, tools.

Screwed Pipe Fittings—forged, malleable brass, joints.

Drainage Fittings—recessed joints.

Pipe Fittings—threading offsets, elbows, assembling.

Heating and Ventilation—steam, vapor, vacuum, hot water.

Gas and Gas Fitting—producers, meters, fittings, pressure, flow, underwriters requirements.

Brazing—lead burning.

Welding—oxidation, blow pipe, thermit.

Blacksmithing—Forges, firing, fluxes, anvil work, tempering.

Refrigeration—ammonia compression, various methods.

Water Supply—wells, city main, pumps, piping methods.

Sheet Metal Work—problems, patterns, mitering, wiring, burring, edging, tucking.

Free
Coupon
Below!



A new set—just out! A practical, illustrated, Reference Library and Study-Course for Master Plumbers, Journeyman and Apprentice Steamfitters, Gas Fitters and Helpers, Sheet Metal Workers, Draughtsmen, Master Builders, Engineers and all Building Trade Students. This valuable set of handy, pocket-size Guides explains in practical concise language and well-done illustrations all the principles, advances and short cuts of the Plumbing and Heating trade—based on modern practice. Contains careful, detailed instructions on how to figure and estimate various jobs. Use FREE COUPON below to examine, without obligation, this valuable work.



AUDELS PLUMBERS & STEAMFITTERS GUIDES - 4 Vols. \$6

1670 Pages—3642 Trade Illustrations

\$
6
A
Set

\$
1
PER
MO.

A
NEW
SET
JUST
OUT!

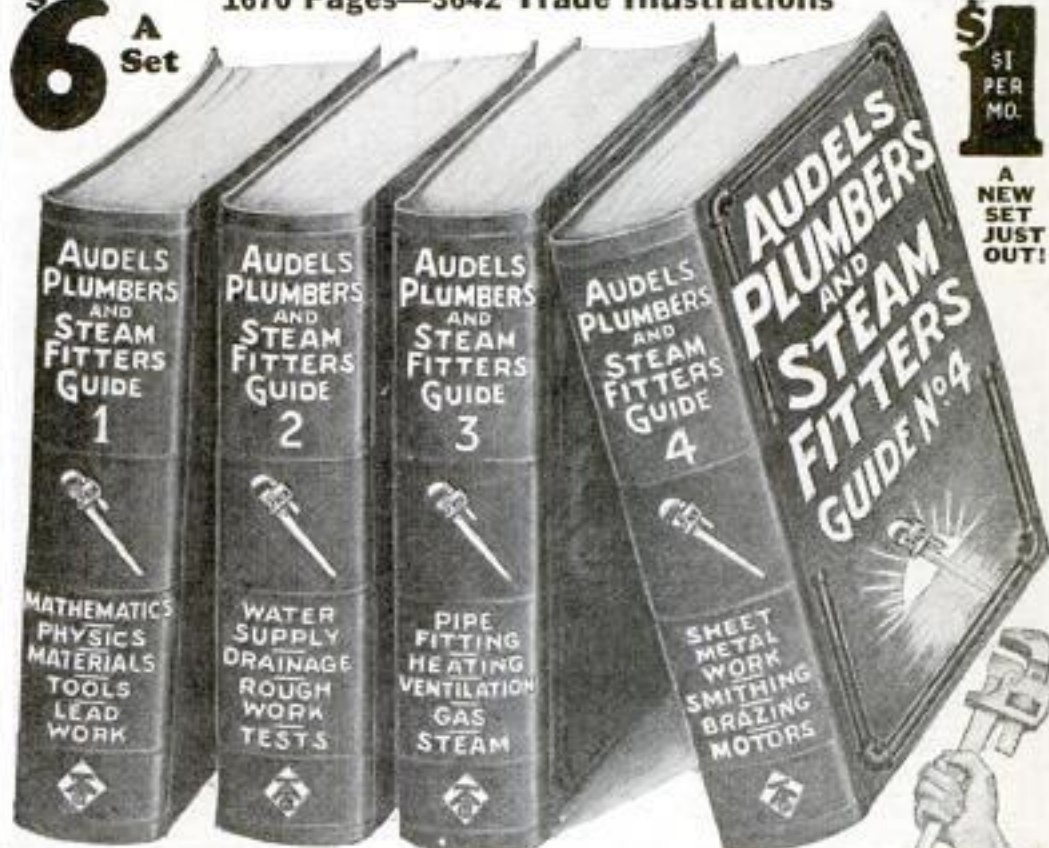

Pocket Size—Easy to Carry and Read FLEXIBLE BINDINGS—GOLD EDGES

These great self-educators teach the plumbing, heating and steamfitting trade in an easy step-by-step manner. There are thousands of practical examples, covering the entire trade—as well as new methods, new ideas, efficiency plans, short cuts, time and money saving suggestions. A practical and valuable Daily Helper on every plumbing job. Every point made clear with easily read text and clear illustrations and diagrams.

Complete Course for Home Study and Reference



Audels Plumbers and Steamfitters Guides give you, at a low price COMPLETE inside trade information and instruction. You can gain a thorough, practical knowledge of the trade by half an hour a day of easy reading. The definitions, tables, diagrams, descriptions, explanations, rules, sketches and illustrations will be found easy to follow and to apply to daily work.

Send No Money—Nothing to Pay Postman!

Send coupon now—today! Not a cent to pay until you have examined books. No obligation unless satisfied. This is your big opportunity for advancement.

**FREE
EXAMINATION
COUPON**

THEO. AUDEL & CO., 65 W. 23d St., New York.
Please send me (postpaid) for free examination, AUDEL'S PLUMBERS and STEAMFITTERS GUIDES, 4 numbers. If satisfactory, I will send you \$1 within 5 days and \$1 monthly until \$6 is paid.

Name.....

Address.....

Occupation.....

Reference.....

10T30

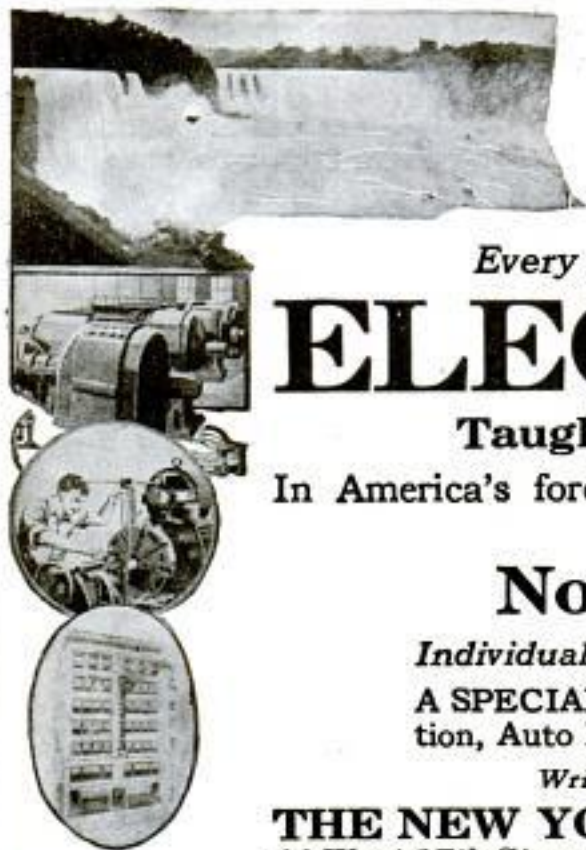

Learn By Doing!

Every phase of all branches of ELECTRICITY

Taught By Actual Practice
In America's foremost institution for trade training.

Established 1902

No Books Used

Individual Instruction. Start Any Day.
A SPECIAL and SEPARATE Course in Ignition, Auto Lighting and STARTER Systems.

Write for FREE 64-Page Catalog

THE NEW YORK ELECTRICAL SCHOOL
44 West 17th Street NEW YORK CITY

STUDY AT HOME

Directed by

The University of Chicago

Courses in English, History, Chemistry, Business, Education, Mathematics, Psychology, and 35 other subjects command credit toward a Bachelor degree. Begin any time. Address 15 Ellis Hall, University of Chicago, Chicago, Ill.

Music Lessons

WITH ACCREDITED SCHOOL

At Home

Any Instrument Write naming course you are interested in: Violin, Cornet, Mandolin, Guitar, Banjo or Hoop Organ—and we will send FREE CATALOG. SEND for it NOW!
University Extension Conservatory, 192 Siegel-Myers Bldg., Chicago

Complete Conservatory Course by Mail

Wonderful home study music lessons under great American and European teachers. Endorsed by Paderewski, Master teachers guide and coach you. Lessons a marvel of simplicity and completeness.

Whatever Your Question;—be it the pronunciation of Fascista, the spelling of a puzzling word, the location of Esthonia, the meaning of soviet, realtor, vitamin, etc., this Supreme Authority—

WEBSTER'S NEW INTERNATIONAL DICTIONARY

contains an accurate, final answer. 407,000 Words 2700 Pages. 6000 Illustrations.
Regular and India-Paper Editions G. & C. MERRIAM CO., Springfield, Mass.

Write for specimen pages, prices, etc., and FREE Pocket Maps, per Popular Mechanics.



TELEGRAPHY

Horse and Wireless and RAILWAY ACCOUNTING taught thoroughly. Big salaries; great opportunities. Oldest, largest school. Endorsed by Telegraph, Railway, Radio, and Government officials. Expenses low—opportunities to earn large portion. Catalog free. DODGE'S INSTITUTE, Jones St., Valparaiso, Ind.

DON'T STAMMER

Master speech. Make friends. Double income. Learn how easy it is. Dime burner transcription and phonograph record. 153 Stinson, The Lewis Institute, Detroit



WANTED! U.S. RAILWAY MAIL CLERKS

STEADY WORK—NO LAYOFFS—PAID VACATIONS
TRAVEL—SEE YOUR COUNTRY
Common Education Sufficient—Many other jobs obtainable

\$1900 to \$2700 Year
MEN—BOYS 18 UP SHOULD
MAIL COUPON IMMEDIATELY

Franklin Institute, Dept. H-191, Rochester, N. Y.

Sirs: Send me, without charge, (1) Sample Railway Mail Clerk Examination questions and free sample coaching; (2) tell me how to get a U. S. Government job; (3) send list of places at which examinations will be held; (4) send copy of illustrated book, "How to Get U. S. Government Jobs."

Name

Address



Radio Needs

Earn \$50 to \$250 a Week in RADIO

Trained Men

Easy to Become a RADIO EXPERT Train at Home in Spare Time

Big Jobs Waiting in the Radio Business Up-To-Date Receiving Sets Given With Course

If you are making less than \$50 a week—if you want to get into the big pay class in the world's fastest growing industry—get into Radio—NOW. Coupon brings you full information.

Big Jobs are open for trained men, in every section of the country. Radio manufacturers—distributors—broadcasting and receiving stations—railroads and steamship companies and branches of the government, need trained Radio experts NOW! Opportunities are open everywhere for men to go into business for themselves as Radio Experts. The pay is big. Thousands are now making \$50 to \$250 a week in Radio. This new industry is making new millionaires almost over night.

Learn Quickly at Home by Tested Method

You can learn Radio quickly, and easily, in your spare time at home, with the help of the National Radio Institute—teaching Radio successfully by mail since 1914. This famous, tested course makes Radio as simple as ABC—and so fascinating you will scarcely realize that you are mastering one of the world's most important industries. In a short time you may become the Radio Expert of your town or wherever you wish to locate. You get the benefit of our years of experience and you learn Radio RIGHT when you learn our way!

This is the Course That Pays for Itself

We mean every word of it! We have developed the famous method that makes it unnecessary for your training to be an expense. Instead of making any man "scrimp" to get his training, our system makes your course pay you returns practically from the start. When you learn our proven way your course will pay for itself, and more—much more! Get the details of these amazing methods.

Don't Worry About Age or Education

It makes no difference what your age is or what your previous training has been. Radio is a field in itself. It calls men of all ages from youth to settled middle age. Success does demand training in Radio and the N. R. I. Course gives you the training necessary to Success.

You learn by doing—through the N. R. I. Course. All materials and equipment necessary are furnished you along with your course. You are sent receiving sets to build and install—real sets for experimental work and pleasure. This is a practical course that teaches you to get the practical results that big pay jobs demand.

Helpful Employment Service

We are constantly in touch with openings for trained Radio men. The men we train get first chance at these fine jobs through our Free Employment Department—at no extra cost. When you complete your training we help you until you get the job you want.

Mail Coupon Quick for FREE BOOK and Special Offer

The Coupon below will bring you the most amazing book on Radio ever written. It will open your eyes to the opportunities for you in this establishment, big pay field and tell you how to become a Radio Expert in your spare time at home. It has helped thousands of men to success in Radio.

Important: We have Special limited Offer for those who act quickly. Mail the coupon or write a letter Now.

National Radio Institute
Dept. 15MB
Washington, D. C.

Get This Free Book



NATIONAL RADIO INSTITUTE,
Dept. 15MB, Washington, D. C.

Without obligation send me your book "Rich Rewards in Radio" which tells about the opportunities in Radio, how spare time study at home will qualify me quickly as a Certified Radio-trician so I can get one of those splendid positions, and how your Employment Service helps me to secure a big pay job.

Name.....AEP.....

Street.....

City.....

Proof that Radio Pays

See what these N. R. I. Men are doing

Buys New Car with Earnings

"I am at present employed as service manager for the Geo. F. Dent Radio Service Co. and I am still taking the course.

"I have great success selling, building, repairing and installing all kinds of Radios. At present I am getting a salary and commission which, although I have only been with the firm for 3 months, has enabled me to purchase a new car."

RICHARD E. JONES,
Bay City, Michigan.

Makes \$50 to \$80 a Week More

"Your course leads so much further ahead than practical electricity that there is nothing I left to say. Since I took your course I have earned from \$50 to \$80 a week more."

FRANK FOWLER,
Gordon, Nebraska.

Increases Pay 160 Per Cent

"I was just receiving \$3.00 per 8 hours when I enrolled with N. R. I. and now I am receiving \$1.00 an hour (160% increase). That is where N. R. I. put me. The course has been worth \$2,500 a year to me and in another year it will be worth \$3,500 a year."

ANDREW M. SHUBIS,
Lebanon, Pa.

**Earn \$50 to \$250
a week
in Radio**

BARBERING

Now One of the Highest Paid Professions! \$90 to \$150 Every Week!



Easy to Learn—Quick

to Earn! That's BARBERING for YOU! And the best part of it all is this—scientific barbering, as taught the modern MOLER way, makes YOU a Master Barber in a short course of intensive training, at small expense! You soon step out as your own Boss, if you wish, in your own Shop, which we will gladly help you equip.

MOLER Graduates are Always Busy! MOLER trained Men are always given the preference, for they alone possess the valuable, thorough MOLER training in the application of all the latest scientific Barbering methods, including the Electric hair cutter, the mechanical massage, and the latest vogue in ladies' hair bobbing. MOLER also gives special training in ladies' marcelling and an easy practical course in the treatment of skin diseases.

EARN WHILE LEARNING!

"Where there's a Will there's a Way" to earn BIG pay! Write to the nearest MOLER College, there is one near you, and learn how you can earn while you learn the barber trade. Ask for the new FREE MOLER Barbering Booklet B. Find out HOW MOLER helps you help yourself AFTER you graduate, as well as BEFORE! Find out why MOLER Men are making DOUBLE the money others made last year, before Ladies' Shingle Bobbing became so popular. You're NEXT in line for big pay—the MOLER way. Send Coupon TODAY!

Moler System of Colleges

30 Branches in United States and Canada

New York, N. Y.	Detroit, Mich.	Atlanta, Ga.
Chicago, Ill.	Denver, Colo.	Memphis, Tenn.
St. Louis, Mo.	Omaha, Nebr.	Dallas, Tex.
Kansas City, Mo.	Milwaukee, Wis.	Houston, Tex.
Cincinnati, Ohio	New Orleans, La.	San Antonio, Tex.
Cleveland, Ohio		

MOLER SYSTEM OF COLLEGES

Address Nearest Branch

(Street Address NOT Needed)

Please send me without obligation on my part your Booklet B.

Name

Address

City.....State.....

Make Yourself a Popular Favorite with the TENOR BANJO

Easy to Play—Learn at Home in Spare Time



\$18 TENOR BANJO FREE When You Enroll

You Can Play It in 30 Minutes

45,000 successful students back up our claim that you can play a piece in 30 minutes by following our printed instructions. You get this \$18 TENOR BANJO, FREE, as soon as you enroll for 52 easy lessons. New low price and easy terms!

Picture Lessons Make it Easy

You can't fail to learn because the pictures explain every move. You don't have to be able to read notes. Better than oral instructions—and your lessons are always before you. We teach you in our large New York conservatory, by mail.

Play for Fun or Money

Don't be a wallflower. Get in on parties. Entertain your friends. Be popular. Play at dances, etc. Form an orchestra. Earn money in spare time. Our 52-lesson course will make you an accomplished player. Play as you play.

WRITE FOR SPECIAL FREE OFFER

Famous teachers will explain how we can positively teach you to play. You get the FREE \$18 TENOR BANJO with the first lesson. We also give you, free, a genuine Seal Grain Fabrikoid Carrying Case. Write for details.

First Hawaiian Conservatory of Music, Inc.

9th Floor, Woolworth Bldg., Dept. 60, New York, N. Y.

Approved as a Correspondence School under the Laws of the State of N. Y.

STOP GROPING IN THE DARK

Be Yourself—Get Into Your Stride—MAKE GOOD!



All men—women, 18 to 65 wanting to qualify for Government Positions, \$140-\$300, traveling or stationary—Write Mr. Oxment, 111 St. Louis, Mo., immediately.

A FILE	Stop Forgetting	NOT A FILE
	<p>Make Your Mind an index from which you select facts, figures, names, faces. Develop concentration, self-control; overcome bashfulness, forgetfulness.</p> <p>Write today for FREE memory and concentration test and illustrated booklet, "How to Remember."</p> <p>PROF. HENRY DICKSON Dept. 70510 Evanston, Ill.</p>	

LAW Personal Instruction By Mail

Be a lawyer or law trained business man. Quality to earn \$2,500 to \$15,000 a year. University methods. TUITION LOW. EASY TERMS. Text books furnished. Practical and authoritative non-resident course. Endorsed by bench and bar. Prepares for bar or business. Over 60,000 students. PERSONAL INSTRUCTION. Guarantee to coach free any graduate failing to pass bar exams. SPECIAL REDUCED TUITION OFFER now in force. Write today for particulars and book on law FREE.

AMERICAN CORRESPONDENCE SCHOOL OF LAW
Dept. 1357 3601 Michigan Avenue, CHICAGO

Learn Watchwork, Jewelrywork and Engraving.

A fine trade commanding a good salary, and your services are always in demand. Address Horological, Dept. P, Bradley Institute, PEORIA, ILL. for our latest catalog.

Learn Advertising at HOME

The highest paid men in the world are advertising men. You can learn easily and quickly at home during your spare time. Larger opportunities now in advertising than ever before. Tremendous demand for our graduates at big pay.

Send for FREE Book. Giving interesting information and vital facts—just what you want to know about advertising. Write today!
PAGE-DAVIS SCHOOL OF ADVERTISING
Dept. 1357 3601 Michigan Ave., Chicago, U. S. A.

For 22 years  from this
 Recognized College of Engineering
 A Home-Study Course in
DRAFTING

Everything today is built from drawings made by Draftsmen. Industry calls for 50,000 new men yearly. Draftsmen work hand in hand with the architect, the engineer, the designer, the builder. And thus many men rise from such positions to be heads of great contractors' organizations, directors of railroads, chief engineers—responsible positions commanding very attractive salaries.



Mr. John Hocke

**DRAFTING
 HALL OF FAME**

Mr. John Hocke who is now successfully practicing architecture in Chicago, is a graduate of Chicago Technical College, '13.

He says: "The instruction I received from your College has provided a thorough foundation for solving any problems as they present themselves in my office."

NOTICE—A well established Placement Bureau assists both graduates and undergraduates to find positions.

FREE TRIAL LESSON

Prove your fitness and liking for one of industry's highest paid professions. We want you to know what Drafting is like . . . how readily you can progress . . . how we train and teach you by mail. So, before you enroll . . . FREE . . . without cost or obligation . . . we send you a trial lesson to study in your own home.

**Within Ten Months
 Increase Your Income**

No special training or talent is required. In ten months' time or less . . . we can train you . . . at home, in your spare hours . . . to be a good Draftsman.

And remember this: In Drafting a big income is open to every properly trained man. Thousands today are earning \$35 to \$100 per week. The reason is simple: Good Draftsmen are in constant demand.

Book of Facts FREE

We will send you a 40-page Book. It tells you all about Drafting . . . and our courses. What prominent men say . . . where Draftsmen are employed . . . their salaries . . . their opportunities . . . what our students have done and are doing . . . how many have increased their salaries even before finishing their courses . . . how many hold high-sal-

aried executive positions today. Tells how 34 instructors give you from this recognized 22-year-old college a practical, short, home-study course.

**The Coupon Below
 Means Money to You**

Find out what Drafting may mean to you . . . mail that coupon. Here is a field in which you can work and win. We make the test easy, for, with no obligation, we send you a trial lesson FREE. Note the fairness of this offer, the absence of exaggerated promises.

\$25 Outfit Included

When you enroll, you will need drafting instruments; so, included in the cost of the course, is a \$25 "lifetime" set. If you have instruments, credit will be allowed. Note that we do not claim to give you these instruments "free". Tuition is low, payments easy.

—In Chicago—Earn While You Learn—

Those who can come to Chicago will find opportunity to earn living expenses in part-time positions, outside of school hours, while attending day or evening classes at the College.

Chicago Technical College, founded 1904, is known as one of America's oldest and largest schools of specialized engineering. Over 1000 men enroll in resident day and evening courses yearly.

Diplomas in Civil, Mechanical and Electrical Engineering and Architecture granted after two years. Degree of B. S. conferred after three years in the day course. Short courses offered in Drafting, Plan Reading, Estimating, etc. Evening classes for day workers.

If interested in attending Day or Evening Classes at the College in Chicago write for 72-page "Blue Book"—mailed free.

**Send Today for FREE Trial Lesson
 Fill Out the Attached Coupon NOW**

Chicago TECHNICAL College

Drafting—Engineering—Electricity—Architecture . . . all branches

Chicago Technical College,
 Dept. 1030, 118 E. 26th St., Chicago, Ill.

Send me, without cost or obligation, your
 FREE Trial Lesson and your 40-page Book
 of Facts about Drafting.

Name.....
 Address.....
 City and State.....



SHOW CARD LETTERING

Learn at Home

HERE is the very course you need if you want to get a good paying position as a Show Card Letterer or Sign Letterer, or have a business of your own. This course is complete and practical and especially arranged to meet the needs of the student who studies at home. It was written by E. L. Koller, Principal of the School of Art of the International Correspondence Schools, member of the American Federation of Arts, and The National Society of Craftsmen.

Mr. Koller has had twenty years' teaching experience, and his success in helping other men and women is an indication of what he can do for you.

H. L. Wood, a clerk, made more than \$700 "on the side" before he had completed his course and also won \$125 in prizes. Harry William Lord writes that he has more than doubled his salary as a result of studying this I. C. S. course in spare time. William Whitman, a former wagon builder, now has a sign painting business of his own and is earning nearly three times as much as he did before enrolling with the International Correspondence Schools.

There is no doubt that Show Card Lettering and Sign Lettering offer a real opportunity to ambitious men and women. Just mark and mail the coupon and we'll gladly send you a booklet telling all about the I. C. S. course in Show Card Lettering, or any other subject in which you are interested.

INTERNATIONAL CORRESPONDENCE SCHOOLS

Box 5534-E, Scranton, Penna.

The oldest and largest correspondence schools in the world

Without cost or obligation on my part, please tell me how I can qualify for the position or in the subject before which I have marked an X:

SHOW CARD LETTERING

- | | |
|---|---|
| <input type="checkbox"/> Business Management | <input type="checkbox"/> Salesmanship |
| <input type="checkbox"/> Industrial Management | <input type="checkbox"/> Advertising |
| <input type="checkbox"/> Personnel Organization | <input type="checkbox"/> Better Letters |
| <input type="checkbox"/> Traffic Management | <input type="checkbox"/> French |
| <input type="checkbox"/> Business Law | <input type="checkbox"/> Stenography and Typing |
| <input type="checkbox"/> Banking and Banking Law | <input type="checkbox"/> Business English |
| <input type="checkbox"/> Accountancy (including C.P.A.) | <input type="checkbox"/> Civil Service |
| <input type="checkbox"/> Nicholson Cost Accounting | <input type="checkbox"/> Railway Mail Clerk |
| <input type="checkbox"/> Bookkeeping | <input type="checkbox"/> Common School Subjects |
| <input type="checkbox"/> Private Secretary | <input type="checkbox"/> High School Subjects |
| <input type="checkbox"/> Spanish | <input type="checkbox"/> Illustrating |

TECHNICAL AND INDUSTRIAL COURSES

- | | |
|---|--|
| <input type="checkbox"/> Electrical Engineering | <input type="checkbox"/> Architect |
| <input type="checkbox"/> Electric Lighting | <input type="checkbox"/> Architects' Blueprints |
| <input type="checkbox"/> Mechanical Engineering | <input type="checkbox"/> Contractor and Builder |
| <input type="checkbox"/> Mechanical Draftsman | <input type="checkbox"/> Architectural Draftsman |
| <input type="checkbox"/> Machine Shop Practice | <input type="checkbox"/> Concrete Builder |
| <input type="checkbox"/> Railroad Positions | <input type="checkbox"/> Structural Engineer |
| <input type="checkbox"/> Gas Engine Operating | <input type="checkbox"/> Chemistry <input type="checkbox"/> Pharmacy |
| <input type="checkbox"/> Civil Engineer | <input type="checkbox"/> Automobile Work |
| <input type="checkbox"/> Surveying and Mapping | <input type="checkbox"/> Airplane Engines |
| <input type="checkbox"/> Metallurgy <input type="checkbox"/> Mining | <input type="checkbox"/> Agriculture and Poultry |
| <input type="checkbox"/> Steam Engineering <input type="checkbox"/> Radio | <input type="checkbox"/> Mathematics |

Name.....

Street Address.....

City..... State.....



1,000 Hotel Positions Open!

HOTELS, restaurants, clubs, apartments everywhere need trained men and women. Over 70,000 high-class positions paying up to \$10,000 a year are open each year in the hotels of the United States. In 1925 the Hotel Business is America's largest industry in new construction. Nearly a billion dollars' worth of New Hotels and Restaurants being built this year will need over 60,000 trained men and women.

Hotels start you at salaries up to \$3,500 a year, with your living. At any time you have your choice of over 1,000 hotel positions open.

You can have one of these high-class big-pay positions, with luxurious apartment and meals and fascinating work. No previous experience necessary. The Lewis Schools guarantee to give you the valuable knowledge that it has taken some of the most successful hotel men years to obtain—men who are now making \$5,000 to \$50,000 a year. We train you by mail in your spare time at home with the Lewis Simplified Study Plan, and put you in touch with big opportunities. All of your training under the personal direction of Clifford Lewis, former U. S. Government Hotel and Restaurant Expert, now Managing Consultant for over 150 Hotels of 50 to more than 600 rooms each, throughout the United States, totaling over 16,000 rooms. Our students employed, our methods endorsed by leading hotel men everywhere.

Send today for FREE BOOK, "Your Big Opportunity," showing how we can train you for one of these splendid positions in 20 weeks or less, and explaining our Money-Back Guarantee.

Lewis Hotel Training Schools

CLIFFORD LEWIS, Pres.

Room X-376

Washington, D. C.

Welding

Mr. Mechanic, be in demand! Expert welding is in demand in every part of the world. Earn top wages, or go into business for yourself. We train you at Home, in your Shop, or on the Job. "Kerr's Training Course for Welders" is a thorough course in practical experience, covering all metals. It trains you in WHAT TO DO, WHY IT IS DONE, and HOW TO DO IT. Write at once for information (state if you own or have access to a welding outfit). KERR'S WELDING SCHOOL, Box 1313, Los Angeles, California (2B)

LAW High-Grade Instruction

By Correspondence

Prepares You for

the Bar—Est. 1892

University Methods. Standard Text-Books.

Approved by Bench and Bar. Graduates practicing in every state. Send today for Free Catalog and Rules for Admission to the Bar.

CHICAGO SCHOOL OF LAW, 502 Reaper Block, Chicago, Ill.



If I Send You a Suit

made in the latest style from the finest goods, will you keep it, wear it, and show it to your friends as a sample of my sensational \$25.00 suits, guaranteed regular \$50.00 values? Could you use \$3.00 an hour for a little spare time? If so, write me at once for my wonderful new proposition. Just write your name and address on a card and mail to Dept. 894.

Knickerbocker Tailoring Co.

133 So. Peoria St.

Chicago, Ill.

LEARN WATCH REPAIRING



You can learn by our modern and original system of instruction every part of the Watch Repairing Trade at home as good or better than at a shop. You can earn money while learning and secure a well paying position or start in business after completing our course of instruction. Good watch repairers are always in demand and earn from \$50 to \$75 per week. For particulars apply to the Wisconsin School of Watch Repairing 166 Mason St., MILWAUKEE, WIS.

Men! Here's a Contract



NEW HAIR in 30 Days Or Absolutely No Cost

Save Yourself From Baldness. Stop Falling Hair. Here Is Your Contract—
Grow New Hair in 30 Days Or This Trial Won't Cost You One Cent.

By ALOIS MERKE

Founder of Famous Merke Institute, Fifth Avenue, New York

THAT'S clear, isn't it? I make no conditions. No matter how fast your hair is falling out, no matter how much of it is gone—this offer stands. I don't care what treatments you've tried without results—here is a new scientific system that will give you a new head of hair—or I pay the whole cost of the treatment myself.

How am I able to make this amazing offer? Because the Merke System of hair growth is founded upon a recent scientific discovery. I have found during many years of experience in the Merke Institute, Fifth Avenue, N. Y., that in most cases of baldness the hair roots are NOT dead, but merely dormant—asleep!

Here's Proof!

"The condition of my hair was very bad. After six weeks' treatment with the Thermo-cap, my head was covered with short hair and it was no longer dull and lifeless. I kept up the treatment and in return I have as good a head of hair as any one could wish."

Clarence Terpening, 158 South Cedar St., Galesburg, Ill.

"Your Thermo-cap has done a wonderful thing in bringing back my hair where all other things had failed. The top of my head is now entirely covered with hair after using the Thermo-cap for about two months and new hair seems to be coming in all the time."

Harry A. Brown, 21 Hampton Place, Utica, N. Y.

It is an absolute waste of time—and money—to try to penetrate to these dormant roots with massages and tonics, which merely treat the surface skin. You wouldn't expect to make a tree grow by rubbing "growing fluid" on the bark—you'd get at the roots.

And that is just what my scientific system does. It penetrates below the surface of the scalp. It stimulates

the dormant roots. It awakens them. The tiny capillaries begin to pump nature's own nourishment into them. Hair begins to grow again. And here's the wonderful thing about this system. It is simple. You can use it at home—in any home that has electricity—without the slightest discomfort.

This Is Your Bona-Fide Contract

Thousands of men and women have been treated successfully at the Merke Institute. Hundreds daily are getting amazing results with this less expensive home treatment. I do not say that all cases of baldness are curable. There are some that nothing in the world can help. Yet so many men and women write in daily about the wonderful results that I gladly make this offer. Here is your contract—try this remarkable treatment for 30 days. Then if you're not simply delighted with the new growth of hair—write me at once. Say that my system hasn't done all I claimed for it—and I'll see that the 30 day trial doesn't cost you one cent.

Free Booklet Tells All

There's no room here to tell you all about your hair—and about the amazing contract I offer you. But I will be glad to tell you all if you are interested. It's free—absolutely without any obligations. Just mail the coupon and I will send you, without cost, a wonderfully interesting booklet that describes in detail the system that is proving a boon to thousands in this and other countries. Mail this coupon and the booklet will reach you by return mail. **Allied Merke Institutes, Inc., Dept. 1610, 512 Fifth Avenue, N. Y. C.**

ALLIED MERKE INSTITUTES, Inc.
Dept. 1610, 512 Fifth Ave., New York City.

Please send me—without cost or obligation—a copy of your book, "The New Way to Grow Hair," describing the Merke System.

Name.....

Address.....

City..... State.....

LEARN CARTOONING

Successful cartoonists earn big salaries. Many of the most popular cartoonists of today learned to draw in their spare time, at home, through the Landon Course of Cartooning and now earn \$75 to \$200 or more per week.



The Landon Picture Chart Method of teaching ORIGINAL drawing makes cartooning easy to learn. Hundreds of sketches like the above explain every step in creating ORIGINAL heads, figures, animals, etc. Send 6c in stamps today for sample Landon Picture Chart and full explanation of this wonderful course, also long list of successful Landon students and information showing possibilities for you. *Please state your age.*

The Landon School, 738 National Building, Cleveland, Ohio

Former Students Who Are Now Successful Comic Strip Artists

BLOSSER—Now drawing "Freckles and His Friends."
BYRNES—Now drawing "Reg'lar Fellers."
BRANNER—Now drawing "Winnie Winkle."
LOCHER—Now drawing "Cicero Sapp."
TAYLOR—Now drawing "Mom 'n Pop."
EDWINA—Now drawing "'Cap' Stubbs."
CRANE—Now drawing "Washington Tubbs II."
ETHEL HAYS—Now drawing "Flapper Fanny."
PAUL FUNG—Now drawing "Gus & Gussie."
KNICKERBOCKER—Now drawing "This and That."

BIG OPPORTUNITY IN ENGINEERING

Become a Practical-Technical, Electrical or Mechanical Engineer. Earn big money. More good positions open than trained men to fill them. Send at once for *New, Illustrated Catalog D*. Gives actual facts on famous *Finlay Simplified and Condensed Method of Training*. Courses taught range from 3 months to 2 years. Thousands of Finlay Graduates holding responsible, high-salaried positions.

GET PRACTICAL-TECHNICAL TRAINING

By elimination of non-essentials *Finlay Condensed Method* makes success possible in Electrical or Mechanical Engineering in 2 years, instead of 4. We train Hand and Head. That is the secret. Now in 23rd successful year. New Building. Completely equipped laboratories and shops. Department of Architecture, Structural and Mechanical Drafting. Faculty of trained Experts. Day and night sessions. Degrees awarded. Students assisted to positions. *Full term begins September 15.*
FINLAY ENGINEERING COLLEGE - KANSAS CITY, MO.

\$3 an Hour for Your Spare Time or a Real Business Now—later a Fur Shop of Your Own

Learn "Furcraft"

Learn by mail, evenings at home. Make up New Furs and Make Old Furs Like New. Learn Fur Repairing and Cleaning. Learn our secret processes. Learn glazing, ironing and storage. Big demand, big need in every neighborhood. A wonderful uncrowded field. Learn now. Earnings start in 30 days. Men and women equally successful.



Free Book

Tell us all about this greatest of Spare Time Money Makers. Big opportunity now in your neighborhood. Be first. Write at once for Free Book and get full details of this money making business. **NORTHWESTERN FUR COMPANY**
 1777 Sunderland Building, Omaha, Nebraska

"THERE'S MONEY IN IT"

AT HOME LEARN TELEGRAPHY AT HOME MORSE AND WIRELESS

TEACH YOURSELF

in half usual time, at trifling cost, with the wonderful Automatic Transmitter, **THE OMNIGRAPH**. Sends unlimited Morse or Continental messages, at any speed, just as an expert operator would. Adopted by U. S. Government, and leading Universities, Colleges and Telegraph Schools. 3 Styles. Catalog free.

If you own a Radio Phone Set—and don't know the code—you are missing most of the fun.

OMNIGRAPH MFG. CO., 13-19 Hudson St., NEW YORK



Start Little Mail Order Business—Free Book

Home employment evenings. Beginners Outfit furnished. Book Free. Pier, 842 Cortland St., NEW YORK

Learn

RADIO

At Home—By Mail

\$3,000 to \$10,000 a year. How to build, repair, install, set radios now, quickly learned. Simple, easy home-study plan. 1000-mile set free with course. Low cost, easy terms. Send now for free big book on radio opportunities.

RADIO ASSOCIATION OF AMERICA
 4513 Roosevelt Ave., Dept. A-10, Chicago, Ill.

WANTED—RAILWAY MAIL CLERKS

\$1900 to \$2700 a Year for Life

(ALL POSTAL PAY JUST RAISED)

Every second week off with full pay—no "lay-offs" because of strikes, poor business, etc.—sure pay—rapid advancement to higher positions. City and country residents stand same chance. Common sense education sufficient—no political influence.

TRAVEL—SEE YOUR COUNTRY DON'T DELAY—ACT AT ONCE

Mail Coupon today—sure. Every day's delay means so much less chance of appointment from the next examinations—so do it at once.

Take this First Step for a U. S. Government Job
 Use Coupon Before You Lose It

COUPON

FRANKLIN INSTITUTE, Dept. H-178, Rochester, N. Y. Kindly send me, entirely free of charge, (1) A full description of the position checked below; (2) Sample examination questions; (3) Free Sample Coaching; (4) A list of U. S. Government Jobs now obtainable; (5) Tell me how I can get the position here checked.

...Railway Mail Clerk (\$1900 to \$2700) ...Customs Positions (\$1140 to \$1860)
 ...Postoffice Clerk (\$1700 to \$2100) ...Internal Revenue (\$1140 to \$1860)
 ...City Mail Carrier (\$1700 to \$2100) ...Rural Mail Carrier (\$2100 to \$3300)
 ...Income Tax Auditors (\$2040 to \$3000)

Name

Address



H.A. McCARRIE

Be a Dental Laboratory Expert!

My Graduates
Are Successful!

Let McCarrie train you

My Students Did These Jobs!



Lower stress-breaking lingual bar case, required where lower front teeth are missing.



Full upper plate, ordered by Dentist where patient has lost all upper teeth.



Lower removable bridge, needed where molars are missing on one side only.

What Is Dental Laboratory Work?

Successful, busy Dentists no longer make their own plates, crowns, bridges, etc. They send "impressions" to a Dental Laboratory where the work is done by EXPERTS. Gold, silver, porcelain, rubber are some of the materials used. The work is pleasant, interesting, easy.



Laboratory of Glen Davis

In Tennessee—a McCarrie graduate. "I encourage my graduates to go into business for themselves and I help them succeed."



"Earnings four times larger!"
"I am still with Dr. Medina, doing all his work and making good. My earnings are four times larger than before I entered your school. Thank you for assisting me to this fine position."
J. CARRILES.



"Course intensely practical."
"Any man who wants to become a first class mechanical dentist can do so at your school. You teach by making the student do actual work."
E. SCHNEIDER.
(Figs.)



Deutschman of So. Dakota.
"I now have a good job working for New York Dentists. I like my work fine. Thank you very much for helping me."



"I can say frankly that I appreciate your good help and cooperation. Any man in earnest can master mechanical dentistry at your school."
Harry D. Stone,
(Montana.)

Be McCarrie Trained
If You Would Be
Successful!

Many McCarrie Graduates Earn \$65 to \$125 A Week!

Don't crowd into the old over-crowded trades. Before you decide which line of work to go into—look into the Dental Laboratory business. You'll find it's an interesting, easy, WELL-PAID Mechanical profession—easily learned in a few months in my big schools at Chicago, Detroit and Cleveland. You'll discover there's a brighter future, bigger opportunities to make real money in "Mechanical Dentistry," because 70,000 busy Dentists must send their Laboratory jobs to Experts, specialists.

LEARN QUICK THE McCARRIE WAY!

I have successfully trained many men and women with only common schooling and no previous experience. No text-books, no classes in my schools. You learn here by doing actual Dental Laboratory jobs on standard materials, with standard tools which I supply without extra charge. Individual, personal instruction only.

R. R. FARE FREE to Chicago, Detroit, Cleveland

—to every student who enrolls. Actually Free, because I have not raised the price of tuition a penny since announcing this offer. For a limited time also, I am supplying every student with a complete outfit of new tools and materials. Tuition within reach of the untrained fellow who wants to get ahead. Easy terms.

Mail COUPON for FREE CATALOG, Special Offers, Complete information. Don't wait.
Send today!

JOB — or a Laboratory of Your Own!

Very little capital needed to go into business when you have McCarrie training. My instruction includes training in Laboratory methods and management. When you finish, we will help you find a good location for a Laboratory of your own, help you start, help you make a success of it. Or if you prefer a job at good pay, we give you absolutely free the services of our Employment Department which has placed many of my graduates in fine positions.

A JOB While You Train

My schools are located in three wonderful cities where we can always help you find a spare-time job if you must "work your way through." We maintain a special employment department to find positions for my students. So don't hesitate because you haven't ready cash in your pocket. Show me you're willing and ambitious and I'll go the limit for you.

H. A. McCarrie, Director
McCarrie Schools of Mechanical Dentistry
1338 S. Michigan Ave., Dept. 2601-J, Chicago.
I want to know more about the Dental Laboratory business, your schools and training. Also send me your special offers mentioned in POPULAR MECHANICS (Without cost or obligation).

Name.....
St. No.....
City..... State.....

McCarrie Schools of Mechanical Dentistry

1338 S. Michigan Ave., Dept. 2601-J, CHICAGO



High School Course in Two Years!

You Want to Earn Big Money!

And you will not be satisfied unless you earn steady promotion. But are you prepared for the job ahead of you? Do you measure up to the standard that insures success? For a more responsible position a fairly good education is necessary. To write a sensible business letter, to prepare estimates, to figure cost and to compute interest, you must have a certain amount of preparation. All this you must be able to do before you will earn promotion. Many business houses hire no men whose general knowledge is not equal to a high school course. Why? Because big business refuses to burden itself with men who are barred from promotion by the lack of elementary education.

Can You Qualify for a Better Position

We have a plan whereby you can. We can give you a complete but simplified high school course in two years, giving you all the essentials that form the foundation of practical business. It will prepare you to hold your own where competition is keen and exacting. Do not doubt your ability, but make up your mind to it and you will soon have the requirements that will bring you success and big money. YOU CAN DO IT.

Let us show you how to get on the road to success. It will not cost you a single working hour. Write today. It costs you nothing but a stamp.

American School

Dept. H-774, Drexel Ave. and 58th St., Chicago

American School

Dept. H-774, Drexel Ave. and 58th St., Chicago

Send me full information on the subject checked and how you will help me win success.

- | | |
|-----------------------------|---------------------------|
|Architect |Business Law |
|Building Contractor |Lawyer |
|Automobile Engineer |Machine Shop Practice |
|Automobile Repairman |Mechanical Engineer |
|Civil Engineer |Shop Superintendent |
|Structural Engineer |Employment Manager |
|Business Manager |Steam Engineer |
|Cert. Public Accountant |Foremanship |
|Accountant and Auditor |Sanitary Engineer |
|Bookkeeper |Surveyor (& Mapping) |
|Draftsman and Designer |Telephone Engineer |
|Electrical Engineer |Telegraph Engineer |
|Electric Light & Power |High School Graduate |
|General Education |Wireless Radio |
|Vocational Guidance |Undecided |

Name.....

Address.....



Fine opportunity for outdoor men

Interesting vigorous outdoor work in a growing organization where merit wins advancement. Good starting wages. Permanent positions and a real future for men who make good. Even our present field force of 500 Davey Tree Surgeons cannot meet the increasing demand. So we are selecting now, to enter our employ in 1926, a few sturdy, clean young men, thorough Americans, single, between 20 and 30 years old, free to travel, industrious, with good practical education, and able to give good references. Write for qualification blank to serve in place of personal interview. The Davey Tree Expert Co., Inc., 283 Federal Bldg., Kent, Ohio.

"STAMMERING

Its Cause and Cure"

You can be quickly cured if you stammer. Send 10 cents, coin or stamps, for 258 page cloth bound book on Stammering and Stuttering. It tells how I cured myself after Stammering and Stuttering for 20 years. BENJAMIN N. BOGUE
5925 Duquesne Building, 1147 N. Ill. St. Indianapolis

BE AN ARTIST

Comics, Cartoons, Commercial, Newspaper and Magazine Illustrating, Pencil Crayon Portraits and Fashions. Our simple method quickly develops your talent in spare time. By Mail or Local Classes. Write for terms and list of successful students. ASSOCIATED ART STUDIOS, Dept. B, 100 W. 23rd St., NEW YORK

Learn Motion Picture Photography at Home



New plan qualifies you quickly in spare time at home for this great, fascinating profession. Careers men earn \$100 to \$250 a week and more. No previous experience required. Our experts train you by mail.

MOTION PICTURE CAMERA FREE

Handsome Motion Picture Camera given free if you act quickly. Takes real motion pictures on standard professional film used in all theatres. Earn money on side.

Send for Illustrated Book—FREE

Write today for handsome, illustrated book explaining great opportunities in Motion Picture Photography, also Commercial, Studio Portraits, News Photography, with details of FREE Motion Picture or View Camera. Address:
New York Institute of Photography Dept. 49 143 W. 36th St. NEW YORK CITY

His Salary Four Times as Big!

The Reason—Higher Accountancy

"At the time of my enrollment for LaSalle training in Higher Accountancy," writes E. B. Risberg, "I was working in the blacksmith shop of the LaCross Well Drill Works—ten hours a day and six days a week. Since that time—and in a period of about four years—I have advanced from an initial position as stock clerk with the Milwaukee branch of a big packing company to my present excellent position with the largest elevator manufacturer in America. Today my salary is more than 400 per cent greater than at the time of my enrollment."

Nothing surprising about Risberg's advancement. The demand for executive accountants and Certified Public Accountants far exceeds the supply. Salaries range from \$3,000 to \$10,000 and better a year. Many LaSalle-trained accountants, now at the head of their own accounting firms, earn up to \$20,000 a year. Read these excerpts from the letters of accountants who have gone forward to success by following the LaSalle *salary-doubling plan*:

"Salary and earnings have increased over 183 per cent."—Frank B. Trisco, Minnesota.

"Accountancy has increased my salary practically 150 per cent in the last three years."—C. T. Thorson, Washington.

"Have been chosen Credit Manager of our Brooklyn store and Consulting Accountant of all our stores

—at a tempting salary even to a Public Accountant. I can frankly say I got all my confidence from my training with LaSalle."—G. S. Hillyer, New York.

You Have the Same Good Opportunity

Is it worth two cents and two minutes of your time to learn in detail of the opportunities that would be yours in the field of Accountancy?



All this information, together with an outline of the steps by which you may quickly fit yourself to take advantage of such opportunities, is clearly set forth in LaSalle's 64-page book, "Accountancy, the Profession that Pays," a book of invaluable assistance to the man who is seriously considering Accountancy as a career.

Get Copy of Plan—Free

The coupon will bring it to you without the slightest obligation, and with it details of the LaSalle *salary-doubling plan*, also the inspiring testimony of men still in their twenties and early thirties who have broken away from the low-pay ranks and today are expert accountants—with incomes ranging from \$3,000 to \$10,000, \$15,000, \$20,000 a year.

Your start toward a bigger salary is as near you as the point of your pencil. For the sake of a brighter future—ACT.

LASALLE EXTENSION UNIVERSITY

The World's Largest Business Training Institution

CLIP AND MAIL

LASALLE EXTENSION UNIVERSITY Dept. 1064-HR Chicago

I would welcome an outline of your *salary-doubling plan*, together with a copy of "Accountancy, the Profession that Pays," also copy of "Ten Years' Promotion in One," all without obligation.

Higher Accountancy: Leading to position as Auditor, Comptroller, Certified Public Accountant, Cost Accountant, etc.

Other LaSalle Opportunities: LaSalle opens the way to success in every important field of business. If more interested in one of the fields indicated below, check and mail now.

Business Management: Training for Official, Managerial, Sales and Departmental Executive positions.

Modern Salesmanship: Leading to position as Sales Executive, Salesman, Sales Coach or Trainer, Sales Promotion Manager, Manufacturer's Agent, Solicitor, and all positions in retail, wholesale, or specialty selling.

Traffic Management—Foreign and Domestic: Training for position as Railroad or Industrial Traffic Manager, Rate Expert, Freight Solicitor, etc.

Railway Station Management: Training for position of Station Accountant, Cashier and Agent, Division Agent, etc.

Law: Training for Bar; LL.B. degree.

Commercial Law: Reading, Reference and Consultation Service for Business Men.

Banking and Finance: Training for executive positions in Banks and Financial Institutions.

Modern Business Correspondence and Practice: Training for position as Sales or Collection Correspondent, Sales Promotion Manager, Mail Sales Manager, Secretary, etc.

Expert Bookkeeping: Training for position as Head Bookkeeper

Industrial Management: Training for positions in Works Management, Production Control, Industrial Engineering, etc.

Modern Foremanship and Production Methods.

Personnel and Employment Management.

Business English.

Commercial Spanish.

Effective Speaking.

C. P. A. Coaching for Advanced Accountants.



Name Present Position

Address



\$1000 a Month John J. Jirnee, 1133 Fourth Ave., Astoria, L. I., now earning \$12,000 a year, recommends Cooke Training. He says, "It alone is responsible for my success."

(Center Above)

\$9,000 a Year Auto Electrician pays W. E. Fenner, Albany, Ore., over \$9,000 a year. He was trained for this training on his recommendation.



Thousands of
COOKE TRAINED ELECTRICAL MEN RECOMMEND THIS TRAINING TO YOU

\$700 in 24 Days "Thanks to you I made \$700 in 24 days in Radio," says K. G. McNabb, 868 Spring St., Atlanta, Ga. "I recommend your training everywhere."



\$125 a Week "Depend on me as a booster," says A. Schrock, Phoenix, Ariz. "I make over \$200 a month. Your advertisement started me to success."

these men **EARN:**

\$3,500 to \$10,000 a year

Be an ELECTRICAL EXPERT
Learn at HOME in your SPARE TIME!



L. L. COOKE, Chief Engineer, Chicago Engineering Works, who has trained thousands of men for Big-Pay Jobs in Electricity.

Don't you keep on working for only \$25 or \$35 a week. Get into Electricity.—Thousands of Cooke Trained Men who knew nothing about it a short time ago are now earning \$70 to \$200 a week in the Electrical Business—and they don't work half as hard as you do. Why stick to your small pay job? Why stick to a line of work that offers no chance—no promotion—no big pay? Get into the world's greatest business. Electricity needs you. I'll show you how to do it. Get ready for the big pay job now.

Electrical Experts Are In Big Demand
Even ordinary electricians—the "screw driver" kind—are making big money, but trained men—Electrical Experts who get the top salaries—are needed more now than ever before. Thousands of Cooke Trained Men easily earn \$350 to \$10,000 a year. That's the kind of a job you want—where you can plan, and boss and supervise the work of others or go into business for yourself. Get started toward one of these big-pay jobs now. Learn to earn \$70 to \$200 a week—you can do it with Cooke Training—recommended by more than ten thousand successful graduates. Just mail the coupon below.

success in electricity. Let me give you that training with my simplified, complete home course,—the world's famous "Cooke Training"—built on my 30 years of engineering experience with the help of nearly 50 other engineers. Learn to earn \$70 to \$200 a week—only spare time needed.

My Training Pays for Itself!

You can start earning extra money a few weeks after you start my training. I give you special instructions for doing simple electrical jobs in your spare time—show you how to get these jobs and tell you what to charge. Many of my students make as high as \$25 a week extra this way while studying. My Course more than pays its own way.

Your Satisfaction Guaranteed

I am so sure I can make you a big success in electricity, just like I have done for the men whose pictures you see here and thousands of others who now boast my training that I will guarantee your satisfaction with a signed money-back guarantee book. If my training doesn't satisfy you after you have finished, you get back every penny you pay me. A two million dollar institution stands back of this guarantee.

Mail Coupon NOW

Get my big free book—"The Vital Facts about Electricity." Read about the success of hundreds of other men—men who recommend this training and whose names and addresses are given in my book. Get the real dope about your opportunities in Electricity.

ENGINEERS' ASSOCIATION ENDORSES COOKE TRAINING

The American Association of Engineers with 15,000 College and Practical Engineer Members has approved Cooke Training and the E. E. W. 1002. Their printed and publicly distributed report of their investigation is the only endorsement of a school they have ever issued. Full details of this endorsement sent with my free book.

Employment Service and Help—No Extra Charge

I will train you for a big pay job and then help you get it without extra charge. Hundreds of Employers look to me for the electrical men they hire. Last year I placed over one thousand men at big raises in pay. Hundreds of others were promoted by their employers through the help of my Vocational Service and other hundreds went into business for themselves with the help of my special Business Training. Mail coupon for big free book which explains this service and fourteen other features, many of which cannot be had anywhere else.

Age or Lack of Experience Bars No One

You don't need experience. You don't have to be a college man. You don't have to be even a high school graduate. As Chief Engineer of this big two million dollar institution—one of the world's greatest Training Schools, I know just what training you need to make a big

Don't deny yourself this chance to make big money. Get the facts NOW—Mail coupon at once for facts and my guarantee.

L. L. COOKE, Chief Engineer

CHICAGO ENGINEERING WORKS, Inc.

Dept. 17
2150 Lawrence Ave.,
Chicago, Ill.

L. L. COOKE, Chief Engineer,
CHICAGO ENGINEERING WORKS,
Dept. 17
2150 Lawrence Ave., Chicago, Illinois

Send me at once, without obligation, your big illustrated book and complete details of your Home Study Course in Electricity, including your outfit and employment service offers.

5 WONDERFUL WORKING OUTFITS GIVEN WITHOUT EXTRA CHARGE

- 1 LABORATORY AND EXPERIMENTAL OUTFIT.** Complete material for interesting experiments.
- 2 BELL AND ALARM OUTFIT.** Electrical apparatus, material and tools—a complete installation kit.
- 3 ELECTRIC LIGHTING OUTFIT.** Switches, Wires, lights, etc. Everything needed to make well equipped electric lighting circuits.
- 4 ELECTRIC POWER OUTFIT.** The Famous "Cooke" Motor and other apparatus. Not a toy—but a real, honest-to-godness workable machine.
- 5 TRANSFORMER OUTFIT.** Complete parts for building and winding this widely used equipment.



The 'Cooke' Trained man is the 'Big Pay' Man. Name _____ Address _____ Occupation _____

Classified Advertisements

WORLD'S BEST WANT AD MEDIUM

Advertisements in this section, 25 cents per word, each insertion, minimum 10 words, payable in advance. To be inserted under proper classification in November issue, copy should be in our office September 18th.

ADVERTISING AGENCIES

TO secure agents or salesmen or for selling farms and reaching investors, use classified (want) ads in largest newspapers and magazines. Price list No. 39 sent free. Ankrum Advertising Agency, 29 W. Jackson Blvd., Chicago, Ill. The largest classified advertising agency in the U. S.

ADVERTISE in 24 Big Sunday Newspapers, 24 words \$15.00. Catalog listing 1,000 leading Dailies, Weeklies, Magazines, 4c stamps. Union Advertising, Baltimore Bldg., Chicago.

CIRCULARIZE, guaranteed lists. Agents' names \$5.00, 1,000, Pennell, Covington, Ky.

YOUR 25-word advertisement in 56 Eastern Newspapers only \$2.00. Shaw, 221A Northeast, Washington, D. C.

ADVERTISING in all magazines and newspapers at publisher's lowest rates. Rate Book free. Taylor's Advertising Service, Dept. F, Freeport, Ill.

WE specialize in Magazine and Newspaper advertising. Advice free. The Universal Agency, Bremer Arcade, St. Paul, Minn.

25 WORDS—355 Rural Weeklies, \$14.20. Ad-Meyer Agency, 4112-M Hartford, St. Louis.

FOR ADVERTISERS

ADVERTISING 222 Magazines .68c word, \$6.00 inch, \$45.00 page. Sample 10c. 131 Magazines, 5,000 Newspapers, 28 words \$180.90. Inch, 98 words, \$620.50. 28 words 100 magazines, 100 newspapers, \$5.00. Inch \$12.00. Diamond Advertiser, Norton, Mass.

GUARANTEED mailing lists. Write for rates. French, 1903 E. Chase, Baltimore, Md.

I WRITE letters, folders, booklets, complete followup for manufacturers, mail-order dealers. Long experience. Write for details. L. Taylor, Box M44, Freeport, Ill.

INCH display 100 monthlies \$4; three months \$8. Cope Agency, 233P, Champaign, Ill.

COMBINATION Winner 125 Monthlies, Thrice, 10c word; \$8.00 inch. Interstate, Munising, Mich.

GUARANTEED names. Actual buyers, \$5.00 thousand, 50c hundred. Demuth Company, Englewood, N. J.

ADVERTISE in 300 country newspapers, 28 words \$10. Keator, Hartford Bldg., Chicago.

25 WORDS, 88 magazines, \$1.00; Thrice \$2.00. Inch display \$2.00; Thrice \$5.40. Smith's Service, 1194, Waukesha, Wash.

FREE. Advertising rates. Newspapers and magazines. Pennell, Covington, Ky.

SALES PROMOTION

\$50 TO \$50,000 Daily Sales developed during 26 years for clients by my direct-mail plans, copy, campaigns. A \$25,000 annual volume increased ten-fold in twelve months. Another, from an initial expenditure of \$720 developed in four years sales by mail of half million yearly. Ten years Sales Promotion Manager Larkin Co. Submit sales problems for Free diagnosis. James C. Johnson, 118A Woodbridge Ave., Buffalo.

QUEX Sales Letters Get More Business. Write him today. Quex, 4418 Michigan Ave., Chicago.

STRONG copy based on sound plans. Outline your project for free analysis and plan. P. Wyross Company, Lansdowne, Penna.

AUTOMOBILE SUPPLIES

AUTO Body Polish: Make your own; Gallon costs less than pint bottle; Formula \$1 bill. Keno Sales Co., 1452 East 118th St., Cleveland, Ohio.

MIRRORS Re-Silvered at Home. Costs Less 5 cents per square foot; you charge 75 cents. Immense profits, plating autoparts, reflectors, tableware, stores. Refinishing metalware, etc. Outfits furnished. Write for information. Sprinkle, Piaster 77, Marion, Ind.

MILLERITE-ETHYL-Super-Fuel Ingredient for Gasoline. Increases Power and Mileage—Saves Gas. Make it yourself by my simple Formula and clean up five to fifty thousand a year. This and eighteen other High Class Automobile Specialties described in the valuable literature I'll send you upon request—Hurry! Exclusive Territory? Miller, Chemist, 1109-1111 Grand Central, Tampa, Fla.

VULCANIZING Auto Tires is a Paying Business. We have Plants near you from \$100 up. We save you 50%. Catalog Free. Instruction Book \$1. Equipment Exchange, 188 East 11, Los Angeles, Calif.

AUTO Trailer \$39.00. Light weight, 3/4-ton capacity; over 300 in use in our home county. Catalogue free. Bower Mfg. Co., Box 8, Fowler, Ind.

AUTOMOBILE Parts—New and Used Parts for all cars. You can save 25 to 75% buying from us. Satisfaction guaranteed. Free Catalogue to repairmen. Century Parts Company, 4105 Olive St., St. Louis, Mo.

CLOSE-TITE your open car—and secure all the comforts of a Sedan, \$33.00 to \$70.00 f.o.b. factory. Leonard-Bruzzer Company, Fond du Lac, Wis.

BE safe—snap on Van's Headlight Tell-tales and avoid arrest. 25c. L. J. Van Duzer, 2121 Bonafide, Ave., Los Angeles, Calif.

NEW feature in manifold saves gas 20%. Address Prouty, Highland Park, Detroit.

TIME Before You, As you Drive: Watch and Holder on your steering wheel. Complete postpaid, \$1.00. Or free circular. Coffey Mfg. Co., Centralia, Ill.

SCIENTIFIC Gas Saver. All autos, 1 free to introduce. Critchlow, J121, Wheaton, Ill.

AUTOMOBILES

COMPRESSORS—only \$10.50 monthly. Fully automatic, lighting or power lines operate. Special prices. Hobbarths, Troy, Ohio.

AUTOMOBILE—Make your own motor car, toy size, operated with motorcycle engine. Any boy can make it. Great sport touring in your own car. Costs very little aside from engine. Full directions with drawing and dimensions in The Boy Mechanic, Book 3. Send No Money. Just write a postal. Pay the postman the few cents postage and \$2 for the book when he hands it to you. Popular Mechanics Press, Room 810, 200 E. Ontario St., Chicago, Ill.

AUTOMOBILES: 753 ideas on repairing, improving, and making devices for touring. All this you may have in Popular Mechanics three new books with the following titles: Auto Repairman's Handbook, Auto Owner's Handbook, Auto Tourist's Handbook. Send No Money. Just write a postal and say, "Send me Popular Mechanics three Automobile Books." When the postman hands you the books, pay the few cents postage and \$1.50. Popular Mechanics Press, Room 810, 200 E. Ontario St., Chicago, Ill.

PATENTS. Time counts in applying for patents. Don't risk delay in protecting your ideas. Send sketch or model for instructions or write for Free book, "How to Obtain a Patent" and "Record of Invention" form. No charge for information on how to proceed. Communications strictly confidential. Prompt, careful, efficient service. Clarence A. O'Brien, Registered Patent Attorney, 5896 Security Bank Building (directly across street from Patent Office), Washington, D. C. See pages 156 and 157.

DYKE'S Automobile and Gasoline Engine Encyclopedia. The latest edition contains information on repairing and adjusting every part of every motor car now in use. Tells how to find out what is wrong and how to fix it. Mechanics everywhere depend upon this compendium to keep them up-to-date. Send No Money. Just ask for Dyke's Auto Encyclopedia on a post card. When the postman hands you the book, pay the few cents postage and \$6. Money back if not delighted. Popular Mechanics Press, Room 810, 200 E. Ontario St., Chicago, Ill.

AUTOMOBILE SUPPLIES, ACCESSORIES AND HOUSEHOLD GOODS WANTED

100,000 REPRESENTATIVES Wanted! Sell by mail, through Agents, or Direct! Detailed Information—25c! None free. Surety Service, World Distributors, 351 Harvard St., Rochester, N. Y.

FOR FORD OWNERS

FORD owners, Chevrolet, Overland: Do your hubs loosen, go on too far, keys wear, wheels wobble? Avoid costly renewals. Use our improved hub bush, quickly applied. Thoroughly tightens. Prepaid \$0.50 each. Auto Specialties, 327 Pasadena Ave., Youngstown, Ohio.

THE Peerless Fuse and Terminal Block protects your battery and wiring. Eliminates fires from short circuits. \$1.00 prepaid. Agents wanted. O. Freeberg, 1704 13th Street, Moline, Ill.

FORD Owners who dislike motor "burking" in traffic, who wish to take long steep hills on high, who perhaps desire extreme speed, should use Avaco Valve Action which scientifically and simply increases valve capacity on a Ford. Durable, easily installed, inexpensive. Honest money-back guarantee. Write, Auxiliary Valve Action Company, Fitchburg, Mass.

DELIVERY Bodies for Ford Model T. Chassis with Inclosed Cab. Suitable for Contractors, Grocers and Farmers. Three styles. Price \$37.50. Write Daniel Zimmerman, Craigville, Ind.

"ECONOMICAL closed car comfort. California Tops for Ford and Chevrolet Roadster and Touring cars. Easy to install. Quality high. Price low." Write factory today. Koupet Auto Top Company, Belleville, Illinois.

ACID process expands old pistons to new oversize—stops piston slap—oil pumping. No special tools necessary. Instructions \$1.00. Mechanic, Box 546, Sedan, Kans.

66 MILES on 1 Gallon. Wonderful Vapor Humidifier, 1 free to introduce. Critchlow, K121, Wheaton, Ill.

FORD sport, speed bodies and specialties. See Ad. page 161.

DIRECT Engine Driven Tire Pumps for Ford Cars. Clagett Mfg. Co., Upper Marlboro, Md.

UNDERSLING with "RKO" Swing Lo Irons. See "Red-i-Kut" ad page 142.

MOTORCYCLES, BICYCLES AND SUPPLIES

1923 HARLEY-DAVIDSONS, \$168; 1922, \$118; 1921, \$111; 1920, \$85; 1919, \$65; 1917, \$50; 1916, \$45; 1915, \$40; 1914, \$35. Guaranteed. Money refunded if not satisfied. Circular free. Wisconsin Cycle Sales Co., 726 National Ave., Milwaukee, Wis.

PARTS For all makes; prompt Service. Expert advice. 75 Used Machines; description on request. Glinesman's 3199 Blvd., Jersey City, N. J.

USED Harley-Davidson Parts. At big discounts. All parts—All models. Bargains in used motorcycles. Oliver Cycle Motor Co., 1045 N. Grand, St. Louis.

DON'T buy a Bicycle Motor Attachment until you get our prices. Shaw Mfg. Co., Dept. 27, Galeburg, Kans.

USED parts for all motorcycles, cheap. State wants. Schuck Cycle Co., 1922 Westlake, Seattle, Wash.

USED Harley-Davidson Parts 40% to 80% Discount. Tower Cycle Co., 4303 North Florissant, St. Louis, Mo.

NEW and used parts for Motorcycles and Bicycles. Get our prices on parts needed. Kingshighway Motor Co., 1166 N. Kingshighway, St. Louis, Mo.

SEND for Bargain Bulletin. All makes of rebuilt motorcycles at lowest prices. Used parts half-price. Ash Motor Corporation, Rochester, N. Y.

AVIATION

WANTED—Airplane Pilots and Mechanics. We have calls for a number of experienced airplane pilots and mechanics, also limited number of apprentice helpers who are willing to work for flying training. No fees charged. All applicants are requested to enter paid subscription to *Slimstream Monthly*, "The Commercial Flyer's Magazine" at \$2.00 per year. Send application and subscription now, stating experience and if temporary work will be accepted. *Slimstream Publishing Company, Dayton, Ohio.*

PATENTS. Time counts in applying for patents. Don't risk delay in protecting your ideas. Send sketch or model for instructions or write for Free book "How to Obtain a Patent" and "Record of Invention" form. No charge for information on how to proceed. Communications strictly confidential. Prompt, careful, efficient service. Clarence A. O'Brien, Registered Patent Attorney, 5896 Security Bank Building (directly across street from Patent Office), Washington D. C. See pages 156 and 157.

MORE Pep for your Curtiss airplane engine! Our special valve action attachment enables your Curtiss motor to develop greater power. Simple to install. Results guaranteed. Complete set \$10.00. Write for particulars. Heath Airplane Company, Chicago, Ill.

EVERYTHING for the aviator: shoes, motors, spares, dopes, varnishes. Largest stock in country. Prompt shipment. Genuine Resistal aviators' goggles. Good condition, \$2.50 pair. Two slightly cracked used Jennies and Canucks \$350.00 each. Lots of special bargains. Write for catalog. Nicholas-Beasley Airplane Co., Marshall, Mo.

EARN \$3,500 to \$10,000 a year. Learn Airplane Engineering Now at Home. The World Flyers were Airplane Engineers. Write for free catalog. Western Airplane Corporation, Dept. K-10, Monadnock Block, Chicago.

JOIN the Gary Flying School and take your International Certificate! Captain J. A. Yonge, war and commercial pilot of ten years' experience, offers a complete flying course on entirely new lines. Considerable "solo" flying time and advanced air instruction are two special features. Write now for information. Gary Flying School, Gary, Ind.

TEN lessons in the air of twenty minutes each will make you a pilot by our advanced method of training. This, together with our five weeks shop course at \$100.00, makes America's oldest aircraft factory the most popular flying school. Work after class hours guaranteed. Heath Airplane Company, Chicago, Ill.

AIRCRAFT Supplies Price list 5c. Goggles \$2.90. Aerodriven Boat attachment blueprints, \$1. High Speed sled blueprints \$1. Set 2 sleds, 1 boat, only \$2. Worth double. Propellers for sleds, boats, airplanes. Ostergard Aircraft, 4271 North Narragansett, Chicago.

LEARN to Fly with experienced teachers. Former students of ours are now flying the mail. Others are with Ford. Our course includes Dual Instructions (with teacher), Solo Flying (without teacher), and Acrobatics. Average time required to solo, 6 to 7 hours. No bond required. Send 10c for booklet. Partridge, Inc., 3515 West 82nd Place, Chicago. Post Graduate Course in night flying.

HEATH propellers represent the most efficient method of aerial drive. Each propeller individually designed for the particular work to be done, as laid out by America's oldest aeronautical engineers. Propeller catalog 4c; sled blueprints \$2.00. Resistal goggles \$2.90. Heath Airplane Company, Chicago, Ill.

MOTORS: Curtiss OXX-6 Class A (under Fifty Hours) for Plane, Sea-Sled, Motor boat, etc., \$140.00. All Motor and Plane Spares at Best Prices. Send for Catalogue. Monumental Aircraft Co., 339 N. St. Paul Place, Baltimore, Md.

COMPLETE Scale Plans, with Building-Flying Instructions for following 3-ft. Model Aeroplanes, 25c each postpaid: JN4D-2; DeHavilland; NC-4; Curtiss Tractor; Blériot; Neuport or Taube Monoplanes; Cerril Pooler Bacer. Complete 48 pp. catalog 5c. Listing hundreds of parts and supplies for experimenters. Ideal Aeroplane Co., 165 1/2 Spring St., New York.

SINGLE and Two-seater light planes. Parts, instructions. Blueprints \$2-\$5. Propellers \$10. OX5 Motors. Circular free. Aviation Engineering Co., Lawrence, Kans.

LEARN to Fly! Write for booklet. Robertson Aircraft Corp., Anglum, Mo.

THE American School of Aviation announces a new correspondence course in Mechanics of Aviation. A thorough training in Practical Aeronautics. American School of Aviation, Dept. 1861, 3601 Michigan Ave., Chicago, Ill.

AVIATION Fans: Send one dollar for beautiful pair sterling silver wings, mounted on bar pins with safety catch, and identification card issued by National Flyers' Association. Thousands being worn by pilots' aviation mechanics, and aero enthusiasts. Wallace Aero Company, Bettendorf, Iowa.

DIXIE: The Famous Light Plane You Can Build Yourself at Small Cost. Complete Working Drawings \$5.00. Dixie, Blueash, Ohio.

BOOKS AND PERIODICALS

PHILOSOPHY and Phenomena of Spiritualism. The author relates his thirty years' personal experience with spirits while in and out of his body. Led by them through the Spirit world, he visited Heaven and Hell and found many convincing proofs of Life after Death, and Spirit return. 500 pages. \$3.25. Franklin A. Thomas, Author, Malden, Mass.

"NATURE'S Finer Forces": Vibrations; Lights; Colorations; Electromagnetics; Odouras; Radio; Coldlights; Inventions; Wonderful Opportunities; Fifty Lessons; Marvelous Cures; Illustrated. Satisfaction Guaranteed. 270 pages, \$2.00. DeLuxe \$3.00. M. Stevens, 242 Powell, San Francisco, Calif.

DIRECTIONS for Building Imitation Marble Front Houses, and for Manufacturing Signs, Tombstones and Monuments from White Cement. Circular Free. Peter de Linde, Zion, Ill.

INDUSTRIAL Alcohol. Wright's book. Full directions for making drawings. \$2.50. Spon & Chamberlain, 120 P. M. Liberty Street, New York, N. Y.

FREE—Send for my Neutheouth, Self-culture, Occult, Mystic and Scientific book literature. Martens Publisher, Burlington, Iowa.

MILLENNIUM: Israel restored; Paradise restored; Essay 4c. Jabe Studio, Los Angeles.

SNOWSHOES. How to Make and Use Them. Make your own from the crystal-clear instructions in *Boy Mechanic*, Book 2. Many illustrations show how the Indians made their wonderful shoes that enable you to skim across the tops of light drifts as though you were on air. Get ready for winter now. Only \$2 for this marvelous book. It also has directions for making ice boats, bob-sleds, merry-go-round for the ice, mono-plane glider, and many other outdoor devices. Send No Money. Just write a postal. Pay the postman when he delivers the book. Popular Mechanics Press, Room 810, 200 E. Ontario St., Chicago, Ill.

WATCHES. Where Did Our Watches Originate? Popular Mechanics book. Time and Its Measurement, tells where and how. Learn how the Chinese keep time, how musical watches are made, how to make a 24-hour watch, and how modern watches are made. All this and much more in *Time and Its Measurement* by James Arthur. Send No Money. Just write a postal and say, "Send me *Time and Its Measurement*." When the postman hands you the book, pay the few cents postage and the price of the book, \$1.50. Popular Mechanics Press, Room 810, 200 E. Ontario St., Chicago, Ill.

ELECTRICAL Kinks on all phases of practical electricity are to be found in *Popular Mechanics* new book, "Electrical Kinks." There are 47 ideas on wiring, 45 on making electrical devices, 19 on lighting, 5 on transformers, 5 on motors, 8 on generators, 11 on switches, 22 on testing, 12 on repairing, 11 on battery manufacture and repair, 5 on telephones, and 9 on electrician's tools. 214 articles, 162 pictures. Send no money. Just write a postal asking for "Electrical Kinks." When the postman hands you the book, pay the few cents postage, and \$1.50 for the book. Popular Mechanics Press, Room 810, 200 E. Ontario St., Chicago, Ill.

DRAFTING. Learn Mechanical Drawing. Everyone should learn this fascinating work. Big demand for men who can make accurate drawings to scale. This pocket-size, cloth-covered book starts you at the beginning and leads you by a series of simple lessons to the more difficult assignments that you would get in an architect's or engineer's office. Send No Money. Just write a postal and ask for "A Practical Course in Mechanical Drawing." When the postman hands you the book, pay the few cents postage and the price of the book, \$1. Popular Mechanics Press, Room 810, 200 E. Ontario St., Chicago, Ill.

MENTAL and Spiritual Healing: All Schools and Methods. Why pay \$100 to learn to heal? Technique complete \$3.50. International Book Concern, Los Angeles.

"FROM the Ball-Room to Hell." Startling book. 25c. Printhop, Beckland, Wis.

BOOKS Printed and Published. Send us your manuscript for offer. Meador Publishing Company, 27 Beach Street, Boston, Mass.

MASTER-KEY (Success Wonderful). 410 Pages, Cloth, \$2.50. Bargains New—Used books. Special Free offer. Phipps Library, 1014 Belmont, Chicago.

CURIOUS Books, Unique Novelties, Stunning Pictures, Samples, 10 cents prepaid. Linds, 214 W. 34th Street, New York.

LAMPS. Make Your Own Lamps and Shades. Popular Mechanics crystal-clear books on this subject are filled with designs and photos. The instructions make the work so clear that anyone can follow them. All sorts of lamps are described, from floor lamps to dining room chimes. Two books, \$2. Send No Money. Just write a postal and ask for *Popular Mechanics Two Lamp Books*. When the postman hands you the books pay the few cents postage and \$2, the price of the books. Your money back if you are not delighted. Popular Mechanics Press, Room 810, 200 E. Ontario St., Chicago, Ill.

NOVELTIES, CURIOS, ETC.

STRANGE Novelty—"A Mystical Circle" (Patent Pending). Black and White make colors and tints. This circle while spinning on its brass point shows primary colors, hues and shades. A perplexing, puzzling paradox. Scientific, entertaining, amusing, surprising. Wonderful advertising novelty. Directions and quantity prices given. Try to solve "The Mystical Circle." Send 10c in silver or stamps for two samples. Caldwell Novelties, Inc., Bloomfield, N. J.

MEXICAN Jumping Beans—Nature's Greatest Curiosity. 3 for 25c, 20 for \$1.00 prepaid. Swinden Supply Co., Tilton, N. H.

LOOK! New catalog and French novelty 25c. Ruth Box 202, Morris, Ill.

PICTURES AND POSTCARDS

MANY Members waiting to exchange with you. Membership 50c. List 10c. Big collection assured. Join now. Popular Exchange, Windsor, N. C.

JOIN Live Postcard Club; Membership lists including Catalog, 10c. Harvey Teeble, Decatur, Ind.

TRUE-BLUE. Old reliable, 37 years. Exchange cards, letters, stamps. Year, \$1; quarter, 25c; booklet, 10c. Ed Ericson, 1025 E. Troy, Wis.

PERSONAL Christmas Cards, \$1.00 dozen, all different. Samples Free. Agents wanted, Stanley, 41 Warren Avenue, Boston.

10 CHICAGO cards, 3 dimes. We remind them if you wish. Postco, 121 N. Francisco, Chicago.

POSTCARDS: 25 Bewitching beauty poses; 10, Smith's Novelty, M9147 Bishop St., Chicago.

GAMES, ENTERTAINMENTS AND PLAYS

GAMES, tricks, toys, puzzles, Jokers. Send 10c for sample and catalogue. Quality Sales Agency, 1152 W. 17th St., Chicago, Ill.

VENTRILLOQUISM taught almost anyone at home. Small cost. Send 2c stamp today for particulars and proof. George W. Smith, Room 8-35, 125 N. Jefferson Ave., Peoria, Ill.

PLAYS, Minstrels, Musical Comedies, Vaudeville Acts, Monologues, Make-Up, Wigs. Catalogue "D" Free. Banner, 1661 Market St., San Francisco, Calif.

OUTDOOR Sports are best when you make your own apparatus. This is easy when you have such crystal-clear instructions with pictures and dimensions as are found in *Popular Mechanics* New book, "Outdoor Sports The Year 'Round." Make a windwagon for summer, and convert this into an ice boat for winter. Make a Ski glider in which you can sail like an airplane. Build your own motor sled, or ice yacht. Make a small electric automobile and take your friends for a ride. 226 articles in this wonderful book, and 317 illustrations. Send No Money. Just write a postal and ask for "Outdoor Sports The Year 'Round." When the postman hands you the book, pay him the few cent postage and \$1.50, the price of the book. Popular Mechanics Press, Room 810, 200 E. Ontario St., Chicago, Ill.

MAGIC TRICKS, BOOKS AND JOKER NOVELTIES

MAGIC—Tricks, Books and Supplies. For Amateurs as well as the great professionals. Anyone can learn through our instructions. Feature Acts in Mind Reading, Spiritualism, Rope Ties, etc. Large illustrated Professional Catalog, 20c. Chicago Magic Co., 148 S. Dearborn St., Dept. B, Chicago, Ill.

AMAZE and Mystify your friends! Easy to learn. New Book, "33 Card Mysteries" and big 1925 Catalog Magic and Novelty, postpaid 10c. Lyle Douglas, Station A, Dallas, Texas.

FREE with \$25 order die box. Send 20c for our large catalogue of tricks, wigs, sensational escapes. Oaks Magical Co., Dept. 518 Oshkosh, Wis.

"AGE and Month Mystifier" will tell age and month of Birth, of anybody between one and eighty-three. Price fifteen cents. Chas. Wall, 817 Broadview Ave., Toronto 6, Canada.

MAGIC goods, cards, books, novelties, tricks. Catalog free. C. Fenner, 2401 Jefferson, Louisville, Ky.

FREE Books. Mysteries, Magical Novelties. Catalogue Particulars Free. Singer, 535 Hancock, Wis.

SEVEN Magical Delusions and Catalogs—25c. Gilmaglio, Morgan Park, Ill.

MAGIC for Beginners. Some of the most startling of stage illusions are fully explained in Boy Mechanic, Book 1. Full directions for making apparatus and for performing such tricks as: Escape from a padlocked box. Startling electrical illusions. Spirit hand that answers questions, making the spirits play a violin, and many others. Get this book now and mystify your friends. Send No Money. Just write a postal asking for Boy Mechanic, Book 1. When the postman hands you the book, pay \$2 plus the few cents postage. Popular Mechanics Press, Room 819, 200 E. Ontario St., Chicago, Ill.

STAMP COLLECTING

READY About October 10th, 1926 Edition Scott's Postage Stamp Catalogue. More than 1,500 pages of complete and authoritative information about every postage stamp ever issued by any government in the world up to date of going to press. Illustrates every type of stamp and watermark. Completely describes every stamp, paper used, perforation, method of reproduction, watermarks, color, and gives prices at which each stamp may be purchased, cancelled or uncancelled, from this company. Send in your order now. Cloth \$2.00, with thumb index \$2.50; forwarding extra. Shipping weight 2 lbs. P. S. Write for information on our greatly enlarged line of 50% approvals for the medium collector. Stamps average from 5 to 50c in price. Scott Stamp & Coin Co., 33 West 44th Street, New York, N. Y.

MYSTIC'S "Mysterious" Packet! Contains stamps from the lands of cannibals, heathens, sun worshippers, and wild savages. Included are Kenya and Uganda, Persia, Africa, Dutch Indies, Gold Coast, Federated Malay States, Eritrea, Nyassa, Travancore, Siam, Congo, etc. This wonderful packet containing 165 all different (mostly unused) for only 8 cents to approval applicants. Mystic Stamp Co., Dept. 8, Camden, New York.

START a Stamp Collection—70 different stamps from 70 different foreign countries, including Africa, Asia, Australia, Europe, West Indies, etc. Our pamphlet which tells "How to make a collection properly," and price list of albums, packets and sets all for only 16 cents. Queen City Stamp Co., Room 28, 664 Race St., Cincinnati, Ohio.

NET Approvals. Premium to new applicants sending reference. Tower Stamp Co., 42 Westville St., Dorchester, Mass.

"EXHIBITION," "War Prisoners," "Airmail," "Pictures," "Eagles," "Dues"; six sets unused, different countries, five French, five British, five Portuguese Colonies, Packet Dutch Indies, 100 different foreign, 15c to approval applicants. Deering, 23 Fairmount, Marlborough, Mass.

FREE—25 Portuguese Colonies to approval applicants. 2c stamp. Lightbown's, Osborne Road, Southsea, England.

STAMPS for United Cigar Coupons. List and S. Flame (Cat. 78c)—15c. Peck, 214 Wright, Tulsa, Okla.

OVER 100 Different Stamps from Iceland, Congo, Nyassa, Mozambique, Cochín, etc. Perforation Gauge, Scale, Set List, etc., for 10c only, to applicants for our fine approvals. Parn Stamp Co., 945 Vista Drive, Los Angeles, Calif.

PERSIA—ancient land of Arabs, massacres, mysteries! Packet 25 different Persia, including scarce and high values; set unused Red Cross stamps; fine packet 50 different, including Nyassa, Kenya, Uganda, Gold Coast. Entire big lot 16 cents to approval applicants furnishing references. Scout number O. K. Extra! Scarce Haiti stamp, catalogued \$1, free if order sent immediately. Send 6c for Mexican Revolution currency and price list stamps and coins. Russian coin 7 cents; Three different European coins 16c; Two different South American coins 15c. Stamps—five different Tanganyika 16 cents; four different Kenya 11 cents; six different Mozambique Col. 10 cents; 5 kinds Ireland 6 cents; 5 kinds Nyassa 6 cents; 7 kinds Borneo 16 cents; 4 Liberia 11 cents; 17 kinds Mexico 11 cents; 50 kinds Spain 17 cents. Belmers, 903 Platoon, Fort Worth, Texas.

ARABS! Bandits! Head-Hunters! Egypt (sphinx); Malay (tiger); Benadir (elephant); Tunis (arab); Turkey (sacred mosque); Belgium (showing battle between angel and "old horns"); Congo (head hunter)—All of these mysterious and remarkable stamps are contained in our Famous Phantom Packet—55 fine varieties (to approval applicants only) for eight cents. Nothing like it; order at once! Pacific Stamp Co., Box 515, Helena, Mont. Extra! Send us with your order for the Phantom Packet at 8c, the names of three of your friends who collect stamps; and we will give you, free of charge, a scarce set of 11 dif. Albania—bandit land!—cataloguing over \$1.50. Supply limited; write immediately!

ANCHERS \$\$\$ Outfit—only 12c! Fine triangle stamp; set German stamps with (pre-war) value forty million dollars (interesting!); perforation gauge, mm. scale; small album; 2 approval sheets; airmail set; scarce stamp from smallest republic on earth; newspaper set; packet good stamps from Travancore, Johore, Dutch Indies, etc. Entire outfit for 12c to approval applicants! (Nice pocket stock book, value 25c, with every order!) Ancher Stamp Co., 148 1/2 Clerk St., Jersey City, N. J.

FAMOUS Fenway Outfit. All for 12c: triangle stamp; small album; 250 hinges; 5 large French Colonials; 2 special deliveries; Airmail set; Red Cross set; Fantastic Fenway Packet containing 55 different, including Abyssinia, Azores, Cape of Good Hope, Bosnia, Crete, Congo, etc. This wonderful outfit and 16-page price list only 12c; to new approval applicants. Fenway Stamp Co., 161 Massachusetts Ave., Boston, Mass.

500 FOR 25c. Mixed Stamps from 40 different Countries, Australia, North, Central, and South America, Russia, Africa, China, Japan, British, French Colonies, War issues, etc., also 500 stamp hinges, packet approval book, perforation gauge, and 5 United States stamps issued from 1861 to 88. Biggest bargain ever offered. Satisfaction guaranteed or money back. Hussman Stamp Co., Dept. PM, St. Louis, Mo.

COLLECTORS' Complete Outfit 25c. Includes 32-page book "How to Collect Stamps," Illustrated Album, 100 hinges, 100 different stamps, also 1 set Bosnia, Epirus, Newfoundland, Ukrainians, Airplane, sample copy "Stamp News." All 25c just to introduce my fine approvals. Harry Isor, 891 State Life Building, Indianapolis, Ind.

500 DIFFERENT stamps and The Stamp Collector's Magazine one year for \$1.00. Sample Copy Free. Philatelic Publishing Co., 82 Nassau St., New York.

500 STAMPS, 17c. Includes Finland, Flume triangle, Ceylon, Guatemala, Australia (swan), Dominican Republic, New Zealand, etc. To approval applicants, 17c. Plenty U. S. Elmer, 15 School Street, Boston, Mass.

CHINA, 12 var. 2c with approvals, Henry Hunt, 1021 Bellevue, Compton, Calif.

PREMIUM to applicants for 50% approvals. Kinman, 634 Union, St. Louis, Mo.

BEST one-cent stamps in America. F. P. Hand, 1117 So. 60th St., Philadelphia, Pa.

LITTLE Erie Special—91 varieties, cataloguing over \$3.50, for 30 cents with approvals, Lake Erie Stamp Co., 1390 Gladys, Lakewood, Ohio.

300 DIFFERENT Unused stamps 45c. Fine approvals for reference. State Stamp Co., New Kensington, Pa.

10 X 5 = 16c. CLEARING out our exceptionally fine line of 5c sets; we offer 10 different sets (regularly 50c, high catalogue value) for only 16c to approval applicants. Edgewood Stamp Company, Milford, Conn.

250 DIFFERENT Stamps 10c; 100 U. S. 25c; Eng. hinges, 1,000—12c. Lists free. Midwest Stamp Co., Kemper Bldg., Kansas City, Mo.

FREE! Set 12 Azerbaijan to approval applicants sending 2c stamp and reference. F. H. Marsh, 524 Hamilton Ave., Indianapolis, Ind.

\$10.00 WORTH of stamps, over 500 different from all over the world, only 50c. A still better collection of over 1,000 different \$1.25. Beautiful premium free if order reaches me before 10th of the month. Cedric W. Lemont, Delaware, Ohio.

ANNIVERSARY Celebration! Thousands stamps free! Write, Stricklen Stamp Co., Staunton, Va.

1,000 MIXED 20c. 100 Var. Precancelled 20c. Charles Peuch, Elma, Wash.

1 CASH Free, Chinese Lucky pocket coin to all Collectors sending for approvals enclosing postage. Rare bargains, big discounts to regular agents. Tell Your Friends. Pettet Stamp Co., 690 S. Boulevard, Atlanta, Ga.

500 MIXED U. S. Old and New 10c. Weatherby, Medina, Ohio.

CIGAR Bands: Fine collection, 115 American and German bands, 50c. Lloyd's, Box 538, Houston, Texas.

1,000 DIFFERENT 85c. Grossman, Box 150, Madison Square Station, New York City.

INDIA, Travancore, 5 different, 10c. 80% Approvals. State countries desired. Kiben, 3477 West 63rd, Cleveland, Ohio.

GOLDEN stamp, packet cataloging \$1, only 5c. Approvals. Glenn Smith, Girard, Kans.

1,000 DIFFERENT \$1.00. 50 French Colonies 15c; 100, 50c. Fred Onken, 630 79th Street, Brooklyn.

DANZIG Stamps—Splendid assortment Danzig Stamps free for 2c. Midland Stamp Company, Toronto, Canada.

FREE! 30 Diff. large, showy picture stamps for a request for my 1, 2 and 3c approvals; also the higher priced desirable stamps at 50% discount. Chas. Thomas, 1412 N. 16th St., Philadelphia, Pa.

25 PRECANCELS—and copy "Badger's Precancel Partner," 4c to approval applicants. Badger's Partner, Brooksville, Fla.

LOOK! Look! Look! 50 different stamps, small album, perforation gauge, 100 stamp hinges, all for 12c to approval applicants. Peter Casamento, 159 22nd St., West New York, N. J.

1,000 DIFFERENT genuine stamps, only \$1.00. Guaranteed satisfactory or money back. Nickles, 2939 Rodman, Washington, D. C.

FREE! Rare stamp to approval applicants. Albert Behnke, Davenport, Iowa.

100 GOOD varieties 4c, to approval applicants. R. Sherman, 2823 Sedgwick Ave., New York City.

STAMPS of your favorite Country on approval at 50 to 70% discount. Henry Steininger, 933 Monroe Street, North Bergen, N. J.

FOREIGN Stamp Collection Sent Free. Cornish Co., Schenectady, N. Y.

5 AIRMAIL—20 unused 4c. 1,000 different 98c. 500 different 38c. Both \$1.25. Buckey, 528 Alameda, Dayton, Ohio.

FREE! 10 beautiful Rhein-Buhr stamps to approval applicants. Penna Stamp Co., Manor, Pa.

100 DIFFERENT Airmail, Triangular, Menagerie, etc., 10c. Canada Stamp Company, Station F, Toronto, Canada.

55 DIFFERENT United States 10c. Valuable approvals at 60% discount. Seidenberg, Baroda, Mich.

APPLY for our Superior Approvals and receive absolutely free 100 different foreign postage stamps. W. Streitberger, 505 DuBois St., Union City, N. J.

105 CHINA, etc., stamp dictionary, list, 2c. Album (500 illustrations), 3c. Bullard, Sta. A, Boston.

UNITED STATES Stamps. Complete stock Postage, Dept's., and Revenues. Price list free. Voorhees, 7 So. Dearborn St., Chicago.

PENNY Approvals that Satisfy. Nell Greenberg, Box 5441, Philadelphia, Pa.

200 DIFFERENT stamps from many countries, catalog value about \$4.00; only eight cents to approval applicants. H. W. Myers & Co., 2931 Acton St., Berkeley, Calif.

BORNEO Rhinoceros, Australian Kangaroos and 104 Different Foreign Hinges, Etc., to Approval Applicants for 10c; 50 Different U. S. 10c. Moseley, Bloomfield, Mo.

COVERTCO Packet, 250 varieties unused and used stamps 15 cents. Covert Stamp, 39 State, Rochester, N. Y.

ZAMBESIA, Zambar, Abrasinia, Herzegovina, Allenstein stamps, menagerie collection, album, 10c. Liberty, 3974 Arsenal, St. Louis, Mo.

110 NEW Europe All Different, a wonderful collection cataloging several dollars, free to collectors requesting our Net Approvals. Postage 2 cents. Badger Stamp Co., Milwaukee, Wis.

ROYAL Surprise Packet, 10 French Col., 10 British Col., 10 Port. Col., Small Album, 250 Hinges, Perforation Gauge and Millimeter Scale and a packet of 100 Diff. Stamps all for 10c to new approval applicants. Royal Stamp Company, 6020 Broadway, Dept. P, San Antonio, Texas.

24 VARIETIES Cuban stamps, 10 cents. List of 6,000 low-priced stamps free. Address Chambers Stamp Co., 111P, Nassau St., New York City, N. Y.

STAMPS, 100 all different. Postage 2c. Lists free. P. M. Quaker Stamp Co., Toledo, Ohio.

FREE! Loose Leaf Postage Stamp Album at rate of 8 pages each month given with subscription to monthly Journal. Send 2c stamp for prospectus. United Stamp Co., Marquette Bldg., Chicago, Ill.

STAMPS, 50 varieties, Africa, Brazil, Peru, Cuba, Mexico, etc., 10c. 50 different U. S. 25c; 1,000 mixed, 40c; 1,000 hinges, 10c. List free. C. Stegman, 5948 Cote Brillante, St. Louis, Mo.

PACKET of 23 stamps, no two countries alike. Packet hinges. Set of \$1 and \$2 U. S. Rev., all for 5c. P. M. Miami Stamp Co., Toledo, Ohio.

20 UNUSED stamps free. All different. Postage, 2c. P. M. Fisk Stamp Co., Toledo, Ohio.

110 DIFFERENT Stamps, many unused, high values, free to collectors requesting our Net Approvals. Postage 2 cents. Christensen, Milwaukee, Wis.

CURIOSITY Packet, 104 unused in blocks 12c. Big 20-page List, set Air Mails Free. Rueger, 31 Cambridge, Dayton, Ohio.

1,000 U. S. AND Foreign Stamps 25c. Phil. Lundstedt, Cape Cottage, Maine.

FREE, Hungary Charity No. 565 to 567 and a surprise packet given to those requesting for my 1, 2 and 3c approvals and also my 50% discount and better. Chas. W. Schmidt, 3227 Benner St., Waukegan, Philadelphia, Pa.

STAMPS on approval—1/4c up. Free Premium. Herbert Keigwin, Middletown, N. Y.

STAMPS sent on approval at 70% discount. Reference required. Emory Benell, Hanover, Pa.

FREE—50 varieties to approval applicants sending 2c. Richard P. Lamprecht, Valparaiso, Ind.

RARE COINS

OLD Money Wanted. We paid \$2,500.00 for one silver dollar to Mr. Manning of Albany, N. Y. We buy all rare coins and pay highest cash premiums. Send 4c for large Coin Circular. May mean much profit to you. Numismatic Bank, Dept. H, Fort Worth, Tex.

100 WAR coins, curious designs, 75c; 20 Large foreign bills, 25c; 10 Confederate bills, 25c; 5 Mexican bills, 25c; 10 Austrian bills, 25c; Revolutionary War bills, 1775, 30c; 10 Civil War cents, 60c. Retail catalogue free. Nagy, 8P, South 18th, Philadelphia.

UNITED STATES and Foreign Money. Medals, Catalogue and Villa Bill 10 cents. Alexis Mengelle, Colorado Springs, Colo.

CALIFORNIA gold quarter 27c; half 52c; Continental bill 40c; Confederate \$100, 20c; 1818 cent 25c. A. Wylie, Wheaton, Ill.

HOME Mail Order Business Selling European Bonds, Banknotes, Coins. Tremendous Profits! We Start You. Furnish Free Literature. Circulars Free, or Send \$1.00 for Big Outfit Everything. Hirsch, 70 Wall St., New York.

40 OLD coins, all different, \$1.00. Monroe Half-Dollar, Uncirculated, 90c. Alabama Half-Dollar, Uncirculated, \$1.00. List free. Claud Denney, Box 315, Dallas, Texas.

OLD Money Wanted—Do you know that coin collectors pay up to \$100.00 for certain U. S. cents? And high premiums for all rare coins? We buy all kinds. Send 4c for large coin circular. May mean much profit to you. Numismatic Bank, Dept. H, Ft. Worth, Tex.

\$2 TO \$500 Each Paid for hundreds of Old or Odd Coins. Keep All Old Money. It may be very valuable. Send 10 cents for Illustrated Coin Value Book, 4x6. Get Posted. Guaranteed Prices. We Buy and Sell. Clarke Coin Office, LeRoy, N. Y.

GET Profit and Pleasure in collecting Old Coins. Send 15c for Sample Old Coin, together with my Large Illustrated Coin Catalogue. You'll be delighted with it. Send for it right now. B. Max Mehl, Professional Numismatist, Mehl Bldg., Dept. P, Fort Worth, Texas. Largest Rare Coin Firm in U. S.

OLD Coins, Large Spring Selling catalogue of coins for sale free. Catalogue quoting prices paid for coins, ten cents. William Heald, 101A Tremont Street, Boston, Mass.

CALIFORNIA gold, 3/4 size, 27c; 1/2 size, 33c; three-cent-piece and catalogue, 10c. Norman Shultz, Colorado Springs, Colo.

UNITED STATES Flying Eagle Cent and Bargain Price List 10c. M. Arty, Box 483, Muskogee, Okla.

1,000 MARK German Government Bond (1922 issue) 35c. 100 Kronen Austrian Bond 25c. American Exchange, Dept. PM, Popejoy, Iowa.

SCENERY TO RENT

SETTINGS for Opera, Plays, Minstrels. Plush drops. Address Amelia Grain, Philadelphia.

FOR BOYS

MOUTH-ORGAN Instructor, sixteen big pages, eighteen musical selections, 25c. Boy Electrician, 10c. Toy-maker, 10c. Big package Pocket Perfume, 10c. G. Eisea, Bowling Green, Ohio.

GLIDER—Complete instructions with drawings and dimensions are given in The Boy Mechanic, Book 1. In addition to this, there are directions for making nearly 1,000 other useful and interesting devices. Send No Money. If you live in the U. S., just write a postal and you may pay the postman when the book arrives. Popular Mechanics Press, Room 816, Chicago, Ill.

BOYS and Girls Earn Xmas Money. Write for 50 Sets St. Nicholas Christmas Seals. Sell for 10c a set. When sold send us \$3.00 and keep \$2.00. No Work—Just Fun. St. Nicholas Seal Co., Dept. 43, Brooklyn, N. Y.

MODEL Airplanes. Build your own. Enjoy flying them. Win prizes with them in contests. Full instructions, pictures, and dimensions in Boy Mechanic Book 4, just published. 1,549 articles, 1,320 pictures. Send No Money. Just write a postal. When the postman hands you the book, pay the few cents postage and \$2. Popular Mechanics Press, Room, 810, 290 E. Ontario St., Chicago, Ill.

CAMERAS AND PHOTO SUPPLIES

PHOTOGRAPHIC equipments and accessories of every description are listed and illustrated in our 228-page catalogue. It will pay you to secure a copy which is issued free, as our prices are low. We also deal in used goods which are sold under the same guarantee as new goods. Ask for our Bargain Book. Central Camera Co., Dept. E-98, 112 S. Wabash Ave., Chicago, Ill.

MODERN Photography in all its branches now taught by mail. New Successful Method. Students earning \$300.00 while learning. Big opportunity. Write for particulars and unusual offer open for short time. Dept. 1351, International Studios, Inc., 3601 Michigan Ave., Chicago.

SIMPLIFIED Photo-engraving Process. Line and half-tone cuts. Particulars 2c. Horton & Fisher, Princeton, Ill.

HAVE You a Camera? Write for Free sample of our big magazine, showing how to make better pictures and earn money. American Photography, 118 Camera House, Boston, 17, Mass.

KODAK Films—Special trial offer; your next kodak film developed, 5c—prints, 2c each. Moser & Son, 1917 St. James Ave., Cincinnati.

FILM Developed—One roll—Six prints—Two enlargements—25 cents (Silver). Meritz Photo Co., 1307 Maryland St., Los Angeles, Calif.

FILMS Developed. Special Trial Offer. Any Size Kodak film developed 5c, prints 3c each. Trial 6x10 Enlargement in handsome folder 40c. Overnight Service. Roanoke Photo Finishing Co., 209 Bell Ave., Roanoke, Va.

SUPERIOR quality finishing. Trial offer: Any size 6 exposure roll developed and printed, 25 cents. One only 8x10 enlargement unmounted from negative, 35 cents. Carkhuff Photo Finishing Co., 2129 W. Van Buren St., Chicago.

BIG Money Saved on Photographic Lenses and Apparatus—goods exchanged; repairing done. Ralph J. Golsen, 1128 Argyle St., Chicago, Dept. P.

BETTER Photo Finishing. Send one roll film and 15c for trial offer. Moore's Photo Studio, Alstead, N. H.

MOTION PICTURES

MOVIE films, 1,000 ft. reels. Complete stories, \$2.50 each; shipped anywhere on receipt of remittance with order. Independent Films, 177 Golden Gate Ave., San Francisco, Calif.

FILMS of every kind and character. Comedies—Westerns—Andy Gump Cartoons—Educational and Special Feature Subjects. Rock Bottom Prices. Wonderful Guaranteed List Free. Dixie Film Co., P. O. Box 467, Memphis, Tenn.

NEW and Rebuilt Machines for Big Theatres—Schools—Churches—Traveling Shows. Also Films—Supplies and Complete Theatre Equipments. Bargain List Free. Monarch Theatre Supply Co., Dept. P, Memphis, Tenn.

ONE Hundred Feet Turnan Film One Dollar. Film Classic, Fredonia, N. Y.

BIG Money Nightly—Good assortment Complete Outfits, installation plan. Scenic Home Outfit, \$25.00. Good Movie Camera, \$37.00. Ralph J. Golsen, Dept. M, 1128 Argyle St., Chicago.

NEW \$150 Sept Movie Camera \$75—used \$50. 100 foot Movie Camera \$40—Printer \$25—New 2,000 foot Master Projector \$50—Motor driven \$75—Home Projector \$37.50. 800 foot Film \$3—Comedies \$5—5 reel Drama \$10—Passion Play \$75. Films Rented, Ray, 324 5th Ave., New York.

FILM—Film—Film. You will find what you want at the lowest prices on our new big list—it's free. Monarch Theatre Supply Co., Dept. P. M., 724 So. Wabash Ave., Chicago, Ill.

MAKE money writing photoplays; details free to beginners. No correspondence course. Producers League, 230 Wainwright, St. Louis.

FILM—Million Feet for Sale. Cowboy—Drama—Comedy and Feature Specials. Mix—Hart—Chaplin and best Movie Stars, \$3.00 per reel up. Genuine List Free. We Supply the World. Dept. G, Monarch Films, Memphis, Tenn.

DON'T fail to send for the big Free Bass Book of Cinema Apparatus. The Cyclopaedia of M. P. Cameras and Projectors. Get in the game that has made thousands independent. Write or wire for your copy. Bass Camera Company, 105 N. Dearborn St., Chicago, Ill.

\$35.00 PROFIT nightly. Small capital starts you. No experience needed. Our machines are used and endorsed by government institutions. Catalog free. Atlas Moving Picture Company, 482 Morton Bldg., Chicago.

\$\$\$ FOR Ideas. Photoplay plots accepted any form; revised, criticized, copyrighted, marketed. Advice free. Universal Scenario Corporation, 206 Security Bldg., Santa Monica and Western, Hollywood, Calif.

COMPLETE moving-picture outfits, everything for the theatre, school, church and traveling show, sold on easy payments. Free catalog. Monarch Theatre Supply Co., Dept. M.A., 724 So. Wabash Ave., Chicago, Ill.

NEW Moving-Picture Machine complete. With 4 reels of films, \$70. Virgil Poe, Hay, Washington.

MOVIE Films Price List free. Donald Elder, 589 Broadway, Chelsea, Mass.

TELEGRAPHY

TELEGRAPHY—Both Morse and Wireless—taught thoroughly and quickly. Tremendous demand. Big salaries. Wonderful opportunities. Expenses low; chance to earn part. School established fifty years. Catalog free. Dodge's Institute, H St., Valparaiso, Ind.

EDUCATIONAL AND INSTRUCTION

YOU can have a business profession of your own and earn big income in service fees. A new system of foot correction; readily learned by anyone at home in a few weeks. Easy terms for training; openings everywhere with all the trade you can attend to. No capital required or goods to buy, no agency or soliciting. Address Stephenson Laboratory, 1 Back Bay, Boston, Mass.

SHOWCARD Writers, Artists—Mix 509 beautiful colors. Book gives proportions plain English, \$1.00 prepaid. Money refunded. Art Book Publisher, 2033-35 College, Indianapolis, Ind.

EARN \$25 weekly, spare time, writing for newspapers, magazines. Experience unnecessary. Copyright book free. Press Syndicate, 981, St. Louis, Mo.

GREATEST book of ages. Every man, woman, girl and boy must own one. \$2.00. Crenshaw, Distributor, 2217 Dryades St., New Orleans, La.

USED educational matter bought, sold, exchanged. Handling, 799 Broadway, New York.

USED educational matter. Lowest prices; terms. Catalog free. Mention Subject. Economy Educator, 449-A Sansome, San Francisco.

LINOTYPE Instruction; largest, oldest school in existence; established 19 years; 1,600 have attended; course \$200; including printing, \$350. Empire School, 206 E. 19th St., New York.

DRAFTING, complete \$90 course for \$15. Prepared by experts. Satisfaction guaranteed. Claude Roper, Dawsonville, Ga.

TOUCH Typewriting in 6 lessons. \$1.00 complete. H. D. Staats, La Crosse, Wis.

BOOKS! Latest editions. Radio, Chemistry, Electricity. Winfield Harrison, Fitzgerald, Ga.

LEARN Modern Barbering, Shingle Bobbing at Home. Practice on the Family. My practical, scientific instructions on modern barbering complete \$1 (bill). Teaches you expert barbering at home. Foster, Expert Barber, 13 E. 60th St., Chicago, Ill.

USED educational matter of all kinds. Hold on repurchase basis. Big saving. Money-back guarantee. Lists free. (Courses bought.) Lee Mountain, Pisgah, Ala.

LEARN Watch, Clock and Jewelry repairing at home. My three-book course complete \$3.00. James Koch, Watchmaker and Jeweler, 1015 Market St., Marcus Hook, Pa.

ARTIFICIAL Marble sanitary flooring instructions, ornamental casting, concrete, plaster, papier-mache decorations, garden furniture, statuary, Rubber-moulds. 16 years' instructing the public, particulars and 240 illustrations free. Chris Mahler, Huntington, N. Y.

FORMULAS and Short-Cuts for all problems of Engineering and Mechanics. Quickly learned. Easily applied. Scientifically correct. Send for Booklet. Lightning Method Publishers, Box 999, Long Beach, Calif.

SELF-STUDY Pamphlets, shorthand or double-entry bookkeeping. 25c; circulars, Evolution Pickups, etc., free. Marr, Teacher, B405, Nashville.

LEARN bricklaying in School run by 600 building contractors. No apprenticeship or age limit. Good demand for our graduates. Qualifies you to work anywhere. Associated Building Employers, 400 A. B. E. Building, Grand Rapids, Mich.

DOUBLE Entry Bookkeeping mastered in 60 hours with 8 keys; guaranteed; diplomas. International Bookkeeping Institute, Dept. 8, Springfield, Mo.

LOOK! Improve your handwriting! Instructions 25c (silver). Prince, 130 W. 104th, New York.

"WHAT to Invent for Profit" free. Patent News-N, Washington, D. C.

POWER Gas and The Gas Producer. Here is a book that tells all about the subject. Filled with illustrations and definite examples of installations of gas producers for power gas. A 184-page, cloth-covered book for only \$1. Send No Money. Just write a postal and ask for "Power Gas and The Gas Producer." When the postman hands you the book, pay the few cents postage and \$1. Popular Mechanics Press, Room 810, 200 E. Ontario St., Chicago, Ill.

RADIO OUTFITS AND SUPPLIES

RECEIVE 1,800 miles on a one-tube set. Complete with tube and batteries \$10.95. Marko, 3027 Logan Blvd., Chicago, Ill.

AERIAL Wire: Forty-Three Thousand Turns in an Aerial—It's Added Capacity to the Wire Itself—Sound Theory—Engineer's Tests—Not Worthless Claims—Radio Owners Write. Sample Showing Construction 5 Cents. Patent Buyer Solicited; Ideas Basic; Sell Interest to Market Big. Wound Wire Aerial Company, Reedville, Va.

MAKE money with patented radio accessory; easily constructed; it gets the coin. W. G. Conger, Independence, Mo.

HAVE you received a copy of our new 32-page "Ham" Bulletin? Hundreds of rare bargains in transmitting and receiving apparatus. Write for copy free today. Chicago Salvage Stock Stores, 509 So. State St., Dept. PM6, Chicago.

RADIOS for Cameras. Liberal allowances made for Kodaks, Cameras, Binoculars, Office Equipment, and Electrical House-Appointments in trade on Radio Sets. Ar-To-Co Radio Exchange, Ottawa, Ill.

EVERYBODY Buys—Radio Applause Cards, Biggest hit yet! Convenient and Economical. Send 50 cents for dozen samples, and big money making proposition. (Nothing free.) National Radio Applause Card Co., W. 5th St., Mansfield, Ohio.

200,000 SATISFIED customers hear distant stations on Lambert Crystal Sets. Copyrighted plans \$1.00. Complete kit and plans \$5.00. Leon Lambert, 539, Wichita, Kans.

RADIO Sets, Parts Cheap. Box 17, Sta. A, New Haven, Conn.

RADIO Sets Built, Rewired or Overhauled. Any Circuit. Six Years' Experience. O. K. Radio Shop, Junction City, Kans.

PORTABLE Radio Receiver. Build your own. Full directions with illustrations given in Popular Mechanics new Boy Mechanic, Book 4. Hundreds of other useful articles telling how to make all sorts of things. Send No Money. Just write a postal. When the postman hands you the book, pay the few cents postage and \$2 for the book. Popular Mechanics Press, Room 810, 200 E. Ontario St., Chicago, Ill.

TRADE AND TECHNICAL SCHOOLS

CHICAGO Technical College offers short, intensely practical courses in Drafting and Engineering—civil, mechanical, electrical, structural—Architecture, Building, Construction, Plan Reading, etc. Courses fitted to your needs. No time wasted. Instructors are experts. Graduates in demand at big salaries. Opportunities for part-time work while studying. Day and evening classes. 22nd year. Enter any time. No special preliminary training required. Low tuition—easy terms. Write for 52-page illustrated Blue Book, describing opportunities open to our graduates. Chicago Technical College, 25 Chicago Tech. Building, Chicago.

TELEGRAPHY—Both Morse and Wireless—taught thoroughly and quickly. Tremendous demand. Big salaries. Wonderful opportunities. Expenses low; chance to earn part. School established fifty years. Catalog free. Dodge's Institute, Fern St., Valparaiso, Ind.

GET a Foreman's Job in any trade. Train yourself to earn more money. Become an expert Blue Print Reader. You can do it in spare time. My training will give you advancement in a few weeks. Write now—tell me what trade you want—I will send my plan at once. Carroll Rumsey, 105 Drexel Bldg., Philadelphia, Pa.

LEARN bricklaying in School run by 600 building contractors. No apprenticeship or age limit. Good demand for our graduates. Qualifies you to work anywhere. Associated Building Employers, 400 A. B. E. Building, Grand Rapids, Mich.

CARPENTERS. Popular Mechanics Carpenters' Handbook is filled with ideas for those who like to tinker with tools and for professional carpenters. It contains 49 articles on saws and sawing, 17 articles on benches and bench equipment, 22 articles on doors and door hanging, 18 articles on lumber, 13 articles on mitering, 74 articles on tools and their care, 22 articles on shop equipment, and many other—366 in all, and 229 illustrations. Send No Money. Just write a postal asking for "Popular Mechanics New Carpenters' Handbook." When the postman hands you the book, pay the few cents postage and \$1.50, the price of the book. Popular Mechanics Press, Room 810, 200 E. Ontario St., Chicago, Ill.

LEARN Photo-Retouching. One of the most profitable fields of commercial art. Positions always open. Earnings \$50 to \$100 a week. We offer a thoroughly practical and easily mastered course of twenty-five lessons. No special ability required. Write at once for full particulars. School of Commercial Illustrating, 588 Century Bldg., Indianapolis, Ind.

\$12.00 TO \$25.00 Per Day—that's what my students earn. I train men in a few weeks to be expert Sign Painters, Auto Painters, Paper Hangers, Decorators. No Mail Course. All practical work. Write H. Glick, Department 150, for free catalogue. Chicago Painting School, 148 West Austin Avenue, Chicago.

RADIO School—Seven months' course. Year round instruction. Students enter any time. Positions secured for graduates. Send for catalogue. Mass. Radio School, Boston, Mass.

BUSINESS OPPORTUNITIES

AGENTS: \$11.80 daily easy (send for sworn proof) Introducing New Insured Hosiery. 57 styles, 40 colors, guaranteed seven months. No capital or experience required. You simply take orders. We deliver and collect (or you can deliver, suit yourself). Credit given. Pay you daily, monthly bonus besides. Winter line now ready. We furnish samples. Spare time will do. Marchoe Textile Company, Station 27810, Cincinnati, Ohio.

BUILD splendid business making chipped glass number and name plates, signs, medallions. Write for particulars. Simcox Utility Co., 1123 Broadway, New York.

100,000 REPRESENTATIVES Wanted! Sell by Mail, through Agents, or Direct! Detailed Information—25c! None free. Sursly Service, World Distributors, 551 Harvard St., Rochester, N. Y.

PATENTS Procured; Trade Marks Registered—A comprehensive, experienced, prompt service for the protection and development of your ideas. Preliminary advice gladly furnished without charge. Booklet of information and form for disclosing idea free on request. Richard B. Owen, 30 Owen Bldg., Washington, D. C., or 41-B Park Row, New York.

WHY work for others? Make and sell your own goods. We show you how. Free book explains everything. National Scientific Laboratories, 1907A Broad, Richmond, Va.

FREE Booklet describes 52 plans for making \$20.00 to \$100.00 weekly in home or office business of your own. Deans Co., 2323 Myrtle, St. Paul, Minn.

MAIL Order Booklet, where to buy Books, Novelties, Specialties, 10c. Harvey Teeble, Decatur, Ind.

SUCCESS With Your Own Products—Make them yourself. Formulas, Processes by experts. Trade-Secrets. Modern master methods. Catalog free. B. Thaxly Co., Washington, D. C.

MIRRORS Be-silvered at home. Costs less 5 cents per square foot; you charge 75 cents. Immense profits, plating autopaets, reflectors, tableware, stores. Refinishing metalware, etc. Outfits furnished. Write for information. Sprinkle, Plater 127, Marion, Ind.

BATTERY Shop Equipment and Supplies at Wholesale. Adams-Barr, Columbus, Ohio.

CEMENT Masons, Plasterers, Contractors. Build successful business, stuccoing old and new buildings with Everlastone Indestructible Stucco; also installing Corikatoe Floors over worn-out flooring. Write immediately for agency proposition. Everlastone Products Corporation, 828 W. Pratt St., Baltimore, Md.

"PRICELESS Mail-Order Pointers," 32 pages success facts. New and offered free. Particulars stamp. Walter Anderson, 3111, Villa Park, Ill.

A GUARANTEED money-making plan \$1. Free circular. French, 1903 E. Chase, Baltimore, Md.

PATENTS. Time counts in applying for patents. Don't risk delay in protecting your ideas. Send sketch or model for instructions or write for Free book "How to Obtain a Patent" and "Record of Invention" form. No charge for information on how to proceed. Communications strictly confidential. Prompt, careful, efficient service. Clarence A. O'Brien, Registered Patent Attorney, 5896 Security Bank Building (directly across street from Patent Office) Washington, D. C. See pages 156 and 157.

CHEMICAL Expert furnishes Manufacturing Formulas and Processes with complete working directions. Reliable individual service only. No lists. Charges reasonable. Correspondence invited. Dr. Arthur Van-Heerden, 508 South Oakley, Chicago.

THE Truth about California, by a man from the East. Complete facts—no bunk. 25c. L. J. Van Duser, 2121 Bessallo Ave., Los Angeles, Calif.

NEW Plan, Mail Order. Copyrighted, Guaranteed, Spare Time, Sure, Quick, Positive Profits, Permanent Business. Circular Free. Fred Horst, Bellingham, Wash.

ATTENTION! You can have a business of your own. Establish and operate New System Real Estate Business, brokerage and insurance agency in your community. Office at home. Earn \$5,000 year. Representatives wanted everywhere. Send stamp free booklet. Hayes Realty Association, Cincinnati, Ohio.

SIGNS, Cards, Banners Easily Painted with Letter Patterns. Samples for Stamp. Corwin Adr. Service, Lockport, N. Y.

\$20 A DAY cleaning cisterns. All profit. Make your own cleaner for less than \$2. Instructions \$1. Circular free. R. B. Specialty Co., 1951 Mears Ave., Cincinnati, Ohio.

LEARN Hotype: Earn \$3,000 yearly; established 19 years; day, evening; cost \$200; including printing, \$350. Emulve School, 206 E. 19th St., New York.

ADVERTISING—24 words in 300 monthlies and 75 weeklies combined \$5. Cape Agency, 233P, Champaign, Ill.

ANY desired guaranteed formula furnished. Central Laboratories, 233P, Champaign, Ill.

DIME brings 100 interesting Propositions. R. F. Brang, Brodheadsville, Pa.

FREE Advertising rates. Newspaper and magazines. Pennell, Cornington, Ky.

MANUFACTURE Doll Beds at home. Instructions. Sample \$1.75. Springer, 415 South Lowndale, Kansas City, Mo.

SAWDUST and chemicals make Sanitary flooring. Profitable business. Directions \$1.00. Universal Supply Co., Auburn, N. Y.

\$40.00 A WEEK; made at home with our \$16.00 potato chip outfit; we work with you. General Sales Co., Muncie, Ind.

STANDARD Tested Formulas; Fifteen Guaranteed Money Makers. Only 10 Cents. G. Buckram, 63 Court St., Room No. 1, Boston, Mass.

BESILVERING Mirrors—Genuine Guaranteed Trade-secret, 56c. Closer Laboratories, 2511-R, Foster, Chicago.

MAKE Money! 150 Plans Free! Wolverine Bureau, (A-1), Muskegon, Mich.

MAIL Order Business—\$15 weekly and up guaranteed. Send stamped envelope for it. Valuable. W. Johnson, P-5428 K, Wells, Chicago.

NO strikes or layoffs. My secret money-making plan will show you how to make \$75 to \$100 a week anywhere in spare time. Steady business. No experience or capital needed. Mail dollar bill for complete instructions. Chemist, P. O. Box 680, Johnston, Pa.

MAKE a splendid income acting as our agent. All or spare time. Particulars free. Russo, 3011M Broadwood Avenue, New York.

SELL Copyrighted Business Plans by Mail. 1,000% Profit! Particulars Free. G. Hinds, Monticello, Ill.

BIG money at home. Particulars free. Send dollar. William Cox, Waterloo, Iowa.

PUT yourself in business with little or no investment. Unlimited money-making possibilities. First time offered to public. Free information. Franklin Sales System, 339 Bremer Arcade, St. Paul, Minn.

\$13.95 IN 4 months. Wonderful Vapor Humidifier for Autos. 1 free to introduce. Critchlow, L121, Wheaton, Ill.

COST \$3.00, your profit \$104.75. Transferring Decalcomania letters on autos, trunks, bags etc. Send today for outfit or free samples. World Monogram, Dept. 73, Newark, N. J.

MARBLE mixing instructions, covering wood or cement flooring 1/2 in. thick, fireproof, waterproof, low cost, sanitary, all colors. Particulars, 200 Illustrations free. Chris. Mahler, Box 123, Huntington, N. Y.

TRIPLE Your Sales! Learn New Secrets of Selling. Large Free Folder Explains. Cutler Limited, Reading, Pa.

\$50 A WEEK Evenings. Mail Order Business. Booklet Tells How. Sample and plan 25c. Free—9 articles worth \$3. B. Bradford Co., Shawnee, Okla.

GET into the Mail Order Business. We furnish catalogs, merchandise, etc. Write for information. H. Weisman & Co., 551 Lake St. P. Chicago.

GET Money in your Mail. My Mail Order plans will start you in Business at Home. Price \$1.00. E. Noon, Windsor, Va., 131.

YOUR ship will never come in unless you send it out. European Bonds, "The Venture of the Century," bought, sold cash or installments. Information without obligation. Frank O. Everett, 35 Wall Street, New York.

MAKE toys and novelties at home. Big profits. Instructions and Illustrations, 25c. Astrolite Company, Sharpsburg, Pa.

\$8,000 MARK German Government Bonds only one dollar; remit money order. Julius Louisa, 312 S. Clark, Chicago, Ill. Established thirty-one years.

CLAIMS of Every Description Collected. Fidelity Credit Co., 802 East Clay, Richmond, Va.

PATENTBOOK, 139 mechanical movements and Illustrations, sent free. Labiners, 3 Parkrow, New York.

MAKE big income operating a collection agency. No capital necessary. We teach you fully. Write Collection Instruction Institute, 316 Waverly, Syracuse, N. Y.

BATTERY Charging pays big profits using Constant Potential. Only \$16.50 monthly. Write Wilhoart, Troy, Ohio.

LATEST Money-Making Specialty Formulas, Trade Secrets. Southern Trading, 50, Flushing, N. Y.

SELL books and formulas by mail. Money making circulars at one fourth cost. Big profits. Particulars free. Eifeo, 523 So. Dearborn, Chicago.

\$3,000 TO \$6,000 Yearly. Want it? Others are making it. Send check or money order today for our invaluable books "How to Sell Real Estate," \$3.00—and "How to Conduct Real Estate and Insurance Business," \$1.50. Absolute satisfaction guaranteed. Free circulars. Realty Book Co., Dept. 52, Cleveland, Ohio.

GOLD, Silver, and Colored Sign Letters for windows, automobiles, trucks. Make them yourself with our Process and Letter Patterns. Fast Sellers. Big Profits. No Experience. Stamp brings actual sample. Wilderding, 1144 Pleasant Street, Oak Park, Ill.

GO into the Crispette business. Everybody likes Crispettes. You can make a lot of money. We start you. Write for facts. Long Eakins, 1939 High St., Springfield, Ohio.

MANUFACTURE Millerite! Ethol-Super-Fuel Ingredient for Gasoline. Increases Power, Mileage—saves gas—easily mixed—profits great—valuable Formula Literature of this, Lightning Electrolyte, Kor-Kit, Pro-Tex-U, Amazon Rubber Repair, and fifty other Biggest selling Specialties in all lines will be sent on request. Miller, Chemist, 1115 Grand Central Ave., Tampa, Fla.

MAIL Order Business. No part time, or house to house methods. Particulars on request. Hugh Allison, Box 6, Station A, San Diego, Calif.

CHEMICAL Expert will furnish Formulas and Trade Secrets. All lines. Lists Free. W. L. Cummings, Ph. D., 228 Gordon Ave., Syracuse, N. Y.

ENTER a new business. Earn \$3,000 to \$6,000 yearly in professional fees making and fitting a foot specialty, openings everywhere, with all the trade you can attend to; easily learned by anyone at home in a few weeks, at small expense; no further capital required, no goods to buy, job hunting, soliciting or agency. Address Stephenson Laboratory, (1) Back Bay, Boston, Mass.

SCHEMER, Alliance, Ohio, prints Big profit Schemes, one subscriber making \$25,000 from three; another \$10,000 from one. Try your luck. Three months, 30c; COPY 10c.

MAIL Order Business is your opportunity. Brenner's Famous Handbooks teach how to start small, grow big. Sell merchandise, service, ideas; enormous profits. Spare time to begin. Get complete set, 11 books, \$3.00, and be posted. Brenner, 325 Walnut, Philadelphia. Descriptive Catalog and big batch interesting mail order information, 25c. None free.

"HOW to Sell Patents" free. Patent News-H, Washington, D. C.

INVENTIONS fully protected two years \$15 total cost. Particulars free. Patent News-K, Washington, D. C.

FREE Book. Start your own little Mail Order business; home employment evenings. Beginner's Outfit furnished, including 500 circulars, samples, things to sell; you deal with Manufacturers. Also tell easy way to get Agents by mail to sell your novelties. Instructive Book free. Pier, 978 Cortland Street, New York.

INVENTORS—Write for our Guide Book, "How to Get Your Patent" and Evidence of Invention Blank. Send model or sketch of your invention for our free Examination and Instructions. Randolph & Co., Dept. 435, Washington, D. C.

WE Start You in Business, furnishing everything; men and women, \$30.00 to \$100.00 weekly operating our "New System Specialty Candy Factories" anywhere. Opportunity lifetime; booklet free. W. Hillyer Rasmale, Drawer 4, East Orange, N. J.

WANTED, Patent Finance. Address W. C., Patent News, Washington, D. C.

EARN \$10 daily silvering mirrors, plating and refinishing metalware, autos, chandeliers, bedsteads, headlights. Outfits furnished. E. Deale Laboratories, 1133 Broadway, New York.

MAKE Money at Home—making toys. We show you how. Send \$1 for complete working drawings and instructions. DeKalb Designing Co., Decatur, Ga.

GET Money in Your Mail. "Lambert's Mail Order Secrets" contains successful methods never before published. \$1.00 postpaid. Particulars free. Leon Lambert, Wichita, Kans.

SIGNS and Showcards Easily painted with Letters Patterns. Large variety of Styles and Sizes. Sample for stamp. John Rahn, A2433 Greenview Ave., Chicago.

LEARN the collection business. Good income, quick results. Interesting booklet, "Skillful Collecting" free. National Collectors Assn., Long St., Newark, Ohio.

"WHAT to Invent for Profit" free. Patent News-C, Washington, D. C.

FORMULAS AND TRADE SECRETS

CONCRETE Waterproofing Processes, making Hard, Light Colored, Damp-proof concrete building blocks. Concrete Machine Co., 5 Main St., St. Louis, Mo.

FORMULAS, Processes by experts. Trade-Secrets. Modern master methods. Catalog free. B. Thaxly Co., Washington, D. C.

WHY work for others? Make and sell your own goods. We show you how. Free book explains everything. National Scientific Laboratories, 1907A Broad, Richmond, Va.

PROVEN Formulas Insure Success. Make and Sell Your Own Products. Formulas That Win. Catalogue Free. Pacific Publishing Co., Princeton, Ore.

I HAVE a Secret formula for making Luminous Paint and making fireproof Paper, and 7 other secret formulas for 50 cents. Send money order or cash. Write to address below. Edward R. Wilson, 2009 5th St., Detroit, Mich.

MANUFACTURE mirrors, reliable formula. A. Cramer, 78 Wylie, St., Schenectady, N. Y.

RELIABLE Formulas. Free Labels. Catalogue 2c. P. Miller Agency, Kensett, Ark.

RESTALL Chemical Wood Stone—For public building, kitchen and bath room flooring. Can be molded into dolls, souvenirs and novelties. Circular Free. Maxim Chemical Co., Maxim Building, New Castle, Ind.

ANY desired formula furnished, guaranteed. Write, Central Laboratories, 233P, Champaign, Ill.

10,000 FORMULAS. A real Gold Mine of money-making ideas. Tells how to make almost everything under the sun. You can make and sell Cosmetics, mucklage, anti-freeze solutions, battery solutions, beverages, cheese, chewing gum, cleaning preparations, extracts, hair preparations, inks, bluing, leather polish, mirrors, perfumes, polishes, typewriter ribbons, carbon paper, washing powders, liquid soap, and hundreds of other profitable articles. Send No Money, just write a postal and ask for Henley's 20th Century Book of Formulas. When the postman hands you the book, pay the few cents postage and \$4. Money back if you are not delighted. Popular Mechanics Press, 200 E. Ontario St., Room 810, Chicago, Ill.

FORMULAS The best Chemical Science can devise—Guaranteed Reliable Processes in all lines. Stamp brings big bunch valuable literature, interesting lists. Don't buy till you see what I can give you. 27 years supplying the best. Miller, Chemist, 1133 Grand Central, Tampa, Fla.

500 FORMULAS—Including Luminous Paint—Renewing Dry Batteries—Mechanics' Soap—Gas Tonic—25c. Catalog Free. Ideal Book Shop, 2511-PM, Foster Ave., Chicago.

BEVERAGES, Syrups, Extracts, Flavors, Etc. Other good manufacturing specialties. Free information. The Formula Co., 1613 Queen Anne Ave., Seattle, Wash.

STANDARD Tested Formulas: Fifteen Guaranteed Money Makers. Only 10 cents. Bucknam, 63 Court St., Room 1, Boston, Mass.

MECHANICAL data, tables and formulas for solution of mechanical or engineering problems. \$1.50. J. Clarke, 5 Trumbull, New Haven, Conn.

1,000,000 FORMULAS, 1,016 pages, \$1.98. 500 Formulas Free if you order quick. Ideal Book Shop, 2511-PM, Foster Ave., Chicago.

LATEST Money-Making Specialty Formulas, Trade Secrets, Southern Tradinx, 51, Flushing, N. Y.

CHEMISTRY

LABORATORY Apparatus, Chemicals. Catalog 3c. Chemical Apparatus Co., 4402 West End, Chicago.

ANALYSIS, Research, Technical Information. Robert Henderson, Consulting Chemist, Madison, Mo.

YOUR chemical problem solved and working process furnished Five Dollars. Write me. W. Stedman Richards, Consulting Chemist, address, Box 2402, Boston, Mass.

TECHNICAL information, analysis, formulas, trade secrets. Jacob Shuyter, Chemist, 2525 East St., Davenport, Iowa.

CHEMICAL Catalogue for Experimenters, 5c. George Ott, 1218 Chestnut, Reading, Pa.

AGENTS WANTED

NO Dull Times in the Food Business. Selling Federal Pure Food Products is the greatest, surest and safest business in the world today, and here is your opportunity to get into it. You can make \$3,000, \$5,000, \$10,000, or more per year—the only limit is your ability to take care of the business. You will need no experience or money to get into this business as we send you our handsome \$15.00 Sample Case on Trust and teach you everything you need to know. We furnish you with license. **No Dull Times**, for the People Must Eat, and our food products are the fastest selling, surest and quickest repeat order goods in the world. Sell on sight in every home where food is used—repeat orders immediately and every week thereafter. A real big business all your own. Every new customer adds a great deal to your weekly income. Your business once established, has a market value just like a store and can be easily sold. The greatest money making opportunity of your lifetime because you risk absolutely nothing as we guarantee your sales, and we will not let you fail. Remember! Guaranteed! Best products, biggest sellers, surest repeat orders. No capital or experience is required. We furnish capital and everything necessary for you to become a Federal Distributor. Exclusive territory will be given honest men or women who write at once. Federal Pure Food Company, 2309 Archer Avenue, Dept. A, Chicago, Ill. Largest packers of Pure Food specialties in the world. Reference, any bank, Dun or Bradstreet rating agency, Express or Railway Company in America.

FREE—Get This Quick! Chicago's Wonder Shirt line. Sell newest, stylish, snappy, Stylenor Shirts. Amazing values at low prices. Make \$100.00 weekly easy. Complete assortment of large swatches makes selling Stylenor Shirts a cinch. Experience or capital unnecessary. Be your own boss. We will show you how to build a big business of your own. We will deliver and collect. Exclusive territory open. Write today, for big free outfit. Stylenor, 81 W. Van Buren, Chicago, Ill. Dept. 560.

AGENTS, Salesmen—Sell New Thermo-static Automatic Carburetor Control Attachment for Fords. Big Profit, full or part time. Burns 95% air. Doubles Mileage. Attached in 2 minutes. No drilling. Does automatically exactly what Ford manual says do by hand. Cadillac now using Thermo-static Carburetor Control under Blawie license. Write today. A. C. Blancke & Co., Dept. 805NX, 602 Lake St., Chicago.

200% PROFIT on Goods of Your Own Label. That's what selling this line means. Don't spend your life advertising and distributing a product with another's name and getting only part of the profits. Build a business of your own. Get the full benefit of repeat orders on the strength of your private label. This proposition is unbeatable. Read! No money risk. No overhead. No manufacturing and packing costs and worries. Every cent profit on goods sold is yours. We make your goods, stock them, print your own attractive label on them. All you do is sell them. And they sell fast. Every product in the line is an everyday necessity. Toilet Articles, Food Products, Labor-Saving Household Specialties, Medicinal Preparations, etc. Goods are shipped promptly with enough extra goods free to cover transportation charges to wherever you live. Write for full details and for our wholesale price list. Continental Chemical Company, 1900 West Broad Street, Richmond, Va.

MILLERITE: Here it is! You've read about this New Wonderful Ethyl-Super-Fuel Ingredient for Gasoline—Increases Mileage—Saves Gas—Knocks Carbon—Easily Mixed from my simple Formula—profits great—\$3,000.00 to \$50,000.00 for you if you hurry! Don't pass this by you'll be sorry—but send today for full descriptive literature of this and other valuable Formula Lists describing latest, biggest, selling specialties in all lines as Mendit, Fabric Mending Cement, Marcel Permanent Hair Curling Fluid; Denta-perl Tooth Whitener; Balloons and other thin dipped rubber goods; Plynox—few drops kills roach infestations; Amazon Self Vulcanizing Repair; Pro-Tex-U only Guaranteed Fire Extinguisher; Pure Food Products; Toilet, Medical, Household, Automobile Office Specialties—latest in all lines. 27 years supplying the best in Formulas and manufacturing information. Highest References. Miller, Chemist, Tampa, Fla.

I WANT a Partner-Agent to take care of my business in your town. I furnish everything including the world's finest line of 175 household products, and split the total selling price with you 50-50. Beautiful sample outfit makes selling easy. Toilet Preparations, Food Products, etc. Highest quality—lowest prices—quick sales—permanent repeat business. I pay largest commissions in this line and offer free Chrysler or Hudson Coach besides. Get my amazing offer quick. Address me personally. Sidney F. Mills, Director of Sales, Health-Products Co., Dept. FF-206, 117 Duane St., Cincinnati, Ohio.

\$8.50 TO \$20.00 daily easy. Introducing New Insured Hostery for men, women, children. 57 styles, 40 colors. Must wear or replaced free. Repeat orders sure. Nyland made \$395 in one month. Edwards, \$460.60. Mrs. Bone, \$445.25. Why not you? Even spare time work should pay you \$3 per hour. Your pay daily in advance. We deliver and collect. You spend all your time writing orders. No experience or capital needed. We furnish samples. All grades, colors, including silks. No matter what you are now doing, it will pay you to get our offer. Maceoche Textile Company, Station 25410, Cincinnati, Ohio.

SELL Women's Fashion Shoes. Castle-Blair representatives earn \$50 a week as side line—\$500 a month full time—\$3 an hour spare time. No sample shoes to lug around. No delivering or collecting. Most liberal commissions in cash in advance. Our 65 Paris and New York styles in pictures that talk. "Automatic" sample outfit makes sales easy, free! First to qualify from each locality awarded valuable territory right. Write at once. Castle-Blair, Inc., 318 S. Michigan Blvd., Dept. C110, Chicago.

MAKE Money Selling Plants. Our men now making \$35 to \$75 weekly selling shrubs, roses, fruit and ornamental trees, etc. Thousands of new homes need plants. Every home a possible customer. Complete nursery line. Demand increasing. We teach you. Outfit free. We deliver. We collect. Pay weekly. Hooker Bros., 410 Actna Bldg., Rochester, N. Y.

IF I Send you a Suit made in the latest style from the finest goods, will you keep it, wear it, and show it to your friends as a sample of my sensational \$25.00 suits guaranteed regular \$50.00 values? Could you use \$3.00 an hour for a little spare time? If so, write me at once for my wonderful new proposition. Just write your name and address on a card and mail to Dept. 892, Kniekerbecker Tailoring Co., 128 So. Peoria St., Chicago.

\$40.00 WORTH for \$23.50. That's what you can offer with our line of men's finest Virgin Wool suits, guaranteed regular \$40.00 values for only \$23.50. Do you think you could sell such values? As a matter of fact, you don't have to think about it. 2,500 men have already discovered and demonstrated the tremendous sales possibilities of this line. Get the verdict of these men. It is an amazing story. Your name and address on a postcard will bring it to you without obligation. Send for it—Today—to Dept. 631, William C. Bartlett, Inc., 850 West Adams St., Chicago.

IF We Give You shoes made-to-your measure in any one 60 leathers, 50 different styles, will you keep them, wear them, show them to your friends as sample of our \$19 Made-To-Order shoes to sell at \$6.85? Advise us today. Your complete outfit will go forward Absolutely Free at once. Dent, 1010, Tailor-Made Shoe System, 45 So. Wells, Chicago.

SELL Christmas Cards. All Your Friends Use Them. Make your Christmas money. Engraved cards exclusively; best value in design, quality and price. Customer's name printed or engraved. Good commission. No money needed. Write for selling outfit and particulars at once. No replies considered after Nov. 20, or outside of U. S. Knight & Co., Box M-76, Riccarton, N. J.

AGENTS: Any old car looks like the "dickens." The finish dull, dirty and lusterless. Sell him a can of Albalop. One application of this wonderful cleaner and polisher, combined with "elbow grease," will make the old bus look like new for several months. Great for leathers and wood finishes. Handsome profits—Guaranteed results. An investment of 50 cents for a can and Agent's proposition, plus effort, will set you up in business. Albalop Distributors, 52A Vanderbilt Avenue, New York.

AGENTS—Make big money taking orders for furniture, house furnishings on easy payments; direct to user from big catalog; full or part time. One man made \$28.00 in an hour; another \$50.00 on one order; extraordinary opportunity for few good men in small towns to represent this 67-year-old house; new plan; experience unnecessary; no collections; we furnish everything free. L. Fish Furniture Co., Dept. A9, 2237 West Pershing Road, Chicago.

SELL Shirts and Overalls Direct to Wearer. Big Profits. Work full or spare time. No experience required. Big variety Dress Shirts with splendid line Union-Made Work and Flannel Shirts, Overalls, Coveralls, Work Pants, Leather and Sheep-lined Coats. Write today for free selling outfit. The Nimrod Shirt Co., Dept. 8, 4922 Lincoln Avenue, Chicago.

AGENTS—Best seller; Jem Rubber Repair for tires and tubes; supersedes vulcanization at a saving of over 800 per cent; put it on cold, it vulcanizes itself in two minutes, and is guaranteed to last the life of the tire or tube; sells to every auto owner and accessory dealer. For particulars how to make big money and free sample, address Amazon Rubber Co., Philadelphia, Pa., Dept. 505.

SUCCEED With Your Own Products—Make them yourself. Formulas, Processes by experts. Trade-Secrets. Modern master methods. Catalog free. B. Thaxly Co., Washington, D. C.

AGENTS—Steady income. Large manufacturer of handkerchiefs and dress goods, etc., wishes representative in each locality. Factory to consumer. Big profits, honest goods. Credit given. Send for particulars. Freeport Mfg. Co., 59 Main St., Brooklyn, N. Y.

65c PROFIT every dollar! Minute demonstration makes sale. Homes, stores, offices, factories, etc. Big repeater. Free sample offer. Mallard Chem. Co., (A) St. Louis, Mo.

QUICK, easy sales; splendid profits and sure repeat orders handling Carefree Linenier. Start small, grow big with tremendously successful plan. Sincere men and women seeking real money-making opportunity write Garfield Manufacturing Company, 119 N. Fourth, Philadelphia.

\$12 FOR 2 Hours' Spare Time. New line. Wall-Auto Emblems. No Competition. Every member buys on sight. Biggest money maker. Free Sample Plan. Write! Crafts Co., 3314A Lawrence, Chicago.

WE pay \$48 a week, furnish auto and expenses to introduce our Soap and Washing Powder. Bus-Beach Company, Dept. A42, Chippewa Falls, Wis.

PATENTS. Time counts in applying for patents. Don't risk delay in protecting your ideas. Send sketch or model for instructions or write for Free Book "How to Obtain a Patent" and "Record of Invention" form. No charge for information on how to proceed. Communications strictly confidential. Prompt, careful, efficient service. Clarence A. O'Brien, Registered Patent Attorney, 5896 Security Bank Building (directly across street from Patent Office), Washington, D. C. See pages 156 and 157.

MAKE. Sell Changeable size belts. Latest design; big profits full or spare time. Samples 75c. Artlex Company, 494 Milwaukee Ave., Chicago, Ill.

AGENTS—good, steady income. Exceptionally useful household article. The Handycap Company, Newark, N. J.

AGENTS—Amazing New Fluid mends rips, tears, holes, in 1 minute without sewing. Won't pull, boil, wash or tear off. Sells to every woman for 50c. Your profit 100%, \$25.00 a day easy. Send 50c for sample tube to Nu-Way Co., Dept. M-100, Mt. Healthy, Ohio.

MIRRORS Re-Silvered at Home. Costs Less 5 cents per square foot; you charge 75 cents. Immense profits, plating automats, reflectors, tableware, stoves, Refinishing metalware, etc. Outfits furnished. Write for information. Sorinkle, Plaster 126, Marion, Ind.

GET Free Sample Outfit! Earn \$3,000 to \$5,000 a year selling the most complete line guaranteed Hosiery and Underwear in America. No experience needed. You can become District Manager and have others working for you if you act quick! Write today. Malloch Knitting Mills, 5510 Grant St., Grand Rapids, Mich.

AGENTS, \$60 a week. Brand New line of Christmas Cards. All designs patented. Nothing else like it. Cost no more than ordinary kind. Easy Sales. No competition. Pay you daily. Any man or woman can make big money working spare time. Write for sample outfit. Sunshine Studios, Dept. 380, Dayton, Ohio.

SELL Guaranteed Shoes—earn \$250 to \$500 a month. Exclusive territory, complete sales outfit free. We deliver and collect. No capital or previous experience needed. Write today. Style-Plus Shoe Co., 417 Baltimore Bldg., Kansas City, Mo.

AGENTS—\$100 a week for full time; \$25 to \$50 spare time. Equipment and car free. Exclusive territory. Sound, permanent proposition. A rare opportunity but you must act quickly. Write for particulars today sure. American Products Co., 4011 American Bldg., Cincinnati, Ohio.

AGENTS, Every County. Patented Ottoman Clothesline hangers. No knots, sagging, slipping, trouble. Costs 30c, sells 25c. Demonstrator 40 cents. Ottoman, 2043 West 105, Cleveland, Ohio.

TEN cent package Metler's Compound makes one pint ink. Sample 5 cents. A. Metler, Baldwin St., New Brunswick, N. J.

ALL you do is show the new patented E-Z polishing glove. Everybody a prospect. Territory rights. Cash for repeat business from consumers, dealers, etc. Send 50c for money-back sample, or write. Henry R. Rupen Co., 217 No. Desplaines St., Chicago, Dept. 10.

200% PROFIT. New Discovery cuts auto upkeep. Recommended by Auto Clubs. Samples free. Taylor Products Co., West Nighthaven, Columbus, Ohio.

AGENTS, \$60 a week. Take orders for New Insured Hosiery. All styles, colors. Finest Silk. All or spare time. Auto furnished. Write for samples. Wilkint Hosiery Co., Dept. 578, Greenfield, Ohio.

SOMETHING new! Marvelous Fountain Pen and Pencil in one. \$100.00 week assured. Free combination to workers. Maros, 417 West 21st, New York.

FAST-SELLING. New Ideas in Bags, Women Oil Cloth, Sanitary, Durable, Beautiful colors. Send \$1.20 deposit for sample and details. Liberal profits. Guaranty Mail Order Co., Dept. P.M. Clayton, N. J.

MAKE \$3.00 An Hour Taking Orders for Pie Crimpers, Nu-Style Egg Rollers, Knife Sharpeners, Wrenches, Jiffy Egg Beaters and 30 Other Big Profit Sellers. Agents' Outfits Free. Write Quick. General Products Co., Dept. 7-C, Newark, N. J.

NEW Specialty Costs 16c. Sells for 50c. Real \$1.00 Value. 30 Other Big Profit Sellers. Agents' Outfit Free. Write Quick. General Products Co., Dept. 7-N, Newark, N. J.

PHOTO Medallions earn \$100 and more every week for our representatives. Take orders for Famous P. & G. Photo Specialties—the quickest sellers and biggest profit-makers in the field. Includes Artful Portrait Paintings—just like genuine oil paintings—Clock Medallions, Photo Medallions, Powder Compacts, etc. Don't wait—write Now! Pudlin & Goldstein, Dept. "A," 259 Bowery, New York.

\$50.00 TO \$150.00 Weekly—Latest Paris and New York Models Ladies' Smart-Style made-to-measure Hats sell on sight. No money required for stock. Write for samples and territory wanted. Smart Style Milliners, Dept. 55, Cincinnati, Ohio.

AGENTS, Demonstrators, State Managers: Big opportunity, big profits awaits first in the field! Protected territory. Send 10c for sample and particulars. Chemetal Co., Dept. B, 104 Hanover St., Boston, Mass.

WONDERFUL invention eliminates needles for photographs. Preserves records. Abolishes scratching. Day's supply in pocket. \$20 daily. Sample on approval if requested. Everplay, Desk. B-10, McClurg Bldg., Chicago.

AGENTS Wanted—Something New—Fyr-Fyter sells easily. Makes a spectacular demonstration; car owners, homes, factories, stores, practically buy on sight. Our men make \$10 to \$50 a day. Exclusive territory to producers. If you wish to establish a business of your own with unlimited possibilities for making big money, write us today. Fyr-Fyter Co., 903 Fyr-Fyter Bldg., Dayton, Ohio.

GREATEST temper-saving device! Takes slack and kinks from telephone and electric iron cords. \$25 daily. Samples on approval if requested. Neverknot, Dept. 101, McClurg Bldg., Chicago.

\$50,000. PICTURE Man Friedman made canvassing. Beginners can make \$100.00 weekly with my sales talk. Experienced men make more. Free book "Profits in Portraits" explains. Samples Free. Picture Man Friedman, Dept. 8-M, 541 W. Lake, Chicago.

SELL the Oversized Johnson \$7.00 Red Pen direct to users at \$3.50. The cream of the selling season is here. Send for agents' sample at \$1.75 and full details, or send for details only. Johnson Pen Co., Dept. P, 117 S. First St., Rockford, Ill.

WHY work for others? Make and sell your own goods. We show you how. Free book explains everything. National Scientific Laboratories, 1907A Broad, Richmond, Va.

MAKE \$15.00 daily selling "Fixit" Rubber Repair (Liquid Rubber) for tires and tubes. Sensation of 1925. Fastest seller. Big money maker. Sample free. Marquette Rubber Co., 2325BB Wolfram St., Chicago.

AGENTS Astounded—\$4.80 profit every \$5.00 sales; deliver and collect as you go; no license required; sample free. Barnes, 24 Calender, Providence, R. I.

AGENTS, Distributors, Salesmen—Opportunity to earn \$65—\$100 weekly, handling quick selling auto specialty; large profits; every auto owner interested; you can clean up some big quick money. Free folder explains. Equipment Eng. Co., Seneca, Kans.

AGENTS: Photo pillow tops are again popular, easy to sell and big money to be made; we make quick delivery. United Service Art, 2539 South State St., Chicago, Ill.

EASY to Earn \$60 a Week Showing women amazing new kind of stylish shoes. No experience needed to earn \$15 a day. Hundreds already doing it. Write quick for Best Samples. Style-Arch Shoe Company, Dept. 3010, Cincinnati, Ohio.

AGENTS: \$300—\$500 monthly easy taking orders for Money Rim Tool. Autoists and trade buy on sight. M. Money Rim Tool Company, Hillsfield, Mich.

MEN or Women Agents, Full or spare time, selling Stationery. Every Man and Woman a customer. Sample outfit Free. Schaffer Stationery Company, 1308 Ewing St., Fort Wayne, Ind.

LATEST Formulas. All lines. Lowest prices. Get my lists before buying. Murphy, Chemist, Tujunga, Calif.

BUILD splendid business making chipped glass number and name plates, signs, medallions. Write for particulars. Simplex Utility Co., 1133 Broadway, New York.

\$20 PROFIT daily selling self-threading needles, needlebooks; cost 3-5c each; sell 25c; three samples 25c. Catalog free. Needlebook Specialty Co., 661 Broadway, New York.

WHY work for others? Make and sell your own goods. We show you how. Free book explains everything. National Scientific Laboratories, 1907A Broad, Richmond, Va.

AGENTS: Make \$5 to \$10 Daily introducing Ware's Iron Rust and Stain Remover. Everybody wants it; everybody buys. Just send name; we tell you how it is done. Vegge-Lene Company, Desk 22, Warsaw, N. Y.

MAKE \$10 to \$100 weekly. Spare time, at home. 20 Successful plans, many require no canvassing or capital. Steady income assured. Particulars Free. Golding Publishing Co., 461 West 148th Street, New York City.

MAKES Autos Run like on cool, moist night. Wonderful Vapor Humidifier. 1 free to introduce. Critchlow, P121, Wheaton, Ill.

GENUINE Gold Leaf Letters anyone can put on Store windows. Guaranteed to never tarnish. Large Profits. Enormous Demand. Free Samples. Write today. Metallic Letter Co., 455-A North Clark, Chicago.

EVERYBODY uses Extracts. Sell Duo Double Strength Extracts. Complete line of household necessities. Big repeaters. Write today. Duo Co., El. Atlas, N. Y.

\$100 A WEEK: Agents, Crew Managers, sell Extracts, Toilet Articles, other necessities. Guaranteed line. Particulars free. Midwest Drug Co., 191 E. Nighthaven St., Columbus, Ohio.

AGENTS—(Iriscope) Violet rays Glare Shields. Best item ever produced. For every Motorist. Emerald Glare Shield Company, Freeport, Pa.

MAGNETOS, Starters, Generators, Ignition Systems, Spark plugs, Parts, Rebuilding. Meinert Magneto Co., 1783 E. 21st St., Cleveland, Ohio.

BIG Money—fast sales; everyone buys gold initials for their auto; sell \$1.50, profit \$1.44. Ten orders daily easy. Samples, information free. World Monogram, Dept. 16, Newark, N. J.

AGENTS—Big Seller—\$20 a Day Easy selling Taylor Caps—made-to-measure—every man buys—some want 2 or 3 caps. Samples Free and Cap Free to good agents. Write quick for fast money-making proposition. Address Taylor Cap Manufacturer, Dept. 8-R, Cincinnati, Ohio.

AGENTS: \$8 to \$10 Daily Easy—Introducing "Chieftain" Fine Quality, Guaranteed Tailored Shirts. Just show samples. Write orders. We deliver and collect. Your pay every day. No capital or experience necessary. Spare time pays you big. Send today for Free Samples. Cincinnati Shirt Company, Sery, 15810, Cincinnati, Ohio.

SOMETHING new—Presto Rubber Repair for tires, tubes; all rubber goods put on cold, no heat, acid or tools; vulcanizes itself in few minutes. Sells to auto owners and dealers. Sample free. Pioneer Products Co., Dept. A, Roebing, N. J.

EARN Money selling 20 pkgs. sewing needles at 25c pkg. Keep \$2.00, send \$3.00 when sold. Extra premiums free. Write today. We trust you. The Stylus Co., Box 2488, Boston, Mass., Dept. M.

FREE Booklet describes 52 plans for making \$20.00 to \$100.00 weekly in home or office business of your own. Downs Co., 2323A Myrtle, St. Paul, Minn.

MARVELOUS New Invention—400% Profit. Johnson's Liquid Quick Mend. Tremendous demand. Plan Unique. Act quick. Over hundred other fast-selling specialties. J. E. Johnson Co., Dept. 431, 69 E. South Water St., Chicago, Ill.

SELL Xmas Cards. Price and workmanship unequalled. Particulars Free. Jacobus, 37 Newton, Irvington, N. J.

GET Our Proposition First. Sample Free. Sell the best \$13.50 work and business suit. Com. \$4. Satisfaction guaranteed. Cooperative Garment Mfrs., 1722 Division, Chicago.

\$110 WEEKLY selling finest guaranteed union made-to-measure men's suits only \$12.50; boys' two-pants suits \$10.95. Six latest patterns that sell on sight. Also all-wool overcoats, vests, caps, riding breeches. Big commissions advanced. Free attractive outfit. Double Service Manufacturers, 1327-35 AF Washington, Chicago.

FREE sample outfit. \$13.50 suits. \$3.00 profit. Whirlwind seller. Write Chicago Super-Built Garment Co., Box 453, Chicago.

MAKE \$20 Daily selling Changeable letter Window Signs to merchants. Experience unnecessary. Send for free sample offer. Maze Company, Dept. P. S., Norwood Station, Chicago.

AGENTS can make money selling rubber name Door Mats. Liberal cash commission. Arme Rubber & Flooring Co., 1900 W. Broad, Richmond, Va.

EVERY Autoist will buy Auto Mitten Dusters, 200% Profit. Free Sample Offer. National Fibre Brocure Works, St. Louis, Mo.

WORLD'S Largest Neckwear Manufacturer wants Salesmen Sell Direct. Remarkable opportunity. Commission 32%. Complete line. Greatest Values. Write Beacon, 1630 Beaconwear Bldg., Boston, Mass.

FURNITURE refinishing, polishing, painting, handyman shop; wonderful profits; start yours on nearly nothing. John Ireland, 1457 So. Ninth, Philadelphia, Pa.

NEW Embossed Letter Display Cards for stores and offices; quick sales, big profits, repeat orders. Embossed Letter Card Co., 2120 E. 14th St., Cleveland, Ohio.

FREE 25c Sample everywhere. Empey, 9 Oak St., Charlestown, Mass.

AGENTS, sell spectacles. Big pay, experience unnecessary. I help you. Debbins, 146 West 27th Street, Indianapolis, Ind.

AGENTS—\$10.00 Daily Selling Key cases. Sample and proposition 25c. Sberk, 215 Walnut, Lebanon, Pa.

WHY work for others? Make and sell your own goods. We show you how. Free book explains everything. National Scientific Laboratories, 1907A Broad, Richmond, Va.

66 MILES on 1 Gallon. Scientific Gas Saver. All autos. 1 free to introduce. Critchlow, 0121, Wheaton, Ill.

AGENTS, Cash In with some of America's fastest sellers. Particulars Free. Russell Johnson, Clarkfield, Minn.

SALARY and Commission. Selling our Chromatic Scale Dulcimers. Write F. Reh-fuss Co., La Crosse, Wis.

FREE information about mail-order business. Clever ideas make fortunes. Mail Order News, 390 Bristol Building, New York.

AGENTS: Two out of three buy Exercise Underwear. Your chance to convert Right. Pays well. Particulars free. Art-silk, 446 West 37th Street, New York.

MAKE \$15 daily selling men's neckwear direct to wearer. Write today. Continental Mercantile, 51 Allen St., New York.

SELL Leather Work Gloves Direct to Wearer. Investment unnecessary. Excellent sideline for agents now selling work shoes and garments. Craftsman Company, 200 S. Peoria, Chicago.

BE independent. Make—sell your own specialties. Immense profits. Catalog dependable Formulas, special selected Agents' best sellers. Free. Lustrco Co., 832 East Pershing, Chicago.

EVERYBODY buys from Gibraltar representatives all over country taking order for famous Gibraltar line consisting of shirts, overcoats, raincoats, pants, hosiery, neckwear and other articles. Outfit representing full line free. Gibraltar Fashion Shop, 724 Roosevelt, Chicago.

RADIO Crystal Rejuvenator. Brings seemingly dead crystals back to life. Carry quantity in pocket. Sample 25c. Crystalife Co., Box 717, Oakland, Calif.

PENNANTS: Colleges, Resorts, Clubs, Students and Agents Get Busy. Schools, Auto, Tourists. Butter Specialties, Saugettes, N. Y.

GENERAL Distributors, Agents, salesmen, wanted for quick-selling automobile specialty; can average \$75.00 to \$100.00 weekly, selling direct to the trade, through subagents; lifetime opportunity for men looking for a No. 1 sales proposition; permanent business that yields results right from the start. Free folder explains. Atkinson Co., Mfrs., Cynthia, Ky.

NO-WATER Hand Soap. Cleans dirtiest hands without water. Great Money-maker. Simple to make. Guaranteed Trade-secret. \$1. Clover Laboratories, 2511-W Foster, Chicago.

MAGIC Cloth—One Rub keeps Snow or rain blurred windshield clear 24 hours. Big seller. Easily made. Guaranteed Trade-secret, 50c. Clover Laboratories, 2511-W Foster, Chicago.

SELL Made-to-Order Christmas Greeting Cards to individuals and business concerns. Sender's name on better cards. Half usual price. Commissions Daily. Sample outfit free. Selling season now on. The Fletcher Co., Inc., Orleans, Vt.

MAKE \$75.00 A Week and Up, selling our fine made-to-measure, all-wool suits—Direct to wearer—all one price, \$31.50. Biggest values. Commissions in advance. We deliver and collect. 629 swatch samples furnished. Write today. W. Z. Gibben, Inc., Dept. L-517, 161 W. Harrison St., Chicago, Ill.

AGENTS—\$35 cash weekly and a free suit to each agent for taking orders for our high-class made-to-measure tailoring—suits from \$14.95 to \$39.50 and no experience needed. Write for our big Free Sample Outfit. Progress Tailoring Co., Dept. K-217, Chicago.

60% PROFIT, 125 Varieties Brushes, Mops, Exclusive rights. Newway Brush Co., Hartford, Conn.

MEN Wanted—to earn \$5 to \$100 per week introducing a fast-selling auto accessory. \$2.00 profit on every \$4.00 sale. Will send a sample at our risk. Write Stransky Co., Dept. B-10, Pakwana, S. Dak.

CAN you sell Ford size tires at \$3.50 each? Write for plan. Details free. American Accessories Co., Sales Dept. 178, Cincinnati, Ohio.

AGENTS, Sell Pat. Tie Clips: 50% profit; every man a customer. Dime samples. Oscar Arndt, 1059 Belton, Chicago.

AGENTS: \$100 Weekly; No experience; Genuine Gold Leaf Sign Letters and Script. Consolidated Company, 626 S. Dearborn, Chicago.

AGENTS Can Earn \$100 Weekly Selling High Grade Line. Free Sample Offer. Everybody Prespect. Leton Company, 257 West 63rd St., Chicago, Ill.

NEW Idea Windshield Cleaner; Medicated-Felt beats rubber all hollow; one rub, presto! entire windshield stays clear 24 hours. One agency sold 40,000. Security Mfg. Co., Dept. 52, Toledo, Ohio.

EARN \$25 to \$100 Weekly in spare time. No peddling or investment necessary. Permanent. A lifetime opportunity. Write, Joe Malek, 1269 Transportation Bldg., Chicago, Ill.

BRAND new specialty for merchants. Repeat orders make position permanent. Exclusive territory. Lang, 115 W. North Ave., Chicago.

A BIG income and a speedy seller are offered in our Felt Rug proposition. Write now for particulars. Newark Felt Rug Co., 27c 16th Ave., Newark, N. J.

AGENTS: Earn from \$40.00 to \$75.00 a week. Our free outfit of the finest and cheapest priced line of shirts now offered. Enable you to do this easily. Write us at once. Our references—R. G. Dun Co., or any bank in Chicago. Illinois Shirt Co., 500 So. Wells St., Chicago.

WHY work for others? Make and sell your own goods. We show you how. Free book explains everything. National Scientific Laboratories, 1907A Broad, Richmond, Va.

\$100 WEEKLY—Pleasant Work: Appointing local agents to introduce Mother Hubbard Foods; no canvassing, no delivering, no money invested. Adam Inthout, 550 Congress, Chicago.

A BUSINESS of your own. Make and sell chipped glass name and house number plates, checkerboards, signs. Booklet Free. E. Palmer, Dept. 512, Wooster, Ohio.

AGENTS—Moose Corn and Callous Remover will build you a steady repeat business. Send today for pocket-size trial outfit. The Moss Co., 248 Searle Bldg., Rochester, N. Y.

AGENTS—Make a dollar an hour. Sell new kind of sharpeners. Sharpens all knives and tools quickly. Demonstrating sample free. Premier Mfg. Company, Dept. 59, Detroit, Mich.

AGENTS, our new Co-Operative plan makes you a partner in our business and pays you profits, the same as stockholders; the most liberal plan in the United States today. \$25 to \$75 weekly easily made. B. & G. Rubber Co., Dept. 818, Pittsburgh, Pa.

PORTRAITS, photo pillows, toys, frames, sheet pictures, medallions, merchants' signs, food products, rubber aprons, guaranteed hose, toilet requisites, luminous crucifixes. Catalog 50 specialties free. 30 days credit. Jas. C. Bailey Co., Desk A-10, Chicago.

"RED Devil" Ant Exterminator—Guaranteed. Sells to every home and farm; big money-maker. Agents Wanted. One can enough to destroy twenty ant beds. 35c. Cosacovich Supply Co., Brownsville, Tex.

FREE Sample—"Rain Shield Wiper" Retail \$1.00—cost 25c. Just invented. No Cloth—No Paste—No Attachment. Seld Clear and Rainy Days—(1) Rub keeps Windshield Clear 24 hours. Automobiles buy quickly. Riley made \$128—three days. Experience Unnecessary. Wonderful Sideline. Nulife Corporation, Hartford, Conn.

AGENTS—"Life of Bryan" just out, 400 pages beautifully illustrated. Earn \$100.00 to \$200.00 weekly. Send 10 cts. now for complete outfit. Address Buxton, 21 W. Elm, Chicago.

BUSINESS Guide with Free Legal Service Sells everywhere; Wells cleared \$1,185 in 35 days. Write for free outfit. Nichols Co., Naperville, Ill. Dept. 4B.

REAL chance for you to connect with fast selling wonderful repeating line of Boys' and Juvenile clothing in protected territory. Winning Demonstrating Outfit and successful sales plan. Insures success. Write Juvenile Outfitting Co., 716 Market Street, Philadelphia.

SELLS At Sight. Prints merchant's ad on wrapping paper, boxes, bags, etc. Good commission. Automatic Ad-Stamp, Joplin, Mo.

AGENTS—To Sell St. Christopher Shrine in Catholic Homes. Wonderful seller. United Religious Goods Co., 207 United Bldg., Covington, Ky.

AGENTS—Write for free samples. Sell "Well Finished" Children's Garments, direct from factory to wearer. Fall line ready. Wm. Freedman, 560 Broadway, New York.

WHY work for others? Make and sell your own goods. We show you how. Free book explains everything. National Scientific Laboratories, 1907A Broad, Richmond, Va.

USE No Liquid, Paste, Powder. New Prepared Cloth Cleans all Metals—Just (1) Rub. Retail 25c—Cost 10c. "Sample Free." Nulife Metal, Hartford, Conn.

WHOLESALE Guidebook—where to buy thousands goods wholesale. 10c. System, Rolling Prairie, Ind.

SELL "Stove Gloss," heat resisting, quick drying black enamel for Stoves, etc. Big repeat seller. 100% profit. Sample 35c. American Chemical Laboratories, 728 East 142nd, New York.

MANUFACTURE your own goods. State rights for sale for patented article 400% better than article selling by millions annually. Best offer gets your state. Fulfilled investigation courted. Free booklet. C. T. Peiton, Fallon, Nev.

MANUFACTURE Chipped Glass Numbers; particulars Free. Beveridge, 160-22 Locust Avenue, Jamaica, N. Y.

AGENTS—Make \$100 weekly selling nationally advertised "Cathaspirin." Large demand. Big repeater. Easy sales. Write today for special offer. Cathaspirin Co., Chillicothe, Ohio.

DUSTLESS Sponge Cloth. New Invention. (1) Rub—Dusts, Cleans and Polishes Automobiles, Furniture, Pianos. Retail (50c)—Costs (10c). "Sample Free." Nulife Sponges, Hartford, Conn.

AGENTS: Sell the wonderful, new, chemically treated cloth, for cleaning glass surfaces. Does the work cheaper, quicker, better than chamolis or cleaning compounds. New York stores using exclusively for show-cases, mirrors. Big seller. Steady repeats. Send 25 cents for convincing sample. Agent's proposition. Alapal Distributors, 52B Vanderhilt Avenue, New York.

AGENTS—\$5 started me earning \$200 weekly, with Mail-Order Business. Outfits furnished. Free particulars. Peerless Service, 447 Waterville, Me.

AGENTS Wanted in Every County in the U. S. A. for Electric Blankets, Bed Warmers, Caps and Warming Pads. Wallace Electric Appliances, P. O. Box 147, Oakland, Calif.

FREE Valuable Information for Beginners, Mail-Order Men, Agents. 300% Profit. Nite Mail Order Supply Co., 609 27th St., Denver, Colo.

MAN or Woman Agent—Guaranteed Hosiery—Special Low Prices—24-Hour Shipments—Complete Assortment Styles Men, Women, Children—Full Fashioned Silk Included. Liberal selling Comm. Splendid Opportunity for Honest, Ambitious Person. Write for Samples. United Eastern Textile Co., Pottstown, Penna.

EARN \$10 daily silvering mirrors, plating and refinishing metalware, autos, chandeliers, bedsteads, hoodlights. Outfits furnished. E. Decie Laboratories, 1153 Broadway, New York.

ROBT. H. INGERSOLL of \$1 Watch fame wants good men to sell his Dollar Strapping outfit, an ingenious invention for sharpening all makes of safety razor blades. Great Economic value. Meeting with nationwide approval. Easy to sell. Big repeat business. Agents having remarkable success. Full particulars. Robt. H. Ingersoll, 475C Broadway, New York City.

HERE'S your opportunity to make real money and establish a permanent business for yourself with the Dainty Maid Line of Lingerie and Dresses. Highest commissions and sales cooperation insure success. Don't allow this opportunity to pass. Write for our wonderful sales proposition. Dainty Maid Co., Bremer Arcade, St. Paul, Minn.

AGENTS—50% cash profit every sale with \$5 to \$10 commission on sure repeat business. Live wires, men or women, build permanent income \$100 week up. Something new every man and woman uses. Write quick. Everett Co., Dept. 35, Sault Ste. Marie, Mich.

SCIENTIFIC Gas Saver. All autos. I free to introduce. Critchlow, M131, Wheaton, Ill.

NEW Plan for Agents: Goods supplied on credit. Big line. Fine outfit free. No money needed. Write quick. Blair Laboratories, Dept. 54, Lynchburg, Va.

EMBOSSED Display Signs Mean Big Money and independence for you. Sell every merchant. Make 250% profit. This proposition is different. Write and see why. Artistic Sign Works, 799 Broadway, New York.

EVERYBODY Buys Davis' Nifty Toilet Goods Assortments. Useful, handsome gifts free to our customers. Over 250 high quality products. All repeaters. 100% profit. 25 years of success. Write! Davis Products Co., Dept. 56, Chicago.

FIBRE Brooms—detachable handles, fine finish. Good profits, repeat sales. The Fibre Broom People, 147 New Jersey Ave., Brooklyn, N. Y.

AGENTS—\$60 to \$200 weekly putting up our Burnished Genuine Gold window letters; scripts. Experience unnecessary. Free samples. Premier Letter Co., 121 N. Francisco, Chicago.

WONDERFUL! Startling! Amazing! Our Ex-Cel Luminous Crucifix and Magical (Luminous) Necklace shine brilliantly in the dark. Sell on first demonstration. Big profits to you. Write for further particulars, or better still, send for sample and territory protection immediately. Crucifix \$1.50, Necklace \$1.00, postpaid. W. G. Hannan Co., Dept. B, 2589 So. State St., Chicago.

YOU Can Make Good Durable Paint and Varnish 40¢ per gallon. Write Dept. 2, Emmelmann Bros. Mfg. Co., Indianapolis, Ind.

SELL the Livest, Quickest Selling Specialties Ever Known—Famous "Hahway" self-lighting pocket Cigar Lighters and Gas Lighters. Low Prices. Easily Demonstrated. Sell to Dealers. Employ Sub Agents. Exclusive Territory. Make over 100% Profit. P. Bernhardt, 148 Chambers Street, New York.

EARN big money fast applying gold initials to autos. Every owner buys—\$1.35 profit on \$1.50 sale—particulars and samples free. Write quick. Lithogram Co., Dept. 17, East Orange, N. J.

BIG Money Selling New Household Cleaning Set. Washes and dries windows. Sweeps, scrubs, mops. All complete only \$2.95. Over half profit. Write Harner Brush Works, 132 3rd St., Fairfield, Iowa.

\$31.00 PROFIT—with \$1.50 Outfit—Big Money—Easy Work. Selling Gold Monograms for Automobiles, Luggage, Windows, Waxons. No Experience. No License. "Samples Free." NuLife Monograms, Hartford, Conn.

AGENTS: \$65 to \$100 a week. High grade all wool suits made to measure \$25 and \$30. Biggest comm. in advance. Money back guarantee. Free sample outfit. Write A. B. Ferrin, Mer., Box 1087, Chicago.

AGENTS, sell spectacles. Dobbins, 146 West 27th Street, Indianapolis, Ind.

\$250.00 MONTHLY Selling Radio Direct from factory. Wholesale prices. United Radio, Box 62-B, Gary, Ind.

AGENTS—Make \$75 to \$100 a Week. "Fixit" Rubber Repair Seals punctures and blowouts. Sample free. Marquette Rubber Company, 2325BB Wolfram St., Chicago.

NEW camera takes and finishes photos in one minute. Make money selling cameras or taking photos. Exclusive territory. Crown Co., Dept. 951, Norwalk, Conn.

AGENTS and Salesmen who are willing to apply themselves and make 15 to 20 calls daily can easily earn \$19 to \$29 every six working hours. The line is attractive and the business pleasant. Every home, every office, every factory or place where many are employed furnishes your customers and the opportunity for numerous sales. Your profits are about 400% and the orders rapidly run into money. We give you complete cooperation and prompt service. Even those without previous selling experience succeed beyond their fondest dreams. We want to send you full particulars and simply ask your name. A postal will do. Write at once to Perry Novelty Corporation, Desk X-11, 1793 Jerome Avenue, New York City.

WILLIAMS' No-Water Hand Soap. In tubes, has taken Auto owners by storm; washes dirtiest hands perfectly clean without water; easy demonstration makes quick sale. 150% profit. Williams Co., Dept. 265, Montclair, N. J.

BIG Money and Fast Sales. Every owner buys Gold Initials for his auto. You charge \$1.50; make \$1.35. Ten orders a day easy. Write for particulars and free samples. American Monogram Co., Dept. 40, East Orange, N. J.

MAKE \$25 to \$50 Week, representing Clow's Famous Philadelphia Hosiery, direct from mill—for men, women, children. Every pair guaranteed. Prices that win. Free book "How to Start" tells the story. George Clow's Company, Desk 31, Philadelphia, Pa.

\$300 FIRST Two Weeks—made by Weland, Johnstown, Pa., selling "Slide-O-Graf Jr." Novel, effective—sidewalk advertisement projector. Sells fast, big non-competitive field. \$14 Profit every sale. Standard Slide Corp., 207 W. 48th St., New York.

LIVE Agents Make \$10 Day selling Bureka Strainer and Splash Preventer for every water faucet. Takes on sight. Widely advertised and known. Get details today. A. B. Seed Filter & Mfg. Company, 73 Franklin, New York.

AUTO owner tire agent wanted each locality to use and take orders for handmade Mellinger fabric and cord tires; guarantee bond 8,000 and 12,000 miles (no seconds); shipped prepaid on approval; get your tires free; no capital or experience required; make \$100 to \$200 weekly. Write for wholesale prices and sample kit. Address, Mellinger Tire Co., Dept. 300, Kansas City, Mo. or Dept. 300, Philadelphia, Pa.

NEW Marvelous Discovery "Bestever Powdered Hand Soap" Works like Magic. Removes grease, grime, paint, stains without harm to hands. Sells like wildfire to Stores, Factories, Garages. Quick Repeater. "Sample Free." Write immediately. Bestever Products Co., 1945 E. Irving Park, Chicago.

AGENTS—Make a dollar an hour. Sell Mendets, a patent patch for instantly mending leaks in all utensils. Sample package free. Collette Mfg. Co., Dept. 404, Amsterdam, N. Y.

MOST Wonderful Seller. 96¢ Profit every dollar. No stock to carry. License unnecessary. Sample free. Mission Factory PM, 519 No. Halsted, Chicago, Ill.

MAN in each town to plate auto parts, reflectors, bathroom fixtures, refinish beds, mirrors, chandeliers; by new method. No capital or experience required. Simple plan of manufacturing at home starts you in big money-making business. Outfit furnished. Free particulars and proofs. Gun Metal Co., Ave. H, Decatur, Ill.

HELP—THREADING Needles, Needle Books, Machine needles, find sales in every home. Fine side lines, easily carried, big profits, sample and catalogues free. Prentice Lee, 145 East 23rd St., New York.

AT Last! Diamond Rival Discovered! Amazing blue white Rajah Gem astounds jewelry world and deceives experts! Beautiful Sample case Free! \$100 weekly! Write Quick! Rajah Diamond Co., Dept. P-7, Salisbury, N. C.

YOU can be your own boss with our Key-Check outfit. Good for \$5 a day stamping names on pocket key checks, fobs, etc. Sample check with your name and address, 20 cents. Pease Die Works, Dept. M, Winchester, N. H.

AGENTS, Distributors, Crew Men average \$60-\$100 with Harker Products; 10¢ brings sample of leader; money back if you wish; free folder shows how to start small and grow big. Act; Send today; big surprise awaits you. Harker Co., Bridgeport, Conn.

AGENTS make 500% profit handling auto monograms, window letters, transfers, novelty signs. Catalog free. Hinton Co., 1153 N. Wells St., Chicago.

ONLY one sale a day means \$200 per month! Marvelous new adding machine. Retail \$15.00. Work equals \$350 machine. Adds, subtracts, multiples, divides, automatically. Computes feet and inches. Speedy, accurate, durable, handsome. Five-year guarantee. Offices, Stores, factories, garages, lumbermen buy one to dozen. A fortune for live agents. Write quick for protected territory and free trial. Lightning Calculator Co., Dept. F, Grand Rapids, Mich.

BIG Profits, New \$3.50 Automatic Adding Machine. Quick Sales. No competition. Ten daily easy. Absolutely accurate. Fully guaranteed. Pocket size. Business people everywhere positive customers. Exclusive territory to workers. Act quick. Bassett Company, 1438-H Hollywood Ave., Chicago.

SELL Lightbrite Electric Signs. They make you big money. We finance you. Price kills competition. Write for information. Modern Sign Co., Inc., 5721 Woodward Ave., Detroit, Mich.

SKAT Sales Agents Wanted. All or Part Time for Skat Hand Soap, Metal Polish, etc. Strictly Commission. The Skat Company, Hartford, Conn.

AGENTS: Our gold-eyed needle case proposition is positively good for \$50 to \$200 weekly; proof and particulars free; sample outfit 15¢; factory prices. Patty Needle Co., 231 Davis Sq., Somerville, Mass.

LATEST Moner-Making Specialty Formulas, Trade Secrets. Southern Trading, 52, Flushing, N. Y.

ARTICLE costs 5¢, sells quickly for dollar. Particulars free. Baggs, 3239 Archer Ave., Chicago, Ill.

GOLD-LEAF Sign Letters; make and sell; 1,000% profits. Particulars, Johnston Co., Quincy, Ill.

AGENTS: \$50 to \$100 a week guaranteed. World's greatest value, tailored to order all wool suits and overcoats—\$31.50, none higher. Fall line the greatest ever. Write for new sales plan. Details free. J. B. Simpson, Inc., Dept. 1116, 843 Adams, Chicago.

AGENTS, both sexes, we manufacture and control new household article. Fast seller. Big profits. Exclusive territory. Write Now. Connolly, 123 Liberty St., New York.

ORIENTAL Perfumes bring 100% net profit. Good sellers and better repeaters. Rosetta Parfumerie, Inc., Woodlawn 10, Chicago.

AGENTS—Write for Free Samples. Sell Madison "Better-Made" Shirts for large Manufacturer direct to wearer. No capital or experience required. Many earn \$100 weekly and bonus. Madison Mfgs, 511 Broadway, New York.

AGENTS: Big Money Monogramming by Transfer Method. Catalog Showing Over 50 Styles and Particulars Free. Motorists' Accessories Co., Mansfield, Ohio.

INSTANT Weld. Repairs largest punctures without cement or heat. Lenn's profit one day. \$50. Write quick. Free sample; territory going fast. Tourists' Pride Mfg. Co., Desk T, Minneapolis, Minn.

\$60-\$200 A WEEK. Genuine Gold Letters for store windows. Easily applied. Free samples. Liberal offer to general agents. Metallic Letter Co., 438-D North Clark, Chicago.

200% PROFIT selling Gem kettle bottoms. "The article with a dozen uses." Housekeepers buy on sight. Columbia Specialty Co., Box 130, East Liverpool, Ohio.

WANT distributing agent for Handick, powdered handsoap; removes anything from the hands without injury to skin; everybody a customer; great opportunity for hustler to get in business; sample free. Solar Products Co., G 124, West Lake, Chicago.

AGENTS—Clever Invention! Inkspoon makes every pen a fountain pen. Fast office seller; big profit, demand increasing everywhere. Exclusive territory offered. Sample free. H. Marul Company, Tribune Bldg., New York, N. Y.

TO secure agents or salesmen or for selling (want) ads in largest newspapers and magazines. Price list No. 30 sent free. Ankrum Advertising Agency, 20 W. Jackson Blvd., Chicago, Ill. The largest classified advertising agency in the U. S.

POLMET—The Wonderful Polishing Cloth that cleans all metals without liquid, paste or powder. Approved by "Good Housekeeping" and "Modern Priscilla"—sells fast at 27¢. Sample free. Gale & Co., Inc., 15 Edinboro St., Boston.

AGENTS: \$100 a week paid to men who will help me in spare time in local assembly of amazing new kind of 5 tube radio set. I show you how. Demonstrator set given free to those enrolling for my Radio course. No capital needed. Write quick for details of work. Frank Condon, Dept. 6-32, 2632 Prairie Ave., Chicago.

WASH Clothes the new way. Use the Torrent Automatic Washer. You will be delighted. Special offer to one in each locality. Storm Royalty Co., 3610 Enright Ave., St. Louis, Mo.

WONDERFUL Vapor Humidifier for autos. I free to introduce. Critchlow, N121, Wheaton, Ill.

WE Start You Without a Dollar. Soaps, Extracts, Perfumes, Toilet Goods. Experience unnecessary. Carnation Co., Dent, 201, St. Louis.

GET Our Free Sample Case—Toilet articles, perfumes and specialties. Wonderfully profitable. La Derna Co., Dept. A, St. Louis, Mo.

AGENTS: 500% profit. "Happy Home Maker Shampoo" builds your own big business. Martin of Indiana made \$75.00 in one day. Missouri man made \$750.00 one month. Exclusive territory. Geo. A. Schmidt & Co., 236 W. North Ave., Chicago.

EASY, pleasant work for Mechanics, Shop Men, Clerks, during spare hours; will add many dollars to their salaries. Also want persons who can give full time. Big wages assured. Novelty Cutlery Co., 67 Bar St., Canton, Ohio.

MAIL-ORDER Houses and Distributors: We pack French made beauty creams, face powders, perfumes, toilet preparations with your label. Chemist, 944A North Clark, Chicago.

Agents make \$100 Week placing Advertising Cigar Lighters with glass front. Every dealer wants one. Average profit \$25 each. Write for free plan. Drake Mfg. Co., Dept. M, Milwaukee, Wis.

AGENTS \$1. Retail \$3. Your Profit \$2. Wonderful, pocket Adding Machine with Magic Writing Pad. Particulars Free. Typewriter Supply, 905 Hersch Bldg., Pittsburgh, Pa.

IF you want good live agents—fellows who can get the business—ask me how others are doing it. I'll gladly render the necessary assistance. Geo. F. Baker, Mgr. Classified Advertising, Popular Mechanics Magazine, Chicago.

"HOW to Sell Patents" free. Patent News-O, Washington, D. C.

WHY work for others? Sell by mail. Let Uncle Sam work for you. Particulars Free. National Enterprises, Box 1174-PM, Omaha, Neb.

"KKK" Sample pocketpiece 16c. Catalog Kluster jewelry free. Agents wanted. Morris, Box 1174-PM, Omaha, Neb.

10,000,000 FORDS need "Greater Grip" Fan Belts. Big Profit selling Dealers. Write quick. Teuscher Belting Co., St. Louis.

EASY Money Applying Gold Initials. Monograms on automobiles. Anyone can do it. Simply transferred from paper; takes 5 minutes. Make \$1.50, cost 5c. Samples free. "Raleo," 1043 Washington, Boston, Mass.

CALIFORNIA Rosebuds selling like hot cakes. Agents coinng money; new stuff. Big profits. Catalog free. Mission Factory PM, 519 No. Halsted, Chicago, Ill.

CAN you sell to colored people? Write, Eaton Co., Dept. 101, 2500 Second Ave., Birmingham, Ala.

HIGH GRADE SALESMEN WANTED

FREE selling outfit—substantial commission, bonuses and prizes. Make big money selling our tailored-to-measure suits and overcoats at \$10 to \$15 less than local tailors charge. Five prices that meet every purse—\$18.50 to \$36.50. Highest quality, all-wool, guaranteed, perfect fitting garments. 150 choice patterns. Absolute "no-pulling-out" halfcloth fronts. Positive 8-day service. Protected territory. Free advertising. Experience unnecessary—our Sales Manual tells you "how." Write us about yourself giving two business references for quick action. Wholesale Direct Tailors, Dent, 1202, Elliest St., Buffalo, N. Y.

SALESMAN: If You Think in Terms of \$6,000 the First Year Write Us Personally. Strong line for retail store. Nationally advertised. Established concern has unusual opportunity. Liberal weekly advance to producer. Continental Co., 1922 Euclid Avenue, Cleveland Ohio. Dent, 200.

AUTOMOTIVE Specialty Salesmen. Steady Profits. Results Guaranteed. Adams-Barr, Columbus, Ohio.

GO into Business for Yourself. Make storekeeper's profits without storekeeper's troubles and expenses. We'll show you how. In fact, we'll put you in business, furnish everything you need to get started, teach and train you, carry all stock for you and all without the investment of a penny on your part. However, you must have selling experience or at least the ambition and desire to sell, and above all, you must have the willingness to work hard for success. If you have these, we'll take you and work with you until we've made you a success. We have done it with hundreds of others. We can do it for you—provided you are honest, willing to work hard and follow instructions. If you are, write us. You'll hear from us at once with Facts. Address Dept. 853, Goodwear Chicago, Inc., 844 West Adams Street, Chicago.

SALESMEN—Get this big sensational, order-getting shirt outfit Free. Sell Stylemor Shirts all year round. It's Chicago's Wonder shirt line. Advanced fall showing of smartest, snappy patterns. Large double swatches, low prices, quick service, makes shirt selling easy. Belard of Texas made \$16.00 in two days. We deliver and collect. Write today for big free outfit. Stylemor, 81 W. Van Buren, Chicago, Ill., Dept. 660.

\$10.00 DAILY easy. We start you in auto accessory business. No investment, no experience necessary. Exclusive territory. Motor Products Co., 1760 Lund Ave., Chicago.

MR. BRUSH Salesman: Old Established New York Brush Manufacturer requires the services of men in all territories to sell their extensive line of Sanitary Twisted in Wire Brushes. We pay larger commissions than any other Brush House in the country. Write immediately for proposition. Wire Grip Sanitary Brush Corp., 15 Mercer St., New York.

SALESMEN: Newly invented, fast selling, slug-proof ball gum tender, \$10 commission one sale. Investment salesman can make \$1,000 monthly selling operators. Specify full or part time. Peerless Products Company, New York Life Building, Kansas City, Mo.

THE Daisy Desk, an educational equipment of the latest improved type. Salespeople wanted, exclusive territory. Charles W. Hall & Co., Inc., Valparaiso, Ind.

SALESMEN, we have a valuable proposition, something different; all electricity users customers; patented goods, low prices. Write Marvel Light Mfg. Co., 387 Broadway, New York.

\$20 DAILY selling "World's Greatest Foot-Comfort Shoes" direct to men or boys. Quick sellers everywhere. Low priced. Just take orders; we mail shoes direct. Big cash profit and repeats. Territory protected. Best season now. Write quick. Dept. 229, Easy-Wear Shoe Co., Indianapolis, Ind.

MAN, do you want a Permanent, Profitable Business of your own selling men's and boys' Ready-to-Wear All-Wool Suits and Overcoats? We undersell stores. Free outfit to reliable man. If High Quality, Low Price, Prompt Deliveries, and Service mean anything to you, write Henry W. High Company, 300 S. Franklin, Dept. 602, Chicago.

SALESMEN—Four Square Suits reduced to \$9.99. Same deposit. Four patterns. Guaranteed two years. Write quick for free outfit. Stone-Field, KA2554 Wabash, Chicago.

ENVELOPE Sealer selling \$4.50 seals 3,500 envelopes hour! Tremendous Demand. Exclusive Territory. Big Repeats. Write today. Free particulars. Bed-E, 2004 Nottingham Bldg., Boston.

2—SMALLEST sales net \$17.50. National Collection and Law Service, P. O. Box 663, Baltimore, Md.

BEST Seller. Jem Rubber Repair for tires and tubes; supercedes vulcanization at saving of over 800%; put it on cold, vulcanizes itself in two minutes, guaranteed to last life of tire or tube; sells to every auto owner and accessory dealer. Get particulars how to make big money and free sample. Amazon Rubber Co., Philadelphia, Pa. Dept. 516.

SALESMAN—To sell shirts direct to consumer for concern backed by fifty years' experience manufacturing high-grade shirts. Liberal commissions. Write for particulars. Trafalgar Shirt Co., 41 East Broadway, New York City.

WANTED—Salesmen to represent factory direct and sell our miniature cedar chests, ten sizes brass-trimmed and plain. Charles W. Hall & Co., Inc., Valparaiso, Ind.

TAKE orders for coffee, sugar, flour, meats, canned goods, staple groceries; also paints, radio sets, tires, auto and tractor oils. No capital or bond required. We deliver and collect. Permanent business. Big pay. Write at once. Hitchcock-Hill Co., Dept. 50, Chicago.

MAKE \$100 Weekly in spare time. Sell what the public wants—long-distance radio receiving sets. Two sales weekly pays \$100 profit. No big investment, no canvassing. Sharpe of Colorado made \$955 in one month. Representatives wanted at once. This plan is sweeping the country—write today before your county is gone. Ozarka, Inc., 126 West Austin Ave., B. Chicago.

ADVERTISING Specialty Salesmen: Increase your income by selling Advertising Pocket Knives. Customers use from 100 to 5,000 each season, and you receive a liberal commission. Novelty Cutlery Company, 522 McGregor Ave., Canton, Ohio.

WHY work for others? Make and sell your own goods. We show you how. Free book explains everything. National Scientific Laboratories, 1907A Broad, Richmond, Va.

QUALITY Shoes factory to consumer at popular prices. Your cash profits \$1.00 to \$2.00 pair. Greatest up to date in America; let us prove it. Repeat orders guarantee steady income. The Long Wear Shoe Company, Dept. F. E., Minneapolis, Minn.

SALESMEN—Take orders all-wool Tailor-made suits for men and boys, \$13.95 and \$19.95. \$4 commission. Free outfit. Fashion Clothing, 2532 Lake, Chicago.

SIDELINE Salesmen: 35c articles eliminate automobile accidents; big profits. Sample free. French, 625 Buder Bldg., St. Louis, Mo.

WONDER Fluid charges batteries instantly. Chance to make fortune selling to garages and dealers. Gallon free to agents. F & M Sales Co., 2069 Eastern Ave., Cincinnati.

ARE You Old at Forty? See our advertisement on page 76 of this issue. The Electro Thermal Company, 2137 Main Street, Steubenville, Ohio.

TAILOR Salesman, \$100—\$150 week selling hand-tailored, union made-to-measure overcoats, \$23.50—\$29.50. Commissions advanced. Wood & Co., 651 So. Wells, Chicago.

OUR Legal Guide and Salesman's instructor will mean money to you. One Dollar. Geo. Stewart, 157 W. Santa Barbara, Los Angeles, Calif.

SALESMEN—Capable men can make real money handling trunks, bags and suit cases as sideline. Commission basis. Appomattox Trunk & Bag Co., Petersburg, Va.

\$12 AN hour actually earned selling the new Double-Wear Work Shoe. \$5 value selling at only \$2.95. A world-beater. Liberal commission. Write quick. The Double-Wear Shoe Company, East Lake St., Dept. B, Minneapolis, Minn.

SALESMEN: Become Independent. Own Your Business, experience unnecessary selling our \$7,500 Accidental Death, \$50 Accident, \$25 Sick Weekly Benefits, \$12.50 Yearly. Other amounts proportionate. Guaranteed steady income from renewals. \$256,000 Deposited Insurance Department, Universal Policy, Dept. A, Newark, N. J.

DISTRICT salesman for union made, hand tailored, all wool suits and overcoats at \$23.50. Prefer married man with sales experience. \$35.00 weekly to start. Apply D. H. Harvey, Box 90, Chicago.

\$60-\$200 A WEEK. Genuine Gold Letters for store windows. Easily applied. Free samples. Liberal offer to general agents. Metallic Letter Co., 438-B North Clark, Chicago.

SALESMEN for easy selling specialty. Beautiful Attractive, Appealing, Laminite Window Bulletin increases merchants' business 100% to 200%. Protected territory. Big Commission. Thousands being sold. Build yourself a big permanent business. Display Products Co., Ltd., 106 Gibraltar Bldg., Kansas City, Mo.

WANTED—Tailoring Salesmen, make \$60 to \$125 per week. Biggest merchants in many towns have started with our line. We are the largest made-to-measure tailoring house in the country, furnishing elaborate sample equipments, including 500 all-wool fabrics. You make your own profits from \$8.00 to \$15.00 on each order. Guaranteed absolute satisfaction, perfect fit, best workmanship, or no sale. Write for our line and all accessories to be sent free. Tell us all about yourself. Address N. O. Perry, Sales Manager, Box 483, Chicago, Ill.

IF I send You a Suit, made in the latest style from the finest goods, will you keep it, wear it, and show it to your friends as a sample of my sensational \$25.00 suits guaranteed regular \$50.00 values? Could you use \$3.00 an hour for a little spare time? If so, write me at once for my wonderful new proposition. Just write your name and address on a card and mail to Dept. 893, Knickerbocker Tailoring Co., 133 So. Peoria St., Chicago.

\$15.00 DAILY Easy. Sensation of 1925. It's new, just out. "Fixit" Rubber Repair for Tires and Tubes. Fastest seller, and biggest money maker in America. Act quick. Sample free. Marquette Rubber Co., 2323A Wolfram St., Chicago.

EASY to Sell Groceries, Paints, Lubricating Oils, from samples to consumers in towns and country. Prices meet all competition. No capital or experience necessary. Profitable, steady work. Commission advanced. Satisfaction guaranteed; 53 years in business. Write Lovrin & Browne Co., Wholesale Grocers, 1775 So. State, Chicago, Ill.

FOUR \$7.50 sales to merchants net you \$20.00 daily. Sayers Systems, 2803 Sheffield Ave., Chicago, Ill.

CALIFORNIA Rosebuds selling like hot cakes. Agents coming money. Absolutely new. Big profits. Catalog free. Mission Factory SP, 519 No. Halsted, Chicago, Ill.

\$50 DAILY Selling Salesboards—Make up to \$33 on single sale, selling largest, lowest priced line; no samples to carry; write for 3-color catalogue and full particulars. Lincoln Sales Co., Dept. E, 212 N. Sheldon, Chicago.

TRAVELING Salesmen calling on retail stores wanted by large manufacturer to sell unique line of business-boosting articles. Year round, fast selling, main or side line. If not earning \$150 weekly, address Elsasser Works, 222 Charles St., Boomville, N. Y.

SALESMEN Wanted: Auto Key Purse, New Invention. Wonderful side-line. Low price, long life advertising specialty. Wide Awake Advertisers will use thousands. Commission 20%. Norelty Cutlery Co., 522 McGregor Ave., Canton, Ohio. Established 1879.

OIL or Coal? "The Burning Question." Interesting booklet, discusses high efficiency low-priced residence oil burners. Copy free. Write E. L. Miller, Manufacturer Climax Burners, 33 Climax Bldg., Kansas City, Mo.

\$145.00 WEEKLY. Wonderful Vapor Humidifier for autos. 1 free to introduce. Critchlow, R121, Wheaton, Ill.

HELP WANTED

WANT a U. S. Government Job? \$1,140 to \$3,000 year. Become Railway Mail Clerks. (Travel—See your country). Rural and City Mail Carriers, Post-Office Clerks, Clerks in Government offices. Steady work. Paid vacations. Experience unnecessary. Full particulars and sample coaching, free. Write immediately, Franklin Institute, Dept. H-3, Rochester, N. Y.

WANTED—Confidential correspondents everywhere; secret service. Write Association American Detectives, Department 105, Haddon, Oregon.

MEN: We will establish you in a permanent business paying big income. Your credit is good for merchandise people must buy every day. No special experience necessary. Write today for free Booklet "McConnon's System." McConnon & Co., Factory M48, Winona, Minn.

FIREMEN, Brakemen, Baggage-men, Sleeping car, train porters (colored) \$140-\$200. Experience unnecessary. \$10 Railway Bureau, East St. Louis, Ill.

A PAYING Position Open to Representative of Character. Take orders Shoes—Hosiery direct to Wearer. Good income. Permanent. Write now, Tanners Shoe Mfg. Co., 8-410 C Street, Boston, Mass.

A REPRESENTATIVE Wanted take orders Rugs direct at Mill Prices. We deliver and collect. Exceptional opportunity now. Permanent weekly income. Seven wonderful quality rugs in Sample Case. Write Maltley-Payne Mfg. Co., 80410, Boston, Mass.

WANTED—Boys—men. Learn Automobile Repairing. \$30.00 week. Sample training free. Franklin Institute, Dept. H-400, Rochester, N. Y.

\$170-\$225 MONTHLY. Railway Postal Clerks, Postoffice Clerks, Carriers, \$143-\$192 month. Customs, Internal Revenue, Departmental Clerks, \$1,500 up. Information free. Chicago Civil Service College, A-141 Kesner, Chicago.

HOTELS Need Trained Men. Nationwide demand for high-salaried men; past experience unnecessary. We train you by mail and put you in touch with big opportunities. Big pay, fine living, interesting work, quick advancement; permanent. Write for Free Book "Your Big Opportunity." Lewis Hotel Training Schools, Suite X-351, Washington, D. C.

\$115-\$400 MONTHLY paid by Station—Office positions. Free passes; experience unnecessary. Write Baker, Dept. 41, St. Louis, Mo.

YOU Are Wanted. Government Jobs. \$1,700 year. Thousands appointments yearly. Sample coaching free. Write immediately, Franklin Institute, Dept. H-17, Rochester, N. Y.

BUILD splendid business making chipped glass number and name plates, signs, medallions. Write for particulars, Simplex Utility Co., 1133 Broadway, New York.

\$300.00 FOR your spare time. You should easily make every spare hour bring you two dollars. Your Pay Daily. No collecting or delivering. Just write orders for Macoshee New Style Guaranteed Hosiery. It costs but a 1c postal to learn all about our special offer. Experience unnecessary. Profits begin at once. Our confidential booklet with full inside information free. Macoshee Textile Company, Station 26010, Cincinnati, Ohio.

WHY work for others? Make and sell your own goods. We show you how. Free book explains everything. National Scientific Laboratories, 1907A Broad, Richmond, Va.

MAN Wanted to book orders for Nursery Stock and hire Agents. Outfit and Salesmanship lessons free. Highest commissions. Exclusive territory. Pay weekly. Wayne Nurseries, Inc., Newark, New York.

ARE you old at forty? See our advertisement on page 76 of this issue. The Electro Thermal Company, 2137 Main St., Steubenville, Ohio.

MEN—Wanted aboard ocean liners. Good pay. Experience unnecessary. Send self-addressed envelope for list. Box 30-X, Mount Vernon, N. Y.

LINOTYPE instruction; Earn \$60 weekly; cost \$200, including printing \$150; 1,000 have attended. Empire School, 206 E. 19th St., New York.

MEN, 18 Up. Be Railway Mail Clerks. \$1,900 year. Particulars free. Write immediately, Franklin Institute, Dept. H-17, Rochester, N. Y.

LEARN Paying Mechanical Business from Handyman Instruction Sheets, Sample Sheet and Much Money Making Information 10 Cents. P. Bucknam, 63 Court St., Room 1, Boston, Mass.

MEN, 18 up, wanting Post Office Clerk, Carrier, Railway Mail Clerk positions, \$112 to \$225 monthly. Steady. Experience or correspondence course unnecessary. Write P. Bradford, 112 N. 50th St., Philadelphia, Pa.

SILVERING Mirrors, French plate. Easily learned; immense profits. Plans free. Address, Wear Mirror Works, Excelsior Springs, Mo.

OUR genuine gold window sign letters are an excellent money-making proposition for handy men. Slann Sign System, Bethune Ave. E., Detroit, Mich.

ALL men, women, boys, girls, 17 to 65, willing to accept Government Positions, \$117-\$250 traveling or stationary. Write Mr. Ozment, 101 St. Louis, Mo., immediately.

STORIES, poems, plays, etc., are wanted for publication. Good ideas bring big money. Submit manuscripts or write Literary Bureau, 522, Hannibal, Mo.

RAILWAY Postal Clerks, \$1,900-\$2,700 Postoffice Clerks, Carriers, \$1,700-\$2,500 annually. Thousands appointments annually. Many other lifetime openings. Common education sufficient. Experience unnecessary. Particulars free. Chicago Civil Service College, A-41 Kesner, Chicago.

MEN wanting forest ranger positions, \$1,500-\$2,400 year. Write for free particulars of exams. Mokane, B-21, Denver, Colo.

EARN \$10 daily silvering mirrors, plating and refinishing metalware, auto, chandeliers, bedsteads, headlights. Outfits furnished. E. Dele Laboratories, 1133 Broadway, New York.

FINGER Print Experts—Excellent paying positions; particulars free. Finger Print Headquarters, 188 East 79th, New York.

U. S. GOVERNMENT wants men. \$1,700—\$1,900 and up at start. Railway Mail clerk examination coming. Let our expert (former Government examiner) prepare you for this and also Rural Carrier, Post Office, Customs, Internal Revenue, and other branches. Write today for free booklet, Dept. 8, Patterson Civil Service School, Rochester, N. Y.

MEN 18 Up. Be Railway Mail Clerks, Mail Carriers, Post-Office Clerks. \$1,700—\$2,700 year. Steady. Examination schedule—free. Write immediately, Franklin Institute, Dept. H-17, Rochester, N. Y.

65 MILES on 1 Gallon. Wonderful Vapor Humidifier for autos. 1 free to introduce. Critchlow, G124, Wheaton, Ill.

INVENTORS desiring to secure patents should write for our book "How to Get Your Patent," tells our terms and methods. Send sketch for our examination and instructions without charge. Randolph & Co., Dept. 418, Washington, D. C.

MAKE money writing Photo-plays; details free to beginners. No correspondence course. Producer's League, 230 Wainwright, St. Louis.

MEN wanting forest ranger, railway mail clerk and other Gov't positions write for free particulars of exams. Mokane, Dept. H-23, Denver, Colo.

MEN, 18 Up. Be Railway Mail Clerks. \$1,900 year. Particulars free. Franklin Institute, Dept. H-17, Rochester, N. Y.

MEN to build radio sets in spare time. Leon Lambert, 538-H, Wichita, Kans.

INFORMATION

PRACTICAL Information on any Mechanical subject, \$1.00. Technical Research Bureau, 377 National Ave., Milwaukee, Wis.

COMPLETE Information on any book published. Or will supply lists of books that are the best on any subject. Information is free. Room 809, Popular Mechanics Building, Chicago, Ill.

ADVICE on any subject \$1.00. Universal Bureau, 3810 Enright, St. Louis, Mo.

DISCOVERIES for farmers. 861 discoveries in "Popular Mechanics Handbook for Farmers." Tells how to make such useful devices as follows: portable greenhouse, fruit-picking ladder, tomato ripening device, land roller, exhaust water heater, ditch sizer, self-closing garage door, barrel header, poultry water fountain, dump sled, manure scraper, combination rabbit hutch and poultry house, and hundreds of others. Don't send a penny. Just write a postal and ask for "Popular Mechanics Handbook for Farmers." When the postman hands you the book, pay the few cents postage and \$1. the price of the book. Popular Mechanics Press, Room 810, 280 E. Ontario St., Chicago, Ill.

WANTED—BUSINESSES FOR SALE

IF You Want to Sell Your Business for Cash quickly and privately, we take the prospective buyer directly to you at our expense, no matter where located. We specialize in selling out-of-town businesses. If your business is worth \$5,000 or more, write us. The Mutual Security System, 68 W. Washington St., Chicago.

BUSINESS SERVICE

DELAWARE Incorporator. Charters; Fees Small; forms. Chat. G. Guyer, 901 Orange St., Wilmington, Del.

COLLECT Your Bad Debts. Six Collection Letters gets the dough; makes friends; for 60c. Interstate Sales Co., Box 700, Minneapolis, Minn.

MAILING LISTS

2,200 CALIFORNIA Garages. Guaranteed. Entire list \$8.00. Murco Supply Tujunga, Calif. Box-J

COMPLETE list, correct and up-to-date, \$3.00 thousand. Clarke Co., 511 Chanel, New Haven, Conn.

UP to date list \$5 per 1,000 names. J. E. Mallinson, Carolina, R. I.

GUARANTEED names. Actual buyers. \$5.00 thousand, 50c hundred. Demuth Company, Englewood, N. J.

NAMES—postcards—cuts. Ben Meyer, 35 West 31st, New York.

TYPEWRITERS AND SUPPLIES

TYPEWRITERS, all standard makes, \$10 up. Fully guaranteed. Free trial. Write for complete illustrated lists. Northwestern Typewriter Exchange, 121 N. Francisco Ave., Chicago.

UNDERWOOD Typewriters—only \$3.00 down. Easy monthly payments. Low prices at less than manufacturers. 10 day's free trial. Rebuilt, all worn parts replaced. Just like a new machine. 5-year guarantee. Write for big free catalogue C-151. Shipman-Ward Mfg. Co., 1517 Shipman Bldg., Chicago, Ill.

TYPEWRITERS All Makes. Save One-half. Thoroughly rebuilt in our factory by the famous "Young Process." Fully guaranteed. Free trial. We handle all standard makes. Cash or sold on easy terms. Write for catalog. Young Typewriter Co., Dent. 575A, Chicago, Ill.

PRINTING, ENGRAVING AND MULTIGRAPHING

1,000 LETTERHEADS or Envelopes, \$2.95. Prepaid. Samples. Advance Printers, Wauwatosa, Wis.

250 BOND letter heads and envelopes \$3.00 Prepaid. John S. Williams, Aurora, Ind.

"PUT it across with printing." Samples? Jacobus Service, Irvington, N. J.

HAMMERMILL Bond Letterheads \$4.00 1,000; 5,000, \$15.00. Samples free. Commercial Printing Co., 7052 N. Clark St., Chicago.

ONE hundred good bond letterheads and envelopes, \$1.50 postpaid. Jeffersonian, Atoka, Okla.

500 MULTIGRAPH Letters \$2.35 with printed head. Envelopes, Cards, bargains. Price list Free. Carlson's, 8743 Essex Ave., Chicago.

250 LETTERHEADS 250 white envelopes delivered printed \$3.00. Eastern Label Co., V. Clintonville, Conn.

20-LB. Bond Letterheads, 6% envelopes. Billheads, Statements; \$3.00 thousand. Low quotations on all good printing. Service Press, Middletown, N. Y.

PRINTING. 5,000 Bond Letterheads \$11.75. Ewan, 49 Pearsall Ave., Jersey City, N. J.

GUMMED Labels—3,000 \$1.00. Catalogue 2c. MacTaggart, 1225 Arch, Philadelphia, Pa.

GUMMED Labels! Interesting Catalog Free! Edward Harrison, "Attractive Printing," Baltimore.

\$2.50 BOX Stationery Free for 12 minutes' spare time. 100 sheets and envelopes, name, address or monogram, raised printing. Send for proposition and samples. H. E. Hull, 37 Meridian St., Meriden, Conn.

GUMMED Labels, 500 name and address, 2 lines 35c. 3 lines 55c. Catalogue, Eastern Label Co., A. Clintonville, Conn.

QUALITY Printing, anything; estimates furnished. Adams, 180 Harman St., Brooklyn, N. Y.

DRAWINGS and Cuts made to order. "Cressman," Washington, N. J.

250 EACH Hammerrill bond envelopes and letterheads, \$2.75, postpaid. Culpepper Press, Faith, Ark.

ADVERTISING Pencils Build Business Inexpensively. Your Advertisement Before Prospects Continuously. Lowest Prices. Samples. Lauber Pencil Company, 740 Hoopland, Dayton, Ohio.

500 8 1/2 x 11 HAMMERMILL Letterheads, printed, \$1.60. Postage extra. King's, Warren, Ill.

1,000 EACH letterheads and envelopes \$5.50. Samples. C. Hultquist, 810 Forrest Hill, Peoria, Ill.

250 EITHER letterheads, envelopes, cards, statements \$1.25 postpaid. 500 \$2.00. Model Company, Manchester, Iowa.

"NEARGRAVURE"—250 each Letterheads—Envelopes—Cards \$3.33 postpaid. Solidays', Knox, Ind.

YOUR Name on 22 Fine Cards 10c and stamp. Clinton's, Clintonville, Conn.

200 ATTRACTIVE letterheads delivered \$1.25 cash. Todd Printing Co., Cincinnati, Ohio.

1,000 LETTERHEADS, Envelopes, Cards, \$3.00 postpaid; 500, \$2.25. Samples Free. Artavia Press, 68 Houghton, Worcester, Mass.

ENGRAVING, printing, and multigraphing. Cost you no more to get the best. Write The Universal Agency, 332 Bremer Arcade, St. Paul, Minn.

EVERYTHING Printed! Distinctive samples free. Franklins, B-32, Milford, N. H.

250 BOND Letter Heads (8 1/2 x 11), Envelopes or cards, \$1.50; 500, \$2.25. Geo. Pfeiffer, Hackensack, N. J.

225 BOND letterheads, envelopes, billheads, cards, \$1.25 each. Combination, \$4.00. Economic Press, Leonia, N. J.

WE print Stationery, Booklets, Catalogs, Circulars, Samples. Commercial Press, Batavia, Ohio.

250 LETTERHEADS, 250 white envelopes printed and mailed \$3.00. Samples printing free. Sunco, Mohawk, N. Y.

QUALITY Printing! Reasonable Prices! Send for Free Standardized samples and prices. Folders, Circulars, Catalogs our specialty. Ernest Fantus, 525 South Dearborn, Chicago.

1,000 LETTERHEADS or Envelopes, \$3.00. Sent Prepaid. Samples Free. Monitor Press, Morrisville, Pa.

PRINTING OUTFITS AND SUPPLIES

COMPLETE printing outfits, presses, type, ink, paper supplies. Write for Catalog. Press Co., C-11, Meriden, Conn.

PRINTING Outfits, Presses, Type, Supplies. Stamp for information. Nicholas, M-110 High St., Boston.

PRINTING Outfits—Presses, type supplies, type novelties. Send stamp for catalogue. Model Press, York, Penna.

DUPLICATORS AND DEVICES

YOU can make 50 to 100 copies of a letter, notice, etc., at a cost of three cents on a Hever Quality Duplicator. Write for free trial offer. The Hever Duplicator Co., 14 S. Wells St., Chicago, Ill.

STENCIL Duplicator—\$3.00, \$2.50, \$1.00. Clear Printing, Typewriting, Handwriting. Returnable. Primos Specialty Co., 3-M, Primos, Pa.

NEW Hotospeed stencil duplicator and outfit, \$40. Lee Calpepper, Faith, Ark.

ADDING MACHINES

NEW \$3.50 Automatic Adding Machine. Adds, Subtracts, Multiplies. Absolutely accurate. Capacity \$999,999.99. Fully guaranteed. 75,000 pleased users. Makes adding easy, positive, quick. Eliminates mistakes. Saves Time. Postpaid \$3.50. Bassett Co., 1458 S. Hollywood Ave., Chicago.

FREE Trial. Marvelous new Adding Machine. Adds, Subtracts, Multiplies, Divides, automatically. Work equals \$350.00 machine. Price only \$15.00. Speedy, durable, handsome. Five-year guarantee. Used by largest corporations. Write today for catalogue and free trial offer. Lightning Calculator Co., Dent. E. Grand Rapids, Mich.

BOATS AND LAUNCHES

BUILD your own boat. Row, hunting, fishing, speed, hydroplanes and cruisers from our Knock-Down frames, 55 models. Send 25c for 64 page catalogue. Brooks Boat Co., Inc., Rust Ave., Saginaw, Mich.

HANDYMEN: Build your own boat. Do your own concrete work. Popular Mechanics has two new books that tell how to make 21 kinds of boats and how to make 173 articles from concrete. Each book is filled with pictures that make the instructions clear as crystal. Send No Money. Just write a postal and say, "Send Popular Mechanics Boat Book and Concrete Handbook." When the postman hands you the books, pay the few cents postage and \$1, the price of the books. Popular Mechanics Press, Room 810, 200 E. Ontario St., Chicago, Ill.

BOATS that always go are propelled by Ford Engines. Ford engine booklet free to boat owners. Harry Rider, 201B East Avenue, South Norwalk, Conn.

MAKE 10' Rowboat. Blueprint 30c. Weashe-Geo, 21st Office, Detroit.

OPTICAL GOODS

BINOCULARS, Binoculars, Binoculars! A glass for every use and every pocketbook. 58 styles, 4 to 24 power, \$9.50 to \$108.00. Guarantee of absolute satisfaction or money back. Get the Geneva price list first. Send for descriptive circular today. Geneva Optical Co., 41 Linden St., Geneva, N. Y.

RUBBER STAMPS

RUBBER Stamps, Cutting Dies for Cards, etc. Mail orders filled promptly. F. D. Hale, 84 Tonnetta Ave., Jersey City, N. J.

RAZORS AND BLADES

GILLETTE style blades, all new. Dozen 45 cents; 3 dozen \$1.25. Automatic trimmer 75 cents. F. Wallace Kutx, 132 Chamber St., Philadelphia, N. J.

HIGHEST Grade German Barber Razors \$2; Dozen \$15. John Dorey, 238th Street, Riverdale Avenue, New York.

BLADES resharpened 3c each. New Gillette type 40c dozen Guaranteed. Standard Safety Razor, Pittsburgh.

AI QUALITY keen new blades for Gillette razors. Dozen 55c. Pettet Wetterquist, 1635 13th Avenue, Rockford, Ill.

FOR SMOKERS

HOMESPUN Chewing and Smoking Tobacco—5 lbs. \$1.25; 10 lbs. \$2.50; 20 lbs. \$4.50. Hickory Ridge Farms, Mayfield, Ky.

GUNS, SPORTING GOODS, ETC.

ARE you a rotten shot? Hunting season should find you prepared to fill the bag. Our new shotgun peep sight, \$2.50 postpaid, will make you a good shot. Booklet "Wing Shooting Made Easy," description and testimonials on request. Wilbur Gun Sight, P. O. Box 183, Times Square, New York City.

DIAMONDS, WATCHES AND JEWELRY

MAGIC Costume Ring—Gold or Silver, Tricolor Stone turnable at will red, blue or green. Beautiful working model free. Cognito Co., 4, Elizabeth, N. J.

ANTIQUES, WAR RELICS AND INDIAN GOODS

ARROW head, eagle claw, petrified fossil, foreign coin and thousand Indian article catalogue, 25c. Indiancraft P. Company, 468 Connecticut, Buffalo, N. Y.

RELICS from Europe's battlefields. Weapons, medals, etc. Illustrated catalogue 25c (with sample War Photographs). Lieut. Welsh, 1889 Albany Ave., Brooklyn, N. Y.

SEND 5c for fine, new list Indian relics, antique firearms. F. E. Ellis, Webster Groves, Mo.

GENUINE Indian Relics, Arrow Heads, 50c. Edw. Martner, Prairie du Chien, Wis.

FOR THE HOME

ADDITION and Multiplication table for home and office use. Conveniently arranged. Mistakes are costly. Save money and pen by using the table and having your sums correct. 40c each or three for \$1.00. P. O. money order preferred. Every home needs a table or two. Harry G. Lillie, P. O. Box 385, Marysville, Ohio.

MAKE tables, chairs, book-racks, other furniture at home in spare time. We furnish complete plans and specifications anyone can use. Special—mahogany end table plans, 25c. The Practical Mechanic, South Haven, Mich.

FURNITURE; Make Furniture at Home. It's easy and fun. If you like to tinker with tools, you should learn how to make useful articles. Popular Mechanics books tell how to make all sorts of furniture needed in any home. You can make your own furniture for about half what it costs to buy, and make good wages at it in the bargain. Send for these three books: *Miscellaneous Furniture and How to Make It*, Book 1, Book 2, Book 3. Send No Money. Just write a postal. When the postman hands you the books, pay the few cents postage, and \$3, the price of the three books. Your money back if you are not delighted. Popular Mechanics Press, Room 810, 200 E. Ontario St., Chicago, Ill.

LOOMS—Only \$9.90 and up. Big money in weaving Colonial Rugs, carpets, etc., from rugs and waste material. Weavers are rushed with orders. Send for free Loom Book; it tells all about home weaving and quotes reduced prices and easy terms on our wonderful new looms. Union Loom Works, 480 Factory St., Boonville, N. Y.

GRANDFATHER'S Clock Works, \$5.00. Build your own case; Instructions free; make good profits selling your friends. Clock works with chimes for old or new cases. Write for full particulars. Clock Co., Ruffner St., Philadelphia.

SHOP Notes. We have a few back numbers of Shop Notes for those who wish to complete a set. The following issues are available. 1908, 1912, 1913, 1914, 1915, 1917, 1919, 1920, 1921, 1922, 1923, 1924, 1925. Single copies are 50 cents each. Special prices of \$6 for the complete set. Send No Money. If you order 2 or more, just write a postal giving the dates you want. When the postman hands you the package, pay him for the books, and the few cents postage. Popular Mechanics Press, Room 810, 200 E. Ontario St., Chicago, Ill.

MUSIC AND MUSICAL INSTRUMENTS

PIANO Jazz; teachers Ear Playing, Negro Harmony, Player Piano Effects, Chimes, Blues, Chords, Sweet Harmony, Particulars free. Write "Piano Bill," Toronto, District 3, Canada.

EVERYTHING Sold for Band and Orchestras—Saxophones, Banjos, Ukuleles, Drums, Trumpets, Violins, Reeds—All accessories. Salesmen Wanted. Jay, Conns and Basses Instruments sold. Also Radios. Easy Payments. Repairing and plating. Write for Prices. Sternberg's Music Shoppe, PM 8, 59 East Adams Street, Chicago.

BAND and Orchestra Instruments—All makes of new and used instruments sold, exchanged and repaired. Standard and popular music sold. Write today for catalog and Free subscription to "Musical Booster" magazine. "Deal with the Professional House." Crawford-Rutan Co., 1071 Grand Ave., Kansas City, Mo.

WRITE Songs. Big money and reputation. Write for information. J. Gordon Pub. Co., 201 N. Hoyne Ave., Chicago.

WONDERFUL bargains in regular-stock Sheet Music. 6 Carrie Jacobs Bond's, 90c. Others, classical or popular, state preference, 6, 25c; 30, 51, prepaid. Fine Christmas presents. Want agents. Circulars. Hubbard's Bargain Music, Riverside, Calif.

PLAY a tune in 10 Minutes, or Send It back. Instant noteless player. For Ukulele, Banjo, Guitar, Mandolin. Arthur Apter, 510 1/2 East 5th St., Los Angeles, Calif.

SONG Poem Writers—Have Proposition. Ray Hibbler, D1, 4040 Dickens Ave., Chicago.

SING Beautifully—quickly (without teacher). Write—Simplex Method, 4112M Hartford, St. Louis.

I WANT Song Poems. Casper Nathan, 2544 N. Racine, Chicago.

CORNETISTS—Trombonists—Saxophonists—Clarinetists. Get "Free Pointers." Name Instrument, Virtuosi School, Concord, Mass. "MUSIC Composed" to words. Bauer Bros., (formerly of Sousa's Band), Oshkosh, Wis.

VIOLINS. Deep, Mellow, Soulful—on credit. Easy terms for wonderful instrument. Get details today. Gustav F. Henning, 2424 Garford St., Denver, Colo.

VIOLINS—Genuine hand-made; sweet, soulful, mellow, yet powerful. Instruments of finest tonal quality. Free trial. John Lehto, 935 14th St., San Pedro, Calif.

PHONOGRAPHS AND RECORDS

BUILD your own Phonograph. We furnish everything. Write for free Phonograph Parts and Radio Catalog. American Phonograph Co., 3752 Belmont, Chicago.

BUILD Your Phonograph. Spring Motors, Electric Motors, Tomorrows, Amplifiers. Accessories. Latest Equipment also in Radio Mechanism and Cabinets. Catalog mailed for ten cents. Hoosier Mfg. & Supply Co., 213 Baldwin Block, Indianapolis, Ind.

PATENT ATTORNEYS

PATENTS—Our book "How to Obtain a Patent" sent free upon request. Contains full information about patents, trade-marks and designs. If you will send us a sketch of your invention we will promptly make search of the Patent Office records and advise you as to patentability, our charge for the service being \$5.00. Prompt, efficient service with moderate charge. Over twenty years experience. Band and commercial references. Talbert & Talbert, Registered Patent Lawyers, 297 McGill Bldg., Washington, D. C.

PATENTS. Trade marks, copyrights, Prompt, personal, reliable service. Over 36 years' active practice. Write for terms. Book free. Address E. G. Siggers, N. U. Bldg., 918 F Street, Washington, D. C.

STRONGER patents for less money. Drawings, specification, claims, \$20. Send half fee with sketch and description for prompt, efficient action. American Patents Corporation, Barrister Building, Washington, D. C.

ESTABLISHED 1864. Milo D. Stevens Company, Free Booklet, Patents, Trade-Marks, Copyrights. Offices Monadnock Block, Chicago; Barrister Building, Washington, D. C.

INVENTORS—Send for form "Evidence of Conception" to be signed and witnessed. Form, fee schedule, information free. Lancaster and Allwine, Registered Patent Attorneys in United States and Canada, 221-Ouray Bldg., Washington, D. C.

PATENT Book Free. Charles W. Lovett, Patent Attorney, Lynn, Mass.

MONROE MILLER. Ouray Bldg., Washington, D. C. Patent Attorney; Mechanical, Electrical Expert. Free Blue Book gives candid advice.

PATENT Procured. Prompt Service, Personal, careful and efficient service. Highest references. Moderate fees. Send sketch or model for actual search and advice. George P. Kimmel, Master of Patent Law, 54 K. Legal Bldg., Washington, D. C.

MILLIONS spent annually for ideas! Hundreds now wanted! Patent yours and profit! Write today for free book—tells how to protect yourself, how to invent, ideas wanted, how we help you sell, etc. American Industries, Inc., 500 Kresge Bldg., Washington, D. C.

PATENTS and Trade-Marks obtained. Prompt service. Write for our new book on patents. Established in 1889. D. Swift & Co., 269 7th St., Washington, D. C.

PATENTS, Trade-Marks, Designs. This firm has 27 years' experience and gives expert personal service at reasonable rates. We properly protect your invention. Write for free information and exact cost of procuring patent before proceeding. John B. Thomas & Co., 902 F. St., N. W., Washington, D. C.

PATENTS Procured; Trade Marks Registered—A comprehensive, experienced, prompt service for the protection and development of your ideas. Preliminary advice gladly furnished without charge. Booklet of information and form for disclosing idea free on request. Richard B. Owen, 30 Owen Bldg., Washington, D. C., or 41-B Park Row, New York.

FRED H. HAYN, M. E., formerly First Assistant, Examiner U. S. Patent Office, 23 years' exp. I. W. Hellman Building, Los Angeles, Calif.

INVENTORS—Write for our Guide Book, "How to Get Your Patent" and Evidence of Invention Blank. Send model or sketch of your invention for our prompt examination and instructions free. Randolph & Co., Dept. 430, Washington, D. C.

PATENTS. Booklet free. Highest references. Best results. Promptness assured. Send model or drawing for preliminary examination. Watson E. Coleman, Patent Lawyer, 644 G Street, Washington, D. C.

"INVENTORS' Guide" sent free on request; this book contains illustrations of patented inventions and gives valuable information and advice for all who have original ideas or improvements. Frank Ledermann, Registered Attorney and Engineer, Woolworth Bldg., 1712, New York.

INVENTORS: Send sketch or model for advice and exact cost of patent. Ask for our Free book: "How to Obtain a Patent." Tells what every inventor should know. Established twenty-eight years. Highest references. Prompt service. Reasonable charges. Chandless & Chandless, 474 Seventh, Washington, D. C.

HERBERT JENNER, patent attorney and mechanical expert, 606 F Street, Washington, D. C. I report if patent is obtainable and exact cost. Send for circular.

PATENTS. Time counts in applying for patents. Don't risk delay in protecting your ideas. Send sketch or model for instructions or write for Free book "How to Obtain a Patent" and "Record of Invention" form. No charge for information on how to proceed. Communications strictly confidential. Prompt, careful, efficient service. Clarence A. O'Brien, Registered Patent Attorney, 5896 Security Bank Building (directly across street from Patent Office), Washington, D. C. See pages 156 and 157.

PATENTS—Write for our Guide Books and "Record of Invention Blank" before disclosing inventions. Send model or sketch of your invention for Free Inspection and Instructions. Terms Reasonable. See advertisement on pages 158 and 159. Victor J. Evans & Co., 934 Ninth, Washington, D. C.

LACEY'S Patent Sense. Valuable book free. See ad page 160.

PERCY S. WEBSTER. Savings and Loan Building, Stockton, California. Long established organization. Send for free book on Patents.

UNPATENTED Ideas Can Be Sold. I tell you how and help you make the sale. Free particulars (Copyrighted). Write W. T. Greene, 806 Jenifer Building, Washington, D. C.

"INVENTOR'S Advisor," the valuable Patent book with 139 mechanical movements and illustrations, sent free upon request. M. M. Labiner, Patent Attorney, 3 Parkrow, New York.

COMMERCIALIZE your inventions according to My Cooperative Plan before patenting. Write for booklet. Ralph Burch, Patent Lawyer, Jenifer Building, Washington, D. C.

PATENT Application Blanks free to inventors. Patent News-D, Washington, D. C.

FOR INVENTORS

PATENTS. If you have an invention which you wish to patent you can write fully and freely to Munn & Co., for advice in regard to the best way of obtaining protection. Please send sketches, or a model of your invention and a description of the device, explaining its operation. All communications are strictly confidential. Our Handbook on Patents is sent free on request. This explains our methods, terms, etc., in regard to Patents, Trade Marks, Foreign Patents, etc. "Scientific American" contains Patent Office Notes, Decisions of interest to inventors and particulars of recently patented inventions. Munn & Company, Solicitors of Patents, 623 Woolworth Building, New York; 524 Scientific American Bldg., Washington, D. C., 413 Tower Bldg., Chicago, Ill.; 396 Hobart Bldg., 582 Market St., San Francisco, Calif.; 221 Van Nuys Building, Los Angeles, Calif.

PATENTS—Our book "How to Obtain a Patent" sent free upon request. Contains full information about patents, trade-marks and designs. If you will send us a sketch of your invention we will promptly make a search of the Patent Office records and advise you as to patentability, our charge for the service being \$5.00. Prompt, efficient service with moderate charges. Over twenty years' experience. Bank and commercial references. Talbert & Talbert, Registered Patent Lawyers, 582 McGill Bldg., Washington, D. C.

WILL finance patent (good invention) for interest. F. A., c/o Patent News, Washington, D. C.

PATENTS Procured; Trade Marks Registered—A comprehensive, experienced, prompt service for the protection and development of your ideas. Preliminary advice gladly furnished without charge. Booklet of information and form for disclosing idea free on request. Richard B. Owen, 30 Owen Bldg., Washington, D. C., or 41-B Park Row, New York.

I SELL Patents. Established in 1900. The only man in America who has spent the past 25 years exclusively at this work. An experience highly valuable to you. If you have a good patent to sell. Charles A. Scott, 773PM Garson Avenue, Rochester, N. Y.

PATENTS Wanted. Send Description and Patent Number. Address Box 126, Dowagiac, Mich.

INVENTOR'S Universal Educator—contains 900 mechanical movements; 50 perpetual motions. Tells how to obtain and sell patents. Suggests new ideas. Explains how to select your attorney and avoid patent sharks. Price (revised edition) \$2.00 postpaid. Albert E. Dieterich, 621 Ouray Bldg., Washington, D. C.

MONROE Miller, Ouray Bldg., Washington, D. C. Patent Attorney; Mechanical, Electrical Expert. Before proceeding, read free Blue Book.

IF you have a practical, useful invention to sell, write promptly. American Patents Corporation, Barrister Building, Washington, D. C.

MODELS, experimental work for inventors. Confidential, reasonable. Technical Research Bureau, 577 National Ave., Milwaukee, Wis.

PATENTS, inventions wanted; send description, P. O. Box 1552, New Haven, Conn.

INVENTORS—Write for our Guide Books and "Record of Invention Blank" before disclosing inventions. Send model or sketch of your invention for our free inspection and instructions. Terms reasonable. See advertisement on pages 158 and 159. Victor J. Evans & Co., 157 Ninth, Washington, D. C.

LACEY'S Patent Sense. Valuable book free. See ad page 160.

STRONGER patents for less money. Drawings, specification, claims, \$20. Send half fee with sketch and description for prompt, efficient action. American Patents Corporation, Barrister Building, Washington, D. C.

DUNKIN Engineering Co., Patents developed. Models furnished. Special Machinery. Production Engineering, 13000 Superior Ave., Cleveland, Ohio.

PATENTS. Time counts in applying for patents. Don't risk delay in protecting your ideas. Send sketch or model for instructions or write for Free Book "How to Obtain a Patent" and "Record of Invention" form. No charge for information on how to proceed. Communications strictly confidential. Prompt, careful, efficient service. Clarence A. O'Brien, Registered Patent Attorney, 5896 Security Bank Building (directly across street from Patent Office), Washington, D. C. See pages 156 and 157.

UNPATENTED Ideas Can Be Sold. I tell you how and help you make the sale. Free particulars (Copyrighted). Write W. T. Greene, 807 Jenifer Building, Washington, D. C.

RESPONSIBLE established electrical manufacturer will buy outright or manufacture on royalty new inventions of household utilities or appliances. Details necessary. L. J. Efferth, 6345 Carnegie Ave., Cleveland, Ohio.

HAVE You an Invention? If so, write for our free book, "How to Get Your Patent," tells our terms and methods. Send model or sketch for our free examination and instructions. Randolph & Co., Dent, 144, Washington, D. C.

GET your own patents. Legal blanks, complete instructions \$1. Cutting Sons, Campbell, Calif.

INVENTIONS fully protected two years, \$15 total cost. Particulars free. Patent News-G, Washington, D. C.

PATENTS Sold or placed on Royalties, both U. S. and Canadian. Patented or Pending. For immediate action, write Arthur S. Billings, Suite 401 Dekum Bldg., Portland, Oreg.

PATENTS FOR SALE

PATENT for sale, Printers' necessity. Stamping. Robert Anderson, 35 Washington St., Lancaster, Pa.

FORD Motor Oilier. Every Ford needs one. Low manufacture cost. Outright or royalty. Geo. Hamilton, Box 4, Jacksonville, Fla.

FOR Sale—Patent on Improved Nut Lock. Absolutely practical. Market unlimited. This is a valuable invention which I will sell either outright or place on royalty basis. For further particulars, address Isaac W. Griffith, Box 719, Johnstown, Pa.

PATENTS for Sale, Outright or Royalty. Pocket Electric Book Lamp. Practical. Possibilities enormous. F. L. Schmidt, 54 East 15th Street, New York, N. Y.

OUTRIGHT or Royalty Basis: Patented screw driver; can be operated with one hand by using finger and thumb; locks automatically. Stanley Mistalske, 1182 Milwaukee, Chicago.

FOR Sale—Patented Fountain Comb. A new novel invention, and one which should meet with a ready market when placed on sale. A big money-maker. Outright or place on royalty. For particulars, address Chas. Balko, Box 31, Van Meter, Pa.

PATENT 1,520,636 developed passed the experimental stage. An artificial game-fish lure, that swims like a natural minnow. 10,000,000 anglers will want it. Costs 10c to make, retail at \$1.25 to \$3.00. Write, W. Felker, 1409 Buchanan St., Racine, Wis.

PATENT for sale on a Barb-Wire Stitcher. Simple to make. Easy to operate and everlasting. Char. Stark, 5901 White Ave., Cleveland, Ohio.

ROYALTY basis, household necessity; an article of unusual merit; wonderful sales possibilities. Henry Peers, 664 No. Dearborn, Chicago.

INFANT'S improved stocking supporter fastens to diaper and releases in an instant. John Rounp, Hesston, Kans.

OUTRIGHT or Royalty. Compound vacuum, electric washing machine. Perculating, Rotatable. M. Latshaw, 1502 N. 62nd St., Philadelphia, Pa.

PATENT for Sale, Apple Pieker. Just patented. Nothing like it. Cheap to manufacture, easy to handle. Demand unlimited. H. L. Taylor, Westfield, Wis.

PATENT—Only practical Stop Direction Signal on automobiles. Sale or royalty. F. Cox, 820 Cass St., Chicago.

SAW-FILING and Setting Machine, one operation, with Model. Sell outright. See Popular Mechanics, Sent., 1924, issue. Best offer takes it. Bernhard Wilthil, 14 Myrtle, Flushing, N. Y.

FOR Sale—Open-car device which holds side curtains rigid and prevents stretching, tearing, seeping and breaking of glass. C. A. Bixby, Bixby, Okla.

MR. MANUFACTURER or Distributor of Office Supplies: I have an article which will appeal to every stenographer, secretary and typist. Sales possibilities enormous and can be easily proven. Manufactured for a dise. Outright or royalty. Write M. Ross, 1314 49th Ave., Oakland, Calif.

PATENT pending on high ratio radio vernier dial. Responsible manufacturers write C. Bailey, Massillon, Ohio.

EXERCISING Machine scientifically designed. Everlasting. Just patented. Outright or royalty. For particulars, Setomaxor, Box 142, Hato Rey, P. R.

AUTOMATIC window stop Patent; Eliminates pulleys, ropes, cord. V. Wolff, Sta. 9, Omaha, Nebr.

FOR Sale—Patent for Celery and Cabbage planter. L. Keppler, Tarpon Springs, Fla.

MR. MANUFACTURER, Layman or veteran—Side Dump Scraper Hoist, load wagon, does ditching. E. B. Hawkins, Applegate, Oreg.

MR. INVENTOR: If you have a patent or invention for sale, write Hartley, 44 Central St., Bangor, Me.

U. S. PATENT 6-23-25, No. 1,543,241—Canada No. 246,388. Wright's Rotary Flour-bin. Novel invention, three in one! Large size for barns, chicken houses, to keep grains separate. Manufactured cheap. Sheet metal; Rodent proof! Attil Wright, Marshfield, Wis.

PATENTS For Sale: To sell, buy or obtain patents, write Patent News-P, Washington, D. C.

YOU have a worth-while patent, haven't you? Why don't you tell our two million readers about it? Most of them are specially interested in patents and new inventions. Ask me to tell you how other inventors successfully sold their patents. Geo. F. Baker, Manager Classified Advertising, Popular Mechanics Magazine, Chicago, Ill.

SURVEYING INSTRUMENTS

LARGEST stock of new and used surveying instruments in the country direct from factory. Satisfaction guaranteed or money refunded. Wessler, 619 N. Broadway, St. Louis.

MODELS AND MODEL SUPPLIES

PATENTS. Time counts in applying for patents. Don't risk delay in protecting your ideas. Send sketch or model for instructions or write for Free Book "How to Obtain a Patent" and "Record of Invention" form. No charge for information on how to proceed. Communications strictly confidential. Prompt, careful, efficient service. Clarence A. O'Brien, Registered Patent Attorney, 5896 Security Bank Building (directly across street from Patent Office), Washington, D. C. See pages 156 and 157.

CASTINGS for new model steam engine, 1" bore x 1" stroke. Send stamp for circular No. 7. Model Machine Shop, 417 East 71st St., New York City.

MODEL Steam Engines, Boilers and Model Pipe line fittings. Model Making Supplies. Send 20c for this year's illustrated catalogue and hand book. Bathe Mfg. Co., Dept. D., 5214 Woodland Ave., Philadelphia.

MECHANICAL drawing from sketches. Confidential, neat accurate. Technical Research Bureau, 377 National Ave., Milwaukee, Wis.

SPECIAL machine builders, tool and die makers, inventor's models, production work of all kinds. Dept. L. Quality Hardware & Machine Co., Ravenswood and Thorndale Avenues, Chicago, Ill.

WE make working models for inventors and do experimental work and carry a complete stock of brass gears and model supplies. Send for catalogue. The Pierce Model Works, Tinley Park, Ill.

PATTERN Making. There's a Fascinating trade that pays good money. It isn't so difficult to learn, either. Popular Mechanics has helped many a young man into this trade by supplying the necessary instructions. These are contained in our valuable book, "Pattern Making," by G. H. Willard. 312 illustrations, Special chapters on moulding and core making. Send No Money. Just write a postal. When the postman hands you the book, pay the few cents postage and \$1. the price of the book. Popular Mechanics Press, Room 810, 200 E. Ontario St., Chicago, Ill.

DIES, Tools and General Manufacturing. Models and Manufacturing of new inventions our specialty. Logan Machine Co., 126 S. Clinton St., Chicago, Ill.

WE Build Models, design, develop and manufacture articles in large or small quantities. Homeyer Mfg. Co., 1885 E. 17th St., Cleveland, Ohio.

THE Modelmaker. For those interested in making working models. Send 10 cents. Address P. M. 129 Liberty Street, New York.

MANUFACTURING

METAL-CRAFT — Eventually — Metal-Craft. Competent Engineers, Designers and Producing Organization await your commands on dies, stampings, die-casting, deep pressing, screw-machine and wire products. Plating, Enameling, Burnishing, Assembling, Wrapping and Packing to your specifications. Large completely equipped plant which guarantees prompt, efficient service. It is not the quality of raw materials alone, nor the precision in manufacture, and not just the service rendered that has given Metal-Craft the good reputation they bear—but all of these, as a constant certainty. In Combination. Estimates promptly furnished. Metal-Craft Manufacturing Company, Box 259-W, Chicago.

MECHANICAL Work: all branches. Perfect models. Articles manufactured to order. Reliable. Parma Engineering Co., Brooklyn Station, Cleveland, Ohio.

RESPONSIBLE Sheet Metal Manufacturer will buy or manufacture on royalty new inventions of Sheet Metal. Prefer small articles. A. Artusier, 333 Southwest Blvd., Kansas City, Mo.

ELECTRIC heating elements designed, manufactured. Chas. Olsson, 1371 Forest Home Ave., Milwaukee, Wis.

WE design and build special machinery, tools, dies, jigs, and fixtures. Experimental work. Light stamping, quantity production. Reliable Machine Co., 400 West 23rd St., New York City.

WIRE goods made to order. Cooley Mfg. Co., 530 N. Western Ave., Chicago.

METAL Stampings, Dies and Special Machinery. Mail us your drawing or sample for estimate. Send for our free catalogue of Model Supplies. The Pierce Model Works, Tinley Park, Ill.

METALWORKERS. Popular Mechanics New Lathe Handbook, and The Drilling and Thread Cutting Handbook make a most valuable combination for anyone interested in metal work. 500 ideas, 510 illustrations. Send No Money. Just write a postal and ask for The Lathe Handbook and Drilling and Thread Cutting. When the postman hands you the books, pay the few cents postage and \$1. Popular Mechanics Press, Room 810, 200 E. Ontario St., Chicago, Ill.

LIGHT stamping and manufacturing. Acme Tool Co., Mason City, Iowa.

OUR factory will make your models, manufacture your articles as well as build your tools, dies and fixtures. Standard Die & Specialty Co., 1932 Austin Ave., Chicago, Ill.

FOR MECHANICS

KINKS on Metal Work. Popular Mechanics New Book, "Machinist's Kinks" contains 419 discoveries of extreme value to anyone who likes to work with metal. For the mechanic, machinist, or for the man who likes to tinker at home, 287 illustrations. Cloth bound. Send No Money. Just write a postal asking for "Machinist's Kinks." When the postman hands you the book, pay the few cents postage and the price of the book, \$1.50. Popular Mechanics Press, Room 810, 200 E. Ontario St., Chicago, Ill.

HOME Mechanics. Ideas for all sorts of odd jobs about the house. These are contained in two books recently published by Popular Mechanics Press. One is "Home Mechanics," the other is, "Popular Mechanics Handbook for Women." Over 700 discoveries that will be useful to the whole family. Boys and girls will learn to use tools when they have the clear directions contained in these fascinating books. Send No Money. Just write a postal and ask for "Home Mechanics" and the "Handbook for Women." When the postman hands you the books, pay the few cents postage and \$1. the price of the books. Money back if you are not delighted. Popular Mechanics Press, Room 810, 200 E. Ontario St., Chicago, Ill.

DISCOVERIES of value to men in all walks of life, are to be found in Popular Mechanics Shop Notes for 1924 and 1925. Full directions are given for making such articles as the following: Electric pump for farm, leather pulley, tractor belt tightener, boring and turning attachment for small lathe, barrel hoist and rack for garage, price ticket printer for stores, special attachments for hand grinder, hydraulic ram, film drying cabinet, and hundreds of others. Send No Money. Just write a postal and ask for Shop Notes for 1924, and 1925. When the postman hands you the package, pay the few cents postage and \$1. Popular Mechanics Press, Room 810, 200 E. Ontario St., Chicago, Ill.

MACHINERY, TOOLS AND SUPPLIES

SHAW Garden Tractor—Plows, seeds, cultivators, runs belt machinery, cutter bar attachment. See page 416 September issue this magazine. Literature free. Shaw Manufacturing Company, Department C, Galesburg, Kans.

We design and build special machinery, make models, dies, stamping tools, do general machine work and light manufacturing. Marshall Mfg. Co., Kansas City, Mo.

NO. 60 Heald auto cylinder grinder, \$750. One U. S. Milling Machine \$125. 20" Siver drill press \$55. 15" Handy shaper \$215. 18"x6" Porter engine lathe \$175. 20"x16" Lodge and Davis engine lathe, taper attachment, \$550. Terms to suit on single machine or complete shop. Complete line machine and supplies. Cincinnati Machinery Supply Co., 218 E. Pearl Street, Cincinnati, Ohio.

FOR SALE—nine-inch engine lathe. H. E. Haesly, Winona, Minn.

CONCRETE Building Block Machines and Molds. Catalogue free. Concrete Machine Co., 5, N. Main St., St. Louis, Mo.

ENGINES, MOTORS AND DYNAMOS

MOTORS \$2.98; Good. Practical, twentieth horsepower, 115 volt alternating-direct current. Tenth horsepower \$3.98. Order Now. Pay Postman. Perry Trading Company, Dept. M10, 815 Lake, Racine, Wis.

GUARANTEED New Motor Bargains: Gilbert, 1/10 AC-DC, \$1.50; General Electric, 1/4 AC, \$14.75; 1/2 AC, \$34.00; 3/4 AC, \$43.90; 1 H.P., \$56.00. Many other bargains, both new and rebuilt. Tell us your needs. Send for our complete price list. Hyre Electric Co., 615 M So. Dearborn St., Chicago, Ill.

PRICES Smashed! 5 H.P. Gasoline Engine \$65; 7 H.P. \$75. 500 pound Cream Separator \$30. Brand new. Satisfaction guaranteed. Fantus-Majestic, 1350 South Oakley, Chicago.

BRAND new 1 KW Westinghouse. 32 volt, 1,150 speed, light and power Generators at \$48.00 each. 25% cash, balance C.O.D. General Distributing Co., Security Storage Bldg., Duluth, Minn.

GUARANTEED 1/4 hp, 110 volt, 60 cycle, single phase, used motors with pulley at \$7.50, cash with order. We repair, rewind, electric motors and generators, etc. Bargains on electric fans. General Distributing Co., Security Storage Bldg., Duluth, Minn.

1/4 H. P., 110 V., 3,000 speed motors. Will run alternating or direct current; also 32 V. \$4.65 each. Cash with order. Bargains in large motors and generators. Queen City Electric Co., 1738 Grand Ave., Chicago, Ill.

BENDING MACHINES

THE famous Hossfeld Wrenchless Universal Bender is the last word in bending machines; bends metal, cold or hot, into most any conceivable shape, including Eye-bolts and Automobile Spring Eyes. Bends up to 1" bars or 1 1/4" Pipe cold. Used by the largest corporations, yet so inexpensive that even a farm shop need not be without one. Send for circular. Hossfeld Mfg. Co., Box 344, Winona, Minn.

BLACKSMITHS

BLACKSMITH Notice: Young smith or handy man make more money doing hard jobs easy. In job shop or factory be a Master Machine and Plover Blacksmith and Expert Tool Dresser. With Colored Tempering Charts. All for One Dollar. Samples Free. W. M. Toy, Sidney, Ohio.

ELECTRICAL

BURGLAR Alarm Supplies. Midnight Alarm, 3218 Cambridge St., Toledo, Ohio.

ELECTRICAL Devices such as bread toaster, grill, door opener, clock, engine, fire alarm, furnace regulator, furnace lock, locomotive, and dozens of others are fully described and pictured in Boy Mechanic, Book 1. You can make these for yourself with the crystal-clear instructions in this valuable book. Don't send a penny, just write a postal and ask for Boy Mechanic, Book 1. When the postman hands you the book, pay the few cents postage and \$2. Popular Mechanics Press, Room 810, 200 East Ontario St., Chicago, Ill.

FOR SALE—MISCELLANEOUS

PRINTING Presses, Type, Materials. Make easy money printing for self and others. Interesting circulars. Stamp. Watson, 30 Beckman St., New York.

TYPEWRITERS \$1—\$35. Motorcycles \$5—\$50. New Victrolas \$13. Send cash. Agents wanted. Knight's, 1512 Locust, St. Louis, Mo.

FOR SALE—We have left one new, shop-worn, Remington, Automatic twelve gauge shotgun with canvas case that we will sell for \$42. Motorcycle Equipment Co., Hammondport, N. Y.

BEAUTIFUL \$12.00 Brass Bird Cage. Introductory price \$6.00, postpaid. Money refunded if unsatisfactory. American Cage Co., Box 10, Racine, Wis.

ADDRESSOGRAPHs. Letter Folders, Multigraphs, Envelope Sealers, Duplicators, less than half price, guaranteed. Pruitt Co., 117 No. Market, Chicago.

BUY—Exchange—Sell! Many of our readers have for sale or exchange the article you are looking for—and lots of them are looking for the very items you want to turn into cash. Get together! Let our two million readers know your wishes—they'll help you! Send your ad today to Geo. F. Baker, Manager Classified Advertising, Popular Mechanics Magazine, Chicago.

WANTED—MISCELLANEOUS

CASH sent immediately for gold, silver, platinum, diamonds, watches, bridge-work, crowns, and all valuables. Satisfaction guaranteed. Dept. 50, Busch Products, 2350 Eighth Ave., New York.

MAIL us your Discarded Jewelry, Diamonds, Old Gold, Silver, Platinum, Magnetite Points, Gold Crowns, Bridgework. Cash promptly mailed. Your goods returned if offer refused. D. Davis, 1726 Roosevelt Rd., Chicago.

REAL ESTATE, FARM AND ORCHARD LANDS

ORCHARD Farm Only \$1,850. Big Horses, Stock, Crops, Implements; nearly 160 fruit trees; near advantages; 50 acres mellow fields, estimated \$5,000 worth wood; attractive 10-room house, basement barn. Only \$1,850, part cash. Details pg. 9 Illinois Free Catalog, Strout Farm Agency, 235-P, 4th Ave., New York City.

HERE'S your land! \$10 down and \$10 a month buys 20 acres of my best land in Cent. Mich. for \$400 or 10 acres for \$250. Write at once for free 48-page picture book. G. W. Swigart, P-1259, 1st Natl. Bank Bldg., Chicago.

ATTENTION—"Get acquainted." Cash for your property. Farm, Hotel or Retail Store, no matter where located; confidential service. Hayes' Business Agency, Cincinnati, Ohio.

\$5.00 DOWN, \$5.00 monthly; 10 acres unimproved poultry, fruit, stock, woodland; \$100; Ozarks. Fishing, hunting, trapping. Alvin Zimmermann, 1800 N. Fifth, Kansas City, Kans.

SELL your property quickly for cash, no matter where located. Don't pay big commission. Particulars free. Real Estate Salesmen Co., Desk B, Lincoln, Nebr.

DOGS AND PETS

FOR SALE—blue foxes, red fox, mink, skunks, muskrats, ferrets, opossums, squirrels, rabbits. B. Tippman, Dept. H, California, Minn.

HUNDED Hunting Hounds, Fur Catchers, Catalogue. Kaskaskennels, M32, Herrick, Ill.

THOROUGHBRED Collies, Puppies and Grown dogs usually for sale. G. J. Dunne-wind, Comstock Park, R-1, Michigan.

RELIABLE Rabbitry, Flemish Giants, New Zealand, Belgian Hares, Malkranz Rabbitry. New Bethlehem, Pa.

REAL cooners and bird dogs C. O. D. on trial. Frye's Kennels, Finger, Tenn.

BEAUTIFUL registered bull pups \$15. Bulldogs. 501 Rockwood, Dallas, Texas.

PERSONAL

YOU will become acquainted with the best Men, Women and Children in the world through our Club and Magazine. Trial membership 10 cents. Geo. Stewart, 157 W. Sts. Barbara, Los Angeles, Calif.

SEND 25c and your date of birth for forecast of your vibrations for 1926. Arrel Synclaire, Numerologist, Box 25, Patton, Calif.

FUTURE, Present, Past and what you should be, 25c (Silver). Fred Klotz, Reading, Pa.

COMFORT Resilient Spring Arches relieve callouses, arching feet. New patent. (Size shoe? \$3.50 C.O.D.). Dr. Hilton's Arch, 803 Edgmont Avenue, Chester, Pa.

STOP tobacco, cigarettes. Guaranteed Remedy on trial. Helle Company, 4153 Gladwin, Detroit.

SEND for free valuable information about tobacco, the folly of its use, and how to overcome the habit easily. Investigate. It will surely benefit you. Orsamin, Box 503D, Detroit, Mich.

ASTROLOGY—Stars Tell Life's Story! Send birthdate and 10c for test reading. M. Kleman, 373 William Ave., Winnetka, Minn.

UNUSUAL Horoscope—Six pages, 2,500 words, consisting of extensive four-page Special Horoscope, Astro-Analysis, and two-page valuable guide giving daily and monthly advice covering entire year. Send 50c and birthdate. Money returned if dissatisfied. Prof. Bolles, Box 125, Cranford, N. J.

TOBACCO or Snuff Habit cured or no pay. \$1.00 if cured. Remedy sent on trial. Superba, Co., TP, Baltimore, Md.

MISCELLANEOUS

PEARLS and Slugs. Pearl Hunters should send their pearls and slugs by registered mail or express to Herbert H. Vertrees, Fresh Water Pearls, Box 407, Pittsfield, Ill.

THE Drill Lathe convertible; For the Home worker, Experimenter and Radio engineer. D-L Machine Agency, 418 E. 69th St., Chicago.

MEXICAN made pistol holsters, cartridge belts; hand-laced holsters and belts. Fancy goods; list free. Ingersoll Leather Co., 307 Fannin, Houston, Texas.

CIGARETTE machine. Pocket size, 40c. No Stamps. DeSoto, Carterville, Mo.

WRITE Right with Protecto Ink. Sample Sent 10c. You Will Want More. R. Darby, Mather, Pa.

A BEAUTIFUL Oil Painting of your photo. Send 25c for particulars and color chart. Albert W. Seaman, 2104 Liberty Avenue, Terra Haute, Ind.

EARN \$3,000 yearly; course \$200; including printing, \$350; largest linotype school in existence; established 19 years; more than 1,000 have attended. Empire School, 206 E. 19th St., New York.

MINERAL Wealth under Foot. Learn to find it. Cash it in. Thousands profit, so can you. Information 10c. Baskett, Jordin, Mo.

ARE you old at forty? See our advertisement on page 76 of this issue. The Electro Thermal Company, 2137 Main St., Steubenville, Ohio.

FORMS to Cast Lead Soldiers, Indians, Marines, Trappers, Animals. 151 Kinds. Send 10c for Illustrated Catalogue. Henry Schlercke, 1634 72nd St., Brooklyn, N. Y.

CAN you draw? Make money at home. Something new. Sample Free. Easy and Simple. No canvassing. "Straley," 1017 W. Mulberry, Springfield, Ohio.

CUTS anybody can make. Simple, cheap process. \$1. Specimens, particulars, 2c stamp. M. Day, Winfall, Ind.

ARTIFICIAL Eyes. Booklet free. Denver Optic, 559 Barclay, Denver, Colo.

HOMOPATHIC and Biochemic preparations sent postpaid to all parts of the world. Manual and booklets free. Halsey Bros. Co., 111 N. Wabash Ave., Chicago, Ill. Established 1855.

KEYS duplicated 25c. Lakewell, Locksmith, 175 W. Lake, Chicago.

SKI-MAKING and Running. Fully treated in a series of crystal-clear articles in Boy Mechanic, Book 3. Tells you how to make your own skis, how to run and jump, how to climb hills, and travel on level ground. Get this book now and prepare for a winter of real sport. Send No Money. Just write a postal. Pay postman the few cents postage, and \$2 for the book when he hands it to you. Popular Mechanics Press, Room 810, 200 E. Ontario St., Chicago, Ill.

BE A BRICKLAYER

Thousands
of **Big Pay Jobs**
are waiting for
men who can
handle the
trowel!

Make
\$60 to \$90 a Week
I Train You At
Home in Your
Spare
Time!

My Remarkable Job Analysis Method Fits You For Big Money

NOW you can learn the highest paid trade of all—BRICKLAYING—right at home, in your spare time. By my remarkable Job Analysis Method, perfected by experts after years of study and effort, I teach you exactly how to do EVERYTHING that a regular, A-1, journeyman brick mason does on the wall. I show you how to construct four, eight, twelve and seventeen inch walls; how to build panels, pilasters, piers, arches, corners, angles, jambs, cornices and all other units of construction. I tell you all about the various kinds of bricks and their uses; how to mix mortar; how to handle the trowel; all about the various Bonds; everything—EVEN HOW TO READ BLUE PRINTS, ESTIMATE AND CONTRACT. I cover the trade from A to Z. In a few months time you can fit yourself to step out and get a big pay job—\$50.00, \$60.00, \$70.00 a week and UP.

Not A Series of Dry Books—I Teach You the "Secrets" of this High Paid Trade JUST AS THOUGH I STOOD RIGHT BEHIND

With the Job Analysis Method you LEARN BY **YOU!** DOING. You actually handle the bricks, trowel, and mortar (in a garage, basement, attic or other handy place) and do each and every job that a bricklayer does on the wall. You get practical experience as you go along. Every job, every motion simply and clearly explained and fully illustrated with diagrams, photos, charts and blue prints. Better training in a few months than many apprentices get in four years. No time killed running errands for the boss or doing odd jobs for the men. No waste motion—every minute counts—careful, personal instruction from start to finish—real progress every day.

FREE
Book Gives You
Details of This
Amazing
Opportunity

MAIL
COUPON
Today!!

Big Opportunity to Become Foreman, Contractor or Builder

Tremendous opportunities ahead. Make \$8.00, \$10.00, \$12.00 to \$15.00 a day right from the start and later make still more as foreman or "get-in" for yourself as contractor or builder. Thousands are making fortunes in the building business. You can start big and then go as much higher as you like. I know what I'm talking about because I myself have been a "brickie" and have also trained and hired other brick masons for years. I KNOW what the future holds for any ambitious man who learns this big pay trade.

ACT! Learn More About This WONDERFUL OFFER!!

Write for my FREE book, "The Quick Way To Big Pay Everyday." The book tells all about my Job Analysis Method; about my experience as Bricklayer, Foreman, Contractor, Builder, and Real Estate Operator; how I train you at home in spare time; how to get a job; in fact, how I teach you to see, act, think and talk like a regular "brickie." ACT NOW—THIS VERY MINUTE. Clip the coupon while it is right before you. Let me send your FREE copy by return mail.

The National School of Bricklaying
Dept. J-10, Washington, D. C.

Send for Your
**FREE
COPY!**



W. P. Cissel,
Chief Instructor,
The National School
of Bricklaying, Dept. J-10,
Washington, D. C.

Send me your FREE book on "The Quick Way to Big Pay Everyday," which tells all about how to become a bricklayer and how you train me at home in my spare time.

(Write or Print Name Clearly)

Name

Address

City



A Great Book Free with this pay-raising library

For a short time only we will give every subscriber to the New Library of Machine Shop Practice a copy of French's Engineering Drawing—the greatest book on mechanical drawing ever written. This book makes drawing as plain as day—tells you all about instruments, plans and methods—and prepares you to handle any drawing job you will ever have to do. It comes to you absolutely free with

Machine Shop Practice

9 volumes — 3065 pages — 3608 illustrations
(A combined home study course and reference library)

The New Machine Shop Library is written for practical men. It gives you the best methods for every kind of machine shop work. It explains machine tools and their operation, drawing and design, tool work, gears and grinding, jigs and fixtures, automatic screw machines and their tools and all of the mathematics you will ever have to use. It is plainly written, completely illustrated—the very best kind of help to the machine shop man who wants to advance himself.

Sent
**F
R
E
E**



No money down—
only 7c
a day

FREE EXAMINATION COUPON

McGraw-Hill Book Co., Inc., 370 Seventh Ave., New York
Send me for 10 days' free examination the New Library of Machine Shop Practice. If satisfactory I will send you \$1.50 in 10 days and \$5.00 monthly until the special price of \$19.50 is paid. If not wanted, I will return the books at your expense.

On receipt of my first payment of \$1.50 it is understood that I am to receive, free of charge, a copy of the second edition of French's Engineering Drawing.

Signed.....
Address.....
City and State.....
Position.....
Employer..... P. M. 10-1-25



My Agents Make \$60 to \$200 Weekly

Full or spare time all my agents declare that the Carlton line is the biggest and best money maker of all. It's so easy to sell

CARLTON DRESSES

The new line is a winner. Latest Paris and New York styles in silk and wool from \$6.75 to \$19.95. Coats \$22.50 up. Exclusive models. Sell on sight.

Sample Outfit FREE

No samples to lug—no deposit—no investment for you. I give you portfolio of beautiful, large art plates, so perfect, so life-like that you don't need a lot of selling talk.

Write Today Get in line now. I make it easy for you to get the BIG money. I back you up with all the resources of this company until you are a success. Address Z. Dicker, Pres. Carlton, Inc., Dept. 161-A, 337 S. Franklin St., Chicago, Ill.

World's Handiest Calculator

NEW POCKET SIZE

BABY CALCULATOR
CHICAGO U. S. A.
PATENT APPLIED FOR

0 0 0 0 0 0 0

1 2 3 4 5 6 7 8 9 0
+ - × ÷ =

ADDITION
SUBTRACTION
MULTIPLICATION
DIVISION

Does work of large \$100 machine and very simple to operate.

Adds
Subtracts
Multiplies
Divides

\$2.50
TOTAL COST

Is GUARANTEED for 5 years. Made of steel. No upkeep. No repairs. Everybody who figures needs one.

A SPEED MARVEL

Positively the LOWEST PRICED practical calculator on market. New Trial Offer, price \$2.50, send money order or pay postman when machine is delivered. (\$3.50 cash outside U. S.) Supply limited. ORDER TODAY.

AGENTS WANTED

Baby Calculator Sales Co., P. O. Box 1118, Dept. 30, Chicago, Ill.

INSTALL YOUR OWN

FREE
PLANS

HOT WATER HEATING PLANT
CUT-TO-FIT GUARANTEED

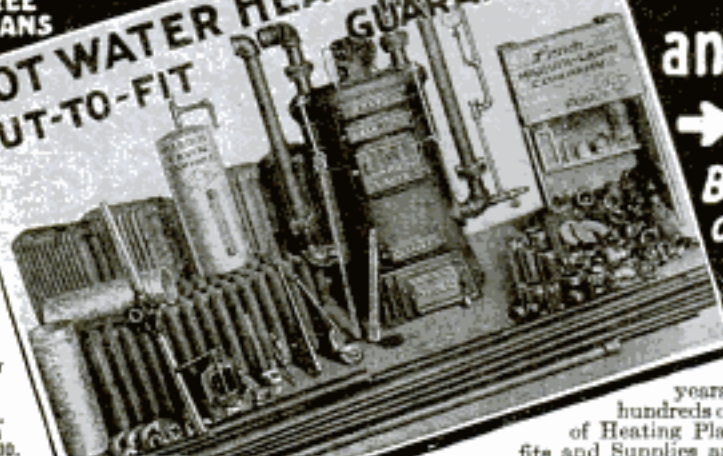

Complete
Hot Water
Plants
ready for
shipment.
Outfits as
low as \$200.

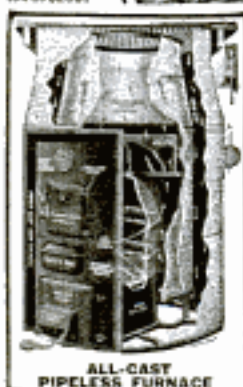

ALL-CAST
PIPELESS FURNACE

PLUMBING and HEATING → SAVE HALF ← By our New Easy Method and Lowest Wholesale Prices.

Send the coupon for our FREE bargain catalog which explains our new easy method of installing factory-fitted Heating Plants and Plumbing Systems. During 50 years, we have saved our customers hundreds of thousands of dollars in the cost of Heating Plants, Furnaces, Plumbing Outfits and Supplies and Water Systems.

FREE Planning Service

Send us rough sketch of your rooms and we will figure the wholesale cost of Heating Plant designed especially to fit your home. We will show you kinks and wrinkles where you can make savings that will surprise you. With our simplified plans and new easy method you can do the installing. We loan tools FREE.

Mail Coupon for FREE Money-Saving Catalog

Every Hardin-Lavin System is guaranteed highest quality, grade A material and is backed by our million dollar plants and Bonded Guaranty. Our wholesale Bargain Catalog tells the whole story. SEND FOR FREE COPY

HARDIN-LAVIN CO.

ESTABLISHED 1876
When in Chicago Visit Our New Plant at
107-17A West Pershing Rd., CHICAGO

HARDIN-LAVIN COMPANY,
107-17A West Pershing Rd., Chicago, Ill.

Gentlemen: Please send me your FREE BARGAIN CATALOG with special wholesale prices. I am interested in:

Water Supply System Str. Htg. Plant Warm Air Furnace
 H. W. Htg. Plant Pipeless Furnace Bathroom Outfit

NAME.....

ADDRESS.....

P. O.....STATE.....

National helps you become a Real

Auto Expert



If you want Bigger Pay Get BETTER Training

... You can double your chances for Success and Big Pay in the auto business by picking the best school. The Big Money goes to the man who KNOWS. Do you want to be a half-baked mechanic or a trained expert? Your future depends on the quality of training at the school you choose.

... Leaders in the automotive industry have gone on record that National Automotive turns out well-trained men. For 21 years men have received such thorough training at National Automotive that they stand head and shoulders above apprentices and other half-trained men. We don't try to see how many men we can turn out from National—but how good we can make those we do train.

... Over \$1,000,000.00 has been invested in buildings, equipment, etc. at National Automotive. The best instructors obtainable are on the staff. They give you personal instruction—help you perform actual jobs. Over 14,000 successful graduates testify that National's thorough training methods have helped them to make more money.

This Catalog Tells You Everything

... Before you decide ... read this big FREE CATALOG that tells the truth about opportunities and training methods in the Auto Industry. This book is full of startling facts that you should know. Send for it now.

NATIONAL

Automotive & Electrical School

Dept. 67, Santa Barbara & Figueroa Streets

LOS ANGELES

**America's 21-Yr. Old
Auto School**

Complete modern equipment ... carefully chosen instruction staff ... located in the world's biggest auto center ... hundreds of big-pay jobs awaiting you right here. Earn while you learn and enjoy life in California!

**Come to
Los Angeles**

auto experts. In your leisure hours you can visit Hollywood movie studios, the ocean beaches and mountain resorts ... Summer the year around.

Over 1,000,000 autos are in use about Los Angeles—making this the ideal place for your leisure hours you can visit Hollywood movie studios, the ocean beaches and mountain resorts ... Summer the year around.

Name _____

Address _____

City _____

State _____

Free

Your
FUTURE
ASSURED

National
Automotive &
Electrical School,
Dept. 67
Santa Barbara & Figueroa St.
Los Angeles, California

Please send me, absolutely
FREE, your big, 84-page illus-
trated catalog, postage prepaid.

The National System of Tested Training Made More Money For These Men:

"I now own this garage, which is valued at \$12,500. Not so bad for one year."—

A. R. SUTHERLAND, Mendocino, Calif.

"I have the agency for the Nash car, and with my garage business, netted \$6500 last year."

E. S. SYLING, New Castle, Pa.

"Had not been back three hours until I got a job."

B. F. ALICK, Prescott, Ariz.

"Am in charge of a fleet of trucks at \$75 a week. National is responsible for it."

DON B. STERLING, Bakersfield, Calif.

"I wrote 9 auto schools. I went to National because they did not offer me my R. R. fare. I decided that if a school could afford to pay my way to their school, their training must not be up to much."

SILVEN ROBELL, Provo, Utah.

"Am night foreman in a garage, earning three times more than before."

GRANT SHUTE, Los Angeles, Calif.

"I no more than got home than a man from the St. Helens Garage came after me. Started at \$50 per week, now making \$350 per month."

EDWARD KLUTH,
Castle Rock, Wash.





Earn up to \$250 per Mo.

Expenses Paid
Many Chances for
Advancement

BE A RAILWAY TRAFFIC INSPECTOR

Trained Men Wanted

Prepare for this fascinating work with assurance that you will not have to hunt for a position upon graduation. For over seven years our graduates have been provided with positions or their money refunded. Start at \$110 a month or more, expenses paid. You take no risk and can prepare in your spare time.

From a Graduate

Ralph E. Becker: "Ten days after receiving my diploma I was given a position with a large railway company in the east. Traffic inspection offers steady employment and the opportunity to travel all over the country."

Advancement Rapid

with experience. Meet high railway officials. Travel or remain near home. Highly confidential and important work.

More Men Needed

We must train more men for positions soon to be open. Send coupon for full details, including low cost.

Standard Business Training Inst., Buffalo, N. Y.
Send me, entirely free, Booklet No. D-85, giving full particulars about course in Railway Traffic Inspection.

Name.....
Street.....
City.....

TELEGRAPH-RADIO

\$18 to \$35 a week while training for Radio and Telegraph Operator jobs at \$150 to \$300 per month. Write for particulars.

CHICAGO TELEGRAPH INSTITUTE

Dept. 1201

1338 S. Michigan Avenue, CHICAGO

LAW

STUDY AT HOME
Become a lawyer. Legally trained men win the highest positions and biggest success in business and public life. Be independent. Greater opportunities than ever before. Big corporations are headed by men with legal training. Earn \$5,000 to \$10,000 Annually.
We guide you step by step. You can train at home during spare time. Degree of LL. B. conferred. LaSalle students practicing law in every state. We furnish all text material, including fourteen-volume Law Library, "Low cost, easy terms. Get our valuable 198-page "Law Guide" and "Evidence" books free. Send for them NOW.
LaSalle Extension University, Dept. 1064-L, Chicago
The World's Largest Business Training Institution



DO YOU LIKE TO DRAW?

It's Easy To Learn When Shown In The Right Way

Some of the cleverest cartoonists and comic artists in America today learned how to draw quickly—by following **CARTOONIST EVANS' SIMPLE AND EASY METHOD**. This school is recommended by foremost cartoonists because they know the students are handled right. If you like to draw, send 6c in stamps for **portfolio of cartoons and full details**. The course is **NOT EXPENSIVE**.

The W. L. Evans School of Cartooning 821 Leader Building CLEVELAND, OHIO

\$1700 to \$2700 Year

RAILWAY POSTAL CLERKS

CITY CARRIERS—POST OFFICE CLERKS

(All Postal Pay Just Raised)

MEN—BOYS, 18 UP

Steady work. No layoffs. Paid vacations
Travel—See Your Country

Common education sufficient. Mail coupon today—SURE!

WRITE for big book on wrestling. Tells secrets you've always wanted to know.



Learn How to WRESTLE

In Your Own Home
By Mail

Yes, learn to become an expert wrestler right in your own home, by mail, from the greatest wrestler the world has ever known. Be an athlete, be strong, be healthy. Learn how to throw and handle big men with ease. Learn to defend yourself. Learn from the World's Champions.

Farmer Burns and Frank Gotch Secrets

Farmer Burns, who taught Frank Gotch—trainer of SEVEN World's Champions, will teach you Scientific Wrestling—Physical Culture—Jiu-Jitsu and Self-Defense. Write today for big wrestling book, illustrated with many fine pictures—shows holds and secret tricks used by champions. Tells how easy it is to learn the marvelous breaks, falls and holds that make you an expert. Send today for this wonderful book. Enclose only 10c to help cover cost of wrapping and postage. Be sure to state age. No obligation.

Farmer Burns, 1777 Ry. Exch. Bldg., Omaha, Neb.

Send Now for Farmer Burns' Book



\$100.00 EARNED BY YOUNG ARTIST IN 2 DAYS

Well-trained artists earn splendid incomes. The Federal home-study Course is a proven result-getter. If you like to draw, send 6c in stamps for 56-page book "Your Future."

State your age and present occupation.
FEDERAL SCHOOL OF COM'L DESIGNING
609 Federal Schools Building
Minneapolis, Minn.



Make Your FORD a Closed Car

Limo weather-proof sections change your 1923-'24-'25 Ford Touring or Roadster into classy limousine-style closed car in a jiffy. Doors open from outside. Sliding front panels for ventilation. Three-ply double covered veneer frames. Color matches your top; quickly installed. Guaranteed. Low priced. Write for prices.

BUOB & SCHEU P80 Webster Street, Cincinnati, O.

I PAY \$100 a week MEN



Make \$100.00 a week and up selling our fine made-to-measure, all-wool suits, direct to wearer. **Biggest values—positively sell on sight**. Biggest commissions paid in advance. We attend to delivery and collections. 6x9 swatch samples—over 100 styles all one price—furnished FREE. Part or full time men write at once.

W.Z. GIBSON, Inc., 161 W. Harrison St., Dept. N-516 Chicago



FRANKLIN INSTITUTE, Dept. H-174, ROCHESTER, N.Y.

Sirs: Send me without charge, (1) Specimen Railway Postal Clerk Examination questions; (2) List of government jobs open to men, 18 up; (3) Send free sample coaching; (4) Send free illustrated book, "How to Get U. S. Government Positions."

Name

Address

Wanted—Your Services

As a Real Estate Specialist

Make big Money—I made \$100,000 in less than 5 years. Learn how I did it. Use my successful system. Begin at home—in your spare time. Make money my way. Start now. Free book tells how.

ARE you in the same hole I was in?
Are you stuck in the rut of *hard work and poor pay?*

Are you dissatisfied with your *job, your income and your prospects?*

Are you having a struggle to make both ends meet?

Are you putting up with the *crumbs of life* while others are getting all the *cake?*

Then you are the man I want to talk to. Listen!

When I made up my mind to get started in the real estate business, in my spare time, I was receiving a salary of \$100 a month.

I was doing work I was not fitted for and which I thoroughly disliked.

I was living in a gloomy boarding house, wearing cheap clothes, striving to keep out of debt, and getting mighty few of the good things of life.

In less than two years after I started to specialize in real estate, I was making nearly *one thousand dollars a month*. And, in less than five years, I cleaned up a net profit of *over one hundred thousand dollars*.

To get the whole story of my success in real estate, and how you, too, can succeed, write at once for my free book, "How To Become A Real Estate Specialist." It contains *my history and your opportunity*.

Follow in My Footsteps

I have studied real estate conditions in this country very carefully, and my investigations convince me that the next ten years are going to be banner years for real estate.

Furthermore, my experience satisfies me that there is no better business to get into. It is more healthful than most indoor jobs—you can start in spare time—you can begin with little or no capital—it does not require years of study like medicine, pharmacy, dentistry, law, engineering, electricity, architecture, etc.—the beginner is paid the same rate of commission as oldtimers—the business is practically unlimited—it is estimated that there are thirty million properties in the country and that ten million of them

are always on the market—it is a permanent business, not affected by fads or fashions—it is constantly growing as population increases—it puts you in touch



Put your name before the world

with the best people—it is a dignified, pleasant and worthy occupation with great possibilities for big profits.

What Others Are Doing

As positive proof of the success of my modern methods, read the following brief extracts from some of the letters that come to me from those who are using my scientific system—following in my footsteps—making money my way:

"I have nothing but words of praise for your System and will gladly recommend it to anyone who wants to achieve success in real estate. Already I am selling a property for one of my clients valued at \$10,500, and I am getting 4 per cent out of it."—*J. W. Y., Chicago, Ill.*

"Without boasting, I have now a new car, two new typewriters, a stenographer and a dandy office, and money in the bank, all through my own efforts and without any capital to start with."—*Mrs. P. M., Westport, Conn.* "Sold a property yesterday by your plan. My

commission \$250."—*J. C. K., Curtis Bay, Md.* "Sold a house and two lots in Portland, Oregon, and a large property here. Your system is great!"—*Wm. A. W., Shiocton, Wis.* "Your system is a blessing to the 'old-timer' like myself, and for a beginner, he should not attempt to commence the real estate business without it."—*R. H. N., Oakmont, Pa.* "Your system is as essential to quick sale of real estate as a spark plug is to an automobile. It has been instrumental in connecting me with the customers that have the cash."—*A. J., Dallas, Texas.*

Act Promptly

There isn't room here for any more such letters, but mail the coupon now—before you lay this magazine aside—and receive, without cost or obligation, a copy of my new book, "How To Become A Real Estate Specialist." From it you will learn how you can use my successful system to make money my way—how you can get started right at home—in your spare time—without capital or experience—and establish yourself as a Real Estate Specialist, in a high grade, money-business of your own.

Be prompt! Your opportunity is *here and now*. "Wise men act while sluggards sleep." Write your name and address on the coupon and mail it at once to American Business Builders, Inc., Dept. A-448, 18 East 18th Street, New York City.

MAIL THIS!

American Business Builders, Inc.,
Dept. A-448, 18 East 18th St.,
New York City

Send me—without cost or obligation—your free, illustrated book, "How To Become A Real Estate Specialist."

Name.....

Address.....

Learn to Draw in 1 Hour

Without previous study you can become a cartoonist or commercial artist with the **Davis Reflectograph**—wonder invention of the age. So simple that children use it for map drawing and penmanship lessons. Works directly from models, landscapes, photos, prints, etc. It teaches perspective and composition by natural methods. Affords entertainment in the home by enabling you to make amusing caricatures of your friends, and is useful in making place cards, etc. There is a big market waiting for **Reflectograph** artists—we tell you how and where to sell your work in a Course of Lessons on

"SELLING REFLECTOGRAPH ART"

written by T. C. O'Donnell, former Editor of **Cartoons Magazine**—FREE with each order. **Reflectograph** outfit complete, with Lessons, \$3, postpaid. Send for yours—TODAY.

The Davis Reflectograph Company
INC.

1215 Exeter St., Cincinnati, Ohio



8 BIG BOOKS on Electricity

Here is an amazing offer on 8 big electrical books, brimful of interesting and valuable facts and illustrations on electricity; facts that will increase your pay if you learn how to use them. Read all about our

NO MONEY OFFER

To make it possible for every man with a spark of ambition in his make-up to benefit by this easy way of learning, we have set aside a limited number of complete sets to be sent **FREE**, without a penny down. Look the books over; read them and see how complete and thoroughly all subjects are treated and yet how plain and easy to understand. Take ten days to do this and then if you don't realize how helpful and profitable they can be to you, send them back. If, however, your own good judgment proves their value and you see how profitable having them will be, just send us \$2.00 and only \$3.00 per month until the special price of only \$29.80 is paid.

Facts That Increase Your Pay

Knowing means earning. The man that has specialized knowledge or knows where to get it, **ALWAYS** makes the most money. Here is your opportunity, your chance to get into the Bigger Pay Class. You don't have to read the books through; the jiffy index is complete and simple. **YOU CAN PUT YOUR FINGER ON THE FACTS YOU WANT TO KNOW IN A FEW SECONDS.** Get these books now, don't hesitate—no offer could be more liberal.

MEMBERSHIP FREE

In addition to this unusually complete set of 8 full volumes bound in new flexo covers, we will for a limited time include a certificate of consulting membership in the American Technical Society which will entitle you to **FREE** consultation service. Twenty highly paid experts will be ready to help you, entirely without cost to you. Don't let this opportunity slip by; send for your books **NOW**. Use the coupon below.

AMERICAN TECHNICAL SOCIETY,
Special Dept. E719a, Chicago, Ill.

You may send me the 8 Big Books—Applied Electricity. If I like them I will send you \$2.00 in ten days after I receive them and \$3.00 per month until only \$29.80 has been paid; otherwise I will return the books and will not owe you anything.

Name _____
Address _____
City _____ State _____
Employed by _____

419 IDEAS On METAL WORKING

A most wonderful collection of practical short cuts and labor saving ideas for working metal is in the New book,

Everybody's Handbook of Machinist's Kinks

Successful machinists everywhere contributed their most valuable discoveries to this gold mine of ideas. Like the other Popular Mechanics books, this one is filled with pictures that make the ideas clear and easy to duplicate.

287 ILLUSTRATIONS

A faint idea of the contents of this new book may be obtained from the following brief tabulation of a part of the subjects covered:

Special shop equipment	Drifters	Pulley repair
Erecting machines	Machine parts	Rolling bearings
Machine repairs	Special bolts	Gear fitting and mounting
Special machinist's tools	Screws for special jobs	Belting holes
Special gauges	Shoe formulas	Special jigs and fixtures
Micrometers for special work	Templates	Drifting kinks
	Testing methods	
	Chasing kinks	

Every article "Written so you can understand it." Every article tells how to make or do some job with metal or metal machinery.

Send No Money

Just drop us a postal and say, "Send me the New Everybody's Handbook of Machinist's Kinks." When the postman hands you the book, deposit the price and pay the few cents postage. Your money back if you are not delighted.

SPECIAL With this valuable new book, we will give our popular Drilling and Thread Cutting Handbook.

You may have the two for the unusually low price of **\$1.98**

POPULAR MECHANICS PRESS

Room 710, 200 E. Ontario Street CHICAGO, ILL.

Handbook for Farmers

861 discoveries by practical farmers, telling how to make, repair or improve the various devices and machines used about a farm or garden. 683 illustrations. "The Most Remarkable Book Ever Published for Farmers," says one authority. **Send No Money.** When the postman delivers the book to you, hand him \$1 plus the few cents postage.

POPULAR MECHANICS PRESS

Popular Mechanics Building, Room 711, Chicago, Ill.



Gold Mine of Ideas for the HOME

Discoveries made by home owners, including dozens of devices that will be useful about every home. There are 329 of them and every one has been tested and is practical. Popular Mechanics New

Home Mechanics Handbook No. 1 should be in every home.

329 Discoveries—203 Illustrations EASY TO MAKE

You may know what you want, but do you know the best way to make it? This book tells how other folks have made the dozens of devices that make a home a good place to live. It tells how to make such articles as follows:

Clothes hangers	Shoe rack	Door stop
Portable shelves	Ironing board	Flag pole
Indoor tent	Coal bucket	Ash tray
Power pump	Foot scraper	Sewing machine motor
Wheelbarrow	Call bell	Refrigerator
Electric whip	Food cooler	Blowtorch
Fireless cooker	Tin snips	Anvil
Pipe bender	Pipe wrench	Window box
Power grinder	Level	

SEND NO MONEY

Just write us that you want a copy of Home Mechanics

SPECIAL: With it we will send the Auto Repairman's Handbook, containing 334 money, time- and labor-saving ideas for repairing all makes of cars. 337 illustrations. Indispensable to every one who works on his own car. When the two books arrive pay postman only 98c. Money refunded if you do not think them worth many times this special price. Write at once to get both books.

POPULAR MECHANICS PRESS

707 Popular Mechanics Bldg. CHICAGO, ILL.

ELECTRICAL EXPERTS IN DEMAND



Good Positions Await Trained Men *Salaries of \$12 to \$30 a day not unusual*

THE Electrical field needs men. It needs them badly. Hardly a week or a month passes but what some new use for electricity is discovered. And each new use means new positions—*better positions!*—for men who have trained themselves as experts in this wonderfully fascinating work.

The recent growth of Radio is simply an example of the progress that is yet to be made. No work offers greater opportunity to the man of an inventive turn of mind than Electricity. Salaries of \$12 to \$30 a day are not unusual.

Best of all, you can study Electricity in your own home in spare time, without losing a day or a dollar from your present work. The International Correspondence Schools will teach you everything you need to know, just as it has been teaching other men in just your circumstances for more than 34 years. There is no doubt about the ability of the I. C. S. to help you.

Thomas A. Edison says:—"I have watched the progress of the International Correspondence Schools almost from the very beginning. To me their rapid growth is easily understood, because

I realize the practical value that is back of them and know something too of the success attained by many ambitious men throughout the country who have taken their courses."

And Dr. Charles P. Steinmetz, the late "electrical wizard" of the General Electric Co., said:—"I am familiar with the textbooks and method of instruction used by the International Correspondence Schools in their courses in Electrical Engineering, and I also know of a number of young men who have taken these courses with great benefit. I believe that any young man who is interested in electricity, but who cannot find an opportunity to go through an engineering college, if he will apply himself to one of these courses will find it a practical and economical way to acquire a knowledge of the profession."

Just mark and mail the coupon printed below and full information about Electrical Engineering, Electric Lighting, Electric Wiring, Electric Railways, Radio or any other work of your choice will come to you by return mail. Today—not Tomorrow—is the day to make that all-important start toward success.

----- TEAR OUT HERE -----
INTERNATIONAL CORRESPONDENCE SCHOOLS, BOX 5532-E SCRANTON, PA.

Explain, without obligating me, how I can qualify for the position, or in the subject, before which I mark X.

- | | | | |
|--|--|--|--|
| <input type="checkbox"/> Electrical Engineer | <input type="checkbox"/> Toolmaker | <input type="checkbox"/> Salesmanship | <input type="checkbox"/> Certified Public Accountant |
| <input type="checkbox"/> Electrician | <input type="checkbox"/> Gas Engineer | <input type="checkbox"/> Advertising Man | <input type="checkbox"/> Traffic Management |
| <input type="checkbox"/> Electric Wiring | <input type="checkbox"/> Civil Engineer | <input type="checkbox"/> Window Trimmer | <input type="checkbox"/> Commercial Law |
| <input type="checkbox"/> Electric Lighting | <input type="checkbox"/> Surveying and Mapping | <input type="checkbox"/> Show Card and Sign | <input type="checkbox"/> Good English |
| <input type="checkbox"/> Electric Car Running | <input type="checkbox"/> Mining Engineer | <input type="checkbox"/> Painting | <input type="checkbox"/> Stationary Engineer |
| <input type="checkbox"/> Heavy Electric Traction | <input type="checkbox"/> Architect | <input type="checkbox"/> Railroad Positions | <input type="checkbox"/> Civil Service |
| <input type="checkbox"/> Electrical Draftsman | <input type="checkbox"/> Architectural Draftsman | <input type="checkbox"/> Illustrator | <input type="checkbox"/> Railway Mail Clerk |
| <input type="checkbox"/> Electric Machine Designer | <input type="checkbox"/> Architects' Blueprints | <input type="checkbox"/> Designer | <input type="checkbox"/> Textile Overseer or Supt. |
| <input type="checkbox"/> Telegraph Expert | <input type="checkbox"/> Plumbing and Heating | <input type="checkbox"/> Business Management | <input type="checkbox"/> Agriculture |
| <input type="checkbox"/> Practical Telegraphy | <input type="checkbox"/> Sheet Metal Worker | <input type="checkbox"/> Private Secretary | <input type="checkbox"/> Poultry Raising |
| <input type="checkbox"/> Mechanical Engineer | <input type="checkbox"/> Navigator | <input type="checkbox"/> Business Correspondent | <input type="checkbox"/> Automobiles |
| <input type="checkbox"/> Mechanical Draftsman | <input type="checkbox"/> Chemical Engineer | <input type="checkbox"/> Bookkeeper | <input type="checkbox"/> Spanish |
| <input type="checkbox"/> Machine Shop Practice | <input type="checkbox"/> Pharmacy | <input type="checkbox"/> Stenographer and Typist | <input type="checkbox"/> Radio |

Name..... Present Occupation..... Business Address.....

Street and No..... City..... State.....

Canadians may send this coupon to International Correspondence Schools Canadian, Limited, Montreal, Canada

If you want a job while training, I'll help get you one. Come to my big schools at Chicago, Cleveland or Detroit



Easiest, pleasantest work you ever saw! Your own boss, money and success yours from the very beginning. You can start with a "shoe-string." We prepare you in a few months to run a business of your own, to do any job. Common schooling, ability to use your fingers ALL YOU NEED! Free R. R. Fare to Chicago, Cleveland or Detroit for a limited time!



**Jobs at
\$60 to \$125
a Week!**

In a business where there are many times as many jobs as Experts, salaries are high, hours are easy, opportunities are everywhere. McCarrie-trained Graduates always get the preference—Dentists everywhere recognize the high-standing of our graduates. No books here—learn with tools and instruments. Start quick—get ready in a few months for your big opportunity! Mail Coupon today!

RUBBER PLATES

Learn to make partial upper or lower plates with soldered, cast or wire clasps, with palatal bars; with lingual bars. McCarrie-trained Students learn to make full rubber plates of every type, including Vulcanite base-plates, buttoned gums, carved gums, etc.

CROWNS

Here's only a small part of your practical training in Crown-work: Two-piece, seamless, open-face, Richmond, cast-base porcelain, Carmichael, split-pin, carved (swaged) cusp, cast cusp, etc.

BRIDGE WORK

Complete training in both fixed and removable bridge-work. Interchangeable teeth, gold dummy, Sanitary, porcelain dummy jobs—Roach, Gilmore, Blechhoff and all forms of cast-clasp work is taught—not with books but in actual Laboratory.

METAL BASE DENTURES

Cast bases of Aluminum, gold, Watt's metal, etc., are included in your training. Both centrifugal and air pressure casting machines are used. Free Catalog contains complete list of subjects in course.

FREE!
R. R. Fare
TO
Chicago
Cleveland
OR
Detroit

This Dental Laboratory Expert earns \$20 a day!

What's the use of training for the old, overcrowded trades? If you're going to prepare for big-salaried jobs or a profitable business of your own GET INTO THE NEWEST PROFESSION — "Laboratory Dentistry." Biggest opportunity for success of the century, because there are ten times as many jobs as men to fill them, because there are a dozen cities crying for Laboratories for each EXPERT capable of operating one!

60,000 DENTISTS NEED LABORATORY WORK!

Only a few hundred Laboratories in all the U. S.—most of them in Chicago and New York. Dentists can't afford to do their own mechanical jobs. They can buy the services of a Laboratory Expert at \$3.00 an hour and sell their own time at \$6 to \$15 an hour. Dentists will encourage you to learn mechanical work, start a "Lab" of your own, give them quicker service than sending to Chicago or New York. Dentists can't wait and keep their patients waiting.

WE HELP YOU OPEN A LABORATORY OF YOUR OWN!

Many of my graduates open a Laboratory of their own. To encourage more men to go into this wonderful profession, we will help you find a good location for your Laboratory, and help you make a success of it. Write for complete information on how you can find yourself in a profitable business of your own after you become a Dental Laboratory Expert.

INTERESTING CATALOG—FREE!

Right this minute there are openings for 150 Dental Laboratory Experts in locations where they can do a business of \$5,000 to \$20,000 a year. But you can't cash in, take advantage of these OPPORTUNITIES until you're trained. Catalog tells you how quickly and easily you can get ready, how hundreds of others have SUCCEEDED! Tells you how you learn in a few months BY DOING ACTUAL LABORATORY JOBS under one of the world's greatest Mechanical Dentists! Brings you FREE R. R. Fare offer and other big inducements. Write for free Catalog today!

EARN while you LEARN!

Day students make all or part cost of course by part-time night work. Night students can find plenty of good jobs "to see them thru." We'll help you!

McCarrie School of Mechanical Dentistry

1338 S. Michigan Ave.
Dept. 2701-K Chicago, Ill.

McCarrie School of Mechanical Dentistry,
1338 S. Michigan Ave. Dept. 2701-K, Chicago, Ill.

Without obligation, please send me your Free R. R. fare offer and free catalog with complete information about how I may become a Dental Laboratory EXPERT. How you will help me open a Laboratory, how you will help me find a job while I take my training, etc.

Name.....
St. No. or R. F. D.....
City..... State.....

Can you fix it

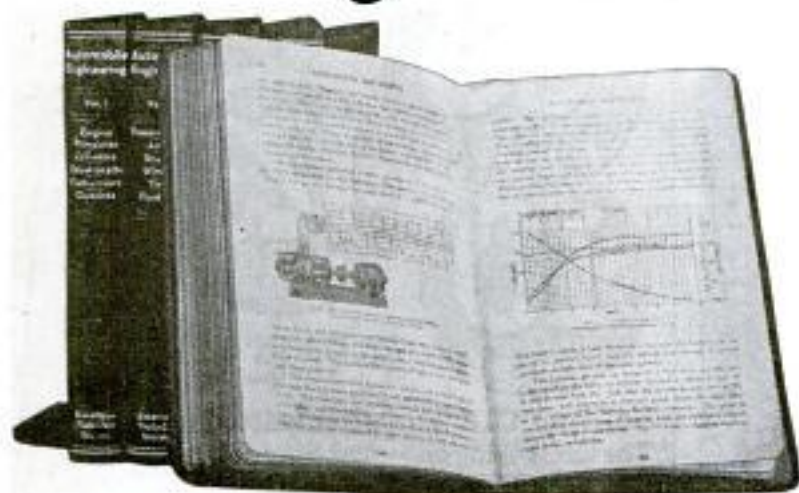

New books have "Jiffy Index," making all facts instantly available. You find anything you want to know in a moment.

These books tell how

HERE are the most interesting, the most practical books we have ever published on automobile construction, operation and repairs. Brimful of facts, photographs and explanations so easy to understand that anyone can learn how in almost no time.

Over 2500 pages, with diagrams, blueprints and everything else needed to make anyone an authority on automobiles.

Whether you want to qualify as garage owner, auto repair expert or merely wish to know how to keep your own car 100% efficient, you will welcome these books, especially on our

No Money Offer

This plan brings this valuable information within the reach of everyone. You don't send us a single penny. You don't have to pay us anything—just send your name and address and we'll send you the complete set of 5 volumes, specially bound in Flexo covers.

Read them carefully; keep them 10 days; find out anything you want to know, and then if you want to keep them, send only \$2.00 then and \$3.00 per month until the special low price of \$19.80 is paid. There is no further obligation.

American Technical Society Membership Free

This is a great organization for the publishing and spreading of specialized knowledge—we have over a million dollars of resources, enabling us to get the cooperation of the largest automobile manufacturers and dealers, who have furnished us plans and photographs. If you send NOW for this new edition of Automobile Engineering, we will include a Consulting Membership in this great organization.

Eighteen automobile experts will be ready to help you at all times. You can write or wire any time for special information. Answers will be sent to you promptly—without cost.

Don't Hesitate

There are no strings to this offer—it means just what it says. Send name and address on the coupon and *ALL* of the five books—the complete set—will be sent to you for examination.

Remember one fact only which you can find in these books may save you an expensive repair or help you to a better job.

Learn All About Autos

Get these five big books on this liberal offer and learn all the things you want to know about autos.

Carburetors, engines, springs and spring suspension, brakes, 4-wheel drives, lubrication systems—all are fully covered.

These complete and comprehensive auto books are yours if you want them on this easy plan. Send for a set NOW; there's nothing to pay.

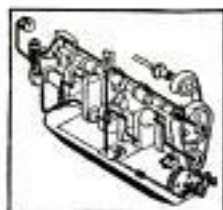

Jiffy Index
Jiffy Index Puts Facts At Your Fingertips

You don't have to read the books through; the index enables you to put your finger on the information wanted in a jiffy.

For Free Offer, Use Coupon

American Technical Society,
Spec. Dept. A-719, Chicago, Ill.

I would like to look at the 5 Auto Books described above. Send them on your FREE offer. I will examine them carefully and return them in 10 days unless I like them; in which case I will send you \$2.00 then and \$3.00 per month until the total price of only \$19.80 is paid. You are to also send me Free Consulting Membership Certificate in the American Technical Society.

Name.....

Street.....

City..... State.....

Employed by.....

BOYS

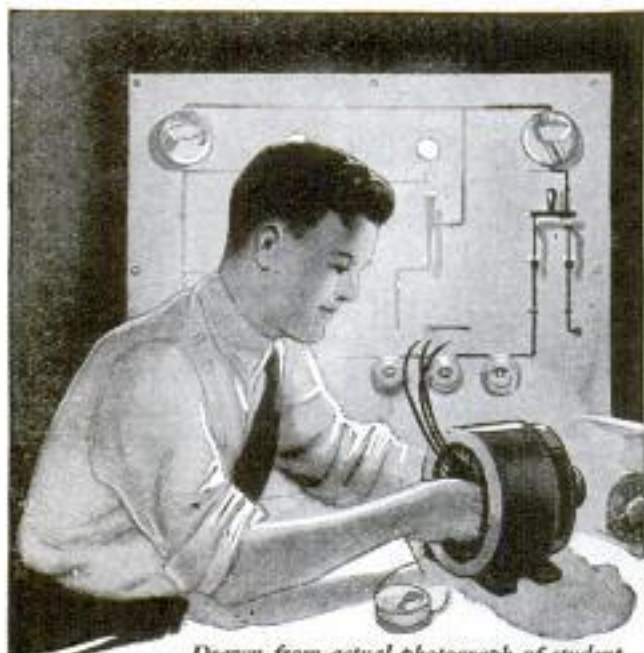

Drawn from actual photograph of student doing spare time electrical work

Learn Electricity Make Big Money!

How would you like to earn two or three dollars every evening after school and prepare yourself for a fine big job at the same time? Here's the opportunity of a lifetime for you fellows who like Electricity. Begin right now to prepare yourself for a regular man's size job in this fascinating field. Your chances for a big success are simply wonderful—the pay is big (thousands of men earn \$70 to \$200 a week) and advancement comes swift and sure.

I Will Train You at Home

With my easily learned, spare time Electrical Course I will train you at home like I have trained hundreds of other boys who are now big successful men. It will not interfere with your school work and you can earn more than the small cost of the course doing odd electrical jobs in your spare time. The Course pays for itself. I will show you how to get this work and how to do it. Some of my boy students make \$10 to \$15 a week this way.

Tools, Apparatus and Radio Course —Given Without Extra Charge

Send me the coupon below and I will tell you all about the big outfit of tools, apparatus and instruments and a new Radio Course that I am giving to my students for a limited time. I will send you my big interesting Electrical Book and a sample lesson, too—all Free. You will be tickled with the things I will send you Free. Mail the coupon right now.

L. L. COOKE, Chief Engineer
Chicago Engineering Works
Dept. O-17 CHICAGO

Look What This Boy Is Doing

"Although the School term is coming to a close, and I am pretty busy with my examinations, I manage to keep up with my electrical studies and work."

"I guess I forgot to tell you I am now in business for myself. Am doing fine, but owe it all to you. If it had not been for your course, I, being under age, could not have secured my license in this town. But I got it, and now have all the work I can do, averaging \$20 to \$30 a week, through spare time work."

"I went out on a job tonight after school, on which I made \$3 and brought home another on which I made \$2.50—\$5.50, for 4 hours' work and no material furnished by me."

ROGERS SMITH,
1215 Chestnut St.,
Greenville, N. C.

Use This "FREE BOOK" Coupon

L. L. COOKE, Chief Engineer,
Chicago Engineering Works,
Dept. O-17 2150 Lawrence Avenue, Chicago
Send me your Big Outfit Offer, your big Electrical Book, Sample Lesson and particulars of your Electrical Course and Extra Radio Course. This will not obligate me in any way.

Name.....

Address.....

This Coupon only for use of boys 15 years old or more.

WONDERFUL NEW INVENTION

Stay-Prest

TROUSER PRESSER

\$93
the
First Week

\$10
in One
Evening

\$123
in 36
Hours

FREE



Selling Outfit to Salesmen

The latest thing out—new Stay-Prest Trousers Presser—is selling like wild-fire. No wonder salesmen make \$100 a week from the start. Perfected by four patents to put in a lasting crease without heat or steam. Removes wrinkles and bagginess. Saves nap of cloth. Cuts tailor bills. Fits any trousers. A substantial, quality product, beautifully finished in black leatherette and heavy nickelplate. Built to last years. Folds to 15 inches. Demonstrate in 40 seconds. Men buy one to six. 250,000 sold already. Your big profits in advance. Simply write orders. We deliver and collect. Four patents—no competition.

Make This FREE Test

See how amazingly easy it is to sell Stay-Prest. Test it without cost either full time or sideline. Write immediately for handbook of further facts and offer of free demonstrator. Send no money—only postcard. With millions of prospects—every one interested—you can't avoid making extra dollars every day.



Folds
to 15
inches

THE GETGEY-JUNG CO.

R-121, C & J Bldg.

Cincinnati, Ohio

\$25000 A WEEK!

Mad, with the new and improved
"Krispy" Potato Chip Outfit.

Potato Chips the lunch of the hour. Everybody is eating them. One stand in small building sells \$100 worth in a week. Think of it! Grocers, druggists, pool rooms, cigar stands, tourists' counters, parks—all sell thousands of packages. Supply them. Get the big profits. Chips easily, quickly made at home. No experience necessary. Write today. Get the big profit fast growing business now.

SERVICE & EQUIPMENT CO., 905 Hoag St., Toledo, Ohio

Nestler Rubber Fusing Stations

An opportunity is offered one man in each community to secure the sole and exclusive right to operate the famous Nestler Rubber Fusing Process of servicing pneumatic tires. Unlike any other method on earth. The Nestler method is the perfected and only known way of successfully retreading pneumatic auto or truck tires, including all sizes of balloon tires. Every car owner needs Nestler Service. Nestlerized repairs outlast the tire. No previous experience necessary. We teach you the business in two weeks or less. Moderate capital required. Big profit on each tire you do. Here is your opportunity to have a permanent and highly profitable business in your own name. Remember only one man can secure this profitable franchise in each community. Act now if you want to be that man. Write today for two interesting books describing the Nestler Rubber Fusing Process and the methods that are being employed by Nestler licensees everywhere to build up prosperous businesses.

NESTLER RUBBER FUSING CO., Inc.
Dept. R, 245 West 55th Street, New York City

How I Was Shamed into Popularity!



For some reason I could never get out of the wall-flower class. But one night I had a bitter experience that changed everything. Here's what happened.

BY JAMES PRESTON

You know, I once thought nerve alone was enough to get one by anywhere. That is, I thought so till I met Olive. You never in your life saw two people take to each other the way we did. It was sheer joy to both of us just to be together. She liked me a lot and made no secret of it, and—well, I'll admit I tumbled pretty hard myself. If only that dance party hadn't come along.

But dances are what parties are made for. I sat out two or three fox-trots watching Olive spin around in the arms of other men. How gracefully they glided! And there I was, sitting back and letting these other fellows monopolize the prettiest girl on the floor. You can imagine how I felt! I decided right there to take a turn with her myself.

Just a Poor Boob

The fact that I didn't know how to dance well didn't mean anything to me—then. It looked easy and I thought I could get by. So at the beginning of the next dance, I swallowed whatever fear I felt, and taking a hold that must have been screamingly funny—I started what I thought was dancing.

Wherever did I get my nerve? And where did that girl ever get her patience? I must have stumbled twenty times—and then in the middle of the dance she winced with pain and stopped to rub her toes.

"Jack," she said—her voice tried hard to be friendly—"Jack, let's not finish this dance. I'm too tired anyway," she added, struggling with herself to be nice to me.

I guess I turned a million colors. Just then I wanted the ground to swallow me up. It was quite a while before I saw Olive again.

But that night I turned that terrible experience over in my mind. And suddenly it dawned upon me why I was so rarely able to make a date with girls. With equal suddenness it occurred to me that there was a quick, simple remedy that I had often read about, yet never heeded.

A Free Booklet That Started Something

The next morning I mailed a magazine coupon to Arthur Murray, America's foremost dancing instructor, asking him for his booklet, "A Short Cut to Popularity," and the test lesson all entirely free. Here was an easy, inexpensive way to find out whether I could learn to dance, and learn in a few evenings.

A 32-page booklet and the free test lesson came. The book explained how easy it is to become a good dancer—that dancing is as easy as walking, once you know how—and how quickly anyone can learn.

It showed me how right in my own room, without music or partner, and with no one to watch me, I could quickly learn to do all the latest steps. It explained how the ability to dance well gives poise and self-confidence—overcomes timidity—enlarges one's circle of friends—makes one welcome at every affair—and brings good times.

What I Learned in Just a Few Minutes

There was a lot more, of course. That booklet was a revelation to me. But the free test lesson—well what it did amazes me yet. I tried the steps as explained and diagrammed in the lesson and found that the hardest dance step took me only a few minutes to learn. I was ready to cheer! All I wanted was to get on a dance floor. I could just imagine how surprised my friends would be.

They were—and the girls are only too glad to accept when I ask for a dance now. I haven't known a lonesome evening since I mailed the coupon.

Whether you've had an experience like mine or not, take a tip from one who knows and avoid the possibility of embarrassment. You can do it—anyone can do it—this easy, pleasure-giving way.

Do as I did. Get the free book and Test Lesson and read them carefully. Mail the coupon and enclose only 10 cents to cover postage and mailing. Do it now. Address: Arthur Murray, Studio 503, 801 Madison Avenue, New York City.

Arthur Murray, Studio 503,
801 Madison Avenue, New York City.

Please send me your test lesson and a copy of your beautifully illustrated 32-page book, both free. I enclose 10 cents to cover postage and printing.

Name.....

Address.....

City..... State.....



LEARN TENOR BANJO

Charles McNeil, one of the world's greatest banjoists—8 years with Isham Jones' Recording Orchestra—now offers you his famous Home-Study Tenor Banjo Course.

This is your opportunity! For the first time in the history of musical instrument teaching, we are offering a practical up-to-date Home Study Course on the world's most popular instrument today—the tenor banjo. Charles McNeil, the man who devised this Course is the first man to ever play a tenor banjo—in fact, he helped to develop it.

This is the same Course used so successfully by the Chicago Tenor Banjo Institute in training professional banjo artists.

Easy to Play the McNeil Way!

This course can now be yours. Just as if Charles McNeil were actually sitting at your elbow teaching you the correct finger positions—chords, melody, harmony, etc., etc. The McNeil Home Study Course for the tenor banjo is suitable for beginners, advanced students and professional artists. An "A" to "Z" course—includes everything you will ever need to know about tenor banjo playing. Includes photograph records played by Charles McNeil, illustrating jazz strokes, breaks, etc.

Send coupon for free booklet and full details on this latest Home Study Course

Chicago Tenor Banjo Institute

Dept. 1357
5029 N. Bernard St., CHICAGO, ILLINOIS

Charles McNeil, Director, Chicago Tenor Banjo Institute,
Dept. 1357, 5029 N. Bernard St., Chicago, Illinois.

Dear Sir:—Without obligation please send me your free booklet with full details on your new Home Study Course.

- Beginner.
 Advanced Student.
 Professional Artist.

Kindly check your classification as above.



Men Wanted TO COME TO DETROIT AND Learn a Trade AT THE DETROIT SCHOOL OF TRADES

Endorsed by Contractors, Builders and Manufacturers

Come to Detroit. Enroll in our School. Learn one of these high paying trades and your success in life is assured. We teach you on the actual work. You use the tools; not books.

Bricklaying	Electrical	Auto Mechanics
Plastering	Paper Hanging	Auto Trimming
Plumbing	Painting and	Metal Finishing
Carpentry	Decorating	Auto Painting
Estimating	Sign Painting	(Duco-Zapon)
and	Show Card Writing	Acetylene Welding
Contracting	Auto Stripping	— and —

SPECIAL CUSTOM SHOP COURSE

Why work for low wages when you can make from \$9.00 to \$14.00 per day at any of these trades after a short practical training at our School?

Reasonable tuition rates. All tools furnished free.

RETURN COUPON

DETROIT SCHOOL OF TRADES,
217-221 Woodward Ave., Dept. 1025-A, Detroit, Mich.

Please send me without obligation on my part full information regarding your School of Trades.

Name.....

Address.....

City and State.....

Trade interested in.....

We have no facilities for negroes.

YOU Can Be a Dental Laboratory Expert

Make Up to \$150 A Week This Expert Is Stivison Trained



He Can Earn More in one day than the average Mechanic does in a week. He got it the same way you will get it if you select the

Stivison Way

Personal Instruction to Each Student in One Big School for Mechanical Dentists. Students are taught on Patients' work that is actually used. Only Modern Methods Taught. Thousands of dentists need Laboratory Experts.

Stivison Trained

Graduates Always in Demand Jobs Hunt You. Every Dentist does Laboratory Work that he would gladly have done by an expert and pay Big Prices.

Real Dentist's Tools are furnished and instructions given by Real Dentists on work that Dentists need.

Our attractive Illustrated Catalog tells of many others who are earning big money and how easy you may be able to get into the Big Pay Class. If you live in Maine or California, it costs no more for you than it does for one living in Mo. or Kas., because WE PAY YOUR R. R. FARE TO KANSAS CITY. WE FURTHER ASSIST YOU in paying your TUITION by allowing You to Earn While You Learn. Bear in mind, the Catalog is Free and no man ever got in the Big Pay Class by wondering what he should do. Decide now and write for this "Short Cut to Success" today.

STIVISON DENTAL INSTITUTE

501 McMillen Bldg. Kansas City, Mo.

SEVENTEEN MEN WANTED

HAND-PICKED

Seventeen men who like Drafting work will be given an unusual opportunity. Must be over 21 years of age and now employed. Must have 7th grade schooling and be able to give at least two character references.

SUCCESS TO BE FORCED ON THEM

Expert Draftsmen are urgently needed right now in the building trades at big salaries. More and more Draftsmen, capable of doing original work, not merely tracing or copying, are wanted by steel mills, railroads, auto shops, factories, architects, shipyards, and the national, state, county, and city governments.

CAN YOU QUALIFY?

The seventeen men selected will be trained at home by a practical new method, while still retaining their present positions. Their training will be planned to enable them to qualify for a good position in the shortest possible time.

If this interests you, and you want to share in this opportunity, mail coupon for full information.

MAIL THIS COUPON

AMERICAN TECHNICAL SOCIETY
Dept. D-774-A, Chicago

Please send me complete information about the offer made in Popular Mechanics Magazine.

Name.....

Address.....

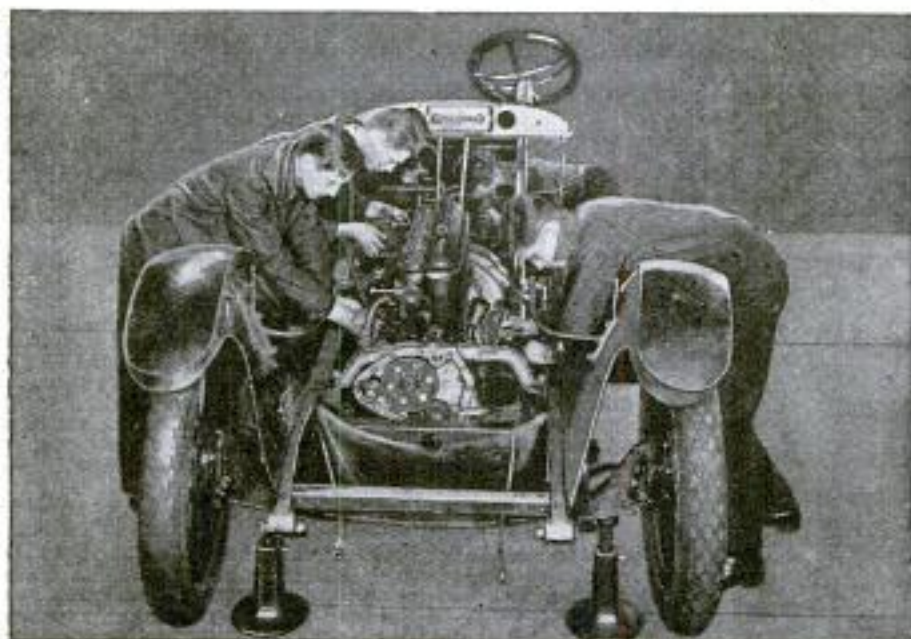

How to Succeed - - - Within a Few Months

IF you would succeed while you are still young, you must gain the knowledge which is necessary to success in the shortest possible time. You cannot afford to spend years "getting experience." Every minute of the days you spend in learning must be utilized to the best advantage. You haven't time to sweep floors or run errands.

The men whose pictures appear above have found a proven way to master the fundamentals of America's greater industry in the shortest possible time. They are some of the students in the Stewart Automobile School in New York. Every minute of their time in the school is spent in learning vital facts. They "Learn the Trade" with tools under the direction of skilled instructors. The result is, that these men gain a knowledge in a few months, which would take them years if they worked in a garage trying to "pick it up" as they go along.

Send the coupon below for our new booklet that tells about the school and what other men have done.

AUTOMOBILES!

America's Largest Industry

Trade reports show that the Automotive Industry is the largest and fastest growing business in America even though it is still young. Railroads have started to use trucks to haul freight to their trunk lines. Bus lines are springing up all over the country. Everywhere you look there is evidence of the tremendous growth of the automobile business.

And it is in a growing business ability receives its best reward. In the automotive business skilled men are needed. If they have the proper training they will advance rapidly. Special training is necessary to business success. Send the coupon below for a free copy of the booklet that tells of the automotive industry and what big men think of its future.

The Record of 16 Years

For sixteen years the Stewart Automobile School has been training men for success in the automobile business. Thousands of graduates are now holding high paid positions. Others own their own business. We will gladly give you names and addresses of graduates who will tell you what the school has done for them. Some of their letters are reproduced in the booklet we will send you free.

Send The Coupon

Mail this coupon today for a free copy of the booklet that tells of the automobile business, your opportunity, and all about the Stewart School. You will find it a book of hard cold facts told in a man to man way. Send the coupon today.

Please send me a free copy of the booklet that gives me facts about the automobile business and my opportunity in it. Also tell me about your school. I am under no obligation.

Name.....

Address.....

BOSS YOUR OWN BODY



STRONGFORT
The Perfect Man

It's your job. You were given mentality that you might be master of your body. And right now you should decide to become "boss." Don't let your physical weaknesses, your deficiencies dominate you. Don't suffer from afflictions, debility, dyspepsia, rheumatism, constipation, "nerves" and vitality depleting ailments—no matter how brought on.

BREAK THE SHACKLES—NOW!

It's the only way you will get anything worth while out of the life before you. You might as well be put away in a pine box as be going about only half alive. Face the Facts. Don't drift along in the fool hope that sometime, somehow, you will be better. You won't, unless you make your Mind the Master of your Body.

Try and see yourself as others see you—as you yourself look upon the weak, sickly, miserable creatures you meet in business and social life. Then take steps at once to **Build Up Your Body** and give your **Brain** a chance to **bring you success** instead of failure—popularity among the people you know—a welcome wherever you go—a share of Life's prizes, which are won only by red-blooded, strong, all-around Men.

I'LL HELP YOU DO IT

I hold out to you the helping hand which has lifted thousands of others out of the quicksand closing about them—out of the mire of physical and mental weakness—and placed their feet securely on the solid ground of renewed health, strength and mental energy. **Write to me confidentially** (as frankly as you would to your dearest pal or bunkie) and tell me your particular trouble—or just fill out and mail me the coupon at the bottom of this page—and I'll show you how to break the bonds that bind you and make yourself a 100% MAN again.

I've spent 25 years of my life learning HOW weak, ailing, hopeless humanity can **Come Back**; regain lost health, strength, vigor and vitality; and now I am ready to give my fellow men the results of my quarter century study, research, investigation and experimentation.

I have collated and arranged all the facts I have dug up about the human body, all the secrets of Nature I have discovered, all the ways in which her tremendous powers of recuperation may be utilized—and constructed from them the basic science of

STRONGFORTISM

The New Science of Health Promotion

The one big, underlying Fact on which **Strongfortism** is based is the unassailable Fact—which modern physicians of every school now acknowledge—that the well-being of the human body depends absolutely on a thorough, scientific, all around Development of the Muscular System.

Nobody knows what causes the contraction and expansion of muscular tissue—it is one of the Sphinx-like riddles of the Universe; but every scientific man now knows that the most important organs of the body operate through this action, that Life itself depends on it. Most of the miserable chronic ailments to which man is heir have their origin in the **under-development** or **over-development** of some one or more of the involuntary, internal muscles.

Strongfortism does not treat the symptoms of a trouble, as do most patent medicines and druggist's dope. It tackles the **cause** of it; puts the affected organ in shape to do its work; builds up the **Whole** system, internal and external; causes **All** parts of it to work in harmony, as the Creator intended they should—and health, strength and vigor follow as surely as day follows night.

SEND FOR MY FREE BOOK

"Promotion and Conservation of Health, Strength and Mental Energy"

It will give you more valuable information than you ever before found between the two covers of a book. It will show you how to eliminate from your system, in a very short time, the distressing disorders which have made you feel yourself a misfit in the scheme of humanity; how to build up your body, strengthen ALL your vital organs, turn your anaemic blood into a radiant red and feel the thrill of New Life coursing through your veins. It will teach you how to become **FIT** physically and mentally; fit for business, for society, for the home, a power among men, a pleasing personality. My pupils and graduates in all parts of the world will back up every word I say—you'll find photos and letters from some of them in the book. What I have done for them I can do for YOU. I GUARANTEE IT. SEND FOR THE BOOK NOW. IT'S FREE. Fill out the coupon. Don't delay. SEND IT TODAY.



LIONEL STRONGFORT

*Physical and Health Specialist
for Over 25 Years*

Dept. 32

Newark, New Jersey, U. S. A.

CONSULTATION COUPON

Absolutely Confidential

Mr. Lionel Strongfort, Dept. 32, Newark, N. J.

Please send me absolutely free enlightenment on the Promotion and Conservation of Health, Strength and Mental Energy. I enclose a 10 cent piece (1 dime) to help cover postage and have marked (X) before the subjects in which I am most interested.

<input type="checkbox"/> Colds	<input type="checkbox"/> Flat Chest	<input type="checkbox"/> Rheumatism
<input type="checkbox"/> Catarrh	<input type="checkbox"/> Increased Height	<input type="checkbox"/> Weak Eyes
<input type="checkbox"/> Asthma	<input type="checkbox"/> Pimples	<input type="checkbox"/> Weak Heart
<input type="checkbox"/> Hay Fever	<input type="checkbox"/> Insomnia	<input type="checkbox"/> Poor Circulation
<input type="checkbox"/> Headache	<input type="checkbox"/> Short Wind	<input type="checkbox"/> Round Shoulders
<input type="checkbox"/> Thinness	<input type="checkbox"/> Constipation	<input type="checkbox"/> Lung Troubles
<input type="checkbox"/> Rupture	<input type="checkbox"/> Indigestion	<input type="checkbox"/> Muscular Development
<input type="checkbox"/> Lumbago	<input type="checkbox"/> Nervousness	<input type="checkbox"/> Great Strength
<input type="checkbox"/> Tobacco or Other Bad Habits (Specify)		

Mention Other Ailments Here.....

Name.....

Age..... Occupation.....

Street.....

City..... State.....

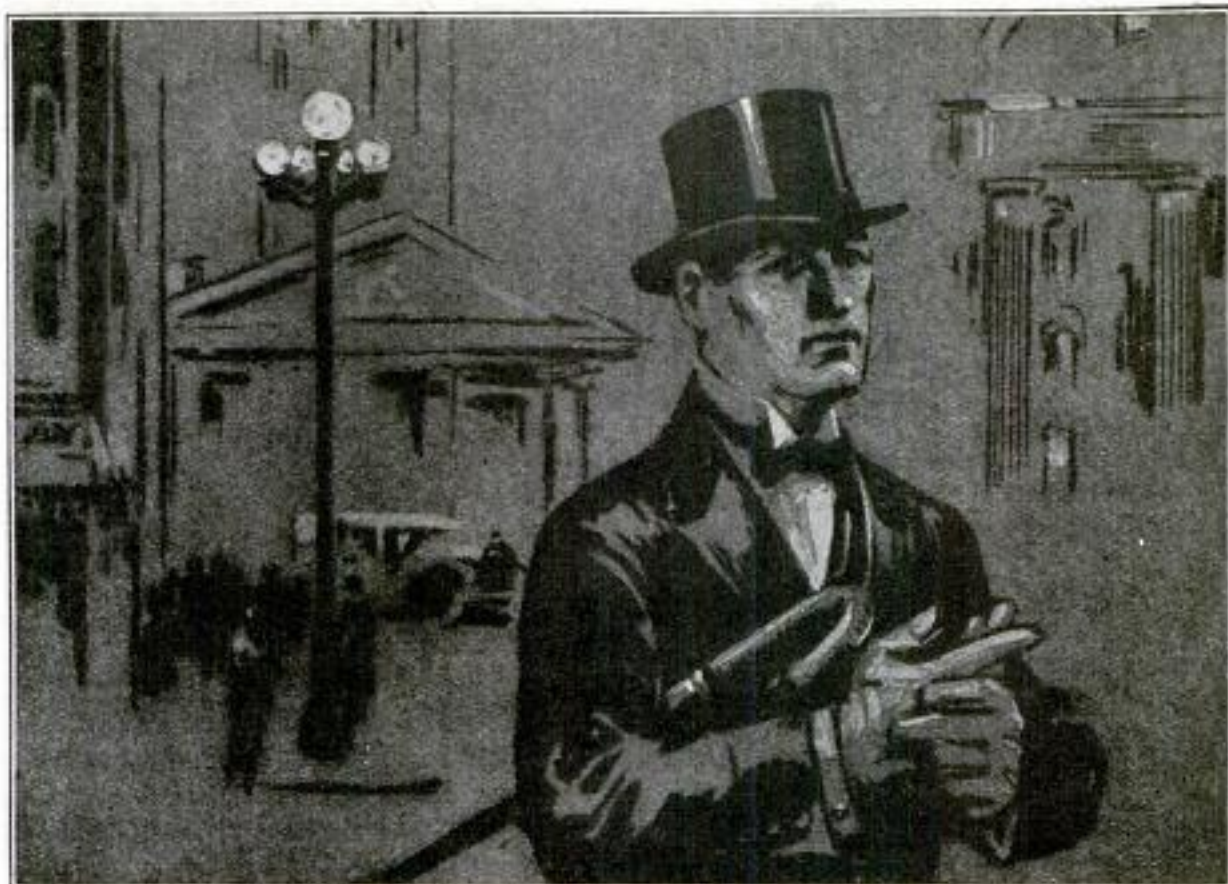

Follow this Man!

Secret Service Operator 38 Is on the Job

Follow him through all the excitement of his chase of the counterfeit gang. See how a crafty operator works. Telltale finger prints on the lamp stand in the murdered girl's room! The detective's cigarette case is handled by the unsuspecting gangster, and a great mystery is solved. Better than fiction. It's true, every word of it. No obligation. Just send the coupon.

FREE The Confidential Reports No. 38 Made to His Chief

And the best part of it all is this. It may open your eyes to the great future for YOU as a highly paid Finger Print Expert. More men are needed right now. This school has taken men just like you and trained them for high official positions. This is the kind of work you would like. Days full of excitement. Big salaries. Rewards.

Earn \$2500 to \$10000 a Year *You study at home in spare time*

No advance education is needed. Any man who can read and write, and think can make good. A wonderful book tells all about what others have done. Shows pictures of real crimes and the men who solved them. We'll send you a FREE copy with the free reports. Get the special offer now being made. Mail the coupon.

UNIVERSITY OF APPLIED SCIENCE
1920 Sunnyside Ave., Dept. 13-57 Chicago, Illinois

UNIVERSITY OF APPLIED SCIENCE
1920 Sunnyside Ave., Dept. 13-57 Chicago, Illinois

Gentlemen:—Without any obligation whatever, send me your new, fully illustrated Free book on Finger Prints and your offer of a FREE course in Secret Service Intelligence and the Free Professional Finger Print Outfit.

Name.....

Address

.....Age.....

\$1.00 DELIVERS to Your Home



Complete Outfit

Violet Ray

ONLY \$1.00 brings this complete, scientific Violet Rays outfit to you. Treat yourself and family at home, save delay, costly doctors and medicines. Thousands use Violet Rays at home to relieve pain and sickness. The identical outfits doctors have bought from us for years and with which they successfully treat many ailments, including those listed below.

QUICK RESULTS—No Medicine

Violet Rays work quickly, it's scientific, goes after the cause. That's why results are quick, permanent. Dr. Duncan, Kewanee, Ill., writes, "Violet Rays is the finest thing I ever used . . . to relieve pain, treatments are so pleasant all my patients like it." Use it yourself at home, you save Doctor's bills.

BEAUTY AID

Brings natural, magnetic beauty of health, no dieting, exercise or drugs. FREE book tells in detail how high priced beauty specialists use it to improve scalp and skin.

EARN CASH

Men, women, without experience earn liberal profits in spare time showing Violet Rays to neighbors. Proves results first demonstration. Sells on sight. Get attractive offer and wholesale prices now.

SEND FOR FREE BOOK

Explains how Nikola Tesla discovered Violet Rays, how it works, why it heals. Tells what doctors and plain folks accomplish in conquering pain, disease and nervous trouble with Violet Rays.

Reveals Marvelous Scientific Discovery Shows charts of human body, explains where pains start, how to banish them. Offered FREE for a limited time only, to introduce Violet Rays. Send for FREE copy.

Check Your Ailment Below for Free Advice

Here is a partial list of ailments successfully treated with Violet Ray:

Catarrh	Eye Diseases	Lumbago	Skin Diseases
Chilblains	Falling Hair	Nervousness	Sore Throat
Colds	Hay Fever	Neuritis	Sprains
Constipation	Headache	Paralysis	Tonsillitis
Earaches	Goitre	Piles	Whooping Cough
Eczema	Insomnia	Rheumatism	Asthma

Mail Coupon—Send No Money

VI-REX COMPANY

211 S. Peoria St. Dept. 210 Chicago

Please send me without cost or obligation your free book describing your VI-REX Violet Ray outfits, and details of your \$1.00 offer.

Name _____

Address _____

City _____ State _____

SOLID GOLD



SEND ONLY

10c

For this Solid White Gold Ring with Full Cut 1 Ct. Blue-White Radiant Deelite Diamond

Only a down payment of 10c required and we make immediate shipment of this beautiful solid gold ring.

WE TRUST YOU

**Shipment Same Day
No References Needed**

Elsewhere you would pay upwards of \$150 for a genuine diamond of the same cut, fiery flash and brilliancy as the Deelite Diamond. For ours, pay only \$12 and you may pay it \$1 per week. Make first payment only to Postman when he delivers package. Send name, address and finger size at once (state if ladies or gents desired) and get your Deelite ring by return mail. *An absolute guarantee goes with each ring.*

E. R. Deelite Co., 530 Broadway, New York City

BE A REPORTER!

Learn most fascinating of all professions. Romance, thrills, travel. Meet prominent people. Solve Mysteries. Good positions open. Good pay. We train you quickly. Write National School of Journalism (Not Inc.), Dept. P-1, Six N. Michigan Boulevard, Chicago, Illinois.



BECOME A RAILWAY POSTAL CLERK

Pay has been raised from \$1850 to \$2600 a year. Steady job. Pleasant work. Common education sufficient. No "pull" necessary. Mail coupon for FREE Catalog.

Patterson Civil Service School

Dept. 810 ROCHESTER, N. Y.

Send me without charge your Catalog, describing this and other U. S. Government positions.

Patterson Civil Service School
Dept. 810
Rochester, N. Y.

Name _____

Address _____

*A Practical Resident School**NOT A Correspondence School*

Greer Training Pays You Dividends All Your Life



Learn the Automotive or Electrical Trade

Never before was there such an opportunity for ambitious young men to build a future for themselves in either of these attractive fields. A short, intensive training at an exceptionally low cost.

We now operate one of the largest and most completely equipped electrical trade schools in the United States. This equipment and practically the entire electrical school was purchased from the United States Government. All the U. S. veterans in the Chicago district desiring to learn the electrical trade received their training in the U. S. V. B. Trade School. Even their chief instructor is here, prepared to teach you the electrical trades in a most approved manner.



SHOWING ONE FLOOR OF THE BIG GREER SHOPS

2 Courses for the Price of One

For but a limited time, I offer you the opportunity to get your training in both of these big-pay fields at the cost of one alone.

GET THIS TRAINING IN 8 TO 12 WEEKS

(No additional charge for a life-time membership)

Come to the big Greer shops and learn all about autos, trucks and tractors. You'll see how different kinds of cars are built and how they work. Soon you'll find yourself tackling the electrical problems, and you'll simply "eat 'em up." You'll do actual work on ignition systems, starting and lighting systems and trouble shooting—with a capable instructor by your side. These things positively cannot be learned any other way but by actual practice.

The system of training used in the Greer Shops is the proven method for quick, sure results. It builds up both your ability and your confidence. You'll be a new man when you have finished.

It is impossible to tell you all about Greer College here. The coupon in the corner will bring you the whole story in an interesting illustrated book. It contains information that will be very valuable to you. Clip the coupon now and send it in. It costs nothing to find out all about this wonderful opportunity. You have everything to gain and nothing to lose. Fill it in now.

FREE EMPLOYMENT SERVICE Our employment bureau has a line on the best jobs open at all times. We help you get the place for which you are best qualified. If you need extra money while training, we help you arrange for part-time work. The courses may be taken in evenings by those who must work all day. Remember, there's no time to lose. Make the start now by tearing off that coupon. It will bring you our big free book and the special offer now open.

Get
This
Free
Book



ERWIN GREER
President
Dept. 1001
2024 S. Wabash
Ave.,
CHICAGO

Please send me FREE BOOK concerning auto and electrical courses and special offer for immediate action. I understand that this request does not obligate me in any way.

Name.....

Address.....



ERWIN GREER
President and active Head of Greer College, the man who founded this institution over 23 years ago.

GREER

COLLEGE
**AUTOMOTIVE
& ELECTRICAL
ENGINEERING**

Dept. 1001, 2024 So. Wabash Avenue, CHICAGO



Tobacco Is Hurting You

Look at the facts square in the face, Mr. Tobacco User. You may think tobacco is not hurting you.

That is because you haven't as yet, perhaps, felt the effects of the nicotine poison in YOUR system. For you know that nicotine, as absorbed into the system through smoking and chewing tobacco, is a slow working poison. Slow, yes—but sure.

Tobacco is lowering your efficiency. It slows a man down. Makes it harder for you to concentrate your mind on your work. You haven't near the amount of "pep" and energy you would have if you stopped using it. There's many a man twice as old as you in years who's twice as young in energy, simply because he lets tobacco alone.

Some day you will realize to what an alarming extent tobacco has undermined your system.

When your hands begin to tremble—
and your appetite begins to fail—
and your heart seems to "skip a beat" now and then—
and slight exertion makes you short of breath—
then you have a right to suspect that
TOBACCO is getting the upper hand.

Any well-informed doctor will tell you that these are only a few of many symptoms of tobacco poisoning.

And YOU know that the use of tobacco in any form is an expensive, utterly useless habit. You know you ought to quit.

Tobacco Habit Banished Let Us Help You

It doesn't make a particle of difference whether you've been a user of tobacco for a single month or 50 years, or how much you use, or in what form you use it—whether you smoke cigars, cigarettes, pipe, chew plug or fine cut or use snuff—**Tobacco Redeemer** will positively remove all craving for tobacco in any form in a very few days. Not the slightest shock to the nervous system. Your tobacco craving will usually begin to decrease after the very first dose—there's no long waiting for results.

Tobacco Redeemer contains no habit-forming drugs of any kind and is marvelously quick, scientific and thoroughly reliable.

It is in no sense a substitute for tobacco. After finishing the treatment you have absolutely no desire to use tobacco again or to continue the use of the remedy. It helps to quiet the nerves and make you feel better in every way.

Results Guaranteed A single trial will convince you. Our legal-binding, money-back guarantee goes with each full treatment. We will refund every cent you pay for the treatment if after taking it according to the easy-to-follow directions, it should fail to banish the tobacco habit completely.

SEND Coupon for Free Proof Let us send you our free booklet on the deadly effects of tobacco, together with testimonial letters from men all over the country telling how they have been absolutely freed from the tobacco habit by this simple home treatment. You could not ask for stronger proof that **Tobacco Redeemer** will free you from the habit than the evidence we will gladly send on request. Just mail the coupon—or a postal will do.

NEWELL PHARMACAL CO.
Dept. 300 Clayton Station St. Louis, Mo.



Free Book Coupon

NEWELL PHARMACAL CO.

Dept. 300 Clayton Station St. Louis, Mo.

Please send, without obligating me in any way, your free booklet regarding the tobacco habit and proof that **Tobacco Redeemer** will positively free me from the tobacco habit or my money will be refunded.

Name

Street and No.

Town..... State.....

Pat Schaefer Will Heat Your Home Without Coal!



PAT SCHAEFER

No longer do you have to depend on an uncertain supply of high priced coal. No longer do you have to contend with the soot, ashes, smoke and grime of dirty coal and wood. No more fires to kindle and tend. Pat Schaefer unconditionally guarantees to give you a new heating satisfaction without a change to your present furnace or stove—with a money back guarantee and a free trial privilege of his wonderful discovery.

Set This New Oil Burner Right in Your Stove or Furnace



Mr. Schaefer's discovery has brought an already standard oil burner to a degree of perfection never before anticipated and as a result makes possible an offer never before made—actual trial of a wonderful heating invention in your own stove or furnace with the understanding that unless it gives you heating satisfaction it costs you nothing.

Fits Any Stove or Furnace

This new burner will be sent to any one for trial in their own home. It comes in sizes to fit any

heating stove, cooking range or furnace. No holes to drill. No changes whatever. Easily installed in a few minutes. Burns ordinary kerosene in stoves and furnace oil in furnaces. Already tried in thousands of homes—some with perfect satisfaction where the temperature is 20 to 40 degrees below zero. Yet it can be regulated to any degree of heat wanted, for mild Fall and Spring days, by the simple turn of a valve.

Cheap, Clean, Simple

Mr. Schaefer's invention really makes it possible to burn gas in any stove—by combining air with ordinary kerosene or fuel oil. This gas burns with an intense, hot, clean flame. There are no ashes, smoke, or soot—no noisy motors. The cost of operation is very small. It is absolutely safe and will last a lifetime. Mr. S. K. Pedro of South Carolina writes: "Beats all other burners seen in this country. A sensation." Mr. Geo. Flynn of Michigan writes: "It is cleaner, cheaper, hotter and steadier than coal or wood."

Now, and for all time, do away with household drudgery and dirt. Eliminate the thousands of steps that coal and wood necessitate.



30 Days' Free Trial

Send immediately for special low introductory price and 30 days' trial offer. Interesting book included which tells of the different types of Mr. Schaefer's burners and how you can install one in your own stove or furnace. Act now. Fill out and mail the coupon immediately to



OLIVER OIL BURNER CORPORATION

210 Chestnut St. Dept. M-130, St. Louis, Mo.

Oliver Oil Burner Corporation,
Dept. M-130, 210 Chestnut St., St. Louis, Mo.

Send me your free book and special free trial offer. I am interested in your offer, without obligation to myself. I am interested in a burner for

() Heating Stove () Range () Furnace

Name.....

Address..... County.....

City..... State.....

() If interested in selling check in square here.

AGENTS AND SPARE TIME WORKERS \$250,000 Already Paid!

and only a start has been made. Spare time workers, full time workers, agents and salesmen, here is an unprecedented opportunity to cash in on a nation-wide slide of this wonderful invention. One agent made more than \$215 in one day. One made \$1000 in one month. The demand for oil heat for both heating stoves and furnaces is nation-wide. Heretofore, price alone has prevented millions from adopting it. Now, with the perfected Oliver—selling at a fraction of the cost of other oil burners—every home can afford the luxury of oil heat. Olivers also fit cooking ranges giving you all-year round sales. Spare time workers can realize tremendous profits right in their own neighborhoods. Write at once for free sample case and free territory plan, or check the coupon and mail it immediately to W. A. Schaefer, The Oliver Oil Burner Corporation, Dept. M-130, St. Louis, Mo.

BE A POPULAR BANJO PLAYER

Learn in Few Months

JUST think! You can now quickly learn to play the banjo or any other instrument right in your home without a teacher—at a cost of only a fraction of what other old slow methods cost. No tiresome exercises or confusing scales. You play real notes from the very beginning. Our new quick method reduces all music to a few simple principles. So easy even a child of ten can follow them. No need to know a thing about music. Progress is amazingly rapid—you'll soon become the most popular person in your "Set". Already this splendid quick way has shown 350,000 people all over the world truly how to master their favorite instruments.



LEARN TO PLAY BY NOTE

Mandolin Saxophone
Piano 'Cello
Organ Ukulele
Violin Cornet
Banjo Trombone
or any other instrument

Free Book and Demonstration Lesson

point the way to this wonderful musical opportunity. Send for them today. Have your share of the fun. Surprise your friends. Don't hesitate one minute! Pick your favorite—sign the coupon and mail it now. Instruments supplied when needed, cash or credit.

U. S. SCHOOL OF MUSIC, 710 Brunswick Bldg., N. Y. C.

Please send me free book "Music Lessons in Your Own Home," with introduction by Dr. Frank Crane, Demonstration Lesson, and particulars of your Special Offer. I am interested in the following course:

.....Have You Inst.?

NAME

Address



Billiards Five Champion Lessons \$1

Be A Champ

Robert Conners, world's champion Professional 3 cushion player, one of the experts who contributes to this successful system.

You can now become an expert billiard player. A group of past and present champions have prepared a short cut method of teaching that any layman can easily master. After completing these five simple lessons you can easily become the champion of your neighborhood and possibly go after national honors. These lessons start with the October issue of Sportlife Magazine. There will be one complete lesson in each of the next five issues. It will pay you to subscribe for the next five issues for these all-champion billiard lessons alone—and besides this, you get up-to-the-minute articles, advice and a digest of the world's sport activities. The side lights and tips on your favorite sport will make you a better athlete and perhaps a champion.

Sportlife is issued monthly and each sport is covered by an acknowledged authority in his respective field, thereby ensuring the pages of Sportlife with authentic articles written by the greatest authorities. Many timely photographs of various sport events are also included—you see the world's stars in action.

Rush coupon today along with a dollar bill for five issues and start with the first billiard lesson in the October issue. Mail now before the supply of this issue is exhausted.



**Sportlife, 500 Macfadden Building,
1926 Broadway, New York**

Enclosed please find one (\$1.00) dollar for which kindly send me the five issues of Sportlife containing the all-champion easy method billiard course, to begin with the October issue.

Name

Address

City.....State.....

Be a Plumber!

Earn Big Money Good Plumbers Are In Demand

Work the year around—GET BIG PAY—Apprenticeship requires 4 years. This is not necessary. The Kansas City School of Plumbing offers the PRACTICAL METHOD to learn all branches of the trade quickly.

LEARN in 8 to 12 WEEKS—REAL PLUMBERS TEACH YOU. LEARN to do any job—step right into a big pay job or start a Shop of your own. The Plumber modernizes the Home. Plumbers can earn more in one day than some folks make in a week. Be a Plumber. Write for information, LOW TUITION Fee and opportunities offered. Do it today.

KANSAS CITY SCHOOL OF PLUMBING
2620 Troost Avenue KANSAS CITY, MO.



FREE Electrical Training Book

Mail postcard for amazing FREE book on electricity. Shows you how to earn \$150 to \$600 a month in this immense field. Famous S & H shop-type training fits you quick at home for big jobs. Exclusive system. Lack of experience or education no bar. Write S & H Engineering Co., 1422 W. Monroe St., Dept. M-1, Chicago, Ill.



FLY

Young man learn aviation. Build this classy plane and learn to construct and operate aircraft. Use your motorcycle engine or car "Motor" 30 h. p. motor. We furnish parts very reasonable to build this wonderful little "Motorplane," the World's first successful motorcycle engine airplane. Send \$3.50 for complete set of blue prints and postcard of this latest Model M-7-2.

IRWIN AIRCRAFT CO.
126 O Street, Sacramento, Cal.

NEW BIG POWERFUL MIRACO Ultra 5 TUBE RADIO



GET SPECIAL OFFER
Factory prices save you 1-2 to 1-2. Users everywhere report Miraco Ultra 5 gets program coast to coast, Canada to Gulf, loud and clear on speaker; outperforms \$100 to \$250 sets. Many hear Europe. Marvellous value—let testimony of users convince you. Smaller sets \$13.75 up. Write, AGENTS DEALERS Write! MIDWEST RADIO CORPORATION
407-D E. 8th St., Cincinnati, Ohio

MIRACO RADIO GETS 'EM COAST TO COAST

WANT WORK AT HOME?

Earn \$18 to \$90 a week RESTOUCHING photos. Men or women. No selling or canvassing. We teach you and furnish WORKING OUTPUT given with each enrollment. Limited offer. Write today. Artcraft Studios, Dept. 20, 3500 Sheridan Rd., Chicago

Agents—\$54 a Week

Everybody needs food. Our new selling plan gives customers better quality and lower prices. Men and women representatives wanted now. \$54 a week. Automobile given. No experience or capital required. 350 Zanol Products—all fast sellers. Pure food products, toilet preparations, soups, etc. All needed in every home. Big orders. Big profits. Steady, repeat business. Write quick.

American Products Co.,
4314 American Bldg., Cincinnati, Ohio



Sweeney Says You, Too, Can Have Money in Bank, \$5,000 Home, 2 Cars

**"E. J."
Himself**



Listen man: Do you want money? Do you want independence? Do you want a sure trade that pays \$50 a week up? Do you want to travel and see the world? How would you like a good driving job? Or a place in a repair shop? Or your own service, tire or battery station?

BIG SPECIAL OFFER

Never before have I made such an amazing offer. I now make it possible for you to come to this Sweeney Million Dollar Trade School right now. If you are mechanically inclined—if you are willing to work and make a little sacrifice for a few weeks you can ABSOLUTELY PROMISE YOURSELF to make your dream come true. You don't need experience; you don't need education. I train you in REAL SHOPS—with tools, not books. And I will PAY YOUR TRIP TO KANSAS CITY—no matter where you live—to prove these things to you. Here's a million dollar investment to back my GUARANTEE. Over sixty thousand men in all parts of the country will tell you what I say is true. Over 20,000 of my men are in business for themselves.

HERE'S a letter that shows what you can do. \$10,000 CASH says it is true and genuine. Why man—I can show you 500 or a thousand letters just as good. YOU may not have to go broke to pay for your training. But even if you do, what's the odds? See how well it paid Hawkins to go broke.

Dear E. J.:—

All I can say is I was broke when I left Kansas City—had only 25 cents over my ticket to Meridian; came here—went to work in the Dodge Service Station. Then in N. East Service Station—then opened up a service place of my own. Now moved in a larger place— $\frac{1}{4}$ block square. Keeping six mechanics busy. Just built a nice home for over \$5000. Own my own car, and wife has hers—sedan. Owe no one, have good stock on hand and money in the bank. I can honestly say—it was Sweeney's wonderful training that did it. Before I went to Sweeney's I worked in a dry goods store as clerk—drawing one of top salaries, \$22.50 a week. Now the expenses of my three kids in boarding school are more than the \$22.50 a week I used to make.

I am still with you in the air at night—using an eight tube set, Western Electric amplifier. A. J. Hawkins, Meridian, Miss.

MEN WANTED Get This FREE Book Today!

Just send me your name and I will send you a 64-page big illustrated book. I have put into this fascinating book a lifetime of mechanical experience. It is full of real pictures—shows how mechanics do all kinds of expert jobs. Lists the opportunities in the business. Tells just what to do—where to go—to make good. Explains step by step how to learn to be a skilled mechanic. Answers every question. Many a mother and father reading this book have been inspired to make sacrifices and help their sons out. Tells all about the world famous Sweeney System—adopted by U. S. GOVT. during the war to intensively train soldier motor mechanics. Shows how easy it will be for you to FIT YOURSELF for a real job, independence and prosperity. I will send this to you free—no cost—no obligation. Write for it today. No colored students accepted. Answer this NOW. Remember I am making the most amazing offer in the history of this school.

E. J. SWEENEY

**Send this
NOW**

**E. J. SWEENEY,
President**

**LEARN A TRADE—
Sweeney**

**AUTOMOTIVE & ELECTRICAL SCHOOL
1031 SWEENEY BLDG. KANSAS CITY, MO.**

EMORY J. SWEENEY, President
Dept. 1031, Sweeney Building, Kansas City, Mo.

Send me free, without any obligation on my part, your 64-page catalog and special offer.

NAME.....

GIVE AGE.....

P. O.

STATE.....



LUMINOUS PAINT

Make Your Watches, Clocks, Etc., Visible by Night

The very latest discovery in the scientific world, hitherto, practically unobtainable. LUMINOUS PAINT, which, applied to the surface of any article, emits rays of white light, rendering it perfectly visible in the dark. THE DARKER THE NIGHT, THE MORE BRIGHT IT SHINES. Quite simple to use. Apply—You can do it. A little applied to the dial of your watch or clock will enable you to tell the time by night. You can use the push buttons or switch plates of your electric lights, match boxes, and innumerable other articles; make your own Luminous Crosses, Luminous Rosaries, etc. Small bottles, price 25c. Larger sizes, 50c and \$1 postpaid. JOHNSON SMITH & CO. Dept. 425, RACINE, WIS.

Serpent's Eggs

Box contains 12 eggs. When lit with a match, each one gradually hatches itself into a snake several feet long, which curls and twists about in a most life-like manner. Price per box, 10c postpaid, 3 for 25c.



CIGARETTE MAKER



Roll your own and save money. Makes them better and quicker besides saving more than half. Use your favorite brand of tobacco. Neat, useful and handy. Pocket size, weighs 1/2 oz. Made entirely of metal, nickel-plated. Price 25c postpaid.

MIDGET BIBLE

GREAT CURIOSITY Shows Bible into World. Size of a postage stamp. 200 Pages. Held to bring good luck to the owner. A genuine work of art. Must be seen to be appreciated. Make good money selling them to friends, church acquaintances, etc. PRICE 15c each, 3 for 40c, 12 for \$1.35, 100 for \$7.50. Also obtainable in Leather Binding, with gold edges. Price 90c each, 3 for \$1.35, \$4.50 per doz. Magnifying Glass for use with Midget Bible, 19c.



STAGE MONEY

With a bunch of these bills, it is easy for each person of limited means to appear prosperous by flashing a roll of these bills at the proper time and peeling off a genuine bill or two from the outside of the roll, the effect created will be found to be all that can be desired. Prices, postpaid: 48 Bills 20c, 125 for 50c, or \$3.50 thousand postpaid.

Wonderful X-Ray Tub

A wonderful little instrument producing optical illusions both surprising and startling. With it you can see what is apparently the bones of your fingers, the lead in a lead pencil, the interior opening in a pipe stem, and many other similar illusions. A mystery that no one has been able to satisfactorily explain. Price 10c, 3 for 25c, 1 dozen 75c. JOHNSON SMITH & CO.



Good Luck Ring

Quality and Novel Design

A VERY striking and mysterious ring. Silver finish, steel and crescent design, with two brilliant, flashing gems sparkling out of the eyes. Said by many to bring Good Luck to the wearer, hence its name, Good Luck Ring. Very unique ring that you will take a pride in wearing. ONLY 25 CENTS.

Address orders for all goods on this and opposite pages to

JOHNSON SMITH & CO.

Dept. 425

RACINE, WIS.



A Deluxe Edition of our new 1925 CATALOG mailed on receipt of 25c. Handsome cloth binding. Only 60¢ of its kind. 420 pages of all the latest tricks in magic, the newest novelties, puzzles, games, sporting goods, interesting books, curiosities, in books, pens, pencils, etc., unobtainable elsewhere. Remit by Money Order, Check, Coin, Stamps, etc. Stamps of foreign countries also accepted.

Exploding Cigarettes



JUST LIKE ORDINARY CIGARETTES. BUT SUCH REAL STARTLERS! This box contains ten genuine cigarettes of excellent quality. They appear so real, but when each cigarette is about one-third smoked, the victim gets a very great surprise as it goes off with a loud BANG! A great novelty provoker yet entirely harmless. Price 25c per box.

Popular Watch Charms

15c ONLY 3 for 40c; \$1.35 doz.

Very pretty little curiosities and decidedly novel. Fitted with Magnifying Lenses that enlarge the picture to a very surprising degree; in fact, it seems almost incredible that a clear picture could be possible in such a small compass, and how sharp and distinct they show up when you look through. Come in assorted views—Admirals, views of Passaic Canal, Lord's Prayer in type, etc.

Mystic Skeleton

A jointed figure of a skeleton 14 in. in height, will dance to music and perform various gyrations and movements while the operator may be some distance from it. 10c & pd.

NEW BOOK ON ROPE SPLICING

Useful Knots, Hitches, Splices, etc.

A most practical handbook giving complete and simple directions for making all the most useful knots, hitches, rigging splices, etc. Over 100 illustrations. All about wire rope attachments, heaving blocks, tackle, etc. 27 Healdie Knots illustrated. Of great value to mechanics, riggers, carpenters, boatmen. Price 20c postpaid.

MAGIC FLUTE

Wonderfully Sweet Toned and Musical

The Magic Flute, or Harmonicon, is a unique and novel musical instrument that is played with nose and mouth combined. There is just a little knack in playing it which, when once acquired, opens up a wide world of pleasure with ample room to produce very sweet music that somewhat resembles a flute. There is no fingering, and once you have mastered it you can play all kinds of music with facility and ease. When played as an accompaniment to a piece or any other musical instrument, the effect is as charming as its appearance.

Address orders for all goods on this and opposite pages to

JOHNSON SMITH & CO.

Dept. 425

RACINE, WIS.



A Deluxe Edition of our new 1925 CATALOG mailed on receipt of 25c. Handsome cloth binding. Only 60¢ of its kind. 420 pages of all the latest tricks in magic, the newest novelties, puzzles, games, sporting goods, interesting books, curiosities, in books, pens, pencils, etc., unobtainable elsewhere. Remit by Money Order, Check, Coin, Stamps, etc. Stamps of foreign countries also accepted.

BLANK CARTRIDGE PISTOL

Protection against Burglars, Tramps & Dogs

Prices
50c
\$1.00



Well made and effective; modeled on latest type of Revolver; appearance almost as though to scare a burglar. When loaded it may be as effective as a real revolver without danger to life. It takes standard .32 Cal. Blank Cartridge obtainable everywhere. Price 50c, superior quality \$1.00 postpaid. Blank Cartridges, by express, 50c per 100. Holster (Cowboy type) for Blank Cartridge Pistol, 50c. JOHNSON SMITH & CO., Dept. 425, Racine, Wis.

BOYS! BOYS! BOYS! THROW YOUR VOICE

Into a trunk, under the bed or anywhere. Lots of fun fooling the teacher, policeman or friends. THE VENTRILO a little instrument, fits in the mouth out of sight, used with above for Bird Calls, etc. Anyone can use it.

Never Fails. A 32 page book on ventriloquism, the Ventrillo, ALL FOR 10 CENTS



Everything about the Ku Klux Klan told in a clear, fearless manner. Book tells all—How it started and was oppressed in 1871—The New Ku Klux Klan—How Organized—How Members are Enrolled—Oath of the Klan—Questions for Candidates—Creed—Objects of the Order—Obedience—Fidelity—Pledge of Loyalty—Ku Klux Klan and the Masons—The Jews—The Masons—Real K. of C. Oath—The Negro Ku Klux Klan, etc., etc. Latest and most complete book on the Klan published. Price 35c, Postpaid. Stamps or Coin

LOOK 35c Look

Wonderful instrument. Greatest thing yet. Nine separate articles in one. Everybody delighted with it. Odd, curious and interesting. Lots of pleasure as well as very useful. It is a double Microscope for examining the wonders of nature. It is also an Opera Glass, a Stereoscope, a Burning Lens, a Reading Glass, a Telescope, a Compass, a Pocket Mirror, and a Laryngoscope—for examining eye, ear, nose and throat. It is worth all the cost to locate even one painful cinder in the eye. Folds flat and fits the pocket. Something great—you need one. Don't miss it. Sent by mail, postpaid. Only 35c or 3 for \$1.00

25 CENTS BABY TANK

Goes backward or forward. It crawls along, overcoming obstacles just like the larger tanks. Performance of most amazing nature. It runs ten times longer than most mechanical toys. Hand-somely finished and completely rugged in natural colors. 25c postpaid.

Female SEX Indicator 25c Male Sex Indicator

Hold the MAGIC INDICATOR over a man's hand—instantly it moves in a straight line, backward and forward. Hold it over a woman's hand and it describes a complete and continuous circle. The same action can be obtained over a letter written by a man or woman, etc. It is fascinating, baffling. We have never been able to figure out how it's done—but we've never seen it fail. Many novel and entertaining feats may be performed with the Sex Indicator. For example, similar results can be obtained with animals, cats, dogs, rabbits, over birds, chickens, canaries, etc. Also used to predetermine the sex of children and birds, etc. In fact it is sold as a patented egg tester in Europe. Price 25c, or 3 for 85c, postpaid. JOHNSON SMITH & CO., Dept. 425, RACINE, WIS.

THE TEDDY CAMERA



Takes and Finishes an Excellent Photograph on a Card 3 1/2 x 2 in One Minute

It is the newest method of photography in which skill and experience are not necessary. Not a plate nor a film camera, but a camera that produces the complete picture. Does not use either plates, film, or dark-room. All the troubles of picture-taking in the ordinary manner are swept away. It eliminates all the fuss and trouble and, above all, there is **No Waiting**, for you actually see the finished picture in **One Minute**. You merely place the cards in the camera, press the shutter, drop the card into the automatic developing tank attached to the camera, and in **One Minute** you have a **Completed Picture** all finished and ready to show. It is so simple and easy that any child who can use the handle can take good pictures. The camera weighs little more than hold a postal, and measures about 4 1/2 x 3 1/2 inches, easy to carry about and always ready to take and finish a picture in one minute. The **Lens** is of high grade, universal focus, needs no adjustment, and takes clear and brilliant pictures at any distance. The **Shutter** works perfectly and responds to very slight pressure. It loads in broad daylight. The **Developing Tank** is attached to the camera and holds a single solution that develops, tones and fixes the picture in one minute with absolute certainty and with no care or attention on the part of the operator. It cannot be overdeveloped. Produces a picture 3 1/2 x 2 inches. Send today and have the never-failing pleasure of making excellent pictures of your family, friends or neighbors, your house or your domestic pets. Price of Camera Complete with Developer and Package of Cards, **ONLY \$2.50**. Extra packages Sensitized Cards 15 cents per package; extra Developing Solution 25 cents. All prices are postpaid to any address in the world.

\$2.50

carry about and always ready to take and finish a picture in one minute. The lens is of high grade, universal focus, needs no adjustment, and takes clear and brilliant pictures at any distance. The shutter works perfectly and responds to very slight pressure. It loads in broad daylight. The developing tank is attached to the camera and holds a single solution that develops, tones and fixes the picture in one minute with absolute certainty and with no care or attention on the part of the operator. It cannot be overdeveloped. Produces a picture 3 1/2 x 2 inches. Send today and have the never-failing pleasure of making excellent pictures of your family, friends or neighbors, your house or your domestic pets. Price of Camera Complete with Developer and Package of Cards, ONLY \$2.50. Extra packages Sensitized Cards 15 cents per package; extra Developing Solution 25 cents. All prices are postpaid to any address in the world.

Every Boy His Own Toy Maker

Greatest boys' book written. Tells how to make a Pinhole Camera, a Cannon, model Railroad, a Telephone, Boomerang, Telegraph Instrument, Box Kite, Talking Machine, Microscope, Electric Motor, Electric Door Bell, Water Wheel, Paddle Raft, a pair of Skis, a Dog sled, Bird House, Rabbit Yard, etc. 64 pages, 150 illustrations. **PRICE, 10c postpaid; 3 for 25c.**

INVISIBLE INK

The most confidential messages can be written with this ink, for the writing **Makes No Mark**. Cannot be seen unless you know the secret. Invaluable for many reasons. Keep your postals and other private memorandums away from prying eyes. Great fun for playing practical jokes. **Only 15c a Bottle; 3 for 40c.**



JAPANESE ROSE BUSHES

The Wonder of the World
Japanese Rose Bushes bloom all the year round. Just think of it. Six weeks after planting the seed, the plants will be in full bloom. It may not seem possible, but we positively guarantee it to be so. They will bloom every ten weeks, Summer or Winter, and when three years old the bush will be a mass of roses, bearing from five hundred to a thousand roses on each bush. The flowers are in three shades—white, pink, and crimson. The plants will do well both in and out doors. We guarantee at least three bushes to grow from each packet of seed. **Price, 10c packet, 3 pkts. for 25c postpaid.**

Kissing Permit

A handsome metal badge, nickel plated, that you can wear, giving you fun out of all proportion to its trifling cost. **PRICE 10c each, 3 for 25c, or 12 for 75c postpaid.**



False Mustache

Here you are, boys! Just the thing for a little harmless masquerading. On and off in a twinkling. Lots of fun putting one on in a crowd of friends. The sudden transformation is astonishing. Fine for private theatricals, minstrel shows, charades, tableaux, etc. Change your appearance beyond recognition. **PRICE 10c, 3 for 40c postpaid.**



Microphone Transmitter Button



You can easily make a highly sensitive detector by using this Transmitter Button to collect the sound waves. You can build your own outfit without buying expensive equipment. It is simple and inexpensive. You can install an outfit in your home and have conversations being held all over the house. You can connect up different rooms of a hotel. This outfit was used by secret service operatives during the war. It is being used on the stage. It is ultra-sensitive and is the greatest invention in micro-physics. You can connect the button almost anywhere—card board boxes, stove pipes, still radiators, on the wall behind a picture frame, etc. Button is so light and small it cannot be detected. Persons can be overheard without suspecting it. You can listen in on conversations in another room. A deaf person in the audience can hear the speaker. Connected to phonograph, piano or other musical instrument, music can be heard hundreds of feet away. Button may be used to renew telephone transmissions often makes an old line "talk-up" when nothing else will. The ideal microphone for radio use carries heavy current and is extremely sensitive. Experimenters find the Button useful for hundreds of experiments along the lines of telephones, amplifiers, loud speakers, etc. Many fascinating stunts may be devised, such as holding the button against the throat or chest to reproduce speech without sound waves. \$5.00 is given to anyone who sends in a new suggestion for the use of the Button providing the manufacturers find it suitable for use in their literature. **PRICE \$1.00 POSTPAID ANYWHERE.**

Send remittance (Postage Stamps accepted) for all articles listed on above and previous page to

MAGICIAN'S OUTFIT

Apparatus and Directions for a Number of Mysterious Tricks Enough for an Entire Evening's Entertainment

ANYONE CAN DO THEM 75c



It is great fun mystifying your friends. Get the Conjuror's Cabinet, and you will be the clearest fellow in your district. It contains the apparatus for seven dramatic tricks, including The Disappearing Rose, that, when placed on the lap of your coat, vanishes from sight at will; The Magic Vase and Ball Trick in Wooden Ball is placed inside, and upon replacing the lid the vase disappears and is found in someone else's pocket; The Magic Ball with which you can apparently cut your finger almost in two; the Wonderful Card Trick in which an entirely different card altogether is found; The Disappearing Coin Box in which a coin is placed in the little wooden barrel, and, when opened again, is found to have vanished entirely, or can be made to change into a coin of another denomination; The Famous Disappearing Penny Trick; The Glass Goblet and Vanishing Coin Trick is easily dropped into a glass of water, and when the water is poured out the coin has vanished. With the tricks described above we send full printed instructions for performing each trick, so that anyone can readily perform all the tricks to the great amusement of their friends and the public. Any boy of ordinary intelligence, with this Cabinet of Tricks in his possession, can give a parlor entertainment not inferior to some regular magicians. Besides the tricks contained in the Cabinet, there are many other tests and illusions fully explained with full printed instructions, for which you only make out the necessary apparatus. This successful Cabinet of Tricks for **ONLY 75 CENTS POSTPAID TO ANY ADDRESS.**

Great Fire Eater

Most Sensational Trick of the Day!
With the Fire Eater in his possession any person can become a perfect salamander, apparently breathing fire and ejecting thousands of brilliant sparks from his mouth, to the horror and consternation of all beholders. Harmless fun for all times, seasons and places. If you wish to produce a decided sensation in your neighborhood don't fail to procure one. We send the Fire Eater with all the materials, in a handsome box, the cover of which is highly ornamented with illustrations in various colors. **Price of all complete only 30 cents, postpaid.**

SQUIRT ROSE

25c
A REAL STARTLER. This is the most popular of all squirt tricks. The flower in your coat looks so fresh and sweet that everyone is tempted to inhale the delightful perfume. This is the moment to press the bulb. Guess-who? Don't they jump? There is a very long rubber tube that easily reaches to the pocket of your coat or trousers, and the bulb is large enough to make a decent show with one loading. **PRICE 25c each, or 3 for 65c postpaid.**

PISTOL, OPERA & FIELD GLASS

PRICE POSTPAID, \$1.00
It is made in the shape of and looks like a regular Automatic Pistol. No one is likely to stop and ask you whether it is real or not. This is likely to prove itself very handy in an emergency. On pressing the trigger it opens up, as shown in the illustration at the right, revealing nine most useful articles—Opera and Field Glass, Telescope, Mirror, Magnifying Glass and Burning Lens, Reading Glass, Sun Dial, Sun Compass, etc. In the handle of the revolver there is a place for various pocket accessories, such as pen, pencil, stationer, pen, etc. The Pistol is of sheet metal, blood finish, that can be carried comfortably in pocket. **PRICE \$1.00.**



GOLD TEETH
You know how fashionable it is to have gold crowns—if you can afford it. These gold-plated shells fasten over your real teeth and look like very wealthy floss. Can be slipped on and off in an instant. Get some and surprise your friends. **PRICE 5 Cents Each, 3 for 15c, or 50c for 1 doz. postpaid.**

SURPRISE MATCHES

More fun than fighting with your wife. Look just like ordinary matches. Put up in boxes just like regular Safety Matches. As the victim tries to light one he gets quite a surprise. **PRICE 10c per box, 3 boxes for 25c postpaid, 12 for 75 cents.**

SEEBACKSCOPE

By merely placing this clever instrument to your eye, you can see what is going on behind your back, and sometimes you see very interesting things when no one thinks you are looking. Why it is just like having eyes at the back of your head. **PRICE ONLY 25 Cents Postpaid, 3 for 50 cents.**

The "Little Giant" Typewriter

A First Class Writing Machine For \$1.50
A perfect little typewriter for \$1.50. There are thousands of persons who would like to use a typewriter but whose needs and business do not warrant the expense attached to the purchase and use of a fifty or seventy-five dollar machine. To such persons we confidently recommend our Little Giant. It is strongly made, but simple in construction, so that anyone can quickly learn to operate it, and write as rapidly as they would with pen and ink. The letters of the alphabet most frequently used are so grouped as to enable one to write rapidly, the numbers 1 to 10, and the punctuation marks being together. With this machine you can send your best girl typewriting love letters, address envelopes, make out bills, and do almost any kind of work not requiring a large, expensive machine. With each typewriter we send a tube of ink and full printed instructions for using the machine. **Price complete \$1.50 by mail postpaid to any address in the world.**



JOHNSON SMITH & CO. Dept. 425 Racine, Wis.



Choose as Your Profession Electrical Engineering

Electricity offers a brilliant future to the young man who is about to choose his career. Never before has there been such wonderful opportunity in this great field. Big paying positions in electrical work the world over are open to trained men—men who possess specialized, practical knowledge. Come to the School of Engineering of Milwaukee—one of the largest and best equipped electrical schools in America. Here you are trained in both theory and practice by a faculty of experts. You learn in large, finely equipped laboratories. If you have 14 high school credits or equivalent, you can become an Electrical Engineer with a Bachelor of Science degree in three years. If you lack these credits they can be made up at School of Engineering in a short, intensive Junior E. E. course.

A Complete, Practical, Electrical Education

Learn by the thorough approved scientific methods which our twenty years of specializing enable us to give you. In addition to Electrical Engineering, the following complete courses are given: A. C. and D. C. Armature Winding—Electric Light, Heat, Power Wiring and Testing—Practical Electricity—Drafting—Electrotechnics—Commercial Electrical Engineering—Junior Electrical Engineering and Automotive Electricity.

Earn While You Learn

By our special system you may earn part of your way while learning. Our Employment Department will help secure you a position to which you may devote a part of each day, spending the remainder at the school. This plan both solves the students' financial problems and provides splendid experience at the same time. Low tuition fee. Board and room reasonable. Daily Broadcasting WSOE, School Orchestra, Fraternities.

**New Term
Begins Sept. 28**

Write for FREE Catalog

Write today for our free, illustrated catalog. Read about this wonderful institution and the great opportunities that lie before you. Find out about our specialized method of training and the details of our "Earn While You Learn" plan.

SCHOOL of ENGINEERING of Milwaukee

Founded 1905
Dept. P. M. 1025 415 Marshall St. Milwaukee, Wis.

SCHOOL OF ENGINEERING OF MILWAUKEE
P. M. 1025, 415-17 Marshall Street, Milwaukee, Wis.

Without obligating me in any way, please mail free 72-page illustrated book, "Electricity and the One Best Way to Learn It," and particulars regarding the course I have marked with an X.

- Electrical Engineering.
- Electrotechnics.
- Commercial Electrical Engineering.
- Junior Electrical Engineering.
- Automotive Electricity.
- Auto Electrical Service Engineering.
- Radio Sales and Service and Broadcasting.
- Armature Winding.
- Light, Heat, Power Wiring and Testing.
- Practical Electricity.
- Home Laboratory Service.
- I am interested in your "Earn While You Learn" Plan.

Name..... Age.....

Address.....

City..... State.....

Education.....

AGENTS Some Set At \$200 Looks Like \$5.00 Worth Gives You \$1.05 Profit!

With Our Great Introductory Offer

Giving These \$1.25
Dress-Making Shears **FREE**

VALUE
\$1.25



With each sale of our wonderful 11
piece Toilet Article Assortment for
only \$2.00. TOTAL STORE VALUE \$4.60

\$21.00 a Day PROFIT on only TWENTY Sales



MY! HOW THEY SELL!

You get the attention with the free Shears. Walter Harris sold 800 boxes in six weeks. Profit over \$100 a week. You can do this too.

Act Now! Sell like hot cakes year round. A baby could sell Lucky 11. Don't wait a minute. Save time. Send \$1.75 for complete outfit including display case. At least write for circulars explaining our unique plans, including 30 other packages. **ACT NOW!**

E. M. DAVIS CO., Dept. 5634, CHICAGO, ILL.



Music Instructor

These books are illustrated and gotten up to make the method of self-teaching so simple that any one without any knowledge of music could learn to play any of the following:

SAXOPHONE	25c	MANDOLIN	25c
ACCORDEON	25c	PIANO	25c
BANJO	25c	UKULELE	25c
GUITAR	25c	VIOLIN	25c

The above prices are postpaid. :-: Any above 5 titles, \$1.00 postpaid.
J. C. DORN, 725 S. Dearborn St., Dept. 17, CHICAGO



BUILD SHIP MODELS!

Easy to build and sell. Plans and instructions: Pirate Ship, 52c—Viking Galley, 42c—Magellan's "Victoria," 77c—Hudson's "Half Moon," 92c—Chinese Junk, 47c—or all for \$2.90.

RICHTER & STROESSER, 495A Eleventh Avenue, Milwaukee, Wis.

Agents Wanted Ridea Neracar.

Sales quick, easy, profitable. Easy to demonstrate. Learn in five minutes. This automobile on two wheels is the answer to the universal demand for safe, clean, comfortable, economical transportation—85 to 100 miles per gallon, 300 miles for \$1.35 miles per hour. Step in from the side—no bars to straddle.

Fenders protect clothing from dust and grease. Thousands in daily use by business men and women the world over. In a year or so dealer developed a business of 80 per month. Another sells 20 in 15 days.



Write Today

Address Dept. R

NER-A-CAR CORPORATION, SYRACUSE, N. Y., U. S. A.



Be a Machine Draftsman—earn \$50 to \$150 a week



Be a Structural Draftsman—earn \$50 to \$200 a week



Be an Architectural Draftsman—earn \$50 to \$150 a week



Be an Electrical Draftsman—earn \$50 to \$125 a week



Be an Auto Draftsman—earn \$50 to \$125 a week

3 Drafting Lessons Actually FREE!

to prove you can LEARN AT HOME, IN YOUR SPARE TIME!

We have invented a new, simplified way to teach Drafting—the first real improvement in Drafting home-instruction in history. We want you to see it, try it—without one penny of cost or obligation. We want to show you how we get away from the copying methods used in the past. See how we make you think, solve problems, do actual drafting room jobs from the first lesson!

Draftsmen Wanted \$60 to \$200 a week!

70,000 fine jobs advertised this year. Get ready to fill one. Get out of the rut. Make something of yourself. Plan your future in Drafting. Even if you have only common schooling, even if you know nothing of Drafting, we guarantee to make you a real Draftsman or to refund your money! Special surprise offer right now to the first 500 men who answer this ad—reduced price, easy terms. Coupon brings complete information.

A New, Rapid, Easier Training

Copying drafting lessons prepares you to be only a "tracer." This new "Job-Method" gives you actual drafting-room jobs in a new one-step-at-a-time way. With pictures which you can understand almost without reading the "lessons." And that is why American School-trained Draftsmen can qualify for a good job at big pay when they graduate.

Win Success Through Drafting

Drafting is easy, fascinating work. Short hours. Big pay. And the Draftsman is always in line for promotion for executive positions. This training is Complete. It includes high-school subjects (if you need them) and all the Engineering and Mathematics required of Drafting Experts.

Coupon Brings Three Lessons Free!

Get them. Test your own ability to learn Drafting and get ready for a fine job and big pay. Coupon also brings surprise offer, and complete information about your opportunities for success in Drafting.

Mail It Today!

Complete Costly Drafting Outfit GIVEN!

You need a fine outfit like this to do precise, neat Drafting. Not one penny of extra charge for this complete, valuable, high grade outfit. Imported instruments. Table, board, mahogany-edge T square, triangles, ink, thumb-tacks, etc., everything you will need. Retail value \$20. Coupon brings this Free Offer.

CHIEF DRAFTING ENGINEER,
AMERICAN SCHOOL,
Dept. D-774, Drexel Ave. & 58th St., Chicago

Rush 3 Free Drafting Lessons, Surprise offer, complete information, money-back guarantee, etc., to prove I can become a real draftsman at home in spare time.

Name.....

Street No.....

City..... State.....

CHIEF DRAFTING ENGINEER
AMERICAN SCHOOL
Dept. D-774
Drexel Ave. & 58th St., CHICAGO

Get Into This



Are you ambitious? Are you seeking a better job or a business of your own? If so, here's your chance—a chance to really cash in. There are more amazing money-making opportunities in the automobile business now than ever before. Follow the lead of the thousands of "Michigan State" graduates.

They have already proved what real training will do for an ambitious man. They are making big money. You can too!

This school has 20,000 graduates. 700 students here now. Come to Detroit, a fine city. Big business, pleasant climate all year around. Come now, and fit yourself for a better job or to run a garage business of your own. Thousands of battery shops, auto electrical shops, tire and welding shops are needed now. Only trained men can run them. Good work is what car owners want, and it takes a trained man to do it.

LEARN THE AUTO BUSINESS IN THE HEART OF THE INDUSTRY

Without any previous experience—just a liking for mechanics—you can learn the auto business from A to Z in a few weeks at the Michigan State Automobile School—the factory endorsed school in Detroit—the heart of the industry. Then step out, equipped with knowledge and training, to a future of certain, big money making. You have great advantages, learning the business here. It's the fountain head of the



automotive industry. You are taught under factory endorsed methods. You learn both theory and practice on latest equipment. Go through the great Ford plants. Visit the other auto factories. Learn their methods first hand—and it all means greater opportunities and more certain success. The Michigan State Automobile School, in Detroit, the automobile center, is the logical place to learn the auto business.

Read What Factories Say:

THE STUDEBAKER CORPORATION OF AMERICA

"We do not know of a better automobile school than the MICHIGAN STATE."

HUDSON MOTOR CAR COMPANY

DETROIT, MICH. U.S.A.

"This school is thought very highly of by the automobile men of Detroit, and is considered one of the best equipped and most efficient schools in the country. You will make no mistake in attending the M. S. A. S."

DODGE BROTHERS

INCORPORATED

DETROIT, U. S. A.

"We believe the Michigan State Automobile School of this city to be an exceptionally high class school, and no doubt a diploma from this school would assist materially in obtaining employment with high class automobile dealers."

PACKARD MOTOR CAR CO., DETROIT

"We do not believe you would make any mistake in attending this school if you wish to become thoroughly experienced in the automobile business."



BUICK MOTOR COMPANY

"We believe the MICHIGAN STATE AUTO SCHOOL, Detroit, would best meet your requirements, as its course in technical training is most thorough and complete in every detail."

SAVE YEARS of DIRTY WORK

Some men think they can learn the business by starting in green as a helper in a garage. They are wrong. Years of dirty work will be wasted learning wrong methods from poor mechanics. Save all this by coming to the auto center for a few weeks. Learn right, under expert instructors. Learn the short cuts and best ways of doing electrical repairs, engine work, all about autos, trucks and engines.

Start Now! A thorough training in Detroit, at the "Michigan State," fattens the pay envelope or starts you in business for yourself. You can take a full Automotive Course in 12 weeks. Or our great Master Course in 30 weeks. Or specialize in any of its money-making branches; be an Auto Electrician, Battery Service Man, Engine Man, Welder, Tire Expert or Machinist. All courses include training in Business, Shop Management, Service Selling, etc., by one of the big men from Detroit's auto plants. Classes always open. You can start at once. Jump right on the train for Detroit.

MICHIGAN STATE

310 Auto Building

Detroit, Michigan

Learn Autos Where Autos Are Made

BIG MONEY Business

Here Is A CHART OF FACTS—

authentic figures which point out the opportunities. Autos are increasing faster than repair shops or mechanics can keep up with them. 18 million are in use now. The auto industry leads all others in value of production. There are more autos than telephones. 269 cars to every service station. This shows as plain as A-B-C where the big chance is today.

YOU CAN HAVE SUCCESS LIKE THIS

Here is Harold Grenert—one of the thousands of "Michigan State" graduates who have achieved quick success. He is just an ordinary fellow, much like the rest of the boys and men who come to this School to get their start on the Road to Success. Read his letter:

From \$20 a Week to \$70

Holyoke, Mass., May 2, 1925.
"I now have complete charge of all electrical equipment on the busses operated by the Hartford, Conn., and Springfield, Mass., Bus Co. I have three electricians under me. I receive \$70.00 a week as a salary. Two years ago I left a \$20.00 a week job. Thanks to the M. S. A. S. training, I now receive \$70.00."

What thousands of others have done, you can do too. You have even a better chance than they had, because there is a bigger demand for trained men than there ever was before. Service managers tell us that 100,000 new trained auto mechanics are needed every year. Not nearly enough are starting, and a trained man can get a good job any place and any time.

Detroit-Trained Auto Men Earn Big Money

Detroit-trained men are in demand. Your diploma from the "Michigan State" is a valuable money-making asset. The Michigan State Automobile School is known the world over. Wherever autos are used—Detroit-trained men get the best job, highest pay. Leading factories, dealers, service stations, garages, shops and farms want men who have trained their heads as well as their hands—the M. S. A. S. Detroit-kind.

Send the Coupon Get all the interesting facts. They will open the way to a bright future for you. Write a letter or a postcard or use this coupon. **Do it now.**

Colored students not enrolled, except for our home study course)

AUTOMOBILE SCHOOL

6729 Woodward Avenue Detroit, Michigan

The Factory Endorsed School



FREE Management Course

Business Course by Packard service manager is free to all students. Teaches how to locate a garage, about equipment, systems, financing, selling, advertising. Worth \$100.00 alone. No extra charge.

Good Positions Open

The demand for trained men is greater than the supply. We cannot fill all the calls we get. Look into any garage that is run by trained men—everybody busy, earning big money. These opportunities can be yours too with "Michigan State" training.

Earn while you learn if necessary. Some students work evenings to pay their way. Others work days and take our evening classes.

Home Study Course

FREE For students who can not come to Detroit at once we have a fine Home Study Course. You can start to learn at home. Then come here later with no extra charge for the Home Study Course. It will help you to get a garage job right away. Write for full information about this and explain your circumstances.



One of the expert instructors teaching students on a new G.M.C. Truck. Complete equipment in every line is here for you to learn on, and skilled men to guide your practice.

18,000,000
Automobiles in U.S.
One Car to Every
6 People
269 Cars to Every
Repair Shop
Thousands more Trained
Men are Needed

Mail Coupon To-day

Michigan State Automobile School 310 Auto Building
DETROIT, MICH.
Send me FREE and without obligation complete information about Detroit-training to make the most money.

Name.....

Street or R. F. D.....

City..... State.....

I am interested in { 12 Weeks' Auto Course,
30 Weeks' Master Course,
Home Study Course.

Try This Out Pay Only If Satisfied

Send Only Your Name and Address



We will mail you free of charge the first issue of a six months' subscription to that popular magazine "Strength." We give you seven days in which to look this magazine over and if you are pleased with it you send us \$1.00 only and the remaining five issues will be mailed to you monthly. If you are not satisfied,

keep the one copy and send no money.

"Strength" Is a Magazine You'll Like

That is why we make you this offer. And to be able to get a half year's subscription to it at the price of only \$1.00, is an unusual opportunity.

"Strength" Overflows with Pictures

of beautifully-formed women, powerfully-muscled men, star athletes, acrobatic stage performers, etc.

"Strength" Is Full of the Doings of Strong Men

the world over. You'll be thrilled by their physiques and the accounts of their feats of strength. There are other highly interesting articles on athletics, aerobatics, physical training health-promoting and disease-destroying.

Every Item Interesting—Every Picture Inspiring



You will get hours of interesting, instructive and helpful reading from each issue of "Strength." You'll get better health by following its teachings.

USE THIS FREE TRIAL COUPON

THE MILO PUBLISHING CO., PM-10-25
2743 N. Paltherp St., Philadelphia, Pa.

Gentlemen: Please send me the first copy of a six month subscription to "Strength" magazine. If I like it I will send \$1.00 immediately.

Name _____

Address _____

City _____ State _____

ART

We Teach COMMERCIAL ART

Meyer Both Company, maintaining the most widely known Commercial Art Studios in the World, offers you a practical training based upon 25 years' success in producing over a quarter million commercial drawings for leading advertisers.

Many of the full page illustrations appearing in leading national magazines are drawn by Meyer Both Trained Artists.

Our graduates are filling attractive positions in every section of the country. Home study instruction.

GET FACTS BEFORE YOU ENROLL IN ANY SCHOOL

Ask the advertising manager of the leading newspaper in your locality about us. Send 4c in stamps for illustrated book telling of the success of our students, and the unusual opportunity for both men and women in this attractive profession.

MEYER BOTH COMPANY

Dept. 16
Michigan Ave. at 20th St.
CHICAGO, ILL.

NOTE—To Art and Engraving Firms; Secure practical artists among our graduates. Write us.

Learn Mechanical Dentistry

Most profitable profession today. Intensive 3 months' course. We guarantee to teach you. Practical instruction; individual attention; unequalled curriculum. Lowest co-operative tuition fee. Tools and materials free when you enroll. Write for Free Catalog NOW! N. Y. School of Mechanical Dentistry, Dept. F-68, Penn Arcade, 147-153 W. 33rd St., N.Y.

LAW IN YOUR SPARE TIME

Same course by correspondence as given for 15 years at classes of this college. **L. L. B. DEGREE CONFERRED.** 3 year university course prepared for bar exam. Money back guarantee. Low fee, easy terms, includes 1934 12 volume library, lectures, lessons, all expenses. Write for free book. HAMILTON COLLEGE OF LAW, G-10, 1412 S. Michigan Ave., Chicago

FREE
\$20 Fine Tone
Musical
Instruments



We have a wonderful new copyrighted system of teaching note music by mail! To every pupil taking this course we will give free a \$25 superb Violin, Tenor Saxo, Ukulele, Hawaiian-Guitar, Banjo, Mandolin, Banjo-Ukulele, Banjo-Mandolin, Cornet or Banjo-Guitar absolutely free. Also teach Piano and Organ. Very small charge for lessons only. Four lessons will teach you several pieces. Over 100,000 successful players. We guarantee satisfaction or no charge. Complete outfit free. Write today. Dept. 214. No obligation. Slingerland School of Music, Lincoln Park P. O., Chicago, Ill.

Copyrighted material

Rouse Your Bigger and Better Self to Action!

I'll help you prove to the world that you **CAN** succeed!



ELECTRICITY

Remember, there is no substitute for practical training in great shops

COMPLETE ELECTRICAL TRAINING

In 12 Happy Weeks at COYNE I have perfected an unusual course of instruction in Electricity, a course that is absolutely thorough, that is easy to master, that covers every phase and factor of the subject, that fits men for the BIG electrical jobs—the HIGH-SALARIED thrilling jobs.

You don't need advanced education, knowledge of higher mathematics, or experience

My Employment Department assists you while you learn, and after you graduate.



Read My Big SPECIAL OFFER

- Will Fascinate You!
- Will Thrill You!
- Will REWARD You!

WHY LEAD AN INFERIOR EXISTENCE? No need to drag through life with little or nothing of this world's goods in return for your hard, earnest labor. The chances are 100 to 1 you've got the right stuff in you. You've simply got to APPLY IT IN THE RIGHT DIRECTION.

EVERY HONEST, SINCERE, WORTHY, AMBITIOUS FELLOW is entitled to an even break in life. Right now is the time to solemnly promise yourself to get rid of the jinx that's chasing you through life!

HUNDREDS OF COYNE-TRAINED MEN EARN \$60 TO \$200 A WEEK

I have started thousands of men, young and old, on the road to permanent success; have guided them to true happiness and independence. I have evidence to back up my claims—thousands of letters from men who never knew what it was to earn more than a few dollars a week or month until they took my splendid course in Electricity.

RAILROAD FARE TO CHICAGO

from any point in the U. S., also extra courses in Radio Electricity and Auto, Truck and Tractor Electricity included WITHOUT EXTRA COST if you act promptly. Remember, Chicago is a wonderful city to see at any time of the year. It is a city of opportunities and the great electrical center of the world. Clip the Happiness Coupon below at once.

Tune in COYNE Radio Station

Tune in on our own Radio Broadcasting Station, WGEB, 250 meters. The famous Coyne Student Broadcasting System is on the air every Friday night. Students may join the orchestra, also take part in the athletic and entertainment activities at COYNE. FREE

COYNE ELECTRICAL SCHOOL

H. C. LEWIS, President Established 1899
1300-10 W. Harrison St., Dept. 9357, Chicago

Send for My Big FREE Book and Details of R. R. Fare and 2 Courses without Extra Cost

Be sure to send at once for my big FREE BOOK containing 151 actual photos of electrical operations and methods; also my special offer of Railroad Fare to Chicago and 2 Big Courses without extra cost. Write today, sure, before this offer is withdrawn.

SEND COUPON NOW

H. C. LEWIS, President
COYNE ELECTRICAL SCHOOL
1300-10 W. Harrison St.
Dept. 9357, Chicago, Illinois

Dear H. C.—You can just bet I want one of those big, handsome FREE 12x15 books, with 151 actual photographs of electrical operations and shop scenes, printed in two colors. Send it quick, before the supply is exhausted. Be sure and tell me all about Special Offer of Extra Courses and Railroad Fare.

Name

Address



Salary increased 300% in few months

Chief draftsman of big company received big increase even before he had completed his course with the I. C. S.

"AT THE time I started my I. C. S. course I was working in a paper mill," writes A. J. Hutchins, Chief Draftsman for the American Strawboard Company.

"Before I had completed the course I was called upon to make drawings in one of the company's largest mills and was appointed Superintendent of Construction at an increase in salary of 300 per cent."

Every mail brings letters from students of the International Correspondence Schools telling of increases in salary due to spare-time study.

Why don't you study too and prepare for a real job at a real salary? You can do it if you really try.

Just mark and mail the coupon and we will send you complete information about the I. C. S. Drafting courses or any other course in which you are interested.

INTERNATIONAL CORRESPONDENCE SCHOOLS

Box 5533-E, Scranton, Penna.

Oldest and largest correspondence schools in the world

Without cost or obligation on my part, please tell me how I can qualify for the position or in the subject before which I have marked an X:

- | | |
|---|--|
| <input type="checkbox"/> Mechanical Drawing | <input type="checkbox"/> Structural Drafting |
| <input type="checkbox"/> Draftsmen's Course | <input type="checkbox"/> Ship Drafting |
| <input type="checkbox"/> Architectural Drawing | |
| <input type="checkbox"/> Electrical Engineering | <input type="checkbox"/> Architect |
| <input type="checkbox"/> Electric Lighting | <input type="checkbox"/> Architects' Blueprints |
| <input type="checkbox"/> Mechanical Engineer | <input type="checkbox"/> Contractor and Builder |
| <input type="checkbox"/> Machine Shop Practice | <input type="checkbox"/> Concrete Builder |
| <input type="checkbox"/> Railroad Positions | <input type="checkbox"/> Structural Engineer |
| <input type="checkbox"/> Gas Engine Operating | <input type="checkbox"/> Chemistry <input type="checkbox"/> Pharmacy |
| <input type="checkbox"/> Civil Engineer | <input type="checkbox"/> Automobile Work |
| <input type="checkbox"/> Surveying and Mapping | <input type="checkbox"/> Airplane Engines |
| <input type="checkbox"/> Metallurgy <input type="checkbox"/> Mining | <input type="checkbox"/> Agriculture and Poultry |
| <input type="checkbox"/> Steam Engineering <input type="checkbox"/> Radio | <input type="checkbox"/> Mathematics |
| BUSINESS TRAINING COURSES | |
| <input type="checkbox"/> Business Management | <input type="checkbox"/> Salesmanship |
| <input type="checkbox"/> Industrial Management | <input type="checkbox"/> Advertising |
| <input type="checkbox"/> Personnel Organization | <input type="checkbox"/> Better Letters |
| <input type="checkbox"/> Traffic Management | <input type="checkbox"/> Show Card Lettering |
| <input type="checkbox"/> Business Law | <input type="checkbox"/> Stenography and Typing |
| <input type="checkbox"/> Banking and Banking Law | <input type="checkbox"/> Business English |
| <input type="checkbox"/> Accountancy (including C.P.A.) | <input type="checkbox"/> Civil Service |
| <input type="checkbox"/> Nicholson Cost Accounting | <input type="checkbox"/> Railway Mail Clerk |
| <input type="checkbox"/> Bookkeeping | <input type="checkbox"/> Common School Subjects |
| <input type="checkbox"/> Private Secretary | <input type="checkbox"/> High School Subjects |
| <input type="checkbox"/> Spanish <input type="checkbox"/> French | <input type="checkbox"/> Illustrating |

Name.....
Street.....
Address.....

City..... State.....

Occupation.....

If you reside in Canada, send this coupon to the International Correspondence Schools Canadian, Limited, Montreal

DRAWING EASILY LEARNED



Haven't you often wished that you could draw cartoons, illustrate some idea, sketch some pretty face, etc.? You can do all of these things. One of America's most famous Cartoonists and Illustrators has developed a great, simple system for success in all branches of Commercial Art. This system has revolutionized the entire theory of drawing. It means that drawing can be as easy for you as writing—much simpler than learning shorthand, bookkeeping or typewriting. We are now placing this original system for learning Drawing, Art and Cartooning, consisting of 34 lessons with over 500 illustrations, within reach of every one. If you will devote a few hours each week to the Course WE ABSOLUTELY GUARANTEE that you will learn to draw and draw well before you have half finished the Course. If we fail to make this claim good, we will refund every cent paid us. By eliminating a large office force for answering correspondence, expensive catalogs, etc., we are enabled to make a price of \$2.98, the cheapest price ever known for a high-grade, home study course. Many have sent us letters similar to that of Rob't P. Davis of Detroit, who wrote: "I can't see how you ask so little, when others with inferior Courses get from \$20 to \$60 for theirs. It is more than I expected." Learn to draw. It is a big asset, no matter what field you are in.

Send No Money

Just order the Course, and **\$2.98** on arrival pay postman only plus a few cents postage, payment in full for the entire Course and Free Drawing Outfit. If not entirely satisfied, return within five days and we will REFUND MONEY. Address:

LEDERER SCHOOL OF DRAWING, Dept. 12-A, Chattanooga, Tenn. Orders from outside the U. S. A. are payable \$3.24 cash with order.

FREE: If you order the course at once, we will include a drawing outfit, consisting of artist's pencils, pens, paper, eraser, thumb tacks, etc., enabling you to go to work without any additional cost.

BIG MONEY IN POULTRY

Now's the time to get into the poultry business. This Fall eggs will jump way up in price. You can start small. Handsome profits in spare time. Free book tells all about our new, up-to-date, money-making poultry course, prepared by experts, and about our remarkable plan of close, careful, individual assistance. Write for a copy today.

National Poultry Institute, Dept. 608-B, Washington, D. C.

LEARN WATCH REPAIRING

Be a watchmaker—you can learn this profitable trade by correspondence in a few weeks in your own home by the DeSelms Chart System. After you complete the course you will know a watch from A to Z. You will know just what the matter is and how to repair one. When you graduate you will be a practical watchmaker and capable and competent to fill any position. Positions for our graduates. Ask for our free book. It explains our system and terms.

THE DeSELMS WATCH SCHOOL
LOGANSPORT, INDIANA





Ludwig

THE TRAP DRUM KING

Trap Drummers! With one of these Ludwig Trap Drums outside you will be able to make from \$75 to \$200 a week. Nearly all famous drummers use Ludwig equipment. Write in today for full information on all outfits. Ludwig & Ludwig, The World's Largest Manufacturers of Percussion and Rhythmic Instruments, Drum Makers to the Profession, 1611 N. Lincoln St., Dept. 1357, Chicago, Ill.

WANTED

MAIL CARRIERS (CITY OR RURAL)
\$1700 to \$3300 Year

Steady—common education sufficient. Big chance for men, 18 up.

Send me, WITH-OUT CHARGE, list of places at which I may get a position as Mail Carrier—Tell me how to get the position, and send free sample examination coupon.

Franklin Institute
Dept. H320
Rochester, N. Y.

Mail Coupon
Today
Sure

Name.....
Address.....

B. W. COOKE
Directing
Engineer

Be an AUTO EXPERT

Earn
up to
\$150
a Week



Put an end to Low Pay right now! Don't keep on working for \$35, \$40, \$50 a week. Be an Auto Expert. Get into the class of men who earn up to \$10,000 a year. Clip that coupon this very minute—I'll send you my big book "Auto Facts" absolutely free! I'll show you how you can make the BIG MONEY. I'll give you proof that you can raise your pay quick—write now!
B. W. Cooke.

NOW FREE!

The Book that Shows the Way to a BIG PAY JOB AND A RAISE

I'll send you Absolutely Free the same amazing book that has shown hundreds of men like you the quick way to the BIG PAY class as Auto Experts. It is the book that has doubled and tripled men's salaries quick—the book that has brought big extra spare time money to men all over the world—and put others in their own money-making Auto Businesses in record breaking time.

It points the way to a BIG JOB and a QUICK RAISE IN PAY FOR YOU!

Send Coupon Now

Be sure to send coupon at once for this remarkable book. Right now I am in a position to make you an outstanding offer of 4 Big Outfits which I'll include without a penny's extra cost. Get all the particulars at once!

Clip Coupon Now!

The **5** Thousand Dollar Industry

Every year car owners spend 5 Thousand Million Dollars for Auto Up-keep alone. That's why there are so many wonderful opportunities everywhere—in city or town, village or country—to start your own business—to be your own boss quick and make up to \$10,000 or \$15,000 a year with Cooke "Job-Way" training behind you. This Auto Business is the ONE BUSINESS for the man who wants BIG SUCCESS and MORE PAY—and wants it quick! It's the BIG PAY BUSINESS FOR YOU! Get all the facts. Clip Coupon Now!

LEARN AT HOME! The Cooke "JOB-WAY" Now!

Don't lose a day or a dollar to become a trained Auto Man. Keep your Job and Pay! My Free Book shows how I make you for Big Pay right in your own home. You don't need a bit of ready cash either. My big offer brings you the training you need to MASTER Auto Work—to boss the job—for just a few cents a week. If you are between the ages of 18 and 60, and can read and write plain, easy English—then write today. I'll show you the way to reach the Big Pay class quick! Find out why Cooke "JOB-WAY" is known as "The Training that pays its Own Way". Remember nowhere else on earth can you get the original, genuine copyrighted Cooke "JOB-WAY" Home training. Mail that coupon to me now. It will bring you the full particulars!

See How I Back You Up

A Big pay JOB and a QUICK RAISE is what you want. See how the demand for B. W. Cooke "JOB-WAY" trained men grows greater and greater. Remember Department stands behind you year while you work.

\$300 in a Week!

\$21 a week is all 18 year old Joseph Woronecki, 186 Altek St., Hartford, Conn., was making when he sent for my Book. Now he writes "By following your way I am making good money. Last week I drew in clear money THREE HUNDRED DOLLARS." I think of it. \$300 in a week! That's the kind of BIG PAY opportunities that are waiting for you!

Make Money Quick!

My training brings results so quick. It's positively amazing! Take J. P. Plow, Box 370, Ironwood, Michigan. Right in the beginning of his training, he writes me that he has already boosted his pay \$30 a week since the day he enrolled. And he adds, "I can't get away without thanking you for—your course is one in a Million." Find out about this remarkable "quick-results" training today.

Get into the **AUTO BUSINESS**

The biggest business in the world!

My big Free Auto Book shows you how. Think of it—18,000,000 cars on the roads today! Millions of new cars added every year! With all this tremendous growth there are less than half as many Repair and Service organizations per 1000 cars as there were 10 years ago! Thousands of money-making opportunities for you in this gigantic industry, the business that has become the BIGGEST IN THE WORLD. Even larger than the Steel Industry in value of production. Thousands of trained men are needed for the BIG JOBS—to boss the workbench.

MORE BIG PAY JOBS are open for the trained man than ever before!

Big Outfits included FREE of Extra Cost

Act quick! Right Now I am including Absolutely Free of extra cost, a fine set of Master Mechanics' Tools—Portable Electrical Test Bench and Radio Receiving Set—all equipment, also 292 Wiring Diagram Charts worth more than many which sell for as much as \$10.00.

Clip Coupon for full details.

MAIL "JOB-WAY" COUPON

B. W. COOKE, Directing Engineer, Chicago Motor Training Corporation, 1916-1926 Sunnyside Ave., Dept. 716, Chicago, Ill.

Send me your Free Book "AUTO FACTS" and PROOF that you'll show me the way to a QUICK RAISE and BIG PAY as an AUTO EXPERT. Also send your new 4 Outfits Offer. It is understood that this obligation is in no way, and that no salesman will call on me.

Name..... Address.....

B. W. COOKE DIRECTING ENGINEER
CHICAGO MOTOR TRAINING CORPORATION
1916-1926 Sunnyside Ave., Dept. 716, Chicago



\$100⁰⁰ a Week
For Drawing Funnies

Earn Big Money as a Cartoonist!

Millions of dollars were spent last year on comic strips, political and sport cartoons, animated cartoons, etc. Thousands of new cartoonists are needed now to meet the ever-increasing demand for this work. Never before have the opportunities in this fast-growing field been so many, so varied or so high-paying.

Easy Now to Learn CARTOONING at Home

Regardless of how little you know about cartooning now, you can easily qualify for a position in this attractive, high-salaried business. This home-study-method starts you at the simplest fundamental principles of cartoon-making and takes you through every branch of humorous and serious cartooning.

You will be amazed at how quickly it teaches you to draw salable work. Many students of this method began to sell their drawings before they were half through their courses. The training paid for itself long before they finished it.

Learn cartooning this easy way. Enjoy the fascinating life of a successful cartoonist—easy hours, freedom from routine, your own boss, and \$3,000 to \$15,000 a year for this work that is play!

Send for FREE BOOK

Learn more about the wonderful opportunities in Cartooning, and details about this remarkable home-study method. A handsomely illustrated booklet has just been prepared which, upon request, will be sent to you without the slightest obligation. This booklet gives a thorough outline of the cartooning field, and explains in detail this wonderful new method of teaching Cartooning. Send for it today! Washington School of Cartooning, Room 3010-C, 1113-15th St., N. W., Washington, D. C.



WASHINGTON SCHOOL OF CARTOONING
Room 3010-C, 1113-15th St., N. W., Washington, D. C.

Please send me, without obligation, your Free Booklet on Cartooning and full details of your home-study method of teaching Cartooning.

Name.....
(Print Name Plainly)

Address.....

City.....State.....
(If under 16, please give age.....)

Get this FREE Record!

DOUBLE-DISC phonograph record of two beautiful Musical Saw solos sent without charge. Hear the marvelous possibilities of this sensational instrument.

Complete Outfit
Sent On
Trial



No notes to read. No tedious practice. Just three short, simple lessons and you play popular and classical music. I guarantee success; no charge whatsoever if I fail. Thousands of my students are amazing friends, playing in dance and broadcasting orchestras or at lodge and church entertainments. Write for SPECIAL INTRODUCTORY OFFER of Saw, Hammer, Bow and Resin, FREE with Course of Instruction and how you can obtain complete outfit on trial.

MUSSEHL & WESTPHAL
250 West Water St. Fort Atkinson, Wis.



Wonderful, new device, guides your hand; corrects your writing in few days. Big improvement in three hours. No failures. Complete outline FREE. Write C. J. Osment, D-34, St. Louis, Mo.

Clear-Tone

The Wonder-Working Lotion

Used like toilet water. Is positively recommended for quickly and permanently removing

PIMPLES, BLACKHEADS,

Acne Eruptions on the face or body, Barbers Itch and Eczema, Enlarged Pores, Oily or Shiny Skin. Endorsed by druggists, physicians, skin specialists, barbers, and over 100,000 men and women test cases, who succeeded with Clear-Tone after failing with everything else.

FREE Write today for my FREE Booklet, "A CLEAR-TONE SKIN," telling how I cured myself after being afflicted for fifteen years.

E. S. GIVENS, 128 Chemical Building, Kansas City, Mo.



Will You Wear This Suit?

Show it to your friends and neighbors as a sample of our fine quality, hand-tailored All-Wool Suits, guaranteed \$40 values at amazing low price of \$23.50, take their orders, keep handsome profit for yourself and send orders to us.

Agents Making BIG MONEY

\$3.00 to \$5.00 an hour in spare time, \$75 to \$150 a week for full time. We supply handsome Swatch Line Outfit, large size samples and all latest styles in elegant Leather Case.

Positively finest selling outfit ever furnished salesmen. Write for yours at once, pick out your suit and get started making the Big Money right away. Address Dept. 204.

JAMES OLIVER, Inc., 848 W. Adams St., Chicago

Write name and address below and mail at once.

Name.....

St. and No.....R. F. D.....Box.....

Town.....State.....

Electricity Needs You!

Get Into This Interesting Big Pay Work—

LEARN TO EARN \$70 TO \$200 A WEEK

Yes, you can make \$70 to \$200 a week in Electricity and not work half so hard as you do now. You can earn \$3,500 to \$10,000 a year as an Electrical Expert and I will show you how to do it. And with the 5 Big Outfits given to students, you can make extra money in your spare time, right at the start, while you are getting ready for the big job which I will help you get. The whole world is rapidly being electrified. Over a million homes a year are being wired for electric light. Hundreds of huge power houses are constructed every year. Entire railroad systems are replacing steam with electricity. Radio—Automobiles—Mining—Manufacturing—all depend on it. Electricity is the biggest thing in the world today.

TRAINED MEN NEEDED EVERYWHERE

Right now there are more big jobs open to trained men than there are men to fill them. Even ordinary screwdriver electricians make \$8.00 to \$10.00 a day, but here's your chance to get a real job—a bossing job—the kind that pays \$12.00 to \$30.00 a day—or go into business for yourself—and you can get ready for it in a few short months' time right in your own home.

EXPERIENCE UNNECESSARY

Don't hold back—Don't rob yourself of the things you want just because you may not know anything about electricity now. Nine out of ten of the thousands of successful, big-money men I have trained didn't know the first thing about it when they started with me. Don't let lack of education stop you either. If you can read and write I can make you the success you want to be and I will guarantee your satisfaction with a signed, MONEY BACK guarantee bond.

WHY I CAN TRAIN YOU QUICKLY

As Chief Engineer of a two-million dollar corporation, and with 25 years of engineering experience, I know exactly what you must know to earn \$12 to \$30 a day as an Electrical Expert. That's exactly what I give you. My students get the big jobs because through my connections with the great Electrical Industry I know where the big jobs are and I train my "boys" to fill them and then I help them get them. The Cooke Trained man is the big pay man—ALWAYS.

SEND FOR MY BIG FREE BOOK

The whole big story of electricity—everything laid open before your eyes—hundreds of pictures—hundreds of letters from other men who earn up to \$10,000 a year—it's all in my book—"The Vital Facts About Electricity." And you can have a copy free. Send me your name on the coupon below, today—NOW—while the feeling to be somebody—to be a big-money-maker—is upon you. Read about it in my book first.

L. L. COOKE, Chief Engineer

Chicago Engineering Works

Dept. 517, 2150 Lawrence Avenue, Chicago, Ill.

L. L. COOKE, Chief Engineer, CHICAGO ENGINEERING WORKS
Dept. 517, 2150 Lawrence Avenue, Chicago, Ill.

Send me your book "The Vital Facts About Electricity" and full particulars of your Home Study Course, Five Electrical Outfits Offer, and your Employment Service. This does not obligate me to enroll with you.

Name.....

Address.....

City..... State.....



Martin Ferri, Tiltonville, O., jumped from \$100.00 to \$300.00 a month after taking my Course. He specializes in Auto Electricity.

The
"Cooke"
Trained
Man
Is the
Big Pay
Man!

Free!

the coupon
brings
you this
Big
Book
Free!





The Making of an Unusual Salesman

Here are Some of the Records

**Big
JOBS
Now
Open**

After spending fourteen years as conductor on a railroad, I came in on my passenger run and never went out again. I saw there were wonderful chances in the selling field; so I started in selling real estate. The first month I did not make a sale. I saw I needed something to help me, so I took up LaSalle training Salesmanship. The next month I made \$700 and last month I averaged better than \$67 a day throughout the month.

C. A. THOMAS, California.

My salary was practically doubled a short time ago, but my greatest satisfaction comes from knowing that the amount of business I have written this year is easily five times greater than before.

S. N. WILLIAMS, Kentucky.

With or without previous experience, you may become an unusually successful salesman. Men who sent for this book from one to six months ago have doubled their earnings.

If you are seeking advancement or greater opportunity, get full particulars of the LaSalle *salary-doubling plan*. The coupon will bring it to you, together with two valuable books—"The Making of an Unusual Salesman" and "Ten Years' Promotion in One," all without obligation.

If a successful career is worth two cents and two minutes of your time, clip and mail the coupon NOW.

LASALLE EXTENSION UNIVERSITY

The World's Largest Business Training Institution

Dept. 1064-SR Chicago

Please tell me about your *salary-doubling plan* as applied to my advancement in the business field checked below. Send also copy of "Ten Years' Promotion in One," all without obligation.

Modern Salesmanship

- | | |
|---|--|
| <input type="checkbox"/> Business Management | <input type="checkbox"/> Modern Business Correspondence and Practice |
| <input type="checkbox"/> Higher Accountancy | <input type="checkbox"/> Modern Foremanship and Production Methods |
| <input type="checkbox"/> Traffic Management | <input type="checkbox"/> Personnel and Employment Management |
| <input type="checkbox"/> Railway Station Management | <input type="checkbox"/> Expert Bookkeeping |
| <input type="checkbox"/> Law, Degree of LL. B. | <input type="checkbox"/> Business English |
| <input type="checkbox"/> Commercial Law | <input type="checkbox"/> Commercial Spanish |
| <input type="checkbox"/> Industrial Management Efficiency | <input type="checkbox"/> Effective Speaking |
| <input type="checkbox"/> Banking and Finance | <input type="checkbox"/> C. P. A. Coaching |

Name.....

Present Position.....

Address.....

Learn How to BOX

JIMMY DEFOREST World's Greatest Trainer Will Teach You BY MAIL



In 20 weeks I will teach you all there is to know about boxing—just what I taught Jack Dempsey and a host of other champions and great contenders. Every six months I select champions in all weight classes from my pupils. I train them at my own expense at my Long Branch, N. J., camp. Then TEX RICKARD, greatest of all promoters, stages them in bouts in his new Madison Square Garden at New York. Send today for my big FREE book, "The Golden Age of Boxing." Enclose 10 cents to cover cost of mailing. You've never before seen a book like this! Profusely illustrated with photos of great fighters and fully describes my course and FREE OFFER. There's fame and fortune waiting for you if you become a good boxer. Get my book and read all about it.

JIMMY DEFOREST, Box 620

347 Madison Ave.,

New York City

Learn to Mount Birds



Learn at home by mail, to mount birds, animals, game heads; tax furs, make rugs and robes. Complete lessons. Easily and quickly learned by men, boys and women.

FREE Write today for Free Taxidermy Book. Tells all about it. Every Sportsman, Hunter, Trooper and Nature lover should know this wonderful fascinating art. Save your trophies. Big profits guaranteed. Our school is 20 years old - 75,000 graduates. Investigate today. Write for Free Book.

Northwestern School of Taxidermy

9777 Elwood Bldg., Omaha, Neb.

LEARN PIANO TUNING AT HOME

with our TUNE-A-PHONE, Action Model, tools, charts and lessons you learn easily and quickly. Earn big money. Estb., 1898. Money-back Guarantee. Diploma given. Low tuition; easy terms.

Write today for our FREE book, "Winning Independence." Niles Bryant School of Piano Tuning, 40 Bryant Bldg., Augusta, Mich.

LEARN WATCHMAKING AND ENGRAVING



BY OUR PROFIT-SHARING PLAN
OUR GRADUATES SUCCEED

One of our Iowa students started in a very small way—now doing over \$20,000 a year. Another in Wisconsin, over \$10,000 the first year. Day or night classes. Call or write for FREE BOOK

Chicago School of Watchmaking, Dept. 901, 4844 Lincoln Avenue, CHICAGO

YOU CAN OIL PAINT

Amazing new method teaches men or women to earn after first lesson. OIL PAINT photos—portraits, landscapes of art subjects. Earn \$18 to \$100 and more a week. OIL PAINT OUT-FIT GIVEN. Send now for free illustrated book. PICTORIAL ART STUDIOS, Inc., Dept. MP, 2731 No. Clark St., Chicago

LEARN PHOTOGRAPHY!

Earn \$200 to \$500 monthly. Or start your own business. Photography and Photo-Engraving taught by largest college of its kind in world. Established 1893. Big demand for graduates. Write for freebook. Illinois College of Photography, Box 4105, Effingham, Ill.

ELECTRICITY

COMPLETE COURSE FOR HOME STUDY \$10

Hawkins Electrical Guides, 10 Numbers \$10. Complete home study course with questions and answers. Teaches entire subject of practical, modern electricity. Plain language, clear diagrams. 3500 pages, 4700 illustrations. Authentic, highly endorsed—help you to better position and pay. Examination Free, \$1 a month if satisfied. Here is your opportunity. Send this coupon today!

FREE EXAMINATION
THEO. AUDEL & CO., 65 West 23rd St., NEW YORK CITY

Please send me free examination coupon and full particulars about Hawkins Electrical Guides.

Name.....

Address..... 10T30



All Branches of Building Offer You Big Money

Be an expert builder.
Train at home
 . . . in spare time

\$6,000,000,000 for building this year. That's the estimate of America's foremost building banker. Think of the endless opportunity this offers every man in any branch of the building business. Wherever you live you see it . . . new homes, new schools, theatres, shops and office buildings. You know men who have made fortunes in real estate, contracting . . . in some branch of building. The newspapers are crowded with records of real estate transactions and enterprises.

This opportunity calls you—no matter what your job is now

Bank clerk or carpenter . . . superintendent or mason . . . store clerk or office man . . . it makes no difference. You can succeed in the building business. Experience is not necessary. Keep right on at your present job. Learn to be an expert in some branch of building . . . or have a business of your own. Learn in spare time. You will find it mighty worth while. If you are in the building game now you know the large wages . . . \$10 to \$20 a day . . . paid to foremen, superintendents and estimators . . . to experts in all branches of the building business.

You can get into the building business quickly . . . easily. Or if you are in it and want to advance . . . to get ahead and make more money . . . you can get the training *now* that you must have for success.

Building Construction, Financing, Real Estate, . . . Plan Reading, Superintending, Estimating and all other branches

These are a few things you learn from the Chicago Technical School for Builders. All branches of building . . . all the knowledge you require to have a building business of your own.

You learn at home, in your spare time. All

lessons are in plain every day English, as easy to read and understand as your newspaper. And you learn from actual blue print plans . . . from practical building experts. A 22-year old institution of high standing offers this fine home-study course.

Notice!

This course covers the entire field of building and construction so thoroughly that upon its completion our graduates will be qualified and fully trained in all the following important divisions of building: Contracting, Real Estate, Banking, Loans and Insurance, Appraisal and Cost Accounting, Building Management, Public Estimating and Promoting, Building Inspecting and Superintending, Buying and Selling Building Material, Quantity Surveying.

Free Trial Lesson and Blue Print Plans

Find out about this builders' course, *now!* The coupon will bring you absolutely *free* and without obligation the first lesson. It's a book . . . "How to Read Blue Prints" . . . written by a practical building expert. With it we send you *free*, actual blue print plans and a book that tells all about the Chicago Technical School for Builders . . . about the practical men who prepare all lessons, handle all questions and correspondence. It tells what the course

has done for others . . . and what it offers you. All sent *free*, to make it possible for you to see the simplicity of this course . . . and its great opportunities . . . before you send one penny. Send in the coupon *today*. It may start you tomorrow toward owning a business of your own . . . or becoming a high salaried expert in some branch of the Nation's second largest industry.

CHICAGO TECHNICAL SCHOOL for BUILDERS Dept. 103, Chicago Tech. Building, 118 East 26th Street, Chicago, Ill.

Chicago Technical School for Builders,
 Dept. 103, Chicago Tech. Bldg.
 118 East 26th Street, Chicago, Ill.

Please send me, without obligation, your Free Books and Blue Prints and the facts about your Building Course. Send postpaid to my address at the right.

(Write or print name plainly)

Name

Address

City and State

Occupation

FREE Trial!

In your own home—

Become a crack Xylorimba player right in your own home. Easiest instrument to play. Everyone enjoys it—anyone can learn to play it. We furnish you free 14 complete lessons. Learn to play in a few hours. Earn \$80.00 to \$200.00 a week. Deagan instruments are world-renowned—used extensively in leading dance, theatre and concert orchestras, and for Radio Broadcasting. Yet, the cost of the Deagan Xylorimba is no greater than the cost of any other good instrument.



DEAGAN XYLORIMBA

With this instrument you can play either for profit or for fun. Deagan instruments furnish the "spice" of the music. Used exclusively in recording studios for phonograph records.

Free Lessons—A Year to Pay

Our free trial and easy payment plan make it easy to learn at home. Send coupon below for illustrated literature and details of our special free trial offer.

-----SEND THIS COUPON-----

J. C. DEAGAN, Inc., Dept. 1357
Berteau and Ravenswood Avenues, Chicago, Ill.

Gentlemen: Without obligation, please send me literature and full information regarding your Free Trial Deagan Xylorimba offer.

Name

Address



Hotels Start You With Salaries up to \$3,500 a Year
— with your living

HOTELS, restaurants, clubs, apartments, everywhere need trained men and women—salaries to start up to \$3,500 a year with your living. Over 70,000 high-class positions paying up to \$10,000 a year are open every year in the hotels of the United States. Today this is the 1st INDUSTRY IN AMERICA—with over \$992,394,968 in new hotels being built in 1925—exceeding by \$200,000,000 the next largest industry. These new hotels, restaurants, etc., will need over 60,000 trained men and women.

You can have one of these high-class big-pay positions, with luxurious meals and apartment and fascinating work. No previous experience necessary. The Lewis Schools guarantee to give you the valuable knowledge that it has taken some of the most successful hotel men years to obtain—men who are now making \$5,000 to \$50,000 a year. We train you by mail in your spare time at home with the Lewis Simplified Study Plan, and we put you in touch with big opportunities. Our students employed, our methods endorsed by leading hotel men everywhere. Send today for Free Book, "YOUR BIG OPPORTUNITY," showing how we can train you for one of these splendid positions in 20 weeks or less, and explaining our Money-Back Guarantee.

LEWIS HOTEL TRAINING SCHOOLS
Room X-388 Washington, D. C.

-----FREE BOOK COUPON-----

LEWIS HOTEL TRAINING SCHOOLS, Room X-388, WASHINGTON, D. C.
Send me without obligation the Free Book, "YOUR BIG OPPORTUNITY."

Name

Address

City



Must Men Past 40 Face Surgery?

Medical authorities agree that 65% of all men past middle age (many much younger) are afflicted with a disorder of the prostate gland. Aches in feet, legs and back, frequent nightly risings, sciatic pains, are some of the signs—and now a member of the American Society for the Advancement of Science has written a remarkably interesting Free Book that tells of other symptoms and just what they mean. No longer should a man approaching or past the prime of life be content to regard these pains and conditions as inevitable signs of approaching age. Already more than 20,000 men have used the amazing method described in this book to bring better health—and to restore the prostate gland to its proper functioning. Send immediately for this book. If you will mail your request to the Electro Thermal Company, 2150 Main Street, Steubenville, Ohio—the concern that is distributing this book for the author—it will be sent to you absolutely free, without obligation. Simply send name and address. But don't delay for the edition of this book is limited. Western Office, Dept. 21R, 711 Van Nuys Bldg., Los Angeles, Calif.

Tri-State College of Engineering

Makes you a Civil, Mechanical, Electrical or Chemical Engineer in two years, 48 weeks each. No entrance examinations. High School Diploma not required. Compact courses made up of essentials only. Expenses low. For catalog address, Box M-10, Angola, Ind.

10c Learn Electricity

25c book "Electricity and Magnetism" key to electrical knowledge and small motor building.

For a short time only.....

KNAPP ELECTRIC CORPORATION
Dept. 109 Port Chester, N. Y.

10c



SAXOPHONE MUSIC Catalog

Just out—complete catalog **FREE** of latest jazz hits, also standard saxophone solos, duets, trios, quartets—2000 selections. Largest general dealers of saxophone music and supplies in the world. **Expert repairing.** Send for free catalog today.

FINDER & URBANEX, Dept. 901-A, 1322 West Congress St., Chicago

LEARN Penmanship

I can teach you Penmanship by mail during your spare time. Fifteen years of experience proves my ability. Good penmanship secures positions and increases salaries. Free book, "How to Become An Expert Penman," which explains my Method. I will write your name elegantly on a card if you enclose stamp to pay postage. Write today

T. M. TEVIS Box 25-M CHILLICOTHE, MO., U. S. A.





Play Your Way to Greater Popularity

with the fascinating
HAWAIIAN GUITAR

Play all the
LATEST HITS
just as the
Hawaiians do

\$15
HAWAIIAN GUITAR
with Genuine Seal Grain
Fabrikoid Cover

FREE
when you
enroll

Be the most popular member of your set. Get in on all the good times. Play all the new song and dance hits. Entertain your friends—or play professionally. Be in demand everywhere. We will help you.

Learn Quickly and Easily in Spare Time at Home

Even if you don't know one note from another, our method is so simple, plain and easy that you begin a piece your first lesson. In half an hour you can play it! You study in spare time—when you like—as long as you like. And your lessons are always before you to refer to at any time.

Our Native Hawaiian Instructors Will Show You How

You receive expert instruction from such world-famous players as Kolomoku, Kalaluki, Ferera and Seville. They quickly teach you the secrets of this fascinating instrument. And remember—the services of these gifted native masters of the Hawaiian Guitar are obtainable only through this old-established New York Conservatory.

Complete Conservatory Course

You get 52 complete printed lessons. Nothing is omitted. Pictures explain every move. And no matter how little you know about music, no matter if you have never touched a musical instrument, our easy picture method will make you an accomplished player.

Only 4 Motions to Learn

Then you can play any music—popular songs, classical, old-time melodies, native Hawaiian airs—or real jazz—separately or with accompaniment. You'll never be lonesome when you can play the Hawaiian Guitar. By our simple method you learn—and learn quickly. No waiting for class to form—you can begin now.

New Invention Makes It Easy

Our course includes a marvelous invention which helps you to make rapid progress. You will be astonished how quickly you learn to play this popular musical instrument, the Hawaiian Guitar, just as the Hawaiians do!

Our Written Guarantee

Anyone can play the Hawaiian Guitar. We guarantee in writing to teach you. The success of 45,000 students backs up our claim. Like them, you can soon be a full-fledged player, your popularity established and constantly increasing, a professional career ahead of you if you desire. And we coach and advise you after graduation—with no extra expense.

Pay as You Play

We make it easy for you to obtain the many advantages of this big Conservatory. You start with a small first payment—then pay while learning. It comes to only a few cents per lesson. And bear in mind—your only investment is the moderate cost of your lessons—we furnish everything else.

This Sweet Toned Hawaiian Guitar FREE

This sweet-toned Hawaiian Guitar would cost you at least \$15 in any music store without the genuine Seal Grain Fabrikoid Case. We give you the entire outfit free when you enroll, including everything necessary to carry on your studies and play the instrument. We can do this because we make them in huge quantities in our own factory.

**First Hawaiian
Conservatory of Music, Inc.**
9th Fl., Woolworth Bldg.,
Dept. 48 New York

Approved as
a Correspondence School
Under the Laws of the
State of New York

No
Extras
—We
Furnish
Everything

Including the Free
Hawaiian
Guitar,
in genuine
Seal Grain
Fabrikoid Case
—picks,
steel playing
bar and 52
pieces of
music.

Other
Courses
Famous
teachers conduct our
courses in
Tenor Banjo,
Violin,
Mandolin,
Banjo-Ukulele,
Ukulele.



This is the Popularity Coupon—MAIL IT NOW

First Hawaiian Conservatory of Music, Inc.
Dept. 48, 9th Floor, Woolworth Bldg., New York, N. Y.

Please mail full information about your 52-lesson
Hawaiian Guitar Course. I am not obliged to
enroll unless I want to.

Name.....
Address.....
City.....
State.....

60 MILES ON A GALLON OF GASOLINE

TESTS SHOW FORD CAN RUN 60 MILES ON A GALLON

The amazing fact that a Ford can run 60 miles on 1 gallon of gasoline was recently brought to light through tests conducted by America's foremost engineers, where it was shown that a gallon of gasoline contains sufficient heat units which if properly atomized and mixed with air would give this additional mileage. Great strides have already been made in this direction by the recent invention of a simple attachment which can be installed in a few minutes without any alterations to the motor. It is common for Ford Owners to make from 40 to 44 miles per gallon after this marvelous device is attached.

MOST WONDERFUL INVENTION TODAY BRINGS JOY TO FORD OWNERS

Starts Ford Instantly

Starting a Ford Car in cold or zero weather is something every Ford Owner dreads—everybody realizes that difficult starting is an abuse on the starter and battery. Thousands of Ford Cars are "laid up" during the Winter just for these reasons. This great difficulty has been overcome. The SUPER positively starts a Ford Car instantly in the coldest weather.

Marvelous Device

The SUPER is no trick affair—requires no mechanical adjustments and contains all the scientific principles of carburetors costing \$20 to \$35 and in its natural action uses up every particle of unused gasoline and breaks it up into a perfect vapor. The hitherto impossible is now realized by the SUPER.

Everybody Satisfied

Saves 3 to 7 Dollars Per Month

The best investment I ever made. The SUPER is saving me from three to seven dollars each month, besides putting new life into my motor.

A. H. WORRA, Iowa.

Makes 44 Miles Per Gallon

I have tried the SUPER and the results of the experiment are satisfactory. One quart of gasoline runs my Ford 11 miles over improved roads which is just about again as far as I could run with the plain Ford Carburetor.

G. E. YODER, Penn.

Finds That Our Claims Are Correct

I find that your claims for increased mileage are correct and that a big saving is made by your SUPER. In fact, the best device I have met with in that line.

M. J. VAN LEEUWEN, Mass.



The Heart of the Motor

Eliminates Oil Pumping in Front Cylinder

What a wonderful relief to Mr. Ford Owner when he realizes that he can run his car without the motor pumping oil in the front cylinder. Sounds like an awful lot to expect of any device, but that is what the SUPER does and this is only one of its many advantages because it puts real efficiency into any Ford Car.

Complete Combustion

The SUPER is so designed that it takes advantage of the present Ford Carburetor and properly atomizes the light as well as the heavy elements of the fuel, converting every atom of gasoline and kerosene into power preventing liquid fuel from passing into the cylinders, thus avoiding carbon formation and oil dilution.

Easy to Sell

Sells Like Hot Cakes

This is a recent letter from one of our distributors: "Enclosed find draft for 200 more SUPERS, rush as I need them badly. I sold and banked \$104.00 in one day. Hope to sell 1000 SUPERS next month."

A. W. LEONARD, Penn.

Making Big Profits Every Noon

I have been working the SUPER at noon only. Yesterday noon I made more money with the SUPER than I did at my 11 hours' hard work in the factory all day.

J. L. LEHNER, Wis.

Had No Previous Selling Experience

This letter shows what ambition does: "I sold six SUPERS in less than 2 hours tonight. I think it's a pretty good start—for it's the first thing I ever sold."

E. MANGOLD, Ind.

\$60.00 TO \$150.00 PER WEEK EASY

You just can't help making Big Money selling the SUPER because a trial sells itself and soon everyone in the neighborhood get talking about this marvelous device. Men like Leonard, Shaw, Manner, Kinsley, Peters, Sands, Beck and Hall are not exceptional salesmen, but just the type of men that saw an opportunity and were quick to grasp it when within reach. No previous selling experience is necessary, just a little ambition on your part to make money is all we ask and we will extend the same opportunity to you. Spare time will pay you well. If you can devote your entire time so much the better, because the SUPER is a whirl-wind seller and takes hold in a locality like wildfire.

Men Wanted Everywhere To Introduce

We want distributors in all parts of the country to take orders and deliver the SUPER and to look after the repeat business that is bound to follow and to such distributors we are willing to assign territory. You do not have to own a Ford to take up this proposition but if you have a Ford it is easier to explain its many advantages. However a Trial of the SUPER convinces the most doubtful person and tells a wonderful story.

▶ A REAL FUTURE HERE

WEEKS SUPER CARBURETOR CO.

426-1462 Eleventh St., Milwaukee, Wis.

MAIL TODAY

WEEKS SUPER CARBURETOR CO.
426-1462 Eleventh Street, Milwaukee, Wis.

GENTLEMEN: Please mail me full free particulars about your wonderful invention.

Name

St. or R.F.D.

Town

County

State

EVEREADY HOUR
EVERY TUESDAY AT 9 P. M.
(Eastern Standard Time)

For real radio enjoyment tune in the "Eveready Group." Broadcast through stations—

WEAF New York	WCAE Pittsburgh
WJAR Providence	WGR Buffalo
WEEI Boston	WOC Davenport
WEAR Cleveland	WCCO { Minneapolis
WWJ Detroit	{ St. Paul
WFI Philadelphia	WSAI Cincinnati

*The proven
 Dry Cell for all
 Radio Dry Cell
 Tubes*



Eveready
 Columbia
 Ignitor
 Dry Cell
 "A"
 Battery
 for all
 Dry Cell
 Tubes
 1½ volts

Recommend good batteries

IN AN effort to reduce the first cost of a radio set, a newcomer in radio often buys inferior batteries. You know such "saving" is really wasteful. Tell your friends who are about to buy receivers that the best batteries obtainable will prove to be the most economical. Tell them to buy Eveready Radio Batteries—they last longer and, because they are greatly superior, they give complete satisfaction.

Manufactured and guaranteed by

NATIONAL CARBON COMPANY, INC.
 New York San Francisco
 Canadian National Carbon Co., Limited, Toronto, Ont.

EVEREADY Radio Batteries

—they last longer



No. 770
 45-volt
 Extra
 Large
 Vertical
 Price
 \$4.75
 For use
 on multi-
 tube sets



No. 767
 45-volt
 Large
 Horizontal
 Price
 \$3.75
 With
 variable
 taps

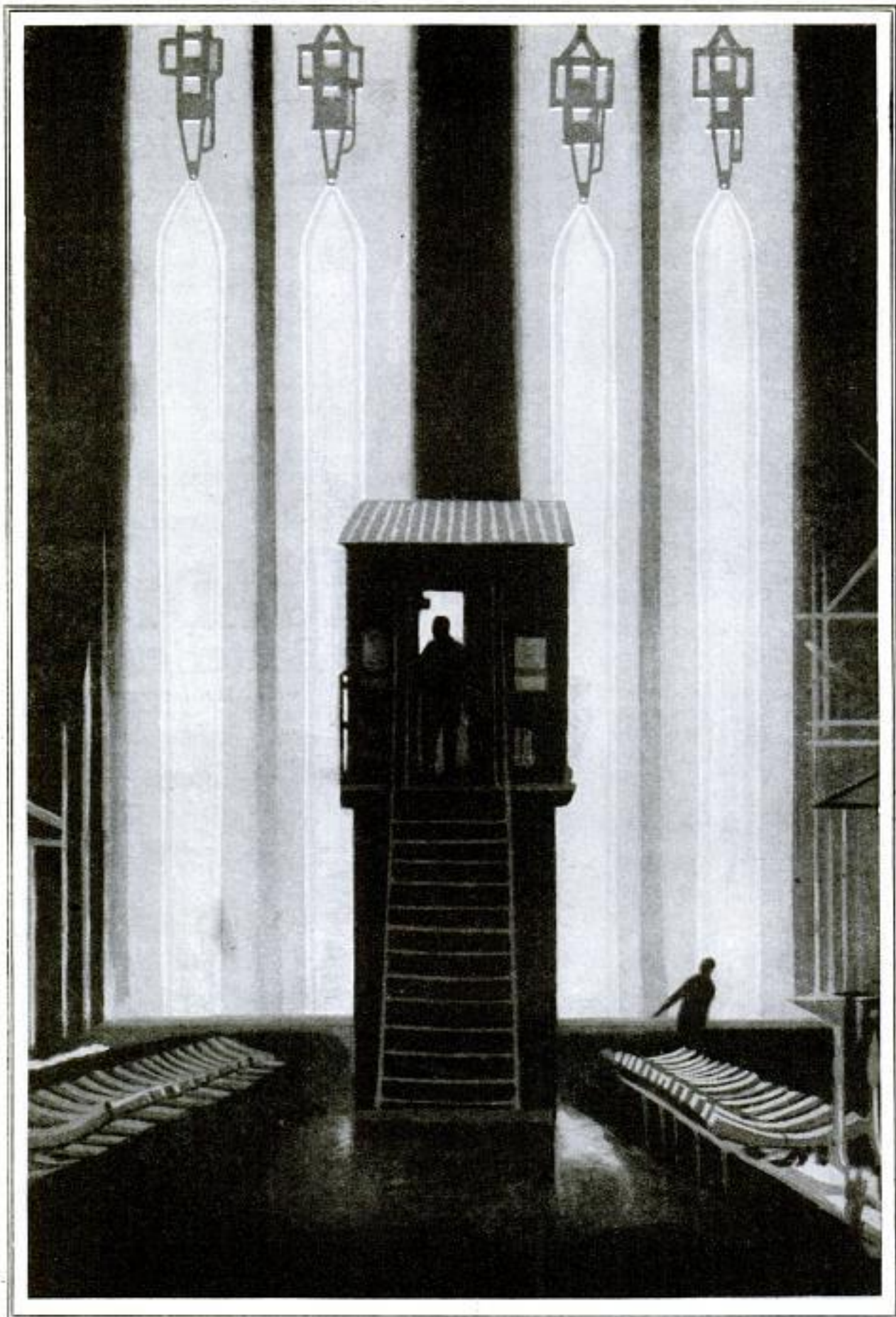

Like Cathedral Columns, Huge Glowing Cylinders of Molten Glass Rise Slowly Upward from the Furnace Pit as Air Blows the Incandescent Mass into Fragile Tubes—See Page 619

Popular Mechanics Magazine

REGISTERED IN U. S. PATENT OFFICE

WRITTEN SO YOU CAN UNDERSTAND IT

Vol. 44

OCTOBER, 1925

No. 4

Cancer Germ Seen through Camera's Eye

Most Powerful Microscope Ever Made Photographs Germs No Lens Has Disclosed Before as Step Forward in Disease Fight 121

ISOLATION of what research workers believe to be the real germ of cancer is claimed by two English scientists, working with a new type of ultra-microscope which photographs organisms so minute that the human eye cannot see them even with the best, earlier microscope.

The discovery does not mean an immediate cure for cancer, but it is hoped that further research work will indicate methods of vaccination which will render the virus harmless. The work so far accomplished indicates that the germs discovered by Dr. William Ewart Gye and Mr. J. E. Barnard, the two English scientists, are insufficient directly to cause cancerous growth, but that they combine with a chemical substance present in tumors to produce cancer.

Behind the discovery of the germ cell is an interesting story of a store proprietor who has worked mornings for many years as a hatter in order to earn money to spend his afternoons as a scientist. He is J. E. Barnard, the greatest living authority in England on microscopes. His unusual hobby won him a membership in the Royal Society, and when the war broke out, caused him to be placed in charge of microscope work for the army medical corps.

For four years, associated with Dr. Gye, he has sought to isolate the cancer germ, which is so small that it passes through the finest earthenware filters. Their success finally was made possible

by the perfection of a complex microscope which utilizes the powerful short-wave ultraviolet light to photograph the micro-organisms, which ordinary sunlight will not do.

Describing their work, Dr. Gye explains that the cancer virus they isolated, when combined with virus-free extract of tumor and injected into the veins of mice and chickens, set up malignant cancerous growths. The tumor extract, called by Dr. Gye the "specific factor," apparently helps the cancer virus to break down the defense of the cells of the animal, allowing the virus to enter them, infect the tissue, live and multiply, and at the same time provoke the cell to continued multiplication, thereby producing cancer.

The work of the English scientists continued investigations made twelve years ago by Dr. Francis Peyton Rous, famous pathologist of the Rockefeller Institute, who tracked down the virus and established its existence as a very small but active microbe, though he was never able to see or photograph it.

Even with the microbe isolated and identified, the search for a cancer cure still has a long way to travel. It is known that the disease may be produced by constant irritation of the flesh, whether caused by a bruise or by some other agency. Certain heavy oils, paraffin and coal tar are among the known irritants. In recent experiments with crude oil, Brit-



Dr. Michael Levine, American Scientist, Who Seeks Relation between Plant Cancer and Human Disease

Montefiore Hospital
Cancer Laboratory

529

Copyrighted material

*Dr. William Barnard Jones
Hatchmakers Gernymn St. London, Eng.*

*Down Hill Road + Cambridge Ave
New York City.*

121 ish research workers produced tumor growths in mice when subjected to eight out of twelve samples of oil tested. A curious result was that only the crude, heavy oils produced cancer, while the refined and volatile liquids, such as gasoline and kerosene, did not have the same effect.

Despite the fact that the connection between such irritants and the start of cancer has been known for many years, Dr. Gye explains that he is still in the dark as to how the irritant produces the infection. In the laboratory experiments, the virus, along with the specific extract, was injected into the animals, but this, he continues, "was done in the laboratory and not by nature."

Microbes, such as those of cancer, belong to a family of about fifty, all invisible to the eye using the ordinary microscope. A sequel to the discovery of the cancer virus may be the discovery of a preventive vaccine, as distinct from a cure for cancer. The English doctor is now at work on the experimental farm of the National Institute for Medical Research, carrying out tests on chickens, with a view to finding an active agent which will render immune, first birds, then people, against cancer.

All these medical and scientific wonders depend largely upon the perfection of the new ultra-microscope, the latest weapon in the war on disease. The ordinary microscope allows the observer to see, at its greatest degree of magnification, anything larger than a wave length of ordinary

light. The ultra-microscope goes farther. It permits the observer to see, not the invisible particles of bacteria, but the deflection they cause to an intense beam of light passing at right angles to the microscope, and across a film of liquid containing the microbe. The scientist, looking through the eyepiece of the instrument sees only a dark background. If, however, a moving particle, like a mote in a sunbeam, crosses the light, which does not shine into the microscope, that moving particle reflects the light and a faint, luminous appearance is seen by the eye to be moving on the black background of the lens.

The new microscope looks very unlike the ordinary brass-mounted lens of the laboratory worker or the field entomologist. It resembles an engineers' lathe, and is rigidly built to withstand vibration or looseness of any kind, and to insure the greatest possible precision. An essentially novel part of the mechanism is a "dark ground illuminator" made of quartz lenses, which, unlike ordinary glass, transmit the short-wave, ultraviolet rays for photographing the filtrate containing the cancer virus.

This optical system allows the amazingly minute microbes to be seen by their reflected light. Mr. Barnard found that the green line in the spectrum of mercury, as in the mercury-vapor lamp, best enabled the eye to see the reflected light of the germ particles. He therefore uses this lamp to reveal the presence of these ultra-microscopic microbes to the eye.

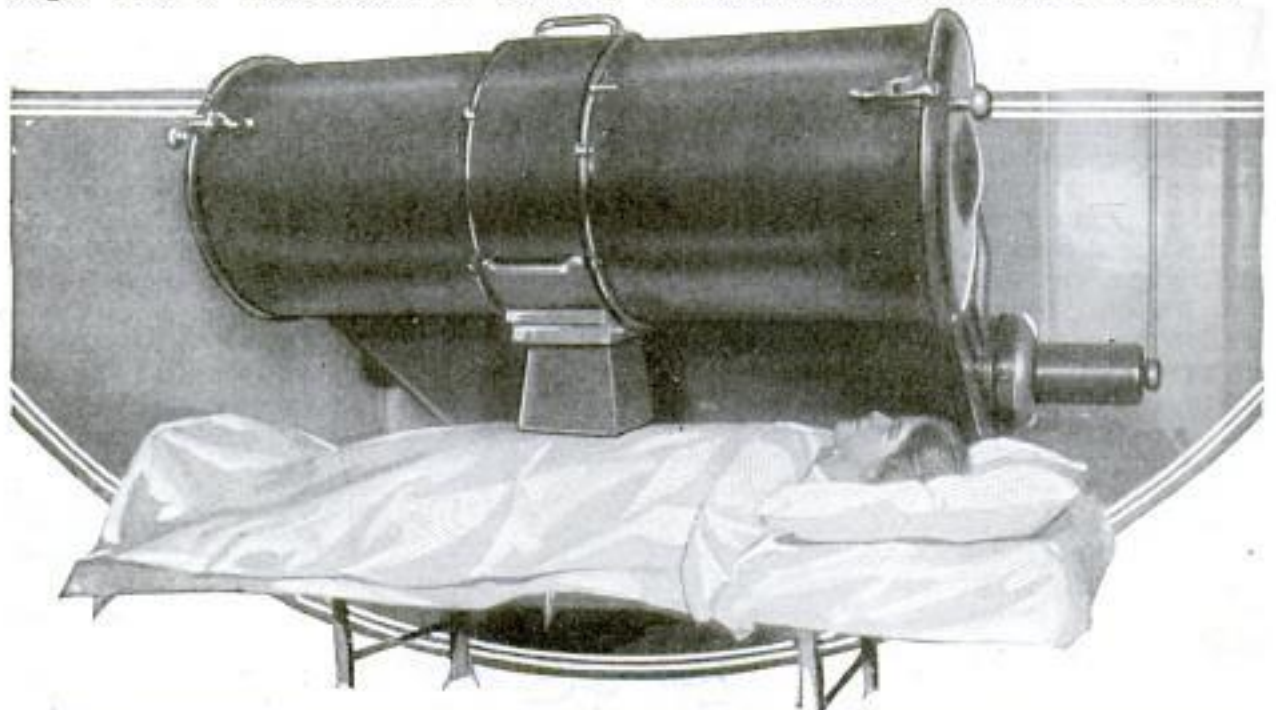

Three-Hundred-Thousand-Volt X-Ray Machine for Deep Therapy Treatment of Cancer, the Latest Curative Method Established in Chicago Hospital to Attack Diseased Cells

St. Luke's Hospital

**MANY QUEER PHONE PROBLEMS
MET IN FAR LANDS** 218

When a telephone installation gang in the Balkans recently started to trim off some obstructing limbs on a plane tree, a riot was nearly precipitated because the natives held this tree in veneration and to cut off any part of it is considered a sacrilege. Several years ago, when telephone engineers were constructing a system in the South Sea islands, it was found almost impossible to get the natives to work a sufficient length of time to set the poles. Then, again, it was found necessary to provide a special type of shovel to accommodate the bare feet of the workers. In Iceland, at times in winter, the wires become incased in ice sheaths six inches in diameter, and poles twenty-three feet high have been known to be completely covered by drifting snow. Iceland ponies form the chief method of transportation for supplies. In northern Sweden a telephone line has been constructed up beyond the Arctic circle and is used by the government for the transmission of weather bulletins and information of snow conditions for wandering tribes of Laps, who depend upon half-wild reindeer herds for their food and clothing. At the request of the Lamas, a telephone line has been constructed to the Forbidden City of Lhasa, more than 144 miles of this line being constructed over the roughest possible kind of country. In Egypt, a line has been run through the Valley of Kings. These examples illustrate some of the special requirements which have carried the telephone into remote and picturesque quarters of the globe.

**SALT BEDS UNDER VAST AREA
A THOUSAND FEET THICK** 210

That the southwest United States rests on a bed of salt averaging 500 feet thick, is the conclusion geologists are drawing from the nature of cores brought up from oil wells all over the region. The bed is known to be under the surface soil of 40,000 square miles of Texas and is believed to extend far into New Mexico, Oklahoma and Kansas. Some Texan wells have been drilled through strata of salt more than a thousand feet thick.

**ART OF VEGETABLE SCULPTOR
FINDS READY MARKET** 169

Flowers carved from vegetables are being used for table decorations at Pacific



Basket of "Flowers"—Carved by Woman Who Discovered Source of Extra Money in Art Developed as a Pastime

coast banquets and are furnishing pocket money to the woman who makes them. Taught by an uncle and enjoying the work as a diversion, the "sculptor" did not turn the practice into a money-maker until clubs and associations began to order bouquets made up of carrots, red beets, turnips, potatoes and radishes. Eggs are also used and twigs of trees and bushes furnish the necessary greens. Carving is done from the bottom of the vegetable upward.

**BRUSH - \$1.00; HAND
FOUNTAIN-PEN TYPE CLEANER** 27

HAS OIL IN HANDLE 120¢ - \$2.00.

Built and acting like a fountain pen, a new typewriter key cleaner is meeting favor from stenographers. The small brush is screwed into a glass handle which contains a cleaning solvent. This fluid seeps slowly into the brush and the typist always has a film of the penetrating oil on the keys as she rubs them. Instant disappearance of ink and dust is reported. The hollow handle will hold oil for thirty-five to fifty cleanings.



Mrs. Josephine J. Roman, 131
North Ave. 19, Los Angeles, Calif.
Hershey's
236 W. Chicago

Dr. E. H. Sellards, Director of Bureau
of Economic Geology, University of Texas.

1928



Weight Lost during Sleeping Hours Is Measured Accurately by These Delicately Adjusted Scales

WEIGHT LOST IN SLEEP SHOWN BY DELICATE SCALE

Scales so accurately adjusted that they can measure the ounces lost by a man during a night's sleep are being used at Carnegie Institute to study changing conditions in the body. The balance is so delicate that it records the exact amount the subject loses in a few minutes through the evaporation of perspiration or by exercise. Everyone becomes lighter by a small amount during the hours of sleeping, and the exact loss is determined by weighing at night and in the morning.

SOME PLANTS WORK OVERTIME UNDER LIGHT, OTHERS NOT

Plants which must have a night's rest in darkness, others which can stand a reasonable amount of night life in a "gay white way," and still a third class that flourishes under continuous lighting, have been segregated into groups as a result of research work at the Boyce Thompson institute at Yonkers, N. Y. That some plants thrived amazingly when raised under electric lights has been known for

many years, but the research work disclosed for the first time that others must have their regular nightly rest in darkness. Radish, lettuce, barley and clover proved they could thrive under continuous twenty-four hour lighting, maturing much earlier than when grown under ordinary conditions. Buckwheat and soy beans, on the other hand, were retarded when subjected to night lighting, while certain flowers, including salvia and cosmos, refused to bloom at all unless they got their night's rest regularly. Certain sharp contrasts were disclosed by the investigation. Tomatoes grew faster and made better plants when they received up to seventeen hours of light each day, but with more than seventeen hours' lighting the plants dwindled, while continuous light killed them entirely. Clover, on the other hand, flourished under twenty-four hour light and produced flowers in thirty-five days, whereas it may take field clover two years to flower. In addition to lighting experiments, the laboratory tried introducing carbon dioxide gas into the greenhouses with marked beneficial effect in the case of several plants.

Central Leather Co
no more dresses. 6% case

WATER IS FROZEN SO QUICKLY AN EXPLOSION RESULTS

Freezing water too rapidly for the eye to follow the action is the experiment being performed by a refrigeration expert



Water Exploding into Ice as It Comes in Contact with Refrigerating Liquid

refrigerator 17 18 atom

216

for Plant Research

Mr. David C. Ange. new material

Into a glass containing a freezing liquid, the scientist hurls a quantity of water. Within one fifteen-hundredth of a second the descending water is congealed. It



NINE-HUNDRED-FOOT LOG RAFTS IN STRANGE RACE

155

Racing down the Pacific coast from Astoria, Oreg., to San Diego, Calif., a huge raft of logs, 900 feet long, made a record recently when the trip was completed in fifteen days. Its rival, another



International

Tug Pulling 5,000,000 Feet of Chained Logs Wins Race down Pacific Coast

large raft, reached the port a full day behind. While the contest was mainly one between the tugs that pulled them, the rafts themselves were important factors, for upon their careful construction depended much of the success of the journey. The logs, joined together with large chains, were shaped into the form of a giant ship with a sharp nose to aid in making speed. The winner contained 5,000,000 feet of lumber. At about the middle, a support was rigged to hold a warning lamp which was lighted at night to prevent collisions with ships.

Emed. Thompson editor

explodes into bits of ice and cold vapor the moment it hits the liquid in the lower glass. The instant the water left the upper holder, the experimenter snapped the camera and caught the explosion.

215

DOGS TALK WITH THEIR TAILS

Dogs talk with their tails, a famous author of animal stories asserts, and traces the ability to their wild ancestors. When a savage canine saw another approaching, he walked toward him warily until he was certain the other had no evil intent. Each had a white tip to his tail and when the home dog decided the other might be a potential friend, he raised the white flag of truce and waved it to and fro. The other responded in like manner and so all dogs do today.

8135

HONEY BATH FOR SICK PEARLS RESTORES THEIR LUSTER

Baths in newly gathered honey are recommended by a European gem expert to restore the luster to pearls that have grown dull. Treatments of forty-eight hours at two-week intervals for a period of about six months, are said to produce the most satisfactory results and the honey should be removed with alcohol instead of water.

Com. George H. Holden, Esq.

TIGHTENER FOR CLOTHES LINE ELIMINATES EXTRA POLES

171

Intermediate supports or poles to keep the clothes lines from sagging are replaced



by a small drumlike tightener that may be quickly attached to the wall or any convenient place. It has two short, projecting arms between which the end of the

rope is fastened. The line is drawn to the desired tightness by winding the revolving drum. To loosen the line, the ratchet mechanism in the drum is disengaged by turning a wing screw at the bottom.

William Knutler, 108 Keil St., North Tonawanda, N.Y.



Parcel-Post Packages of Merchandise Which Failed to Reach Their Destination at Washington, D. C., Because of Poor Addressing; F. C. Staley, Superintendent of the Division of Dead Letters Is Checking Them Preparatory to Their Sale at Auction



Checking Over the "Nixies" before Sending Them to the Dead-Letter Office, Above; Left, a Set of False Teeth and a Bottle of Poison Hidden in a Book



Some of the Post-Office Nixie Sleuths at Work, Trying, with City Directories and Telephone Books, to Run Down the Correct Addresses and Send Letters on Their Way; Over 500 of These Clerks Are Employed in the New York Post Office and More Than 600 in Chicago



153



One Day's Collection of More than 25,000 Dead Letters in the Washington Post Office; New York and Chicago and Other Large Cities Have Proportionately Larger Numbers

Uncle Sam's Swivel-Chair Sleuths Solve Millions of Mysteries Every Year

Dead-Letter Office Reveals Many Tragedies and Comedies

That Drift to "Port of Missing Mail"

by WALTER E. RODERICK

UNCLE Sam employs in the post-office department hundreds of sleuths who, seldom moving from their desks or letter racks, annually solve thousands of mysteries, some tragic, some humorous, but all of them having a more or less important bearing upon the lives of the letter writers of the nation.

These swivel-chair detectives are the clerks in the "nixie" section and the dead-letter office. Each year they are presented with more than 200,000,000 cases to solve and in approximately 179,000,000 of them they give the correct answer.

That is a pretty fair average when the knottiness of some of their problems is considered. They not only have to out-guess the man who meant to send his letter to Pittsburgh, Pa., instead of to Pensacola, Fla., and supply missing street numbers for other thousands of absent-minded and careless individuals, but also are called upon to decipher some of the queerest written enigmas that might

have baffled even a Sherlock Holmes. And all this service is costing the federal government in the neighborhood of \$5,000,000 a year simply because individuals and firms are too lazy or too indifferent to place a "return card" on their envelopes. A return card is post-office parlance for the name and address of the sender, which should always be placed in the upper left-hand corner of the envelope; never on the back. There is no excuse for this oversight, the post office points out, because every person knows his own address even if he doesn't know that of the person to whom he is writing.

Because of the huge and ever-increasing volume of nixies the post-office force is not able to give each individual letter as much attention as in the days when there were fewer and more careful letter writers. Where only about fifteen improperly or incompletely addressed letters used to arrive each day at the post office in Washington, D. C., there is now a

1403 H. St. N. W., Washington D. C.



Letter-Opening Machine Used in the Dead-Letter Office; with One Clerk Feeding It and Another Removing the Opened Letters, the Machine Can Handle 300 Missives a Minute, Preparing Them for Examination to Find Clues to Sender or Addressee

daily average of about 8,000. When it is considered that a vastly larger number pour each day into post offices in cities like New York, Chicago, Boston and Philadelphia, some idea may be gained of the magnitude of the task of keeping this backwash from the mail stream from piling up and hopelessly clogging the system. Yet the nixie sleuths and the dead-letter experts, with knowledge gained by long experience, are almost uncanny in their ability at getting these waifs and strays either back to their authors or to the persons for whom they were intended when dropped into the corner letter box.

Let's see how these sleuths operate. Suppose a letter is sent to "Mr. I. M. Wrong, 12th and Walnut streets, Washington, D. C." It reaches the Washington post office and is dumped from the sack on a counter where a long line of distributors stand tossing letters into pigeon-holes bearing the labels of the various substations in the city. The distributor knows there is no Walnut street in Washington. If there is a return card on the envelope he sends it back to the writer to supply a correct address. If there is none, he tosses it into a box marked "miscellaneous." There the letter first leaves the normal current of the mails. It becomes delayed or "sick" mail, and must be given "hospital" treatment. It is a nixie.

From these miscellaneous boxes the mail is carried over to a central miscellaneous rack in charge of an expert distributor. He is the first sleuth to tackle the puzzle. These expert distributors carry thousands of streets in the backs of

their heads. Their minds operate like cash registers. As soon as the optic nerve registers a street name, up jumps the name of a city. Broadway, Fifth avenue, Lennox avenue at once bring to mind New York. State street, Michigan avenue, Clark street and Madison street conjure up Chicago. Broad, Walnut and Chestnut streets associate themselves with Philadelphia, Olive street with St. Louis, Euclid avenue with Cleveland, and so on. In the case of the letter in question, the distributor re-addresses it to Philadelphia where

it is delivered. Of course, there are many cities with similar street names and some letters make the rounds of several before reaching the rightful owners.

The distributors also have to be familiar with the nicknames applied to various sections and suburbs of cities, names that are not listed in postal guides, but which are often used by the ignorant in addressing letters. They must know, for instance, that "Kerry Patch" is in St. Louis, "Streeterville" in Chicago and "Hell's Kitchen" in New York city.

DO YOU KNOW

That 21,000,000 letters went to the dead-letter office last year?

That 803,000 parcels did likewise?

That 100,000 letters go into the mail yearly in perfectly blank envelopes?

That \$55,000.00 in cash is removed annually from misdirected envelopes?

That \$12,000.00 in postage stamps is found in similar fashion?

That \$3,000,000.00 in checks, drafts and money orders never reach intended owners?

That Uncle Sam collects \$92,000.00 a year in postage for the return of mail sent to the dead-letter office?

Take another case. Suppose the letter is addressed to the right city but bears an impossible street number. The expert distributor passes that along to the direc-



Dead-Letter Detectives
Examining Opened Letters
in Washington Post
Office in Search of Clues
for Forwarding Them

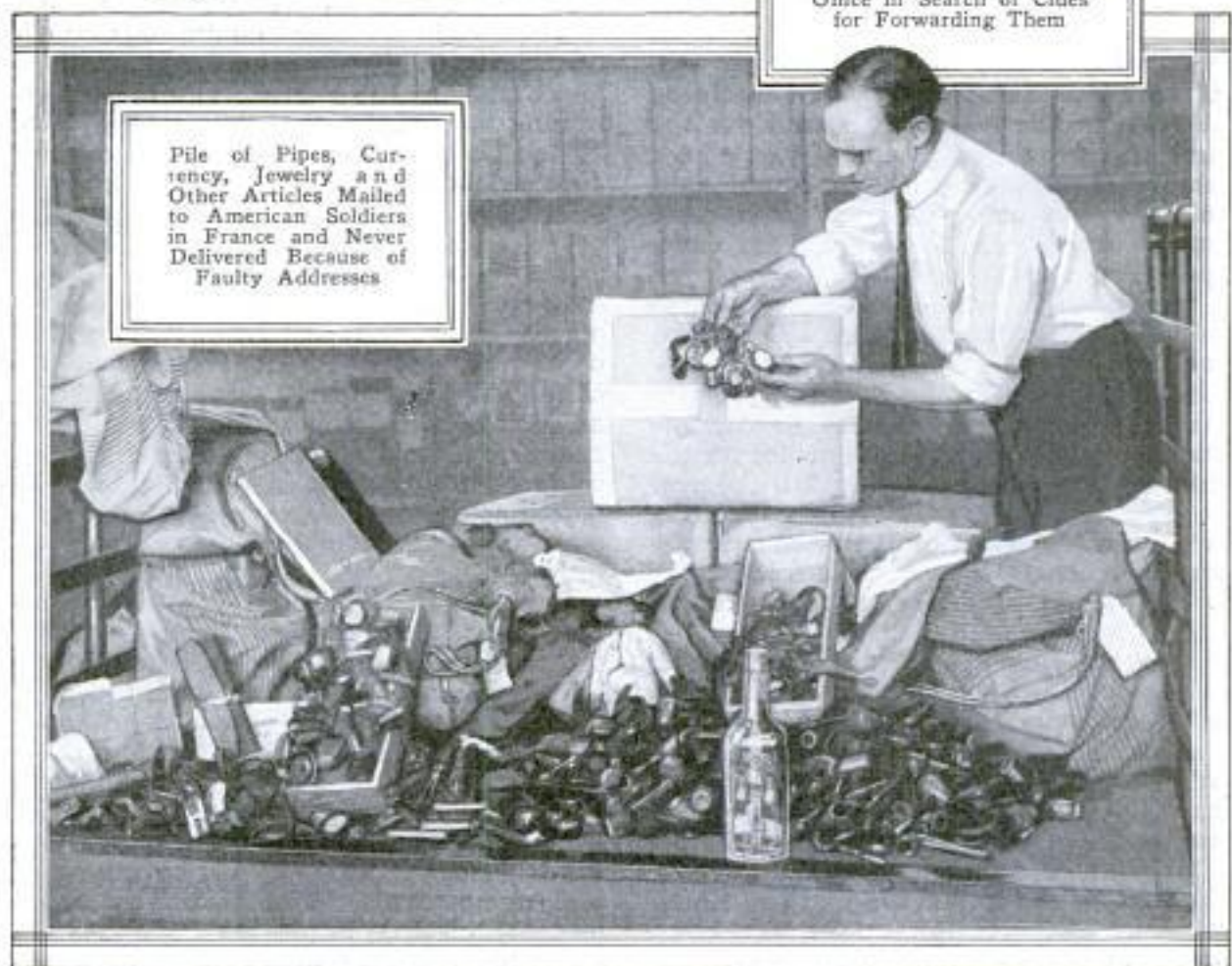

File of Pipes, Cur-
rency, Jewelry and
Other Articles Mailed
to American Soldiers
in France and Never
Delivered Because of
Faulty Addresses



William M. Mooney, Washington Postmaster, and Some of the Brain Teasers Solved by His Sleuths and Eventually Forwarded

tory-service division. This is what is commonly referred to as the nixie section. Here sit rows of women clerks—the women came in during the war and have stuck to their posts—with city directories cut up into sections alphabetically. Thus one clerk may have names beginning with "T" and another the section containing the "G's." These sleuths search out the name of the addressee and if there be a number of residents with the same name, pick out the one whose address more nearly corresponds to that on the envelope. There are over 600 clerks employed in the directory-service branches of the Chicago post office and over 500 in New York city.

If the sleuths in the directory service give up a letter as hopeless or carriers return it after vainly trying to locate the addressee, the letter is not yet turned over to the dead-letter office. It goes to a "rest camp," a rack that is placed near the general-delivery window, where it is held for ten days before being sent to the dead-letter office.

There are four dead-letter offices. One is at New York, which handles the dead mail for that state and all New England. The Washington office handles all mail from Pennsylvania and the south Atlantic states. The third is at Chicago, which handles the mail for the entire Mississippi valley, while the fourth, at San Francisco, takes care of all letters west of the Rockies. The daily receipts at the Washington dead-letter office average from 25,000 to 30,000. Here the letter is opened for

the first time. For this purpose a machine is used which opens 300 envelopes a minute. The opened envelopes are distributed among other sleuths, who run through the contents searching for clues to the identity of the sender. Perhaps the letter has been carelessly addressed to Pittsburgh but the writer hopes the addressee is enjoying better weather "in Palm Beach." The letter is forwarded to Palm Beach, but a fee of three cents is charged. The fee also is charged if the letter, after being opened, is returned to the sender. These fees amount to \$92,000 a year.

All dead mail which cannot be delivered is destroyed with the exception of that containing money. A record is kept of that and held for a year. Each year the dead-letter offices take \$55,000 in cash, \$12,000 in stamps and \$3,000,000 in checks, drafts and money orders from misdirected mail. Recently a letter came to the Washington office containing five crisp new twenty-dollar bills. It had been sent by a woman in Iowa to another woman in Pennsylvania as conscience money. The dead-letter sleuths could find no clue to the identities of either the sender or the addressee.

There are twelve regional dead-letter offices for handling parcel post because of its bulk. Most of this goes astray because it is improperly wrapped and the address is torn from the package. Merchandise is held for thirty days and then sold. If it is insured, it is held sixty days. Auctions are held semiannually, or more often if the accumulation of stuff necessitates.

Firearms and such forbidden articles as explosives, poisons and drugs are destroyed. All sorts of schemes are resorted to in sending poisons and drugs through the mails. Books are hollowed out and bottles inserted. A harmless-looking pocketknife turned out to be a pistol. The Washington authorities stopped wholesale shipment of drugs into the District of Columbia jail by means of picture postcards. The postcards would be split, the drug in powder form inserted and the layers of cardboard pasted together again.

TRAIL OF PREHISTORIC MAN IS FOUND IN ROCKS



Prehistoric Animals Pictured on Rocks in National Park; a Reindeer Being among the Subjects

Animal life of prehistoric eras is pictured in carved rocks on a bluff near the cave-dwelling ruins of Zion National park. Painstakingly sculptured in the hard rock are images of what appear to be dinosaurs, reindeer and big men. It is believed that the dwellers in the rock

and adobe cliff homes near by were the artists who did the work many thousands of years ago. An authority recently stated that much ancient art, such as that of the Cro-Magnon race, is as good as that of moderns, but the pictures just discovered are merely the crudest outlines.



Explorers in Zion National Park Stumble on Shattered Remnants of Homes Used by Cliff Dwellers

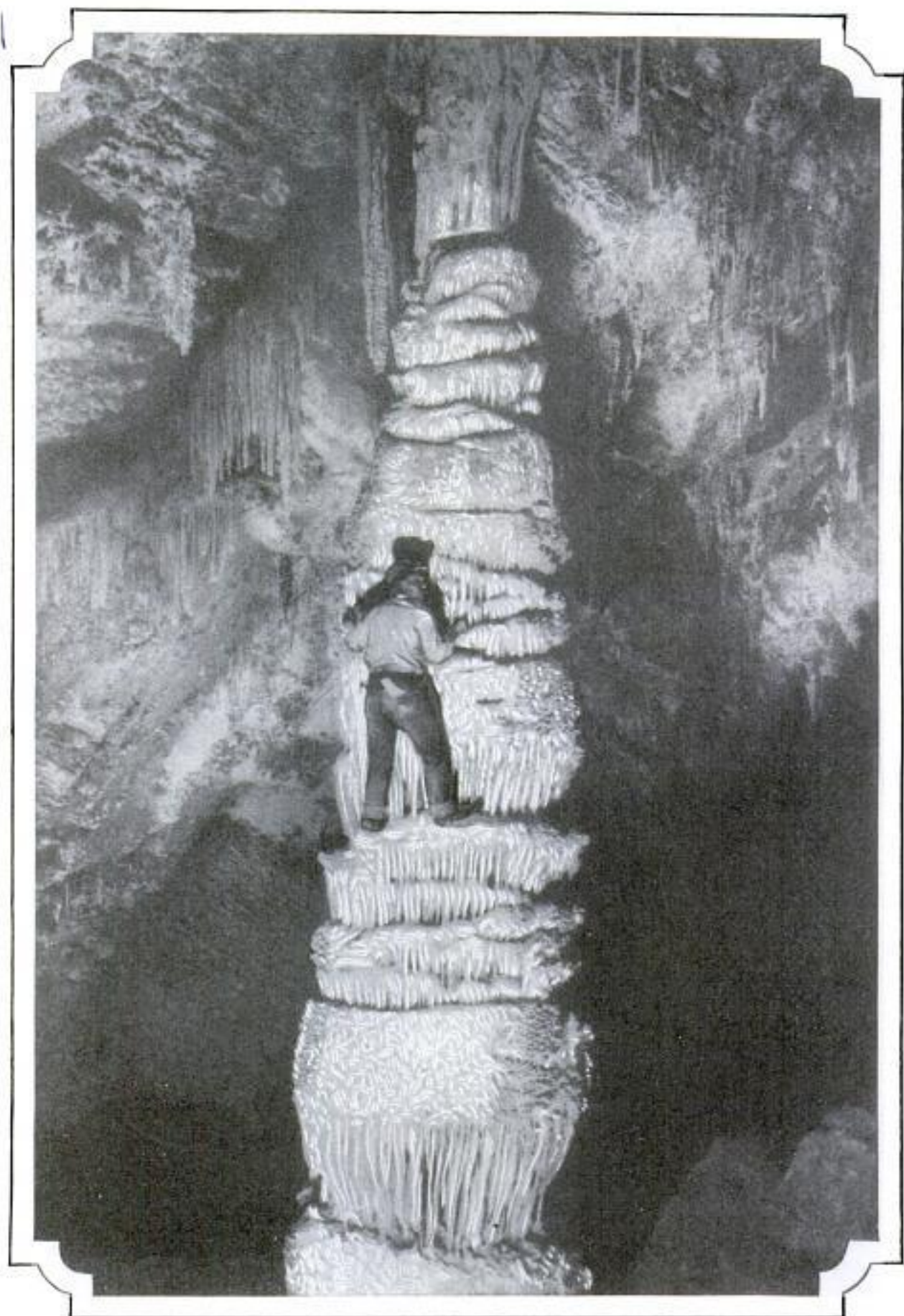

© J. W. Walker
One of Nature's Cavern Wonders, Stalactite and Stalagmite Linked as a Fantastic Pillar with Smaller "Icicles"
of Stone Adorning the Sections That Form a Ladder

NEVADA CAVE ATTRACTS GAZE OF SCIENTIFIC WORLD 111

Dwarfing all others so far discovered in Nevada, the newly located Whipple cave, near Ely, is attracting the attention of scientists. Plans are now being made to open it to the public. One of the attractions is stalactites of gigantic size formed by the slow dripping of water from the roof. Subterranean caverns containing these deposits of lime and other minerals are paying properties in several parts of the world, particularly in Australia and the United States. Mammoth cave, in Kentucky, is visited by great throngs of tourists every year who pay to follow a guide for miles underground and inspect the beautifully colored growths that the slow, steady dripping has produced.

CINDER IN ENGINEER'S EYE INSPIRES AN INVENTION 164

Because a cinder fell into the eye of Thomas E. Murray, senior vice president of the New York Edison company, more than 100 tons of dust and cinders are being removed daily from the air of that city. Mr. Murray was riding on a train, fifteen years ago, when he suffered the inconvenience so common to travelers. The way his eyes watered and washed the obstruction out set him thinking. Why not adapt the same method to removing such objects from the smoke before they get into the air? He set to work, and after many experiments, the apparatus now in use was devised. It consists mainly of a long, horizontal tank half-filled with water, along the top of which, within a few inches of the water level, extends a sheet of steel called a baffle plate. As the gases and cinders leave the fire, they are forced by a strong draft into the tank while the smoke, passing over the surface of the water receives additional cleansing before it reaches the flues. The system has created a unique job for one man. He is the official smoke watcher for the plant. His task is to sit in a tower all day where he can command a full view of the chimneys. By his expert scrutiny of the smoke, he can determine if the fires are being regulated properly. When too much smoke appears, he warns the stokers by means of red lights turned on from his desk.

Chicago Daily News
9/21/25

LIGHTED COLOR ROLLS TELL STORIES FOR CHILDREN 134

Pictures and stories are shown to children in a novel way by means of an electric lighted cabinet in which illustrated and



Story Cabinet in Use; Bulb Back of Roll Lights Up Pictures and Text

printed rolls are inserted and turned with a crank. The reel passes in front of the bulb and is viewed in a convenient space at the front. The rolls are easily changed, the box consumes but little current and is simply and safely operated.

FREE SHADE IS LATEST LUXURY FOR DESERT MOTORISTS

To give his customers opportunity to rest and refresh themselves after their cars are filled, a California gasoline-station proprietor has erected a large wooden shed under which motorists may enjoy free shade from the hot desert sun.

Welcome Shelter from the
Sun Greets the Motorist
under This "Free
Shade" Shed



There is sufficient space for several automobiles at once, and besides furnishing tourists with a welcome comfort, the shelter provides them with a safe parking place for their cars.

Corradly, Calif.
Copyrighted material

Toy Brothers & Beaumont
Main St. N.Y.
85

HIGH-PRESSURE LOCOMOTIVE HAS GREATER POWER

118

Locomotive That Develops between 350 and 400 Pounds' Steam Pressure

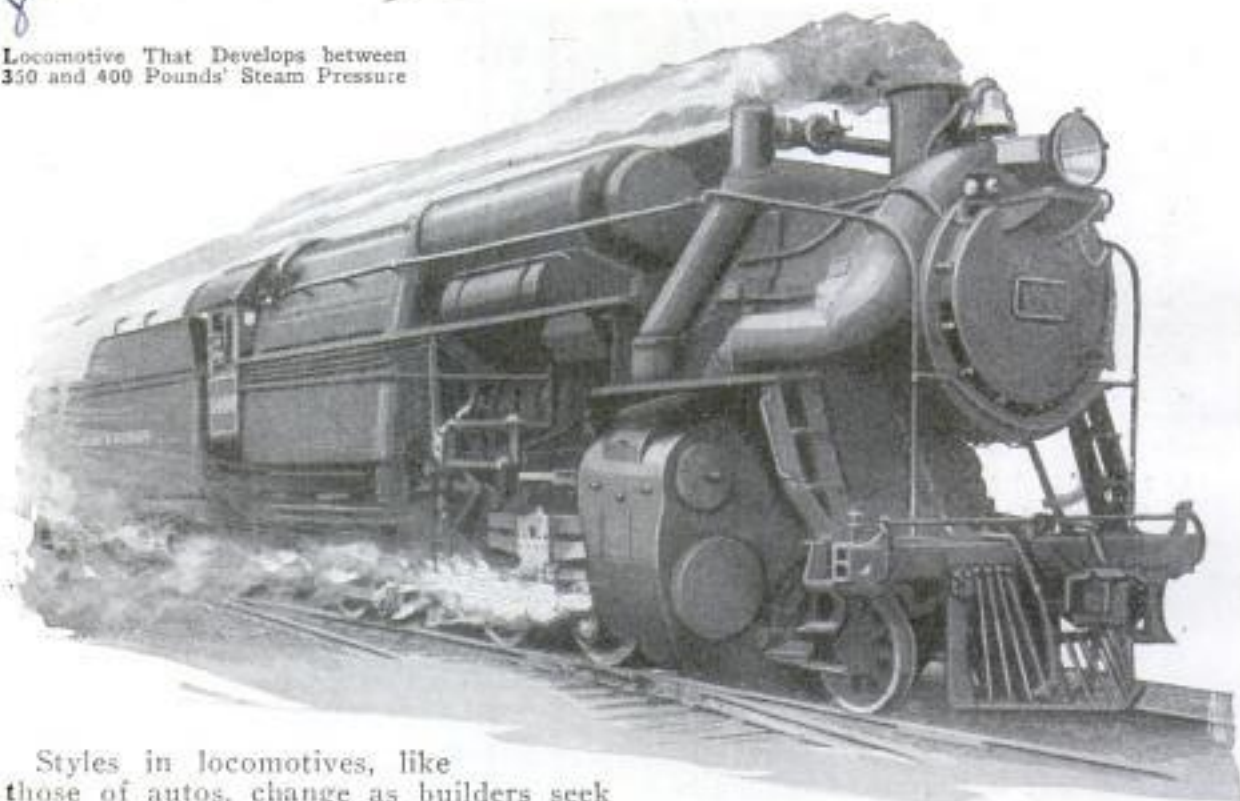

Styles in locomotives, like those of autos, change as builders seek greater efficiency. One of the most radical departures is the "Horatio Allen," an engine owned by the Delaware & Hudson railroad and named after the first man to operate a locomotive in America. The slim streamline design of the usual greyhound of the rails has been discarded, making the engine appear higher and stockier than the usual type. It has both flues and a series of pipes like the tubes in a Scotch marine boiler. These pass directly over the grates producing a steam pressure of from 350 to 400 pounds and increased pulling power. The "Horatio Allen" weighs 297,000 pounds on its drivers, each of which is fifty-seven inches high. An interesting example of locomotive efficiency was presented in Indiana recently when two engines were hooked to a railroad bridge and raised it to a height of over twenty-three feet so that a dredge could pass underneath. Raising and lowering were accomplished in eight and one-half minutes.

by steam in wooden vessels. Acid soda is then added and the substance boiled for several hours, after which it is strained through flannel and churned. Oil or sour milk may be added if desired, but they are not necessary. By adding a small quantity of honey, the taste is improved and the artificial butter is said to keep better and go ten per cent farther.

2676

CLOCK ON AUTO-RADIATOR CAP VISIBLE ON DARKEST NIGHT

A combined clock, water gauge and thermometer has been invented which will fit any lock-on radiator cap. The hands and figures of the clock are illuminated so that they are visible on the darkest night. As the timepiece is directly in the driver's line of vision, it is never necessary for him to take his eyes from the road. The thermometer gives the temperature of the radiator and the gauge tells of any shortage of water.



BUTTER MADE FROM TALLOW TO SAVE MILK

Butter which contains no milk but is said to be palatable, nutritious and cheap is being prepared by a European chemist. He uses waste fats and tallow, first washing them in cold water and then cutting them into small pieces and melting them

ator and the gauge tells of any shortage of water.

197
Cmhr Isearge H.
Holden

The Brinkman
Thermometer Co. 240 W. 24th St. Lancaster, Pa.



Roping the Engines to the Bridge before Lifting; the Wooden Uprights at Each End Formed a Track for the Structure



Steel Bridge Up Twenty-Three Feet Six Inches and Canal Dredge Passing Underneath with Ample Clearance; the Actual Raising and Lowering Were Accomplished in Eight and One-Half Minutes, Then the Bridge Was Quickly Placed Back on Its Supports and the Wooden Uprights Cleared Away

Aerial at Marion Mass.

Clark Hunter Wenatchee Wash

202



Insulators for the Sending Apparatus of Transatlantic Radio Stations Are Taller Than a Man

INSULATORS BIGGER THAN MAN USED FOR ANTENNA

Transatlantic sending aerials require main insulators which are taller than a man, in striking contrast to the tiny insulators of the listener's receiving antenna. Part of the great size and strength is due to the fact that the aerial is charged with currents of 100,000 volts and more. Another reason is that the insulator must help bear the severe load of the antenna wire; in one station this wire is three-eighths of an inch thick and one and one-half miles long.

There are five chickens to every person in the United States. Latest figures on the yearly egg production set the crop value at above \$600,000,000. Live poultry is valued at about \$400,000,000, and yearly sales as food amount to half a billion dollars.

From the State Journal 182 Kansas City Star 8/3/25

THREE MILLION LADYBUGS WARRIOR ON ORCHARD PESTS

Catching ladybugs in the high mountains of Washington state to save the fruit ranches of the low lands has developed into a profitable, though decidedly unusual industry on the Pacific coast. One bug hunter, who is known as the "king of the ladybug industry" supplied 3,000,000 of the insects to fruit growers this year, but reported the "crop" was 6,000,000 short in the hills. The insects are transported in cages to the fruit ranches and "planted" in quantities of about 1,000 to the acre. They thrive and multiply rapidly, and with their numerous progeny attack the green and woolly aphids, the peach-tree louse and other orchard pests.

180 VESTIBULED STREET-CAR TRAIN ADDS SAFETY ON CURVES

Flexible vestibules, somewhat like those on railroad trains, have appeared on street cars run in units of two in Chicago. This arrangement permits passengers to go from one car to the next in safety, particularly on curves, and the trailer combination has proved of value in saving time and relieving congestion on several routes. Springs outside the vestibule keep persons from riding on the truck.

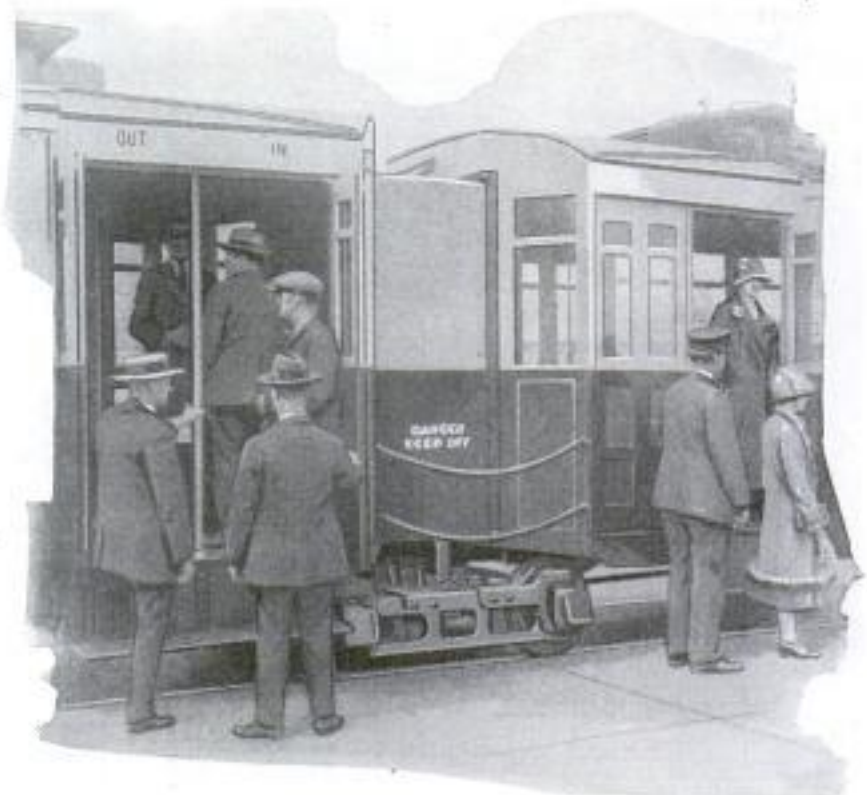

Electric Train of Two Cars Connected by Flexible Vestibule

Chicago Surface

WHERE STUDENTS ARE PAID FOR GOING TO SCHOOL

To fill a need for men who really know tools and machines, a school has been opened by a Detroit automobile maker in which the students are paid for their work. Because of the increase of mass



Exterior of School Building, and Inside One of the Shops with Students at Work for Which They Receive Pay

as part of the schooling. In addition to this wage, the boy is paid for holidays, a three-weeks summer vacation, and two dollars a month goes to his credit in a personal saving fund. This

production, where every individual is confined to a single operation, and where the men working at machines are not machinists, the old-time skilled craftsman is in greater demand than ever before and at higher wages. Boys from twelve to fifteen years of age are taken into the school and kept until they are eighteen. They come from families where they might have to leave school at these ages because of decreases in family incomes through the loss of parents or the coming of incurable illness. Among them are boys from China, Italy, Mexico and Russia, and each one is laying the foundation for an exceptionally good mechanical and general training. The boys are paid nineteen cents an hour for a forty-eight hour week in addition to the classroom and shop work which they are given

money cannot be drawn out without the approval of the director of the school, and this is done in order that the student may be encouraged to save without taking any money out of his earnings, which in almost all cases have to aid in the support of a family. In the classrooms, the younger boys receive the same educational advantages they would have in public schools up to the eighth grade. After this, particular emphasis is laid on mechanical subjects, such as drawing, mathematics, physics or mechanics, a little metallurgy and some chemistry. Every job which the boys work on in the shop has a commercial use, and if the parts they have made pass the same rigid inspection as that to which articles made in the regular factory are subjected, they are purchased by the car maker.

32 98
546



Left, Top to Bottom, Members of the New York Zoological Society Expedition Tuning In on the World from the Deck of the Ship "Arcturus"; Netful of Flounder Being Lifted aboard a Fishing Boat off Massachusetts, and a Rope-Scallop Dredge Net Being Hoisted onto the "Arcturus"; Right, Examining the Net Used for Catching Low Animal Life and Vegetation That Are Found near the Surface

Cont. Hamilton M. Wright
1508 Park Row Bldg.
POPULAR MECHANICS
New York City

32 98

547

Fishing

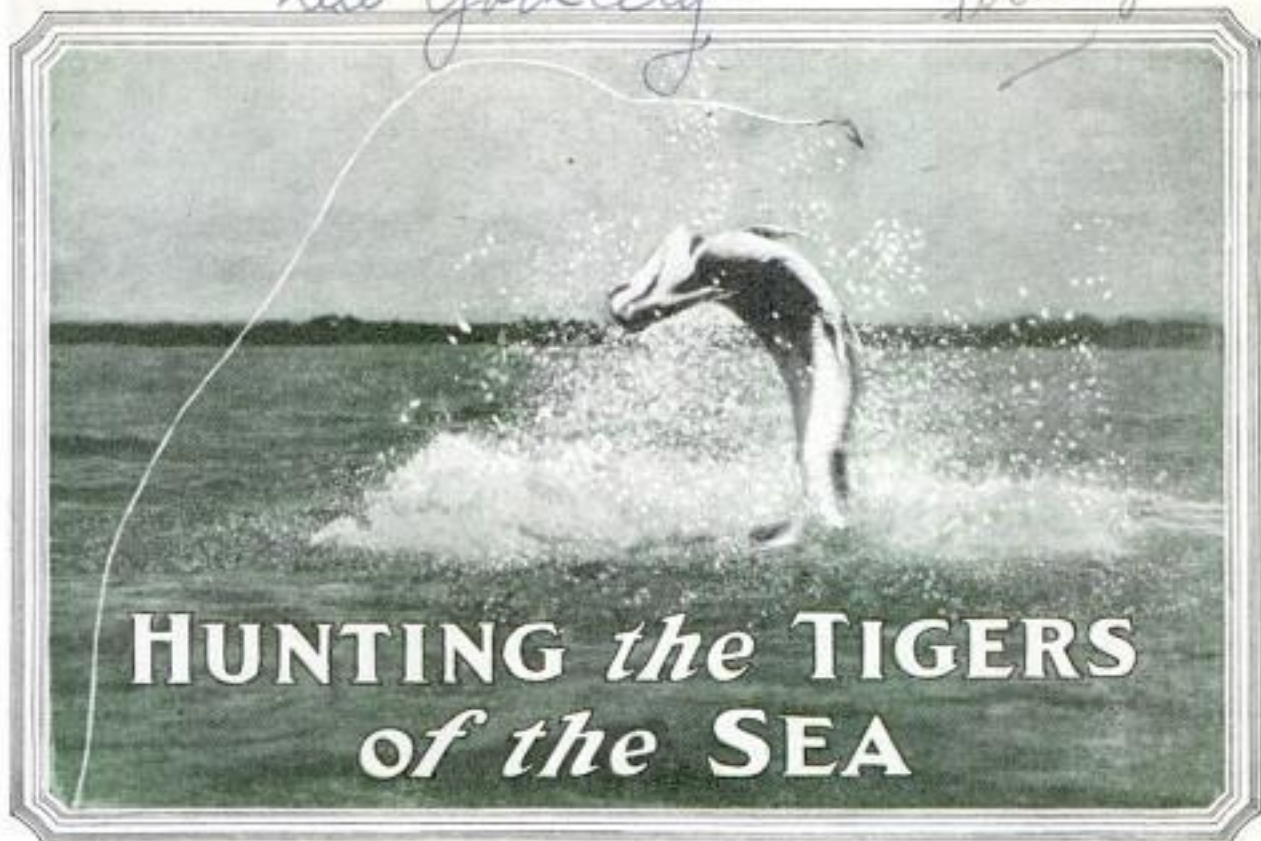

HUNTING *the* TIGERS *of the* SEA

Remarkable Picture of 180-Pound Tarpon Throwing the Hook Free and Escaping after a Terrific Two-Hour Battle off the Florida Keys

SIX-FOOT shimmering tigers that live in the sea, terrible flesh eaters that will snap the leg off a swimmer or turn cannibal and attack their own kind, lend a thrill to fishing off the Florida reefs that is found almost nowhere else.

Game fish which will put up a battle royal when hooked with rod and line are plentiful, but fish which are dangerous to the fisher are few. The shark is a coward at heart and the natives of the tropics consider a knife sufficient protection against it.

But a barracuda will fight anywhere and anytime, and the daggerlike teeth of its powerful jaws make it one of the most dangerous denizens of the sea. Get one on a hook and you will soon realize that you are "up against" a being stronger than yourself. With feet braced and the reel screaming under the drag, you may fight the big fish until the flesh is worn off your hands and your whole body aches, perhaps only to see it break away and disappear after hours of struggle.

The barracuda is only one of a host of fighting fish which swarm among the Keys between the Gulf of Mexico and the Atlantic. Into their crystal-clear water huge roamers, some of them weighing many hundreds of pounds and capable of swimming at express-train speed, come to feed on the lesser finny tribes, or like the

cannibal barracuda, attack each other. In one-half day a fishing party of three recently caught twenty-four fish. One was a huge barracuda, six feet in length, armed with cruel inch-and-a-quarter-long teeth that could have slashed a man half in two. It took the bait behind the launch and seemed like a sliver of snowy ice beneath the slightly greenish water. When hooked, it leaped five feet above the waves, its great body glistening like silver, as it hung for a moment suspended in mid-air, while the sun made a rainbow of the spray. In twenty minutes it was worked close to the launch, with three or four of its fellows following close. They seemed to sense that the hooked fish was in distress. Another baited hook was thrown out, one of the barracudas took it, and both were held near the launch, for there were many amberjacks on the reef, and as these fish are perhaps the most curious in the world, the fishermen had little doubt that soon they would have some of them up near the surface to find out what it was all about.

Like a flash they made their appearance. Great thick-bodied hump-backed fish, gleaming in bronze and gold under the tiny wavelets, three or four feet long. One of the barracudas was pulled in and fresh bait cast out. An amberjack took it. "Zip, zee," sang the reel as it made a

slanting dive for the bottom, hunting the holes in the rocks where it makes its home. The fisherman put the drag on the reel, and the beads of sweat broke from his face as he fought the hard-bitted jack. Down in the flickering depths appeared a great form that looked as large as a cow. It came slowly out of the dark reflection above a black rock into the clear water above a white patch of sand and seaweed. There it hung suspended, apparently watching the big jack that was fighting for the bottom. It was a monster in size. But then, the ocean was alive with fish. From everywhere they seemed to have come attracted by the killing. Everywhere was motion of fish and water. Only this great black form remained inert.

"Wow, what a whopper," cried one of the party. "It's a jewfish. I'll bet he weighs 300 pounds."

A piece of cut bait was thrown in front of the vast form, which now was almost directly beneath the side of the launch. But the great creature—formed like a black bass of Brobdignagian proportions—flapped its tail and slowly disappeared. It wouldn't take cut bait.

Quaintest, strangest, swiftest, most curious of habit, and most sought for of all game fish in southern water is the sailfish. It is only within the last twenty years that people have understood how to catch it, and even today very little is known of its habits. No one knows where they breed. Along the beginning of March

and to the end of April the fish are seen swimming in pairs, and sometimes in threes or more, toward the south. The belief is that they work their way far off and spawn in the deep sea, where their young remain until sufficiently grown to elude their enemies. The smallest sailfish ever officially landed on rod and reel in the Gulf stream off the Florida coast weighed five and one-half pounds and the next smallest is said to have weighed about eight pounds.

Imagine catching a fish that can swim at the rate of seventy miles an hour, that can leap over thirty feet of water, and that has been known to make thirty-two successive leaps, and you will have some idea of the thrill of landing one of these crested monsters. That does not conclude the sailfish's accomplishments. It

has been known to "walk the water" on its tail for a distance of 175 feet. The entire body is kept out of water and pitched at an angle of about forty-five degrees to the surface. Only the tail remains in the water, as the sailfish lashes itself over the surface, shaking the whole body from side to side, and wagging and throwing its huge head with violent jerks,

as in a frenzy of rage and terror it endeavors to cast the hooks from its mouth.

The sailfish jumps when it is first hooked and fresh. If it walks the water, it is usually after it has jumped. It may take out 300 feet of line in less than three seconds, and then leap in front of another launch 500 feet away. The weight of the wet line makes a heavy drag on it. Yet fishermen are careful not to let it get all the line, for if it ever does, it is gone. There is not a stranger or more beautiful-looking game fish. Its enormous crest or sail, which is really a huge fin, is of the loveliest ultramarine blue spotted with great purple blotches. This



Huge Sailfish Caught off Coast of Florida; These Undersea Express Trains, Traveling at Enormous Speed, Are Most Prized Catch in Southern Waters

3298



Nine-Foot Shark, Turning on Its Back in a Spinning Effort to Break the Heavy Manila Rope Which Carries the Huge Hook with Which This Sea Terror Was Caught

sail folds at will into a deep black-lined groove on the top of the back and is directly connected with the spinal column. When a sailfish begins to get tired—sometimes it fights so bravely that it is brought to the side of the boat practically dead—it usually “lowers sail.”

In the spring these fish are seen off the reefs where they hunt for food by the hundreds. As many as thirty-seven, a world's record, have been caught, and liberated, in a single day near Long Key.

Its back is colored with the deep blue of the Gulf stream. The belly is shimmering silver. Underneath, near the throat, are two streamerlike fins, that also fold into grooves. The tail is swallowlike, of the mackerel type, for the sailfish occupies a position midway between the mack-

erel and swordfish groups, according to Dr. E. W. Gudger of the American Museum of Natural History. Its bill, or pike, is a long rounded spear roughly covered, like a deer's horns when it is “in the velvet.” Before the sailfish seizes the small fish on which it preys, it raps it with the bill. Sometimes it will follow the bait trailed behind the launch for ten minutes and rap it several times before finally seizing it or turning away. The sailfish moves with lightning rapidity. The fisherman's contest with it calls for finesse. It is the skill of the rapier thrust rather than the bludgeon stroke that lands it.

If you ask how fast a sailfish can swim, the answer is that it can swim as fast, if not faster, than a dolphin, not the porpoise, which is a warm-blooded mammal,

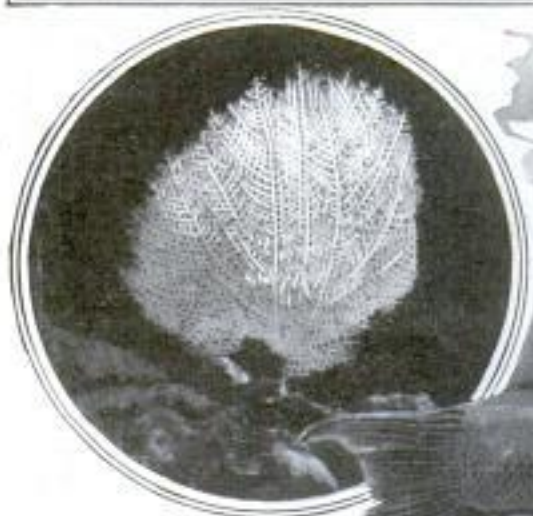
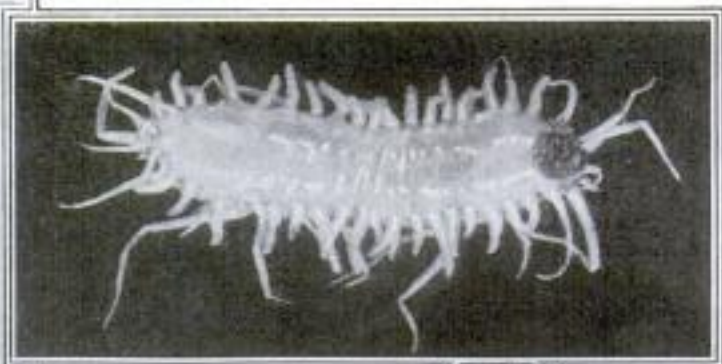

Top, Balloon Fish, from Hawaii, Which Displays Anger by Swelling Its Body, and a White, Tentacled Sea Cucumber; in Circle, Curious Sea Vegetation Photographed in the Depths of the Sargasso Sea by Scientists Accompanying Dr. William Beebe on the "Arcturus" Trip

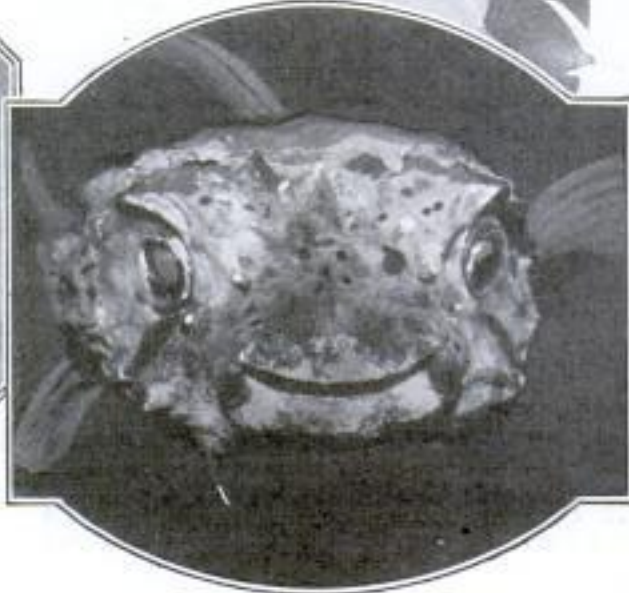

Left, Businesslike Set of Teeth of the Monkfish, Another Deep-Sea Curiosity; Right, the Porcupine Fish, a Rare Specimen Recently Added to a Private Aquarium, and above It, Sheep Fish Caught off San Francisco (© U. & U.)

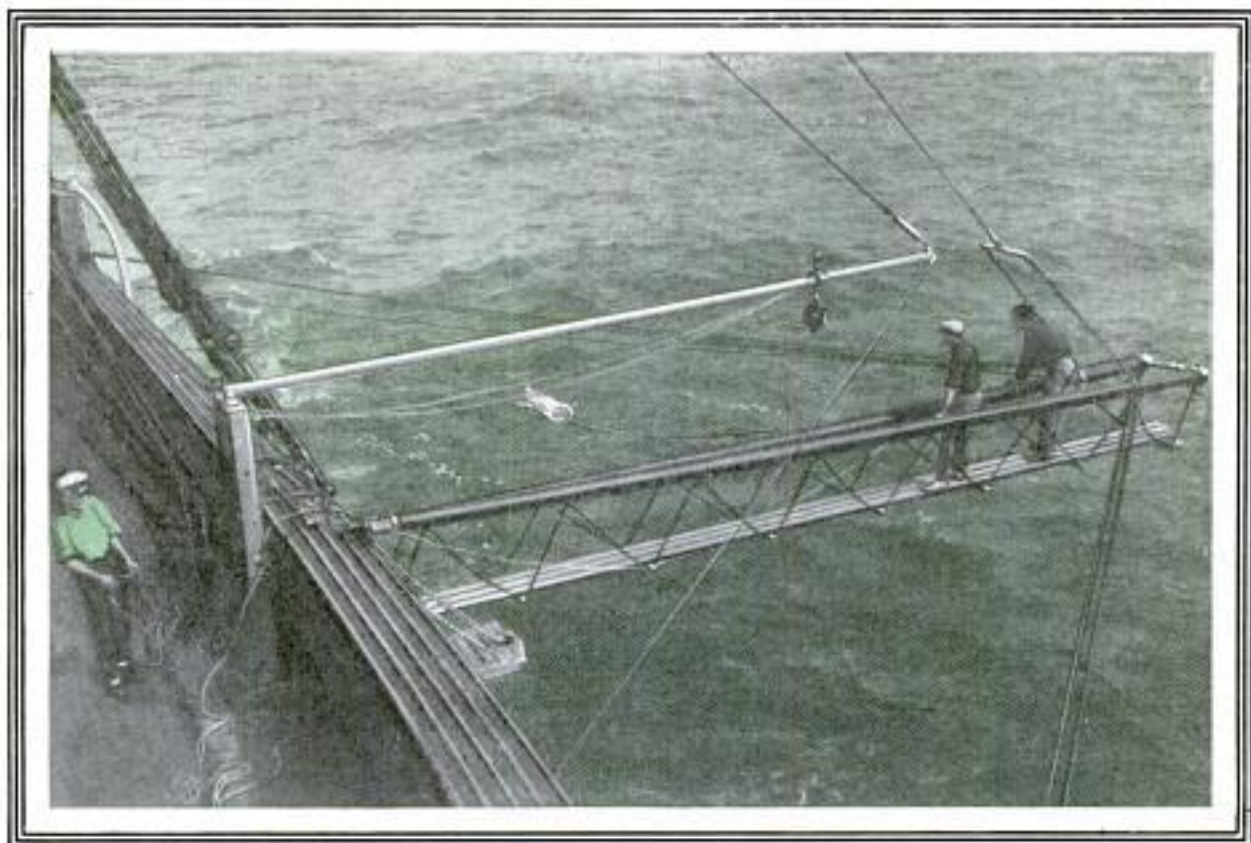

Hauling in the Deep-Sea Specimen Net on the "Arcturus" during Her Cruise through the Mysterious Sargasso Sea in Search of New Forms of Marine Life

but the wonderful amethystine fish whose greens and golds and purples, turquoise, blue, silver, and black and opal, blend into a riot of metallic colors that can never be described because the skin of the living dolphin seems to reflect light like a prism, and give forth changed hues if you view it from a slightly different angle.

You never know what sort of fish you will catch in these iridescent waters. You may hook one sort and land another. A. F. Meisselbach of Little Silver, N. J., once had a strike from a big sailfish. He yanked it hard and set the hook. He played the fish for half an hour, and worked it near the launch, when it seemed to be ready to give up the fight. Suddenly Meisselbach felt a tremendous tug on the line, and thought his sailfish was making a last effort. Then the line went slack. Another tremendous tug, and Meisselbach found he had a twelve-foot shark on his line. At last he landed it, and towed it to shore behind the launch. An autopsy disclosed that the shark had eaten the sailfish in installments. The head with the hook was deep in the shark's throat, and there were two big hunks of sailfish in the stomach. The tugs on the line occurred when the shark took its bites.

On a pound-for-pound basis, the shark is not to be compared in savage voraciousness with the barracuda. This formi-

dable fish reaches a length of six feet and a weight of fifty-seven pounds in these waters, though on the west coast of Africa, in the gulf of Guinea and off the north coast of South America it is said to reach eight or ten feet. It rushes at the bait as soon as it is cast over the side. It is so voracious that it is no trick to hook it, but it will make a splendid fight, often hurling its long heavy body far from the sea. When first caught it is silver-white, gleaming in a thousand changing metallic hues. Its teeth, large as the fangs of a gray wolf, are snow-white. Compared with a small barracuda, a muskellunge of equal weight is not in it for strength, ferocity and endurance. The barracuda breeds in these waters and is very prolific. There must be millions of them in an area of a few hundred miles along the coast. As many as 500 in a single group have been seen attacking a school of mackerel.

Sometimes the amberjack fights in company with barracuda in attacking other fish, or it may be just a coincidence that the two marauders are found together. But they will hang on a school of fish like wolves on the fringe of a drove of cows with calves.

If you call the barracuda the tiger of the seas, the amberjack certainly deserves the title of the bulldog of semitropical

3298
waters. Its jaws have a tremendous grip and it can crush shellfish in its hard, bony, toothless mouth. In fact, it hunts along the reefs and hides in the crevices of the rocks at the bottom. When hooked, it makes for these crevices, bores down as deep as it can and wags its big head from side to side like a dog wrestling with a rag, sending a thrilling code to the fisherman at the other end of the line. It is a masterhand at getting under a boat, and if it ever does, good by! It has the line frayed in two in a second. It is a wonderful experience to see one of these great fish at the end of your line, beneath the water, as a thrilling battle draws to its close. You see the first faint gleam of the fish far under the water. Then a rush, perhaps, and you are startled to find the great thing you have been fighting outlined sharply in the clear ocean, still seeming wild and not within your grasp. And he may not be, at that. You do not know at what moment the faint yellow outline far in the depths, that you know to be a shark following your fish may come up and seize it. And how desper-

ately it struggles when a shark approaches it.

The cleverest of all fish in throwing the hook is the tarpon. It has more tricks to get rid of it than any other of the great game fish. It has been known to extend its gills, wag the giant head and cast a hook fifty feet. The tarpon is a giant herring. Commercial fishermen report having seen thousands at a time in the passes between the Gulf and the Atlantic. Today you can see a hundred most any day, if you are lucky.

Just a word about the marlin swordfish, a great chap that is beginning to be caught in the Keys. It is known to get up to 400 or 500 pounds and more. It raps the bait like a sailfish, and save that it is a larger, stronger fish, offers all the sport given by "His crested Majesty of the Gulf stream." At first glance it looks like a sailfish with a reduced sail.

There are millions of gamy fish in the Florida Keys, and, it is believed, there always will be, for nets are not allowed, nor could they be used in these rock and coral-infested waters.



Landing a Seventeen-Pound Robalo off Florida, and a Coast Man Wrestling a Shark



Cruel Teeth of Barracuda, the Tiger of the Sea

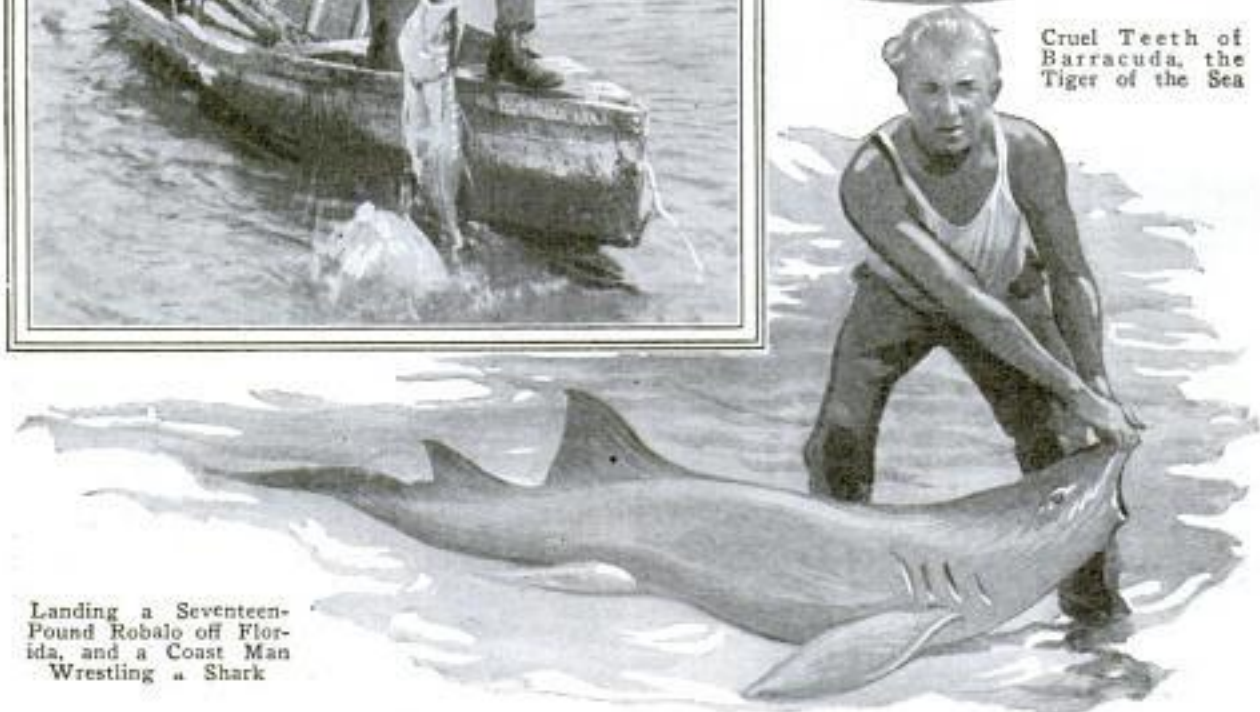

WORLD MAP OF ALUMINUM THIRTY-FIVE FEET LONG

35



Huge Aluminum Relief Map of World with Ribbons Indicating Passenger Lines

Routes of the shipping board's twenty-three cargo and three passenger lines are graphically shown by ribbons stretched across a huge aluminum relief map of the world, fifteen feet high by thirty-five feet long. Time divisions are shown at the top so that a glance tells the hour in different parts of the world. The metal is placed upon the framework in sections and was cast from an original in wax prepared by the navy department.

GRIP ON SCREWDRIVER BLADE HOLDS NUTS IN PLACE

584

Holding nuts and screws in places where space is cramped is simplified with a screwdriver that has a gripping attachment which slides upon the blade of the tool where it is held by a setscrew. The attachment has two jaws that extend just beyond the end, so that they can be placed about the head of a screw or a nut and locked while either is being started. When not in use the gripper is slid up toward the

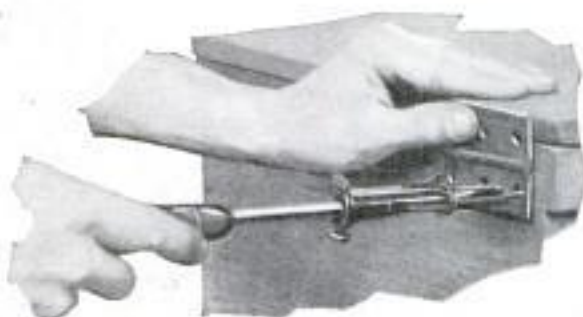

Driver with Spring Grip, Holding Screw in Place Until It Can Be Started

handle. The latter is made of a rubber composition, which is said to furnish insulation against voltages up to 2,200 and to be unbreakable.

STORIES OF BIG HAILSTONES SUPPORTED BY RECORDS

105

While hailstones as big as eggs are considered of unusual size, the department of agriculture, in examining weather records has discovered several instances in which the ice particles weighed more than a pound each, and at least one where they were reported to have weighed four and one-half pounds. On April 17, 1874, in Natal, hailstones weighing a pound and a half perforated corrugated-iron roofs, and in New South Wales, in 1847, stones

fourteen inches in circumference fell during a storm. The fall of four and one-half pound hailstones was reported in Cazorla, Spain, on July 15, 1829, and in a storm almost as destructive at Cette, France, when houses were wrecked and ships sunk.

Weather Bureau

J. B. Peasall Mfg. Co. 10-23 S. Water St. Rochester, N.Y. Copyrighted material

New Jersey City -
New York Tunnel



Coolidge's Father Inspecting Cabinet the President Made When He Was Ten Years Old

CABINET MADE BY COOLIDGE WHEN TEN YEARS OLD

That President Coolidge, when a boy, possessed much skill at making things with his hands, is shown by a miniature cabinet he constructed when ten years old. Manual training was not taught in the schools in those days, but in spite of a lack of coaching or instruction, young Calvin managed to build a creditable piece of furniture which today, after nearly fifty years, is still in good condition and is one of the prized possessions of the Vermont homestead.

COMBINED SCOOTER-CYCLE FOR SIDEWALK USE

Combining the features of an ordinary bicycle and a scooter, a child's vehicle now on the market may be operated safely on the sidewalks, keeping the riders away from street perils. It is propelled either by a pedal and sprocket-chain drive, or may be pushed along with one foot while standing upon a lower cross brace with the other. A comfortable seat, rubber tires and a brake, worked from the handlebars, are fea-



Scooter and Bicycle in One Can Be Used on Sidewalks and Has Rubber Tires.

tures. The vehicle is so low that learning to ride it as a bicycle has fewer hazards than with those of regular size.

MAN-MADE HURRICANE TO FREE TUNNEL OF AUTO GAS

Approved plans for the ventilation system of the two-mile tunnel under the Hudson river, which will have an estimated traffic of 46,000 cars a day, provide for a number of huge electric fans for forcing a seventy-five-mile wind through an airway under the road to rid the passage of exhaust gases. Used air will be sucked out through ceiling vents, set every thirty feet, into another large airway, so that there will be a continual current of air at every point in the tunnel. The intake and outlet flues and the ventilating apparatus will be contained in four large plants, two on each side of the river. The system was tested in a mine, where touring cars and trucks were operated under various conditions. A special operating feature of the auto tunnel will be the order to "stop all motors" at the command of traffic policemen who will be stationed along the tube.

WOMEN MOTOR DRIVERS EQUAL MEN IN SKILL

Women automobile drivers have just as much ability as men, if not more, says a report, prepared by the American automobile association, on a series of tests. From the experiments, the conclusion was drawn that women are no more likely to lose their heads than men, and that there is no reason why they should be more emotional. Students were selected for two of the most important tests, one that measured quickness of reaction to a dangerous situation and the other, consistency of response. The average reaction time for the ten college women tested was .56 second, while that of twenty-five men was .59 second. Women have also been thought more variable than men, but this too was contradicted by the consistency tests in which the women showed a mean variation of only .17 second, while the men averaged not less than .22 second.

Columbia bicycle - Steinfeld & Co. New York City
11-13 E. 26 St. N.Y.C.

Tests made by a number of Government Research.

conducted by Dr. G. A. Moore

TEN-TON PLANE BUILT FOR LONG SEA TRIPS

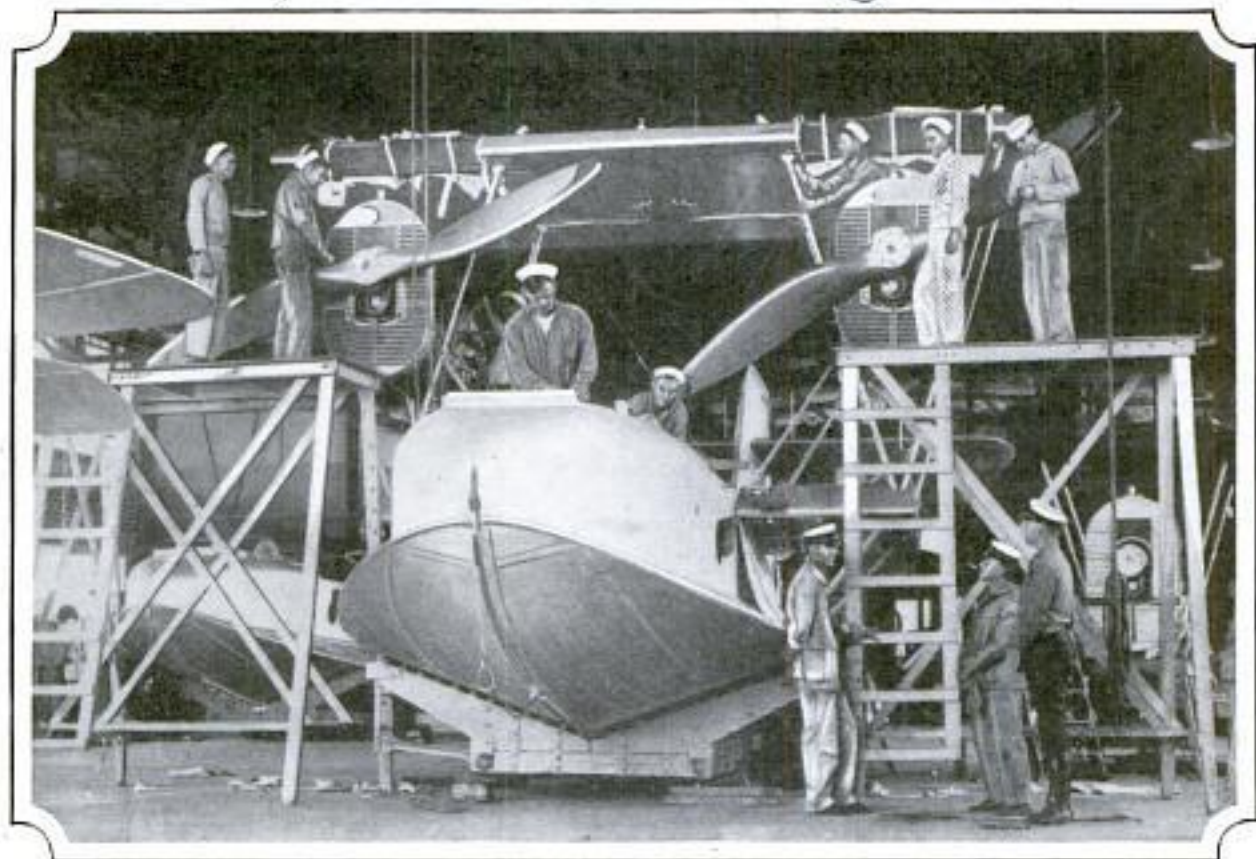

Latest Navy Plane, Especially Designed for Long Ocean Voyages, Has Wings Seventy-Two Feet Across, and Is Said to Be Seaworthy Even When Alighting on the Roughest Waves

Weighing nearly ten tons and with a wingspread greater than the width of a city lot, the new navy plane developed for the coast-to-Hawaii dash is equipped with a keel which makes it seaworthy in the heaviest waves, it is claimed. The ship, known as type PN-9, has a wingspread of 72 feet, weighs 19,500 pounds and can carry 1,350 gallons of gasoline. Expert officers and enlisted men of the navy assembled the giant man-made bird at the air station in San Diego, California.

WEIGHING A SUNBEAM ¹²⁴

Like a jet of water, a beam of light pushes against any obstacle placed in its path, and though the force is extremely minute, it has been measured by scientists. A delicate fiber of quartz is used for this purpose from which is hung a small, vertical rod with two shorter pieces at the lower end. These, in turn, carry disks of thin metal, two of them blackened and two polished. The apparatus is in reality a fine balance, and in the measurements, is placed under a glass covering from which all the air has been exhausted. The beam of light is first directed upon

the blackened disks. Its force causes the quartz fiber to twist. The movement is measured by means of a small mirror attached to the apparatus which reflects a spot of light upon a fixed scale.

THERMOSTAT FOR AUTO MOTOR KEEPS TEMPERATURE EVEN 42

To bring the engine temperature to the most efficient point in the shortest time,



a thermostat now on the market is said to operate effectively under all weather conditions and eliminate the need for radiator coverings. It is connected to the water line, and works at the same adjustment for hot or cold weather and at different speeds and loads. It is said to reduce crankcase dilution and water in the lubricating oil, thereby saving fuel and affording better operation.

*Prof. Lebedeff
Russian.*

*The Dole Valve Co.
1923
Chicago*

From
Wax Models
to
Giant Liners

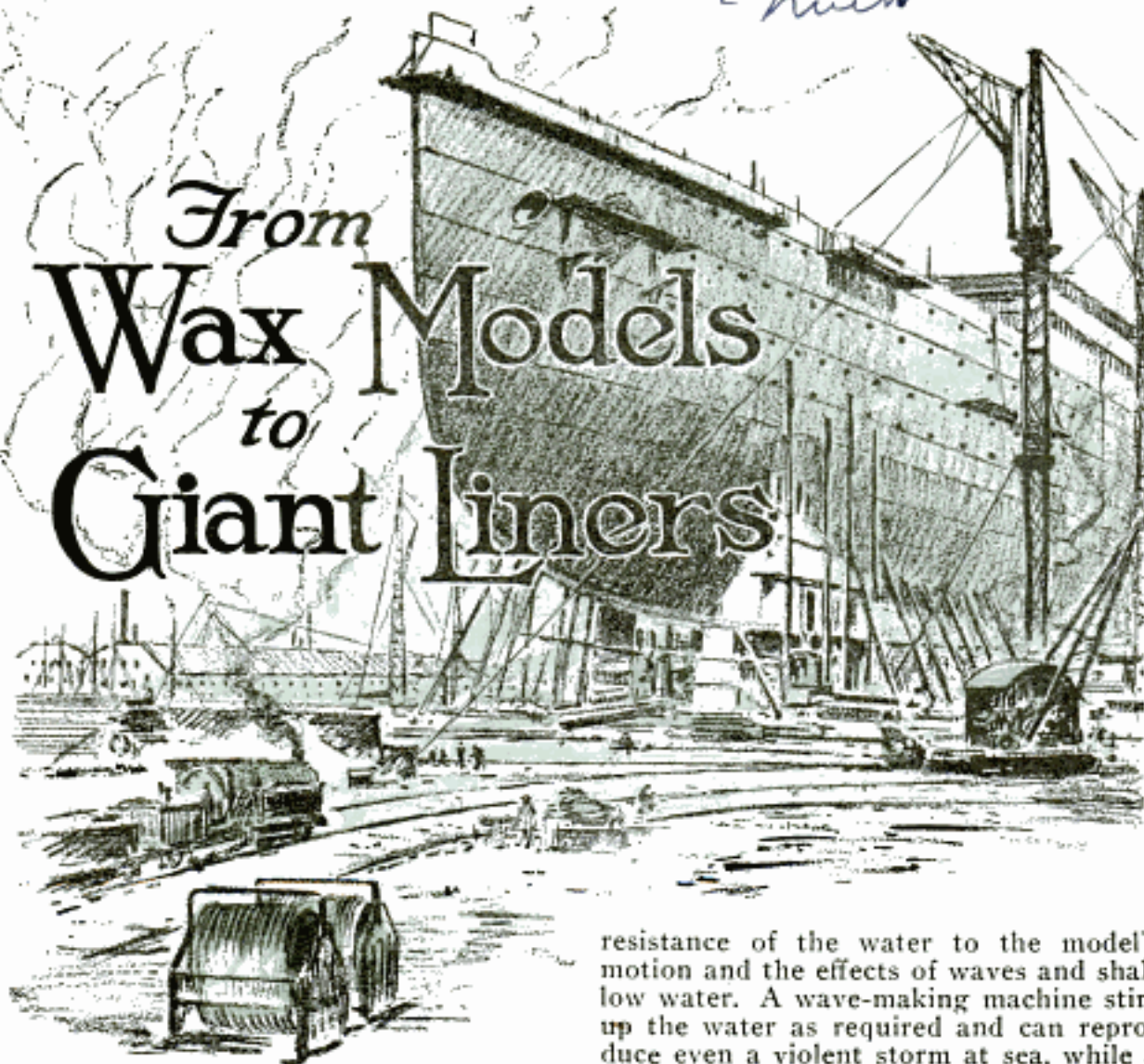

IT is a long step from a little wax-coated ship model, towed along through a shallow tank hardly big enough to float a canal boat, to a giant ocean liner plowing through the seven seas. But without the toy model, the designer would be unable to tell in advance how the future liner will perform in storm or calm, or its speed in the open sea or the shallow waters of rivers and harbors.

Ships built for the United States navy have been tested in advance through models in the towing basin at Washington navy yard, but in recent years the same practice has been followed to gather data on hull lines for merchant vessels. At Teddington, Eng., a concrete tank, 550 feet long, thirty feet wide and twelve and a half feet deep, was built several years ago to carry on the experimental work.

The hull designs are built up out of wax and then hitched to an electrically propelled carriage, which spans the tank and moves at a uniform rate. It carries the scientific instruments used to measure the

resistance of the water to the model's motion and the effects of waves and shallow water. A wave-making machine stirs up the water as required and can reproduce even a violent storm at sea, while a false bottom can be raised at will to measure the retarding effect of shallow water.

By making the models of wax, it is possible to alter the lines to try out effects of slight variations. The whole series of tests, including the building of the model, can be completed within a week, the results showing resistances over a wide range of speeds and the horsepower required to drive the ship at the desired speed at sea.

Methods of shipbuilding and designing are constantly changing, one of the latest developments having saved six months in the building of a big passenger liner on the Great Lakes. Instead of waiting until the hull was completed and launched to start on the superstructure, as is the usual practice, the carpenters and joiners began this work at their plant at the same time the keel was being laid at another. The parts of cabins, social hall, galley, dining rooms, and other accommodations were cut, fitted and then bundled up and laid away, each piece being carefully numbered according to the blueprints.

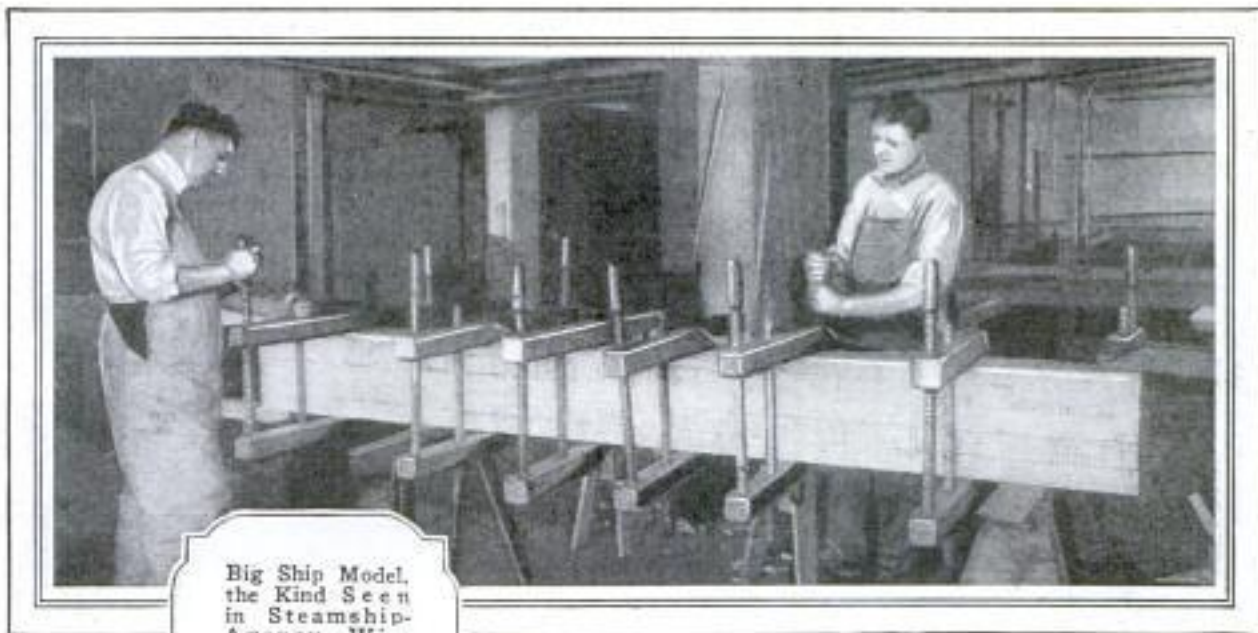

Big Ship Model, the Kind Seen in Steamship-Agency Windows, Are Built Up from Heavy Planks and Carved Out in Minute Detail

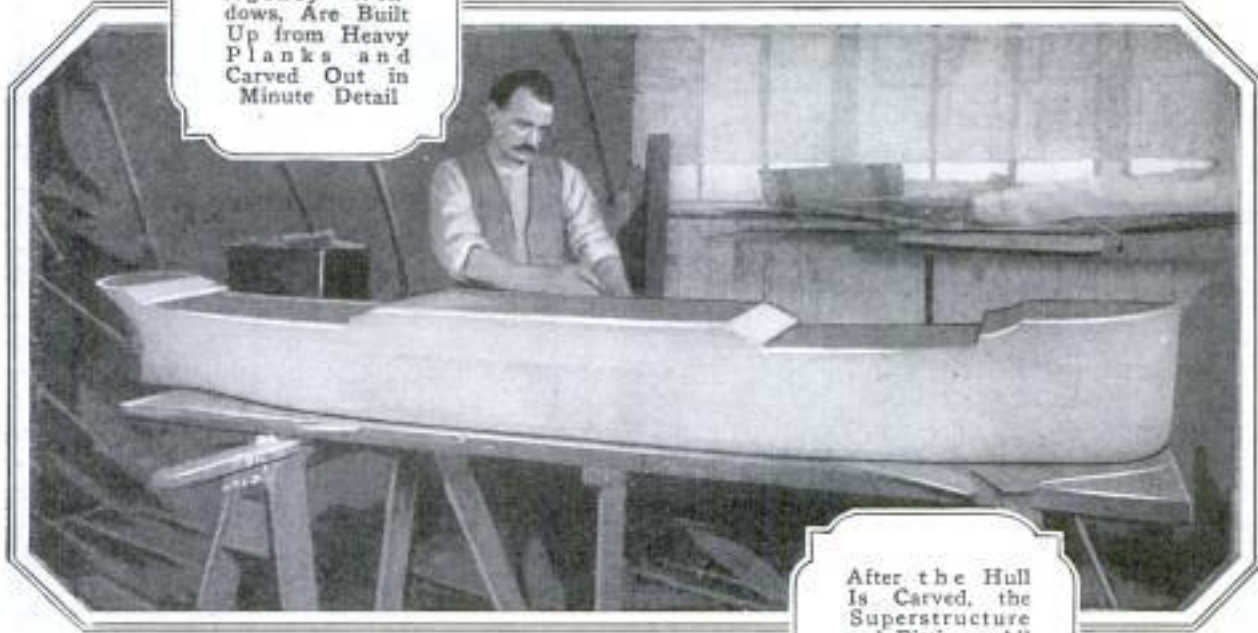

After the Hull Is Carved, the Superstructure and Fittings, All the Work of Skilled Craftsmen, Are Nailed or Glued in Place

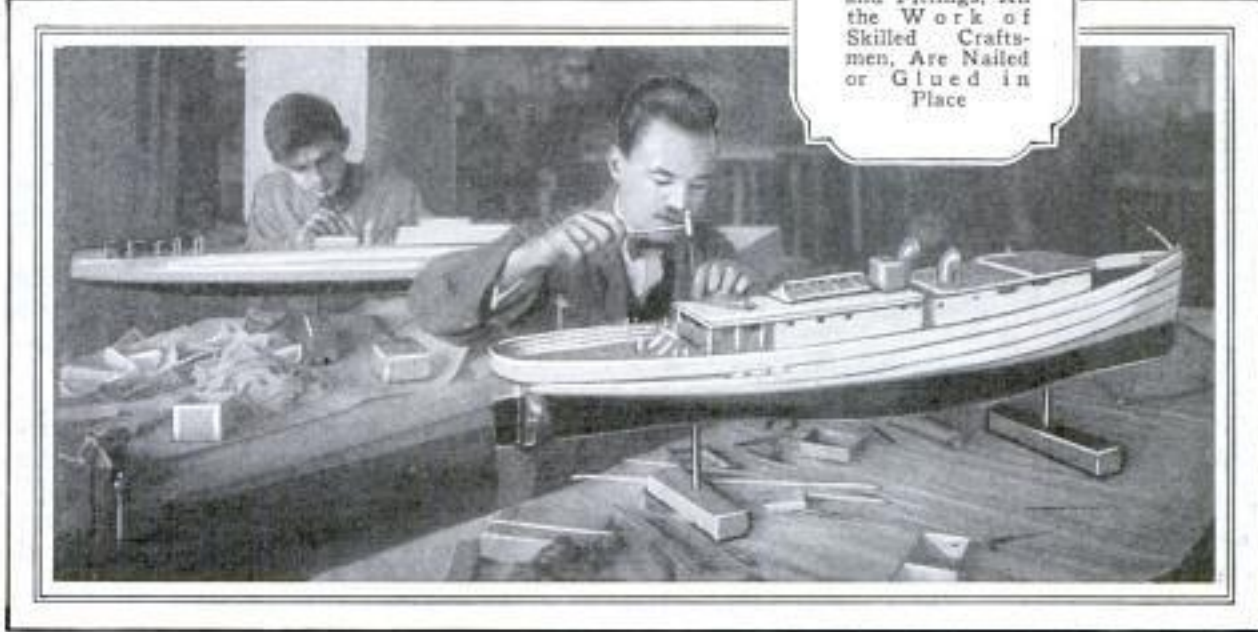

2088

POPULAR MECHANICS

The Launch of a Great Lakes Ore Freighter. Showing the 600-Foot Hull Sliding Sideways into the Water



When the hull was completed, engines installed and the whole launched, it was towed to the finishing yard and the previously prepared superstructure erected. Another new departure was the construction, on land, of the complete pilot house. When the time came to install it, the room was lifted by a derrick and swung into place as one unit.

Ship construction has developed rapidly since during the war the fabricated vessel was invented, with its plates and beams cut and bent at steel mills and shipped to the yards, with rivet holes drilled for assembly. Unfortunately wholesale methods are only practical when large quantities of ships are to be built, and since the war there has been no occasion to try them out again.

The ordinary process of building starts when the vessel has its conception in the brain of a naval architect. When he gets his assignment, he is told the kind of service the vessel is to be used for, whether wholly passenger or freight or both, and the part of the world it is to operate in. If it is to call at tropical ports, the arrangements are entirely different from those suitable in North Atlantic service, for the ventilation and refrigeration schemes will be entirely different. He also must know the possible ports of call to replenish fuel, water, stores and provisions.

When he has visualized the ship in his mind, he proceeds to set down on paper careful scale drawings, as a rule preparing three sets of plans. One is the gen-

eral arrangement, showing passengers' cabins, cargo spaces and storerooms, machinery and fuel bunkers, ballast and fresh-water tanks, provision rooms, officers', engineers' and crews' quarters, and the navigating and victualing facilities, including galleys and dining rooms. The next plan shows the midship section, giving the various dimensions of steel work and materials to be used in construction. Finally comes the sheer draft, which includes three drawings, the sheer line, or broadside view of the vessel, with constructional details; the half-breadth plan, showing one-half of the ship as it will appear from above, and the body plan, showing the sections of the ship when looking from the end.

From the first drawings the model is built, if it is desired to test out the hull shape in the tank. On a hollow framework, approximating the outline of the ship, the soft wax is built up, hardened and then shaved down until an exact scale model is produced.

After the testing, draftsmen make the complete working drawings, just as the architect produces blueprints for a house. These go to the mold loft, an immense low-roofed structure where a broad expanse of floor is painted to produce a horizontal blackboard. Here the lines of the ship are chalked out full size and "faired" by means of battens, or long, thin pieces of wood, keeping the full breadth and height, but contracting the length to insure fairness. The fairing gives correct figures for the curves by which plates and

Where Brain and Skill of Desert Tribesmen

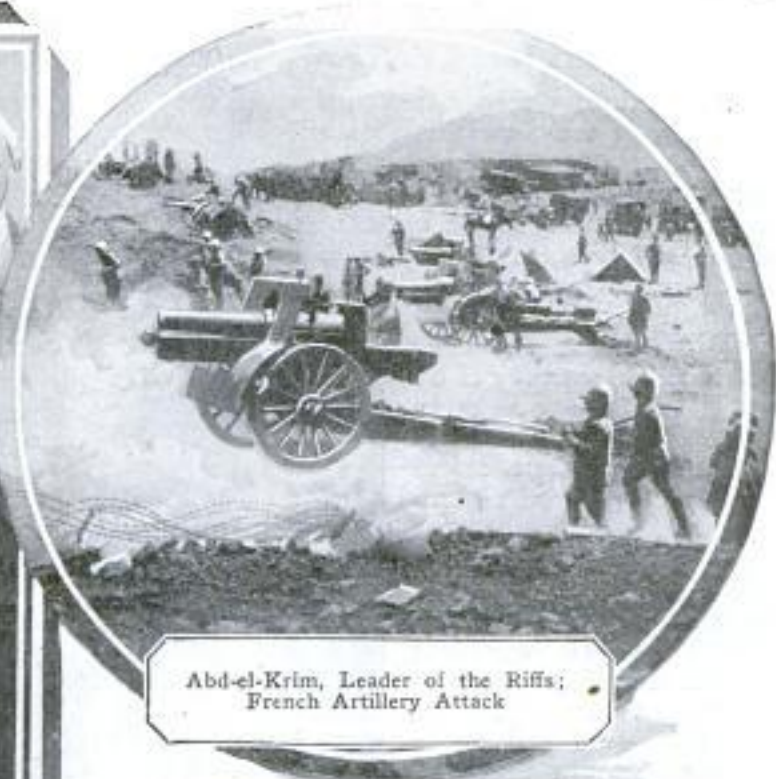

Abd-el-Krim, Leader of the Riffs;
French Artillery Attack



Warring as Savagely as Did the American Indian of Old, the Fearless Riff Horsemen Discounted the Science of Both Their French and Spanish Adversaries in Desert and Mountain Fighting

Nashville Bridge Co.

Nashville News

POPULAR MECHANICS

561

Jones + Laughlin Steel Co.

OIL ENGINE BRINGS NEW ERA IN RIVER TRAFFIC

205

What amounts to a revolution in the methods of transportation on inland waterways is promised by the advent of crude-oil internal-combustion motors of the Diesel type. These motors are like those used in automobiles except that the charge in the cylinders is ignited by the heat of the

compression and not by an electric spark. Not only is the operating cost of the oil engines much lower, but fewer men are required to run them. The government fleet on the Mississippi river is composed of steam-propelled craft. These boats represent the most modern ideas in tow boat construction, but they still fall short of the ideal in that the cost of operation is too close to their earning capacity. If that margin can be widened by the use of Diesel engines, through greater power at lower cost, river traffic is expected to witness a great revival. The largest boat of this type yet built was expected to go into service on the Ohio river about October 1. It is 126 feet long and will handle a tow of about 6,000 tons at five miles an hour.

IE
ING I
pict
abilit
A

BUILDING BLOCKS LIKE BOOKS ADD TO CHILDREN'S FUN

135

Hinged building blocks that open up like books and are lettered and printed in

Building with Book Blocks That Open Out on Hinged Sides and Are Decorated with Pictures and Stories



Toy Professor, Beacon, N.Y.
P.O. Box 22
Western Electric Co. & M.
Stamathones, Cicero.

FAN-SHAPED GLARE PROTECTOR FITS WINDSHIELD MIRROR

3129

Auto windshield mirror for watching traffic behind and a glare protector have been combined in one adjustable unit that may easily be fitted to the most convenient position for the driver. The shade opens up and closes like a fan by pulling a little catch. It is made of green-celluloid segments, linked together to spread out over a sufficiently wide area to protect the eyes without cutting off the view.



gay colors, afford the child the double pleasure of reading and looking at pictures and making things at the same time. They may be washed without damaging the colors, are adapted to a wide variety of objects, such as towers, houses, bridges, churches and airplanes, and when not in use, fit in a box or on library shelves.

PROCESS FOR TEMPERING LEAD TO IMPROVE TELEPHONE

Increased life of telephone cables is one of the benefits anticipated from a recently discovered process for tempering lead, an objective of science for hundreds of years. The method involves a special heating treatment and the use of alloys. The product is said to possess some of the qualities of steel, making lead pipe so rigid that it cannot be bent by hand and greatly improving the coating placed over telephone cables.

Allen Glare Protector Co., Waverly, N.Y.

skeleton must be built, and these data are sent back to the designer, who makes his final calculations and then orders work to proceed.

Back in the mold loft the final body lines are transferred to "scribe boards," thin wooden, or sometimes paper, patterns, by which the actual bending is regulated. For every plate and frame which goes into the ship, a pattern is produced to guide its shaping. Every rivet hole is shown and every twist and curve carefully reproduced.

When the first steel, the parts of the keel, reaches the yard, keel blocks are in place for its erection. These blocks are huge timbers piled on top of each other, starting near the water line of the launching slip and rising gradually, at the rate of one-half inch to the foot, so that the hull when completed, can slide down them into the basin. As soon as the keel sections are riveted together, forming an immense flat girder the full length of the ship, work begins on the double bottom, which gives the ship a series of watertight tanks beneath its lowest deck. Large brackets are fitted along the outer ends of the connecting plates, in line with the floor, and to these are attached the steel frames which extend from the bilge tanks in the double bottom to the upper deck. The hull now takes form rapidly, the ribs are covered with steel plates, riveted into

place, stem and stern are formed and decks laid. Boilers and engines are hoisted into place before the deck is placed over them, and finally the ship is ready for launching.

After this all that remains is the work of completing, furnishing and equipping the liner. The last item is an enormous task in itself. A new vessel, the "Malolo," designed by William Francis Gibbs, who made the plans for reconditioning the "Leviathan," requires thirty-two acres of linen for tablecloths, napkins, sheets and towels alone. The ship, being built at Philadelphia, is 582 feet long, has a displacement of 22,050 tons and a cruising speed of twenty-two knots, or over twenty-five miles an hour, making her the fastest big passenger ship ever built in the United States. She is expected to cut two days from the round-trip schedule between San Francisco and Honolulu. Besides her vast linen supply, her equipment includes 96,000 pieces of china and glassware, and 27,000 pieces of silverware.

Her ovens and ranges will cook by electricity, she will have more bathrooms than any ship ever built, and her water pumps will handle enough water each day to supply a city of 1,936,000 inhabitants. The comforts of the "Malolo" will set a new record for ships, including suites de luxe with private verandas, children's playgrounds, and a swimming pool.

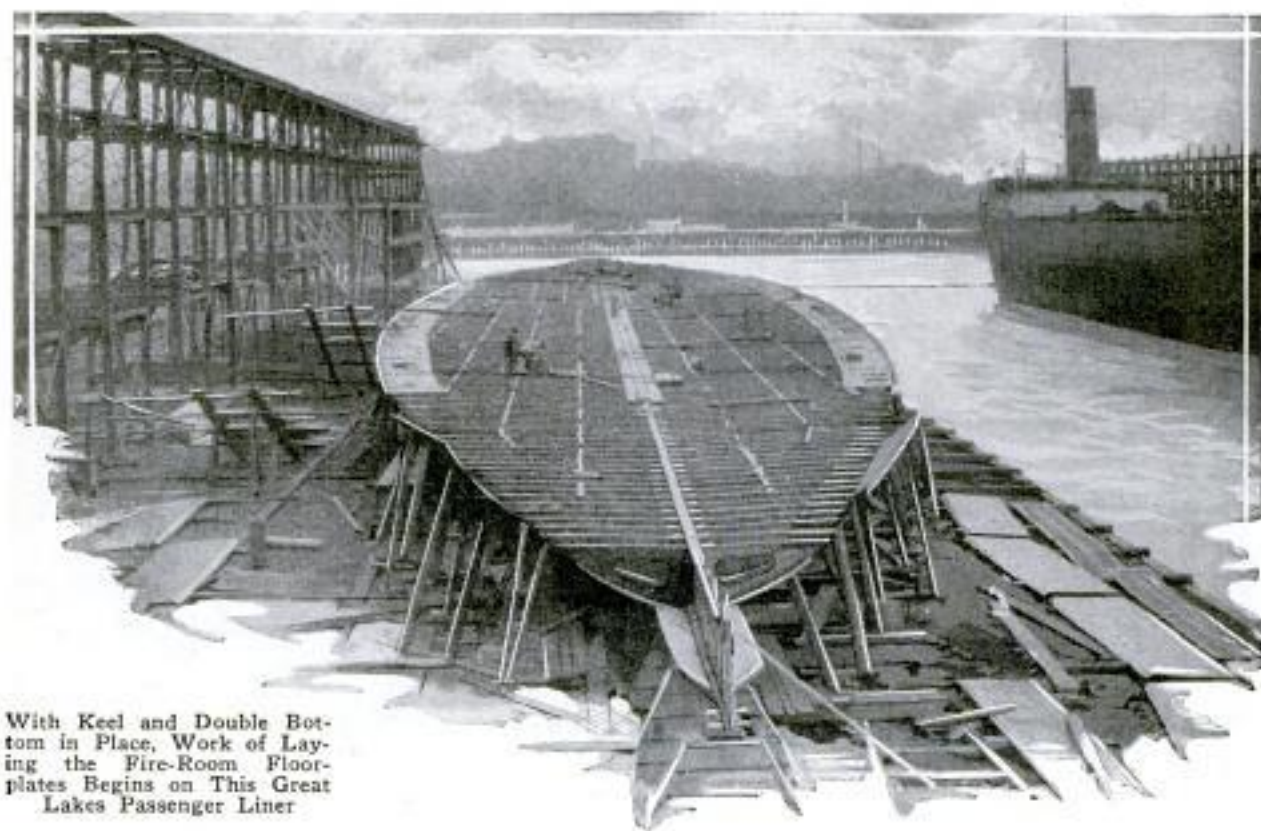

With Keel and Double Bottom in Place, Work of Laying the Fire-Room Floor-plates Begins on This Great Lakes Passenger Liner



Pilot House Being Lifted Aboard after Its Erection on Land

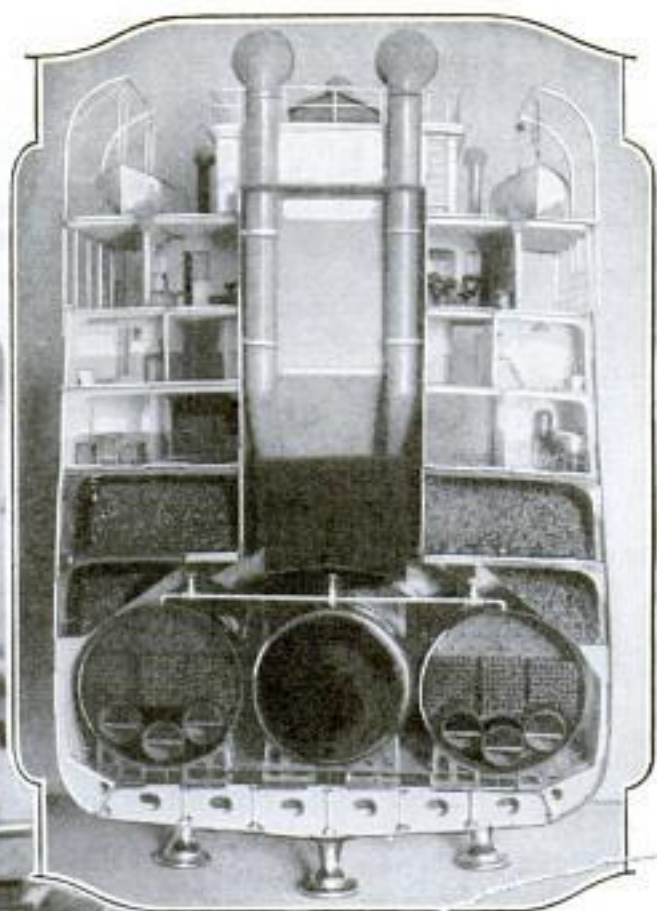

Cross-Sectional Model of Big Liner, Showing Midship Details from Keel to Boat Deck and Bridge

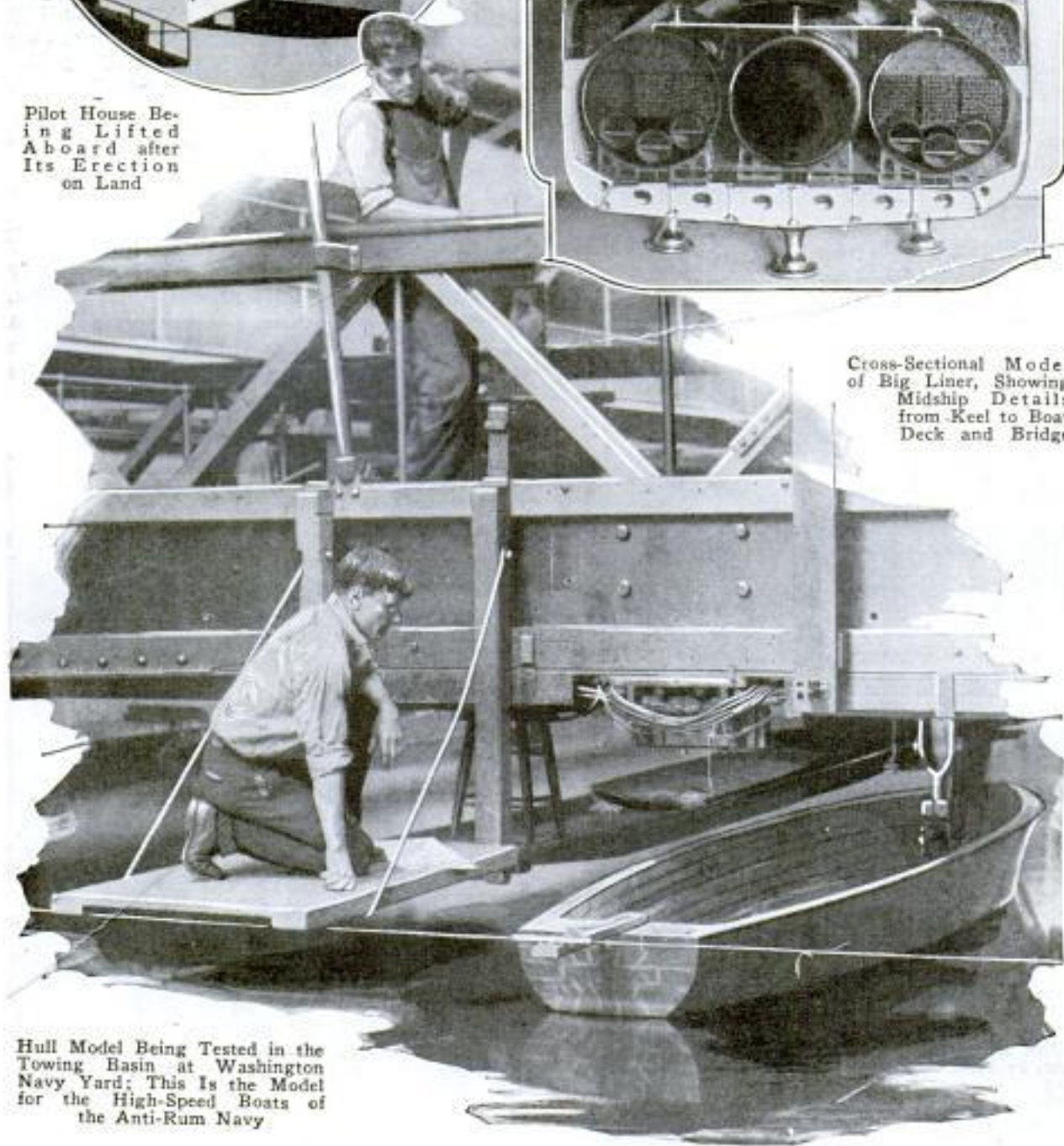

Hull Model Being Tested in the Towing Basin at Washington Navy Yard; This Is the Model for the High-Speed Boats of the Anti-Rum Navy

Discounted the Science of Modern Warfare



American Flyers Enlisted
to Fight These Desert
Rough Riders



Above, French Officers Are Watching Riffs Drive Back French and Spanish Troops Not Far from Fez, Chief City of Morocco; Right, Moroccan Chief Who Sided with the Europeans through Fear of Abd-el-Krim

International 361

B.A. Martin Co.,
421 S. 47th St.
Philadelphia, Pa.

Louisiana Motor
Transportation
424 Girod St., New Orleans, La.

564

POPULAR MECHANICS

AIR-FILLED CUSHION HEADREST GIVES TRAVELER COMFORT

For the autoist, steamer traveler or invalid, an air-inflated rest for the head and

117
Price - \$10.00.



Air-Inflated Cushion in Use in Auto; Straps Keep It from Slipping Down

shoulders, is tied with tapes about the waist to prevent it from slipping out of position. When it is not in use, it is deflated and may be folded into small space. It is strongly constructed in colored and figured materials to match costumes or furniture.

MODELS SHOW NAVY'S GROWTH FROM MASTS TO MOTORS

Development of the United States navy from the days of the picturesque sailing ships to modern times with their electric-

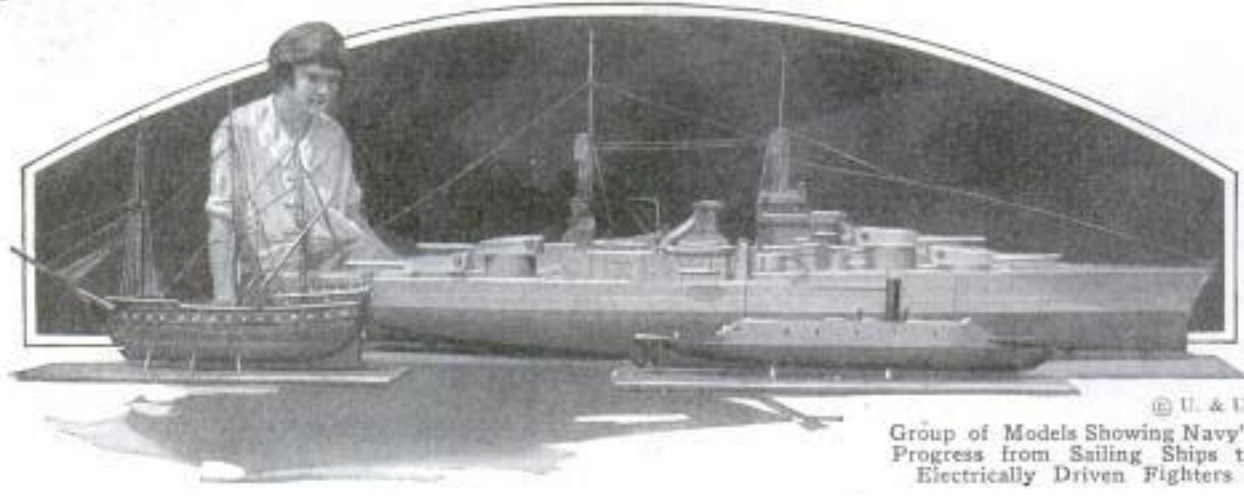

Group of Models Showing Navy's Progress from Sailing Ships to Electrically Driven Fighters

driven steel-clad fighting monsters, is graphically shown in an exhibit of models in the National Museum at Washington.

Included in the display, is a tiny replica of the "Bonhomme Richard," John Paul Jones' famous flagship, one of the "Merimac," first of the ironclads, and a model of the "New Mexico," one of the latest additions to the navy.

AUTO-HORN CODE SIGNALS USED TO HELP END ACCIDENTS

"Horn talk" by which autoists may communicate with each other on the road is being taught to members of a large automobile association through a copyrighted code. Its purpose is to help end accidents and to promote mutual assistance among drivers. Based on the Morse code, the signal system comprises most of the things necessary to say on the road. One long blast of the horn means "Please let me pass." A short blast, equivalent to the telegraphers' dash, means "Thank you." A dot and dash mean "You are exceeding the speed limit." Dash-dot-dash-dot signifies "Can I assist you?" Four dots stand for "How do you do?" Two dots mean "OK." Three dots say "Please stop. I want information." The SOS of the broad highway goes like this on the motor horn: ". . . - - - . . ."

MOST DANGEROUS AGES SHOWN BY ACCIDENT REPORTS

A child between five and nine years old is more likely to be struck by an automobile than at any other age until reaching sixty and above, according to a National Safety council's analysis of figures from the census bureau. The same report shows that the greatest risk from drowning occurs at an age of between fifteen

and nineteen years, the most active swimming ages. Babies of one also show a high mortality rate from drowning and

National Safety News
August 1915

this was held to reflect the hazard of allowing a toddling child to venture unwatched among washtubs and near creeks. A large number of deaths from scalds and burns was noted at the ages of two and three, the survey showing 37.3 per 100,000 infants in those age groups. The total declines rapidly after four and does not rise greatly until seventy, when many of the perils of childhood again are a menace. Death from falls and from asphyxiation as well as from autos and burns indicated the hazards of old age. Falls alone caused 552 deaths per 100,000 persons at the age of eighty and over. The report shows that they are, by far, the most important accident hazard for the aged. Firearms take their greatest toll at about high-school age, illustrating the risk of allowing inexperienced persons to handle them. Deaths from poisoning are most numerous among babies one year old, and mechanical suffocation, that is, by pillows, blankets and the like, is almost wholly confined to infants less than one year of age.

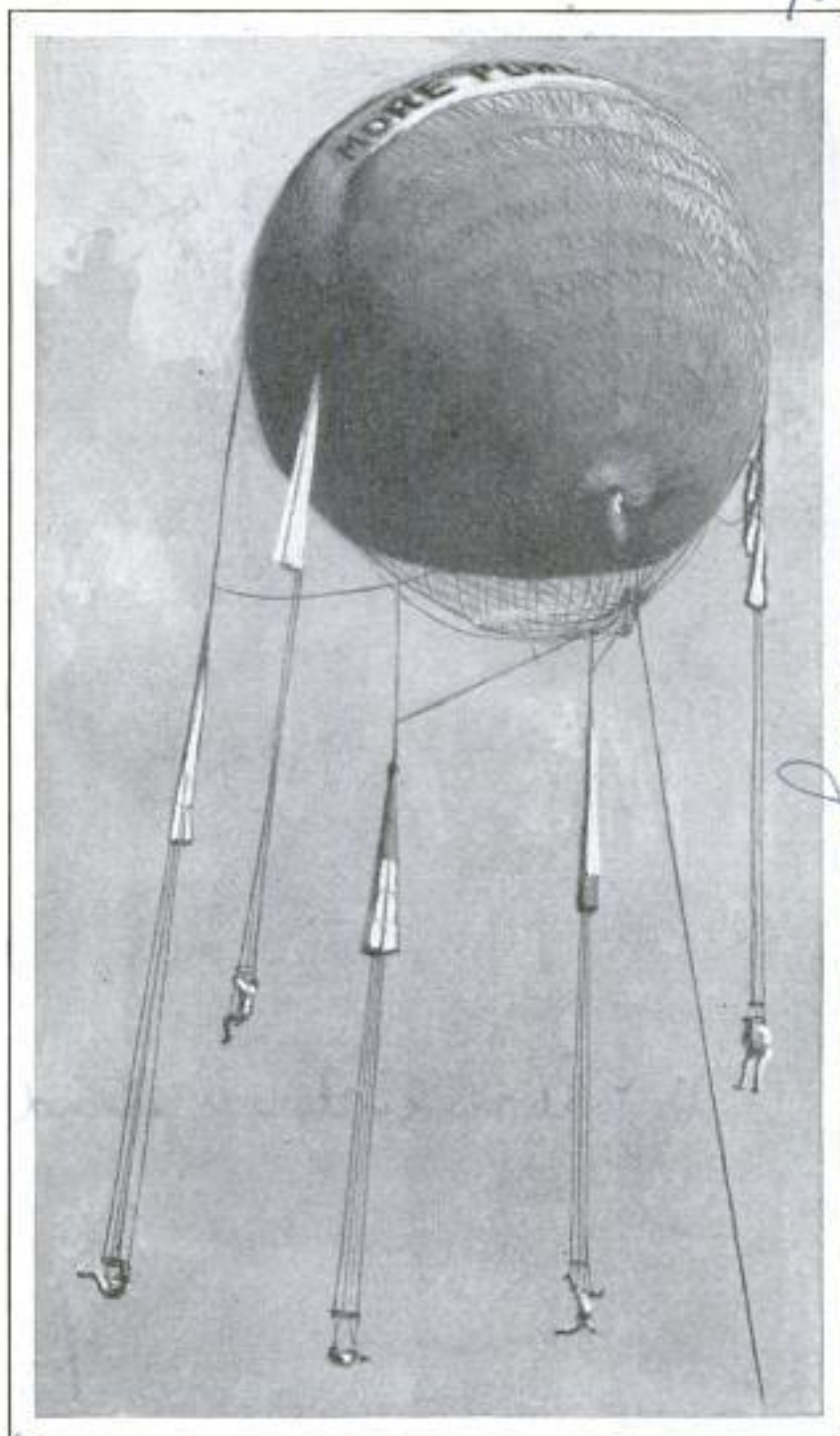

Cluster of Daring Parachute Jumpers Hanging from Balloon—Just Before Strings Were Pulled and Men Dropped 3,000 Feet

*Lake Merritt, Oakland, Calif.
 owner - Dean Hanger*

NEPTUNE'S DRUG STORE

104

Elements in enormous quantities are held in solution in the waters of the ocean. Scientists have estimated that, although iodine exists in the sea to the extent of only two parts to 1,000,000, there are 60,000,000,000 tons of it in the oceans. Its extraction would bring approximately \$540,000,000,000 at present prices. California produces 250,000 tons of common salt each year from the sea water. About a quarter of a pound of the mineral is contained in each gallon. Bromine in limited quantities is also being obtained from the sea.

FIVE PARACHUTE JUMPERS RACE FROM SINGLE BALLOON

120

Dangling from a single balloon that carried them to an altitude of 3,000 feet, a team of five daring parachute jumpers dropped simultaneously during an exhibition in California, and all landed safely in the waters of a lake. The feat involved the careful adjustment of the rigging to prevent tangling of the ropes. During the ascent, the jumpers performed acrobatic stunts hanging by their hands or feet.

Thrift Magazine

*Chicago Daily News
 7/18/25*

B. + A. S.

agent. *Kuffel + Esser Co. 127 Fulton St. New York City.*

566

POPULAR MECHANICS

Holopshane, light meter



Maker: Holopshane Sales Co. 842 Madison Ave. New York

in dye and paint making. A disk of white blotting paper is placed on the spot where the illumination is to be tested, as on a worker's bench. The operator looks through an eyepiece of the meter and sees two elliptical patterns, one within the other, produced by action of a glass cube within the tube of the instrument. The light reflected by the tested object passes straight through the glass cube and the telescope. But the light from a small lamp within the tube reaches the eye only after having been reflected at right angles. The operator moves the lamp in and out until the two ellipses seem to match in brightness. Graduations engraved on the side of the tube then give the intensity rating of the light.

Using Meter Which Eliminates All Guessing as to Amount of Light Reaching Worker's Bench

PORTABLE LIGHT METER GIVES ACCURATE READINGS

Weighing but three pounds including its batteries, an easily portable light meter has been devised for finding the intensity, location and distribution of light in factories. It also is used for matching colors

BRIDGE MODELS AID ENGINEERS PLAN REAL STRUCTURES

Small models of the proposed bridges between New Jersey and Staten Island, N. Y., were inspected by engineers to give them, and others interested in the project, an idea of the proportions of the structures, the length of spans and other details. The display was made more realistic by the use of mirrors to represent water and toy boats with sticks for masts which were placed under the bridge showing that it was high enough to afford vessels a clear passage.

W. J. Lewis, Staten Island Chamber of Commerce

Printed by Herbert Koenig.

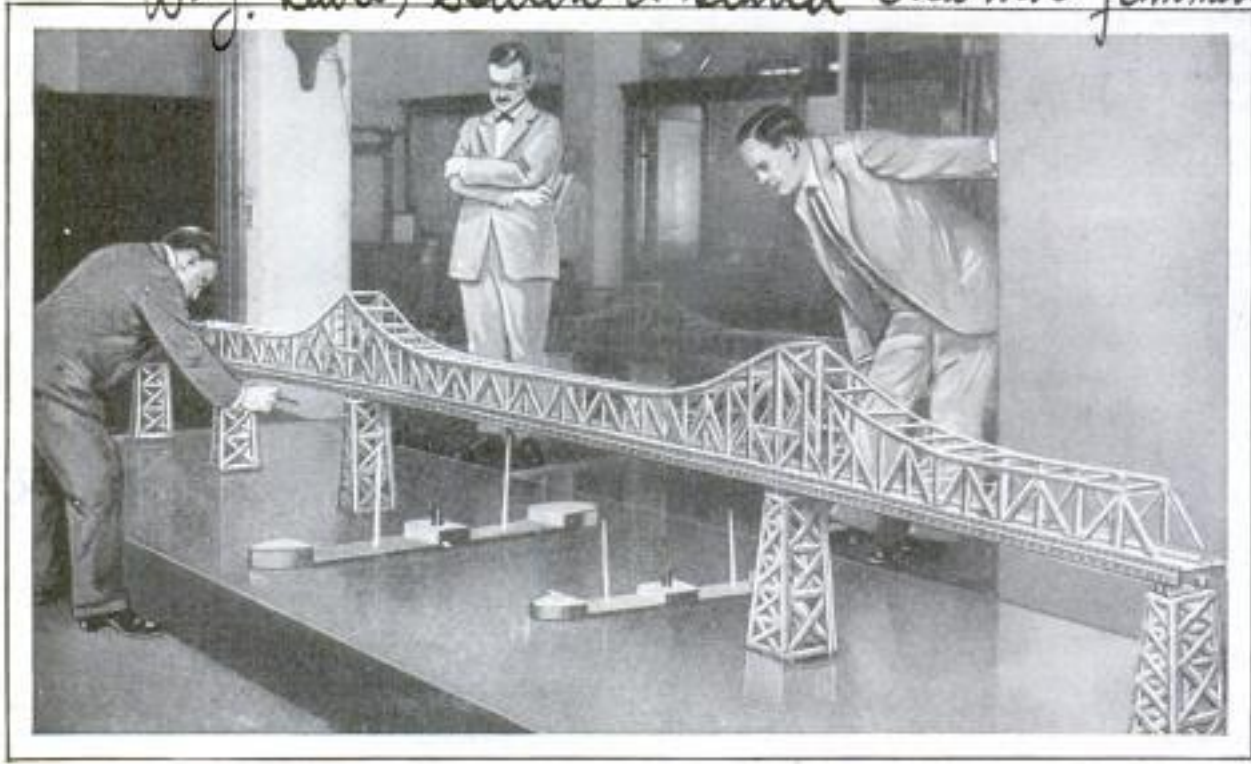

New York Engineers Examining Models of Proposed Bridges between New Jersey and Staten Island; Mirrors Represent Water and Toy Ships, Built to Scale, Show Clearance under Spans

N. D. Douglas, New York Port Authority *M. D. Kuffel, Elizabeth, N.J.*

3408 Cont. & Co. Winters
Electric National Bank Bldg.
POPULAR MECHANICS
Washington, D. C. 567



Fighting Insects

U. S. Department of Agriculture

THE immigration authorities at Ellis Island may be successful in barring from entry to the United States foreigners unable to fuse in the melting pot of American society, but at least three immigrants have sneaked in the back doors and, as parasites, are preying upon this country to the toll of approximately \$325,000,000 annually.

These undesirable immigrants—the boll weevil, the European corn borer and the Japanese beetle—have so entrenched themselves as to defy successfully all known methods of warfare. The militant attitude of these foreign foes, and others of their kind, is said to threaten civilization and to foreshadow the next war in the United States as one with bugs or insects instead of with human enemies.

This is not the prediction of an alarmist. Couched in different language, Dr. L. O. Howard, entomologist of the department of agriculture, has issued a warning of impending disaster unless organized warfare is made upon insects. Read the exact words of this authority who has been studying the subject for about sixty years:

“The prime insect pests of the world are, through commerce, becoming widespread, and the self-protection of nations demands the most intimate knowledge of the injurious insects of all countries, since all of them are potential pests of other regions. This subject was considered at some length at the recent Pan-Pacific Food Conservation congress, and one of the resolutions adopted at that confer-

ence recommended the appointment of an international crop-protection committee to promote surveys, to encourage research work, to promote the development by each country of larger numbers of trained workers, and to obtain agreements and understandings between countries regarding the giving of prompt notification of the appearance of new pests and to secure the co-operation of countries in the prevention of spread.”

Thus we have the germ of what may be termed “The League of Nations against Bugs.” If this organization had been functioning, probably the boll weevil would have been arrested in attempting to cross the boundary between Mexico and this country, and the shipments of broom corn from Hungary and Italy in 1909 and 1910 would have been fumigated before entering the United States, thus preventing the ravages of the European corn borer. Similarly, the Japanese beetle would not have gained entry into Pennsylvania, New Jersey and Delaware.

The boll weevil, arch enemy that it is, costs the United States \$300,000,000 each year, or a toll of approximately \$1,500,000,000 during the past five years. “Brought by accident, across the Rio Grande at Brownsville,” relates the chief of the bureau of entomology, “and then more or less by accident to Alice, it found itself in a boll-weevil heaven—a whole state growing cotton in just the way to make its life a delight, in just the way to promote its extraordinary powers of multiplication, and so its enormous progres-

vis: 2500

3408



Boll Weevil in Cotton Boll, Above, and Mule Outfit for Spraying Field



Larva, Above, and Weevil, Greatly Enlarged, Below

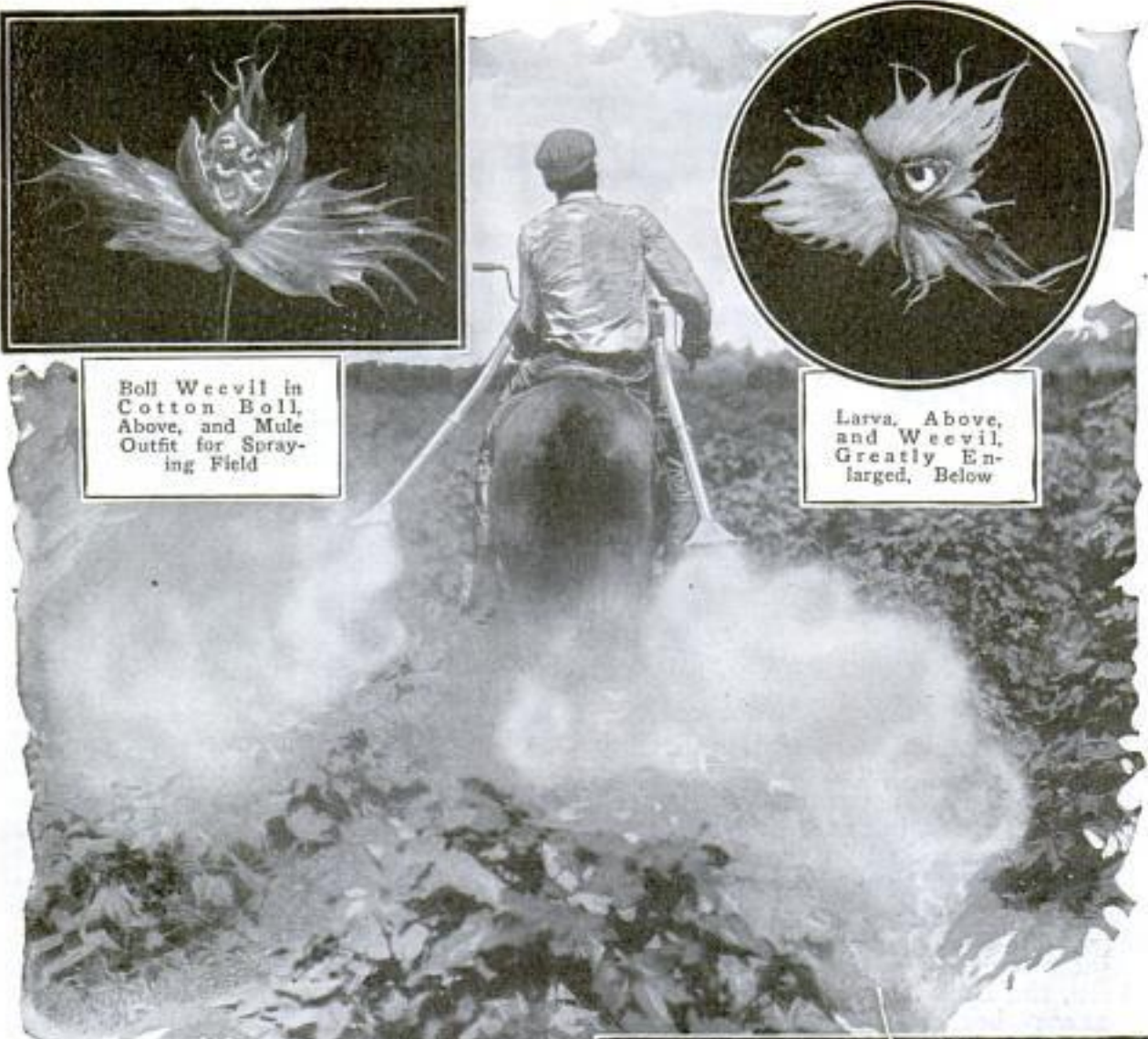

sive spread until now the whole vast cotton belt is occupied." Aircraft, flying low over cotton fields early in the morning and late in the afternoon, scattering death-dealing dust upon boll-weevil infested plants, suggest the concerted wholesale efforts to destroy this insect. Machines, drawn by one or two mules down rows of cotton and distributing veritable clouds of poison dust, are not uncommon sights in the south. Then, too, the small farmer may use a handspray in distributing calcium arsenate in the form of dry powder over his fields. Early planting of the crop and early fall destruction of the cotton plants are among the other control measures recommended.

Dr. Frederick B. Power and V. K. Chestnut, of the bureau of chemistry, are studying the cotton plant and the results of their studies will be interpreted in terms of further control measures of the boll weevil. For instance, we may

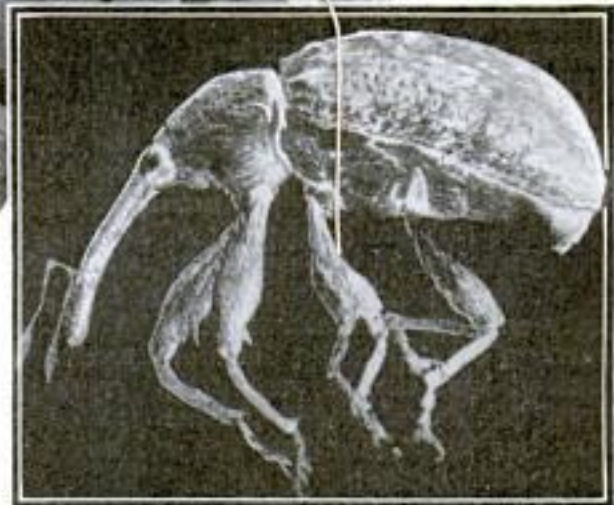

have a fatal bait, an insecticide that will not only lure the insects but make sure of their destruction. The chemical warfare service is diverting war-time poison gases to the uses of destroying boll weevils.

The menacing attitude of three other immigrants—the Japanese beetle, the

European corn borer, and the gipsy moth—is indicated when we are told that of the more than \$2,500,000 appropriated for the bureau of entomology for the fiscal year of 1925, over \$1,200,000 must be utilized in coping with these pests. This sum will be devoted to the establishment of quarantine zones for

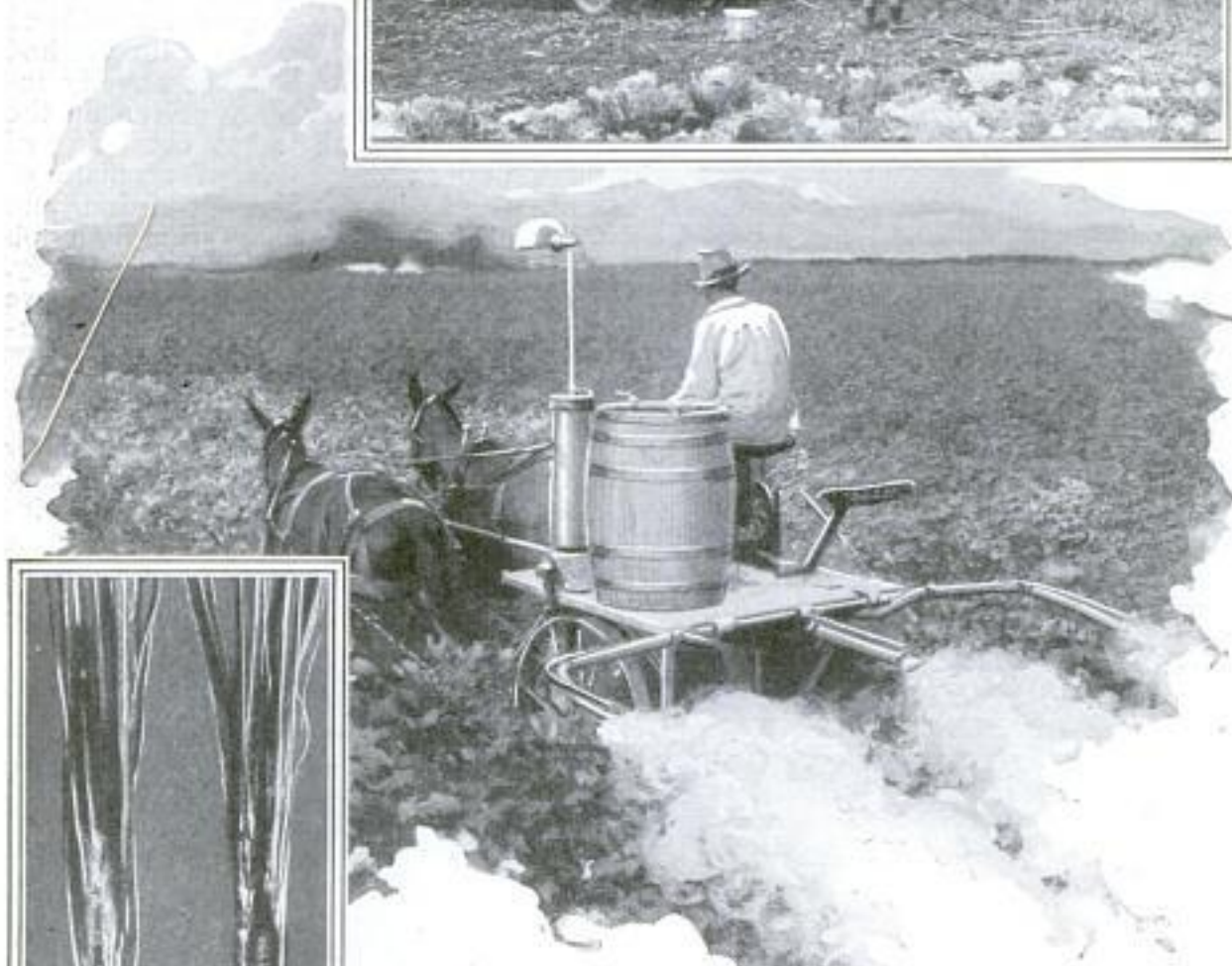

Spraying Fruit Trees to Kill Japanese Beetle; Two-Mule Sprayer for Cotton; Left, Corn-Borer Larvae

cluded field examinations in susceptible localities

preventing the spread of these insects with the hope of gaining partial control. The areas infested

not only in the area east of and including the Mississippi river basin states, but also in Texas, New Mexico and Arizona.

A quarantine sign near Concord, Mass., reading, "Warning—European corn borer quarantine; do not carry green corn beyond this point; Federal and State laws provide heavy penalty for violations," is suggestive of one of the methods used in preventing the spread of this foreign foe. The primary control is the practice of burning or otherwise destroying, be-

by the European corn borer include large slices of territory in New England, New York, Ohio, Pennsylvania and Michigan. Scouting operations, however, have in-

3408

fore May 1, all cornstalks, corncobs, corn stubble, vegetable, field and flower-crop remnants, weeds and large-stemmed grasses of the previous year. Other precautionary measures recommended by the government include the following:

Keep cultivated fields free of

weeds, cut corn close to the ground, cut and remove sweet-corn fodder from the field as soon as the ears are harvested.

The Japanese beetle has infested an area of approximately 2,400 square miles. While this pest is limited to Pennsylvania, New Jersey and Delaware, its operations may be said to be intensive. The appetite of this insect is not discriminating. The bureau of entomology has indicted the Japanese beetle for preying upon no less than forty-odd economic plants.

Control measures recognize the enforcement of quarantine areas, thus restricting movements of products liable to contain the beetle. The common method of attacking it where it has already entrenched itself, is to spray poison on the infested material, the spray consisting of three pounds of powdered arsenate of lead, mixed with two pounds of flour and fifty gallons of water. A thorough job of spraying is recommended. Lately, natural enemies or useful parasites have been introduced from Japan to make warfare on this insidious foe.

The ever-growing army of insects is encouraged and propagated by our modern ways of travel. Or, to quote Doctor Howard, "So what is termed 'advancing civilization' is not only encouraging in-

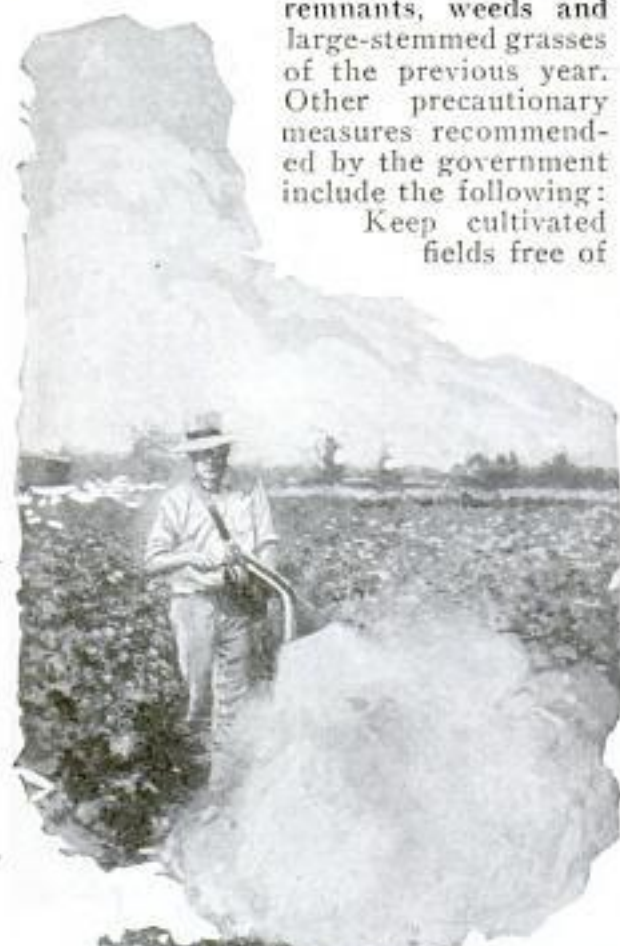

Hand Spraying of Cotton Field; Below, Sign Warning of the European Corn Borer

3408

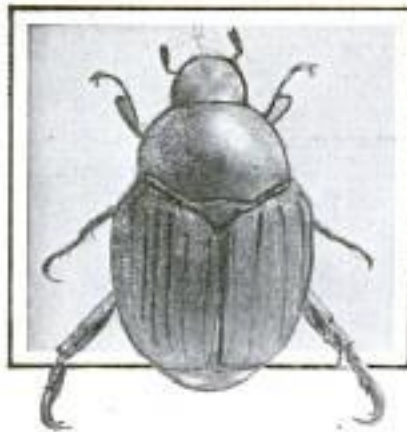

Above, at Left, Is the Destructive Japanese Beetle, and Next to It a Parasite Which Lays Its Eggs on the Body of the Beetle; the Eggs Develop into Larvae Which Feed on Their Host and Thus Kill the Beetle; Top, Right, Is a European Corn Borer

Below, Sign Posted to Prevent Spread of the Japanese-Beetle Plague



WARNING!
Japanese Beetle Quarantine
 The following products must be inspected and certified:
THROUGHOUT THE YEAR—Nursery, Greenhouse Stock, Plants, Plant Sticks, Sand, Salt or Earth, Peat, Manure.
BETWEEN JUNE 15 AND OCTOBER 15—Greed, Sweet or Sugar Corn, Parsnips, Parsley, Carrots with Lettuce, Out-of-Door Drains and Forage Crops.
 Federal Department of Agriculture

Below, Is a Moth Developed from European Corn Borer, One of the Imported Crop Pests



Left, Corn-Borer Larvae in Stalk, and Feeding on Immature Ears of Field Corn, Below



ways." In support of this, he cites the example of T. Chalmers Mitchell and his companions, who, in flying from Cairo, Egypt, to the Cape of Good Hope, a few years ago, demonstrated that the airplane might spread insects.

sects to multiply almost beyond bounds, but it is facilitating and hastening their spread in many

FIRE MASK WITH GLASS FRONT PERMITS WORK IN SMOKE

128 Firemen's helmets with protected glass fronts in use in Germany are said to per-



Side View of Helmet Which Has Wide Glass Front and Gas-Storage Tanks Behind

mit the wearer to work with ease in smoke that would quickly suffocate an unprotected person. The chemical apparatus is carried in a convenient holder on the back, tubes connecting it to the mouth-piece, running under the left arm. The wide glass window allows free vision.

TOWN TO BE TURNED INTO LAKE TO SUPPLY NEW YORK 181

Once a prosperous farming center, the village of Gilboa, N. Y., founded in 1760, is being converted into a huge artificial lake, 150 feet deep, five miles long and holding 22,000,000,000 gallons of water to supply New York city. A big dam, overtopping the town's church steeple before the structure was razed, has been constructed to stop the creek that flowed through Gilboa. The water is to be carried through eighteen miles of tunnels cut through the Catskill mountains, to feed the Ashokan reservoir. The bore makes a drop of 500 feet and, in places, is large enough to accommodate an electric railway. Most of the 200 residents of the village scattered before completion of the dam, but a few lingered until the expira-

tion of the thirty-day notice they were allowed under condemnation proceedings begun eight years ago. A cemetery of more than 1,000 graves was moved to make way for the project, which will cost approximately \$22,000,000 and has taken six years to build.

178 PORPOISE, KILLED FOR ITS OIL, SEEN AS LEATHER SOURCE

Approximately 60,000 square feet of leather is lost annually by not utilizing the carcass of the porpoise after the oil is extracted, according to an English expert. The animals are said to have a skin from which ten to twenty square feet of leather can be produced. It consists of an upper layer and underlying "splits," the first of which is thick and strong enough for the manufacture of heavy boots, and the second, being like suede leather, is particularly adapted to use in fancy goods, gloves and women's and children's shoes, as well as for covering furniture.

85 DOOR SILENCER PROTECTS CLOSED-CAR WINDOWS

Rubber bumpers for the doors of closed cars are now on the market, to prevent rattling and the likelihood of breaking the windows when slamming the doors shut. They are quickly installed and replace the plain attachments with which the car already is provided. Their distinguishing

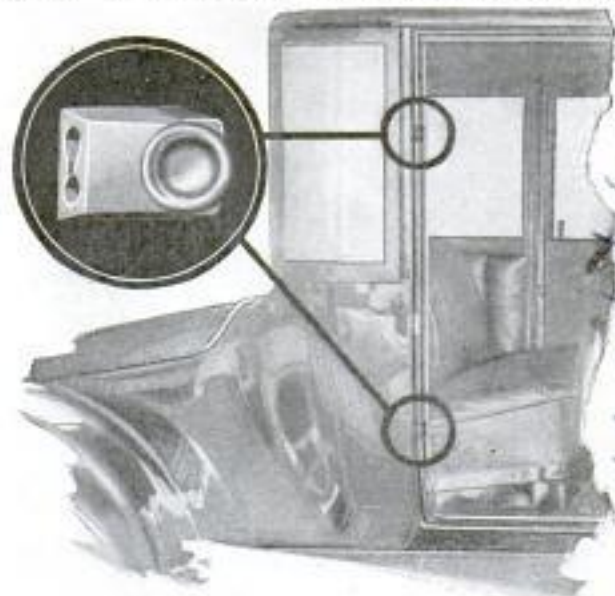

Bumper Showing One Air Cushion, and Car Marked to Indicate Positions in Use

feature is a little cushion that absorbs the impact of the door and forms a vacuum to grip it tightly, when closed.

Jorgensen Specialty Co.
Eric, Pa. *1.00 for set of 6.*

new York Times. 8/4/25

copyrighted material

119

1457 Broadway New York
U. S. Sales and Trading Co. 28 So. Edwards St. Brooklyn, N. Y.

BATHING BEACH SCENE OF NIGHTLY TREASURE HUNT



© Keystone
Searching the Beach for the Sparkle of Metal; Sifting Sand, and a Recovered Treasure

Groups of men with shovels, flashlights and sifters appear at Coney island when the bathers have departed at night, and make careful search through the sands for bracelets, rings, necklaces and other trinkets that may have been lost during the day. Their hunts are frequently rewarded as they learn to distinguish the glint of metal in the sand. They make their search soon after the beach is clear, so that articles will not be carried out by the waves.

post for night-mail and passenger planes. Its billion-candlepower beam is visible to high-flying craft for some 250 miles in clear weather, and under favorable conditions may be seen in parts of Belgium, Germany, Switzerland and Italy, as well as practically all over France.

176
WATER HARDER THAN STEEL

At a turbine station in Switzerland several jets of the issuing water are so rigid that a strong man armed with an iron crowbar would be unable to drive it through them, according to reports. The streams rush out of nozzles only one and one-half inches in diameter at a pressure of nearly two tons to the square inch.

at Sully
GIANT SEARCHLIGHT IS VISIBLE OVER TWO HUNDRED MILES 190

Intended originally as a beacon for war pilots, a powerful searchlight has just been installed on Mont Afrique, near Dijon, France, at a height of about 1,500 feet. In peace times it will act as a guide

172
HAND CUTTER FOR GLASS TUBES SAVES TIME AND WASTE

Glass tubes of different sizes are easily cut in any desired lengths with a hand tool that requires but little skill to operate and is not likely to break the work. The tube is held at right angles to the cutter and clasped within a small lever which is pressed down with the thumb. The glass is revolved toward the operator, and as it turns, the blade cuts into the tube around its entire circumference. A few light taps then will break the piece off squarely. The instrument may be attached to an ordinary glass cutter.



La Science et La Vie.
July 1925 0.51

19th St. + S 2nd Ave. Chicago

FIFTEEN-POUND PORTABLE SAW IS ELECTRICALLY DRIVEN

Weighing only fifteen pounds, a new electrical saw will cut thousands of feet of lumber daily, it is claimed. The tool is so

Price - \$80.00



Lightweight Electric Circular Saw Cuts Variety of Materials and Is Operated with One Hand

light that it can be operated with only one hand. It has a grip handle, with a make-and-break trigger switch. It is portable, and, deriving its power from any lighting socket, may be used in shop, millyard or home, as required. To operate it, the base

is simply set on the desired line. A slight pressure on the handle moves the machine forward and the teeth steadily pull their way through the lumber. This portable saw is said to be equally effective in tearing through wood, bone, wallboard, fiber, linoleum, hard rubber and light-gauge soft metal.

HIGHER SPEED ON GOOD ROADS URGED FOR AUTO SAFETY

Present laws regarding motor vehicles are "as out of date as the hand crank," according to the American Automobile association in advocating increased speed on good highways that congestion may be relieved and greater safety insured. Officials of the association point out that the speed laws have not kept pace with the rapidly increasing number of cars and that there is no line drawn between speeds appropriate for different traffic, weather, car and road conditions. According to Richard Haldeman, chairman of the good roads board of the association, "the motoring public is driving too fast over the dangerous streets and is being held back for fear of technical violation in streets where there is no reason to run slowly." Dirt roads and concrete should not be blanketed with the same speed regulations, the association holds.

More emeralds are mined in Columbia than in any other country in the world.

ARMORED BANK TELLERS' CAGES TO FOIL BANDITS

To protect the lives of bank employes and to guard the money, armored tellers' cages have been designed to foil attacks with the aid of bullets or gas. They are like small forts or "pill boxes," lined with heavy steel and are constructed so that they may be placed in front of the vault. Customers transact business at what appears to be an ordinary window. But they cannot see the man behind the rail, only his reflection in a mirror, and the clerk looks at the customer's image projected to his side of the cage over a steel wall. Conversation is carried on through a speaking tube. It is elbow-shaped to prevent entrance of gas to the cage and may be further shielded by a cloth filter. Additional safeguard against gas is afforded by a sheet of glass just above the teller's head. All moneys or papers that change hands are placed in a small steel drawer so arranged that it can be locked instantly by the clerk from his side of

the window. It slides out on ball bearings in position for the customer to reach it, and steel cleats prevent its being pulled out from the cage. The mirrors are placed so that the customer can see whatever is put into the drawer and safeguard himself against errors. Steel bars are placed across the reflecting space on the outer side of the cage so no one can climb into the teller's compartment. The mirrors afford a clear view from both sides and the speaking tube decreases the volume of the voice very little. A simple and effective means is provided for ventilating the interior of the cage, which is securely roofed with steel. There are peepholes through which the teller may command a view of the main room, and openings for a weapon in case occasion demands his help in resisting an attack. The cage has been on exhibition in a mid-western city and has gained the endorsement of a bankers' association.

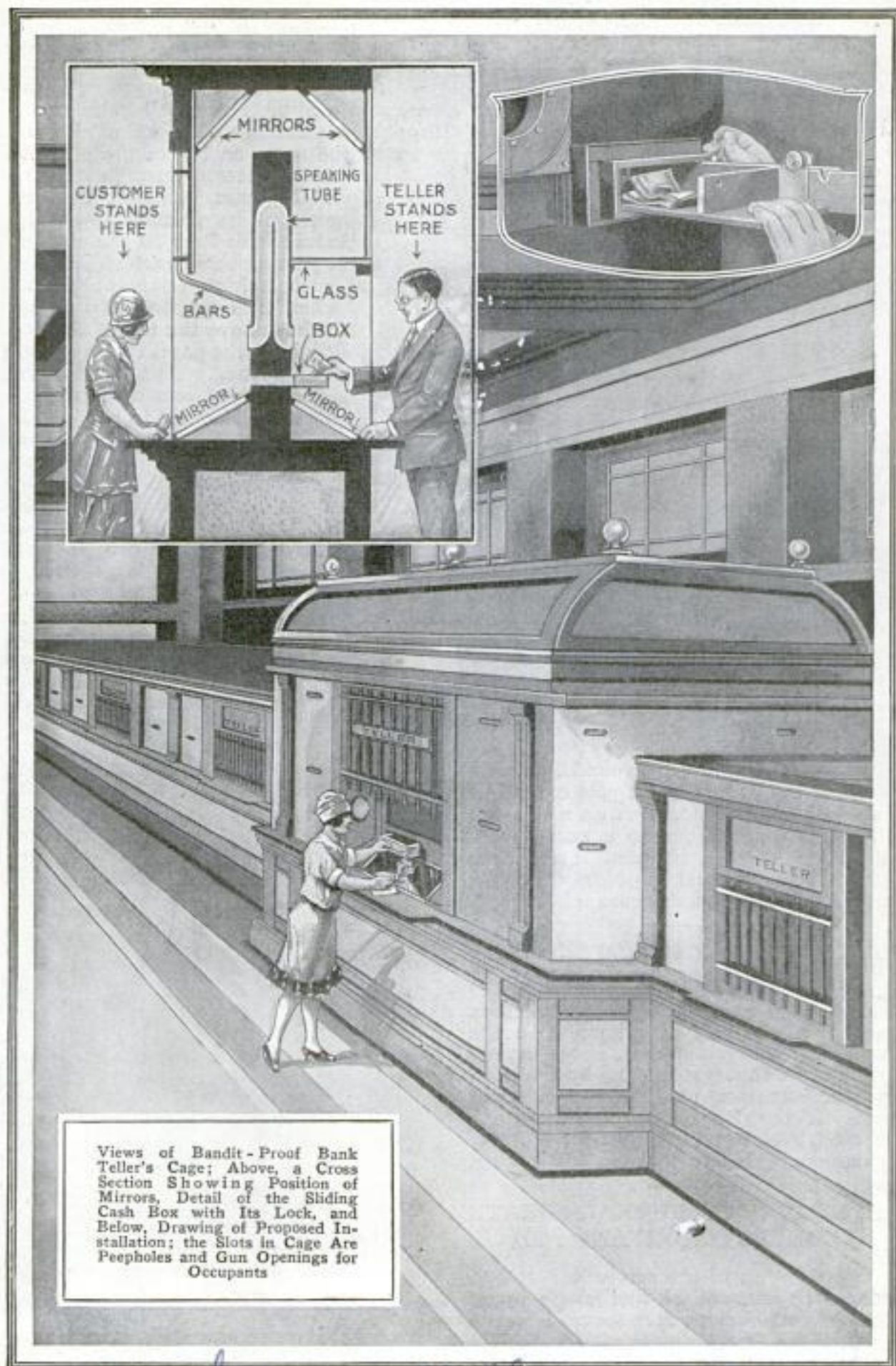

Views of Bandit-Proof Bank Teller's Cage; Above, a Cross Section Showing Position of Mirrors, Detail of the Sliding Cash Box with Its Lock, and Below, Drawing of Proposed Installation; the Slots in Cage Are Peepholes and Gun Openings for Occupants

Esrohn + Wells
 1550 W. 51st St
 Chicago

J. B. Zeig Mfg. Co., Frederickton, Ohio

576

POPULAR MECHANICS

MERRY-GO-ROUND AND SWING ARE COMBINED IN ONE

147 Children are finding pleasure and health in a combined merry-go-round and swing

Platform Suspended from Top of Pole Is Pushed Back and Forth as Swing or Rotated as a Merry-Go-Round

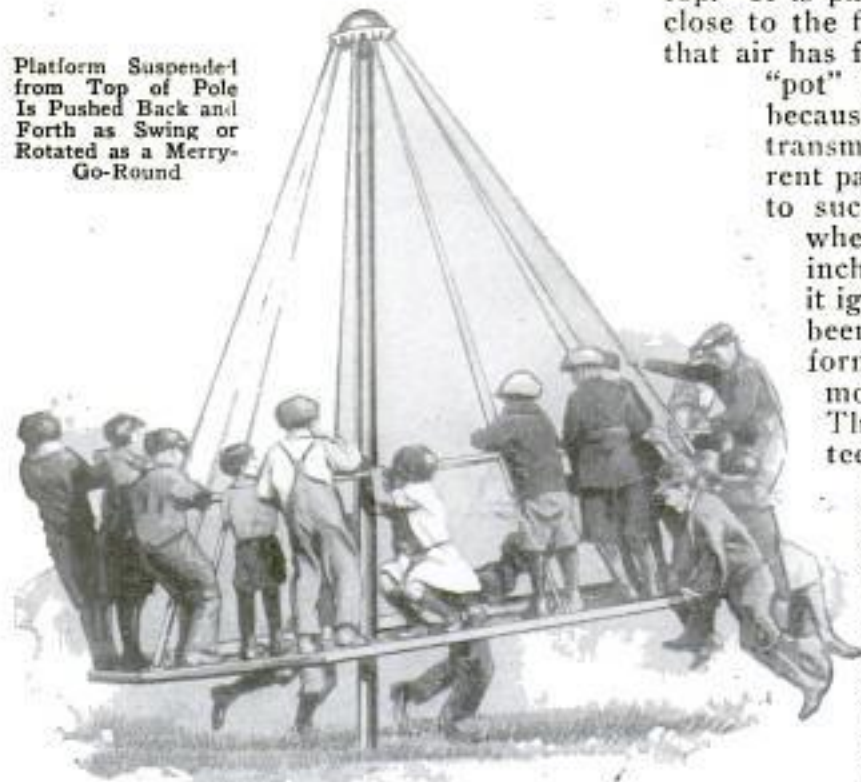

now being used in playgrounds. Ropes from the top of a ten-foot pole extend to a circular wooden platform on which the children stand, holding to a guard rope, waist-high. Other children furnish the motive power, either pushing the platform backward and forward or around.

HAUNTED HOUSES OFTEN MEAN LOOSE WATER PIPES

Mysterious noises, sometimes heard in unoccupied houses, may simply be the sounds caused by loose water piping, according to a theory advanced by the Indiana committee on public-utility information. If the lengths are not securely fastened, vibrations, set up near by, may be communicated to the vacant dwelling.

AIR HEATER ON FURNACE GRATE REDUCES SMOKE AND ASH

As a solution of the smoke evil and to reduce the amount of fuel waste in all kinds of coal-burning furnaces, a Chicago inventor has placed on the market a small preheater that is said to effect almost com-

plete combustion in the fire box. It is shaped like a coffeepot, is made of a carborundum product which will not melt, and is hollow, with a wide opening at the base and a number of small holes at the top. It is placed at the back of the fire, close to the flues, on top of the grate so that air has free access through it. The "pot" becomes intensely hot and because of its peculiar properties transmits this heat to the air current passing into it, which is raised to such a high temperature that when it is released, about four inches above the top of the fire, it ignites the gases that have not been burned. This prevents the formation of soot and gains almost full benefit from the coal. The heater is from ten to nineteen inches high, weighs from twelve to 125 pounds and is installed without any alterations on the furnace. Two or more can be used, if desired, in large boilers. Tests have shown that the device will reduce the amount of ashes and clinkers over forty per cent and the coal consumption more than fifty per cent. It is also claimed that poor grades of fuel can be burned with almost as good results as the more expensive qualities with the aid of the heater. One reason for incomplete combustion in ordinary furnaces is that most of the oxygen is used up before the air has passed through the coals, according to government experiments.



Drawing Illustrating Preheater in Operation. Air Passing under Grate, through Pot and Igniting Gases

*Boomer Utilities 6/18/25
Hume & Hannay Bldg. 3423
Chicago*

(Combustion Products Co. Sdgs. 406 Conway Chicago)

Chas. J. Swannell 12/9/26



FOUR YEARS AT ANNAPOLIS

III—The Third Year

WITH June week gone, the midshipman entering his third year passes into the second class, and immediately leaves on the summer cruise, which is followed by the annual September vacation. To the eighth of an inch band of gold braid on his left sleeve, he adds a second one, a quarter of an inch away. His increased rank carries with it harder work during the cruise at navigation and in executive positions.

The midshipmen have a chance to try all departments in warship operation on their training trips, from shoveling coal in the stokehold to guiding the big vessel, under the eye of a naval officer instructor. Engine-room force and deck crew alike are drawn from the middies' ranks, and since the newer oil-burning battleships are not assigned for the practice squadron, the entire regiment draws the unpleasant task of coaling ship, followed by a session of scrubbing down and repainting.

Back at the academy in October, the regular grind of lessons and drills is resumed, the technical lessons being a bit more severe than during the second year. The daily work, however, is brightened with a few more privileges in recreation hours, and plenty of athletics. Sport is as much a study as any other subject; every boy is graded and must average 2.5 to pass. He must be able to swim, must go through the regular gymnasium drills creditably, and must participate in one or more of the outdoor games.

Social life also is not neglected, regular "hops" being held in the armory. Discipline at these is as strictly regulated as in the daily routine. The second-class midshipman is permitted to leave the grounds an hour before the ball starts, to call for the lady. Without special permission he may not take her home before the hop is over, and he must be back in his quarters within forty-five minutes after the last dance.

The midshipman and his girl walk to and from the hops, since members of the regiment are forbidden to ride in any vehicle except during their September leave. The second-class man, with his increased allowance of \$8 a month, is able to spend a bit more than in the previous years, but the difference of \$3 does not go far. A little booklet entitled "Dope for Drags"—a midshipman's girl is always a "drag" since academy rules forbid his taking her arm but permit her to take his—finds a ready sale among the midshipmen to send to friends who contemplate visiting the academy.

Next month the story of the last year of life at the naval academy will be told.



Above, Midshipmen at Work in the Blacksmith Shop, and Right, Part of the Midshipmen's Regiment Standing Inspection on the Terrace of Bancroft Hall



Future Officer Working in the Machine Shop, Above, and a Lesson in the Interior Functions of a Steam-Launch Boiler, One of Many Mechanical Models

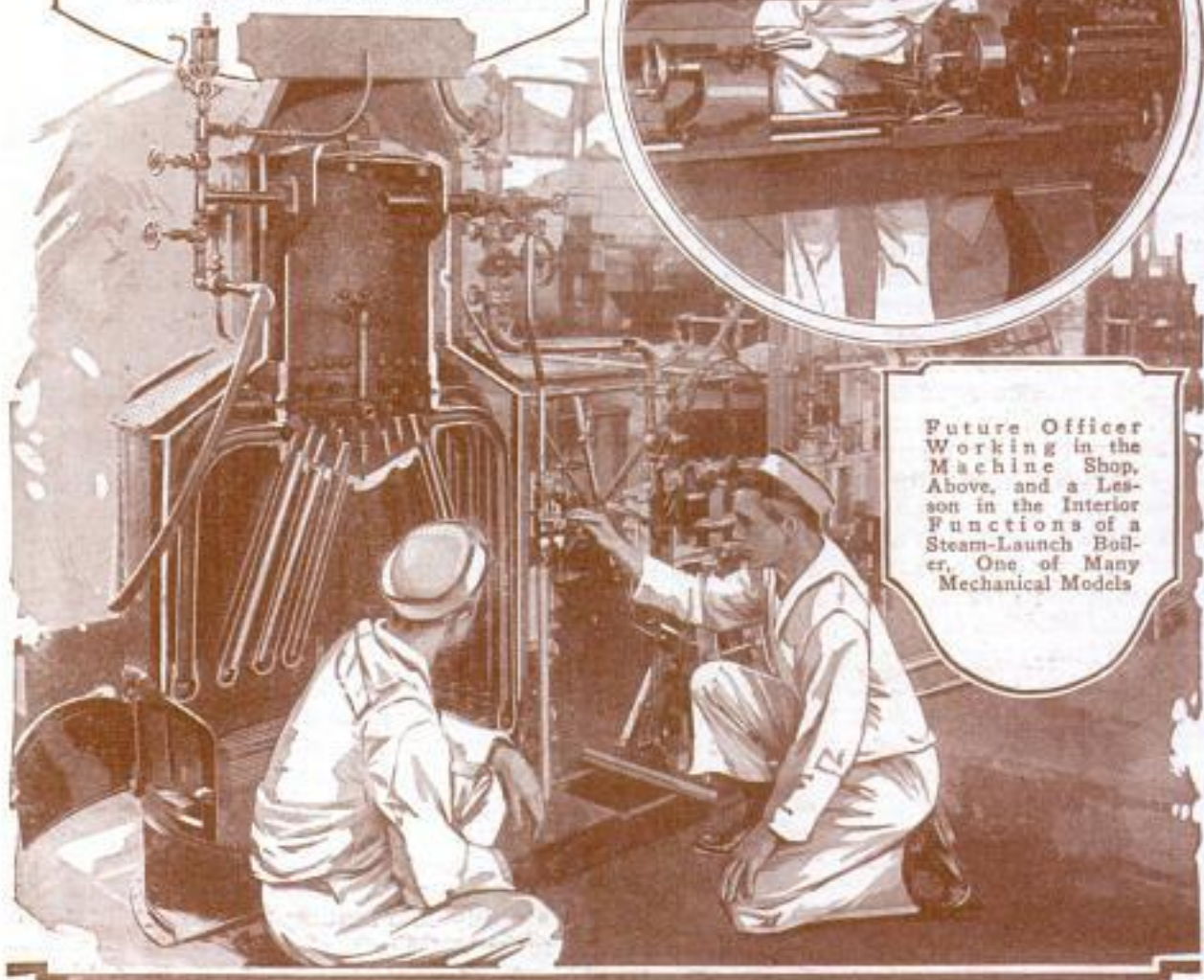

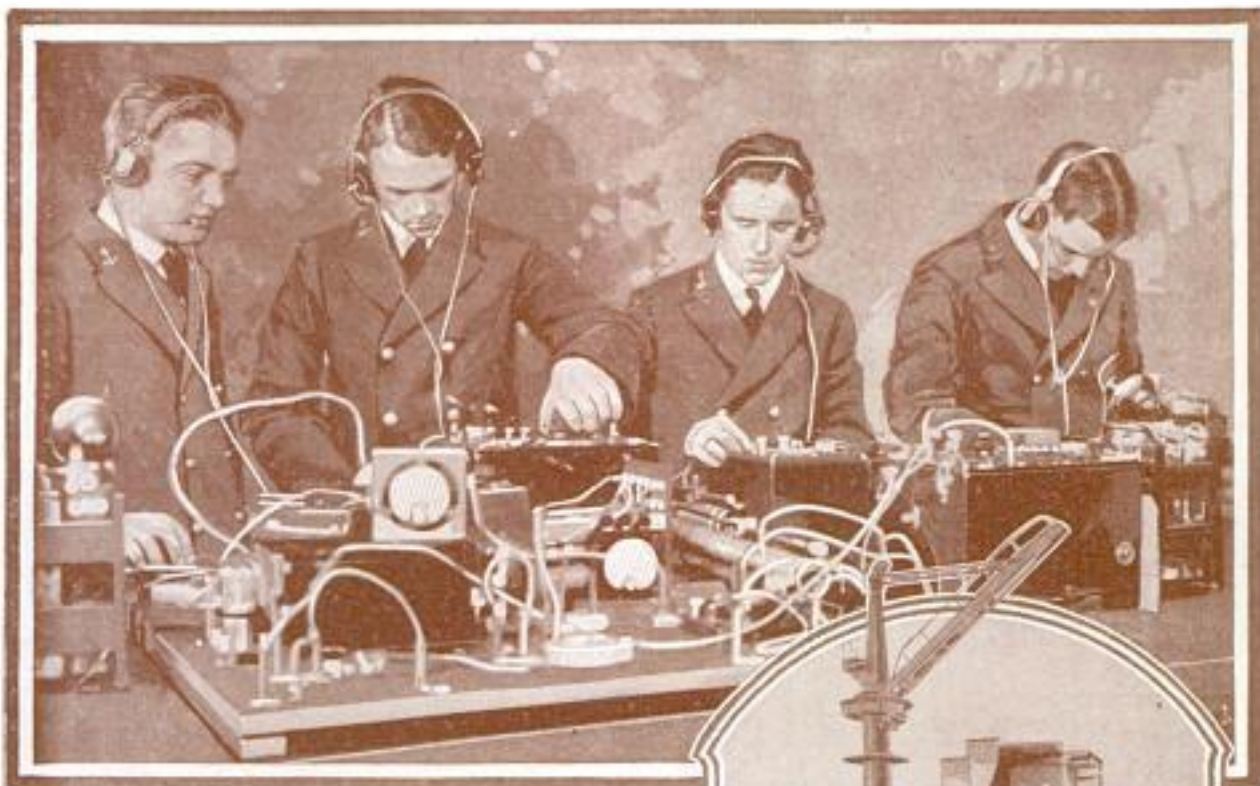

Above, Part of a Radio Class Experimenting with Naval Sets; Right, a Sectional Model of a Battleship, with Which the Midshipmen Are Taught the Arrangement of Decks, Engine Rooms, Ammunition Hoists and the Construction Details of the Big Ships They Some Day May Be Called Upon to Command; Below, a Scene in the Electrical Laboratory, Where the Classes Are Given a Thorough Working Knowledge in the Building and Operation of Motors, Lighting and Signal Equipment Used on Shipboard; in the Left Foreground, Apparatus for Making Brake Horsepower Tests

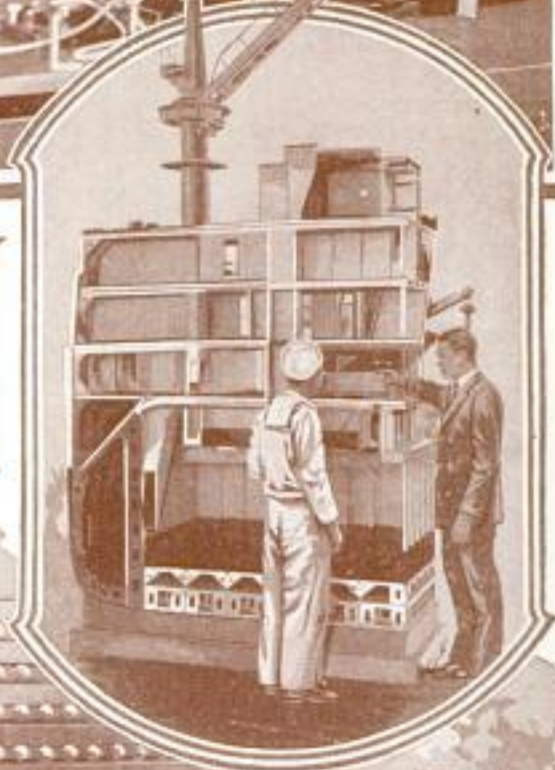



Infantry Drills for Use of Landing Parties from the Fleet Are Taught the Regiment of Middies; at Left Is a Scene on the Rifle Range; Below, a Squad Ready to Start the Afternoon Workout in the Gymnasium, Where Physical Tests Must Be Passed with the Same High Grades as Demanded in Classrooms

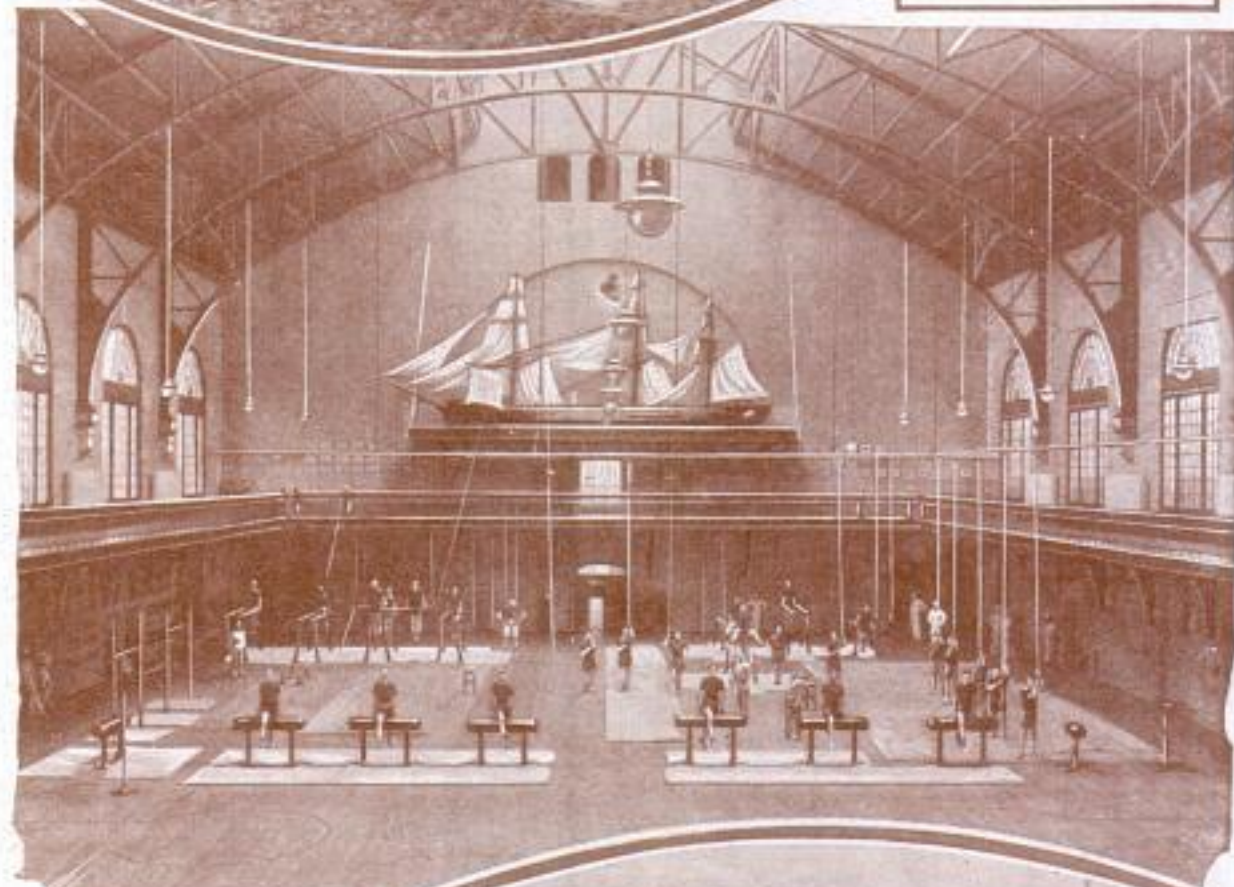

There Is Plenty of Hard Work to Be Done during the Summer Cruise, but When the Day's Labor Is Done Comes "Happy Hour," Given Over to Music and Games; Here Is an Impromptu Orchestra of Middies Gathered around the Ship's Piano, Hauled Out on Deck for the Occasion; Music, like Sports, Is Encouraged as One of the Best Ways of Keeping Up Morale





Above, Infantry Drill on Farragut Field, with the Severn River in the Background; Right, Tecumseh, Wooden Figurehead of the Old U. S. S. "Delaware," to Which the Middies Pray for Passing Marks, and, Below, the Celebration of His Successful Worshipers When Grades Are Posted



2484
582



Middies at the Wheel of a Battleship on Summer Cruise, and, Center, Handling the Signal-Flag Locker and Preparing to Hoist Code Flags to Guide the Squadron



Future Admirals at Their Morning Job of Holystoning the Deck of a Battleship during the Summer Cruise. When They Get a First-Hand Knowledge of a Sailor's Work

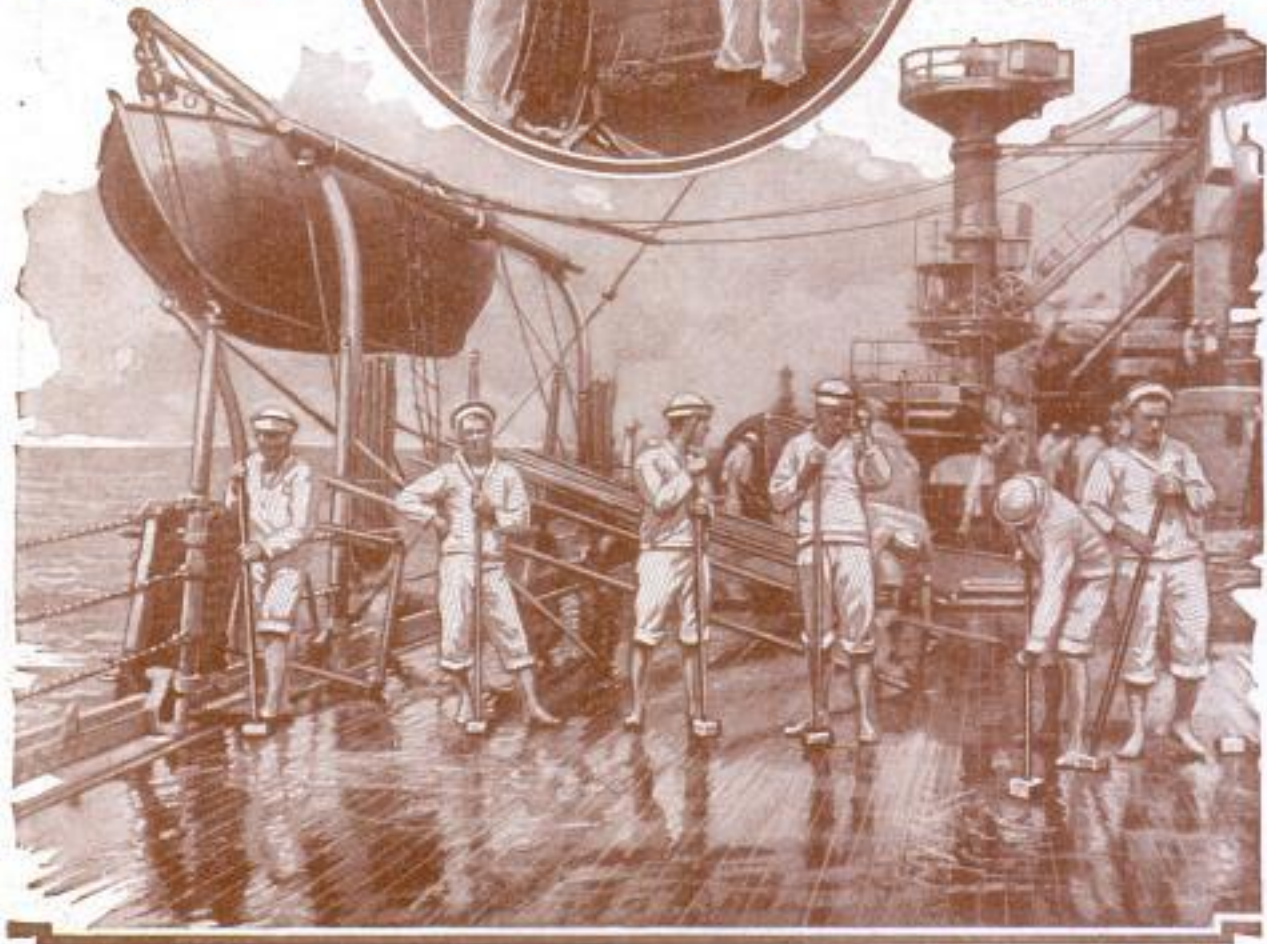



Above, Mess Table Set in a Gun Turret on Summer Cruise and, Right, Sea Bags Being Carted Down to the Dock on the Severn to Be Ferried Out to the Squadron Lying in the Bay



Above, Repairing a Target after Big-Gun Practice at Sea; Two Direct Hits Have Been Made in the Canvas Sheet, Towed Miles Away behind Another Ship; at Right, a Scene in the Fire Room; the Middies Get the Older Coal-Burning Battleships for Their Summer Training Instead of the More Modern Oil Burners and Learn How Hot a Fire Room Can Get



In a Spirit of Democracy Use of All Kinds of Vehicles Is Forbidden to the Middies, But Here Is One Who Could Not Resist the Lure of the Queer Carriages That Ply between Gibraltar and the Spanish Towns behind the Big Rock, One of the Interesting Scenes Visited on a Summer Training Cruise



Left, Red-Cross Squad with Stretcher Following the Landing Party during a Sham Battle Fought on Farragut Field, at the Mouth of the Severn; Below, Chapel Service on Deck; Religious Services Are Mandatory at Annapolis, but the Middy Has His Choice between Chapel or One of the Churches in the Town; at Sea the Ship Chaplain Officiates for All



**TRACE THE HISTORY OF STEEL
BACK THROUGH AGES** 106

Chippings from an old iron pillar that has stood in Delhi, India, since 300 B.C., a metal cramp from the tomb of Cyrus, founder of the Persian empire, specimens of steel and iron from ancient Ceylon, and nuts and bolts from a Viking ship of the eighth century have been collected by Sir Robert Hadfield, the famous steel expert, while tracing the beginning of the steel industry, and were exhibited recently before the British mining and metallurgical congress. In comparison with these early specimens, samples illustrating the latest developments in electrical melting and in X-ray processes were displayed. The beginnings of the iron age have been traced as far back as 4,000 B.C. The era of steel received great impetus in 1856, when Bessemer invented his process for making a high-grade steel.

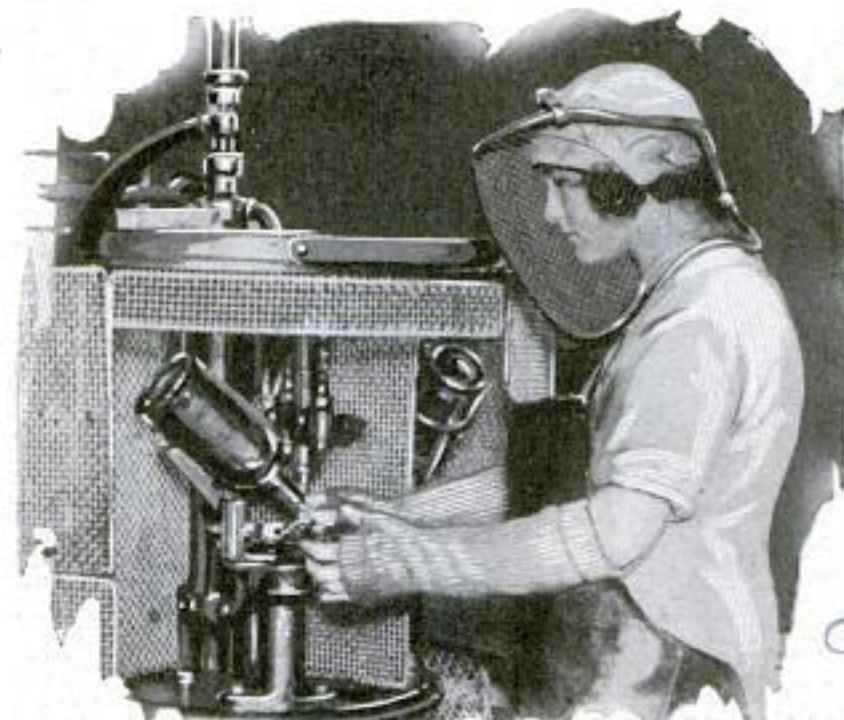

Soda Bottles Frequently Burst While Being Filled; Girl Workers Are Being Armored to Protect Them from Flying Glass

*Messrs. Schwepes & Co. Works
London, England.*

**TRIPLE CROSSING HELPS SOLVE
TRAFFIC PROBLEM**

Engineers solved a vexing traffic problem near San Diego, Calif., eliminated a death trap and made faster schedules for a railroad and traction line possible by constructing a three-tiered crossing. A subway was built under the steam tracks for vehicles. Its floor lay two feet below the sea level and automatic pumps had to be installed to eliminate seepage and storm waters. The railway line was left at its original level and the electric trains run on a viaduct, 1,000 feet long and well above the ground. Before this arrangement, a number of fatal accidents had occurred and trains lost time as they were required to come almost to a halt at this point.

3246

**GIRLS PROTECTED BY ARMOR
FROM BURSTING BOTTLES** 14

Wire masks, somewhat similar to those used by baseball catchers, are being fur-

nished in an English factory to girls who fill bottles with soda pop. The precaution was made necessary to protect the girls against flying glass, as the bottles break frequently under the high pressure of the carbonated waters. Heavy felt sleeves and a thick leather apron complete the costume.

Made by Messrs. Schwepes & Co. Works London, England.

**SUITCASE IN THREE SECTIONS
HAS SPACE FOR HATS** 116

Separate compartments are provided for hats, shoes, suits and other articles in a three-section suitcase especially convenient for the sportsman but serviceable to any traveler. Two smaller spaces open out at the ends and fold together to form the upper part of the case. A strap about the center, holds the sections from falling apart. Articles can be packed or unpacked without disturbing the contents of the entire holder.



Folding Suitcase Open, to Show Separate Compartments for Hats, Clothing and Other Articles

*Ward
413 Market St.
Newark, N.J.*

*Crab. J. L. Armstrong
2523 San Marcos Ave.
San Diego, Calif.*

Auto Equipment Co
569 Third St
Dakeland Calif
586
56
2

**CAR SEAT MADE INTO TABLE
 BY AID OF FRAME SUPPORT**

Using the automobile cushion as a picnic table is made an easy matter with the aid of a frame support whose legs fold flat



Collapsible Frame Used to Support Auto Seat and Convert It into Table for Picnics

for stowing beneath the seat when not in use. To make a table, the legs are unfolded, the cushion placed on the flat top, and a cloth or newspapers draped over all. Two of the supports, with as many seats, will make a narrow but comfortable bed for campers.

**DURABLE DOLLAR BILL SOUGHT
 TO REDUCE PRINTING COST**

Five one-dollar bills were made for every one of the 114,000,000 or so persons in the United States last year at a printing and paper-manufacturing cost of nearly \$4,000,000. Because of its great popularity, the dollar bill now constitutes fifty per cent of all the paper money and it wears out so quickly that presses in the government plants are continually turning out new ones to replace those that become unfit for service. About 800 tons of them were printed last year. Investigations are under way to determine if a better quality of paper may be obtained to prolong the life of the bills. For many years, linen and cotton have been used in the ratio of seventy-five per cent of the former to twenty-five of the latter. The government is wondering if this is the best proportion to use, and samples of paper with varying amounts of the materials are being tested by rubbing, pulling and subjecting them to water and oils to deter-

New York Times 7/26/23
article by Williams
Arthurton also pay
139

mine their resistance. The effect of beating the fibers and bleaching them during the process of manufacture is also being studied as is the sizing operation, which consists in giving the paper a bath in animal glues to strengthen it. Hemp, esparto, a grass from Spain, and ramie grass from China, are also being tested as substitutes for linen and cotton fiber.

**MOVIES DETECT DEAD "VOTERS"
 IN ELECTION FRAUDS**

97

Eighteen thousand dead men "voters" have been uncovered in a municipal election at Marseilles, France, through the use of a motion-picture machine. An anti-trust organization, finding itself defeated by a narrow margin, noted that the total vote had increased from 80,000 to 100,000 in a few years. Because France allows only five days for exposure of fraud and a recount of ballots, the leaders hit upon the idea of taking a moving picture of the long list of voters. Then the films were projected for copy in front of 300 letter writers. An inquiry was sent to each of the 100,000 names on the list. Shortly 18,000 letters came back marked "unknown" or "dead," and the fraud was exposed.

**HAMMER CHANGED TO HATCHET
 BY REMOVABLE BLADE**

68

Quickly attached to the hammer by inserting it between the claws, a blade fits the implement for use as a hatchet, saving the need of an extra tool. There are no screws or bolts, prongs on the blade



Fitting Blade on Hammer and Using It as Hatchet

and a specially curved edge holding it firmly to the hammer. Detached, the cutter may be used as a chisel, and can be carried in the pocket or belt.

Earling Tool Co
Evanston Station
Chic.
Granville, Ohio

3456 cont. H. J. Wilkins, Esq.
4, Crowhurst Road,
Ariston, S.W. 9, London, Eng 587

Harnessing the Sun



FROM the ancient days when the sun was worshiped as the source of all life, science has progressed until today its rays have been harnessed to cure disease, increase crops, make chickens lay, season lumber, produce synthetic foods and test the permanency of paint, leather and other materials.

Only thirteen per cent of the entire radiation from the sun, it has been found, is visible to the eye in the light waves we see. Passed through a prism, or broken up by drops of water, as in a rainbow, the light rays separate into the seven primary colors of the spectrum—red, orange, yellow, green, blue, indigo and violet. Below this visible spectrum eighty per cent of the sun's rays are grouped in the infrared band, which produces heat, and above the visible rays are the remaining seven per cent, the ultraviolet, chemical, or actinic band, which produces, among other things, sunburn.

The enormous heat generated in electrical furnaces, far surpassing any temperatures heretofore created by man, has made possible the production on a commercial scale of fused quartz, the only material so far found which will transmit the latter group of rays, and with that discovery it is now possible to inclose any strong artificial light in a quartz globe

and proceed to utilize this invisible part of the light, exactly duplicating the curative rays of the sun.

Fused quartz is a peculiar material which has the remarkable quality of transmitting the light through itself and around bends and corners and finally delivering the rays at the other end. Light applied at one end of a long, curved or bent rod of quartz will come out the other end, so that the curative rays can be delivered at any spot needed. One of the applications of this peculiarity is in curing hay fever by applying the rays directly within the nose, where the plant pollen has produced the infection. A slender rod of quartz, receiving light at one end, is inserted directly into the nasal orifice and the healing rays, fatal to bacteria, are delivered where they are needed.

Because of the great strength of the rays, fifteen minutes' exposure to a strong mercury light inclosed in a quartz bulb will produce a bad case of sunburn, but with gradual and repeated exposure a rich coat of tan may be obtained. The rays are so strong that protective goggles must be worn to guard the eyes, which otherwise would suffer as much as though looking directly into the flaming ball of the sun.

American experimenters a few months

ago found that the ultraviolet rays from quartz lamps would cure children or chickens of rickets, a disease of deformed and undeveloped bones due to the absence of calcium. In London a free clinic has been opened in the slums for the treatment of poor children who,

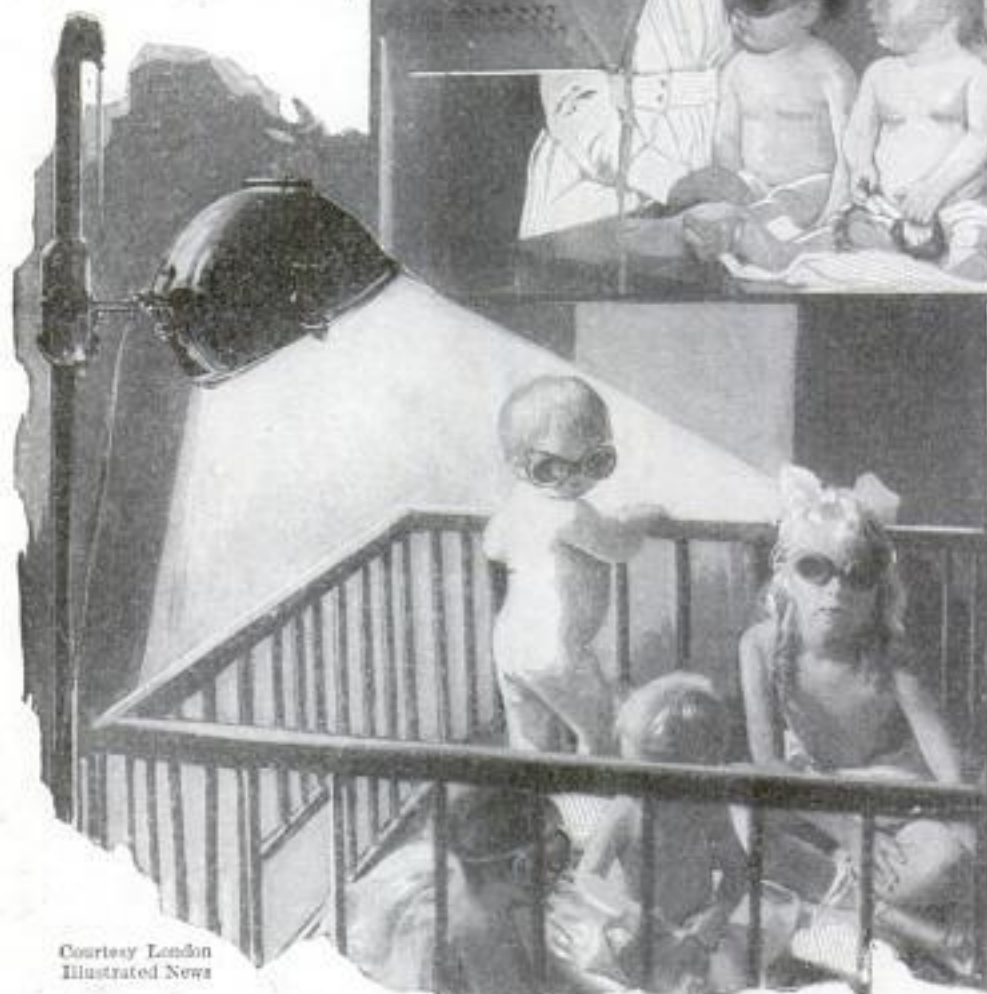

Courtesy London
Illustrated News

because of tenement life and poor surroundings, have

failed to get the proper amount of natural sunlight to develop their bone structure.

Tests have shown that the invisible rays, whether natural or produced from artificial light, will cause the deposit of phosphorus, calcium and iron, three of the chief bone-building materials in the body.

In Guy's hospital and the Infants' hospital in London, immense 30,000-candle-power mercury lights inclosed in quartz are used in the sun-ray treatment rooms. Doctors and nurses, with their skin deeply bronzed from continual exposure, wear hoods and masks to protect them from the burning light, while the patients, with

With Goggles to Protect the Eyes These Groups of Babies Are Receiving the Ultraviolet Treatment Which Will Restore Them to Health

goggles strapped to their foreheads and dressed only in trunks or a towel, bask under the glare. A half hour's treatment is the most they can stand during the first few days, but gradually the period of treatment is lengthened to four hours a day, after a protective coat of tan has been acquired. Bad skin complaints vanish magically, and dull, stunted boys

and girls put on weight, straighten up and become quick and intelligent in their movements.

The ultraviolet rays which produce these remarkable changes are unbelievably small. Their wavelength is measured in terms of a unit which is, roughly, the ten-millionth part of the thickness of a human hair. The red heat rays cease to be visible when they have reached a shortness of 7,500 of these minute units, and the violet ray at the top of the spectrum passes into invisibility at 3,900 units. With delicate scientific apparatus, however, explorers of this unknown band have pur-

sued the shorter rays down to a region where their length is but 420 ten-millionths of the diameter of a hair. Beyond this point is the region where the mysterious change from light to X-rays takes place.

Their discovery revealed the reason why sun bathers in the high Alps of Italy could walk barefoot in the snow while they were cured and tanned by the sun. In warmer and lower climes, the excess of infra-red heat rays cuts off the free play of the curative part of light, while high up in the mountains the germs of such diseases as tuberculosis yield to the killing action of the invisible waves. The clear air of the heights, free from smoke and beyond most of the dust clouds which hover above the earth, offers a free road for the natural ultraviolet rays of the sun, the most powerful of which are so small they cannot penetrate a distance equal to the thickness of an invisible microbe.

In producing artificial sunlight, however, the scientists found that a small 22-volt mercury-vapor light in a quartz tube, suitable for suspending over a child's cot, was so powerful that its rays could sterilize

132,000 gallons of water in twenty-four hours, killing all the disease germs it contained.

Dr. Leonard Hull, one of the English experimenters, is establishing these artificial sunlights in many of the public baths of London, so that the children of the

Giving Light Treatment for Rickets to Children in London Hospital

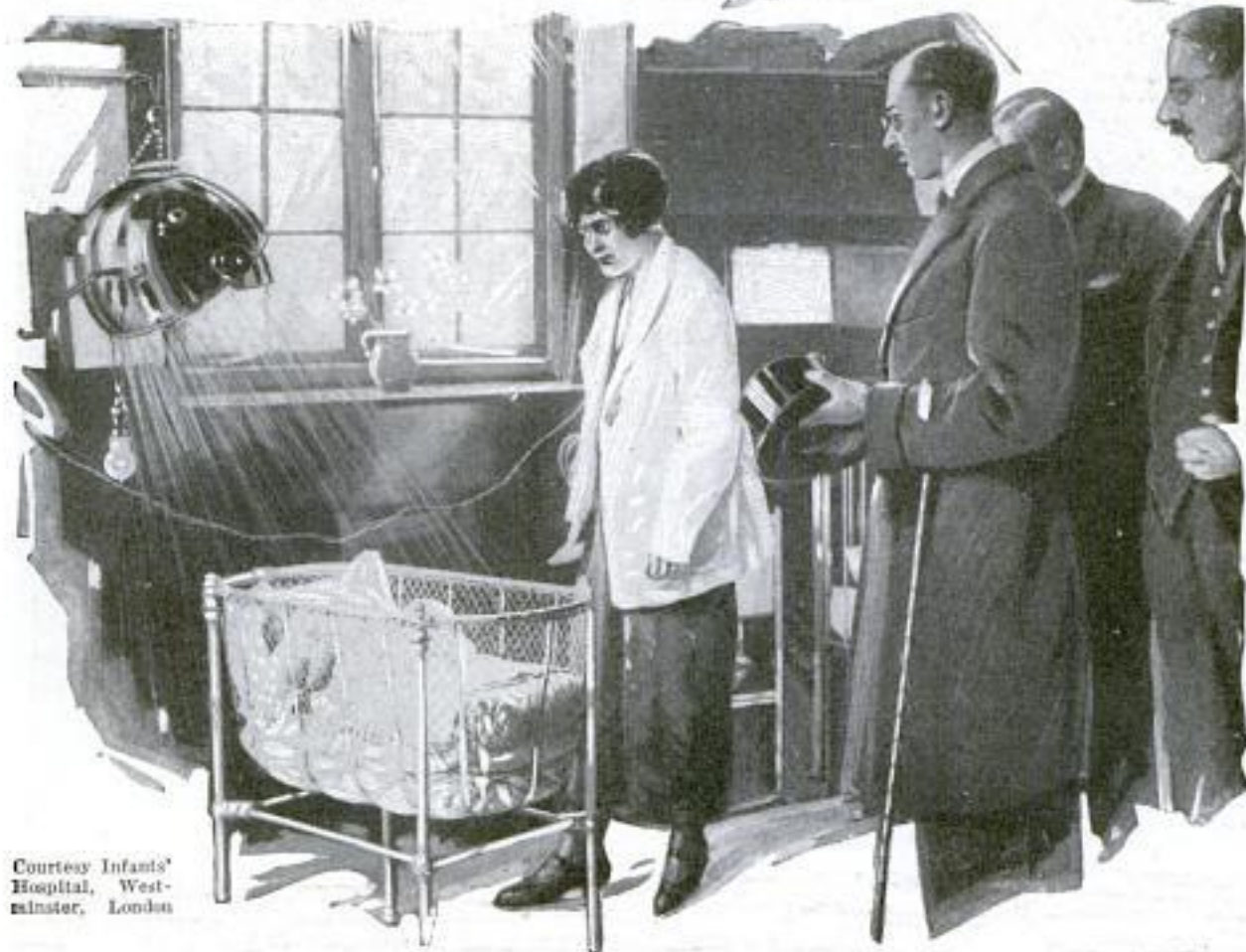

Courtesy Infants' Hospital, Westminster, London

poor can take a light bath along with one in water. Another Englishman, F. E. Lamplough, is perfecting a new form of glass which will pass most of the ultraviolet rays and which can be produced at a cost of seventy-five cents to one dollar a square foot, far cheaper than the expensive quartz. The latter costs so much, because of the vast amount of electricity used in fusing the material, that only one quartz window, in Johns Hopkins hospital, Baltimore, has so far been installed. If the new glass proves successful, nearly every one will be able to afford a sun-bath window in the home and can harness the natural sunlight to prevent disease.

Still another experimenter has developed an arc lamp, with tungsten electrodes, following his accidental discovery that this metal would produce far more ultraviolet rays and less of the heat waves than other materials. In an address before the Roentgen society in London recently, it was claimed that two or three

minutes' exposure twice a week to this powerful artificial sun would cure functional complaints, nervous debility and the neurasthenia caused by the hurry and worry of modern life. With this strange light, the patient can lie, fully clothed, on an electrical couch, grasping a bar electrode in his hands, and thus become one plate of a powerful electrical condenser.

The United States bureau of standards, experimenting with the germicidal effect of ultraviolet rays, found that bacteria in sewage could be killed in half a second by exposure to them. At Yale, two professors trying to discover why cod-liver oil cures rickets, found that it actually emits ultraviolet rays in the child's body. They likewise found that cottonseed and linseed oil could be treated with the rays, and then used as a medicine to accomplish the same cure.

In stimulating plant growth, experiments have shown that wheat, grown in the dark, can be converted into a ripened food after two minutes' exposure. The

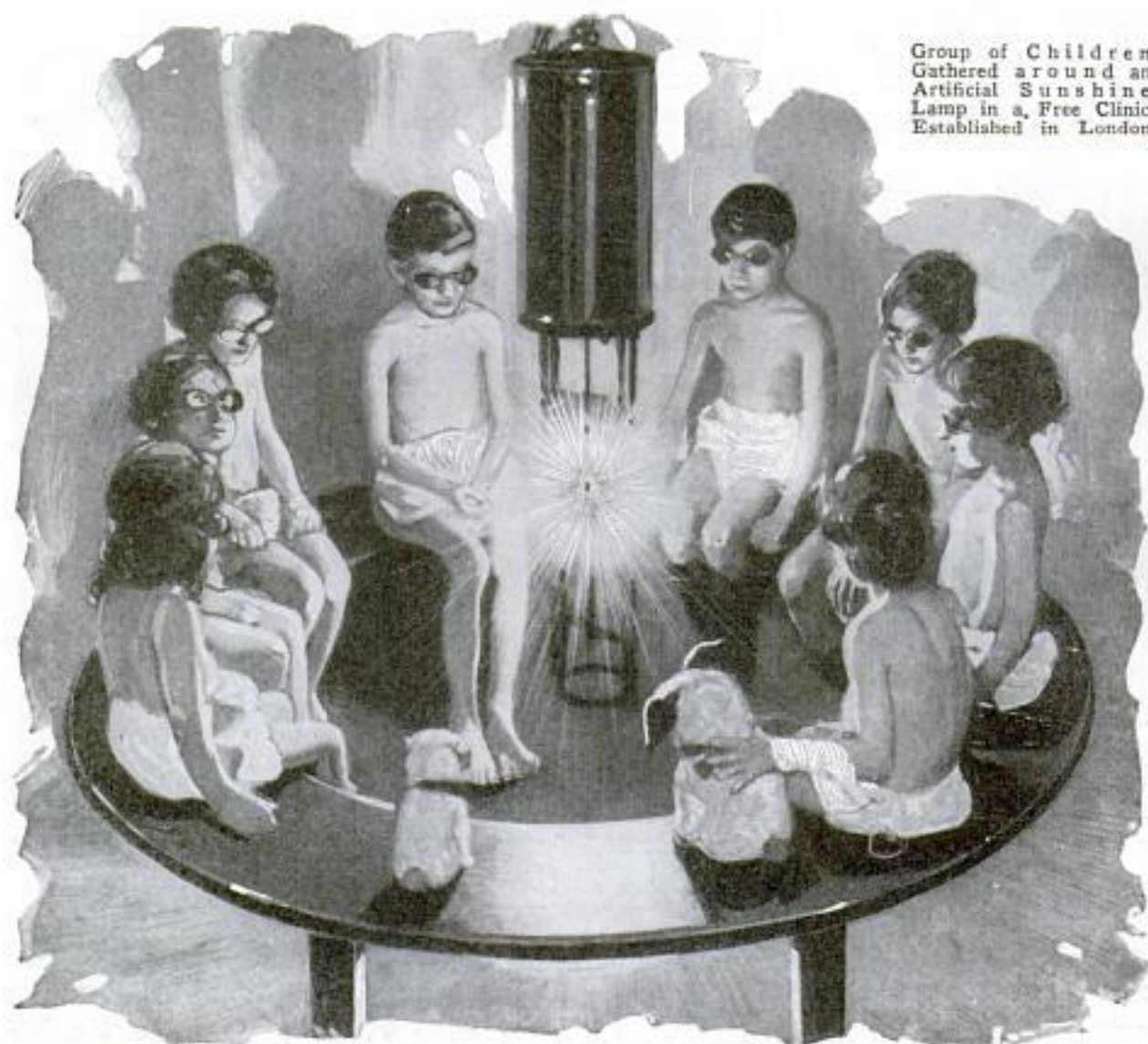

Group of Children Gathered around an Artificial Sunshine Lamp in a Free Clinic Established in London

3459

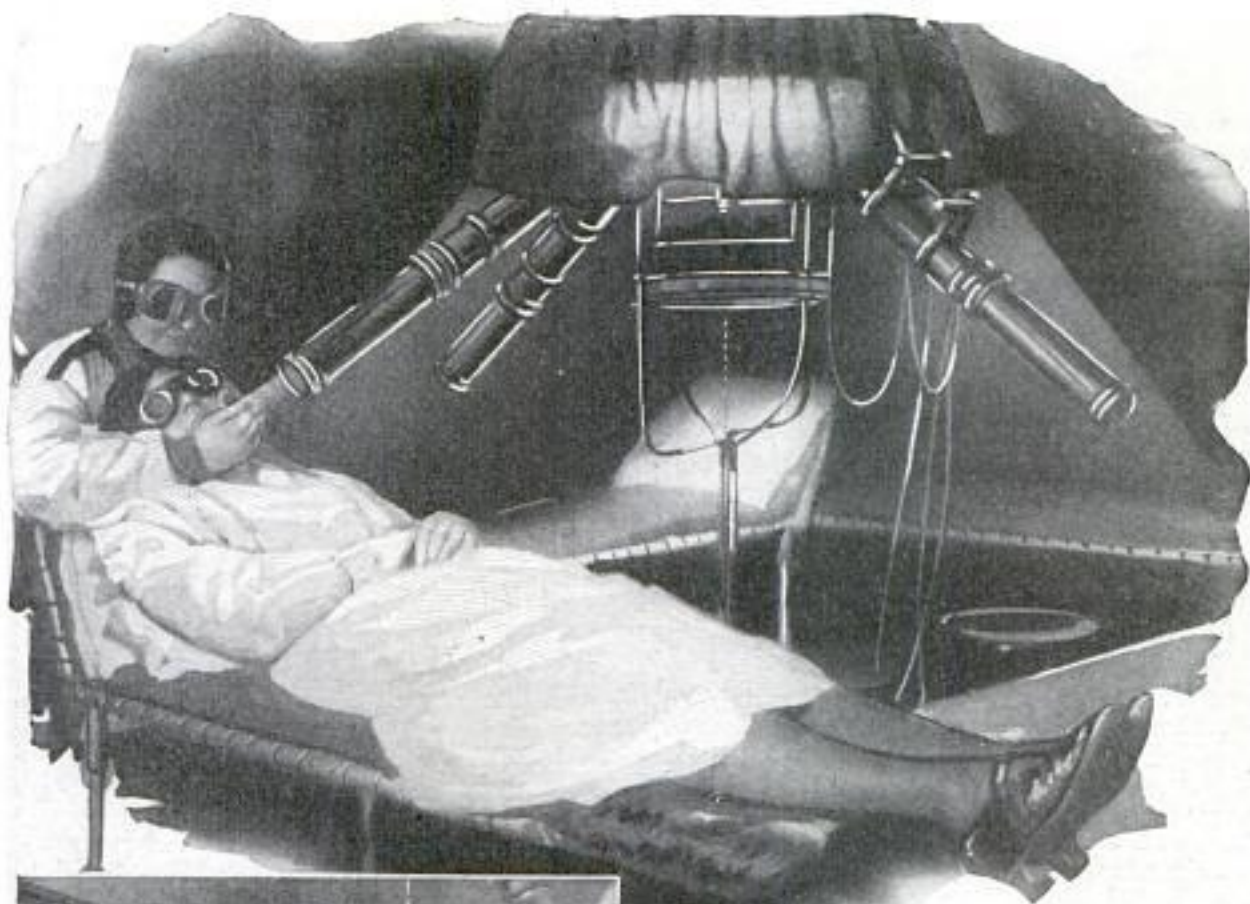

Courtesy Guy's Hospital, London

Treatment with Light Passing through Quartz Telescope, and, Below, with Fused-Quartz Rod Inserted in Nose



rays also have been used to produce synthetic sugar by passing them through ordinary formaldehyde. Chemists have known for some time that sugar cane and other plants make sugar by a process in

which solar rays, falling on the plant, are caused to extract carbon from the air, and this carbon, added by the plant to water absorbed by its roots, is converted by nature into formaldehyde from which sugar eventually can be extracted.

Because of the concentration of the rays possible with artificial sunlight, producing a deep tan in less time than the sun itself would take, paint manufacturers are utilizing the ultraviolet-ray lamps to age paints to the equivalent of several years' natural exposure within a few days, to test the lasting qualities of their product. Lumber also is being given months of seasoning within a few hours.

3202

SNOW-WHITE HORSES RARE

To obtain six snow-white horses, an Italian commission recently visited the leading farms in Hungary. The animals were wanted to draw the Pope's carriage in the Holy Year celebration. Many animals were inspected which at first sight appeared snow-white but showed spots on closer examination. The desired horses were found only after a long search.

New York Home News
4/30/25 material

Mrs. S. C. Winters
 Leventrich
 Washington, D. C.

3370 These artists can be addressed
 in care of The Handicraft Guild
 Art Club of Washington
 2017 d St. N. W.
 Washington
 D. C.

Art and Utility Combined in Handicraft



Mrs. Frank
 Smith with
 Samples of Her
 Work in Bas-
 ketry. One of
 the Activities of
 the Handicraft
 Guild of Wash-
 ington, and, Be-
 low, Mufflers
 and Spreads
 with Designs
 Woven into the
 Cloth



Metal Objects Are Carefully
 Modeled and Pounded Out in
 Olaf Langstad's Workshop
 Which the Guild Devotes to
 This Ancient and Artistic Form
 of Handiwork



At Her Loom in the Nation's
 Capital, Mrs. Emma Sommar
 Weaves Bedspreads, Scarfs and
 Many Other Articles Like Those
 Produced by the Mountain Wo-
 men of Kentucky, Tennessee and
 North Carolina, an Art That Has
 Been Inherited from the Early
 Colonial Days

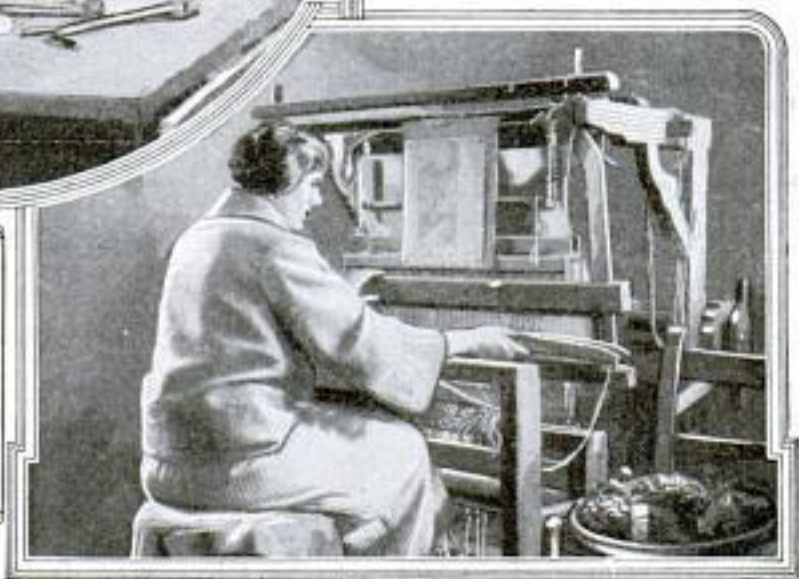

150.

**PRISONERS SHARE
IN PROFITS OF
FLAX MILL**

A prison-operated flax mill, which boasts it is the largest in the world, gives employment to 175 convicts in the Oregon state penitentiary, and the workers share in the profits of the industry, drawing fifty cents a day in pay from the state. The mill has twenty-four scutching machines, while its nearest competitor in point of size is a mill in Ireland with twenty-three machines. More than two thousand acres in the Willamette valley were planted to flax this year, the state furnishing the seed for the farmers and buying the crop when cut and delivered at the prison mill. The quality is said to compare favorably with the best Canadian, Irish or Belgian flax. The convicts employed in the industry are all so-called trusties and work under civilian overseers without any armed guards to watch them.

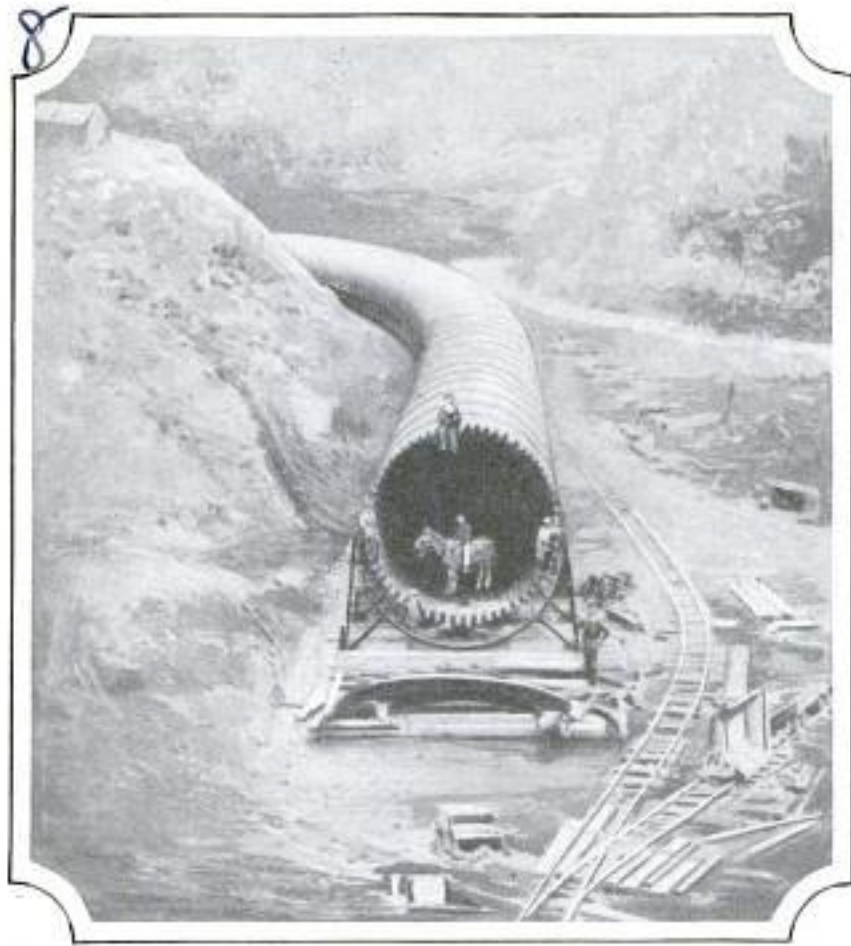

Record-Breaking Wooden-Stave Flume; Notice the Horse and Man Standing Inside and the Workman Perched on Top

**PIPE SIXTEEN FEET IN DIAMETER
BUILT OF WOODEN STAVES**

Winding a quarter of a mile through the mountains in northern California, a huge wooden pipe, sixteen feet in diameter, has been constructed to convey water to a power house. Steel hoops and braces bind the staves tightly together to prevent breaks under the high pressure.

**CURE FOR WOODPECKER HOLES
IN POLES IS SOUGHT**

Woodpeckers using telegraph and telephone poles for food-storage bins are causing serious damage in various sections, especially those in which oak trees abound. The birds find a barkless pole is easier to bore than a tough, live tree. Into each hole made with their bills the woodpeckers place an acorn against the season of hunger. When rain comes, the nut swells and cracks the wood. Hundreds of such holes may be found in a single pole. Coatings of creosote keep out insect borers, tin bands discourage squirrels, but nothing has been found yet that will stop the woodpecker.

**WRENCH IS SELF-ADJUSTING
TO MANY SIZES OF NUTS**

A new type of spanner wrench, which adjusts itself to a considerable range of hexagonal and square nuts, has been placed on the English market by a Liverpool company. The construction is simple. The handle, pinned to the head, ends in a camlike curve, which forces a serrated jaw up through a slotted channel in the head until it grips the nut. The harder the nut is to turn, the greater the grip of the wrench. All the wearing surfaces are casehardened.



Harwood Specialties Co.
Liverpool, England.

2060

150

Cofeco
Oregon Public Utility Information Bureau - Portland, Ore.

80



Suspension-Bridge Building in the Heart of the Congo; a Native Workman Building a Roadway High above the Impenetrable Jungle, Following the Monkey Route through the Trees

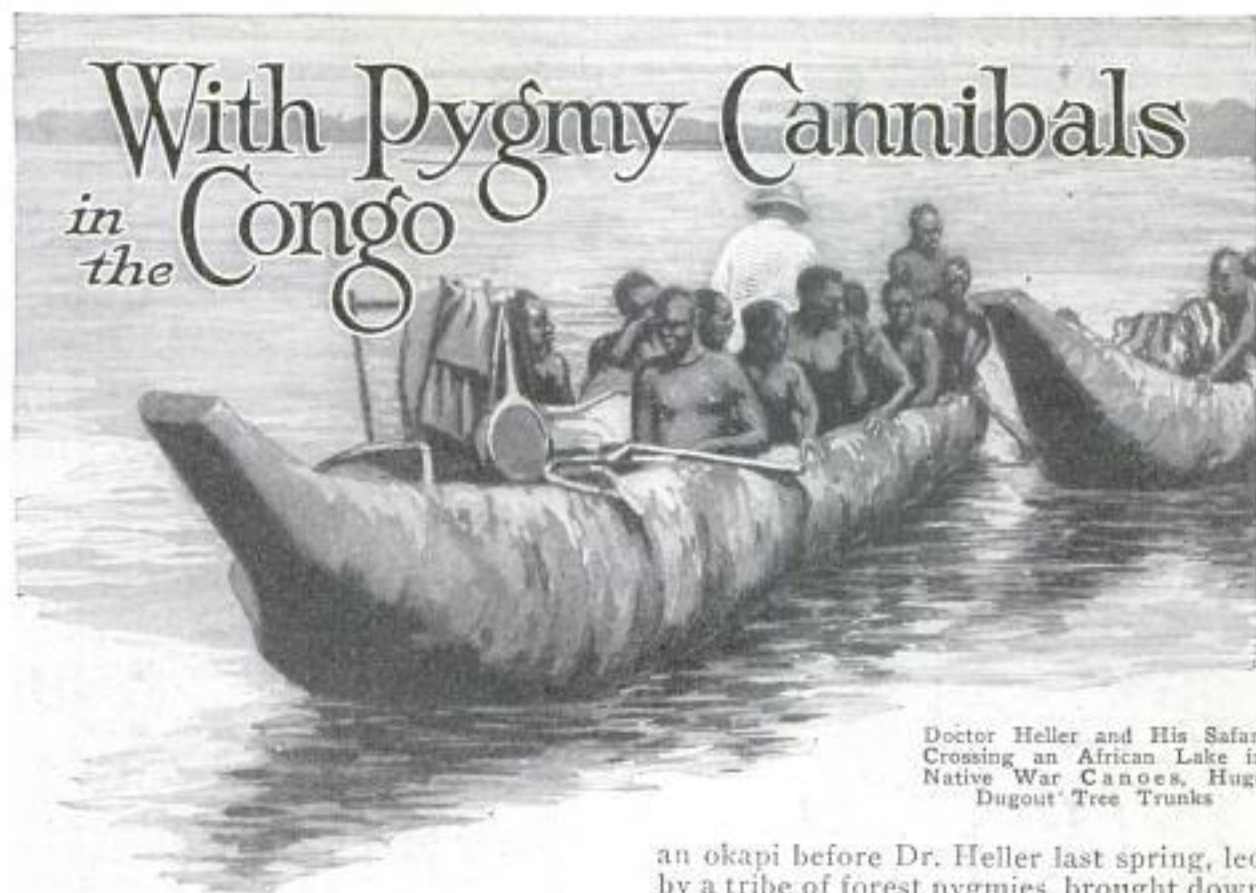

Doctor Heller and His Safari
Crossing an African Lake in
Native War Canoes, Huge
Dugout Tree Trunks

SOMEWHERE in the darkest part of darkest Africa, a few miles south of the equator and in the midst of the dense tropical jungle which forms the backdoor of the Belgian Congo, an American explorer and big-game hunter and his wife, with sixty Wambubu cannibals for servants, are now hunting gorillas.

The hunter is Dr. Edmund Heller, who, as Roosevelt's right-hand man, and at other times with Carl Akeley, Paul Rainey, or alone, has walked over most of the little known miles of Africa. His wife, Hilda Heller, daughter of the late Professor Hempl, philologist of Leland Stanford university, and a big-game hunter in her own right, is filming his battles in the jungles and also assisting in collecting specimens for the Field museum, Chicago.

Their present gorilla hunt, following one Dr. Heller made last year, when a 350-pound monster with an arm spread of twelve feet was shot, winds up a two-year expedition in that one part of Africa which still remains wild and dark. During it they have collected thousands of specimens ranging from frogs and butterflies to enormous gorillas, baboons, chimpanzees, and, rarest of all, an okapi, an animal so seldom seen that its very existence was for a long time in doubt. Only one American expedition had ever bagged

an okapi before Dr. Heller last spring, led by a tribe of forest pygmies, brought down a fine specimen.

This "trophy of trophies" has a body somewhat like that of a zebra, a three-horned head resembling that of a giraffe and the bulk of an ox. Famous hunters by the score have invaded its hiding place in the past and come back with lions, tigers, elephants, rhinos and other jungle denizens, but no okapi. The lair of the one known herd is the dense Semliki, a forest of the Congo, which was first explored twenty-five years ago by Sir Harry Johnston, the English explorer and writer. He described it as "almost unbreathable with its Turkish-bath heat, its reeking moisture and its powerful smell of decaying vegetation," where one "seemed, in fact, to be transplanted back to the Miocene times, to an age and a climate scarcely suitable for the modern type of humanity."

In the edges of the forest live a tribe of little, four-foot tall pygmies, whose only commerce with the outside is through the Wambubu cannibals, with whose old chief, Morea, they are on friendly terms. Through Morea, Dr. Heller arranged with the pygmies, armed with their primitive bows and arrows, to lead him to the lair of the okapi. There is more scientific romance and folklore woven about the strange beast than about any other living animal. Before it was first seen by a white man, vague tales of a cloven-hoofed,

horned horse filtered out of the jungles via the cannibal tribes, and the adventurers who heard

according to W. H. Osgood, curator of zoology for the museum. "The cheeks and jaws are yellowish white, contrasting with the dark neck. The forehead is a deep-red chestnut, and ears of the same color are tipped with jet-black. A black line follows the ridge of the neck down to the nostrils. The muzzle is sepia with a tinge of reddish yellow around the upper lip.

"The neck, shoulders and body range from sepia and black to a rich red. The tail is a bright red with a black tuft. The hind quarters are snowy white or cream-colored, touched here and there with tawny, and marked with purple-black stripes that give them a zebra-like appearance. It lives on foliage and twigs."

The three small horns on its skull may at one time have been as prominent as those of the giraffe, but the process of arrested development—or evolution—apparently has set in, and, while promi-

ned development—or evolution—apparently has set in, and, while promi-

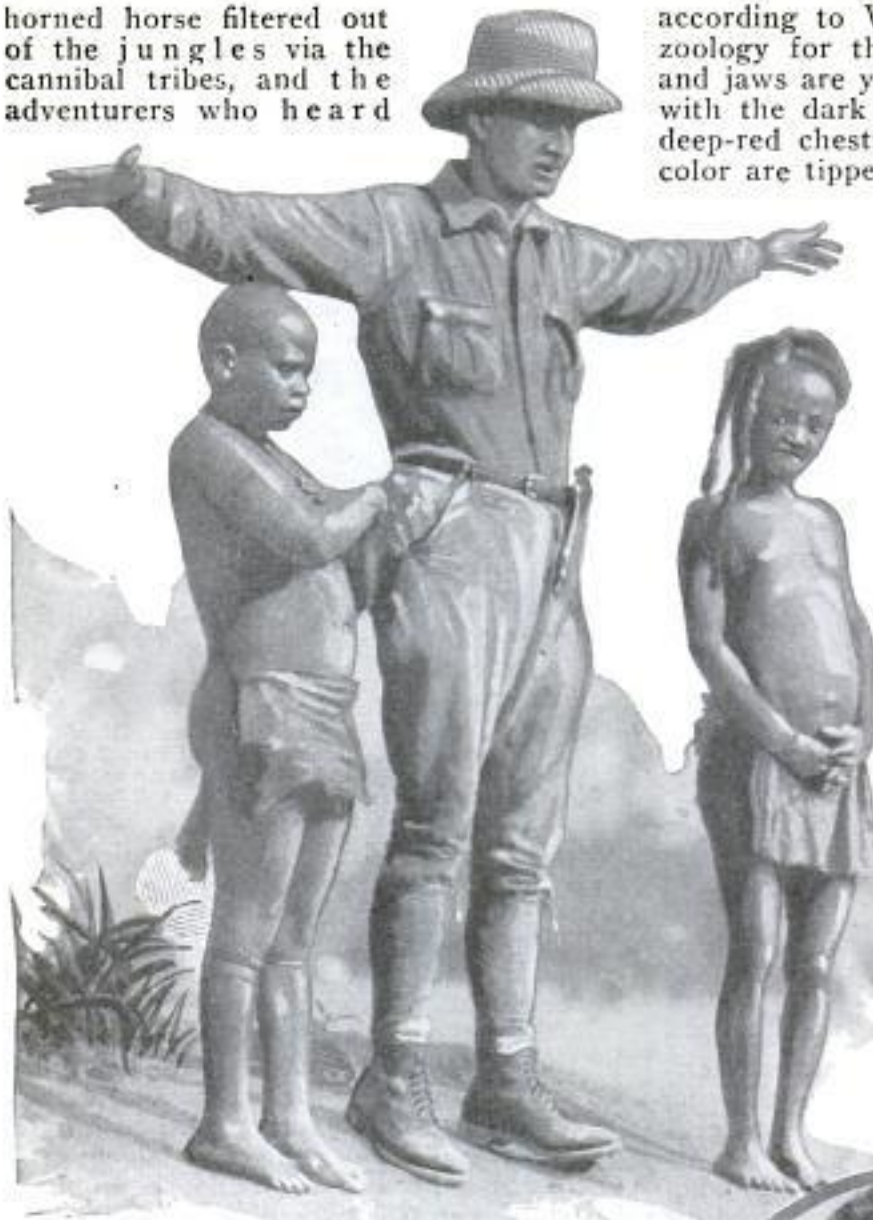

Heller, Who Is Five Feet Ten Inches Tall, with Two of the Full-Grown Forest Pygmies; Below, the Chief Musician to a Cannibal King

them brought back stories that the unicorn of fable might actually exist there. One naturalist who sought a glimpse of the mysterious beast, but was defeated when he had to turn back because of fever, reported he believed it was a living survival of the Hipparion, or three-toed horse, which existed millions of years ago.

While the body of the okapi suggests that of a zebra, the long forelegs pitch the fore quarters upward, somewhat like the tilt of a giraffe. The neck is short, not much longer than a stag's and the giraffelike head, with three rudimentary horns, is crested with large ears. "The color of the animal is extraordinary,"

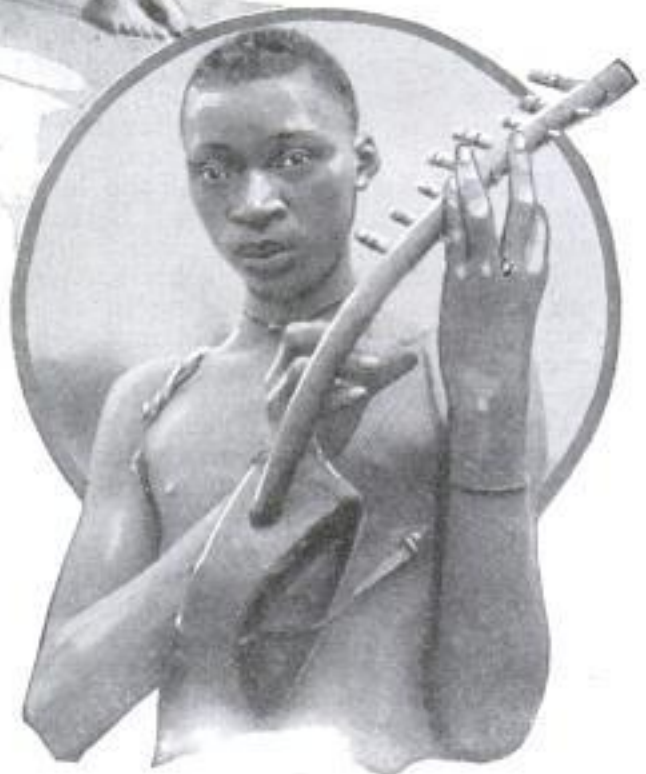

ment, they are worn down and covered with tufts of hair. Scientists believe it is most closely related to the giraffe, and, in fact, may be the animal from which the giraffe has sprung. They ascribe the degeneration of the horns to the fact that it retreated to the dense forests for its own protection, choosing to become wary and run rather than fight. The giraffe, on the other hand, chose the open spaces and developed its horns for protection.

Despite the rareness and shyness of the okapi, it took Heller and his band of pygmy assistants only two months to bag a huge old bull. In the two years of his latest venture into Africa, Dr. Heller and his

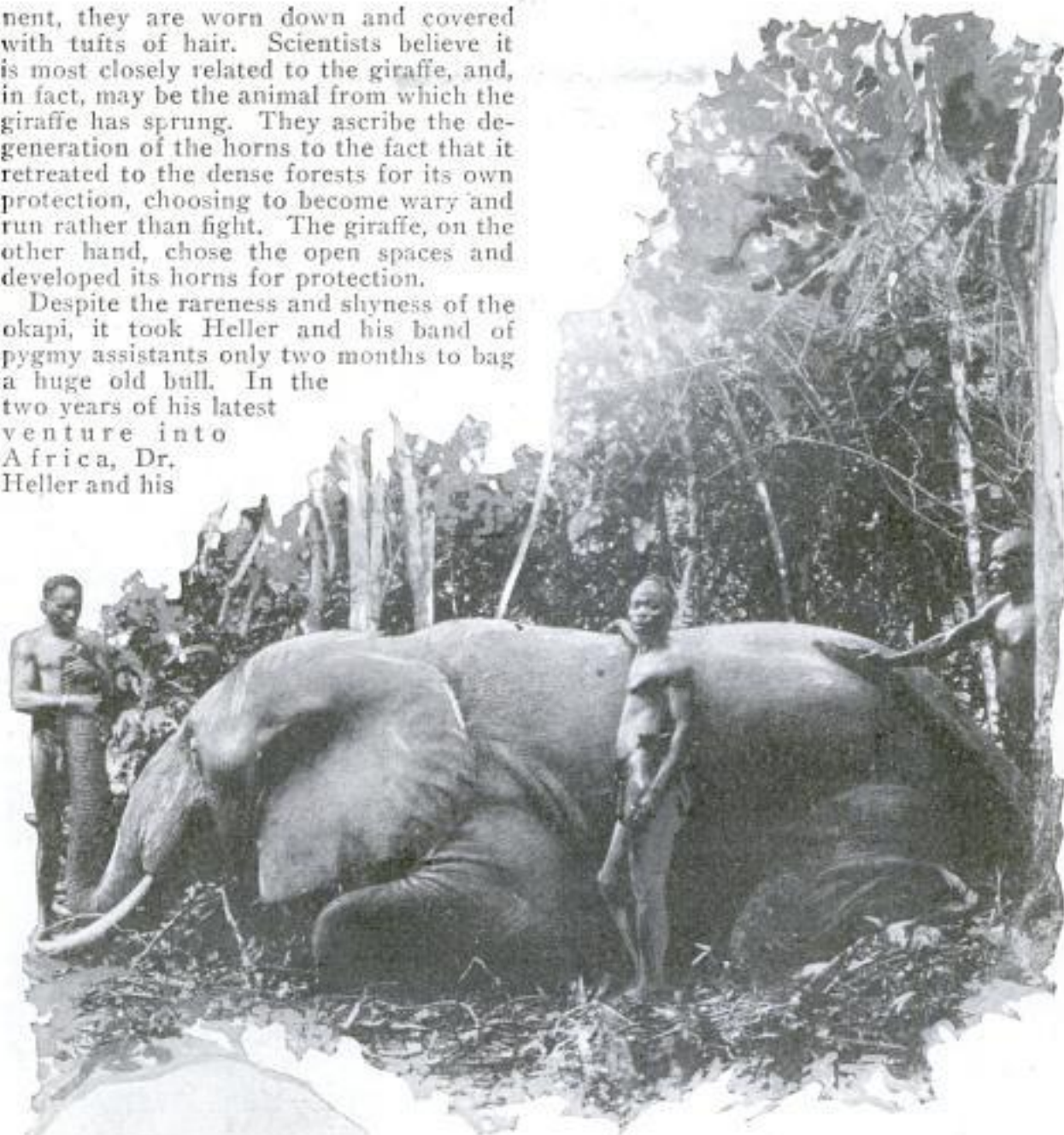

Big Bull Elephant Killed by the Heller-Collins Expedition, and Natives Making Fire with Sticks

wife have had more adventure than is usually crowded into a half dozen lifetimes. Besides bearding the fiercest jungle animals in their lairs, they have fought everything from hostile natives to tropical diseases. On one occasion a cannibal chief sent word the expedition could not pass through his territory, and to emphasize the warning captured two of the safari porters, cut off their hands and sent these back to Heller by messenger.

Heller and Maj. A. N. Collins, a British big-game hunter who was then associated with him, passed out loaded rifles to the few porters who could shoot, and empty ones to all those who could not, and pressed on. News of the supposedly formidable armament preceded them, and



Not Holding Hands, but a Pet Baboon Hunting Chiggers, a Proof of Real Affection: Below, an Okapi, the Strange and Exceedingly Rare Animal, with Its Coat of Many Colors, Similar to One Heller Bagged

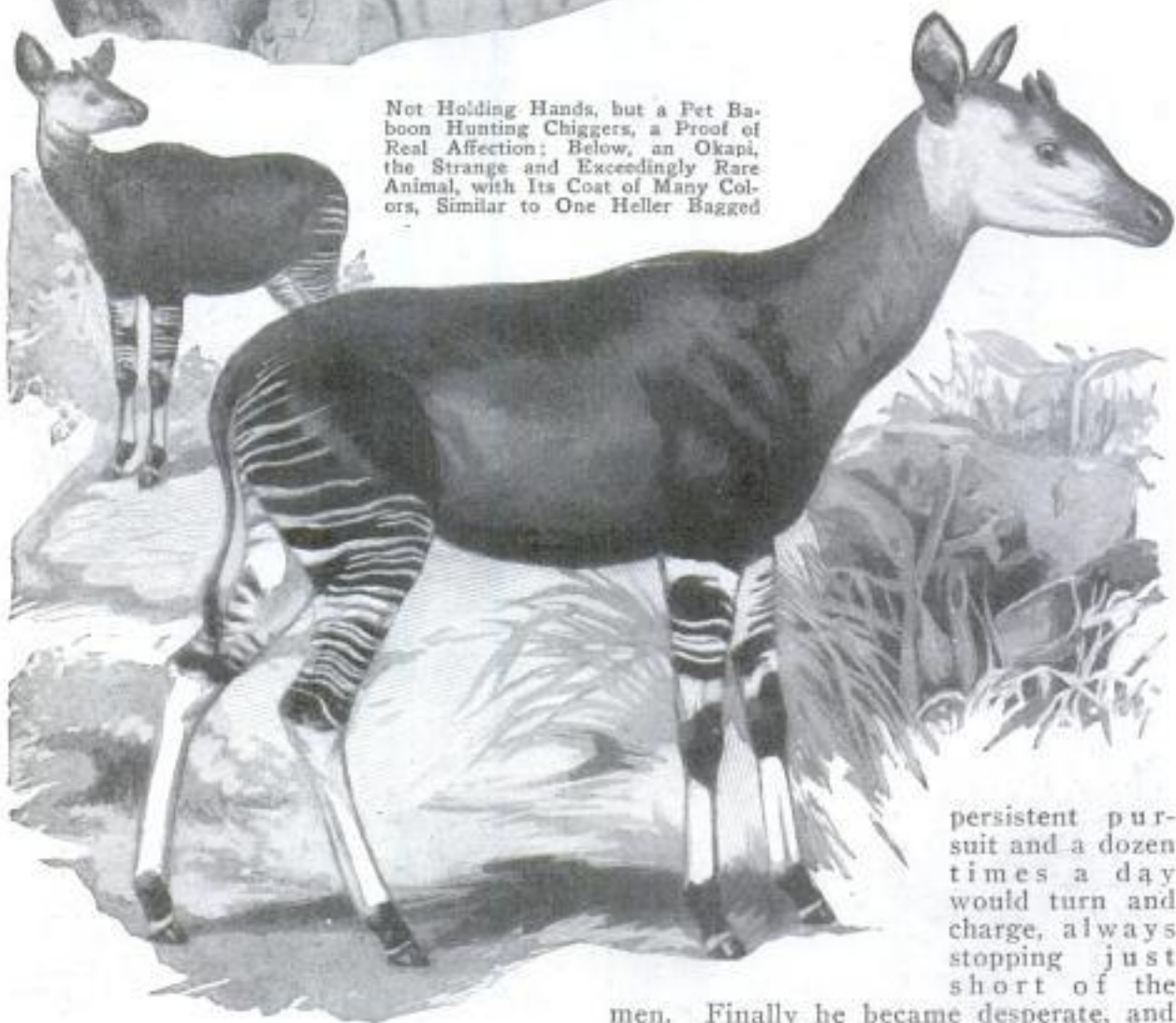

when they reached the chief's village, he and all his followers, save one of his sons, had fled to the forest. The son remained behind to make peace, but was placed under arrest by Heller and carried along as a hostage until the safari were out of the danger zone. The dread sleeping sickness of the Congo has menaced the expe-

dition from the start. The Belgian authorities gave each porter recruited a rigid medical examination, but on the first day out from one village, three of the natives dropped dead on the narrow jungle trail.

In a gorilla hunt staged by Heller and Major Collins last year, they spent several weeks in the big-ape country tracking the animals and getting movies and still pictures at close range. One huge old male got angrier and angrier over the

persistent pursuit and a dozen times a day would turn and charge, always stopping just short of the

men. Finally he became desperate, and with bloodcurdling roars turned and charged through the jungle brush, which was so dense he could not be seen until he was right on the hunters. Major Collins fired and dropped him at a distance of twelve feet. He was one of the largest ever shot, with an arm spread of twelve feet and a weight of 350 pounds. The hunters obtained two live chimpanzees

and baboons which they trained. They became such pets that they followed the expedition for weeks without being chained. Collins brought his chimpanzee to America and presented it to the Philadelphia zoo, but Heller's was killed one night in his tent by a leopard. The explorer was sound asleep, with the chimpanzee and a baboon curled up together in a corner of the tent, when the leopard sneaked in and grabbed the animal. The frightened baboon leaped across the tent and onto the chest of the sleeping man, screaming for help. Heller awoke in time to get a shot at the leopard, but missed in the darkness.

While with Heller, Major Collins collected more than a thousand species of rare butterflies for the museum, and together they shot six elephants, a red forest buffalo, a yellow-backed duiker (a small antelope), forest hogs and a rare white forest pig, besides many other

animals. Another feat of the expedition was the climbing to the snow line of Mount Ruwenzori, a 16,794-foot peak which rears its lofty head only a few miles north of the equator. Heller reached snow at 12,000 feet, and there, looking down on the steaming equatorial jungle, suffered winter cold within sight of one of the hottest places on earth.

Heller became an explorer and naturalist twenty-five years ago, and is hailed by Doctor Osgood as the greatest naturalist-hunter living.

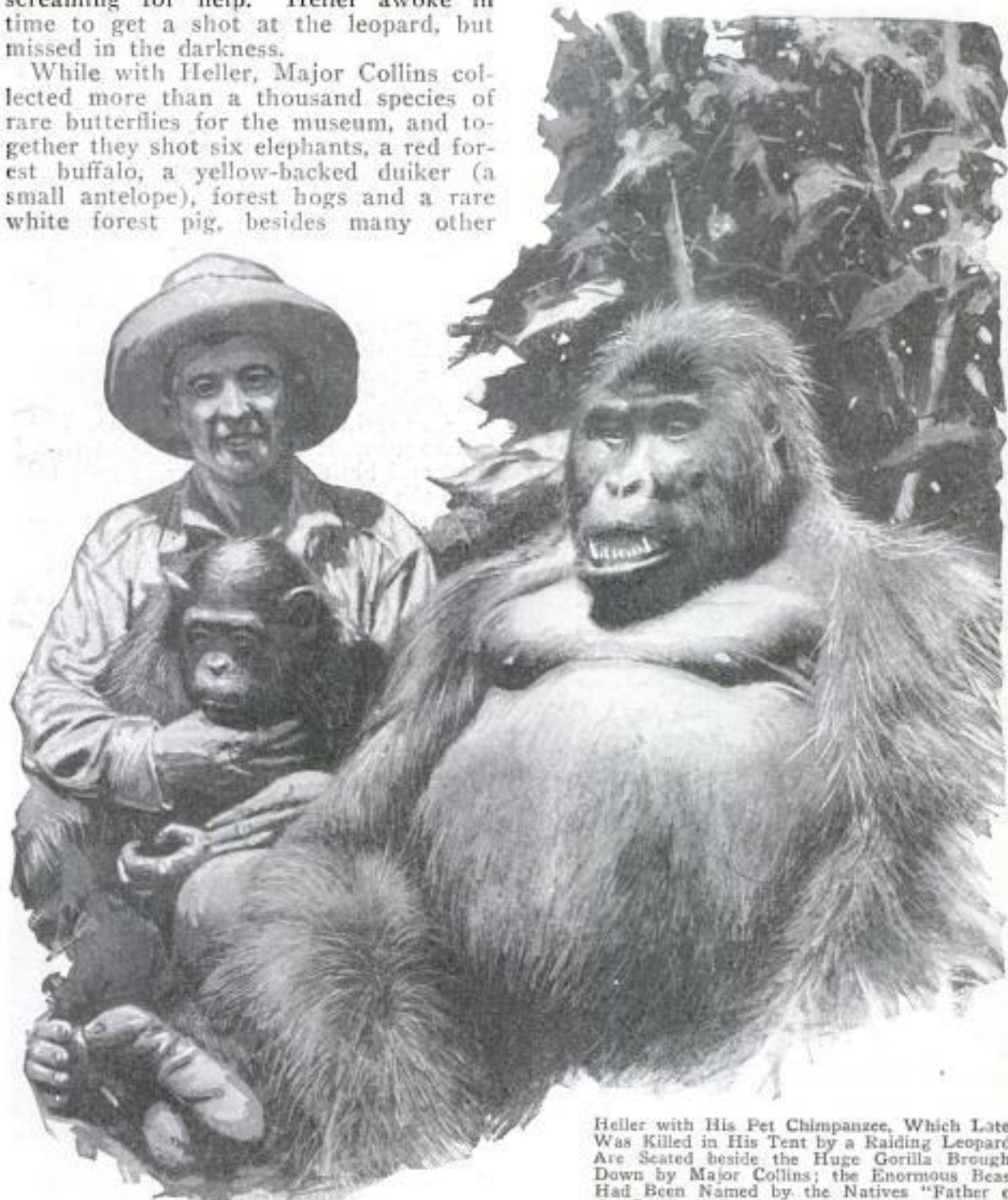

Heller with His Pet Chimpanzee, Which Later Was Killed in His Tent by a Raiding Leopard, Are Seated beside the Huge Gorilla Brought Down by Major Collins; the Enormous Beast Had Been Named by the Natives "Father of the Gorillas" Because of His Immense Stature.



Future Generations May See in the National Museum
How Present Age Wove Cord-Tire Fabric

LOOM FOR WEAVING TIRE CORD PLACED IN MUSEUM

Among the latest inventions to be placed on exhibit in the National museum in Washington is one of the looms for weaving the cord fabric used in auto tires. The strands are in position, and a portion of the completed work is left on the curved section that shapes the covering to illustrate the process of manufacture.

MARBLE MUSIC SHRINE BRINGS JOY TO THOUSANDS

159
Music's history since 500 B. C. has been engraved in golden letters on the walls of the Benedict Music Monument in Roger Williams park, Providence, R. I. The

structure, built on the lines of the Parthenon, is of white marble and is set in a grassy glade which forms a natural amphitheater, at times holding 50,000 persons. Orchestras, bands and vocalists entertain the audiences from the steps and interior of the monument.

BIRDS AS WEATHER PROPHETS ABLE TO FORETELL STORMS

213
That birds are able to perform feats that are impossible to human beings has long been known to science. They have, for instance, a most marvelous sense of direction. This cannot be put down to memory, for young birds reared in England will go straight to the same African haunts to which their parents went weeks before them. But it is as weather prophets that birds excel, according to an English naturalist. Swallows, martins and swifts, he says, will tell if the following day is to be fine. If they are flying really high, say 500 to 1,000 feet above the ground, a whole week of sunshine may be expected. If they are only fifty feet high, the outlook is doubtful. But if they skim a few feet above the ground, rain is certain. A tame raven invariably slept on the southwest porch of a home. Twice in two years, it changed to the northwest side, and both times a terrific gale blew from the southwest. When a wood filled with singing birds is suddenly silenced, a thunderstorm is usually due. It often is observed, too, that if migrating birds fly north instead of south late in fall, a mild winter may be expected.



His Love of Harmony Led a Rhode Island Millionaire to Will This Marble Shrine to Music to the People;
Many Thousands Enjoy Concerts Played in the Rotunda

Vohwinkel to Elberfeld.

LATEST IN ELEVATED TRAIN CONTROLLED BY CABLE ¹⁶¹

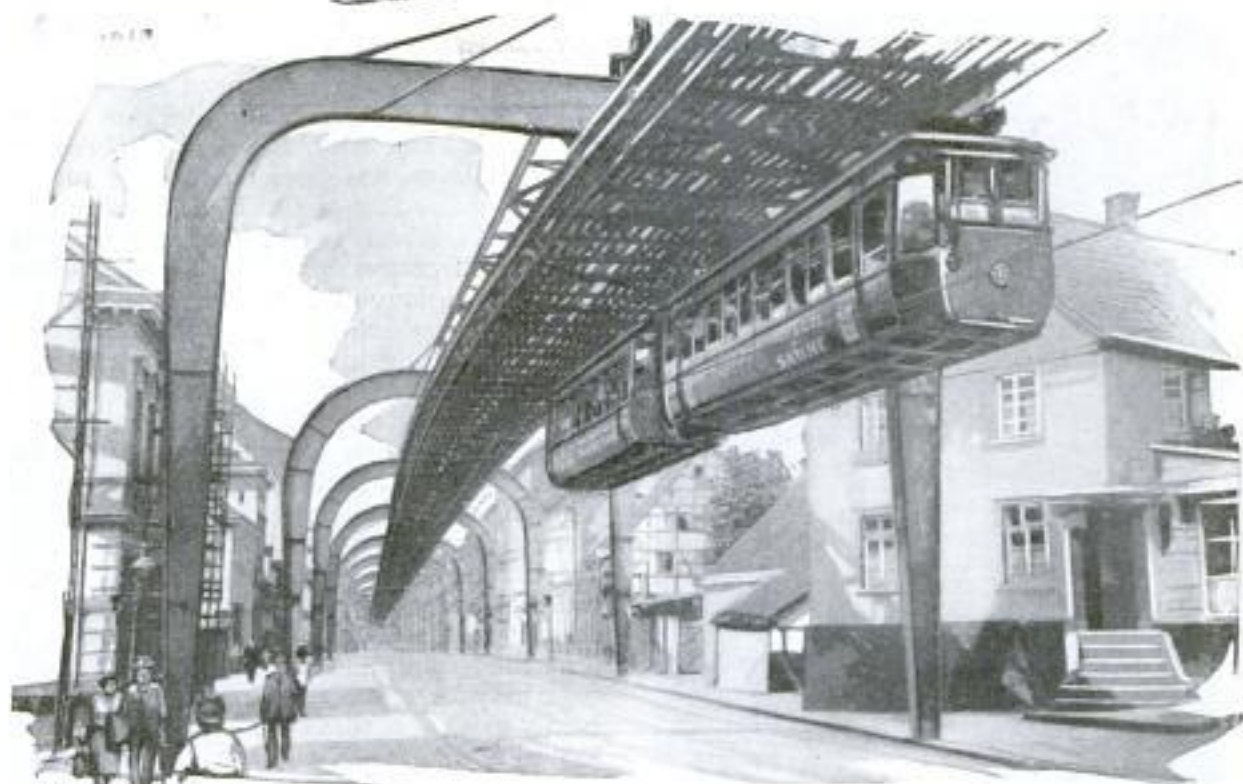

© Henry Miller News

Suspended from Overhead Track, Trains on Cable-Controlled Elevated Line in Germany Make Fast Time While Supports, Set on Curb, Relieve Congestion and Admit More Light to Street

For the purpose of saving the expense of one track and a third rail a suspended elevated railway system is being used in interurban service between two German cities. The train, made up of two cars, hangs on a rail on the under part of the elevated structure. Power is furnished by a cable in contact with the top of the car.

to dry before it is cut into small blocks. From 600 pounds of the root, only about six first-quality pipe bowls can be obtained. The rest is unsalable or goes into inferior pipes. Boxwood, pear and cherry have been used as substitutes for briar but only cherry wood has been greatly popular.

¹⁷⁰
**HUNDRED POUNDS BRIAR
MAKE ONE PIPE**

Few smokers realize that it takes about 100 pounds of briar to produce a pipe free from flaws and of the best quality. The material is gathered in the forests around the Mediterranean, especially in Corsica, Italy and Algeria, where it grows as a spindly shrub about fifteen feet high. The root is round and about the size of a coconut. This is sawed up into slabs, boiled to season it, and then left in the mountain air for several months



**FOOT-PROPELLED ⁵⁷
LAWN ROLLER**

Foot power drives a cycle lawn roller, so carefully geared that although the rolls and machinery weigh several hundred pounds, a slender woman may operate it. From the pedals, chains transfer the force to the heavy rear roller. Another cylinder in front is used both for rolling and steering, the latter being done through a shaft running from the handlebars. The machine is designed mostly for use on fairly small grounds.

Special Gears on Mower Make Pedaling Easy

*Herald and
Examiner 8/4/25*

*Wm. A. Johnson
London, Eng.*

Conquer Aug. 1925.
Harold J. Shepley
Jr. B. Es. S.

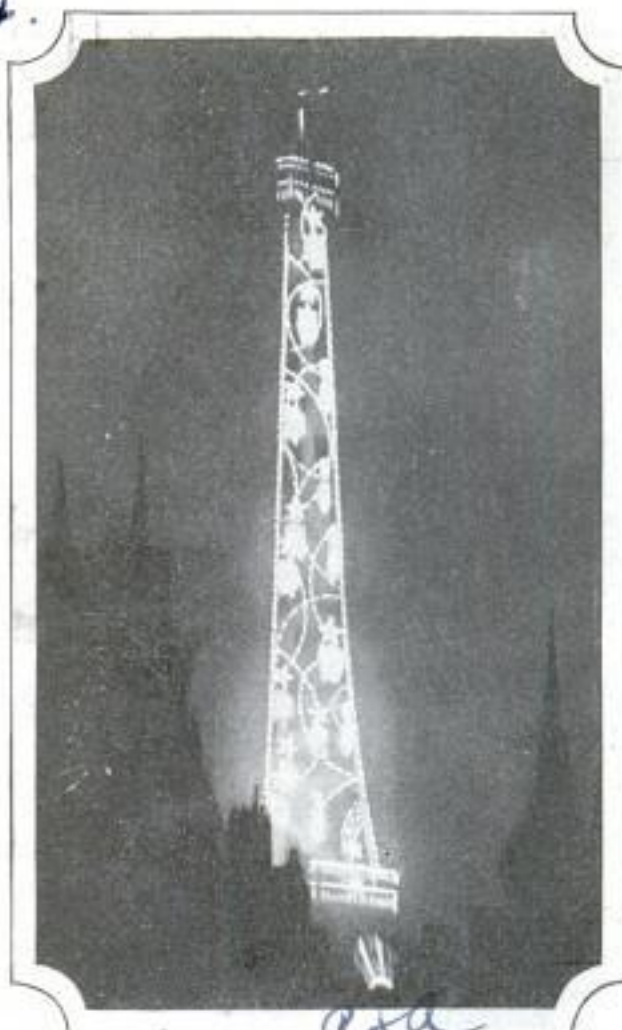

Thousands of Bulbs Used to Light French Tower; Government Gets Big Sum from Advertiser

112

LIGHT EIFFEL TOWER AS AD FOR AUTO FACTORY

Thousands of bulbs are being used to illuminate the famous Eiffel tower in Paris, recently leased for advertising purposes to a French automobile manufacturer who paid a huge sum to the government for the use of the "world's tallest structure." From almost every part of the city the tower can be seen when the lights are on. The giant framework, built in 1889 for the Paris exposition, rises to a height of 984 feet. Visitors from all parts of the world ascend to the crow's nest, by foot or elevators, to enjoy the view of the French metropolis and surroundings it affords.

Timing an echo from a plane to the ground is the latest means of estimating the height of the craft.

LOST BIBLE CITY UNCOVERED ON THE SEA OF GALILEE

209

Lost to men for many centuries, with its very location a matter of dispute, the Bible city of Capernaum, where Jesus made His home after the men of Nazareth rejected Him, has been uncovered on the shores of the Sea of Galilee. The excavation, undertaken by Franciscan friars under the direction of a British archaeologist, has uncovered the ruins of a fine synagogue which the excavators believe is the very one in which Christ preached before, angered at the infidelity of the people of the town, He exclaimed: "And thou, Capernaum, which art exalted unto heaven, shall be brought down to hell." The ruins show the synagogue and the city were destroyed by an earthquake, probably in the second century, so that the city did not long survive Him. Despite the damage done by the quake, it is believed that the synagogue and some other buildings may be completely restored, as there is no evidence that the ruins were ever looted and stones carried away to be used elsewhere. Many fine examples of pottery and other household utensils have been found. As a result of the war, historical excavations are proceeding rapidly at many places in Palestine. Under the Turkish rule, it was very difficult to obtain permission to open historical mounds to get at the ruins, and even when permission was obtained from the government, the cost was excessively high, since myriads of government officials had to be constantly bribed not to interfere. Under the British protectorate, conditions have changed, and several expeditions are now opening ruins, mounds and towns in various parts of Palestine.

123

CURVED STENCIL PRINTER IS FAST DUPLICATOR

Shaped somewhat like a desk blotter, a curved stencil duplicator is said to permit rapid operation, covers a wide area and is not difficult to handle. The frame is constructed of wood, treated to prevent warping or other changes under different temperatures. Stencils are easily inserted and ink is supplied through a pad of fine wool covered with a closely woven cotton fabric.

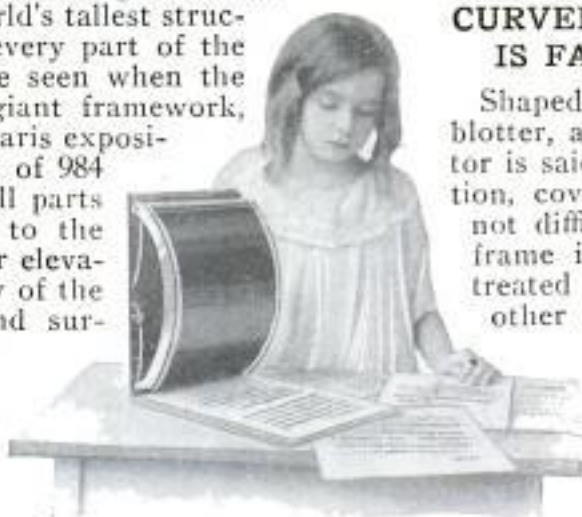

Using Blotter-Shaped Duplicator for Stencil Copying

Office Efficiency Distributors Co.
200 Market St., San Francisco, Calif.



Three Miles for Every Meal on Wheels

Dining Cars Are Run That Distance to Serve More than Thirty Million Persons Every Year

By PAUL PADDOCK

MORE than 80,000 travelers are served daily in the 1,500 dining cars on American railroads. The average check is approximately one dollar, but each meal actually costs about \$1.35, not counting interest on capital invested in the car or depreciation.

These figures are based on reports from forty roads, which showed that last year

over 30,000,000 meals were served at a loss of approximately \$10,500,000. This is explained by fluctuating patronage, high upkeep costs and the limited time each day a diner is in service.

Food supplies represent slightly more than fifty-one per cent of the total expense. Ten thousand stewards, chefs and waiters draw wages totaling over \$11,000,-



Photos Courtesy Santa Fe R. R.

Waiters Passing through Wide Serving Compartment in the Latest Type of Dining-Car Kitchen, and Cashier Totaling Checks as Is Done in a Restaurant

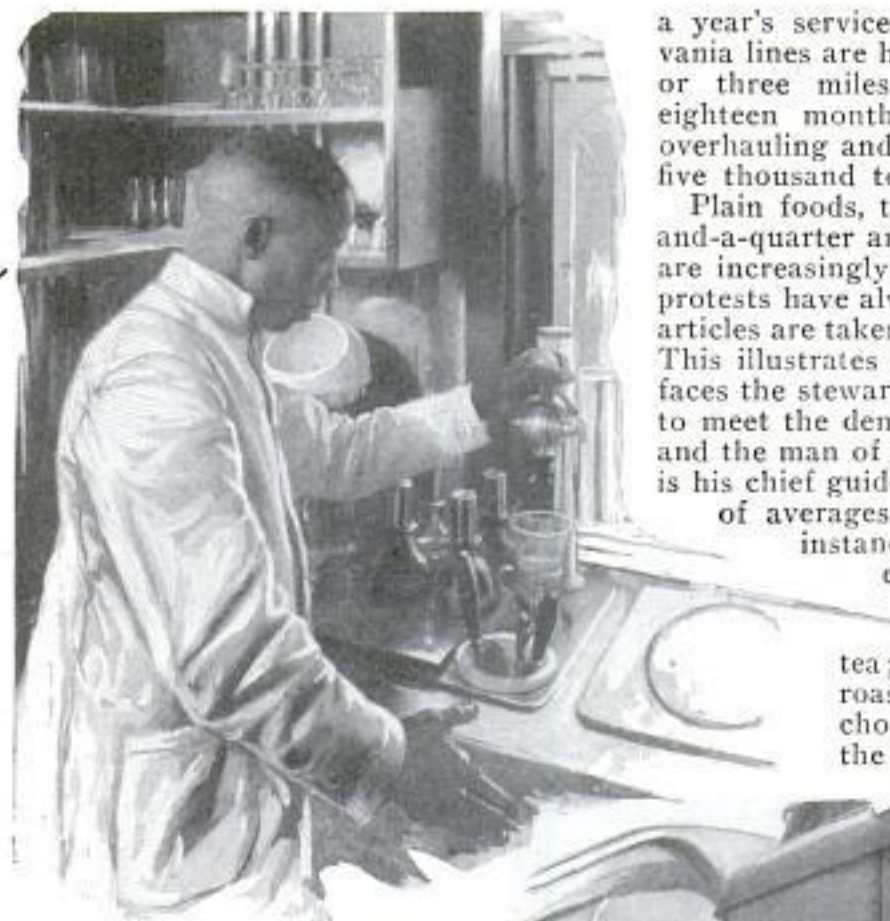

a year's service, diners on the Pennsylvania lines are hauled about 100,000 miles, or three miles to each meal. Every eighteen months they are shopped for overhauling and repairs at a cost of from five thousand to seven thousand dollars.

Plain foods, the eighty-five-cent, dollar and-a-quarter and dollar-and-a-half meals are increasingly popular, officials say, but protests have always followed when fancy articles are taken from the menus entirely. This illustrates one of the problems that faces the steward. He must stock his car to meet the demands of both the epicure and the man of simple tastes. Experience is his chief guide and he relies on the law

of averages to a large extent. For instance, he knows that out of every hundred persons, about eighty-five will want coffee and fifteen tea; thirty-five will ask for roast beef, with chicken, fish, chops and steaks following in the order named. Fruit leads

000, representing about forty-six per cent of the total outlay. Fuel, water, ice, stationery, printing, medical examinations (two are given each year to every member of the crews), telephone, laundry and room rent for employes compelled to lie over between runs, are among the additional items that must be paid for out of every dollar received for a meal.

The whims of the American appetite have been studied since 1868, when the "Delmonico," the first exclusive dining car in the world, was placed in service on the Alton railroad. Lighted with candles, the floor covered with oilcloth, the ceiling of painted canvas and with only a hole in the kitchen wall through which foods were handed to the waiters, the car gave little promise of the modern, all-steel palaces on wheels that cost \$50,000 each, seat from thirty to thirty-six persons at once and carry a crew of from seven to thirteen to serve almost anything, from caviare and truffles to beans and spaghetti. In the course of



Courtesy Penna. R. R.

Beverages and Ices Are Served Patrons, While Traveling, Directly from a Completely Equipped Soda Fountain Installed in the Club Car; Below, Waiters and Chefs Loading Dining Car with Food Supplies for the Day.

all other dishes among the desserts, and then come puddings. Apple is the favorite pie.

What the captain is to a ship, the steward is to the diner. He is absolute master of his crew. He orders every article of food and is responsible for all stocks on his car, including the 150 kitchen utensils, 1,000 pieces of crockery and glassware, 800 pieces of silver and 900 tablecloths and napkins, with which the modern car that seats thirty-six persons is equipped. He must always order sufficient quantities to insure against running short on the road, the "unpardonable sin" in the railway world.

The steward never knows, except on special excursions and similar occasions, whether he will have ten patrons or a hundred, but he must be ready for the larger number. Sometimes his foresight wins him the undying gratitude of passengers. Only a short time ago, a Chicago, Milwaukee and St. Paul diner fed hungry passengers over a forty-eight-



Dining-Car Chef, the Skilled but Seldom Seen Servant of the Hungry Traveler, and Interior View of a Club Car That Furnishes Refreshments, Rest and Recreation



Courtesy Santa Fe R. R.

Roomy Kitchen of Recently Patented Dining Car, and Cigar Counter, an Extra Luxury for Traveling Smokers

hour delay when the trains were stalled by a land slide in the Rockies. Hours before the train is scheduled to leave, the steward appears in the coach yards, supervises the starting of the fires and the preparation of the car for the run. Housewives who complain that their kitchens are too small, should step inside that of the Broadway limited diner. The floor space is less than twenty feet long and about two and one-half feet wide, but four cooks seem to find plenty of room to broil steaks and chicken at the charcoal-burning stove, bake pies and prepare three or more vegetables for the dinner that will include twenty-four articles and will be ready in

less than one hour. The pantry has floor space that measures about four feet by five. Lockers, cupboards, refrigerators and work tables are distributed to save as much space as possible. The latest thing in diners is a patented car recently put into service on the Santa Fe road. Patrons are spared the inconvenience of waiting for their turns in a close passageway, as a club car, adjoining the diner, provides seats for them. The kitchen arrangement permits waiters to circulate through a wide compartment and gather up their food without delay. Besides the customary lounging and card rooms, the club car has a soda fountain and a cigar counter.

89

Dr. W. S. Burgess of Bureau of Hygiene

ANTISEPTIC FLUID KILLS GERMS WITHOUT ACTUAL CONTACT ²¹²

An antiseptic which can pass its healing properties through a quartz tube like X-rays and kill bacteria without ever coming in actual contact with them has been discovered by two French physicians. The material, hypochlorite of sodium, has been used as a germ destroyer for a long time, but the French scientists found that when a dilute solution of it was placed in a quartz vessel and then inserted in a bowl of contaminated fluid the solution still acted as a powerful germicide. The discovery is considered particularly important as it permits the killing of germs in such liquids as milk without affecting their purity through dilution with the salts themselves. While the exact reason for the action of the liquid in the tube remains unknown, it is believed further research work will show a connection between the healing properties of the antiseptic and the ultraviolet rays which are now known to be responsible for the germicidal and healing action of sunlight. Quartz tubes will transmit ultraviolet rays, while ordinary glass will not. M. Philippe Bunau-Varilla, one of the experimenters, advances the hypothesis that the molecule of sodium hypochlorite in attacking organic matter, emits rays analogous to the ultraviolet rays of the sun, and that these pass through the tube.

RUBBER-LINED BOTTLE CORK ALSO SERVES AS OPENER ¹⁷³

Mineral waters and other bottled goods can be kept in fresh condition by means of a combination cork and opener now on the market. It has a notched ring in the top for lifting off the metal cap, and its



Rubber-Lined Stopper Keeps Effervescent Beverages Fresh in Opened Bottles; It Is Also an Opener

bottom part is bell-shaped and lined with rubber, so that it can be slipped tightly over the top of the bottle.

Aug. 8. Frederic M. Deland
16 Avenue de l'Opera, Paris, France

ELECTRIC DRIER FOR THE HAIR ALSO SERVES AS HEATER

After a shampoo, the hair is quickly and thoroughly dried with a small electric heater attached to a lighting socket. As



This Electric Hair Drier Will Serve Also as a Bed Warmer; Screen Prevents Burns

there is no air blast, the hair is not tangled and there is little danger of taking cold. A screen over the heating unit prevents burns. It may also be used for warming beds and heating rooms and adds comfort to the morning shave in chilly weather when hung on the bathroom wall.

WHY TIMEPIECE IS A WATCH ²¹⁴

Few who carelessly glance at their timepieces realize how the watch came to be called by that name, but word students teach that it is derived from an ancient symbol meaning "to be on watch." From this it came to mean a special period of time at which the soldier stood guard. In the Gospel of St. Mark appears the phrase "about the fourth watch of the night." Centuries ago a candle was marked in sectional lengths, to keep tab of the hours as they passed. Naturally when a timepiece was invented to replace this crude beginning, it slipped into possession of the name it now bears.

Dust tossed up twenty miles by eruptions of the volcano Krakatao remained in the air for a period of three years, scientists have announced after a study of the colors of the sunset.

Marion Electric Corp
Marion, Ind.

James
James

Ravens City, Ind. 7/27/25
211
M. Home
8/1/25

GREATEST ARTIFICIAL LAKE HAS SEVEN HUNDRED-MILE SHORE

For the triple purposes of power, frost killing and flood control, Cherokee Bluffs, Ga., said to be the greatest artificial reservoir in modern times, is being rushed to completion on the Tallapoosa river in Alabama. It covers 40,000 acres and has a shore line of more than 700 miles. The lake will impound 530,000,000 gallons of water as against only 29,000,000 held by level dam reservoir. Largest man-made water holder prior to this. Presence of the vast surface of water will tend to keep down frost in many miles of fruit orchards near by. Three huge electric generators, each driven by a 45,000-horsepower turbine, will develop power. Holding back the water will help end floods on the Tallapoosa and Alabama rivers. Work is expected to be completed during 1926.

HOME COMFORTS IN AUTO BED WITH KITCHENETTE CASE

With its occupants high and dry above ground moisture, an auto bed for weekend and longer vacation trips is being used by two English girls.

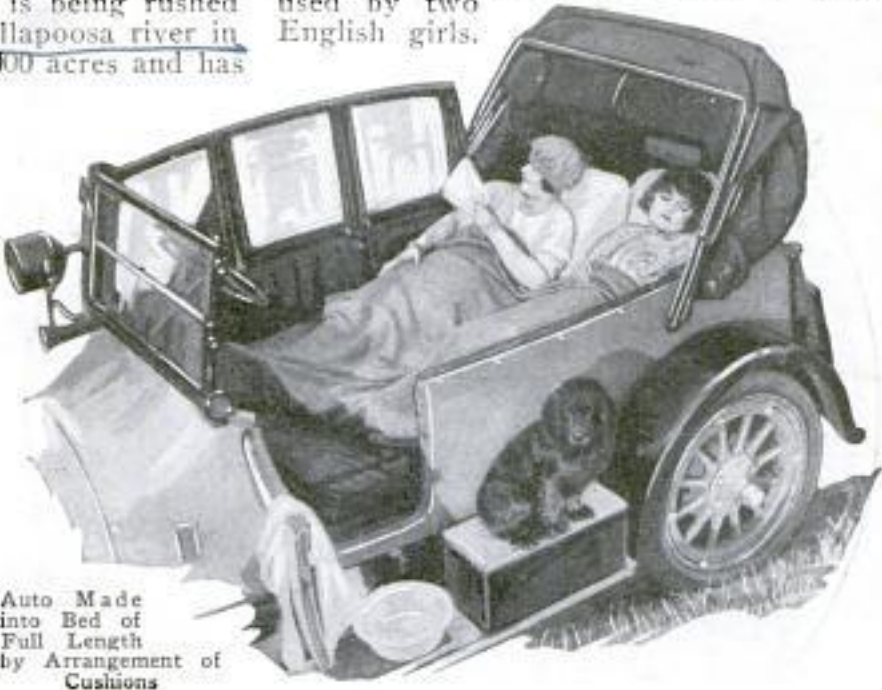

Auto Made into Bed of Full Length by Arrangement of Cushions

and Mrs Melville Hardy architect

WIRE ROLLER FOR CONCRETE GIVES SMOOTH SURFACE

In finishing concrete surfaces, a wire roller now on the market, pushes the coarse stones down and squeezes the finer material upward as well as ridding the material of excess water. On wide walks or floors, the roller may be fitted with a long handle or a rope by which it can be

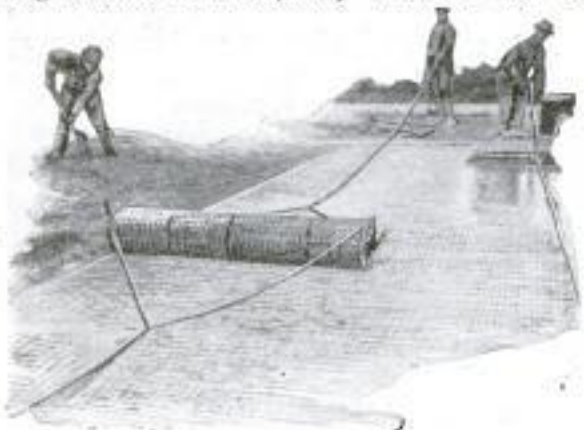

Smoothing Concrete with Roller That Presses Down Small Stones and Has Rope Handle

pulled back and forth so that it will not be necessary for workmen to step on the soft concrete.

*Perforated Roller Works
Kankakee, Ill.*

Ingenious placing of the seats and their backs to make a full-length bed, together with convenient stowage of pillows, sheets and blankets in daytime, gives all the comforts of home and none of the troubles of tent camping. In a suitcase is carried a complete kitchen outfit and small stove. Summer nights a netting can be thrown over all to keep out mosquitoes, and in inclement weather or to guard against prowlers, the top is raised and the removable windows hoisted and locked.

FARM POPULATION DECLINES U. S. STATISTICS SHOW

Farm inhabitants of the United States decreased by some 180,000 last year, according to figures prepared by the department of agriculture. The rural population on January 1, is placed at 31,134,000 compared to 31,316,000 a year earlier. The decrease was not universal for the whole country, however, as New England and the south Atlantic states experienced increases, while other divisions showed losses, with the mountain states leading in the decline. While 2,075,000 persons left the farms last year, 1,396,000 returned to them. Although the balance is still in favor of cityward migration, the back-to-the-farm movement is increasing.

Dr. E. Randall Johnson, Buffalo, N.Y.

**DOG-TEAM TAXI FOR CHILDREN
— HAS MONKEY DRIVER**

One of the amusements for children along the Riviera is a ride in a two-

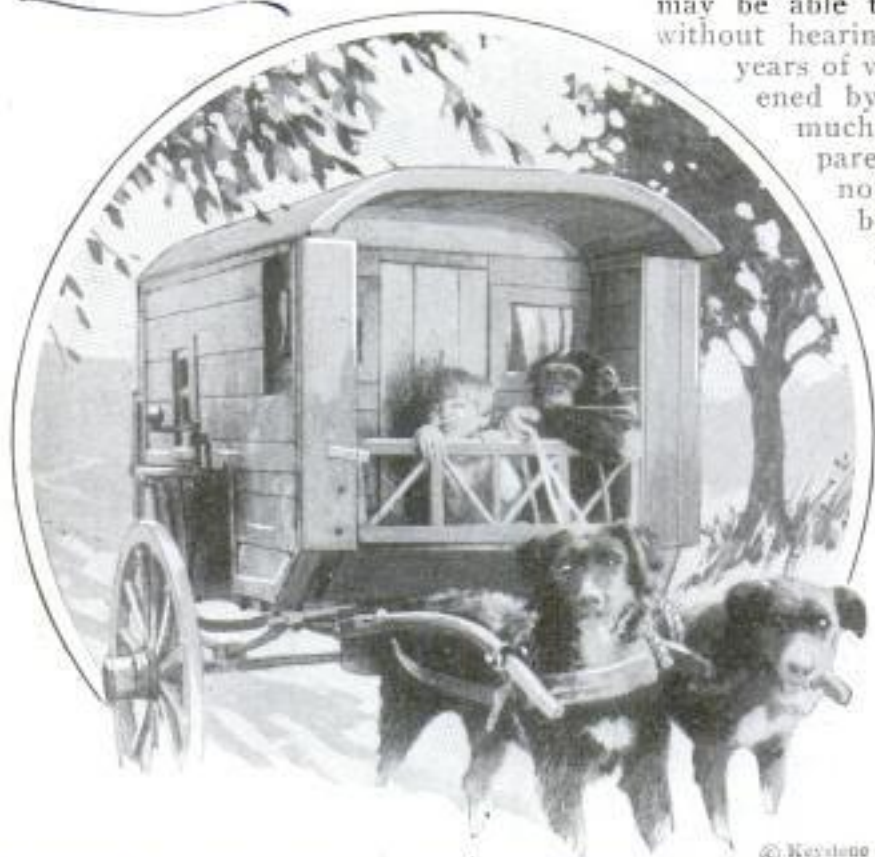

Dog-Team Taxi, with Monkey for Driver, Furnishes Fun for Children and Grown-Ups along the Riviera

wheeled covered taxi hauled by a team of dogs, which is driven by a trained monkey. Passengers may ride in the main compartment of the vehicle which has windows in front and at the sides, or may sit with the "teamster." The monkey has been taught to handle the reins in realistic fashion and the dogs are securely harnessed between double shafts.

**MYSTERY IN HABITS OF FISH
TO BE SOLVED BY TAGS**

For many years, the mysterious movements of schools of mackerel have puzzled fishermen in north Atlantic waters. Places where the fish abound one season, may be barren the next, and while they generally migrate in a south-to-north direction annually, their habits are so uncertain that fishermen are unable to outguess them. Government agents now propose to keep track of the mackerel by means of identification tags. Numbers of the fish will be caught, labeled and released. By recapturing them, it is expected that some clue may be gained as to their travels.

**TEACHERS NOW PICK SINGERS
WITHOUT HEARING VOICE**

As the result of a theory of voice advanced by an eastern dentist, teachers may be able to select singing students without hearing them produce a note, years of vocal lessons may be shortened by a dental operation and much money now wasted by parents on children who have not the slightest chance of becoming great singers may be saved. This theory maintains that vibrations of the air in the cavities beside the vocal cords and not the cords themselves produce the voice. By taking a cast of the mouth cavity, it is considered possible to determine if the person's oral equipment is shaped correctly for the production of singing notes, or if an operation such as altering the position of the teeth or changing the shape of the mouth arch might remedy matters. Casts have been taken of the mouth cavities of some of the world's leading singers, and from study of these,

the dentist has evolved his theory of voice production. By performing an operation on a patient, he is reported to have greatly improved her voice

**ASH TRAY WITH TILTING TUBE
EXTINGUISHES CIGARETS**

Ash tray and cigaret extinguisher are combined in a convenient accessory that has a rubber base to protect the surface on which



it rests. Opposite the match box, there is a tilting tube with a closed end at the bottom. By simply inserting the cigaret into this snuffer, it is immediately put out, sparing the unpleasantness of fumes and the

trouble of crushing the stub. The tray is removed from the base for washing.

Cooper Over Thermometer Co., Pequot, Conn.

43

3361

*U.S. Dept. of Commerce agents
Woods' table, Mass. 56*

3070 Cont. Mel Wharton 135 E 12th St
Portland, Oregon

POPULAR MECHANICS

Wm. Rush, Chateau Forest, Mont. 611

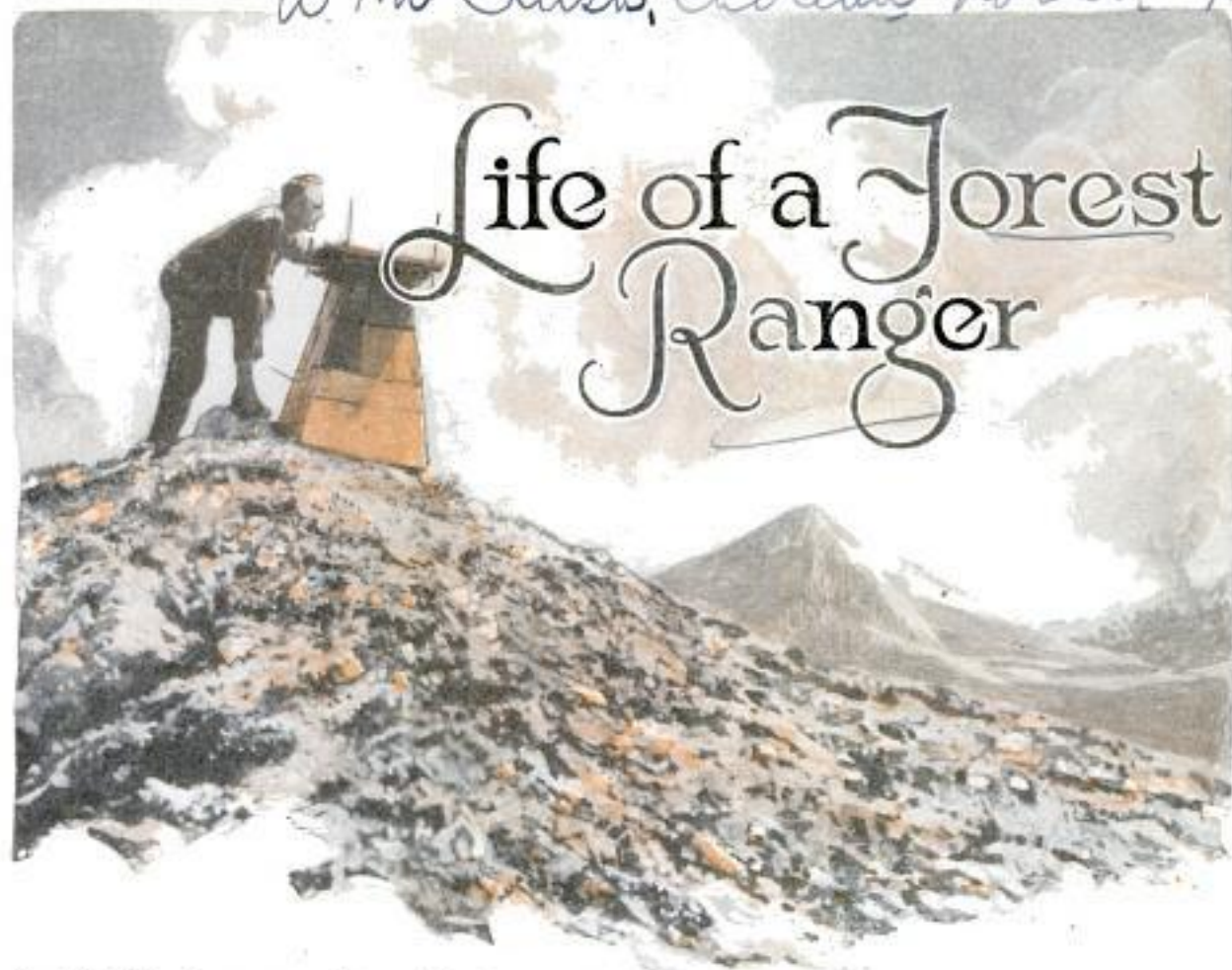

LIVING in a cozy log cabin in some grassy mountain meadow beside an ice-cold brook filled with trout, sole boss of a wilderness of forests and mountains frequently larger than some eastern states, protector of all the big game, with saddle and pack horses in the corral and Uncle Sam to furnish provisions and pay one for living there—the life of a forest ranger has an appeal all its own.

But when the dry days of summer come and a lookout on some lofty mountain peak telephones down at 2:00 a.m. that a fire has started in a distant valley, all the romance disappears. For the ranger must leave his bed and, with food and tools in a pack, start out, on horseback or afoot, to cope single-handed with a fire that may be burning over an area the size of New York or Chicago.

And he must reach the scene by dawn, if possible, for just at that hour of the day a forest fire dies down, resting a bit before renewing its attack. It is then that the lone fire fighter has a chance to start digging and back-firing to head it off.

Summer is a period of hard, back-breaking work for the forest guards, while the early spring, late fall and even the below-zero days of winter are the periods when he has time to really enjoy the romance

of his life. Even then there is plenty of work to do. The timber must be inspected and that which should be cut marked for the woodsmen who follow. In spring and fall, tree planting and other reforestation work are carried on, insect pests are investigated, telephone lines constructed and maintained; roads and trails for use of both rangers and campers built; dwellings and lookout houses built and repaired; fences erected; water developments, fish and game studied, and in winter a game census is taken.

With 157,000,000 acres of national forests to be looked after—an area slightly larger than the combined states of Oregon, New York, Florida and Pennsylvania, the service finds plenty to do. Most of the forests are in the high mountains of the west, in fact, eleven western states and Alaska contain all but 6,000,000 of the total acreage. The forests there are chiefly pines, firs, spruce, cedar, hemlock and other evergreens, which become highly inflammable in summer. The ground beneath them is covered with the accumulated vegetable decay of the centuries, piles of twigs, dead leaves, weeds, and grass of previous generations frequently making a bed several feet deep.

3070

the control of the forest supervisor. Each district is presided over by a district ranger, and each ranger may have under him a fire lookout and a fireman, while forest patrols constantly cover the entire area to enforce the laws against

Rangers Flashing Fire Warning with Heliograph, or Sun Telegraph

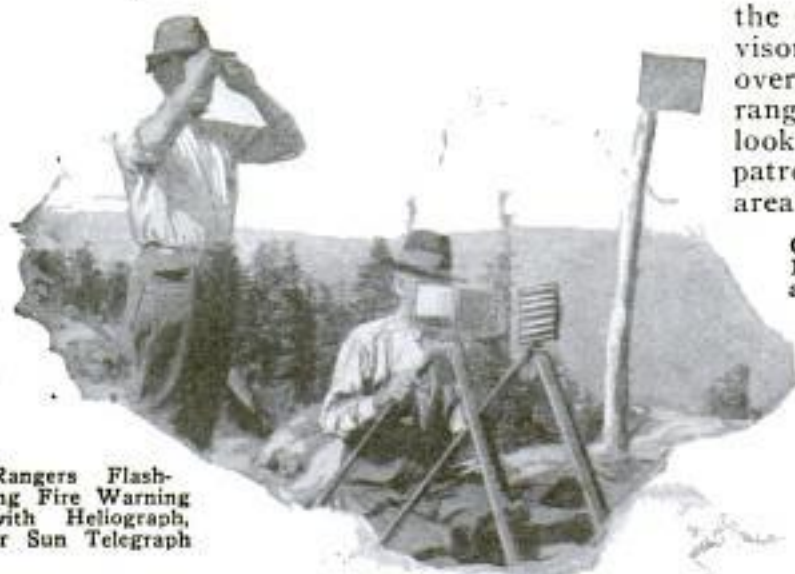

Camp in a Mountain Meadow and, Below, a Fire Truck of the Forests



A match or cigaret stub dropped in this debris may start a smoldering fire that will burn quietly for days until a high wind fans it into violence, or a stroke of lightning may fire one tree and start flames sweeping through the woods. Some 6,000 fires are fought each year by the forest service, about forty per cent of them being traced to lightning and the other sixty to careless campers.

Such a start may be overcome, if the fire fighter reaches the scene quickly, but if the fire gets going, it may burn for days or even weeks until a heavy rain extinguishes it. One can often back-fire and end a blaze, but others sweep across thousands of acres, and sometimes take a heavy toll of life. Most of the national forests are divided into districts, under



cutting timber, running too many sheep or cattle on the range, killing game or violating the camping rules.

The lookout has the loneliest job of all. Perched in a tiny house on top of the highest peak in the district, he may not see another person for weeks, though he is in daily telephone communication with all the officials of the district. His job is to keep ceaseless watch for the telltale column of smoke that marks a new fire. When that appears, he proceeds to locate it as accurately as possible. He has a map of his district mounted on the

table in his tower, with its compass points properly orientated. On the map is placed a circle, laid off in degrees, and with its center over the spot which represents the location of his post. When smoke is sighted, he takes its bearing and telephones the direction and probable distance to



Telephone Lines Must Be Kept in Constant Repair to Carry Fire Warnings; Above, Fire Crew Digging Down to Mineral Earth as They Start Back-Fire

the fireman of the district. The fireman is stationed as nearly as possible in the center of the timber he is to protect. He has a cabin to live in; tools to fight the fire with, and "grub" for three days made up into a pack, ready to sling on his shoulders and start for the fire at a minute's notice. For night travel he is equipped with a miners' lamp and he must get as near the fire as he can, so as to be able to tackle it in the morning, as soon

2070

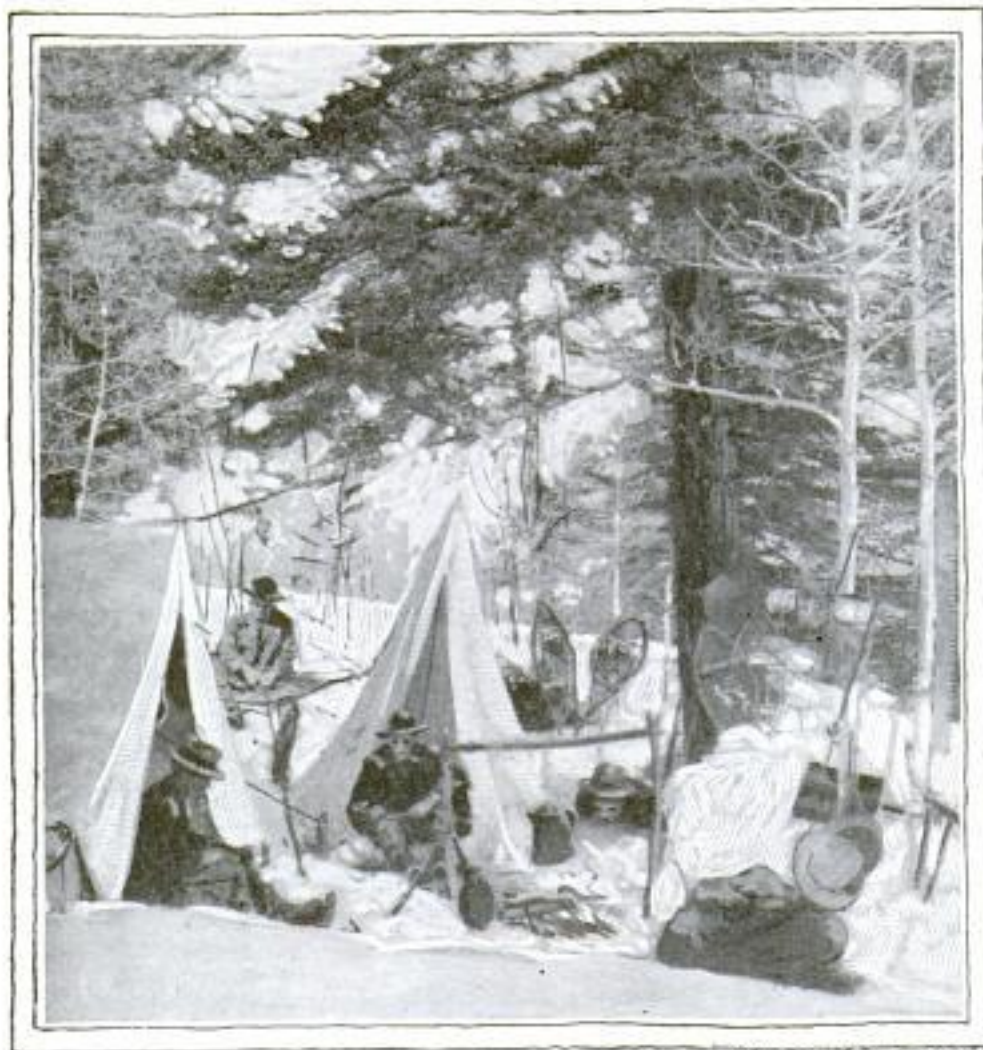

Winter Camp in the Snow, and a Queer Wooden Lattice Tower, Used as a Lookout Station



after daylight as possible. If he arrives within an hour or so after a fire started, the job of extinguishing it is usually simple and he can do it alone, but with the large areas each man has to cover, it is sometimes impossible for him to reach the fire in less than three or four hours, and then it may have grown to such a size that he must call for aid. Here is where the lookout comes in again. From his vantage point he can tell just how the fire is progressing and can telephone the district ranger for additional men. Regular horse packs of tools and supplies are kept on hand for these emergencies so that no time will be lost assembling outfits.

Hundreds of miles of horse and foot trails are kept cleared in the forests to facilitate reaching fires quickly. Even motor roads are now being built and firemen equipped with regular city fire-fighting apparatus. The trench and back-fire remain the stand-bys of the forest ranger, however, and it is here he finds his back-breaking work. He picks out a favorable spot ahead of the fire and digs a trench, from twelve to twenty inches wide, all the way down to mineral soil, which may be



anywhere from one to several feet below the surface. Then he back-fires on the side of the trench nearest the fire, and watches that no sparks cross to the other. The back-fire, if successful, meets the advancing blaze and the two burn themselves out together.

To be a successful ranger, a man must have a working knowledge of many trades, from stringing telephone wires to building bridges. Getting some of the lookout nests on their mountain tops is one of the hardest jobs he has. The lumber is all cut at the nearest valley planing

mill and then taken as near the scene as it can go by truck. From there on, it is loaded on pack horses, and sometimes, when even the horses cannot climb to the site, every piece must be carried by men.

The forest patrolmen are mounted and have the most varied and interesting life in the woods. They travel the trails frequented by visitors and see that campers do not build fires in dangerous places, leave without extinguishing them or violate any of the other forest rules.

In exceptionally dry periods campers are often barred entirely. During the dry summer on the coast in 1924, the Olym-



Lookout Station Fastened with Cables to a Windy Mountain Peak; Locating a Distant Smoke Cloud by Compass and Map, and a Fire Truck Filling at Its Water Supply

pian mountains were practically closed to visitors. Few could get permits to enter, and then only to pass from one ranger station to the next. Their camping sites were specified and they were forbidden to smoke. Over the trails they took, the patrolmen were sure to pass within a few hours, and a single match or cigaret stub was sufficient to cause them to speed up, arrest the culprit and take him to the nearest judge.

H. N. Andreasen,
928 N. Richmond St
Chicago, Ill.

**DIME BANK FITS VEST POCKET
— LIKE FOUNTAIN PEN**

51

To outward appearance a fountain pen, but in reality a vest-pocket bank for saving dimes, a handy container is being distributed by mid-western banks to their customers. The article is made of nicked metal, and has a clip at the top whereby the tiny bank, holding \$4, may be held safely in the vest pocket or in a woman's hand-bag. The slot is in the top and by slanting the coins in stacking them, the actual width of the holder is less than that of the ten-cent piece.

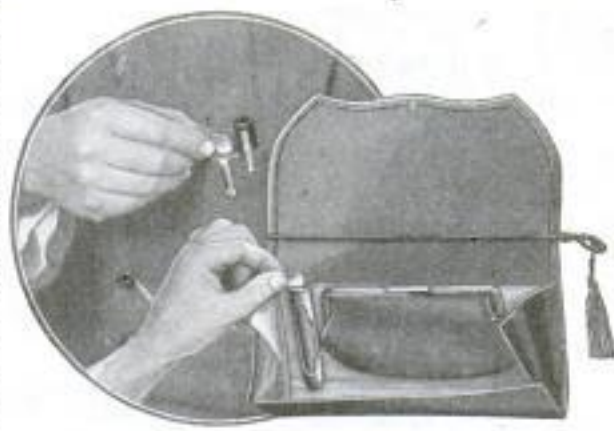

Inserting Dime in Bank Attached to Pocket, and How Holder Is Carried in Purse

**FULL WORKSHOP IS COMBINED
IN A SINGLE TOOL**

A complete workshop, combining everything from a wood and metal-working lathe to a portable electric drill in one small outfit and which can be carried around in the hand, has been placed on the market. It includes power-driven grinder, buffer and wire brush, as well as a circular saw, in addition to its other features, yet the entire outfit is contained on a base only twenty-five inches long by six inches wide, to which is fitted a metal

cover with a carrying handle. The lathe bed, capable of taking work twelve inches long with a six-inch swing, is mounted directly on the wooden base, with the power unit—a back-gear motor—attached to the lathe head. A separate revolver-type handle is provided which may be attached to the motor and the entire power unit lifted off to make a portable electric drill. The motor has an extension cord for attachment to any light socket. A reversible tailstock with both wood and metal-turning centers is supplied,

while the other lathe equipment includes a chuck, spur center, faceplate, parting tool and gouge chisel. To convert the outfit into a power-driven saw, a small, rigid metal table, on which is mounted a five-inch circular saw, is clamped to the lathe rails.

RUBBER BASE FOR TELEPHONE

Flexible rubber instead of felt for the telephone base is said to serve better as a shock eliminator and assure a clearer conversation as well as prevent scratches and mars on polished surfaces. It is manufactured in brown or green and fits the standard-size instrument.

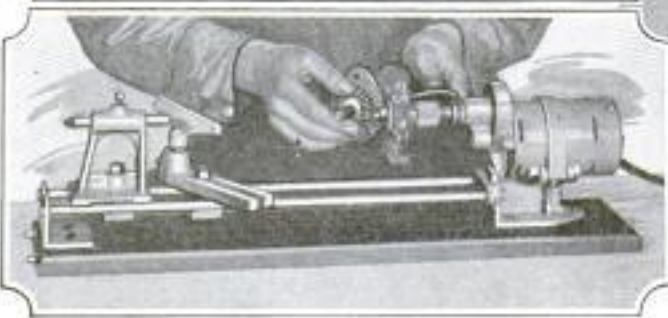
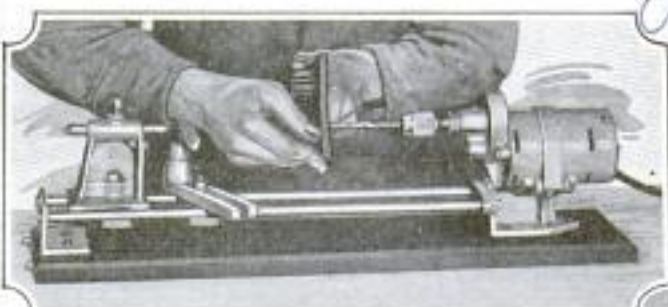

Versatile Tool in Operation, Doing Drilling, Buffing and Wood-Turning; the Motor Is Connected to a Lighting Socket and May Be Detached to Form a Portable Electric Drill

Electro. Magnetics Tool Co. Sept. 13 58
Price \$75.00
1800
19th & 52nd Ave
Chicago, Ill.

A. H. Brown Co. Inc.
Price - \$1.00
1915 Chestnut St
Phila.

Kansas City Star 7/16/25

Harry P. Durbin

St. Louis Post Dispatch

COW PONIES KILLED TO SAVE THEIR FOOD FOR SHEEP 96

Montana ranchmen are joining to wipe out of existence 400,000 wild horses that are denuding the ranges of grass needed for sheep and cattle. The old-time cow pony, its use nearly gone as fences split up the old free plains, has been officially sentenced to death by the state. It is figured that the savage steeds of this one state consume feed worth \$109,000 yearly and sufficient to keep 2,000,000 sheep alive. Other states are also working to eliminate them. Arizona and New Mexico ship theirs under a special freight rate as "chicken feed" to Petaluma, Calif., world poultry center. About 8,000 head are sent to an eastern port, whence the choicest portions of the body go to Europe for human food, and the rest is ground into dog food. In the roundup the ponies are driven into wide corrals, then roped and their throats cut, a business that the old-time cowboy refuses to take part in. The hides are ripped off and the bodies, piled high, are burned with the aid of oil. It is figured that in a few years the cayuse or broncho, as it is variously known, will have disappeared save from the ranks of those riding for professional rodeo exhibitions and circuses, and those employed in motion-picture work.

3386

WATCH CASE ON AUTO DASH RECORDS DRIVING TIME 00

The motorist's pocket watch is made to serve as dash clock by a holder which may be clamped to the instrument board of the car by means of a thumb-screw. The time-piece is inserted by raising the front of the case and snapping it shut. A rotating band with arrow-head, when brought to the proper position, marks the time of starting and gives a record of the duration of the trip.



With finger-sold. \$2.50

☞ Sawdust, mixed with oil and sowed like seed in shallow pools and ponds, is being used to combat mosquitoes.

H. K. Lettner 19
Woodbridge W.
Detroit, Mich

PIANIST WEIGHTS HIS WRISTS TO STRENGTHEN HANDS 46

Five-pound weights, attached to the wrists, are being used by a young Ameri-



Austin Ray

Practice on Piano Becomes Gymnastics with Five-Pound Weights Attached to Wrists

can pianist in practicing, to develop the muscles of the hands and fingers and keep them supple. Discovery of the beneficial effect came by accident. The youth was in a concert hall one winter night, waiting to hear a prominent Russian artist. Soon the manager reported that the foreign pianist would be unable to play. The American agreed to substitute. He hurried backstage to warm and loosen the muscles of his hands and fingers, and noticed two heavy paint cans. He hung one of these on each wrist and was surprised at the way his circulation speeded up. Practical application, he decided later, was to use weights in strengthening the muscles.

OLD SNAKE YARNS REFUTED 103

Stories about snakes that curl themselves into hoops and roll toward their victims or that break into many pieces and wriggle off to escape, are fables according to biologists of the department of agriculture, for no such reptiles exist. The so-called stinging snake is also a myth, they declare, crediting the origin to the existence of a snake with a sharp-pointed tail. The jointed snake, it is said, is nothing but a harmless lizard that has the ability to drop its tail when it is in danger of being caught by that member.

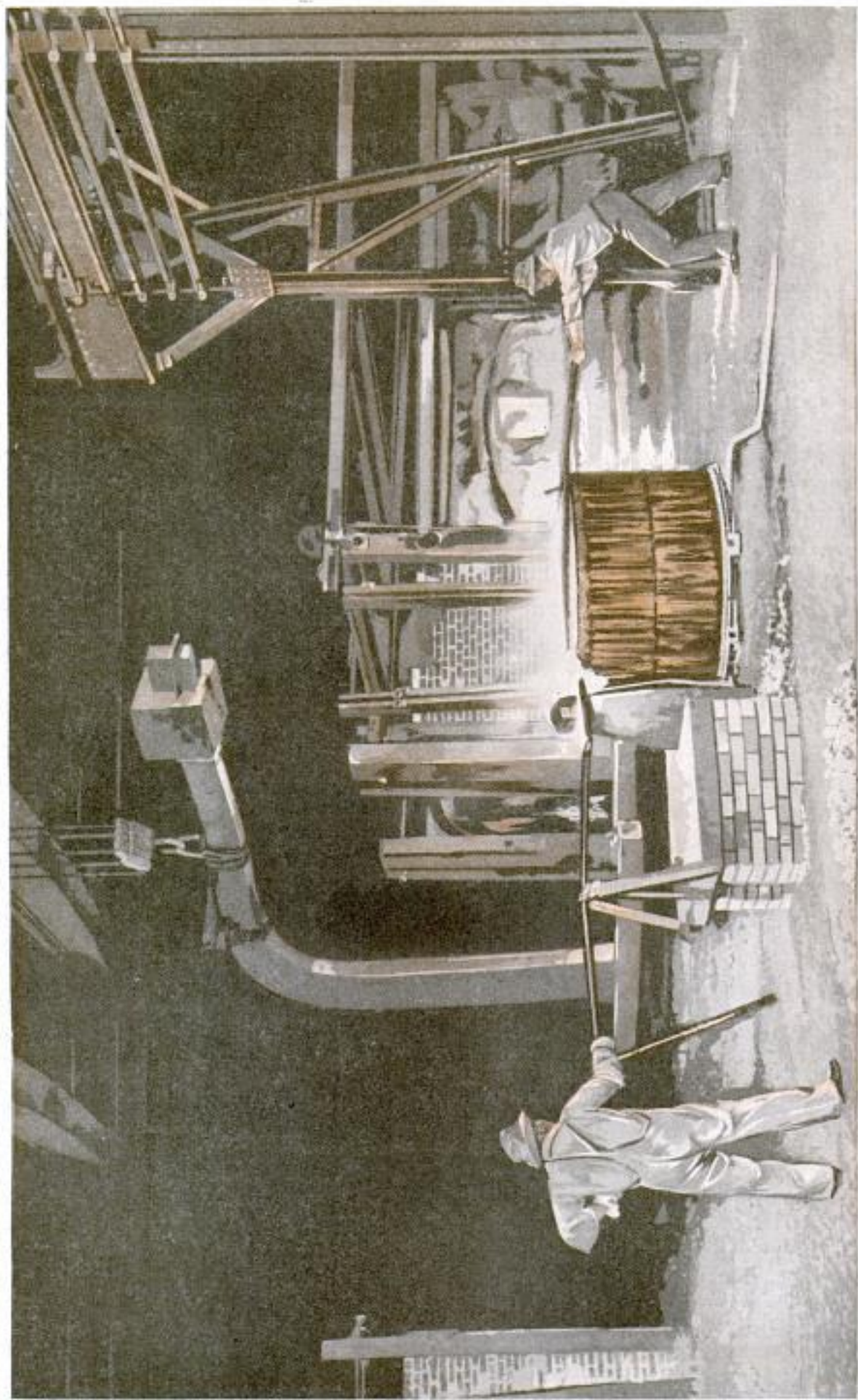

Photos Copyright, Pittsburgh Plate Glass Co.
Glowing Cherry-Red from the Heat, the Great Clay Pots, Filled to the Brim with Molten Glass, Are Drawn from the Furnace by Huge Electric Tongs, Then Masked Workmen Skim Off the Impurities

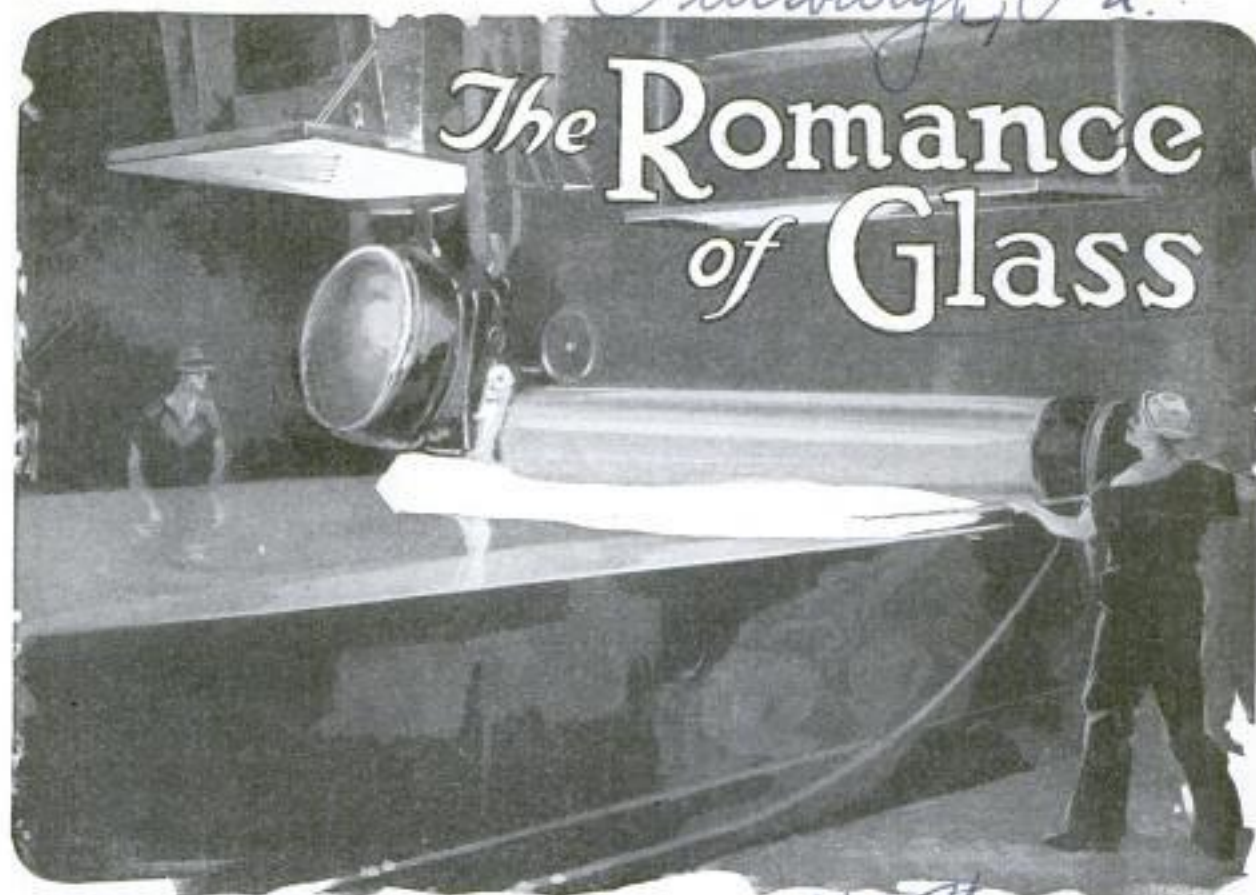

The Romance of Glass

AN ancient crystal gazer, peering into his mystic sphere in an Egyptian temple, many centuries before the Christian era foretold the future, and in predicting it, concentrated men's interest in the strange material from which the bauble was made.

But the seer failed to discern in that future the day when the glass of his crystal, born in the fusion of soda and sand, would be rolled into plates for windows, blown into bottles and flasks and jars, or that the demand for windows in motor cars would result in the invention of a radically new method of making the product, improving on a process that had changed but little in more than 2,500 years.

That is the romance of glass, an accidental discovery, according to Pliny, of some Phoenician sailors cooking their dinner on the sands, which founded a business that now employs 80,000 Americans and turns out a product valued at \$400,000,000 annually. Pliny's tale may be true or only a plausible fancy, but true or false, in some such chance discovery beyond human record or tradition one of the greatest of modern industries had its origin.

From such a humble start glass making produced "The Window of Paradise" of Rheims cathedral, the wonderful glass ornaments of ancient Egypt and Assyria,

the fragile, beautifully colored Venetian glass, the first microscope and spectroscope and camera, and on down to the windows and bottles and the automobile windshields of today.

The glass mosaics of Egypt and the rare Venetian and Roman glassware, as well as the great cathedral windows of the Middle Ages were all wrought in colored glass, for the manufacture of transparent glass on a commercial scale is a comparatively modern achievement.

Despite the vast progress made in the last hundred years, more than three-fourths of all the plate glass produced in the United States today is made in virtually the same way as that pictured on the walls of the tombs of Memphis and Beni Hassan. The materials are dumped into clay pots, the pots heated for hours in furnaces, and the molten material, skimmed of its dross, poured onto tables and rolled into thick rough sheets. The pots and furnaces are bigger because great electrically driven cranes are available to handle the heavier containers, the rolling tables are bigger because power is available to move the giant rollers, and the grinding and polishing machinery is all of modern invention, but the process is basically the same.

Men still dip up molten glass "gatherers" on the end of blowers' pipes and with

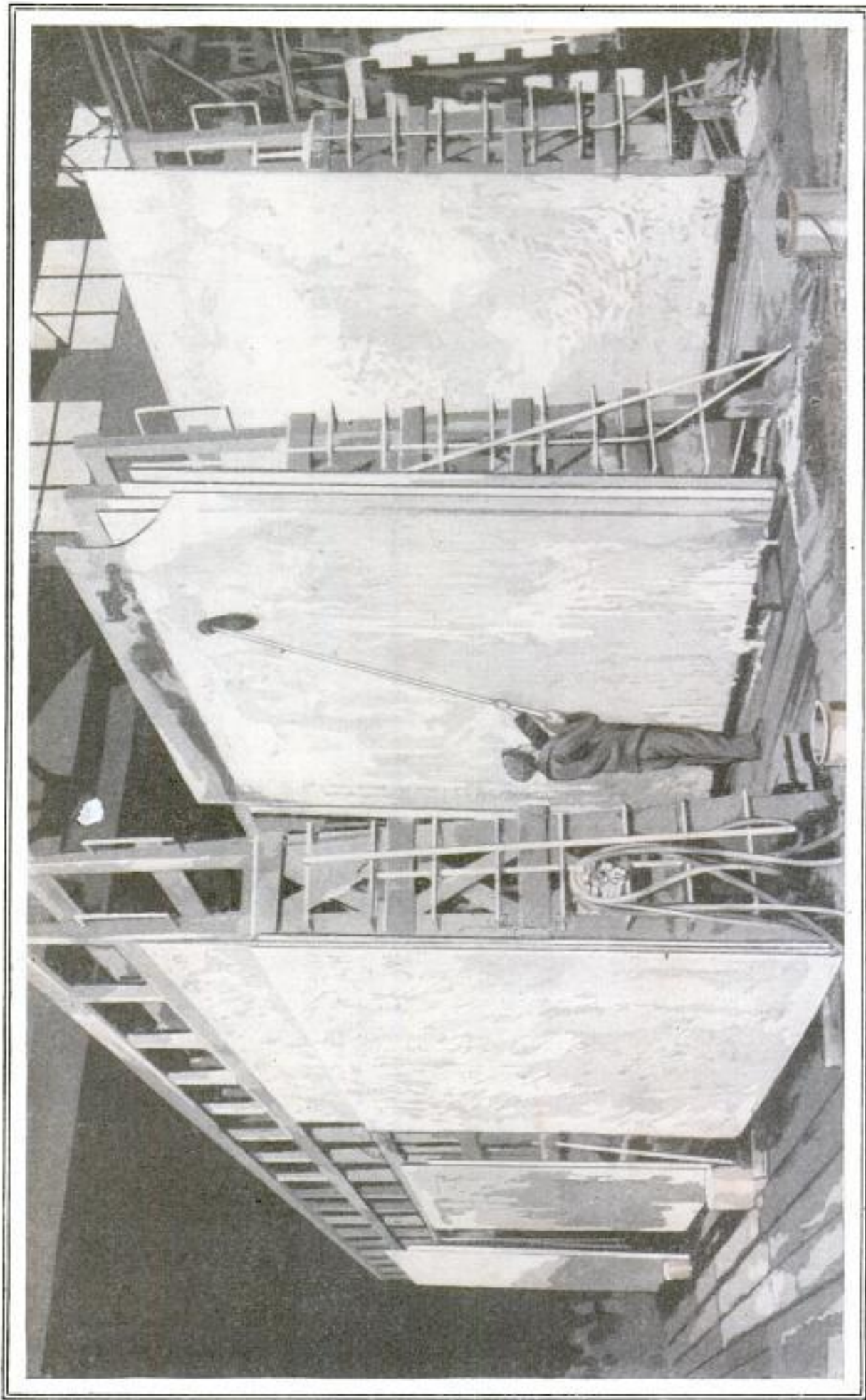

Huge Sheets, Polished on One Side, Are Stood on Edge While Workmen with Long-Handled Mops Wash Off the Plaster Which Held Them to the Surface of the Polishing Table, Using a Bath of Mariatic Acid to Remove the Adhering Coating Before the Sheets Go Back to the Polishers

lung power expand the incandescent bubbles, though compressed-air blowing is rapidly displacing them. In all of the commercial plate-glass plants men are still tramping out pot clay with their bare feet and building up the pots by hand, though within the last half dozen years one automobile maker, who uses one-fourth of all the plate glass made in the United States, has developed a process by which pots are dispensed with, and raw material thrown into a furnace pours out as a steady stream of molten glass, is cooled, ground and polished almost without human hands touching it.

The terms "plate glass" and "common window glass," contrary to popular belief, have nothing to do with the thickness of the material, but only with the way in which it is made. Common glass is blown first into huge cylinders, these are cut into sections, the sections split down the side, and then, by reheating, caused to collapse and unroll as flat sheets. With compressed-air blowers, a machine dips up a huge mass of the molten material, and rises into the air,

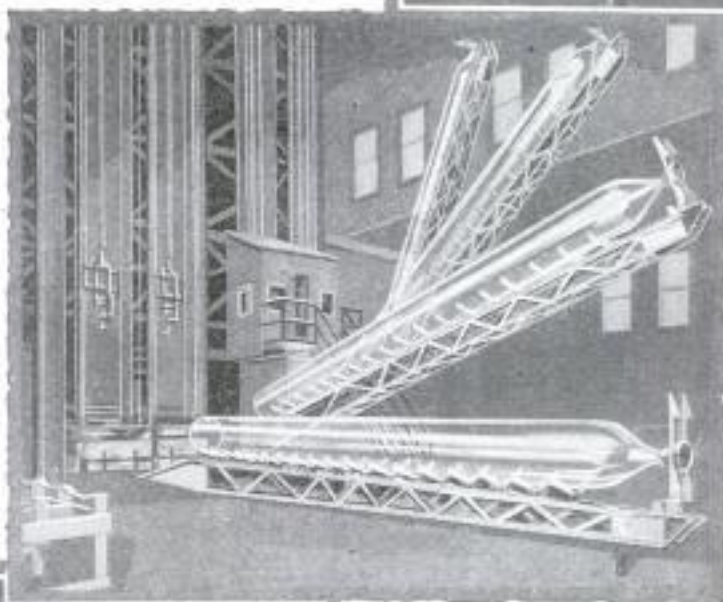
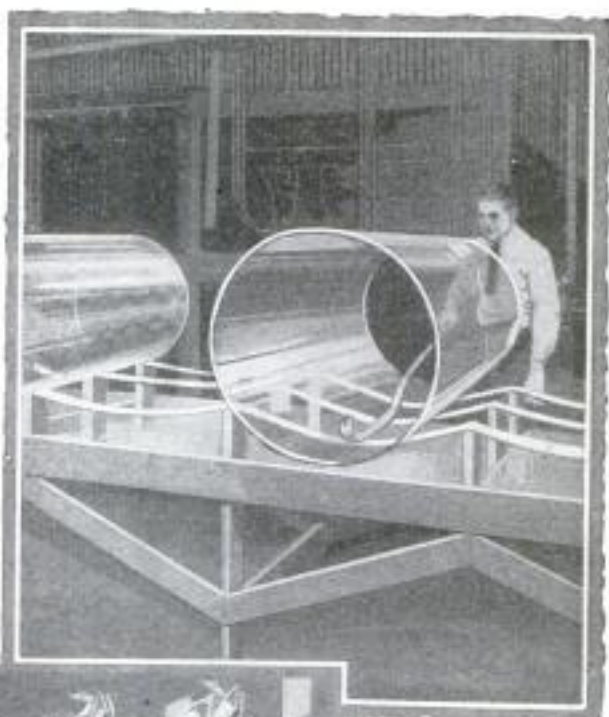

blowing steadily until a shimmering, incandescent tube, forty feet or even more in length, rises like some great cathedral column.

Plate glass, on the other hand is poured from the melting pot onto a great metal table, then

rolled to the required thickness by a huge steel roller, which spreads the heap of liquid smoothly over the table top. The sheet then passes into a long cooling chamber, where graduated gas flares keep it from losing heat so rapidly as to set up mechanical stresses and cause fractures from within. Emerging after a trip of 400 feet or more through this gradual process, the rough plate, which may be twice the thickness of the desired finished product, is bedded down in quick-setting plaster on a circular table, and wheeled under a battery of rapidly revolving grinding disks. Fed with abrasive sand, first coarse and then finer and finer, the disks wear the surface away, until a final polishing with rouge and felt disks gives a perfectly smooth surface.

The plate is then turned over and the process repeated on the other side, fol-

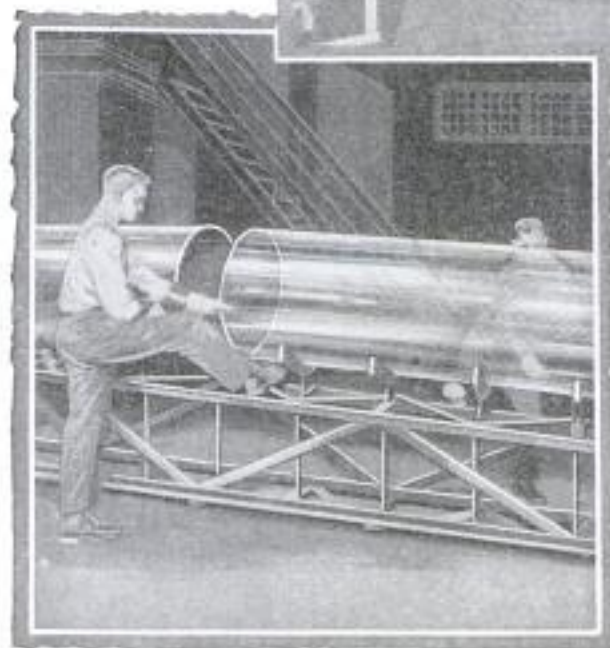

Plain Window-Glass Cylinders Are Split Open and Flattened after Being Cut in Short Lengths

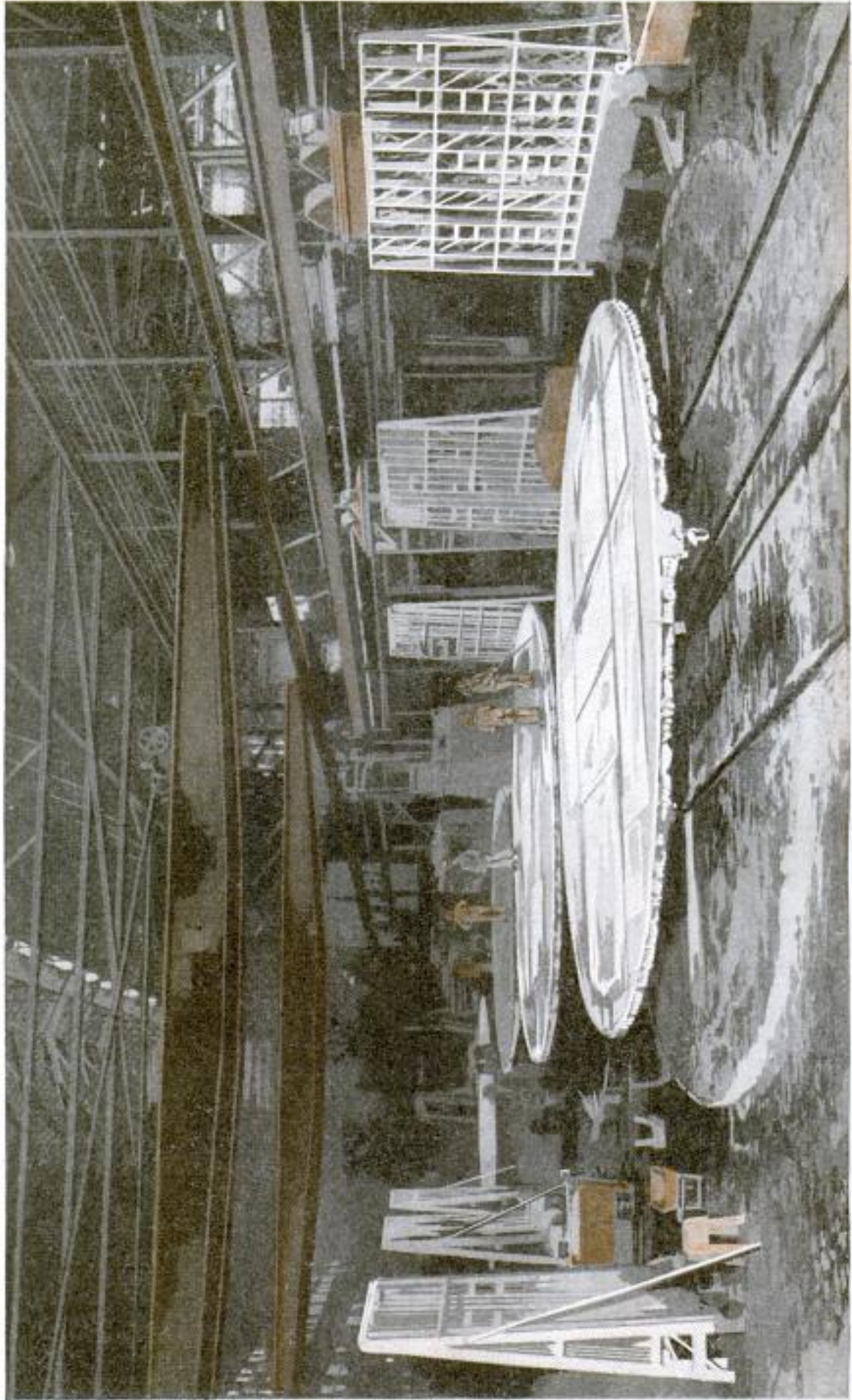

Sheets of Rough Glass Are Set in Plaster on Huge Circular Tables and Then Tramped Down by the Feet of the Workmen to Force Out Air Bubbles; the Tables Are Pulled by Tractors to the Polishing Room, Where Revolving Disks Wear the Surface Down Until It Is Smooth

lowing which a washing with acid removes all traces of the plaster and leaves a finished plate, ready to go to the trimmers who cut out any flaws and reduce the rest to standard sizes.

The difference between plate and common window glass is that the two surfaces of the former are absolutely parallel, and hence there is no distortion of light passing through it. Common window glass, on the other hand, gives distorted images and wavy lines, since its surfaces were created by blowing a cylinder which then was collapsed and spread flat by further heat.

The making of plate glass is a long and expensive process, not only because of the polishing it undergoes, but because the pot in which the material is melted must be so perfect as to withstand terrific heat. The clay for the pot is carefully chosen, left to lie in the yard for many months to season, and then is mixed with water and under the bare feet of the workmen, trod down until it is a perfect paste.

With small rolls of it, the pot builder starts work, building up the huge receptacle layer by layer, kneading and tamping each handful in place as he goes. The pot itself then requires weeks or months

of further seasoning, and its life is often less than twenty days.

The demands of the automobile industry for vast amounts of plate glass for windshields and windows—since distortion of objects might prove fatal to the driver and his passengers—resulted in the invention of the almost wholly mechanical process, which replaces pots and other time-worn methods. Engineers declared it would be impossible to pour material into a furnace and have a continuous ribbon of glass emerge and travel down the cooling leers and polishing tables because the strain on a 400-foot ribbon of half-molten glass would be so great as to break it. The problem was finally solved, and in two plants the glass actually travels 442 feet without breakage or distortion.

The same plants that produce plate and common window glass likewise turn out many varieties of colored and special glasses. Metallic pigments added to the molten mass in the pot produce beautiful and brilliant colors without destroying the transparency of the material. The white tops of restaurant tables, and the black base and white sides of the soda fountain, which look like some rare marble, are nothing but glass.

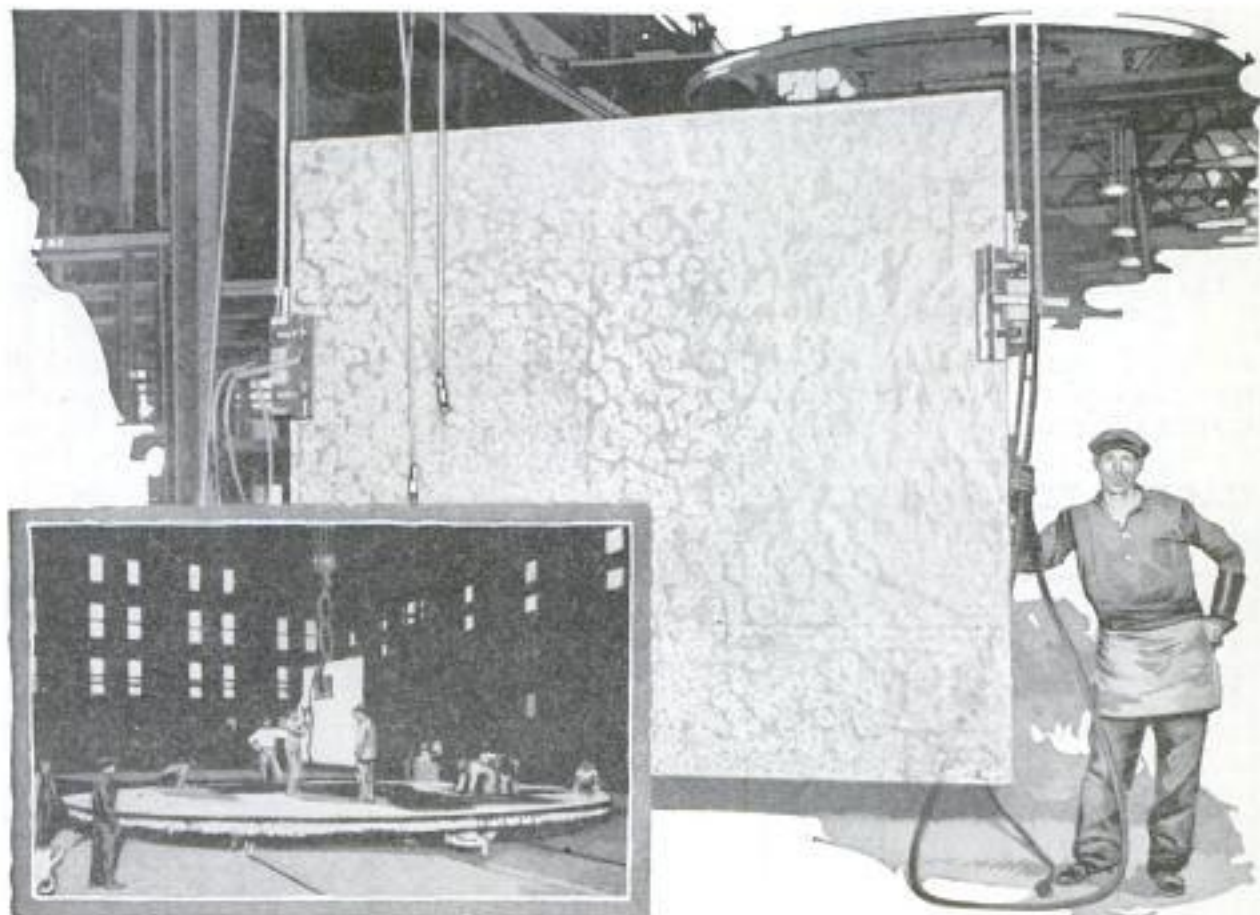

Overhead Cranes Carry These Big Sheets of Rough Glass from the Pouring Tables to the Polishing Beds; Right, a Polished Sheet Ready to Have the Plaster Washed Off

CONCRETE CORN CRIB BREATHES PREVENTING LOSS OF GRAIN

Corn and other grains are kept from decay or destruction by animal pests in a concrete crib constructed of stavelike blocks, each having a steel-barred opening to permit ample ventilation. These vents, set in staggered fashion, occupy space equivalent to about twenty per cent of the wall surface of the crib. Air passes through them freely and at the same time, the bars exclude rats and mice. Steel bands

to exhaust pipes or manifolds, and performs by means of an energized spring, which makes about 5,000 strokes to pump a gallon of fuel. The gasoline delivery is controlled by the carburetor float valve.

Among the advantages claimed for this attachment, which already has been used with success on racing cars, is its ability to keep an even supply of gas flowing to the carburetor, regardless of grade, altitude, vibration or temperature. It also is said to prevent

50
The Portable Elevator Mfg. Co
Bloomington, Ill.

with
Box 1247 Rapids,
Mich.
Janice
Grand
Island
Mich.
3201

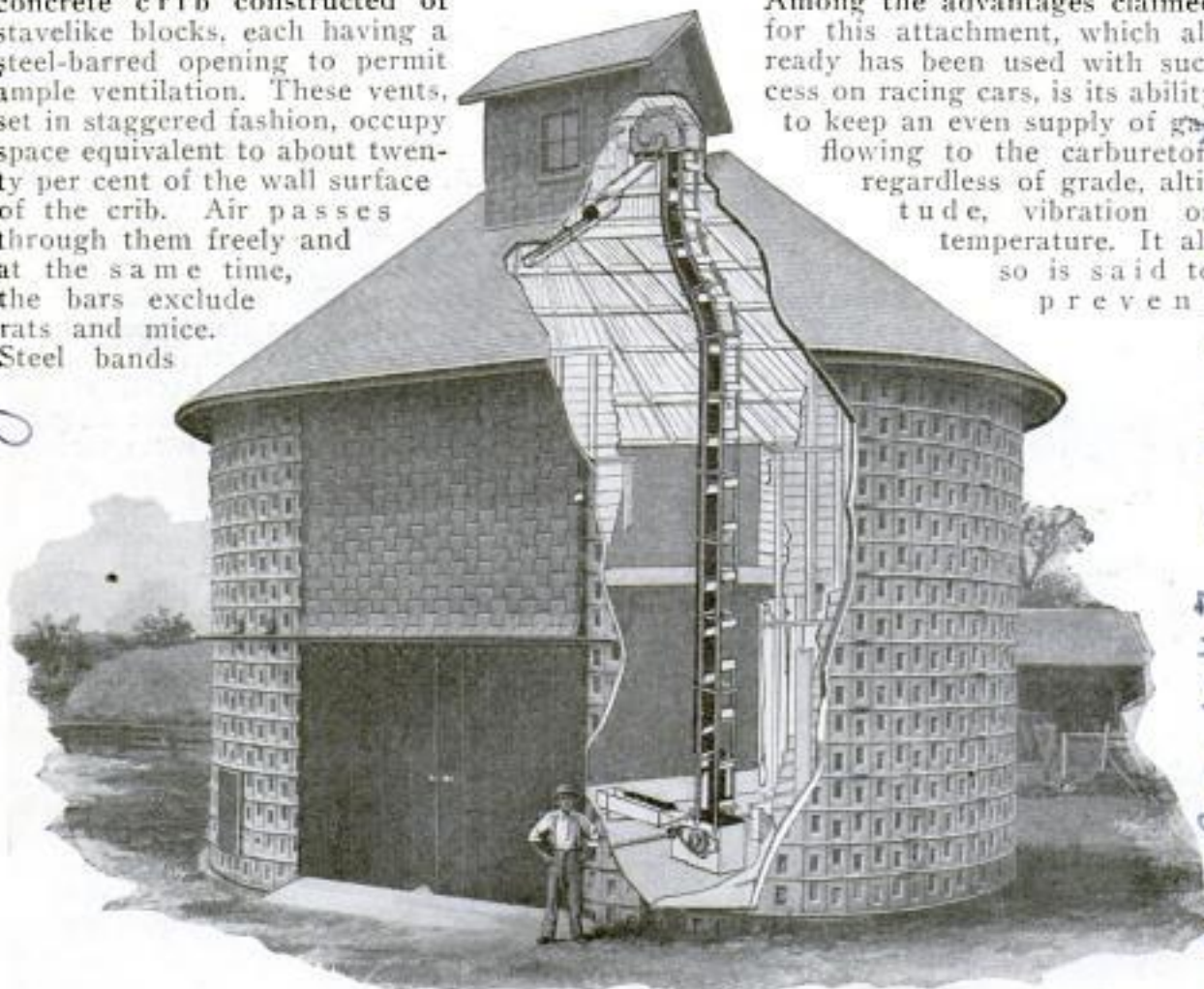

This Concrete Corn Crib Has Openings in the Blocks to Allow Ventilation; Steel Bars in Openings Prevent Entrance of Rodents, and a Chainless Lift for the Grain Simplifies Filling

surround the walls, to afford added strength and rigidity, and a chainless lift carries the grain to the bins.

MAGNET FUEL PUMP FOR AUTO INSURES CONSTANT SUPPLY

Vacuum, gravity and air-pressure fuel-supply installations in use on motor vehicles, may be replaced or supplemented by a small pump operated by the battery current and controlled by the ignition switch. It may be installed even by unskilled persons in the supply pipe at any convenient location except in proximity



flooding the engine, reduce crankcase dilution, especially in mountain driving when the engine is used as a brake, and to automatically expose a faulty feed line, for if there is an air leak, the pump makes a peculiar noise as a warning. The regular capacity of a single unit is eight gallons an hour, but twelve gallons may be pumped in an emergency. More than one pump may be installed on larger engines.

SUNFLOWER DIET FOR CATTLE

Sunflower seeds have developed into an important silage crop in Canada, where the seeds are used as cattle feed. Last year Alberta produced a sunflower crop of nearly 200,000 tons, the largest ever recorded. The seeds are declared to be the cheapest fodder crop ever harvested.

Ireland & Matthews Mfg. Co
1500 Beard Ave. Detroit, Mich

7/24/25

TRIPLE FARM-LABOR CAPACITY WITH MODERN MACHINES 146

With the aid of modern machines, farmers are now able to till three times as much soil as they did seventy-five years ago, a government survey shows. It was not until within the last decade that the small gasoline tractor, auto truck and electric power came into agricultural importance. Farm and labor together account for approximately sixty per cent of the total cost of farming, and a better knowledge of the power requirements of farm operations and the adoption of more efficient types of power units will do much to cut down production costs, it is pointed out. Colleges are now studying how to increase the speed of farm tools by improving shapes and methods. One university has found that an ensilage cutter can be run at a saving of fifty per cent in power by use of proper speeds and an improved blower. Three billion dollars are expended yearly for animal and mechanical power for American farms and the total power used reaches about 16,000,000,000 horsepower-hours.

10 4

AUTO AS STARTER FOR PLANES SAVES HAND LABOR

When airplane motors "stall" on an English flying field, a small automobile fitted with a cranking attachment speeds to the ship, giving the propeller the turns that generally start the engine. The propeller shaft is actuated by a chain gear driven by the motor of the auto. This is quickly adjusted to the plane by means of an extension clutch and not only saves the difficult and sometimes dangerous work of starting the blade by hand but shortens delays.

TAIL LAMP FOR SADDLE HORSES. PROPOSED FOR SAFETY 13 7

When the suggestion was made in Chicago that saddle horses be equipped with



Autogram

Rider Wearing Battery Lamp as Tail Light for Horse

tail lights for safety on the park bridle paths after dark, the question arose as to how the lamp could be attached. An eastern inventor proposed as the simplest solution that the rider might carry a battery and a bulb in a small box strapped across the chest and arranged to rest close to the horse just back of the saddle. A glass-covered compartment holds the light so that it will be in plain view of riders or vehicles approaching from the rear.



Preparing to Start an Airplane Motor with Cranking Arm on Light Auto. Shaft Is Turned by Chain Drive Geared to Engine and Is Regulated by Driver

Used at Great Round Britain Air Race

King's cups.

Still Unchanged in a Changing World



Left, Bullock Cart with Its Slow but Certain Steed, Serves as a Thirteen - Passenger "Roadster" When Children in India Want a Pleasure Ride

Below, the Donkey Helps Take a Family of Albanian Turks for an Outing: True to the Custom of the Harem, the Woman Keeps Her Face Covered When Abroad

© Keystone



Many Trappers in Alaska and Other Far Northern Fields, Find the Reindeer Teams and Sleds Ideal for Travel over the Snows as They Are Faster than Dogs



© Keystone

Though Albania Is Progressing in Many Other Lines, Many Natives Cling to the Domestic Buffalo as a Source of Motive Power; the Beasts Are Slow but Strong and Steady, and the Driver Controls His Team with His Voice and a Short, Sharp Stick



Joy Riders at the Outposts of Civilization



When Indian Princes Travel, the Splendor of Their Elephant Cars Attracts Wide Attention; Gaudy Trappings Cover the Beasts, Their Tusks Are Decorated by Artists, and the Whole Turnout Sparkles with Its Rich Display of Wealth; Left, a Ceylon Messenger Boy with a Load That's All in the Day's Work, for They Can Easily Carry Packages Twice Their Own Weight



The Ornate Zulu's Rickshaw at Right Is for Europeans Only; Below, a Camel Train in South Australia Hauling a Load of Wheat to the North



Four in One Camp Equipment Co,
1601 Second Ave.

628

POPULAR MECHANICS

Rock Island, Ill.



From Top to Bottom, Outfit Used as Luggage Carrier,
Table, Bed and Tent Support

61 AUTO CAMP OUTFIT COMBINES FOUR ARTICLES IN ONE

Luggage carrier, double bed, table and a couch that may be used away from the car are combined in a convenient unit that fits the auto running board, is easily set up and taken apart, and is strongly constructed. As a baggage rack, the attachment is clamped to the board, the sidepiece of sheet steel being high enough to form a deep pocket for the luggage and strong enough to support heavy loads. This piece becomes one end of the bed when the carrier is pulled out

and is also the table top. It is large enough for serving six persons. Angle-iron legs, with clamp hooks for holding kettles, support it. By driving stakes in the ground and clamping the bed to them, the canvas strip that serves as a mattress and its row of coiled springs at one end, can be used independently of the car. The outfit is also used as a tent support.

136

WOMEN IN INDUSTRY INCREASE

Twenty-three out of every 100 women and girls over fifteen years old are employed in gainful occupations, according to an analysis of census figures by the women's bureau of the department of labor. The number increased from 3,750,000 in 1890 to 8,250,000 in 1920, the greatest gain being shown in "typical city industry," such as factories, trade and clerical occupations. Wages and working hours are not yet on a par with those of men in the same fields, according to the report, which also shows that the majority of women in a number of states work more than forty-eight hours a week. Ten of the thirteen states included in the bureau's survey allowed more than one-half of the working women to labor longer than eight hours a day.

Christian Science Monitor 7/23/20
CLIPS FASTENED TO SHOE TOPS

2292 KEEP RUBBERS ON

With a simple and quickly adjusted gripping device now on the market, rubber galoshes can be held securely on in spite of mud or loose fits. It consists of a metal hook that slips over the top of the shoe at the rear and holds a spring-jaw gripper which is fastened directly to the rubber. There is a tape connection between the two metal parts that may be taken up to insure a tight hold when wear on the rubber shortens the distance. The attachment is inconspicuous and saves the unpleasant task of adjusting muddy rubbers while walking.



Names and addresses of manufacturers of articles described in this magazine will be furnished free by our Bureau of Information.

*Renel S. Olave,
Rutland, Vt.*

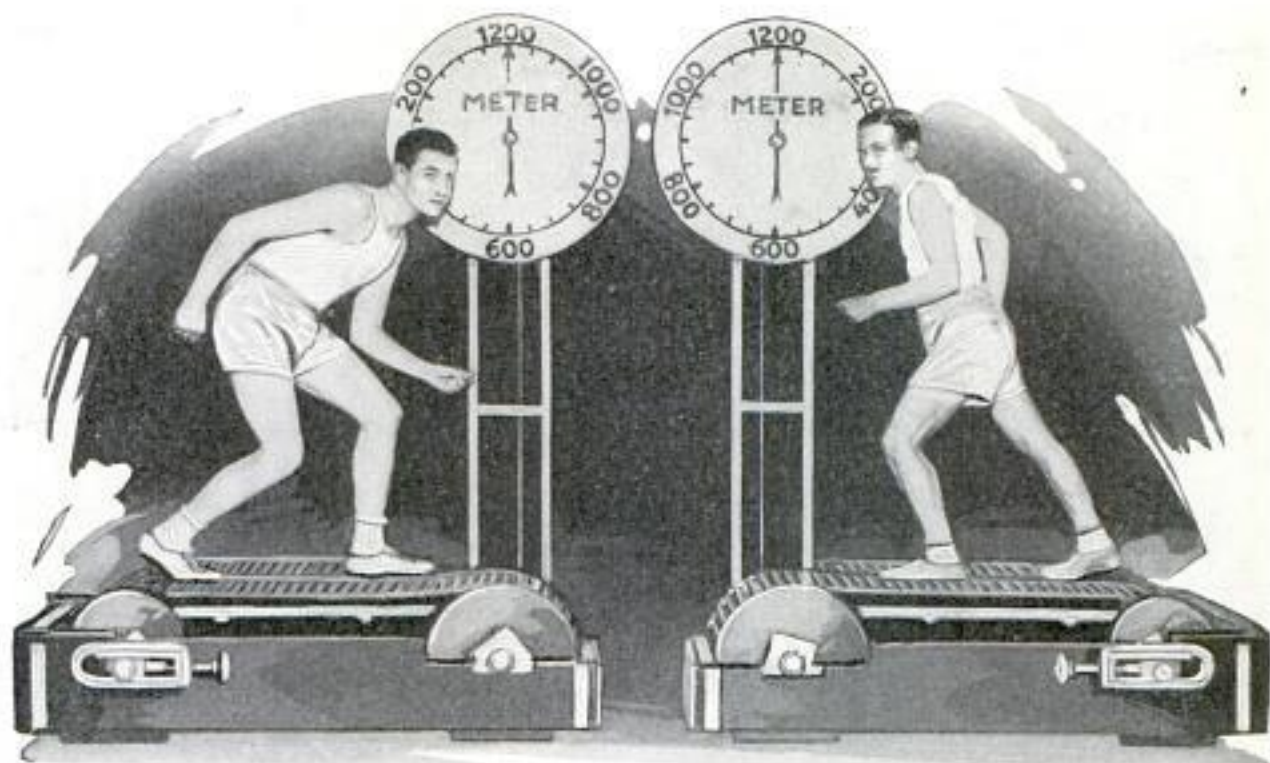

© Kerstons

Treadmill Walkers Performing for Circus Crowds; Distance Is Ticked Off on Big Dials Geared to Rollers

**WALKING RACE ON TREADMILLS
 ADDS TO CIRCUS THRILLS**

Long-distance walking competitions on treadmills, geared to meters which show how far the contestants have gone, furnish spectators at a circus in Berlin a novel diversion from the usual entertainment features. The dials can be seen plainly, and the arrows give the relative "position" of the performers.

82
 74

**FOLDING BOX FIVE YEARS OLD
 STILL IN SERVICE**

A collapsible packing box and an egg crate devised by a Washington inventor, have been in service five years and are said to be still in good condition. The larger container, extended, has a depth of seventeen inches, but folds to a height of six and one-fourth inches, while the crate, a foot deep when adjusted for filling, collapses to a depth of four inches. Besides saving valuable shipping space,



Packing Box and Crate Used for Five Years

boxes such as these have proved an important factor in conservation of lumber.

**GIRLS TAUGHT ELECTRIC TERMS
 TO AID HOUSEWORK**

Domestic-science teachers are training their girl and women students in the simpler electrical terms in order to help them to understand what they buy when they order a new instrument for the home, and what the cost of power will be. When the installation man tells you that the new range will cost three cents a kilowatt-hour for your cooking, he means that electrical units are called "watts" and "kilowatt" means a thousand of them. "Voltage" means the force required to send electricity into the kitchen and is as important to know as the watts. Quantity of electricity is expressed in "amperes," the flow through the wires being expressed as so many amperes a second, just as one describes the water flow as so many gallons a minute.

Kansas City Star 7/24/25

*Adolph Von Schlaenbach
 Washington, D.C.*

3054 Arunah Ave

Edw. Nelson Edwards
630 Baltimore Md.

POPULAR MECHANICS

to be built by
Dr. M. J. Kelly,
Franklin Co.
together with
TOLL BRIDGE SIX MILES LONG
TO CROSS FLORIDA BAY



Spring Motor Concealed in Bag Cranks Small Motion-Picture Camera through Flexible Shaft

13 **MOVIE CAMERA IS CRANKED BY MOTOR IN BAG**

Cranked by a small spring motor held in a bag slung from the operator's shoulder, a new motion-picture camera is almost small enough to be called pocket size. A flexible driveshaft allows use of the machine at almost any angle. Due to the light weight and a handle like that of a saw, there is no need for a tripod, the camera being rested on one palm and steadied with the other hand.

138 **THE WORLD'S BIRD POPULATION**

Statistics gathered by the department of agriculture indicate that the total bird population of the world is approximately 75,000,000,000 or about forty times the number of human beings. Records showed that there are an average of approximately 224 birds for every hundred acres of land. On this basis, the bureau of biological survey estimated that in the northeastern and central states of America, there are 82,660,089 robins, 69,300,883 English sparrows, 50,514,499 song sparrows, 33,815,491 catbirds and 22,126,185 bluebirds. Nine species in all, made a total of 364,455,847, while the other kinds swelled this figure to 1,052,722,161, the estimated number for that part of the United States, or about a fifth of the whole bird population for this country.

Bureau of Biological Survey, U. S. Dept. of Agriculture

88 **TOOL TACKS AND STRETCHES SCREENS QUICKLY**

Screen cloth is attached to the frames and stretched at the same time by a combination tool provided with removable steel claws for drawing the mesh into position for the insertion of a staple which is driven in by a plunger. When it is desired to use the implement on plain work, the claws may be taken off. The tacker holds a magazine consisting of seventy-seven staples joined together in one strip,

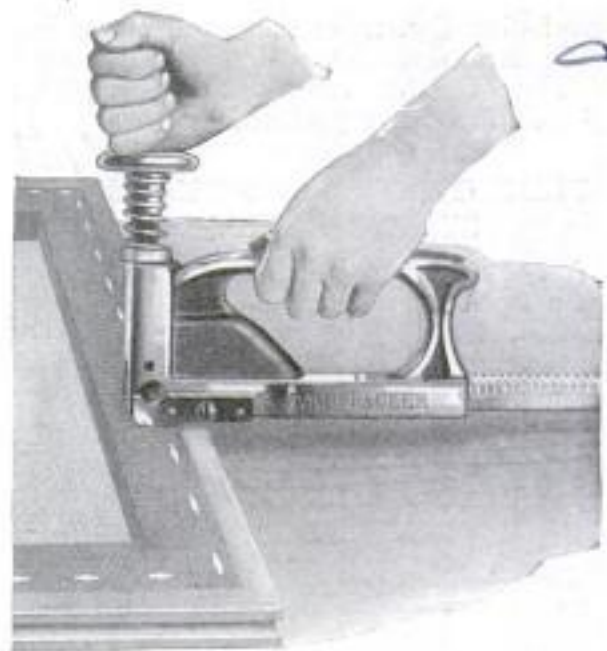

Screen Stapler and Stretcher in Operation; the Teeth That Grip and Mesh Are under the Plunger

preventing waste and saving time in re-loading. The outfit weighs less than two pounds, may be carried in the hip pocket and will withstand heavy usage.

J. O. Crofoot Co.
Arlington Va

C. A. P. Properties, Inc. de Javelle
Copyrighted Material
Oct 11

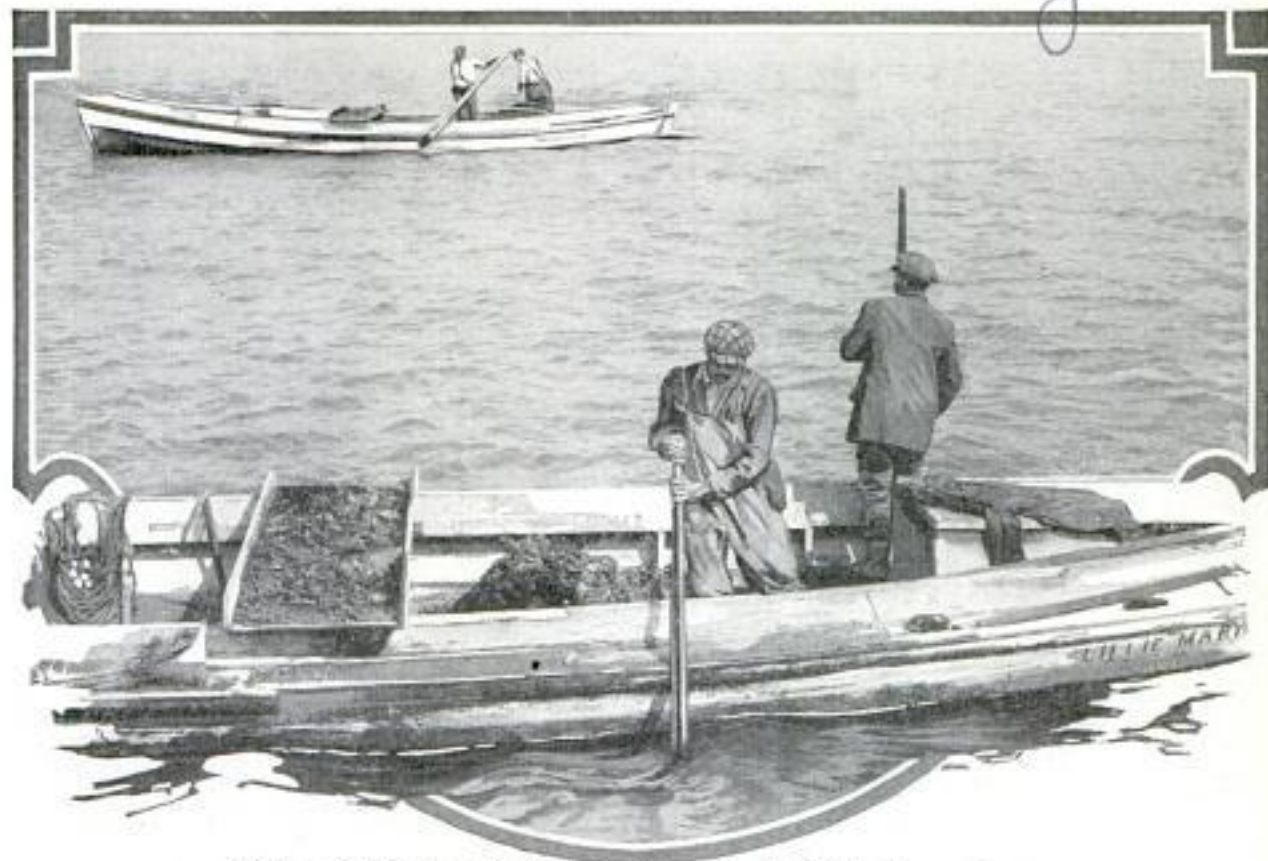

Lifting and Emptying the Grappling Tongs Used to Catch Parent Oysters

Hatching Oysters in Incubators

BY devising a way to propagate shellfish, science probably has saved the oyster from extinction. Due to the march of modern industry and the serious inroads of natural enemies, oyster culture, the most valuable fishery on the Atlantic seaboard, with an output estimated at \$16,000,000 and providing employment to 65,000 people, has been falling off.

During the summer months the mother oyster lays its eggs. Nature has provided each one with 16,000,000 eggs. Of that number, however, not more than a few hundred survive under the best conditions, and only one out of the entire lot lives long enough to reach the consumer's table.

The eggs grow into tiny, clamlike forms provided with a propeller with which they swim around. Within perhaps fifteen days they cease swimming and "set," that is, they attach themselves to some hard clean surface such as a rock or a post. Then they have nothing more to do except to breathe, eat and grow. Those that fall upon a soft muddy bottom are smothered. The infant oyster, so tiny that the human eye cannot see it without the aid of a powerful microscope, faces a continual battle for life. Larger organisms feed on it, and it must struggle with tides, waves and

winds, which carry myriads of them out to sea.

It was an American scientist, Prof. W. K. Brooks, of Johns Hopkins university, who discovered that artificial propagation of the oyster was possible. He was followed by William F. Wells, of New York, who, for an entire year, lived on a lonely fishermen's island with oysters for company. Thus he learned their habits and hit upon a means of prolonging their existence.

At the oyster hatchery that serves as a laboratory for Mr. Wells, the oyster eggs are gathered and placed in glass jars with clarified water. After being fertilized, they rise to the surface, when it becomes easy to siphon them off into large stone crocks. Later they are placed in a device like a cream separator which revolves 7,000 times a minute. After several minutes, the tiny oysters that have clung to the sides of the revolving bowl are removed through rinsing. It is necessary to take the word of the expert that there are oysters in the water, however, for to the naked eye, not even the smallest speck is visible. According to Mr. Wells, hundreds of thousands of these baby oysters, if not a million, could be contained in a tablespoon of water.

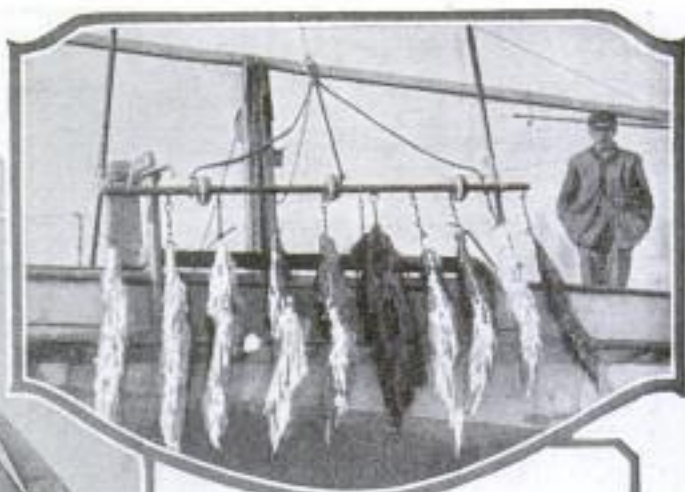

Mop of Twisted Rope Yarn to Snare the Starfish That Destroy Oysters; When Caught, They Are Killed in Vats of Boiling Water



On Board an Oyster Boat, Showing Hand Dredge and Winch in Operation; Sailing Craft Still Serve the Fishermen along the Atlantic Coast

As in Other Kinds of Fishing, the Motorboat Is Coming into Prominence to Help in Gathering the Annual Sixteen-Million-Dollar Oyster Catch

3239

This is only the first step of the oyster's long journey to the consumer. In about four weeks the oysters are old enough to set. They then will attach themselves to a surface on which they can stay and begin to grow. So, early each summer the oyster planter tows large scowloads of old shells to sea and then scatters them in a level layer where the young oysters may be allowed to grow to adult size, which requires about four years in New England waters and two years in the warm waters of the Gulf of Mexico.

The "oyster farmer" leases his "grounds" from the particular state on which they may abut. The fisherman who wishes to plant shells or seed pays a rental of from one to ten dollars per acre a year, or a tax. Stakes or buoys mark the boundary lines of each farm, and state police boats patrol the waters to protect the fields from being molested or robbed.

After the oyster grower has put down the shells and secured a good set of young oysters, he often finds

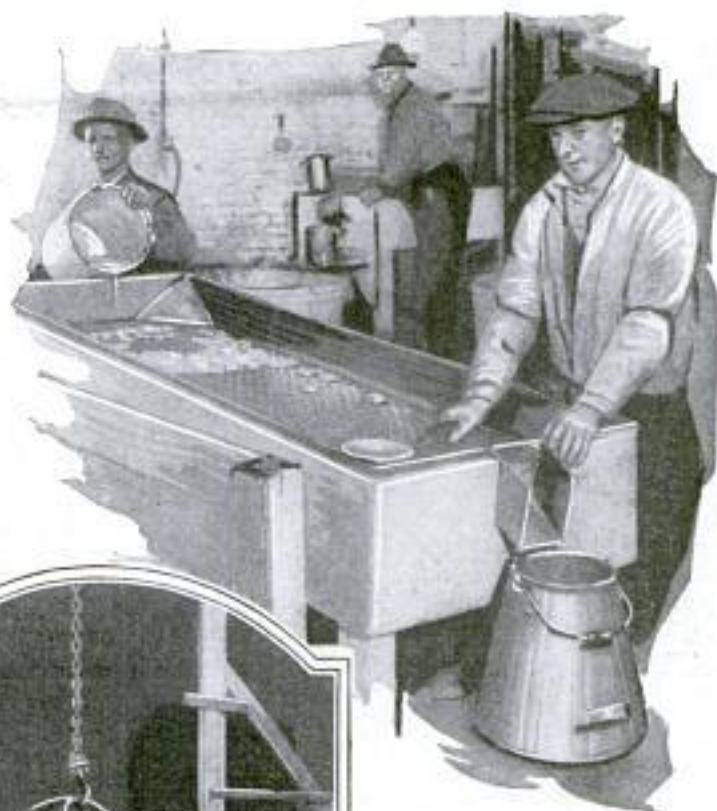

that he has but offered a new haven for various kinds of worthless, hungry loafers of the sea, which fall upon the oysters and devour them in great numbers. Fully ninety-nine per cent of the oysters produced in the United States are harvested on the Atlantic coast.



Steps in the Oyster's Journey from Sea to Stew; Above, Washing Fresh Meats on Skimming Board; Center, Basket of Canned Oysters Ready for Steaming, and Below, Labeling and Boxing Cans

National Electric Mfg. Co.
Chatfield Woods Bldg
Pittsburgh, Pa.

Bradford
Municipal
Corp.

634



Boring Hole in Concrete Ceiling with Overhead Electric Drill on Telescoping-Tube Support

131

CEILING DRILL FOR CONCRETE SAVES TIME AND WORK

How to drill holes economically in concrete is one of the problems that this form of construction has created. As a solution, an electric drill now on the market, bores openings overhead while the operator stands on the floor below. The tool is held in place by means of adjustable telescoping pieces of steel tubing and handles are provided at a convenient working height so that the operator can turn the drill. A coil spring below the telescoping joints provides the necessary pressure to make the bit take hold. The motor is controlled from below.

MELT AUTO TIRES FOR ROADS OF RUBBER IN ENGLAND

Discarded auto truck tires, shredded and melted, are being used to make rubber roads in Bradford, England. Blocks cut from the tires were tried first but it was found difficult to keep them in place. Then it was decided to melt the tires, after cutting them to bits. A secret solvent is added to the bits of rubber and the whole is oiled. Then it is poured, nearly three inches thick, over the concrete surface. Wooden trowels, coated with clay to prevent sticking, press the material flat and then it is smoothed with a heavy hot roller. It is said the cost of the material is offset by money obtained from the sale of steel bands inside the tires.

133 HOT AIR AS A POLISHER

Just as sand blast is used to smooth and polish various surfaces, a current of hot air, applied with tremendous velocity, gives metal a brilliant luster. Articles to be treated are placed in a basket in a centrifugal apparatus that whirls them at high speed. As they turn, a blast of heated air is blown in through a pipe. A high polish is said to be obtained in a few moments. Nickelplated objects which have become tarnished are made bright in little time. The only precaution necessary is to pack the articles in the basket so that the air will strike them on all sides.

no information

SIX-WHEELED BUS FOR RIOTS HOLDS THIRTY-TWO MEN

129

When riots occur in Dresden, Germany, a six-wheeled motor bus, seating thirty-two policemen, is driven to the scene. The vehicle has balloon tires and a four-wheel drive, and is said to be capable of great speed. The police are trained to enter and leave the bus in military order to save time and confusion.

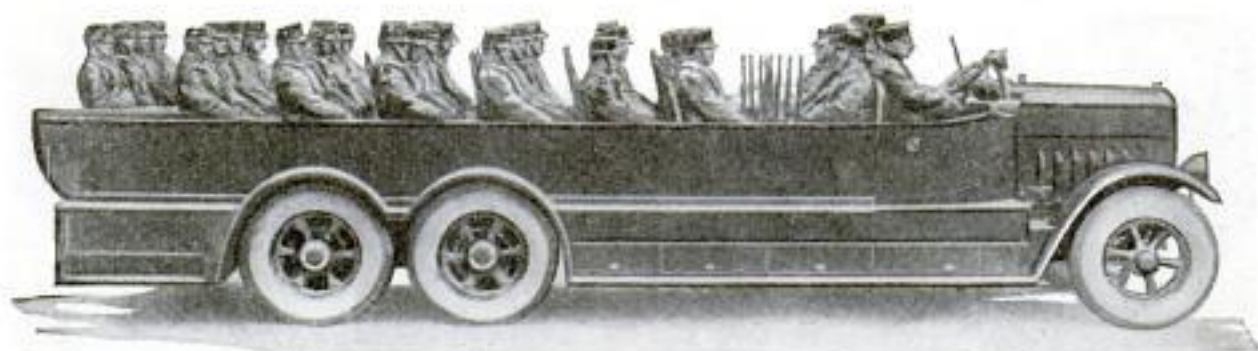

Six-Wheeled Motor Riot Car for Service in Germany, Loaded with Thirty-Two Policemen besides the Driver: Seats Hold Four Each, Preserving Military Order While Traveling

28 Scientific & International
 Research Corp. 111 Fifth Ave
 The World's Most Wonderful Power Plant
 New York

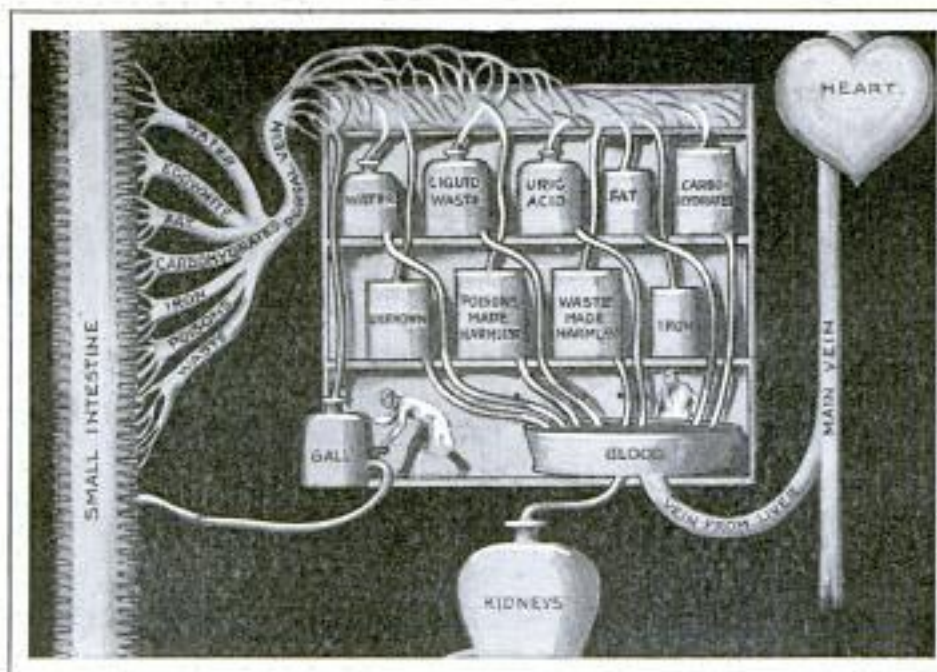
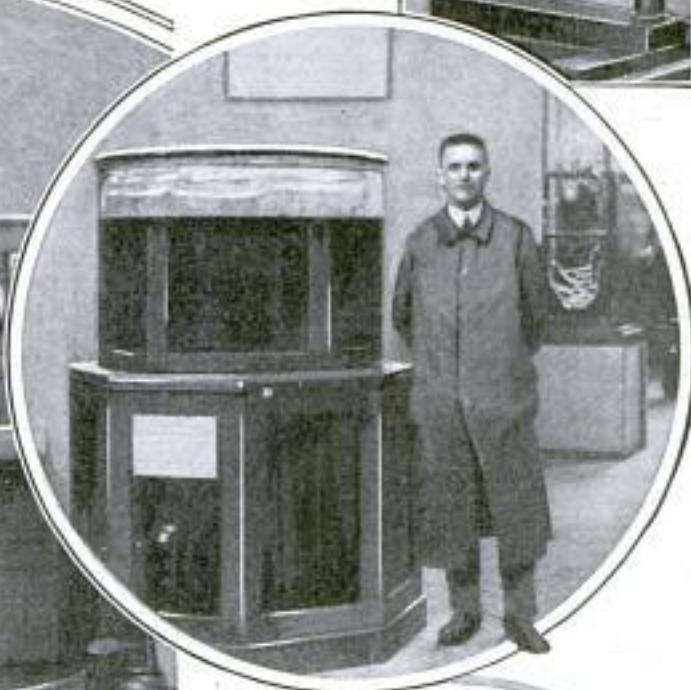
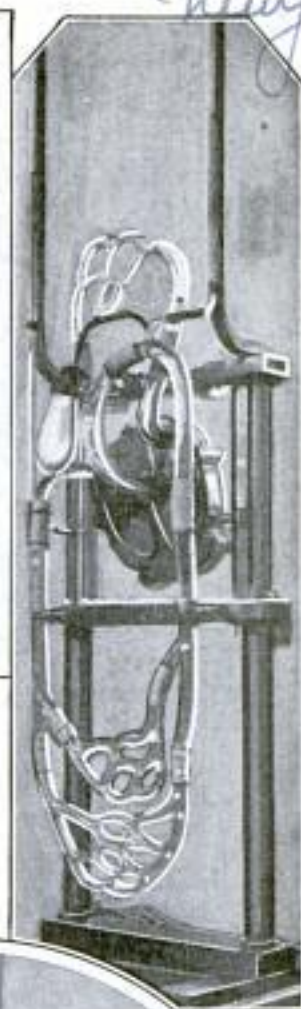

Diagram of Human Liver, the Chemical Laboratory Which Changes Foodstuffs into Substances Usable in Nature's Marvellous Plant, Showing Products and Disposal; Right, Model of Circulatory System Which Forces Red Liquid through Tubes Just As Heart Sends Out Blood



Every Half Hour, the Heart Pumps Enough Blood to Fill the Huge Glass Container Above; at Left, is an Exhibit Illustrating the Amount of Food Consumed by Average Person in One Year

U.S. Machine Agency

636 416 E. 69th CHICAGO

Anderson + Hackett, 111 N. Olive St. Los Angeles, Calif.

COMBINED DRILL AND LATHE HELPS RADIO BUILDER

For the fan who likes to build his own radio sets, a combination hand drill and lathe that clamps to the workbench,

STEERING POST REGISTRY CARD HELPS OBEY AUTO LAW

To help comply with a law in many states that the auto-registration card must be in sight at all times, often impossible when a closed car is locked and the card is under the dash,

a holder for fastening it to the steering post, under the wheel, has been put on the market. An aluminum frame in which the card is placed, under a celluloid sheet, is bent around the post, then tied with a strip of aluminum whose ends are bolted together. The inquiring policeman may see the card through the windshield, if need be.

94

Out of business 2/20/26

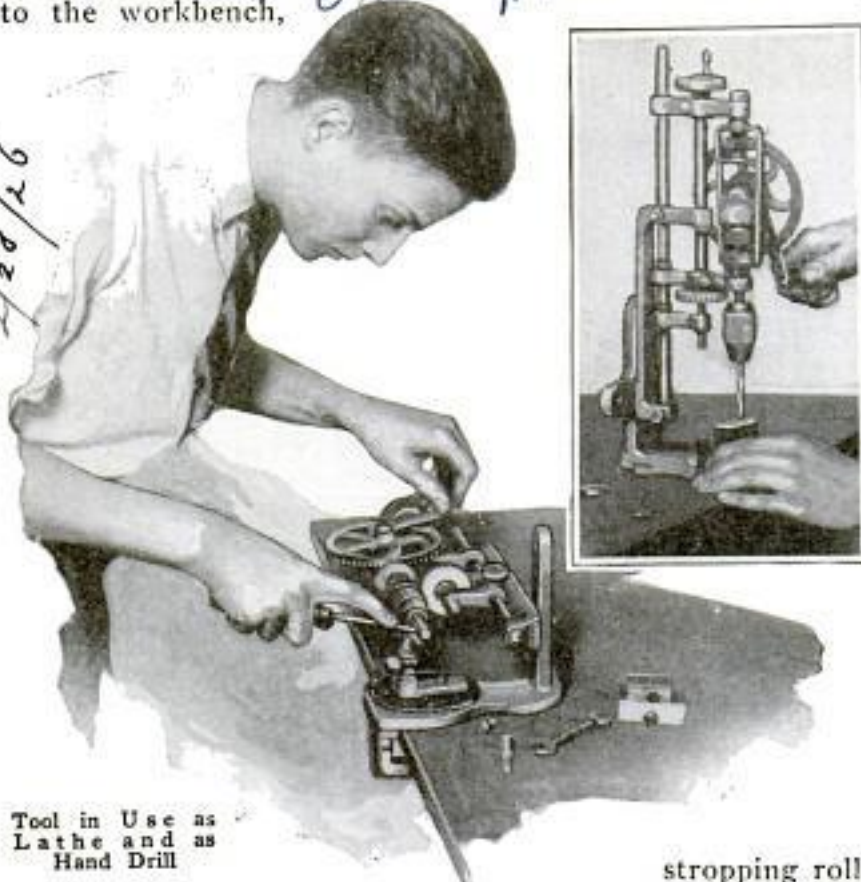

Tool in Use as Lathe and as Hand Drill



122 SELF-SHARPENING SAFETY RAZOR

Simply by rolling it over the hand or a table, a safety razor now on the market, is said to be sharpened quickly and thoroughly. Back of the cutting edge is a small

has many uses and is so compact that it will fit in almost any tool kit or can easily be carried. As a drill, it is high enough for working on large cylinders for coils and deep enough to drill panels for radio sets. It is fitted with two screw-feed wheels, one for feeding and quick return and the other for sensitive drilling. By shifting another screw, the drill is turned to a horizontal position where it can be locked and used as a hand lathe for light turning, grinding, coil winding, filing and fitting parts, and many other purposes. If desired, the drill may be tipped at an angle for special work, or the frame may be detached from the base, and with suitable handles, which are provided, may be used as a portable drilling outfit for repairing automobile fenders, boring holes in walls or partitions, or other tasks where a hand or breast drill is needed.

stopping roller, or hone, fixed to a shaft which is geared to the blade holder in such a way that the blade is reversed with each change of direction and the amount of pressure of the blade against the roller is regulated. A latch at the base of the handle locks the blade in position for shaving after it has been sharpened.

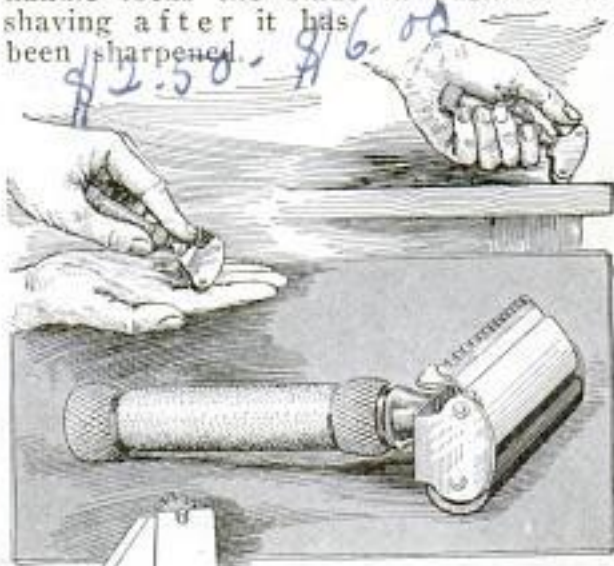

\$12.50 - \$16.00

It costs approximately \$40,000 to operate the steamer "Majestic" on a single round trip between Southampton and New York. The vessel consumes about 11,000 tons of oil in the 6,400 miles.

Razor Complete, Geared Blade, and How It Is Sharpened by Drawing It over Hand or Table

Paul Cook & Sons Co., Everett, Wash.

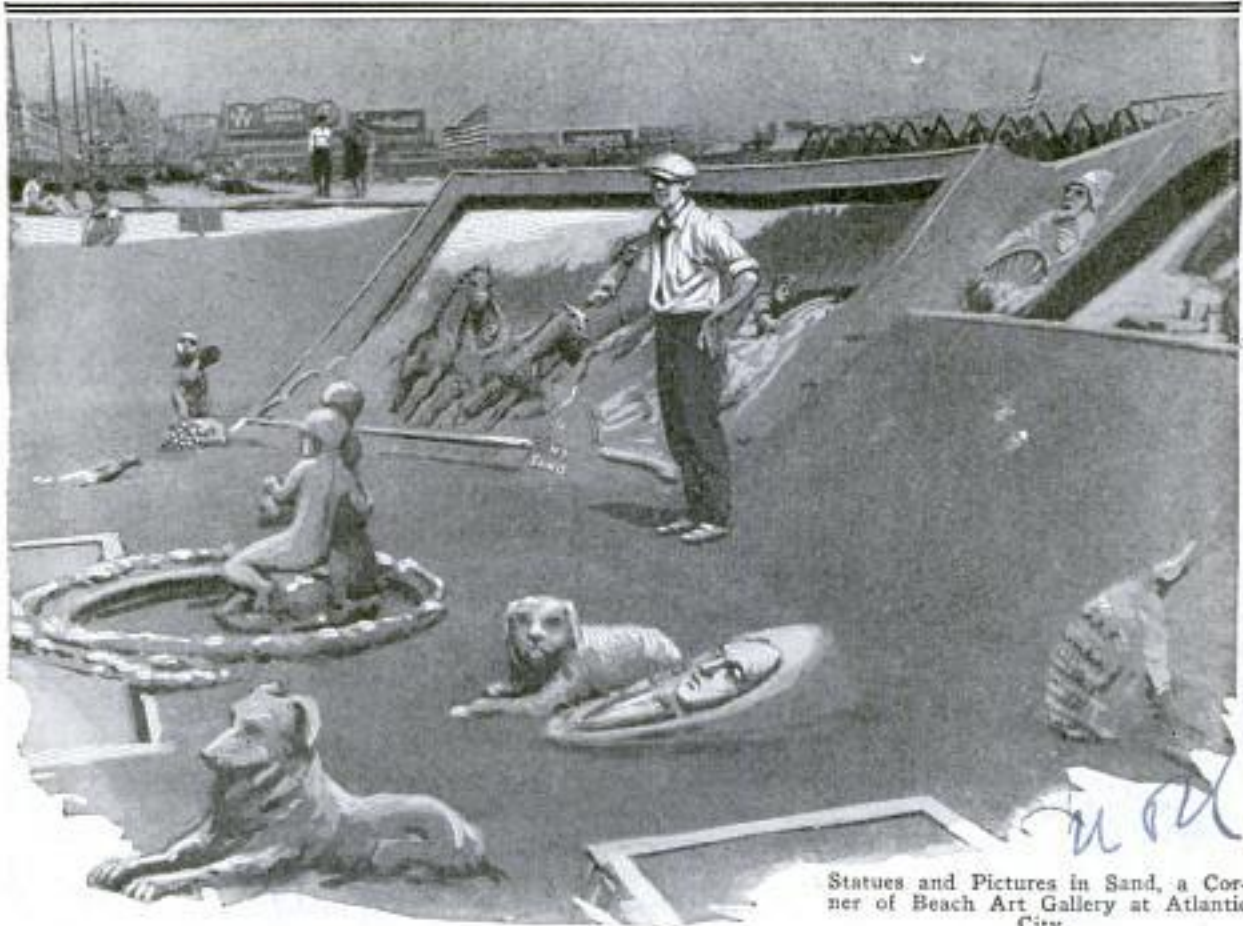

Statues and Pictures in Sand, a Corner of Beach Art Gallery at Atlantic City

ART GALLERY MODELED IN SAND IS NOVELTY AT BEACH

What skill and patience can do with as simple a medium as sand was illustrated in the art gallery fashioned on the beach at Atlantic City. Reproductions of famous paintings were molded in relief with a "frame" of sand about them, statues, masks, figures of animals and bas-reliefs of wide variety being included in the collection, which was displayed in the open-

QUEER HARPS MADE TO ANSWER NEEDS OF MODERN MUSIC

Demands of the jazz era for novelty in music have brought forth two new instruments to add to thousands invented since the first drum—a hollow tree—was beaten by a shinbone. These are the "mandolin-arpa," a miniature harp arising from the neck of a mandolin with scroll-like edges, and the "swinging harp," now being played for the radio. The latter is said to have a liquid tone resembling chimes. Odd devices are not limited to modern days. Cuckoo clocks long ago were used in opera, and one composer wrote a part for a sewing machine. Grotesque fiddles and pianos were in demand during the last century, and Handel is said to have

expressed a desire to introduce a cannon report in one of his scores. The present-day zenith was reached recently in a New York concert in Carnegie hall when a pistol shot was used to emphasize a bit of jazz. A machinist makes a good salary playing a handsaw on the stage. 240

SWIVEL-END SOLDERING IRON REACHES DIFFICULT PLACES

Soldering in difficult places is simplified with an electric iron, supplied with current from a wall socket, that has a swivel point adjustable to any angle up to forty-five degrees. It is said to be well adapted



Iron with Swivel Point That Simplifies Soldering in Corners and Other Spots Hard to Reach

for use in building radio sets, has a heating element that has been constructed to resist burning out, and is also equipped with a straight point with two interchangeable threaded tips.

New York Times 7/19/25

Ch. W. Lina Pagani, Milan, Italy
Ch. W. C. H. Longbottom

Ward Mfg. Co. 937 Wellington Ave. Chicago

Time and Money-Saving Tools

32999



Spring-Wire Egg Holder Curves Inward to Afford Firm Grip, Permits Easy Insertion and Has Feet at the Bottom for Stability

© C. A. Oldroyd

Darning Ball of Rubber Will Not Break or Dull the Needle and Prevents Injury to the Fingers Besides Being Easy to Handle



Electric Ironer Does Quick and Accurate Work and Folds Up Out of the Way When Not in Use



Combination Window Lock and Bell Burglar Alarm Is Easily Fitted to the Sash by Means of Gripping Jaws



White - Enamel Griddle Greaser with Removable Wick



Bottom for Kettles to Prevent Burning Is Adjustable to Different Sizes



Right, Two Tables in One from This Article with Adjustable Top Give Space for Eight Diners



Left, Electric Candlestick Lights Up Only When Lifted



Anyone wishing further information on devices described in the editorial pages can

3299

for Woman's Workshop in Home



Little Disk Inserted Before Paraffin Is Poured on Jelly Aids in Removing the Covering and Does Not Disturb Contents of Glass

These Curtain Rings Roll on Top of the Rod, Are Quickly Adjusted Like Spring Clamps, and Prevent Wear on Hangings

© C. A. Oldroyd



Food Grater with Sanitary Glass-Topped Hopper Prevents Injury to Fingers and Keeps Material Pressed against Blades, Saving Time and Labor



Handy Scourer Cleans and Sharpens Knives at the Same Time

Rubber Sleeve Protector Is Quickly Slipped On and Can Be Washed with Hot Water and Soap



Right, Easily Operated Can Opener Removes Tops from Square as Well as Round or Oval Containers by Turning the Finger Screw

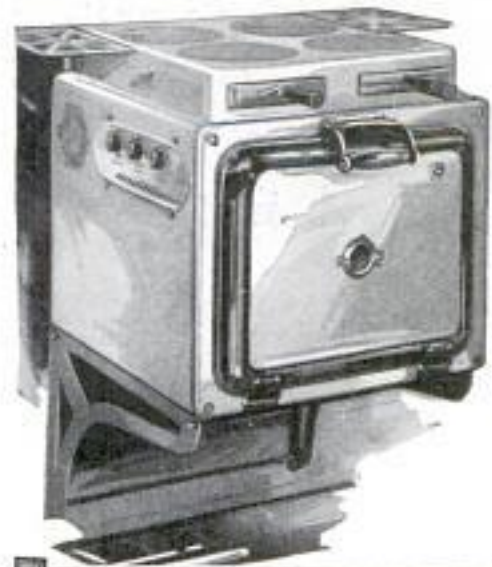

This Compact, Lightweight Electric Range Has No Legs, But Is Supported on a Wall Bracket



Wire Holder for the Paintbrushes Helps Keep Handles and Bristles in Good Condition

obtain it by addressing Bureau of Information, Popular Mechanics Magazine, Chicago.

Varnum Door Engine Co.,
 640 949 W. 16th St
 3452 Los Angeles Calif

POPULAR MECHANICS



Gates Opening as Release Is Unlocked at Entrance to Grounds, and View of Motor Mechanism Showing How It Is Geared to the Gate Support

d. w. George B.
 Varnum

DOORS ARE OPENED AND CLOSED BY ELECTRIC MOTOR

Greater security and convenience are sought in opening and closing heavy steel doors in banks and big gates at entrances to public or private grounds through an electric installation now on the market. For driveway gates, contact of a master key in a lock switch completes a circuit through a mechanism geared to the gates and set in a pit where it is protected from water. The barriers close when an auto or other vehicle passes over blades that project from the roadway. If desired, a telephone may be installed outside the grounds near the entrance by which guests can announce themselves and receive admission when the switch at the house is turned. The gates open automatically to outgoing vehicles by means of a trigger arrangement set in the drive.

CONQUER GREAT ODDS ON TRIP TO TOP OF MT. LOGAN

Fighting their way back to civilization through 150 miles of virgin territory, a third of which was traversed with the aid of ropes, a party of six adventurers has returned after gaining the summit of Alaska's Everest, Mt. Logan, 19,580 feet above sea level. Because of its formidable natural barriers, the peak has been considered second only to the Himalayan mountain in point of danger and difficulty. Months were devoted to preparation for the exploit. One member of the group was forced to descend after he had climbed

led by Capt. H. H. McCarthy.

to a height of 19,000 feet because of painful frostbites, but otherwise there were no accidents. Bad weather followed the party on the return trip from the Yukon. Twenty days were required for the homeward journey which led over broken ice and swollen rivers.

LAWN-EDGING TOOL TRIMS SOD WITH UNIFORM GROOVE



To give lawns a spick and span appearance along the walks, an easily operated edger has been devised. It slices the sod with a simple pulling motion, reaches into corners and gives a groove of uniform width and depth. No stooping is necessary.

USEFUL INVENTIONS BY WOMEN LIGHTEN HOUSEHOLD TASKS

Patent-office records both in this country and in England show that women's activities as inventors are increasing and that many of their ideas are directed particularly to better ways of doing things about the home. According to reports from London, two women there are mak-

Associated Counselors
 1st National Bank Bldg
 Chicago

ing a business of inventing and placing their patents on the market. Among the household aids which women have devised are a combination cake knife and server. It is an attachment that may be placed on any knife so that slices of bread or cake can be transferred to a plate without touching the fingers. A workbasket that has a celluloid ring around the top on which are threaded reels of silk and cotton and to which scissors, tape measure and other accessories are attached by hooks, is a woman's solution of the usual tendency of the sewing materials to get into disorder. A folding-lattice drier, secured with rustless nails, may be placed across the top of the clothes horse or between two chairs to support articles of clothing that must be laid flat when drying. This also is a woman's invention and was constructed so that it could be collapsed into small space when not in use. A combination bed and table with a spring mattress concealed underneath an oak top is another device patented by a woman.

54

DASHBOARD MAP ON ROLLER USED WITH ONE HAND

An auto map that can be used with one hand and interieres with steering but little, is attached to a spring roller screwed into the dashboard beneath the instruments. Replacing hand maps, which usually mean stopping the car and having the wind whip and tear the paper, the new chart is framed on two ends, giving it rigidity. To inspect, the driver simply pulls out the roll. The spring returns it to position out of sight, when reading is done. Entering another state, a new map may be inserted readily.



Roller Map Spreads Out Flat for Convenient Reference and Requires Only One Hand

Pathfinder Auto Map Co.
Minneapolis, Minn.

COWBOYS GAINING IN NUMBER BECAUSE OF RODEO NEEDS

Rodeos, or round-ups, for which skilled riders are needed, and the demand for them in motion pictures have resulted in



Cowgirl Demonstrating Her Skill as Rider on Plunging Steer during Competition at a Western Rodeo

an increase in the past few years in the number of cowboys in the United States. During 1925, it is estimated, there were more than 100 round-ups to which the public paid admission. One band of trouping ranch riders even went to Europe and played before the crowned heads and their subjects. The western boy or girl who learns to ride anything on four legs can be fairly certain of well-paid work, even though on the ranches the man with flapping chaps and drooping sombrero is being replaced by a hired helper

with blue overalls and dingy felt hat. "Outlaw" horses, so-called, are also much in demand of late. Owners value them at \$1,200 to \$1,500 and more, but rent instead of selling them. Steer-riding events are popular with the public. Brahma cattle, a wild crossbreed of gentle East Indian beasts and ferocious Mexican animals, are found best for this purpose.

*Regina Shrogin at
mandan, n. d. roundups.*

Nordberg Mfg Co
 Chicago + *Oklahoma Ave.*
 642
 Milwaukee, Wis
POPULAR MECHANICS

MOTOR-DRIVEN TRACK SHIFTER SAVES TIME AND LABOR

30 Easily operated by only one man, a track shifter propelled by a forty-horse-power gasoline motor is said to do the

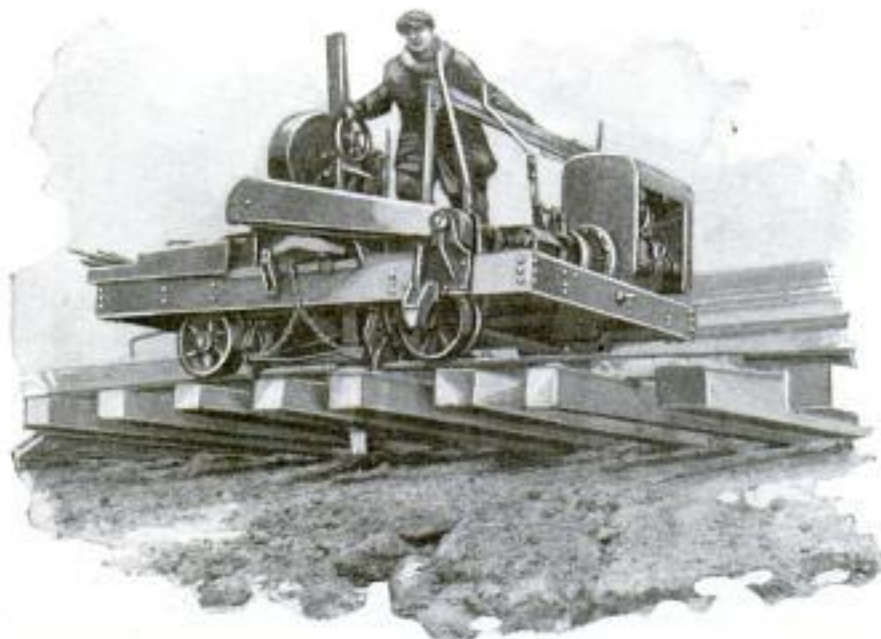

Track Lifter in Operation: Spud Is Set between Rails, and Truck, Clamped to Them, Is Elevated upon It

work of a crew of twelve or more men, and in a fraction of the time. It consists of a powerful lifting apparatus mounted on a truck which can attain a speed of twenty-five miles an hour in going to and from jobs and has space for carrying extra men and equipment. In operation, a spud or foot is lowered to the ground at a point off center between the ties and set at such an angle that when upward force is exerted, the track, which is clamped to the truck, is lifted to one side. The shifter is then moved a few feet ahead and the process repeated until the whole section has been shoved to the desired position. When necessary, the track may be raised directly upward simply by placing the spud midway between the rails. The outfit is intended to reduce traffic delays, save time and cost on construction jobs, and is said to operate successfully even when the ties are frozen to the ground without danger of kinking the rails or bending the tie plates.

64 **MEMORIAL PLANNED FOR HUSKY THAT BORE SERUM TO NOME**

Dog lovers of New York city are planning to erect a memorial to "Balto," the husky that played a leading part in carrying serum to fever-stricken Nome, Alaska. The monument will show the tense figure

Francis D. Ballantine
Commissioner of Parks
Chairman of Committee

of a dog straining to reach a goal against great odds. "Balto's" deed recalls other canine heroes and the remarkable feats they accomplished. Among the most famous of St. Bernard dogs was "Barry,"

who saved forty persons during his ten years of service among Alpine snows. One of the dog's most notable feats was the rescue of a ten-year-old child whom he found in the fatal sleep that precedes death by freezing. "Barry," according to the story told by a monk of the hospice, warmed the victim by his breath, finally made the boy climb on his back and so carried him to safety. A monument has been erected to the memory of "Barry." Another dog hero was "Bob," a Newfoundland, made a member of the humane society of England and recipient of two medals of

honor. When only one year old, "Bob" saved his master from drowning after a shipwreck, and in later years rescued several other persons from similar death and from fire.

3282
DETACHABLE GOLF CLUB GRIP IMPROVES THE STROKE

Easily slipped on the handle of the golf club, a slightly protruding circular grip is said to improve the stroke by permitting greater relaxation of the hands. It acts as a guard to keep the club from slipping so that the player does not



Grip Ring Detached and on Club in Position to Prevent Slipping of Hand

have to clench his fingers so tightly, allowing greater freedom both on long and close shots.

Chicago
W. Washington Blvd.
565
Relax Golf Grip

Who Smokes More— You or Your Fireplace?



1200 Second Ave. S. D.
Minneapolis, Minn.

By ROBERT TAYLOR JONES Architects
Small House Service Bureau

EVERYBODY knows that the place for the smoke from a fireplace is the chimney, and everybody knows also that it does not always go there.

This is a problem seriously interesting to you, if you are going to build a home.

Let us see what makes the smoke come out into the room rather than go up the flue where it belongs.

First let us think of a fireplace as a kind of a masonry cavern made fire-proof so that a fire can be built there with impunity. Now if you run the flue straight up through the roof so that there is no obstruction anywhere, the smoke certainly ought to go up without any question. But, just a minute; suppose the fireplace is only six inches deep;

then the fire itself must come at least to the face of this masonry cavern, and the smoke would just as easily go out into the

room as up the flue. If the fireplace arch is very high with this shallow depth, perhaps all of the smoke would miss the flue. On the other hand, let us suppose that the fireplace is three or four feet in depth and the arch very low. There would then be

no question that all the smoke would go up the flue. Quite evidently the depth and the height of the fireplace have something to do with this matter of final direction of the smoke.

We can state two very simple rules in this connection. First, the minimum open depth of any fireplace from front to back is twenty-one inches. Second, the depth of the fireplace with a masonry throat must be at least two-thirds as great as the height of the

fireplace opening. There you have a very definite way to associate proper sizes for the fireplace. As you raise the height of

Do You Realize

THAT wind velocity has as great an effect on house heating as does temperature.

That, roughly speaking, one mile of additional wind velocity per hour has the same effect as one degree lower temperature.

That weather strips on windows and doors will prevent losses due to the necessary cracks around these openings.

That construction at the eaves and in attic spaces can be easily and cheaply improved to prevent wind losses.

That smaller fuel bills and smaller heating plants will pay for the slight additional costs of construction.

3394

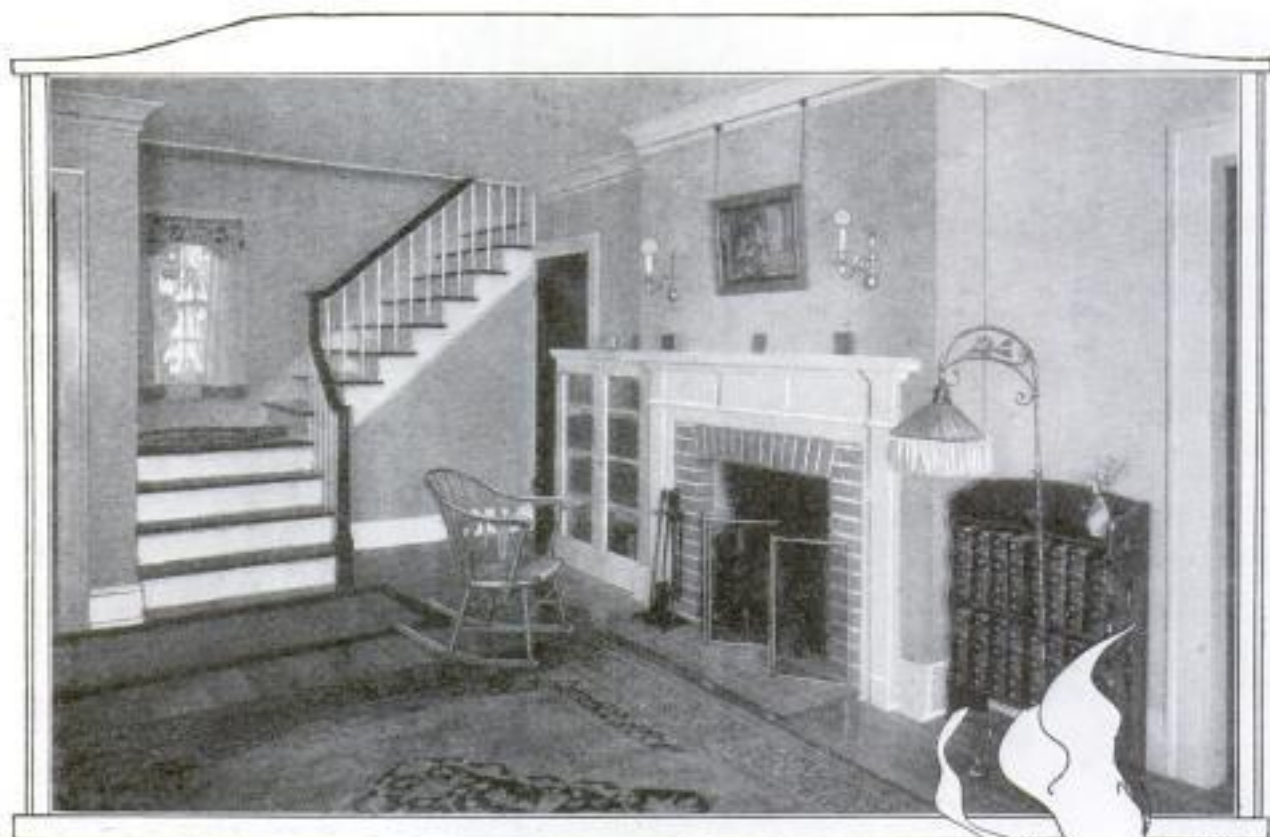

Here is a fireplace that does not smoke, and below is the reason why. Plenty of depth and proper down and up drafts; the fireplace at the right smokes because it is not deep enough.

the opening, you must increase the depth of the hearth. If you have a fireplace large enough to walk into, six feet or more in height, you would require a minimum depth of four feet. If the height is thirty-six inches, then the depth should be at least twenty-four inches. A most excellent rule.

The second consideration is the connection between the fireplace and the flue. If we run the fireplace directly into the flue without the least obstruction, and if all the details are handled properly, all the smoke will go up. But all the heat will go up also. The problem is to get all the smoke out and reflect some of the heat back where you are sitting.

We call the connection between the flue and the fireplace the throat. We baffle the smoke by means of this throat. Some of the heat must go with the smoke to help the smoke rise—to increase the draft. Some of it must be radiated out—therefore the oblique surface opposite the baffle.

Further, this oblique surface, which we may call the roof, ought to go high enough so that the smoke will be thrown against the front arch of the fireplace. You can see how important this is, for if the roof is set at a lower level, the smoke quite certainly will be thrown underneath

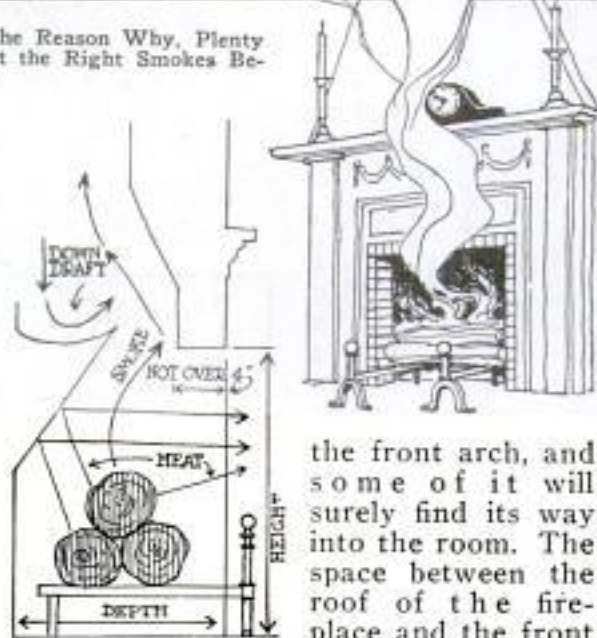

the front arch, and some of it will surely find its way into the room. The space between the roof of the fireplace and the front arch must be so wide that it lets out all the smoke, yet narrow enough to hold some of the heat in. What is the proper dimension? Happily we have another rule to guide us here. It is this. There must be at least sufficient horizontal area in this restricted place, called the throat, to equal one-tenth the area in the front of the fireplace. Thus, if the fireplace is three feet high and four feet wide, you have twelve square feet. One-tenth of this is 1.2 square feet or 172 square inches. If the throat is made as wide as the fireplace, as it should be, and the fireplace is four feet wide, you



Be Sure Your Flue Goes High Enough to Create a Draft, and Remember the Bricks Dropped Down the Inside by a Slovenly Workman Are Worse Than Useless

"TOO MANY BRICKS UP HERE ANY WAY!"



must have a little over three and one-half inches for the depth of the throat to get the required area. Let me say again that this is the minimum. Four inches of depth would be better.

There are several ways to build a flue. Just one of them is right. So you do not have many things to distinguish between in this respect. First, the flue must be as straight as it is possible to make it. Second, engineers have proved that a round stack is better than a square one. A

square one is more efficient than an oblong one. It is not easy to make it round, building as we do with rectangular bricks, so the next best thing is to make it square. There is less friction in a square flue than there is in one that is oblong with the same cross-sectional area. Less friction means better draft, quicker movement of the smoke and a brighter fire. Since this

is true we ought to do everything we can within reason to decrease friction in the flue. One way to do this is to plaster its inner walls with cement mortar as smooth as we can make it. But this plaster may fall off or it may crack. If one of these things happens and an opening is thus afforded to the masonry, then—if the masonry should crack or the mortar fall out of the brick joints—we would have a defective flue. How many times have you read in the newspaper that Mr. So-and-so's house caught

fire through a defective flue? Let us eliminate the whole villainy of the defective flues by lining them with tile. It is utterly foolish to build a flue for a residence fireplace without using these tile liners. They are required by many city ordinances. Now, if you carry the flue up above the roof—high enough, in fact, so that it comes well above the ridge of the roof—you will not have any back drafts blowing the smoke in the flue downward. Have a separate flue for every fire. That is a principle always to be observed. Thus we have built a good fireplace; put in as good a throat as we can with masonry, and a flue that carries the smoke away as it should; what more can we do? Well, we can make the throat a flexible affair. The conditions of the fire are not uniform. More heat and less smoke at one time and more smoke and less heat at another—just the combinations that prevent good operation of a fireplace. Engineers have studied this problem and have devised a mechani-

cally operated throat made of metal that can be opened more or less depending on the condition of the fire. There are a number of good devices of

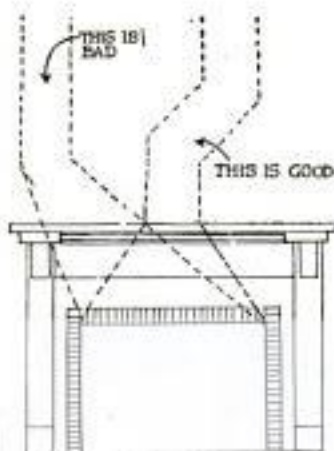

If the Flue Must Angle Be Sure the Angle Is Right

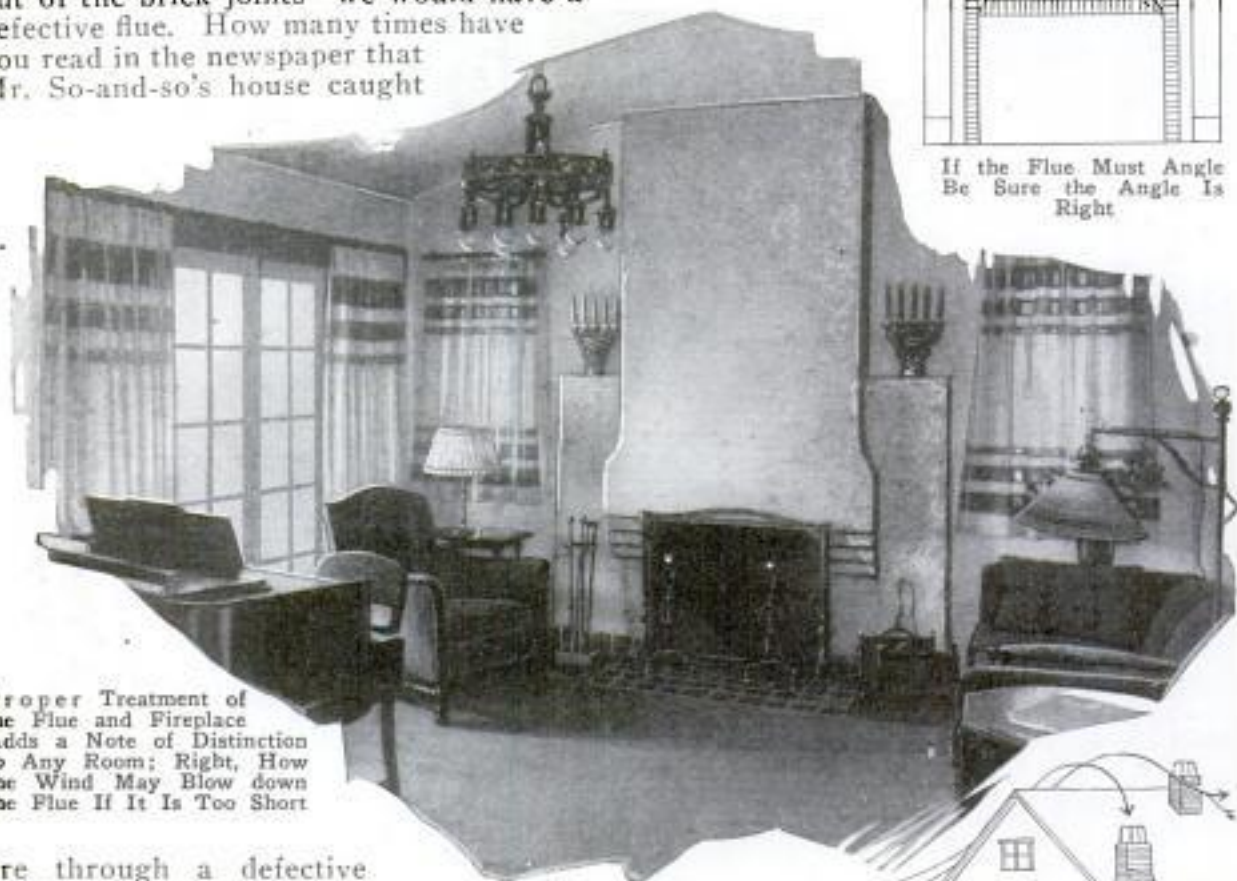

Proper Treatment of the Flue and Fireplace Adds a Note of Distinction to Any Room; Right, How the Wind May Blow down the Flue If It Is Too Short

fire through a defective flue? Let us eliminate the whole villainy of the defective flues by lining them with tile. It is utterly foolish to build a flue for a residence fireplace without using these tile liners. They are required by many city ordinances. Now, if you carry the flue up above the roof—high enough, in fact, so that it comes well above the ridge of the roof—you will not have any back drafts blowing the smoke in the flue downward. Have a separate flue for every fire. That is a principle always to be observed. Thus we have built a good fireplace; put in as good a throat as we can with masonry, and a flue that carries the smoke away as it should; what more can we do? Well, we can make the throat a flexible affair. The conditions of the fire are not uniform. More heat and less smoke at one time and more smoke and less heat at another—just the combinations that prevent good operation of a fireplace. Engineers have studied this problem and have devised a mechani-

this kind on the market; that shown in

one of the illustrations is not necessarily the best. The principle is to have a damper in the throat that can be operated from the hearth or front of the fireplace and adjusted to the conditions of the fire from time to time as may be necessary. The additional expense is small, and its use is recommended if you mean to have a real fire in the fireplace.

HAWAII TO FORM A CONTINENT SCIENTIST PREDICTS

According to a New York scientist who has made a special study of movements of the earth, the Hawaiian islands are gradually pushing up out of the ocean, and within a generation, will form a territory as large as Japan. The change will take place without serious shocks, he says.

Edwin Fairweather

Chicago Daily News

7/18/25

Nation's Business

HOW FOLKS EARN THEIR LIVING SHOWN BY BUSINESS SURVEY

During the increase of population in the United States from about 24,000,000 in 1850, to more than 105,000,000 in 1920, a lack of uniformity in increase in many occupations was noted. Some entirely disappeared, new ones, like auto driving and electrical work, came into prominence, and others showed little change. In 1850, to every 1,000,000 inhabitants there were 1,323 wheelwrights, but the class has nearly disappeared today, while 1920 found an army of 7,587 machinists to every million inhabitants as compared with the 1,039 in 1850. The proportion of clergymen is nearly the same today as seventy-five years ago, the reports showing one for every 949 persons in 1850, and one for every 912 in 1920. The relative number of physicians and surgeons has decreased, blacksmiths have been greatly reduced, and but 519 sailors were found to each million inhabitants in 1920 as compared with 3,044 in 1850. There were twenty-five times more plumbers to each million in 1920 than in 1850. Electricians numbered 2,014 to the million in 1920, steel workers 8,006 and barbers almost as many.

AUTO DASH LAMP SLIPS IN PLACE WITHOUT HOLES OR CUTTING

A dash lamp for automobile instrument boards, which can be slipped onto the edge of the panel, does not require the use of tools, drilling of holes or other preparation. Electric connection is quickly made and the light is firmly held against jarring or wobbling when the car is in motion. In case the arrangement of instruments on the board is to be altered, the lamp can readily be removed or its position changed without defacing the surface of the panel.



Ready for a Gas Attack; Horse and Dog Wearing Cheesecloth Masks and Rider Garbed in Complete Protective Suit

GAS MASKS FOR ARMY ANIMALS TO SERVE IN TIME OF WAR

Although the use of poison gas in warfare may be outlawed, the United States army will be prepared to protect its carrier pigeons, horses, mules,

dogs and other animals from the fumes should occasion arise, for special masks have been devised to shield beasts and birds in the service. The protector for horses and mules consists of a cheesecloth bag which covers the nostrils and upper jaw only, for they breathe only through the nose so that it is not necessary to cover the mouth. Their eyes need no protection against tear gas for they have no tear ducts. The dog mask is similar, but covers both upper and lower jaws. The pigeons will wear no protectors while in flight, but will be guarded from gas by a special shield entirely covering their transport cages.

RUBBER JEWELRY LATEST FAD

Strings of rubber beads closely resembling glass gems, have appeared in the Paris shops, to be worn while bathing. With these novelties are shown swimming suits of light rubber that cover the wearer from neck to feet, so that a person may take a dip without getting wet.

new York Times
7/12/25
Second Corps Area
Lawrence &aland.

et al.

3445

Metal & Speculations Mfg. Co.
Chicago 338 N. Kedzie

Klinger + Co.
Berlin
Germany

648

POPULAR MECHANICS-

SUNBURN COLLAR AND BUOY COMBINED FOR BATHERS

Worn deflated, a rubber collar being marketed in Germany protects the neck and shoulders of swimmers from sunburn.



Collars Inflated and Being Used to Buoy Up Swimming Beginners; When Flat, They Protect against Sunburn

Blown up and held in position by the chin and back of the head, it acts as a buoy to aid beginners in swimming and those who wish to go long distances through the water. The cushion is very light in weight, yet will hold up two persons in bathing costume or one soldier with his pack. tests are said to have shown.

THEATER FAR UNDER EARTH AMUSES IRON MINERS

Two hundred and thirty-five feet beneath the surface, a theater in a northern Minnesota iron mine is believed to be the lowest auditorium in the world. Originally installed

for instruction in safety, the theater has developed until now the underground workers are entertained at noon hours and other spare time with theatrical and other amusements. The cavern is comfortable, with good lighting and heat. Music is largely furnished by the workers, the concertina being the favorite instrument.



Buffing Surface with Portable Finisher Showing How It Is Adjusted for Beading

Shell Co. gasser
Reyes no. 27,
Armstrongs Ltd,

OIL WELL DIGS OWN GRAVE WHEN GAS BLOWS OUT

How an oil well dug its own grave and then proceeded to bury its 115-foot derrick in a hole large enough to hide a city office building is the story of one of the giant "gassers" that blew in from a depth of 3,650 feet near Los Angeles not long ago. The drilling crew had taken every precaution against such an accident as the well was known to be in a high-pressure zone. It was cemented but this protection had little effect on the gas, which blew out with it vast quantities of sand and water. The eruption continued for thirteen days. The well showed no trace of oil during the disturbance. The water was fresh and was conducted

to adjacent farms where it was used for irrigation. While "gassers" are common, they rarely cause such deep craters and often the derrick can be used again.

3404
ELECTRIC SANDER IS PORTABLE AND REACHES CORNERS

For finishing automobile bodies, metal furniture, safes and various kinds of metal work, a portable sanding machine, operated by a motor and mounted on a stand with casters for quick moving, saves time over hand-filing and buffing methods and produces more satisfactory results, according to the manufacturers. Flat disks coated with a hard cutting material whirl about by means of a gear in a flexible shafting. They can be used edge-wise or on the broad surface, are easily removed and are so flexibly adjusted that they yield to irregular areas such as sharp curves, moldings and beadings. The motor is attached to a swivel base which permits swinging it half-way around.

The Carborundum Co.
Magara Falls, N.Y.

*Wilsonian "auditorium" at
 Spence mine, Glens Falls, N.Y.*

2 miles west of Los Angeles.

Copyrighted material

Building a Neat, Sturdy Radio Mast

By F. D. BURKE

HHEIGHT is an important consideration in erecting an outdoor aerial. A mast of light weight and maximum strength, which can readily be made by a boy, is the solution of many an aerial-erecting problem, especially on an apartment-house roof, where usually so many are found that it is nearly impossible to put up another without touching or running close to some already there, which means interference from other sets. When one gets up 30 ft. above the roof there is much less trouble. The mast is built in two sections, each consisting of four spruce longitudinals and crosspieces tied together with galvanized sheet-iron fittings and braced with ordinary bicycle spokes. The lower section is 14 ft. 6 in.

high, and the wooden parts are $\frac{3}{4}$ in. square. The upper section is 16 ft. high and its wooden members $\frac{5}{8}$ in. square. The wood parts for both sections can be cut from two boards 16 ft. long, 10 in. wide and $\frac{7}{8}$ in. thick. If spruce is not obtainable, fir or hard pine will do. The angle fittings are cut from No. 18 gauge galvanized sheet steel, in accordance with the dimensions shown in the detail drawings. They are attached to the longitudinals and crosspieces by 6-32 round-head machine screws, each screw being provided with a nut and washer. The fittings are spaced as shown.

The builder should start assembling the mast by first bolting all the fittings to the longitudinals, which should then be con-

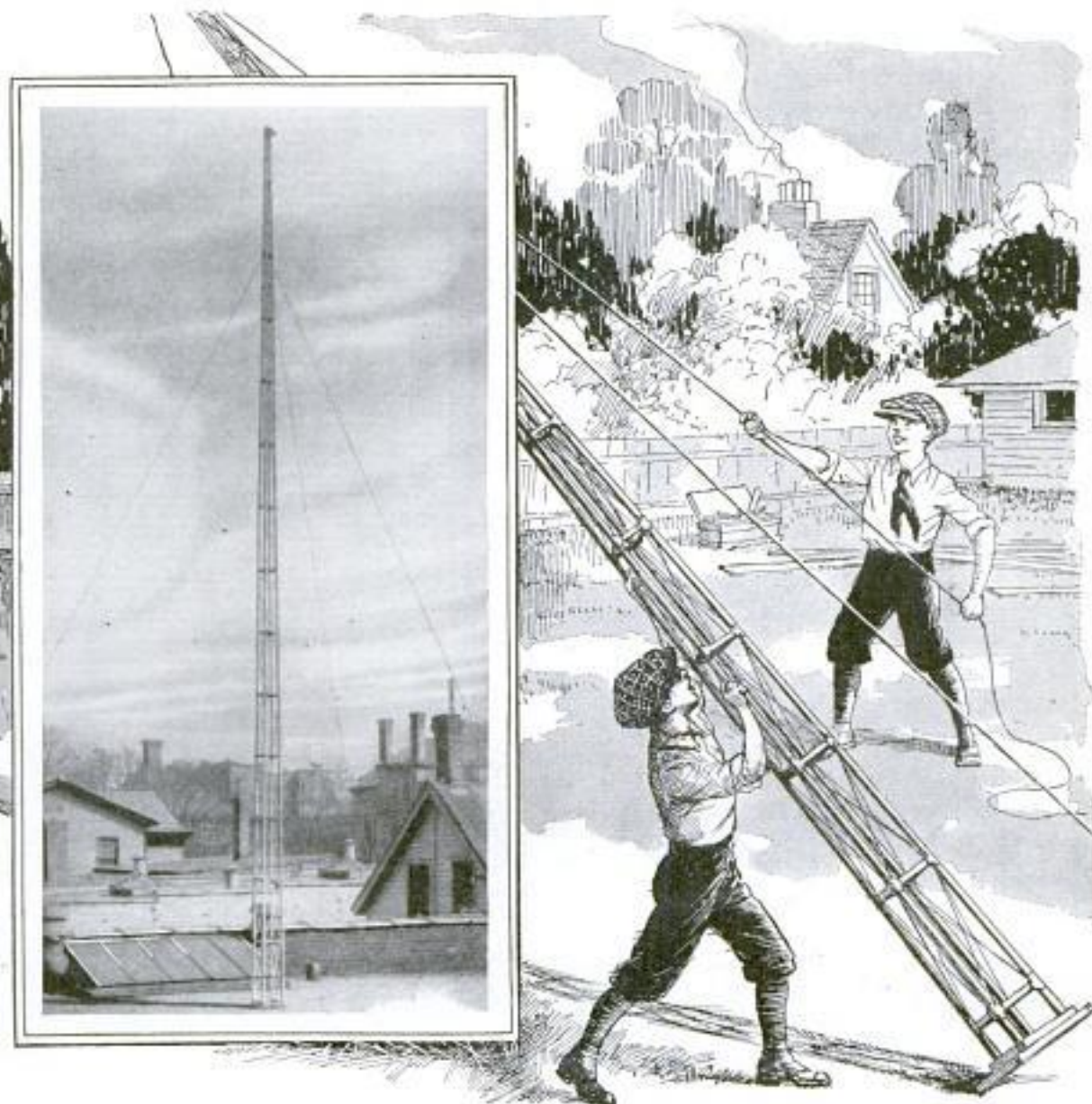

Erecting a High Aerial on a Roof, Which Insures Better Reception and Eliminates the Danger of Getting Tangled Up with Other Aerials

nected in pairs by the crosspieces. The partial assemblies are braced with bicycle spokes. The method of attaching these spokes to the fittings is clearly shown. Finally the two sides of a section should be connected by the remaining crosspieces. The upper ends of the four longitudinals for the top section are brought together and capped with a fitting, cut to the shape and dimensions given in detail drawing. It is then bent to shape and attached to the longitudinals. The mast-head is provided with a pulley for raising and lowering the antenna. The mast is braced by three lengths of $\frac{1}{8}$ -in. stranded-steel cable. The total cost of all the material need not exceed \$10. If greater height is desired more sections can be added, in which case the bottom section should be constructed of $\frac{7}{8}$ -in. square stock and the two upper sections of $\frac{3}{4}$ and $\frac{5}{8}$ -in. stock.



ones, to hold screws and nuts of different kinds and sizes. In the center of the bench, where the worker usually stands, a tilting table is provided which makes it possible to clamp the radio set to it at the most convenient angle. This table is simply a piece of 1-in. wood, such as maple or oak, about 30 in. long and 7 in. wide. It is attached to two awning fittings and 5-in. lengths of pipe to be set in holes drilled in the bench top as indicated. Provision should also be made for an electric soldering iron, which every radio builder should possess. The

plug is located on the front of the bench near the right side, where it will be handy. Sheet-metal brackets screwed to the bench top make a good rest for the iron. Two vises are attached, one fixed and the other movable. If desired, the lid on the tool box, which is divided into three sections to cover the three compartments, can be equipped with latches to permit locking them with a padlock so that the youngsters cannot run off with the tools. If not so equipped the covers should have finger holes bored for lifting them.—L. H. Georger, Buffalo, N. Y.

Handy Workbench for the Radio Fan

Every radio fan, who builds and experiments with different kinds of receivers, needs a workbench. One that is especially designed for this purpose is shown in the illustration. The special advantage of this bench is that it incorporates a tool box under part of the top, permitting easy access to the tools at all times, and has a tilting table on which the work can be held in any convenient position.

The bench is made of 2-in. wood, except for the lower shelf, the tool box and the lids, which are of 1-in. stock. The top should be made of well-seasoned oak or maple. The shelf adds rigidity and also provides a good place for unfinished sets, cabinets and batteries. The tool box is arranged at the back of the bench top. It is about 6 in. deep, and is divided into compartments. One is used for pliers, screwdrivers and wrenches, the second for heavier tools, such as hammers, saws and drills, and the third is divided into smaller

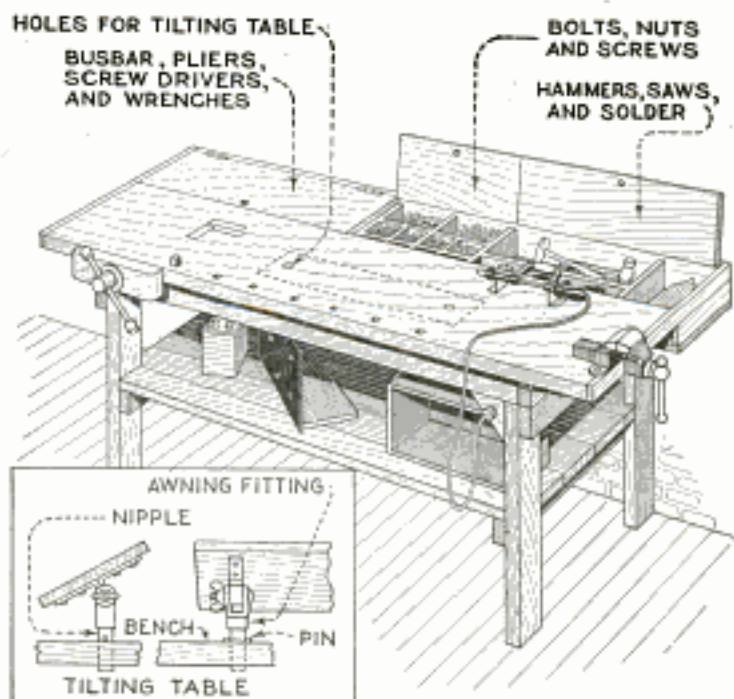

Handy Radio Workbench Saves Many Steps; Insert, Method of Mounting the Tilting Table

Building a Loud Speaker in Standard Cabinet

Receiving sets with loud speakers contained inside of the cabinet are on the market and this feature has a decided

and a wood screw driven through. This holds the horn securely without permitting any vibration between the horn and the cabinet. The front of the horn should clear the panel about $\frac{1}{8}$ in., for if it touched, the slight vibration of the horn

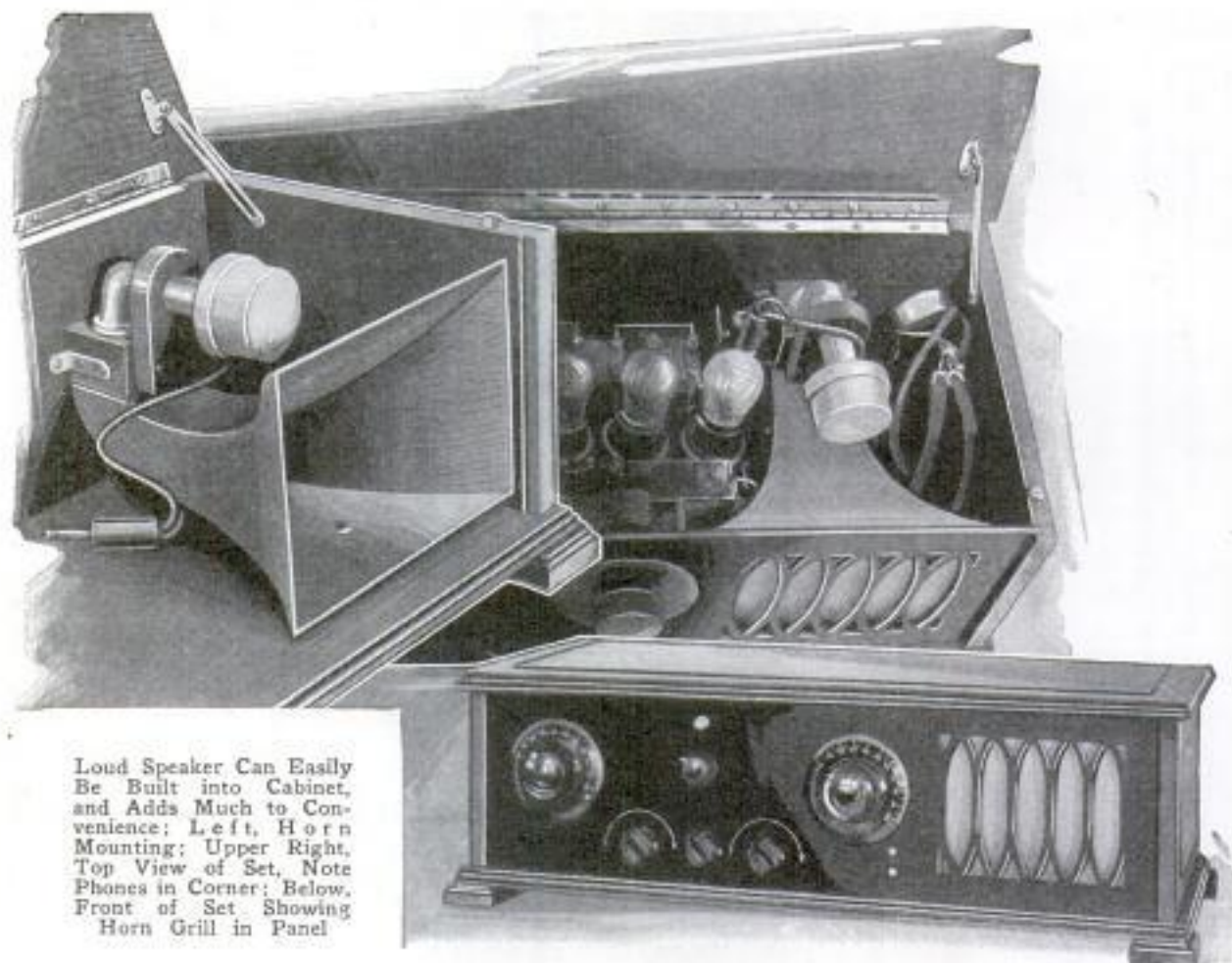

Loud Speaker Can Easily Be Built into Cabinet, and Adds Much to Convenience; Left, Horn Mounting; Upper Right, Top View of Set, Note Phones in Corner; Below, Front of Set Showing Horn Grill in Panel

advantage in that the risk of upsetting the outside horn and ruining the finish of furniture is entirely eliminated. The amateur who is building his own set can likewise incorporate the horn in the cabinet, and do a good job. Even the cutting of the grill is easy, although it takes time, care and patience.

As is obvious from the photograph, which shows three views of a built-in loud speaker and the grillwork on the panel, the arrangement is simple. A loud-speaker unit of wood, otherwise contained in a neat box, was used on account of its appropriate size, good tone quality and remarkable volume, although any small loud speaker that will fit inside of the cabinet will do. This loud speaker was 9 in. long, and the cabinet therefore had to be $9\frac{1}{2}$ in. deep, which is a standard size. Two angle brackets were screwed to the neck of the horn and to the back of the cabinet, a small wedge was slipped under the horn

against the panel would spoil the tone. This arrangement makes the loud speaker a permanent fixture in the cabinet, so that it is not removable with the panel and baseboard, the latter being cut out so that it will clear the horn about $\frac{1}{2}$ in.

The speaker may be connected to the set inside of the cabinet, so that no cord or plug is visible on the outside. This method of connection makes it

necessary to wire the set so that the loud speaker works all the time except when the phone jack is plugged in, which must then automatically cut out the loud speaker. The wiring diagram shows how this is done. The plate terminal of the last tube is connected to the

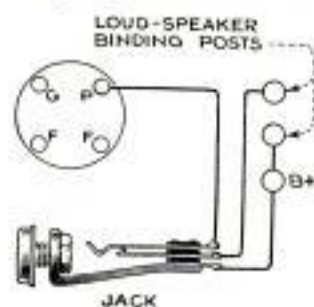

jack. The cord on the loud-speaker unit may be shortened if desired. After the cord is cut, the insulation is carefully removed for about $\frac{1}{2}$ in. on the end, and a short length of No. 26 copper wire is wound tightly around the strands. The ends are then soldered in the cord tips.

The grill may be cut out according to any symmetrical pattern. A simple and neat design, the cutting of which requires little work compared to some of the more elaborate designs, is shown in the photo. The design is first penciled on paper and is cut out. It is then clamped to the back side of the panel and the outline is traced on the panel with a sharp scribe. A number of holes are then drilled to start sawing, which is done with a coping saw, using a metal-cutting blade and cutting inside of the scribed line. Care must be taken in sawing, or the bakelite will chip. Later a small file is used to make the edges true and smooth. A piece of thin silk gauze is glued to the panel behind the grill. This can be done with collodion. Note that there is space for the headphones between the horn and the cabinet.

Condenser Improves Quality of Reception *531-Q*

A small condenser placed across the secondary terminals of the second-stage transformer in the average receiver will tend to eliminate squeals, and will improve the quality of reception. The size of the condenser can be determined by trial, but one of .00025-mfd. capacity will be found about correct in most cases.

The type with the clips usually used for mounting the gridleak on the grid condenser, will be found suitable for this purpose, as in most cases these clips can be bent to fit under the transformer terminals. This is a simple method of improving the set, and can be applied to any type of circuit.

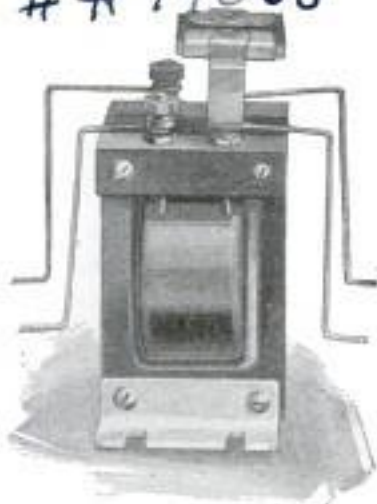

☐ If the phones don't seem satisfactory in operation, try reversing the polarity.

Discarded Automobile Radiator Makes Good Ground

An excellent ground can be made for the radio set by using a discarded copper automobile radiator, which can be pur-



Worn-Out Automobile Radiator Buried in Yard Makes Good Radio Ground

chased from a junk dealer or at an automobile-wrecking plant. The ground wire is first soldered on, and the radiator is then placed in the ground at a depth of from 4 to 6 ft. A layer of earth, about 1 ft. deep, is tamped down firmly on the radiator, and a layer of salt is sprinkled over this. Alternate layers of dirt and salt are tamped in until the hole is filled. —L. A. Krider, Hatton, Wash.

Eliminating Hand Capacity

Hand capacity, which makes close tuning difficult, often can be eliminated by mounting the variable condensers farther away from the panel. This can be done by providing a longer condenser shaft as follows: A short length of $\frac{1}{4}$ -in. brass rod, long enough to extend through the panel, is placed in one end of a thread spool and the condenser shaft in the other. If the rod and shaft do not fit tightly, drill them and the spool to take cotter pins. Mount the condenser in the desired position on the subpanel by means of two $\frac{1}{16}$ -in. brass strips, $\frac{3}{4}$ in. wide, bent to form brackets of sufficient length to support it.



Where Static Conditions Are Prevalent Nearly the Whole Year, Short-Wave Receivers of This Type Have Been Found Most Satisfactory

Low-Loss Instrument Can Be Used for Both Long and Short-Wave Reception

By F. L. BRITTIN

LOW loss is a much misunderstood term and is often abused. The popular demand for low-loss apparatus has led to the marketing of improved instruments, however, by which losses are materially reduced. The newer types of inductances and condensers are far superior to those used a short time ago. The three-tube receiver described in this article was built in Popular Mechanics' radio laboratory with special attention to the elimination of losses and, in exacting tests, has given entire satisfaction.

A second main feature of this receiver is its wide range, from 50 to 550 meters, permitting its use on the lower wave bands, which although still in the experimental field, are of general interest. Many of our readers in the warmer countries tell us that they are getting excellent re-

in the tropics the greater part of the year. The extreme low range of this receiver is obtained by the substitution of a tuner unit wound for the shorter waves, for the unit used to bring in the longer ones. The connections of both units are the same, so no rewiring is necessary. The set only costs \$36.00 to build. The instruments on the front panel are all of the one-hole mounting type, which greatly simplifies the work of assembling.

The tuner unit is of the three-circuit type and will tune practically any radio circuit. It consists of an untuned primary, a main or secondary inductance, and a tickler or feedback coil. All of these coils are brought to separate taps and may be connected in various combinations. The untuned primary is of the adjustable coupling type and can be set for volume and selectivity to suit any aerial.

When wiring the circuit, make all leads as short and direct as possible. The front panel can be of any good insulating material such as bakelite or formica.

The tuner unit is mounted at the extreme right, next the condenser, and then the two rheostats, which are of the carbon-pile type and take up very little space. The filament switch is mounted below the tuner and the condenser, and the horn jack is located below the rheostats. The subpanel is mounted on metal brackets, which are screwed to the front panel by means of four 1/2-in. nickelplated, 6-32 brass machine screws. This makes a strong assembly, and the brackets are sufficiently high to



Anyone Who Is Able to Use a Few Tools Such as Pliers and Screwdriver Can Readily Build a Set of This Type

sults on the short waves and have less interference of static, which is troublesome

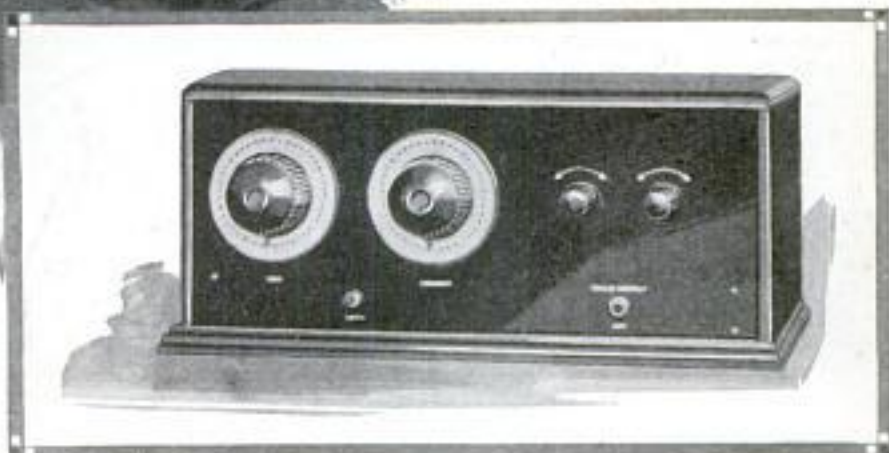

Copyright 1925, Popular Mechanics Magazine

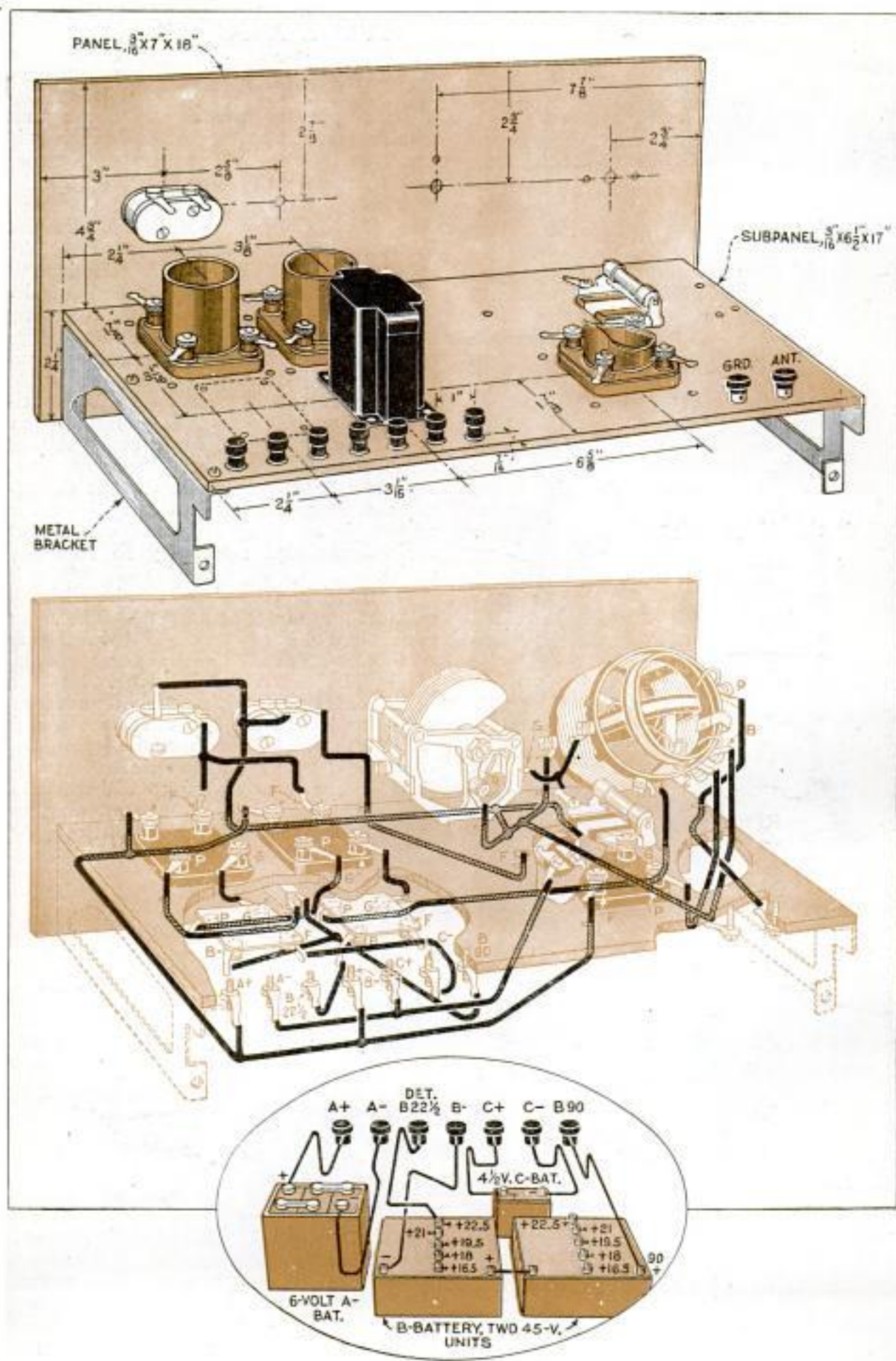

dial is used to control the volume, and obtain the clearest possible signals. Adjust the primary coil down near the sec-

higher than necessary to get good results. Learn to tune a receiver so that it will not reradiate. When the set is oscillating

MATERIAL LIST

- | | |
|---|--|
| 1 bakelite or formica panel, 3-16 by 7 by 18 in. | 2 vernier dials. |
| 1 bakelite or formica subpanel, 3-16 by 6½ by 17 in. | 1 4½-volt C-battery. |
| 1 B-T low-loss tuner, type B, 200 to 565-meter range. | 2 Thordarson a.f. transformers, 3½ to 1 ratio, subpanel-mounting type. |
| 1 B-T low-loss tuner, type SW, 55 to 150-meter range (for lower wave bands only). | 1 open-circuit jack. |
| 1 B-T 250 MMF, type L, variable condenser. | 1 filament switch. |
| 2 Bradleystats. | 2 Benjamin shelf-supporting brackets. |
| 9 binding posts. | 4 doz. tinned copper lugs, long type. |
| 1 grid-condenser, .00025-mfd., with gridleak clips. | 8 6-32, ½-in. nickelplated brass machine screws, with nuts. |
| 1 gridleak, 2 meg. | 5 2-ft. lengths of No. 14 tinned copper wire. |
| 3 standard sockets. | |

ondary for loud signals, and up, or away from the secondary, for greatest selectivity. When once found, the adjustment of the tuner seldom requires changing, except to bring in distant stations. The left-hand rheostat controls the filament of the detector tube, and the right-hand rheostat controls both amplifying tubes. These rheostats never should be turned

it is transmitting, and this will interfere with your neighbors' sets. Keep the tuner dial adjusted just below the point where beats or whistles are heard. These sounds are sometimes heard at times when the set is not oscillating and may be caused by two stations operating at nearly the same wavelengths, but in that case will have a constant note.

Handy Radio Tool Chest Made from Cash Box

The average radio builder does not take proper care of tools and small parts, which are usually scattered about and never at hand when needed. The little tool box shown in the drawing is easily made and

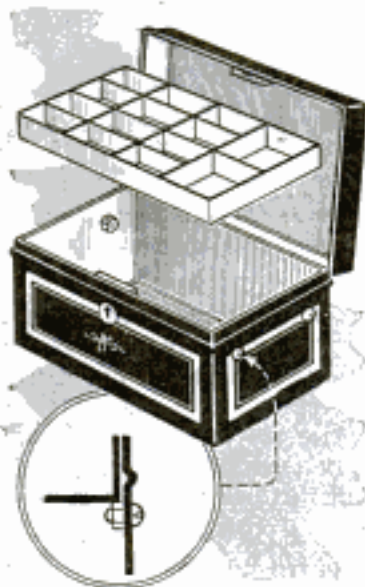

will cost much less than the manufactured type. Procure a tin cash box, 12 by 8 by 5¼ in. in size. Make a tray, 1 in. deep, either of tin or light wood (such as cigar-box wood) and divide it to suit the individual need. This tray is supported in the box by

means of four 8-32 round-head brass screws, placed through holes bored in each end of the box, and secured inside the box with nuts. The method is clearly shown in the illustration. The projecting screws hold the tray in position when it is placed in the box, the screws being run

through the sides of the box at a point to bring the top of the tray, when in position, level with the top of the box. The tray provides space for small screws, nuts, and odds and ends, while the larger compartment below affords room for such tools as pliers, screwdrivers, etc. The tool box can be made of wood if the builder prefers, but the cost of the tin box is so low that it will appeal to the majority.—Lester P. Young, Culver, Ind.

Loud-Speaker Diaphragm Modulates Tones

Claimed to eliminate all harsh sounds when inserted in the horn of a loud speaker, a modulating diaphragm has lately made its appearance on the market. It consists of a soft felt disk held in a grooved nickelplated ring, and is placed in the throat of any sound-emitting instrument, such as a radio horn, phonograph, cornet, etc., in the manner shown in the illustration.



*Andiphone Co. of America
59 Cortland St.*

new spark

Loops; How to Select and Use Them

By E. R. HAAN

CHIEFLY because of its selectivity and comparatively small pick-up of atmospheric disturbances, the loop is rapidly replacing the outside aerial. When one first uses a loop on a receiver that has previously been operated with an outside

two stages of transformer-coupled a. f. amplification, or three stages of resistance-coupled amplification.

Most loops in general use are directional; that is, they have to be pointed toward the broadcasting station as in Fig.

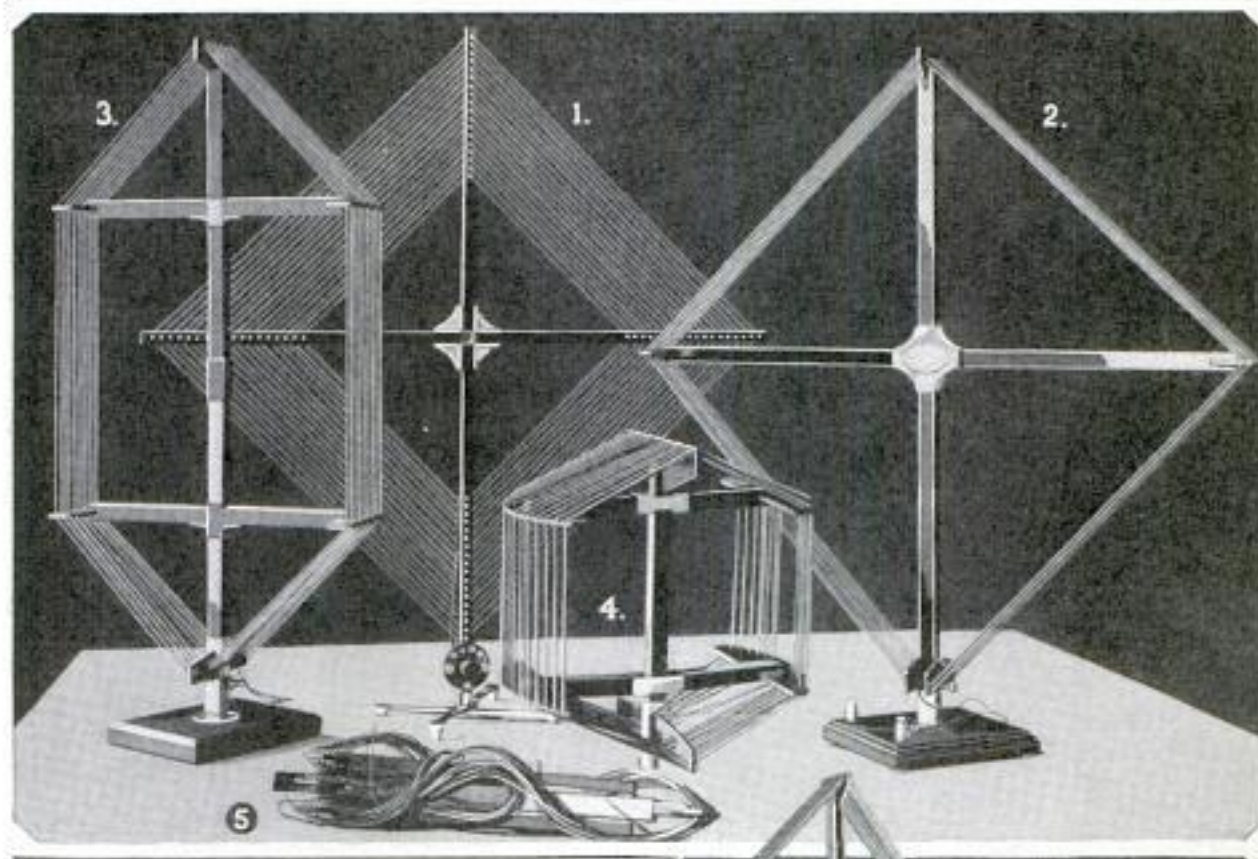

A Few of the Most Popular Loops; 1, Pancake Type; 2, Diamond-Shaped Box Type; 3, Console Type, Exposed; 4, Console Type, Inclosed; 5, Small Loop Folded, and 6, Proper Method of Rotating a Loop

aerial, a loss of volume will be noticed, but this will be more than compensated for by the improvement in the quality of the reception. Of course, this does not mean that any receiver will work on a loop. Small sets having less than three tubes will not, and many other sets have to be changed to make them work on a loop satisfactorily. In general, the tuning inductance necessary with an outside aerial is not used with a loop-operated set, as the loop itself is the inductance. Radio-frequency amplification is necessary, however. One stage of r. f. amplification has been found sufficient on some types of receivers but three stages are better. Some three and four-tube reflex sets are designed to operate on a loop, but usually do not give as good results as a set embodying r. f. amplification, a detector and



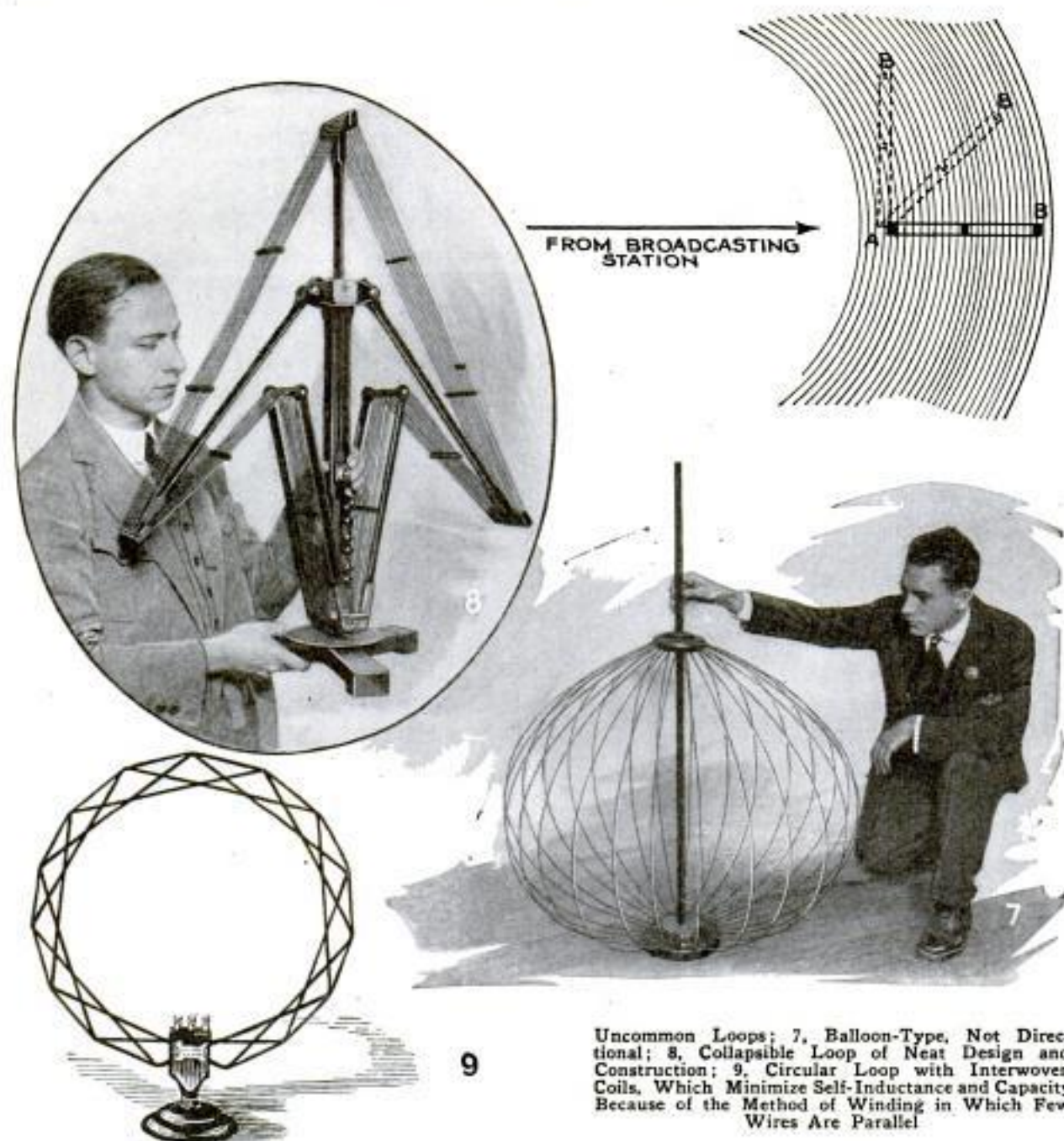

Uncommon Loops; 7, Balloon-Type, Not Directional; 8, Collapsible Loop of Neat Design and Construction; 9, Circular Loop with Interwoven Coils, Which Minimize Self-Inductance and Capacity Because of the Method of Winding in Which Few Wires Are Parallel

6, to obtain the loudest reception. On many sets signals can be tuned out entirely by turning the loop at right angles to the station from which the signal is coming. When at right angles to the direction of the broadcasting station the waves strike both halves of the loop simultaneously, setting up currents in opposite directions, which neutralize each other, resulting in no signal. When turned at a smaller angle to the path of the waves the latter strike one side of the loop winding before the other side, so that a current is set up in the wires in the same direction. This effect is greatest when one side of the loop winding is pointed directly toward the station, and consequently the efficiency of the loop in re-

ceiving signals from that station is highest in this position (see Fig. 8).

There are two general types of loops in common use, namely, the pancake type, shown in Fig. 1, and the box type, shown in Figs. 2, 3 and 4. Both types have their advantages and disadvantages. Greater selectivity is claimed for the former and greater volume for the latter. The loop shown in Fig. 3 is designed to turn in a small radius. This makes it possible to set it on a console, against a wall, whereas, if either of the loops shown in Figs. 1 and 2 were used, it would be necessary to place the console across a corner. Fig. 4 shows a small box loop designed for the inside of a console. In this way it is entirely out of sight, and is turned by means

of a small knob or dial mounted on the panel. A loop of this kind can be put in any console and will operate satisfactorily without loss of selectivity. Owing to its small size, 13 in. high by 11½ in. wide, it cannot be expected to give the volume obtained on larger loops. When used with the Popular Mechanics superheterodyne eight, however, very little loss of volume was noticeable.

The method of installing such a loop is clearly shown in the detail drawing. The loop is set into a grommet or deck socket fastened to the bottom of the lower compartment. A short length of ¼-in. brass rod, the length depending on the height of the control knob on the panel above, is slotted about ¾ in. to fit on the bakelite comb on the loop, and fastened to the comb with two small brass screws. Careful measurements are taken and holes are drilled, one in the bottom

of an inside diameter of ¼ in. This acts as a bearing for the brass rod. A plate of ⅜-in. sheet brass, about 2 in. long and 1 in. wide, is drilled for the brass tube and for two small screws, soldered to the pipe and screwed to the top surface of the bottom of the instrument compartment. A small brass miter gear is fastened to the top of this vertical rod. The horizontal rod is also of ¼-in. stock, slipped through a similar tube; the tube is soldered to the frame of a jack, which is fastened to the panel in the usual way. Another miter gear is fastened to the end of this rod to mesh with the first one, and a knob with a pointer is fastened to the rod in front of the panel. Turning this knob rotates the loop. The letters N, S, W and E should be engraved on the panel so that the operator may readily know the position of the loop. It will be found necessary to leave both tubes a little long when cutting them off, and then to file the ends

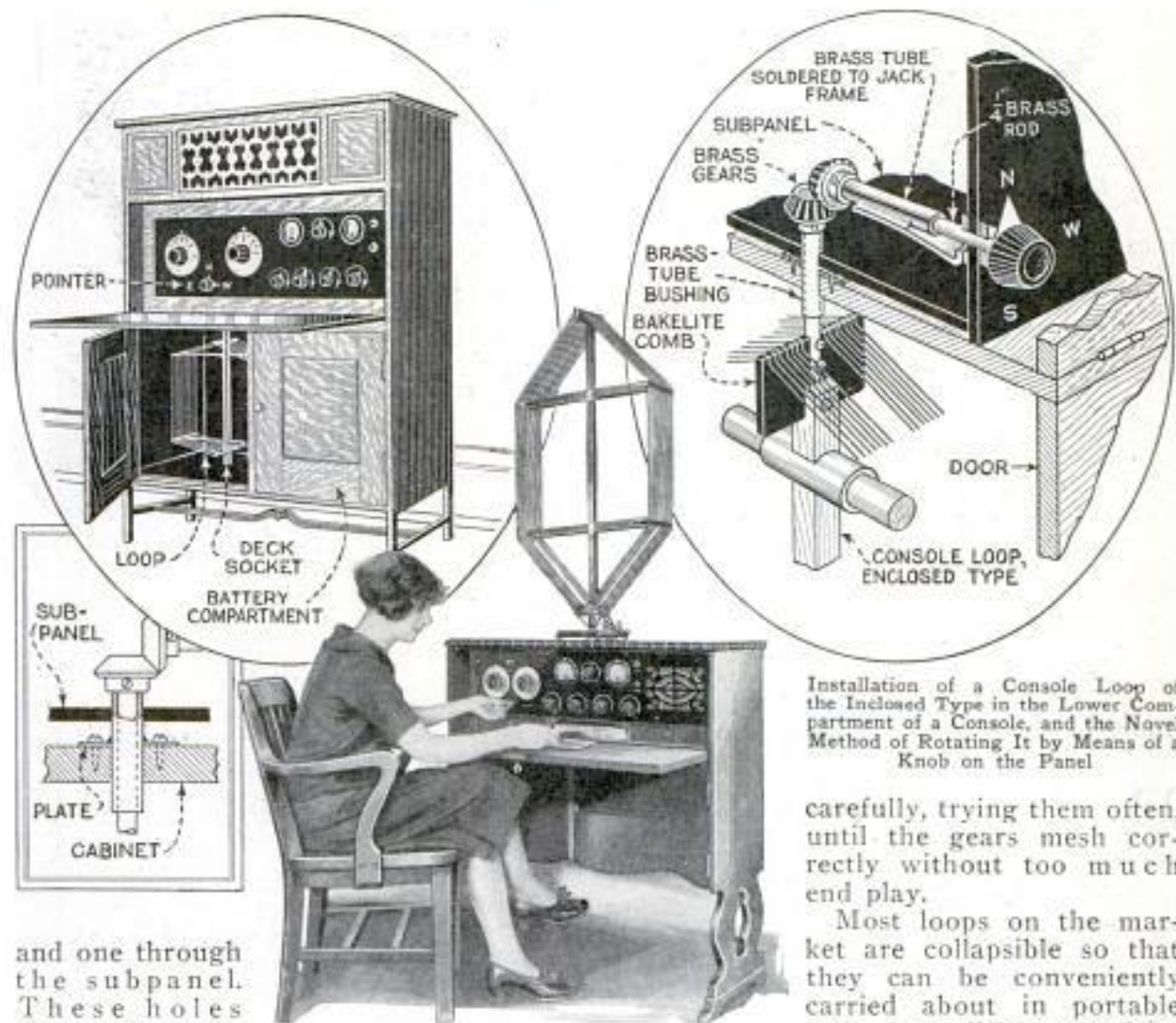

Installation of a Console Loop of the Enclosed Type in the Lower Compartment of a Console, and the Novel Method of Rotating It by Means of a Knob on the Panel

and one through the subpanel. These holes must be sufficiently large to accommodate a section of fairly heavy brass pipe or tubing having

is shown folded in Fig. 5. It is claimed that the receiver can be tuned to some ex-

carefully, trying them often, until the gears mesh correctly without too much end play.

Most loops on the market are collapsible so that they can be conveniently carried about in portable sets. A small box-type loop

tent, with the balloon loop, Fig. 7, because it can be folded to various shapes. The small basket-woven circular loop, shown in Fig. 9, is claimed to have a minimum self-inductance and capacity.

Most loops contain about 80 to 90 ft. of wire. Both ends are connected to the receiver at the aerial and ground binding posts, and no ground connection is used. Some loops have an additional binding

post between those connected to the ends. This is used for regenerative purposes, where the loop is energized as is done in some circuits. Other loops, such as the one shown in Fig. 1, are tapped and equipped with an inductance switch, with which it is possible to decrease the amount of wire used on the loop. Such a loop has been found quite an aid in increasing selectivity of some sets.

Tool Combines Coil Winder, Former, Cutter and Vise

A handy radio tool now available combines several useful tools in one. It is

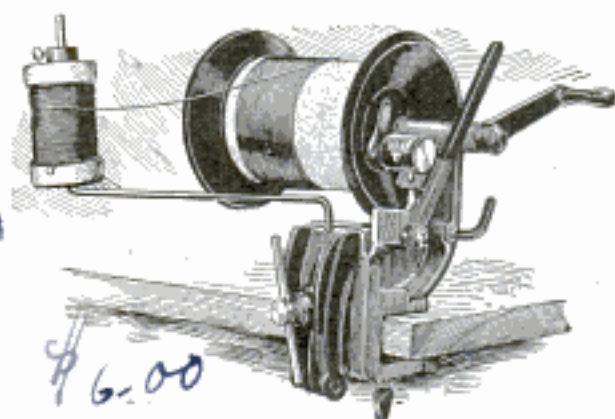

Made to Clamp to the Work Table. This Handy Coil Winder Is Five Tools in One

clamped to the work table as shown in the illustration, and consists of an adjustable coil winder fitted with an automatic counter; it is provided with two cone disks for holding straight tubes, or rotors. The end of the shaft is provided with two steel pins, and, by means of these, uniform loops can be made to fit No. 6 or No. 8 screws or binding posts. Another useful feature is the wire cutter, which is shown at the right of the counting device. The tool is also equipped with a vise, and a flat metal surface is provided on which light hammering can be done. The arm holding the spool of wire for coil winding is clamped in the vise, the movable jaw being notched to hold it.

How to Select a Good Phone Plug

Avoid plugs having loose tips that can be unscrewed readily. If the plug is of this type, loose contact will result, and dust accumulation will in time impair reception. Insecurely fastened terminals cause noises and loss of volume that are often attributed to the set. Good insulating material is also necessary. Choose plugs that improve the appearance of your

set; for example, do not use a large plug on a small panel. If the plug is marked with a red terminal receptacle, this side of the plug should be connected to the high-voltage B-battery lead. Trace the connections in the jack and see that the proper part of the plug makes the corresponding connection in the jack. Some of the better-made loud speakers have an indicating red cord for the high-voltage B-line and this must be correctly connected through the plug and jack in order to obtain best results.

Convenient Jig Facilitates Drilling for Switch Points

The gauge shown in the drawing is for laying out switch points accurately on the panel, and is a great timesaver. A piece of $\frac{1}{16}$ -in. brass sheet is cut to the shape shown in the illustration, the large hole at the bottom being drilled to suit the bushing through which the switch is fastened to the panel. To accommodate the various switch-lever lengths, lay out three circles of holes, in radii of 1, $1\frac{1}{4}$ and $1\frac{1}{2}$ in. To use, drill the hole for the bushing as shown in the upper illustration, lay the jig on the panel and insert the bushing. Place the switch lever in the bushing to determine the radius necessary for drilling the switch-point holes. Drill one switch-point hole and mount a switch point; this will hold the jig tight to the panel. The remainder of the holes can now be drilled, and they will be found to be exactly spaced, a difficult thing to do without a jig of this type, or some form of template.—H. G. Bauman, Chicago, Ill.

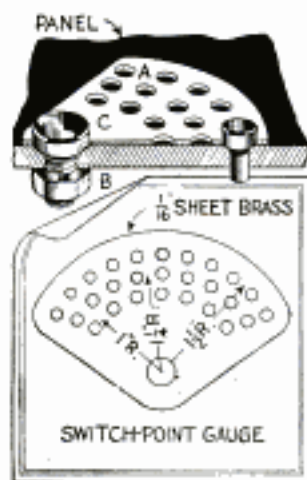

Specially Automatic Machine Co
Chelsea, Mass 582-R

\$6.00

counted \$2.25

505

Herbert H. Groth
314 W. Superior St.
Chicago



When the Sink Is Clogged

Simple Methods of Cleaning Sinks That Can Be Employed
by the Housewife and Handy Man

WHAT do you do when the sink gets stopped up? Do you call up the janitor or the plumber, and do without using the sink until he arrives with his tools? In nine cases out of ten there is no need to call in outside help when the water in the sink fails to flow away, as the trouble can be cured in a few minutes with a couple of simple tools, and sometimes with no tools at all.

In the first place, there would be very little trouble with the sink if a little care were taken in its use. Pouring coffee grounds and tea leaves down the sink is simply inviting trouble, yet many people do this habitually. Strainers that can be set in one corner of the sink, and into which the coffee and teapot can be emptied may be purchased very cheaply, and it is just as easy to pour the contents of the pot into the strainer as into the sink. Also, dish water that is heavy with grease should not be poured into the sink until the grease has been "cut" with a liberal quantity of soap powder.

When the sink does become clogged, first try to clear it by allowing the water to flow until there is three or four inches

of water in it. Place the hand over the sink outlet in the manner shown in the illustration, the palm being slightly cupped, the heel of the palm raised, and then drive the palm down sharply. The column of water under the hand will often dislodge the obstruction in the pipe. If this fails, a common plumbers' force cup may be obtained, and this will usually remove the obstruction. In the absence of a force cup, which, however, should be a part of the equipment of every home owner's tool box, the sink screen can be removed and

an improvised pump plunger made from a rag padded around the end of a stick, so that it will fit tightly in the outlet pipe. The plunger is raised and lowered gently in the pipe until it is cleared. The pipe should be full of water to the top before the plunger is placed in it. One precaution should be observed in the use of both the force cup and the plunger. If

the sink is not freed after about a dozen strokes, do not use the tools again until the plug has been removed from the trap and a fairly stiff wire run through the pipe, in both directions, in order to locate the obstruction, if possible, and help to



Above, Cleaning a Stopped-Up Sink, Using the Hand as a Force Cup; Left, the Plumbers' Force Cup and an Improvised Plunger

remove it. If the stoppage is a very complete one, continued use of the force cup or plunger may force a leak in a screw joint. In some cases the obstruction may not be in the trap or in the piping near it, and the force cup or wire may fail to remove it. The second illustration shows how a reader fixed a stoppage of this kind. He took a block of wood, 5 in. long and 2 in. square, and

had combined with the grease in the pipe to form a hard soap, and had completely stopped up the drain. Potash or caustic soda, dissolved in hot water and poured down the drain, will often clear it, and there is a preparation

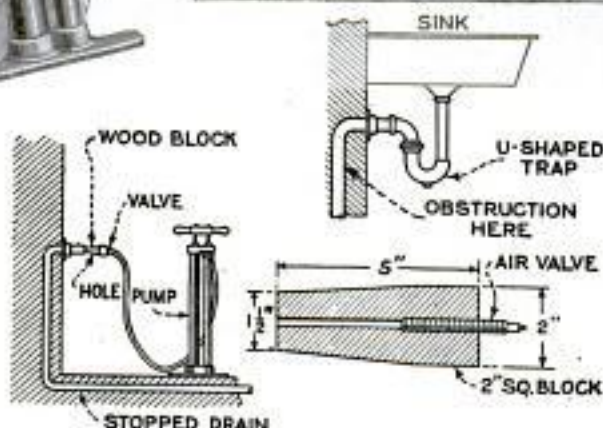

A Force Pump Made from an Automobile Tire Pump Which Will Remove Obsolete Obstructions from the Drain Pipe

rounded and tapered it until one end would fit into the drain pipe, after the trap had been removed. A hole was bored through the center of the block, of such a diameter that the valve from an old inner tube could be screwed into it tightly. When the wooden plug was driven into the end of the pipe and the pump connected to the valve, a few strokes of the pump sufficed to clear the pipe. It is necessary, of course, to remove the wing end of the valve before it can be screwed into the plug, but this is easily done with a hack-saw.

Many people use lye to clear out the sink. Lye should never be used for this purpose; it will only make the trouble worse. In one case the use of lye necessitated the taking up of a complete length of drain pipe underlying a cellar floor, which, fortunately, was merely of earth, in order to clean out the drain. The lye

known as "the plumbers' friend," which, when used in the same manner, is very effective, and, incidentally, is also one of the best things to use for cleaning out automobile radiators when they have become coated with deposits from hard water, as it will not injure metal.

Killing Weeds Chemically

Weeds that spoil the appearance of city lawns, can be effectively eliminated by the use of sulphuric acid, applied to the weeds separately, according to William H. Dehn, a member of the American Chemical society. This seems to be a laborious method, but although it takes time to do it, only one application is necessary and there is no other labor to do. From one to ten drops of concentrated sulphuric acid is applied to the center of each weed, depending on its size. The work of treating a large number of weeds can be done best by means of a glass dropping funnel of medium capacity. There are two meth-

ods to do the work. The acid may be applied to the largest weeds at random, and those not treated the first time may be treated the next day, and so on until all the weeds have been exterminated. The second method is to cover only a small portion of the garden at once, treating every weed that can be found. It is advisable to delay watering the lawn for several hours after the acid has been applied to the weeds, as water will wash the acid away. Furthermore, this would tend to spread the acid over the grass with the result that this also might be killed. All kinds of weeds can be killed with this method, but dandelions are most troublesome, owing to their large roots and quick propagation. It has been found that one pound of acid per year is sufficient to keep 1,000 ft. of lawn free from weeds. Weeds should not be allowed to go to seed, if effect is to be permanent.

Farmer Builds Pleasing Garage from Silo Blocks

While we were building a circular tile silo it occurred to us that we could build a garage in the same way, which we proceeded to do. The garage was made 19½ ft. in diameter. Two windows and a double door of the usual swinging kind were provided. A large workbench was built on one side, and this left space for oil and gasoline tanks. A garage of this type is not only novel and pleasing in appearance but requires less building materials.—Floy Bates, Hardin, Mo.



Novel Circular Garage on Farm Is Built from Silo Blocks

Folding Holder for Basement Clothes Line

Many housewives use the basement for drying the wash on rainy days, but seldom have a convenient method of fastening

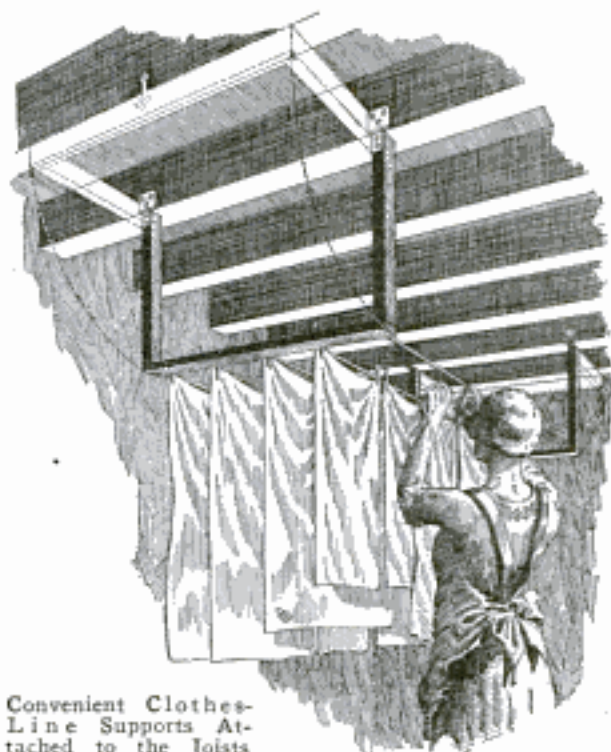

Convenient Clothes-Line Supports Attached to the Joists

the clothes line. The device shown in the illustration provides a simple, space-saving support for a number of lines, and when the lines are removed it can be swung out of the way and locked against the ceiling, as shown. It is made of 2 by 4-in. lumber and extends 12 to 18 in. below the joists. The length of the supports will depend on the number of lines to be suspended. A 3-ft. width, however, gives ample space for several lines. The frames are hinged to the joists so that the ends of the upright pieces butt against the lower edge of the joist, and the two hangers should be placed so that the pull of the lines is against the joists. Nails or small hooks on the upper edge of the crossbars provide anchoring places for the lines.—Lowell R. Butcher, Des Moines, Iowa.

Destroying Caterpillars on Grape Vines

The grapes in the back yard were being destroyed by the caterpillars, which could be found under all the large leaves. The vine was almost dead when the owner began to cut off all the large leaves and those eaten by the caterpillars. This allowed the sun's rays to reach the grapes and destroyed all the caterpillars.

Shaving Shelf for the Lavatory

In the small bathrooms found in many apartments a detachable shelf for the lavatory will be found very handy for hold-



Small Shelf on Edge of Bathroom Lavatory Proves Handy for Shaving

ing shaving equipment. Such an accessory is simple to build. Plane a piece of 1-in. pine, $6\frac{1}{2}$ by $11\frac{1}{2}$ in. in dimensions, and miter around the edge a piece of round-edge molding, $\frac{3}{8}$ in. thick and $1\frac{1}{2}$ in. wide, allowing a projection below of $\frac{1}{2}$ in., while the round edge rises $\frac{1}{4}$ in. above the shelf. Notch the end strips to fit over the roll on the lavatory, and nail underneath the center a block, about 3 by 3 in., the vertical edge being placed $3\frac{1}{4}$ in. back from the edge of the shelf, which bears against the faucet. Now put the shelf on the edge of the lavatory with the end against the lavatory back, and mark the position of the faucet. Allowing about $1\frac{1}{2}$ in. for the width of the faucet, nail a short length of $\frac{1}{4}$ -in. round leather to the edge of the shelf by means of staples. Pass the leather around the faucet, to measure for length, allowing enough stock for the $1\frac{1}{2}$ -in. loop shown in the detail. Bevel off the end and bend it back against the thong, and bind it with thread. Make a button just large enough to permit the loop to be slipped over it, and screw on the edge of the shelf. A turnbutton, with one end 2 in. long, is placed near the center of the edge, where it will clasp the bowl of the lavatory when turned. In use, the thong is buttoned around the faucet and the turnbutton

turned into the bowl, holding the bracket against the lavatory apron. The dimensions given above fit the 17 by 21-in. lavatory, but the shelf may be varied to fit other types. It should be finished with three coats of good flat white paint and one of white enamel.

Don'ts

An analysis of accidents resulting from the misuse of electrical equipment has led a large electric service company, says the New York State Committee on public utility information, to draw up the following list of "Don'ts" for users:

Don't tinker with bare wires, even in your own home. Ambulance rides are unpleasant.

Don't leave the cord attached to the electric iron while you attend to other household duties. If you want to see a house burn, they do it better in the movies.

Don't use the electric vibrator while in the bathtub. You may receive one big unexpected vibration that will make future bathing unnecessary.

Don't hang lamp cords over a nail. Frayed insulation may mean a short circuit.

Don't hang electric-light bulbs against wooden walls or partitions. And don't cover lamps with tissue paper.

Tail-Light Shock Absorber

The filaments of auto tail-light lamps are frequently broken by shocks. This can be prevented to a great extent by mounting the lamps on rubber arms, as shown in the illustration. A strip of rubber, about $1\frac{1}{2}$ in. wide and $\frac{3}{16}$ in. thick, is bolted to the end of the bracket with a wooden distance piece between them if needed. The holes can easily be drilled through the rubber by means of a sharpened brass tube, using water as a lubricant. Other types of tail lights may be used by slightly altering the attachment.

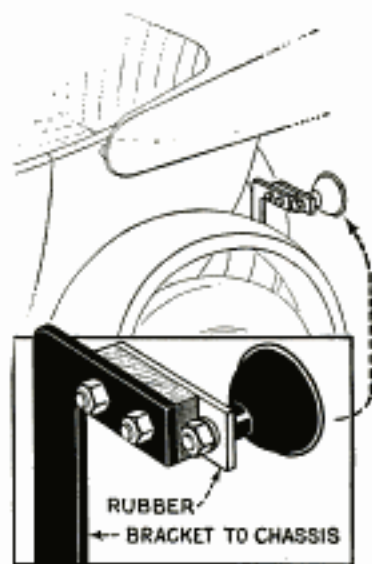

Wind-Propelled Toy Wagon

Any boy will be interested in a toy wagon equipped with a propeller, which drives it ahead against the wind. It is

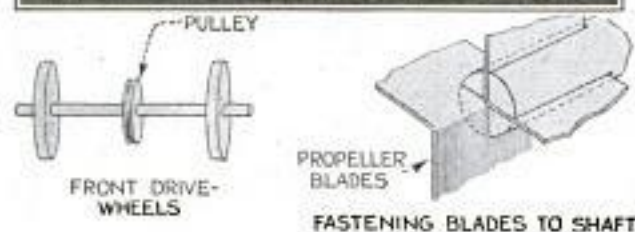
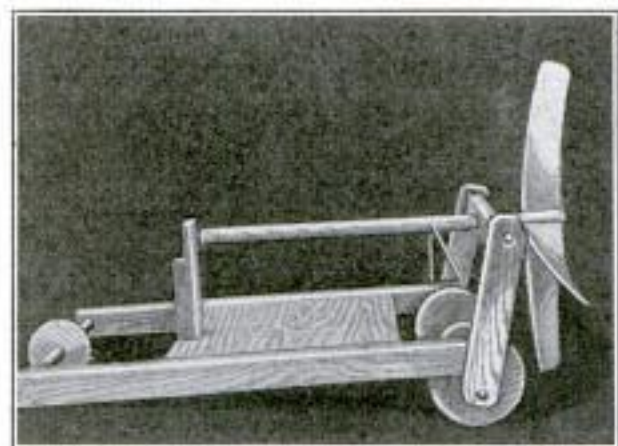

Self-Propelling Wind Wagon That Any Boy Can Build; It Consists of a Light Wooden Frame and Has a Sheet-Metal Propeller Which Drives It against the Wind with Surprising Speed

made entirely of wood with the exception of the propeller blades, which are cut from some light sheet metal. The proportions of the various parts of the wagon can be approximated from the photos and drawings. The wagon has three wheels, although four can be used if desired. The wheels are fixed rigidly on the axles, and the latter are held to the frame by means of nails driven into them through holes that serve as bearings, as shown. The propeller shaft is also of wood and is mounted, in the same manner as the wheel axles, in the short upright at the rear and through a crosspiece in front, so that it extends beyond the crosspiece sufficiently

for the mounting of the propeller. This is made from two short lengths of light sheet metal, each being bent over at right angles in the center to form two blades, and inserted in the shaft, for which purpose the shaft is split as shown. The

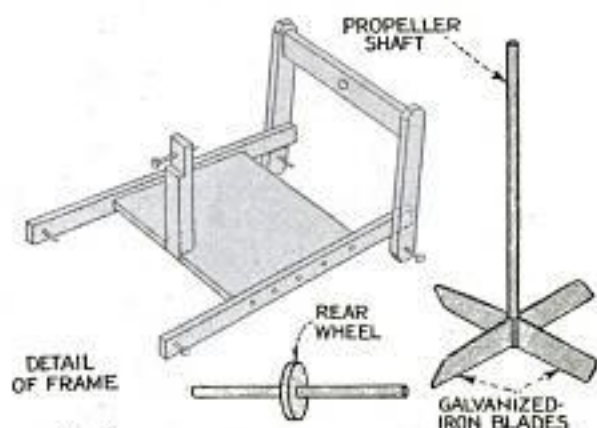

blades are then twisted to give them the necessary pitch. A twisted cord over the propeller shaft and around the pulley between the front wheels transmits the wind power to the wheel axle, thus driving the car forward against the wind.—R. W. Wagner, Ayrshire, Iowa.

Lino-Fronted Easel Makes Pinning of Paper Easy

Pinning bromide paper to the wooden easels generally used with enlarging apparatus is a difficult job, as a fair amount of pressure must be used to force the pin into the easel, and this pressure may force the easel out of adjustment.

By covering the front of the easel with thick cork linoleum, these difficulties are at once overcome, for the pin is forced into the surface with the slightest pressure.

Moreover, the lino is elastic, and the holes made close up again, so that the easel front always shows an even surface.

A piece of thick linoleum is cut to the same size as the easel board and glued to the latter. While the glue is setting, a board of the same size as the easel is clamped over the lino-covered front, to make sure that the surface will be smooth all over. The bromide paper is pinned on in the usual way. The thickness of the linoleum should be such that the point of the pin cannot penetrate it.

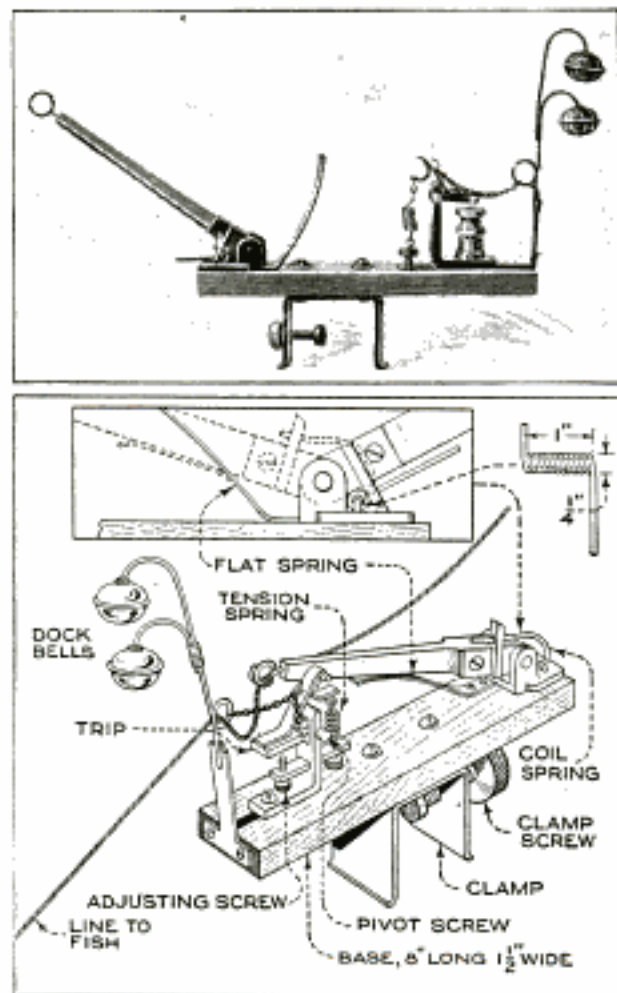

Novel Fish Trap Sounds an Alarm Every Time a Fish Is Caught

Novel Fish Trap Never Fails

The fish trap shown in the illustration was designed to operate on the order of a spring mousetrap. It has been used for two seasons and has never failed to accomplish its work; when the fish bites, the trap does the rest. It is especially convenient for the fisherman who uses several lines at the same time, as it makes it unnecessary for him to watch the lines constantly, and all he has to do is to release the fish from the hook when the bells indicate that one has been caught.

A block of wood, about 8 in. long, is used as a base. On the underside, a clamp and screw are arranged for fastening it to the edge of a rowboat or dock. A wooden lever is pivoted at one end of this base, and two springs are used to give it a strong thrust when the trap is sprung: a flat one in front to give the initial thrust, and a small coil, of the mousetrap type, behind, to pull it backward and hold it down. The trip should be made for accurate adjustment and can be assembled from the bell-ringing mechanism of an old telephone. It consists of a vertical

piece to which a small crossarm is pivoted. One end of the crossarm is arranged so as to project just over a pin near the end of the lever, to hold it down. The tension of the trip on the pin is adjusted by a small coil spring and screw, to suit weather conditions; if the water is smooth, the trip should hold the pin down very lightly, but if it is rough, the trip should hold it down more securely. The trip is also connected by a chain to a vertical metal arm that is attached to the end of the base, and holds two bells that ring instantly when the arm is jerked. At the same time, when the arm is pulled forward, the chain will tighten and release the trip. The chain should be adjustable so that its length can be varied. The fish line is securely fastened to the ring at the end of the lever, and inserted between the turns of the coil on the flexible arm, just tight enough to allow the line to pull the arm forward for releasing the trip. The entire outfit can be made of odds and ends and does not involve much expense.—F. F. Howe, Milwaukee, Wis.

Sawbuck Holds Cordwood Immovable

Numerous methods are used to prevent cordwood from turning in a sawbuck, but the most satisfactory one I have used is shown in the accompanying drawing. Sections of an old discarded crosscut saw are bolted to the sides of the sawbuck by means of wooden strips, as shown. The teeth of the blades bite into the log and prevent it from turning or rising.—C. M. Wilcox, Torrington, Conn.

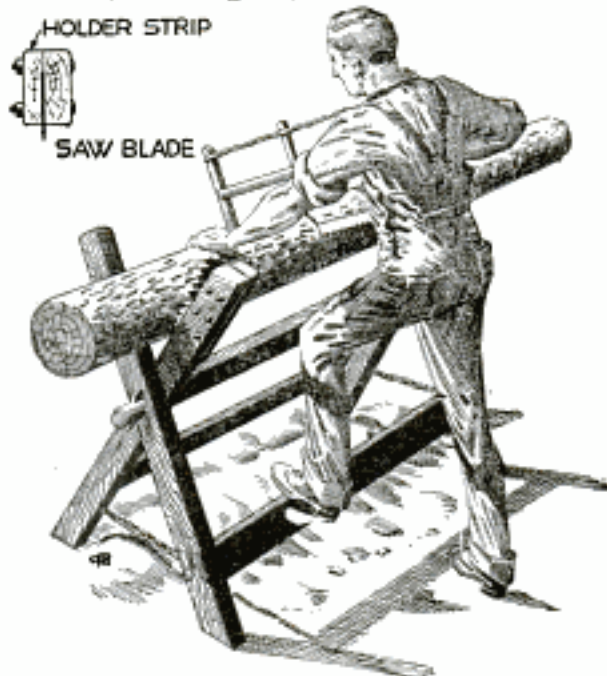

Sections of Saw Blade Fastened to Sawbuck Prevent Wood from Turning

Improving Ground for "Tulite" Bulbs

"Tulite" bulbs in the headlights of Ford cars sometimes cause trouble by the lights flickering when the wiring is known to be good. In such cases the headlight sockets, if shaken by means of the plug at the rear end, will cause the light to dim or go out. It is often found that the sleeves attached to the headlamp shell, and in which the sockets slide, are rusty and dirty, caused by rain driving in between sleeve and socket. The sockets are also covered with rust. The dirt at this point causes a poor ground—or none at all—for the bulbs, in which both filaments are grounded through the headlamp shell to the frame. The remedy is to wrap sandpaper about the little finger or a stick and polish the inside of the sleeve and the outside of the socket. Many of the sockets are a loose fit and can move side-wise in their sleeves, thus causing a poor ground and too much vibration for the bulbs. A remedy is to pinch the end of the sleeve in the headlight slightly with pliers, until the socket is a free sliding fit, with no sideplay. As there is an open-end slot cut in the sleeve for the focusing lug on the socket, this can be easily done. To reach the sleeve in the headlamp, the lens, bulb, reflector-focusing screw and socket must be taken out of the lamp, and for best results they should be focused after the work is completed.—E. T. Gunderson, Jr., Humboldt, Iowa.

Improvised Porch Seat

With the bracket shown in the drawing a long seat may be arranged at the porch railing, so that it can be removed and stored away quickly. Form the bracket of heavy flat stock, and rivet it securely at the joint. Be sure to have the seat pitch toward the back a trifle, so that it will be more comfortable. After the brackets are hung up, an ordinary 2 by 12-in. board is laid across them. Rugs or robes thrown over the seat will make it more comfortable.—Louis Schneider, Clinton, Mo.

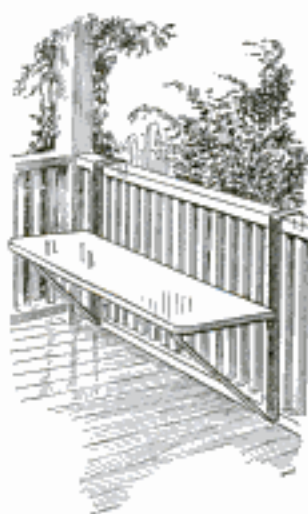

Unusual Paper Weights

The photo shows paper weights holding the impression of my boy's hand and foot,



Baby's Foot and Hand Cast in Metal Make Interesting Paper Weights

taken when he was five weeks old. He is now a man and the paper weights, which are still in use, are interesting souvenirs.

I made them in the following way: Impressions of the foot and hand were taken in dentists' compound, and from them molds were made by pouring plaster of paris into the impressions. When the plaster had set the impression and mold were separated and the rest of the mold shaped as desired. The castings I had made of brass in a foundry. After finishing them by rubbing with emery cloth, they were polished and goldplated. If no dental compound can be obtained readily, ordinary paraffin or wax can be used. It should be worked soft and the impression then taken. By immersing it in cold water immediately it will harden at once, which is necessary to prevent it from bending and thus ruining the impression.—C. H. Tillotson, Los Angeles, Calif.

☞ To paint a monogram or other device on leather do not use oil paint, which will spread, but mix some coach color, which is ground in japan or turpentine, and thin it with a little turpentine, adding a little carriage-finishing varnish as a binder.

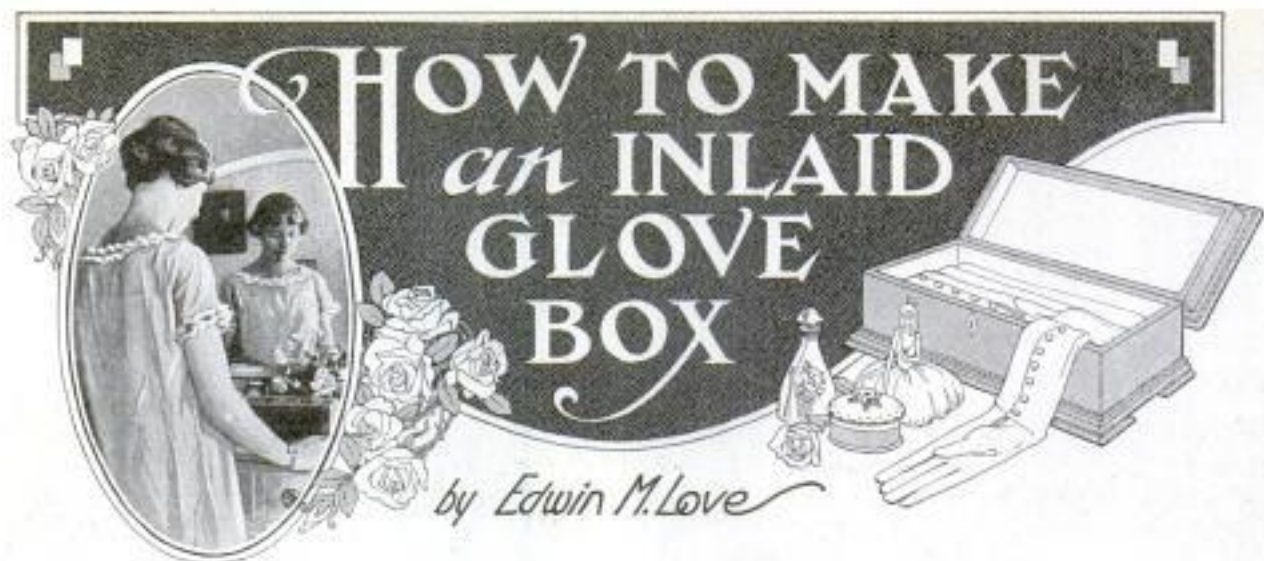

FOR the man who likes to use tools, inlaying offers a field full of the pleasure derived from the construction of a beautiful and useful article. Carefully done, it is by no means beyond the skill of the average home mechanic.

The glove box illustrated was built of Tobasco mahogany, inlaid with pyralin "ivory," a material well adapted to such work because of its toughness and the ease with which it can be worked. Any beautifully figured hardwood is suitable, but only fine material should be used for so small an article, in which the handwork is the main item.

Make the top of stock $\frac{3}{8}$ by 6 by 12 in., sized to $5\frac{1}{2}$ in. in width and 12 in. in length. Surface very carefully, testing for wind or twist by sighting over straightedges placed near each end of the piece. Set the smoothing plane down for a fine shaving, and finish with a scraper. If the grain is very curly, as is likely to be the case with figured wood, it is advisable to do nearly all the surfacing with a scraper. Gauge

for thickness and surface the other side to the line. Use the best side for the top.

The molded edge is detailed in the sectional drawing, Fig. 1. If no molding plane is available, rabbet the ends and edges $\frac{1}{16}$ in. deep from the faces and $\frac{1}{8}$ in. wide, afterward planing to roundness the corners of the tongue so made. If the ends are done first, splitting of an edge can be taken out when that edge is molded. Sandpaper roughly.

Use the same care in the preparation of the stock for the ends and sides. Make the ends exactly $\frac{5}{16}$ by 3 by $4\frac{5}{8}$ in., and the sides $\frac{5}{16}$ by 3 by $11\frac{1}{2}$ in. The ends of the sides are rabbeted to receive the ends of the endpieces (see Fig. 3). Lay out the shoulder marks $10\frac{5}{8}$ in. apart, squaring from the face edge, and, using the outside as the face side, gauge lines $\frac{1}{16}$ in. from the face across the ends and to the depth of the rabbet. Stand the piece in the vise and rip as in Fig. 2, splitting the line. When the rabbets are ripped, cut out the waste wood

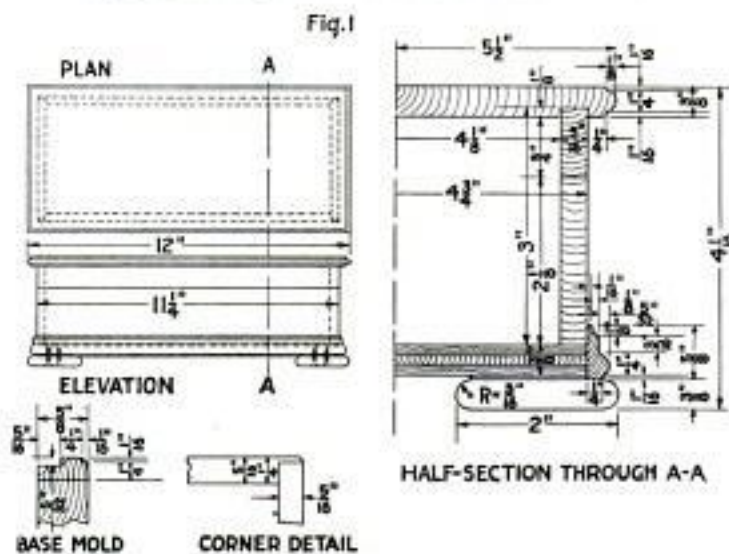
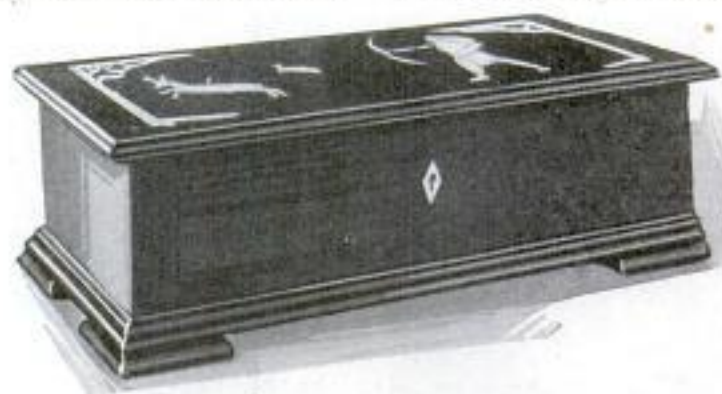

across the grain, Fig. 4, and mark the second side by the first. If the cut across the grain is made first, there is every chance that a miscut will spoil the piece. Unless the wood is very close-grained, size the end grain of ends and sides with liquid glue, and lay aside to dry.

Make about 3 ft. of $\frac{3}{8}$ -in. molding for the base of the box. Fig. 1 details this. Put a piece of $\frac{3}{8}$ -in. stock in the vise and rabbet one corner to a depth of $\frac{1}{2}$ in., with a width of $\frac{5}{16}$ in., while the other is rabbeted $\frac{1}{16}$ by $\frac{1}{16}$ in. Bevel the resulting corner in the wide rabbet, and with a small gouge carve the $\frac{1}{8}$ -in. cove. Round the raised corners to obtain the elliptical profile, afterward ripping the molding off.

Now scrape off surplus sizing glue and assemble the box by clamping the ends from the sides, Fig. 6, using blocks to prevent clamp bruises. Place these directly over the joints to avoid splitting the rabbet or opening the joints. If another pair of clamps are available, place them endwise; but if not, allow the glue to set a little, and then remove the side clamps to draw the ends up. Replace again on the sides. Square carefully, and then nail

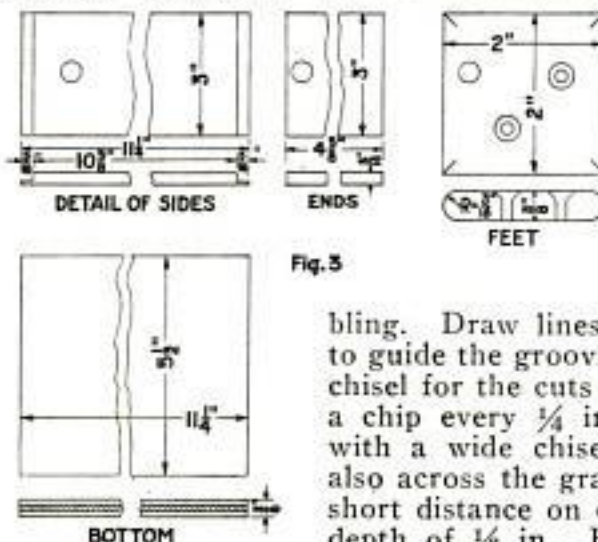
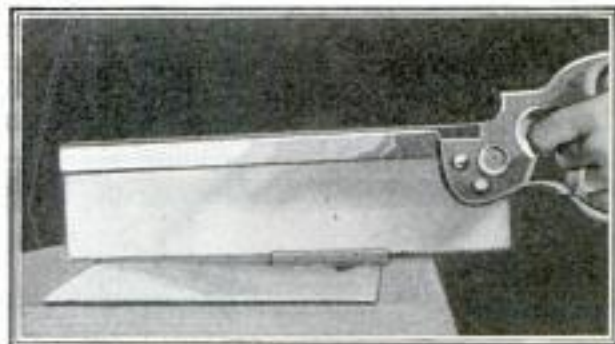

Fig. 2

Fig. 3

Fig. 4

pencil line $\frac{1}{16}$ in. from the bottom to guide the molding, which is mitered around and glued in place by spanning the clamps over the bottom with blocks bearing against the flats of the molds and the box sides, to prevent scars. This is easier said than done, but it can be done, and neatly. No nails should be used where they will show.



Lay the top, face down, on a bench, stand the box on it with even margin around, and scribe for housing into the top, marking one end for identification in assembling.

Draw lines $\frac{1}{16}$ in. inside the first to guide the grooving. Use a $\frac{1}{4}$ or $\frac{3}{16}$ -in. chisel for the cuts with the grain, cutting a chip every $\frac{1}{4}$ in., and trim the edges with a wide chisel. Use a wide chisel also across the grain, but only advance a short distance on each cut. Groove to a depth of $\frac{1}{8}$ in. Figs. 7 and 8 illustrate this process. Pyralin is obtainable at art stores in sheets as small as 10 by 12 in., which cost \$1.50 for 40-ply. Trace or cut out the inlay patterns and paste them to the ivory with glue, as in Fig. 10, and cut out with a jewelers' saw, which can be borrowed from almost any jeweler or art metal worker. A coarse blade, $\frac{1}{16}$ in. wide, is fine enough. Trim with a half-round needle file, beveling all places where undercutting is insufficient. Place the figures on the top as indicated in the photos, Figs. 1, 11 and 12. Holding each solidly, trace around it with a sharply pointed soft pencil. Lay aside the inlay, and carve out the mortises with a small gouge or knife. Beginning at the center, score across the grain with the knife point, removing chips with a light shearing cut, holding the handle in the right hand while the forefinger of the left guides the point. Avoid cutting too deeply. When near the outline, proceed more slowly, finally trimming almost to the



Fig. 2, Ripping an End Rabbet; Fig. 4, Cutting Out Waste Wood in Rabbet

over the bottom a piece of $\frac{3}{8}$ -in. three-ply panel veneer, using 1-in. brads driven at various angles to increase their holding power. This bottom piece may be cut accurately to size or may be nailed on and trimmed later (see Fig. 6).

When the glue is dry, remove the clamps, trim the projections of the sides and bottom, and smooth up. Gauge a

line with a rocking motion of the point, as in Fig. 11. If the outline is carefully followed, the inlay will clamp in so tightly, that aside from the change of color and texture, the joint cannot be seen.

Fill with glue and sawdust any too deep places in the mortises; lay in a heavy coat of celluloid cement and clamp in the inlay, using a scraper blade to protect from bruises.

Assemble the top with the box. When dry, scrape off all glue spots, and rub the moldings smooth with 00 sandpaper, using a small piece wrapped around a thin

the shellac, it will attack the ivory. If, as with mahogany, there is an open grain, rub on filler previously stained, and rub off across the grain. When dry, shellac,

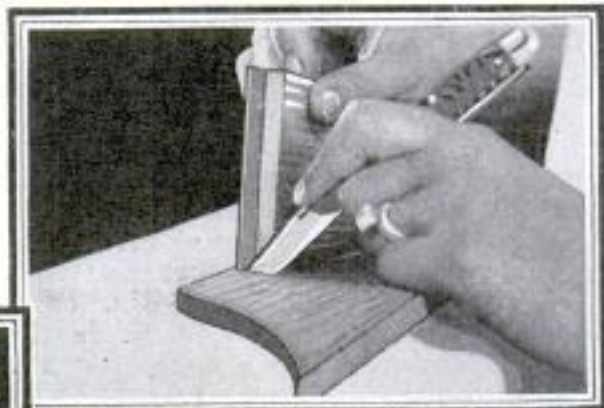

Fig. 5

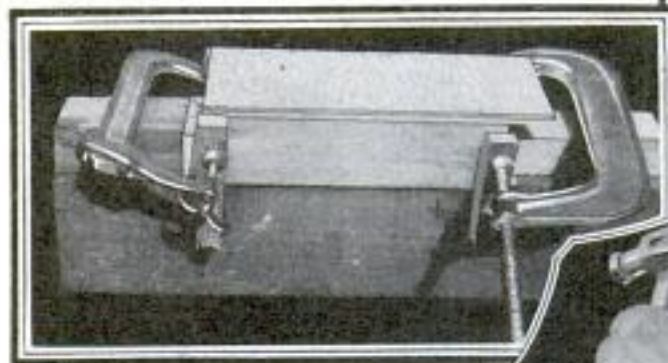

Fig. 6

Fig. 5. Using One Side as Template for Other; Fig. 6, Clamping Box; Figs. 7 and 8, Cutting Grooves in Box for Housing Side and End



Fig. 7

strip of wood, as shown in Fig. 12. Pay heed to the corner joints, bringing the profiles down to match without any dubbing off. Scrape the top smooth. Now set a pair of dividers or scribes for $\frac{3}{4}$ in. and scribe the lid joint. Rip sides and ends to this line. Rough off the edges with a plane, lay a sheet of sandpaper on a smooth surface, and rub the box edges to a true, smooth line. Hinge, and dap in lock and keeper. For the key escutcheon, inlay a diamond of ivory.

Grind the point of a three-cornered file to form a cutting tool, and engrave the necessary lines in the figures, filling them to emphasize them. Make the legs as detailed, securing them with two short screws. Shim the inside corners with cardboard.

Give the box a final smoothing up and inspection. With a tiny brush paint over the inlay with shellac, allow to dry, and then paint in the stain, working rapidly to insure evenness of color, and yet carefully, for if the stain strikes through



Fig. 8

and give three or four coats of varnish, rubbing each coat down with 000000 sandpaper. Finish by rubbing to a satin gloss with rottenstone and water.

Though not an orthodox method of finishing, the following will be found very satisfactory for the home mechanic. Set the box on a clean newspaper, and pour on the top a considerable quantity of varnish. With a clean, blunt scraper, or a straight-backed knife, level the varnish from center to each end, inclining the scraper in the direction of motion. This results in a heavy coat free from air bubbles, brush marks or bits of lint, the only likely defect being a slight waviness of surface. Next, trace around the molded edge with a varnish brush, avoiding wiping bristles over the top. Brush the sides and ends, working from the center toward the ends. When this coat is thor-

oughly dry, scrape smooth, rub with 00 steel wool and 6/0 split sandpaper, and repeat the process. To sharpen a scraper for this job, file the edge square, remove the burr, and hone to a gloss on a fine stone, polishing the faces as well as the edge. Clamp it in a vise, lubricate with beeswax, and with a burnisher or smooth gouge and light strokes, turn the corners to form the cutting burrs. This results



Fig. 10

Fig. 9. Full-Sized Layouts of Inlays, Ready to Cut Out and Paste to Pyralin; at Right and Left, on Top, Are the End Inlays; Fig. 10, Cutting Out the Inlays with a Jewelers' Saw; the Inlay Patterns Are Pasted to the Pyralin and the Patterns Are Cut Out, Then Trimmed to the Lines with a Small Half-Round File

Fig. 9

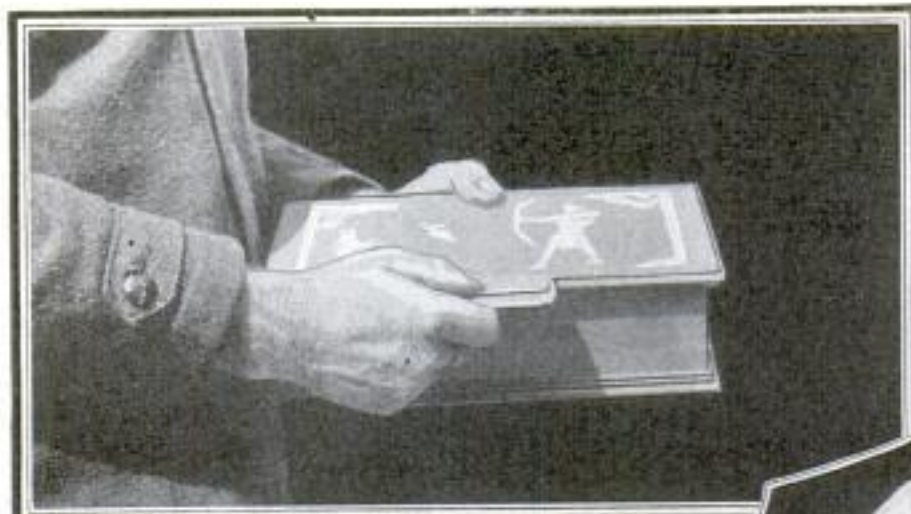

Fig. 12

Fig. 11, Trimming Mortise for End Inlay; Fig. 12, Sanding Top Molding

in a fine, keen edge that will not scratch the varnish.

Line the box with silk-covered pads made by covering cardboard forms softened with thin layers of cotton. Put in top and bottom pads, then side pads, and last of all the ends. Glue felt over the underside and feet.

Intensifying or Reducing Negatives with One Solution

Few amateur photographers are aware that there is a method by which they can either reduce or intensify negatives with perfect safety and ease, and by a formula that is practically fool-proof.

The negative should first be well washed and then immersed in a solution of sulphate of copper (blue vitriol), acidified with a few drops of sulphuric acid. The strength of the solution does not matter, as the effect is gradual and easily watched. The plate assumes a pale cream color, and this must be carried through to the glass back. Then a thorough washing is required. Now comes the point where the final result is to be decided. On the duration of immersion in the following solution depends the intensification or reduction of the negative.

Any of the developers used for paper can be applied as a redeveloper, preferably amidol or hydroquinone. In these, the negative can be restored to its original density; if taken out earlier, a reduction is obtained, or it can be held in the developer until it is of considerably greater depth than before. A trial with a few old negatives will give one familiarity with the peculiarities of this process. It is particularly adaptable to removing halation

in interiors or night photos, or converting a slow printer into an ideal negative. All depends on the length of time it is redeveloped. If the back is allowed to become entirely darkened, complete intensification will result, but

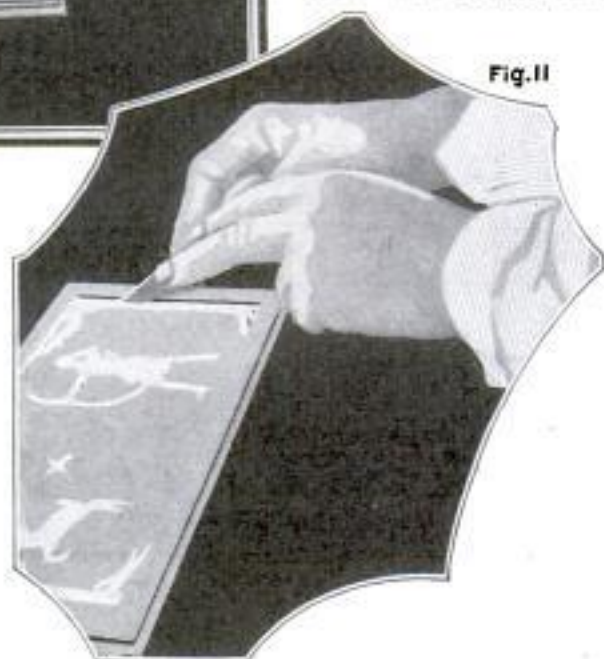

Fig. 11

any objectionable high lights can be left on the back for later removal.

Finally the negative, after a slight washing, is placed in an average solution of hyposulphite of soda (not an acid one—just plain hypo and water). In this the white portions of the negative are permanently removed, clearing it up and greatly improving its printing qualities. A thorough washing is then necessary.—George Parke, Chicago, Ill.

Ventilating the Feet

Those bothered with perspiring feet will find relief in the simple kink shown in the photo. Two holes are punched in the shoe at the point shown, about $1\frac{1}{2}$ in.



Two Shoelace Eyelets in Side of Shoe Prevent Excessive Perspiration of Feet

above the sole, and eyelets set in; any shoe-repair man will do this for a few cents. The holes are hardly visible when the shoes are worn so it does not detract from their appearance. The motion of the foot makes the shoe act as a bellows, drawing in and expelling air, which will keep the feet cool and prevent excessive perspiration. On cold days, a strip of adhesive tape pasted over the eyelets on the inside will make the shoe as warm as before.—R. W. McPherson, Lincoln, Nebr.

Neat Thread Cabinet

The thread cabinet shown in the photo was made from an ordinary file box. Holes are drilled through the front to permit the threads to be pulled out. Blind holes are made in the sides for wire spindles to carry the spools. These spindles are a little longer than the inside width of the box and can be sprung into place without needing much straightening afterward. To prevent the ends of the threads from slipping back into the box, a sheet of rubber, cut from an old inner tube, is tacked to the inside surface of the front of the cabinet. Small holes are made in the rubber and the threads drawn through. If desired, a small piece

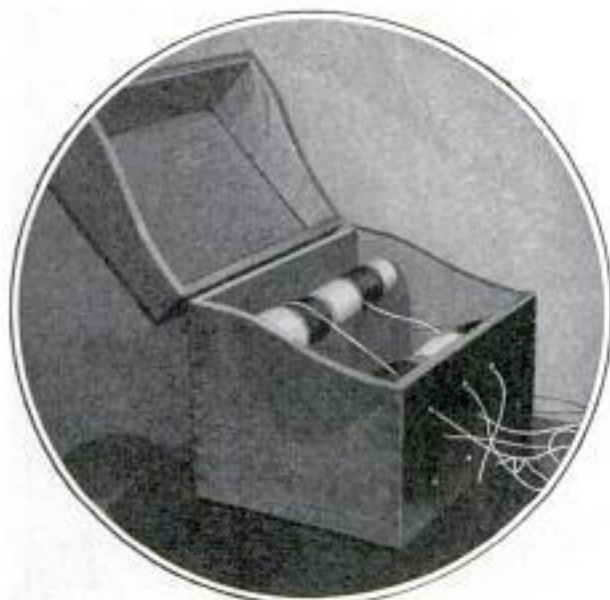

Simple Thread Cabinet Made from Old File Box

of paper can be pasted over each hole to designate the size of the threads. From 10 to 20 spools of thread can be stored in a single cabinet in this way.

Small holes in cooking utensils may be filled by a common pin, or piece of copper wire, inserted in the hole, riveted, and soldered.

Jack Fits Different Wagons

The main lever of the jack shown in the illustration is a piece of $1\frac{1}{8}$ -in. hardwood, 5 or 6 inches wide at the widest portion,

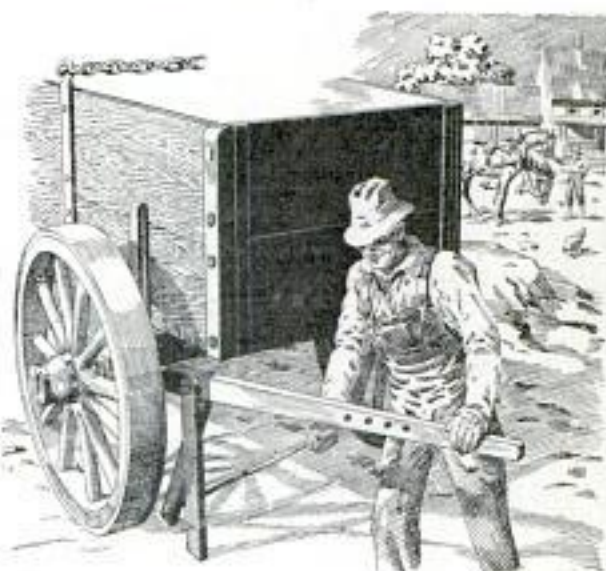

Simple Homemade Jack for the Wagon That Can Be Adjusted to Varying Axle Heights

and tapering to a width of 2 in. at the handle end. It is 6 ft. long. Two legs of the same material, and a little longer than the height of the wagon axle, are bolted loosely, one on each side of the handle, 10 in. from the wide end, with a $\frac{1}{2}$ -in. carriage bolt. A $\frac{3}{8}$ -in. rod, 40 in. long and having a hook forged on each end, is fastened to the right leg near the bottom. A row of holes is bored in the long lever, commencing 12 in. from the smaller end and spaced 4 in. apart to within 1 ft. of the hinge bolt. To use the jack, take hold of the handle with one hand and the rod with the other. Place the short end of the lever under the axle with the handle end a little above the level, and the loose leg resting on the ground back of the axle. Pull back on the rod until the other leg rests on the ground, then bear down on the handle and hook the outer end of the rod in one of the holes in the handle.

Simple "Bug Chasers"

There are two unusual and little-known methods of preventing beetles from attacking the young cucumber vines of the backyard gardener. One is to place a nasturtium seed in each hill when the cucumbers are planted. The other is to scatter pieces of mothballs about the plants. Both of these methods have been tried, and found to do the trick as well as commercial "bug chasers."—C. M. Wilcox, Torrington, Conn.

Making Gravity Feed Efficient

Failure of the gasoline to get into the carburetor when the car ascends a steep

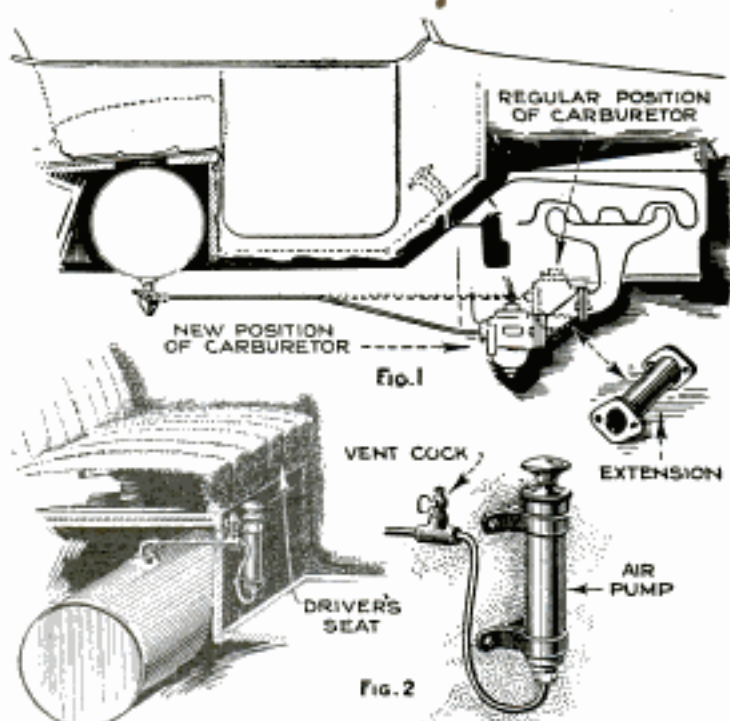

Two Simple Methods of Getting Gasoline into the Carburetor of Gravity-Feed Car When Ascending Steep Grades

grade is a difficulty frequently experienced by owners of Ford cars. This trouble can be prevented to a great extent by simply lowering the carburetor from the position indicated by the dotted lines in Fig. 1 to a position about 4 in. below, and cutting, bending and fitting the tubing to correspond. Such a shift necessitates the use of an offset extension to connect the carburetor to the intake manifold, which can be made from a short length of iron pipe provided with a flange of $\frac{3}{8}$ -in. flat iron welded to each end. The extension must, of course, be fitted tightly and gaskets used where connection is made to the carburetor and manifold. If this arrangement is not desired, the same result can be accomplished by providing a small hand air pump below the front seat, and connecting this to the gas tank, as shown in Fig. 2. The most convenient location for the pump is at the right side of the driver's seat. A hole is drilled in the top of the gasoline tank and a short length of copper tubing soldered in it. A vent cock is soldered to the other end and from the vent cock another short length of tubing is run to the pump. The gasoline-tank cap is fitted with a rubber washer permitting it to be closed tightly and the small air vent is plugged with a drop of solder. The air-vent cock in the pump line is al-

ways open when the pump is not used, to permit the entrance of air into the tank. But when a steep grade has to be ascended, the vent cock is closed and air is pumped into the tank. The increased pressure will then force the gas up into the carburetor so that no more trouble will be experienced.—G. A. Luers, Washington, D. C.

Finishing Wood Silver-Gray

One of the easiest ways of getting a silver-gray finish on wood is to use a thin stain made as follows: Thin 5 lb. fine silica with equal parts of coach japan and turpentine, then mix with $7\frac{1}{2}$ lb. white lead. Apply this to the wood and let it stand until it sets. Then, with a piece of stiff felt or leather, rub the mixture into the grain until it rolls up in small particles. Next take an old rag and rub the entire surface clean, so as to leave the filler in the grain of the wood while the surface is practically clear. The addition of a little lampblack or Prussian blue to the filler will give it a darker tint and make the grain more prominent.—A. C. Cole, Chicago, Ill.

Safety Device on Baby Swing

Baby swings of the kind shown in the drawing are more or less dangerous as the spring may jump off the hook, which, of course, lets the child fall. This danger of accident can be eliminated by using a length of strong cord and threading it through the eyes as indicated. Now, if the spring should come off, the swing cannot fall and the spring is not likely to strike the child's head, which happened in one case, causing brain concussion and resulting in death.—F. A. Inman, Grand Haven, Michigan.

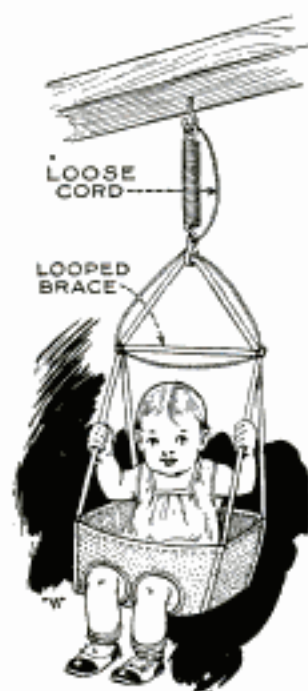

Easily Cleaned Poultry Nests

An Indiana poultry man who has arranged his nests in the manner shown in

on the ceiling and remain there for the night. Get out your vacuum cleaner and attach the hose and extension tube, which will enable you to reach the ceiling with

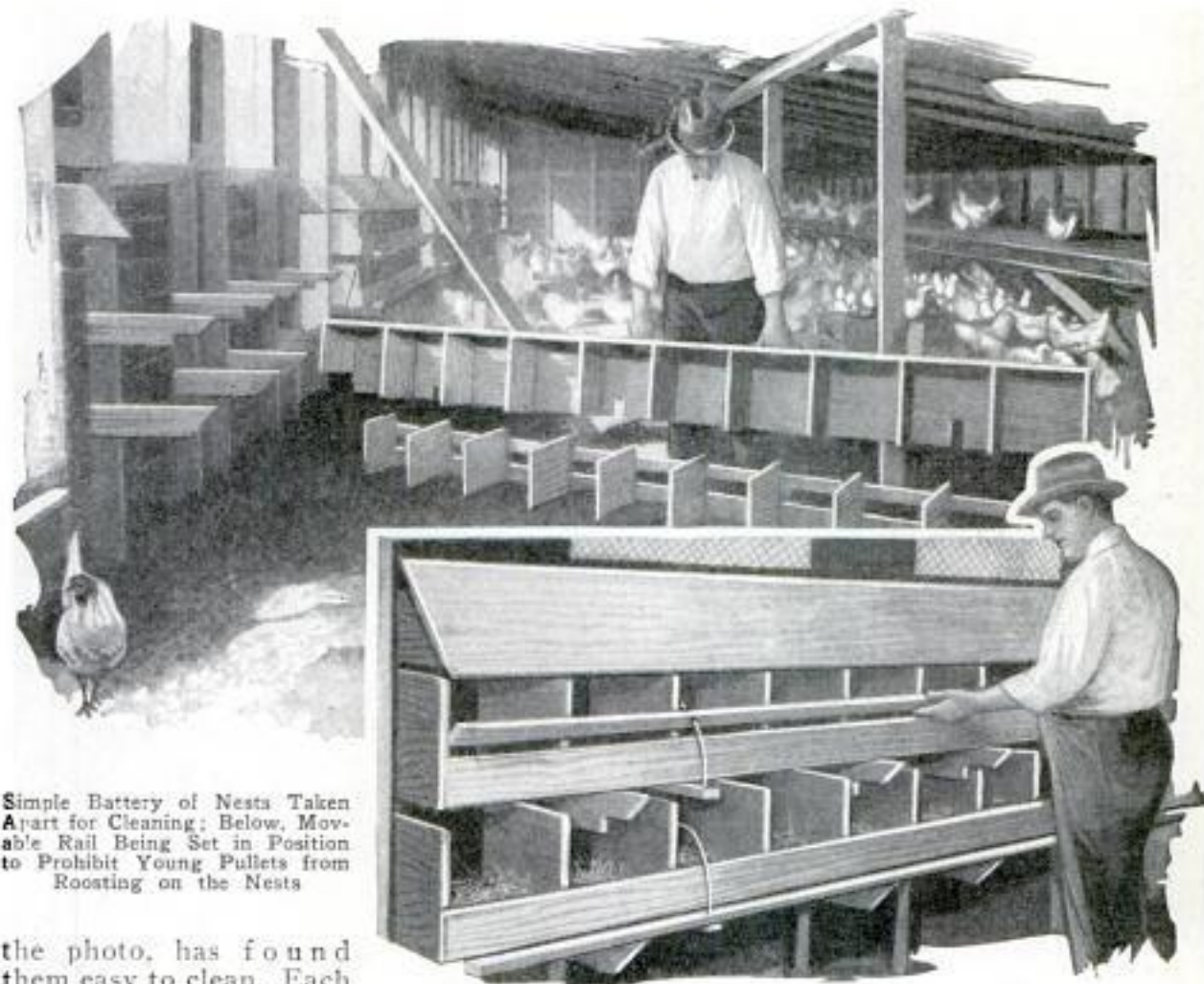

Simple Battery of Nests Taken Apart for Cleaning; Below, Movable Rail Being Set in Position to Prohibit Young Pullets from Roosting on the Nests

the photo, has found them easy to clean. Each unit has 10 nests and is suspended on brackets nailed to the studdings of the chicken house, as indicated. An extra rail runs along the unit to prevent young pullets from roosting on the front edge of the nests. This rail is a length of 2-in. pine, perforated so that it can be slid up and down on two guides of heavy wire. In its upper position the rail prevents the hens from roosting on the edge of the nests. After all the hens have found their proper roosting place at dusk, the rail is lowered so that fowls can get out in the morning.—J. C. Allen, West Lafayette, Ind.

Using Vacuum Cleaner as Fly Catcher

Swatting flies is effective, but it is a slow process of extermination and is to some extent a waste of time. Why not do the work effectively in a few moments? No matter how many flies have gained access to the house, just be patient and wait until evening. Then the flies get

ease. Now, start the vacuum cleaner and pull in the flies, keeping the open end of the extension tube about an inch below the ceiling. In a short time you will have quite a collection of flies in the bag.

Bumper on Carpet Sweeper

The usual strip of felt that is tacked around a carpet sweeper becomes hard in time, and often hangs in loops about the sides so that it becomes inefficient and valueless. A length of rubber tubing tacked around the sides of the sweeper will prevent marring of objects such as table and chair legs when the sweeper is used.



How to Make a Nodding Doggie

By W. P. MOTT

THE nodding doggie is an amusing toy for small children, and is not at all difficult to construct, neither is any elaborate tool equipment necessary. As may be gathered from the illustrations, it is made in three parts, the body and the movable head and tail. Two lengths of cord are attached to the movable parts, tied together some distance below the toy and provided with a small weight at the lower end. When the body of the dog is held in the hand by means of fingergrrips, and the weight on the end of the strings is allowed to swing like a pendulum the dog nods his head and wags his tail, in a manner very lifelike to the children, as shown in Figs. 1 and 2.

The parts for the toy can be cut from any easily worked soft wood. The simplest way to make the pieces is to cut them from wood of the proper thickness

to be cut into shape is laid out in $\frac{1}{2}$ -in. squares, the design can very readily be copied from the drawing.

The head and tail are pivoted in the body on small wire nails, care being taken to round off the corner of the body under the neck so that the head can swing downward freely when the toy is operated. When the parts have been assembled, the dog is mounted on a platform or base, $5\frac{3}{4}$ in. long, $1\frac{1}{2}$ in. wide and $\frac{3}{16}$ in. thick. Small slots are cut in this to take the small projections on the dog's feet, and the latter are then glued into the slots. The handgrip consists of two strips of $\frac{3}{16}$ -in. wood, $\frac{1}{2}$ in. wide and 4 in. long, glued or nailed to a $\frac{1}{2}$ by 1 by $1\frac{1}{2}$ -in. block, the ends of the strips and the block being joined flush, and the assembly then nailed to the underside of the platform, a little to the rear of the front feet and flush with the back.

The cords are 2 ft. 6 in. long and are passed through small holes drilled on the center line of the platform; one of these is drilled $\frac{1}{2}$ in. in front of the handgrip and the other $\frac{3}{4}$ in. behind it. The method of attaching the upper ends of the

cords is clearly shown in Fig. 4. The other ends of the cords are joined together and a weight of about 3 oz. hung to them.

In the original, a small nut was mounted on the front end of the platform so that the dog



Fig. 1

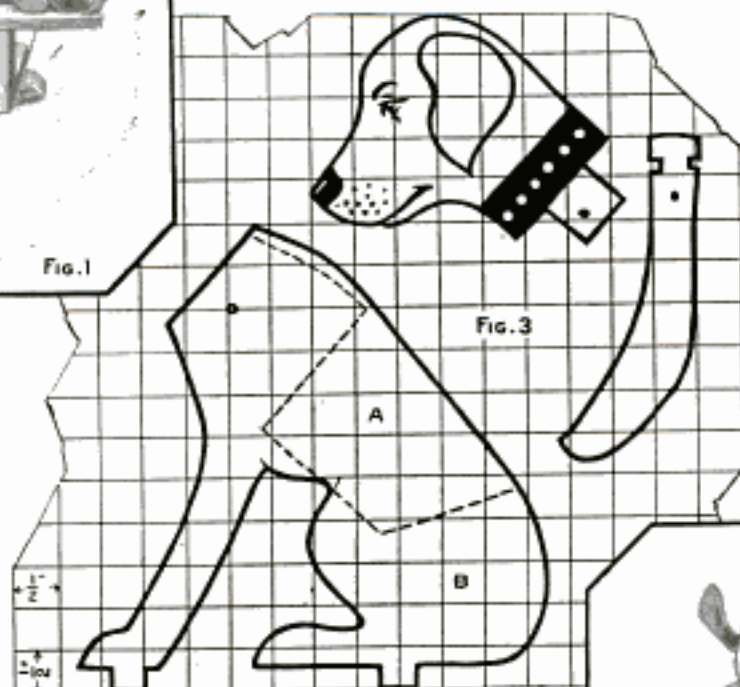

Fig. 3

Figs. 1 and 2 Show How the Nodding Doggie Works; the Center Drawing Is a Scale Layout of the Parts

with a coping saw or fretsaw, but, if these are not at hand, a good job can still be done with nothing more than a pocket-knife. The body is made in three parts; two like the full-line shape shown in Fig.

3 and one of the shape shown by the dotted lines and marked A, in the same figure. The three parts are then assembled as indicated in Fig. 4, so that a slot is left at each end of the body for the head and the tail. Fig. 3 details the parts laid out to scale, and if the wood

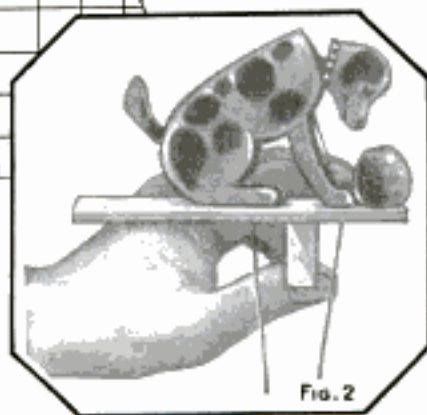
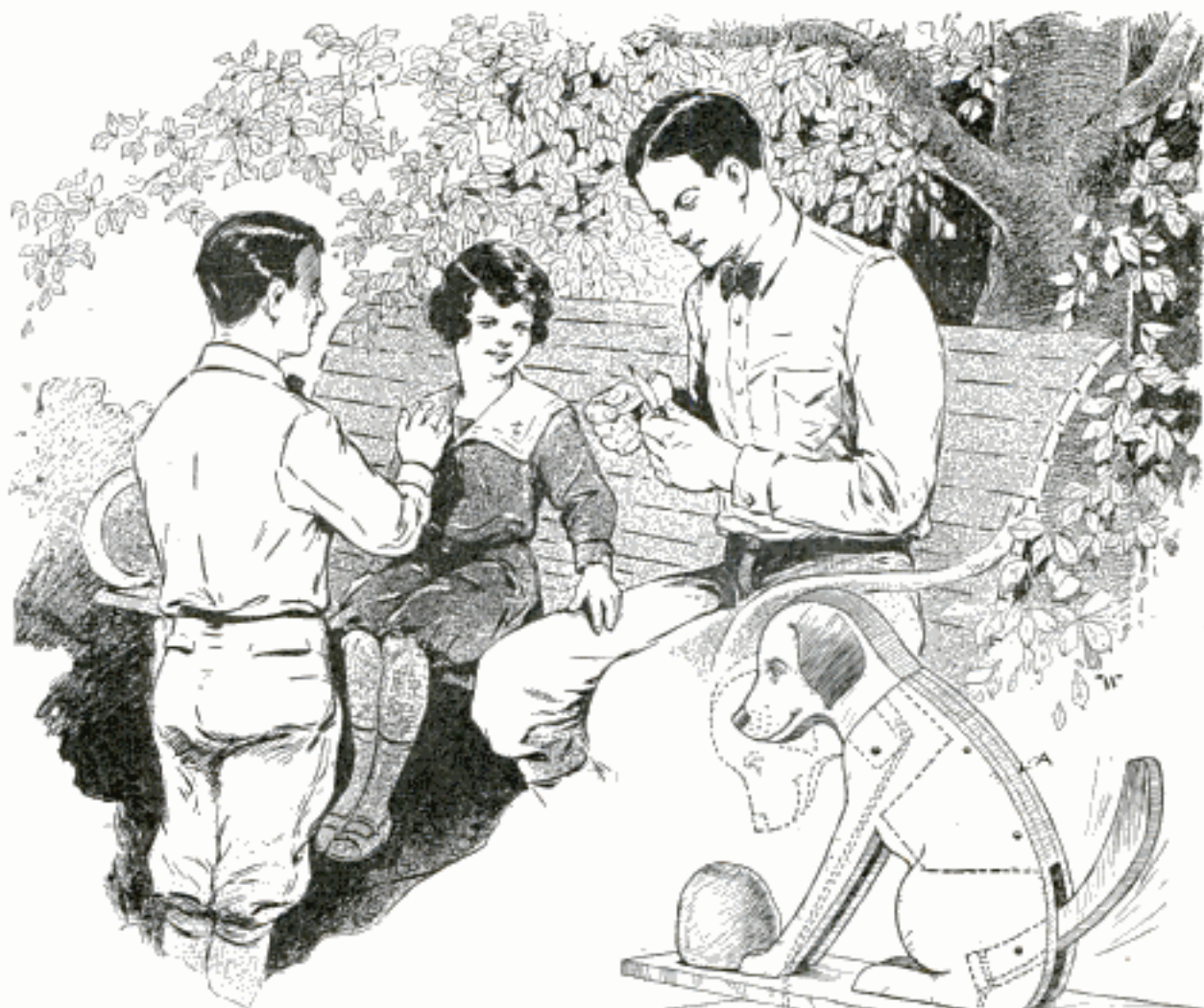

Fig. 2



Assembly of the Parts of the Nodding Doggie. Showing How the Cords Are Attached to the Head and Tail and Led through the Platform



appeared to be drinking from it, but this may be omitted if desired, or any similar device substituted for it. The coloring, too, may suit the maker. The original coloring is walnut with ears and muzzle burned to the correct hue with a hot

iron. By using any of the enamel paints that are made for toys and decorative articles, an attractive toy can be made.

Warm Up Engine as Soon as Possible Experts Advise

Experts of the bureau of standards have found that hot water in the jacket of the automobile engine helps reduce the thinning of the oil in the crankcase. In a cool cylinder, it is explained, the fuel is only partly vaporized, and the unvaporized gasoline does not burn. Instead, it remains in the cylinder and mixes with the oil, and is carried into the lubricating system of the engine. After a period of operation, the oil becomes so diluted that its lubrication value is considerably lowered, and it has to be replaced. A very small portion of gasoline suffices to produce

serious dilution in the crankcase. Everything possible should be done to warm up the engine quickly when starting, as dilution has been found to take place much more rapidly when starting than when the engine has reached its normal operating temperature. In fact, the consumption of gasoline when starting may be as much as twenty times the normal rate, and much of the unburned gasoline gets into the oil. Dilution is also made worse by frequent stopping and starting of the engine, with alternate short periods of warming up and cooling off. Dilution may also be lessened by high temperature of the crankcase oil, as heat tends to separate the gasoline from the oil.

Improved Typewriter Desk

When traveling, improvised methods of typewriting must often be devised. One salesman obtained a light, strong board,



Salesman's Method of Improvising a Desk on His Wardrobe Trunk

which fitted in his wardrobe trunk. When he desires a desk, the board is simply strapped on one section of the trunk and its front edge is supported with an iron-rod brace, as shown in the photograph. This rod is slipped through the pulls of the lower drawers and the upper end fits snugly in a hole drilled in the board.—P. C. Grose, McComb, Ohio.

Making Woven Chair Seats

There is an almost unlimited variety of materials that can be used for making woven chair seats. Rushes have been used, but they present certain difficulties, and considerable skill is required to join the leaves together to make a good job, so that this method is not advisable for the amateur. Two other materials, much easier to manipulate and to obtain, are fiber, which is merely strong paper twisted into a strand, and rope. There are three types of chair seats; square, rectangular and irregular. The first two are the easiest to weave and the last one presents only the slight difficulty of filling up the irregular spaces in the front corners. This, however, is easily learned after a few attempts.

The fiber or rope should first be dipped in water. In the case of fiber this means that it should be merely moistened, while the rope may be soaked without harm.

The moistening will cause the material to contract somewhat upon drying so that the finished seat will be tighter and better-appearing. Fig. 1 shows how the work of weaving a rectangular seat is begun. The loose end is tacked inside of one of the end rails, and the strand is then brought over and under the front rail, around the end rail and across to the opposite rail. This operation is repeated at each corner until the seat is completed. If the seat is square, the strands will meet in the center, but in a rectangular seat the end rails will be filled up before the side rails, and an open space will be left at the center as shown in Fig. 2, which must be filled up in some manner. This is done by bringing the strand over and under the sides through the center as shown. As the weaving progresses the seat is stuffed. This may be done with tough brown paper or newspaper, which is crumpled up and tightly packed into the seat with a curved stick. The most convenient method of doing the work is to cut off a long piece of the fiber or rope and hold it together with a rubber band. If it is necessary to joint two pieces, make the knot at some point where it will not show on top.

An irregular seat of the style most commonly seen is shown in Fig. 3. The first thing to do is to fill in the seat until the center is a perfect square. This is done by tacking the ends to the inside of the



Fig. 1

Chair Seats of Fiber or Rope Can Be Woven by Amateurs without Difficulty

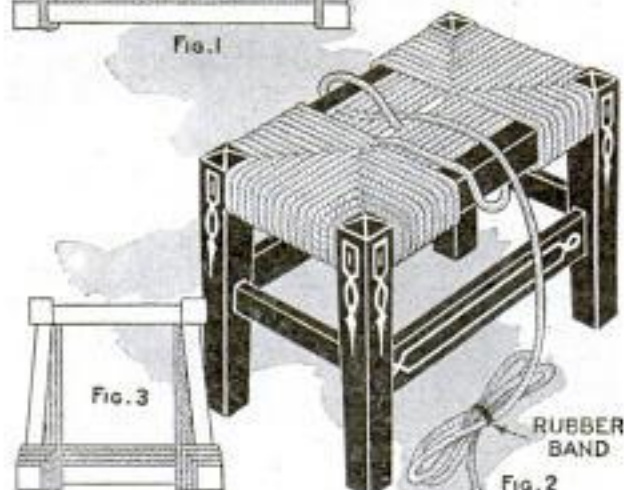

Fig. 3

Fig. 2

side rails, both ends of the strand being thus fastened. It will be noted that the operation of filling in the corners cannot be continuous. However, after the cor-

ners have been filled out, the weaving is done in the same way as described above, by starting to work from one of the corners at the back. After the work is done, the loose end of the material can be either tacked to the chair rails or inserted between strands and given one or two twists. The finishing touch is given by applying a coat of paint or other finish. This is usually necessary in the case of fiber, to prevent it from fluffing up and assuming a furry appearance after some use, and also to protect it against the weakening effect of moisture. In most cases the most pleasing effect is obtained by the use of green stain followed with a coat of shellac.

Making Large Shrunken Tub and Tanks of Wood Water-Tight

A small wooden tub had shrunk so much that the hoops did not hold the staves together, and would not hold water more



than a few inches above the bottom. No larger container in which the tub could be submerged was at hand, and so the following method was adopted: The tub was placed under a water faucet and a piece of canvas laid inside. A gentle stream of water was allowed to run into the tub, and it was found possible to fill the tub right up to the top, as the canvas sheet stopped the leaking almost completely. Once the tub was filled, the faucet was turned down so that only enough water ran into the tub to make up for leakage. Soon the staves had swelled to normal size, and the canvas sheet was removed. By using a piece of canvas large enough to overlap the edge of the tub, the process of swelling will be greatly hastened. This method is of particular value in case of tanks that are too large to be placed into a still larger vessel, or cannot be removed for this purpose.—C. A. Oldroyd, Barrow-in-Furness, Eng.

Easily Built Clothes-Drying Cabinet Fits over Radiator

In any house having steam or hot-water heat, a clothes drier, built over a radiator,

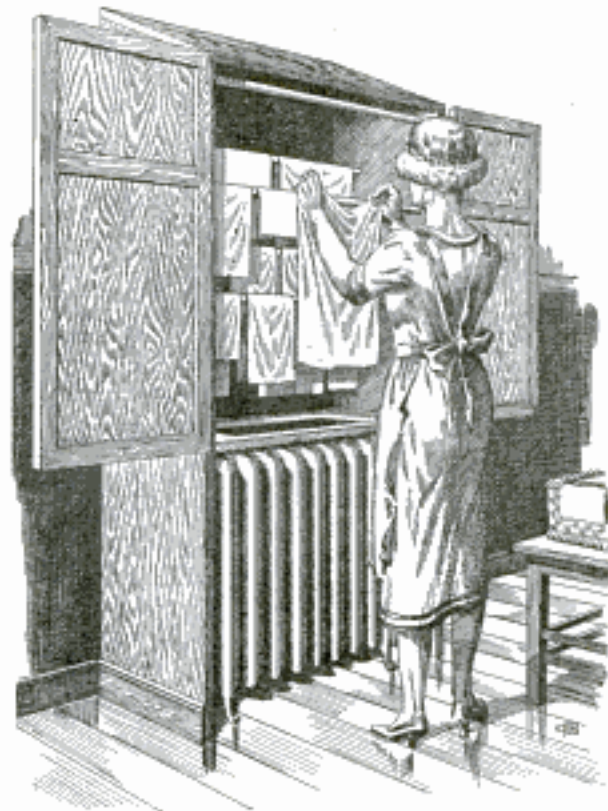

Household Clothes Drier Built over Steam or Hot-Water Radiator

will be found convenient. It is made of $\frac{3}{4}$ -in. lumber, and a neat job can be done without difficulty by a fairly experienced amateur. The bottom of the cabinet over the radiator is open, but the other parts are solid except that the top is perforated with a number of holes to let out the damp air. Round sticks are fitted inside to hang the washed articles on.—R. W. Watson, Yonkers, N. Y.

Doubling Life of Eraser

Don't throw away that typewriter eraser merely because it has been worn down to the circular metal support at the center; just about half of the eraser remains, and it can be used almost down to the last particle. Take a strong letter opener, or the blade of a pair of shears, and bend back the metal on each side of the rubber until it stands out at right angles at one part of the circumference. This leaves the rubber free for use, and the upturned metal serves as a support for the fingers, making the eraser actually easier to use than when originally purchased.—P. F. Wall, Chicago, Ill.

Auto Drives Corn Sheller

Driving a corn sheller from the rear wheel of an auto by friction is about the simplest method that can be devised, as



Corn Sheller Run from Rear Wheel of Auto by Friction

it dispenses with a belt or any kind of a coupling unit. The corn sheller is set at right angles to the rear wheel of the auto so that the flywheel touches the tire. Plenty of power is provided in this way.

Handling Lighting Current Safely

While the transformer and rectifier have made it possible to use lighting current instead of batteries for the amateur's purposes, some of these, particularly the younger ones, are likely to forget that a current of 110 to 220 volts is not quite the harmless power that batteries supply. Short circuits and faulty installation generally not only are sources of danger to the home, but may interrupt the service of the whole neighborhood.

The wiring must be run in accordance with the regulations of the national board of fire underwriters, which specify that no wire smaller than No. 14 shall be used; that this must be properly insulated and spaced; equipped with approved fittings, and have joints soldered. Every amateur should acquaint himself thoroughly with these regulations before attempting to wire his laboratory, for, if fire develops from any cause traceable to electric wiring, and these regulations have not been followed, there may be difficulty in collecting insurance claims.

The laboratory tap should be taken off the supply mains at some point between

the service switch and the distribution panel, thus making the laboratory circuit a branch circuit in itself. Then, if a short occurs, lights will not be affected provided the fuses are of the proper size. Of equal importance is the type of outlet used for connecting transformers.

The safest, simplest, and at the same time one of the most inexpensive forms of outlet, is a standard safety switch controlling a standard outlet box. It is inclosed in a steel box, fitted with fuses, and is so constructed that no current-carrying part can be touched while "live." The outlet is the kind used for connecting grills, toasters, and other household devices, and will receive any standard separable plug.

Fuses should be smaller than those in the service switch, say 6 to 10 amperes, if the latter are 15 or 20. Then, on a short, the laboratory fuses will blow without disturbing those controlling the entire house.

When using a chemical rectifier, it is always advisable to have the jars boxed in, or otherwise inclosed, so that wire, tools, or other metallic objects falling on the jar tops will not cause short circuits.

Renewing Worn Shirts

Shirts often wear out or tear near the neckband and are then usually discarded, even though the rest of the shirt is in

good condition. A simple repair, which makes it possible to renew the shirt without any sign of alteration, if it is done carefully, is shown in the illustration. The sleeves are removed and the top of the front of the shirt and a portion under each sleeve are cut away as indicated by the dotted lines. The neck-



band is then replaced and the sleeves sewed on again. The repair, if undertaken in time, need not shorten the front more than an inch or so.—F. E. Walker, Atlanta, Ga.

Discarded phonograph needles make excellent glazier's points; they are driven into the sash in the usual way, before the putty is applied.



All Shop Notes published in 1924, in book form—Fifty Cents—from our Book Department

Making a Soldering-Iron Heater

By C. H. STARR

AN arrangement that possesses many of the advantages of the electric soldering iron, but can be constructed at a fraction of its price, is shown in the accompanying illustrations. There are many cases where the cost of the electric tool is too high for the small-shop tinkerer, and this attachment will take its place with very little loss in efficiency.

The first thing to obtain is a piece of iron pipe of an internal diameter sufficient to accommodate the iron to be used. This is then wrapped with a thick layer of mica, which is held in place with a few turns of cotton thread while the heating element is being wound in place. The latter consists of two renewal elements for small electric heaters or toasters. Those used by the writer, for a heater wound on a piece of $\frac{3}{4}$ -in. pipe, were 110-volt 660-watt spiral heater elements. The two are connected in series by twisting the ends together tightly with a pair of pliers. The joint, of course, cannot be soldered. The terminal ends are made by winding two turns of iron stovepipe wire around each end of the mica-covered pipe and twist-

ing each end of the element and the two ends of each stovepipe wire together tightly. A length of asbestos tape, or a narrow strip of asbestos cut from a sheet, is wound between the turns of the element to serve as spacers, preventing the turns from touching each other accidentally, and thus short-circuiting part of the winding. A thick outer layer of asbestos is then wound or wrapped over the element and held in place by a winding of wire or

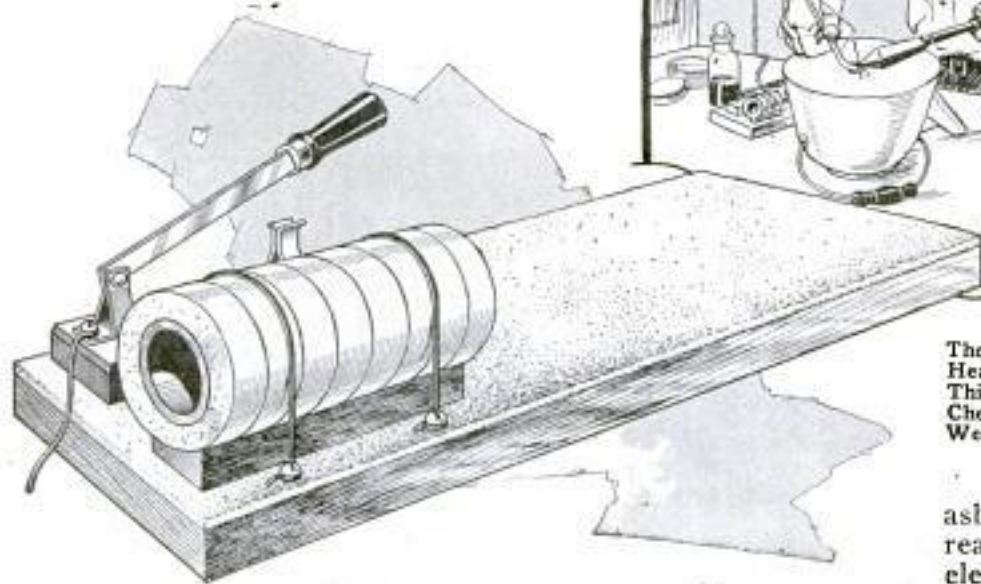

The Completed Electric Heater for Soldering Irons; This May Be Made Very Cheaply and Will Prove a Welcome Addition to the Shop Equipment

asbestos tape. The reason for using two elements in series is

that they are designed to operate singly in the open air, and, if used in the heater tightly wrapped in asbestos, where the heat cannot be carried off quickly, they would rapidly burn up. Resistance wire

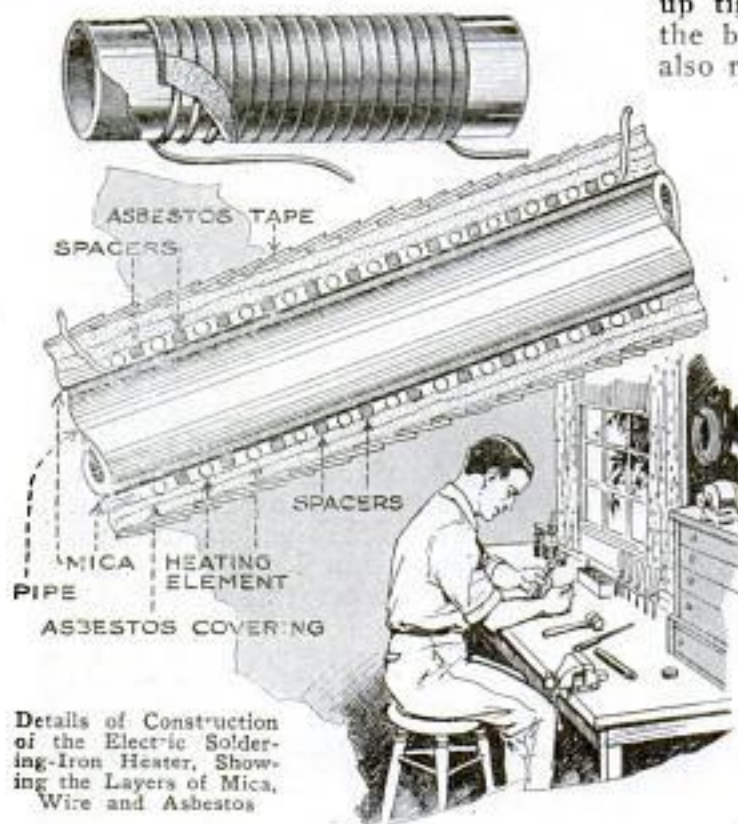

can be used instead of the heater elements for the winding, if the maker desires, but it is difficult to arrive at the correct amount of wire to give sufficient heat without burning up.

The complete heater is mounted on a piece of board of convenient size, the board being first covered with a layer of asbestos sheeting. A single-pole single-throw switch is mounted at one side of the heater, on the board, for shutting off and throwing on the current, and a holder for the soldering iron can be mounted at one end of the board. The heater can be fastened down, as shown in the drawings, by means of wire passed over the top and caught under the heads of round-head wood screws driven into the board. It is advisable to put some strips of sheet asbestos between the heater and the baseboard. The whole outfit can then be painted with water glass.

Remedying Worn Ford Hubs

Ford rear hubs and axle shafts sometimes become worn so that if the nut on the outer end of the axle shaft is drawn up tightly, the hub bolts will strike on the brake-shoe support bolt. They will also rub on the brake-shoe springs, causing a squeak much like a loose rim. Often the brake shoe will drag by rubbing with the outer edge on the brake drum when released.

As an alternative to replacing the hub or using a sheet-iron shim on the axle, the brake-shoe bolt can be removed and the head filed down thin. If the brake shoe drags, the outer edge can be filed or ground off slightly. Another plan, which is better than either of the above, is to remove the hub bolts and replace them with the heads inside the brake drum. As they are special carriage bolts with a short square part under the head, the holes in the brake drum must be either countersunk or squared by filing or with a drift. Because of the shortness of the squared part, only the drum need be changed. This leaves the nuts on the outside of the wheel, where they can be tightened when needed without removing the wheel. As the rounded heads of the bolts do not project so much as a nut and riveted bolt end, there will be more room inside the brake drum. A drawback is that the bolts would be harder to break off in case of anything jamming within the brake drum, and might cause more strain on the axle housings.

Novel Wire Straightener

We use an immense amount of fine spring wire for making a small clip used in radio construction, and unless the coil is taken out before making it into clips, it gives all kinds of trouble. The common type of straightening rolls did not appeal to us, so we took a small $\frac{1}{16}$ -hp. electric motor, which we had on hand, drilled a hole

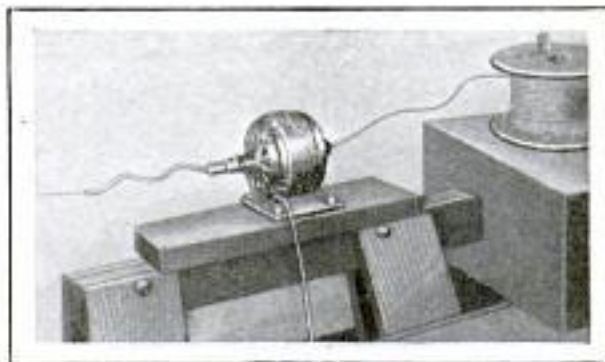

Taking the Coil Out of Spring Wire with a Small Motor and a Bent Tube

straight through the shaft lengthwise and attached a wavy tube to one end with a small collar and setscrew, as shown in the photo. The wire is taken direct from the spool, threaded through the hole in the spindle and the tube, and then into the clip-making machine. An automatic switch and cutout is used between the clip machine and the straightener so that the motor only runs when the clip machine does.—A. E. Granville, Cincinnati, Ohio.

A Brass Drift Block on Drill Press

When using small drills with tapered shanks in the drill press, it is necessary to use sleeves to build up the shank to the size of the hole in the press spindle. Generally these sleeves are slipped on the drill and then, by taking the drill in one hand, it is struck against the vise, bench anvil or other piece of iron. This keeps the tang of the sleeve all battered up and continually causes trouble when inserting the drill and sleeve in the spindle. The trouble can be overcome by fastening a soft brass block in a convenient place on the drill press and tapping the sleeves on this. The tang of the sleeve should strike the brass block.

Short Truck Makes Sharp Turns

On narrow piers, the short truck shown in the photo, has been found to be of great use, as its size enables it to turn around in a very small space. It is just an ordinary truck having the driveshaft shortened so that it measures only 6 ft. from hub to hub. The rear end is fitted so as to make a quick hook-up to a trailer possible.—W. M. Strong, Providence, R. I.



Truck with Shortened Driveshaft Makes Sharp Turns on Piers

Cutting Pipe at Angles

Cutting pipe accurately at an angle with a hacksaw is no easy job, as it is difficult to scribe a line on the pipe. However, by using the rig shown in the drawing, a clear mark can be made.



Time-Saving Method of Marking Pipe for Cutting at an Angle

All that is necessary is a stand with an adjustable top to hold the pipe at the desired angle, and a can of white paint into which the end of the pipe is dipped. The stand is readily knocked together in a few minutes. The top is hinged onto the vertical part and two slats are tacked on to hold it at the proper angle. The drawing clearly shows how the rig is used. After dipping, the pipe is set away to allow the paint to dry, or if the job must be done at once, a mark can be scribed along the edge of the paint. It is, of course, necessary to have both the stand and the paint pot on a level floor.—Charles Kugler, Philadelphia, Pa.

Walnut Stain for Cypress

To finish cypress like walnut, first apply a very thin coat of shellac to insure an even foundation. Then use a stain made as follows: 2 lb. burnt umber, 1 lb. raw umber, 2 qt. boiled linseed oil, 1 qt. best brown japan, and 2 qt. turpentine. First break up the oil color with japan, then add the oil and last the turpentine. Test the stain on new wood and vary the amount of thinner to obtain the desired color.

Milk-Bucket Support Holds Pail Conveniently

Holding a milking pail can be made much easier by using a support of the kind shown in the drawing. Take a piece of heavy wire about 5 ft.

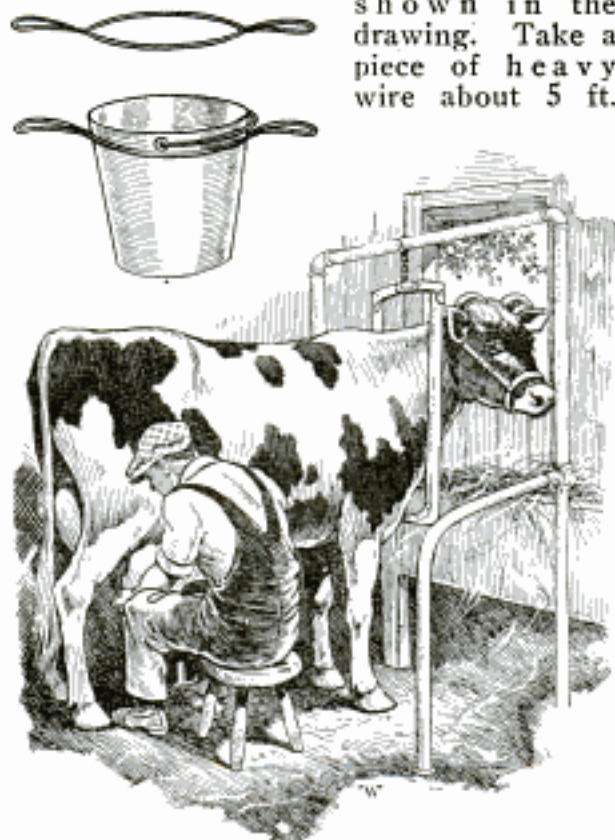

Simple Support for the Milking Pail Holds It Conveniently on the Knees.

long, bring the ends together and splice them. It is better to solder the joint so that the wire ends will not catch and tear the clothes. Set the milk pail inside of this loop, and twist the wire on each side near the top of the bucket to form two small handles of equal size. Give these handles a slight curve so that they will fit over the knees securely and at the same time comfortably.—Harold Pinkerton, Pawnee City, Nebr.

Taking Up Play in Brass Bushings

It is often necessary to take up the play in brass bushings such as used in all kinds of electric motors, gas-engine pistons, etc. It is customary to remove the old bushing and press a new one in place, and then ream it to fit the shaft that goes through it, but it is often necessary to replace such a bushing when there is no new one on hand. In such cases, an effective repair can be made by pressing the old bushing out and applying a thin coat of solder all around its outside, then round the edges of the hole slightly where the bushing is to be pressed in. Press the bushing back

in place and, with an adjustable reamer, ream it out to fit the shaft. A repair of this kind has always proved just as good as a new bushing and has saved many delays.—Ed Sundholm, Albert City, Iowa.

Removing Stains Caused by Fire

Stains on brickwork from fire and other causes can be removed with the following mixture: Take 1 gal. soft soap, 2 lb. fine powdered pumice and 1 pt. liquid ammonia. Mix thoroughly. Brush the surface of the bricks to remove the loose soot and dirt and then apply the mixture with a fiber wall brush or a whitewash brush. Allow it to remain on the wall for twenty or thirty minutes, then rub it briskly with a good scrubbing brush, dipping the brush occasionally in clean water.—A. C. Cole, Chicago, Ill.

Lead for High-Pressure Packing

In the shop it is sometimes necessary to devise containers, which will stand pressures in excess of 3,000 lb. per square in. Seamless containers, which are used for hydrogen, oxygen and other gases, will be tight under such high pressures without leakage. For shop purposes, however, the container must invariably be made up of pipe and fittings, or stock that can readily be machined. Welded joints in high-pressure containers are not entirely dependable because of the lack of uniform strength in the welded joint, and the possibility of error due to workmanship. A problem of holding a 4,000-lb. pressure

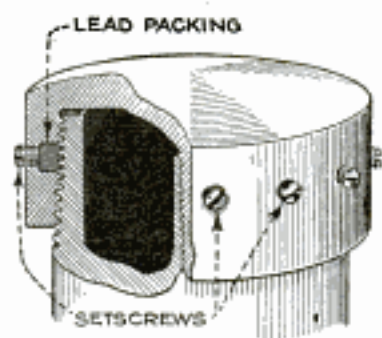

progressed through various stages of experimenting. The most commonly used method of making a tight joint by tinning the parts and sweating

them together failed entirely, presumably due to the expansion of the parts when they were subjected to pressure. The final solution, which is shown in the illustration, was found in the use of lead packing. A circular groove was turned in the inside of the cap, which screwed onto the body, and this groove was filled with lead, made tight with a number of packing screws, driven from the outside. With this seal all leakage can be elimi-

nated. It is not necessary to use a single length of lead for this joint as lead pellets under the screws will serve the purpose just as well, these being forced together under the pressure of the screws. More lead can always be added if leaks develop. Besides the simplicity of this form of packing, which makes it extremely useful, it has the advantage of being readily disassembled when this becomes necessary as is frequently the case.—G. A. Luers, Washington, D. C.

Quick Well-Drilling Method

A well can be quickly drilled as shown in the drawing if the soil is not too rocky or sandy. The work is done by three men. One pumps the water and two manipulate the pipe. The pipe should be churned up and down and twisted to agitate the dirt at the bottom of the hole and to mix it with the water, so that the dirt will be washed up out of the hole. As the hole deepens, more pipe is added at the top, and, if desired, the pipe can be left in the hole when completed. This method cannot be used successfully where strata of gravel are encountered unless one has some other means of getting through the gravel. The writer used this method to sink a well 25 ft. deep and the whole operation of drilling consumed only about one hour after spudding in.—Ed. Wetzel, Union, Oreg.

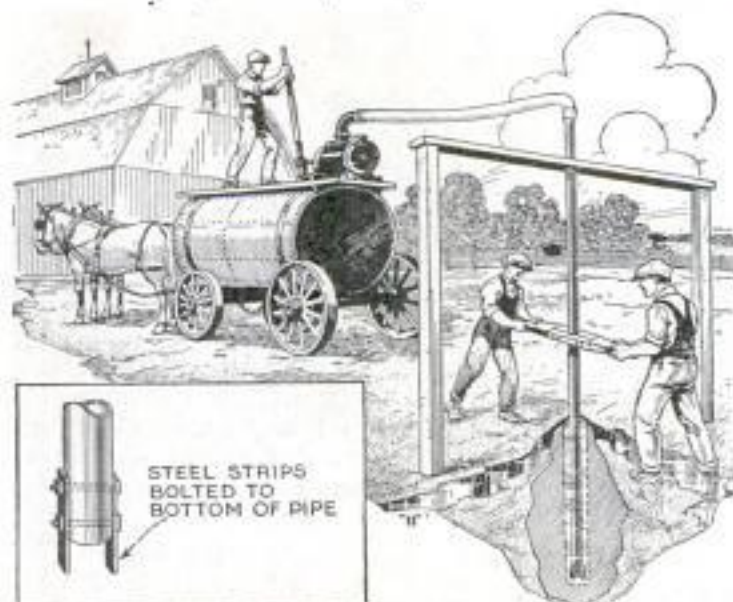

A 25-Foot Well Can Be Sunk in One Hour by Using This Method of Drilling



Conveyor Carries Plaster to Floors of Building to the Plasterers in Three Minutes

Plaster Conveyor Saves Time

In finishing a large building, the contractor saved much time and labor by rigging up the conveyor shown in the illustration, which delivered the plaster to the three stories directly on the worker's mortar boards in about three minutes. The sand, gypsum and water are mixed in a rotary concrete mixer and discharged onto a 16-in. rubber belt set at an angle of 45°, the speed of the belt being so regulated that the plaster cannot slip back. At the discharge-end a taut wire scrapes the material from the belt into a small car which is pushed around on a narrow-gauge track to the mechanics. As each is reached the material is shoveled onto his mortar board as required.

Where exceedingly accurate, smooth holes are required, there is no better tool to produce them than a properly made carbon-steel hand reamer, and if the work must be done in a chucking machine, a carbon-steel chucking reamer. This is particularly true of brass.



Files and How to Use Them

A Popular Mechanics Model Workshop Article

Part I

THE file, like the chisel, is one of the oldest of mechanics' tools. Not even the machine tool has supplanted the file, although, of course, the machinist is no longer dependent upon the file alone for producing flat, true surfaces on metal. The word true is used in a comparative sense, of course, although the mechanic who has mastered the use of the file can produce a remarkably true surface with it. The machine tools, such as the planer, shaper and surface grinder, have taken the place of the file and scraper for making broad metal surfaces flat and true, but for other purposes, the file still retains all its original usefulness. In the jobbing shop especially, the file is the indispensable tool, and facility in its use should be an aim of every budding mechanic. Once learned, the art is never forgotten. To the uninitiated, it might seem that "anybody can use a file"; this is true, but comparatively few can use a file properly and effectively.

A knowledge of the various types of files and their uses is necessary before we go on with any discussion of how to use them. There is a wide variety of shapes and sizes

of files and a number of different "cuts" for each shape. Many of the shapes are used but seldom in the machine shop, but the mechanic should know something of them all.

Files are classified not only according to their shape, but also according to the cut, and there are three general cuts in common use, the single cut, double cut and rasp. The single-cut file has single rows of teeth cut parallel across its faces at an angle of from 65 to 85°, depending on

the form of the tool and the work for which it is intended. The double-cut file has two rows of teeth cut on each face crossing each other; the angle of the first row (the "over" cut) is from 40 to 45° for general work, and the angle

of the second (the "up" cut) from 70 to 80°. This is changed in files intended for finishing work to 30° for the over cut and around 85° for the up cut. The latter is generally slightly finer and not quite so deep as the over cut. The tooth formed by the double cutting is broken in shape, and the cutting face of the file presents

a number of small pointed teeth, inclining forward. Fig. 1 shows the difference

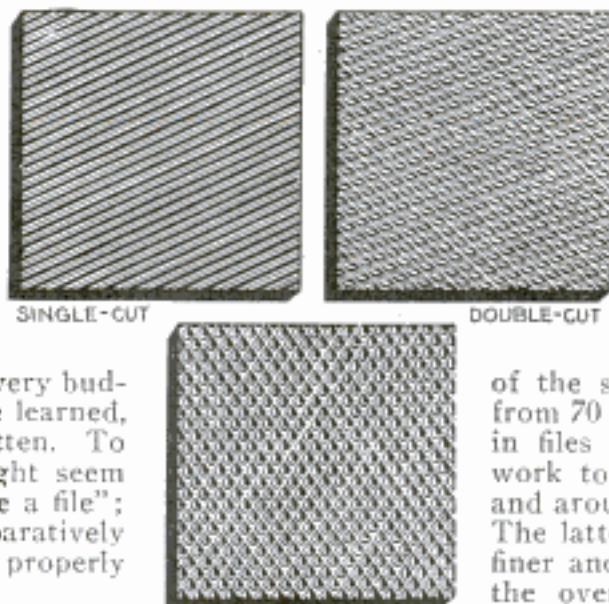

RASP
Fig. 1

between a single-cut and a double-cut file and also the third cut, the rasp. The teeth of this file are formed by a punch instead of by a chisel, consequently they are disconnected and do not extend across the file like the others.

The spacing of the teeth forms a further division of single and double-cut files. The names of the different grades, ranging in order of their spacing, are as follows: rough, coarse, bastard, second-cut and smooth for single-cut files; and coarse, bastard, second-cut, smooth and dead-smooth for double-cut files (see Fig. 2). It will be noted that the rough files are usually single-cut and the dead-smooth double-cut. As the length of the file increases, the number of teeth per inch decreases, so these grades can only be compared in files of the same length. There is a wide variation in the number of teeth per inch of length in files made by different makers, but a fair average is as follows: bastard, from 20 to 25 teeth per inch; second-cut, from 30 to 40; smooth, from 50 to 60; dead-smooth, up to 80 per inch. Fine Swiss files and "American Swiss" run from about 40 to 200 teeth per inch. There are a number of other definitions that the machinist should be familiar with, among them the following; see Fig. 3: The length

of a file means the distance from the heel to the point, and does not include the tang. The heel is the portion next to the handle. The back is the convex side of a half-round or similar file, and a file is termed bellied when it has a fullness in its center. A file is safe-edged when it has no teeth cut on one surface, so that this side may be presented safely to a surface that does not need filing. A file whose sides are thinner at the point than at the middle is called tapering or tapered, and it is full-tapered when it is thinner at the point and heel than at the middle. A blunt file is one that has the same sectional shape from heel to point.

Figure 4 shows a number of the most common shapes of files used in the shop. The hand file is the one generally used by machinists for finishing flat surfaces. It is tapered in thickness from the middle to the point, but parallel from the middle to the heel. The edges are generally parallel from point to heel. It is usually double-cut, and comes in bastard, second-cut, smooth and dead-smooth grades. Flat

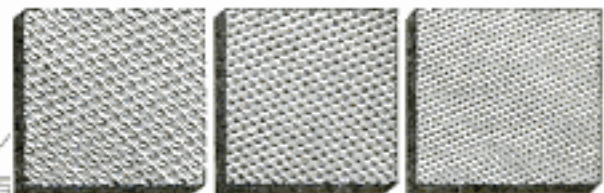

FIG. 2

Bastard, Second-Cut and Smooth Cuts; Fig. 3, Illustrating the Various Terms Used in Describing Files

files are parallel both in thickness and width from heel to middle and tapered in both sections from middle to point. The teeth may be either single or double-cut, and of the same grade of cut as the hand file. It is one of the most useful

files in the shop and is used for a wide variety of work. For lathe work, many mechanics prefer the mill file, which is parallel in thickness from heel to point, and tapered in width from middle to point. It is extensively used for draw-filing and is also used for sharpening mill saws, in which case a round-edge file is generally used to file the gullets of the saw.

Another very useful file is the pillar file, which is like the hand file, but nar-

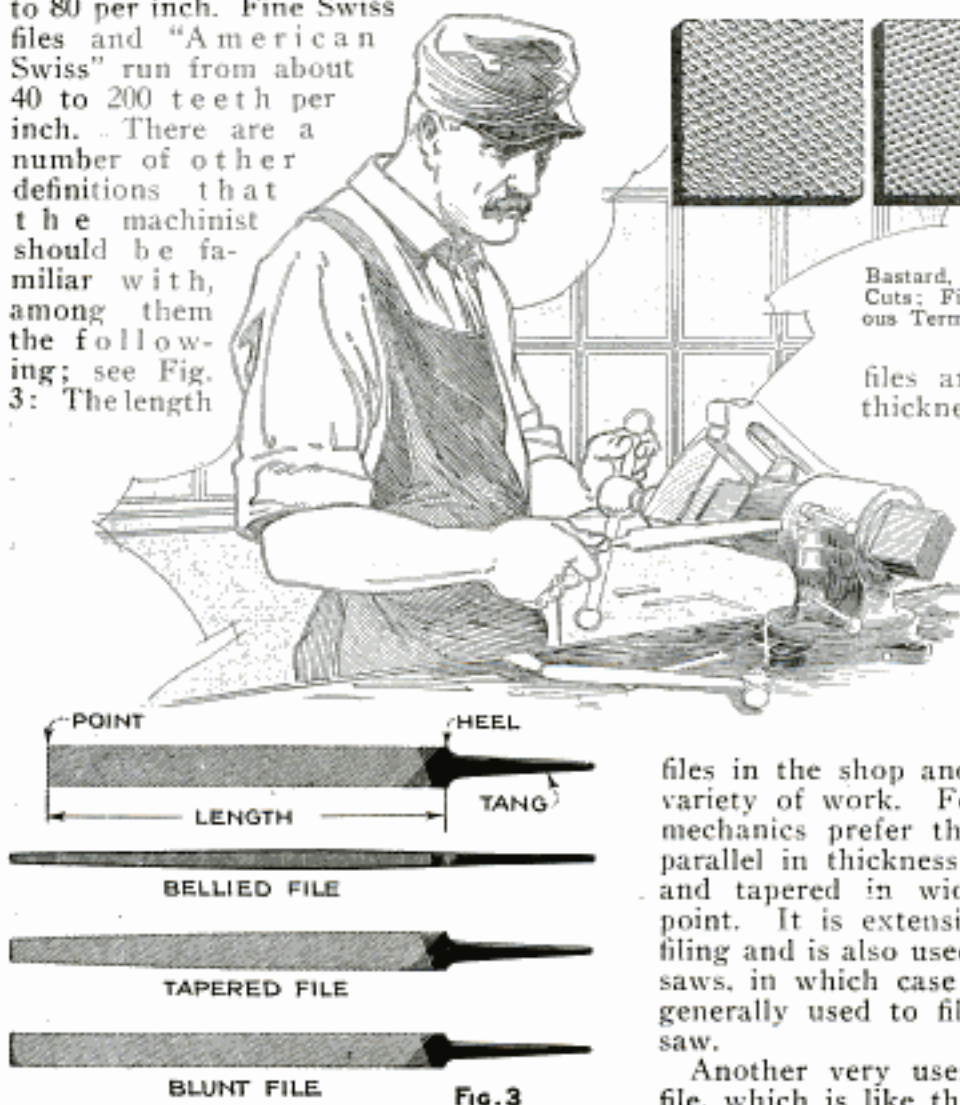

FIG. 3

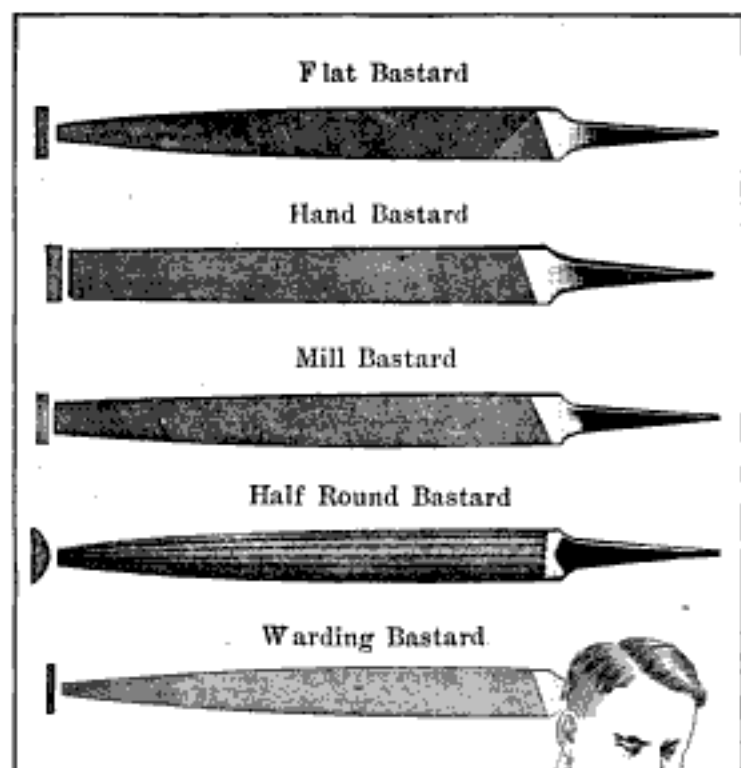

Fig. 4

A Number of the Most Commonly Used Shapes of Files, the Bastard Cut Being Generally Used

rower and shorter. The double-cut bastard is the one most generally used. Round files are made both tapered and blunt, the bastard cut being favored for slotting, enlarging round holes, filing fillets, etc.; slim round or rat-tail files are of regular length but are smaller in diameter. Square files are also made either taper or blunt, and are principally used for enlarging square slots and holes, filing keyways, and work of a similar nature. Both forms have usually bastard double-cut teeth.

The half-round file—a favorite in the shop—is not really half-round in section, but only about one-third of the circle. The commonest file of this class is double-cut and bastard, but second-cut and smooth half-round files are also generally used in the shop. The convex side of files of finer cut than the bastard is single cut. This file is extensively used for finishing curved surfaces, such as fillets that are

of greater radius than can be filed with a round file, for enlarging holes, relieving the lips of brasses, etc. Warding files, as their name indicates, are used by locksmiths for filing the wards of keys, but they are also used in the machine shop to a large extent. They are of the same thickness from heel to point, but considerably tapered in width from the middle to the point. The file generally used in the shop is double-cut, bastard and smooth. The knife file also has a name that indicates its form as it is shaped somewhat like the blade of a knife. It tapers toward the point and also toward one edge. The cuts used are the same as those of the warding file.

The three-square or triangular file has three sides of equal width, and is made in the taper, blunt and slim forms. They are usually double-cut, bastard, and are useful for filing angular surfaces of many kinds. The angle of the sides is 60 degrees. There are many other shapes of files, such as the pit-saw, the tumbler, the handsaw, the featheredge, and the cabinet, but as these are but little used in the machine shop, they will not be

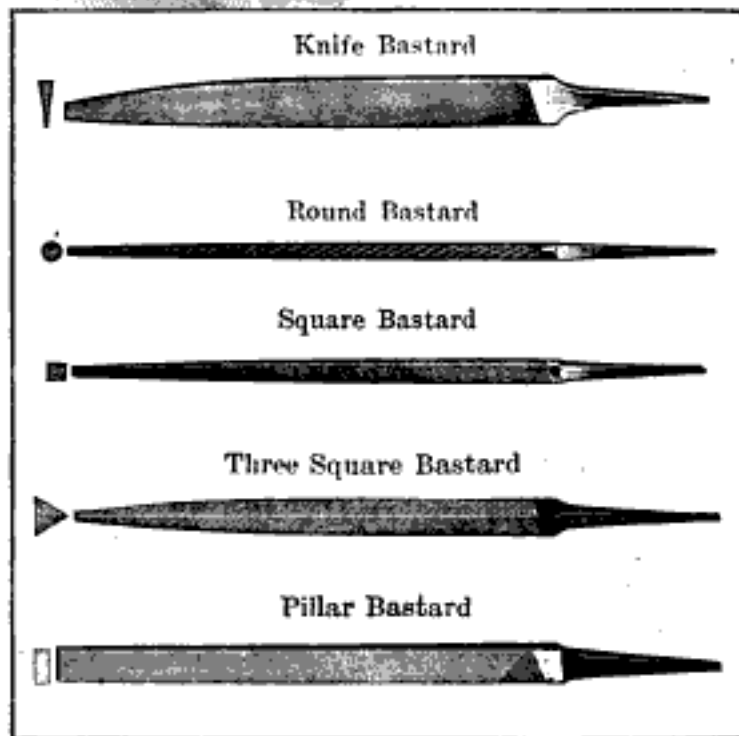

considered here. Those who wish to study the subject of files further will find all the information they require in the literature of the file manufacturers.

However, there is another class of files that are generally used in the shop by the toolmaker, and, as these files are also of use to the machinist, they are illustrated in Fig. 5. These are known as files of precision or toolmakers' files, and range in length from about 2 to 12 in. The range of cuts is from about bastard to super-smooth, and then there are cuts beyond super-smooth that have no equivalent in the ordinary machinists' file. The cuts in toolmakers' files are numbered, and the numbers run from No. 000, which corresponds approximately to a rough-cut, to No. 8. Number 2 is about the same as super-smooth, and the numbers from 3 to 8, as previously mentioned, have no equivalent in the ordinary file.

Figure 6 illustrates a file of en-



Fig. 5

Toolmakers' Files or Files of Precision; These Are the Shapes Most Used in the Shop



tirely different characteristics from all the others previously described, the circular-cut file.

This is the Vernaz file, named after the inventor, and known in the United States as the vixen file. It is also known in some shops in England and Ireland, as a milling file, from the resemblance of the teeth to those of a milling cutter. As may be seen from the illustration, the teeth are milled from the solid metal, instead of being raised from the surface of the file by the action of a chisel, as in the usual process of file cutting. The teeth being curved make the cut a shearing one, and it is found that the edges cut well whether the file is driven straight or at an angle. The file is also self-clearing, and produces very smooth surfaces, as it does not "pin" or retain small particles of the metal being cut between the teeth, thus scratching the surface. On wrought iron, mild steel and similar fibrous metals this file is considered much better than the common form.

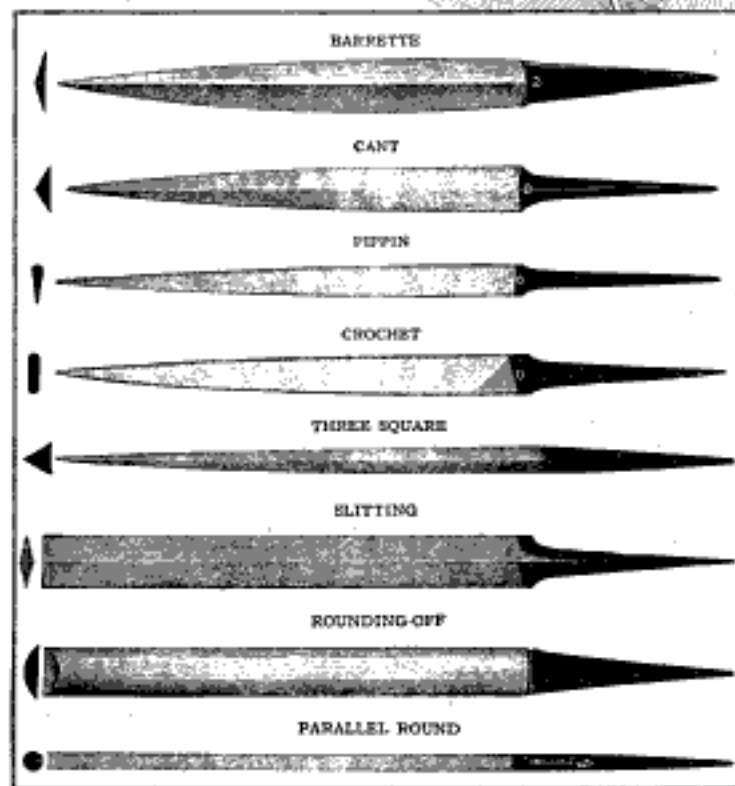

The proper method of using files for work of various kinds will be described



Fig. 6

The Vixen File, Which Has Teeth of Entirely Different Shape from the Ordinary

in the second part of this article, which will appear in a succeeding issue.

Method of Removing and Preventing Scratch Marks from Matches

There are many places where it is very hard to remove as well as prevent match-scratch marks. The following method has been worked out, and is so successful it is well worth knowing.

To remove the scratch marks the only substance that will really clean up the woodwork is soap and the application of a stiff nailbrush. But the method of preventing these bothersome marks is simple and very effective. Obtain a small quantity of albolene and rub the woodwork well with it, then remove surplus with a flannel rag. You can scratch all day and no marks will result, neither will the match light.

Creosoting Poles Set in Ground

A telegraph company has developed a method of creosoting telegraph poles that are already set in the ground, to prevent rotting at the ground level, where decay usually begins. A hole, about 1 ft. deep, is dug around the pole and in this a cylinder of sheet metal is set, leaving about an inch clearance between the pole and cylinder. The edges of the sheet metal are soldered together and melted sulphur is poured in between the cylinder and the pole

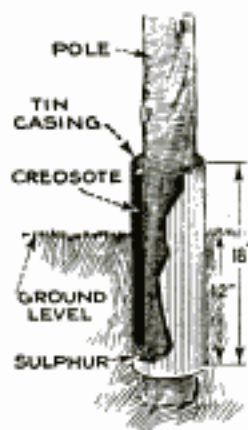

and allowed to solidify in order to form a waterproof bottom, about 1 in. in thickness. In pouring the sulphur care is taken to avoid coating the wood, which would defeat the purpose. The container

thus formed is then filled with creosote. The hole outside of the tin casing is filled up again. The creosote will gradually penetrate the wood up to a distance of about 2 ft. above and below the ground line. In this way the pole is protected nearly as well as if it had been impregnated at the butt in the regular way before it was set in the ground.

Double-Purpose Counter Aids Toolroom Storekeeper

The drawing shows an improved store-room counter over which tools and materials are passed to the shop. Half of the counter is flat and the other half is made to form a box. Constructed in this way, any kind of material can be handled conveniently. Some parts are best handled by sliding them over the counter, while



Shop Storeroom Counter Found More Useful Than Ordinary Counter

other pieces that might roll off are more safely handled by placing them in the box. The counter is hinged at one end so that the doorway can be used for the passage of trucks when necessary. Steel plate, about $\frac{3}{16}$ in. thick, is the material used in making the counter.—Harry Moore, Montreal, Can.

Ⓞ The use of shale, slate, soft limestone, and any other material that crumbles, slivers, or peels off should be avoided as an aggregate in concrete.

Pipe Cleaner for Inaccessible Parts of Typewriter

The usual cleaning brushes for typewriters are often too thick and bulky to reach into the corners of the mechanism and between parts placed close together, such as the type guide in front of the ribbon and the shuttle through which the ribbon passes. A pipe cleaner of the brush type makes an excellent cleaner for these. It is inserted from the top between the parts to be cleaned, and when withdrawn, it will carry away the dirt lodged there. Care must be taken, however, that the cleaner does not become wedged by pulling it out with too much force.

For cleaning similar small mechanisms, such as clocks, electric motors of fractional horsepower, etc., the pipe cleaner will also be found invaluable. If the parts are spaced too far apart to be effectively wiped with the cleaner inserted in the usual way, it may be doubled up so that it provides a surface of twice the former width. For oiling inaccessible parts, too, the cleaner is very useful, principally on account of its length. It is dipped into the oil bottle for about $\frac{1}{2}$ in.; the material forming the brush of the cleaner will then absorb sufficient oil to lubricate several small bearings. A new cleaner should be used every time a mechanism is oiled.

Hook for Suspending Fowl

If one has many chickens or squabs to kill and pluck, the device shown in the illustration will save both time and labor. It consists of a piece of heavy galvanized-iron wire, bent to the shape shown, the ends being bent over to form hooks. The device is hung from the ceiling by means of a cord. In use, the legs of the fowl are slipped into the hooks, holding the bird in a convenient position for plucking. This method of suspension is better than the use of a rope with a slip noose.



Simple Tool for Examining Tires before Vulcanizing

When a tire is taken to a vulcanizing shop for repairs, the workman makes a thorough examination of the inside to de-

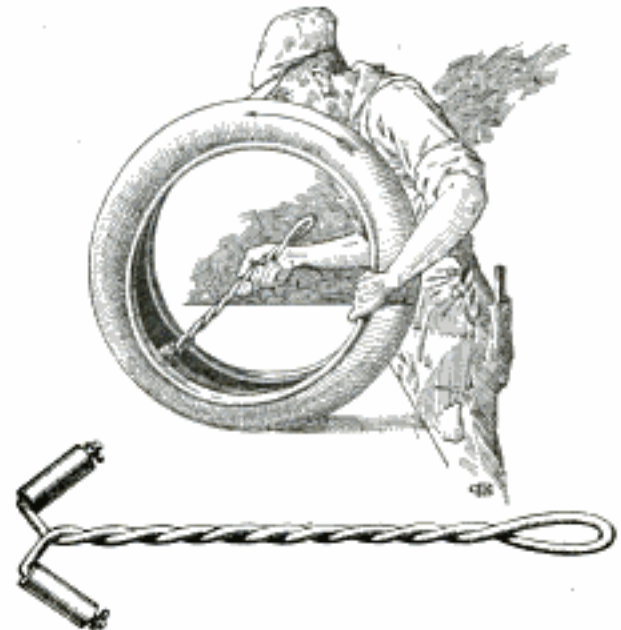

Twisted Iron-Rod Tool with Wooden Rollers Enables Tire Man to Make Thorough Examination of Fabric

termine the condition of the fabric. With heavy tires this inspection involves the use of blocks to hold the stiff beads apart, but this can be done much more easily by means of the tool shown in the illustration. It consists of a $\frac{3}{8}$ -in. iron rod, doubled in the middle and twisted and bent to the shape indicated. Two $1\frac{1}{2}$ by 6-in. wooden rollers are mounted on the ends, and held in place by means of washers and cotter pins. The tool is easily inserted between the beads and is then given a quarter turn so that the rollers spread the beads. By pressing down on the tool and rolling the tire back and forth, the inside is easily examined.—G. E. Hendrickson, Argyle, Wis.

Removing Nails from Painted Work

When, in repair or alteration jobs, it becomes necessary to drive nails out of a painted or varnished board, the putty and paint around the head of the nail will not crack and spoil the piece, if the job is done as follows: Set the nail to be withdrawn over a soft-pine block; and with two or three taps with a hammer drive the head clear of the putty and into the pine. The block is then removed and the nail withdrawn in the ordinary manner, leaving the hole, instead of jagged and torn, neat and unchanged in diameter.—A. G. Roach, Sudbury, Ont., Can.

Steam Boiler Converted into Tank to Drive Compressed-Air Winch

The accompanying photo was taken in the yards of a shop that repairs and builds

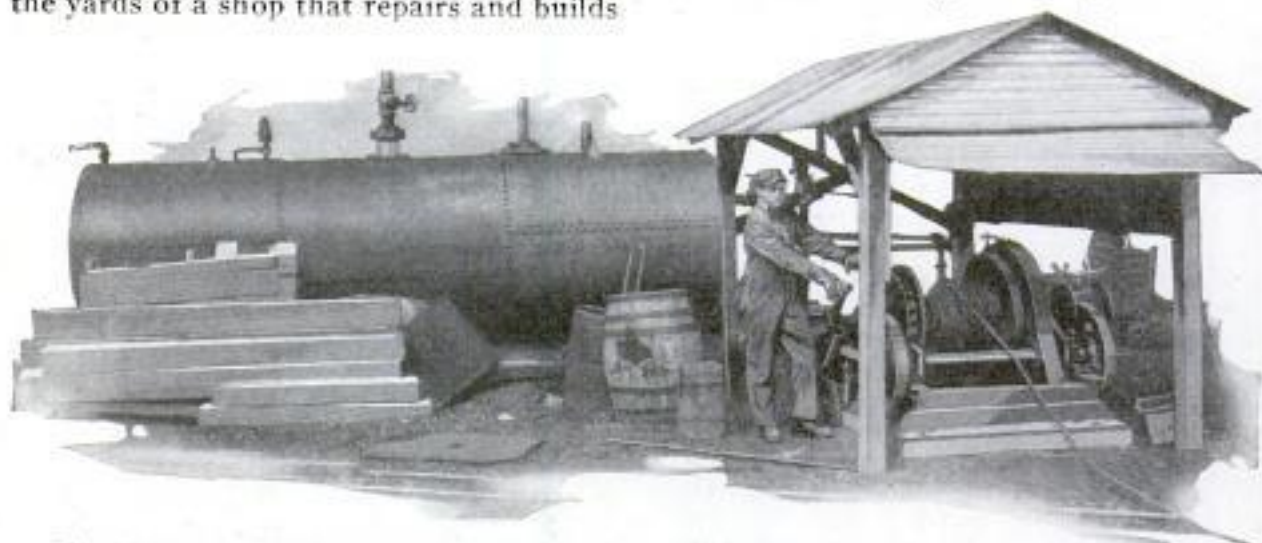

Old Steam Boiler Used as Compressed-Air Tank to Operate a Winch, Trip Hammer and Other Air Tools.

logging equipment. The winch is operated by compressed air, which also operates a trip hammer and other tools in the shop. A 40-hp. motor is used to pump air into the tank, which is simply an old steam boiler, made over and adapted to this purpose. A pressure of 100 lb. is maintained. —A. F. Kroemer, Portland, Oreg.

Scribing Shafts

A useful device for scribing shafts, or other round work can easily be made up from a sleeve and two scales. A hole drilled through the sleeve takes a 12-in. scale, while a smaller cross hole receives a shorter and narrower scale. Both scales are tightened against each other and against the sleeve by a bent-rod handle. This carries a short pin, which tightens against the side of the hole when the handle is turned in line with the axis of the sleeve. To set and use the device the handle is loosened and the sleeve is slid down until the horizontal scale touches the top of the work. This scale is then moved in or out

until the distance between the edge of the upright scale and the end of the horizontal scale is half the diameter of the work. This reading can easily be seen in

the cross hole. The handle is now tightened and the work turned until the line meets the end of the scale.—Harry Moore, Montreal, Can.

Finding Boiler Efficiency

Here is a handy rule for roughly determining boiler efficiency when the chimney-gas temperature and the heat value of the fuel are both known:

"Multiply the temperature of the exit gases in degrees Fahrenheit by 625 and divide by the heat value in b.t.u. per lb. Then subtract the result from 100. The result is the approximate boiler efficiency

in per cent." The rule worked out with surprising accuracy even in the case of the New York City power plant, where the high efficiency of 92.7 per cent was obtained recently. The chimney-gas temperature was reduced to 193°. The heat value of the fuel was about 14,500 b.t.u. per lb. Applying the rule, multiplying 193 by 625 and dividing the result by 14,500 we get 8.3, and this subtracted from 100 gives 91.7 per

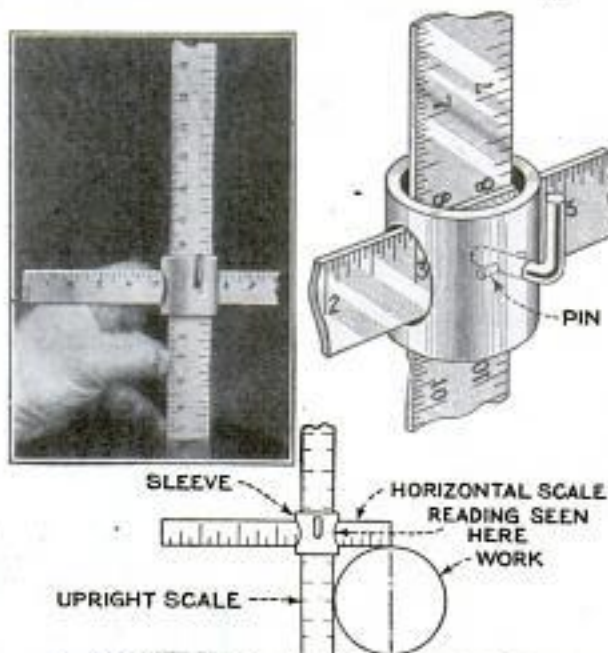

Double-Scale Holder Facilitates Scribing Shafts

cent. In other words, this rule was only one per cent off when applied to this unusual example.

For oil burners the rule becomes:

"Multiply the temperature of the exit gases in degrees Fahrenheit by 5,000 and divide by the heat value of the oil in b.t.u. per gallon. Then subtract from 100. The result is the approximate boiler efficiency in per cent."

It must be understood, of course, that in applying this rule the fireman is doing his best to effect complete combustion. If the fire is so poor that the gases contain a large per cent of carbon monoxide, the rule naturally will not hold; nor will it if the exit gases contain too much air.

The usual, but much more complex, procedure in determining boiler efficiency is to find the heat in the steam evaporated by the boiler and divide it by the heat given off by the fuel. In other words, boiler efficiency, like all other efficiencies, is equal to output divided by input. These rules, however, simplify the whole affair. They are based on the reasoning that by deducting the heat passing out of the chimney from the original heat contained in the fuel, we have the approximate amount of heat absorbed by the boiler. Then by dividing the latter amount by the former we arrive at the approximate boiler efficiency.—W. F. Schaphorst, Newark, N. J.

Repairing Cracked Windows

Cracked window panes are likely to fall out entirely when a hard wind blows or a heavy door slams. This can readily be prevented, however, by reinforcing the broken pieces with strips of tin, about 2 in. long and $\frac{3}{4}$ in. wide. A number of teeth are cut in each side of the strips as indicated in the detail. The strips are slipped into the cracks and the teeth bent over on opposite sides. This will hold the pieces together securely.—Warren H. Froelich, Menomonie, Wis.

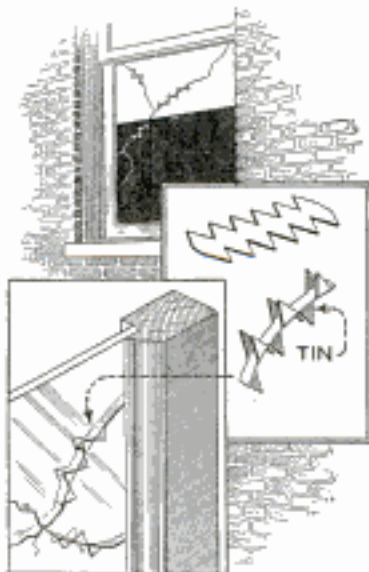

Making a Stropping Wheel

Pattern and cabinetmakers will find the stropping wheel shown in the drawing will give a better edge to their tools than the ordinary cloth buffing wheel. It con-

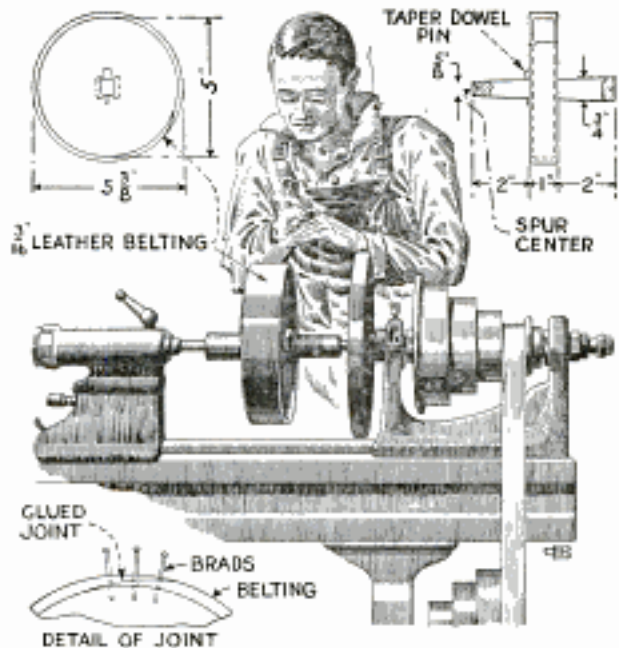

Stropping Wheel Faced with Leather Belting Found Convenient

sists of a 5-in. disk, turned out of a piece of 1-in. pine. A tapered hole, $\frac{5}{8}$ in. square at the smaller opening, is cut in the center for a shaft, which should be made from a piece of hardwood, such as maple or oak, and should measure 5 in. long and $\frac{3}{4}$ in. square at the large end. This is planed square and tapered so that it can be driven into the wheel to a tight fit and a hole is drilled through the shaft for a small dowel pin, which locks the wheel on the shaft. Center holes are punched in the ends of the shaft, one for the live center and one for the dead center. Mount the wheel in the lathe and trim down the surface of the wheel. A 1-in. strip of leather belting about $\frac{3}{16}$ in. thick is laid around the wheel, adding about 1 in. for a lap joint. The ends are shaved down to a taper, as indicated in the detail, and the leather is glued to the wheel. Brads are nailed at the joint to keep the leather tightly on the wheel while the glue sets, after which they are removed and the leather surface trued up. A $\frac{1}{8}$ -in. recess is turned in each side of the wheel to facilitate sharpening of gouges. In use, the wheel should be mounted in the lathe so that the joint will not catch the tool.

⚠ Tampering with screws can be prevented by dropping a little solder on the head of the screw, so as to fill the slot.

Painting Wire Fences

When spraying paint on wire fences, there is considerable waste of paint. Experiencing this, a painter who had quite

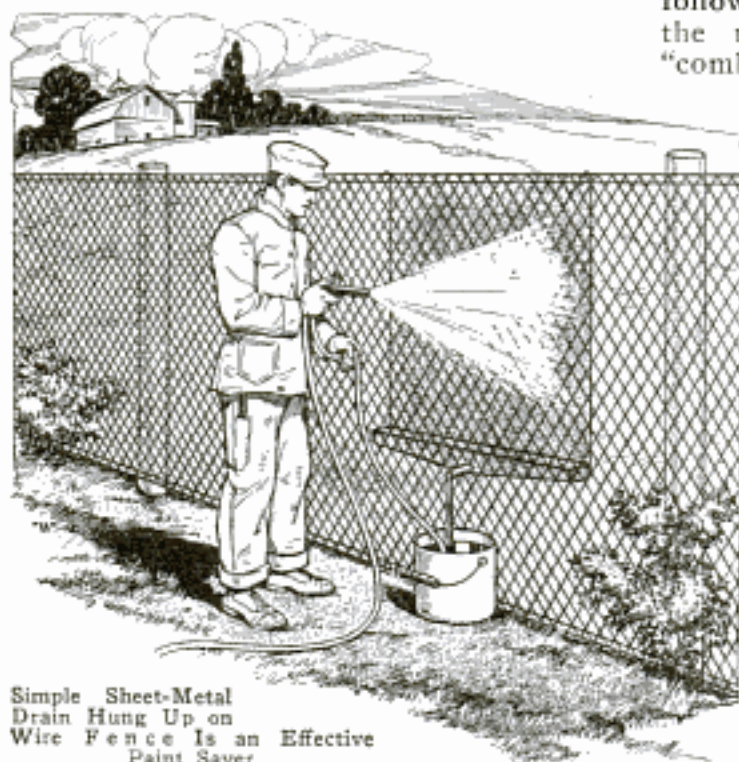

Simple Sheet-Metal Drain Hung Up on Wire Fence Is an Effective Paint Saver

a bit of fence to paint devised a drain to catch and return the surplus paint. The drain is simply a large piece of sheet metal with the lower edge bent to form a trough so that when the drain is hung up as indicated the paint flows down into the trough, from which it runs into the pail and may be used until practically every drop is consumed.—J. P. Doolan, Alliance, Ohio.

Inserting Bolt in Awkward Place

An easy way to get a bolt in a hard place is to get a fine piece of copper wire, or, if this is not at hand, a wire from a piece of door screen will do. Double the wire and pass it through the hole from the side that is easiest to put the nut on. Draw the wire through far enough to put it in a position where it can easily be wrapped around the threaded end of the bolt. Now pull gently on the other end of the wire, guiding the head end of the bolt with the fingers or pliers. The wire steers the other end, and the bolt cannot fall out. This idea works well in putting fenders on a car, as often some of the bolts are in an awkward place in the corner of the frame.—Garry Runions, Lunenburg, Can.

Soldering Aluminum

Although aluminum is one of the most difficult metals to solder, the task is comparatively easy if a few simple rules are followed. Most of the solders offered on the market consist of "straight" and "combination" solders. The straight solder is used for soldering aluminum to aluminum, and the combination for soldering any metal except cast iron to aluminum.

The parts to be soldered with straight solder should first be cleaned with gasoline, and by brushing the surface to be soldered with a steel-wire brush to remove all grease. Then heat the parts with the flame of the blow-pipe until the solder begins to melt upon them and brush the melted solder well into the metal. If any dross remains on the surface, brush or scrape it off. Each part should be tinned separately, then pressed together and soldered. To use combination solder successfully, one must "tin" the metal to be soldered to the aluminum with some of the combination, using any good flux. After cooling, remove all traces of the flux and prepare the aluminum with some of the straight solder, as described. The parts may then be joined with some of the straight solder without any flux.

Cutting Equal Lengths of Twine

Thousands of farmers cut up their corn and put it in the shock to be hand-husked later, and the husked fodder is then tied up in bundles with twine. Cutting this twine into equal lengths takes too much time and this led to making the simple device shown in the illustration. The twine is wound upon a simple reel over four hooks or nails so placed as to provide the right length of tie cords, as indicated, and after a

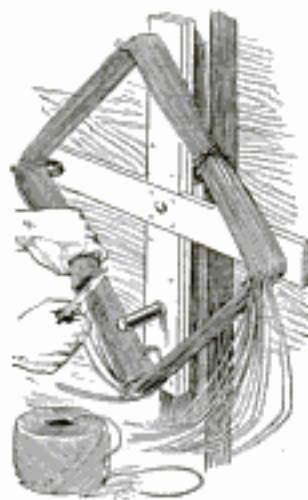

number of turns the whole bunch is cut with a knife or pair of shears, which makes all the cords of equal length.

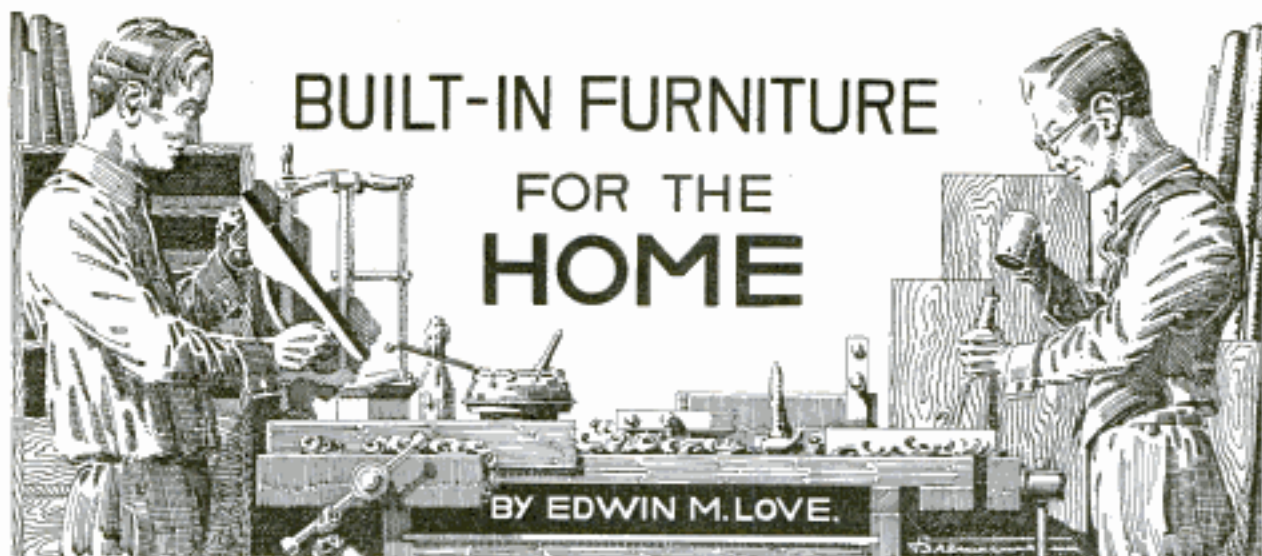

Part XI—A Built-In Writing Desk

BUILT in combination with the fireplace or as an individual unit, the writing desk illustrated lends itself easily to use in almost any living room. It is 4 ft. 1 in. wide, 4 ft. $\frac{3}{4}$ in. high, and 11 $\frac{1}{4}$ in. deep. It should, of course, be built near a window if the space is available without doing violence to the beauty of the room. Build the front frame of 1 $\frac{1}{8}$ by 2-in. net stock, making the stiles 3 ft. 11 $\frac{5}{8}$ in. long and the upper and lower rails 3 ft. 8 in., securing each joint with two $\frac{3}{8}$ -in. hardwood dowels. The upper edge of the lower rail is 6 $\frac{1}{4}$ in. above

the bottom ends of the stiles; and the lower edge of the upper rail is 4 $\frac{1}{8}$ in. below the upper ends of the stiles. Set the frame aside to dry, and glue up stock for shelves, partitions and top, using 1 by 2-in. and 1 by 3-in. material with 1 by 12-in. stock to get the necessary width. Note that the two main partitions are 12 $\frac{1}{4}$ in. wide, the front edges forming stiles. Joint

the face edges of stock for the ends, using 1 by 12-in. pine or fir, and lay off for dados, $\frac{1}{4}$ in. deep, as follows: From the bottom end to bottom of the $\frac{3}{4}$ -in. gain for the bottom shelf, 5 $\frac{7}{8}$ in., 2 $\frac{5}{8}$ in. successively to the

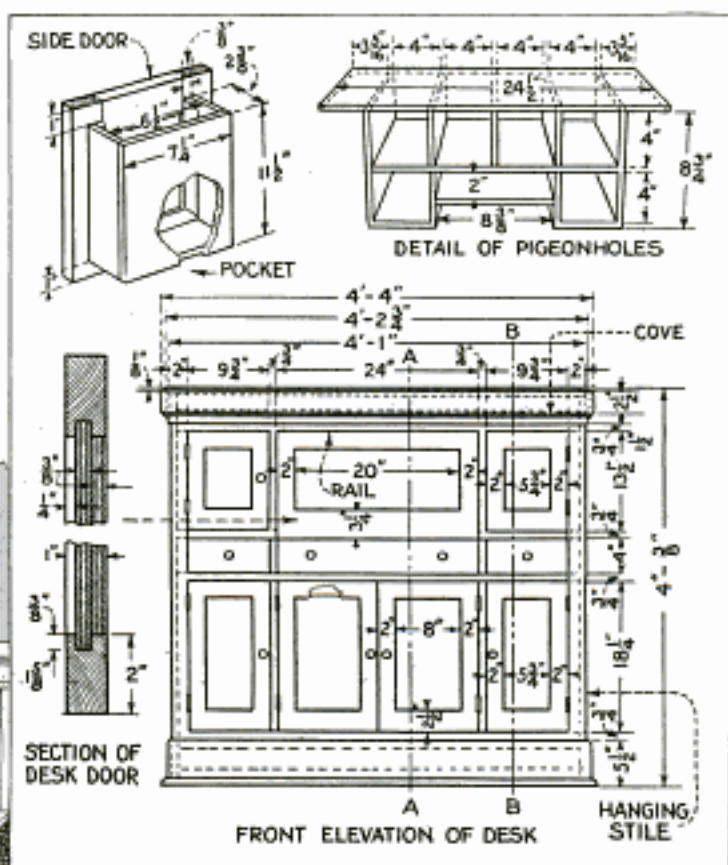

Front Elevation of Writing Desk, Detail of Pigeonholes and Pockets on Side Doors, and Method of Building Up Door for Desk Section

slides of 1 by 2-in. stock to the partitions by nailing from the face edge of each with eight-penny finish nails, being careful to keep them square with the front edge. Toenail four-penny finish nails from the ends into the front rail to further strengthen them. The end guides are built up into a T-section by nailing 1 by 2-in. stock edgewise on the face of 1 by 3-in. stock so that, when placed in position against the ends of the cabinet, the 1 by 2-in. guide will be flush with the inside edge of the stile, leaving projection enough on the 1 by 3-in. to form a slide. The desk shelf is 4 ft. long and for the end compartments is $12\frac{1}{4}$ in. wide; but for the desk compartment it is cut back 1 in. and the front edge is made into a quarter-round, curving downward as shown in the details, so that a corresponding cove on the lower edge of the door permits the door to open to a horizontal position with the inside surface flush with the shelf. The dados for the thin partitions are $7\frac{1}{4}$ in. long, $\frac{1}{4}$ in. deep and $\frac{3}{8}$ in. wide. The outer ones are $4\frac{1}{8}$ in. from the ends, and the others are spaced 3 in. apart. Slide the shelf into the end dados and scribe for notching around the stiles, afterward putting in place and nailing solidly to the lower partitions. Nail through the end board into the shelf, or toenail the shelf from the inside with six-penny finish nails.

The upper partitions are made as indicated in the detail, the front edges being notched for the upper rail and dados made in each side for the thin shelves supporting the pigeonholes and thin partitions. Before nailing them to the shelf, tack backing strips on the shelf to insure alignment with the lower partitions, and toenail fast; or if an additional refinement is desired, dado into the shelf.

The thin partitions for the end compartments are $13\frac{3}{4}$ in. long and $7\frac{1}{4}$ in. wide. Lay them off by the dados in the shelf and slip into place. Fit the partitions and nail the tops through the $\frac{3}{8}$ -in. shelf.

To assemble the pigeonholes, notch the

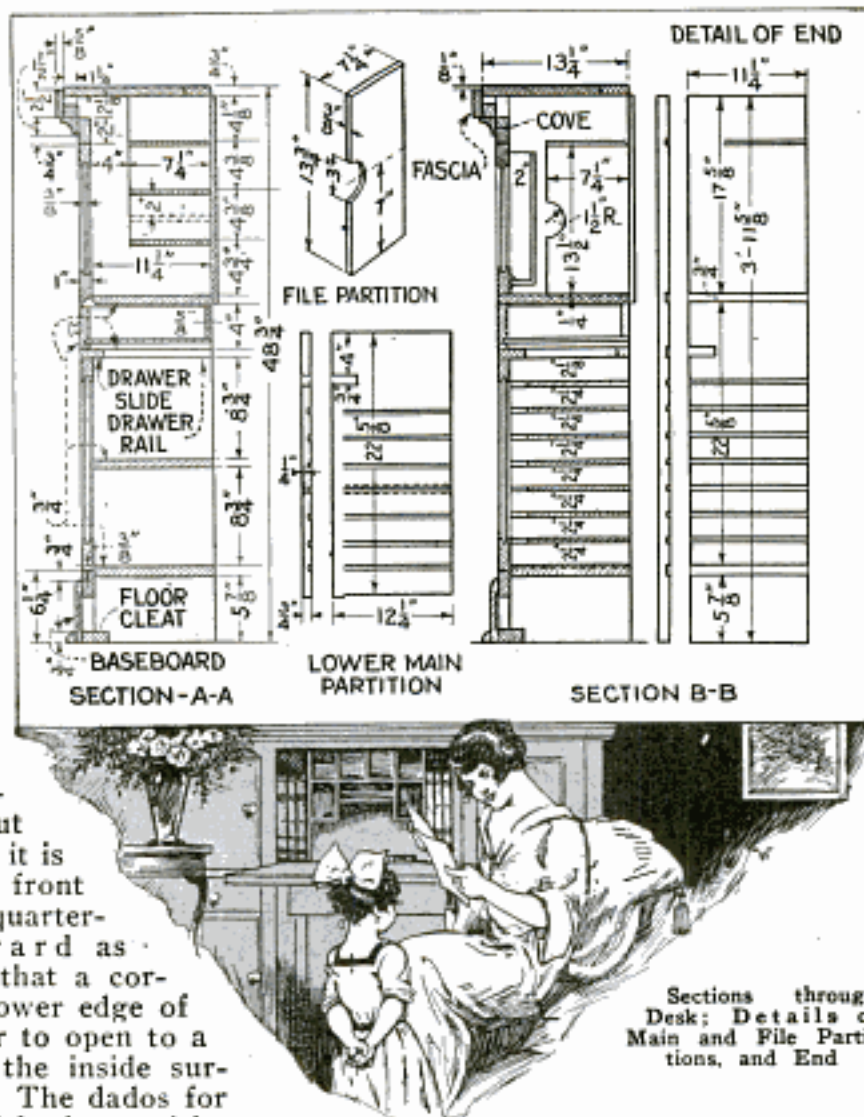

long partitions for half the width and cut corresponding notches in the middle shelf, so that the two will come flush front and back, and nail in the short center partition. Cut in the short lower shelf, nail on the ends, and nail on top the long upper shelf. The bottoms of the lower pigeonholes are cut in between the vertical members. Slide the assembly into place above the desk.

The three-ply panel-veneer back shown is optional. If used, it is necessary to remove the plaster from the lath behind the upper part of the cabinet, so that the back will not hold the cabinet away from the wall; or the back may be cut between the partitions, using 1-in. window stop tacked to the ends and partitions as backing. In this case, of course, the pigeonholes and thin partitions must be set forward $\frac{3}{8}$ in.

Set the cabinet against the wall, plumbing it in both directions and leveling the rails. Toenail through the ends into the floor, and nail a 1 by 4-in. cleat to the floor flush with the bottom rail as back-

ing for the baseboard. Nail through the back into the studding with six-penny finish nails, or if the back is not used, cut in wall cleats between the partitions.

Scribe the top against the wall, tack in place and lay out for ends and front by

the left-hand door of the pair, which is $2\frac{1}{2}$ in., so that the rabbet will still leave an outside width of 2 in. The lower rail of the desk door is $3\frac{1}{4}$ in. wide, but all other lower rails are $2\frac{1}{2}$ in. Build the desk door like the others, keeping the

MATERIAL LIST

- | | |
|---|---|
| 1 piece, $1\frac{1}{8}$ by 2 in. net by 16 ft., pine or fir, S4S, sanded. | 1 piece, $\frac{3}{8}$ in. net by 8 in. by 16 ft., pine or fir, S4S, sanded. |
| 1 piece, $1\frac{1}{8}$ by 2 in. net by 14 ft., pine or fir, S4S, sanded. | 1 piece, 2-in. cove, 8 ft. |
| 1 piece, $1\frac{1}{8}$ by 2 in. net by 12 ft., pine or fir, S4S, sanded. | 1 piece, $\frac{3}{8}$ by $\frac{3}{4}$ in., base shoe. |
| 1 piece, $1\frac{1}{8}$ by 3 in. by 10 ft., pine or fir, S4S, sanded. | 1 piece, $\frac{3}{8}$ by 3 in. by 8 ft., wainscot cap, sanded. |
| 1 piece, $1\frac{1}{8}$ by 4 in. by 2 ft., pine or fir, S4S, sanded. | 1 piece, $\frac{3}{8}$ by 6 in. by 8 ft., baseboard, sanded. |
| 1 piece, 1 by 12 in. by 14 ft., pine or fir, S4S, sanded. | 1 piece, $\frac{5}{8}$ in. by 5 in. by 6 ft., drawer side, sanded. |
| 1 piece, 1 by 12 in. by 12 ft., pine or fir, S4S, sanded. | 1 piece, $\frac{3}{8}$ by 4 in. by 4 ft., drawer back, sanded. |
| 1 piece, 1 by 12 in. by 6 ft., pine or fir, S4S, sanded. | 1 piece, 1 by 5 in. by 4 ft., drawer front, sanded. |
| 2 pieces, 1 by 2 in. by 10 ft., pine or fir, S4S, sanded. | 1 piece, $\frac{1}{8}$ by 3 by 3 ft., three-ply pine or fir panel veneer. |
| 1 piece, 1 by 3 in. by 12 ft., pine or fir, S4S, sanded. | 1 piece, $\frac{3}{8}$ in. by 1 ft. 6 in. by 4 ft., pine or fir panel veneer. |
| 1 piece, 1 by 4 in. by 4 ft., pine or fir, S4S, sanded. | 1 piece, $\frac{3}{8}$ by 6 in. by 8 ft., T&G drawer bottom. |
| 1 piece, $\frac{3}{8}$ in. net by 12 in. by 14 ft., pine or fir, S4S, sanded. | 11 $1\frac{1}{4}$ -in. glass drawer pulls (knobs). |
| | 1 desk lock. |
| | 5 forg catches. |
| | 1 elbow catch. |
| | 1 desk chain. |
| | 7 pairs $2\frac{1}{2}$ by $2\frac{1}{2}$ -in. loose-pin butts. |

Cost of materials, about \$14.00.

Time to build, about 40 hours.

measuring from the cabinet itself, the top being 4 ft. $2\frac{3}{4}$ in. long, giving a projection of $1\frac{1}{4}$ in. When cut, nail solidly to the ends and partitions. Cut a strip of 1 by $1\frac{1}{4}$ -in. net pine around the cabinet, $2\frac{5}{8}$ in. below the top. Miter around the fascia of $\frac{3}{8}$ by $2\frac{1}{2}$ -in. net wainscot cap, showing a margin of $\frac{1}{8}$ in. on the top. The cove miters underneath this. Miter the base and shoe around, scribing the ends where they fit against the baseboard of the room. If the desk is built in combination with the fireplace, or in a recess, the fascia and base will probably terminate in the fireplace or wall.

Build the doors of $1\frac{1}{4}$ -in. stock. The stiles and upper rails of all doors are 2 in. net in width, except the lock stile of

panel back $\frac{3}{8}$ in. from the inside face so that another thickness of panel veneer may be put in the recess to bring the surface flush. By beveling the edges of this piece somewhat, a very snug joint on all sides can be obtained. Work a cove on the lower edge to mate with the round on the shelf, and hang the door with the hinge inside. Surface all doors to a thickness giving $\frac{1}{16}$ in. clearance on the shelves.

Make the drawers without lips, so that the fronts slide flush with the stiles and rails. Give a side clearance of less than $\frac{1}{8}$ in. and $\frac{1}{16}$ -in. clearance vertically. Rabbet the sides into the ends of the fronts and the back between the sides; and assemble front, sides and back before inserting the bottom.

Clip Holds Emery Cloth on File

Emery cloth, with a file as a "backer," is often used in the machine shop, especially in the hardening departments where scale is removed from work so that color changes during annealing and tempering processes can be watched easily. Ordinarily, a strip of cloth is mounted on a file by stabbing the tang through it, as

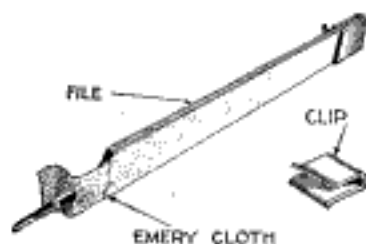

shown, and the other end is held in place with the left hand. The simple clip illustrated will hold the cloth to the file and keep it stretched, permitting the left hand to be used in the natural way.—C. M. Wilcox, Torrington, Conn.

Storing Small Screws, Bolts and Nuts

The most annoying problem to the amateur mechanic is the storing of small parts, screws, nuts, bolts, and those little things that come in handy every day, yet are continually cluttering up the workbench. The container easiest to obtain and one that is most adaptable to systematic storage, is a red tobacco tin. It has a tight-

fitting cover, is easily labeled by scratching the description of its contents on the painted cover, and best of all, nine of them fit exactly into a discarded Ford coil box. The box should be cleared of wires and coils, and can then be hung on a wall or attached to the bench with screws. As it also has a clamp-on cover, it affords a portable receptacle which will fit into most tool boxes. A list of contents can be typewritten and affixed to the outside for convenient reference.—George Parke, Chicago, Ill.

Divider for Cutting Sweet Clover

When cutting sweet clover with a grain binder the sickle sometimes cuts off the clover before the divider separates it. This trouble is especially the case if the clover is quite tall. To prevent it, we made a divider by bolting a length of 2 by 4-in. material on the side of the frame so that it extended about 2 or 3 ft. beyond it. Then we took a 1 by 2-in. strip, fastened one end to the projecting end of the 2 by 4-in. length, and bolted the other end to the reel-support standard. Another 1 by 2-in. piece was fastened at the point with the upper end set out about 2 ft. and a third short 1 by 2-in. piece just long enough to clear the reel, was fastened on the inside. In tall clover we remove the outside reel support.—Will E. Smith, Thief River Falls, Minn.

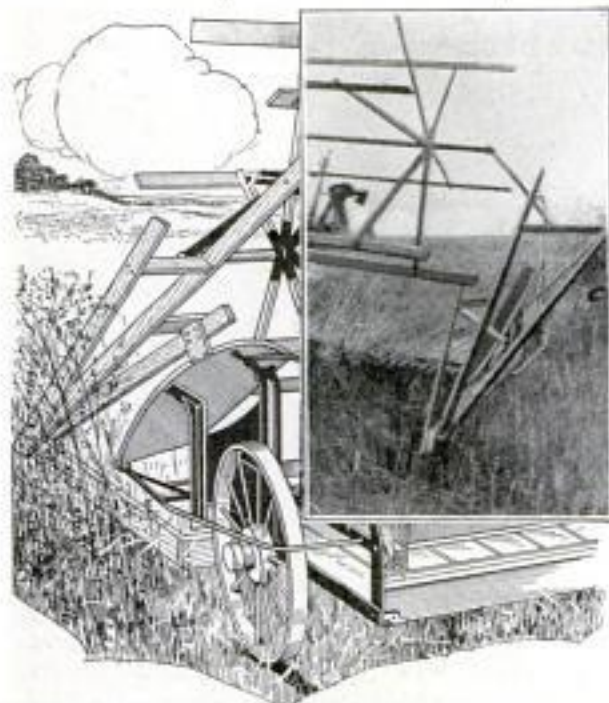

Divider on Mower Facilitates Cutting of Long Sweet Clover

Guard Prevents "Kick-Back" on Saw

"Kick-backs," which may seriously injure the saw operator, can be prevented by means of a simple guard of the kind shown in the

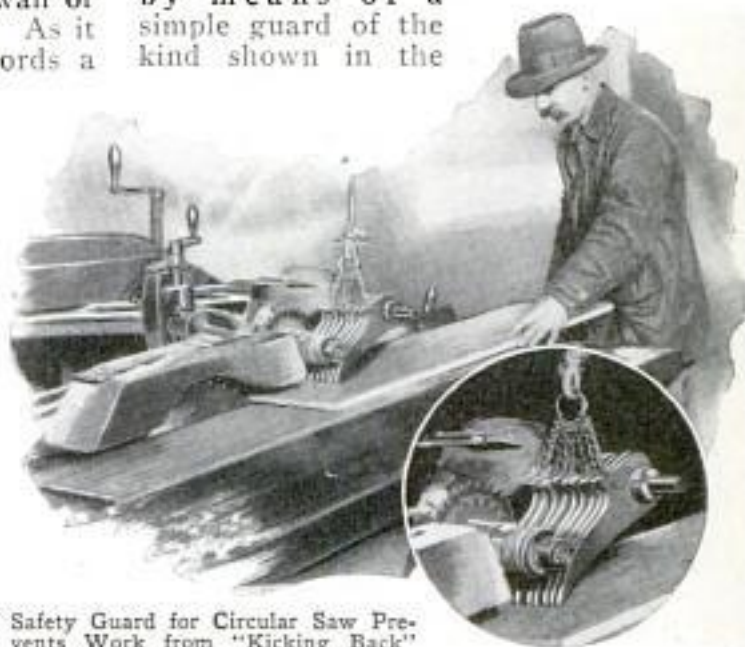

Safety Guard for Circular Saw Prevents Work from "Kicking Back"

photo. It consists of a number of flat blades, which rest on the work, and are suspended above it by means of a chain. The sharp ends keep the work from coming back.—Auguste Mathieu, Chicago, Ill.

Tapping Holes in Small Steel Rod

I had to tap two $\frac{1}{8}$ -in. holes in the end of a small steel rod. In the first place I had no $\frac{1}{8}$ -in. tap; in the second, it is hard for an amateur to tap so small a hole in steel and there is grave danger of using too much pressure and breaking the tap, which, in so small a size, is very brittle. As in this case the threads did not have to hold much, here is what I resorted to: I drilled $\frac{1}{4}$ -in. holes instead of $\frac{1}{8}$ -in., coated them with muriatic-acid paste, and filled the holes with solder; then drilled holes slightly smaller than $\frac{1}{8}$ in. and cut the threads with the same screws I intended to drive into the holes permanently. They are now in place and very secure.—G. H. Mansfield, Cuyahoga Falls, Ohio.

☞ Coal tar stains paint, and therefore it is necessary to insulate it with shellac. Remove as much of the tar as possible by scraping and apply a thin coat of brown shellac. Paint will stick to the shellac, and the stain will not penetrate after this treatment.

Ridding Manholes of Gas

In an eastern city the linemen working in manholes are provided with a rubber blanket, which they use to free the work-

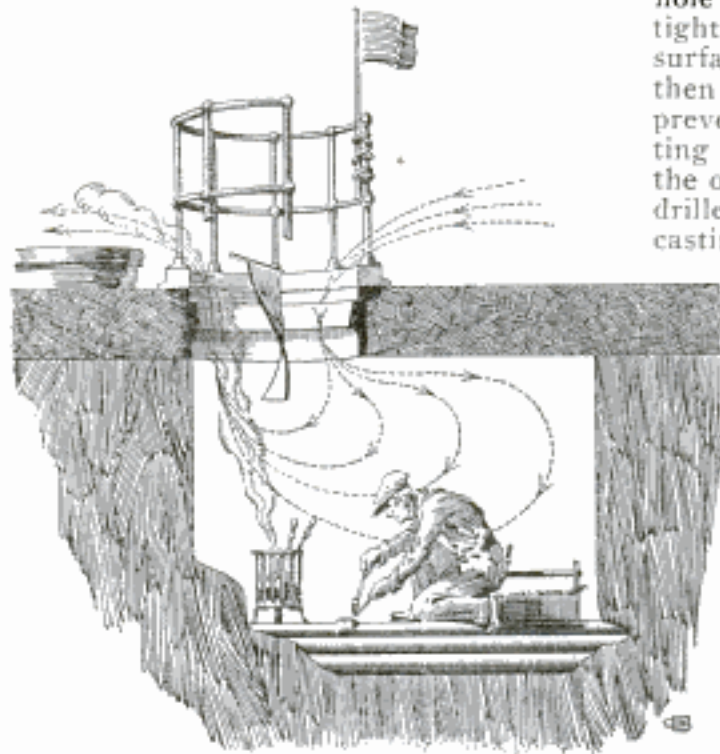

Simple Method of Ridding Manholes of Gas with Rubber Blanket Which Causes Draft

ing chamber of noxious gases. The blanket is hung in the mouth of the hole as shown in the illustration so that a current of air is set up. The fresh air comes in on one side of the blanket and the bad air and gases go out on the other side, as indicated by the arrows.

Outside Oil Line on Ford Motor Makes Quick Repair

Some months ago a Ford on which a connecting-rod bearing cap had come loose was brought into the shop. Investigation showed that no harm had been done to the block or crankshaft and that a new connecting rod would easily remedy the matter. However, the oil pipe was crushed beyond repair, and the owners, a public utility company, would not permit the delay necessary to take the motor apart to install a new pipe. I recalled having seen various outside oil lines for Ford motors, and here was a case to use one. There was none on hand, but there was plenty of $\frac{1}{4}$ -in. copper tubing and fittings, and a little thought showed me that a few feet of this tubing and an L-fitting would do the trick.

The transmission cover was removed and a hole drilled and tapped for the L-fitting about $\frac{1}{2}$ in. to the right of the magneto plug and even with the back edge of the plug base. Care was exercised to tap the hole only so deep that the ell would fit tightly and not project beyond the inner surface of the cover. Some waste was then stuffed in the oil-filler opening to prevent any particles of metal from getting in, and a hole, slightly smaller than the outside diameter of the copper tubing, drilled in the back side of the oil-filler casting about $\frac{3}{4}$ in. from the top. This hole was reamed out with a taper reamer until it was just large enough for the tubing. After this hole was finished, the waste and particles of metal were removed. With the transmission cover back in place, the tubing was bent to run from the L-fitting, around the corner of the block, along the right side of the motor under the exhaust pipe, carburetor, etc., to the hole drilled in the filler casting. After allowing about $\frac{1}{2}$ in. inside the filler opening, the piece was cut off and installed, care being exercised to see that the tube made a gradual slope to the front end of the motor. When the motor was

ready for running, it was started at once, and the oil-filler cap was removed so that the results could be observed. A minute after the motor started the oil began to drop from the tube, and in another minute it had increased to a full flow. The principle of operation is this: Some of the oil in which the flywheel runs, is picked up

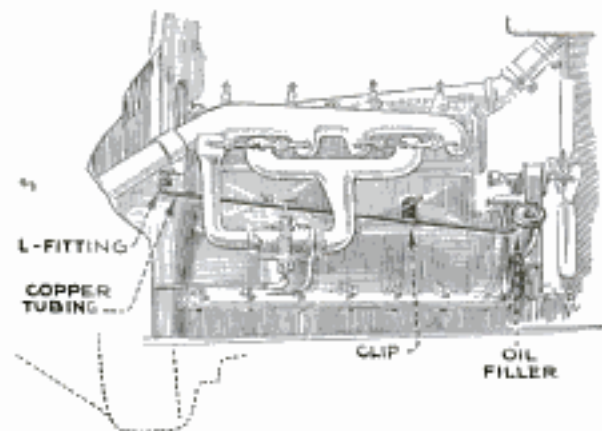

An Improved Outside Oil Line Installed on a Ford Motor

and centrifugal force throws it off, a portion of it finding its way out into the line of tubing, where gravity does the rest. —Leon D. Quick, Milesburg, Pa.

3458

How to Lower Your Building Costs



Plan No. 6A20

© Architects' Small House Service Bureau

THE easiest way to lower home-building costs and make your dollars buy full value is to eliminate waste. What is meant by waste?

You have observed homes nearing completion and noted unused lumber lengths, studs, joists, flooring, bricks, etc., strewn around the house and lot. These leftovers usually provide the home owner with kindling wood, but at \$30 per 1,000 feet it makes mighty expensive fuel. Another source of waste is the unnecessary use of elaborate finish and expensive equipment. For example, you can spend too much money for your heating plant. You can select a type of brick totally out of comparison, so far as expense is concerned, with the cost of your home. You can build an extravagant, complicated roof, you can overload it with unnecessary, meaningless details and "frills."

These have little or no architectural merit, render no service, detract from the beauty of the house, and certainly pile up your cost to an unjustified amount.

The plan illustrated here is in many ways a model Dutch Colonial home. It is planned to eliminate waste and to provide maximum convenience and comfort within a limited floor area.

For example, it can be placed upon a forty-foot lot. The living room is twenty-two feet deep, eleven feet three inches wide. A simple, but attractive fireplace is the dominating feature. There is plenty of space for large pieces of furniture. The kitchen sink is placed underneath a window with drainboards on one or both sides and with cupboards running to both sides so as to cover the whole end wall of this room.

If it is desired to use a coal-burning range, an additional flue can be added in the corner of the kitchen. In the entry way are spaces for brooms and vacuum cleaner, and shelves for the storage of provisions. A feature of this house is the ample supply of closets, ten in number. There is also an attic reached through the closet of one bedroom.

The house is planned to be built of frame construction, siding exterior, shingle roof, brick base course, painted white with green blinds in contrast with the red-brick trim. Here is a big small home that looks good and is good. It has been erected many times at prices ranging between \$6,000 and \$7,000, depending upon location, quality of materials and equipment.

QUESTIONS regarding home building addressed to this magazine will be answered by the Architects' Small House Service Bureau of the United States, Inc., controlled by the American Institute of Architects and indorsed by the department of commerce, United States government. Blueprints, specifications and material lists for the house shown above may be obtained at a nominal cost. Inclose self-addressed, stamped envelope for reply. If further information is desired send five cents and stamped envelope for a 24-page booklet explaining how the small home bureau functions and showing twelve sample plans.



Q. How can I tell if my storage battery is low?
A. Get a good hydrometer at any auto-accessory or radio store and follow the instructions for using it.

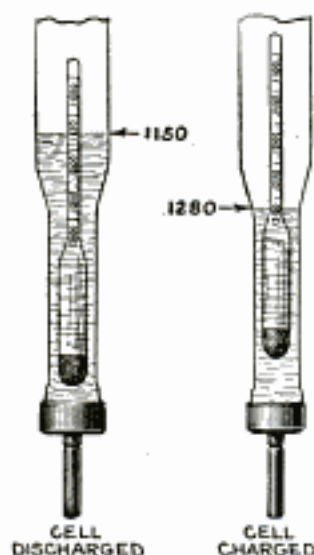

Fig. 1

been completed, and the caps replaced on the cells.

Q. How should the prongs on a vacuum tube be cleaned to make a good electrical connection with the spring prongs in the socket?
A. Use a small nailfile to clean the tips of the tube prongs as shown in Fig. 2, taking care not to file off the solder.



Fig. 2

Q. Will the addition of a step of r.f. amplification add volume to my receiver?
A. R.f. amplification will increase the range of the receiver, but will not affect the volume on stations within 100 miles. Beyond this range it will strengthen the weaker signals.

Q. I am told that the use of spaghetti tubing will decrease the efficiency of my set. Is this true?
A. Good spaghetti tubing is not detrimental. It should be used wherever there is danger of shorting. It is of advantage when used in different colors to identify high and low voltage, also for retracting leads.

Q. Do you consider a variable gridleak necessary?
A. A variable gridleak has its advantages, if set at the right place and then left undisturbed. It offers a temptation to the operator to change the setting whenever signals do not seem to be coming in as they should, with the result that the greater part of the time, it is out of adjustment. Hard tubes, when used for detectors, are not as critical as they were some time ago, and a 2-meg. fixed gridleak will answer the purpose in most circuits.

Q. Should dry cells always stand upright? I have very little room in my cabinet, and would like to lay the cells flat to gain room.
A. There is no reason why you cannot do this. There was a popular belief not long ago that such cells should stand upright, but battery manufacturers now state that their batteries are just

as efficient and have the same life when used in any other position.

Q. Can the new a.c. tubes be used in any circuit?
A. Yes, they are constructed in the same manner as the ordinary tubes except that there is no filament. Any circuit can be adapted to them. Directions for doing this are inclosed with each tube.

Q. What kind of a circuit is used in the neutrodyne receiver?
A. This is a tuned r.f. set, with one or more stages of r.f. amplification, a detector and one or more stages of a.f. amplification, in its usual form. The method of neutralizing the internal capacity of the tubes is an outstanding feature of this circuit, and the good results obtained have made it very popular.

Q. What size of wire should be used for connecting the storage battery to the set? Should a fuse be used; if so what size?
A. The underwriters require that 14-gauge rubber-covered wire be used; if a fuse is used, its capacity should not be greater than 10 amp.

Q. What is the purpose of the detector in a radio set? How does it work?
A. The purpose of the detector is to rectify or filter the r.f. vibrations induced in the aerial circuit so that they can be converted by the receivers into sounds which are not beyond the range of the human ear.

Q. I now have all the materials to build the Popular Mechanics Superheterodyne Eight, but do not wish to use a loop. We are not greatly troubled with static in this locality, and I would prefer the outside aerial to the loop. What change must I make in the set?
A. Build the set as described in Feb. and Mar. 1925.

Then build a small external unit consisting of a variocoupler and .001-mfd. variable condenser. Mount these instruments on a small panel. Tap off the primary of the variocoupler to a switch on the panel, and connect the switch lever to the ground. Take the secondary leads to the two outer loop posts in the set. Connect the center loop post to one of the outer loop posts. Next connect the end of the primary of the variocoupler to the rotor plates of the variable condenser on the small panel, and after this is done, finish by connecting the stator plates of the condenser to the aerial. This will permit you to tune the outside aerial in the usual manner, and does away with the loop.

Q. Can the house-lighting circuit be used for an aerial and how must I connect it to the set?
A. In frame houses the lighting circuit can often be used, but as you are dealing with 110-volt lines be careful in handling them. Take four lengths of lampcord, join the ends of two lengths and connect this common end to one screw of the light plug, which should be of the separable type. Similarly, connect the other two lengths and attach to the aerial post on the set. The lengths of lampcord are kept together with narrow strips of tape. Follow the drawing, Fig. 3, carefully.

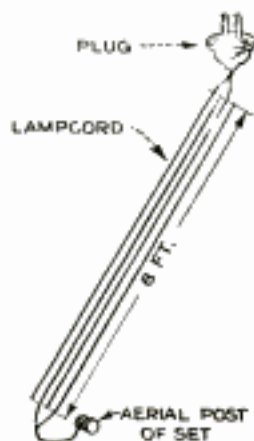

Fig. 3

Use the saw that *cuts* —and go ahead



The man who likes to work with tools and who is trying to do a better job all the time, needs a saw that will let him go ahead.

A GOOD SAW does not get in a man's way.

It cuts clean and true, fast and easy.

If you have to hack the board in two . . . if your saw binds or chatters or runs hard and heavy . . . if you must strain to cut to the line . . . if an easy job of sawing is hard for you —

Then you are paying a high price for a poor saw!

Henry Disston found out how to make saws that work better, faster and easier.

He did a good job for

men who work with tools.

And, in turn, men who work with tools made the Disston Saw Works the greatest on earth.

Three generations of carpenters have used Disston saws in growing numbers—

Until, now, the Disston Saw is "The Saw Most Carpenters Use."

You want the same master qualities in your saw—Disston steel, Disston balance, taper, finish!

It is cheaper in the end—your tool dealer will say.

HENRY DISSTON & SONS, INC., PHILADELPHIA, U. S. A.

Ask Disston

Tell us what work you are doing, in wood, metal, stone, ivory, rubber, leather, cloth, fibre or other material. We will tell you how to saw it better and easier. Disston issues many books to aid saw users.

DISSTON



Building for America's growth

The early builders of America made their houses of rough hewn logs or of stone or adobe lifted from the earth. Settlements grew to towns, towns to cities. Small stores and shops were built, and these in turn were torn down to make room for bigger ones. Roads, bridges and railways were constructed. Factories and skyscrapers were erected. And so, swiftly, the America of today appeared, still growing.

In the midst of the development came the telephone. No one can

tell how much of the marvelous later growth is due to it—how much it has helped the cities, farms and industries to build. We do know that the telephone became a part of the whole of American life and that it not only grew with the country, but contributed to the country's growth.

Communication by telephone has now become so important that every American activity not only places dependence upon the telephone service of today, but demands even greater service for the growth of tomorrow.



AMERICAN TELEPHONE AND TELEGRAPH COMPANY
AND ASSOCIATED COMPANIES

BELL SYSTEM

One Policy, One System, Universal Service

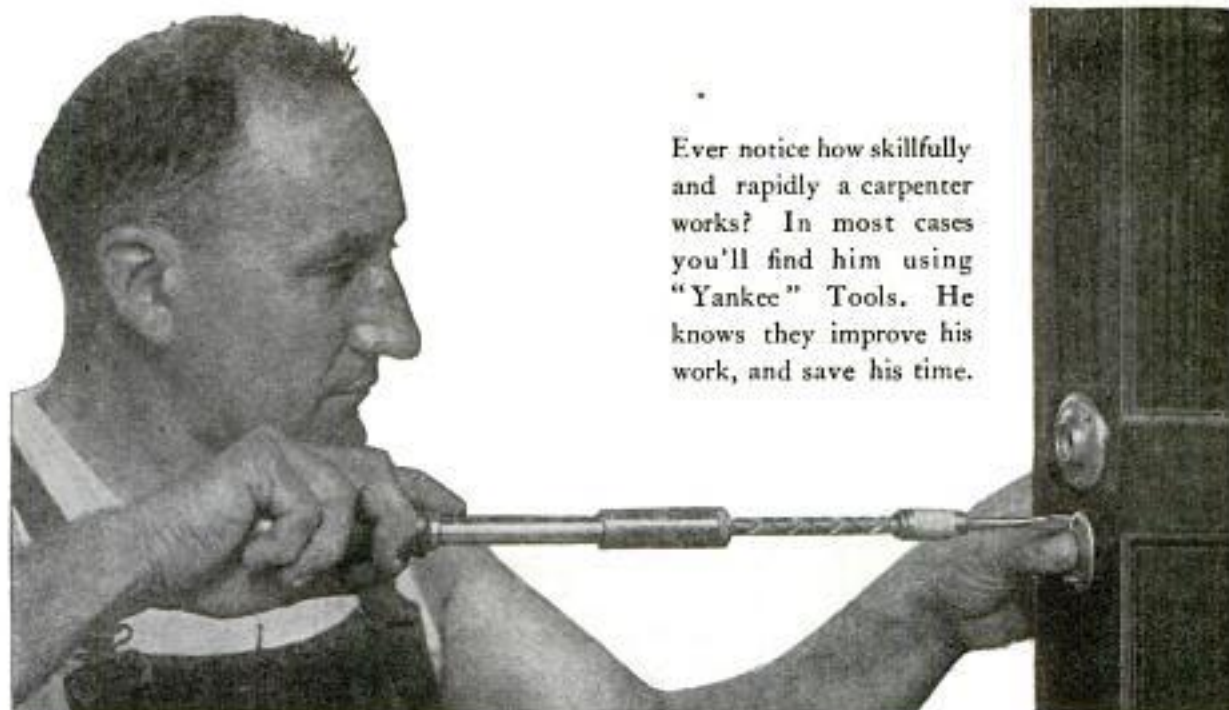

Ever notice how skillfully and rapidly a carpenter works? In most cases you'll find him using "Yankee" Tools. He knows they improve his work, and save his time.

Here's a tool that respects your time

You can do any kind of a screw-driving (or drawing) job, in fast time, if you use a "Yankee" "Quick-Return" Spiral Ratchet Screw-driver No. 130-A.

There is a spring in the handle that brings the handle back after each push; and the tension of this spring keeps blade in screw-slot, leaving one hand free to hold the work.

All you need do is push. The spring in handle and the "Yankee" Ratchet do the work.

Three Ratchet adjustments. Right-hand Ratchet, Left-hand Ratchet and Rigid, secured by touch on Ratchet Shifter.

"YANKEE" "Quick-Return" Spiral Ratchet Screw-driver No. 130-A

Three sizes of bits supplied with each tool. No. 130-A, Standard Size. No. 131-A, Heavy Pattern. No. 135, Light Pattern.

"Yankee" Spiral Ratchet Screw-drivers, without the "quick-return" feature, No. 30-A, No. 31-A, No. 35.

"A" indicates improved model with longer driving nut.

Some other "YANKEE" Tools

Ratchet Bit Brace

Ratchet Hand Drills

Ratchet Breast Drills

Ratchet Bench Drills

Dealers everywhere sell "Yankee" Tools

"Yankee" on the tool you buy means the utmost in quality, efficiency and durability

NORTH BROS. MFG. CO., Philadelphia, U. S. A.

"YANKEE" TOOLS

Make Better mechanics



This FREE Tool Book will interest you.

Every "Yankee" Tool is illustrated and described. Write for your copy.

Last Year—
Bad Crowding of Shorter-
Wave Stations



This Year—
Better, But Crowding Still Troublesome



Next Year—
No Crowding!

Straight-Line Frequency Means—

That the distance on your dials from one station to the next adjacent one is uniform—throughout the short-wave stations, as well as the longer waves.

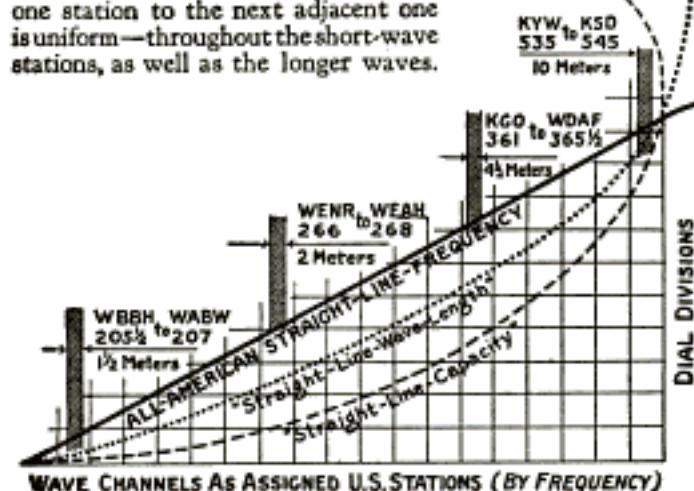

WAVE CHANNELS AS ASSIGNED U.S. STATIONS (BY FREQUENCY)

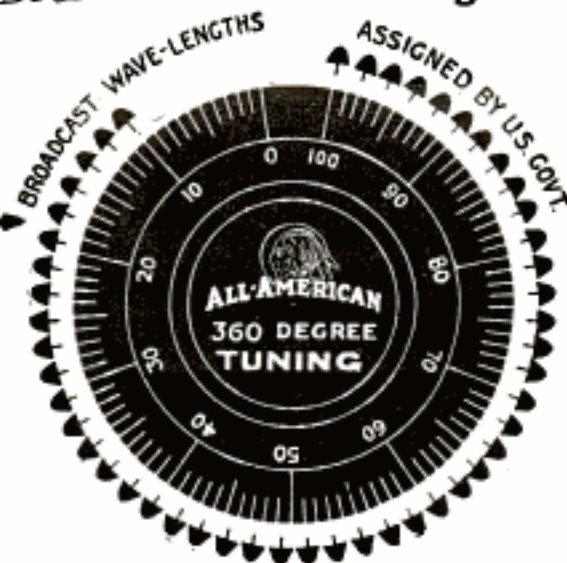

20-KILOCYCLE INTERVALS ARE SHOWN;
ALTERNATE CHANNELS OMITTED
FOR CLEARNESS

ALL-AMERICAN STRAIGHT-LINE-FREQUENCY TUNING

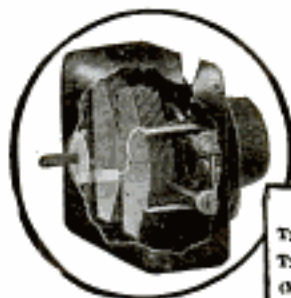

ALL-AMERICAN Straight-Line-Frequency CONDENSERS
Type C-35 Max. 500 Micromicrofarads
(Min. 10.5 mmf.) . . . \$4.50
Type C-50 Max. 500 Micromicrofarads
(Min. 11.8 mmf.) . . . \$5.00
(Min. Capacity is measured at 400 meters)

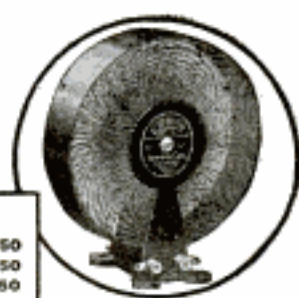

ALL-AMERICAN Toroid Coils
Type T-1 Antenna Coupler . . . \$ 3.50
Type T-2 R. F. Transformer . . . 3.50
Set of 3 Coils Complete . . . 10.50

Ease and certainty in tuning—no more crowding of short-wave stations—no need to buy vernier dials—no gears or other back-lash makers—body capacity absolutely not distinguishable—electrical efficiency unsurpassed—on one-half the panel space: that is the ALL-AMERICAN Straight-Line-Frequency Condensers.

New power for distance reception through close coupling—tuning of arrow-like sharpness—elimination of all oscillation worries through the self-enclosed endless magnetic field—non-radiating reception: that is ALL-AMERICAN Toroid Coils—Antenna Coupler and Radio Frequency Transformers. See them at your dealer's.

A new edition of the famous RADIO KEY BOOK, together with complete information about the new ALL-AMERICAN Straight-Line-Frequency TUNING, is yours for 10 cents, coin or stamps. Send for it today sure!

ALL-AMERICAN RADIO CORPORATION, E. N. RAULAND, President, 4221 Belmont Ave., CHICAGO

RMA

OWNING AND OPERATING STATION WENR—266 METERS

ALL-AMERICAN

Pioneers in the Radio Industry

It is not a "Hot Shot" unless it is an Eveready Columbia

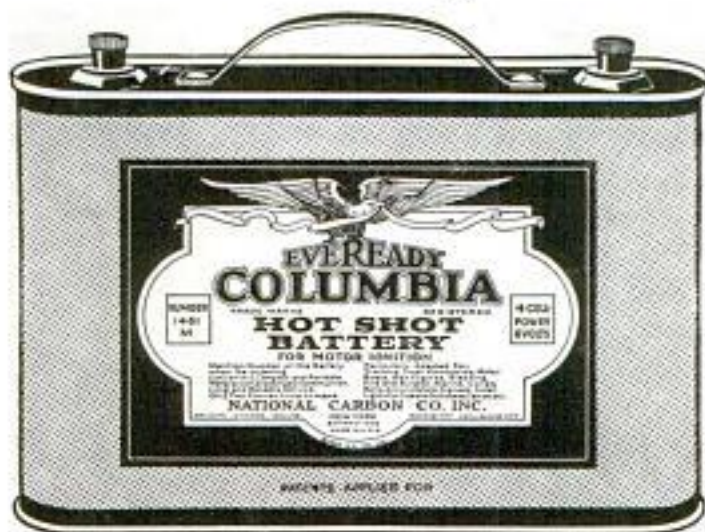

WHEN you ask for a "Hot Shot" Dry Battery, it will pay you to make sure you get one. Any group of dry cells connected in a package is not a Hot Shot. "Hot Shot" is a trade-marked name and means only Eveready Columbia. Hot Shots come in three sizes, containing 4, 5 or 6 cells, giving 6, 7½ or 9 volts. In a neat, durable, water-proof steel case

with convenient carrying handle. Every one is labeled "Eveready Columbia Hot Shot." Experienced battery men prefer these batteries because of their superior service—they last longer. It will pay every dry battery user who needs 6, 7½ or 9 volts to ask for Hot Shots and to make sure of getting them. There is an Eveready Columbia dealer nearby.

Manufactured and guaranteed by

NATIONAL CARBON COMPANY, INC.
New York San Francisco

Canadian National Carbon Co., Limited, Toronto, Ontario

gas engine ignition
motor boat ignition
tractor ignition
starting Fords
lighting tents and
outbuildings

running toys
telephone and
telegraph
doorbells
buzzers
heat regulators

ringing burglar alarms
protecting bank vaults
electric clocks
calling Pullman
porters
firing blasts

**EVEREADY
COLUMBIA
Dry Batteries**
-they last longer

Ingersoll

YANKEE



\$1.75

The Most Popular Watch in the World

WHAT a tribute to an article to say that over a period of thirty years time more people have chosen it than any other!

Ingersoll Yankees have been chosen by 60 million people—in all parts of the world, in all walks of life.

Is there any better demonstration of the quality? Of dependability? Of value? Of genuine service?

The Yankee now on sale is a new model with many new features of grace and beauty—clean-cut, handsome and “easy-to-look-at.”

Look for the
Red Handle
 with the
Black Head
 (Color Combination
 registered as
 trade mark
 U. S. Patent Office)
 EXCLUSIVELY
PLUMB

The **PLUMB**
 Balanced Nail Hammer
 At good hardware stores
 \$1.30 (except in Far West
 and Canada)

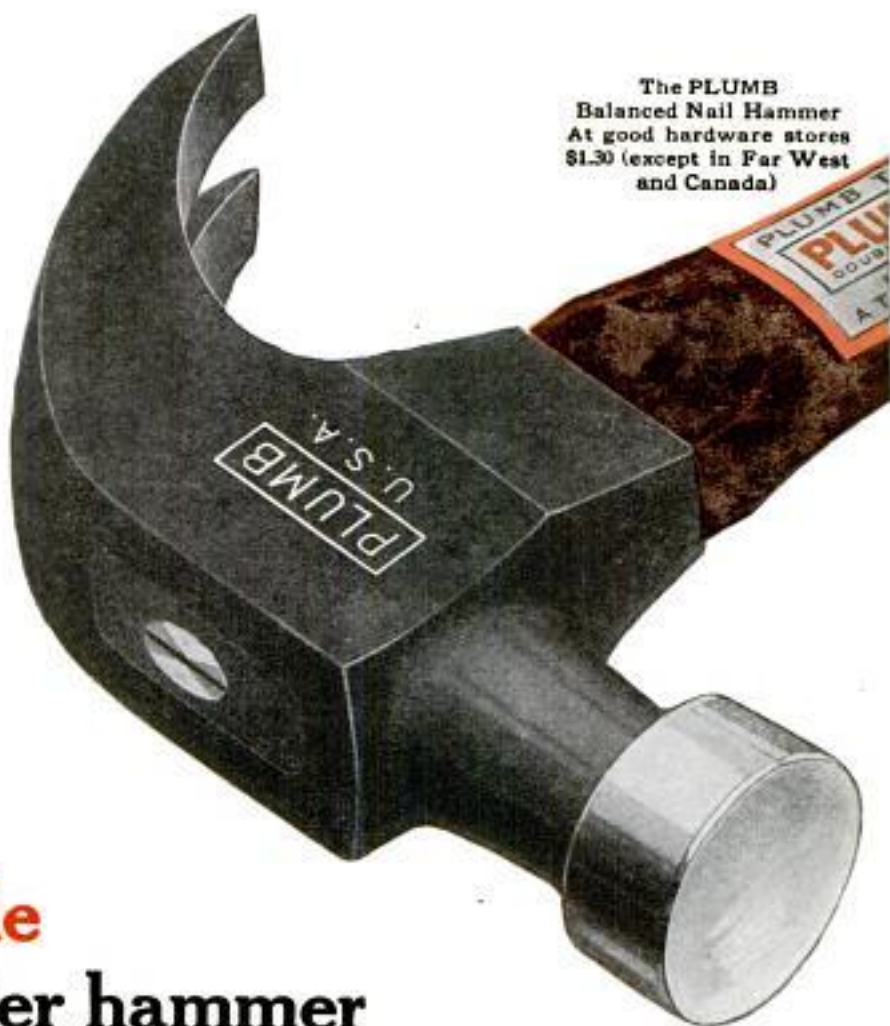

Black head on red handle means a better hammer

SEE what PLUMB has done to give particular tool-users a hammer they will appreciate.

A hammer, too, that will retain its good qualities through a lot of hard use.

With its larger face, for accuracy;
 Its shorter neck, for better balance;
 Its claws improved in pulling power;
 Its head specially tempered — hard
 for service, tough for wear.

The Plumb Take-Up Wedge retightens the black head of this hammer with a turn of the wrist. It keeps all Plumb heads tight on Plumb red handles.

The Take-Up Wedge preserves balance and hang and accuracy.

It keeps Plumb tools (exclusively) good as new!

FAYETTE R. PLUMB, Inc.
 Philadelphia, U. S. A.



Instantly, with a turn of the wrist, you retighten the head of any Plumb Tool. V-shape of wedge expands wood of handle against all sides of eye all the way in.



Music Master Receiving Sets

A Logical Development

Music Master

*Resonant Wood
Insures Natural
Tone Quality*

TYPE 300

Five Tubes. New circuit. Connect with standard bell or cabinet type MUSIC MASTER Reproducer or with specially designed art model reproducer illustrated. Great selectivity, extraordinary volume, wonderful tone quality. Solid mahogany cabinet, beautifully ornamented, brown mahogany art satin finish. Price..... \$300

MUSIC MASTER Reproducer Model XII. Drum Type. Specially designed art model illustrated. Price . . . \$35



*Canadian
Prices
Slightly
Higher*

MUSIC MASTER Receivers insure efficiency of reception equal to the quality of reproduction which has achieved a world-standard in **MUSIC MASTER** Reproducer.

Combining the proved powers of **MUSIC MASTER** reception and the demonstrated supremacy of **MUSIC MASTER** reproduction in one splendid radio ensemble of supreme efficiency, **MUSIC MASTER** reasserts its pre-eminence as the *Musical Instrument of Radio*—there IS no substitute.

Authorized dealers everywhere are ready to demonstrate radio as you have always wanted to hear it. See Music Master—hear—compare—before you buy ANY radio set.

*Ten Models \$50 to \$460
Guaranteed Unconditionally*

*Sold by Authorized Music Master
Dealers Everywhere*

Music Master Corporation

Makers and Distributors of High-Grade Radio Apparatus
CHICAGO PHILADELPHIA, 128-130 N. Tenth St. MONTREAL
NEW YORK Canadian Factory: Kitchener, Ontario PITTSBURGH

MUSIC  **MASTER**
RADIO PRODUCTS

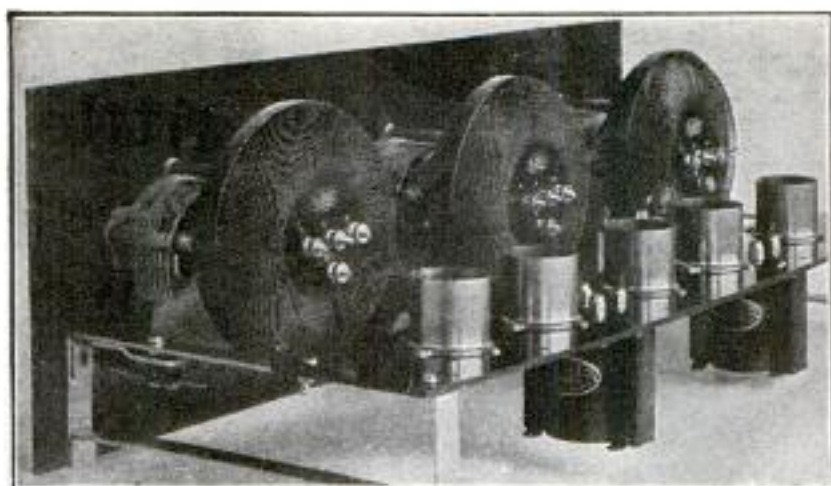

Amazing new receiver

NOW anyone can build it in an amazingly short time this new easy way. Experts assemble it at factory. You simply wire. Note revolutionary new principle it contains.

NO excuse now for not having a fine radio. At a surprisingly low cost, too. For a remarkable plan is showing thousands a new way to build their own. It is so easy that anyone can do it in an hour's time. So fascinating that many continue to build them for others. No wire bending or soldering. Merely attach a few ready-cut, flexible eyeletted leads, and the job is done.

And in addition to the fun and pride of building your own, the finished receiver actually contains a phenomenal feature not yet found in the most expensive sets; that brings results otherwise impossible.

This feature follows the discovery of a new inductance principle that overcomes many vital weaknesses of present day sets. It is based on an entirely new type coil—the Erla *Balloon *Circloid.

Circloids are the backbone of the Erla kit and are largely responsible for the striking improvements this kit alone offers. Note these four advantages in particular:

1. Greater distance. Circloids have no measurable external field to affect adjacent coils or wiring circuits. This makes possible higher amplification in each stage, with increased sensitivity and greater range.

2. More volume. Higher r. f. amplification enables Circloids to bring in distant stations scarcely audible in

ordinary sets with volume enough on the loud speaker to fill an auditorium.

3. Increased selectivity. Circloids have absolutely no pick-up qualities of their own. Only signals flowing in the antenna circuit are built up.

4. Finer tone quality. The self-enclosed field positively prevents stray feed-backs between coils. Hence no blurring or distortion. Tones are crystal clear.

Circloids are sold singly and in sets of three; also in kits containing three Circloids and three .00035 condensers.

Write for free information on kit—also book See how a few minutes of fun will give you the newest and most nearly perfected set known to radio science. Examine it at any Erla dealer's, or send the coupon for full information, illustrations and diagrams contained in the remarkable new book, "Better Radio Reception," describing the sensational new Circloid principle. Enclose 10c for mailing and postage on book.

*Trade Mark Registered.

Electrical Research
Laboratories,
2500 Cottage Grove Ave.,
Dept. 5-A, Chicago, U. S. A.



Send me free information on kit. Enclose 10c for postage for book, "Better Radio Reception."

This sign identifies authorized Erla distributors. All are equipped to give complete radio service.

Name.....

Address.....

City..... State.....

Dealers—Exclusive franchises are available to high class dealers in localities still open. Write or wire immediately.



Whether You Smile or Cuss Depends on the Service Behind Your Radio

WHAT is this radio service which we claim is so necessary?

Do you drive a car?

Do you ever have little things go wrong with it?

You have become so used to minor troubles that you don't condemn the car on which they occasionally occur.

No—

You go right to a service man—a man who knows your make of car. You don't

go to a handy man who claims he can fix any car.

That's automobile service, and is one of the main reasons for the auto being the success it is today.

The same service condition exists in radio—the only difference being that people don't yet understand it.

The radio instrument which never requires service has never been built—it never will be. Like automobile manu-

OZARKA

120 Austin Avenue P,
Chicago, Illinois



**YOU'LL KNOW
THE MAN BY
THIS BUTTON!**

Openings for a Few More Ozarka Factory Representatives

OZARKA Incorporated, is now entering its 4th year. From a beginning with one engineer, one stenographer, one salesman—our present president, the Ozarka organization has grown to over 3,100 people. There must be some good reason for this growth.

Ozarka instruments have made good—they have more than met competition. Ozarka representatives have made good not only because Ozarka instruments were right, but because they have been willing to learn what Ozarka engineers were willing and capable to teach them—Ozarka unusual salesmanship and Ozarka service.

There are still openings for the right men in this organization—men who believe in the future of radio—men who are tired of working for some one else—men who want a business of their own. Prove yourself by sales and willingness to learn and exclusive territory will be given you. The man we want has lived in his community for some time. He has the respect of his fellow men because he has never "put anything over" just to make money. He may not have much money, but he is not broke and is, at least, able to purchase one demonstrating instrument.

Send for FREE Book

Radio offers a wonderful opportunity to men who are willing to start at the bottom and build. You need not know salesmanship, but will you learn what we will gladly teach you? You may not know radio, but we can and will teach you if you will do your part. With such knowledge and willingness to work, it doesn't seem possible that you cannot make good. Sign the coupon below, don't fail to give the name of your county.

Better still write a letter, tell us about yourself and attach the coupon. If interested in our salesman's plan ask for "Ozarka Plan No. 100."

Without obligation send book "Ozarka Instruments No. 200" and name of Ozarka Representative.

I am greatly interested in the FREE book "The Ozarka Plan" whereby I can sell your radio instruments.

**Ozarka
Incorporated**

120 Austin Ave. P,
Chicago, Illinois

Name.....

Address..... City.....

County..... State.....



facturers, the better radio manufacturers do all within their power to make their instruments mechanically perfect. Nevertheless, like the auto, little things will sometimes go wrong—they are serious to the radio owner but very simple to a factory trained service man.

The handy man who can fix any radio simply experiments until he locates the trouble—such a method was disastrous to the auto in former days—it is disastrous and expensive in radio today. It is not sound. Ozarka instruments are sold only by Ozarka factory representatives, men who are factory trained in sales and service, men who sell no other radios but Ozarka.

These men don't pretend to know all about radio but they do know all there is to know about Ozarka—isn't that the kind of radio service you want?

Ozarka instruments are sold under a very definite plan. An Ozarka representative will gladly set up an Ozarka in your home—he won't tune it—he won't tell you what it will do—you must operate yourself. If the results you receive by your own operating won't convince you that the Ozarka gives you the distance, volume, selectivity, tone and ease of tuning that you demand, then don't buy it.

Ozarka instruments are built to sell themselves but no Ozarka is sold without factory-trained service behind it.

INCORPORATED

120 Austin Avenue P,
Chicago, Illinois



"I will save Kalamazoo customers \$1,000,000 this year. I invite you to share in this great saving. My new book, just out, tells you all about it." W. S. DEWING



Mail coupon for FREE book



All Kalamazoo Gas Stoves, Combination Ranges and Coal and Wood Ranges have been tested and approved by Good Housekeeping Institute

This FREE Book—Just Out Beats 20 Big Stores

Save 1/3 to 1/2 at Factory Prices



Combination Ranges \$59⁸⁰ up



Gas Stoves only \$5⁰⁰ down



Furnaces \$59⁹⁰ up

Here is Our Policy
 30 days Trial.
 360 days Approval Test.
 560,000 Customers.
 24 hour Shipments.
 25 Years in Business.
 Satisfaction of Money Back.
 Cash or Easy Payments.
 Safe Delivery Guaranteed.
 Above All Else—Quality.

You can't get the quality, the variety or the value in twenty big stores in twenty cities that you will find in this new Kalamazoo catalog. This catalog is the guide book of the stove and furnace industry. Don't under any circumstances buy a stove, range or furnace anywhere until you consult it. Over 200 styles and sizes—all finest quality, all at rock-bottom factory prices.

New Porcelain Enamel Ranges

Here in this book, fully illustrated with many color pages, are heating stoves; gas stoves; coal and wood ranges in black, nickel, delft blue, and pearl-gray porcelain enamel; combination gas and coal ranges in black, nickel and porcelain enamel; furnaces—both pipe and one register type; oil stoves and household goods. Kalamazoo specializes in porcelain enamel ranges of lasting beauty. Our sales on these ranges increased 300% last year.

Cash or Easy Terms—30 days FREE Trial

It explains our generous credit terms—some as low as \$3.00 down and \$3.00 monthly. It tells about our 30 days FREE trial in your home and 360 days approval test. It states our \$100,000 bank bond guarantee—the strongest ever written. If you are not thoroughly satisfied, we will refund your money and all freight charges. It also tells how we give you 24 hour shipping service.

560,000 Pleased Customers

You have heard of Kalamazoo-Direct-to-You for 25 years. You have seen our advertisements before. *But have you ever answered one?* If you haven't now is the time for you to save money on the same plan that 560,000 Kalamazoo customers know is *right!*

KALAMAZOO STOVE CO., Manufacturers
391 Rochester Ave. Kalamazoo, Mich.

MAIL THIS COUPON TODAY

MR. W. S. DEWING, President, Kalamazoo Stove Co.
 391 Rochester Ave., Kalamazoo, Mich.

Dear Sir: Please send me your FREE catalog. I am interested in _____ ranges, _____ heating stoves, _____ gas stoves, _____ oil stoves, _____ furnaces, _____ kitchen cabinets, vacuum cleaners, bed davenport, cedar chests. (Check article in which you are interested.)

Name _____
 Address _____
 City _____ State _____

"A Kalamazoo
 Trade Mark
 Registered **Direct to You"**

New Thrills Await You With a "Twenty-Six"

A BETTER model than the 1925 Stream-Line didn't seem possible. Yet here it is. The 1926 Big Twin—king of the road.

Sixteen improvements, with more comfort, economy, and "class". See it at your dealer's today. Get a good close-up of the wide fenders—balloon tires—the trim, handy switch panel, and all the other new features.

Test it. Let him take you for a free ride over the Thrill Trail. See if this super-motorcycle isn't more responsive, more eager, more alive than ever!

Ask the dealer about his easy
Pay-As-You-Ride Plan.



Harley-Davidson The Motorcycle

Money-making sales opportunities in open territories. Ask how others have made big successes selling Harley-Davidsons.

Mail the coupon

HARLEY-DAVIDSON MOTOR COMPANY, Dept. P, Milwaukee, Wis. Send me FREE, interesting literature showing the new 1926 Big Twin Harley-Davidsons in actual colors.

Name.....

Address.....

City.....



It makes life's writing easier~

FOR every age and every station—for men, women, and children—the New Remington Portable is an invaluable helper. For the *child* it is an inspiration which facilitates composition and hastens the writing age. For the *student* it saves valuable time for athletics and other school activities. Then too, typewritten work brings better marks, and correspondence has no burdens.

For the *traveler* it has extreme lightness; for the *professional man* it combines every advantage; and for all it is a time-saving convenience, possessing in compact form all the writing merits of a larger machine.

Our NEW model has several mechanical improvements that give it an efficiency never before equaled in a portable typewriter. It is the lightest and most portable Portable with 4-row standard keyboard; it is the most compact Portable; it has the longest writing line of any Portable; it accommodates full width paper and long envelopes; it has the finest touch and action; it does beautiful work; its durability has been proved; and *all* the writing is visible.

Be sure to examine the New Remington Portable, or write for our illustrated "For You—For Everybody." Address Department 12.

REMINGTON TYPEWRITER COMPANY
374 Broadway, New York—Branches Everywhere

Remington Typewriter Company of Canada, Limited, 68 King St. West, Toronto

Remington Portable

We believe we make the best typewriter ribbon in the world—and its name is PARAGON

The New Model Now Available

The New Remington Portable is sold by Remington offices and dealers everywhere. It is backed by a service that is universal.



21 Jewel Santa Fe Special

on credit

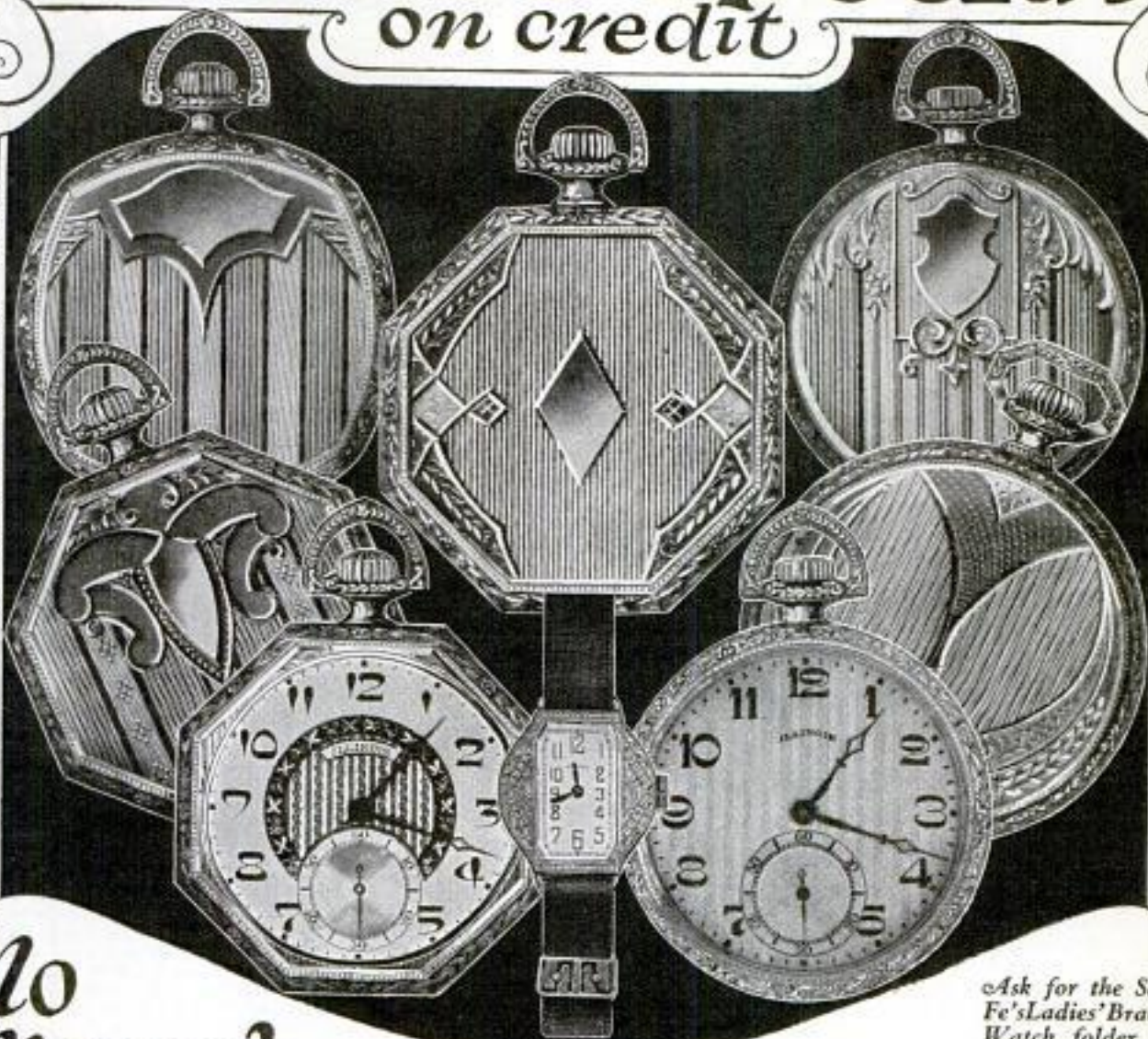

No Money Down

WE will send this famous watch direct to you, express prepaid on FREE Approval. Examine watch and be convinced it's the best watch buy you ever saw. You save $\frac{1}{8}$ to $\frac{1}{2}$ your money by purchasing a Santa Fe Special Watch. We trust you—wear watch while paying for it.

Ask for the Santa Fe's Ladies' Bracelet Watch folder and Diamond folder.

Mail Coupon for FREE Watch Book →

Clip the coupon, fill out and receive the FREE WATCH BOOK. All the newest watch case designs in white or green gold, fancy shapes and thin models are shown. Read our easy payment offer. Select the watch you would like to see, we will send it to you on approval, express prepaid. Wear the watch 30 days FREE—return at our expense if not fully satisfied.

SANTA FE WATCH COMPANY
Dept. A-6, Thomas Building Topeka, Kansas
The Home of the Great Santa Fe Railway

SANTA FE WATCH CO.,
Dept. A-6, Thomas Building
Topeka, Kansas

Please send prepaid and without obligation your Watch Book Free, explaining your "No Money Down" Offer on the Santa Fe Special Watch.

Name.....

Address.....



Maybe his wife was right

He had ability, he dressed well—but several recent opportunities in the office had gone to other men. Maybe his wife was right. She had tried to be tactful when she told him—and now he was going to do something about it.

Nearly all young men are inclined to have a grimy-looking skin, spotted with blackheads and dull in appearance. Few realize that this hinders their success in life. Pompeian Massage Cream helps you overcome this handicap by giving you a clean, ruddy complexion.

Clears the Skin: Pompeian Massage Cream thoroughly cleanses the pores. It helps clear up blackheads and pimples by stimulating healthy circulation, and by keeping the skin clean and the pores open.

Your Druggist Has It Use it regularly at home

Easy to Use: Rub it in; rub it out. After shaving or washing, rub it in gently. Continue rubbing and it rolls out, bringing with it all the dirt and skin impurities. Result—a clean, healthy skin with clear, glowing color.

SPECIAL OFFER 1/3 of 60c jar for 10c

For 10c we send a Special Trial Jar containing one-third of regular 60c contents. Use coupon below.



The Pompeian Co., Cleveland, Ohio, Dept. 27
Gentlemen: I enclose a dime (10c) for trial jar of massage cream.

Name

Address

City State



NEW WEBBING of that fine quality for which Bostons have always been so famous; in many attractive color combinations, wide web or narrow; price range, 25c to \$1.00.

And all equipped with the All Rubber Oblong Button, which holds stockings taut without tearing and "the Pad without a pucker."

No wonder Bostons are so popular the world over.

GEORGE FROST COMPANY, Makers, BOSTON



"No, Jim — I've stopped smoking.

Gained six pounds in a week. You know how I used to smoke— a package of cigarettes and a cigar or two a day—it sure had some hold on me. But I'm cured—

took a scientific home tobacco treatment—fixed me up in two weeks.

"Wasn't hard on me at all—noticed improvement the first day—I feel like a new man. It didn't interfere with my work—didn't leave any dragglah after-effects—the money I saved in the last two weeks has paid for the treatment alone.

"Why don't you take it! It has cured men like you and me for over forty years—it is a doctor's individual prescription that sure fixes you up. Just send the coupon for full information NOW. No obligation. All correspondence is strictly confidential."



The Keeley Institute, Dwight, Ill.

Please send me, without any obligation on my part, your free booklet which will tell me how to rid myself of the tobacco habit.

Name

Town

Street State PM-19



TRADE MARK REG.

WURLITZER

SUPREMACY IN MUSICAL INSTRUMENTS

Learn to Play

You are always popular and sure of a good time if you can play some musical instrument. By yourself, with your friends around the piano, in orchestras or bands,—there is no end to the pleasure music will give you. And there is no easier way to earn money in your spare time. Choose your instrument now and let Wurlitzer help you buy it and learn to play it.

Try Any Instrument in Your Own Home At Our Expense

You may now have any known musical instrument for a week's free trial in your own home. There is no obligation to buy—no expense for the trial. You may return the instrument at the end of a week if you decide not to keep it.

Monthly Payments

The Wurlitzer plan makes it easy for you to own the instrument you want. Payments are conveniently arranged in small monthly sums—a few cents a day will pay.

Wurlitzer instruments are known everywhere for their unusual tone quality and excellence of workmanship. They are used by the greatest

professional musicians, bands and orchestras. Harry L. Jacobs of Sousa's Band, Brooke's Marine Band, and Chicago Grand Opera says: "I am proud to be the owner of one of your new cornets. It is positively superior to anything I have had in all my years of cornet playing."

Easy to Buy

Thousands of amateur musicians are playing on Wurlitzer instruments. Many of them could not have bought except through the Wurlitzer selling plan. Wurlitzer is the world's greatest music house, with stores and dealers in all parts of the country. But no matter where you live you will receive the same service by mail as though you lived next door to the factory. Send the coupon today.

Send for Free Catalog

The greatest musical catalog ever published. Over 3,000 articles—every known instrument described and illustrated—many of them shown in full color. Gives you all details of the Wurlitzer plan. Send coupon now.

The Rudolph Wurlitzer Co., Dept. 1777
117 E. 4th St., Cincinnati 329 S. Wabash Ave., Chicago
129 W. 42nd St., New York 250 Stockton St., San Francisco

Send me absolutely free, your new illustrated catalog of musical instruments. Also tell me how I may try any instrument in my own home at your expense and how the Wurlitzer plan makes it easy for me to buy. No obligation.

Name _____

Address _____

City _____

State _____

Instrument _____

(State instrument in which you are interested.)

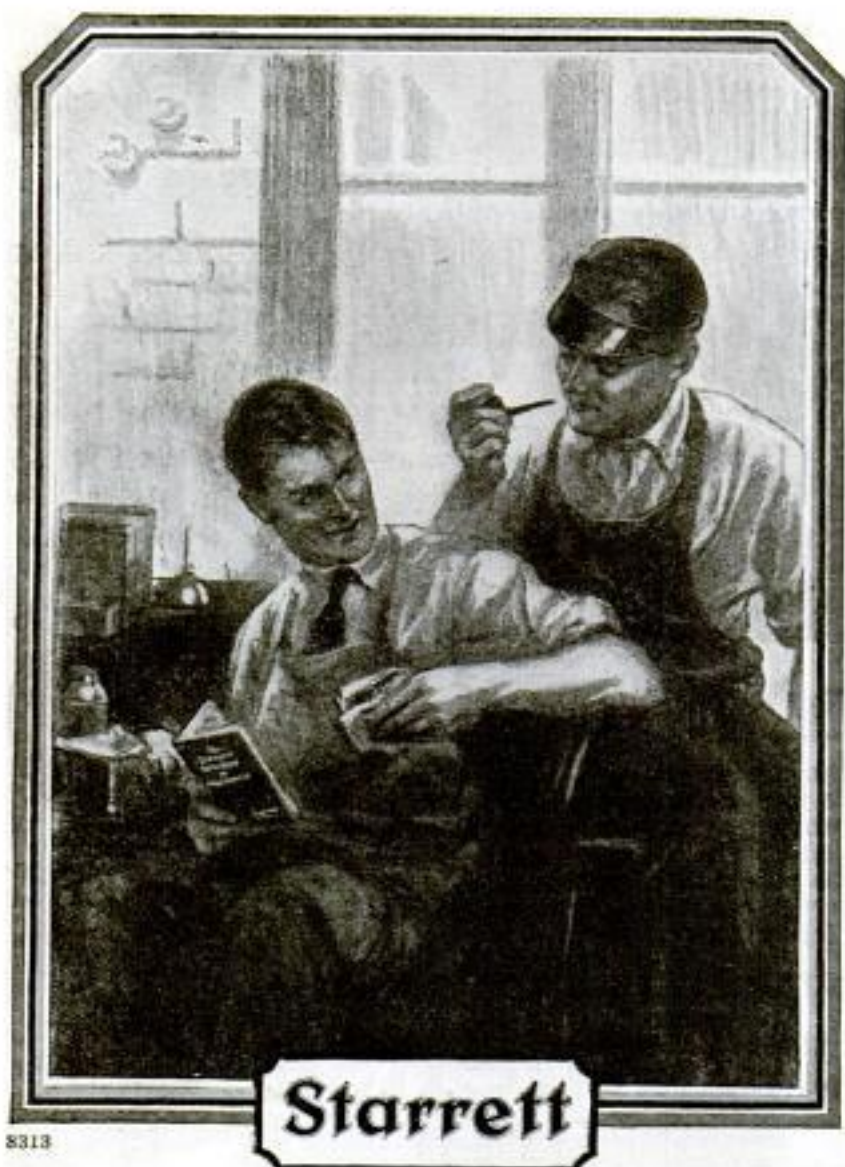

Starrett

8313

Who
Is The Man
That
Gets Ahead



Handbooks, Vols. I, II and III

Are you interested in doing better work? If a beginner, do you want to know how to use your tools the way the best men in the shop use theirs? How to turn but work that's *right* the first time? How to size up and go through with a difficult job with no lost motion? Get Vol. I of the Starrett Books.

If you are a practical machinist, couldn't you use to splendid advantage a book which puts at your finger tips important formulas and technical dope—tables that relate to machine speeds, power transmission, drilling, gear cutting, turning and milling, materials,

etc.? Get Vol. II of the Starrett Books. If you work on cars and parts, wouldn't you appreciate a clearly written, well illustrated book that covers the latest and most approved methods and general practice in automobile and engine repair work? Get Vol. III of the Starrett Books.

The famous Starrett Handbooks give you this information. Profusely illustrated, approximately 200 pages of well printed text written for the man in the shop. And all for only 75 cents each. Send us that amount, if hardware dealer cannot supply you.

Catalog No. 23 "AP" sent free on request.

THE L. S. STARRETT CO.

World's Greatest Toolmakers
Manufacturers of Hacksaws Unexcelled
Steel Tapes—Standard for Accuracy
ATHOL, MASS.



75¢
Each



Does Happiness Cost Too Much?

THERE is no catalog number for "happiness," but we sell it just the same. You'll not find it illustrated, but it appears on every page. The frock for the young lady's first party; the boy's bicycle; dad's radio; mother's new coat. Don't they all mean happiness? And could all of them be had if Sears, Roebuck and Co. wasn't able to sell good merchandise at such low prices?

A customer recently wrote us: "I take great pleasure in showing my furniture to my neighbors. I shall always advertise you by your honesty and great bargains."

Things like that—and every day's mail contains a great many such letters—make us feel that we are a real factor in the lives of millions of American families. You could hardly blame us for feeling a bit proud in helping these folks to a little happiness they might not otherwise have been able to obtain.

Sears, Roebuck and Co. brings the trading centers of the Old World and the New World as well direct to the doors of our nine million customers; they see in our catalogs, at prices they can afford, the things they need, and the luxuries they have wanted.

One-fourth of all the families in the United States know that we guarantee them a saving on everything they buy; know we sell only quality merchandise, honestly illustrated and described. They know, too, that we ship all orders in less than 24 hours.

Our New Big Catalog for Fall and Winter is ready. It shows 35,000 bargains on everything needed for the family, the home and the farm. Send for it today.

Sears, Roebuck and Co.

CHICAGO · PHILADELPHIA · KANSAS CITY
DALLAS · SEATTLE



WORLD'S LARGEST STORE

We own and operate Radio Station
W.L.S. Tune in on 344.6 meters.

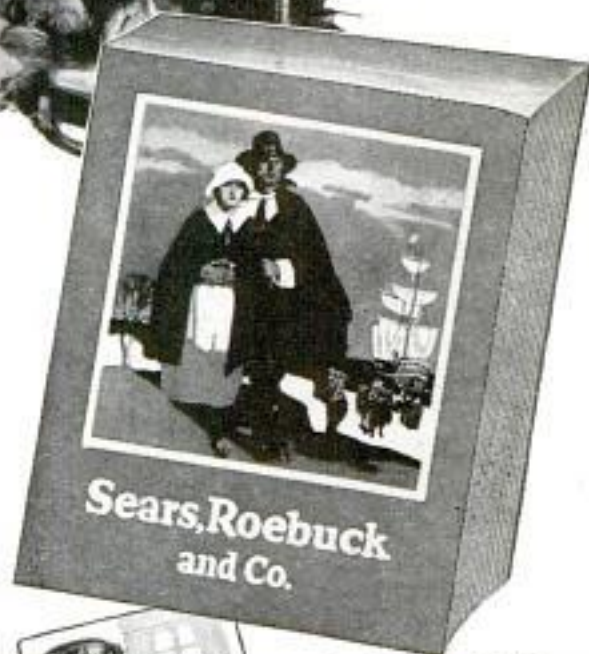

Send for Your FREE Copy
If you haven't a copy of our New Big General Catalog, send for it today. This convenient coupon will bring you our great Fall and Winter book, with its 35,000 bargains.



Mail the coupon **TODAY** to store nearest you
Sears, Roebuck and Co. 80P84
Chicago · Philadelphia · Kansas City · Dallas · Seattle
Send Latest General Catalog.

Name.....

Postoffice.....

Rural Route..... Box No.....

State.....

Street and No.....

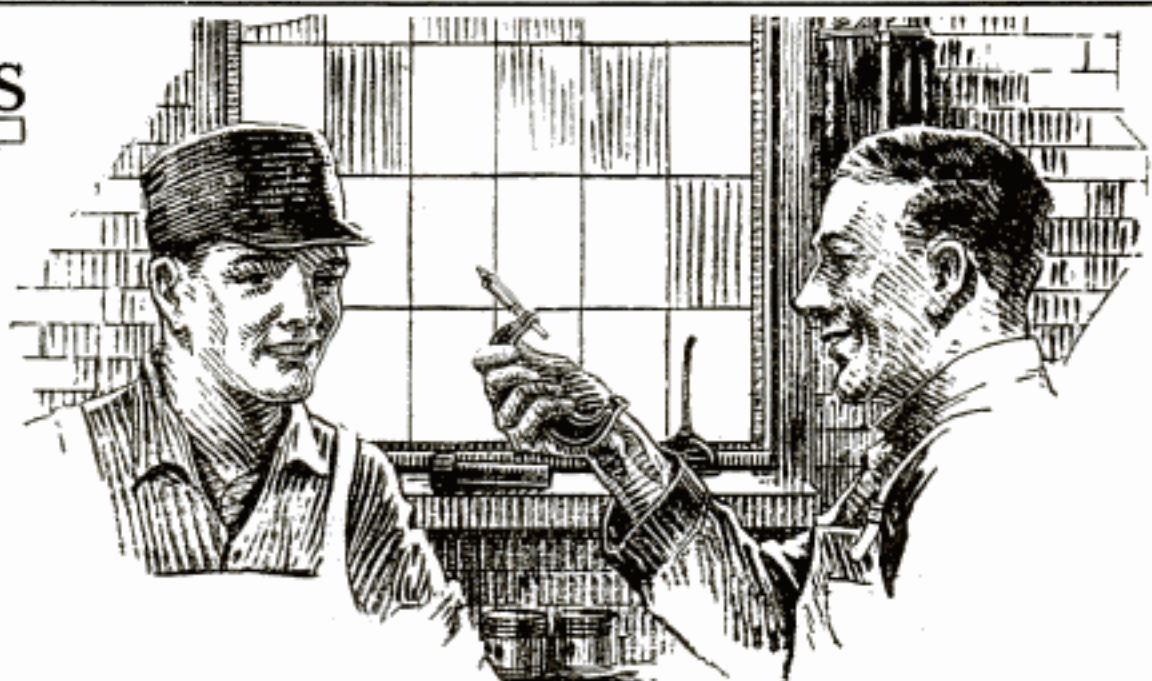
“Yes, Jim, that’s why I got a better job”

“In the first place, remember, I have a kit of good tools. While the rest of you boys were shooting pool or at the movies, I was studying and building up my kit with Brown & Sharpe Tools getting ready for a bigger job. Some of the tools I didn’t really need then, but I was certainly glad I had them later. When my chance came, I was ready—that’s why I got a better job.”

Every mechanic finds that only with the best tools can he do his best work. With a good kit he is qualified to go higher—he is equipped for the bigger job when it comes. Build up your kit with Brown & Sharpe Tools.



Send for Small Tool Catalog No. 29

Brown & Sharpe Mfg. Co.

PROVIDENCE, R. I., U. S. A.



BROWN & SHARPE TOOLS

“Standard of the Mechanical World”

A Genuine Underwood No. 5

The ace of standard writing machines!
The best business machine is best for you. Read our offer!

\$3
—and
It's
Yours!

Pay
Like
Rent

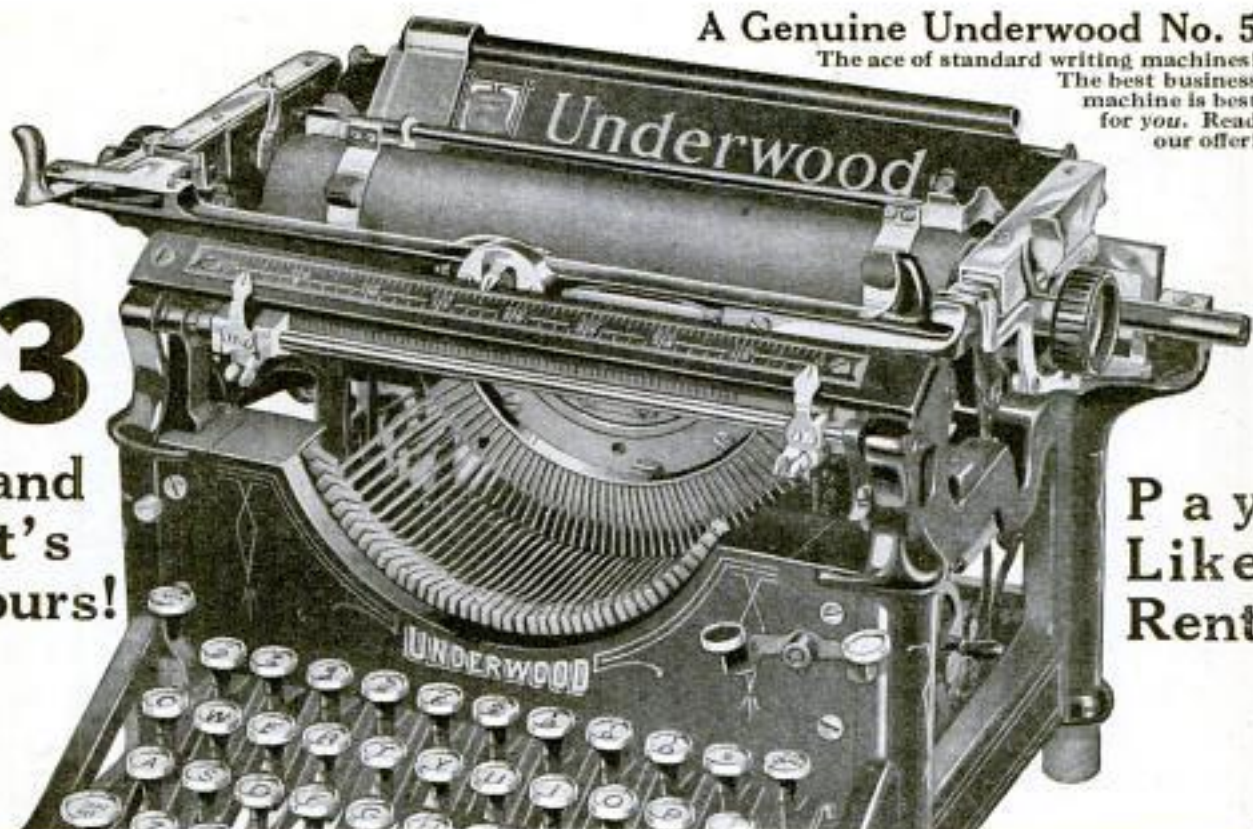

Own a Typewriter !

A Bargain You Can't Ignore! Every Member of the Family Will Use and Enjoy It! Try It Free and See!



GET YOUR typewriter *now*. A genuine, Shipman-Ward rebuilt Underwood—"the machine you will eventually buy." Don't send a cent, but do get our special offer—valuable book on typewriting—*free*.

You can learn to write on this standard-keyboard Underwood in a day. In a week, you'll feel lost without it! The free trial will *prove* it. Our rebuilt plan gives you the *best* machine and a *big* saving.

Act NOW If Ever!

Speak up, if you want one! Underwood No. 5 is so popular this lot we're completing now won't be long in selling! Rebuilt from top to bottom—*every single worn part replaced*. New typewriters are guaranteed for a year; we guarantee this one *five* years! That's our Better-Than-New Guarantee. And we guarantee a big saving!

We don't want a penny now. Nor any money at all, unless this proves the typewriter bargain of your

life. The trial is *free*. If you buy, our easy terms make it a pleasure to pay. There's no excise now, for not owning a typewriter—and the finest make! We include all tools, cover, etc., all complete all ready to write. Write us now. Deal direct; we are the largest factory of the kind; we offer the right machine at the right price; we sell the largest business houses.

Typist's Manual

FREE

Get our catalog free; quotes lowest prices and most liberal terms in existence. We'll send a manual free, too; it contains valuable instruction for learning rapid typing, useful pointers for all who use a typewriter, examples of business forms, social correspondence, work for others, etc. Clip coupon now!



Mail This NOW For Free BOOK

SHIPMAN-WARD MFG. CO.
2127 Shipman Bldg., Chicago

Please send FREE, full offer, catalog, typing manual, and outline your free course in Touch Typewriting, without obligation!

Name.....

Street or R. F. D.....

P. O.....State.....

Attachments

that give your motor more uses

WHY not quip your motor for drilling, grinding, polishing and buffing? The Goodell-Pratt small motor attachments make it easy. Just fit any of them on the shaft and the motor is ready to go to work.

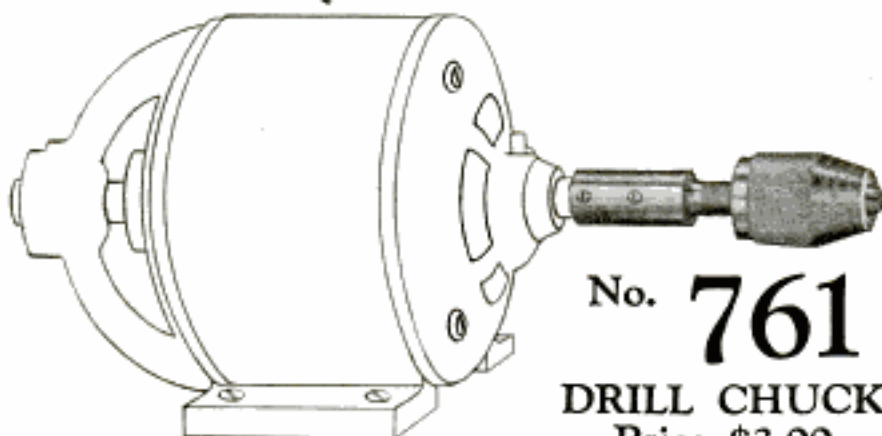

No. **761**
DRILL CHUCK
Price \$3.00

Fits motors with $\frac{1}{2}$ -inch shaft. Enables you to drill in iron or steel. Three hardened steel jaws hold round-shank drills from 0 to $\frac{3}{8}$ inch in diameter. Length over all, $4\frac{1}{4}$ in.

No. 757 Drill Chuck fits motors with $\frac{3}{8}$ -inch shaft. Similar to 761, but smaller; holds round-shank drills from 0 to $\frac{5}{16}$ inch. Length $3\frac{1}{8}$ inches. Price \$2.00.



No. **762**

Saw Arbor and Buffing Spindle: Has a shank that can be fitted on a $\frac{1}{2}$ -inch shaft. Arbor takes grinding, polishing and buffing wheels, wire brushes, etc., with $\frac{1}{2}$ -inch hole. Flanges open $\frac{3}{4}$ inch. The tapered spindle on the end of the arbor has a deep, clean thread for handling the great variety of wood-centered wheels. Length $5\frac{1}{4}$ inches. Price \$3.00.

No. 579 Spindle with R. H. threads. Price \$1
No. 760 Spindle with L. H. threads. Price \$1



No. **759**

Buffing Spindles: Have a clean, deep, tapered thread for holding wood-centered wheels. They are made with both right- and left-hand threads. The shank is made to fit a $\frac{3}{8}$ -inch shaft. Length $3\frac{1}{8}$ inches.

Write for Catalog No. 15

See all the other of the famous 1500 Good Tools that Goodell-Pratt make. All shown in the big general catalog. Write for a copy. It's free.

GOODELL-PRATT COMPANY, GREENFIELD, MASS., U. S. A.

Toolsmiths

Makers of Mr. Punch

GOODELL-PRATT

1500 GOOD TOOLS

500 PUNCTURES Yet Leaks No Air



We Want Agents

A new Puncture Proof inner tube has been invented by Mr. F. K. Milburn of the Milburn Puncture Proof Tube Company, Chicago. In actual test it was punctured with 500 nail holes without the LOSS OF AIR. This amazing new inner tube increases mileage from 10,000 to 12,000 miles; eliminates changing tires and makes riding a real pleasure. Many users have run over 20,000 miles without removing a tire from the wheel.

These wonderful, no-trouble, puncture proof inner tubes cost no more than ordinary tubes and Mr. Milburn wants agents everywhere to help him introduce them.

CAR OWNERS WANTED

To sell and demonstrate this wonder tube. Interests everyone immediately. Automobile owners buy on sight. It makes no difference what car they drive or what tires they use. Our salesmen are coining money on our "DIRECT FROM FACTORY" scheme of selling. Absolutely no competition. We control all basic patents. No capital required to start. Previous selling experience not necessary.

EARN \$5,000 to \$10,000 A YEAR

Read What These Men Say

J. D. Cooper—"I have made 30,000 miles with my Milburn Puncture Proof Tubes and have not as yet removed a rim or casing and my casings are still in excellent condition."

J. C. Jerves—"I sold 50 Milburn Tubes in the first three days."

Chas. Cayton—"I sold twelve tubes yesterday in ten minutes."

L. S. Knapp—"My first few hours out I sold eight tubes, no trouble at all to sell them. The most wonderful tube on the market today, I think. I am hoping you will give me the agency for a big territory."

D. Edeler—"I have driven seventy-five nails in one of the 30x3 tubes and twenty were spike nails. It has gone above the test that you recommended to me it would do."

Earn \$5,000 to \$10,000 yearly or more. Get into business for yourself. Sell Milburn Puncture Proof Inner Tubes. Every car owner is a prospect. Your field is unlimited. Get in while it is good. Be independent. Find out all about it now and get started at once. Then you will be ready to make big money like our other sales agents are doing.

FREE TUBE SPECIAL FREE TUBE OFFER

Send coupon or write today for special free tube offer and further details. References, Industrial State Bank of Chicago, National Bank of the Republic, Chicago, Baker State Bank of Chicago. Don't hesitate. Fill out the coupon and send it in or write and send name and we will send you all details. This is your opportunity, so don't delay. Address

F. K. MILBURN, Pres.
**Milburn Puncture
Proof Tube Co.**
335 West 47th Street
CHICAGO, ILLINOIS

MILBURN PUNCTURE PROOF TUBE COMPANY
335 West 47th Street, CHICAGO, ILLINOIS
F. K. MILBURN, Pres. If the money-making opportunity is as big as you claim, I am interested in getting the facts, so that I can get a share of the profits selling Milburn Puncture Proof Tubes. Without obligation, send me literature, mention about commission and FREE TUBE OFFER TO AGENTS.

Name.....
Address.....
City.....
State.....

\$1 Brings your Choice of these 3 Big Specials

Buy From Us and Save Money

Simply pin a dollar bill to this ad, put it in an envelope with your name and address and Mail It Today. Your choice of these exceptional values will come Prepaid for a 15 Day Trial. If you can duplicate your purchase for less money anywhere, send it back and your dollar will be returned. If satisfied pay balance in ten equal monthly payments.

No Red Tape—Prompt Delivery
Transactions Confidential
Rush Your Dollar Today



A10

A11

A10 Beautifully hand-carved 18K White Gold Ladies Ring. 3 Genuine sparkling, blue-white Diamonds. Price \$37.50

\$1.00 Down; \$3.65 a Month

A11 Rectangular style 14K Solid White Gold Wrist

Watch set with 4 Genuine, brilliant, Blue-white Diamonds, 4 blue sapphires. Guaranteed 16 Jeweled Movement. Price \$42.50

\$1.00 Down; \$4.15 a Month.

A12 Gent's 12 size 17 jewel Guaranteed Elgin Watch, 14K Gold Filled Engraved Case guaranteed for 25 yrs. Complete with gold filled Knife and Chain. Price \$37.50. \$1.00 Down; \$3.65 a Mo.

FREE

A complete Booklet with over 3,000 other big bargains in Diamonds, Watches and Jewelry.

Send for it.

10 Months to Pay on Everything.

AUTHORIZED CAPITAL \$1,000,000.

L.W. SWEET INC.

Dept. 65-R | 1660 BROADWAY, NEW YORK

Foot Pains go in 5 minutes if you wear FAIRYFOOT CUSHIONS. Must help or no pay. Write to FOOT REMEDY CO., 22nd St. & Millard Ave., Dept. 28, Chicago, Ill.

AMAZING NEW ADDING PENCIL ADDS-COUNTS-CHECKS

TOTAL SHOWS HERE

Adds as accurately as a \$500 machine. Convenient, rapid and useful. Carry like pencil or pen. Simply press pencil point on numbers; addition entirely automatic, instantaneous; total shows constantly. To clear, just twist top. No larger than fountain pen. Not only adds, multiplies and counts with astonishing ease, but permits accurate checking. A remarkable time saver--infallible action. Adds as you write.

10 Days Trial—Send No Money

Just send name and address. Adding Pencil sent postpaid. Pay postman \$2.95 upon delivery. Test it ten days on our guarantee of satisfaction or money back if not positively delighted. Act now—order direct.

AGENTS Big money maker for agents. Everybody is interested. Write for proposition.

The Adding Pencil Co.
1201 Arcade Building
ST. LOUIS, MISSOURI



COUNTER
Eveready
SALESMAN



MAKES YOU \$5,000 A YEAR

Scores of men making \$5,000 a year and more. EVEREADY in big demand in confectionery, drug, grocery, cigar stores, waiting rooms, newsstands, hotels, cafeterias, restaurants, poolrooms, barber shops, soft drink parlors, etc.

WE GUARANTEE AGENTS

100% to 150% profit on every deal. \$12 initial investment starts you—buys 12 Evereadys (with sales-attracting bell attachment, 25c each extra). Complete investment averages from \$100-\$200, depending on number of EVEREADY's put out. Profits quickly pay back your investment. Sell or lease EVEREADY's, then keep merchants supplied with stock (salted peanuts, candies, nut meats, etc.) Daily repeat orders. Our contract with big nearest specialty houses enables you to buy all your supplies wholesale—in separate bags or bulk.

(Patent applied for)

WHOLE OR PART TIME Volume steady business and big profits in short time. Nothing else like EVEREADY—automatic—easy sell—no locks, clips or stickers. **Hurry—ACT NOW**—for exclusive rights in your community. Dealers: 10 days must prove claims or full refund. **THE INTERSTATE CO., 2403 E. 9th Pl., CLEVELAND, O.** (References: Midland Bank, Cleveland) OR—start on "shoestring" with new EVEREADY Metal Kiosk Display—just out—write for details!

NOW! New Low Engine Prices

Only \$5⁶⁹



Month for a few months—easy to own the famous standard WITTE Engine. Uses Kerosene, Gasoline, Distillate or Gas. Equipped with celebrated Troubleproof WICO Magneto. Simplest and cheapest to operate. New device makes starting easy. 50% surplus power. Sizes 2 to 25 H.P.—all styles. Sold direct from factory to you on **FREE BIG NEW ENGINE BOOK** NINETY DAYS' FREE TRIAL. Write today for my new illustrated engine book—sent absolutely Free. No obligation to you.

WITTE ENGINE WORKS

1741 Witte Building, - - - KANSAS CITY, MO.
1741 Empire Building, - - - PITTSBURGH, PA.
1741 Witte Building, - - - SAN FRANCISCO, CALIF.

30 Days' Free Trial

Select from 44 Styles, colors and sizes, famous Ranger bicycles. Delivered free on approval, express prepaid, at Factory Prices. You can easily save \$10 to \$25 on your bicycle. Prices \$21.50 and up. \$5 a Month on any Ranger if desired. Parents and girls can easily earn small monthly payments. Pay as you ride. Best quality, at factory prices, express prepaid. Lamps, wheels and equipment, low prices. Send No Money, do business direct with makers.



Mead CYCLE COMPANY
DEPT. 108 CHICAGO

Write today for free Ranger Catalog, factory prices and marvelous easy payment terms

AGENTS YOUR SUCCESS GUARANTEED

Fastest money ever made with greatest seller ever known -- 3-in-1, world's only hot water bottle, ice bag, and fountain syringe combination. One minute demonstration positively makes a sale. No capital nor experience necessary. Write immediately for revolutionizing sales plan. The Lobl Manufacturing Company, Dept. 83 Middleboro, Mass.

Make \$100.00 a week

You, too, can make the big money which men and women in the selling game earn today. Build up a permanent, profitable business of your own selling our nationally known silk hosiery direct to wearer. No investment--profits begin immediately. Our free instructions make it so easy and pleasant that you cannot fail. No experience necessary. Work full or spare time. **FREE** Men and women--write today for our new plan which shows you how to make \$60 to \$125 a week and be your own boss. Write today--**COLDWELL HOSIERY CO.** Department A-22, 315 Fourth Ave., New York

Learn about our big bonus offer.

SARGENT

PLANES

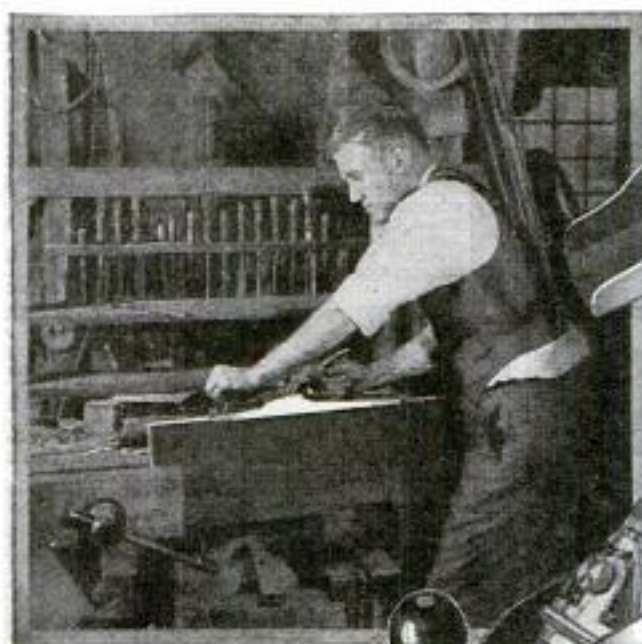

*Sargent Steel
Block Plane
No. 5206*

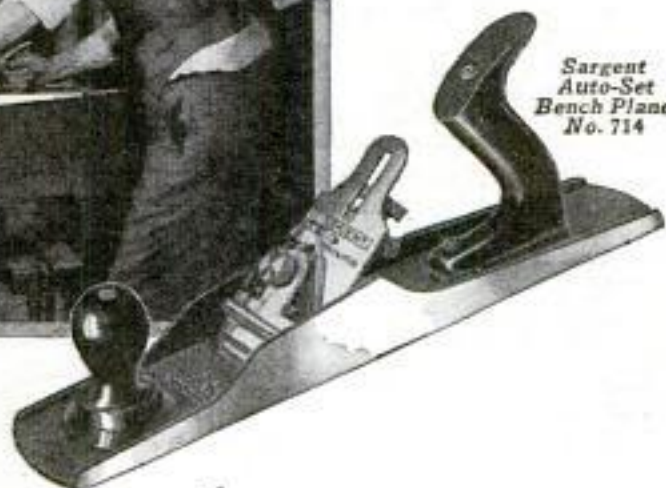

*Sargent
Auto-Set
Bench Plane
No. 714*

Give your work the professional touch

SARGENT PLANES will help you—just as they have helped thousands of carpenters in shops and out on building operations everywhere—to get the best from your work. They are tools of the master craftsman, but so moderate in cost that they should be in every home and school workshop. They will soon pay for themselves in improved work and a saving in time. They are so strongly built of finest materials that you may never have to replace them.

The Sargent Auto-Set Bench Plane has a feature found in no other plane. The cutter may be removed, sharpened and replaced without changing original adjustment. It is really a great time and labor saver. The Sargent Steel Block Plane is one of the most compact and capable small planes on the market. It is great for end work and the smaller jobs.

Most good hardware stores sell them. We will send you the Book of Sargent Planes upon request.

SARGENT & COMPANY, Manufacturers
49 Water Street New Haven, Conn.



Men's Sizes \$5
Boys' Sizes \$4

Practicoat

MEASURED by any rule, the Practicoat passes the test of manly looks, snug fit and long wear. That's why practical men wear it in the shop, office and home.

Its \$5 price is an achievement of modern standardization and quantity production; its ironclad guarantee makes your satisfaction certain.

If your dealer does not carry the Practicoat, order through us.

AMERICA'S
GREATEST
KNIT JACKET
VALUE

Manhattan
KNITTING MILLS
8-14 West 30th Street,
New York City

RAISE BELGIAN HARES
NEW ZEALAND REDS—Chinchillas—Flemish Giants
MAKE BIG MONEY—We supply stock and pay you
Following prices for all you raise: Belgian Hares \$2 each—
New Zealand \$3 each—Chinchillas \$4 each—Flemish Giants
\$5 each. 20 page illustrated book, catalog and contract, also
copy of *Far Farming magazine*, tells how to raise skunk,
mink, fox, etc., for big profits, all for 10c. **417-7500**

OUTDOOR ENTERPRISE CO., Box 25, Holmes Park, Mc.



General Electric Company, Schenectady, New York



**I Made \$21.00
In Five Hours**

—Writes Peter Werner, III,
Sell Madison "Better-Made"
Shirts for Large Manufacturer
Direct to wearer. No capital or
experience needed. Many earn
\$100.00 weekly and bonus.

Write for Free Samples

MADISON SHIRT MILLS, 511 Broadway, New York

Roofing Book FREE

**World's
Best Roofing at Factory Price**

Don't buy Roofing of any kind until you get our big Free Roofing Book, describing full line of Edwards Famous "Tighttote" Galvanized Roofings, Sidings and Ceilings, and our lowest factory prices. Then see for yourself how much we save you by selling direct and saving you all in-between dealers' profits.

EDWARDS Metal Shingles

Absolutely rust proof. By our patented "Tighttote" process, edges as well as sides of metal sheets are heavily coated with zinc—not a space the size of a pin point exposed to weather. Fire and lightning proof. Outlasts three ordinary roofs. Forever wind and weather proof. Need no repairs—and all roofing expense. Patent INTERLOCKING DEVICE makes water tight seams—all nail heads covered—no chance for rust or leaks.



Wide variety of styles, all sizes of Portable Fireproof Metal Garages. Lowest prices ever made. Postal brings Big Garage Catalog free.

Write Today for free samples and proof that we can save you a lot of money on any kind of roofing siding or ceiling you may need. Ask for Roofing Book No. 154.

THE EDWARDS MFG. CO.,
1000-1050 Butler St., Cincinnati, O.

EDWARDS Galvanizing Test

Edwards "Tighttote" Galvanized Roofing can be bent, twisted or struck by lightning, and the galvanizing will not crack or flake. Bend it or hammer it—you can't loosen or scale the galvanizing. No other galvanized roofing can withstand this test.

Low Priced Garages

**FREE
Samples &
Roofing Book**



DARCHE "CALL-ME" ELECTRIC ALARM AND LIGHT CLOCK

Will ring until you get up and STOP it. No home complete without one. Can be used as an "alarm clock" or "mantel clock." With a little effort on your part you can get one.

FREE OUR OFFER TELLS YOU HOW

Agents, here is a big money-maker, no competition, sells on sight. A good punch board proposition. Write today for our descriptive literature. An ideal GIFT for any occasion. Mahogany finish. Size 10 1/4 x 8 1/4 x 4.

Darche Mfg. Co., 641 Washington Blvd., Chicago

CORONA FOUR

With standard office keyboard—an office typewriter in portable form.

Write for literature

Corona Typewriter Co., Inc.
112 Main St. Groton, N. Y.



Beautiful HOUSES \$900 and BUNGALOWS

CAN BE BUILT FOR AND UP

This and many others in my new book, Building Plans for Modern Homes, will save you hundreds of dollars. One of the most complete and comprehensive books of plans ever published by any architect. New edition just off the press. Nearly 600 floor plans and photographs of Colonial houses, bungalows, etc., costing from \$200 up; gives sizes and cost to build. Sent postpaid for \$3.00.



FREDERICK H. COWING
ARCHITECT
101 Tremont St., BOSTON, MASS.

SOLDERALL

METAL IN PASTE FORM

The
Only
convenient
metal
solder



Every Electrical
Connection needs
Solderall for perfect reception

25¢

The SOLDERALL CO., NEWARK, N.J.

Build Robust Health and Vitality!



Vit-O-Net Magnetic Health Blanket a reservoir of energy

Be in topnotch physical condition and stay there! You can now have a tremendous reserve of real vitality. No longer will you feel nervous, fagged out or dull. The Vit-O-Net Magnetic Health Blanket gives you new life—new power. Eliminates disease-breeding poisons thru the pores and other waste channels.

VIT-O-NET HEALTH BLANKET

Builds Health Without Drugs

Successfully used for treatment of Rheumatism, Neuritis, Nervousness, Colds, Catarrh, Kidney troubles, etc. Magnetic warmth of Vit-O-Net soothes and strengthens. Improvement is noticed immediately. Endorsed and used by prominent physicians and leading health authorities. In daily use in scores of America's greatest hospitals. Whether you are in good or poor health you need a Vit-O-Net—the best insurance against sickness you can purchase. Pays for itself over and over again.

Read these—“I can attribute my good health to the help of Vit-O-Net.” “Received greater benefit from Vit-O-Net than from treatments costing \$1,600.00.” “No words can express my love for my blanket.” “Would not take \$500.00 for it or do without it for nerves.” “I am an entirely new man.”

Get Free Health Document! Tells why 90% of diseases are caused by improper elimination. Reveals valuable health secrets you ought to know. Write for your copy today!

Representatives Wanted

Vit-O-Net Mfg. Co. 4105 Ravenswood Avenue Desk 5105, Chicago, Ill.

I Want 700 Agents At \$90.00 a week

Men and Women! Write me today and by this time next week I can place you in a position to make \$2.00 to \$5.00 an hour in your spare time, up to \$15.00 a day full time. Thousands of our representatives are making that and more with our **New Plans**. Simply introduce and take orders for famous **World's Star Hosiery and Underwear** sold direct from mill to home—a complete line for whole family. Permanent customers and repeat orders make you steady, big income. No delivering or collecting. No capital required.

Write Quick! It's a chance to make thousands of dollars. Your profits begin at once. Exclusive territory. No experience needed. Write today and I'll send all facts and tell how to start free. (Established 29 years.)

World's Star Knitting Co. 280 Lake Street Bay City, Mich.

Oh How Lovely

AGENTS

Saleswoman—Salesmen!

Make big money taking orders for our beautiful Dress Goods, Fibre, Wash Fabrics and General Yard Goods. Large Book of Fabric Samples furnished to Agents. Write today.

National Imp. & Mfg. Co. 573 Broadway, Dept. 6, N.Y. City

1000 ACTUAL FABRIC SAMPLES

Play a Conn Saxophone

This Free Book tells about exclusive features which make the Conn easiest of all wind instruments to play. Send now for your copy and details of Free Trial; Easy Payments on any Conn instrument for band or orchestra.

C. G. CONN, Ltd.
1031 Conn Bldg., Elkhart, Ind.

CONN BAND INSTRUMENTS

Creighton Hale, famous movie star and accomplished saxophonist uses a Conn, as do most prominent stars

LOFTIS

BROS. & CO. EST'D 1858
THE OLD RELIABLE ORIGINAL CREDIT JEWELERS
Dept. E-894 108 N. State St., Chicago, Ill.
Stores in Leading Cities

DIAMONDS WATCHES

CASH or CREDIT

Send for Catalog

Over 2,000 illustrations of Diamond-set Jewelry, Watches, Wrist Watches, Pearls, Mesh Bags, Silverware, etc. Sent prepaid for your **FREE EXAMINATION**

No. 20 Five radiant Blue White Diamond. Set in 18-k White Gold. All Platinum. Special at \$185. Terms, \$18.50 down, then **\$475 A Week**

No. 68 Blue White Diamond. Set in 18-k White Gold. \$127.50. Only \$13.75 down, then **\$350 A Week**

No. 33 Blue White Diamond. Solid 18-k White Gold. \$99.00. Only \$6.35 down, then **\$175 A Week**

Our Diamonds are exquisitely beautiful, high-grade, QUALITY Gems. Blue White of dazzling brilliancy—the finest offerings of the European Diamond markets. Personally selected by our expert diamond buyers.

No. 49—“Wing” design beautifully engraved. Solid 18-k White Gold, 17 Jewels. \$35.00. Delivered on first payment **\$100 A Week** of \$3.50, then

TERMS: Goods delivered on first purchase price; balance in equal amounts—payable weekly, semi-monthly or monthly, at your convenience. Satisfaction Guaranteed or Money Refunded.

No. 822 Dazzling Blue White Diamond. Solid 18-k White Gold. Price \$89.00. Pay \$9.00 down, then **\$225 A Week**

No. 55 Sparkling Blue White Diamond. Solid 18-k White Gold or Solid 14-k Green Gold. \$100. Terms, \$10 down, then **\$250 A Week**

No. 823 Blue White Diamond of dazzling brilliancy. Solid 18-k White Gold. \$87.50. Delivered on first payment of \$3.75, then **\$100 A Week**

Buy of LOFTIS, the Direct Importer. Select as many articles as you wish and have all charged in one account. Catalog explains everything.

We invite comparison of quality and prices. All Goods Delivered on First Payment.

Diamonds With Hearts

WEDDING RINGS

No. 824—The “Elite” Wedding Ring. Solid 18-karat White Gold. **\$750**

The “Elite” all Platinum, \$225 up. With Diamonds: Three Diamonds, \$65; five Diamonds, \$80; seven Diamonds, \$95; nine Diamonds, \$110; surrounded by Diamonds, \$225.

High-grade Railroad Watches

Guaranteed to Pass Inspection HAMILTON No. 992, 21 Jewels. Adjusted to 5 Positions, G. F. case, guar. 25 years **\$55**

ILLINOIS “BUNN SPECIAL,” 21 Jewels. Adjusted to 6 Pos. G. F. case, guar. 25 yr. ELGIN'S LATEST RAYMOND, 21 Jewels; 8 Adjustments, Runs 40 hrs. one winding **\$50**

17 Jewel Elgin

No. 15—Green Gold, 17-Jewel Elgin Watch; 25-Year Quality Case; 12 Size, Gilt Dial, \$30; \$3 down, then **\$100 A Week**

Send for the Loftis Catalog

RADIO FANS Listen in on WHT every Monday night from 7 to 7:30; every Friday night from 9:30 to 10, central standard time. Loftis Bros. & Co.'s hour of music.

How Good The Bristles Feel!

The first thing you notice about a WHITING-ADAMS BRUSH is how good the bristles feel. How strong and springy they are! Then you notice what a clean-cut, perfectly-balanced, and "usable" article the whole brush is. Ask your dealer to show you one.



WHITING-ADAMS BRUSHES

Making a Brush to Last a Lifetime is a Lifetime Job



Send for Illustrated Literature

JOHN L. WHITING-J. J. ADAMS CO.
Boston, U. S. A.

Brush Manufacturers for Over 116 Years and the Largest in the World

Different from all others—the NEW BENJAMIN



AIR RIFLE

Made on a different principle from all other Air-Rifles. The Benjamin is really a strong air-pump used to compress the air in the air chamber to any degree of power desired. From one to six strokes of the pump give all the force necessary. Each additional stroke gives increased power. The Benjamin works on the same principle as all air-drills and air-hammers—with this difference:

You control the shooting force as you desire. Look at this block of hardwood. It shows how Benjamin power is regulated as you wish.

You can't have accidents with a Benjamin. It's safe, always, because you control the power. The Benjamin never loses shooting force, and has no springs to get out of order or shake your aim. Write us for an interesting folder about this wonderful air-gun.

If your dealer does not handle same, send direct to factory—
(PRICE \$5) POSTPAID

BENJAMIN AIR-RIFLE & MFG. CO., 115 N. Broadway, St. Louis, Mo.

Ask your dealer for demonstration.

Pacific-Coast Representatives
THAYER & BOWER
Los Angeles, Calif., and San Francisco, Calif.



FACTORY TO YOU AT WHOLESALE PRICES

ELECTRIC FIXTURES

FOR 8 ROOM HOUSE COMPLETE **12.75**



Hundreds of other bargains in our **FREE CATALOG** WHOLESALE PRICES
Mail Coupon Today

PARAMOUNT ELECTRIC Co.
Dept. S—251 MARKET ST., PHILA., PA.

Please send me FREE your Big Bargain Catalog—

Name _____
Address _____
P. O. _____ State _____
Occupation _____



AGENTS!!!

300 to 500% PROFIT

Goods have Fine Appearance, Good Quality. Sells easy, and agents make big money. Write today for FREE CATALOGUE AND SAMPLES.

National Soap Company
512 W. Huron St., Dept. D-2, Chicago



SQUAB BOOK FREE!

Squabs are selling at highest prices ever known. Greatest market for 20 years. Make money breeding them. No mixing feed, no night labor, no yards to attend. Start small, grow big. Start now. Read how our customers sell squabs for \$12 a dozen. We have been established for 24 years. Better look into this. Let us send now, at no cost to you, our big, illustrated free book telling how to make money breeding squabs. Address

Plymouth Rock Squab Co., 634 H. St., Melrose Highlands, Mass.

NEW VEST POCKET ADDING MACHINE

ADDS - SUBTRACTS
MULTIPLIES - DIVIDES
Does all the work of a \$300.00 machine, yet fits the vest pocket. Easy to operate—does any kind of figuring in a jiffy. The neatest and best constructed portable adding machine made.

\$2.95



Counts Clear Up to 999,999,999
Total reliable at all times. A pull of the finger clears it. Invaluable to anyone who goes figures. Saves many times its cost by preventing mistakes.

10 Days' Trial Send no money. Just name and address and we will send machine postpaid. Pay postman on delivery \$2.95. Use it 10 days to prove it does all we claim. Your money back if not perfectly satisfied. Don't be fooled by cheap imitations. Order your Vest-Pocket now from this ad.

Reliable Adding Machine Corp., Dept. 47
184 W. Washington St., Chicago, Ill.

AGENTS Here's a money maker. Everybody wants one. Splendid profit. Write for special offer.

10 DAYS TRIAL \$2 Brings You this Genuine DIAMOND



Lady's wide top solitaire. Latest style 18 K. white gold hand engraved and pierced ring gives the blue white, perfect cut diamond extra brilliance and large appearance. Regular price \$85 - Special bargain price only \$62.50

A few cents a day will pay for this handsome ring. Simply send \$2 to us today. Wear ring for 10 days' trial.

GUARANTEE

Absolute satisfaction; if you don't agree this ring is an amazing bargain, we will refund your money. If satisfied, pay balance in 10 equal monthly payments.

Free Catalog showing bargains in Diamonds, Watches and Jewelry from \$10 to \$1000. Cash or liberal credit terms. **WONDERFUL VALUES.** Write Dept. A-26

BAER BROS. Co.
6 MAIDEN LANE - NEW YORK

Make \$60 to \$100 A WEEK

New 300 Candle Power Lamp—Burns 96% Air

Introduce wonderful patented invention. Burns only 4% fuel—cheap kerosene or gasoline. Uses less than wick lamps. Greatest advancement in lighting of the age. Table lamps, wall lamps, hanging lamps, lanterns. Powerful, brilliant, soft, restful white light—like daylight. Brighter than a score of wick lamps. No Smoke—No Soot—No Odor.

FREE Outfit Offer Easy to earn big Money. No experience—no capital required. Work all or spare time. Simply take orders. We deliver and collect—pay you big commission same day. Vivian of Minn. made \$400 in 39 days. Green of N. Y. made \$33 in one day. Hundreds making \$10 to \$40 a day. Get territory quick. Big season now on. Write today for Free catalog and special agents offer.

THE AKRON LAMP COMPANY
110 Lamp Building Akron, Ohio



Lights with Match

DIAMOND

Self-Filler DE LUXE Style Pen

"INDEPENDENT"

All the best features of a Fountain. Lasts longer. Writes smoother. Improves hand-writing. Eliminates fatigue. GUARANTEED.

\$2.00
By Mail

14 Kt. White Gold Point. Chased Rubber Holder. Lever Filler. Pocket Clip.

Your Name in Gold Inlay, 25c.

Write for Pen Catalog. Agents Wanted.

J. C. Ulrich & Co., 161 Washington St., New York
Known the World Over for 40 Years.

Fibre-Lite Limbs

AND BRACES \$35 TO \$175

GREAT INVENTION. MAKES WORK EASY. AGENTS WANTED
\$100 WEEK SAVES WORMAN CO. 252-P. HENNEPIN AVE. MINNEAPOLIS, MINN.

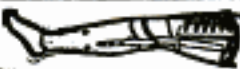

AGENTS 500% PROFIT

GENUINE GOLD LEAF LETTERS

guaranteed to never tarnish. Anyone can put them on stores and office windows. Enormous demand, large profits. Paul Clark says: Smallest day \$28.70. H. L. Reel made \$920 in two months. Write today for free sample and liberal offer to general agents.
METALLIC LETTER CO., 433-B N. Clark St., CHICAGO

\$25 A DAY Selling Suits Fifth Ave. New York Custom Tailors

want agents to sell advertised brand all wool tailored to measure suits and overcoats direct to wearers. **Lowest Prices in America.** Sell on sight. No capital or experience required. Big line swatch samples Free. **Biggest Commissions** paid daily. Permanent positions \$75 to \$100 weekly. Auto Free to Agents.
MONARCH TAILORING CO., 100 Fifth Ave., Dept. 52-A, NEW YORK

Keep fit to Music



When the baseball season is over, Benny Bengough, star of the New York Yanks keeps fit and makes big money playing the Buescher Saxophone with Harold Oxley's Orchestra. Summer and winter he's the center of attraction, always in perfect condition.

Easy to Play Easy to Pay

Three free lessons give you a quick easy start. You can master scales in an hour and play jazz in a week on a

BUESCHER True Tone SAXOPHONE

If you want to be popular, just learn to play this "King" of instruments. Young folks love it. Its syncopation sets them going. The Saxophone player is always welcome, everywhere. And in 90 days you can join a band or orchestra if you wish. Why not try it now?

Six Days Free Trial, Easy Payments

Send for a Buescher Saxophone or a Cornet, Trumpet or Trombone for six days free trial in your own home. Send no money. If you like the instrument pay a little each month. Clip the coupon now for your free copy of the beautiful Saxophone Book or catalog of any instrument. No obligation whatever. Do it today. Now.

BUESCHER BAND INSTRUMENT CO.

Everything in Band and Orchestra Instruments
940 Buescher Block Elkhart, Ind.

254



This 64 page book tells about the various models, with pictures of professionals using them. Send for copy of this wonderful

Saxophone BOOK

Clip the Coupon NOW!

Mail BUESCHER BAND INSTRUMENT CO.
940 Buescher Block, Elkhart, Indiana

Gentlemen: Without obligation to me, send your beautiful book "The Story of the Saxophone". Check here If you prefer other literature describing other band or orchestra instruments, check below.

Cornet Trumpet Trombone Tuba

Mention any other
Write plainly, Name, Address, Town and State in Margin Below

Make Your Tires
PUNCTURE-PROOF
IN ONE MINUTE
Agents
AND **DISTRIBUTERS**
Wanted
580
NAIL & SPIKE
PUNCTURES
WITH NO
AIR LOSS
25¢
PER TIRE
IN
FOUR
SIZES

GALACITE will repair a puncture in ONE MINUTE without taking the tire off the wheel or rim; and in addition it will make the tire Puncture Proof for life. GALACITE seals instantly and permanently, punctures, leaks, porous places and leaky valves. No more flat tires, no more getting out and changing tires in a hot sun. No soiled clothes. A scientific laboratory product. Tested in every part of the United States. Backed by a MONEY BACK GUARANTEE to do everything we claim. Guaranteed not to injure tube, valve or tire; on the contrary it preserves and lengthens the life of tube and tire, often

INCREASING TIRE MILEAGE FROM 10,000 TO 12,000 MILES
Take a hammer and drive as many nails into a tire as you wish, 50-100-500, it makes no difference. GALACITE seals the punctures permanently, as soon as they are made. We guarantee it for one year, but it will last indefinitely.

CAR OWNER AGENTS WANTED
EARN \$5,000 TO \$10,000 A YEAR

TREMENDOUS PROFITS. Agents and Distributors everywhere to demonstrate and sell to car owners, garages, filling stations. Work all or spare time in your own home town or traveling. GALACITE sells itself. Every customer becomes so enthusiastic that he helps you sell his friends. A revolutionary invention that will make you independent. You can also manufacture and sell GALACITE PUNCTURE PROOF INNER TUBES.

ACT QUICK SEND NO MONEY. Just your name and address will bring complete particulars by return mail. Get this information right now. Test it out. Get started while the field is still unswayed.

C. F. JOHNSON & CO. Dept. 934, 19 W. Jackson Blvd. CHICAGO, ILLINOIS, U. S. A.
*Galacite Trade Mark Reg. Copyright 1923



Elto

(Designed and built by Ole Evinrude)

Quick Detachable Rowboat Motor

Powerful, Light Weight, Speedy, Quiet Running, Practically Vibrationless. Starts on a quarter turn. Easily carried with you anywhere you go. No rowing, no work, no bother. Just ride and enjoy the greatest of water sports. Slow down for fishing. Speed up for racing. Great power.

Write for FREE Catalog describing all the new features, especially the famous Propello Pump. Only Elto has it. Write today.

ELTO OUTBOARD MOTOR CO. Dept. AA
110 E. Superior, Wis.
Manufacturers Home Bldg., Milwaukee, Wis.



WORLDS OF HEAT
RADIANT KEROSENE OIL HEATER
Everbrite
Burns 8 to 10 hours on gallon of Coal Oil. Turns on like gas—cheaper—cleaner—more comfortable than coal or wood fire. No wick—no smoke—no odor. Will heat the whole house in coldest weather. Portable—may be moved from room to room. Simple; turns up and down—off and on like city gas. Thousands in Happy Homes everywhere. Handsome, durable—gives intense heat.
FREE Simply send name today for circular and full details how it works and amazing offer.
EVERBRITE STOVE CO. 210 Gateway Station KANSAS CITY, MO.

\$15,000 a year earned by State Agent Roscoe, of Texas; \$5,000 a year by District Agent Hubbell, of Iowa. If interested in Agency write today. Good territory open. Big Money.

DOES YOUR BOAT LEAK?

Send for our Booklets, "How to make Your Boat Leakproof," and "Marine Glue—What to Use and How to Use It."



JEFFERY'S MARINE GLUES
IN ALL THE VARIOUS GRADES

Any old boat so long as the frames are in fair condition can be made watertight by following the instructions in the above booklets.

For sale by all Yacht, Boat and Canvas Supply Houses; Hardware, Paint and Oil and Sporting Goods Dealers.

L. W. FERDINAND & CO.
156 Kneeland Street Boston, Mass., U. S. A.

Tire AGENTS
WANTED

Use and Introduce **MELLINGER CORD TIRES**

15,000 MILES GUARANTEED

Lowest Wholesale Prices

in America. Shipped prepaid on approval. Make

big money all or part time. No capital or experience.

Sample sections furnished.

YOUR TIRES FREE! Simply send name today

for valuable **FREE BOOK**; tells how thousands have

gone into big business. **SPECIAL AGENTS' OFFER.** Wholesale

Prices and **FREE SAMPLE KIT.** Write nearest address.

MELLINGER TIRE & RUBBER CO.

PHILADELPHIA, PA. Dept. 1915 KANSAS CITY, MO.



STOP FORD CRANKSHAFT END-PLAY!

C-A ADJUSTABLE BEARING corrects and prevents

end-play without removing motor. Eliminates many

troubles. Easy to install—simply drop pan. Only

\$3.75. Ask your dealer or send prepaid by

ADJUSTABLE BEARING CO. Dept. P BRAZIL, IND.

Illustration of the adjustable bearing component.

You—and This New Machine
Can Earn \$500 a Month
Operate a Tire Repair Shop
70,000,000 Tires in use. America's greatest opportunity for men with small capital. We furnish everything—\$100 and up. Easy payments. We train you **FREE** right at home. Start making money at once. Write today for **Free Book of Opportunity.**
Haywood Tire Equipment Co. 1344 S. Oakley, Chicago

MAKE YOUR Ford INTO THIS Sport Car—Save \$50 to \$150 with Red-i-Kut Life-Size Patterns \$5.00

Famous wire-knit **RED-I-KUT** life-size patterns and picture instructions show how you can easily convert your Ford into this Fast, Sporty, Sport Car as thousands have done, with easily obtained materials. No need to lay up the car. Best seat fabric making 4-passenger car. Look at **Wilfred Eno's**. Eno says: "It took me 3 days to build it and I sure am proud to hear about you." He built that speedy sport car. I never cut any steel or did any woodwork before but see can't go wrong with Kuempel patterns." St. Louis, Mo.



The Lark life-size patterns for each part of the body so you can't go wrong, picture instructions and **CONICAL DISK WHEEL PATTERNS.** Only \$5.00 delivered. \$4 extra brings patterns for Jiffy Top and Green windshield. 22 gauge **RKD Steel** for Lark \$10 complete. Extreme West \$11. Order now while we can make good delivery, and really enjoy these wonderful days in your Lark. Keep, Clean, Up-to-the-minute. You can build it. Over 11,000 in use. Don't hesitate. "Swing Lo" Underlying Irons, no frame cutting kind. \$6.99. Only \$4.99 when ordered with Lark patterns. Send for more for new material of other distinctive sport body patterns from \$9.00 up—"RED" Steel "Swing-Lo" Irons, Tires and Windshields. **ORDER RIGHT NOW!**
KUEMPEL CO., 65 Kuempel Bldg., Guttenberg, Iowa

The "Lark" Class—Snap



21 Jewels!

**\$1
DOWN**

Nothing less than 21 Ruby and Sapphire jewels is good enough for the Burlington masterpiece.

Quality and Style

Adjusted to second—temperature isochronism—positions, 25 year gold strata case, in 100 designs. Unsurpassed quality, rock-bottom prices. \$1 down brings your choice. Balance in small monthly sums.



Send for FREE Book Write today for FREE Burlington Watch Book Find out about this big special offer made for a limited time!

Burlington Watch Company Dept. 13-57
19th Street and Marshall Boulevard Chicago, Illinois

MOTORCYCLES

LESS THAN HALF COST

Ace, Indian, Cleveland, Harley-Davidson, Henderson Motorcycles and Sidecars, new, used and rebuilt. **Rider Agents Wanted.** Write for FREE trial offer, agent's free outfit and big bargain bulletin. **New American Bicycles** in different styles and colors. Write for illustrated catalog giving our money saving prices.

AMERICAN MOTOR CYCLE CO.

2647 W. Chicago Ave., Dept. 1029, Chicago



DENINGER WILL TRUST YOU

\$40 SEND 10c IN STAMPS FOR CATALOGUES—BIG MONEY SAVING FOR YOU

Used and rebuilt motorcycles \$25 to \$100, used bicycles \$9.00, tandem \$20. All machines fully guaranteed. New bicycles and motorcycles at factory prices, save dealers' profits. Motorcycle and automobile tires \$3. Complete line frames, engines, supplies.

DENINGER PRICE CUTTER, ROCHESTER, N. Y.

PAY AS YOU RIDE

SHAW MOTOR ATTACHMENT

MAKES YOUR BIKE A MOTORCYCLE!

A high grade 2 1/4 H. P. motor attachment quickly clamped on any bike frame. Speed 4 to 40 miles an hour. 90 to 125 miles per gallon of gas.

Special Low Price Now! Write today for Complete Description and Special Low Prices on SHAW Motor Attachments and the SHAW Complete Motorcycle. **SHAW MANUFACTURING COMPANY**
Dept. 37 Galesburg, Kansas



\$75 to \$150 WEEKLY

INSTANT WELD Welds Rubber Instantly. Better, quicker, and easier than vulcanizing. Once on—always on. No Heat or Cement required. Repeat orders sure. Big profits. Appoint sub agents. Write today.

TOURISTS PRIDE MFG. CO.
Desk No. 40 J Minneapolis, Minn.

Do Your PRINTING

Cards, stationery, circulars, labels, paper. Complete Outfits \$8.00 up, Rotary Jobber, \$150, Card Cutters \$3 Save Money. Print for others, big profit. Easy with ruleless. Write for catalog, presses, type, paper, cards ink, etc. **THE PRESS CO., L-37, MERIDEN, CONN.**

MOTORCYCLES



RELIABLE STANDARD MAKES that you can **DEPEND** on. Enjoy the glorious experience of going wherever you like—when ever you like. The price is within your means—25% to 50% less than others. These machines are **reliably** used, **thoroughly** guaranteed or rebuilt. Send for catalogue. **MYEROW BROS.,**
Berkeley St. Boston, Mass.



The up-to-date trains for up-to-date boys

IVES Trains have all the 1925 improvements. They are the *only* trains with electric locomotives (Series R) that you can stop and reverse by a touch of your finger on the control switch, located away from the track.

You boys will get a wonderful "kick" out of this reversing device—making the locomotive stop and back just like a real engineer. A mere touch of the finger does it! This year you can have an Ives Electric Reversing Locomotive on either O-gauge or 2 1/4-gauge track.

Both in action and appearance Ives Trains are exactly like the modern equipment of famous railroads. There is an almost endless variety of passenger and freight cars, electric target signals and semaphore signals with electrically-operated arms, bridges, tunnels, stations, and the efficient Ives Transformer. Prices range from the \$1.50 mechanical train to the big complete \$50 electric outfit. Sold by toy, department, electrical, hardware and sporting goods stores.

Send for the Ives Railroad Book

THE 32-page book of Ives Trains and Accessories contains illustrations in colors of the full line and tells all about the new 1925 features exclusive with Ives. Mail the coupon today with 10 cents. **THE IVES MANUFACTURING CORPORATION, Dept. D1, 198 Holland Ave., Bridgeport, Conn.**

IVES ELECTRIC AND MECHANICAL TRAINS

The Ives Manufacturing Corporation,
Dept. D1, 198 Holland Ave.
Bridgeport, Conn.

Please mail me your 32-page railroad book. I enclose 10 cents (stamps or coin).

Name.....

Address.....

City..... State.....



Build and Fly 3 ft. Models of Famous Aeroplanes!

There's no fun like building your own Model Aeroplane. It's the most interesting job you ever tackled. Shows you how big machines are built. You can fly it too, right from the ground under its own power. Any bright boy can do it; Ideal Scale Drawings and Building-Flying Instructions show you how, and Ideal Model Aeroplane Construction Outfits contain everything needed. For 25c we will send you the complete plans for any one of the following famous Aeroplanes:

Every Boy's Airplane

The finest idea in Model Airplanes. Looks like a real one; clips together easily and quickly, ready to fly in 2 hrs. Our catalog tells all about it.



Curtiss JN 4 D-2 Training Plane; DeHavilland "Round-the-World Flyer;" N. C-4 Naval Seaplane; Curtiss Military Tractor; Bleriot; Nieuport or Taube Monoplane; or Cecil Peoli Racer. Send 25c now and get plans for the one you want to build. (All 8 plans for \$1.50.)

Catalog Model Aeroplanes, Flying Toys, Parts and Supplies, 5c postpaid.

Ideal Aeroplane & Supply Co.
408 West Broadway, New York

Ask your Dealer for Ideal Model Aeroplane Construction Outfits.



Look at this Picture!

Would you believe that T. C. Gates of Newark, N. J., was wearing two Carnes arms?

Well he is and here is what he says about them: "I use both of my Carnes arms every minute in the day performing my usual duties. I do all my own writing; feed myself; dress myself, even to fastening my own collar. I would advise anyone who has the misfortune to lose one or both arms to get a Carnes arm."

FREE CATALOG—Let us send you our illustrated catalog filled with pictures showing actual uses of the Carnes arm and hundreds of testimonials such as Mr. Gates gives.

Carnes Artificial Limb Co.

67 Carnes Building
904 East 12th St. Kansas City, Mo.



WANTED! TIRE SALESMEN

Experienced men who have been working for big companies and who want to make more money.

BEARCAT CORDS

are the smarter looking, longer wearing, better quality, guaranteed tires that 35,000 Chicago Motorists demand. Popular wherever shown. Sold to dealers. Write for proposition which will give you bigger, always-increasing income.

SIMPLEX TIRE & RUBBER CO.
20355 Michigan Ave., Dept. 19, Chicago

SEND FOR THE INTERNATIONAL CATALOG



Our net price list. Full line of auto bodies and accessories for Ford at Wholesale Prices. Save big money on bodies by buying Direct from Factory.

FOR FORD—Prices from \$27.85 up. Factory to consumer direct—Pay Only One Profit.
International Body Works, 914 W. Ohio Street, Dept. 7, Chicago, Illinois

SEND NO MONEY 2 Genuine Diamonds 4/100 Each

Cut Stones, No Chips
SOLID GOLD \$25

Terms if desired (\$ mos. to pay)
Outside U. S. cash with order

14 kt. White gold top. Gold Emblem (any Lodge) or any Initial (Old English), yellow or white gold, Inlaid in Genuine

HOPE RUBY

Also, in Black Onyx

Send size of finger and ring will be sent for inspection.



New No. 6132

This Reg. Trade Mark guarantees you genuine diamonds.

Send for Free Catalog **B F O A S M** Any Letter
BUFFALO JEWELRY MFG. CO., "THE MAIL ORDER HOUSE" Dept. P 801 Washington St. BUFFALO, N. Y.

AGENTS WANTED! Salesmen—Distributors

to use and introduce attachment that makes Fords run on 94% air. **THERMOSTAT** on exhaust automatically turns down needle valve as engine warms, exactly as Ford Manual says do by hand.

BLANCHE AUTO THERMO

An Automatic Carburetor Control Makes Fords start easier winter or summer—saves half gas and oil—cuts repair bills one-half—reduces carbon formation one-half. Sells on sight to every Ford owner as easily as giving him a \$100.00 bill, because it saves \$100.00 every 10,000 miles. **CADILLAC NOW USES AS STANDARD EQUIPMENT THERMOSTATIC CARBURETOR CONTROL UNDER BLANCHE LICENSE.** You can make Big Money selling this wonderful proven device. Experience not necessary. Blanche plan will start you without capital in a business of your own that makes you from \$200 to \$2000 a month profit. Write for free circulars now!

A. C. BLANCHE & CO. Dept. 805-N, 602 W. Lake Street CHICAGO, ILLINOIS



"If I hadn't been all through it myself, I wouldn't have the assurance to say to you 'cheer up.'"

ERICKSON.

Those who wear them say: ERICKSON LEGS are Wonderful

because they do not chafe, overheat or draw end of stump.



If you have had a recent amputation send for new booklet on **TEST LEGS** for beginners.
E. H. ERICKSON CO.
38-A Washington Av. N.
MINNEAPOLIS - MINN.

Copyrighted material

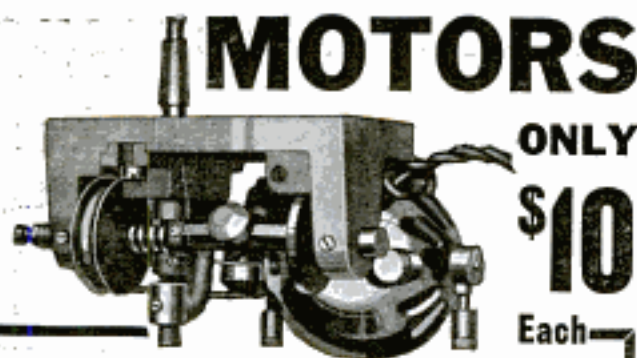

MOTORS

ONLY

\$10

Each

Ideal for home-made phonographs, experimental purposes and combination **phonograph-radio** sets.

We have a limited number of small motors which are greatly under-priced for quick clearance. You will never again equal this low price, when this lot is sold.

They are **universal motors**, 110 volts, 60 cycle single phase, complete with turntable, cord and socket for immediate use. 1400 R. P. M. Motor has 1" pulley with flange for $\frac{1}{4}$ " flat belt. Housed in highly polished, nickel-plated shell.

Don't lose out on this remarkable offer. Order your motor today. Tomorrow may be too late. **DO IT NOW!** Price, **\$10.00** f. o. b. Steger, Illinois.

Industrial Division

Steger & Sons Piano Manufacturing Company
Dept. 50, Steger Building CHICAGO, ILLINOIS



Effective and Positive System is secured by

Gerstner TOOL CASES

for MACHINISTS and TOOL-MAKERS. Avoid lost, mislaid or damaged tools. Catalog free.

Gerstner Sons

422 Columbia St., DAYTON, OHIO

CLASS 25¢ PINS

BUY DIRECT FROM THE MAKER
CATALOG FREE

Either pin shown made with any 3 letters and 2 figures, 1 or 2 colors enamel. Silver plate 25¢. St. \$2.50-4.00. Sterling silver, 40¢ ea. \$4.50 doz.

BASTIAN BROS. CO.

830 Bastian Bldg., Rochester, N. Y.

3490

2534

A REAL BOY'S ROOM

His walls are filled with pictures, pennants, drawings, held up with

MOORE PUSH-PINS

Glass Heads—Steel Points

Moore Push-less Hangers

"The Hanger with the Twist"

The points do not mar wall paper

10c pkts. Everywhere

MOORE PUSH-PIN CO., Philadelphia, Pa.

Delivered to You Free

for 30 days trial on approval. You can have your choice of 44 Styles, colors and sizes of the famous **RANGER** Bicycles. Express prepaid. **Factory-to-Rider** Prices save you \$10 to \$25 on your bicycle.

\$5 a Month if desired. Many boys and girls easily save the small monthly payments. Parents often advance first payment.

best quality, at factory prices, express prepaid. Lamps, wheels and equipment, low prices. Send No Money, do business direct with makers.

Mead CYCLE COMPANY
DEPT. K-108 CHICAGO

Write today for free Ranger Catalog, factory prices and marvelous easy payment terms



Great *New* Invention

for seekers of

Health Power Beauty



Elco Health Generators at last are ready for you! If you want more health—greater power to enjoy the pleasures and delights about you, or if more beauty is your desire—write! Ask for the book on these inventions which has just been prepared. It will be sent to you without cost. It tells you how Elco Health Generators aid you in leaving the lethargy and hopelessness of bad health and weakness behind forever. Re-vitalize yourself. Bring back energy. Be wholly alive. Write today!

10 Days Free Trial—Write for FREE BOOK



These great new inventions generate *High Frequency Violet Ray, Mechanical Vibration, Medical Electricity and Ozons*. Combined or separate.

They operate on the electric light in your home or on their own motive power at less than 50 cents per year. Elco Health Generators are positively the only instruments which can give you in one outfit Electricity, Violet Ray—Vibration and Ozons—the four greatest curative agents. Send coupon below. Get the Free Book NOW!



For All These:

Rheumatism	Asthma
Gout	Hay Fever
Lumbago	Sore Throat
Neuralgia	Catarrh
Sciatica	Deafness
Headache	Insomnia
Neuritis	Pain
Nervousness	Development
Circulation	Skin Disease
Weakness	Pimples
Paralysis	Scalp Disorders
Eye Trouble	Obesity

MAIL the COUPON for FREE Book!

Do not put this paper down without sending the coupon. Don't go on as you are with pains and with almost no life and energy. You owe it to yourself to be a better man or woman. You were put here to enjoy life—not just to drag through it. So do not rest another day until you have put your name on the coupon here. That will bring the whole story of these great new inventions. Do it today—now.

Health Power Beauty

Lindstrom & Company

30 West Lake Street. Dept. 13-57, Chicago, Ill.

Please send me your free book, "Health—Power—Beauty" and full information on your 10-day Free Trial Offer.

Name

Address

THIS CLEAR, STEADY,
ACCURATE, POWERFUL

6-Power Pocket Telescope



Money back if not thoroughly satisfied in every respect. A wonderful little scope for beach, woods, motor boats, hunting, athletic games and general use.

\$2

Postpaid with excellent limp leather case!

Length closed 3 1/4 in., maximum diameter 1 3/16 in.

Every One Brand New and Guaranteed by both this company & the maker

Made by the Wollensak Optical Company, one of the finest makers of lenses and optical goods in the world. Thoroughly tried and tested in actual use before putting on the market. No bigger'n a jack-knife, easily carried in vest pocket, yet a powerful, precise monocular that brings distant objects close in full detail, without the "vibration" present when higher power telescopes are used. Adjustable twice as quickly as binoculars. Nothing cheap in appearance or construction. Mighty neat, black, baked-in enamel, with non-slip grip. Absolute satisfaction or money back. \$2 prepaid. Check, money-order, or C.O.D.

Boston Sporting Goods Co. Dept. P, 80 Boylston St. BOSTON - MASS.

MARVELOUS Hand Made Tools

Try This Test Yourself

Lock any other wrench with a Cornwell wrench of equal size and exert pressure until one of them breaks. No wrench made will break a Cornwell. These tools, including complete line of chisels, bolt and rivet busters, punches, wrenches, screw drivers, pliers, etc., are made of finest Swedish Charcoal Process Molybdenum Steel, from our famous Cornwell secret formula. They are forged, heat treated, and hardened and tempered in oil. All tools made by hand, NOT drop forged and case hardened.

LET US DEMONSTRATE CORNWELL TOOLS

Ask for salesman to call and show you many startling demonstrations that no other tools in the world will stand. Or send for free descriptive booklet, order tools and make these demonstrations at our risk.

Money Back If Not Satisfied If you ever saw tools as good as these, return your order and get your money back. Guaranteed finest tools made in the world. Any tools not standing amazing tests described instantly replaced or money refunded.

Amazing Booklet—FREE CORNWELL QUALITY TOOLS CO.

Dept. A, Cuyahoga Falls, Ohio
Send me illustrated booklet with prices on Cornwell Secret Formula Hand Made Tools.

Name Occupation
Address
City State



TURN WASTED TIME INTO MONEY!

Every Purchaser Finds Numerous Uses for the Torit Acetylene Torch No. 13

Uses Acetylene only.

No oxygen or air pressure is required. Tips suck in air. Simply connect to Presto auto tank, light gas, and the outfit is put to work.

Beats anything you ever tried for soldering, heating or light brazing.

Outfit consists of 4 tips for different kinds of work, soldering copper, 5 feet tubing, tank connection, and full instructions.

ST. PAUL WELDING & MFG. CO., 177 W. 3rd St., St. Paul, Minn.



SHOP FIGURING

can be quickly done on the Gilson Slide Rule. It adds, subtracts, multiplies and divides fractions and decimals. Gives lettered and numbered drill sizes. Also gives size of mill to use for any size tap, with easy thread. In addition to the above the "Gilson" is a complete general purpose slide rule. Get one and become an expert with figures. Many shops have purchased these rules for their Mechanics and Draftsmen. The engine-divide scales are on white celluloid, mounted on aluminum and are grease and water proof. Diameter 4". Price with complete instructions, \$1.50. Lead-in case 50c extra, cash or C.O.D.

Satisfaction Guaranteed. Catalogue Free. GILSON SLIDE RULE CO., Niles, Mich.

BURN YOUR NAME ON TOOLS

WITH THE ARKOGRAF

PROTECT YOUR TOOLS FROM THEFT

Write with electricity any name or design on the hardest and finest tools and instruments, or any metal, like writing on paper with pen or pencil. Complete Outfit \$3.50 — Prepaid Anywhere Interesting Illustrated circular free. Write today. Agents wanted. ARKOGRAF PEN CO., 1171 E. Stark St., Portland, Oregon



ALUMINUM SOLDER

SOLDERS ALUMINUM of any description. NO ACIDS OR FLUX NECESSARY. For home, shop and garage use. Your tool kit is not complete without HAMILTON LEAD CO. ALUMINUM SOLDER. (Name on every bar.) Send 25c for 2 six inch bars, or \$1.00 for 9 bars; postpaid.

HAMILTON LEAD CO., HAMILTON, OHIO



CRESCENT Wood Working Machines

continue to steadily increase in popularity. Tell us just what you are interested in and we shall be glad to mail circular. Band Saws, Jointers, Saw Tables, Planers, Planers & Matchers, Hollow Chisel Mortisers, Bore, Disk Grinders, Swing Cut Off Saws, Cut Off Table, Universal Wood Workers, Shapers, Single End Tenoners.

THE CRESCENT MACHINE CO. 93 Columbia St. Leetsia, Ohio, U. S. A.

15 Jobs With This Tool And a Screw Driver



Mechanic's handy tool booklet free

That is what a garage man did with the "Red Devil" Giant-Grip Tool and a screw driver. Combines a husky plier and wrench—takes the place of a multitude of tools—grabs like a vise and can't slip. "Red Devil" Giant-Grip No. 444, 7 1/2 inch size, \$1.00 at dealers—or if not in stock, add 25 cents for postage and order from our factory.

SMITH & HEMENWAY CO., INC. Mfrs. of "Red Devil" Tools, 122 Coit St., Irvington, N. J.

File a Saw in 5 Minutes and Make Big Money

Here's the way Charles Fuller of Lima, Ohio, is becoming independent:

"I have developed a wonderful and profitable business with the Foley Saw Filer. I get 50¢ per saw for filing and \$1.25 per saw for recutting new teeth. I would not continue business without Foley Saw Tools."

You can do the same. With a Foley Automatic Saw Filer you can sharpen a saw perfectly in 5 minutes. No experience necessary—makes you an expert filer.

Write for Free Circular about Foley Saw Tools

FOLEY SAW TOOL COMPANY

914 E. Lake St.
Minneapolis,
Minn.

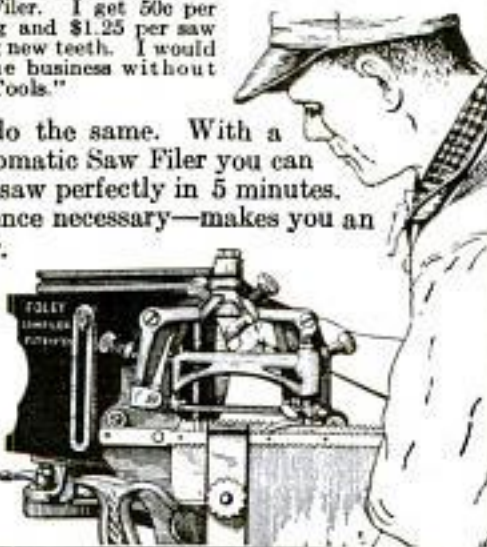

"WONDER" Cold Pipe and Tubing Benders

Do Not Crack, Flatten or Crimp the Pipe



Hand and Motor Operated

14 SIZES OF MACHINES

What It Costs to Bend Pipe Our Way. Per Bend

1" Pipe..... 5¢ 4" Pipe..... 35¢
2" Pipe..... 10¢ 6" Pipe..... 60¢
3" Pipe..... 15¢ 8" Pipe..... \$1.00

SEND FOR CATALOGUE

American Pipe Bending Machine Co.
59 Pearl Street BOSTON, MASS.

CLASS RINGS & PINS

Largest Catalog Issued—FREE

Sample loaned class officers. Prices \$2.25 to \$8.00 each. No order for class, society, club emblems too large or too small. Special designs made on request.

METAL ARTS CO., Inc., 7705 South Ave., Rochester, N. Y.



"Interlox" MASTER SLIDE RULE

Takes accurate inside or outside measurements

MASTER RULE MFG. CO., 841-43 E. 136th St., New York

Works fast. Slides in and out quickly. Durable made of brass trimmed boxwood. Any length 2 to 8 feet. 20 cents per lineal foot. If set at dealer's, sent postpaid.

Dealers and Agents: request attractive proposition

Illustration of the Interlox Master Slide Rule.

Illustration of the Servisteel Tap and Die Set.

SERVISTEEL TAP AND DIE SET
WORCESTER STEEL PRODUCTS CO.
WORCESTER, MASS., U.S.A.

SERVISTEEL TAP AND DIE SET, ONLY \$3.75

FOR THE HOME—THE FARM—THE WORKSHOP

Our No. 32 Automobile Set furnished in our highly finished chestnut box contains 5 each taps and dies (1-4, 5-16, 3-8, 7-16 and 1-2"), in the S. A. E. thread, 1 die stock, an 11/2" tap and reamer wrench.

Our No. 31 Set is the same as No. 32 except that the thread is U. S. S. instead of S. A. E. You are purchasing a splendid set at a very low figure.

Send us your order at once and be one of our many satisfied customers.

Let us also send you our circulars illustrating our full line of tools.

Worcester Steel Products Co., Dept. 40, 23 Union St., Worcester, Mass., U.S.A.

Heats 7 Rooms at about the Cost of One!

"With the Bulldog Furnace, we find it takes little more coal to heat the whole seven room house than it did to heat one room with a stove using chestnut coal." J. B. Smith, 18 Elm St., Somerville, N. J.

More Heat with Half the Coal

"I had a hot air furnace in our house before I got the Bulldog and our 7-room house was always cold. With the Bulldog it only takes half as much coal and we had weather below zero, and the house was nice and warm in the morning when we got up. We never have the draft on more than a half hour at a time, and it has the place red hot." Jess. T. Conrad, Shamokin, Pa.



BULLDOG PIPELESS FURNACE

If you are even thinking of a pipeless furnace, or any furnace, write for our free catalog. The Bulldog is one furnace you MUST investigate. Comes completely erected. Fits any height of basement and you install it yourself.

No Money Down

The Bulldog is sent for free inspection

Then, if satisfied, you make only small monthly payments at our amazingly low price. Factory connections in both East and West. We ship from nearest point. Don't consider buying any furnace until you find out about the Bulldog. Write at once for our special offer and our free catalog together with the wonderful record of Bulldog success. Mail this coupon today.

Babson Bros.

19th and California Ave., Dept. 13-57 Chicago

Without obligating me in any way please send me your free catalog and special offer on the Bulldog Pipeless Furnace.

Name

Address.....

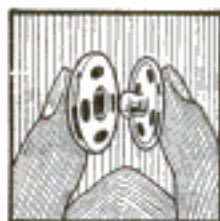

\$25 in cash for ideas

\$25.00 in cash will be given for each practical new use for Wilsnap Fasteners. Remember, this is not a prize contest where your idea goes into competition with hundreds of others. We mean exactly what we say: \$25.00 in cash will be given for each practical new use for Wilsnap Fasteners. For each practical new use.

Wilsnap Fasteners are used principally on women's clothing. They are also used on Wilsnap Lingerie Clasps as in the illustration at the right, above. But we seek new mechanical uses.

Wilsnap Fasteners (made in six sizes) are also used for radio and other electrical connections; on windshield cleaner handles, in pipe organ construction, in vanity cases, etc. What new mechanical uses can you discover?

In a simple way Wilsnap Fasteners hold together objects or articles which must be frequently and conveniently connected and disconnected.

If you are not familiar with Wilsnap Fasteners, we will send you samples free on request, or you can purchase them in most Notion Departments.

Conditions: To be acceptable your suggested use must be new; it must be one that would meet with widespread use; we will pay a reward of \$25.00 in cash for each acceptable idea; you may submit as many ideas as you wish; your new use can apply to any or all six sizes of Wilsnap Fasteners.

Experimental Dep't.

The Wilson Fastener Co.
125 E. St. Clair Ave., Cleveland, Ohio

DYNA-MOTOR

As a dynamo it will operate induction coils, light lamps, charge storage batteries, electroplate, etc., makes an ideal machine for experimenting. As a motor they will operate heavy models, sawy wheels, and other appliances.

16 Watt	\$6.50	22-Watt	\$8.00
Dyna-Motor		Dyna-Motor	
64 to 700 Watt		Dynamose, Armatures, Commutators, Panchina, Parts for Schools and Students.	

Send for Catalog
LOOMIS ELECTRIC COMPANY
1427 N. Artesian Ave. CHICAGO, ILL.



WADE BENCH LATHE

AMATEUR MECHANICS, MODELMAKERS, INVENTORS, STUDENTS
A real machine tool for the home work bench—capacity 4" dia. x 12" length. For Metal—Wood—Composition Materials—Turning—Facing—Boring—Drilling—Winding—Thread Cutting. Accurate—Strong—Quiet—Compact. Slide-rest has travel entire length of bed. Leadscrew inside bed. Send for literature—Price \$28. **THE GEROLD CO., Dept. P-35, 120 Liberty St., New York**

Taylor

COMPASSES

Let your pocket-book tell you what style of compass to buy; then ask for a *Taylor*—75c to \$9.00. Hunter or open cases, Bar needle or floating dial, Gold or non-tarnishing silver-metal. Your dealer carries them.



Taylor Leedawl

RADIO

A compass is essential in the modern radio laboratory. If you own a loop aerial you will want a *Taylor* Compass.

A booklet on *Tycos* Compasses is yours for the asking. It's free.

Taylor Instrument Companies

ROCHESTER, N. Y., U. S. A.

CANADIAN PLANT, TYCOS BLDG., TORONTO
THERE IS A TYCOS OR TAYLOR TEMPERATURE
INSTRUMENT FOR EVERY PURPOSE

REDUCED PRICES ON ENGINES

Now—big sale on most practical farm engine ever built—the famous OTTAWA. Low cash prices—easy terms—on all sizes 1 1/2 to 22 H. P. Each engine pull big surplus of power. Easy starting. You must be satisfied or money refunded. 30 days trial. 10-year guarantee. **FREEBOOK**—“How to Know Better Engines.” Write for your copy now. A postcard will do.

Direct from Factory



OTTAWA MFG. CO.
531-D King Street, OTTAWA, KANS.
Desk 531-D, Magee Bldg., PITTSBURGH, PA.

**Relieve the Pain
Prevent Infection**

Use Absorbine, Jr. 'the magic bottle' to heal cuts, bruises, burns, rash, skin eruptions and to reduce swelling. It's a safe, powerful and effective antiseptic liniment.

\$1.25 a bottle at your druggist's
W. F. YOUNG, Inc., Springfield, Mass.

Absorbine Jr.
THE ANTISEPTIC LINIMENT

INSTALL YOUR OWN**FREE PLANS****HOT WATER HEATING PLANT
CUT-TO-FIT GUARANTEED**

Complete Hot Water Plants ready for shipment. Outfits as low as \$200.

**PLUMBING
and HEATING****→ SAVE HALF ←
By our New Easy Method
and Lowest Wholesale Prices.**

Mail the coupon for our FREE Bargain

Catalog. Gives illustrations, complete descriptions, sizes and wholesale prices on Heating Outfits of all kinds, Water Supply Systems, Complete Bathroom Outfits and Plumbing Supplies, Fittings, Pipes, etc. All at wholesale. Send today for your copy.

**50 Years and Million Dollar Plants**

behind our bonded guarantee. Every Hardin-Lavin System is figured to eliminate long runs of piping, to save valuable time and unnecessary materials and expensive labor. We furnish Heating Plants or Plumbing Outfits cut-to-fit at the factory for the exact job and we thread and mark all the larger pipes. Any Handy Man with our simplified plan and new easy method can do the installing.

MAIL COUPON TODAY

We have saved economical buyers hundreds of thousands of dollars. Everything you get from us is guaranteed highest quality, Grade A merchandise with new, exclusive features.

HARDIN-LAVIN CO.

ESTABLISHED 1876

When in Chicago Visit Our New Plant at
107-17B West Pershing Rd., CHICAGO**HARDIN-LAVIN COMPANY,
107-17B West Pershing Rd., Chicago, Ill.**

Gentlemen: Please send me your FREE BARGAIN CATALOG with special wholesale prices. I am interested in:

 Water Supply System Stm. Htg. Plant Warm Air Furnace
 H. W. Htg. Plant Pipeless Furnace Bathroom Outfit

NAME.....

ADDRESS.....

P. O.....STATE.....

NO JOKE TO BE DEAF**—EVERY DEAF PERSON KNOWS THAT**

I make myself hear, after being deaf for 25 years, with these Artificial Ear Drums. I wear them day and night. They stop head noises and ringing ears. They are perfectly comfortable. No one sees them. Write me and I will tell you a true story how I got deaf and how I make you hear. Address

**GEO. P. WAY, Artificial Ear Drum Co. (Inc.)**
80 Hoffman Bldg., 2539 Woodward, Detroit, Mich.**NOW—a
world famous Remington on****5 DAYS
FREE
TRIAL**

Write today for details of how you can now get a world famous rebuilt Remington by our new Free Trial and Easy-to-Pay Plan. It looks and writes like new. Our 45-year reputation and guarantee are your protection. Here is a real bargain—don't miss it.

AMERICAN WRITING MACHINE CO.

Dept. 601, Newark, N. J.

**21 Jewel ~ Extra thin
STUDEBAKER****The Insured Watch**A
Lifetime
Time-
pieceSold direct from
the factory at a
saving of 50%.

SENT FOR

**\$1.00
DOWN!**

Only \$1.00! The balance in easy monthly payments. You get the famous Studebaker 21 Jewel Watch—insured for a lifetime; 8 adjustments, including heat, cold, isochronism and 5 positions—choice of 60 new Art Beauty Cases in green gold, white gold or yellow gold effects. Latest thin models.

ChainFree! For a limited time we are offering a beautiful Chain FREE!**Write** For FREE Book
Send today for wonderful Studebaker Book of Advance Watch Styles and our \$1.00 Down Offer—FREE!**STUDEBAKER WATCH CO.**
Dept. W22 South Bend, Indiana
Canadian Address: Windsor, Ontario

This
48
Page
Book
tells
all about

FROST-RADIO Your Copy FREE!

WE want every reader of Popular Mechanics who has not yet received his copy to write for one of our 48-page catalogs of **FROST-RADIO** products.

It illustrates this only complete line of high quality radio parts and accessories, explains care and operation of **FROST-FONES** and **FROST-RADIO** parts, and contains a wealth of interesting information about the newest and best in radio.

Use **FROST-RADIO** Parts and Accessories in Your Popular Mechanics' Circuit

To insure conformity to the original design of the famous Popular Mechanics' Circuit you should select from your dealer's store the **FROST-RADIO** items incorporated in this great hookup. Some of these are illustrated here—others you will find are pictured and described in the **FROST-RADIO** Catalog. All of these items are of the superb quality which led to their being selected by Popular Mechanics for their circuit.

Prices slightly higher on Pacific Coast

HERBERT H. FROST,
Incorporated
314-324 W. Superior Street,
Chicago

NEW YORK CITY CLEVELAND
KANSAS CITY LOS ANGELES

Export Office: 314 West Superior Street, Chicago



Frost-Radio
Fan Tab Jacket
45c to 90c

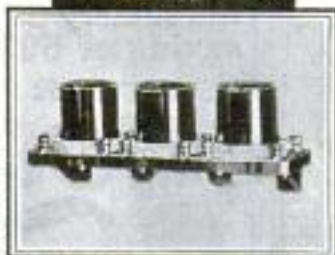

Frost-Radio
Bakelite Cushion
Socket: \$3.25



Frost-Radio
Vertor Bakelite
Ebonstat: \$1.25

FREE two unusual RADIO CATALOGS



FOR "FANS"

OUR new 64-page Radio Catalog including all the best and latest Kits, Parts and Accessories for broadcast receiving sets. Lowest prices in the country!

FOR "HAMS"

NEW 32-page booklet of army and navy transmitting apparatus and miscellaneous specials for "hams" such as W. E. Choke Coils, Generators, Resistance Boxes, etc.

More than 1,000,000 fans and hams make our store their headquarters—get these books and find out why

Write for either or both

509
South
State
Street



Dept.
P.M.6
Chicago
Ill.

UTAH LOUDSPEAKER

Ours is the strongest guarantee! Use it 10 days. If not the finest you ever heard, return it and get your money. Dealers Everywhere.
Utah Radio Products Co. Dept. 50, 1427 S. Michigan Ave.
CHICAGO, ILLINOIS

ULTRADYNE

MODEL L-2
Famous Superheterodyne

Write for interesting
booklet on the famous
Ultradyne.

Phenix Radio Corp.
114-E East 25th St., New York City

The NEW ERECTOR

The World's Greatest Toy

\$15 A DAY EASY

I have thousands of customers all over the world on my big line of over 200 household necessities. I need representatives in every territory, all or spare time, to handle this business, take orders and make big money under my new plan of distribution. Real necessities at rock bottom, money saving prices is the secret of my agents' success. No capital or experience needed. Write quick for Free Outfit Offer.

Ho-Ro-Co Mfg. Co., 530 Ho-Ro-Co Bldg., St. Louis, Mo.

DEAFNESS IS MISERY GOOD HEARING A JOY

Millions of people know that, but Multitudes of persons with defective hearing and Head Noises are again enjoying conversation, go to Theatre and Church because they use Leonard Invisible Anti-septic Ear Drums, which are Tiny Megaphones fitting in the Ear entirely out of sight. No wires, no batteries, no head piece. They are Unseen Comforts and inexpensive. Write for booklet and sworn statement of the inventor who was himself deaf.

A. O. LEONARD, Inc., Suite 161 70 5th Ave., New York



Apex Vernier Dials

are constructed on exhaustively tested and truly scientific principles and are engineered to meet the precise requirements of experts—consequently they *more* than meet the expectations of the average radio user. They bring in distant stations with alacrity and positiveness seldom encountered and provide control and accuracy essential to full radio enjoyment. They impart a degree of elegance that creates a marked improvement in the appearance of any set. Clockwise or counter clockwise.

Royal Brass Finish, 4 in. \$2.00; 3¼ in. \$1.65
Satin Silver Finish, 4 in. 2.50; 3¼ in. 1.90
DeLuxe Gold (24K) 4 in. 3.00; 3¼ in. 2.50

Apex Rheostat Dials

are little brothers to Apex Vernier Dials. Accurate, handsome—a necessity to satisfactory operation and beauty of appearance.

Royal Brass Finish 75c Satin Silver Finish 85c
DeLuxe Gold (24K) \$1.00

If your dealer is unable to supply you, order direct from us.

Apex Electric Mfg. Co.
1410 W. 59th St., Dept. 1001, CHICAGO

LATEST WHOLESALE RADIO CATALOG

FREE Simply send name TODAY for big 48-page catalog of latest radio goods at Wholesale. Live dealers and agents wanted.

STANDARD RADIO CO., 102 East 13th, Kansas City, Mo.

RADIO (PENCIL POINT) SOLDERING IRON
(COMPLETE WITH 6 FOOT CORD)
WORKS ON D.C. OR A.C.
HANDY FOR ALL SOLDERING WORK
NO TOY - WILL DO THE WORK OF HIGH PRICED IRON!
GUARANTEED ONE YEAR.
95¢ SEND FOR RADIO CATALOG WITH LATEST HOOK-UPS
PREPAID **VAN-ASHE RADIO CO.**
200 No. 10th St., ST. LOUIS, MO.

RADIO TEXT BOOK & CATALOG

FREE

Contains—
75 Radio "Hook-Ups"
300 Illustrations
556 Articles
84 Pages

"Build Your Own with RASCO Parts"

RADIO SPECIALTY CO.
98-E Park Place, NEW YORK, N. Y.



The Best Aerial
is a
Beldenamel Aerial

LEADING radio engineers agree that an enameled aerial is superior to a bare copper aerial, because the rapid corrosion of the bare copper wire, exposed to atmospheric fumes and smoke, quickly reduces the aerial efficiency.

Use a Beldenamel Aerial, because every strand is coated with baked Beldenamel to keep the wire bright and shiny. You do not have to clean a Beldenamel Aerial. The Beldenamel coating is not affected by moisture or atmospheric fumes. It lasts indefinitely. Try a Beldenamel Aerial, and hear the difference.



Belden

Send for Free Illustrated Booklet

Belden Manufacturing Company,
2306-E So. Western Ave., Chicago.

Please send me your latest illustrated booklet, free, describing Belden Radio Products and their use in radio work.

Name.....

Address.....

BURGESS RADIO BATTERIES *Win Again*



The illustration pictures the take-off of the winning flight and the insert is the radio equipment carried. (Burgess 'A,' 'B' and 'C' Batteries furnished the electrical energy to operate the set.)

When the Goodyear III won the right to represent the United States at Belgium, Burgess Radio Batteries supplied the electrical energy for the operation of the balloon's radio equipment.

Almost every day from some where in the world news comes to us of new Burgess adventures.

And that Burgess Batteries have contributed their bit in so many interesting events of sport, commerce and science reflects the esteem in which they are held.

"Ask Any Radio Engineer"

Your own radio dealer down the street sells Burgess Batteries. He probably sells the famous Burgess Flashlights, too.

BURGESS BATTERY COMPANY

GENERAL SALES OFFICE: CHICAGO

Canadian Factories and Offices:
Niagara Falls and Winnipeg

Please Mention Popular Mechanics

WET CELLARS MADE DRY *from the Inside!*

MAKE and keep your cellar dry by filling cracks and coating concrete or brick walls and floor with Smooth-On No. 7. Excellent also for waterproofing garage, stable and wash-room floors, boiler pits, cisterns, septic tanks, water troughs, fountains, duck ponds, swimming pools, manure pits, etc.

Requires about 25 lb. of Smooth-On No. 7 for each 100 sq. ft. of surface and you can do the work yourself. Smooth-On No. 7 is the only practical waterproofing material that can be effectively applied from inside and to wet or dry surface.

Can also be laid in a thicker layer over worn wooden floor for concrete effect and watertight surface that is easily washed and kept free from odors.

Sold in 5 and 10-lb. cans and 25, 50 and 100-lb. kegs.



Write for Prices and
FREE BOOKLET

SMOOTH-ON MFG. CO.

Dept. 61 574 Communipaw Avenue
JERSEY CITY, N. J.



Do it with
SMOOTH-ON No. 7

MOVIES Believe the Bible

See What It Teaches

We sell wonderful religious movie films and real movie machines—so you can show movies at home. Some movie machines as low as \$3.75—others higher. Also fine assortment of comedy, western and feature films with an exchange service for home users.

Write for Big Free Catalog

PARAMOUNT MFG. COMPANY Dept. M9
Boston, Mass.



Cal. 30 U. S. ARMY KRAG CARBINES

All Carbines have the new model 1898 stocks. The barrels, actions and parts are either new or have been refinished by the Government and equal to new. **\$15**
Krag Rifles.....\$12.50 Krag Sporting Rifles.. \$14.00
Springfield 45 Shot Guns 4.50 Springfield 45 Carbines 3.50
and other arms
W. STOKES KIRK, 1627-PM, North 10th St., Phila., Pa.

You Can Save \$35⁰⁰



\$4.45 and up

Recover it yourself. Custom tailor made to fit all makes and models. Roof

and quarters sewed together, with rear fasteners, welts and tacks, complete. Anybody can put it on. Give name, year, model number of your car. Catalog **FREE**. Agents wanted.
LIBERTY TOP & TIRE CO. Dept. L Cincinnati, O.

Copyrighted material

Get Pretty Home Furnishings This Popular Way

CHOOSE from our big new Fall Catalog all the lovely things you desire—then pay while you enjoy their use. On our famous Better Homes Plan you can take a year and a half to pay—down payment as little as \$3. Furniture, Rugs, Curtains, Blankets, Lamps, China, Silverware, can be yours. Also Pianos, Phonographs, Radios. Send coupon for this new catalog TO-DAY.



Save Money At
Our Low Prices

The new
Catalog also
explains the
popular
Larkin Club
and how to
start one.



BIG
CATALOG
FREE

Larkin Co Inc. BUFFALO, N. Y.
Peoria, Ill. Chicago, Ill.

Gentlemen: Please send me at once your new Fall Catalog No. 219 with all details of your Better Homes Easy-Payment Plan. 10

Name.....

Street and No.

Town..... State.....

Buchstein's Fibre Limb
is soothing to your stump—strong, cool, neat, light. Easy payments. Brooos for all deformities.
D. BUCHSTEIN CO.
610 3rd Ave., So., MINNEAPOLIS, MINN.

A PERFECT LOOKING NOSE
Can Easily Be Yours
Trados Model No. 25 corrects now ill-shaped noses quickly, painlessly, permanently and comfortably at home (excepting cases caused by improper bone structure). It is the only adjustable, safe and guaranteed patent device that will actually give you a perfect looking nose. Over 90,000 satisfied users. For years recommended by physicians. 14 years of experience in manufacturing Nose Shapers is at your service. Model 25 Junior for children. Write for testimonials and free booklet, which tells you how to obtain a perfect looking nose.
M. TRILETY, Pioneer Nose-shaping Specialist
Dept. 2476 Binghamton, N. Y.

SPORT BODIES for FORD and CHEV. 490 at \$34.50 UP
Life-size paper patterns—\$8
You can build your own body at small cost. We are manufacturers and our quantity production enables us to quote exceptional low prices. Our unique shipping methods save you 73% in FREIGHT CHARGES. Send at once for free particulars on Central Bodies. Our Book: "HOW TO BUILD A FORD RACER" sent anywhere on receipt of 25c in cash or stamps. WRITE TODAY!
Central Auto Supply Co. Dept. 120, Louisville, Ky.

UNDER SLUNG PARTS Per Set \$6.75

STOPS FALLING HAIR
ASK YOUR BARBER OR DRUGGIST
Millions of men, women and children have found the secret of hair-health in "Lucky Tiger"—the world's greatest remedy for falling hair, dandruff and all scalp disorders. A single application stops that miserable itching. Always sold under a positive Money-Back Guarantee.

LUCKY TIGER

FREE Book on Deafness
Write today for 168 page FREE book giving full particulars and testimonials from hundreds of grateful users whose hearing has been restored by use of our "little wireless phones for the ears."
Wilson Common-Sense Ear Drums require no medicine but effectively replace what is lacking or defective in the natural ear drums. They are simple devices, which the wearer easily fits into the ears where they are invisible. Soft, safe and comfortable.
WILSON EAR DRUM CO., Incorporated
108 Todd Building LOUISVILLE, KY.

Stop Wasting COAL!

Use less coal—get more heat—reduce the trips to "fire-up"—have your home warm and balmy—and SAVE MONEY with the

CROWN FUEL SAVER

A scientific device, easily installed on furnace door. Burns up the smoke and gases which otherwise pass out the chimney. Enables you to burn cheaper fuel. GUARANTEED to save 20% of the fuel—often saves more. Write for detailed description, if you buy coal for homes, apartment buildings, greenhouses, or buildings of any kind.
THOUSANDS IN USE
C. F. S. CO., 410 N. 10th St., Richmond, Ind.
A real opportunity for men desiring to build up a profitable, permanent business. Get our proposition to Distributors



South Bend Lathes are famous, first for quality, accuracy and performance. Today more than 33,000 are in use in all lines of industry in the United States and 64 Foreign Countries.

South Bend Lathe Low Prices are made possible by Standardized Production in large quantities. The saving is passed on to the purchaser. A comparison of prices will convince you of the very real saving you make when you select South Bend Lathes. Free Catalog shows 96 styles in all sizes. Easy Payment Terms if desired. Write today.

SOUTH BEND LATHE WORKS 805 East Madison Street
South Bend :: Indiana

SOUTH BEND LATHES

Quality
as
Outstanding
as
the Price

Easy
Payments
If
Desired

SEE
what you save
on the Lathe you need

	Quick Change Gear Lathe	Standard Change Gear Lathe
9" x 3'	\$241	\$211
11" x 4'	288	248
13" x 6'	366	316
15" x 7'	447	392
16" x 8'	498	438
18" x 10'	721	656

Write for Complete Catalog
No. 84

Just get your hands
on an 019!

Notice how easily a few twirls with your thumb run the jaw to the full three-inch opening. 019 is something new—a general purpose flat type wrench that is **DROP-FORGED**, including the jaw. Length 9 inches. Retail price at hardware and accessory stores, 75c.

Crescent Tool Co.

210 Harrison Street
Jamestown, N.Y.

Originators of the
Crescent Wrench



"All Crescent Tools are guaranteed to be satisfactory in every respect. We authorize all dealers to replace or refund the money on any Crescent Tool that does not give satisfaction—the purchaser to be the judge."

Crescent Tools

SHOW IT—and IT'S SOLD



The Handy Knife Sharpener is the fastest selling home necessity ever offered.

Everyone a prospect. Sells for \$1.00, your profit 65c. Free deliveries. Guaranteed.

Morgan Mfg. Co., Dept. G, 443 S. Dearborn, Chicago

Mr. Brush Salesman

Unusual opportunity is offered for aggressive, ambitious, hustling men to represent an old established manufacturer of high grade, guaranteed, fastest selling line of Sanitary Twisted in Wire Brushes, sold direct to the Home. We have openings for experienced brush men as managers in all territories. We want live wire, energetic Go-Getters. We pay larger commissions than any other Brush House in the Country. If you want to earn some real money, it will pay you to write us immediately for our proposition.

WIRE GRIP SANITARY BRUSH CORP., 15 MERCER STREET, NEW YORK CITY

SEND \$1.00 TODAY

FOR THIS

STEEL POCKET TAPE
MARKED WITH YOUR INITIALS

In extra fine nickel plated case; spring wind, center stop. Tape 1/4" wide; 6 ft. long; clearly marked. For architects, draftsmen, mechanics, business men, and for many household uses.

Returnable for full refund

An **AMERICAN
RULE** Product

AMERICAN RULE MFG. CO.
486 Johnson Ave., Brooklyn, N.Y.





"It's a Hohner!"

For nearly seventy years Hohner Harmonicas have earned and deserved the reputation of being "The World's Best." They are true in tone, accurate in pitch, faultless in construction and reasonable in price.

The Hohner Harmonica is a real musical instrument, endorsed and recommended by leading authorities as a "stepping-stone to serious musicianship."

Hohner Harmonicas are the individual choice of amateur and professional players everywhere. When you buy a harmonica insist on a Hohner; and ask for the Free Instruction Book. If your dealer is out of copies write M. Hohner, Inc., Dept. 181, New York City.

"That Musical Pal of Mine"



Mohawk Radio

5 TUBES—JUST ONE DIAL TO TUNE

AGENTS' NEW SPARK PLUG Visible Flash



Just Out—Amazing Invention—**Beacon Lite Spark Plugs.** You see the flash of each explosion in the cylinders. Tells which are firing right. Greatest improvement in spark plugs since gas engines were invented. Wonderful gas savers. Agents coining money.

\$90 A WEEK
Easy to make with new sure-fire plans. Sells on sight to every auto owner. Phillips, Ont., writes "Sold 2 dozen today, 3 dozen yesterday. Rush 10 dozen." Write for special **Free Demonstrator Offer** and **FREE** deal to introduce these wonder spark plugs in your territory. Write quick—today.

CENTRAL PETROLEUM COMPANY
1630 Century Building Cleveland, Ohio

At Last! Soldering Iron and Blow Torch In One!

Saves Time, Trouble and Money!

For every handy man! Pays for itself in one job! Enables you to do easily a lot of work that would otherwise require a plumber or tinsmith. Needs no pump or pressure system. Needs no stove or charcoal pot, or separate blow torch. No fussing! No trouble!

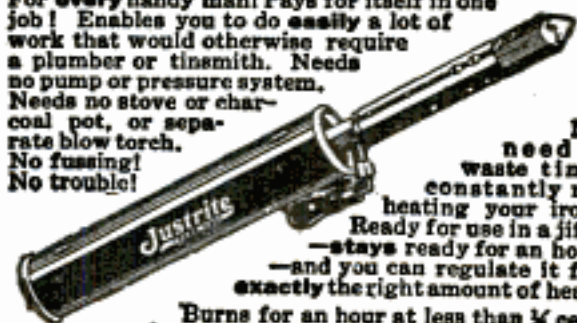

No need to waste time constantly re-heating your iron. Ready for use in a jiffy—stays ready for an hour—and you can regulate it for exactly the right amount of heat!

Burns for an hour at less than $\frac{1}{4}$ cent for gasoline and can be used where nothing else would be available! Just remove copper point and you have an ideal BLOW TORCH for burning off old paint, tempering tools, thawing frozen pipes, etc., etc. Send the coupon below!

Why pay out good money to tinsmiths and plumbers for jobs you can easily do yourself with the Justrite! Send for one on Free Trial TODAY!

For Every
Householder,
Farmer,
Auto Owner,
Mechanic,
Tinsmith,
Radio Fan,
Plumber,
Electrician,
Dentist,
Jeweler,
Painter,
Printer,
Garage,
Repair Shop.

10 Days Free Trial Send No Money

The Justrite will be sent you C. O. D. on ten days trial. If, after ten days you are not absolutely satisfied that it is everything we claim for it, send it back and we will promptly return your money. Just mail the coupon. DO IT TODAY—NOW!

Agents— Special Offer!

We are making an extremely liberal offer to agents, and the sales of this remarkable tool come so fast that you'll be amazed! Just show people how it works, and as soon as they see it in operation—as soon as they see how much time and trouble it saves—they want it! Nine times out of ten a demonstration means a sale. Send post card for special agents' offer.

(Mail This Coupon NOW for 10 Days' Trial)

JUSTRITE MFG. CO., Dept. 13-57
2071 Southport Ave., Chicago, Ill.

Please send me by parcel post, C. O. D., one Justrite Soldering Iron and Blow Torch, packed complete with sal ammoniac and solder, ready for use. On arrival, I will pay the postman \$3.00, plus postage, with the understanding that unless I am absolutely satisfied after ten days' use, I will send back the tool and you will return my money.

Name.....

Address.....



PA INVENTORS.

**JUST
ACROSS
STREET
FROM
U. S. PAT.
OFFICE.**

At the right is a view of my drafting and specification offices where a large staff of experienced experts are in my constant employ. All drawings and specifications are prepared under my personal supervision.



PROTECT YOUR IDEAS **Take the First Step Today**

If you have a useful, practical, novel idea for any new article or for an improvement on an old one, you should communicate with a competent Registered Patent Attorney AT ONCE. Every year thousands of applications for patents are filed in the U. S. Patent Office. Frequently two or more applications are made for the same or substantially the same idea (even though the inventors may live in different sections of the country and be entirely unknown to one another). In such a case, the burden of proof rests upon the last application filed. Delays of even a few days in filing the application sometimes mean the loss of a patent. So lose no time. Get in touch with me at once by mailing the coupon on the opposite page.

Prompt, Careful, Efficient Service

This large, experienced organization devotes its entire time and attention to patent and trademark cases. Our offices are directly across the street from the U. S. Patent Office. We understand the technicalities of patent law. We know the rules and requirements of the Patent Office. We can proceed in the quickest, safest and best ways in preparing an application for a patent covering your idea. Our success has been built on the strength of careful, efficient, satisfactory service to inventors and trademark owners located in every state in the Union.

Clip this Coupon and Mail

TENTS

Write for these FREE BOOKS

**NO CHARGE
for Information**

**On How to
Proceed!**

The books shown here contain valuable information relating to patent procedure that every inventor should have. And with them I will also send you my "Record of Invention" form, on which you can sketch your idea and establish its date before a witness. Such evidence may later prove valuable to you. Simply mail the coupon and I will send you the books, and the "Record of Invention" form, together with detailed information on how to proceed and the costs involved. Do this NOW. No need to lose a minute's time. The coupon will bring you complete information entirely without charge or obligation.



STRICT SECRECY PRESERVED

All communications, sketches, drawings, etc., are held in strictest confidence in strong, steel, fireproof files, which are accessible only to authorized members of my staff. Feel free to write me fully and frankly. Your case will have my personal attention. It is probable that I can help you. Highest references. But **FIRST**—clip the coupon and get my free books. Do **THAT** right now.

Clarence A. O'Brien

Registered Patent Attorney

Member of Bar of: Supreme Court of the United States; Court of Appeals, District of Columbia; Supreme Court, District of Columbia; United States Court of Claims.

**Practice confined exclusively to Patents,
Trademarks and Copyrights**

**FREE
COUPON**

**CLARENCE
A. O'BRIEN**

*Registered
Patent Attorney*

7096 Security Savings and
Commercial Bank Bldg.,
Washington, D. C.

Please send me your free books, "How to Obtain a Patent," and "Invention and Industry," together with your "Record of Invention" form without any cost or obligation on my part.

Name

Address

(Important: Write or Print name clearly)

It Now!

PATENTS TRADE-MARKS AND COPYRIGHTS

Have You An Idea?

Our Offer: FOR THE PROTECTION OF YOUR INVENTION YOUR FIRST STEP

Before disclosing an invention the inventor should write for our blank form

"RECORD OF INVENTION"

This should be signed and witnessed and returned to us together with model or sketch and description of the invention for INSPECTION and INSTRUCTIONS

No Charge for the Above Information

**Our Four Books Mailed
Free to Inventors**

Our Illustrated Guide BOOK

How to Obtain a Patent

Contains full instructions regarding U. S. Patents, Our Methods, Terms, and 100 Mechanical Movements illustrated and described.

Our Trade Mark Book

Shows value and necessity of Trade Mark Protection. Information regarding *Trade Marks and unfair competition in trade.*

Our Foreign Book

We have Direct Agencies in Foreign Countries, and secure Foreign Patents in shortest time and lowest cost.

Progress of Invention

Description of World's Most Pressing Problems by Leading Scientists and Inventors.

We Regard a Satisfied Client as our best advertisement, and furnish anyone, upon request, lists of clients in any state for whom we have secured patents.

**Highest References—Prompt Attention
—Reasonable Terms**

VICTOR J. EVANS & CO.

PATENT ATTORNEYS

Main Offices: 956 9th St., N. W., Washington, D. C.

Opposite U. S. Patent Office



Our New York Office
Suits 1007 Woolworth Bldg.



Our Philadelphia Office
Suits 714-15 Liberty Bldg.



Our Washington Office
Victor Building

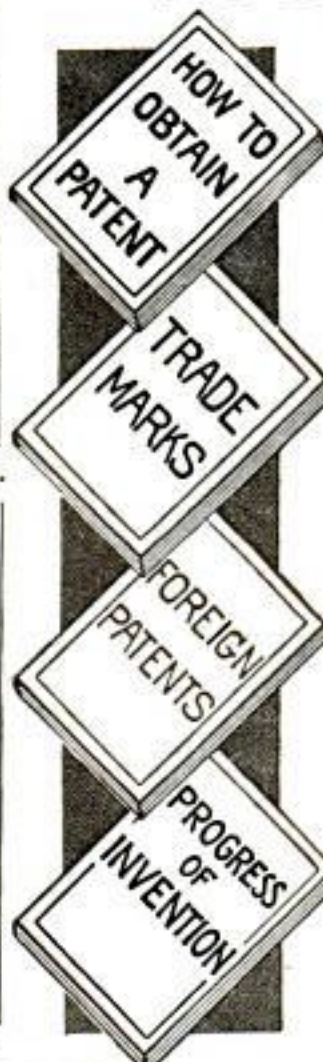

PATENTS TRADE-MARKS AND COPYRIGHTS

IMPORTANT

Do not submit your invention to anyone before you furnish proof that the invention is patentable or application has been filed. IN ORDER TO HAVE YOUR CASE MADE SPECIAL TO AVOID DELAY YOU SHOULD TAKE THE PRECAUTION OF HAVING YOUR CASE MADE SPECIAL IN OUR OFFICE to secure protection, save correspondence and secure early filing date in Patent Office. To secure special preparation of your case send \$25.00 on account with model, sketch and description.



MAIN OFFICE, VICTOR J. EVANS & CO.—VICTOR BUILDING, WASHINGTON, D. C.

All Communications and
Data Strictly Confidential.
Interference and Infringe-
ment Suits Prosecuted

OUR ORGANIZATION OFFERS
PERSONAL SERVICE
By Experienced Patent
Solicitors and Draftsmen

**FREE
COUPON**

**VICTOR J. EVANS & CO.
PATENT ATTORNEYS**

NEW YORK OFFICES
1997 Woolworth Bldg.

CHICAGO OFFICES
1114 Tacoma Bldg.

PHILADELPHIA OFFICES
714-715 Liberty Bldg.

PITTSBURGH OFFICES
514 Empire Bldg.

SAN FRANCISCO OFFICES
Hobart Bldg.

MAIN OFFICES: 956 9th Street, N. W., WASHINGTON, D. C.

Gentlemen: Please send me *Free of Charge* your books as described on preceding page.

Name

Address



Our Chicago Office
Suite 1114 Tacoma Building



Our Pittsburgh Office
Suite 514 Empire Building



Our San Francisco Office
Suite 1010 Hobart Building

U.S. PATENTS



SEND FOR THIS FORM

DON'T LOSE YOUR RIGHTS TO PATENT PROTECTION

Before disclosing your invention to anyone send for blank form "EVIDENCE OF CONCEPTION" to be signed and witnessed. A sample form together with printed instructions will show you just how to work up your evidence and establish the same before filing application for patent. As registered patent attorneys we represent hundreds of inventors all over the United States and Canada in the advancement of inventions. Our schedule of fees will be found reasonable. The form "Evidence of Conception," sample, instructions relating to obtaining of patents and schedule of fees sent upon request. Ask for them—a post card will do.

PATENTS AND TRADE MARKS



Registered Patent Attorneys in U. S. and Canada.
480 Ouray Bldg., WASHINGTON, D. C.
Originators of forms "Evidence of Conception."



PATENTS

Send us sketch or model for advice and exact cost of patent. Our book "How to Obtain a Patent" sent free. It tells how to apply for Patents, Trade Marks, Foreign Patents, Copyrights, etc.; gives information on Patent Procedure; tells what every inventor should know. Thousands of Inventors, who are our clients, are our reference.

CHANDLEE & CHANDLEE, 25 Years' Experience
473 7th St. Washington, D. C.

PATENTS

C. L. PARKER
Formerly Member Examining
Corps, U. S. Patent Office
PATENT LAWYER
MCGILL BLDG.
WASHINGTON, D. C.

Patents, Trade Marks, Copyrights, Patent Litigation
Pamphlet of instructions sent upon request

PATENTS

To the Man with an Idea

I offer a comprehensive, experienced, efficient service for his prompt, legal protection and the development of his proposition.

Send sketch, or model and description, for advice as to cost, search through prior United States patents, etc. Preliminary advice gladly furnished without charge.

My experience and familiarity with various arts frequently enable me to accurately advise clients as to probable patentability before they go to any expense.

Booklet of valuable information and form for properly disclosing your idea free on request. Write today.

Richard B. Owen, Patent Lawyer
9-303 Owen Building, Washington, D. C.
41-E Woolworth Bldg., New York City

Have You An Invention?

If so the WORLD PROGRESS will send you upon request sample copy Free containing SUGGESTIONS TO INVENTORS as to Inventions Needed. We invite manufacturers to address us regarding inventions they want.

Subscription for one year 60 cents

WORLD PROGRESS PUB. CO., Inc.
Room 203 Victor Bldg. WASHINGTON, D. C.

PATENTS

As one of the oldest patent firms in America we give inventors at lowest consistent charge, a service noted for results, evidenced by many well known Patents of extraordinary value. Book, Patent-Sense, free.

Lacey & Lacey, 646 F St., Wash., D. C. Estab. 1868.

BLUE BOOK ON PATENTS

gives instructive information and candid advice.
MONROE E. MILLER, PATENT LAWYER
411-2 Ouray Building WASHINGTON, D. C.
ELECTRICAL AND MECHANICAL EXPERT

INVENTORS PROTECT YOUR IDEAS

Send for our Guide Book, **HOW TO GET A PATENT**, and Evidence of Invention Blank, sent Free on request. Tells our terms, methods, etc. Send model or sketch and description of your invention for INSPECTION and INSTRUCTIONS FREE. TERMS REASONABLE. BEST REFERENCES.

RANDOLPH & CO.
300 Victor Bldg., WASHINGTON, D. C.

NAME _____

STREET _____

CITY _____ STATE _____

PATENTS

TRADE MARKS · DESIGNS · FOREIGN PATENTS

MUNN & CO. PATENT ATTORNEYS

Associated since 1846 with the Scientific American

672 WOOLWORTH BUILDING
New York City

523 SCIENTIFIC AMERICAN BLDG.
Washington, D. C.

412 TOWER BUILDING
Chicago, Ill.

365 HOBART BUILDING
San Francisco, Cal.

220 VAN NUYS BUILDING
Los Angeles, Cal.

Books and Information on Patents and Trade Marks by Request. Associates in All Foreign Countries.

PATENTS

Trade Marks, Copyrights, Patent Litigation Handbook with illustrations, 100 mechanical movements. Sent free on request.

ALBERT E. DIETERICH
formerly member examining corps U. S. Patent Office
PATENT LAWYER and SOLICITOR

621-A, Ouray Bldg.
27 Years' Experience Washington, D. C.

LAST BARGAIN CALL!!
on Ford sport and racing bodies 9 models, \$25 up; speed, power specialties



Racing Gears Underhung Fixtures
Ford underslung specialties and bodies on display. Come in and inspect.
W. V. FORDSPEED BODY MFRS., 250 West 54th St., NEW YORK

WHITE FLAME
BURNERS make your old kerosene lamps and lanterns give a brilliant white light better than electricity or gas. Doubles your light. Saves oil. **NO MANTLE TO BREAK.** Guaranteed Safe and Reliable. Delights every user. Send now for complete sample postpaid 50 cents, stamps or coin. \$ for \$1.25. Money Back if Not Satisfactory. Live Representatives Wanted. Exclusive Territory.
WHITE FLAME LIGHT CO., 60 Clark Bldg., Grand Rapids, Mich.



GEARS ALL KINDS SMALL

The most accurate made and prices reasonable. We carry a complete line of gears in stock for immediate shipment. Can also quote on special gears of all kinds. Send us your inquiries. WRITE FOR CATALOGUE.

CHICAGO STOCK GEAR WORKS
105-109 S. Jefferson St., CHICAGO

PATENTS

Booklet Free Highest References
Promptness Assured Best Results

Send drawing or model for preliminary examination of Patent Office records.

ALL BUSINESS GIVEN PROMPT AND PROPER ATTENTION

Listed Patent Lawyer in the latest editions of the Rand-McNally Directory of Bankers and Attorneys, of Chicago, Ill.; The Baggott & Ryall Directory of Attorneys, New York City; the United Lawyers' List of Attorneys, published in Chicago, Ill.; The Lawyers and Bankers Quarterly, published by the Legal Directory Publishing Company of St. Louis, Mo.; the American Lawyers Annual, Cleveland, Ohio.

WATSON E. COLEMAN,
REGISTERED PATENT LAWYER

644 G Street, N. W., Opp. U. S. Pat. Office
WASHINGTON, D. C.



3,849
Ideas

3,917
Pictures



It's Fun To Make Things

Let the other boys wonder how you can make so many interesting things. Make your own motor sled. Make your own radio. Make your own skis and snowshoes. You can learn how to make almost anything that any boy could want by following the pictures and the simple directions in

The Boy Mechanic Library

And just think of it, there are nearly 4,000 separate articles in the four beautiful volumes! Some of the most fascinating subjects are listed below.

How To Make Things—How To Do Things

Boats	Carpentry	Electrical devices
Winter sports	Painting	Photography
Camping	Toys	Music
Ice boats	Fishing	Outdoor games
Water sports	Fruit growing	Stoves
Toboggans	Entertainments	Furnaces
Tents	Automobile	Wireless
Skis	House decorations	Tricks
Indian snowshoes	Drafting	Puzzles
Skating	China painting	Bicycle
Gymnastium	Decorative metal work	Flowers
Wind wagons	Furniture making	Hunting
Motor sleds	Farming	Kites
Radio	Poultry	Metal working tools
Magic	Models	Secret locks
Trapping	Laboratory helps	Swings
Pets	Household helps	Sleds
Leather work	Wood working	Power devices

Learn how to make things to sell. Learn how to make things to enjoy yourself. Buy the complete library, including Book 1, Book 2, Book 3 and Book 4.

SEND NO MONEY Four Books for only

Simply sign your name and address to the attached coupon and mail it at once. When the postman delivers the books to your door, pay him the price of the books and the few cents postage. That is all.

\$7

POPULAR MECHANICS PRESS

Popular Mechanics Building, Room 710, Chicago, Ill.

***** Mail The Coupon Today *****

Popular Mechanics Press,

Popular Mechanics Building, Room 710, Chicago, Ill.

Please send me at once C. O. D. The Boy Mechanic Library comprising Book 1, Book 2, Book 3, and Book 4. I will pay the postman \$7 and the few cents postage.

Name.....

City.....State.....

Street No. or R. F. D.....

If you want individual books at \$2 each, check the numbers of the books you want: 1 2 3 4



STOP USING A TRUSS

Do Away With Steel And Rubber Bands

FREE TRIAL



FREE to 5,000 Truss Sufferers

To the extent of 5,000 sufferers who may apply I will send, ABSOLUTELY FREE, a sufficient quantity of the Plapao to positively convince them that this is the only logical, common-sense way of treating rupture. Plapao is a highly astringent medication placed within the Plapao-Pad and being absorbed through the skin, creates a wonderful feeling of relief and at the same time tends to strengthen the weakened muscles and thus permanently close the rupture opening. The process of recovery is natural, so you'll have no use for a truss—you can throw it away forever! Old and young have testified under oath that the Plapao-Pads cured their rupture—many of them long-standing, aggravated cases—without delay from work. Patent allowed in U. S. and foreign countries. Awarded Gold Medal at Rome and Grand Prix at Paris.

Send No Money—For a sufficient quantity of the Plapao is sent without charge to enable you to give it a thorough test; you pay nothing for this trial now or ever. Write for it and full information today. Address: Plapao Laboratories, Block 1427 St. Louis, Mo.

GET RID OF THIS

with no effort at all!



Here is the easiest way in the world to rid yourself of that useless, joke-inviting, health-menacing paunch! Simply fasten on *Dr. Lawton's Automatic Waistline Reducer*—and the flabby flesh will vanish. Absolutely automatically! For men and women.

DR. LAWTON'S AUTOMATIC WAISTLINE REDUCER



Hour by hour, with every breath you take and every step you make, the *Waistline Reducer's* Vacuum Applicator massages away unwanted bulge. Made of soft, pliable, glove-like rubber. Fits snugly and comfortably to the figure. Weighs but few ounces. Flexible as a handkerchief.

SATISFACTION A SURETY

Dr. Lawton's Automatic Waistline Reducer is sold under a guarantee bond of absolute satisfaction. Your money back if you do not like it when you get it. Write now—this minute—to Dr. Lawton for full description, convincing literature and low price. Mail the inquiry blank below now to

DR. THOMAS LAWTON

Dept. 61-J, 19 W. 70th Street New York City

Dr. Thomas Lawton, Dept. 61-J, 19 W. 70th St., New York City

Dear Sir:—Send me complete description of Dr. Lawton's Automatic Waistline Reducer, convincing literature and illustrations, and tell me how low it is priced. This obligates me in no way.

NAME.....

STREET.....

TOWN.....STATE.....

Taxidermy Book FREE.

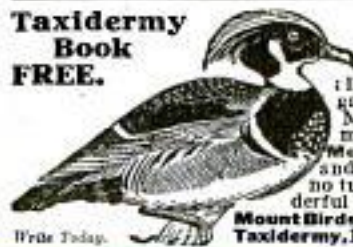

Stuff Beautiful Birds. Learn by mail to

stuff and mount all kinds of birds, animals, fish and game heads, make rugs, tan skins. Mount your own specimens and make money preserving for others.

Men, Women and boys learn easily and quickly. Success guaranteed or no tuition. Write today for our wonderful FREE book "How to Learn to Mount Birds and Animals." N.W. School of Taxidermy, 1777 Elwood Bldg., Omaha, Neb.

Write Today.

NO MORE BALD HEADS



WHEN our VACUUM CAP is used a few minutes daily. We accept no pay until you have tried the Cap 60 days and are satisfied. The Vacuum Cap is an appliance that draws the blood to the Hair Roots and starts a new healthy crop of hair. It stops Dandruff, stops the hair from falling out.

Bought by Doctors and men who know that it is the only reasonable HAIR GROWER known to science. No Drugs Used. Write for application blank, testimonials and booklet on "HAIR," sent sealed in plain envelope, FREE.

THE MODERN VACUUM CAP CO.

M-559 BARCLAY, DENVER, COLO.

PIMPLES

Blackheads—Acne Eruptions

Now Are Easily Removed at Home at a Small Cost!

Banish those unsightly blemishes easily and quickly by using "CLEAR-TONE"—a simple home treatment that has cured chronic cases of long years standing. Use like toilet water. Leaves the skin clear, smooth and without a blemish. Has made many friends with men, women and children. Elegant for men after shaving. If you have Pimples, Blackheads, Acne Eruptions on the face or body, Bar-

bers Itch, Eczema, Enlarged Pores, Oily or Shiny Skin—never mind how bad—"CLEAR-TONE" has cured the worst cases I ever saw. Endorsed by druggists, physicians, skin specialists, barbers and over 100,000 Men and Women test cases, who succeeded with "CLEAR-TONE" after failing with everything else.

FREE!

Send name today for FREE Booklet, "A CLEAR-TONE SKIN," telling how I cured myself after being afflicted for 15 years. And I know every embarrassment one has to endure with a bad complexion. \$1,000 CASH SAYS I CAN CLEAR YOUR SKIN OF THE ABOVE BLEMISHES.

E. S. GIVENS

129 Chemical Building

KANSAS CITY, MO.

Do You Want a Business of Your Own?

Easy to Make BIG PROFITS

With TOSTWICH



Anyone can start a TOSTWICH SHOP and make more money than you ever thought possible.

TOSTWICH is the light lunch sensation that is sweeping the country. (Did you read the story of this new sandwich on page 449 of last month's Popular Mechanics?) Tostwich equipment toasts the complete sandwich by a new process. Positively makes the most delicious sandwich anyone ever ate. So good and satisfying, people won't eat any other after tasting a TOSTWICH. In fact the popular demand for TOSTWICH is now so tremendous that more, many more TOSTWICH SHOPS must be opened up at once!

Make \$3000 to \$15,000 a Year!

Are you tired of working for someone else? Have you a little money saved and waiting for an opportunity to cash in on a real, legitimate money maker? Here it is! Tostwich profits will amaze you. One man writes, "Sold 75,000 Tostwich Sandwiches since March, made \$4500.00 clear profit." Hundreds of others doing as well or better. You can, too. Responsible parties can install TOSTWICH Equipment, complete, for a first payment of approximately only \$100.00. Be independent! Investigate the biggest money maker in years right now while the field is uncrowded. Send coupon at once for full particulars without obligation to you. (Note: If you already own a store, no matter if you sell lunch or not, find out about the easy—additional profits you can make with TOSTWICH—write today.)

TOSTWICH, INCORPORATED, Dept. 1777

646 N. Michigan Ave., Chicago

Send me, without obligation, full details of Tostwich Profit Earning Plan.

Name.....

Address.....

City..... State.....

My occupation is.....

ALTO Motor Driven High Speed Tapping Machine

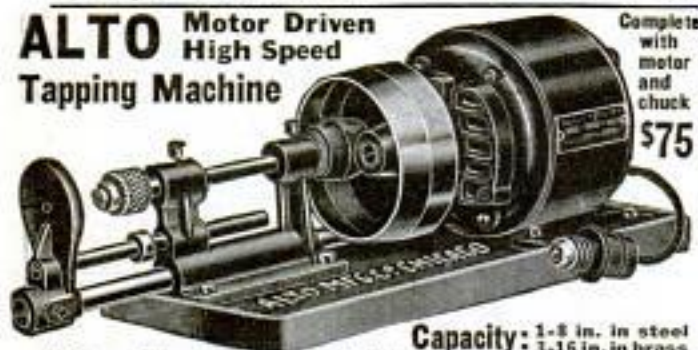

Complete with motor and chuck \$75

Capacity: 1-8 in. in steel
1-16 in. in brass

This machine is very compact high speed in operation. Very simple to operate. Occupies very little space. The lowest priced tapping machine on the market. A great money-saver for Radio manufacturers, machine shops, light metal work and wherever the tapping of small holes has to be tapped.

ALTO MANUFACTURING CO., 1647-51 Wolfram Street
CHICAGO, ILLINOIS



DELTA

No. 37 BICYCLE SPOTLIGHT

PERMITS BICYCLIST TO RIDE THROUGH
BLACKEST NIGHT IN PERFECT SAFETY

The rider whose bicycle is equipped with a Delta 37 does not fear hazardous road conditions of nights as dark as a "stack of black cats" for he has a powerful penetrating bright light of safety. Equals good auto spotlight. Head 4½ inches in diameter. Improved bracket, fits any handlebar. Battery case mounts on all standard bicycle frames. Operates on two dry cells. At your dealer or sent prepaid for \$3.75 complete (less batteries). In Canada \$5.00.

DELTA ELECTRIC COMPANY, 100 Delta Block, MARION, IND.

Standard makers of Electric Bicycle Spotlights and lamps, Motorcycle Spotlights, Auto Spotlights, Auto Ash Reflectors, Electric Hand Lamps, Radio Head-Phones, Flashlights and Flashlight Batteries.

New York
EXPORT DEPT.
30 Water St.

Chattanooga
FAUCETT-HUSTON CO.

San Francisco
SANFORD BROS.
311 Minna St.

The Traffic Cop of the Air

Add a Farband Wave Trap to your Radio Set and "Police" your reception. Guaranteed to tune out any interfering station. The original and only successful Wave Trap. Sent prepaid on receipt of \$8.50 or C. O. D. plus postage. Send for Free Booklet. Farband Electric Co., 15 E. So. Water St., Chicago



Ideas for Housekeepers Over 500 ideas in our Handbook for Women and Home Mechanics. Two books of discoveries for 98c. Send No Money. Just write a postal. Pay postman postage and price. Popular Mechanics Press, Room 710, Chicago, Ill.

Try This on Your Hair Free



Your hair need not thin out, nor need you become bald, for there is a way to destroy the microbe that destroys the hair. This different method is the Dillman Medicated Hair Drill: it will stop thinning out of the hair, lifeless hair, remove dandruff, itching, darken gray hair and threatened or increasing baldness, by strengthening and prolonging life of the hair for men and women.

\$1.00 Package Waiting for You — FREE

In order to prove that the Dillman Medicated Hair Drill will do all we claim, we are willing to give you a regular \$1.00 Package free if you will send us 25 cents to help cover mailing cost. Try it. Then let your mirror be the judge. Send today. No obligations. AYMES CO., 416 S. Dearborn St., TF34, Chicago, Ill.



Learn



Take a W. A. C. Course in Applied Airplane Engineering. Many men earn \$2,000 to \$10,000 a year. Big Free outfit of airplane parts. Write for Free catalog.

WESTERN AIRPLANE CORPORATION
Dept. H10, Nonsneck Bldg., Chicago, Ill.

Aviation



KARAS HARMONIK

AUDIO FREQUENCY



AMPLIFYING TRANSFORMER



The Triumph of a Masterpiece!

—A Marvel of Transformers that Brought Real Musical Quality to Radio Reception

JUST one year ago the Karas Harmonik Audio Frequency Transformer took the radio world by storm.

Nothing like it had ever been known before. For the first time, scientific study had been devoted to perfecting an audio transformer for the reception of broadcast music. The problem of amplifying high, low and medium frequencies to equal degree was finally solved. Bass notes were poured from the speaker in full strength and rich tone quality. The vital harmonics in rich overtones, formerly lost, were brought out in their full beauty by this marvel of audio transformers.

Music critics, who had always condemned radio music as false and distorted, approved the results of Karas Harmonik amplification with great enthusiasm.

Prominent radio engineers subjected Karas Harmoniks to exhaustive laboratory tests—and pronounced it a technical masterpiece. Technical editors who promoted the season's most successful hook-ups specified Karas Harmoniks in their circuits. The triumph of the Karas Harmonik was complete.

But, for all of this, the enjoyment of Karas Harmonik amplification was too greatly confined to one class of radio enthusiasts. Home set builders bought Karas Harmoniks by the tens of thousands. They were free to pick and choose. They were most exacting in their demands for the newest and best developments.

It was the owners of factory-built sets who missed the delightful pleasure of real, true radio music in their homes. Set manufac-

turers were prevented by price from adopting Karas Harmoniks for their sets. So the ready-made set-buyer unless he undertook to switch transformers, had to do without Karas Transformers.

Today there are in use, hundreds of thousands of sets—good sets—which could be vastly improved in musical quality by the simple operation of replacing the old transformers with Karas Harmoniks. Perhaps you own one of these sets. It may be all you desire from the standpoint of selectivity of range, and other tuning qualities. But, if it is not equipped with Karas Harmonik Audio Frequency Transformers, you are NOT getting nearly the musical

quality you can just as well enjoy. Are you going to be content with anything short of the best?

You can install Karas Harmoniks yourself. It's a short, easy job. Or, any radio repair man can do it for you. Make up your mind to do it now—at once. Get a pair of Karas Harmoniks TODAY!

In large cities, most good dealers carry Karas Harmoniks—and in many small towns. If your dealer is out of them, order direct from us. Send no money. Just send the coupon now! KARAS ELECTRIC CO., 4046 N. Rockwell St., Chicago, Ill.

The Distinctive Features that Elevate Karas Harmonik Transformers to the Highest Pinnacle of Success in the Radio World.

1. Many thousands of turns of wire
2. Low ratio of turns
3. Extra large quantity of special formula iron in core
4. Controlled air gap
5. No core saturation
6. Minimum of Reluctance
7. Least Hysteresis and Eddy Current Loss
8. Low Distributed Capacity
9. Scientifically circular shielding preventing intercoupling of electrostatic and electromagnetic fields.
10. Very High Primary Impedance
11. Extremely High Inductance
12. High and Even Amplification of all Audio Frequencies.

Karas Electric Co.,
4046 N. Rockwell St., Chicago, Ill.

Please send me _____ pairs of Karas Harmonik Audio Frequency Transformers. I will pay the postman \$1 apiece, plus postage, on delivery. It is understood that I am privileged to return the transformers any time within 30 days if they do not prove entirely satisfactory to me, and my money will be refunded at once.

Name _____

Address _____

Automatic Hydro Oil Burner Hydro Combustion Hydro Powered

The Automatic Hydro Oil Burner eliminates dirty coal and ashes, back breaking shoveling, hours of cleaning. No cold house on winter mornings, no frozen water pipes—gives even temperature over entire house, makes average heating plant 25% more efficient,—used in steam, hot water, vapor plants or hot air furnaces, installed summer or winter. Mechanical operating cost less than \$1.50 per month, fuel operating cost same as hard coal at \$15.00 a ton. Gives clean basement, storage room of coal bin, adds spare room for maid's room, play room, bridge or Ma Jong room,—no house too small or large, never too hot or too cold. Gives home refinement—apartment house service, no basement drudgery. Easily, quickly installed. Burns without soot, carbon, or smoke. All parts completely accessible. Burns 93% air. Absolutely safe.



Installed Complete Ready to Operate

220 Gal. Tank—Heavy Tank Stand
—Burner—Hydro Motor—Dual Oil—Hydro safety valve—Extra Safety Valve—Thermostatic control complete
—Vaporizer—mixer unit—Pilot Light assembly—All pipes—All pipe fittings
—Overflow safety equipment—Gas Lighting Torch—

Price **\$295.00**
Only

The phantom cut is of the burner assembly only—showing the most advanced and remarkable oil burner features ever introduced. Their simple design, sturdy construction, positive and economical operation make it possible to reduce the price so the mass of home owners can own one. (All Features Patented.)

The Automatic Hydro-Oil Burner is noiseless, uses rotary centrifugal type vaporizer-mixer unit. Hydro (water) motor driven, vaporizes oil and water, mixing with measured air, at the same time and place, in suspension—the recognized way to obtain 100% efficiency. Burner is automatic in action, thermostatically controlled day and night, guarded by three safety devices, one moving part, ball bearing, running in oil—simple, fool proof, needs no attention, fully guaranteed, on market 2½ years.

Diagrammatic Sketch



This illustrates the action of our Rotary Burner—oil is burned in suspension.

DISTRIBUTORS AND DEALERS GET EXCLUSIVE SALES FRANCHISE

New profitable business. But 60,000 burners, all makes in U. S. Public is sold on oil burning, eager to buy popular priced, thoroughly reliable burner. Every town having city water and gas makes excellent field. The distributor's and dealer's discounts make it possible to obtain high class, go-getter salesmen. Distributors and dealers can make from \$5,000 to \$25,000 yearly—salesmen from \$3,000 to \$12,000. Earnings controlled by size of territory. We train distributors, dealers, salesmen, service-installation men—Free. Remember the \$295 outfit is complete and installed, including

thermostatic—automatic control,—others get from \$530 to \$1800 for the same oil burner service.

We want alert, active men who have made a success having vision and ability to handle sales and finance their start—we help in placing your payment paper, and give you exclusive territory.

If seriously interested in territory the surest way is to hop on a train and come at once—but wire first—NOW—territory allotted in order of receipt of telegrams. This is our first and probably our only dealer announcement so act quickly. Complete fully illustrated literature mailed Free.

AUTOMATIC HYDRO OIL BURNER COMPANY 510 Mc Kerchey Building, 2631 Woodward Avenue, DETROIT, MICH., U. S. A.

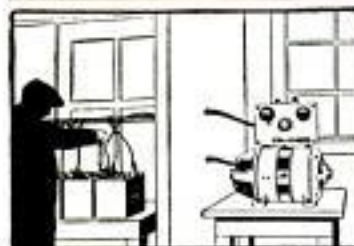

\$150 to \$300 PROFITS EASILY WITH ONE DAY CHARGING

Start your own battery charging business that will pay \$150 to \$300 clear monthly profits. No experience needed. Universal demand for quick charging of auto and radio batteries. You can have these big, easy profits. Only \$35 cash brings a complete HB One Day Battery Charging Outfit, ready to use. Your monthly profits easily carry the small monthly payments. 30 days' free trial on money-back guarantee. The best and lowest-priced complete outfit on the market. Write for free bulletin No. 10.

HOBART BROS. CO. Box M100, Troy, Ohio

MORE HB BATTERY CHARGERS USED THAN ANY OTHER MAKE



\$10 A DAY EASY

McDonald made \$58 in one week! Hampton made \$7.65 in 4 hours—just wearing this beautiful Hand-Tailored Taylor Cap.

FREE CAP FOR YOU. I want to give you a FREE cap. Your friends will be delighted with its class, style and fit and you will make a generous profit taking their orders. Finest materials and workmanship. Choice of 3 styles and 25 fine waterproof fabrics. Send your name right away for details. Write at once.

J. W. TAYLOR, Pres.
TAYLOR CAP MANUFACTURERS, Dept. 55-R,



CINCINNATI, O.

Why Share Your Profits?

\$2.95
WORK
SHOE



Sell Doublewear Shoes and get all you earn. No district managers to split with. You deal direct with us. A complete line. Wonderful values—for example, the quality work shoe shown here for \$2.95. Our salesmen everywhere are making big money. Write for proposition.

DOUBLEWEAR SHOE COMPANY

Oldest and Largest Firm Selling Direct to Wearer

14 E. Lake St., Minneapolis, Minn.

Nothing Like a Genuine Oil "Souwester" to KEEP YOUR HEAD DRY!

Keeps downpouring, drizzling or driving rain, also snow, out of your face and back of neck. Flannel lined, comfortable on cold days. You can't wear 'em out! If you go out in bad weather, hunt ducks, or fish through the ice, order one today and save doctors' bills this fall. State size, and your choice, yellow or olive. Money back if not satisfied with all Iver Johnson goods.

\$1.25
POSTPAID



COLLEGIATE SLICKERS

Genuine Sawyer's Oil Slickers. You can't wet 'em through. Rain can't beat in. Practical and all the rage. State chest measure. Satisfaction guaranteed. **\$6.60**

NOISELESS POKER CHIPS Plain 1½-inch square edge, stack evenly. Light, noiseless and easy to handle. Made in three colors—red, white and blue. Unbreakable. Per 100, **\$1.35 PAID**

BUCKSKIN MONEY BELT Nothing softer than a good money belt while traveling. Sleep with your money safe. Be protected from pickpockets. **\$1.00 PREPAID**

Heavy Canvas Handy Bag for Small Tools, Etc., 50c Ideal for tool, school, lunch, tackle, camp, toilet articles, hunting and cartridge bag. Heavy canvas with canvas partition in center. Flap closes with snap fasteners. 10 x 9 x 3 inches. New. **\$0.50 POSTPAID**



IVER JOHNSON SPORTING GOODS COMPANY, 10 Cornhill, BOSTON, MASS.



Truly Portable Does Everything

Costs only $\frac{1}{2}$ to $\frac{1}{4}$ as much!

The Corona Portable Adding Machine, though covering no more desk space than an ordinary letterhead has *all* the desired features of any adding machine made regardless of size or price! Never before has such efficiency been combined with portability, *real portability!*

And the Corona Portable Adding Machine costs only *one-half to one-fourth* as much!

Modern business has long sought a small conveniently proportioned adding machine—one handy, light, compact—one as easily reached for when wanted as the telephone.

And, of course, one speedy, accurate and dependable, and *economical*.

Here it is—in the Corona Portable Adding Machine. Not built merely as a small, light, machine for small businesses, but built for use anywhere and everywhere adding machines are needed. In hundreds of offices from the largest, such as the Chicago Milwaukee & St. Paul Railroad, The Pullman Company, The Equitable Life Assurance Co., the C. B. & Q. Railroad and similar concerns, to the smallest, the Corona Port-

able Adding Machine is daily proving its ability to do *all* the work speedily and accurately.

If you now own a big machine mounted on a stand or too heavy to be moved from desk to desk, fine. Use it for *overflow* work, but give each figure worker a Corona Portable Adding Machine for his own desk. No waiting, no delay, no standing in line for a turn at the adding machine if your office is Corona equipped.

If you do not own an adding machine the Corona is the one you will likely buy once you give it a trial.

The Corona Portable Adding Machine is principally sold and serviced by Corona Typewriter Dealers all over the world. For free demonstration call the Corona dealer in your city or write for name of nearest one.

**Add!
Subtract!
Multiply!
Divide!**

The Corona Portable Adding Machine adds and lists up to **99,999.99**, has Totals and Sub-totals, Non Print, Clear, and Error Keys, Full Flexible Keyboard, Big Bold Type, and, best of all—it is

Portable!

The Corona Portable Adding Machine is small and compact, weighs only 16 pounds yet its simplified, condensed construction makes possible *heavier and stronger* working parts, on the average, than those used in any other machine.

**Guaranteed
Accurate,
Speedy and
Dependable**

Send for Booklet

The remarkable story of the invention and perfection of the Corona Portable Adding Machine together with time saving tables of Decimal Equivalents and Reciprocals sent free without obligation. Send coupon today.

CORONA

PORTABLE ADDING MACHINE

Built by the Corona Typewriter Co.

Portable Adding Machine Sales Co.,
Dept. 1777, 343 South Dearborn St., Chicago, Ill.
Send me, without obligation, free booklet and the tables
of Decimal Equivalents and Reciprocals.

Name.....

Address.....

City..... State.....

Are You a Sportsman?

Help the Boys and Yourself

Study this Picture by Everett Lowry

Pollution of our streams is only one of many out-of-door destroyers the League is fighting. We are pledged to restore our outdoor resources to our boys.

The League's platform includes the practice of true sportsmanship, preservation of our forests, establishment of adequate state and national game and fish refuges, sufficient fish hatcheries and game farms, prohibition of the sale of game, and of game fish—in fact, every activity for the conservation of our great out-of-doors, as well as conceiving and instigating proper conservation legislation, both state and national.



The Izaak Walton League of America

is an organization of sportsmen and outdoor lovers, banded together to restore our national resources and protect those few that are left us.

It has nearly 2000 chapters and 150,000 members, and has no political or religious affiliations, and is not operated for profit or gain.

You cannot look at this picture and read the program of the League without wanting to help.

Help Today

Subscribe TODAY to the League's magazine, **OUTDOOR AMERICA**, Greatest and Biggest Outdoor magazine in the world.

Stories, Articles and Pictures every month by the world's leading writers and artists.

ONLY \$1.00 PER YEAR

Sign and mail the coupon with
\$1.00 TODAY

IZAAK WALTON LEAGUE,
536 Lake Shore Drive,
CHICAGO, ILLINOIS

Gentlemen: Enclosed find \$1.00 for one year's subscription to **OUTDOOR AMERICA**.

Name.....

Address.....

City.....

State.....



Crosley
2 Tube 51 S. D.
Mahogany finished
cabinet holds all
batteries.....\$23.50



Crosley Pup
A genuine long range
receiving set....\$9.75

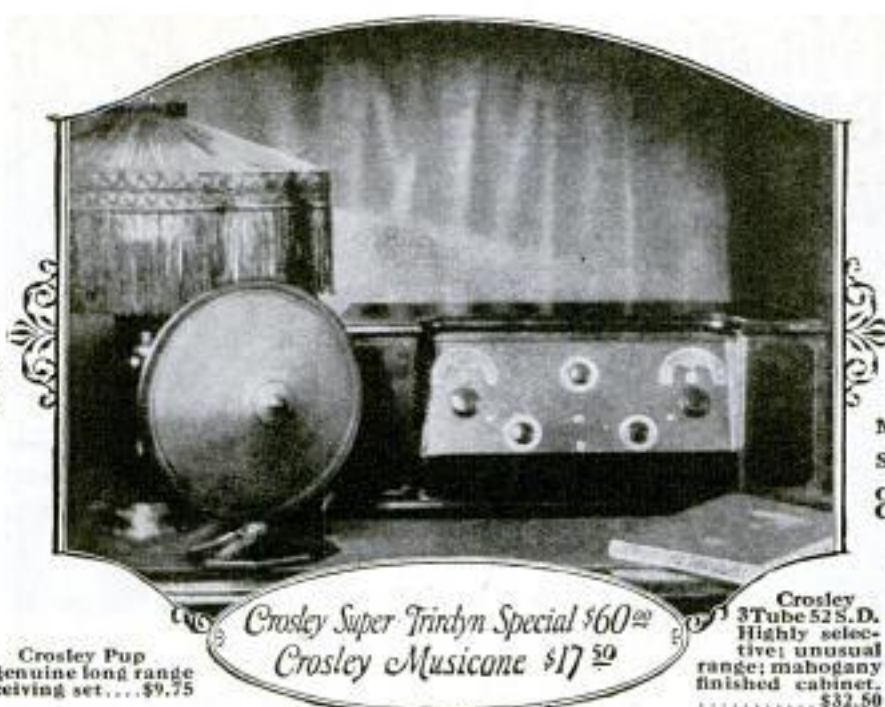

Crosley Super Trirdyn Special \$60.00
Crosley Musicone \$17.50



Crosley De Luxe
Combination
Musicone De
Luxe.....\$ 27.50
Super-Trirdyn
Special..... 60.00
Console Table 25.00
Complete.... 112.50



Crosley
3 Tube 52 S. D.
Highly selec-
tive; unusual
range; mahogany
finished cabinet.
.....\$32.50

Better Results from 3 Tubes than from 5

Instead of passing the incoming signal once through each of 5 tubes, Crosley design, in the Super-Trirdyn, passes it through two of the three tubes several times, each time building up its strength and adding to its volume.

Even the technically uninitiated can see the advantages: simplicity instead of complexity; fewer dials to adjust; sharper accuracy in selecting stations; greater clarity; greater volume; greater ease in logging stations.

This simplicity of design combined with the economies of gigantic production makes possible a price of \$60.00 on the Super-Trirdyn Spe-

cial, the most efficient and beautiful of all Crosley receiving sets. For Crosley is the world's largest builder of radio sets—owning and operating parts factories, cabinet woodworking and assembly plants.

Listen to a Crosley Super-Trirdyn under the most exacting conditions and you will understand why it represents a genuine achievement in radio performance and value which all America was quick to recognize and reward with increasing sales.

Write for an illustrated catalogue of the complete Crosley line or see them at your Crosley dealer's. Authorized sales and service stations everywhere.

Crosley manufactures receiving sets which are licensed under Armstrong U. S. patent No. 1,113,149 and priced from \$9.75 to \$60.00 without accessories.

Add 10% to all prices West of Rocky Mountains. Crosley owns and operates WLW first remote control super-power broadcasting station.

CROSLEY · RADIO

B E T T E R · C O S T S L E S S

THE CROSLEY RADIO CORPORATION, CINCINNATI, OHIO

New Self-Massaging Belt REDUCES WAIST -Easily!

Substitutes good, solid tissue for bulky, useless, distorting fat, yet does it so gently you hardly know it is there.

Formerly those who wished to reduce without dieting or strenuous exercise had to go to a professional masseur. His method brought about the desired reduction. But it was expensive and time-consuming, and few could take advantage of it.

Remarkable New Invention

At last a wonderful new invention brings this same effective method within the reach of all. The Well Scientific Reducing Belt by means of specially prepared and scientifically fitted rubber is so constructed that as you wear it every breath you take and every movement you make imparts a constant massage to every inch of the abdomen. Working for you every second, it reduces much more rapidly than ordinary massage, saving both time and money.

Actually Removes Fat

It does not merely draw in your waist and make you appear thinner. It actually takes off the fat. Within a few weeks you find 4 to 6 inches gone from your waistline. You look and feel 10 to 15 years younger.

The Well Method of reduction is used by athletes and jockeys because it reduces quickly and preserves their strength. Highly endorsed by physicians. Satisfaction guaranteed or your money back.

SPECIAL TRIAL OFFER

Write today for full description and Special 10-Day Trial Offer. The Well Company, 910 Hill Street, New Haven, Conn.

THE WEIL COMPANY, 910 HILL ST., New Haven, Conn.

Gentlemen: Please send me, without obligation, complete description of the Well Scientific Reducing Belt and your special 10-Day Trial Offer.

Name.....

Address.....

City..... State.....

NEW MARVELOUS ONE-MINUTE CAMERA

Takes and finishes pictures inside the camera in one minute. Agents wanted, Exclusive Territory. Make money selling these wonderful cameras of taking photos or both. Six different models. Photos 4x6, 5x4 1/2, 2 1/2x3 1/2, 2x3 and 1 1/2x2 1/4 inches. No experience necessary. Any one can operate these cameras. Write today for special offer.

CROWN MINUTE CAMERA COMPANY, Dept. 940, NORWALK, CONN.

FORD RUNS 57 MILES ON GALLON OF GAS

Other Cars Show Big Gains



This Automatic and Self-regulating device has made automobiles run from 35 to 57 miles on a gallon of gasoline. It removes carbon, prevents spark plug trouble and overheating. Saves cost in few days driving. Keeps away big repair bills. Try it 30 days at our risk.

AGENTS WANTED

Agents are offered up to 300 per cent on every sale. If you want to earn \$250 to \$500 per month send for full particulars today. Just send your name and address to

J. A. STRANSKY MFG. CO.

Dept. M-10, 100 N. Main Street, Pukwana, S. D.



Send
Only

10¢

**For This Latest Model Imported
Jewelled Movement Watch
Runs 8 Days with One Winding
20 Year Guarantee**

Only a down payment of 10c required and we make immediate shipment of this beautiful and serviceable watch.

**WE TRUST YOU
Shipment Same Day
No References Needed**

Elsewhere you would probably be required to pay upwards of \$16 for a full-jewelled open face 8 Day watch of this quality. Our price reduced to \$12 and you may pay it \$1 per week.

Make first payment only to postman when he delivers package.

Send name and address at once. Our money back and 20 year guarantee protect you.

P. J. Deelite Co., 530 Broadway, New York

RADIO SET FREE STUBE



AND \$100 A WEEK JUST
SHOWING IT TO FRIENDS

The Ambo Institute has perfected the finest 5 tube set ever made. Outperforms all others and sells for half store prices. We need men to represent us in every territory and will give demonstrator set free when you have taken six orders from your friends.

READ! Your set is certainly a wow! It performs better than any I've heard. Took orders for it in nights. My profit \$212. Can sell 10 more this season easy. I'm out for a big profit.

H. MASON
Michigan

Coast to Coast Reception. More distance, better selectivity, easier tuning, perfect rich reception of great voices. Big demand in your territory. **All Waves, 40-600 Meters.** Ordinary sets cannot go below 200. Famous Ambo Five gets all stations, local and foreign, 40 to 600 meters. **FREE** of set. You can make \$100 to \$200 a week just showing free demonstrator. Lead you up in Radio business and give you set free. Write quick for information. Postcard will do.

FRANK CONDON, Dept. 29M, 2632 Prairie Ave., Chicago, Ill.



BIG VALUE FOR 10 CTS.

6 songs, words and music; 25 Pictures Pretty Girls; 40 Ways to Make Money; 1 Joke Book; 1 Book on Love; 1 Magic Book; 1 Book Letter Writing; 1 Dream Book and Fortune Teller; 1 Cook Book; 1 Base Ball Book, gives rules for games; 1 Toy Maker Book; Language of Flowers; 1 Morse Telegraph Alphabet; 12 Chemical Experiments; Magic Age Table; Great North Pole Game; 100 Conundrums; 3 Puzzles; 12 Games; 30 Verses for Autograph Albums. All the above by mail for 10 cents, and 2 cents postage.

ROYAL SALES CO., Desk 104, Norwalk, Conn.

Floor Surfacing Pays Big Profits



THIS MACHINE EARNS YOU

\$25⁰⁰
Per Day

Young men, middle aged men, and older men whom we started in the Floor Surfacing business with American Universal Floor Surfacing Machines make from \$25.00 to \$40.00 and more per day and get all the business they can handle.

They are men from factory, store and office jobs who saw only endless drudgery ahead for them as wage earners. They wanted a chance to "get somewhere," to make real money, to be their own bosses and to build a future for themselves and their families. They saw that chance in the Floor Surfacing game and grabbed it. Most of them were "greenhorns" at this business, but they had ambition, energy and good sound "horse-sense," and that is all any man needs to succeed as an American Universal Floor Surfacing contractor.

Every New Floor Must Be Surfaced Every Old Floor Needs Resurfacing

There is surfacing work to be done in every new and old business or residence building in your town. Think man, what that means! Have you energy and "get-up" enough to go out and get the business that is waiting for you on every hand?

Would you don a pair of overalls and guide an electrically driven American Universal Floor Surfacing Machine over a floor for \$25.00 to \$40.00 a day, until you can build up enough business to hire others to do the work for you? If you can and will do so we can help you get into a business that is not overcrowded, that is easy to manage and operate, easy to build and enlarge; a business that

requires very little capital, almost no operating expense and one that can be made to pay big, handsome profits from the very first day you start. No town or community is too small. We can show you successful floor surfacing contractors in villages of 100 people.

No Experience Necessary

Any intelligent man can learn to operate the electrically driven American Universal Floor Surfacing Machine in half an hour, and with a few days' practice, can actually do the work of six men scraping by hand. And with the American Universal you can do better, smoother and more uniform and beautiful work than any man living could ever do by hand.

Write Now for Particulars. Send your name and address to us today with just a note saying, "Tell me how I can get into the floor surfacing business." We'll send you full information about the wonderful opportunity open to you. We'll tell you all about the American Universal Machine, what it does, how it works, what it costs, and give you letters, facts and figures that will cause you to do some tall thinking. Do it right now before you lay this book aside.

The American Floor Surfacing Machine Co. 523 S. St. Clair Street
TOLEDO, OHIO

MOTOR BARGAINS



\$13⁵⁰

for this big

guaranteed

1/4 H. P.

110 Volt

AC Motor

Has many exclusive features. We guarantee to satisfy or return your money.

Grinder and Buffer, \$20

6" and 7" wheels, fan-cooled motor, dust-proof. Send cash with order. Guaranteed to give satisfaction or money refunded (less return charges).

Write for dealers' and quantity discounts.

Northwestern Electric Co.
410-420 S. Hoyne Avenue, Chicago

A new Parks!

Cabinet Shop
Special No. 7

\$250

as illustrated
with motor



The Most Popular Machine Parks Ever Built!

A winner from the start. A real machine, yet convenient size for the small shop. Does everything in woodworking. Has circular rip and cut-off saw, 6 inch jointer, 16 inch bandsaw. Lathe and shaper attached if desired at small cost. Operates from any light socket. Just plug in and go to work! Write for interesting circular.

The Parks Ball Bearing Machine Co.
1500-1540 Knowlton Street, Cincinnati, Ohio
Canadian Factory: 200 Notre Dame East, Montreal, Can.

PARKS
WOODWORKING MACHINES

BLUE WHITE DIAMONDS

12 Months To Pay



No. 956—Price \$38.00
\$2 Down and \$3 a Month

This blazing, blue-white diamond, sparkling with the colors of the rainbow, has every appearance of costing at least \$60. It is set in an attractive, engraved 18 KT. SOLID WHITE GOLD mounting. Two blue sapphires are set in the shanks. Guaranteed to stand any test.

No Red Tape

Free Trial

SEND NO MONEY Pay only \$2.00 to postman after you get this ring. If you keep it, pay only \$3.00 a month for 12 months. If you return it within 10 days we will return your money—every cent.

PRICE CUT TO \$38: WORTH \$60 You now can buy this gorgeous ring at the wholesale price. Compare it with similar rings at \$60.00. We guarantee it to stand any test or comparison. It is the greatest bargain ever offered by any Diamond Importer. We will give you 5% more than you paid for it when you exchange for a larger diamond ring.

FREE Every customer who answers this advertisement will get a \$7.50 value premium as a gift from us. Thousands of bargains at our own risk in this very interesting book.

Write for Catalog

STERLING DIAMOND & WATCH CO.

(Diamond Importers—\$1,000,000 Stock—Established 1879)
1540 Broadway Dept. 1996P New York, N. Y.



5000 WANTED 5000 AT ONCE

Agencies—Salesmen—Agents

\$250.00 to \$500.00 a week selling our new invention household Steel Burglar-Proof Door locks devices. Requires no tool to operate, no defacing of doors. Renders service on all doors; with a guaranteed un-pickable service on your door when you retire at night. Mail a \$1.00 Money Order for yours today. Agents wanted everywhere. Exclusive Territory. Big Commissions. Write

JOHN H. BATES LOCK CO.
Del. A. 6 E. 33rd St., Chicago, Ill.

DONT BURN COAL

use cheap oil

New remarkable invention does away with coal or wood and saves money, time and labor. Simply sets in firebox of any range, heating stove or furnace. Most economical and lowest priced Oil Burner on market. Burns 90% air, 4% cheap oil and gives three times the heat of coal. Easy to install and operate. Absolutely safe. No noise, dirt or odor. Sold on money-back guarantee, 30 days free trial and special low price to first user in each locality. Write for free book on Home Heating. Agents: Write for sample offer and protected territory.



OKAY MFG. CO., Dept. 174 East St. Louis, Ill.

STOP! BUYING RAZOR BLADES



SEND NO MONEY!

JIFFY Safety-Blade Stropper

makes old blades keen as new. Improves new ones. Easy to use. Outfit includes handle for all blades, double horsehide strop, large tube. Jiffy Strop-dressing. Send no money—just name and address. On delivery, pay postman \$1.00 and postage. Money back if not all we claim. Order today! **AGENTS WANTED!**
C. A. Bissman Strop Co., 3738 S. Spring Ave., St. Louis, Mo.

BIG NOVELTY BARGAIN! 10c



Throw Your VOICE

Into a trunk, under the bed or anywhere. Lots of Fun fooling the Teacher, Policeman or Friends. Barrels of Fun.

THE VENTRILO—

a little instrument—fits in the mouth out of sight, used with above for Bird Calls, etc. Sent with full instructions; anyone can use it. NEVER FAILS. Also a 32-PAGE BOOK ON VENTRIL-QUIESM. Permits for Secret Writing, 12 Money Making Secrets and the marvelous.



NOVELTY X-RAY WONDER

With it you can apparently see the bones in your fingers, lead in pencil, etc.; lots of fun with this outfit. Also 10 Big Magic Tricks Free with every order. All the above Novelties 10c by prepaid mail for



VENTRILO COMPANY
Dept. 300 Norwalk, Conn.

LARGEST and OLDEST Mail Order House in Connecticut

Sent On
FREE TRIAL NO MONEY DOWN

Just Name and Address Brings You This Liberal Offer.

DON'T send a penny! Your name and address brings to your home this wonderful New Model Aladdin Lamp for ten days **FREE** Trial absolutely at our risk. Amazingly powerful, steady, white light from common kerosene (coal-oil); no odor, no noise, smoke or sputtering. Simple, safe, clean, easy to handle; no pumping up, no pressure.

BEATS ELECTRIC OR GAS — Burns 50 Hours on One Gallon

Think of It! This wonderful new Aladdin light beats electricity or gas at a fraction of a cent an hour. Tests by U. S. Government and 35 leading universities show Aladdin light is ten times as strong as light from ordinary kerosene lamps. Five times as efficient as the best round wick open flame kerosene lamp. Soon saves its cost. Light nearest to sunlight of all artificial lights. Over seven million satisfied users. Your simple request brings you full particulars of our liberal 10 day Free trial offer, and how you can secure one without cost. Write Quick.



TWICE THE LIGHT ON HALF THE OIL

Agents Wanted!

Make \$200 to \$500 a Month
Become our distributor for this light that sells on sight. Needed and wanted everywhere. Big waiting demand. No capital or experience necessary. Get details quick of this most unusual big-money opportunity for either men or women—space or full time.

Get Your's FREE

MANTLE LAMP CO., 300 Aladdin Bldg., Chicago, Illinois

Largest Kerosene (coal-oil) Mantle Lamp House in the World.

Only \$97⁵ Brings you
This Beautiful
American Professional
Trumpet Outfit!



Then a few small monthly payments—it's yours. Rich, Flexible, penetrating in tone. Lines graceful and symmetrical. Valve action, particularly easy. Triple silver-plated with inside of bell gold-plated, hand-burnished. Complete with luxurious, seal grain Keratol case, velvet lined. Music holder, mouthpiece, mute, included. Special temporary offer makes low price possible!

Don't delay! Act NOW! Many earning high salaries playing our famous instruments. Write today for complete information. Mention if interested in other instruments.

LYON & HEALY

60-61 Jackson Blvd., Chicago
Agents Wanted



We Want Men

with tough, wiry beards to challenge this

Let us send you free a 10-day tube of this unique shaving cream which softens the toughest beard in one minute!

MEN CLAIM that Palmolive Shaving Cream will soften the toughest beard in one minute. No finger rubbing—equally efficient in hot water or cold, hard water or soft.

That's a broad statement, we'll agree. You may doubt it. But, if true, you want that kind of shaving.

Let us give you a 10-day tube free. Find out for yourself. We believe we'll win you, no matter how firmly you are wedded to a rival preparation.

New Principles

Palmolive Shaving Cream is a newcomer in its field . . . yet, today the leader. Millions of men have quit old ways and adopted this new shaving joy.

Probably 80% of its users were boosters for other makes of cream.

All were won over by the test we now offer you. "Don't buy—yet," we urge you. Put the proof burden on us.

* * *

60 years of soap study stand behind this creation . . . made by the makers of Palmolive Soap. 130 formulas were discarded before we found the right one.

1000 men told us their supreme desires in a shaving cream. Only by great effort did we meet them. New principles were required. New laboratory methods and experiments.

Palmolive Shaving Cream thus is different from any other you have known.

5 New Delights

These you'll find—these new shaving joys, these comforts unknown before.

- 1 Multiplies itself in lather 250 times.
- 2 Softens the beard in one minute.
- 3 Maintains its creamy fullness for 10 minutes on the face.
- 4 Strong bubbles hold the hairs erect for cutting.
- 5 Fine after-effects, due to palm and olive oil content.

10 Shaves Free

Now in fairness to us, and in justice to yourself, clip the coupon before you forget. Find out whether the whole world is wise in changing to a new way in beard softening.

PALMOLIVE SHAVING CREAM

2979

10 SHAVES FREE and a can of Palmolive After Shaving Talc

Simply insert your name and address and mail to
Dept. B-1075, The Palmolive Company (Del. Corp.),
3702 Iron Street, Chicago, Ill.

Residents of Wisconsin should address
The Palmolive Company (Wis. Corp.), Milwaukee, Wis.

SM
SUPER PARTS



NEW SLF CONDENSERS

The smallest and lowest loss straight-line-frequency condensers yet produced—metal parts heavily silver-plated. Prices—Type 310, .0005 \$6.—311, .00035 \$5.75—312, .00025 \$5.50.

S-M ALL WAVE INTERCHANGEABLE COILS

Made as oscillators, antenna adapters, compensated R. F. Transformers, etc., for all waves from 50 to 550 meters—fit type 515 six-contact socket. Price per coil, \$2.50. Type 515 Coil Socket \$1.

See these new S-M parts at your Dealers.

FREE Complete description of McMurdo Silver's latest circuit designs. Write today!

SILVER-MARSHALL, Inc.

110 S. Wabash Ave., Dept. E. CHICAGO



Winners—every one of them! Greater power—greater comfort—greater safety! Many new Improvements! Balloon tires on all models—special easy riding Fork—Adjustable Saddle—Removable Cylinders—these are only a few of the features that go to make 1926 Indians the finest motorcycles ever produced! Here they are.

1926 Indian Chief

The master of the road! Powerful as a bull elephant—comfortable as a soft cushioned sofa—safe as a bicycle! Wonderful for touring! Quick action brakes. Wide Handlebars. Starts almost instantly. Balloon tires. Improved adjustable saddle.

1926 Indian Scout

World's most popular twin solo. The favorite everywhere! Peppy—classy—speedy—powerful! Wider cylinder ribs—removable cylinder heads—extra wide handlebars—powerful brake—adjustable saddle—balloon tires. A sport model De Luxe.

1926 Indian Prince

The Personal Motor. An Engineering Triumph! Stream lines. Safe—comfortable—flexible. Lowest in first cost—lowest in upkeep—easiest to handle. Balloon tires optional! Adjustable saddle. Removable cylinder heads. You can learn to ride it in 5 minutes.

Easy Payments

Send for our Free Catalogue describing the 1926 Indians and telling about our easy payment plan that enables you to pay as you ride.

Indian Motorcycle Co.

Dept. P-10, Springfield, Mass.

Make More Money

with our new Household Cleaning Device. It washes and dries windows, sweeps, cleans walls, scrubs, mops. Complete outfit costs less than brooms. Over half profit to agents.

Write

Harper Brush Works
278 3rd St., Fairfield, Iowa



Put it On Your FORD—Free AND MAKE \$12 PER DAY

Get this marvelous new invention in a radiator water gauge. The JARVIS WATER INDICATOR is handsomely nickel plated, has bright dial with beveled glass windows. Fits on radiator in place of cap. Operates mechanically. Warns driver of low water supply. Also protects engine from over-heating. Best seller on market. \$12 per day in quick profits for spare time only. Big money made by being first in your town to introduce it. Write for Free demonstrator plan today.



W. B. JARVIS CO. Dept. M-40, Grand Rapids, Mich.



Def. U.S. Post Office
Lincoln
RADIO PRODUCTS
Collapsible LOOP AERIALS

Popular Prices—Remarkable Results

No better loops at any price. Quantity production keeps prices low. Handsome, convenient and efficient.

LINCOLN 4-POINT TAPPED LOOP . . . \$8.00
Built for any circuit where it is desired to vary the inductance of the loop. Exceptionally fine for Superhets.

LINCOLN CENTER-TAPPED LOOP . . . \$6.50
For any set employing radio frequency amplification. For certain Superhets requiring a center tap. If your dealer cannot supply you, order direct, giving your dealer's name. Write for illustrated catalog P.M.

LINCOLN RADIO CORPORATION, 224 N. Wells St., Chicago

RADIO LATEST CATALOG OF NEWEST PARTS AND KITS **FREE**
Fresh from the press. Shows all the newest standard parts and kits at big savings. Most complete line in America.
Send name and address, also name of friend. Send at once.
BARAWIK COMPANY, 102-112 So. Canal St. CHICAGO, ILL.

Makes Pumping Up Tires Unnecessary



Line up with big money. The highest "Airlox" Valve Cap is a proven success. Air-tight. Eliminates all troubles due to under-inflation; lasts life of tire. Positive necessity to auto owners. Doubles tire mileage. Tested and approved by leading auto manufacturers. \$100 a week for hustlers. Unlimited demand. No competition.

FREE SAMPLES TO AGENTS
to use and introduce in exclusive territories. Immense uncrowded field. Don't hesitate. Write today for facts and FREE SAMPLES.
AIRLOX RUBBER CO.
2512-14 W. Monroe St., Dept. 605-N, Chicago, Ill.

BOOKS THAT TELL "How to Make Things"

Each book contains dozens of practical plans for things you can easily make yourself, clearly explained, fully illustrated. These books have not only been written by practical men, each successful in his line, but they have been tested by thousands of customers who have had success with them. That, after all, is the best assurance that you, too, may benefit from their use. Select those titles that interest you from the following list:

A Practical Course in Mechanical Drawing
Metal Work and Etching
Pattern Making
Mission Furniture Part 1
Mission Furniture Part 2
Mission Furniture Part 3
Arts-Crafts Lamps
Farmer's Handbook
Wood Working for Amateur Craftsmen
Lamps and Shades in Metal and Art Glass

**Take Your
Choice
98c
EACH**

No matter what your age, or what your interests, some of these books will be a profit to you. They are written so you can understand it. Any boy can use them. Some are of special interest to women and girls. The price is unusually low. Order several at once.

Send No Money Simply write the names of the books you want on a postal and mail.

Pay the postman the special price and the few cents postage when he hands you the books.

Any one book, 98c
Two books, \$1.95

Three books, \$2.89
Five books, 4.75

POPULAR MECHANICS PRESS
Popular Mechanics Bldg. Room 707 CHICAGO, ILL.



You Can Make Your Own ELECTRIC LAMPS

If you have the simple instructions in our two lamp making books. Many pictures. Tell how to make portable, chandelier, dining room dome, reading, den lantern, drop light, one-light bracket, piano, desk, library, and many other attractive lamps. All patterns simple and easy to make.

Send No Money. Just write a postal and ask for "The Two Lamp Books." When postman hands you books, pay postage and \$1.98.

Popular Mechanics Press, Room 710, 200 E. Ontario St., Chicago, Ill.

EVERYBODY'S HANDBOOK of Electrical Kinks

This is a brand new book similar to Popular Mechanics other "kink" books. It is made up of 214 ideas and short cuts for doing electrical work of all kinds. It is a book for amateurs as well as professional electricians. If you are interested in wiring, electric lighting, the making of electrical devices, experimenting, repair work, battery manufacture and repair, or telephones, you will find many helpful articles in this book. If you are interested in radio, you should have this book to learn some of the short cuts used by electricians in wiring and making apparatus.

THE BOOK CONTAINS

47 ideas on wiring	11 ideas on switches
45 ideas for making electrical devices	6 ideas on installation
19 ideas on electric light's	22 ideas on testing
5 ideas on transformers	12 ideas on repairing
5 ideas on motors	11 ideas on battery manufacture and repair
5 ideas on generators	5 ideas on telephones

There are 162 Pictures to make the ideas clear. Boys can follow the directions as well as men. If you understand the simple fundamental principles of electricity, this book will be a wonderful help to you.

Send No Money Just write your name and address on a postal card and say that you want the New book of Electrical Kinks. When the postman hands you the book, hand him \$1.50 and the few cents postage. If you live outside the U. S. or do not expect to be at home when the postman calls, send the \$1.50 with your order. Address

POPULAR MECHANICS PRESS Room 707 Popular Mechanics Bldg. 200 E. Ontario St., Chicago

Introductory Offer! "Bearcat" Hand Brush

For Bare-Hand Workers in Home or Shop

**How to
Get One FREE!**

We make this remarkable FREE OFFER to quickly introduce "Bearcat"—the most businesslike, handy and ingenious Hand Brush invention ever known. *It's revolutionary!* As a quick, easy dirt, grease and grime go-getter, it's a "Bearcat" and no mistake. Made of horse hair firmly twisted in wire. Works like lightning. Easy on the hands! Fits palm of hand like a cake of soap *and it bristles with hair all over.* No other brush on the market works on *both hands at once.*

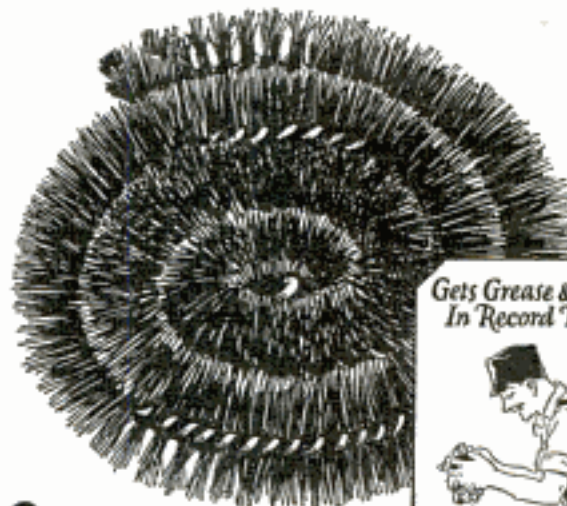

*Gets Grease & Grime
In Record Time!*



Our FREE Brush Offer

To quickly get the "Bearcat" into the hands of actual users, we make this liberal offer. Send \$1.00 for two "Bearcats" at the regular price of 50 cents each and we will include *one "Bearcat" Brush FREE*, with our compliments. The minute your fellow-workers see you using the "Bearcat," the other two brushes are sold!

A Big Money-Maker

This new Hand Brush invention meets the needs of millions of men in all lines of industry—mechanics, machinists, shopmen, foundrymen, farmers, garage men—yes and housewives, too!

We want "Bearcat" representatives in every locality for this fast-selling, popular priced brush.

Send TODAY! Take advantage of our FREE BRUSH OFFER and get our wonderful proposition to "Bearcat" salesmen. This special Introductory Offer is limited—slip \$1.00 in the mail today and see the "Bearcat" perform.

NORTH RIDGE BRUSH COMPANY, INC.
DEPT. D FREEPORT, ILLINOIS



DX TUNING EASY WITH THIS DIAL

Beautify your set and simplify tuning with the B-T Tuning Controls. Smooth, easy action. Readings in dial numbers, wave lengths or call letters. Works with both right and left turning instruments.

No strain or pull on the condenser shaft to impair condenser bearings.

Remember, the B-T Tuning Control is beautiful as well as efficient. **\$2.50**

B-T Tandem Condensers—One Dial in Place of Two

All the high efficiency that has made the B-T "Lifetime" Condenser the choice of the radio world—now available in tandem.

Two condensers that work from a single dial with close balance, secured by the typically sensible B-T "Trimmer" arrangement.



Price: LD-13, .00025.....\$9.00
LD-17, .00035..... 9.50

The latest and best in radio is accurately portrayed in the B-T magazine, "BETTER TUNING." Read about "Straight Line Frequency Condensers," their advantage and disadvantages and other up-to-the-minute articles. 10c per copy. 50c per year. Issued bi-monthly.

BREMER-TULLY MFG. CO.

532 S. Canal St.

CHICAGO, ILL.



Keep Your Shirt Down—Pants Up

Loosen up your belt, take in a man's size breath, stop yanking your trousers, be comfortable, by using our simplified, invisible, tiny, aluminum HIP-SUSPENDERS. Grip shirt seams and stays put—will not tear. Sells on sight. Thousands endorsing; dealers stocking. Enormous seller for pitchmen, agents, demonstrators. Single pair, 50c; agents' special, 3 pair, \$1.00; dozen, \$3.00; 6 dozen, \$16.50; gross, \$28.80. St. Louis Hip-Suspender Co., 2339 N. 9th St., St. Louis, Mo.

FOUNTAIN RULING PEN ONLY \$5.00



Fill it like your regular writing fountain pen—no more mussy ink bottle and quill when you own the Bauer Pen—makes any width line—simple to adjust—has end cap like other fountain pens—carry yours in your pocket—A BIG TIME SAVER.

Special Introductory Price \$5.00

Send for your pen now—use it ten days—if not satisfactory return it and we will refund price.

BAUER SUPPLY CO.

Dept. 28-A

2709 N. 22nd St.

St. Louis, Mo.

ARMY COMPASSES

At a Bargain Price Worth \$5

Genuine U.S. Army Engineer Pocket Compasses. 2" diameter. Jewel bearing. Illuminated needle for night use.

GUARANTEED NEW AND PERFECT

ONLY \$1.35 Post Paid ORDER NOW



Supply is limited. We are closing out all our army goods at sacrifice prices. Get our list. These compasses, secured from Engineer's Corps, are representative of the big bargains we offer.

MICHIGAN TENT & AWNING CO., Mail Order Dept.
1753 Lysander Street Detroit, Michigan

AUTO OPEN A STORE RADIO

Make \$300 to \$500 a Month

Open and own a profitable chain store right in your home town under a tried and proved plan. Be one of large chain now distributing standard radio and auto supplies. Profitable all-year business—no dull months.

Large Corporation furnishes everything including complete advertising equipment. No experience necessary because easily learned; chain store systems furnished free. You can do a large business with small capital—\$750 to \$1500 and easily make \$300.00 to \$500.00 or more profit per month. If you are ambitious to get into business for yourself, write at once.

UNITED AUTORAD SYSTEM
74 East 18th Street, Chicago, Illinois



RADIO "MIDGET" CONNECTORS

for quick and easy connection of wires in assembling sets, or connecting phones in series. Screws hold wire tight; no soldering. Fans buy them by dozen @ \$1.00 or three samples 25c post paid. ILLINOIS RADIO CO., 800 S. 4th St., Springfield, Ill.

POPULAR MECHANICS LATHE HANDBOOK NO. 1



POPULAR MECHANICS PRESS

259 Discoveries For Lathe Operators

This book contains the experiences of 106 successful operators in the U. S. and in the principal foreign manufacturing countries. 83 articles tell how to make special lathe tools and attachments. 33 on gauges and indicators. 23 on special devices for holding work. 9 special lathe centers. 29 on how to do unusual jobs. 28 on boring and drilling. 11 on thread cutting.

212 Illustrations The pictures make it easy for a beginner. Every article is written so anyone can understand it, and every link has been thoroughly tested.

Send No Money Just write a postal. Popular Mechanics Lathe Handbook and Drilling and Thread Cutting Handbook will be sent C. O. D. Pay postage and 20c for the 2 books. **POPULAR MECHANICS PRESS**
Room 10, Popular Mechanics Building, Chicago, Ill.



HB ONE DAY BATTERY CHARGING SERVICE PAYS \$150 to \$300 MONTHLY PROFITS

You can earn a lot more money in your shop with **One Day Battery Charging**. Tire shops, radio stores, accessory dealers have added **\$150 to \$300 monthly to their profits** with One Day Charging Service. **Big money—no experience needed.** Only \$35 cash puts complete HB One Day Charging outfit in your shop. Long easy terms let your profits quickly pay balance. **30 days free trial on moneyback guarantee.** Write for free bulletin 100.

HOBART BROS. CO. Box M10, TROY, OHIO

NOW ONLY \$35 PUTS THIS MONEY MAKING SERVICE IN YOUR SHOP



Make Your Ford Ride Like a Pullman



Remove the shocks and shakes of ruts and bumps and uneven roads. Your Ford will roll along over any road as tho it were a boulevard when equipped with

EDWARDS

Shock Rebound Absorbers

Scientifically designed and built to give the benefit of opposing action of double coil springs,—the only principle which successfully accomplishes the desired result. The outside spring absorbs the shocks; the inside spring smoothes the rebound. Direct suspension permits free and easy action of leaf spring, as designed by Ford engineers. No extra strain on any part of car. Eliminates vibration. Makes car run smoothly.

Quickly and Easily Attached: No holes to drill,—nothing to change from present Ford design. No special tools required.

Dealers and Agents Wanted

Dealers and Agents wanted in every community to demonstrate and sell this wonderful accessory. Get a set for your car today;—show them to your neighbors and they'll want them. Write today for full particulars and special sales proposition to Dealer-Agents. **THE EDWARDS BROS. CO., 510 Main St., Leipsic, Ohio**

Price \$19.75

Per set
Special Discount
to Dealers and
Agents

FREE Diagram, Templates, Instructions for building Calcaterra's 5 tube Tuned **RADIO FREQUENCY** Set for \$55
Write **KELLOGG SWITCHBOARD & SUPPLY CO., Chicago, Illinois**

Save Money on New or Used Auto Parts!

15 years of progress has made our stock of new and used accessories and replacement parts the largest in the world. We can furnish you with anything from a Cotter-Pin to a complete Power Plant.

FREE! CATALOG
of Parts Both

NEW AND USED

The most complete catalog ever issued. Check full of bargains. Save 30% to 80% on your purchases. Buy from Warshawsky. Every item guaranteed to be just as represented.

WRITE TODAY
SURE!

A FEW SPECIAL BARGAINS IN NEW REPLACEMENT PARTS

Prices quoted are F. O. B. Chicago

Ford Cylinder Heads, New, \$3.75

Ford Cylinder Blocks, New, Complete with rings, wrist pins, pistons, bushings, \$20.00

Ford Counter Balance Crank Shafts, A \$10.00 value, \$12.50

Ford Triple Seal Pistons, New, Up to .005 oversize, Complete with wrist pins and bushings, Per set, \$5.00

Ford Gas Savers, New, 2-in. manifold, \$3.50 value, \$1.00

Ford Water Pump, New, \$2.50

Genuine Chevrolet Pistons, New, Up to .005 oversize, \$1.00

Nu-Life Ring Expanders, 5c

Miles Piston Rings, New, 40c

All sizes. A \$1.25 value, . . .

WARSHAWSKY & CO.

"World's Largest Car Wreckers and Replacement Parts House."

No Branches 1915 So. State St., Dept. P. M. 10 Chicago, Ill. No Branches

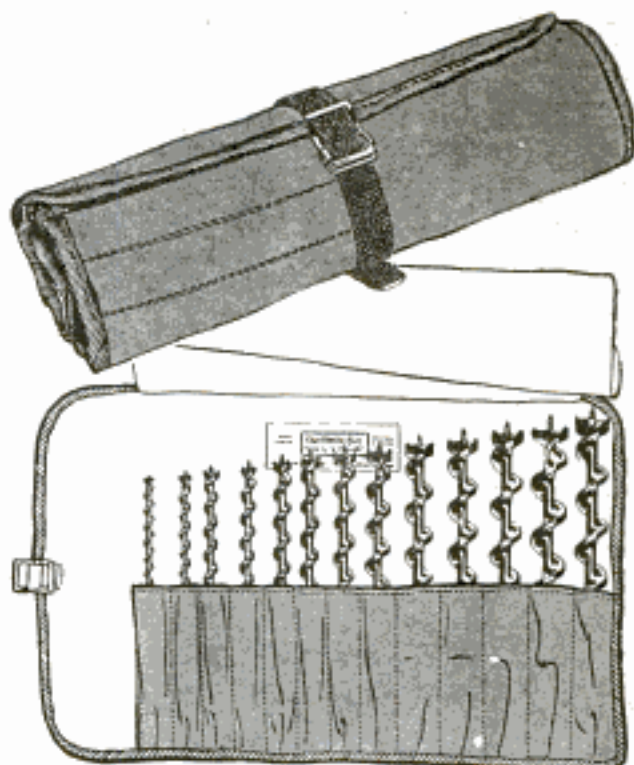

Some Prefer The Borkit For Their Irwin Bit Set

Men who use tools appreciate the wonderful convenience added to any tool chest—by a complete set of Irwin Auger Bits. There is a set to fit every boring need. The name Irwin on a set assures you that you have the finest of woodboring tools.

The Borkit is a set container of Irwin design, made of eight-ounce, double filled, slate colored duck, lined with non-tarnishable flannel. Its compact size, convenience and the protection that it affords the bits have made it a very popular set container.

Ask your hardware dealer to show you Irwin Auger Bits in sets. If he should not handle them send us his name and in return we will send you an interesting booklet on the use, care and selection of bits.

Irwin Home Set, 6 bits - - \$3.50
Irwin Handy Set, 10 bits - - 5.50
Irwin Carpenter Set, 13 bits - 7.25

THE IRWIN AUGER BIT CO.
Wilmington, Ohio

Hardware dealers everywhere sell genuine Irwin Auger Bits. The Irwin mark shown below is stamped on the shank of every Genuine Irwin Bit.

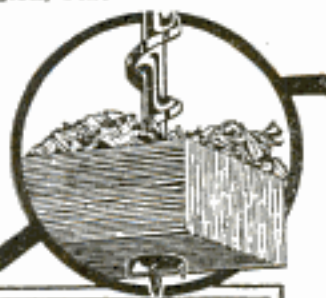

The IRWIN Bit

REG. U.S. PAT. OFF.



"ATKINS"

Always Means Quicker,
Easier Metal Cutting!

YOU—whenever and wherever you cut metal—can save time and money by using genuine Atkins "Tungsten Alloy" Hack Saw Blades.

The Atkins Hack Saw Chart—free—tells the right Atkins blade for every metal cutting job, to save you time, money and material.

The name ATKINS on the blade means the highest grade "Tungsten Alloy" steels chosen by the great Atkins laboratories, tempered by the exclusive Atkins gas-and-oil process, "file tested" to prevent breakage and insure extra life and value.

Ask YOUR Hardware Dealer for genuine ATKINS "Tungsten Alloy AAA" Hack Saw Blades, "All Hard" or "Non-Breakable." We'll gladly send you the Atkins Hack Saw Chart and our valuable booklet "Atkins Saws In The Shop."

E. C. ATKINS & CO. Est. 1857
Dept. P INDIANAPOLIS, U. S. A.

*Leading Manufacturers of Saws, Saw Tools,
Saw Specialties and Machine Knives*

ATKINS

TUNGSTEN SAWS

ALLOY



You Need This Handy Tool!

The new P. D. Q. Wrench with the non-skid grip is the handiest tool money can buy. It grips any bolt, pipe or nut up to 1 1/4 in. with lightning speed and once it takes hold it cannot slip. Requires no adjustments, is practically non-breakable and has a thousand and one uses. Send \$1.00 direct to the factory, on money-back guarantee.

P. D. Q. Wrench Co.
Three Rivers, Mich. 12

PRICE
Only \$1.00

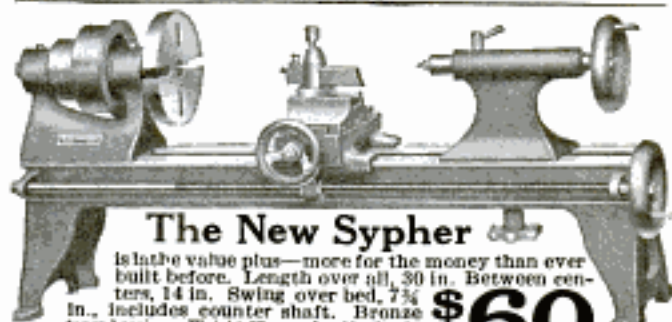

The New Sypher

Is the value plus—more for the money than ever built before. Length over all, 30 in. Between centers, 14 in. Swing over bed, 7 3/4 in. Includes counter shaft. Bronze taper bearings. Weight 60 pounds. Absolutely accurate. A real job. Write today for circular.

\$60

The Sypher Mfg. Co. Dept. D Toledo, Ohio



The Famous KON-VER-TER SLIDE RULE

Instantly adds, subtracts, divides, multiplies, converts fractions or decimals of an inch. Gives sines, co-sines, versed sines, co-versed sines, tangents, co-tangents, secants, co-secants of angles directly. Gives square roots, squares, cube roots, cubes and fifth roots and powers of all numbers. Logarithms, co-logarithms, anti-logarithms. Instructions with rule. De-Luxe Model \$5. Cash or C. O. D.

NEW ENGLAND NOVELTY CO.
Dept. A. WAKEFIELD, MASS.



PILLIOD Tool Cases Excel

Machinists, Tool Makers and Carpenters find them most satisfactory in construction, appearance, service and price. Immediate shipment.

Booklet describing 20 styles on request.

THE PILLIOD LUMBER CO.
Dept. 1 Swanton, Ohio

New Cutter Bar on Shaw Tractor

Read about it on page 416 Sept. Popular Mechanics. The Shaw mows grasses, woods, lawns. Plows, cultivates, runs belt machinery. Fine for truck gardens, estates. Write

Shaw Mfg. Co., Dept. P-10, Galesburg, Kansas



Circulars
Free

KEDS—the athletic shoes worn by champions in every sport. Made only by the United States Rubber Company.



REDDING & COMPANY
(Est. 1859) 9 West 23 St., N. Y. C.

Masonic Books, Monitors, Bibles,
Jewelry, and Lodge Supplies

Send for catalogue of Books and Jewelry; catalogue of Lodge Supplies. No obligations. Mail orders promptly filled.

A Striking and Conclusive
Test of the Steel in
NICHOLSON
Files



TWENTY-FIVE years ago, an Osage Indian in Oklahoma made this razor from a NICHOLSON File of regular stock—the braves using it to shave around the scalp lock.

Now, from the South, a man sends samples of superior quality razors he is making from NICHOLSON Files.

Incidents like these, twenty-five years apart, prove conclusively that year in, year out, only the best file steel is used in NICHOLSON Files.

For shop or home, there is a NICHOLSON File for every need. Your hardware dealer will gladly help you select those best suited for your purposes.

NICHOLSON FILE CO.
PROVIDENCE, R.I., U.S.A.

NICHOLSON FILES ~ a File for Every Purpose

Hand Forged Razor Steel Blades, No. 57

A GENUINE \$2 KNIFE FOR \$1.18 POSTPAID

Direct at Factory Prices

This \$2 KNIFE \$1.18 Postpaid

Hand Forged Razor Steel Blades Handy shaped Blade makes this knife best for mechanics, sportsmen and farmers; light but strong; re-sharpened easily. Stag handle. German silver finish; blades file tested, hand forged from razor steel and warranted.

Sample \$1.18 3 for \$3.00 Postpaid.

Send for our 100-page List and "HOW TO USE A RAZOR" **FREE**

MAHER & GROSH CO., 106 A St., Toledo, Ohio

Information on any book free. Write Popular Mechanics Press, Chicago, Ill.

FREE BARGAIN CATALOGUE, WATCHES, JEWELRY, RADIO SETS, CAMERAS, ETC. ADDRESS Louisiana Distributing Service, Harmon, Louisiana

Buy Now Pay Later! Get Boice Prices Before You Buy!

As the world's largest builders of small bench machines, Boice offers greater values at lower prices with a positive money-back guarantee. Whatever you build, there's a Boice-Crane bench machine to do your work; Circular Saws, Band Saws, Lathes, Jointers and Drills. Write for literature, prices and the Boice "E-Z Pay" Plan before you buy.

14" Band Saw

Table 12"x14", tilts full 45 degrees. Saws 7" stock. Uses blades $\frac{3}{16}$ " to $\frac{1}{2}$ " wide.

Highest quality bronze bushings throughout. Driven by any $\frac{1}{4}$ or $\frac{1}{2}$ H. P. motor. Attached to light socket. Sold with or without motor. Tight and loose pulleys supplied for line shaft drive.



8" Bench Lathe

Turns wood and soft metal. Swings 8" maximum over bed. Capacity 20" between centers. Headstock integral with heavy cast iron bed. 3-step cone pulley for $\frac{1}{2}$ " flat belt for motor or counter shaft drive. Replaceable bronze bearings. Headstock and tailstock have No. 1 Morse taper. $\frac{3}{4}$ " hole thru headstock spindle. Can be fitted with jig saw, circular saw and sand disc attachments, 3" scroll chuck, $\frac{1}{2}$ " Jacobs chuck and arbor for grinding or buffing.

Junior Saw

A speedy accurate machine of all-metal construction. Table 10"x13". Saws $1\frac{1}{2}$ " stock; dados $\frac{5}{8}$ "x $\frac{5}{8}$ "; driven by any $\frac{1}{4}$ to $\frac{1}{2}$ H. P. motor. Portable. Attaches to light socket. Table elevates for grooving — attachments for grooving, sanding, grinding and drilling. Sold with or without motor and base.



W. B. & J. E. Boice, Dept. P. M. 10-A, Toledo, O.
"World's Largest Makers of Small Bench Machines"

The Most Modern Blotorch Made

Gives 400 degrees more heat from present-day gasoline or kerosene, because of the patented Super-heating Burner Baffle and heater plug. If you have tried to nurse along an old type blotorch on the low grade fuel of today you will appreciate what a valuable feature this is.

TURNER BLOTORCH "Safe as a Candle"

The Turner No. 45 enables you to do better work. The patented Automatic Safety Valve prevents pumping a bursting pressure, making explosions impossible. Separate Adjusting Needle obviates the common nuisance of orifice trouble. Patented

Seamless, Solderless, polished Brass Tank has but one opening and that above fuel line—it is leakproof. The Pistol Grip Handle fits any hand comfortably. FEARLESSLY GUARANTEED.

If your dealer can't supply you with the genuine Turner No. 45, write us.



No. 45
1 Quart

The World's Largest Exclusive Manufacturers of Blotorches, Firepots, Brazers.

THE TURNER BRASS WORKS
Industry Ave., Sycamore, Ill.



The New KING Saxophone Catalog

SHOWING latest models and many improvements, telling how KINGS are made and many other features of interest to professional or amateur saxophonists—is ready for distribution. If you play or are interested in learning to play a saxophone or any other band instrument send the coupon below stating what instrument you play or wish to play.

KING Instruments embody the finest craftsmanship and best materials of any made today—this catalog will tell you exactly how KINGS are made by THE H. N. WHITE CO., 5211-67 Superior Ave., Cleveland, O.

The H. N. White Co.
5211-68 Superior Ave., Cleveland, O.
Gentlemen: Please send me free your latest catalog on _____ (Instrument)

Name _____

Address _____

City _____

State _____

A Jefferson Tube Rejuvenator

will keep your radio tubes like new. At leading Radio Stores **\$7.50**

JEFFERSON ELECTRIC MANUFACTURING COMPANY
501 So. Green Street, CHICAGO, Ill.

\$**995**
Five Rooms
and Bath



Save \$200 to \$500

Stop supporting your landlord. Build your own home the Liberty way. Taste the joys and economies of independent ownership this Fall.

Shipped ready cut direct from our mills. A handy man can build it. No sawing. No waste. No middlemen's discounts. No contractor's profits. All freight paid. Materials guaranteed. A substantial, cozy home, not a portable house.

Write today for our free Wonder Book of Liberty Homes No. 13, in colors. All styles from \$380 up. It holds the home of your dreams.

Liberty Homes Company
BAY CITY, MICH.



YOURS WITHOUT COST

Popular
Mechanics
will furnish you
with either its
world-famed

**Popular
Mechanics
Superhetero-
dyne Eight**
—the last word
in Radio



(cabinet, engraved and drilled panels, voltmeters and parts, including full set of blue prints)—or a

Ranger "Motorbike"

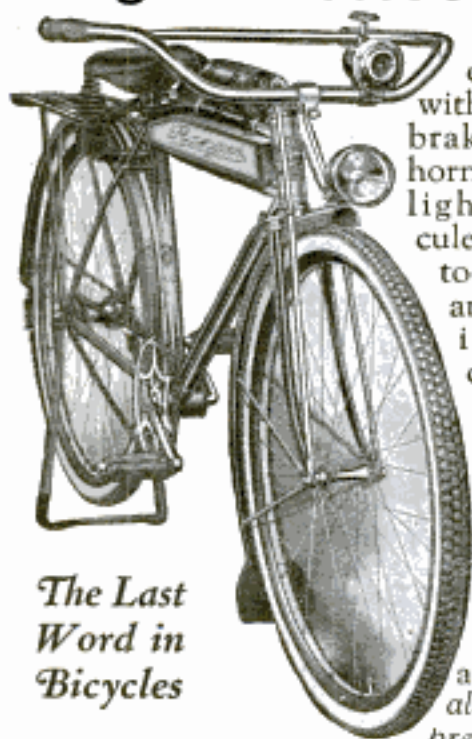

fully equipped with coaster-brake, hand horn, electric light, Hercules carrier, tool tank and tools, in your choice of 18, 20, or 22-inch frame, finished in golden brown and white all charges prepaid, for

*The Last
Word in
Bicycles*

a little of your spare time taking a few subscriptions to POPULAR MECHANICS in your community.

Drop us a postcard today, with your name and address and two references, for full details of this Remarkable Offer, and subscription outfit FREE. Address

Popular Mechanics Magazine
Room 408, 200 East Ontario Street
CHICAGO, ILLINOIS

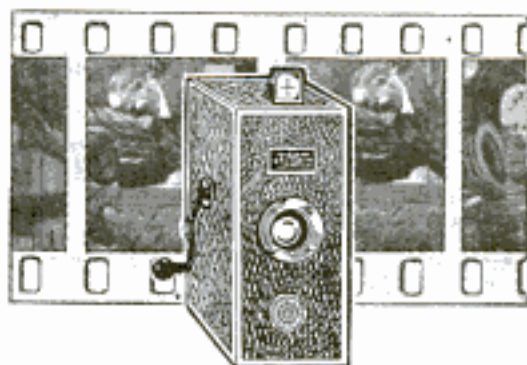

Have your own Hollywood!

Make your own movies. Be the star actor—the camera-man,—the director—yourself! Assemble your own company from family and friends. Cast the parts yourself.

Select your scenarios from the everyday scenes of your own sports, pleasures and experiences. Take real, live, action motion pictures of whatever you please—with the

VICAM STANDARD MOVIE CAMERA

Takes standard size pictures—25 foot reel. Makes movie stills, close-ups, enlargements, etc. **\$37**

Including
2 Magazines

Compact, light in weight, strongly built. Beautifully finished. Perfect in performance. Does all the work of the biggest cameras at a fraction of the cost. Project on wall or sheet.

Vicam Projector \$15

With this projector, movie films can be cut and shown as "stills", or projector can be attached to camera for showing movies.



Write NOW for FREE Booklets

Don't delay knowing all about these wonderful inexpensive Vicam products. Think of the unlimited lifetime pleasure! Send for booklet NOW.

Distributors and Agents Wanted

Vicam Photo Appliance Corporation
1224 Belmont Ave. Philadelphia, Pa.

Make FURNITURE at Home

You Can Do It in Spare Time—It's Easy

THE simple designs in furniture are, after all, the most attractive. And the best of the easily-made styles have been gathered into "Popular Mechanics Furniture-Making Books." These books are filled with pictures that show you how the finished piece looks, and how to lay out, saw, and put together the various parts. You are also told how to finish your furniture in the most attractive ways. Nowhere else will you find instructions more clear. Nowhere else will you find such a marvelous assortment of simple designs to select from. Think of it! 142 different designs, including all the pieces of furniture and the different styles of lamps you need to make your home a pleasant place to live.

142 Pieces

Complete
Instructions
and Designs

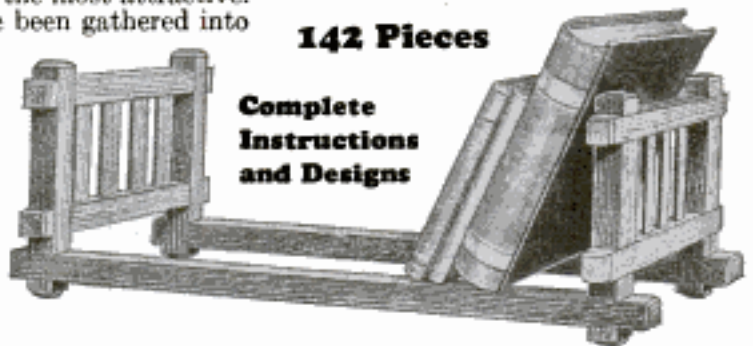

Popular Mechanics Furniture-Making Books

Tell How to Make These 142 Pieces of Furniture and Lamps

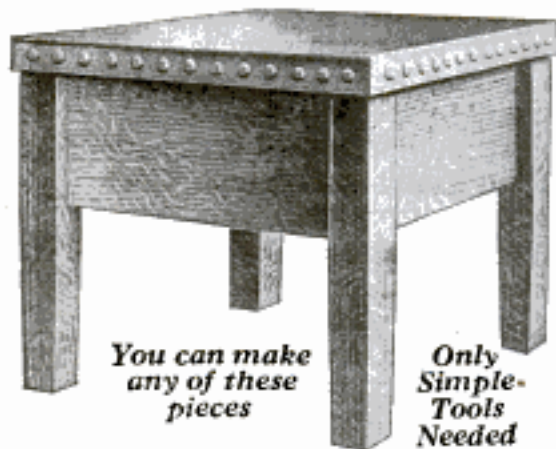

You can make
any of these
pieces

Only
Simple-
Tools
Needed

One-light portable lamp
Two-light portable lamp
Four-light chandelier
Dining-room dome
Reading lamp
Parlor or den lantern
Lantern
One-light portable
Blade for droplight
Four-light chandelier
One-light bracket
Piano lamp
Newel post lamp
Electric candle sconce
One-light bracket
Droplight
Reading lamp No. 1
Reading lamp No. 2
Square dining-room dome
Mission chandelier
Desk light
Droplight No. 3
Chandelier
Hexagonal library lamp
Hexagonal dome
Lamp No. 1
Lamp No. 2
Lamp No. 3
Lamp No. 4
Conventional patterns
The letterly design
The pyramidal design
An oak buffet
Oak stain
A plain oak hall clock
A rocking chair

A carved back arm chair
A plate rack
A tool for marking dowel holes
A magazine table
A waste paper basket
A writing desk
A couch with cushions
Blade for dining room
How to bend wood
A smoking stand
A china closet
A leather-covered footstool
Arts-and-crafts stool
A rustic stand
Wall case with mirror
A table for the desk
A barbed-wire seat
A quarter-sawn oak settee
A screen
A mission book rack
A round extension table
An arm dining chair
A hall bench
A sewing table
A side chair
Another piano bench
Another screen
A folding card table
A magazine stand
A tabouret
A porch swing
A foot warmer
Plate rack
A mission sideboard

Settee
The turning of oak
How to make black wax
40 styles of chairs, beginning with
the Egyptian style made 500
years before Christ
Piano bench
A shaving stand
A waste paper basket
A collarette pedestal
A princess dresser
A sideboard
A window seat
A plant stand
A bedside medicine stand
A hall chair
A side chair
An arm chair
A book case
A lamp stand
Extension dining table
An oak-bound cedar chest

A dresser for child's playroom
Arts and crafts oil lamp
China closet
An oak bedstead
A footstool
A library set in pyro-carving
A grille with pedestals to match
A lady's writing desk
A telephone stand and stool
An oak medicine cabinet
Home-made mission chair
A lamp stand and shade
A porch chair
A tabouret
A wicker chair
A mission book rack
A substantial library table
A mission candlestick
A low-back mission chair
A magazine stand
A lawn swing
A portable table
A combination billiard table and
diversport

Easily made book shelves
A locking case tabouret
A Roman chair
A roll-top desk
A pyro-carver's table
A piano bench
A library table
A princess dresser
A sewing box
A fern stand
A wardrobe
An oak table
A book trough
An oak serving table
An umbrella stand
A chafin-dish buffet
A writing desk
A music rack and book stand
A dictionary and magazine stand
A leather back arm chair
A wall shelf
A pedestal
A magazine rack
A hall tree

IDEAL BOOKS For Manual Training Courses

Men and boys, alike, find these books to be marvels of simplicity and fascination. Boys just starting manual training courses, will find in these books instructions and designs that will make their work both interesting and profitable, for the pieces so clearly described may be readily sold at a good profit.

33 Lamps to Choose From



Save Half the Cost
of Furnishing
Your Home

It's Fun to Make Things.
It's Profitable to Make
Furniture and Lamps

This valuable set known as "Popular Mechanics Furniture-Making Books," includes the five volumes of which thousands have been sold:

1. Mission Furniture and How to Make It, Book 1
2. Mission Furniture and How to Make It, Book 2
3. Mission Furniture and How to Make It, Book 3
4. Lamps and Shades in Metal and Art Glass
5. Arts-Crafts Lamps and How to Make Them

Send No Money

Don't send a penny (if you live in the U. S.). We want you to have these valuable books in your hands before you make any deposit. When the postman hands them to you, pay the postage, and deposit \$4.95 for the five books. If you are not delighted with your purchase, we will promptly refund the entire purchase price. Nothing could be fairer than that. Just write a postal and say, "Send me the Popular Mechanics Furniture Making Books."

POPULAR MECHANICS PRESS
Room 11, 200 East Ontario St., Chicago

\$10⁰⁰ a Day Easily

New Ford Invention



Put on in 10 Minutes



Clamps in regular tank opening—replaces ordinary screw cap.



Fills tank—gauges gas, without removing cushion.

Get Exclusive Rights Now on Greatest Ford Invention

David Gunn of Louisiana sold 22 the first day! J. V. Goulding, Utah, made \$159.00 in five days' spare time. You also can double your income and build a big permanent business of your own. Exclusive territory contract assures you of commissions on all sales in your district. New copyrighted sales plan secures dealers' co-operation. No capital needed—just write today for full information.

Kirstin Fil-Gage

FILLS FORD TANK—GAUGES GAS WITHOUT LIFTING CUSHION

Combined filling device and gasoline gauge—put on any Ford in 10 minutes—fills tank without lifting cushion. It makes the undersent tank handier than rear tank. Gas gauge always in plain sight—luminous indicator read at night. Made and guaranteed by 12-year-old \$300,000.00 Manufacturer. Sells for less than \$5.00. Every Ford owner wants to fill his tank without lifting the cushion—Fil-Gage sells on sight. Send card today. Learn how you can earn \$10.00 a day and up as our exclusive representative.

A. J. Kirstin Co., 1001 First St., Escanaba, Mich.



General Tool Case
Size 8x5x20", weight 7½ lbs. A practical case for all uses. Has strong lock, key, large tray.



Mechanic's Tool Case
Size 12x8x20", weight 17 lbs. A handy case for all mechanics. Has 5 drawers, large lock, 2 keys.

MAIL ORDER PRICES
A \$6.00 Value for **\$4.95**
A \$12.00 Value for **\$10.80**

Cases are made of wood, covered with olive green metal, with brass hardware, very attractive and well made, highest quality throughout. These cases must be seen to be appreciated and no matter what your occupation is, you need one. Order today, pay your postman above prices, we pay postage, and have a real case for your tools. West of Rockies add 10%.

Send for free catalog showing additional numbers of tool cases
MECHANIC'S CASE CO., Dept. P-2—514-516 English St., Earle, Wis.

18,000,000 CAR OWNERS

need it! Three devices in one! Big Seller!

I want an exclusive representative in your section. Opportunity to make \$20,000 a year selling the new Electric Quick-Start & Gas Saver. No capital required. **Write Quick!**

W. W. KUTSCHE, Inventor Dearborn, Mich.

AGENTS This 75-Cent PREMIUM FREE

The New, Patented Ivory and Glass TOOTH-BRUSH HOLDER

Worth 75c FREE with each 50c sale of Given away FREE a standard size tube of

RE-AX DENTAL CREAM

Everybody buys dental cream and everybody buys Re-Ax to get the handy Tooth-Brush Holder that fastens on bathroom wall and keeps tooth brushes sanitary. Everybody wants it.

EARN \$5 TO \$20 A DAY

helping us to advertise and introduce our product. No experience necessary. Shepardson, a new agent, sold 36 out of 37 calls. Read what others say:

"Sold 10 in one barber shop." "Sold 35 in a Ford service station during noon hour." "Sold 47 during noon hour in a manufacturing plant."

You can sell one in every house on every street. All territories good. No credit. Send 25c fee samples and full details.

THE RE-AX CO., 445 East Fort St., Detroit, Mich.

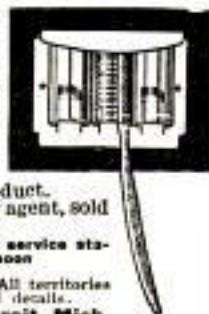

Ten Minutes More for Breakfast

And time to smile at the Wife. If you shave with Barbasol. Quick, cool, clean. No brush. No rub-in. Try it—three times—according to directions. 35c and 65c tubes.



The Barbasol Co.
Indianapolis Ind.

Please mail me your Free Trial Tube of Barbasol.

Name.....

Address.....

P.M.-10-25

For Modern Shaving



LIONEL TRAINS

are Models—
not mere "Toys"

In appearance and in operation Lionel Model Trains are just like real railroads. There is a thrill in operating them that you cannot get from any mere "toy" train. The only difference between Lionel Model Trains and real trains is the size.

For twenty-five years Lionel Model Railroads, Multivolt Transformers, and Model Railroad Accessories have held their leadership.

They have kept pace, year by year, with the improvements and developments of real railroads. They are up-to-the-minute and are the lowest priced consistent with quality.

Take Mother and Father with you to see the latest Lionel Locomotives, Coaches and Accessories—on display at all the best stores. There is a Lionel Outfit priced to suit every purse—complete outfits from \$5.75 up.

THE LIONEL CORPORATION

Dept. D

48-52 East 21st Street New York City

Lionel Automatic Train Control—The greatest achievement in model railroad engineering. Starts and stops trains automatically. Just one of the many wonderful realistic railroad devices in the Lionel Line of Accessories.

Write today for this beautiful new 64 page catalog, illustrated in actual colors. Sent free.



Lionel "Multi-volt" Transformers. Ever-reliable power plants. Run all trains best. A type for every size train.

LIONEL ELECTRIC TRAINS
MODEL RAILROAD ACCESSORIES

"MULTIVOLT" TRANSFORMERS

Here's that Odd Table You Need



Just the table for your radio set. Constructed of the best Douglas fir, thoroughly seasoned. Rigid and substantial, comes in natural wood only, ready for you to finish any desired stain or enamel. Instructions with color card for 24 standard wood finishes accompany each table. Size 31" long; 15" wide and 29" high; packed in carton.

Order Today while this offer lasts. Price \$3.50 cash with order, or we will ship C. O. D. with privilege of inspection.

EXPRESS BODY CORPORATION

50 Lake Street

Crystal Lake, Illinois

A SUPERIOR RADIO AT A LOW PRICE!

**Premier
Wonder**

\$34⁵⁰



Distance—Selectivity—Volume

Buy this high grade radio direct from the factory at wholesale price. All parts high grade. Wonderful tone quality. Test it yourself. The set is guaranteed. Write for Illustrated Circular G-1.

SPORT RADIO WORKS, Aurora, Ill.

Solder in 2 Minutes

with **REDDY HOT OUTFIT**. Complete outfit sent for \$2.00 prepaid. Guaranteed.
E. D. FAHLBERG MFG. CO., MADISON, WIS.

RADIO CATALOG
NEW
1925-1926
EDITION

Contains nationally
advertised High
Quality Sets,
Parts and Kits.

Western Radio MFG CO.
136 W. Lake St. Chicago, Ill.



**Saw 15 Cords
a
Day
—Easy
!**



**"Men! Let Me Tell You About
this New, Improved Power Saw!"**

**Now
Selling at
Very Low
Prices**

HERE, folks is my new model OTTAWA Log Saw—my greatest achievement in over 20 years' experience in building machines to make farm work easier! It's a labor-saver that every farmer with wood or timber to cut needs right now! Easy to **Make Money!** Coal is now price and wood in demand for fuel. Saw 15 cords a day. Just think, wood selling for only 23 a cord would bring owner \$45!

own! I sell it Direct from my Factory—at a Low Factory Price! Makes \$50 saw cuts a minute! Does the work of 10 good hired men. Fastest sawing, easiest moved, lightest weight, most powerful! Saws the human way.

SHIPPING POINTS

OTTAWA, KANSAS
Pittsburgh, Pa. San Francisco, Cal.
St. Paul, Minn. Memphis, Tenn.
Dallas, Texas Albany, N. Y.
Atlanta, Ga. Pueblo, Colo.
Indianapolis, Ind.
Portland, Ore.

OTTAWA "4 in 1" LOG SAW

1-Falls Trees 2-Saws Logs 3-Buzzes Up Branches 4-Does Belt Work

Try 30 Days.

FREE BOOK!

Try a whole month at your own work. You can pay cash, or I'll arrange Easy Terms to suit. And remember, every OTTAWA is backed by my 10-Yr. Guarantee. Send me a post card with your name and address for my new "Wood Sawing Encyclopedia." Big Special Offer and my Low Factory Prices. Right now's the time! Send today!

HARRY OVERMAN, Gen'l. Mgr.

OTTAWA MFG. CO.,

1742-O Wood Street, OTTAWA, KANSAS.
Room 1742-O Magee Bldg., PITTSBURGH, PA.



Cuts Up Branches



Cuts Down Trees Level With the Ground

Now!

**OFFICIAL
Sporting Goods**

Made by World Famous Manufacturers
For Football, Baseball—Sports of Every Kind

Endorsed by
America's Leading
Athletes

New
Catalog
Now
Ready
Sent
Free



Write
Today

"Red" Grange says:

"In recommending your equipment, I feel confident that anyone purchasing it will be more than satisfied."

The Famed "Four Horsemen" of Notre Dame say:

"Your equipment will surely stand the gaff. It is well worth the money."

Ralph Baker says:

"I have been more than satisfied with all the sporting goods purchased from you."

Paddy Driscoll says:

"I have found the quality and price of your sporting goods, also the quick service that you give, unequalled elsewhere."

Lowest Prices

24 Hour
Service

Special Quantity
Discount
to Schools, Clubs, Coaches

Sears, Roebuck and Co., Chicago.

Gentlemen: Please send me a copy of your Special Sporting Goods Catalog, 80P39.

Name

Postoffice

Rural Route.....Box No.....State.....

Street and No.....

Sears, Roebuck and Co.

\$100 Brings 'Em Both to You!

THIS FAMOUS Remington Handy Knife and 6 MONTHS THRILLING ISSUES OF NATIONAL SPORTSMAN!

Big extra gauge master blade with the right shape and steel in it; and a handy punch blade useful a dozen times a day. $3\frac{3}{4}$ " long; nickel silver bolsters, and full brass lined. Solid, heavy construction, with good full handle to fit a husky hand. "Remington" on the blade guarantees the quality—it's a dandy good knife "all ways." Both knife and National Sportsman for 6 months for \$1.00.



NATIONAL SPORTSMAN MAGAZINE
254 Newbury St., BOSTON, MASS.

Best, most absorbing sportsman's magazine in the world, cram jam full of breath taking tales of hunting and fishing for red blooded men—tips on how, when, and where to get game and fish—the right information on guns, revolvers, fishing tackle, camp year, game laws, etc. Big 62 or more pages each month. Think of it—6 months subscription and Remington Knife for \$1.00!



1/2 SAVED

on all Standard Typewriters

10 DAYS TRIAL!

At Last—World's Best Typewriters with every modern writing feature at positively lowest prices and on easiest terms ever offered.



A Year to Pay—5 Years Guarantee

Standard machines so perfectly **Re-Manufactured** by the exclusive **Young Process** that they look and write like brand new. Our exclusive, distinctive process makes possible better typewriters at lower prices.

FREE BIG ILLUSTRATED TYPEWRITER BOOK

Write now. See our amazing typewriter bargains. Read what users say and the unusual service we will give you. Don't wait—write today.

YOUNG TYPEWRITER COMPANY
654 West Randolph Dept. 110A Chicago, Ill.

THE WOTEN, GASOLINE ENGINE

2 CYCLE, 3-PORT

Aircooled and Watercooled. Nearly One-Half H. P. in five pounds. Handiest little engine ever made. Ideal wherever power is needed. Complete line of small gasoline and steam engines, dynamos, motors, batteries, battery chargers, etc. CATALOGUE FREE.

DYNAMIC MANUFACTURING CO.
First Nat'l Bank Bldg., Dept. 6 Chicago



WOMEN GET YOUR DRESSES FREE and Make \$200 a Month

You can do it easily simply by demonstrating my lovely styles in house and street dresses to your friends and acquaintances in part or full time. Every woman is delighted with my styles and fabrics and will want several dresses because my prices direct from factory to customer save nearly one half. No experience is necessary as you simply demonstrate my styles from a beautiful catalog and I fill the orders by parcel post, and pay you every Saturday. My special offer is made to only one person in each locality and enables you to get your dresses free. To be first in your locality you should write me today.

CAROL LEE, 511 Gateway, KANSAS CITY, MO.

Buy SPORT BODIES for FORDS

at FACTORY PRICES!



This Model \$39.50
in Grey Prime

Write for Circular A-1
Showing Other Models.

Sport Body Works, Aurora, Illinois

EASY \$100 a Week

FUGO FIRE EXTINGUISHER

Unusual opening for live agents in every locality. Make \$500 or more a year—easy. Fugo—the instantaneous automatic fire extinguisher—is needed and wanted in every home, store, theatre, garage, shop, school, automobile, etc. Cheapest fire protection available today. Within reach of all.

1 Qt. Size \$5.00 2 Qt. Size \$7.50

Recharged in a life
Amazing 30-second demonstration clinches sale—each one sold sells others. Territory going fast. Write at once for wonderful proposition that will make you big money.

THE NATIONAL FORMETAL CO.
233A St. Clair Ave., N. E. Cleveland, Ohio



Lighting Fixtures

READY TO HANG

(Direct from the Manufacturer)

Completely wired, including glassware. Send for New Catalogue No. 27. Just reduced prices.

Special proposition to DEALERS.

ERIE FIXTURE SUPPLY CO.
STA. A ERIE, PA.



Just Out GREEN, RED, SELLS FOR \$1.25. SAMPLE 67c

Unbreakable Trio Self-Filling Fountain Pens

Guaranteed for 1 year. "It makes Carbon Copies"



Money refunded if you don't think it's the best pen you ever wrote with. Finished in beautiful green or red. Send for wholesale quantity price list and distributing plans. **F. SPORS & CO., 337 Main St., Lecueur Center, Minnesota**

\$5 Down Buys Any Latest Model WITTE Engine

UP TO 10 H-P.

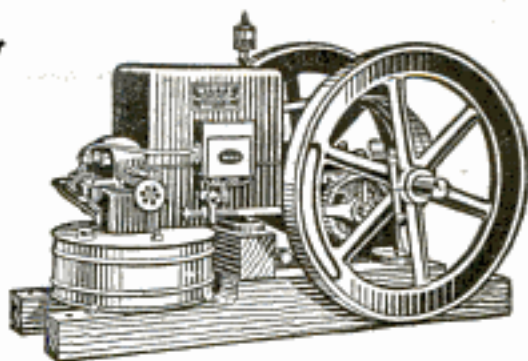

The One-Profit Engine

NOW, more than ever, the need for economical, dependable power is felt by the producer who is faced with ever-increasing labor costs. **WITTE Throttling Governor ENGINES** answer this important question perfectly—now an economical, dependable power plant is within the reach of everyone.

Today the WITTE ENGINE sells at the lowest price in history. Into this WITTE has gone the ripe experience of more than 42 years of engine building—over 100,000 users all over the world have placed upon it their stamp of approval. You, too, can put a WITTE on your place, secure in the knowledge that it represents the **Standard of Power.**

The Witte Throttling Governor

the original and leader of the throttling-governor type. An even steady speed with a big surplus of power for the heavy loads. The minimum in fuel consumption—the WITTE ENGINE burns kerosene, gasoline, gas-oil, distillate or gas at a fuel cost of less than 2c an hour per H-P. Simple, trouble-proof and guaranteed for a life-time of hard work. Completely equipped with WICO Magneto, speed and power regulator and throttling governor.

The WICO Magneto

—the most perfect system of high tension ignition known. Makes starting easy, even at 40 below zero—sure performance in any climate or temperature. Not affected by rain, hail, snow or sleet. The perfect replacement for old-style battery-equipped engine.

Makes All Jobs Easy and Cheap

No need to do the hard, back-breaking work—no need to pay high prices for poor labor—you can show \$1,000.00 more profit every year you have a WITTE working on your place. Investigate now!

All Sizes, 2 to 25 H-P.

Easy Terms. Scrap the Old One—Pay a Little Down on the New Witte!

Ask for Our Big FREE Engine Book

or if interested, ask for our Log and Tree Saw, 3-in-1 Saw Rig or Pump catalog.—ED. H. WITTE.

WITTE ENGINE WORKS
(FOUNDED IN 1870)

1744 Witte Bldg., KANSAS CITY, MO.
1744 Empire Bldg., PITTSBURGH, PA.

THIS WONDERFUL INVENTION

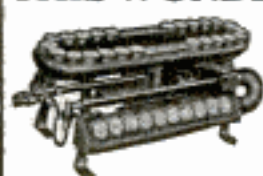

converts any ordinary cook stove into a gas stove. OXO-GAS is made from kerosene and air. Cheaper, cleaner and more efficient than coal. Responsible distributors wanted.

GLORIA LIGHT CO.

111-19 N. May St. Chicago, Ill.

FREE 1000 Illustrations ELECTRIC FIXTURE CATALOG!



Write today for your copy. Save 50% direct from Manufacturer. No Middleman's Profit. OUR SPECIAL: 8 Room Electric Set, ready to hang, \$24.50—Other bargains.



UNITED LIGHTING FIXTURE CO.
83 Flatbush Ave. Dept. P, Brooklyn, N. Y.



\$35 Complete Outfit as Illustrated

Delivery Paid East of the Mississippi

\$38 Delivery Paid West of Miss.

Saw Table Can be purchased with 6-inch saw for **\$22.50**. Delivery paid East of Mississippi. **\$24.50** Delivery paid West of Mississippi.

Motor This heavy duty motor can be furnished separately for **\$12.90** delivery paid East of Mississippi. **\$13.90** Delivery paid West of Mississippi. Complete with Cord, Plug and flat or grooved Pulley. Guaranteed 10% Overload. Special Prices on Quantities of 10 or Over.

PAUL J. DEVITT, 1101-1107 So. 2nd St., Phila., Pa.

MECHANICS BENCH SAW

With this saw you can make your own repairs in shop, home, farm or garage. Makes a clean edge on the toughest wood—no planing necessary. Rips, cross-cuts, bevels, miters, mortises, tenons, or grooves. Attach to any lamp socket. Weight only 61 lbs. Will cut up to 1 3/4" All metal. Saw size 6 in. Table 10x13, base 7x11 height 7 in. Table tilts for beveling 5 degrees left 10 degrees right.

WRITE FOR OUR NET PRICE BUILDERS' HARDWARE CATALOG



It is Easy to Shop by Mail and It Saves You Money!

SPEEDY SERVICE

SPLENDID VALUES

THIS CATALOG FREE
Send for it today

Ask Our Customers
—there are many in Your Community

Outer and Inner Clothing and
Shoes for All the Family—Dry
Goods—Rugs—Jewelry—Furniture

—Auto Supplies—Sporting Goods and
Radio Supplies—Paints—Hardware
—Stoves—Furnaces—Farming Tools

— Many of our Orders are Shipped
the Same Day we Receive them—8 Hour
Service—and practically all of the balance
on the following day—24 Hour Service

The Charles William Stores

The Long Established Mail Order Merchants of
New York City

518 Page Handy Catalog sent free
on request to 884 Stores Building



FREE 10 DAYS TRIAL

We will send you the world's only ball bearing, long wearing L. C. Smith Typewriter with absolutely no obligation to you whatsoever. After 10 days trial, if you are not satisfied it is the greatest value and finest typewriter you ever saw, just send it back. If you keep it, you pay only \$3.00 down and monthly payments so small you'll never miss them.

Our special prices are lowest ever made on the genuine Ball Bearing Silent L. C. Smith—late style models—up-to-date, full size, perfect machines—every modern convenience—absolutely finest quality rebuilt and guaranteed for 5 years. No other typewriter at any where near our price will give as many years of perfect service. We are largest exclusive dealers in L. C. Smith Typewriters in the world. The easiest running and longest wearing typewriter ever built. Anyone can easily operate it with our free course of instructions. Over half a million sold.

Free to You Now! Complete course of lessons and valuable equipment if you mail coupon NOW.
SMITH TYPEWRITER SALES CORP., 300-360 East Grand Avenue, Chicago, Ill.

COUPON BRINGS THIS L.C. SMITH

Smith Typewriter Sales Corp., 300-360 E. Grand Ave., Chicago

Without obligation of any kind, you may send me your free booklet, and special 10 day free trial offer on a genuine L. C. Smith. Your new low prices, including instruction Book, free course of lessons on Touch Typewriting, Tools, etc.

Name.....

Address.....

City.....State.....



Save Money and Repair Bills

When upholstery binding around top, seats or door panels shows wear; eyelets are torn or curtain fasteners broken—**FIX IT YOURSELF.** It's easy and every dollar you save on repair bills you can stick in your pocket. Besides, you'll enjoy the fun of fixing your own car.

Increase Value of Car... Improve Appearance... Get More Pleasure

Complete Postpaid \$2.95

Check—Money Order or C. O. D.

THE Auto-Vehicle Parts Co.
Dept. 10 3301 COLERAIN AVE. CINCINNATI, O.



12-Cell—24-Volt Storage 'B' Battery

Positively given free with each purchase of a WORLD "A" Storage Battery. You must send this ad with your order.

Send Your Order in Today

FREE!

To Each Purchaser of a WORLD 6 V. Auto or Radio BATTERY

WORLD Batteries are famous for their guaranteed quality and service. Backed by years of successful manufacture and thousands of satisfied users. Equipped with Solid Rubber Case, an insurance against acid and leakage. You save 50 per cent and get a

2-Year Guarantee Bond in Writing

WORLD Battery owners "tell their friends." That's our best proof of performance. Send your order in today.

Solid Rubber Case Radio Batteries

6-Volt, 100-Ampere	\$8.25
6-Volt, 120-Ampere	13.25
6-Volt, 140-Ampere	14.00

Solid Rubber Case Auto Batteries

6-Volt, 11-Plate	\$8.25
6-Volt, 12-Plate	13.25
12-Volt, 7-Plate	\$6.00

Send No Money Just state battery wanted and we will ship day order is received, by Express C. O. D. subject to your examination on arrival. **FREE "B" Battery** included. **Extra Offer:** 5 per cent discount for each in full with order. Buy one and get a guaranteed battery at 50 per cent saving to you.

WORLD BATTERY COMPANY
1219 S. Wabash Ave., Dept. 5, Chicago, Ill.

World For **AUTO and STORAGE BATTERIES RADIO**

Approved and Listed as Standard by Leading Authorities

Including Radio News Laboratories, Popular Science Institute of Standards, Popular Radio Laboratories, Radio Broadcast Laboratories, Radio in the Home, and Lefax, Inc.



AGENTS

Make big money selling beautiful, winged radiator caps to Ford owners. Simply pinch the wings and "lift out." Pinch wings to replace. No burned fingers. *Wings are always cool.* Seats securely. Locked with chain and T-bar. Cannot be lost or stolen. Patented. Heavy nickel plate on brass. Rustproof. Agents are making big money. State territory desired.

Send \$1.50 for sample for your own Ford and receive one Cray Gasoline Tank Cap FREE.

CRAY PRODUCTS CORPORATION
1635-C2 Penobscot Bldg., Detroit, Michigan

"THE TUBE WITH A PEDIGREE"



A RADIO tube is only as good as its characteristic curve reading. We furnish with each MUSSELMAN CERTIFIED TUBE a curve sheet showing the exact readings for that particular tube. Both tube and curve sheet are serially numbered, so that you, or any engineer, can check our figures. Remember this point: That a characteristic curve reading is the *only* way anyone can measure the value of a radio tube. List: \$3.00 each. If your dealer cannot supply you, order direct from this advertisement.

Jobbers, manufacturers, and dealers are invited to write for details as to sales franchise.

Manufactured by

The Van Horne Co., Franklin, Ohio

SALES OFFICE

A. J. MUSSELMAN

604 Machinery Hall

CHICAGO

FREE 64 Page Catalog of Radio Bargains

The World's Largest Exclusive Radio Mail Order House Will Send You This Wonderful Book FREE

Contains thousands of bargains in radio sets, semi-finished sets and radio kits of all styles, sizes and approved circuits. Beautiful models of latest designs and types. Elaborate console models with loud speakers built right in cabinets of genuine mahogany and walnut. All sets guaranteed. Coast to coast receiving range. Also contains everything in radio supplies including batteries, chargers, loud speakers, transformers, condensers, rheostats and any other parts you may want for improving your set or building a new one. Guaranteed saving to you of $\frac{1}{2}$ to $\frac{3}{4}$.



American Radynola



**AMERICAN
RADYNOLA**
5 TUBE SET
\$29.50

World's Best 5 Tube Set
Fully built and wired. Beautiful mahogany cabinet. Shiny panel design. Finest low-loss condensers, coils and sockets. Bakelite baseboard, garnis and dials. Regular \$75.00 value. Price \$29.50. Transportation charges extra. Shipping weight 25 lbs.

Set with all accessories including tubes, loud speaker, storage battery, B-1 batteries, aerial and ground equipment. \$59.75. Shipping weight 100 lbs. Complete instructions with set.

Satisfaction Guaranteed. Send for Catalogue Today!

RANDOLPH RADIO CORP.
159 N. UNION AV. Dept. 23 CHICAGO, ILL.

Chemical Tricks for Boys

The
Boys
Hand book
of
Chemistry
only 15 cents

Surprise and puzzle your friends with magic chemical tricks; make your own ink, dye cloth, test water, write secret letters with your own invisible ink; pour blue, brown and black liquid from a glass of water. You can do these and more wonderful feats of chemical magic if you have Chemcraft Junior—the pocket chemical outfit. Get one now. If you order at once, we

will include FREE the Boy's Hand Book of Chemistry, 180 pages of experiments, chemical information, money making suggestions and catalog of supplies.

**CHEM-CRAFT
JUNIOR**
CHEMICAL OUTFIT

Porter Chemical Co.
113 Washington St.
Hagerstown, Md.

**BOTH
25¢
POSTPAID**

Como Duplex Transformers

"The World's Standard for Push Pull Amplification"

Use them in your set and you will realize why they are continually specified by leading Radio Engineers. The fact that they are widely copied is proof of their superiority. "Take no chances—use Como."

\$12.50 per matched pair at leading dealers. Send for literature.

Como Apparatus Corp., Manchester, New Hampshire

Examine Free! Startling Offers Unusual Cash Diamond Buys

As Low as \$60 PER CARAT

60% OF MARKET PRICE

List of Unset Diamond (Choose Your Own Mounting) Sheet No. 2.

No.	Exact Wt.	Description
\$82	1/2-3/32 ct.	Flawless Gem Fine steel white color. Try to match at \$135.00.
\$116	3/4 less 3/16ct.	Wesselson Showy Brilliance. Spread Try to match at \$235.00.
\$237	7/8-1/32 ct.	Flawless Gem Perfection and Proportion Try to match at \$385.00.
\$345	1-3/32 ct.	Jaegerfants Rare color Grade and Try to match at \$550.00.

Write for our latest lists and see the hundreds of startling offers in unset diamonds, beautiful mountings, and others already mounted. You can now get the mounting you like best and the diamond of your choice—both at a price so low, you'll be amazed. Shows how and why: this 75-year-old, \$1,000,000.00, largest and oldest diamond banking institution in the world having just completed big cash deals direct with European diamond cutters, and having other diamonds on which money was loaned, but not repaid, can make these startling legitimate offers passing on the advantages to friends and customers alike. You make further savings here through our cash policy of no charge accounts—no installments, but extra value for cash.

Latest List Diamond Bargains

Send at once for latest list. Every gem described in full detail with exact weight, color, quality etc. Get details of Free Examination Offer. No obligation to buy. List is free.

Mail Coupon NOW!

JOS. DeROY & SONS, 1937 DeRoy Bldg., Pittsburgh, Pa. Only opposite Post Office

Without obligation to buy, send me free, your Latest Bargain List of Diamonds, Watches and other Jewelry.

Name.....
Address.....
City..... State.....

Why Pay Full Prices

Costs Nothing to See

At our risk we send you any bargain you wish for absolutely free examination. No red tape. Try to match at full 60% more if you can or don't keep it. Diamonds of desirable quality at \$125 per carat. Yes, some even lower priced—also finest gems obtainable at higher per carat—but proportionately low bargain prices. Our bargains have guaranteed loan values, also unlimited exchange privilege at full price paid.

GENUINE DIAMOND RINGS Sent for \$2.00

\$2.00 Brings the Most Sensational Price Smashing Diamond Ring Offer Ever Made

Each of these rings is set with guaranteed, perfect cut, blue-white, fiery diamond of first quality; mountings are of 18 kt. white gold, hand engraved in the latest designs.



No. 5
First quality, blue-white diamond set in 18 K. white gold disc, 3 1/4 ct. size, 18 K. white gold mounting.
Price **\$79.50**

Ten Days Free Trial

Simply send \$2.00 and your choice comes to you all charges paid. If for any reason whatsoever you are not satisfied at the end of ten days, return the diamond ring to us and your deposit will be refunded. A legal bond as to quality and value accompanies each ring. **After trial pay balance in 12 monthly payments.**

NO RED TAPE—NO DELAY

FREE BOOK OF GEMS

Most complete jewelry catalog ever published of diamonds, watches and jewelry—newest designs at lowest prices. A full year to pay for everything you order from our \$2,000,000 stock.



No. 10
Dinner ring set with five large diamonds and four French blue sapphires in 18 Kt. solid white gold ring. Price **\$67.50**



No. 15 Perfect cut, diamond center, four French blue sapphires; 18 K white gold ring. Price **\$42.50**

Established 1835
Address Dept. 1441

ROYAL DIAMOND & WATCH CO.

170 BROADWAY NEW YORK

\$351.00
Cleared in one day (Aug. 1925) by **W.H. Adams** Dayton, Ohio

V. A. Marini, Santa Cruz, Cal. (Nov. 1924) reports \$11,275 sales in 3 months. J. Gordon of New Jersey says \$4000 profit in two months. Alexander of Penn. \$3000 profit in four months. Ira Shook, Flint \$363 in one day. Bram, bought one outfit then 10 more within a year. Patillo, Ocala, writes: "Crispettes all you claim and then some." John W. Culp, South Carolina, writes, "Everything going lovely. Wrappers lying all over. It's a good old world after all." Perrin, \$380 in 1 day. Mrs. Lane, Pittsburgh, 8000 packages in



one day. J. R. Bert, Ala. "only thing I ever bought that equaled advertisement."

WE'LL START YOU IN BUSINESS

Furnish secret formulas, raw material, and equipment. Very little capital required; no experience needed.

Build Paying Business of Your Own

No limit to the sale of Crispettes. Everybody likes them. It's a delicious food confection made with or without sugar. Write me for facts about a business that will make you independent. Start now, in your own town.

Profits \$1,000 a Month Easily Possible

Send postal for illustrated book of facts. In contains enthusiastic letters from others—shows their places of business, tells how and when to start, and all information needed. Free. Write now!

LONG-EAKINS COMPANY

1028 High Street Springfield, Ohio

REALLY "EARNS WHILE HE LEARNS"

"I work only four hours a day and average \$60.00 a week," writes Geo. W. McHaney, Tyler salesman, who spends part of his time studying. Later reports: "I made 14 demonstrations, resulting in 12 sales in one hour today (\$9.50 profit)." Hundreds making big money selling Ideal Fiber Cutter "handiest tool in the kitchen." So can you. No experience necessary. No heavy samples to lug. Easy to sell. Write today.

AGENTS

The Tyler Manufacturing Co., Dept. M-3 Muncie, Ind.

FAMOUS "COAST TO COAST" MIRACO GUARANTEED

RADIO'S

Factory Prices SAVE 1/3 TO 1/2

Powerful, New Multi-tube Miraco gets long distance on loud speaker. Set, ONLY \$27.35 Retail

SEND for SPECIAL OFFER!

Users everywhere report Miraco radios get programs coast to coast; outperform sets 2 times as costly. Many hear foreign countries. Radio's most amazing values in guaranteed, factory tested, long distance sets—let testimony of users convince you.

AGENTS FREE! Literature on (DEALERS) latest 1 to 5 tube models and new low prices. Write!

MIRACO RADIO GETS 'EM COAST TO COAST

MIDWEST RADIO CORPORATION
Pioneer Builders of Sets
407 A E. 8th St., Cincinnati, Ohio

3 Ft. Telescope

5 SECTIONS 8 POWER LENSES

Free

Handsome 12 in. leatherette carrying case with straps sent free with Wonder Telescope for short time. Wonder Telescope gives new pleasures to home, farm, camp, travel, sport. See people and objects miles away, on land or sea, as if they were close. See moon and stars as never before. Opens out over 3 feet long, in 6 seconds! Measures 12 inches closed. Brass braced powerful lenses. Entertain your friends day or night. Thousands pleased. Be first in your neighborhood.

Send No Money Send only name and address for Wonder Telescope with FREE Case and Straps. On arrival deposit with Postman \$1.50 plus few genuine postage. Satisfaction Guaranteed or deposit refunded. Order now.

Ferry & Co., Dept. 1777
3224 N. Halsted St. Chicago, Ill.

"I am delighted with the 'Wonder' telescope. Today I have been watching submarines 3 miles off the coast." Wrote Philip Brush, Beverly, Mass. "I am very much pleased with telescope. I saw a Light House 18 miles away."—Clyde Scribner, Taunton, Mass. "Far above my expectations. Can see men working 7 miles away."—S. M. Gearhart, Bolan, Iowa. "I could see a wind-mill on a farm across a lake more than 4 miles away. I am much pleased."—Raymond Cosanova, Hudson, Wisconsin.

Thousands Delighted

"I have had my 'Wonder' Telescope 6 months. I can tell time on the church clock 5 miles away."—
Edw. Foster, long Baltimore, Md. "Could tell color of aeroplane 4 miles away."—Mrs. L. M. Yarrbrough, Stringer, Mass. "Read numbers on freight cars mile away. Saw mountain on moon."—A. C. Palmer, Indianapolis. "Watch my boy arrive at school, 2 miles away."—Mrs. Horn.

Telescope received last month in fax. Can see moon. Miraco's 3 miles and see people fishing.—M. L. Thurn, St. Louis, Mo. "I am nearly 80 years old and if I could see get another, would not take \$10.00 for it."—A. R. Walker, Dayton, O. "Can tell exact minute on Court House clock 2 miles away."—Jessie Beers, Columbus, Ind. "Don't know anything we ever enjoyed so much."—Class. Hunter, Necedah, Wis.

60 MILES ON A GALLON OF GASOLINE

TESTS SHOW FORD CAN RUN 60 MILES ON A GALLON

The amazing fact that a Ford can run 60 miles on 1 gallon of gasoline was recently brought to light through tests conducted by America's foremost engineers, where it was shown that a gallon of gasoline contains sufficient heat units which if properly atomized and mixed with air would give this additional mileage. Great strides have already been made in this direction by the recent invention of a simple attachment which can be installed in a few minutes without any alterations to the motor. It is common for Ford Owners to make from 40 to 44 miles per gallon after this marvelous device is attached.

MOST WONDERFUL INVENTION TODAY BRINGS JOY TO FORD OWNERS

Starts Ford Instantly

Starting a Ford Car in cold or zero weather is something every Ford Owner dreads—everybody realizes that difficult starting is an abuse on the starter and battery. Thousands of Ford Cars are "laid up" during the Winter just for these reasons. This great difficulty has been overcome. The SUPER positively starts a Ford Car instantly in the coldest weather.

Marvelous Device

The SUPER is no trick affair—requires no mechanical adjustments and contains all the scientific principles of carburetors costing \$20 to \$35 and in its natural action uses up every particle of unused gasoline and breaks it up into a perfect vapor. The hitherto impossible is now realized by the SUPER.

Everybody Satisfied

Saves 3 to 7 Dollars Per Month

The best investment I ever made. The SUPER is saving me from three to seven dollars each month, besides putting new life into my motor.

A. H. WORRA, Iowa.

Makes 44 Miles Per Gallon

I have tried the SUPER and the results of the experiment are satisfactory. One quart of gasoline run my Ford 11 miles over improved roads which is just about again as far as I could run with the plain Ford Carburetor.

G. E. YODER, Penn.

Finds That Our Claims Are Correct

I find that your claims for increased mileage are correct and that a big saving is made by your SUPER. In fact, the best device I have met with in that line.

M. J. VAN LEEUWEN, Mass.

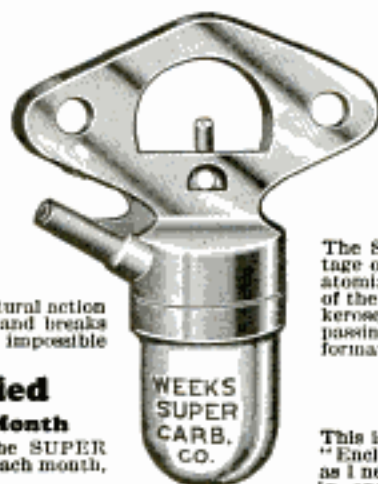

The
Heart
of the
Motor

Eliminates Oil Pumping in Front Cylinder

What a wonderful relief to Mr. Ford Owner when he realizes that he can run his car without the motor pumping oil in the front cylinder. Sounds like an awful lot to expect of any device, but that is what the SUPER does and this is only one of its many advantages because it puts real efficiency into any Ford Car.

Complete Combustion

The SUPER is so designed that it takes advantage of the present Ford Carburetor and properly atomizes the light as well as the heavy elements of the fuel, converting every atom of gasoline and kerosene into power preventing liquid fuel from passing into the cylinders, thus avoiding carbon formation and oil dilution.

Easy to Sell

Sells Like Hot Cakes

This is a recent letter from one of our distributors: "Enclosed find draft for 200 more SUPERS, rush as I need them badly. I sold and banked \$104.00 in one day. Hope to sell 1000 SUPERS next month."

A. W. LEONARD, Penn.

Making Big Profits Every Noon

I have been working the SUPER at noon only. Yesterday noon I made more money with the SUPER than I did at my 11 hours' hard work in the factory all day.

J. L. LEHNER, Wis.

Had No Previous Selling Experience

This letter shows what ambition does: "I sold six SUPERS in less than 2 hours tonight. I think it's a pretty good start—for it's the first thing I ever sold."

E. MANGOLD, Ind.

\$60.00 TO \$150.00 PER WEEK EASY

You just can't help making Big Money selling the SUPER because a trial sells itself and soon everyone in the neighborhood get talking about this marvelous device. Men like Leonard, Shaw, Manner, Kinsley, Peters, Sands, Beck and Hall are not exceptional salesmen, but just the type of men that saw an opportunity and were quick to grasp it when within reach. No previous selling experience is necessary, just a little ambition on your part to make money is all we ask and we will extend the same opportunity to you. Spare time will pay you well. If you can devote your entire time so much the better, because the SUPER is a whirl-wind seller and takes hold in a locality like wildfire.

Men Wanted Everywhere To Introduce

We want distributors in all parts of the country to take orders and deliver the SUPER and to look after the repeat business that is bound to follow and to such distributors we are willing to assign territory. You do not have to own a Ford to take up this proposition but if you have a Ford it is easier to explain its many advantages. However a Trial of the SUPER convinces the most doubtful person and tells a wonderful story.

A REAL FUTURE HERE

WEEKS SUPER CARBURETOR CO.

426-1461 Eleventh St., Milwaukee, Wis.

MAIL TODAY
WEEKS SUPER CARBURETOR CO.
426-1461 Eleventh Street, Milwaukee, Wis.

GENTLEMEN: Please mail me full free particulars about your wonderful invention.

Name

St. or R.F.D.

Town

County

State

How to Give Home-Made Furniture that Finished "Professional" Look

After spending precious hours making furniture by hand, you naturally want to give it as beautiful a finish as possible. Surely the finishing should receive its share of attention, for a beautiful piece of furniture may be ruined if improperly finished, whereas any small defects are minimized if well finished.

The Johnson Book on Wood Finishing gives complete instructions for finishing new and refinishing old wood—soft or hard. It tells how to stain wood artistically—how to remove old paint and varnish—how to secure a beautiful enamel finish, etc. This book is the work of experts—profusely illustrated. It includes color charts—gives covering capacities, etc.

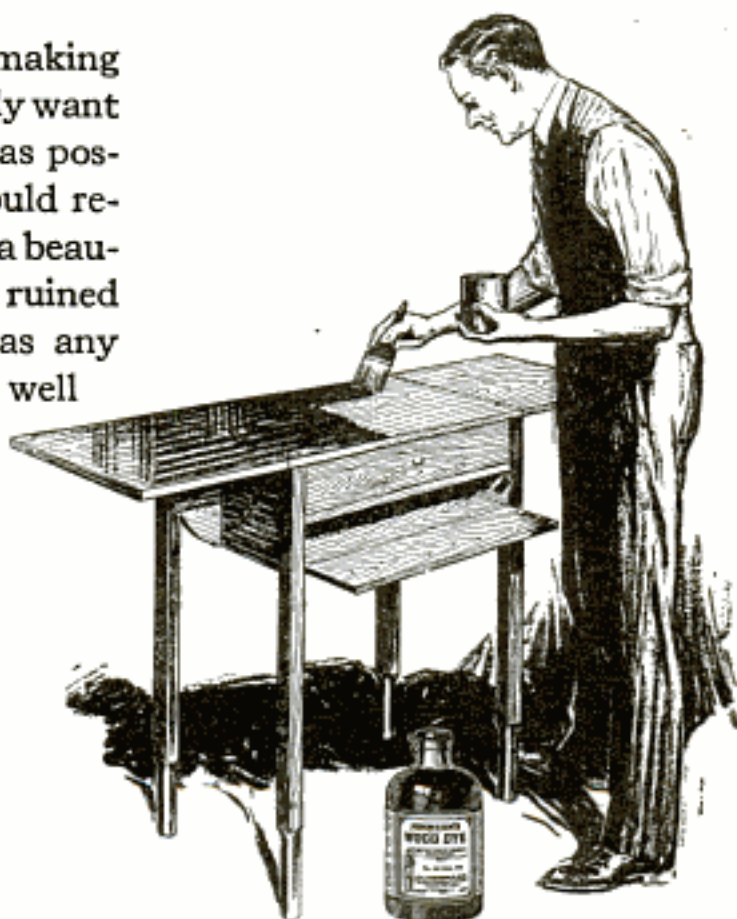

JOHNSON'S WOOD DYE

Johnson's Wood Dye is for the artistic coloring of all wood. It is easy to apply—dries in four hours and will not rub off or smudge—penetrates deeply, bringing out the beauty of the grain.

Johnson's Wood Dye is a dye in every sense of the word. Like most first class products it answers one purpose only—it dyes the wood. A finish must be applied

over it—we recommend Johnson's Varnishes or Polishing Wax.

Johnson's Wood Dye is made in seventeen beautiful shades, among the most popular of which are:

123—Dark Oak	131—Walnut
129—Dark Mahogany	128—Light Oak
127—Brown Mahogany	124—Golden Oak

Select the shade of Johnson's Wood Dye you want and order it from your dealer by name.

—FREE—25c BOOK ON WOOD FINISHING—



Ask for a FREE copy of the Johnson 25c Book on Wood Finishing at stores displaying the sign shown at right. These stores carry Johnson's Artistic Wood Finishes and will be glad to show you wood panels—and answer questions on how to properly finish wood. If no store in your locality can supply the Johnson Book—mail this coupon for a copy—Free and Postpaid.

YOUR DEALER'S NAME.....

Your Name.....

Your Address.....

City and State.....

S. C. JOHNSON & SON, Dept. P.A.10, RACINE, WIS.



Send for this RADIO BOOK FREE

The World's Largest Exclusive
Radio Mail Order House Will Send
You This Wonderful Book FREE

64 illustrated pages containing thousands of bargains in radio sets, semi-finished sets and radio kits of all styles, sizes and approved circuits. 5-tube sets as low as \$29.50. Beautiful models of the very latest designs and types. Elaborate console models with loud speakers built right in cabinets of genuine mahogany and walnut. All sets guaranteed. Coast to coast receiving range. Also contains everything in radio supplies, including batteries, chargers, loud speakers, transformers, condensers, rheostats and any other parts you may want for improving your set or building a new one. Guaranteed saving to you of $\frac{1}{3}$ to $\frac{1}{2}$.



1926 Catalog of RADIO BARGAINS

Save $\frac{1}{3}$ to $\frac{1}{2}$

AMERICAN RADYNOLA 5 TUBE SET

\$29⁵⁰

The Biggest 5-Tube Value on the Market

Positively the world's greatest 5-tube radio bargains. Regular \$75.00 value. Our large quantity production enables us to sell this set for only \$29.50, fully built and wired in beautiful mahogany cabinet of latest design with sloping Bakelite panel of Satin finish, handsomely etched and engraved as illustrated. Constructed of the finest low-loss condensers, coils and sockets. Bakelite baseboard panel and dials. Price for set only. **\$29⁵⁰**

This set with all accessories, including the famous American Bell loud speaker with adjustable unit, 2-45 volt "B" batteries, one guaranteed 100 Ampere Hour, rubber case storage "A" battery, cable for battery connection, 5-201A tubes, Aerial and ground equipment, and everything complete ready to set up and operate. Nothing else to buy. Price **\$59⁷⁵**



Order Direct from This Page! Save About One-Half!

Order direct from this page. Save $\frac{1}{3}$ to $\frac{1}{2}$. Our guarantee protects you. Money cheerfully refunded if you are not satisfied. Write your order and prices plainly. Send post office money order or bank draft for full amount to insure safety. Refer to any bank or commercial agency regarding our reliability. All kits described on this page shipped prepaid East of Rockies (except Canada). American Radynola and the 5-tube Radio Frequency receiver shipped charges collect.

SEMI-FINISHED 5-TUBE RADIO FREQUENCY SET

\$18⁷⁵



This special offer is astounding the radio world. Coast to coast reception on loud speaker. Low loss condensers and sockets. Highest quality transformers. Bakelite rheostats. All wiring concealed under Bakelite baseboard. 7x18 panel—fits into any standard 7x18 cabinet. Complete instructions for operating. Guaranteed saving to you of \$50.00. Price of set all mounted, \$18.75. Cabinet of same model as American Radynola pictured above \$5.65 extra.

You must have our catalog no matter what set or kit you want. Our line is complete and includes all popular sets, such as Superheterodyne, Neutrodyne, Ultradyne, Reinartz, Regenerat'v, Radio Frequency, Browning-Drake, Super-Heterodyne Reflex and all other latest circuits. Kits, sets and parts manufactured by all well known manufacturers such as Frost, Howard, Baldwin, Brandes, Western Electric, Columbia and others.

Our semi-finished sets come with all parts mounted on panel and baseboard ready for wiring. Do not fail to send for our catalog. Remember—we are the largest exclusive radio mail order dealers in the world and carry the best of everything in radio. We save you $\frac{1}{3}$ to $\frac{1}{2}$ on the following kits. Detailed descriptions appear in our catalog.

SEMI-FINISHED 8-TUBE SUPER-HETERODYNE

\$43⁷⁵



World's Famous 8-tube superheterodyne.

Fully mounted on panel and baseboard. Comes completely assembled ready to wire and operate. We have testimonials from thousands of builders of this set. Some have received foreign stations on loop aerial. Unsurpassed in volume and tone quality. Low-loss straight line frequency condensers, vernier dials, finest quality rheostats. Matched Reinder or Columbia long waved transformers. Requires only three screws for attaching panel and baseboard and set is ready to operate. 7x30 panel. Price of set only \$43.75.

Requires following accessories to complete this set: 7x30 cabinet, 8-201A tubes for storage battery operation or No. 199 tubes for dry cell operation. 100 Ampere hour storage battery, 2-45X "B" batteries, loud speaker, center tapped loop aerial. All these items are listed in our catalog at a tremendous saving.



Catalog includes list of broadcasting stations, general radio information and facts about our free service division. Write for it today.

NEUTRODYNE
Genuine licensed Neutrodyne kit of parts, come fully assembled on the panel and baseboard with complete instructions, ready to wire. Price, **\$29.75**

COCKADAY
3-tube Cockaday kit of parts, fully assembled on panel and baseboard, ready to wire. Price **\$15.85**

REFLEX
4-tube Acme Reflex does the work of 7. Fully assembled on panel and baseboard, ready to wire. Price, **\$38.65**

ULTRA-AUDION
One-tube Ultra-Audion, Wizard of radio. Fully assembled and ready to wire. Price with instructions, **\$6.35**

RANDOLPH RADIO CORPORATION
159 N. Union Ave. Dept. 12 Chicago, Illinois

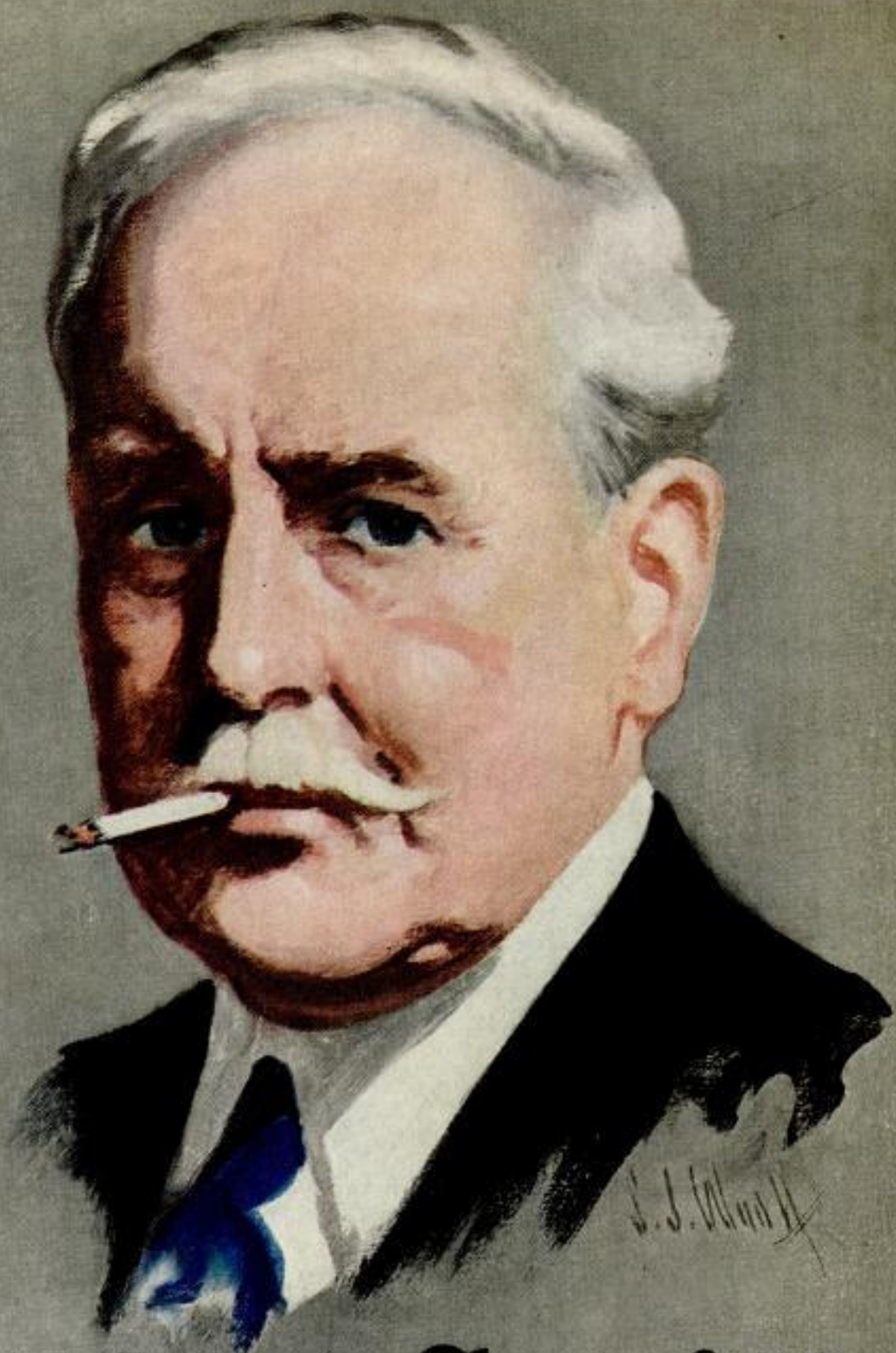

**On taste alone, Chesterfield
has won the endorsement of
men in every walk of life**

SUCH · POPULARITY · MUST · BE · DESERVED
LIGGETT & MYERS TOBACCO CO.