

APRIL

Radio in the Wilderness

N.S.E.

25 CENTS

POPULAR MECHANICS MAGAZINE

WRITTEN SO YOU CAN UNDERSTAND IT

REG. U.S. PAT. OFF. TRADE MARK GREAT BRITAIN No. 410426

REG. U.S. PAT. OFF.



SEE PAGE 547



McSweeney will train YOU for an Auto Expert's job in 60 Days!

Earn from \$3000.00 a year up

Ask for my Big FREE AUTO BOOK

As operator of three great Auto, Tractor, and Electrical Training Shops, one in Cincinnati, one in Cleveland, and one in Chicago, I can make you a Big-Pay Expert, just as I have done for thousands of my students, who are now independent, happy, "fixed" for life in the fastest-growing industry in the world.

I get calls every day from Garages, Repair Shops, Battery Stations, and auto, truck and tractor owners, for McSweeney-Trained Experts. The jobs pay anywhere from \$50.00 a week UP. YOU ought to have one of those positions—and in 60 days I can qualify you for them.

SEVEN BILLION DOLLARS

It is estimated that \$7,000,000,000.00 will be spent for autos, trucks, tractors, and repair work in the year 1925. Get your full share of this tremendous sum—you can if I train you in my practical Job Method.

Own Your Own Business

Hundreds of McSweeney-Trained men own their own businesses. They will employ none but McSweeney-Trained men, because they know what my training means to any man.

GET OUT OF THE RUT

You must make your own decision. Will you stay in the same old rut, getting nowhere? Or will you turn to the road to SUCCESS—the road to big-pay auto jobs—the road to being your own boss? Naturally, you're going to decide to get what you really want in this world—you're going to take the first step by mailing me the coupon and getting my 64-page illustrated FREE Auto Book and my Special offer to you.

I TEACH WITH TOOLS

My three great Shops are equipped with everything needed to make you an expert on all makes of cars, trucks and tractors. I show you how to do every kind of repair and rebuilding job—and then you DO THAT JOB YOURSELF, just as you will after you start out for yourself. When I give you a diploma you will Know Your Stuff!

I'LL PAY YOUR RAILROAD FARE AND YOUR BOARD

This offer, together with my special reduced tuition, is exactly what I'm making you, to help you come to my Shops. I'll pay your railroad fare to my nearest shop, and will board you for eight weeks. This offer is subject to withdrawal without notice, so send the coupon TODAY to my shop nearest your home.

Ask about my Home Training Plan

J. H. McSWEENEY, President

Proof!

Here are the actual RECORDS of a few of the thousands of McSweeney-Trained men who are making big Successes:

A. J. Beall, Jr., Morgantown, W. Va., made \$86,000.00 last year with his garage and agency.

George Smith, West Alexandria, O., is clearing over \$800.00 a month in his garage.

"I found your shops even better equipped than you advertised," writes Staley Feather, Hazleton, W. Va.

"Your shops made my profitable garage possible," writes L. L. Pohlman, Aurora, Ind.

Peckham Johnson, Grassy Creek, Ky., is "drawing a nice salary from an electrical company."

J. A. Young "landed a fine job the day I left Mac's shops."

"I recommend your shops every chance I get. Your training made me a success," Colby Lord, Oakland, Maine.

"Three days after I left your shops I landed a fine job in one of the largest garages in town. I'm doing fine."—C. L. Alabran, Punxsutawney, Pa.

J. H. McSweeney, Pres. (Dept. 1420)
McSweeney Auto and Electrical Training Shops

Dear Mac: Send me your big Free Auto Book, and full details of your Special Reduced Tuition offer, giving me Free Railroad Fare and Free Board.

Name

Address

City or R. F. D. State

No Facilities for Colored Students in Resident Courses.

McSweeney Auto and Electrical Training Shops

Write to my Shop nearest your home

CINCINNATI, OHIO
Ninth & Walnut

[Dept. 1420]

CHICAGO, ILL.
517 S. Laffin

CLEVELAND, OHIO, 1815 East 24th

Music

Far away in a spacious hall, a great orchestra unrolls the rich melody-pattern of a master symphony. Far away in a vast cathedral, an organ pours forth the theme of an age-old hymn. Far away in a world-famed opera house, a drama is revealed in song.

Far away—but with a turn of the dials—*near!* Near—vivid—real—with the Radiola Super-Heterodyne. You are part of the audience—a silent, moveless listener to magical sounds.



Radiola Super-Heterodyne

Brings in far stations without ground or antenna—gets the station you want—gets it simply—clearly! Its tone is as famous as its performance.

This symbol of quality  is your protection

"There's a Radiola for every purse"

RADIO CORPORATION
OF AMERICA
Sales Offices: Suite No. 514
233 Broadway, New York
10 So. La Salle St., Chicago, Ill.
28 Geary St., San Francisco, Cal.

Radiola

REG. U.S. PAT. OFF.

This One



3UHF-OEZ-RC9K

CONTRACTORS AND CARPENTERS MAKE BIG MONEY!



YOU CANNOT AFFORD TO STAND STILL

Radford's Cyclopedia of Construction

will show you how to step ahead of your friends to enjoyable, well paid, independent work. Carpenters, masons, and builders are earning big money. Contractors are making big money and becoming wealthy. You don't want to stand still and let your friends snap up the same chances that are offered to you. It is the natural ambition of every red-blooded man to keep ahead of his fellows.

If you are a carpenter, you don't want to stick to the hammer and saw all your life. If you are a contractor or builder, don't you want bigger work than just houses and barns? You want to do the big work where the big money is.

You have the chance within your grasp to get this necessary training. This remarkable offer is direct to you. No matter

how much work you have or how well you are being paid for it—this offer holds as much interest for you as for the man who is out of work.

Remember, there is always work in the building trades for the trained man. Accept our liberal offer. You have the privilege to

TWELVE VOLUMES

Sent for Only

\$1.00

**We Pay
Express
Charges**

**EXAMINE BOOKS
AT OUR EXPENSE**

All you have to do is to write your name and address plainly on the coupon at the bottom of this page, pin a dollar bill to it and mail it to us. We trust you as a member of the building trade and send you the entire set of books immediately. We prepay all express charges and thus it does not cost you one penny for examination. When you get the books they are yours for five days free examination just as leisurely and as carefully as you please. If you should decide you do not want to keep the books, merely notify us that you are returning them. We pay express charges both ways. We will refund your deposit upon their delivery to us without any red tape or haggling whatever.

**Special FREE Premiums
if you order at once**

If we receive your order at once, we will send with this Cyclopedia one year's subscription (12 numbers) to the American Builder, the world's greatest building paper. We will send free of all extra cost, one complete set of blue printed working plans and typewritten specifications of any of the houses illustrated in the three Books of Plans, which we also send to you free of cost, so that you may make your selection. These plans will be very valuable to contractors, builders and draughtsmen. These plans and specifications are as complete as those charged \$50.00 to \$75.00 for by many architects. The only reason we can offer to do this is because we have the largest architectural establishment of its kind in the world, and are able to produce these complete blue printed working plans and specifications at the very lowest possible price, and to the purchasers of this Cyclopedia we are willing to give the benefit. Without American Builder \$1.00 loss.

RADFORD ARCHITECTURAL COMPANY
1827 Prairie Ave. Chicago, Ill.

P. M.
425

**Radford
Architectural
Company
1827 Prairie
Ave., Chicago**

Please send me, express prepaid, your 12-volume Cyclopedia of Construction, for five days' free examination, with privilege of return at your expense. I enclose \$1.00 deposit which you agree to return if I decide not to keep the books after examination. If I keep the books, I will pay \$3.00 a month until the special price, \$37.50 is paid, otherwise I will notify you within five days after receipt of books.

Your offer also includes Three Big Plan Books (over 300 designs) and one full year's subscription to the American Builder. You also agree to furnish set of Blue Prints and Specifications, if ordered within 2 months after acceptance of books.

Name

Street

Town.....State.....

West of Rocky Mountains and Canada, \$3.00 with this order. Full amount must accompany all Foreign orders.

PIN A DOLLAR BILL TO THIS COUPON AND MAIL TODAY!

NO-RISK GUARANTEE COUPON

Popular Mechanics Magazine

200 E. Ontario Street, Chicago, U. S. A.

H. H. WINDSOR, Founder

H. H. WINDSOR, Jr., Editor and Publisher

London: Hachette & Cie.,
16-17 King William Street, Charing Cross, W. C. 2

Paris: Hachette & Cie.,
111 Rue Reaumur

Melbourne: Gordon & Gotch
509-513 Little Collins St.

ISSUED MONTHLY

SUBSCRIPTION:

SINGLE COPY, 25 CENTS

In United States and its possessions, also Canada, Cuba, and Mexico, per year, postpaid - \$2.50

To all other countries in the Postal Union - 3.00

All subscriptions are discontinued at expiration. Please examine the date printed on your wrapper.

Entered as Second Class Matter Sept. 15, 1903, at the Post Office at Chicago, Illinois, under Act of March 3rd, 1879.

Entered as Second Class Matter at the Post Office Department, Canada.

Published monthly by POPULAR MECHANICS CO.

Copyright, 1925, by Popular Mechanics Co.

Copyright in Australia. Copyright in France

Vol. 43

Contents for April, 1925

No. 4

Advertising	Crimes—machine gun kept on guard in bank	540
signs on backs of ushers announce coming attractions	Cross Word Puzzle—handkerchief patterned after	532
skywriting	Deaf—hear by touch on telephone	545
Agriculture—model farm saves steps	Disabled—war veterans turn pioneers	594
Airplanes	Diseases—diabetes fought with artificial fat	624
how safe is an airplane?	Dust—portable electric blower for cleaning plant	593
speeding plane hooks on blimp	Eclipse—proves sun's effect on radio reception	538
with revolving wings	Electric Lighting—finger lamp throws light on work	540
Armatures—giant, for Russian power plant	Electric Wiring—flat conduit for electric wiring	592
Astronomy	Elephants—eat twenty-three hours a day	596
theater, in Munich, of the stars teaches astronomy	Fingerprints—prints of monkeys' hands compared with criminals	555
Athletics—science and sports records	Fire Apparatus—artificial snowstorms to freeze fires	629
Automobiles—autos shipped in paper sacks	Fire Protection—firemen's helmet held by guard band	583
Automobiles—Equipment and Supplies	Fish—goldfish farms	587
bumper fitted as winch to relieve stalled car	Fishing—salmon eggs as fish bait	588
cigar lighter and spotlight combined	Fog—density of, shown by gauge	546
double tire carrier for truck	Foundry—sea-going foundry for U. S. navy	560
glass side curtains—changed without tools	Furs—chinchilla fast disappearing	604
neutral gear control	Garages—Equipment and Supplies—high-pressure car washing plant	563
Automobiles—Fuel	Garden Tools and Appliances—seed planter operated by hand	603
fuel wasted on level used in climbing hills	Gasoline—dummy at auto filling station	626
supercharger for racer motors	Gauges	
Automobiles—Lighting	auto gasoline gauge with humps	609
parking lights in door handle	gauge dial tells fuel supply of plane	623
shade on headlight stops glare and focuses rays	Geysers—harnessed to steam pipes to turn dynamo	639
Automobiles—Locking, etc.—push-button lock for ignition	Gold	
Automobiles—Radiators—screen for racing autos	electric dredges that dig for gold	623
Automobiles—Repairing—hand cleaner for engine bolt holes	what becomes of gold mined	640
Automobiles—Safety Devices	Golf—putter and stymie jumper fits either hand	578
bumper cuts off ignition and applies brakes	Hammers—three-pronged wedge for	609
front light tells if stop lamp is lit	Heaters—oil, for concrete mixing	635
signals for both ends of auto	Heaters—Electric	
Aviation	portable electric steam radiator operates from light socket	546
airman knocked out by wind	portable, with fan	648
organ of balance to guide airmen resembles human ear	Heating Plants—circulator for warm air furnaces	598
Bacteria—friendly germs made into serum	Horses—tame horses trained to be wild	639
Beauty	Household Devices	646
false eyelashes on adhesive tape	Household Devices—floor polisher and waxer	583
mirror in flap on cuff of glove	Houses—steel, built in single day	570
Boats and Boating	Hydroplanes	
air-propelled boat steered by swinging motor	shot from battleships with smokeless powder "gun" with hull like a boat and wheels for landing	592
oarsmen more efficient than steam or electric motors	Icebergs—heat radiated by icebergs to warn ships	607
Boots and Shoes—lightweight rubber sole with studs prevents slipping	Inventions—national museum for industries to honor inventors	644
Boxes—pasteboard suit box with handle	Irrigation—two-mile dam across Nile river	617
Bricks—portable cleaner for old brick	Jacks—hydraulic oil jack for autos	644
Bridges—memorial bridge to span Potomac	Lakes—leaks in Elk lake stopped with plugs	572
Calculating Machines—"steel brains" figure bonus millions	Light—racing light beams uphold Einstein theory	634
Camping—portable comforts for	Lubrication—pneumatic railroad track greaser	640
Candles and Candlesticks—candle in lamp floated in water	Lumber and Lumbering—log "submarines" cut cost of homes	584
Cathedrals	Magnifying Glasses—telescope magnifier for the weak-sighted	561
pillars of cathedral of St. John the Divine, New York	Masks—mask guards athlete's eyeglasses	543
Caves—new underground wonderland found in Virginia	Mattresses—and pillows of rubber inflated with air	587
Cigar Folder—collapsible, fits into watch charm case	Models	
Cities—ghost towns of the west	toy castle of cardboard masonry	607
Clocks	Mosquitoes—cost of railway's war on	577
inclosed in table lamp stand	Motorcycles—taxi-sleds solve northern snow problems	608
works of watch run two-foot clock	Mountain Climbing—Mount Everest climbers suck oxygen through pipe	538
Concrete—anchor for holding bolts in concrete	Moving Picture Photography—bees filmed by camera-men in masks	604

Tool box 632

Plans in old machine [Continued on Page 4]
Bathing suit 552
Machine in Bank. 540

Radiator portable clean 546

[Contents—Continued]

603

CS copy of 1931

591

592

593

594

595

596

597

598

599

600

601

602

603

604

605

606

607

608

609

610

611

612

613

614

615

616

617

618

619

620

621

622

623

624

625

626

627

628

629

630

631

632

633

634

635

636

637

638

639

640

641

642

643

644

645

646

647

648

649

650

651

652

653

654

655

656

657

658

659

660

661

662

663

664

665

666

667

668

669

670

671

672

673

674

675

676

677

678

679

680

681

682

683

684

685

686

687

688

689

690

691

692

693

694

695

696

697

698

699

700

701

702

703

704

705

706

707

708

709

710

711

712

713

714

715

716

717

718

719

720

721

722

723

724

725

726

727

728

729

730

731

732

733

734

735

736

737

738

739

740

741

742

743

744

745

746

747

748

749

750

751

752

753

754

755

756

757

758

759

760

761

762

763

764

765

766

767

768

769

770

771

772

773

774

775

776

777

778

779

780

781

782

783

784

785

786

787

788

789

790

791

792

793

794

795

796

797

798

799

800

Wardrobe—folding, fits in suitcase..... 609

Warships

latest, built to fight airplanes..... 543

tilt battleships to elevate guns, plan of Edison... 603

Waste Products—waste reclaimed in one chain of plants... 583

Weather—influence shown by tests at zoo..... 578

Whistles—visible air whistle on motorboats..... 625

Wind—aero dynamo to produce electricity on farms... 596

Writing—writer pens 600 words on postage stamp... 631

Yosemite—modeled in cardboard and clay..... 630

AMATEUR MECHANICS

Amber—cement for..... 652

Automobiles—Equipment and Supplies—holder for auto lamps..... 659

Automobiles—Ignition

curing wet weather ignition trouble on Ford..... 660

preventing spark plugs from fouling..... 662

Automobiles—Repairing

removing dents in fenders..... 658

Baths—bathing pool at water's edge..... 651

Boats and Boating

making centerboard well splashproof..... 668

old tires make boat fenders..... 667

Brakes—expanding brake shoes..... 663

Built-In-Furniture—Part V.—Clothes closet linen cabinet..... 665

Carpentry—driving small tacks..... 652

Churn—repairing gasket on barrel..... 659

Cupboard—portable picnic..... 652

Dahlias—growing from seed..... 662

Electric Wiring—finding blown fuse..... 649

Furnaces—how to fire..... 661

Garden Tools and Appliances

collapsible seedling box..... 659

reel for garden hose..... 660

Glass—putting a shine on windows..... 663

Jacks—simple wooden..... 652

Lighting

inexpensive wall light bracket..... 668

lantern trolley for dairy barn..... 663

Mail Box—revolving support for..... 662

Novelties—making novelties with glue..... 653

Photography—bromide paper negatives..... 668

Pipes—Tobacco—making pipes "sit up"..... 660

Wells—ornamental brick well..... 667

Woodwork—turning wooden disks on circular saw... 658

SHOP NOTES

Alcohol—using wood..... 695

Automobiles—Equipment and Supplies—carrying brackets for touring car..... 690

Automobiles—Repairing

filling cylinder score without removing motor from auto..... 698

handy auto trouble mirror..... 694

replacing Ford crankcase cover..... 689

securing Ford dust rings..... 693

Boats and Boating—boat railway for small yacht repairs..... 699

Brass—castings, substitute for..... 695

Cellars—cooling and ventilating farm..... 692

Clamps—for flexible tubing..... 698

Cleanliness—refuse chute for store..... 694

Concrete—protecting eccentric on cement mixer..... 701

Conduits—cleaning underground..... 700

Connecting Rods—production methods on..... 691

Drills

counterweight for electric hand drill..... 695

radial drill press for small shop..... 687

sensitive drill press handle attachment..... 702

Dynamite—safety in handling..... 694

Ebonite—machining and finishing..... 689

Efficiency—Industrial—checking railroad section gangs..... 685

Files—filing without scratching..... 685

Garden Tools and Appliances—device for covering up seeds..... 701

Hoists—trailer, for small contractor..... 683

Jacks—using jack for vise..... 685

Jewelry—soldering..... 692

Lathes

bed brackets..... 702

cutting Woodruff keys in..... 697

Pistons—lapping..... 693

Poultry—dressing..... 691

Signs and Signboards—lettering show windows..... 695

Soils—mixing..... 684

Tinsmith—tinning small work..... 693

Tools—double capacity tool box..... 693

Wire—unwinding rack for fence wire..... 696

Done all... *staircase track & rear 64*

DRAKE'S PRACTICAL MECHANICAL BOOKS

THEY WILL RAISE YOUR PAY—

ORDER ON 5-DAY TRIAL

The books listed below will perfect you in your chosen trade—pave the way to the big positions. Written in non-technical language—easy to read and understand. **Every book covers its subject completely. An entire course of instruction condensed into one volume.** Your choice sent postpaid—you benefit 5 days—money refunded in full if not entirely satisfactory. Order direct from this page.



Automobile Books

- Automobile Starting, Lighting and Ignition, by Manly. 700 pp. Leatherette \$3.00
 Brookes' Automobile Handbook, 1924 Edition. Leatherette \$2.00
 Ford Motor Car, Truck and Tractor, by Manly. Cloth \$1.50
 Starting and Lighting Troubles, Remedies and Repairs, by Manly. Leatherette \$3.00
 Automobile Battery, Care and Repair, by Manly. Leatherette \$2.00
 Automobile Catechism and Repair Manual. Leatherette \$1.50
 Tires and Vulcanizing, by Tufford. Cloth \$2.00
 Gas and Oil Engine Handbook. \$1.50
 Automobile Upkeep and Care, by Manly. Cloth \$1.50
 Motorcycle Handbook, by Manly \$1.50

Shop Practice Books

- Sheet Metal Workers' Manual. Leatherette \$2.00
 Oxy-Acetylene Welding and Cutting. Cloth \$1.25

ORDER DIRECT FROM THIS PAGE—ON OUR MONEY-BACK PLAN

The books listed above are only a few of the many in our catalogue, which you will receive promptly after filling out and mailing us the attached coupon. For quick action order direct from this page—cross name of each book wanted and send in with price quoted. We prepay postage and send the books on our money-back plan.

FREDERICK J. DRAKE & CO.

PUBLISHERS

1008 Michigan Ave., Chicago
 Drake Books Are For Sale at All Book Stores

Mail Coupon For Free Catalogue
 Your Guide to Home Study

- Slide Rule and Logarithmic Tables. Leatherette \$2.00
 Handbook for Millwrights. Cloth \$2.00
 Modern Blacksmithing. Cloth \$1.25
 Machine Shop Practice. Cloth \$2.00
 Mechanical Drawing and Machine Design. Cloth \$2.00
 Pattern Making. Cloth \$1.50

Carpentry Books

- Cloth Binding
 Modern Carpentry, 2 vols. \$3.00
 The Steel Square, 2 vols. \$3.00
 Wooden Boat and Shipbuilding. \$1.50
 Modern Estimator. \$1.50
 Timber Framing. \$2.00
 Builder's Architectural Drawing. \$2.00
 Concrete. \$1.50
 Practical Bungalows. \$1.00
 Low Cost Homes. \$1.00
 Roof Framing, by Van Gasbeek. \$1.50
 Stair Building and Hand Railing. \$1.50

Electrical Books

- Telephony, Including Automatic Switching, by Smith. 450 pp. Leatherette \$2.50
 Practical Applied Electricity. \$2.00
 Alternating Current. \$1.50
 Electric Motor Control Systems. \$1.50
 Wiring Diagrams and Descriptions. \$1.50
 Electrical Tables and Data. \$1.50
 Armature and Magnet Winding. \$1.50
 Modern Electrical Construction. \$1.50
 Modern Electric Illumination. \$1.50
 Electricians' Operating and Testing. \$1.50
 Motion Picture Operation. \$1.50
 Drake's Electrical Dictionary. \$1.50
 Electric Motors, D. & A. \$1.50
 Electrical Measurements and Meter Testing. \$1.50
 Drake's Telephone Handbook. \$1.50
 Easy Experiments. Cloth \$1.25
 Wireless Telegraph and Telephone Handbook. Cloth \$1.25
 Telegraphy Self-Taught. Cloth \$1.25

Steam Engineering

- Swingle's Handbook for Steam Engineers and Electricians. Leatherette \$4.00
 Examination Questions and Answers for Marine and Stationary Engineers. Leatherette \$2.00
 Steam Boilers. Leatherette \$2.00
 Swingle's Catechism of Steam, Gas and Electrical Engineering. Leatherette \$1.50

Painting Books

- Interior Wall Decoration, by Vanderwalker. Leatherette \$4.00
 The Mixing of Colors and Paints, by Vanderwalker. Cloth \$2.00
 Scene Painting and Bulletin Art. Cloth \$4.00
 A Show at Show Cards. Cloth \$4.00
 Sign Painting. Cloth \$4.00
 Strong's Book of Designs. Leatherette \$4.00
 Strong's Art of Show Card Writing. Cloth \$4.00
 Signist's Alphabets. Cloth \$1.50
 Modern Painter's Cyclopedia. Cloth \$2.00
 Automobile Painting. Cloth \$1.50
 Estimates, Costs and Profits, Painting and Decorating. Cloth \$1.50
 New Hardwood Finishing. Cloth \$1.50
 The Amateur Artist. Cloth \$1.50
 New Stencils. Cloth \$1.25
 Chalk Talk and Crayon Presentation. Cloth \$1.25

Farm Books

- Farm Mechanics. Cloth \$1.25
 Farm Buildings. Cloth \$1.25
 Farm Engines. Cloth \$1.25
 Traction Farming. Cloth \$1.50

Business and Reference Books

- Better Business Letters. Cloth \$1.00
 Better Business English. Cloth \$1.00
 Better Advertising. Cloth \$1.00
 Finger Prints Simplified. Cloth \$1.25
 Practical Bricklaying. Cloth \$1.25
 Practical Instruction for Detectives. Cloth \$1.00
 Practical Plumbing. Cloth \$1.50
 Hot Water Heating. Cloth \$1.50
 Elementary Chemistry. Cloth \$1.50
 Courses in Civil Service. Cloth \$1.50
 Cyclopedia of Recipes. Cloth \$1.50
 American Star Speaker. Cloth \$1.50

Modern Languages

- By Prof. P. S. Allen, U. of Chicago
 French without a Teacher. Cloth \$1.25
 Spanish without a Teacher. Cloth \$1.25
 German without a Teacher. Cloth \$1.25
 Everyday French. Cloth \$1.25
 Everyday Spanish. Cloth \$1.25

FREDERICK J. DRAKE & CO.
 1008 Michigan Avenue
 Chicago, Ill.

GENTLEMEN:—Please send me free, postage paid, your illustrated catalogue which lists and describes over 100 Practical Mechanical Books for Home Study.

My name is

and my address



Saved—\$29,808 a Year —80,000 Firms Need Traffic Managers

A few cents in freight rates can make or break a business.

Get that fact clearly in mind and you will understand why business houses are willing to pay five-figure salaries for men thoroly trained in the science of Traffic Management, and why this new and rapidly growing profession holds such fascination for the men who realize that the big job, the big salary, and the big opportunity come only when one can *show results*.

How It Was Done

Here's a case in point: The Sales Department of a large manufacturing concern in Illinois was trying to sell their product in Virginia. The contract at stake was a large one. Another firm apparently had been able to quote a lower price. It looked as though that firm would get the business.

Time was short, but the Traffic Manager was on the job. Acting on only a few days' notice, he was able to obtain the publication, by one of the railroads, of a 33½% reduction, which lowered the freight rate between the two points from 68c to 45c a hundred-weight. What difference did it make?

\$99.36 on each carload—*three cars moved for the price of two*—and it landed the contract. If the concern in question ships only a carload a day, this "slight difference" means a saving of \$29,808 a year!

This is a typical example of traffic management.

Traffic Management—a Field of Unlimited Opportunities

Again, the Traffic Manager of one of the leading firms making Kitchen Cabinets saved his company \$136,000 in 1923—just by working out a plan for shipping his product "knocked down" and packed in paper cartons. In that same year, the Woolworth Company saved—through the activity of its Traffic Department—\$200,000. The opportunities in the traffic field are *tremendous*.

In a recent article in a traffic magazine it was

stated that there were 80,000 firms who needed traffic managers immediately.

Is this condition your big opportunity? Is this the field in which you can double and triple your present income?

Only 2 cents and two minutes stand between you and the answer to those vital questions.

Simply indicate on the coupon the field in which you desire success, and we will send you without cost a book describing the LaSalle salary-doubling plan and the opportunities *in that field*.

Can you afford to turn the page without making this slight effort to insure your business future?

— — — — — Inquiry Coupon — — — — — LASALLE EXTENSION UNIVERSITY

The World's Largest Business Training Institution

Dept. 464-TR Chicago, Illinois

Please send outline of your salary-doubling plan, together with a copy of "Traffic Management," also copy of "Ten Years' Promotion in One," all without obligation.

**Traffic Management—
How Traffic Men Make Money**

Other LaSalle Opportunities

The LaSalle plan opens the way to success in every important field of business. Check below the opportunity that appeals to you.

- | | |
|--|--|
| <input type="checkbox"/> Business Management | <input type="checkbox"/> Banking and Finance |
| <input type="checkbox"/> Modern Salesmanship | <input type="checkbox"/> Modern Foremanship and Production Methods |
| <input type="checkbox"/> Higher Accountancy | <input type="checkbox"/> Personnel and Employment Management |
| <input type="checkbox"/> Railway Station Management | <input type="checkbox"/> Expert Bookkeeping |
| <input type="checkbox"/> Law—Degree of LL. B. | <input type="checkbox"/> Business English |
| <input type="checkbox"/> Commercial Law | <input type="checkbox"/> Commercial Spanish |
| <input type="checkbox"/> Industrial Management | <input type="checkbox"/> Effective Speaking |
| <input type="checkbox"/> Efficiency | <input type="checkbox"/> C. P. A. Coaching |
| <input type="checkbox"/> Modern Business Correspondence and Practice | |

Name.....

Present Position.....

Address.....



CARPENTERS

GUIDES THAT SOLVE PROBLEMS

A Complete Course in Practical Carpentry and Building Work

POCKET SIZE—
FLEXIBLE
COVERS—
3100 ILLUSTRATIONS
— 1600
PAGES

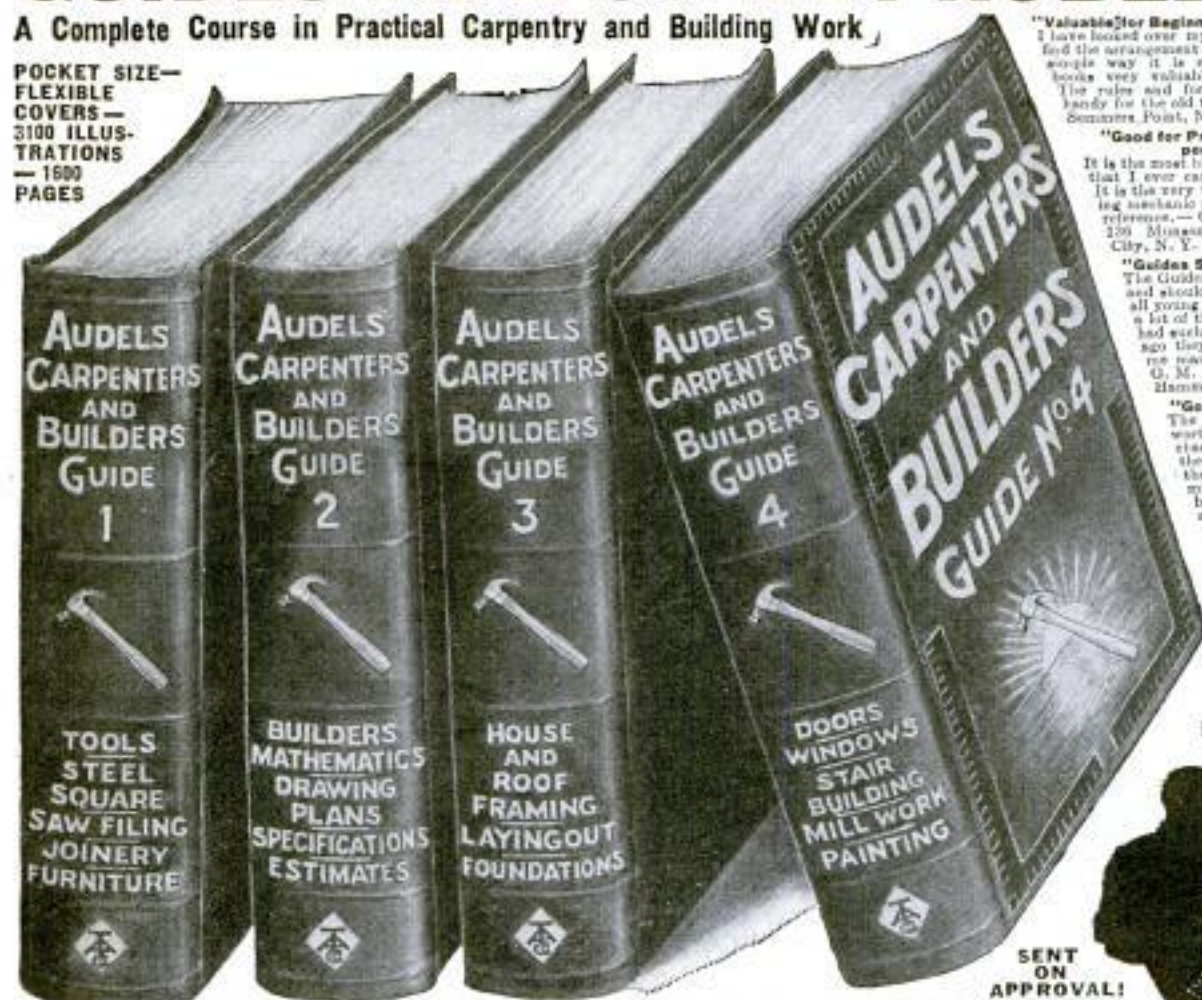

"Valuable for Beginners or Old Timers"
I have looked over my Audel Guides and find the arrangement of subjects and the simple way it is explained make the books very valuable for the beginner. The rules and formulas are mighty handy for the old timers.—Boss Smith, Somers Point, N. J.

"Good for Professional Carpenters"

It is the most handy reference work that I ever came in contact with. It is the very thing that the building mechanic needs every day for reference.—George H. Watson, 239 Mission St., Long Island City, N. Y.

"Guides Save Hard Knocks"

The Guides are truly wonderful and should be in the hands of all young carpenters as well as a lot of the older loads. If I had such information 20 years ago they would have saved me many a hard knock.—G. M. McJohnston, R. R. 1, Hammond, Ind.

"Good for Amateurs"

The books are surely worth more than the purchase price; especially as they serve as a guide to the non-professional like myself who is trying to build himself a home at the least expense.—Otto F. Schultz, P. O. Box 142, Westmont, Ill.

\$1

PER MONTH



SENT ON APPROVAL!

NEW IDEAS—MODERN METHODS—SHORT CUTS

This course, "Audel's Guides for Carpenters and Builders," consists of 4 handy volumes of over 1500 pages with thoroughly illustrated charts, diagrams, graphs, pictures with calculations for every job from making the excavation to constructing the entire building. You will find these new Guides most complete and comprehensive in addition to being both timely and practical. There are 3700 actual examples of efficient construction work with new methods, ideas, solutions, plans, systems, short

cuts, time and labor saving suggestions, new ways that cover the entire theory and practice of the subject illustrated by sketches and forms all specific and practical. Audel's Guides give you the short cut, professional information you want. No need to guess or take chances. Every day you have before you in this set the exact, practical, useful information that will help you with every job that comes up in your daily work.

HOW To Handle the Job That Puzzles YOU

There are thousands of examples of modern construction and building work—new methods, new ideas, proved efficiency plans, short cuts, time saving suggestions, new ways that cover the entire theory and practice of modern carpentry. Every point is easy to read and understand and clearly illustrated with sketches and forms. Inside Trade Informa-

tion for Carpenters, Builders, Joiners, Building Mechanics and all Woodworkers on—Care and Use of Tools—How to Use the Steel Square—File Saws—Make All Kinds of Joints—Draw and Read Plans—Write Specifications—Make Estimates—How to Frame Roofs and Houses—Lay Out Work—Put in Foundations—Full Instruction on In and Outside Building Work—Stair Building—Saw Mill Work—Practical Painting—Thousands of Short-Cuts that save time and money—Information usually obtained only by hard experience.

NO MONEY!

MERELY SEND COUPON AND LOOK THE SET OVER AT AUDEL'S RISK

THEO. AUDEL & CO., 65 West 23rd St., NEW YORK CITY
Send me for free examination AUDEL'S CARPENTERS AND BUILDERS GUIDES. I will send you \$1 within 5 days and mail \$1 monthly until \$5 is paid.

Name.....
Address.....
Occupation.....
Employed by.....
Reference.....

4-1-30

FREE

EXAMINATION

Not a cent to pay until you see the books. No obligation to buy unless you are satisfied. Fill in coupon in pencil. Send now—today—get this great help library for carpenters and builders.

Be a B. W. Cooke "Job-Way"

AUTO EXPERT

Learn
AT HOME
the
Cooke
"JOB-WAY"

Get into the World's Biggest Business!

Earn \$3000 to \$12,000 a year

Why, man, look into this Auto Business—it needs you! Send Coupon for my Big Free Auto Book right now! Think of it—Five Billion Dollars spent every year for AUTO UPKEEP ALONE! No matter where you live, this tremendous field offers unlimited opportunities — EVERYWHERE — for Cooke "Job-Way" Trained Experts.

Make \$60 to \$200 a Week!

Don't sell your time for a penny less! Hundreds of Big Pay Positions open right now, waiting for Cooke "JOB-WAY" Auto Experts—opportunities waiting for you. Just read my book. See how many BIG PAY opportunities there are and chances to start your own business—where \$3,000 to \$12,000 a year and more can easily be made.

Get All the FACTS—Clip Coupon Now!

Get my big Free Auto Book Quick! I'll send it to you without one penny of cost. No obligation. Read all the facts. Find out about the demand for Cooke-Trained Auto Experts. Start to make money quick like Morrison, Carter, Mayville and others! Let me tell you how easily and quickly YOU TOO may become an Auto Expert. Special Offer right now to ambitious men. Coupon brings complete information. Mail it now!

SEE HOW!

FREE 2 BIG REPAIR OUTFITS

MAIL COUPON NOW

**B. W. COOKE, Directing Engineer
CHICAGO AUTO SHOPS, Dept. 416
1916 Sunnyside Avenue, CHICAGO, ILL.**

Send me FREE Auto Book and proof that I can become an Auto Expert at home in spare time. Also send your special offers of 2 FREE outfits.

Name _____
Address _____

Tools and Test Bench Equipment FREE!

Many students use these outfits to make money shortly after starting my training. MAIL COUPON for offer.

I Bring the Automotive World RIGHT TO YOUR HOME!

You Don't Need to Leave Home! Stay Home! Job. Save Hundreds of Dollars. Students' letters in my Big Free Book prove that you needn't leave your doorstep! Read them. See why "JOB-WAY" is so thorough, so practical, and such easily learned Auto Training. Being a practical Directing Engineer, I know what practical, money-making training you need to be a BIG PAY Auto Expert—and THAT TRAINING I give you.

Experience or Education Not Needed! I don't care how little schooling you have. Men of all ages can become Garage Owners and Managers, Superintendents, Foremen, Auto Experts, in the class with BIG PAY executives, after completing Cooke "JOB-WAY" training. I guarantee Under Bond, that I will prepare you to take advantage of the many wonderful opportunities in the gigantic Auto Business!

No Other Training Like "JOB-WAY"!

B. W. Cooke is in no way connected with any other person or training of similar name. You get the original, genuine, copyrighted Cooke "JOB-WAY" training. Includes all Mechanical, all Electrical work, Ignition, Starting, Lighting, Welding, Brazing, also many other big features—everything to make you a HIGH SALARIED Auto Expert. CLIP COUPON NOW. GET MY BIG FREE BOOK! Find out how the training fits you for BIG PAY. See what it has done for others. MAIL COUPON TO ME RIGHT NOW.

Address me personally **B. W. Cooke** Directing Engineer
CHICAGO AUTO SHOPS
1916 Sunnyside Ave. Dept. 416 Chicago, Ill.



“I Was At The End of My Rope”

“WE lived in a fairly comfortable home, but it was a terrific struggle to make both ends meet. I couldn't save a cent and I was deeper in debt than I dared confess to my wife.

“I hadn't had a decent raise in years, and there were nights—too many of them now—when I lay awake for hours wondering what we would do if I ever lost my position.

“For other men were getting ahead of me and I knew that I couldn't stand still. I either had to go up or down. And I was afraid it was going to be down!

“Then suddenly one night it came to me like a flash that the reason I wasn't getting anywhere was mainly because I had never made any definite effort to make myself more valuable to the firm.

“I knew my own little routine job, but that was all. I was just one of the force to my employers. There was really no reason why they should think of me when a better position was open.

“That night I made my decision. ‘If the I. C. S. can raise the salaries of other men,’ I said to myself, ‘it can raise mine. If it can help other men to win promotion and have happier, more prosperous homes, it can help me, too. To-night, right now, I'm going to send in that coupon and find out what the I. C. S. can do for me.’

“It was the best move I ever made. My employers heard about my studying and started to take an interest in me. Six months after I enrolled with the I. C. S. I received my first increase in salary. Within two years I was head of my department. And I'm going still higher.”

An International Correspondence Schools course will help you just as it helped this man whose letter is reproduced here. It will help you to have the happy home—the bigger salary—the comforts that you want for your wife and your family.

For spare-time study is that vital something which makes one man succeed where one hundred fail—that lifts a man out of the rut and makes him a trained worker instead of just a “hand.”



Mail the Coupon today for Free Booklet

INTERNATIONAL CORRESPONDENCE SCHOOLS
Box 5700-D, Scranton, Penna.

Without cost or obligation, please send me one of your booklets and tell me how I can qualify for the position or in the subject before which I have marked an X:

BUSINESS TRAINING COURSES

- | | |
|--|---|
| <input type="checkbox"/> Business Management | <input type="checkbox"/> Salesmanship |
| <input type="checkbox"/> Industrial Management | <input type="checkbox"/> Advertising |
| <input type="checkbox"/> Personnel Organization | <input type="checkbox"/> Better Letters |
| <input type="checkbox"/> Traffic Management | <input type="checkbox"/> Show Card Lettering |
| <input type="checkbox"/> Business Law | <input type="checkbox"/> Stenography and Typing |
| <input type="checkbox"/> Banking and Banking Law | <input type="checkbox"/> Business English |
| <input type="checkbox"/> Accountancy (including C.P.A.) | <input type="checkbox"/> Civil Service |
| <input type="checkbox"/> Nicholson Cost Accounting | <input type="checkbox"/> Railway Mail Clerk |
| <input type="checkbox"/> Bookkeeping | <input type="checkbox"/> Common School Subjects |
| <input type="checkbox"/> Private Secretary | <input type="checkbox"/> High School Subjects |
| <input type="checkbox"/> Spanish <input type="checkbox"/> French | <input type="checkbox"/> Illustrating <input type="checkbox"/> Cartooning |

TECHNICAL AND INDUSTRIAL COURSES

- | | |
|---|--|
| <input type="checkbox"/> Electrical Engineering | <input type="checkbox"/> Architect |
| <input type="checkbox"/> Electric Lighting | <input type="checkbox"/> Architects' Blue Prints |
| <input type="checkbox"/> Mechanical Engineer | <input type="checkbox"/> Contractor and Builder |
| <input type="checkbox"/> Mechanical Draftsman | <input type="checkbox"/> Architectural Draftsman |
| <input type="checkbox"/> Machine Shop Practice | <input type="checkbox"/> Concrete Builder |
| <input type="checkbox"/> Railroad Positions | <input type="checkbox"/> Structural Engineer |
| <input type="checkbox"/> Gas Engine Operating | <input type="checkbox"/> Chemistry <input type="checkbox"/> Pharmacy |
| <input type="checkbox"/> Civil Engineer | <input type="checkbox"/> Automobile Work |
| <input type="checkbox"/> Surveying and Mapping | <input type="checkbox"/> Airplane Engines |
| <input type="checkbox"/> Metallurgy | <input type="checkbox"/> Navigation |
| <input type="checkbox"/> Steam Engineering | <input type="checkbox"/> Agriculture and Poultry |
| <input type="checkbox"/> Radio | <input type="checkbox"/> Mathematics |

Name.....
Street.....
Address..... 3-6-24

City.....State.....

Occupation.....

Persons residing in Canada should send this coupon to the International Correspondence Schools Canadian, Limited, Montreal, Canada.

Take Your Choice—Any One FREE

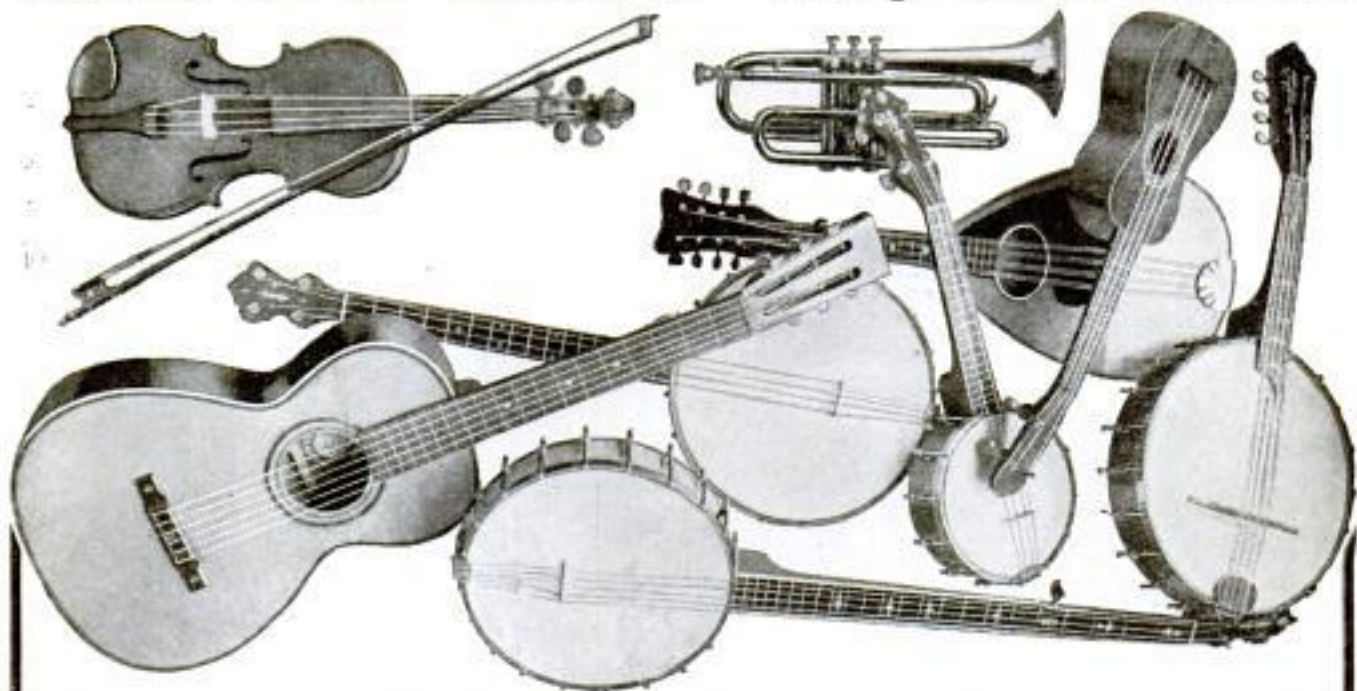

\$20 VALUE VIOLIN, MANDOLIN, GUITAR, UKULELE, HAWAIIAN GUITAR, BANJO, BANJO MANDOLIN, TENOR BANJO, CORNET or BANJO UKULELE **FREE**

And Learn to Play AT HOME in Your Spare Time for Profit or Pleasure

These high-class instruments are actually given away. They are free to pupils. Which one do you want? Which instrument do you want to learn? Send no money—just the coupon.

Everyone Loves Music

Our wonderful new system enables everyone to learn to play their favorite instrument in a few easy lessons. You can learn to play any of the instruments shown in a remarkably short time. Your spare time will do and **it only costs a few cents a week**. No charge for the instrument, just the lessons. That is your only expense. Why not mail the coupon today? You can be playing real music BY NOTE in a few short months if you do.

Play by Note in 4 Lessons

This new system is very simple. Anyone can understand it. You can be playing standard note music in 4 lessons. We guarantee this. You pay nothing if you fail and only a few cents a week for the lessons while learning, nothing for the instrument you want. Every lesson is complete; you go along in easy steps. Learn to play either for your own pleasure or for profit. Do not wait longer to become a musician and be popular among your friends.

Your Success Guaranteed

This is the most remarkable offer you ever read. Just think—the instrument FREE, only a few cents a week for the lessons and your success guaranteed or money back. Why should you delay? You have everything to gain and nothing to lose. Send the coupon now while the Free Instruments Offer is good. We reserve the right to withdraw it at any time without notice. You may never have the same chance again. **Send the Coupon.** *If you own a piano, organ or other musical instrument and want to learn to play it, write for special booklet and terms.*

Slingerland's Correspondence School of Music
Dept. 2 Lincoln Park P. O., Chicago, Ill.

COUPON

Slingerland's Correspondence School of Music
Dept. 2, Lincoln Park P. O., Chicago, Ill.

I want a _____ FREE and learn how to play it by your easy method. Please send me full particulars and detailed information. This request does not obligate me in any way.

Name _____

Address _____

City _____

State _____

LEARN ELECTRICITY

In Twelve
Weeks



In Great Shops!

Coyne trained Electrical Experts are in demand everywhere—because they are men who are practically trained and thoroughly trained for the Big Jobs in Electricity. Send that coupon to me now and see how I fit you for one of the thousands of BIG PAY OPPORTUNITIES in 12 short weeks! No obligation at all! Act quick!

Get
**This Big,
New Free Book!**

FREE! Send for it now. It's a book worth having. Handsomely bound. Beautifully illustrated. Size 12x15 inches. Shows dozens of actual photographs of Coyne students working in my BIG SHOPS. Gives others' experiences. Shows what you can do. Cost me a dollar, but it's yours free if you mail coupon. Do it now.



**NOW!
Radio
& Auto
Course
FREE**

Special Offer right now! I am including Absolutely Free my Big New RADIO COURSE and AUTO, TRUCK and TRACTOR ELECTRICITY.

Coupon brings full details.

Not by Correspondence
ALL PRACTICAL WORK AT
COYNE

Earn \$60 to \$200 a Week!

Clip that Coupon Right Now! Get my Big New Book—IT'S FREE! It points the way to Success for you. Crammed full of hard, dependable, proven Facts. Shows the way to Big Pay in the Largest, Most Interesting Money-Making Field—ELECTRICITY! Find out how a world of Opportunities can be opened up for you as a Coyne-Trained Electrical Expert. See what my PRACTICAL TRAINING has done for others. Read what they say about Coyne.

**I'll Make You An
Electrical Expert
In 12 Weeks!**

Yes, sir, I train you for the BIG JOBS in ELECTRICITY! Coyne IS NOT A CORRESPONDENCE SCHOOL! I train you—thoroughly—on hundreds of thousands of dollars' worth of Electrical Apparatus. You do ACTUAL WORK on REAL EQUIPMENT—the kind you use out on the job. That's why my students MAKE GOOD. That's why you Master Electricity in 12 WEEKS at Coyne!

**Coyne Trains You
For Life**

It makes no difference how little Education or Electrical Experience you have had. I'll make you an Electrical Expert through Coyne's LEARN-BY-DOING METHODS! I have done it for thousands. I will do it for YOU! At Coyne you get a life Scholarship. You can stay longer than the required time if necessary. You can return any time later to take up new work I am continually adding to keep my course up-to-date at all times.

**You Learn in Chicago
the Electrical Center
of the World**

Coyne students master Electricity right in the Electrical Center of the World. You see everything electrical here. Along with my Shop Training you visit the big organizations and power plants—learn their methods first hand.

Earn While You Learn

I back my students up. My Employment Dept. will assist you in getting a part time job to make a good part of your expenses while training. And it will help you get a BIG PAY JOB on graduation.

26 Years of Success

Remember Coyne is a School with an established REPUTATION. Endorsed by Electrical Industry. Over a QUARTER OF A CENTURY of Success that was earned by the BIG SUCCESSSES of Coyne Students. You owe it to yourself to find out what I can do for you. Clip the Coupon Now!

H. C. LEWIS, President.

MAIL THIS COUPON

H. C. LEWIS, President
COYNE ELECTRICAL SCHOOL, 1300-10 W.
Harrison St., Dept. 135-4, CHICAGO, ILLINOIS
Dear Sir:—Please send me, absolutely FREE, your big New Book and full particulars of your Special Offer of Two Extra Courses FREE.

Name.....

Address.....

H. C. LEWIS
President

COYNE

FOUNDED
1899

ELECTRICAL SCHOOL

Dept. 135-4 1300-10 W. Harrison St., CHICAGO, ILL.



THE HOP-OFF

Round-the-World Flyers
leave for Clouser Field,
Santa Monica, Cal., on
30,000 mile trip.
(Wide World Photo.)

Daring Young Men Needed in Aviation

THERE is no field of work in the world today which offers such amazing opportunities to young men of daring and who love adventure as does Aviation. Although still in its infancy, there is a crying demand in Aviation for young men with courage, nerve and self-reliance. For those who can qualify there will be thousands of highly paid jobs which will lead quickly and surely to advancement and success.

Big Opportunities Await The Trained Man

Look over the fields of work which are open to the young man today. You will find that Aviation is the ONE FIELD that is not overcrowded—the ONE FIELD in which there is plenty of room at the top. Think of it! Only 21 years ago Orville and Wilbur Wright made the world's first airplane flight. Now airplanes fly around the world. Yes, Aviation offers the same wonderful opportunities today that the automobile and motion picture industries did 15 and 20 years ago. Men who got in on the ground floor of those industries made fortunes before others woke up. AVIATION IS NEW! It clamors for nerry young men—and the trained man has the world before him in Aviation.

Easy to Become an Aviation Expert—\$50 to \$100 a Week

You can qualify now quickly for one of these exciting highly paid jobs through a new, sure, easy method of training. The study of Aviation is almost as interesting as the work itself. Every lesson is fascinating and packed full of interest. That's why Aviation is so easy to learn—you don't have to

force yourself to study—once you start, you can't get enough of it. Only one hour of spare time a day will give you the basic training in an amazingly short time.

One student, S. F. McNaughton, Chicago, says: "Your lessons are like a romance, and what is more, after one reading, the student gets a thorough understanding. One never tires of reading them." James Powers, Pa., another student says: "I am indeed surprised that such a valuable course can be had from such practical men for so little cost."

PREPARE For One of these POSITIONS

Aeronautical Instructor
\$60 to \$150 per week
Aeronautical Engineer
\$100 to \$300 per week
Aeronautical Contractor
Enormous profits
Aeroplane Repairman
\$60 to \$75 per week
Aeroplane Mechanician
\$40 to \$60 per week
Aeroplane Inspector
\$50 to \$70 per week
Aeroplane Salesman
\$5000 per year and up
Aeroplane Assembler
\$40 to \$65 per week
Aeroplane Builder
\$75 to \$200 per week

Personal Instruction by Experienced Men

Men who have had actual experience in Aviation give you personal attention and guide you carefully through your training. They select the lessons, lectures, blueprints and bulletins. They tell you the things that are essential to your success. Every lesson is easy to read and quickly understood.

Big Book on Aviation FREE

Send coupon below for New Free Book, just out, "Opportunities in the Airplane Industry." It is interesting and instructive and will show you many things about Aviation which you never knew before. Only a limited number offered—get yours before the edition is exhausted.



American School of Aviation

Dept. 1354

3601 Michigan Ave., Chicago, Ill.

AMERICAN SCHOOL OF AVIATION,
3601 Michigan Ave., Dept. 1354, Chicago, Ill.

Without any obligation, send me your Free Book, "Opportunities in the Airplane Industry," also information about your Course in Practical Aeronautics.

Name.....

Street.....

City..... State.....



Be an Electrical Expert



Go into Electrical Repair business of your own

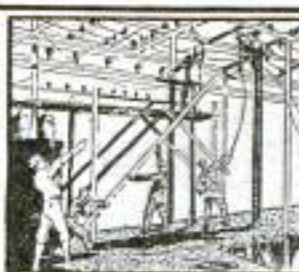

Boss Electrical Jobs



Be an Electrical Contractor



Chief Engineer Dunlap

22
Noted
Electrical
Engineers

This is no one-man, one-idea school. 22 famous Engineers and Executives of the following great corporations and universities helped me make Dunlap-training complete and up-to-date:

- | | |
|---------------------------------------|---|
| 1. General Electric Co. | 8. Underwriters Laboratories, Inc. |
| 2. Commonwealth Edison Co. | 9. Columbia University |
| 3. Crocker-Wheeler Co. | 10. Dartmouth College |
| 4. Celler-Hammer Mfg. Co. | 11. Massachusetts Institute of Technology |
| 5. American Telephone & Telegraph Co. | 12. Lehigh University |
| 6. Westinghouse Electric & Mfg. Co. | 13. University of Vermont |
| 7. Western Electric Co. | 14. Armour Institute of Technology |
| | 15. University of Kansas |
- AND MANY OTHERS



1. Wiring

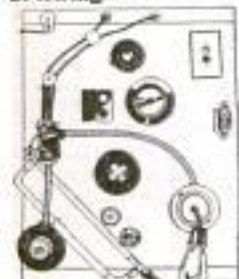

2. Wiring



3. Motor and Meter



4. Radio Set

Earn While You Learn

As early as your eleventh lesson, I give you special training in wiring, radio, repair jobs, etc. Many students easily earn cost of training in spare time. You can, too.

I Give You 4 Electrical Outfits

Dunlap "Job-Method" training makes it easy for you to understand Electrical theories and laws. With this complete valuable equipment which I send you without extra charge, you can master Electrical principles and practice instantly. Dunlap-trained Electrical Experts do not need any post-graduate Laboratory practice—they get it all at home with these 4 outfits.

"Do you Guarantee me a JOB?"

Mail Coupon For My New Guarantee!

The one thing you want to know about my home-training is "WILL IT PREPARE ME FOR A GOOD JOB AND A RAISE IN PAY?" Mail Coupon for my answer, for my written guarantee. If you are less than 40 years of age, if you are now earning less than \$40 a week, if you are ambitious to be an Electrical Expert and earn the Expert's pay, write me at once!

Go to Electrical School AT HOME!

I have made it easy for you to break into the great Electrical business. Dunlap-training prepares you AT HOME in your spare time for the BOSS JOBS in Electricity. Today ordinary Electricians earn \$10 to \$15 a day. With my training, with the backing of the AMERICAN SCHOOL you can beat that a mile! Real Electrical Experts are going to make BIG MONEY in the next few years. No other industry offers you so many wonderful opportunities. **Look into this NOW!**

Write Me AT ONCE!

You don't need ready cash to get my training. A few cents a day all you need. So don't wait. Find out quick how my new guarantee protects you. Find out all about your chances for succeeding in the Electrical business. Only common schooling required. **Rush coupon or write me immediately for all the facts.**

CHIEF ENGINEER DUNLAP

AMERICAN SCHOOL

Dept. EE-474
Drexel Ave. & 58th St.

CHICAGO

MAIL
COUPON
QUICK!

Chief Engineer Dunlap
AMERICAN SCHOOL

Dept. EE-474, Drexel Av. and 58th St.,
CHICAGO

I want to know about your guarantee. Also send me your free book and surprise offers quick!

Name.....

St. No.....

City.....State.....

MAIL
COUPON
TODAY

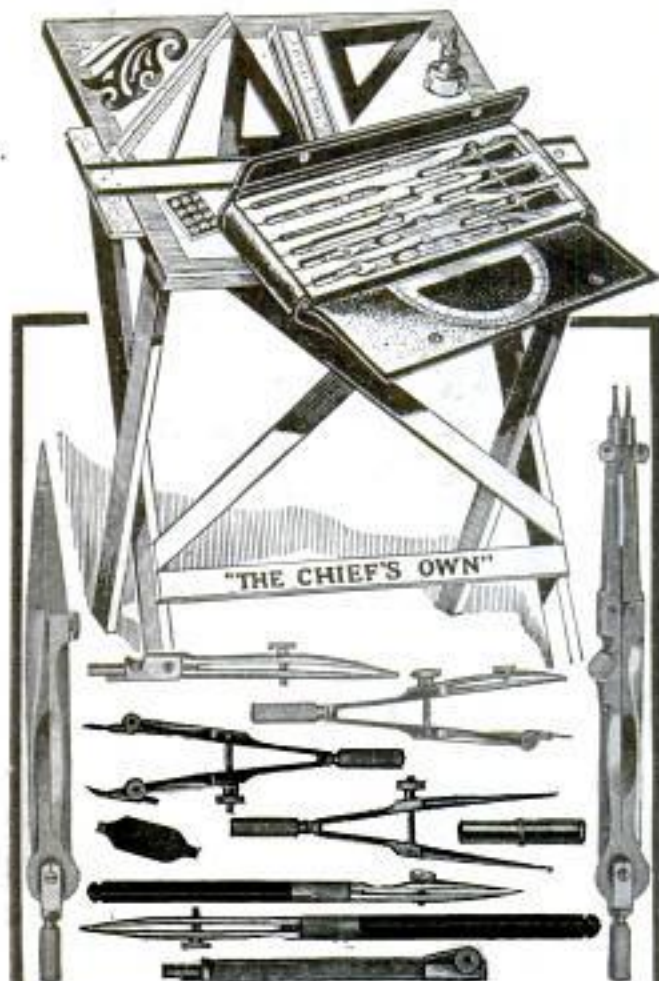

"THE CHIEF'S OWN"

No Extra Charge For This Outfit

As soon as you are my working student, I send you without extra charge, an adjustable and folding drawing table, complete set of imported drawing instruments, also other tools to complete full working outfit. I charge only a reasonable tuition for training you UNTIL YOU ARE QUALIFIED as a REGULAR draftsman.

I Guarantee

To train you on practical work under personal supervision until competent as a regular draftsman, and guarantee further to furnish you with draftsman's complete working outfit, a special "Chief's Own" table and all the instruments you need—just as soon as you become my student—all to be included in the course without extra charge.



Chief Draftsman Dobe

You May Earn a \$90 Drafting Course

by doing certain work for me at home during your spare time without interfering with your present work or position. Find out about this special offer I am making. There is constant demand for skilled draftsmen. Positions leading to something better and higher up. Many opportunities for high paid home work, by which you can double your regular salary. My free book tells about them.

Mail Coupon for FREE Book

CHIEF DRAFTSMAN DOBE
1951 Lawrence Ave., Div. 93-54 Chicago, Ill.
Without any obligation to me please mail your book, "Successful Draftsmanship," and full particulars of your liberal "Personal Instruction" offer to a few students.

Name..... Age.....
Address.....
Post Office..... State.....



Learn How to WRESTLE

In Your Own Home By Mail

Yes, learn to become an expert wrestler right in your own home, by mail, from the greatest wrestlers the world has ever known. Be an athlete, be strong, be healthy. Learn how to throw and handle big men with ease. Learn to defend yourself. All taught in our course of lessons, and illustrated with hundreds of charts and actual photographs by

Farmer Burns and Frank Gotch

Farmer Burns, "the grand old man of the mat," taught Frank Gotch, the World's Champion, all he knew about wrestling, so Gotch said. He will now teach you Scientific Wrestling—Physical Culture—Jiu-Jitsu—Self Defense. Every man and boy in America, no difference what age, needs this wonderful course of lessons. Write today—your name, age and address on a postcard or letter today—your name, age and address on a postcard or letter today—your name, age and address on a postcard or letter today. A splendid book on wrestling and physical culture. Write today stating your age.

Farmer Burns School of Wrestling, 1774 Range Bldg., Omaha

This Week's Book FREE

Ludwig

Trap Drummers! With one of the new Ludwig Trap Drum outfits you will be able to make from \$75 to \$200 a week. Nearly all famous drummers use Ludwig equipment. Write in today for full information on all outfits. LUDWIG & LUDWIG, The World's Largest Manufacturers of Precision and Rhythmical Instruments, Drum Makers to the Profession 1611 N. Lincoln St., Dept. 1354, Chicago, Ill.

TELEGRAPHY

(Morse and Wireless) and RAILWAY ACCOUNTING taught thoroughly. Big salaries; great opportunities. Oldest, largest school. Endorsed by Telegraph, Railway, Radio, and Government officials. Expenses low—opportunities to earn large portion. Catalog free. DODGE'S INSTITUTE, Jones St., Valparaiso, Ind.

LEARN WATCHMAKING

and become independent. Good-paying positions secured. Easy to learn. Send for FREE CATALOG. ST. LOUIS WATCHMAKING SCHOOL, Dept. 5, ST. LOUIS, MO.



Earn \$2000 to \$5000 Year Hundreds positions constantly open Become a Traveling Salesman

Get a position that enables you to travel, to see your country, to stop at the best hotels, to meet people of prominence, and that opens up an opportunity of advancement to

\$10,000 a Year and Up
Men — Women
16 Up

MAIL THE COUPON TODAY SURE!

FRANKLIN INSTITUTE
Dept. 8-702, ROCHESTER, N. Y.

Send me—FREE—information telling how to become a TRAVELING SALESMAN, and your book, "SCIENTIFIC SELLING SIMPLIFIED," containing simple lessons in salesmanship.

Name.....
Address.....

What Is a Bohunk?

A BOHUNK is a man who knows the right thing to do and then deliberately does the opposite. Sometimes we call these fellows fools. Sometimes we use stronger words to describe them. We laugh at them. We pretend they are funny. But we never respect them.

And still—how many fellows are just plain BOHUNKS and never realize it? They are given a good, clean body to start with. They know that this body is one of the most delicately constructed organisms ever put together. Their common-sense teaches them that they must not abuse it—and then: they eat every blame thing they can lay their hands on just to satisfy their appetites. They go on committing sins against their flesh that even a dog would not do. They know that their bodies need exercise just as much as they need food. And still they permit themselves to grow soft and flabby, accumulating poisons, disease and every kind of germ imaginable.

The wise man

Come out of it, fellows. Don't be a plain dumb Dora. Don't you realize you can't keep this up? You're really not living at all. You only think you are. Cut out this foolishness and get busy. Drive those decaying tissues out of your body. Throw out your chest and give your lungs a treat with some good, pure oxygen. Harden up those soft, flabby arms of yours. Take those rolls of jelly off your body. Get some honest-to-goodness muscle. Find out what real health and strength mean. You'll realize then how foolish you've been to go without it. It's been yours right along for the asking.

A new man in 90 days

Come to me and let me help you. You can't do it alone. You may think you can, but you'll find you are wrong again. This is my job. I've been doing this very thing for 15 years and I know just how it can be done. I'm going to pack one full inch of healthy muscle onto those arms in just 30 days. I'm going to add two inches to your chest in the same length of time. Yes, but that's nothing. I haven't done a thing yet. Now come the real works. Just watch 'em grow. I'm going to broaden your shoulders and deepen your chest. I'm going to stretch out those lungs of yours that are now sticking together like pieces of fly paper. Every time you take a breath you will feel the old oxygen shooting through your blood and making your whole body tingle with new life. I'm going to put some real pep into that old backbone. I'm going to build up those muscles in and around your vital organs. You will feel the thrill of vitality throughout your entire system. And all I ask is 90 days. Sounds good—doesn't it? You're darn tootin' it's good. It's wonderful. And the best of it is—I guarantee all this. Do you doubt me? Come on, then, and make me prove it. That's the stuff. That's what I like. Are you with me? Let's go.

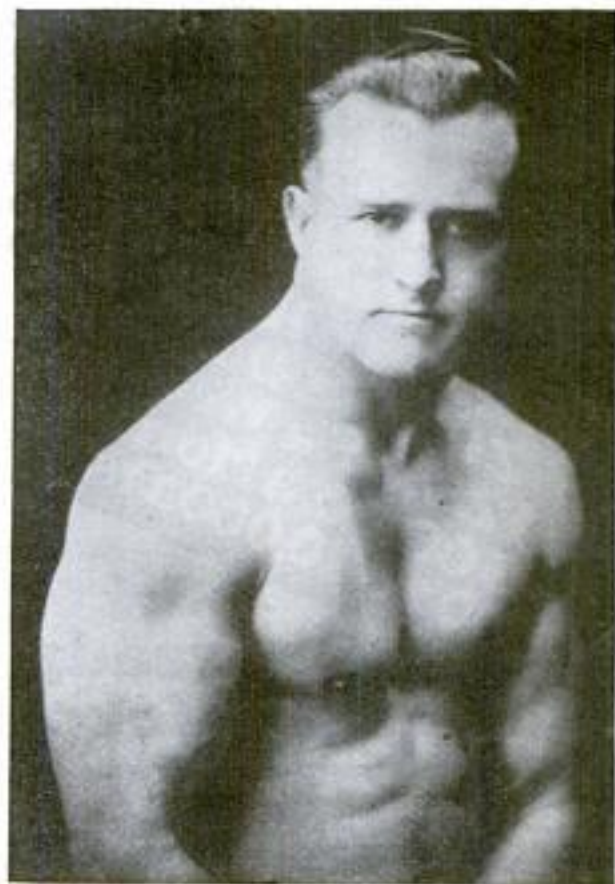

EARLE E. LIEDERMAN
The Muscle Builder

Send For My New
64 Page Book
"Muscular Development"
It Is FREE

It contains forty-five full page photographs of myself and some of the many prize-winning pupils I have trained. Many of these are leaders in their business professions today. I have not only given them a body to be proud of, but made them better doctors, lawyers, merchants, etc. Some of these came to me as pitiful weaklings, imploring me to help them. Look them over now and you will marvel at their present physiques. This book will prove an impetus and a real inspiration to you. It will thrill you through and through. This will not cost you one penny. I want you to have it with my compliments. It is yours to keep. This will not obligate you at all, but for the sake of your future happiness and health, do not put it off. Send today—right now before you turn this page.

EARLE E. LIEDERMAN

Dept. 2004 305 Broadway New York City

It Is F R E E	DON'T SEND ONE PENNY — YOUR NAME AND ADDRESS ON A POSTAL WILL DO	<p>EARLE E. LIEDERMAN Dept. 2004, 305 Broadway, New York City.</p> <p>Dear Sir: Please send me, absolutely free and without any obligation on my part whatever, a copy of your latest book "Muscular Development."</p> <p>Name.....</p> <p>Street.....</p> <p>City..... State.....</p> <p>(Please write or print plainly)</p>
--	---	--



I GUARANTEE

To give you personal, individual training in every branch of Dental Laboratory work, to make you expert in a few months!

\$3.00 an Hour
\$20.00 a Day
\$125.00 a Week
\$500.00 a Month
\$6000 to \$10,000 a Year

Get ready for these Jobs!

Where else can you earn such large salaries after only a few months of training? My training is the quickest way to BIG PAY. At my schools you become Expert in EVERY BRANCH of Dental Laboratory work, not merely skilled in some one part of it. That is why you will read letters in my book from McCarrie graduates telling of winning wonderful successes and enormous salaries.

Open a Laboratory!

That's the big thing my students and graduates aim for—a business all their own! Remember when you are a McCarrie-trained Dental Laboratory Expert IT TAKES VERY LITTLE CAPITAL to open a Laboratory of your own. So I say to my students and to you—train at my schools as the shortest road to a business of your own, good for profits of \$6,000 to \$10,000 a year.

Get This Book Quick!

It will show you how to pull yourself out of the rut, how to lift yourself out of small pay, hard work into the fascinating, professional life of the well paid Dental Laboratory Expert. You need this book if you are earning less than \$75 a week and want to make something of your future. Coupon brings it, mail it today!



H. A. McCarrie, Director, McCarrie Schools of Mechanical Dentistry.

1338-1340 S. Michigan Ave., Dept. 2001-D, Chicago

Send me your two free offers and your Book without cost or obligation. Tell me about the Dental Laboratory business and the training you give at your schools.

I attach letter stating the kind of work I am interested in while training at your schools.

.....Name

.....St. No.

.....CityState

Be a Dental Laboratory EXPERT!

With my training any fellow with a little mechanical ability can become a Dental Laboratory Expert in a few months! Here is a growing, uncrowded business calling for more experts than it can find—men trained as I will train you to make Crowns, Plates, Bridges, etc., for Dentists. This work is interesting, clean, easy. Salaries \$75 to start up to \$125 and more per week for EXPERTS. Why don't you investigate the wonderful opportunities of this profession and break away from poorly paid harder work?

"Work your way thru McCarrie School"

In Chicago (and Detroit) any ambitious fellow can with my help find a well paid position which will enable him to attend my schools evenings. Hundreds now at my schools. Hundreds who have graduated have done this. Others go to my schools days and work evenings.

Day or Evening Instruction

Don't let lack of ready money keep you back. I will help you. When you mail coupon for complete information, be sure and tell me what kind of work you are interested in, so I can arrange to place you at once when you arrive.

This picture shows how I train my students. No classes, no text-books. You learn on actual "cases" from ethical practical Dentists, you learn with standard instruments on actual materials at my schools. Individual, personal instruction, intensive methods, enable you to become expert in every branch of Dental Laboratory in only a few months.



This is Not a "Correspondence" School. You Learn Here by Doing Actual Dental Laboratory Jobs

FREE 1. R. R. FARE TO CHICAGO OR DETROIT
 2. COMPLETE OUTFIT

In order to encourage more men to go into Dental Laboratory work and meet the big demand from Dentists and Laboratories I am making extraordinary inducements right now! Even if you have only common schooling, no matter what your age, get all the facts about this wonderful business and my remarkable offers quick.

Coupon brings complete information, mail it or write immediately.

Address, H. A. McCARRIE, Director

McCarrie Schools of Mechanical Dentistry

Dept. 2001-D, 1338-40 So. Michigan Ave., Chicago

I Tell You

This Free Book Will Show You The Way to Amazing Salary Increases

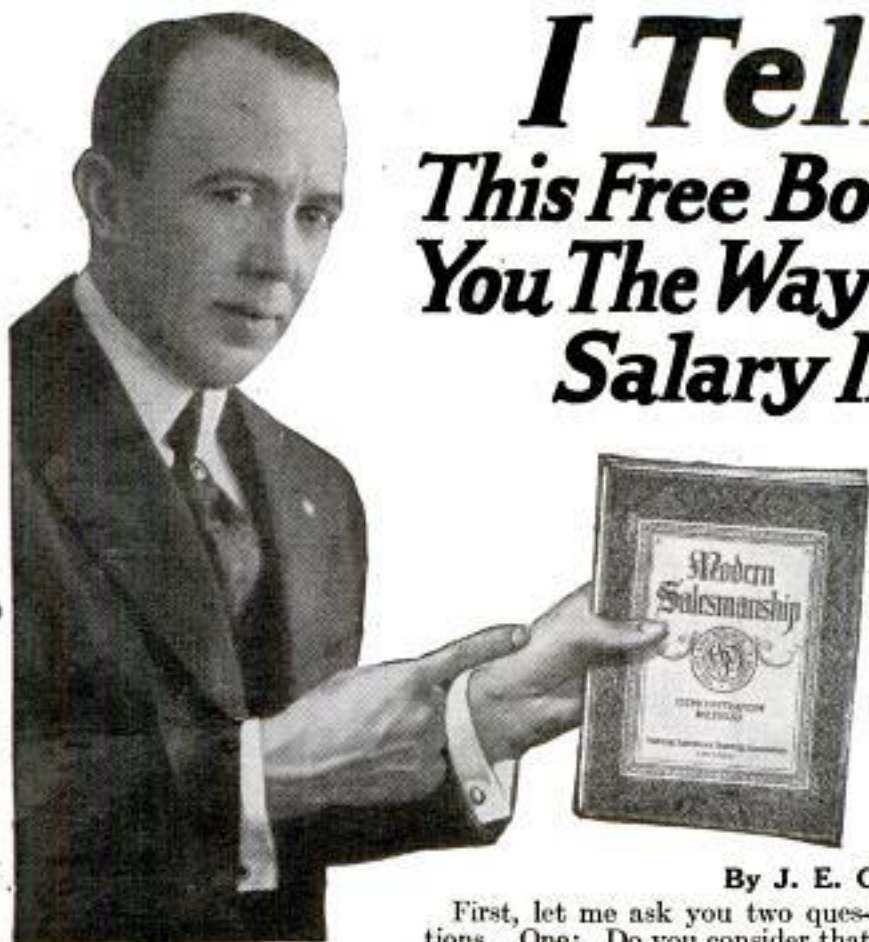

I only ask that you risk two cents on the strength of my word that the contents of this amazing book will show you the way to a prosperity that you never dreamed possible, in a fascinating field that you never thought of entering. This book is now free. Read my offer.

By J. E. GREENSLADE

First, let me ask you two questions. One: Do you consider that you are as intelligent as the average mail-clerk, farmhand, office clerk, mechanic, or bookkeeper?

Second: If you suddenly found yourself with all the money you needed to spend, wearing the best clothes, living in a fine neighborhood, driving a good car and belonging to the best clubs—but having to make good in a job that paid \$10,000 a year, would it scare you? There are men to whom \$10,000 a year is so much that the idea of earning it themselves never occurs to them. They will always be in routine jobs at low pay. Their dreams will never come true. But yours will if you will absorb what I am going to tell you.

Now, in one quick step you can enter the field where opportunities in your favor are ten to one—the Selling field. You know that Salesmen top the list of money-makers—that the salesman is his own boss—that his work is fascinating, interesting and highly profitable! But the thing you doubt is your own ability. All right, but you can become a first-class, money-making salesman in an amazingly easy way.

Proof That Salesmen Are Made—Not "Born"

The story of six men who once thought salesmen were "born," who did not believe they were "cut out for selling," is on this page.

Thousands of men like these six men who formerly thought salesmen were "born," are now enjoying magnificent earnings in the selling field. They were bookkeepers, mechanics, farmers, clerks—even doctors, lawyers and ministers—but in a few months after writing to the National Salesmen's Training Association they were out in the field selling—and making more money than they had ever hoped to make.

Sounds remarkable, doesn't it? Yet there is nothing remarkable about it. Salesmanship is governed by rules and laws. There are certain ways of saying and doing things, certain ways of approaching a prospect to get his undivided attention, certain ways to overcome objections, batter down prejudice, and outwit competition.

Just as you learned the alphabet, so you can learn salesmanship. And through the NATIONAL DEMONSTRATION METHOD—an exclusive feature of the N. S. T. A. System of Salesmanship Training—you gain the equivalent of actual experience while studying.

Years of Selling Experience in a Few Weeks

The N. S. T. A. System of Salesmanship Training and Employment Service will enable you to quickly step into the ranks of successful salesmen—will give you a big advantage over those who lack this training. It will enable you to jump from small pay to a real man's income.

Remarkable Book, "Modern Salesmanship," Sent Free

With my compliments I want to send you a most remarkable book, "Modern Salesmanship."

It will show you how you can easily become a Master Salesman—a big money-maker—how the N. S. T. A. System of Salesmanship Training will give you years of selling experience in a few weeks; how our FREE Employment Service will help select and secure a good selling position when you are qualified and ready. And it will give you success stories of former routine workers who are now earning amazing salaries as salesmen. Mail the coupon today. It may be the turning point in your life.

National Salesmen's Training Association
Dept. 12-D, N.S.T.A. Bldg., Chicago, Ill.

National Salesmen's Training Association
Dept. 12-D, N. S. T. A. Bldg., Chicago, Ill.

I simply want to see the facts. Send me free your book, "Modern Salesmanship," and Proof that I can become a Master Salesman.

Name.....

Address.....

City.....State.....

Age.....Occupation.....

READ!

\$12,000 a Year

A. H. Ward, Chicago, held a small-pay job. Now he averages \$12,000 a year as a salesman.

\$100 a Month to \$100 a Week in Only 3 Months

H. D. Miller, another Chicago boy, was making \$100 a month as stenographer in July, 1922. In September, 3 months later, he was making \$100 a week as a salesman.

\$150 to \$500 a Month

W. P. Clenny, of Kansas City, Mo., stepped from a \$150 a monthly clerkship into a selling job at \$500 a month. In one month he made \$850.

\$6,500 a Year

M. V. Stephens, of Albany, Ky., was making \$25 a week. He took up this training and now makes five times that much.

Small Pay to Big Earnings

J. H. Cash, of Atlanta, Ga., exchanged his \$75 a month job for one which pays him \$500 a month. Now Sales Manager at \$10,000 a Year

O. H. Malfroot, of Boston, Mass., stepped into a \$10,000 position as a SALES MANAGER—so thorough is this training. All these successes are due to this easy, fascinating and rapid way to master certain invincible secrets of selling.

EMPLOYERS

are invited to write to the Employment Dept. of the N. S. T. A. We can put you in touch with just the men you need. No charge for this service to you or our members. Employers are also cordially invited to request details about the N. S. T. A. Group Plan of instruction for entire sales forces. Synopsis and charts sent without obligation.

BE A DRAFTING EXPERT

Earnings up to
\$500
a month



C.E. Wesch
Chief of Staff
"BUILDER of SUCCESSSES"

I'll Train You for this Man's Job!

\$260 A MONTH
A lot better than \$125

Start to make money quick like E. Novak, of Freeland, Pa. Here's what "Job-Method" Training can do for you. Read this letter!

"I will write you a few lines to tell you how you have given me a trade and made a draftsman out of a laborer at \$4.50 for ten hours. Now it is \$20.00 for eight hours' easy work. Your training has helped me 100 per cent—more pay—less hours—and easier work."
"E. NOVAK."

Get this
FREE
Drafting
Book



2 PROFESSIONAL DRAFTING OUTFITS FREE!

For limited time only
TWO OUTFITS FREE.

Big set of Professional Instruments. Same Instruments Engineers use.

Also complete array of Drafting experts' Equipment. Write quick. Clip Coupon now for Special Offer and full information.

MAIL THIS COUPON NOW

C. E. WESCH, Chief of Staff, Associated Drafting Engineers, Dept. 419, 1920 Sunnyside Ave., Chicago, Ill.

Please send me your book, "Drafting the Foundation of Industry," absolutely free. Also complete information of your home-study Drafting course. Free Instruments and Special Offer.

Name.....

Address.....

Get into the Easiest, Finest, Most Fascinating Big Pay Work in the World!

If you're earning a cent less than \$50 a week, *clip coupon now!* Send for my **FREE BOOK.** See how you can become a Drafting Expert, *quickly, easily.* Positions everywhere. Short hours. Big Pay. Unlimited Opportunities.

Great Association of Practical Engineers Brings Famous "JOB-METHOD" Training Right to Your Home

Find out about (this Thorough, Easy, Simplified, Money-making Training. Common schooling all you need. We guarantee to train you successfully—**AT HOME,** with actual Drafting Jobs. Also 2 Professional Outfits **FREE!**

Personal and Individual Lifetime Consultation Service from Accredited Engineers **FREE** to you. Famous "Job-Method," **not** narrow, one-man viewpoint but the result of the combined effort and years of practical experience of famous Engineers. **FREE EMPLOYMENT SERVICE. POWERFUL ASSOCIATION BACKS YOU UP.** Send Coupon Now. Many other big-features special for limited time.

Address me personally

C. E. WESCH
Chief of Staff

Associated Drafting Engineers

We have taken over the famous old Coyne School of Drafting

1920 Sunnyside Ave.
Dept. 419
CHICAGO, ILL.

BIG PAY

Tremendous Opportunities

Amazing careers built on Drafting. The President of one of the greatest Railway Systems in America and President of Million Dollar Corporation started as Draftsman. Drafting Experts are in contact with **BIG MEN** in line for Promotion and **BIG PAY.**

Great Demand for Drafting Experts is your BIG CHANCE!

Factories, U.S. Government, States, Counties, Cities, Railroads, Ship Yards, all need **DRAFTING EXPERTS.** A. D. E. "Job-Method" Training fits you quickly for your choice of a thousand **Wonderful Opportunities.** Act now. Write for free Book.

C. E. WESCH,
Chief of Staff.

When I Overheard What She Said -I Learned Why I Was Unpopular



Only a whispered remark. Momentarily it stung me. Yet it taught me the real secret of popularity. For now I have a host of friends and I'm actually getting some real fun out of life. Here's how it all happened:

"I'm sorry, Dick, but I really should help Evelyn to prepare the refreshments—I know you won't mind."

It was the same old story, I thought bitterly. But why—? Doris was one of the few girls at the party whom I knew real well—yet even she avoided me.

I went out to the far end of the hall, sat down by myself, lighted a cigarette and thought.

The orchestra was playing a catchy, irresistible melody. Others seemed to be having the time of their lives. Yet here I was all alone—just an "outsider" looking on. Was it because I was a poor mixer—a bit more backward than other fellows?

I crushed my cigarette and resolved that I would join right in with the rest of the crowd, and have just as much fun as—

I stopped short. It was Doris's voice.

"Well, thank goodness, Evelyn, I was able to duck that dance with Dick Mitchell—why, he can't even fox-trot."

At that moment every nerve in me jumped. I wanted to say something—tell her just what I thought. Yet that would have only created a scene. No, I would not let them know that I overheard their conversation—and after all Doris was right. So that was the reason why I was unpopular.

Suddenly an idea dawned on me. I had read and heard of other fellows doing such things. I didn't know how true they were—but why not try it out and see, especially since I risked nothing?

I Sent for the Special 16-Lesson Course

The very next morning I mailed a coupon to Arthur Murray, America's foremost dancing in-

structor, asking him to send me his special proof course. I would show them that I could dance—not only the fox-trot but all the latest steps.

The full sixteen lesson course arrived promptly. Even without music or partner it was fun to follow the simple diagrams and instructions. Why, I was so tickled that the very next week I attended a "frat" party and I didn't miss one single dance the whole evening.

I never dreamed that knowing how to dance well could make any one popular so quickly.

Send today for Arthur Murray's special proof course. When your own postman hands the sixteen lesson course to you, simply deposit with him only \$1.00 plus few cents postage, in full payment. Keep the course five full days. Learn everything these sixteen lessons teach you. Arthur Murray personally guarantees your absolute satisfaction or you may return the course and your dollar will be promptly refunded. So clip and mail this coupon NOW. Arthur Murray, Studio 441, 801 Madison Ave., New York.

Arthur Murray, Studio 441,
801 Madison Ave., New York

To prove that I can learn to dance at home in one evening, you may send me the sixteen-lesson course and when the postman hands it to me I will give him \$1.00, plus few cents postage, in full payment. If within five days I decide to do so I may return the course and you will refund my deposit promptly.

Name.....

Address.....

City..... State.....



High School Course in Two Years!

You Want to Earn Big Money!

And you will not be satisfied unless you earn steady promotion. But are you prepared for the job ahead of you? Do you measure up to the standard that insures success? For a more responsible position a fairly good education is necessary. To write a sensible business letter, to prepare estimates, to figure cost and to compute interest, you must have a certain amount of preparation. All this you must be able to do before you will earn promotion. Many business houses hire no men whose general knowledge is not equal to a high school course. Why? Because big business refuses to burden itself with men who are barred from promotion by the lack of elementary education.

Can You Qualify for a Better Position

We have a plan whereby you can. We can give you a complete but simplified high school course in two years, giving you all the essentials that form the foundation of practical business. It will prepare you to hold your own where competition is keen and exacting. Do not doubt your ability, but make up your mind to it and you will soon have the requirements that will bring you success and big money. **YOU CAN DO IT.**

Let us show you how to get on the road to success. It will not cost you a single working hour. Write today. It costs you nothing but a stamp.

American School

Dept. H474, Drexel Ave. and 58th St., Chicago

American School

Dept. H474, Drexel Ave. and 58th St., Chicago

Send me full information on the subject checked and how you will help me win success.

- | | |
|-----------------------------|---------------------------|
|Architect |Business Law |
|Building Contractor |Lawyer |
|Automobile Engineer |Machine Shop Practice |
|Automobile Repairman |Mechanical Engineer |
|Civil Engineer |Shop Superintendent |
|Structural Engineer |Employment Manager |
|Business Manager |Steam Engineer |
|Cert. Public Accountant |Foremanship |
|Accountant and Auditor |Sanitary Engineer |
|Bookkeeper |Surveyor (& Mapping) |
|Draftsman and Designer |Telephone Engineer |
|Electrical Engineer |Telegraph Engineer |
|Electric Light & Power |High School Graduate |
|General Education |Wireless Radio |
|Vocational Guidance |Undecided |

Name.....

Address.....

We Teach COMMERCIAL ART

Meyer Both Company, the largest Commercial Art Organization in the World offers you a practical training based upon twenty-five years of success. This nationally known organization each year produces and sells to advertisers over 15,000 commercial drawings.

This well paid profession equally open to men and women. Home study instruction.

Get Facts Before You Enroll in Any School

Ask the Advertising Manager of the leading newspapers in your city about Meyer Both Company—let them tell you about us. Send four cents in stamps for illustrated book telling of the success of our students.

MEYER BOTH COMPANY

Department of Art Instruction

CHICAGO, ILLS.

Michigan Ave. at 20th St. Dept. 16

Note—To Art and Engraving Firms: Secure artists among our graduates. Write us.

STAMMER

If you stammer attend no Institute till you get my large FREE book entitled "STAMMERING, Its Origin and The Advanced Natural Method of Treatment." Ask for special attention rate and a FREE copy of "The Natural Speech Magazine," published monthly in the interest of those afflicted with stammering, stuttering and other speech impediments. Largest, best equipped and most successful school in the world for the cure of stammering. Established 20 years. No sing-song or time-beat. Write today. Millard Institute of Normal Speech, 2317 Millard Bldg., Milwaukee, Wis.

LAW STUDY AT HOME

Become a lawyer. Legally trained men win the highest positions and biggest success in business and public life. Be independent. Greater opportunities now than ever before. Big corporations are headed by men with legal training. Earn \$5,000 to \$10,000 Annually.

We guide you step by step. You can train at home during spare time. Degree of LL. B. conferred. LaSalle students practicing law in every state. We furnish all text material, including fourteen-volume Law Library. Low cost, easy terms. Get our valuable 108-page "Law Guide" and "Evidence" books free. Send for them NOW.

LaSalle Extension University, Dept. 464-L Chicago
The World's Largest Business Training Institution

MUSIC LESSONS FREE

IN YOUR OWN HOME

You can read Music like this quickly

Piano, Organ, Violin, Mandolin, Guitar, Banjo, etc. Beginners or advanced players. One lesson weekly. Illustrations make everything plain. Only expense about 2¢ per day to cover cost of postage and music used. Write for FREE booklet which contains everything in full.

AMERICAN SCHOOL OF MUSIC, 51 Lakeside Building, CHICAGO

Learn Photography at HOME

Make \$75.00 a Week on the Side

Establish yourself as a Photographic Expert quickly—during your spare time—under a leading photographer. I'll show you how to start your own business—on someone's large order. Send for my special offer—It's only temporary. Act at once. A postal will do. H. R. VANT.

INTERNATIONAL STUDIOS, Inc.
Dept. 1354 3601 Michigan Ave., Chicago, U.S.A.

INFORMATION

On every electrical subject arranged in **HANDY FORM** under these **CHAPTER HEADINGS**

Electro-Therapeutics
 Electric Shocks
 X-Rays
 Welding
 Brazing
 Soldering
 Heating
 Motion Pictures
 RADIO
 Radio Hook-ups
 Telephone
 Telegraph
 Electric Bells
 Cranes
 Elevators
 Pumps
 Electric Ship Drive
 Electric Railways
 Electric Vehicles
 Automobile Starting and Lighting Systems
 Ignition
 Generation & Transmission
 Electric Tools
 Plant Management
 Power Station Plans
 ARMATURE WINDING
 Armature Repairing
 A. C. Motors
 Alternator Construction
 Alternators
 D. C. Motors
 Dynamos
 Magnetic Induction
 Wiring
 Wiring Diagrams
 Electric Lighting
 Sign Flashers
 Cable Splicing
 Power Wiring
 Underground Wiring
 Outside Wiring
 Wiring Finished Buildings
 Tests
A. C. Apparatus
 (Switch Devices)
 (Current Limiting)
 (Lightning Protection)
 Rectifiers
 Converters
 Transformers
 Power Factor
 Alternating Currents
D. C. Apparatus
 (Switches)
 (Fuses)
 (Circuit Breakers)
 (Rheostats)
 (Watt Hour Rules)
 Electro Plating
 Electrolysis
 Storage Batteries
 Magnetism
 Electrical Energy
 Mechanical Energy
 Conductors
 Insulators
 Static Electricity
 Dynamic Electricity
 Magnetic Electricity
 Radio Electricity
 Recent Applications
 Ready Reference
 Index on all subjects

FREE EXAMINATION.
PRICE, COMPLETE, \$4
PAYABLE \$1 MONTHLY

**JUST OUT!**

KEY to a PRACTICAL UNDERSTANDING of ELECTRICITY

Audels Handy Book of Practical Electricity, \$4

Here is an up-to-date, quick Ready Reference. It gives complete instruction and inside information on every electrical subject. Every point clearly explained in plain language and diagrams that are easily understood. Handy to use. Easy to learn from. Subjects arranged in progressive manner for the student and with complete index which gives information instantly to professional workers. A time saver, money saver, and a helping hand for Engineers, Professional Electricians, Students and all interested in electrical work.

Valuable and Helpful Information

Audels Handy Book contains important and valuable wiring diagrams and calculations, machine sketches; instructions and helps on operation, maintenance and repair; outlines showing the entire theory and all modern, practical applications of elec-

tricity; and a big lot of good and useful RADIO information and diagrams. The use of Audels Handy Book of Practical Electricity will make you familiar with many time-saving, short-cut, profitable suggestions. As this handy, pocket-size volume covers the entire field of electricity in such convenient form it will prove to be a practical daily helper to both student and professional worker.

Handsomely Bound in Flexible Red Leather

Audels Handy Book is a magnificent volume that you will be proud to own and carry with you. Gilt Edged. Durable real leather binding. 1040 pages of strong white paper. Large Type. 2600 illustrations and diagrams. A mine of information and a most unusual value at only \$4.

FOUR DOLLARS COMPLETE
\$4 1040 PAGES
2600 ILLUSTRATIONS
LEATHER BOUND-POCKET SIZE

Send no money. Pay nothing to postman. Examine book absolutely free. No obligation to buy unless satisfied. If you want to keep the Handy Book, send \$1 within 7 days and \$1 monthly until \$4 is paid.

FREE EXAMINATION

For the past 40 years we have rendered a specialized educational book service—We accept payment for our books only after **examination** has proven to the purchaser that the books are worth the money. Use this valuable coupon now to take advantage of our free offer in securing

AUDELS Handy Book of Practical Electricity.

**FREE
 EXAMINATION
 COUPON**

Theo. Audel & Co., 65 W. 23rd St., N. Y. City
 Please send me AUDELS HANDY BOOK OF PRACTICAL ELECTRICITY for free examination. If satisfactory, I will send you \$1 in 7 days, then \$1 monthly until \$4 is paid.

Name.....

Address.....

Occupation.....

Employed by.....

This Man Is Sure of His Job



HE saw the handwriting on the wall. Men in his department were being dropped right and left. He might have been the next to go but for a familiar coupon which he saw one day in a magazine. He marked it, and mailed it to Scranton.

Then one day his employer called him in.

"Young man," he said, "I have just received a letter from the International Correspondence Schools telling me you have enrolled and have received a mark of 93 for your first lesson.

"I don't mind saying that this letter has saved your job. I had you on the list of men to be dropped. But I'm going to keep you now. The man who thinks enough of his future to study his job is the kind of a man we want around here."

HOW about you? Are you sitting on the anxious bench wondering if you will be the next to go? Or are you training yourself so that you will not only be sure of your present job but will be ready for the job ahead?

No matter where you live, the I. C. S. will come to you. No matter how limited your previous education, the simply-written, wonderfully-illustrated I. C. S. textbooks make it easy to learn. No matter what career you may choose, some one of the 300 I.C.S. Courses will surely suit your needs.

This is all we ask: Without cost or obligation, put it up to us to prove how we can help you. Just mark and mail this coupon. Today is best.

INTERNATIONAL CORRESPONDENCE SCHOOLS Box 3504-E, Scranton, Penna.

Without cost or obligation, please tell me how I can qualify for the position or in the subject before which I have marked an X:

BUSINESS TRAINING COURSES

- | | |
|--|---|
| <input type="checkbox"/> Business Management | <input type="checkbox"/> Salesmanship |
| <input type="checkbox"/> Industrial Management | <input type="checkbox"/> Advertising |
| <input type="checkbox"/> Personnel Organization | <input type="checkbox"/> Better Letters |
| <input type="checkbox"/> Traffic Management | <input type="checkbox"/> Show Card Lettering |
| <input type="checkbox"/> Business Law | <input type="checkbox"/> Stenography and Typing |
| <input type="checkbox"/> Banking and Banking Law | <input type="checkbox"/> Business English |
| <input type="checkbox"/> Accountancy (including C.P.A.) | <input type="checkbox"/> Civil Service |
| <input type="checkbox"/> Nicholson Cost Accounting | <input type="checkbox"/> Railway Mail Clerk |
| <input type="checkbox"/> Bookkeeping | <input type="checkbox"/> Common School Subjects |
| <input type="checkbox"/> Private Secretary | <input type="checkbox"/> High School Subjects |
| <input type="checkbox"/> Spanish <input type="checkbox"/> French | <input type="checkbox"/> Illustrating <input type="checkbox"/> Cartooning |

TECHNICAL AND INDUSTRIAL COURSES

- | | |
|---|--|
| <input type="checkbox"/> Electrical Engineering | <input type="checkbox"/> Architect |
| <input type="checkbox"/> Electric Lighting | <input type="checkbox"/> Architects' Blue Prints |
| <input type="checkbox"/> Mechanical Engineer | <input type="checkbox"/> Contractor and Builder |
| <input type="checkbox"/> Mechanical Draftsman | <input type="checkbox"/> Architectural Draftsman |
| <input type="checkbox"/> Machine Shop Practices | <input type="checkbox"/> Concrete Builder |
| <input type="checkbox"/> Railroad Positions | <input type="checkbox"/> Structural Engineer |
| <input type="checkbox"/> Gas Engine Operating | <input type="checkbox"/> Chemistry <input type="checkbox"/> Pharmacy |
| <input type="checkbox"/> Civil Engineer | <input type="checkbox"/> Automobile Work |
| <input type="checkbox"/> Surveying and Mapping | <input type="checkbox"/> Airplane Engines |
| <input type="checkbox"/> Metallurgy | <input type="checkbox"/> Navigation |
| <input type="checkbox"/> Steam Engineering | <input type="checkbox"/> Agriculture and Poultry |
| <input type="checkbox"/> Radio | <input type="checkbox"/> Mathematics |

Name.....

Street.....

Address..... 3-6-24

City..... State.....

Occupation.....

Persons residing in Canada should send this coupon to the International Correspondence Schools Canadian, Limited, Montreal, Canada.



LEARN BY DOING

Every phase of all branches of

ELECTRICITY

taught by

Actual Practice

In America's foremost and oldest institution for trade training

No Books Used

Individual Instruction Start Any Day

Write for FREE 64-page catalog

THE NEW YORK ELECTRICAL SCHOOL

44 West 17th St., New York City

BE AN ARTIST

WE CAN TEACH YOU DRAWING in your own home during your spare time. Twenty-five years of successful teaching proves our ability. Artists receive large salaries.

Write Today for Art Year Book

SCHOOL OF APPLIED ART
ROOM NO. 2, BATTLE CREEK MICH.



LEARN WATCH REPAIRING

Be a watchmaker—you can learn this profitable trade by correspondence in a few weeks in your own home by the DeSelms Chart System. After you complete the course you will know a watch from A to Z. You will know just what the matter is and how to repair it. When you graduate you will be a practical watchmaker and repairer and competent to fill any position. Positions for our graduates. Ask for our free book. It explains our system and terms.

THE DeSELMS WATCH SCHOOL
LOGANSPORT, INDIANA



Can you afford to

STAMMER? or STUTTER?

It ruins many chances for promotion. Send postage for large free book "The Correction of Stammering and Stuttering." Methods successful for over a quarter-century. THE LEWIS INSTITUTE, 33 Lewis Bldg., 155 Stinson Av., Detroit, Mich., U.S.A.

Wanted Men and Women to Learn Photography!

Photographers and Photo-Engravers earn \$200 to \$500 a month. The field is uncrowded. Learn these profitable and fascinating professions. Taught by largest and best college of its kind in the world. Established over 30 years. Demand for our graduates far exceeds supply. Good positions secured. Tuition and living expenses low.

Get this FREE Book! Write today for free book describing wonderful opportunities in this field.

Illinois College of Photography, Box 445, Effingham, Ill.



See How Easy It Is To Learn Music This New Way

YOU KNOW how easy it is to put letters together and form words, once you have learned the alphabet. Playing a musical instrument is not very much different. Once you learn the notes, playing melodies on the mandolin, piano or violin is simply a matter of putting the notes together correctly.

The first note shown above is F. Whether you are singing from notes, playing the piano or banjo or any other musical instrument, that note in the first space is always F. The four notes indicated are F, A, C, E, easy to remember because they spell the word "face." Certain strings on the mandolin, certain keys on the piano, represent these same notes—and once you learn them, playing melodies on the instrument is largely a matter of following the notes.

Anyone can now learn to play a musical instrument at home, without a teacher. A new simplified method of teaching reduces all music to its simplest possible form. You can now master singing, piano-playing, or any musical instrument you wish right at home, quickly, easily, without endless study and practice.

Practice is essential, of course—but it's fun the new way. You'll begin to play melodies almost from the start. The "print-and-picture" method of self-teaching is fascinating; it's simply a matter of following one interesting step after another. You learn that the note in the first space is F, and that a certain key on the piano is F. Thereafter you will always be able to read F and play it whenever you see it. Just as you are able to recognize the letters that make a word, you will be able to recognize and play the notes that make a melody. It's easy, interesting.

You don't have to know anything whatever about music to learn to play a musical instrument this new way. You don't have to pin yourself down to regular hours, to regular classes. You practice whenever you can, learn as quickly as you please. All the intricate "mysteries" of music have been reduced to a method of amazing simplicity—each step is made as

clear as ABC. Thousands have already learned to play their favorite musical instruments this splendid new quick way.

You Can Play Your Favorite Instrument Three Months From Today

If you are dissatisfied with your present work, let music act as the stepping-stone into a new career. If you long for a hobby, a means of self-expression, let music be the new interest in your life. If you wish to be a social favorite, if you wish to gain popularity—choose your favorite instrument and, through the wonderful home-study method of the U. S. School of Music, play it three months from today.

You can do it. Youngsters of 10 to 12 years have done it, and men as old as 60 have found new interest and enjoyment in learning how to play a musical instrument. You don't have to listen while others entertain any longer. YOU can be the center of attraction, the talented person who holds the audience fascinated.

Is it the piano you wish to play, the mandolin, the violin, the saxophone? Do you want to learn how to sing from notes? Are you eager to be able to play "jazz" on the clarinet, the banjo?

Free Book Explains All—Send Today

Send for our free book called "Music Lessons in Your Own Home." Everyone who is interested in music should send at once for this valuable book. It not only explains the wonderful new simplified method of learning music, but tells about a special short time offer now being made to music-lovers. With it will be sent an Illustrated Folder which proves, better than words, how delightfully quick and easy the famous Print-and-Picture Method is.

Mail this coupon at once for your copy. But act now before the supply is exhausted. U. S. School of Music, 74 Brunswick Building, New York.

Please Write Your Name and Address Very Plainly, so that there will be no difficulty about the booklet and folder reaching you.

U. S. SCHOOL OF MUSIC
74 Brunswick Building, N. Y. C.

Please send me your free book, "Music Lessons in Your Own Home" with introduction by Dr. Frank Crane, illustrated folder and particulars of your special offer. I am interested in the following course:

Have you above instrument?.....
Name.....
(Please write plainly)
Address.....
City.....State.....

LEARN TO PLAY ANY INSTRUMENT

Piano	Mandolin
Organ	Drums and
Violin	Traps
Banjo	Harmony and
Clarinet	Composition
Flute	Sight Singing
Harp	Ukulele
Cornet	Piccolo
'Cello	Trombone
Guitar	Saxophone
Hawaiian Steel Guitar	Automatic Finger Control
Voice and Speech Culture	Piano Accordion



Earn Big Money as a Cartoonist!

Millions of dollars were spent last year on comic strips, political and sport cartoons, animated cartoons, etc. Thousands of new cartoonists are needed now to meet the ever-increasing demand for this work. Never before have the opportunities in this fast-growing field been so many, so varied or so high-paying.

Easy Now to Learn CARTOONING at Home

Regardless of how little you know about cartooning now, you can easily qualify for a position in this attractive, high-salaried business. This home-study method starts you at the simplest fundamental principles of cartoon-making and takes you through every branch of humorous and serious cartooning. You will be amazed at how quickly it teaches you to draw salable work. Many students of this method began to sell their drawings before they were half through their courses. The training paid for itself long before they finished it.

Learn cartooning this easy way. Enjoy the fascinating life of a successful cartoonist—easy hours, freedom from routine, your own boss, and \$3,000 to \$15,000 a year for this work that is play!

Send for FREE BOOK

Learn more about the wonderful opportunities in Cartooning, and details about this remarkable home-study method. A handsomely illustrated booklet has just been prepared which, upon request, will be sent to you without the slightest obligation. This booklet gives a thorough outline of the cartooning field, and explains in detail this wonderful new method of teaching Cartooning. Send for it today! Washington School of Cartooning, Room 304C, 1113-15th St., N. W., Washington, D. C.



WASHINGTON SCHOOL OF CARTOONING
Room 304C, 1113-15th St., N. W., Washington, D. C.

Please send me, without obligation, your Free Booklet on Cartooning and full details of your home-study method of teaching Cartooning.

Name.....
(Print Name Plainly)

Address.....

City..... State.....
(If under 16, please give age.....)

TENOR BANJO

FREE! FULL SIZE WORTH \$18.

EASY TO PLAY

JAZZ

YOU CAN PLAY IT IN 30 MINUTES
40,000 successful students back up our guarantee that you can play a piece in 30 minutes by following our printed instructions. You get this \$18.00 TENOR BANJO, FREE, as soon as you enroll for 52 easy lessons. Now low prices and easy terms!

PICTURE LESSONS MAKE IT EASY
You can't fail to learn because the pictures explain every move. You don't have to be able to read notes. Better than oral instructions. We teach you in the largest conservatory, by mail.

PLAY FOR FUN OR MONEY
Don't be a wallflower. Get in on parties. Entertain your friends. Be popular. Play for dances, etc. Form an orchestra. Our 52 lesson course will make you an expert. Earn money in spare time.

WRITE FOR SPECIAL FREE OFFER
Famous teachers will explain how we can positively teach you to play. You get the free \$18.00 Tenor Banjo with the first lesson. Pay while you play. Write for other special courses under famous teachers for Hawaiian Guitar, Violin, Banjo Ukelele, Ukelele.

FIRST HAWAIIAN CONSERVATORY OF MUSIC, Inc.
Woolworth Bldg., Dept 60 New York, N. Y.

LEARN WATCH REPAIRING



You can learn by our modern and original system of instruction every part of the **Watch Repairing Trade** at home as good or better than at a shop. You can earn money while learning and secure a well paying position or start in business after completing our course of instruction. Good watch repairers are always in demand and earn from \$50 to \$75 per week. For particulars apply to the **Wisconsin School of Watch Repairing** 166 Mason St., MILWAUKEE, WIS.

A FILE

NOT A FILE

Stop Forgetting

Make Your Mind an index from which you select facts, figures, names, faces. Develop concentration, self-control; overcome bashfulness, forgetfulness.

Write today for FREE memory and concentration test and illustrated booklet, "How to Remember."

PROF. HENRY DICKSON
Dept. 7054 Evanston, Ill.

STAMMER NO MORE

KILL the fear of stammering. Re-education the key. The widely famed Hatfield Method fully outlined in an accurate, dependable, worthwhile book—"HOW TO STOP STAMMERING." It has inspired thousands. Free copy today!

THE HATFIELD INSTITUTE, 109 N. Dearborn, Chicago, Ill.

WHY NOT

spend Spring, Summer and Fall gathering butterflies, insects? I buy hundreds of kinds for collections. Some worth \$1 to \$7 each; simple outdoor work with my instructions, pictures, price-list. Send 10c (not stamp) for my Illustrated Prospectus before sending butterflies.

Mr. Sinclair, Dealer in Insects, Dept. 6, Box 1424, San Diego, Calif.

"STAMMERING

Its Cause and Cure"

You can be quickly cured if you stammer. Send 10 cents, coin or stamps, for 288 page cloth bound book on Stammering and Stuttering. It tells how I cured myself after Stammering and Stuttering for 20 years. **BENJAMIN N. BOGUE** 6920 Bogue Building, 1147 N. Ill. St. Indianapolis

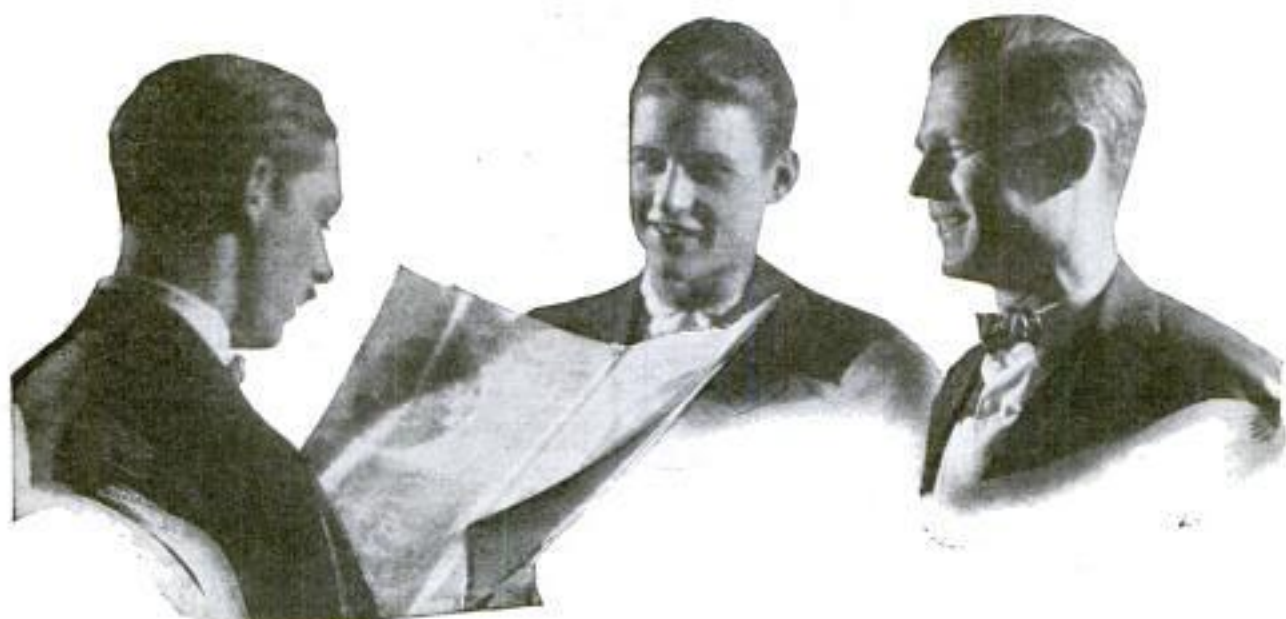

They Quit Laughing When He Got a \$5000 Electrical Job

Of course a lot of fellows laughed when B. G. Melrose told them he was going to become an electrical expert by twenty weeks' training at home. But Melrose knew. He knew that many other men have stepped quickly into big money success through the amazing Shop Type Training of the S & H Engineering Company (Affiliated with the Lincoln Institute of Technology). He filled out a coupon like the one below and that's why Melrose today has a big job paying more than \$400 a month.

You too, can fit yourself quickly for \$5,000 to \$10,000 a year positions or your own big business in electricity through this amazing training. I know exactly what you need to make you an electrical expert. Train only twenty weeks right in your own home. This amazing training is copyrighted and you can get it nowhere else. And remember I'll fit you for the \$5,000 to \$10,000 electrical jobs or I don't want one penny.

BIG FREE OUTFIT

I want you to decide for yourself. Merely fill out and send the coupon. I'll tell you about the big electrical outfit I will give free to help you in your training. Also I will send you my beautiful free book telling you a hundred or more things about electricity and the amazing big money opportunities it offers you—things which you have long wanted to know. Act at once. Send the coupon to

CHIEF ENGINEER BROWN

S & H ENGINEERING COMPANY

Affiliated with Lincoln Institute of Technology
1422 W. Monroe St., Dept. D-1, Chicago, Ill.

STEP QUICK INTO YOUR OWN BIG MONEY BUSINESS

Do like Unholz and Farina. They were common laborers but now after taking this amazing training they own the big Unholz and Farina Electrical Company, their own prosperous business. I have shown many men how to step into a big business of their own. And the beauty of it is I help you earn good money even while you are taking this quick, simple and easy training.

In 20 weeks
I'll fit you for
\$5000 to 10000
ELECTRICAL JOBS
or I Don't Want
a Penny

WARNING

**THIS TRAINING IS
COPYRIGHTED—
YOU CAN GET IT
NOWHERE ELSE**

Remember, this unsurpassed training of S. & H. and Lincoln Institute of Technology is copyrighted. You can get it nowhere else. Don't take chances. Be trained by experts. Fill out the coupon and I'll prove to you that there is no other training like this.

Chief Engineer Brown,
S & H Engineering Co.,
1422 W. Monroe St., Dept. D-1, Chicago, Illinois.

Please send me full particulars of your training in practical electricity and details of your remarkable free offer to those who enroll now. I understand this is free and obligates me in no way.

Name

Address

City State



He Lives Better on \$1,000 a Month! —Salesmanship the Answer

"My salary as a letter carrier," writes J. J. Graney, a California man, was \$1,500 a year. This is the top in the Post Office. After finishing six assignments of the LaSalle course in Modern Salesmanship, I had the opportunity to go with a real estate company, and I have made good. I have not worked nearly as hard since I have been selling, but have increased my earning power about 400 per cent. During September I earned \$225, October \$500, November close to \$700, and I expect to make \$1,000 this month . . ."

Are you—like Graney—following a well-organized plan to double—triple—quadruple your salary? Or are you relying for advancement upon business knowledge picked up thru day-to-day experience? LaSalle has added millions and millions of dollars to the earning power of its members. If a successful career is worth 2c and two minutes of your time, check on the coupon the field of advancement that appeals to you, fill in your name and address, and place it in the mail TODAY.

LASALLE EXTENSION UNIVERSITY
The World's Largest Business Training Institution
Dept. 464-SR Chicago, Illinois

Please tell me about your salary-doubling plan as applied to my advancement in the business field checked below. Send also copy of "Ten Years' Promotion in One," all without obligation.

- | | |
|---|--|
| <input type="checkbox"/> Modern Salesmanship | <input type="checkbox"/> Modern Business Correspondence and Practice |
| <input type="checkbox"/> Business Management | <input type="checkbox"/> Modern Foremanship and Production Methods |
| <input type="checkbox"/> Higher Accountancy | <input type="checkbox"/> Personnel and Employment Management |
| <input type="checkbox"/> Traffic Management | <input type="checkbox"/> Expert Bookkeeping |
| <input type="checkbox"/> Railway Station Management | <input type="checkbox"/> Business English |
| <input type="checkbox"/> Law—Degree of LL. B. | <input type="checkbox"/> Commercial Spanish |
| <input type="checkbox"/> Commercial Law | <input type="checkbox"/> Effective Speaking |
| <input type="checkbox"/> Industrial Management | <input type="checkbox"/> C. P. A. Coaching |
| <input type="checkbox"/> Efficiency | |
| <input type="checkbox"/> Banking and Finance | |

Name

Present Position

Address



Wonderful, new device, guides your hand; corrects your writing in few days. Big improvement in three hours. No failures. Complete outline FREE. Write C. J. Ozment, D-34, St. Louis, Mo.



WANTED!
U.S. RAILWAY
MAIL
CLERKS

STEADY WORK—NO LAYOFFS—PAID VACATIONS
TRAVEL—SEE YOUR COUNTRY
Many Gov't Jobs Open to Women—Mail Coupon Today—SURE

EARN '250 to '500 a Month

Expert Piano Tuners & Technicians in Big Demand Everywhere

This Fascinating Profession Needs YOU.

There are only 9900 competent tuners in the U. S. They are serving only one-third of the pianos in the country. The music industry needs you and will pay you well.

WE MAKE YOU AN EXPERT PIANO TUNER AND TECHNICIAN in 12 WEEKS

We guarantee to graduate you an Expert Tuner and Technician in approximately 12 weeks. Private instruction. You learn by doing. 24 Successful Years in Placing Experts in Big Pay Positions; Our Diploma Identifies You Everywhere. Go into Business for Yourself. Write us today for fascinating details.

You Don't Need a Musical Education to Get Into This Big Pay Class

Polk College of Piano Tuning

Dept. 18 480 Polk Building

LAPORTE, INDIANA
(Formerly of Valparaiso)

New \$85,000 Plant and Equipment.

How to
Make
\$250 to
\$500 a
Month

Send For
FREE
BOOK
TODAY

Ask for Our Special RR Fare Offer

LAW High-Grade Instruction By Correspondence Prepares You for the Bar—Est. 1892

University Methods. Standard Text-Books. Approved by Bench and Bar. Graduates practicing in every state. Send today for Free Catalog and Rules for Admission to the Bar. CHICAGO SCHOOL OF LAW, 802 Reaper Block, Chicago, Ill.



STUDY AT HOME

Directed by

The University of Chicago

Courses in English, History, Chemistry, Business, Education, Mathematics, Psychology, and 35 other subjects command credit toward a Bachelor degree. Begin any time. Address 15 Ellis Hall, University of Chicago, Ill.

EARN \$35 TO \$100 A WEEK



AS A MECHANICAL DRAFTSMAN. Write today for Free Book telling how we train you in spare time, at home, and help you secure a position. Fine set of professional Drafting Instruments furnished Free. Write today.

COLUMBIA SCHOOL OF DRAFTING

Dept. G-129, 14th & T Sts., N. W., Washington, D. C.



200 Kinds of IRON, WOOD and WIRE PUZZLES. Leader and Illustrated List 10 cents. Western Puzzle Works, C. St. Paul, Minn.

BE AN ARTIST

Comics, Cartoons, Commercial, Newspaper and Magazine Illustrating, Pastel, Crayon Portraits and Fashions. Our simple method quickly develops your talent in spare time. By Mail or Local Classes. Write for terms and list of successful Students. ASSOCIATED ART STUDIOS, Dept. B, 100 W. 23rd St., NEW YORK

\$1600 to \$2300 Year MEN—WOMEN 18 UP SHOULD MAIL COUPON IMMEDIATELY

Franklin Institute, Dept. B182, Rochester, N. Y.
Sirs: Send me, without charge: (1) Specimen Railway Mail Clerk Examination questions and free sample coaching lessons; (2) tell me how to get a U. S. Government job; (3) send list of places at which examinations will be held; (4) send copy of illustrated book, "How to Get Government Jobs."

Name

Address

Tom Plumridge, 34 years in the Auto business, is one of the world's greatest Automotive Maintenance Engineers. He has served BOLLING-HOYCE, PACKARD, and other great manufacturers, was Chief Instructor of Rotary Engines for the U. S. during the war. He knows what training an Auto Expert needs to Succeed AND HE GIVES YOU THAT TRAINING.



**EXPERT
AUTO
REPAIRS**
ALL MAKES

IGNITION
CARBURETOR
BATTERY
VULCANIZING
WELDING
PAINTING
TOWING

SALE OF USED CARS

YOUR NAME HERE

SUPPLIES

**BE
AN
AUTO
EXPERT**

If you are now earning less than \$40 a week, if you want to know what my home Auto training will do for you in dollars and cents, write me AT ONCE! I will give you a straight from the shoulder answer in plain English to your question: "Will you guarantee me an Auto Expert's job after I finish your training?"

**I Guarantee
you**



Go To Auto School AT HOME!

I have figured out an easy, sure way for you to become an Auto Expert at home, in your spare time. I invented this method of home-training and you can only get it from AMERICAN SCHOOL. Common Schooling all you need. Easy terms and low tuition places my complete training within your reach.

This is my idea of an AUTO EXPERT:

Yes, you've got to know all about the mechanical and electrical "upkeep" of autos, but you must know more to go after the BIG MONEY. You must know the business end, most of all. And so I train you in Garage Management, Automotive Advertising and Selling, Buying, Shop Practice; how to get business and take care of it, how to build good-will, etc. AMERICAN SCHOOL has been noted for business home-training for 28 years. You can't get better anywhere else. So you see I'm not talking about a mechanic's job at \$30 a week. My training makes you an all-round EXPERT—the Expert who owns or manages the whole business, who bosses the mechanics, the Expert who KNOWS autos, trucks, buses, taxis, tractors like A. B. C.

**TOM PLUMRIDGE, DIRECTING AUTO ENGINEER
AMERICAN SCHOOL** Dept. A-474, Drexel Ave.
and 58th St., CHICAGO

Raises, extra money for Students!

I don't waste a minute of your time with useless theory. Right from the beginning I give you practical instruction, short cuts, actual auto jobs to do. My "JOB-METHOD" combines home-training, actual experience, and money-making in a new way. Students engaged in auto work only part way thru my course, report frequent raises. Others say they earn as much in an evening as a whole month's tuition cost. So don't let lack of money (or anything else) keep you from getting my training. You, too, can make this training pay for itself, and then some.

Let's talk this over!

Look into this opportunity. What I tell you here is only a small part. The rest is in my 36 page book THE WAY TO BIGGER PAY. Find out ALL about the "Upkeep" end of the Auto business. Find out ALL about my "JOB-METHOD" home-training. Find out what my new guarantee means to you in dollars and cents. Find out what a fascinating, BIG MONEY opportunity Auto "Maintenance" offers. Coupon brings my complete offer—mail it today!

LOOK HERE!

Build a Business of Your Own Like This!

They only make 3 million new cars a year, but there are 18 MILLION autos, trucks, buses, taxis, and tractors to KEEP GOING! "Up-Keep" is the big end, the BIG MONEY end of the auto business. Look at the picture! My training prepares you AT HOME in spare time to run or OWN a great "Up-Keep" service station like this. Not as MECHANIC, but as EXPERT! Not DOING the jobs, but KNOWING HOW and BOSSING them!

Start at \$60—Climb to \$200 a Week

Millions of auto owners, corporations with truck or freight-transport fleets, won't put up with the blundering "practical experience" mechanic when they can get instant, guaranteed, trained service from an EXPERT. This idea of Expert "maintenance" service is NEW—it's growing—it is becoming a 5 BILLION DOLLAR A YEAR industry. That's the kind of business to go into, where there's almost NO LIMIT to the money you can make, where there are thousands of big-pay jobs waiting for Experts, and hundreds of opportunities to go into business with little capital.

Here is your coupon

**I WANT TO BE
AN AUTO EXPERT**

Tom Plumridge, Directing Auto Engineer,
American School, Dept. A-474,
Drexel Ave. & 58th St., Chicago

Send me QUICK please, your 36-page book, THE WAY TO BIGGER PAY, and complete information about the "upkeep" end of the Auto business, about your "JOB METHOD" home-training, and about your sensational new guarantee.

Name.....
St. No.....
City.....
State.....

Learn Cartooning



BRANNER

WINNIE WINKLE
When I consider the small investment I made in taking your course and the enormous profits I am making now I feel like a professor.

M. M. Branner.



Gene Byrnes

REG'LAR FELLERS
I attribute my success to the thorough and highly competent course I received from you.

Gene Byrnes.



Fellows

FRECKLES
More words cannot express my appreciation of the course of lessons I received from the Landon School.

Merrill Blosser.



Edwina

"CAP" STUBBS
No one could take your course and regret it—your instructions made it possible for me to do the work.

Edwina Duinn.

At Home in Your
Spare Time by the
World Famous
Landon Picture
Chart Method

YOU can learn to make original drawings with the aid of this remarkable method, just as easily as you learned to write. A series of big picture charts with each lesson of this great course, explains step by step, just how to proceed in making original drawings of your own. Every detail of cartoon drawing is fully covered throughout this complete course. Instructions on originating cartoon ideas are also included. A complete criticism service gives you the full benefit of the experience of one of America's foremost newspaper artists.

Newspapers want more cartoonists and comic artists trained to do snappy original work. That's why they are constantly employing Landon-trained cartoonists, who are now earning from \$50 to \$200 and more a week.

RESULTS TELL THE STORY

Here are four of the famous characters created by Landon students who have attained national reputations as Comic Strip Cartoonists. Hundreds of former students of this School are producing cartoons on political and national affairs, sports, comic strips, etc., for leading newspapers and syndicates all over the United States and Canada. Many newspapers now employ from two to five students of this School; one big newspaper employs nine. Many successful students who prefer to work at home are selling their drawings by mail. The record of results produced by this school is evidenced in the increasing demand by newspaper Editors for Landon graduates.

Send NOW for complete information and sample Picture Chart to test your ability. Please state your age.

The Landon School
1238 National Bldg., CLEVELAND, O.

Learn to Write

I Teach by Mail

I can make a good penman of you at your home during spare time, no matter where you live or how poorly you now write. My simplified system has shown thousands the way to good penmanship during the past twenty-five years—IT CAN and WILL do the same for YOU.

My beautifully illustrated 32-page Book

"How to Become a Good Penman" FREE!!

It contains many beautiful specimens of penmanship showing what others have accomplished by the Tamblin System, with testimonials and general information about our courses. (Your name elegantly written on a card if you enclose stamp for postage.) Ladies taught as successfully as men. Write Today. Address

F. W. TAMBLIN
418 Ridge Bldg. Kansas City, Mo., U. S. A.

F. W. Tamblin

10 CTS. WILL BRING YOU—

A WONDERFULLY INTERESTING BOOK, written by the Trainer of Many of the World's Greatest Strong Men. It tells you—How to Develop—**Vitality, Energy, Endurance, Muscle and Nerve Strength, Perfect Physique**—It tells the weak, How to grow strong—It tells the strong, How to grow stronger—It tells how to develop strong Lungs and Heart—It tells how to gain powerful muscles and vigorous digestion—It is a **PRactical GUIDE TO GOOD HEALTH, STRENGTH and VIGOR**—It tells in plain language, **SIMPLE METHODS** that ANYONE can easily follow—It contains 60 Half-tone illustrations of Giants of Strength—**ALL FOR ONE DIME.** Send stamps or coin today for a copy of this marvelous Book revealing my astonishing discoveries about rebuilding the Human Body, during more than 25 years' experience as America's Foremost Physical Culture Instructor.

PROF. H. W. TITUS, 105 East 13th Street, N. Y., Dept. A3

PIANO JAZZ

By Note or Ear. With or without music. Short Course. Adult beginners taught by mail. No teacher required. Self-instruction Course for Advanced Pianists. Learn 67 styles of Bass, 180 Syncopated Effects, Blue Harmony, Oriental, Chime, Movie and Cafe Jazz, Trick Endings, Clever Breaks, Space Fillers, Sax Stirs, Triple Bass, Wicked Harmony, Blue Obligato, and 247 other Subjects, including Ear Playing and Musical Invention. 110 pages of REAL Jazz, 25,000 words. A Postal brings our FREE Special Offer.

Waterman Piano School, 259 Supera Theatre Bldg., Los Angeles, Cal.

Learn Watchwork, Jewelrywork and Engraving.

A fine trade commanding a good salary, and your services are always in demand. Address **Horological**, Dept. P, Bradley Institute, PEORIA, ILL., for our latest catalog.

Delivered to You Free

for 30 days trial on approval. You can have your choice of **44 Styles**, colors and sizes of the famous **RANGER Bicycles**. Express prepaid. **Factory-to-Rider Prices** save you \$10 to \$25 on your bicycle.

\$5 a Month if desired. Many boys and girls easily save the small monthly payments.

Parents often advance first payment. best quality, at factory prices, express prepaid. Lamps, wheels and equipment, low prices. Send No Money, do business direct with makers.

Mead CYCLE COMPANY
DEPT. C CHICAGO

Write today for free Ranger Catalog, factory prices and marvelous easy payment terms



If I Send You a Suit

made in the latest style from the finest goods, will you keep it, wear it, and show it to your friends as a sample of my sensational \$20.50 suits guaranteed regular \$50.00 values? Could you use \$3.00 an hour for a little spare time? If so, write me at once for my wonderful new proposition. Just write your name and address on a card and mail to Dept. 389.

A. M. WARD, 852 West Adams St., CHICAGO

MECHANICS!

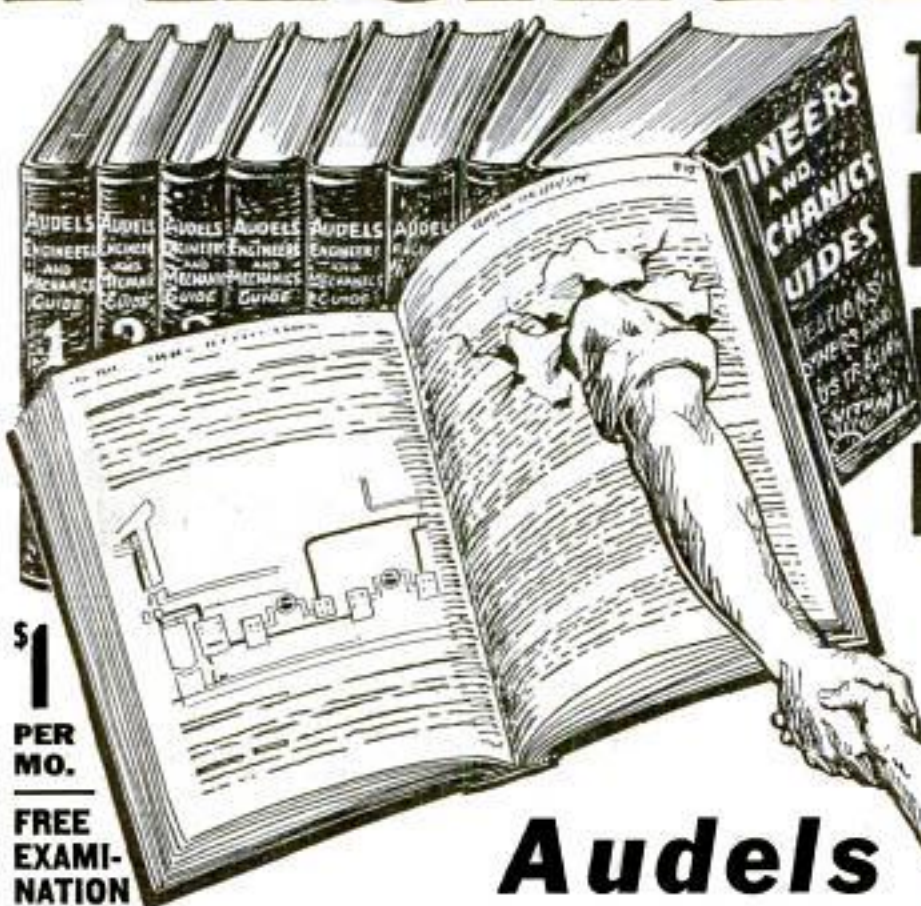

\$1
PER
MO.

FREE
EXAMI-
NATION

TAKE THIS HELPING HAND TO BETTER PAY

Hundreds of Engineers, Electricians and Machinists write us that this Set, **Audels Engineers & Mechanics Guides**, has been the means of quick advances in grade, position and pay.

Audels Engineers and Mechanics Guides

Guides Tell you all about:

THEORY, PRACTICE and OPERATION of ALL Steam Engines: UNIFLOW and POPPET VALVE ENGINES and LOCOMOBILES, Locomotive-Marine Engines; Turbines; Rotary Engines—the Indicator—Lubrication—PRACTICAL MANAGEMENT. GAS, GAS ENGINES—Aeroplanes and Aviation—HOW TO SELECT AN ENGINE. STEAM ENGINE rules and formulae. Steam Boilers; Heat-Combustion; Fuel and Flue Gas Analysis—CO₂ Recorders—Construction of all types of Boilers—Mechanical Stokers—Oil Burners—Setting—Chimneys—Mechanical Draught—HOW TO SELECT A BOILER—BOILER DESIGN based on A. S. M. E. BOILER CODE—OPERATION FIRING. Pipes, Fittings—Heating and Ventilation—Refrigeration—Cooling Towers—Condensers—Distilling Apparatus—Elevators—Cranes—Ropes and Cables—Splicing—Practical Electrical Engineering as an aid for engineers and electricians in obtaining a license—ready reference index, covering entire field of Modern Electricity.

Every Engineer, Mechanic and Electrical Worker will find real help in these books. Daily problems are quickly solved. Short cut methods are explained that save time and labor. Complete, up-to-date information on modern engineering practice is clearly given. Fifteen minutes a day of study will prepare you quickly for a better job and better prospects.

**Pocket Size
Flexible Covers**

8 Numbers, \$12
FREE EXAMINATION
\$1 a Month
8754 Illustrations
4759 Pages

"With the help of your Set, I am holding a position of chief engineer, and am under 21."—J. F. Hoffman, Columbia City, Ind.

No obligation to buy unless you are satisfied. Not a cent to pay until you see the books. Use coupon now and start on the way to better pay.

**FREE
Exam-
ination**



THEO. AUDEL & CO., 65 W. 23rd St., New York

Send me for free examination, AUDELS ENGINEERS AND MECHANICS GUIDES—8 Numbers, \$12. If satisfied, I agree to send \$1 in 5 days, and \$1 a month until paid.

Name.....

Address.....

Occupation.....

Employed by.....

Reference..... 4-T-30



An Easy Way to Learn PHARMACY AT HOME

Graduate pharmacists are always in demand. The work is interesting and pleasant and salaries are good. Many young men open drug stores of their own and become independent.

There's an easy way to learn pharmacy right in your own home in spare time, without losing a day or a dollar from your present work.

The International Correspondence Schools course in Pharmacy supplies the knowledge which it will be necessary for you to have in order that you may pass your State Board Examination.

Just mark and mail the coupon printed below to the International Correspondence Schools, Box 5502-E, Scranton, Pa., and full particulars about the Pharmacy Course or any other work of your choice will come speeding to you by return mail.

INTERNATIONAL CORRESPONDENCE SCHOOLS Box 5502-E, Scranton, Penna.

Without cost or obligation, please send me full information about the subject before which I have marked an X in the list below:

TECHNICAL AND INDUSTRIAL COURSES

- | | |
|--|--|
| <input type="checkbox"/> PHARMACY | <input type="checkbox"/> Civil Engineer |
| <input type="checkbox"/> Chemistry | <input type="checkbox"/> Surveying and Mapping |
| <input type="checkbox"/> Automobile Work | <input type="checkbox"/> Mine Foreman or Engineer |
| <input type="checkbox"/> Navigation | <input type="checkbox"/> Steam Engineer |
| <input type="checkbox"/> Agriculture and Poultry | <input type="checkbox"/> Gas Engine Operating |
| <input type="checkbox"/> Mathematics | <input type="checkbox"/> Wireless <input type="checkbox"/> Airplane Engine |
| <input type="checkbox"/> Electrical Engineering | <input type="checkbox"/> Architect |
| <input type="checkbox"/> Electrician | <input type="checkbox"/> Contractor and Builder |
| <input type="checkbox"/> Mechanical Engineer | <input type="checkbox"/> Architectural Draftsman |
| <input type="checkbox"/> Mechanical Draftsman | <input type="checkbox"/> Concrete Builder |
| <input type="checkbox"/> Machine Shop Practice | <input type="checkbox"/> Structural Engineer |
| <input type="checkbox"/> Railroad Positions | <input type="checkbox"/> Plumbing and Heating |

BUSINESS TRAINING COURSES

- | | |
|---|---|
| <input type="checkbox"/> Business Management | <input type="checkbox"/> Salesmanship |
| <input type="checkbox"/> Industrial Management | <input type="checkbox"/> Advertising |
| <input type="checkbox"/> Personnel Organization | <input type="checkbox"/> Better Letters |
| <input type="checkbox"/> Traffic Management | <input type="checkbox"/> Foreign Trade |
| <input type="checkbox"/> Business Law | <input type="checkbox"/> Stenography and Typing |
| <input type="checkbox"/> Banking and Bankers Law | <input type="checkbox"/> Business English |
| <input type="checkbox"/> Accountancy (including C.P.A.) | <input type="checkbox"/> Civil Service |
| <input type="checkbox"/> Nicholson Cost Accounting | <input type="checkbox"/> Railway Mail Clerk |
| <input type="checkbox"/> Bookkeeping | <input type="checkbox"/> Common School Subjects |
| <input type="checkbox"/> Private Secretary | <input type="checkbox"/> High School Subjects |
| <input type="checkbox"/> Business Spanish <input type="checkbox"/> French | <input type="checkbox"/> Illustrating <input type="checkbox"/> Cartooning |

Name.....

Street.....

Address.....

City..... State.....

Occupation.....

Persons residing in Canada should send this coupon to the International Correspondence Schools Canadian, Limited, Montreal, Canada

\$700 a week

from his own
Photograph Studio



"My income now averages from \$700 to \$1000 a week," writes Michael Gallo, who owns his own photographic studio on fashionable Fifth Avenue, New York. He adds, "My portrait studies bring me as much as \$250 a dozen."

Hundreds of others are earning big money everywhere. Amazing growth of Professional Photography offers chance of a lifetime; high salaried position or your own business. \$20 to \$75 a week in spare time!

LEARN AT HOME

No previous experience or special ability needed. New easy method makes you a Professional Photographer in spare hours at home. Famous experts of New York Institute of Photography train you by mail. All branches: Motion Picture, Portraiture, Commercial, News Photography. Earn while learning.

MOTION PICTURE CAMERA FREE OR 5x7 VIEW

Your choice absolutely free. Motion Picture Camera takes real Motion Pictures on standard professional film used by all theatres—View Camera is latest professional model for all still photography; genuine anastigmat lens.

WRITE FOR BOOK

Handsome big new book explains wonderful opportunities; positions paying \$50 to \$250 a week, how to start your own business, how to earn money in spare time. Send postcard or letter today for FREE BOOK and free Camera offer.

New York Institute of Photography, Dept. 43,
143 West 36th Street NEW YORK, N. Y.



NOTE

If you prefer to come to our New York or Chicago Studios for personal instruction, day or evening classes, write for Catalog R-46 to nearest address: 141 W. 36th St., New York, N. Y., or 609 S. Wabash Avenue, Chicago, Ill.

Music Lessons

WITH ACCREDITED SCHOOL

At Home

Any Instrument Write naming course you are interested in: Violin, Cornet, Mandolin, Guitar, Piano, Harmony, Voice, Public School Music, FREE CATALOG. SEND FOR IT NOW!

University Extension Conservatory, 137 Siegel-Myers Bldg., Chicago

Complete Conservatory Course by Mail

Wonderful home study music lessons under great American and European teachers. Endorsed by Paderewski, Master teachers guide and coach you. Lessons a marvel of simplicity and completeness.

LEARN ENGINEERING

Great Demand for Practical-Technical Engineers. Big Salaries. Wonderful Opportunities. Thousands of our graduates holding responsible high-salaried positions. Practical-Technical Courses from 3 Months to 2 Years in Electrical and Mechanical Engineering. Simple and Condensed Method. Faculty of Trained Experts. New Building. Extensively Equipped Laboratories and Shop. Department of Architecture. Structural and Mechanical Drafting. Degrees Awarded. Positions Secured. Day and Night Sessions. Catalog D. FREE. Ask about our Earn While You Learn Plan.

FINLAY ENGINEERING COLLEGE, Kansas City, Mo.

"BECOME A LIGHTNING TRICK CARTOONIST"

MAKE MONEY CHECK TALKING. SEND \$1.00 FOR SNAPPY PROGRAM OF TRICK DRAWINGS WITH INSTRUCTIONS BY A PROFESSIONAL CARTOONIST. SATISFACTION GUARANTEED. CIRCULAR FREE. BALDA ART SERVICE, 61 OSHKOSH, WIS.

LAW IN YOUR SPARE TIME

Same course by correspondence as given for 15 years at classes of this college. LL.B. DEGREE CONFERRED. 3 year university course prepares for bar exam. Money back guarantee. Low fee, easy terms, includes 125 12 volume library, lectures, lessons, all expenses. Write for FREE BOOK. HAMILTON COLLEGE OF LAW, Dep. G-4 4315 Dearborn St., Chicago

LEARN PIANO TUNING AT HOME

With our TUNE-A-PHONE, Action Model, tools, charts and lessons you can learn quickly and easily and be prepared to make big money. Estb., 1896. Money-back Guarantee. Diploma given. Amazing Surprise in our free book, "Winning Independence." Write for it today. Niles Bryant School of Piano Tuning, 40 Bryant Bldg., Augusta, Mich.

Hawaiian Guitar Read This Big Offer

FREE

Worth
\$18

Large photo shows our native Hawaiian instructors, known as Clark's Hawaiians. Photo two is Messrs. Detborn and Howard, broadcasting from WEAJ Radio Station, New York. Photo number three is Harry J. Clark, chief instructor. These professors welcome you as a student and offer you absolutely **free** a beautiful, full tone, genuine \$18.00 Hawaiian Guitar when you enroll. Look into this offer and rush coupon to us for particulars.



Learn to Play Quickly

With our **short cut method** of instruction, you will quickly learn how to play Hawaiian Guitar which will bring you **popularity** and **social success**. You learn to play from notes. If you never had any musical training, you will quickly get on, because our nine experts have perfected a course of home instruction which is as **simple as learning A B C's**. We don't depend upon printed lessons only for your success, but we furnish photographs of our professors' playing, diagrams, charts and phonograph records. To prove this is as easy, we will send your **first lesson FREE**.

**Rush
Coupon**

Rush Coupon—Send No Money

So positive are we that you will become one of our students, we will send **free** without obligation, our first lesson. Also receive our big book which gives particulars about our course. Write for your **free book** and your **free lesson today**.

**Send
No
Money**

**Hawaiian Studio of
New York Academy of Music
Studio 524-100 Fifth Ave.
New York City**

**HAWAIIAN STUDIO No. 524
of New York Academy of Music
100 FIFTH AVENUE, NEW YORK, N. Y.**

Please rush your book, "How to Learn Hawaiian Guitar" and my **first free lesson**. Also reserve a gift Hawaiian Guitar for me. This obligates me in no way whatever.

Name.....

Address.....

City.....State.....



Herbert Dickerson,
Warrenton, Va.,
makes \$7,500 a year



Automotive Electricity pays W. E. Pence,
Albany, Ore., over \$9,000 a year



J. R. Morgan, Columbus, Ohio, makes \$30
to \$50 a day in business for himself

Electrical Experts Are in Big Demand I Will Train You at Home To Fill a Big Pay Job

Use My Money to Go Into Business for Yourself

Every month I start two of my students in business for themselves. I give them all the money they need, help them get started and help them to a big success. Get the details of this great offer, the greatest in history of home study schools, from my big FREE book.

Age or Lack of Experience No Drawback

You don't have to be a College Man; you don't have to be a High School Graduate. As Chief Engineer of the Chicago Engineering Works, I know exactly the kind of training you need, and I will give you that training. My Course in Electricity is as simple and thorough and complete as it is humanly possible to make it, and offers every man, regardless of age, education, or previous experience the chance to become, in a very short time, an "Electrical Expert," able to make from \$70 to \$200 a week.

FREE Electrical Working Outfit FREE

With me you do practical work—at home. You start right in after your first few lessons to work at your profession in the regular way. For this you need tools, and I give them to you absolutely free—a whole kit, a complete outfit, one that would cost you \$12 to \$15.

Use This "FREE OUTFIT" Coupon

L. L. COOKE, Dept. 14
2150 Lawrence Ave., Chicago

The Man Who Makes
"Big-Pay" Men

Dear Sir: Send at once, Sample Lessons, your Big Book, and full particulars of your Free Outfit and Home Study Course, also the Free Radio Course—all fully prepaid without obligation on my part.

Name.....

Address.....

Occupation.....

It's a shame for you to earn \$15 or \$20 or \$30 a week, when in the same six days as an Electrical Expert you can make \$70 to \$200—and do it easier—not work half so hard. Why then remain in the small-pay game, in a line of work that offers no chance, no big promotion, no big income? Fit yourself for a real job in the big electrical industry.

Be an Electrical Expert Earn \$3,500 to \$10,000 a Year

Today even the ordinary electrician—the "screw driver" kind—is making money—big money. But it's the trained man—the "Electrical Expert"—who is picked out to "boss" the ordinary Electricians—to boss the Big Jobs—the jobs that pay \$3,500 to \$10,000 a Year. Get in line for one of these "Big Jobs" by enrolling now for my easily learned, quickly grasped, right up-to-the-minute, Spare-Time Home Study Course—now.

Your Satisfaction Guaranteed

So sure am I that you can learn Electricity—so sure am I that after studying with me, you, too can get into the "big money" class in electrical work, that I will guarantee under bond to return every single penny paid to me in tuition, if when you have finished my Course, you are not satisfied it was the best investment you ever made.

Guarantee Backed by a Million Dollar Institution

Back of me in my guarantee, stands the Chicago Engineering Works, Inc., a million dollar institution, thus assuring to every student enrolled, not only a wonderful training in Electricity, but an unsurpassed Student Service as well. It's this Service that makes "Cooke" training different from any other training. It's this Service, plus "Cooke" Training, that makes the "Cooke" Trained Man the "Big-Pay Man," everywhere.

Be a "Cooke" Trained Man and earn \$12 to \$30 a day—\$70 to \$200 a week—\$3,500 to \$10,000 a year.

Get Started Now—Mail Coupon

I want to send you my Electrical Book and Proof Lessons both Free. These cost you nothing and you'll enjoy them. Make the start today for a bright future in electricity. Send in Coupon—NOW.

L. L. COOKE, Chief Engineer

**CHICAGO ENGINEERING
WORKS**

Dept. 14

2150 Lawrence Avenue

Chicago, Ill.

The "Cooke" Trained Man is the "Big Pay" Man

Classified Advertisements

WORLD'S BEST WANT AD MEDIUM

Advertisements in this section, 25 cents per word, each insertion, minimum 10 words, payable in advance.
To be inserted under proper classification in May issue, copy should be in our office March 18th.

ADVERTISING AGENCIES

TO secure agents or salesmen or for selling farms and reaching investors, use classified (want) ads in largest newspapers and magazines. Price list No. 30 sent free. Ankrum Advertising Agency, 20 W. Jackson Blvd., Chicago, Ill. The largest classified advertising agency in the U. S.

QUERX Letters Get More Business. Write him today. Querx, 4418 Michigan Ave., Chicago.

25 WORDS—555 Rural Weeklies \$14.20. Ad-Meyer Agency, 4112-M Hartford, St. Louis.

ADVERTISE, hundred magazines, three issues 10c word. Pennell, Cocolington, Ky.

25 WORDS, 75 Country Town Newspapers, only \$3.40. Shaw, 221A Northeast, Washington, D. C.

ADVERTISING in all magazines and newspapers at publisher's lowest rates. Rate book free. Taylor's Advertising Service, Dept. F, Freeport, Ill.

FOR ADVERTISERS

ADVERTISE in 24 Big Sunday Newspapers, 24 words \$15.00. Catalog listing 1,000 leading Dailies, Weeklies, Magazines, 4c stamps. Union Advertising, Baltimore Bldg., Chicago.

I WRITE letters, folders, booklets, complete follow-up for manufacturers, mail order dealers. Long experience. Write for details. L. Taylor, Box 344, Freeport, Ill.

SHOWCARD Writing Made Easy. Complete outfit and instructions \$1.00. D. Gale, 618 Madison Ave., Albany, N. Y.

IMMEDIATE Results or two extra weeks free. Advertisement 21 leading newspapers two weeks only 35c word. Affiliated Newspapers, Bedford Bldg., Chicago.

NAMES, all new. Actual mail order buyers. Men or women. \$5.00, 1000. De-muth Company, Englewood, N. J.

ADVERTISE in 24 Big Sunday Newspapers, 24 words \$15.00. Catalog listing 1,000 leading Dailies, Weeklies, Magazines, 4c stamps. Union Advertising, Baltimore Bldg., Chicago.

CIRCULARIZE guaranteed lists. Agents' names. \$5.00, 1,000. Pennell, Cocolington, Ky.

CLASSIFIED seventy magazines, 3c word; three 8c. Smith's Service, 1194, Wematchee, Wash.

SALES PROMOTION

\$50 to \$50,000 Daily Sales developed during 36 years for clients by my direct-mail plans, copy, campaigns. A \$25,000 annual volume increased ten-fold in twelve months. Another, from an initial expenditure of \$720 developed in four years sales by mail of half million yearly. Ten years Sales Promotion Manager Larkin Co. Submit sales problems for free diagnosis. James C. Johnson, 118A Woodbridge Ave., Buffalo.

AUTOMOBILE SUPPLIES

YOUR life depends upon your heart. Your motor depends upon a Carburetor. Therefore have it right. Trade in your old Carburetor or have it overhauled; Any make. Ship your carburetor to us with instructions and we can make return shipment the same day. Loftus Carburetor Co., 3847 W. Madison St., Chicago, Ill.

GOVERNORS for Gas and Auto Engines. S. C. Governor Co., Springville, N. Y.

OIL Guards for Spark Plugs stop fouling. Dollar postpaid. Box 351, Tyler, Texas.

REAMERS, New, Spiral cut, at less than cost to manufacture. Send for list. A. B. Riker, 440 Court St., Binghamton, N. Y.

AUTOISTS. Make sure your Head-Lights are on. Our "Is-It-Lit" Tell-tales at \$1.25 will advise you. Out of Gas? Our Siphon Pump costing \$2.50 will enable you to borrow gas from the next passing car and get home. Handy Specialty Co., Somerville, Mass.

AUTOMOBILE and Truck Parts. Rebuilt Motors, Transmissions, Axles and Fordson Tractors—Guaranteed. General Machinery, 1320 Cadillac, Detroit.

CYLINDER Regrinding by Wet Process. Guaranteed accuracy. Mirror Finish. Superior to any other method. \$2.00 to \$4.00 per hole; quick service. Bertachy Co., Plattsmouth, Nebr., U. S. A.

NEW automatic device removes and prevents carbon, prevents dilution, saves oil. Increases gasoline mileage; nothing like it on the market. Thirty-day trial. Write By-Pass Valve Co., Plattsmouth, Nebr., U. S. A.

AUTOMOBILE Men: Our valuable book of 10,000 tested formulas gives hundreds invaluable to the automobile man. Free literature. Southern Trading Company, Dept. 34, Flushing, N. Y.

"TRICK" Valve Adjusters and Silencers; new; one-piece. No tools required. 24 for \$1.00. C. E. Richardson, 5 Albee Building, Washington, D. C.

AUTO Trailer \$39.00, light weight, 5-ton capacity; over 300 in use in our home county. Catalogue free. Bower Mfg. Co., Box 6, Fowler, Ind.

QUART can brilliant, durable Young's Autoblack sent postpaid \$1.25. Young Paint Specialty Co., Dept. E, Box 1064, St. Louis, Mo.

START Re-silvering Auto-Parts, Mirrors, Tableware, stoves, Make Money. Outfits. Plans Free. Sprinkle, Plater 77, Marion, Ind.

STAR 8-in-1 Wrench for Autoists. Fits Eight Sizes Nuts, including Spark Plugs. Guaranteed. Agents Wanted. Sample One Dollar. Star Supply Co., Bellevue, Ohio.

STEEL Flywheel Starter Bands, any car, \$3.00; Westinghouse Micarta Silent Timing gears; Buick valve lifters \$1.25. Ring-gears, Drive pinions. (Saving Million miles in tires). Rifners, Salina, Kans.

AUTOMOBILE and Truck Parts at a saving to you of from 55 to 75% off the factory list prices, on Reclaimed parts for nearly all makes and models, from 1914 to 1924. State parts wanted, and send for free parts list on your make of cars. "The largest stock of Reclaimed parts under one roof." Send us your parts orders. Auto Parts Co., Boyle & Papin, St. Louis, Mo.

AUTOMATIC Air Compressor, complete with motor, only \$16.50 monthly. Quickly builds your business. Send postal for particulars. Hobarth, Troy, Ohio.

BARGAINS—Radiators—Sport Bodies built to order—send sketch. All standard makes radiators furnished at bargain prices. State make and model. We guarantee satisfaction. Independent Radiator Co., 1119 Wabash Ave., Chicago.

MILLERITE-ETHYL-Super-Fuel Ingredient for Gasoline. Increases Power and Mileage—Saves Gas. Make it yourself by my simple Formula and clean up five to fifty thousand a year. This and eighteen other High Class Automobile Specialties described in the valuable literature I'll send you upon request—Hurry! Exclusive Territory!! Miller, Chemist, 1109-1111 Grand Central, Tampa, Fla.

AUTOMOBILE Parts—Used parts for most any car at half factory list prices. Allen, Briscoe, Buick, Cadillac, Chalmers, Chevrolet, Dodge, Dort, Grant, Hudson, Hupmobile, Oakland, Overland, Oldsmobile, Reo, Studebaker and many others. Send list of parts wanted. Century Auto Parts Co., 4106 Olive St., St. Louis, Mo.

AUTO and Truck Parts. Save 25-80%. New and used motor, gears, axles, bearings, springs, generators. \$10 up. New Zenith, Johnson, Rayfield, Stromberg carburetors, \$7.50 up; new waterproof Simms and Berlin magnets, \$15; Ford retopping, \$4-\$6; other cars, \$12 up. Brightman Auto Exchange, 321 Windsor Ave., Hartford, Conn.

\$250.00 TO \$300.00 profit monthly easily earned with One Day Battery Service. It costs only \$20 monthly. Send postal to Wilhohart, Troy, Ohio.

REPAIR for rim cut tires; mention straight side or clincher; covers 7 1/2 inches. \$1.00 postpaid. Rim Cut Clamp Co., Box 12, Station A, Elizabeth, N. J.

AUTO Parts. Save 20% to 80%. Send us your old parts; we can duplicate them. Everything for the car or truck. Parts for any car ever made. We are the largest car wreckers and replacement parts house in the world. Ask for our Bargain Lists and Free Catalog. Warshawsky & Co., Inc., 1935 S. State St., Chicago, Ill., Dept. P. M.

AUTOMOBILE SUPPLIES, ACCESSORIES AND HOUSEHOLD SPECIALTIES WANTED

PENNSYLVANIA Distributor reaching more than one million automobile owners will consider meritorious automobile supplies and accessories. If you desire such representation submit description, sample and best-rock prices. James C. Johnson, 118B Woodbridge Ave., Buffalo.

AUTOMOBILES

PATENTS—Write for my free Guide Books "How to Obtain a Patent" and "Invention and Industry" and "Record of Invention" blank before disclosing inventions. Send model or sketch of your invention for instructions. Promptness assured. No charge for above information. Clarence A. O'Brien, Registered Patent Lawyer, 5891 Security Bank Building, directly across street from Patent Office, Washington, D. C. See pages 168 and 169.

AUTO Tourist's Handbook — An indispensable help for those who wish to make a motor trip. Tells how to prepare your car for the long grind to avoid trouble, how to make and use camp equipment, how to cook on the road and how to make comfortable sleeping quarters. Will reduce your touring bill many dollars if you follow the ideas presented. With this we give "Auto Owner's Handbook" filled with helpful ideas for drivers. Send no money. Pay the postman \$1 plus postage when he delivers the two books. Popular Mechanics Press, Room 803, Popular Mechanics Building, Chicago, Ill.

PATENTS—Write for our Guide Books and "Record of Invention Blank" before disclosing inventions. Send model or sketch and description of your invention for our free Examination and Instructions. Highest references. Reasonable terms. See advertisement on pages 170 and 171. Victor J. Evans & Co., 185 Ninth, Washington, D. C.

\$300.00 TO \$500.00 profit monthly in One Day Battery Service. Easy monthly payments allowed. Hobburts brings particulars without obligation. Hobburts, Troy, Ohio.

AUTOMOBILE Owner's Handbook containing 288 ideas for making your car longer lived and more comfortable. Also tells how to make emergency repairs on the road. 221 illustrations. 50 cents. You should also have Automobile Tourist's Handbook which has dozens of ideas on auto camping and touring. 50 cents. Both books for \$1. Popular Mechanics Press, Room 807, Popular Mechanics Building, Chicago, Ill.

AUTOMOBILE ARMATURES

LET us rewind your Automobile Armatures. We guarantee to make them as good as new. Forks \$2.00 each. Most any other two unit armature \$5.00. Single unit Buick, Dodge, etc., \$12.50. Send no money; all work sent out C. O. D. Jones Electric Company, Charlotte, N. C.

FOR FORD OWNERS

FORD Parts—Save from 40 to 50% from the factory list price on guaranteed Reclaimed Ford Parts. Reclaimed Ford Motor, Starter and generator, running condition guaranteed, \$60.00. "The oldest, established parts house in the country." Send us your orders for parts on any car. Auto Parts Co., 901 S. Boyle, St. Louis, Mo.

ONE Day Battery Service pays big in smaller shops. Only \$16.50 monthly. Hobarthco brings particulars. Hobarthco, Troy, Ohio.

2½ MORE volts than any ordinary Ford Timer. More power, more pep, better pick-up, and instant starting. Wipe Timer Brush—replaces roller in any standard Ford Timer. Smooths out worn timer shells. Positive contact—strong, steady spark—uses no oil or grease. Highest grade carbon steel lip, or wearing surface, is harder than glass. Helps keep spark plugs clean. Eliminates much carbon and coil trouble. Sent prepaid for 75c. Fully guaranteed. Order one today. 4 A Products Company, Mfrs., Department A, Denver, Colo.

CYLINDER Regrinding, guaranteed Accuracy. Mirror Finish by wet process. Ford block \$8.00, no delay. Bertschy Co., Plattsmouth, Nebr., U. S. A.

REMOVE and Prevent Carbon. Prevent dilution, save oil. Convert waste into Power. Increase gasoline mileage. No liquid, powders or dope for gas. Nothing like it on the market. Guaranteed one year. Thirty-days' trial. Easily attached to any car. Write Ry-Pass Valve Co., Plattsmouth, Nebr., U. S. A.

KIM-DIMS for Ford cars eliminates the use of dimmers and gives you full bright headlights in two positions. Straight ahead and tilted down. Gives you best of light when you need it most. Complies with the laws in all states. Write for circular. Kim-Dim Specialty Works, Taylorville, Ill.

TAKE end play out of crank shaft. Keep Fan Belt on; more power. Easier starting. Keeps magnets up to Pole pieces. Attached in thirty minutes. Bertschy Co., Plattsmouth, Nebr., U. S. A.

SPEEDY Change Transmission Bands. Install in thirty minutes. Self Oiling. Non Chatter. Non Burning. \$5.00 set postpaid. Distributors Wanted. Wesley Manufacturing Co., Fairview Station, Detroit, Mich.

GET your share of the road. Don't drive with that poor horn! Secure safety. Use a "Schwarze" Motorhorn with a voice like the big car. Fully guaranteed. All dealers or sent postpaid anywhere on receipt of \$1.00. Schwarze Electric Co., Adrian, Mich.

FOR your Ford—Automatic Re-atomizer Prevents foul plugs, carbon formation reduced. More mileage, saves gas and oil. Puts new life in your car. Sent Prepaid only \$2.50. Proposition for Agents. Specialty Mfg. Co., Dept. 10, Hatfield, Mass.

50 CENTS brings patent extension for reverse pedal. Save your shoes. One dollar for three. Try it. C. & M. Co., Ashland, Ohio.

GOVERNORS for Gas and Auto Engines. S-C Governor Co., Springville, N. Y.

FORD Roadster and Touring Tops, 100 available \$10.00 up. Dix Sales Co., 1639 S. State, Chicago.

SAFETY cranks. No more kicks. Retail \$5.00. Send \$1.25 for agent's sample. Postpaid. Western Machine Company, Plattsmouth, Nebr.

FORD sport, speed bodies and specialties. See Ad. page 175.

UNDERSLING with "RKO" Swing Lo Irons. See "Red-I-Kut" ad page 151.

AGENTS for Ford Accessory. No Freezing. No Boiling. See our advertisement on Page 153.

INSERT valve pins in tightest places with patented tool. Saves cost first time used. Only 50c. K. Dahm, 912 49th St., Milwaukee, Wis.

66 MILES on 1 Gallon. Wonderful Vapor Humidifier for autos, 1 free to introduce. Critchlow, PMP-110, Wheaton, Ill.

MOTORCYCLES, BICYCLES AND SUPPLIES

SEND for our Bargain Bulletin and Money Saving Message. It will save you money on Motorcycles, Side Cars, Motor Wheels, Repair Parts and Accessories. Some used parts at less than half. Cleveland and Ace Motorcycles our specialty. See our ad on page 150. American Motor Cycle Co., 2043-5-7 W. Chicago Ave., Chicago.

USED motorcycles and parts cheap. W. C. Ray, Tyler, Texas.

NEW and used parts for Motorcycles and Bicycles. Get our prices on parts needed. Kingshighway Motor Co., 1166 N. Kingshighway, St. Louis, Mo.

MOTORCYCLES \$15-\$75. Engines \$3-\$25. Send cash. \$7.00 puncture healer \$2.00. Bay Exchange, Knight's, 1512 Locust, St. Louis, Mo.

LEARN Safe Opening, Bicycle Repairing, Gun and Locksmithing; Trade Secrets. Literature Free. Nelson Carter, Shreveport, La.

1922 HARLEY-DAVIDSONS, \$135; 1921, \$115; 1920, \$85; 1919, \$65; 1917, \$50; 1916, \$45; 1915, \$40; 1914, \$35. Guaranteed. Money refunded if not satisfied. Circular free. Wisconsin Cycle Sales Co., 726 National Ave., Milwaukee, Wis.

USED parts for all motorcycles, cheap. State wants. Schuck Cycle Co., 1922 Westlake, Seattle, Wash.

DON'T buy a Bicycle Motor Attachment until you get our new catalogue and prices. Also runs washers, pumps, and shop machinery. Shaw Mfg. Co., Dept. 27, Galesburg, Kans.

OVERSTOCKED—200 Used Motorcycles. Must be sold at once. We have Harley-Davidsons, Indians, Hendersons, Excelsiors, Cleveland. Write for our Bargain List. Myerow Brothers, Dept. B, 15 Berkeley St., Boston, Mass.

AVIATION

A NEW two cylinder Lawrence motor for \$75.00, 28 horse power complete with new mahogany propeller, has duplex Zenith carburetor. Delco ignition system cost the government almost \$1,000. New Altimeter 3½ in. dial, can be used on automobile, only \$8.00. OX5 motor cylinders, good as new, \$2 each; OX5 gaskets, 8 intake, 8 exhaust, \$1. New spark plugs, Champion AC, Bethlehem, Rajah, etc., 10 for \$3. 100 Liberty cylinders and crankshafts, thousand pistons, high and low compression, 1,200 valves and also several tons of mixed Liberty parts; attractive price for the lot. Serviceable cylinders good as new from \$5 to \$25. Crawford Airplane Co., Venice, Calif.

BOYS! We have a Practical Home Study Course in Aeronautics. Write for information. It has no competition for five times the money. Lincoln Standard Aircraft Corp., Lincoln, Nebr.

AIRPLANE propellers. New 4-Blade Mahogany sixteen-inch diameter, beautifully finished, postpaid dollar each. Airplane turnbuckles, new, very useful for truing up sagging doors or gates and radio wires; 3-inch 50c dozen; 4-inch \$1.00 per dozen postpaid. Write for our sales bulletin. It's free. Johnson Airplane and Supply Co., Dayton, Ohio.

AVIATION Fans: Send one dollar for beautiful pair sterling silver wings, mounted on bar pin with safety catch, and identification card issued by National Flyers' Association. Thousands being worn by pilots, aviation mechanics, and aero enthusiasts. Wallace Aero Company, Bettendorf, Iowa.

LEARN aviation; write for information. Amrhein Aviation Co., Edwards, Ill.

AIRPLANE Propellers, new, \$3 to \$15; cost \$100. Motors 28 to 100 H.P., \$50 and upward. Airplanes \$300 and upward. Smith Machinery Company, Box 153, Houston, Tex.

TEN lessons in the air of twenty minutes each will make you a pilot by our advanced method of training. This together with our five-week shop course at \$100.00 makes America's oldest aircraft factory the most popular flying school. Work after class hours guaranteed. Heath Airplane Co., Chicago, Ill.

BUILD Your Own Airplane—America's latest Light Sport Plane, raw material and blue prints now ready for builders. Write for particulars. Lincoln Standard Aircraft Corp., Lincoln, Nebr.

THE American School of Aviation announces a new correspondence course in Mechanics of Aviation. A thorough training in Practical Aeronautics. American School of Aviation, Dept. 1861, 3601 Michigan Ave., Chicago, Ill.

COMPLETE Scale Plans, with Building-Flying Instructions for following 3-ft. Model Aeroplanes, 25c each postpaid: JN1D-2; DeHavilland; N.C.-4; Curtiss Tractor; Bleriot; Nieuport or Taube Monoplanes; Cecil Peel Racer. Complete 48 pp. catalog, 5c. Ideal Airplane Co., 165½ Spring Street, New York.

AIRPLANE Wheels—20x1 ball-bearing wire type. While they last \$2.50 ea. New cord tires for same \$6.50 ea. Lincoln Standard Aircraft Corp., Lincoln, Nebr.

SEND 10c for our latest aeronautical catalog. Listing a complete line of airplane goods at reduced prices. Ford and Motorcycle airplane circular 4c each. Heath Airplane Co., Chicago, Ill.

"TWO-SEATER Sportford," uses Ford or air-cooled motor. Blueprints, \$5. Knock-down and complete planes. Used single-seater Sportford, without motor, \$250. Motorcycle engine monoplane plans, \$2.50. Aviation Engineering Co., Lawrence, Kans.

PATENTS—Write for my free Guide Books "How to Obtain a Patent" and "Invention and Industry" and "Record of Invention" blank before disclosing inventions. Send model or sketch of your invention for instructions. Promptness assured. No charge for above information. Clarence A. O'Brien, Registered Patent Lawyer, 5891 Security Bank Building, directly across street from Patent Office, Washington, D. C. See pages 168 and 169.

LEARN to Fly! Write for details of our great opportunity. Varney Aircraft Co., Peoria, Ill.

OPPORTUNITY is at your door. Learn Airplane Engineering Now at Home. The World Flyers were Airplane Engineers. Write for free catalog. Western Airplane Corporation, Dept. K-4, Monadnock Block, Chicago.

HEATH propellers represent the most efficient method of aerial drive. Each propeller individually designed for the particular work to be done, as laid out by America's oldest aeronautical engineers. Propeller catalog 4c; Sted blue prints \$2.00; Jersey Aviator helmets 95c; Resistal goggles \$2.99. Heath Airplane Co., Chicago, Ill.

150 HORSEPOWER Lincoln-Standard, \$900. Special OX5 Curtiss Two-seater, \$700. Propellers—large or small, \$10. Flying Instruction, \$100. Aviation Engineering Co., Lawrence, Kans.

GREATEST Model Catalog, 5c. Glider, Flies 300 Feet, 35c. Circulars Free. W. Phipps, 578 Knickerbocker Ave., Brooklyn, N. Y.

WELDING AND SOLDERING

REPAIRS made on all makes of Welding Apparatus. Address Berino Co., Plattsmouth, Nebr., U. S. A.

ACETYLENE Brazing and Soldering Torches, \$2.00. Light welding and lead burning torches, \$7.00. Postage prepaid upon receipt of price. Marshall Mfg. Co., Kansas City, Mo.

BOOKS AND PERIODICALS

MECHANICAL Drawing—A Practical Course in Mechanical Drawing has helped thousands. It is simple enough for a boy, yet advanced enough for a trained mechanic. Cloth bound, pocket size, illustrated. Only 50 cents. Popular Mechanics Press, Room 807, Popular Mechanics Building, Chicago, Ill.

SUPERSHORTHAND—Samples free. Shorter, speedier, easier reading. Nuhand, Angola, Ind.

25 LESSONS in hypnotism; guaranteed. Regular \$1 course for only 50c. Astrolite Company, Sharpsburg, Pa.

FREE Book, "Elijah Coming Before Christ," Megiddo Missions, Rochester, N. Y.

"MASTER KEY," "Creative Personality," "Power of Will," three greatest books, 1234 Pages, \$4.50. Bargain Catalogues 10c. Phipps-Library, 1014 Belmont, Chicago.

WHAT is the soul? 15 pages 15c. Jabe Studio, Los Angeles.

\$2,000 YEARLY, spare time, publishing local edition of our Almanac and Cook Book. Samples and details 30c. Meador Publishing Co., Quincy, Mass.

EDUCATIONAL books and correspondence courses, bargain prices. Catalogue 1,000 courses free. Courses bought. Students Exchange, 47A West 42d St., New York.

PERPETUAL Motion. Interesting booklet for inventors. Ten Cents. L. M. Publishing Co., Box 999, Long Beach, Calif.

IDEOPHONIC Primers, \$1.94; Chinese, French, Spanish. Languages, 8 West 40th, New York.

LAFFALOG is a monthly devoted to Wit, Wisdom, Essays, Poems and Formulas. Sample copy 10c. P. M. Lutz Printing Co., York, Pa.

HYPNOTISM Amuses, Astounds, Insures health, wealth, happiness. 25 Easy Lessons \$1.00. "Mindreading" (any distance), wonderful, 50c. Success guaranteed. Popular Institute, 11014 Belmont, Chicago.

"POEMS of Inspiration and Action"—book of over 80 splendid poems—35c postpaid. Hansen Company, Brookings, S. Dak.

DIRECTIONS for Building Imitation Marble Front Houses and for Manufacturing Tomb-Stones and Monuments from White Cement. Read my book on Fancy Concrete. Price \$1. Peter De Linde, Zion, Ill.

BOOKS—Illustrated circulars on books sent on request. Book Lovers Shop, 43 Union St., Holyoke, Mass.

ARTS-CRAFTS Library—How to make lamps, decorative lamp shades, metal etched articles, and many other useful art objects. Three cloth-bound pocket-size books. Send no money. Just write a postal. When the books arrive, examine them, and if you are more than pleased, pay the postman \$1.50 and the few cents postage. Popular Mechanics Press, Room 803, Popular Mechanics Building, Chicago, Ill.

176 PRACTICAL Subjects, how to master any of them. A new booklet giving reliable advice on how to study 176 subjects at home is free. Write your name and address on a postal and say, "An Easy Way to Master 176 Practical Subjects" and mail to Popular Mechanics Press, Room 807, Popular Mechanics Building, Chicago, Ill.

CURIOUS Books, Unique Novelties, Stunning Pictures, Samples, 10 cents Postpaid. Linds, 214 W. 34th Street, New York.

PRIVATE Investigators' Guidebook. Expertly Solves Countless Problems. \$1 postpaid. Dorey, Publisher, 1443 Amsterdam Avenue, New York.

FARMER'S Handbook—Filled with discoveries made by farmers who have found ways to save time and labor. 270 pages, containing 861 discoveries on all phases of farm work. 683 illustrations. Send no money—Wait till the postman delivers the book. If you are more than delighted, pay him \$1 plus a few cents postage. Popular Mechanics Press, Room 803, Popular Mechanics Building, Chicago, Ill.

PRACTICAL Psychology Teaches Hypnotism, Personal Magnetism, Magnetic Healing, Auto-Suggestion, Cure Habits and Disease. Easy Lessons. Send for Booklet, 4 cents stamps. Fernando, Dept. M, Springfield, Mass.

WRITERS: Study at home; 30 text books; criticism and advice regarding markets for manuscripts. Catalogue free. Correspondence invited. James Knapp Reeve (former editor The Editor), 50 Alexander Bldg., Franklin, Ohio.

INDUSTRIAL Alcohol. Wright's book. Full directions for making drawings, \$2.50. Spon & Chamberlain, 120 P. M. Liberty Street, New York, N. Y.

FREE—Send for my Newthought, Self-culture, Occult, Mystic and Scientific book literature. Martens Publisher, Burlington, Iowa.

"NATURE'S Finer Forces": Vibrations; Lights; Colorstones; Electromagnets; Odicuras; Radio; Coldlights; Inventions; Wonderful Opportunities; Fifty Lessons; Marvelous Cures; Illustrated. Satisfaction Guaranteed. 270 pages, \$2.00. DeLuxe \$3.00. M. Stevens, 242 Powell, San Francisco, Calif.

HYPNOTISM easily learned. Lessons guaranteed. Postpaid \$1.10. Smith Pub. Co., Dept. 3, Springfield, Mass.

PERSONAL Advancement—The new magazine published by Popular Mechanics Press for all who want to get ahead. Inspiration, education, entertainment, advice. Will help you to decide upon a vocation, to get help in preparing yourself for that vocation, to get the best books on travel, mechanics, and on related subjects. One year free. Send your name and address on a postal to Popular Mechanics Press, Room 807, Popular Mechanics Building, Chicago, Ill.

PICTURES AND POSTCARDS

LIFTIT Photo Mounting Paste won't curl photos after drying. Mounts perfectly flat. Send \$1.00 for pint can. Agents wanted. Liftit Paste Company, P. O. Box 23, Waterloo, Iowa.

JOIN Popular Friendship Club. Exchange view postcards with our enthusiastic members everywhere. Fascinating pastime. Membership two months 10c; six months 25c. Oliver Gandy, 24 Calendar, Providence, R. I.

JOIN Live Postcard Club; Membership lists including Catalog, 10c. Harvey Teeple, Decatur, Ind.

"THE Parisian Model" (miniature), 4 cents. Golden State Sales, Seal Beach, Calif.

POOL your friends. Ten beautifully colored different mountain cards. Fifty cents. Return to me stamped, addressed to friends, for mailing here. Great fun. Hadler, 4085 So. Broadway, Denver, Colo.

ART Pictures, real photos. 12 for \$1.00; samples 25c. Wittman Agency, 3629 E. 50th St., Cleveland, Ohio.

ART Photos—54 samples 25c. 216—\$1.00. Shaw Pub. Co., 5 Isabella, Room 6, Boston, Mass.

HAWAII, India, Japan, etc., postcards, 25c dozen. Durso, 25 Mulberry, N. Y. City.

POSTCARDS from everywhere! Year's Membership \$1. Six months 50c. Popular Exchange, Windsor, N. C.

ERIC'S True-Blue Friendship Club. 16 years old. Startling life membership offer, \$3. Trial, 10c. Quarter, 25c. Ed Ericson, 425, Elroy, Wis.

"FRIENDS-OF-MINE" are Faithful Postcard Exchangers. Become One. Worldwide Membership Three Months 20c, Six months 50c. Emery Jones, 1329 Gladys, Lakewood, Ohio.

JOIN an original club. Blanks free. M. T. James, Box 1034, Milwaukee, Wis.

75 BEAUTIFUL Art Pictures and Bathing Beauties 25c (coin). Photo Sales Co., 6975 Pingree, Suite 301, Chicago, Ill.

50 ART Cards \$1; Membership Friendship Exchange 25c. A. McCreery, Chatham, Ont.

GAMES, ENTERTAINMENTS AND PLAYS

VENTRILQUISM taught almost anyone at home. Small cost. Send 2c stamp today for particulars and proof. George W. Smith, Room M-943, 125 N. Jefferson Ave., Peoria, Ill.

PLAYS, musical comedies and revues, minstrel music, blackface skits, vaudeville acts, monologs, dialogues, recitations, entertainments, musical readings, stage handbooks, makeup goods. Big catalog free. T. S. Denison & Co., 623 So. Wabash, Dept. 11, Chicago.

POPULAR MECHANICS new illustrated Book Catalog lists books of entertainments and games. A copy is free. Address Popular Mechanics Press, Room 807, Popular Mechanics Building, Chicago, Ill.

MAGIC TRICKS, BOOKS AND JOKER NOVELTIES

BOYS—Brainracking, nervewrecking, mystifying paper puzzle forming bow-tie. Puzzle with instructions, only twenty-five cents. Alton Walker, 1650 Humboldt, Manhattan, Kans.

MAKE money with Jordan's New Mind-Reading Act at lodge, club, church entertainments. Clever, simple, mystifying. Easily mastered in a few hours. Never fails. Write for circular. Enclose 10 cents for "Telephone Telepathy." Lots of fun. Herb, 194 Jefferson Ave., Toledo, Ohio.

"33 CARD Mysteries" 10c; New Book just published. Amaze and mystify your friends. Easy to learn. Big 1925 Catalog of Magical Apparatus—Imported Novelties—Puzzles—Jokes—Pocket Tricks—Magic Books—Mind-reading Effects—Escapes—and Stage Supplies included. Largest assortment in the South. Both for 10c silver. Send today! Lyle Douglas, Station A, Dallas, Texas.

MAGIC—Tricks, Books and Supplies. For Amateurs as well as the great professionals. Anyone can learn through our instructions. Feature Acts in Mind Reading, Spiritualism, Rope Ties, etc. Large Illustrated Professional Catalog, 20c. Chicago Magic Co., 140 S. Dearborn St., Dept. B, Chicago, Ill.

LATEST and Best Books on Magic—Magicians' Tricks; How They Are Done \$2.50—Later Magic \$2.50—Latest Magic \$2.15 Postpaid. Popular Mechanics, 200 E. Ontario, Chicago.

JAZZ Sport Silk Handkerchiefs, Miniature Pair Ladies' Silk Bloomers; Worn in Breast Pocket of Coat as Handkerchief, \$1.00 Postpaid. T. Youngblood, 16 Grove, Charlotte, N. C.

MAGIC goods, cards, books, novelties, tricks. Catalogue free. C. Fenner, 2401 Jefferson, Louisville, Ky.

SEVEN Magical Delusions and Catalogs—25c. Gilmaglio, Morgan Park, Ill.

CRYSTAL Gazing Globes. Latest Magical Effects. Otto Waldmann, 1450 First Ave., New York.

POPULAR books, 10c each. Magic tricks, Card tricks, Coin tricks. Geo. Fenner, Louisville, Ky.

FREE—Our puzzle, trick, game, joke, Novelty Catalog. Wright & Son, 601-G Ind. Ave., Peoria, Ill.

SPIRIT Rapping Hand, \$1.00; Vanishing Cigarette, 15c; Vanishing Match, 15c; New catalogues free. C. Pentz, Minneapolis.

TRICKS, puzzles, jokes, magical apparatus, plays, stage supplies, mind-reading, sensational escapes, large illustrated professional catalog, 10c. Oaks Magical Co., Dept. 348, Oshkosh, Wis.

LATEST and Best in Magic Books—Personal Advancement. Popular Mechanics new magazine keeps you posted on the best books of magic. Helpful suggestions for making money with magic performances. Free for one year. No strings to this offer. Send your name and address to Popular Mechanics Press, Room 807, Popular Mechanics Building, Chicago, Ill.

STAMP COLLECTING

500 MIXED Stamps from 40 different Countries. Australia, North, Central, and South America, Russia, Africa, China, Japan, British, French, Colonies, War Issues, etc.; also 500 stamp hinges, pocket approval book, perforation gauge, and 3 United States stamps issued before 1870, all for 25c. Biggest bargain ever offered. Satisfaction guaranteed or money back. Hussman Stamp Co., Dept. P. M., St. Louis, Mo.

WHEN "U-Buy-a-Stamp, I-Give-a-Stamp" Free! A remarkable, entirely original, new way of selling stamps. Bird, animal, triangle and picture stamps galore. Limited mailing list. Write at once. References positively required. Hugh Arzenbright, Staunton, Va.

PERSIA—ancient land of Arabs, massacres and mysteries! We offer: Packet of 25 Different Persia, including many scarce 19th century, beautiful bi-colored stamps, high values, etc., Cat. over \$1.00! Also an unused set large Red Cross Stamps, perforation gauge. Fine packet of 50 different, including unused Nyassa, Kenya and Uganda (Cannibal land!) Gold Coast, etc. This Entire Big Lot for 15c to Approval Applicants. Reference Required. Scout number sufficient. C. D. Reimers Co., 301 Flatiron Bldg., Fort Worth, Texas. Extra! Scarce stamp of Hayti, catalogue \$1.00 (1925), Free with every order sent in 10 days. Act quick!

ANCHER'S \$\$\$ Outfit—only 12c! Fine triangle stamp; set German stamps with (pre-war) value forty million dollars (interesting!); perforation gauge, mm. scale; small album; 2 approval sheets; airmail set; scarce stamp from smallest republic on earth; newspaper set; packet good stamps from Travancore, Johore, Dutch Indies, etc. Entire outfit for 12c to approval applicants! (Nice pocket stock book, value 25c, with every order!) Ancher Stamp Co., 148½ Clerk St., Jersey City, N. J.

BOYS! Have you ever owned a nice, shiny, new pair of steel stamp tongs? Lakeview offers: Famous "Confiscated" set of Bulgaria (stamps that nearly started a war); set of new Germany with (pre-war) face value over forty million dollars; perforation gauge; small album; packet 100 different from Argentine, British Guiana, etc., etc.—and last but not least, a dandy pair of stamp tongs! The entire big outfit only 15c to approval applicants! Lakeview Stamp Co., 106 Station F, Toledo, Ohio.

MYSTIC'S "Mysterious" Packet! Contains stamps from the lands of cannibals, heathens, sun worshipers, and wild savages. Included are Kenya and Uganda, Persia, Africa, Dutch Indies, Gold Coast, Federated Malay States, Abyssinia, Nyassa, Travancore, Siam, Congo, etc. This wonderful packet containing 105 all different (mostly unused) for only 8 cents to approval applicants. Mystic Stamp Co., Dept. 8, Camden, New York.

NYASSA Giraffes and packet of 52 different scarce stamps. Plume Triangle, large \$1.00 U. S. Rev., millimetre scale, perforation gauge and ruler for only 9c. To introduce our Sudden Service approvals. Fennell Stamp Company, Dept. P, Fullerton Bldg., St. Louis, Mo.

FAMOUS Fenway Outfit—2 triangle stamps, small album, 5 blank approval sheets, 250 hinges, perforation gauge, 5 large French Colonials, 2 special deliveries, animal set, red cross set, packet 55 different, including Abyssinia, Azores, Cape of Good Hope, Bosnia, Crete, Congo, etc., 16-page price list, all for 12c to new approval applicants. Fenway Stamp Co., 161 Massachusetts Ave., Boston, Mass.

FOUR Ireland 5c, with approvals. Henry B. Hunt, 1021 Bellevue, Compton, Calif.

LATEST Edition, 1925 Catalogue, 1,000 illustrations, describing, pricing, all stamps in both used and unused condition from A to Z. Wholesale price 50c. Nielsen, 3244 Whipple St., Chicago.

BEST one-cent approvals in America. F. P. Hand, 1117 So. 60th St., Philadelphia, Pa.

GREAT War Packet, containing 100 different stamps from the nations participating in the Great War. Wonderful value—made to sell for 50c. To applicants for our approvals, it is offered for only 20c. Edgewood Stamp Company, Milford, Conn.

START a Stamp Collection—70 different stamps from 70 different foreign countries, including Africa, Asia, Australia, Europe, West Indies, etc. Our pamphlet which tells "How to make a collection properly," and price list of albums, packets and sets all for only 16 cents. Queen City Stamp Co., Room 36, 604 Race St., Cincinnati, Ohio.

110 DIFFERENT Stamps, many unused, high values, free to collectors requesting our Net Approvals. Postage 2 cents. Christensen, Milwaukee, Wis.

IF your usual purchases are \$1.00 to \$10.00 ask for net sheets, priced 60 to 80% discount. Reference required. Herbert Kelwin, Middletown, N. Y.

5 UNUSED sets, Airpost, "Prisoners of War." Picture, Dues, Eagles; 100 different foreign, French Colonies, hinges, premium, 15c. Deering, Newton St., Marlborough, Mass.

1,000 U. S. AND Foreign Stamps 25c. Phil. Lundsted, Cape Cottage, Maine.

1,000 DIFFERENT stamps \$1.00. 2,000 \$4. Fred Onken, 630 79th Street, Brooklyn.

\$1.00 REDUCED to 6c. 100 all diff. unused genuine stamps from Georgia, Venezuela, Poland, Turkey, San Marino, etc.—worth \$1—with 250 hinges, big bargain lists, all for only 6c to new applicants for our approvals. Victoria Stamp Co., London, Canada.

MONEY back mounted packets—little gold mines—20 different stamps in each—at 12c, 27c, 52c, \$1.02. Buy stamps? Sell stamps? Write Cedric W. Lemont, Delaware, Ohio.

FREE: German Aeroplane Set Complete. Kelly, 219 S. Scott, South Bend, Ind.

TEN Large and Showy stamps Free. Postage 2c. Pavn Stamp Co., 945 Vista Drive, Los Angeles, Calif.

FREE—a special set of stamps given to those requesting my net approval; reference required. J. de Jong, 539 West 162nd St., N. Y.

ONE foreign coin, fifty foreign stamps and price list, 10c in stamps. Carter & Oare, 32 E. Goodale, Columbus, Ohio.

FREE Stamps, including Siam, China, Newfoundland. Send postage. H. Buchholz, Norwood, Ohio.

1000 DIFFERENT stamps \$1.00. 100 Different French Colonies 35c. 2000 Unused stamps \$1.00. Claud Denney, Box 315, Dallas, Texas.

ONE thousand mixed Foreign stamps. Majority over 25 years old—\$2.00. A fine basis for a collection. Entire satisfaction guaranteed. Write for interesting booklet on Stamp Collecting—Free. Mekoel Stamp Company, Bethlehem, Pa., U. S. A.

1000 DIFFERENT genuine stamps, only \$1.00. Guaranteed satisfactory or money back. Circular free. C. E. Nickles, 427 Rodman, Washington, D. C.

FREE: New Price list and 33 Different Stamps. Bellance Stamp Co., 109 No. Dearborn Street, Chicago, Ill.

PREMIUM to net approval applicants sending reference. Tower Stamp Co., 42 Westville St., Dorchester, Mass.

NEWFOUNDLAND Postage Stamps "given away!" Thirty variety packet 30c. Rev. Butler, St. Georges, Newfoundland.

FREE: Abyssinia, set of 3, to approval applicants. Postage 2c. 1010 different stamps \$1.25. Park City Stamp Company, Bridgeport, Conn.

110 NEW Europe, All Different, a wonderful collection cataloguing several dollars, free to collectors requesting our Net Approvals. Postage 2 cents. Badger Stamp Co., Milwaukee, Wis.

BORNEO Rhinoceros, Australian Kangaroo and 109 Different Foreign, Hinges, Etc., to Approval Applicants for 10c; 50 Different U. S. 10c. Moseley, 225 South Taylor, St. Louis, Mo.

25 PORTUGUESE Colonies, 9c. Iowa Stamp Co., Cedar Rapids, Iowa.

PREMIUM 25 U. S. with approvals; postage 3c. Ref. please. St. Elmo Stamp Co., 2343 Foster Ave., Chicago.

100 DIFFERENT stamps free to applicants for low-priced approvals. Westland Stamp Co., 79 Westland Ave., Boston, Mass.

FINEST one-cent approvals. Boehm, 401 W. 149th St., New York.

FREE! Scarce, beautiful set Azerbaijan to approval applicants. Penna. Stamp Co., Manor, Pa.

FREE: Pocket Album 50 stamps to approval applicants. Send 6c postage. C. H. Hollister, Mukwonago, Wis.

AFRICA—40 Different 15c. Browne, 90 Kemper St., Wollaston, Mass.

STAMPS sent on approval at 70% discount. Reference required. Emory Renoll, Hanover, Pa.

STAMPS on approval—1c each. Premium with every lot. Gateway Stamp Co., Box 163, Stockton, Calif.

STAMPS Free—Ask for money-saving approvals. John P. Borresen, Cedar Falls, Ia.

20 DIFF. Turkey 8c. Approvals. Fryrear, 1411 4th Ave., Cedar Rapids, Iowa.

TWO stamps from Hawaii, 16 Brazil, 18 Argentine, 22 Chili, 10 Costa Rica, 15 Venezuela, 3 Hejaz, 4 Belgian Congo, 16 Tunis, 15 South Africa, 10c each. 15 Epirus, 100 Portuguese Colonies, 40 India, 35c each. Postage extra. Rowland Hill Stamp Co., 2675 Washington St., San Francisco.

FREE—1000 Different Stamps for selling 30 packets Sachet at 10c each. Hull, 12 West 101st, New York.

\$1.00 WORTH OF Stamps for 3c. Hull, 12 West 101st, New York.

STAMP Collector's Outfit only 20c; includes 32 page Booklet "How to Collect Stamps," illustrated Album, 100 different stamps, 150 hinges and "Profit Sharing" Coupon. Trial Approvals with each order. H. Ioor, 891 State Life Bldg., Indianapolis, Ind.

10 DIFFERENT Iceland, 12c; 6 Epirus (Soldiers) 10c; 6 Guinea Free. Fred Jackson, Montana, Calif.

TRY Cole's approvals. They Satisfy. Cole, 3919 Wallace Street, Chicago.

FREE—Set Irish Stamps, premiums, etc., for 2c stamp, 100 diff. U. S. 22c; 25 Bulgaria 9c; 1,000 hinges 9c; 30 Finland 9c; 500 diff. 45c. Hawkeye Stamp Co., Cedar Rapids, Ia.

CURIOSITY Packet, 104 unused in blocks 12c. Big 30-page List, set Air Mails Free. Raeger, 31 Cambridge, Dayton, Ohio.

35 DIFF. Neoprene free to request for my 1, 2, and 3c approvals, and also my 50% discount. Chas. W. Schmidt, 3227 Benner St., Wissinoming, Philadelphia, Pa.

FREE—Two Sets Nyassa. Also 20 diff. British Colonies, Barbadoes and Jamaica pictorials and packet of hinges for a request for my 1, 2, 3c net approvals. None better. Charles T. Egner, 4821 Frankford Avenue, Frankford, Phila., Pa.

24 VARIETIES Cuban stamps, 10 cents. List of 6,000 low-priced stamps free. Address Chambers Stamp Co., 111P, Nassau St., New York City, N. Y.

STAMPS, 100 all different. Postage 2c. Lists free. P. M. Quaker Stamp Co., Toledo, O.

500 FOREIGN stamps 25c; 50 Foreign coins \$1. A. McCreery, Chatham, Ont.

CONTINENTAL Packet, 250 varieties, all over the world, 15 cents. Covert Stamp, 39 State, Rochester, N. Y.

100 RARE Stamps, all different, bargain list, Stamp Magazine, everything 7c. Stanton, Niantic, Conn.

500 MIXED U. S. and Foreign stamps 10c. R. H. Carlton, 366 W. So. Temple, Salt Lake, Utah.

FREE—50 diff. stamps free to approval applicants only. Rubin Huffman, 495 Pennsylvania Ave., Brooklyn, N. Y.

FREE—50 varieties to approval applicants sending 2c. Richard P. Lamprecht, Valparaiso, Ind.

FOREIGN Stamp Collection Sent Free. Cornish Co., Schenectady, N. Y.

FREE! Loose Leaf Postage Stamp Album at rate of 8 pages each month given with subscription to monthly Journal. Send 2c stamp for prospectus. United Stamp Co., Marquette Bldg., Chicago, Ill.

STAMPS, 50 varieties, Africa, Brazil, Peru, Cuba, Mexico, etc., 10c. 50 different U. S., 25c; 1,000 mixed, 40c; 1,000 hinges, 10c. List free. C. Stegman, 5948 Cote Brillante, St. Louis, Mo.

ZAMBESIA, Zanzibar, Abyssinia, Herzevovina, Allenstein stamps, menagerie collection, album, 10c. Liberty, 3974 Arsenal, St. Louis, Mo.

PACKET of 23 stamps, no two countries alike. Packet hinges. Set of \$1 and \$2 U. S. Rev., all for 5c. P. M. Miami Stamp Co., Toledo, Ohio.

105 CHINA, etc., stamp dictionary, list, 2c. Album (500 illustrations), 3c. Bullard, Sta. A, Boston.

BIG Variety Packet Foreign Stamps Free for 2c postage. Gray Stamp Company, Station E10, Toronto, Canada.

FRENCH Colonies Free.—Pretty Picture Set, Native Chiefs, Tigers, 2c Postage. Empire Stamp Company, 342 Lippincott, Toronto, Canada.

DANZIG Free—Nice Set Danzig Stamps with Biggest Lists issued, 2c. postage. Midland Stamp Co., Station E2, Toronto, Canada.

HAVE you an Abyssinia in your collection? 3 varieties 5c. 1,000 all different stamps \$1.00. Approvals sent upon request. Edgewood Stamp Co., Millford, Conn.

109 DIFFERENT Stamps, 10 Cents. Sonnes Stamp Co., 675 Ivy, St. Paul, Minn.

20 UNUSED stamps free. All different. Postage, 2c. P. M. Fisk Stamp Co., Toledo, Ohio.

RARE COINS

COINS—Get in the Game Boys! Start with set of three different coins, 8c; 5 kinds 12c; 10 kinds 18c; One coin from Argentine or China or Ceylon or India or Brazil or British Africa or Colombia or Japan or Philippines or Egypt or Java or Russia or Serbia, for 8c. Any two 15c. Two different coins from Germany or Austria or England or Canada or Mexico or Jamaica or Cuba or Belgium or Switzerland or Danish Indies, or France or Norway, for 12c. Any two sets 22c. Two kinds old U. S. coins 16c. One Mexican Revolution \$29.00 bill 6c. 500,000,000 Marks (German) bill 6c. Foreign stamps, 500 different, 35c; 1,000 kinds 99c; List and Far East coin 5c. C. D. Reimers Co., 302 Flatiron, Ft. Worth, Texas.

100 DIFFERENT foreign coins \$2.00; 15 Confederate bills 25c; 20 foreign bills 25c; 100 Mixed coins 50c. Retail catalogue free. Nary, 33P South 18th St., Philadelphia.

OLD Money Wanted. Have you an odd or old coin or bill? It may be worth several dollars. Get posted. Send 4c for Coin Circular. May mean much profit to you. Send now. Numismatic Bank, Dept. H, Fort Worth, Texas.

50 OLD coins, all different, \$1.00. 20 different dates. Large U. S. Cents, \$1.50. Monroe Half-Dollar, Uncirculated, 90c. 200 different Austria City Bills 80c. Claud Denney, Box 315, Dallas, Texas.

AUCTION Sale on Coins April 6th. Send Stamp for List. Ely Fleming, Box 2035, Palm Beach, Fla.

THREE Large United States Cents 25c; \$86.75 Mexico Revolution Currency 50c. Moore Coin Company, Commerce, Texas.

OLD Coins, Large Spring Selling catalogue of coins for sale free. Catalogue quoting prices paid for coins, ten cents. William Hosslein, 101A Tremont Street, Boston, Mass.

\$2 TO \$500 Each paid for hundreds of Old or Odd Coins. Keep all Old Money; it may be very valuable. Send 10 cents for Illustrated Coin Value Book, 4 x 6. Get Posted. Guaranteed Prices. Clarke Coin Company, C. St., LeRoy, N. Y.

CALIFORNIA gold, $\frac{3}{4}$ size, 27c; $\frac{1}{2}$ size, 53c; three-cent-piece and catalogue, 10c. Norman Shultz, Colorado Springs, Colo.

GET Profit and Pleasure in collecting Old Coins. Send 10c for Sample Old Coin, together with my Large Illustrated Coin Catalogue. You'll be delighted with it. Send for it right now. B. Max Mehl, Professional Numismatist, Mehl Bldg., Dept. P, Fort Worth, Texas. Largest Rare Coin Firm in U. S.

CALIFORNIA gold Quarter 27c, Half 52c; Confederate \$188.50, 75c; 1837 cent 15c. A. Willie, Wheaton, Ill.

SELL European Bonds, Money, Coins, by mail, and agents. Tremendous Profits! Circulars free. \$1.00 brings outfit—100 samples, everything. Hirsch, 70 Wall St., New York.

FREE exchange service, Ten Mint Issues six cents. Elkowitz Exchange, Elkhorn, Wis.

22 DIFFERENT Coins 50c. 22 different foreign notes 50c. Oddehan, Independence, Mo.

UNITED STATES 2c Bronze with bargain price list 10c. M. Arcy, Box 483, Muskogee, Okla.

U. S. INDIAN White Cent with Price list 10c. Fred Greenleaf, Box 1715, Telluride, Colo.

FOR BOYS

MOUTH-ORGAN Instructor (16 big pages), 25c. Eighteen good selections of music, including "Dixie Land," with complete instructions for playing immediately. Thousands sold. Order today—become popular. 74 American National Songs, complete with music, 25c. G. Eisele, Bowling Green, Ohio.

BOYS, Earn Big Money. Our Free New Plan makes it easy. Write today. Dept. D2, Arab Products, Niagara Falls, N. Y.

LOTS of fun making your own toys. Book of Plans and Instructions 10c. The Boycraft Shop, Box 631, Danville, Va.

ARROW Gun. Something new! Amaze your friends! Accurate, powerful, safe. Quarter brings directions, drawings. Van-Horn, Walton, Nebr.

JUST Out—A New Boy Mechanic Book No. 4—1349 Articles, 1320 Pictures. Tells how to make such things as Radio Receivers, Toy Airplanes, Pushbicycle, Canoe Postboxes, Diving Rafts, Electromagnets, Wind Wagon and Ice Boat, Catamaran, Motion-Picture Camera, Sidewheel Motorboat, Motor-Driven Sleds, Camp Equipment and hundreds of other interesting devices. Price \$2 post-paid. Popular Mechanics Book Dept., 200 E. Ontario St., Chicago.

CAMERAS AND PHOTO SUPPLIES

MAKE your kodak pay you. Every community has prospects. Complete instructions in art, composition, etc., \$1.00. E. Mack, 6150 Winthrop, Chicago.

PHOTOGRAPHIC equipments and accessories of every description are listed and illustrated in our 228-page catalogue. It will pay you to secure a copy which is issued free, as our prices are low. We also deal in used goods which are sold under the same guarantee as new goods. Ask for our Bargain Book. Central Camera Co., Dept. E-92, 112 S. Wabash Ave., Chicago, Ill.

LIFTIT Photo Mounting Paste won't curl photos after drying. Mounts perfectly flat. Send \$1.00 for pint can. Agents wanted. Liftit Paste Company, P. O. Box 23, Waterloo, Iowa.

MEDALLION Hand-Painted, White Ivory or Mahogany, 6x8, Prepaid \$2.85. Send your favorite Kodak Picture or Photo. Circular Free of other Hand-Painted Novelties. Lillian's Art Novelty Co., Fairmont, W. Va.

CAMERA Owners, Just Think; from your own film, a Beautiful Colored and Framed Enlargement for only \$1.25. See details of our offer on page 175. Photo Finishing Company, 2668 S. Michigan Boulevard, Chicago.

TRIAL Offer: Roll Developed and six Duratone Prints 25c, or 6 prints from negatives 20c. Klunkner Film Service, Dyersville, Iowa.

SUPERIOR quality finishing. Trial offer: Any size 6 exposure roll developed and printed, 25 cents. One only 8x10 enlargement unmounted from negative, 35 cents. Carhuff Photo Finishing Co., 2129 W. Van Buren St., Chicago, Ill.

MODERN Photography in all its branches now taught by mail. New Successful Method. Students earning \$300.00 while learning. Big opportunity. Write for particulars and unusual offer open for short time. Dept. 1351, International Studios, Inc., 3601 Michigan Ave., Chicago.

HAVE You a Camera? Write for Free sample of our big magazine, showing how to make better pictures and earn money. American Photography, 116 Camera House, Boston, 17, Mass.

FILMS Developed, Special Trial Offer. Any Size Kodak film developed 5c, prints 3c each. Trial 6x10 Enlargement in handsome folder 40c. Overnight Service. Roanoke Photo Finishing Co., 209 Bell Ave., Roanoke, Va.

BIG Money Saved on Photographic Lenses and Apparatus—goods exchanged; repairing done. Ralph J. Golsen, 1128 Argyle St., Chicago, Dept. P.

KODAK Films—Special trial offer; your next kodak film developed, 5c—prints, 2c each. Moser & Son, 1917 St. James Ave., Cincinnati.

POCKET Kodaks \$2.50 to \$8. Reflex Speed Camera, F. 4.5 lens, \$35. Kodaks exchanged. Write for bargain price list. H. Ray, 324 Fifth Ave., New York.

SPECIAL Trial Offer. Kodak films developed correctly 5c. Gloss Prints 3c each. F. R. B. Photographers, Dept. "C," 1503 Lincoln Ave., Cincinnati, Ohio.

MOTION PICTURES

PASSION Play (5 reels), gigantic puller \$80.00, Uncle Tom's Cabin (5), always popular, \$45.00. Faultless condition. Screen examination. Posters. Portable National Projector (motor drive), almost new \$95.00. Show tent 36x45, complete, perfect, \$65.00. Details. Chas. Wagner, 1017 Monroe, Chicago.

FILM—Million Feet for Sale. Cowboy—Drama—Comedy and Feature Specials. Mix—Hart—Chaplin and best Movie Stars, \$3.00 per reel up. Genuine List Free. We Supply the World. Dept. G. Monarch Films, Memphis, Tenn.

BIG Money Nightly—Good assortment. Complete Outfits, installation plan. Splendid Home Outfit, \$25.00. Good Movie Camera, \$25.00. Ralph J. Golsen, Dept. M, 1128 Argyle St., Chicago.

DON'T fail to send for the big Free Bass Book of Cinema Apparatus. The Encyclopedia of M. P. Cameras and Projectors. Get in the game that has made thousands independent. Write or wire for your copy. Bass Camera Company, 105 N. Dearborn St., Chicago, Ill.

\$\$\$ FOR Ideas. Photoplay plots accepted any form; revised, criticized, copyrighted, marketed. Advice free. Universal Scenario Corporation, 206 Security Bldg., Santa Monica and Western, Hollywood, Calif.

MOVING-PICTURE Machines and Films for Sale. Send Stamp for Lists. National Film Brokers, 1710 W. 45th Street, Kansas City, Mo.

MOVIE films, 1000 ft. reels. Complete stories, \$2.50 each; shipped anywhere on receipt of remittance with order. Independent Films, 177 Golden Gate Ave., San Francisco, Calif.

\$35.00 PROFIT nightly. Small capital starts you. No experience needed. Our machines are used and endorsed by government institutions. Catalog free. Atlas Moving Picture Company, 482 Morton Bldg., Chicago.

AMERICA'S Greatest Fortunes made in the Motion Picture business. We furnish complete theatre equipment on easy payments. Openings everywhere. Catalog free. Monarch Theatre Supply Co., Dept. A, 724 So. Wabash Ave., Chicago, Ill.

MAKE money writing photoplays; details free to beginners. No correspondence course. Producers League, 239 Wainwright, St. Louis.

ELECTRICITY—Make it yourself with our auto generator. Write for particulars. Monarch Theatre Supply Co., Dept. 7, 724 So. Wabash Ave., Chicago.

BECOME Moving Picture Operator. Pleasant Profession. Write Stepanik, 58 West, New Britain, Conn.

NEW and Rebuilt Machines for Big Theatres—Schools—Churches—Traveling Shows. Also Films—Supplies and Complete Theatre Equipments. Bargain List Free. Monarch Theatre Supply Co., Dept. P, Memphis, Tenn.

MOVIE Films 1c Ft. 150 Ft. \$1. Reels \$2. Send Stamp for List. X. Sales Company, Box 1506, New Haven, Conn.

BARGAINS; Machines, Films, Supplies, Stereopticons. National Equipment Co., Duluth, Minn.

HUNDRED Feet "Tarzan" films One Dollar. Lists Film Bargains. Film Classic Exchange, Fredonia, N. Y.

SCENERY TO RENT

SETTINGS for Opera, Plays, Minstrels, Plush drops. Address Amelia Grain, Philadelphia.

EDUCATIONAL AND INSTRUCTION

BUILDING Mechanics, Estimators, Contractors, Architects and Students interested in Building: Get free booklet on "Tamblyn System" Builders' Course in Plan Reading, Quantity Surveying and Estimating. "Tamblyn System" prepared by Gordon M. Tamblyn, General Contractor and Author of "Building Labor Calculator," used by thousands of the most successful Contractors, Estimators and Architects; teaches accurate estimating in a new, easy way. Trains for Estimator, Foreman, Superintendent or Contractor. Advance your future in the building industry. A postal brings full particulars; mail it now to Gordon M. Tamblyn, General Contractor, Dept. C, Room 9, Sweeney Building, Denver, Colo.

\$5! EVERY business needs accounting. Simplified, practical home training in four weeks' spare time. Extraordinary results! Get free booklet. B. Blank Audit Co., 25 West 42nd, Suite 604, New York.

USED Books and Educational matter. Bargain prices. Bulletin free. Write, Instruction Correspondence Exchange, 1968 Broadway, New York.

PERSONAL Advancement tells how to decide upon a vocation, how to plan a course of home study, how to avoid duplication in the books you buy, how to secure the best books on any subject. And it's free for a year. Send your name and address on a postal today to Popular Mechanics Press, Room 807, Popular Mechanics Building, Chicago, Ill.

ROPP'S Calculator and Short-Cut Arithmetic shows the answer as quickly as a watch shows the time to all problems likely to occur in office, store, shop, bank, farm or factory. Price, pocket size, leatherette \$1. Desk size, cloth \$1.50 postpaid. Popular Mechanics Book Dept., 206 E. Ontario St., Chicago.

SHORTHAND—Memorized Correspondence Course produces better stenographers than other methods. Booklet free. Memorized Institute, Roanoke, Va.

LEARN Spelling by Mail. Simple as A B C. Trial Lesson Chart One Dollar Half. Wright's Spelling System, 428 South Hill, Los Angeles.

TO Advance Yourself—analyze yourself! Get Bennett's Self-Study Form, 12 cents. 1675 San Pasqual, Pasadena, Calif.

SECRET Language. Converse without possibility of detection. Especially adapted for telephone conversation. Can be mastered in a few hours. Send one dollar for full instructions. H. E. Barrett, Williamstown, Mass.

SELF Defense Course. Boxing, Wrestling, Jiu-Jitsu. Complete Illustrated Book One Dollar Postpaid. Free Circular on request. Herb Waddell, Champion Wrestler and Self Defense Expert, 607 Gearing Ave., Pittsburgh, Pa.

MOUTH-ORGAN Instructor and eighteen musical selections, 25c. Play in one hour. G. Eisen, Bowling Green, Ohio.

WORLD-ROMIC. Masterkey. Spanish Primer, \$1.94. Languages, 8 West 40th, New York.

STUDY Cleaning and Dyeing by mail. High Salaries. Skilled men in great demand. Address Josef Loebel, Box 218, Roanoke, Va.

USED educational matter sold at lowest prices, easy terms; bought for cash. Catalog Free. Economy Educator Service, 442-A. Sansome, San Francisco.

USED educational matter bought, sold, exchanged. Handling, 799 Broadway, New York.

RAILROAD Postal Clerks start \$132 month, railroad pass. Send stamps for questions. Columbus Institute, E-2, Columbus, Ohio.

USED educational matter, books, etc., bought, sold, rented and exchanged. Big list free. Lee Mountain, East Chattanooga, Tenn.

ARTIFICIAL Marble sanitary flooring instructions, ornamental casting, concrete, plaster, papier-mache decorations, garden furniture, statuary, Rubber-moulds. 15 years' instruction the public, particulars and 200 illustrations free. Chris Mahler, Huntington, N. Y.

"WHAT to Invent for Profit" free. Patent News-N, Washington, D. C.

DOUBLE Entry Bookkeeping mastered in 60 hours with 8 keys; guaranteed; diplomas. International Bookkeeping Institute, Dept. 8, Springfield, Mo.

USED Educational Matter; save over half. Bargain catalogue 1,000 courses free. Used courses bought. Students' Exchange, Dept. A, 47 West 42nd St., New York.

YOU can have a business profession of your own and earn big income in service fees. A new system of foot correction; readily learned by anyone at home in a few weeks. Easy terms for training; openings everywhere with all the trade you can attend to. No capital required or goods to buy, no agency or soliciting. Address Stephenson Laboratory, 1 Back Bay, Boston, Mass.

RADIO OUTFITS AND SUPPLIES

RADIO Receiving Sets easily built by anyone—it is inexpensive and takes but two hours of your time. No experience necessary. Under the free personal guidance and instruction of our experts you can build your own radio receiver and can hear music, lectures, news; also weather, market and foreign reports from thousands of miles away. Our bargain list, diagrams, hook-ups, illustrations and a wealth of other information while they last, sent to you for a two-cent stamp. Address the Radio Shark, 55 Vesey St., Dept. D-281, New York City.

RADIO Wrench: One C & C Reachit Wrench automatically takes and holds all small round or hex nuts in the average radio set; starts screws. Takes the place of many other tools. Sent post paid for \$1.00. Kaufman & Clough Company, Wilmington, Del.

PATENTS—Send for booklet. Contains valuable information for inventors. Bank and commercial references. Prompt service, twenty years' experience. Talbert & Talbert, Registered Patent Lawyers, 573 McGill Building, Washington, D. C.

LOUD Speaking Crystal Set. Broadcastings heard throughout house. Easily constructed. Book, diagram, 25c. Catalog free. Steinmetz Wireless Mfg. Co., Eastend, Pittsburgh, Pa.

RADIO Tubes guaranteed, new and re-filled direct from factory, information free. Agents Wanted. Radio Tube Outlet, 207 Market Street, Newark, N. J.

2,650 MILES Distance with one tube. Any Notice understands our Simplified Instructions, including Panel Layout and Photo 25c. Vesco Radio Co., Box PM-117, Oakland, Calif.

SPECIAL Sale—Genuine Guaranteed Mastertone Radio Tubes all sizes. \$1.95 postpaid. Nangle Co., 601 Washington Blvd., Oak Park, Ill.

RADIO generators, airplane models, 120 to 500 Watts, 16 to 500 Volts, slightly used, cost U. S. Government \$75.00, our sale price \$4.00 to \$9.00. Remit with order to Radio Engineers, 563 Boulevard, L. I. City, N. Y.

RECEIVE 20 miles with fingering. No other apparatus. Just wear radio ring and listen through any head phone, \$1.00 complete. No circulars. Irving Co., 1636 So. Lawndale, Chicago.

GET Radio Sets, parts, at wholesale. Sell to friends. Our discounts insure big profits. Free catalogue. Fuetterer Radio Supply Co., 2117 Locust St., St. Louis, Mo.

TRANSFORMS Crystal Sets to one-tube sets with a roar. Simply wonderful, wonderfully simple. Blue print free. Wm. Stevens, Inventor, Box 20, Cicero, Ill.

NAVY Battery Dynamotors. General Electric 24/1500 volt, 233 amperes, 6000 RPM, \$25.00. Holtzer-Cabot, 12/500 volt, .67 amperes, \$18.00. Harry Klengle, 501 East 84th, New York.

DEMONSTRATORS, Radio, wanted. Amateurs, professionals, see Radio Shack advertisement, page 164.

NEW Discovery; It Pays to Know; Generate Electricity from Water and Air; Four Drawings of Models, Easily Understood. Send \$1.00. We Mail You Drawings and Description. Spark Co., Memonshela, Pa.

SPECIAL—One tube Kodol Radio Set with Radiotron or Cunningham tube. \$12.75 postpaid. Nangle Co., 601 Washington Blvd., Oak Park, Ill.

EXTRAORDINARY Demand for Radio Battery Recharging. Complete outfit only \$50. Get particulars. Willett, 5426-A, Broadway, Chicago.

RENEW Dry Batteries; Process 25c. Universal, 650 Center, Waukegan, Ill.

2,650 **MILES** Distance with one tube. Any Novice understands our Simplified Instructions, including Panel Layout and Photo 25c. Vesco Radio Co., Box PM-117, Oakland, Calif.

BIG profits recharging radio and auto batteries. Outfit, easy payments. Hobbarts, Troy, Ohio.

BUILD your own Radio Cabinet from plans complete in detail; price \$2.50 with instructions. Wal Radio Cabinet Co., Fort Lee, N. J.

FREE Tested Crystal—Send No Money, just two-cent stamp for postage. Pitts, Dept. A, 561 W. Washington St., Chicago.

WORLD'S Greatest One Tube 1000-Mile Radio Without Parts \$9.75. Distributors Wanted Everywhere. A. Bram, Woodbridge, N. J.

DICTIONARY of Radio words and terms, electrical symbols, wiring diagrams, radio diagrams and complete electrical dictionary; new, up-to-the-minute, just published, 188 pages, cloth cover, vest-pocket size, 35c postpaid. Popular Mechanics Book Dept., 206 E. Ontario St., Chicago.

TELEGRAPHY

LEARN Telegraphy; Operators needed, splendid salaries, hours short, work easy and fascinating. Position guaranteed or tuition refunded. Catalog free. McCool Telegraph College, Sandersville, Ga.

TELEGRAPHY—Both Morse and Wireless—taught thoroughly and quickly. Tremendous demand. Big salaries. Wonderful opportunities. Expenses low; chance to earn part. School established fifty years. Catalog free. Dodge's Institute, H St., Valparaiso, Ind.

TRADE AND TECHNICAL SCHOOLS

LEARN Sign Painting, Decorating, Paperhanging, Marbling and Graining — Auto Painting. Practical course takes only few weeks. Write for Free Book and Special Offer. Chicago Painting School, Dept. 9354, 150 W. Austin Ave., Chicago.

GET a Foreman's Job in any trade. Train yourself to earn more money. Become an expert Blue Print Reader. You can do it in spare time. My training will give you advancement in a few weeks. Write now—tell me what trade you want—I will send my plan at once. Carroll Rumsey, 163 Drexel Bldg., Philadelphia, Pa.

FREE book tells how to learn Carpentry and Cabinet Making at home in spare time. Write today. Steuber School of Carpentry, Lockwood, Mo.

BUSINESS OPPORTUNITIES

\$5 TO \$15 daily—Your Pay in Advance, monthly bonus besides. (Muir made \$415.20 in 24 days, sworn proof furnished) Introducing Latest Style Hosiery for men, women, children, 57 styles, 37 colors. 7 pairs guaranteed 7 months, \$1.75. No experience or capital needed. Spare time satisfactory. Just show samples we furnish, write orders. We deliver and collect. All transportation charges paid. Mascohee Textile Company, Station 2584, Cincinnati, Ohio.

YOUR Spare Time—What do you do with it? Has it ever occurred to you to put it to use? Do you know that you can earn from \$3.00 to \$5.00 an hour and more for every spare hour you put to work? Let us show you how. It will cost you but a penny and a minute of your time. Your name and address on a post card will bring you the facts. Write for them today. Address Dept. 374, William C. Bartlett, Inc., 850 West Adams Street, Chicago.

PATENTS Procured; Trade Marks Registered—A comprehensive, experienced, prompt service for the protection and development of your ideas. Preliminary advice gladly furnished without charge. Booklet of information and form for disclosing idea free on request. Richard B. Owen, 30 Owen Bldg., Washington, D. C., or 41-R Park Row, New York.

STOP Daily Grind. Money! Re-Silvering Mirrors, auto-parts, tableware, stoves, outfits; Plans Free. Sprinkle, Piater, 127, Marion, Ind.

BIG profits in your spare or full time. Establish your own permanent business without capital. No peddling nor soliciting. No outfit to buy. We teach you how to get the business that is all around you. Write today for free book—no obligation. Elwood Company, Sunderland Building, Omaha, Neb.

FREE, valuable information on starting a business; large or small capital. Dept. M, Paul Kaye, 149 Broadway, New York.

I MADE \$100,000 as Real Estate Specialist. Free booklet tells how. American Business Builders, Inc., Dept. AA-444, 1133 Broadway, New York.

GET into the Mail Order Business. We furnish you with 16-page Jewelry Catalogs with your name printed on cover. We furnish you with merchandise, etc. Write for information. H. Reisman & Co., 551 W. Lake, Dept. 20, Chicago.

PATENTS—Write for our Guide Books and "Record of Invention Blank" before disclosing inventions. Send model or sketch and description of invention for examination and instructions. No charge for the above information. See advertisement on pages 170 and 171. Victor J. Evans & Co., 192 Ninth, Washington, D. C.

MOVIES: With the one in your locality you can operate a good paying practical business without capital or experience. The A. T. Company, Inc., Maplewood, N. J.

FREE folder describes 27 plans for making \$20.00 to \$100.00 weekly in home or office business of your own. Downs Co. 2323 Myrtle, St. Paul, Minn.

PUNCHBOARDS, Guns, Novelties, Chocolates, Unusual Profits. Circular Free. Grahams, 1849 South Broadway, Denver, Colo.

EIGHT collection letters that will collect any account without friction. Gets the dough and worth dollars, for three dimes. Agents write. B. McKnight Agency, Box 595, Louisville, Ky.

25 MAILORDER Magazines and Papers 50c. Hansen Company, Brookings, S. Dak.

\$15.00 DAILY Start Shop. Learn Painting, Interior Decorating of Homes, Refinish, Retrim Automobiles. Make Auto Supplies at Home. Demand unlimited. Courses sold on approval basis. We trust you. Dewilde, Sheboygan, Wis.

50 SUCCESSFUL Mail-Order Enterprises in Book Form for \$2.00 or send for Descriptive Circular. A. Ehrke, Box 42, W. Park Sta., Cleveland, Ohio.

ACCOUNTING simplified. Key to profits! See "Educational, \$5!" Agents wanted.

BUSINESS opportunities await you in 25 different cities and towns; the wants of each individually itemized. Whole list One Dollar. Address J. W. Bilodeau, Lyndonville, Vt.

START your own moneymaking business recharging auto and radio batteries. No experience needed. Outfit, easy payments. Hobart, Troy, Ohio.

PROSPEROUS Business. Full or spare time. Explanatory circulars, full particulars, 10c. Messlek, Dept. 12MC, 1156 South Seventh, Camden, N. J.

PUT up your own goods. We supply 10,-000 tested formulas, trade secrets covering all lines, for little money. Write quick for astonishing offer. Southern Trading Co., Dept. 31, Flushing, N. Y.

10 IDEAS Patentable Nature 25c. Money Refund Guarantee. P. O. B. No. 424, Omaha, Nebr.

MONEY-MAKING Opportunities Tell You How. \$1.00. B. Bokemeier, Freeport, Ill.

CHEMICAL Expert furnishes Manufacturing Formulas and Processes with complete working directions. Reliable individual service only. No list. Charges reasonable. Correspondence invited. Dr. Arthur Van-Heeden, 308 South Oakley, Chicago.

WONDERFUL Money-Making Plan. \$1 Sample Free. Elm Co., Rockville, Conn.

EARN \$15.00 Daily by Mail. Particulars Free. Tick, 3338 Arkansas St., Oakland, Calif.

BUILD splendid business making chippe-glass number and name plates, signs, medallions. Write for particulars. Simpler Utility Co., 1133 Broadway, New York.

\$2.00 INVESTED year ago returned \$1250.00. Write, Vernon, 1836 North Eighteenth, Philadelphia.

MONEY-MAKING Plans Exposed. Five plans now being sold for one dollar each; original mail-order plan, new formulas, valuable information, mailing list. All 25c. W. S. Toney, Woodville, Okla.

INVENTOR'S Universal Educator contains 900 mechanical movements; 40 perpetual motions. Tells how to obtain and sell patents. Suggests new ideas. Explains how to select your attorney and avoid patent sharks. Special price (for a limited time) \$1.00 postpaid. Albert E. Dieterich, 621-C Ouzay Bldg., Washington, D. C.

SUCCEED With Your Own Products. Formulas by experts. Manufacturing processes. Trade-secrets. Modern master methods. Catalog free. B. Thaxly Co., Washington, D. C.

NEW Plan, Copyrighted, Guaranteed, Spare Time, Sure, Quick, Positive Profits. First Time Offered. Circular Free. Fred Horst, Bellingham, Wash.

WANTED—Men. Everywhere. Start profitable manufacturing business. At home. Spare or Odd time. Big money. No Peddling. Capital or experience unnecessary. Five to ten dollars starts you. Investigate this. Samples and particulars Free. Waychoff, Box 562, Loveland, Colo.

HOW I Sold 400,000 Names. This Great Scheme and List of 120 Name Buyers for \$1.00. Ernest L. Morris, 895-A Market Street, Saint Louis, Mo.

ONE dollar will purchase 25 proven successful money-making plans. No risk; money refunded if dissatisfied. National Service Bureau, 192 Hobson Street, Newark, N. J.

EXPERT information, advice. Any subject. \$1.00. International Information Institute, 15P Moore, New York.

MONEY-MAKING Enterprises. Mail Order Business. Booklet, Plan, Samples, 10c. Harvey Teeple, Decatur, Ind.

START Mail Order Business. New, Simple, Economical Plan. Positively Gets Money Steadily, Surely, Without Fail. Sworn Proof Free. Gerald Hinds, Monticello, Ill.

EARN Big money recharging radio and automobile batteries. Get particulars of special offer. Willett, 5426-B, Broadway, Chicago.

VULCANIZING Auto Tires is a Paying Business. We have Plants near you from \$100 up. We save you 50%. Catalog Free. Instruction Book \$1. Equipment Exchange, 108 East 11, Los Angeles, Calif.

A WORTHWHILE Mail-Order Business of Your Own, by new methods, up-to-date, quick, sure, positive and big, is yours if you want it. Get the latest information while it is new. Circular free. Marion Mac Rae, Publisher, M805 Oregonian Bldg., Portland, Ore.

UNLIMITED possibilities, making toys and novelties at home or on a large scale. Particulars free. New Specialty Co., 448 E. 79th St., New York.

AMBITIOUS men and women to manage a business. No competition. Start costs \$150.00 and your time. Desk B, Crosskey Protection, 619 MacDonald, Richmond, Calif.

MONOGRAMS—Men make big money applying our gold letters on autos. Investigate this offer. Free samples. Hub Monogram Co., Back Bay Station, Boston, Mass.

3,384 MONEYMAKING Plans, Formulas, Trade-Secrets. "Encyclopedia Business Opportunities," 3 Volumes 98c. "Ideal," 5501-PM, North Robey, Chicago.

ENTER a new business. Earn \$3,000 to \$8,000 yearly in professional fees making and fitting a foot specialty, openings everywhere, with all the trade you can attend to; easily learned by anyone at home in a few weeks, at small expense; no further capital required, no goods to buy, job hunting, soliciting or agency. Address Stephen-son Laboratory, (1) Back Bay, Boston, Mass.

MANUFACTURE Millerite! Ethyl-Super-Fuel Ingredient for Gasoline. Increases Power, Mileage—saves gas—easily mixed—profits great—valuable Formula Literature of this, Lightning Electrolyte, Kor-Kit, Pro-Tex-U, Amazon Rubber Repair, and fifty other Biggest selling Specialties in all lines will be sent on request. Miller, Chemist, 1115 Grand Central Ave., Tampa, Fla.

EXCEPTIONAL Opportunity for Sales Manager capable of handling state distribution. Marvellous new Adding Machine. Retail \$15. Work equals \$350 machine. Tremendous possibilities. Unlimited Profits. Write quick for details. Lightning Calculator Co., Dept. B, Grand Rapids, Mich.

MAIL Order Business is your opportunity. Brendser's Famous Handbooks teach how to start small, grow big. Sell merchandise, service, ideas; enormous profits. Spare time to begin. Get complete set, 11 books, \$3.00, and be posted. Brendser, 315 Walnut, Philadelphia. Descriptive Catalog and big batch interesting mail order information, 25c. None free.

CHEMICAL Expert will furnish Formulas and Trade Secrets. All lines. Lists Free. W. L. Cummings, Ph. D., 228 Garden Ave., Syracuse, N. Y.

UNPATENTED Ideas Can Be Sold. I tell you how and help you make the sale. Free particulars (Copyrighted). Write W. T. Greene, 810 Jenifer Building, Washington, D. C.

I MADE \$30 a Week Home. French Breadmaking, 15 years' experience; Free Booklet tells. Ashbrook 67, Marengo, O.

LEARN the collection business. Good income, quick results. Interesting booklet, "Skillful Collecting" free. National Collectors Assn., Long St., Newark, O.

PATENTBOOK, 139 mechanical movements and illustrations, sent free. Labinero, 3 Park-row, New York.

"WHAT to Invent for Profit" free. Patent News-C, Washington, D. C.

ATTENTION! You can have a business of your own. Establish and operate New System Real Estate Business, brokerage and insurance agency in your community. Office at home. Earn \$5,000 year. Representatives wanted everywhere. Send stamp free booklet. Hayes Realty Association, Cincinnati, Ohio.

INVENTORS—Write for our Guide Book, "How to Get Your Patent" and Evidence of Invention Blank. Send model or sketch of your invention for our free Examination and Instructions. Randolph & Co., Dept. 433, Washington, D. C.

WE Start You in Business, furnishing everything; men and women, \$39.00 to \$100.00 weekly operating our "New System Specialty Candy Factories" anywhere. Opportunity lifetime; booklet free. W. Hillier Ragsdale, Drawer 4, East Orange, N. J.

DOLLARS Yearly in your Backyard. No mushroom dope. Particulars free. Metz, 313 East 89th, New York.

EARN \$10 daily silvering mirrors, plating and refinishing metalware, autos, chandeliers, bedsteads, headlights. Outfits furnished. E. Deete Laboratories, 1133 Broadway, New York.

SIGN work made easy with "Perfect" letter patterns. Over 40 styles. Cut from Aluminum, Celluloid, or Oil-board. Beautiful and exact gold-leaf lettering on glass now easy. Instructions free with order for patterns. Write for samples and prices. Ross System, 4704 Vincennes Ave., Chicago.

FREE Book. Start your own little Mail Order business; home employment evenings. Beginner's Outfit furnished, including 500 circulars, samples, things to sell; you deal with Manufacturers. Also tell easy way to get Agents by mail to sell your novelties. Instructive Book free. Pier, 865 Cortland Street, New York.

MAKE Money at Home—making toys. We show you how. Send \$1 for complete working drawings and instructions. Dekalb Designing Co., Decatur, Ga.

START Mail Order Business. Watch yourself grow. Cost 10c. Sell by Mail for \$1.00. Particulars free. E. Noon, Windsor, Va.

SILVERING Mirrors! My exclusive French Tartaric method opens enormously profitable business. Booklet free. Wm. Barstow, 514 23d Street, Oakland, Calif.

PATENTS—Write for my free Guide Book "How to Obtain a Patent" and "Invention and Industry" and "Record of Invention" blank before disclosing inventions. Send model or sketch of your invention for instructions. Promptness assured. No charge for above information. Clarence A. O'Brien, Registered Patent Lawyer, 5891 Security Bank Building, directly across street from Patent Office, Washington, D. C. See pages 108 and 109.

150 MONEY-MAKING Plans Free! Wolverine Bureau, G-13, Muskegon, Mich.

ADVERTISE, hundred magazines, three issues 10c word. Pennell, Covington, Ky.

HONEST proposition for Hustlers in every community. Lamp On Hub, 981 Virginia, Buffalo, N. Y.

SCHEMER, Alliance, Ohio, prints Big profit schemes, one subscriber making \$25,000 from three; another \$10,000 from one. Try your luck. Three months, 25c; copy, 10c.

WOODWORKING. Electric Lawn Mower Sharpening at home. Investigate. 415 South Lawdale, Kansas City, Mo.

SIGNS and Showcards easily painted with Letter Patterns. Large variety of Styles and Sizes. Sample for stamp. John Rahn, A2133 Greenview Ave., Chicago.

INCH Display Advertisement 166 Magazines Year \$30. Wood's Popular Services, Atlantic City (N. J.)

\$3,000 TO \$6,000 Yearly. Want it? Others are making it. Send check or money order today for our invaluable books "How to Sell Real Estate," \$3.00—and "How to Conduct Real Estate and Insurance Business," \$1.50. Absolute satisfaction guaranteed. Free catalogs. Realty Book Co., Dept. 52, Cleveland, Ohio.

THE Venture of a Century. \$2.50 buys 1,000,000 mark German Government 1923 Bond. Wanted German Bonds dated prior to 1926. All foreign bonds and currency dealt in. Frank O. Everett & Co., 35 Wall St., New York.

PUBLISH a local magazine. Phenomenal opportunity. Profits galore. \$5 starts you. Experience unnecessary. We furnish everything. 10c brings sample and particulars. Quality Press, Plaluvier, Nebr.

POPCORN Peppers—All kinds, North-sides Co., 1286 Fifth, Des Moines, Iowa.

MANUFACTURING Corporation wants local managers; start independent business, staple commodity. \$100 to \$200 necessary. References. Unlimited profits. "Foster," 161 Ogden St., Newark, N. J.

LATEST money makers. Your name on mailing list year 10c. Pennell, Covington, Ky.

GO into the Crispette business. Everybody likes Crispettes. You can make a lot of money. We start you. Write for facts. Long Eakins, 1959 High St., Springfield, Ohio.

GOOD Money easily earned at home spare time Silvering Mirrors, Glass Embossing, Chipping, Frosting, Gold Leafing, etc. Patterson & Co., Brooksville, Ky.

MARBLE mixing instructions, covering wood or cement flooring $\frac{1}{2}$ in. thick, fire-proof, waterproof, low cost, sanitary, all colors. Particulars, 200 illustrations free. Chris Mahler, Box 122, Huntington, N. Y.

"BUSINESS Progress" Outlines New Mail Order and local business plans each month. Trial three months' subscription, including other money making business chances, 25c. 734-F Cherry, Kansas City, Mo.

GOLD Window Sign Letters. Manufacture them at home. Unlimited profits and business opportunities. Complete instructions and patterns. No experience required. Particulars, Whitfield, 1144 Pleasant Street, Oak Park, Ill.

GET Money in Your Mail. "Lambert's Mail Order Secrets" contains successful methods never before published. Particulars free. Leon Lambert, 539-D, Wichita, Kans.

COST \$5.00, your profit \$104.75. Transferring decalcomania letters on autos, trunks, bags, etc. Send today for outfit or free samples. World Monogram Co., Dept. 73, Newark, N. J.

FREE Booklet, "How to Become Successful in Real Estate." Macdonald Cooperative Realty, San Diego, Calif.

"HOW to Sell Patents" free. Patent News-H, Washington, D. C.

MAKE toys and novelties at home. Big profits. Instructions and 200 illustrations, 25c. Astrolite Company, Sharpsburg, Pa.

WANTED—BUSINESSES FOR SALE

IF You Want to Sell Your Business for Cash quickly and privately, we take the prospective buyer directly to you at our expense, no matter where located. We specialize in selling out-of-town businesses. If your business is worth \$5,000 or more, write us The Mutual Security System, 68 W. Washington St., Chicago.

CHEMISTRY

YOUR chemical problem solved and working process furnished Five Dollars. Write me, W. Stedman Richards, Consulting Chemist, address, Box 2102, Boston, Mass.

TECHNICAL information, analyses, formulas, trade secrets. Jacob Shtayer, Chemist, 2525 East St., Davenport, Iowa.

FORMULAS AND TRADE SECRETS

A GOLD mine for mail order men. For \$1 will show you how to make best selling Mail order novelty ever offered. The Sex Indicator, or Magic Indicator. You can make these at less than 1c each, and sell for 25c. Also a new way you can use this for big sales. Write Dept. "Z," P. O. Box 1092, Victoria, B. C.

WHY pay hundreds of dollars for formulas and trade secrets? We furnish thousands of reliable, tested manufacturing formulas covering many industries, for little money. Write for astonishing offer. Southern Trading Co., Dept. 32, Flushing, N. Y.

50 MAIL-ORDER plans and 450 formulas; 50 cents. Portland Service, Norwalk, Conn.

250 VALUABLE Formulas 10c; 750, 35c. Rodgers Company, 843 Lorust, Cincinnati.

WHAT do you want to manufacture? \$3.00 brings formula guaranteed to work. Don't ask how we got it—We have. Formula with complete instructions, any product, by return mail. Consulting Chemists Bureau, Box 1709, Boston, Mass.

500 VALUABLE Formulas 25c. Circulars free. Harvey Teple, Decatur, Ind.

BEVERAGES, Extracts, Syrups, Others, Your Favorites. Reliable formulas. Free information. Formula Co., 122 West Howe, Seattle, Wash.

10,000 SELECTED chemical, technological and practical recipes and processes, including hundreds of so-called trade secrets for every business, alphabetically arranged in one large volume of 800 pages. Price \$1 postpaid. Popular Mechanics Book Dept., 208 E. Ontario St., Chicago.

500 SUCCESSFUL money-making Formulas and Trade Secrets 25c. C. E. Dynes, 705 E. 12th St., Muncie, Ind.

HOW would you like to receive 100 letters a day, each containing a quarter? Will send three formulas and plan for 25c silver. Wm. Kramer, Highmore, S. Dakota. Strictly legitimate.

TWO west coast formulas for preserving display fruit, and flowers, in their natural form and colors; \$5 each; complete instruction guaranteed. Forsyth, San Gabriel Post Office, Route 2, Los Angeles County, Calif.

BEVERAGES, Etc. Reliable Formulas. Valuable information. The Formula Company, Ber. Dep't., 122 West Howe St., Seattle, Wash.

500 FORMULAS, including Luminous Paint—Renewing Dry Batteries—Mechanics' Soap—Gas Tonic—25c. Catalog Free. Ideal Book Shop, 5501-PM, North Robey, Chicago.

FORMULAS The best Chemical Science can devise—Guaranteed Reliable Processes in all lines. Stamp brings big bunch valuable literature, interesting lists. Don't buy till you see what I can give you. 27 years supplying the best. Miller, Chemist, 1133 Grand Central, Tampa, Fla.

1,000,000 FORMULAS, 1,016 pages, \$1.98. 500 Formulas Free if you order quick. Ideal Book Shop, 5501-PM, North Robey, Chicago.

AGENTS WANTED

\$8.50 TO \$20.00 daily easy—Introducing New Insured Hosiery for men, women, children, 57 styles, 37 colors. Must wear or replaced free. Repeat orders sure. Nyland made \$395 one month. Edwards, \$460.60. Mrs. Bone, \$445.25. Why not you? Even spare time work should pay you \$3 per hour. Your Pay Daily in Advance. We deliver and collect. You spend all your time writing orders. No experience or capital needed. We furnish elegant outfit. All grades, colors, including silks. No matter what you are now selling, it will pay you to get our offer. Macchese Textile Company, Station 2564, Cincinnati, Ohio.

GET posted—Good prices paid for butterflies, insects. See Sinclair display advertisement, page 24.

NO Dull Times in the Food Business. Selling Federal Pure Food Products is the greatest, surest and safest business in the world today, and here is your opportunity to get into it. You can make \$3,000, \$5,000, \$10,000, or more per year—the only limit is your ability to take care of the business. You will need no experience or money to get into this business as we send you our handsome \$15.00 Sample Case on Trust and teach you everything you need to know. No Dull Times, for the People Must Eat, and our food products are the fastest selling, surest and quickest repeat order goods in the world. Sell on sight in every home where food is used—repeat orders immediately and every week thereafter. A real big business all your own. Every new customer adds a great deal to your weekly income. Your business once established, has a market value just like a store and can be easily sold. The greatest money making opportunity of your lifetime because you risk absolutely nothing as we guarantee your sales, and we will not let you fail. Remember! Guaranteed! Best products, biggest sellers, surest repeat orders. No capital or experience is required. We furnish capital and everything necessary for you to become a Federal Distributor. Exclusive territory will be given honest men or women who write at once. Federal Pure Food Company, 2309 Archer Avenue, Dept. A, Chicago, Ill. Largest packers of Pure Food specialties in the world. Reference, any bank, Dun or Bradstreet rating agency, Express or Railway Company in America.

MILLERITE: Here it is! You've read about this New Wonderful Ethyl-Super-Fuel Ingredient for Gasoline—Increases Mileage—Saves Gas—Knocks Carbon—Easily Mixed from my simple Formula—profits great—\$5,000.00 to \$50,000.00 for you if you hurry!! Don't pass this by you'll be sorry—but send today for full descriptive literature of this and other valuable Formula Lists describing latest, biggest selling specialties in all lines as Mendit, Fabric Mending Cement, Marcel Permanent Hair Curling Fluid; Denta-perl Tooth Whitener; Balloons and other thin dipped rubber goods; Flynox—few drops kills roomful flies; Amazon Self Vulcanizing Repair; Pro-Tex-U only Guaranteed Fire Extinguisher; Pure Food Products; Toilet, Medical, Household, Automobile Office Specialties—latest in all lines. 27 years supplying the best in Formulas and manufacturing information. Highest References. Miller, Chemist, Tampa, Fla.

GENUINE Gold Leaf Letters anyone can put on Store windows. Guaranteed to never tarnish. Large Profits. Enormous Demand. Free Samples. Write today. Metallic Letter Co., 428-A North Clark, Chicago.

DUSTLESS Sponge Cloth. New invention. (1) Rub—Dusts, Cleans and Polishes Automobiles, Furniture, Pianos, Retail (50c)—Costs (16c). "Sample Free." NuLife (E) Sponge, Hartford, Conn.

CALIFORNIA Rosebuds selling like hot cakes. Agents coinng money; new stuff. Big profits. Catalog free. Mission Factory PM, 519 No. Halsted, Chicago, Ill.

AGENTS—Best seller; Jem Rubber Repair for tires and tubes; supercedes vulcanization at a saving of over 800 per cent.; put it on cold. It vulcanizes itself in two minutes, and is guaranteed to last the life of the tire or tube; sells to every auto owner and accessories dealer. For particulars how to make big money and free sample, address Amazon Rubber Co., Philadelphia, Pa., Dept. 503.

SALESMEN and Saleswomen part or whole time sell the wonderful line of Maudrite-Smuggit Hosiery direct to the consumer. Prices and styles unequalled. Highest commissions paid in advance. Maudrite Sales Co., 1340 Broadway, New York.

BIG Money in formulas. Our valuable collection of 10,000 reliable, tested formulas of famous chemists, tells you how to manufacture hundreds of preparations used on a large scale. Write quick for astonishing offer. Southern Trading Company, Dept. 33, Flushing, N. Y.

AGENTS to demonstrate and sell to car owners Nationally advertised Auto Polish that removes the dull, cheapening film from motor cars; quickly restores the factory lustre, and leaves a glass hard, bone dry, dust-proof surface. A scientifically correct Cleanser that is each year saving thousands of car owners the expense of repainting, yet the cost is only \$1.00. Agents everywhere proving that quick sales follow demonstrations; and profits grow steadily from repeat business. For free testing sample and details of agency, address C. S. Mfg. Co., 502 N. Whittier St., St. Louis, Mo.

THE Clothing Industry is the second largest business in the country. Men have made fortunes in it. So can you if you go into it right. We'll put you into it right without one penny of expense to you, supply everything you need to get into the business and clear from \$100.00 to \$200.00 a week, right from the start. This is a wonderful opportunity for the right man. If you think you are that man, write at once. Address Dept. 637, Goodwear Chicago, Inc., West Adams Street at Peoria, Chicago.

IF you are not making at least \$20 daily we want you. Every storekeeper uses signs. Sell them the A. B. C. interchangeable window sign. All metal. Size 7x14. 200 assorted letters and figures. Factory price \$4.50 Dozen, Sells \$1.00 each. Profit \$7.50. Three dozen daily easy. Send for Free Sample Offer. Mase Manufacturing Co., Dept. P. M., 55 East Chicago Ave., Chicago.

WORLD'S Fair Gold Medal Jewel Carpet Renovator. Send one dollar for agents' proposition and enough Renovator to clean five large rugs. Money back if not satisfied after using one package. Big money for ambitious agents. Jewel Mfg. Co., Lansing, Mich.

AGENTS: Dental Cream. Regular 25c seller \$1.00 per dozen. Buy your goods direct from manufacturer. No free samples. No sample outfits for sale. No fancy circulars. No automobiles given free. But prices that enable you to compete successfully with cut rate stores. Send 10c for full size sample and price list of over 100 other toilet articles, food products, and household necessities. Home Products Co., 318 East 160th St., New York City.

PATENTS—Write for my free Guide Books "How to Obtain a Patent" and "Invention and Industry" and "Record of Invention" blank before disclosing inventions. Send model or sketch of your invention for instructions. Promptness assured. No charge for above information. Clarence A. O'Brien, Registered Patent Lawyer, 5891 Security Bank Building, directly across street from Patent Office, Washington, D. C. See pages 168 and 169.

\$5 TO \$15 daily (Sworn Proof) Introducing New Guaranteed Hosiery. Must wear or replaced free. No capital or experience required. You simply write orders, we deliver and collect. Your Pay Daily. Spare time satisfactory. Maroche Textile Company, Station 5854, Cincinnati, Ohio.

WANT Money? Lots of It! Sell Perry Photo Medallions and Lykold Paintings of loved ones. Novel, Appealing. Easy to sell. \$15 to \$40 a day. Advance commissions. Write. Perry Photo Novelty Corp., 1795 Jerome Ave., New York.

\$4 CASH with every sale of Capt. Burke's Fire-Foe, only pistol-type extinguisher on market; operates with one hand; used on U. S. Airplanes; undersells all competition; stops bandits as quick as it puts out fires; factories and institutions buy in quantity; \$20 a day easy. Write for sales plans. Burke Fire-Foe Sales Co., Desk A, Cincinnati.

AUTO owner tire agent wanted each locality to use and take orders for handmade Mellinger fabric and cord tires; guaranteed bond 8,000 and 12,000 miles (no seconds); shipped prepaid on approval; get your tires free; no capital or experience required; make \$100 to \$300 weekly. Write for wholesale prices and sample kit. Address, Mellinger Tire Co., Dept. 300, Kansas City, Mo. or Dept. 300, Philadelphia, Pa.

WANTED, agents who wish to establish for themselves a permanent income by placing the Noteboom Individual Comb Vendor in washrooms. Repeat orders for these penny white sanitary combs, can be the means of making you independent. Brown's Mills Novelty Manufacturing Co., 7th and Chestnut St., Philadelphia.

MEN with Fords make \$10 to \$30 a day selling Trusko, a necessary support for Ford transmissions. Reduces vibration, saves gas, makes riding comfortable, cuts repair bills. Easily attached in 5 minutes. Exclusive territory. Agent's sample, \$1. Sells for \$2, plus installation charge. F. R. Charles & Co., 14-M W. Washington St., Chicago, Ill.

AGENTS, Salesmen, Demonstrators, you will have the devil's own time trying to find a better seller than "Zippos." If there was such a thing we'd have it. Splendid profit on 50c "Go Getter" repeat article that sells on ten second demonstration. Works While You Watch It. Demonstrates value, while others waste time making claims. New discovery! Greatest Scientific Triumph of the age. It's the berries. Haven't room to tell our story here. Write immediately. Karam-Smith Co., 604 Bozan St., Ft. Wayne, Ind.

AGENTS Wanted—Something New—Fyr-Fyter sells easily. Makes a spectacular demonstration; car owners, homes, factories, stores, practically buy on sight. Our men make \$10.00 to \$50.00 a day. If you wish to establish a business of your own with unlimited possibilities for making big money, write us today. Fyr-Fyter Co., 686 Fyr-Fyter Bldg., Dayton, Ohio.

BIG Profits. New \$3.50 Automatic Adding Machine. Quick Sales. No competition. Ten daily easy. Absolutely accurate. Fully guaranteed. Pocket size. Business people everywhere positive customers. Exclusive territory to workers. Act quick. Bassett Company, 1158-D Hollywood Ave., Chicago.

BIG Money—Selling Fiber House Brooms. Sure-Fire Seller and Repeater. Biggest Season Here. Write today. Wearerer Fibre Broom Co., Jonesville, Mich.

MAKE \$25 to \$30 Week, representing Clow's Famous Philadelphia Hosiery, direct from mill—for men, women, children. Every pair guaranteed. Prices that win. Free book "How to Start" tells the story. George Clows Company, Desk 31, Philadelphia, Pa.

ORIENTAL perfumes and cosmetics bring 100 percent net profit. Sample case starts you on the road to success. Write Parfumerie Romola, Woodlawn, Chicago.

AMAZING new Fire Gun sells like wild fire. Salesmen making \$100 to \$300 week, spare and full time. Biggest commissions; also cash bonus. Write quick for Free territory and Free sample outfit offer. Weldon Manufacturing Company, Dept. 701-D, Grand Rapids, Mich.

BUILD splendid business making chipped glass number and name plates, signs, medallions. Write for particulars. Simplex Utility Co., 1133 Broadway, New York.

AGENTS—N-R-G Laundry Tablets, the old reliable money-maker for live agents. Millions sold—200% profit—sales waiting for you. Clothes washed spotlessly clean in 10 minutes without rubbing. Free samples. N-R-G Company, 732-B N. Franklin, Chicago.

AGENTS—Sell "Fragrance," New 16 breath-perfume candles, to Stores. Lorrac Products Co., 69 Charles St., Albany, N. Y.

\$15.00 DAILY Easy. Sensation of 1925. It's new, just out. "Flixi" Rubber Repair for Tires and Tubes. Fastest seller, and biggest money maker in America. Act quick. Sample free. Marquette Rubber Co., 2323A Wolfram St., Chicago.

AGENTS make big money selling new Ford necessity. U. S. Iron Works, Seattle, Wash.

AGENTS—Very high quality fibre broom at low price; 150 to 200 per cent profit; it's a by-product with us or we could not give such high quality; get sample. M. D. B. Co., 102 22d St., Milwaukee, Wis.

SUCCEED With Your Own Products. Formulas by experts. Manufacturing processes. Trade-secrets. Modern master methods. Catalog free. B. Thaxly Co., Washington, D. C.

AGENTS, Monogram Automobiles. 15 Million prospects. \$1.40 profit every \$1.50 sale. Wilbur made \$29.50 first day. Free samples. Worcester Monogram Co., 318, Worcester, Mass.

AGENTS Earn \$50 a day selling Goodyear Raincoats and Waterproof Aprons. No Capital or experience required; large steady income. Write for Free samples and territory reservations. Goodyear Rubber Mfg. Co., Dept. 5, 34 East 9th St., New York.

WE'LL make a classy suit for well dressed man over 25 who will wear and show to friends and help us introduce. Write for order blanks, etc. Chicago Tailors' Ass'n., Dept. 696, Sta. C., Chicago.

GREATEST Sensation—11-piece toilet goods assortment selling like blazes at \$2.00 with \$1.25 Dressmaker's Shears Free to each customer. Winner for 15 years. Davis Products Co., Dept. 56, Chicago.

AGENTS: Our gold-eyed needle cases are wonderful sellers; immense profits; \$50 to \$300 weekly; proof and particulars free; sample outfit 15c. Factory prices. Paty Needle Co., 231 Davis Square, Somerville, Mass.

ABSOLUTELY New. Greatest money-maker ever offered is opinion of agents now selling Lo-Air Alarms—new tire accessory which every motorist knows he needs. Weighs 2 oz.; easy to attach. Retail \$1.50 for set of four—75 cents profit to you. 15 to 20 sets a day is easy. No experience or capital needed. First man in territory will clean up. Rush your request for information to R. W. Moon Sales Co., Desk 100, Bartlett Bldg., Los Angeles.

AGENTS Wanted—For Red Dog Tube Patch. Repairs largest blow-outs or punctures without heat or cement. Startling demonstration sells it. 300% profit. If you can't stand "big money," don't answer. Exclusive territory. Samples free. Auto Products Co., Marion, Ind.

If I Send You a Suit made in the latest style from the finest goods, will you keep it, wear it, and show it to your friends as a sample of my sensational \$20.50 suits, guaranteed regular \$50.00 values? Could you use \$3.00 an hour for a little spare time? If so, write me at once for my wonderful new proposition. Just write your name and address on a card and mail to Dept. 387, A. M. Ward, 852 West Adams St., Chicago.

ENORMOUS Profits. Removes Nicotine Stains from Fingers. C. Fisher, Weatherford, Texas.

DITTO Metal Polishing Cloths. 300% profit. Kireher Products Manufacturers, Hamilton, Ohio.

AGENTS—Men and Women. 35 Million women are anxiously waiting to buy the 3-In-1 Hot Water Bottle—Icebag—Fountain Syringe combination. Commissions daily. No delivering. Write for startling money making plan. Lobl Manufacturing Corporation, Middleboro, Mass.

SEW - THREADING Needles, Needle Books, Machine needles, find sales in every home. Fine side lines, easily carried, big profits, sample and catalogue free. Prentice Lee, 145 East 3rd St., New York.

MAKE \$75.00 A Week and Up, selling our fine made-to-measure, all-wool suits—Direct to wearer—all one price, \$31.50. Biggest values. Commissions in advance. We deliver and collect. 6x9 swatch samples furnished. Write today. W. Z. Gibson, Inc., Dept. D-517, 161 W. Harrison St., Chicago, Ill.

AGENTS! There is big demand for genuine Cuban cigars. Box of 25 Puros Havans sells for \$10.00 up. Price to agents \$4.00. Repeat orders assured. Money-back guarantee. Jose Muros, 417 West 21st Street, New York.

AGENTS—Wanted Everywhere to sell Men's Superbilt dress Shoes direct from Factory to Wearer; no dull times with the Superbilt Agency. Energetic men make Big money. Write F. W. Moritz Factories, 4419-25 North Ave., Milwaukee, Wis.

BIG Profits selling our Specialties. Write for free catalogue and selling plan. J. Hunt Co., Morrisville, Pa.

AGENTS—Huge profits, wonderful pain killer; stops pain instantly from cuts, burns, wounds; heals quickly; sells anywhere. Write quick. R. Metcalf Co., Blandinsville, Ill.

CAN you sell? Suits and overcoats tailored-to-measure at \$19.75? Universal Tailors. H-99 Bedford Street, Boston.

AGENTS, \$18 Daily. Easy Mend Sells every home. Invisible mending for hose and cloth without needle. Satisfaction Guaranteed. W. Thos. Barnett Co., Desk 13, Des Moines, Iowa.

AGENTS: \$16 a day. Latest improved portable talking machine. Does more than machines costing five times its price. Built in just like a suitcase. Fully guaranteed. Pay you daily. Write Perry-Ludlow Co., Class 1962, Dayton, Ohio.

TAILORING Salesmen: Our guaranteed \$21.50 and \$31.50 all wool tailored to order suits are \$10 to \$20 cheaper than store prices. Commission in advance. Protected territory. Beautiful assortment 6x9 swatches free. Manager, Dept. 1060, 843 Adams, Chicago.

AGENTS—Steady income assured, selling rugs. Big catalog and details free. Baker Rug Company, Worcester, Mass.

MOST Wonderful Seller. 96c profit every dollar. No stock to carry. License unnecessary. Sample free. Mission Factory PM. 519 No. Halsted, Chicago, Ill.

\$50-\$200 A WEEK. Genuine Gold Letters for store windows. Easily applied. Free samples. Liberal offer to general agents. Metallic Letter Co., 438-D North Clark, Chicago.

EVERYBODY Needs and Buys the "Business Guide." Wells cleared \$1,150 in 35 days. Send for sample. It's Free. Nichols Co., Dept. 4B, Nanterville, Ill.

FREE Sample. "Rain Shield Wiper." Retalls \$1.00—costs (25c). Just Invented. No Cloth—No Paste—No Attachment. Sold Clear and Rainy Days. (1) Rub keeps Windshield Clear (24) hours. Automobileists buy quickly. Riley made \$198 three days. Experience unnecessary. Wonderful Sideline. NuLife Corporation, Hartford, Conn.

AMBITIOUS agents, write us for big money-making agency for World's Fair Gold Medal Household Necessity. Jewel Mfg. Co., Lansing, Mich.

AGENTS Wanted. Your chance in life to own dignified profitable business. We teach you practical insurance. Earn \$5,000.00 yearly. No capital required. Office at home. Dept. M, Room 215, 75 Montgomery St., Jersey City, N. J.

NEW Office Articles. One for typewriter. Rempe Mfg. Co., 2827 Myrtle St., Oakland, Calif.

100% PROFIT on \$2 seller. New Product, never before used. Cleans rugs, cloths, caps, etc. Every demonstration a sale. Free Auto. Sample 50c. Sheppard, Quimby Co., Box 479, Rochester, Minn.

AGENTS, specialty salesmen, get this good money now. Let us start you in business with Cleaneze and make you independent; you can earn \$10 daily; Cleaneze sells to homes, automobilists, offices, public buildings, etc. Repeats over and over. Free folder sent on request. Gelbach, Manager, Lebanon, Pa.

\$15 DAILY—Spare Time—No peddling. A Mail Order Business of your own. Four successful plans \$1. Blaid Service, Box 219, Rochester, Minn.

LIGHTNING Strange Battery Compound. Charges discharged batteries in 10 minutes. Eliminates old method entirely. Gallon free to agents. Mickman Co., St. Paul, Minn.

JIPFY Switch Clocks turn off electric lights anytime. Installed in one minute. Alone in its field. Sold to stores, banks, poultry farms, etc. Salesmen can make \$15.00 per day and more. Agents and distributors wanted. Write now. Meco Products Corp., 52 Vanderbilt Ave, New York, City.

AGENTS: Big Profits. Gold Sign Letters. Easily applied. Free sample. Liberal offer to General Agents. Interstate Sign, 3953 Armitage Ave., Chicago.

PORTRAIT men and artists, using our better bromide prints will save you money. United Print Co., Station D, Chicago, Ill.

If you want to distribute free samples, circulars, etc., in own locality, write quick. Absolutely no selling. Excellent pay. Moore Advertising Company, Drawer P-488, Zanesville, Ohio.

AMBITIOUS Young Men and Women Are making good incomes in spare time, introducing Zev, the Waterless Hand Soap. It is something new, which every auto driver, mechanic and housewife needs. Send post card for particulars to Parke Corporation, Dept. C, Kalamazoo, Mich.

SELL Beautiful \$7.00 Red and Black Oversized hand made Fountain Pens for \$3.50. Cost you \$1.75. With bonus \$1.55. Post card brings full details, or C. O. D. sample, at wholesale price. Johnson Pen Co., Dept. P, 117 So. First St., Beckford, Ill.

GOLD-LEAF Sign Letters; make and sell; 1,000% profits. Particulars, Johnston Co., Quincy, Ill.

SOMETHING new. Costs 5c, brings \$1. Write quick. Scientific Co., Box 741, Oakland, Calif.

GREAT Seller. "Magic Polishing Cloth." Polishes all metals instantly. No polish needed. Real Money-maker. Enormous Profit. "Sample Free." Bestever Products, 1947E, Irving Park, Chicago.

AGENTS, to sell Little Wonder Check Protector. Vest Pocket size. Perforates amount in figures through written amount on dollar line of check. Perfect Protection. Just out. Sample fifty cents. 200% profit. Exclusive territory. Piqua Check Protector Co., Piqua, Ohio.

AGENTS now making \$100 week with our gold-leaf window letters and script signs. No experience required. Consolidated Co., 632 South Dearborn, Chicago.

SALESMEN Wanted. Sell Dynol Super Gasoline Energizer; increases power and mileage, removes carbon, keeps it out. Guaranteed. 100% profit. Particulars free. \$1.00 brings 16-oz. Sample Can. Herbert Aldridge, 261 Humphrey St., Swampscott, Mass.

START Mail Order Business: Watch Yourself Grow. Cost 5c. Sell by Mail for \$1. Make \$15 to \$30 daily. Information Free. Desk A, Surety Service Company, 551 Harvard St., Rochester, N. Y.

ARE You Old at Forty? See our advertisement on page 175 of this issue. The Electro Thermal Company, 2137 Main street, Steubenville, Ohio.

AMERICAN Woolen Mills Co., Dept. 6034, Chicago, are making a free suit for one agent in each community to introduce their fine tailored to order suits at \$18 and up. Write them today for their offer.

AGENTS, sell guaranteed shirts and hosiery. 60 styles. Large advance commissions. Make big money without investing a nickel. Write A. Helix Hosiery, 396 Broadway, New York.

AGENTS—Sell Newark Felt Rugs on sight. Best values on market. Big, satisfactory profits. Write quick for information and plan. Newark Felt Rug Company, 270 Sixteenth Ave., Newark, N. J.

AGENTS earning \$20 daily selling Amenz made-to-measure shirts. Liberal advance commissions. We deliver and collect. Free Sales Outfit. Menzlin Shirt Company, Dept. 11, 479 East Tremont Ave., New York.

GOLD X-Ray Novelty. The perfect illusion! See the bones in your hand, lead inside a pencil, etc. Rapid seller, large profit. Samples and particulars for 25 cts., stamps or coin. Yankee Novelty Co., 98 Third Ave., N. Y. City.

ROBT. H. INGERSOLL of \$1 Wash fame wants good men to sell his Dollar Strapping outfit, an ingenious invention for sharpening all makes of safety razor blades. Great economic value. Meeting with nationwide approval. Easy to sell. Big repeat business. Agents having remarkable success. Full particulars. Robt. H. Ingersoll, 476-D Broadway, New York City.

PORTRAITS, photo pillow tops, frames, sheet pictures, medallions, merchants' signs, food products, rubber aprons, guaranteed hose, toilet requisites, luminous crucifixes. Catalog 50 specialties free. 30 days credit. Jas. C. Bailey Co., Desk A-4, Chicago.

AGENTS—\$75 Weekly Selling Nustle guaranteed hosiery. Your pay daily. You write orders, we deliver and collect. Special Monthly bonus. Sample outfit furnished. Nustle Hosiery Mills, Dept. 1-4, Philadelphia, Pa.

WONDERFUL invention eliminates needles for phonographs. Preserves records. Abolishes scratching. Day's supply in pocket. \$20 daily. Sample on approval if requested. Everplay, Desk B-4, McClurg Bldg., Chicago.

27,000 RECORDS guaranteed with one Everplay phonograph needle. Preserves records. Abolishes scratching. Day's supply in pocket. \$20 daily. Sample on approval if requested. Everplay, Desk T-4, McClurg Bldg., Chicago.

\$50,000 PICTURE Man Friedman made canvassing. Beginners can make \$100.00 weekly with my sales talk. Experienced men make more. Free book "Profits in Portraits" explains. Samples Free. Picture Man Friedman, Dept. 8-F, 541 W. Lake, Chicago.

ANY man handy with paint brush can start furniture refinishing, painting, jobbing and handyman business on nearly nothing; mostly all profit. Winning plan brings customers quickly. John Braceband, 1457 So. Ninth, Philadelphia, Pa.

MAKE Money Applying Monograms on Automobiles. Easiest Thing today. You simply transfer Gold Leaf initials from Paper. Takes 5 minutes to make \$1.70. Sample Free. "Balco," 325 Harrison, Boston, Mass.

FREE to Agents—\$10 worth of our fastest sellers absolutely Free on our refund plan. New inventions; all household necessities. Write quick. General Products Co., Dept. 1, Newark, N. J.

FISH, Sell Fish, establish route; extraordinary opportunity. Sootin, Liberty, N. Y.

GOODYEAR Mfg. Co., 1744 Goodyear Bldg., Kansas City, Mo., is making an offer to send a handsome raincoat free to one person in each locality who will recommend it to friends. Write today.

AGENTS—Sell Magic Washing Compound. Your name on package. Great re-peater. 300% profit. Miller made \$1,000 in 6 weeks. Sample free. "Besco," 1943-W, Irving Park, Chicago.

AGENTS, both sexes, we manufacture and control new household article. Fast seller. Big profits. Exclusive territory. Write Now. Connolly, 123 Liberty St., New York.

AGENTS—Novelties from Germany and Japan—\$15 daily easy. Samples and Mail order plan \$1. Portagas Novelty Co., Box 282, Sta. C, Los Angeles, Calif.

AGENTS make \$100 Week placing Advertising Cigar Lighters with glass front. Every dealer wants one. Average profit \$25 each. Write for free plan. Drake Mfg. Co., Dept. M, Milwaukee, Wis.

EVERY car owner a customer. \$5 to \$12 on every sale. Distributors Wanted. Write today. Spring Equipment Corp., 239 West 88th Street, New York City.

PORTRAIT men—new low flat price on all kinds of portraits. Family Portrait Co., 330 So. Hoyne Ave., Chicago.

AGENTS—Quick sales, big profits, outfit free. Cash or credit. Sales in every home for our high-class line of Pure Food Products, Soaps, Perfumes, Toilet Articles, etc. Write today for money-making plans. American Products Co., 2331 American Bldg., Cincinnati, Ohio.

AGENTS, \$45 a week. New guaranteed business for men, women, children. Must give satisfaction or new hose free. Full line of silk hose. Latest styles and shades. Write for samples. Parker Mfg. Co., Sample 1178, Dayton, Ohio.

PORTRAIT Agents in Hawaii, Cuba, the Philippines and all foreign countries, write for catalog and lowest prices on Guaranteed Portraits and Frames, Samuels Free. Picture-Man Friedman, Export Dept., 541 Lake St., Chicago.

AGENTS—Sworn proof of \$14.85 daily in advance. Write orders for new insured Hosiery for men, women, children. All styles and colors. Finest silk hose. We deliver and collect. Spare time will do. Auto furnished. Samples to workers. Wilkmit Hosiery Co., Dept. 278, Greenfield, Ohio.

MEN and women in every town to sell our distinctive cards and social stationery. Liberal commissions. Outfit, 10c. Forman Printery, 16D, Plantville, Conn.

AGENTS—Signs for stores and offices. Entirely new. \$50 weekly easily made. World Signs, M-166 W. Washington, Chicago.

"PEP" National Health Drink. Taste like Grape Juice. 50c Bottle makes 8 gallons of delicious beverage. Cost you 20c. Every home buys and repeats. Big catalogue of opportunities free. Myrtil Co., Glens Falls, N. Y.

STOP Daily Grind. Money! Re-Silvering Mirrors, auto-parts, tableware, stoves, Outfits; Plans Free. Sprinkle, Plater, 128, Marion, Ind.

\$20 PROFIT daily selling needlebooks; costs 3c-5c each; sells 25c. value 50c; Three samples 25c. Catalogue Free. Needlebook Specialty Co., 861 Broadway, New York.

AGENTS—To sell the Barrphone, the unexcelled telephone intensifier; Carries a whisper clearly; needed everywhere. No capital invested. Our selling plan guarantees immediate commission. Send for sample and particulars. S. & S. Mfg. Co., 503-504 Metropolitan Bldg., Milwaukee, Wis.

AGENTS—Dealers: Sell something people want at price they will pay. Costs you 7c each. Returns 25c. Saves customer 75c every time he buys. Small, light, easy to carry or mail. Good repeater. Sample 25c coin. Mail Only. Imprint circulars. A. T. S. Co., 216 Superior Ave., Cleveland, Ohio.

AGENTS, here's your chance to sell a money-making monopoly. Resistol makes shoe soles outwear uppers and waterproofs permanently. New, scientific, satisfaction or money back product. \$1.00 can treats 10 pairs of soles. It's a winner! The Resistol Company, 626 Union League Bldg., Los Angeles, Calif.

CAN you sell? Suits and overcoats tailored-to-measure at \$19.75! Universal Tailors. H-99 Bedford Street, Boston.

OPPORTUNITY: Metal Weatherstrips installed without removing sash. Exclusive Agents wanted. Allan Manufacturing Company, Box M, Morris, Ill.

MEN Wanted—To earn \$50 to \$100 per week introducing a fast selling auto accessory. \$2.00 profit on every \$4.00 sale. Will send a sample at our risk. Write Stransky Co., Dept. M-14, Pukwana, S. Dak.

MARVELOUS Radio Gas Lighter sells instantly to every user of gas. Good for 10,000 lights. Returns only 25c; costs \$10 a gross. Your profit 15c on each sale, \$26.00 on gross. Send \$1.00 for sample dozen with self-selling plans. E. M. Masterlite Co., 110 East 23rd, New York.

ENERGETIC men and women wanted to handle the Milford Knife Sharpener. Sells to every home. \$1 for 6 samples. Gilbert Sales Co., Box P, Milford, Conn.

HAVE You Seen the New BeeGee Line? Get our 1925 Catalogue and stop worrying about what to sell. You'll be satisfied with what you make. B. & G. Rubber Co., Dept. 753, Pittsburgh, Pa.

EARN \$10 Daily—Men—women. Permanent Business. Foods, Soaps, Perfumes, Face Creams, Rubber Goods, Extracts, Jewellery, Novelties, etc. 300 Big Sellers. Easy Money. Write Now. Free Catalog. Western Products Co., 263 N. Oakley Blvd., Chicago.

RECEIVE 20 miles with fingering. No other apparatus. Just wear radio ring and listen through any head phone. \$1.00 complete. No circulars. Irving Co., 1634 So. Lawrence, Chicago.

AGENTS—Make tremendous profits handling our complete line of Felt Rugs—Not sold to stores. Bright, attractive colors assuring quick sales. This is a real Money Maker. Write immediately. Eastern Mills, Everett, Mass.

DECIDE today to go into business for yourself. You can easily. Little or no capital, no experience required. Big profits sure with our wonderful plan. You risk absolutely nothing. See our ad on page 136 of this magazine. Doublewear Shoe Co., 319 E. Lake St., Minneapolis, Minn.

\$5 STARTED me earning \$200 weekly with Mail-Order business. Anyone can do the same. Outfits furnished. Particulars free. Peerless Service, 447 Waterville, Maine.

\$20.00 DAILY taking orders for Patent Work Shirts and other patent work garments. Factory to wearer. Your pay daily. We deliver and collect. Write today. Patent Shirt Co., 39 W. Adams St., Dept. 42, Chicago, Ill.

MARVELOUS New Invention—100% Profit. Johnson's Liquid Quick Mend Tremendous demand. Plan unique. Act Quick. Over hundred other fast-selling specialties. J. E. Johnson & Co., Dept. 72, 321 W. Chicago Ave., Chicago, Ill.

AGENTS: Take orders for beautiful Rhinestone initial buckles, dresser clocks, etc. Big commission. Exclusive territory. Sample free. Chaton Novelty Company, 600 Blue Island, Chicago.

AGENTS: Sell full line of guaranteed hosiery for men, women and children. Must wear 12 months or replaced free. All styles, colors and finest line of silk hose. Often take orders for dozen pairs in one family; permanent customers and repeat orders make you steady income. Write for sample outfit. Thomas Mfg. Co., Class 462, Dayton, Ohio.

CLEAN your car for 5c. Dri-Klean-It removes mud, dirt, dust. No soap or water. We have made over 1000 customers in 90 days. Agents wanted. Write American Accessories Co., Dryealan 178, Cincinnati, Ohio.

"DO you know every man's a prospect?" Sell razor knives; take used safety razor blades. Brass durably nickel-plated for vest pocket and heavier models. Sample thirty cents each postpaid. Burleigh Brooks, 130 Liberty St., New York.

WONDERFUL silver cleaner. No rubbing or polishing. Ambitious agents make big money. Send one dollar for four boxes and agents' proposition on this and four other household necessities. Money back if not satisfied after using one box. Jewel Mfg. Co., Lansing, Mich.

SELL our useful attractive household specialties. Housekeepers want and are glad to buy. Steady sellers. Large profits. Central Mfg. Co., Dept. D, Lynn, Mass.

EMBOSSED Window Sign Letters—1,000 for \$9.75. Perfectly cut. Free samples. Foil Sign Works, 1965 Telegraph Ave., Oakland, Calif.

ADJUSTABLE Poultry Hook; catches any size. New invention, now ready. Large Commission. O. O. Bartlett, 232 Willow Ave., Roseville, Calif.

66 MILES on 1 Gallon. Wonderful Vapor Humidifier for autos. I free to introduce. Big profits to agents. Critchlow, PMA-110, Wheaton, Ill.

300% PROFIT—Quick, easy seller, Klean-Rite. New Clothes Washing Compound. No rubbing. Women simply amazed. Free premiums makes sales easy. Fast repeater. Distributing samples free. Everybody grabbing for territory. Write quick. Bestover Products Co., 19478, Irving Park, Chicago.

AGENTS. Write for free outfit. House Dresses and 100 other fast sellers. No capital required. We deliver and collect. Economy Sales Co., Boston, Mass.

TWO amazing sellers: Marco washes hands without water; supplies tourist biggest need; put up in tubes; big repeater. Mystic Felt windshield wiper; one rub keeps glass clear 24 hours. Security Mfg. Co., Dept. 1, Toledo, O.

MAKE Big Money Easily. Quickly. Steadily. New. Simple. Economical Local Service Plan. Unlimited Possibilities. Details Free. Jerold Hinds, Monticello, Ill.

YOU Can Make Good Durable Paint and Varnish 40c per gallon. Write Dept. 2, Emmelmann Bros. Mfg. Co., Indianapolis, Ind.

AGENTS For Ford Accessory. No Freezing. No Boiling. See our advertisement on page 133.

SELLS Like Blazes. New Instant Stain and Rust Remover. For clothing, table linen, etc. Fine premium every sale. Big Quick Profits. Free Outfit. Write Today. Christy, 505 Union, Newark, New York.

FREE Sample Plan Sells Herb-Lax Tablets for you. For constipation, indigestion, biliousness, headache, rheumatism, piles. Wonderfully successful sales-plan. Big profits. Great Repeater. Sample free. Victor Remedy Co., 6442 Ellis Ave., PM4, Chicago.

WE pay \$48 a week, furnish auto and expenses to introduce our Soap and Washing Powder. Russ-Beach Company, Dept. A42, Chippewa Falls, Wis.

IMPORT Your Own Goods. Big German Export Magazine, published in English, offers Thousands of Bargains in latest Novelties. Sample copy 50c. Abca Specialty Co., E-263 Fifth Ave., New York.

BIG New \$2 Seller! Each sale nets you \$1. Every household, hotel, merchant, autoist takes one or more. Secure your territory quick. Volk Mfg. Co., Dept. P, Cincinnati, Ohio.

AGENTS, Sanitary Wringer Mop retails \$1.50. Send \$1.00 for sample and proposition. The Wringer Mop Sales Co., 205 No. Kedzie Ave., Chicago.

FREE folder describes 27 plans for making \$20.00 to \$100.00 weekly in home or office business of your own. Downs Co., 2323A Myrtle, St. Paul, Minn.

NEW Business. Rugs redyed on the floor with Fibertint. Nine colors, applied with brushes. Particulars and dollar box, fifty cents. Texply A. Co., Somerville, N. J.

IF I Sent You a Handsome Raincoat, Will You Show It to Friends? World Raincoat Company, 3208-B Third Ave., New York.

AGENTS—\$240 a month. Take orders for well known line of household specialties, food flavors, toilet preparations, etc. Full or spare time. Build a big permanent business. Must satisfy or money back. Write for free sample outfit and offer. C. H. Stuart & Co., 5567 Spring St., Newark, New York.

NATIONALLY known manufacturer wants men and women representatives everywhere; make \$5 to \$15 daily selling our famous Dozal Household necessities. No experience necessary. Williams Co., 142 Pine, Montclair, N. J.

NEW spark plug invention, the Beacon Lite; visible flash from each explosion in cylinders; big gas savers; sell on sight. Write today for special Free Demonstrator offer and deal to introduce proposition. Central Petroleum Co., 534 Century Bldg., Cleveland, Ohio.

MAN with Car to Appear Agents. No Investment. Permanent connection. Big money. Live wires write. Mention territory wanted. Newton Co., Second Street, Newark, New York.

PORTRAIT and Photo Medallion Agents—Artful Portrait Painting—reproduced from any photograph, finished on canvas just like an expensive oil painting—the new sensation and the biggest money maker in the specialty field. Take orders in combination with the famous P. & G. Photo Medallions and make a steady "clean-up"! Write Now! Puddin' & Goldstein, Dept. "A," 259 Bowery, New York.

WONDERFUL Sapphires. Exclusive special cutting like diamonds, wear forever, same satisfaction at fraction of cost, all colors, finest grade \$3 carat wholesale, new sales plan, stones only or mounted. (Importers) Pauer, 152 Dewitt, Buffalo, N. Y.

FREE samples and a sale in every home. Thousands already getting a \$3.00 value for 20c in Pitkin's Guaranteed Tube Flavors. Valuable territory still open. Write today for free sample and details of a big profitable business of your own. No capital necessary. J. M. Pitkin & Co., 725 Pitkin Bldg., Newark, New York.

TAKE orders \$9.50 Wearwell Guaranteed Suits and Topcoats. Neat in appearance and serviceable. Your commission \$3.00. Selling outfit Free. Prompt delivery. Territory open. Consumers-Wearwell Mfg. Co., 728 Rossetto, Chicago.

200% PROFIT selling Gem kettle bottoms. "The article with a dozen uses." Housekeepers buy on sight. Columbia Specialty Co., Box 73D, East Liverpool, Ohio.

MILLIONS lost by forgery. Wonderful new \$5.00 Check Writer perforates, inks in three colors. Equals work of \$60.00 machine. Five-year guarantee. Full or side line. Protected territory. Write quick for details and free trial. Safety Devices Corporation, Dept. P, Grand Rapids, Mich.

AGENTS—Good salary and commission selling "Ratskyl," new rat and mouse exterminator; ready for use; no bait required; non-poisonous; rodents die outside premises; no odor. Kinzie Specialties Co., 1549 N. Wells, Dept. 301, Chicago, Ill.

AT Last—World's Greatest Adding Machine. Almost human. Retail \$15; work equals \$100 machine. \$500 monthly easily made, demonstrating to stores, offices, garages, factories. Simple, easy; adds, subtracts, multiplies, divides automatically. Speedy, accurate, durable, handsome. Five year guarantee. Tremendous demand, amazing profits. Liberal trial offer. Protected territory. Write quick. Lightning Calculator Corp., Dept. F, Grand Rapids, Mich.

DARN E-Z. Big Money Now. Twenty Million anxiously waiting to buy. Holes in stockings repaired without darning. Special sewing system furnished agents assures generous income. Sure repeater, large profits, protected territory. 35c for sample. Darn E-Z Laboratories, Dept. PMM, Dayton, Ohio.

AGENTS—Sell men's ready-to-wear suits, topcoats and raincoats direct to wearer; no investment; big repeat business; commission in advance and big bonus monthly. Send for free selling outfit. The best line on the market; we undersell stores. Henry W. High Co., 306 So. Franklin St., Suite 502, Chicago.

AGENTS—Something absolutely new and novel in signs. Every office, store and private family a prospect. Make 'em yourself. We sell you materials and letters ready to mount. No! Not tinfoil. Mounted sample 10c. Ross System, 4704 Vincennes Ave., Chicago.

\$5.00 HOUR taking orders "Dixie \$2.95 Combination Coat." Demonstrating coat, selling outfit free. Dixie Raincoat, 728 Roosevelt, Chicago.

300% PROFIT. Fast Seller. Household Necessity. Repeater. Free Sample. Magic Distributing Co., 391 Gladstone, Kansas City, Mo.

\$100.00 WEEKLY and over. Selling our newly patented auto specialties. Free sample and particulars. Jackson Mfg. Co., 1331 14th St., Denver, Colo.

MAKE \$1 an Hour. Be Your Own Boss. Work anywhere and whenever you please. Complete instructions sent for \$1. Satisfaction guaranteed. Jo-La-Ko, Box 862, Station C, Los Angeles, Calif.

ESTABLISH Yourself in a Paying Business through our exclusive territory arrangement on an entirely different cleaning material sold to homes and larger quantity users. Repeats. Free samples. Chemical Specialties Co., 214 Metropolitan Block, Milwaukee.

MEN'S Shirts—\$25-\$75 Weekly—Factory to Wearer. Undersell stores. Free samples. Big Commissions advanced. Illinois Shirt Mfgs., 510 So. Wells, Factory 397, Chicago.

Big money and fast sales; every owner buys gold initials for his auto. You charge \$1.50, make \$1.44 profit. 10 orders daily easy. Samples and information free. World Monogram Co., Dept. 18, Newark, N. J.

MAGIC Polishing Cloth—great seller—big profit. Try this cloth—it's a money maker. Full size sample free. Get this proposition. Newton Co., 1 Main, Newark, New York.

KU-KLUX-KLAN lucky Kluxer pocket-piece and Katalog 10c. Agents making big money. National Emblem Company, Box 1174-PM, Omaha, Nebr.

\$5.00 HOUR taking orders Jackson "\$2.95 Combination Coat." Demonstrating coat, selling outfit free. Jackson Raincoat, 728 Roosevelt, Chicago.

AGENTS get Kloosquik, the newly invented door spring. Whirlwind seller. Retail 50c. You make 100% or more. Sell 50 to 80 a day easy. Write for 45c sample and easy starting offer. Kloosquik Mfg. Co., Dept. A, Bible House, Astor Place, New York.

Big Money Selling New Household Cleaning Set. Washes and dries windows, Scaevs, scrubs, mops. All complete only \$2.95. Over half profit. Write Harper Brush Works, 132 3rd St., Fairfield, Iowa.

AGENTS Kolining money selling Klan jewelry. Dime brings lucky Kluxer pocket-piece and Katalog. Box 524-PM, Omaha, Nebr.

BRING Home the Bacon—selling Stuart's Stain Remover. Removes ink, iron rust, grass and fruit stains. Write for free samples and terms today. C. H. Stuart & Co., 5967 Soaring St., Newark, New York.

AGENTS: Make \$1 to \$5 an hour selling the Famous Bamboo Self-Filling Fountain Pen. Write for Wholesale price list. Cordell McDaniel, Salisbury, N. C.

AGENTS—Make a dollar an hour. Sell Mendets, a patent patch for instantly mending leaks in all utensils. Sample package free. Collette Mfg. Co., Dept. 484, Amsterdam, N. Y.

AGENTS Wanted. Your chance in life to own dignified profitable business. We teach you practical insurance. Earn \$5,000.00 yearly. No capital required. Office at home. Dept. M, Room 215, 75 Montgomery St., Jersey City, N. J.

BIG Profits with Exclusive Territory—\$50 to \$100 weekly easy. More has often been made in one day's work. A hot or cold running water bath equipment for any home at only \$7.50. No plumbing or water works required. Investigate. Send no money. Write today. Sanitary Supply Co., 735 Allen Building, Toledo, Ohio.

\$3.00 AN Hour For Your Spare Time. New discovery. Proven success. Particulars Free. K. Rothe, 3949 Metropolitan, Chicago.

AGENTS wanted entirely new patented domestic article, sells for 50c; 200% profit. Write for particulars. Acme Products, 983AA Broad Street, Newark, N. J.

AGENTS. \$20 daily easy selling household necessity every woman wants. New invention reduces price. Big profit. Fagley & Halpen, 303 Cherry Street, Dept. 5, Philadelphia, Pa.

LATEST money makers. Your name on mailing list year 10c. Pennell, Covington, Ky.

To secure agents or salesmen or for selling farms and reaching investors, use classified (want) ads in largest newspapers and magazines. Price list No. 30 sent free. Angram Advertising Agency, 29 W. Jackson Blvd., Chicago, Ill. The largest classified advertising agency in the U. S.

MAN in each town to plate auto parts, reflectors, bathroom fixtures, refinish beds, mirrors, chandeliers; by new method. No capital or experience required. Simple plan of manufacturing at home starts you in big money-making business. Outfit furnished. Free particulars and proofs. Gun Metal Co., Ave. H, Decatur, Ill.

AGENTS—Make big money selling Sharp-Easy and other new household necessities. Premier Mfg. Company, Dept. 813, Detroit, Mich.

WASH Clothes the new way. Use the Torrent Automatic Washer. You will be delighted. Special offer to one in each locality. Storm Royalty Co., 3610 Enright Ave., St. Louis, Mo.

AGENTS, At Last, Liveat Supply house, wholesale druggists, extracts, medicines, perfumes—everything. Sales for every home. The Jot. Pharrical Co., Allentown, Pa.

A BUSINESS of Your Own—Make and Sell Chipped Glass Name and Number Plates, Checkboards, Signs. Large Booklet Free. E. Palmer, 512, Wooster, Ohio.

TURN your spare time into dollars selling Polmet Polishing Cloth that cleans all metals without liquid, paste or powder. Retail 2c. Our agents say it sells like "hot-cakes." Prove it yourself with free sample sent on request. F. C. Gale Co., 122 Edinboro St., Boston.

AGENTS—Coin money selling our new fabric table cover; needs no laundering, housewives wild about them; send for free offer. Mgr., Box 67, Medford, Mass.

LIVE Agents Make \$10 Day selling Eureka Strainer and Splash Preventer for every water faucet. Takes on sight. Widely advertised and known. Get details today. A. B. Seed Filter & Mfg. Company, 73 Franklin, New York.

"HOW to Sell Patents" free. Patent News-O, Washington, D. C.

AGENTS: 500% profit. "Happy Home Maker Shampoo" builds your own big business. Martin of Indiana made \$75.00 in one day. Missouri man made \$750.00 one month. Exclusive territory. Geo. A. Schmidt & Co., 236 W. North Ave., Chicago.

ABSOLUTELY free box Bassett's Native Herbs sent to introduce. For Constipation, Indigestion, headache, rheumatism. Big money selling, all or part time. Established 1879. Bassett, Dept. 8, Columbus, Ohio.

\$8.00 TO \$20.00 per day. A wonderful seller. Any man, woman, boy or girl can make big wages Selling Crimp Grip Clothes Line Fasteners. It is a perfect rope holder and can be used for many purposes. Crimp Grips are a simple, time-saving device. They last a life time and will not rust; it holds the line tight, and saves time on wash days. Every buyer is a booster. Send 50c for Mounted Sample and one pair of Crimp Grip Clothes Line Fasteners. Write for particulars. Crimp Grip Company, Belvidere, Ill.

GET Our Free Sample Case—Toilet articles, perfumes and specialties. Wonderfully profitable. La Derma Co., Dept. A, St. Louis, Mo.

BIG Money Selling Gold Initials. Quick Sales. Every Car Owner Buys. You Charge \$1.50—Make \$1.44 Every Sale. Your Profit \$20 Daily. No License. No Experience. "Samples Free." NuLife (0) Monogram Company, Hartford, Conn.

AGENTS—Write for Free Samples. Sell Madison "Better-Made" Shirts for large Manufacturer direct to wearer. No capital or experience required. Many earn \$100 weekly and bonus. Madison Mills, 564 Broadway, New York.

EASY, pleasant work for Mechanics, Shop Men, Clerks, during spare hours; will add many dollars to their salaries. Also want persons who can give full time. Big wages assured. Novelty Cutlery Co., 67 Bar St., Canton, Ohio.

POLMET—The Wonderful Polishing Cloth that cleans all metals without liquid, paste or powder. Approved by "Good Housekeeping" and "Modern Priscilla"—sells fast at 25c. Sample free. Gale & Co., Inc., 15 Edinboro St., Boston.

AGENTS—Be independent, make big profit with our soap, toilet articles and household necessities. Get free sample case offer. Ho-Ro-Co., 2725 Dodder, St. Louis, Mo.

AGENTS clear \$50.00 weekly selling Opaline Portraits. Expense money advanced. Credit given. Big line now ready. Samples and Catalog free. Consolidated Portrait Co., Desk 2, Chicago.

AGENTS—Steady Income. Large manufacturer of handkerchiefs and dress goods, etc., wishes representative in each locality. Factory to consumer. Big profits, honest goods. Credit given. Send for particulars. Freeport Mfg. Co., 59 Main St., Brooklyn, N. Y.

SELL Shirts and Overalls direct to wearer. Big profits. Work full or spare time. No experience required. Big variety dress shirts with splendid line Union-made work and flannel shirts, overalls, coveralls and khaki pants. Write today for free selling outfit. The Nimrod Shirt Co., Dept. 8, 4712 N. Kedzie Ave., Chicago.

AGENTS make 500% profit handling auto monograms, window letters, transfers, novelty signs. Catalog free. Hinton Co., 1153 N. Wells St., Chicago.

CAN you sell to colored people? Write, Eston Co., Dept. 101, 2500 Second Ave., Birmingham, Ala.

EARN big money fast applying gold initials to autos. Every owner buys—\$1.25 profit on \$1.50 sale—particulars and samples free. Write quick. Lithogram Co., Dept. 17, East Orange, N. J.

AT Last! Diamond Rival Discovered! Amazing blue white Rajah Gem astounds jewelry world and deceives experts! Beautiful Sample case Free! \$100 weekly! Write Quick! Rajah Diamond Co., Dept. F-7, Salisbury, N. C.

MAIL-ORDER Houses and Distributors: We pack French made beauty creams, face powders, perfumes, toilet preparations with your label. Chemist, 944A North Clark, Chicago.

SELL the Latest, Quickest Selling Specialties Ever Known—Famous "Hahway" self-lighting pocket Cigar Lighters and Gas Lighters. Low Prices. Easily Demonstrated. Sell to Dealers, Employ Sub Agents. Exclusive Territory. Make over 100% Profit. P. Bernhardt, 148 Chambers Street, New York.

BIG Money and Fast Sales. Every owner buys Gold Initials for his auto. You charge \$1.50; make \$1.35. Ten orders a day easy. Write for particulars and free samples. American Monogram Co., Dept. 40, East Orange, N. J.

IF you want good live agents—fellows who can get the business—ask me how others are doing it. I'll gladly render the necessary assistance. Geo. F. Baker, Mgr. Classified Advertising, Popular Mechanics Magazine, Chicago.

BUILD permanent business. Men's, Women's, Children's guaranteed shoes direct to wearer. A. P. Condon, Sales Manager Allen Shoe Co., 110 Summer, Boston.

WE Start You Without a Dollar. Soaps, Extracts, Perfumes, Toilet Goods. Experience unnecessary. Carnation Co., Dept. 201, St. Louis.

BIG profits selling our practical patented specialties. Write for particulars. Welch Brothers Co., North Chicago, Ill.

10,000,000 FORDS need "Teuscher" fan belts. 50% profit selling dealers; 250% selling owners. Write quick. Teuscher Belting Co., St. Louis.

AGENTS—Send for free sample "Preinet"—washday wonder. You can clear at least \$20 to \$100 weekly, according to spare or whole time. You don't have to talk; if she doesn't buy at sight, leave sample; she will be looking for you long before you are able to make the rounds again. Samples furnished free. Premiums for your customers. Exclusive territory. Credit given. Empire Specialties Co., 1549 N. Wells, Dept. 101, Chicago.

YOU can be your own boss with our Key-Check outfit. Good for \$5 a day stamping names on pocket key checks, fobs, etc. Sample check with your name and address, 20 cents. Pease Die Works, Dept. M, Winchester, N. H.

INSTANT Weld. Repairs largest punctures without cement or heat. Lenn's protone one day. \$56. Write quick. Free sample; territory going fast. "Tourist" Pride Mfg. Co., Desk T, Minneapolis, Minn.

EARN \$10 daily silencing mirrors, plating and refinishing metalware, autos, chandeliers, bedsteads, headlights. Outfits furnished. E. Dele Laboratories, 1133 Broadway, New York.

AGENTS sell Wolverine Laundry Soap. Wonderful repeater and good profit maker. Free Auto to hustlers. Wolverine Soap Co., Dept. B37, Grand Rapids, Mich.

EVERYBODY uses extracts. Sell Duo Double Strength Extracts. Complete line household necessities. Big repeaters. Write today. Duo Co., Dept. E1, Attica, N. Y.

AGENTS—Clever Invention! Inkspoon makes every pen a fountain pen. Fast office seller; big profit, demand increasing everywhere. Exclusive territory offered. Sample free. H. Marul Company, Tribune Bldg., New York, N. Y.

AGENTS—Stamping names on Pocket Key Protectors; sample Check with your name and address, 25c. Stamping Outfits, Emblem Checks, Check Fobs, Name Plates, Hart Mfg. Co., Desk 2, 303 Degraw St., Brooklyn, N. Y.

MAKE \$17 daily—Finest Extracts, Food Products, Toilet Preparations, Household Necessities. Credit: Sample Case Free. Write for amazing offer. Perkins Products, B-6, Hastings, Nebr.

AGENTS: Big Money Monogramming by Transfer Method. Catalog Showing Over 50 Styles and Particulars Free. Motorists' Accessories Co., Mansfield, Ohio.

AGENTS: Big Profits. Best and cheapest window letters made. Easily applied. Dime brings five samples. Particulars free. Stalbright Co., 1115 Second Ave., New York.

WONDERFUL! Startling! Amazing! Our Ex-Cel Luminous Crucifix and Magical (Luminous) Necklace shine brilliantly in the dark. Sell on first demonstration. Big profits to you. Write for further particulars, or better still, send for sample and territory protection immediately. Crucifix \$1.50, Necklace \$1.00, postpaid. W. G. Hannan Co., Dept. B, 57 E. 18th St., Chicago.

HIGH GRADE SALESMEN WANTED

BEST Seller. Jem Rubber Repair for tires and tubes; supersedes vulcanization at saving of over 80%; put it on cold, vulcanizes itself in two minutes; guaranteed to last life of tire or tube; sells to every auto owner and accessory dealer. Get particulars how to make big money and free sample. Amazon Rubber Co., Philadelphia, Pa., Dept. 510.

PORTRAIT Salesmen. Sell K. K. K. and all Lodge Emblems, Oil Painted on 14x20 convex glass. Write for circular with wholesale prices. Burdotts Art Co., 304 Fourth Street, Fairmont, W. Va.

SALESMAN: If You Think in Terms of \$6000 the First Year. Write Us. Strong line for retail stores. Nationally advertised. Established concern has unusual opportunity. Liberal weekly advance to producer. Continental Co., 1922 Euclid Ave., Cleveland, Ohio., Dept. 208.

SALESMEN to sell complete line of Advertising Thermometers; liberal commission. The Ohio Thermometer Company, 521 East Pleasant Street, Springfield, Ohio.

SPECIALIZERS: Best Full-Spare Time Specialty. One-At-A-Time Steel Match-Toothpick Holders. Retail \$8.50. Sample \$2.75. Standard Mfg. Co., Butte, Mont.

NEW carbon remover, automatic—only two moving parts. Nothing like it. No liquids, powder or dope. Want high-grade men with cars. An eighteen-karat Knockout. Write By-Pass Valve Co., Plattsmouth, Nebr., U. S. A.

ARE You the Man? We must have more representatives—at once! Style-Center Suits and Topcoats are sweeping the country—and our biggest year is just ahead. If you want a better job than any you have ever had—a steady job—a job that will pay you just as much as you want to earn—write us today! No matter what your previous experience, you can sell these splendid all-wool, tailored-to-measure garments at the attractive price of \$23.50. Hundreds of beginners have made \$75-\$150 a week, easy—right from the start. Scores of Style-Center salesmen are averaging more than \$10,000 a year. Write us today! The Style-Center Tailoring Co., Dept. P4, Cincinnati, Ohio.

IF I Send You a Suit made in the latest style from the finest goods, will you keep it, wear it, and show it to your friends as a sample of my sensational \$20.50 suits, guaranteed regular \$50.00 values? Could you use \$3.00 an hour for a little spare time? If so, write me at once for my wonderful new proposition. Just write your name and address on a card and mail to Dept. 388, A. M. Ward, 852 West Adams St., Chicago.

WANT a \$2,798 Check each month? That's what we paid Mrs. Hunt in November as commission for selling Alexander Film publicity. Our men all pay big income taxes. You can do as well. No investment. High-class work. Big opportunity for men of some calibre. Beyond competition. Write Alexander Film Co., 3389 S. Broadway, Denver, Colo.

\$125.00 WEEKLY selling finest, most complete line of men's \$12.50 suits, boys' two pants suits, \$10.95. Guaranteed Union made to measure. Four latest patterns—Also topcoats, vests, caps, riding breeches. Big commissions advanced. Free attractive outfit. Double Service Manufacturers, 1327-35 K, Washington, Chicago.

MR. BRUSH Salesmen:—Old Established New York Brush Manufacturers requires the services of men in all territories to sell their extensive line of Sanitary Twisted in Wire Brushes. We pay larger commissions than any other Brush House in the country. Write immediately for proposition. Wire Grip Sanitary Brush Corp., 15 Mercer St., New York.

SALESMEN: 4-Square Suits \$12.50. Five patterns. Profits in advance. \$3.00-\$5.50 each sale. Complete line coats, vests, pants, riding pants, women's knickers, slippers, caps, snapons. 24-hour delivery. A. E. Stone-Field, 2556 Wabash, Chicago.

TAILORING Salesmen: Our guaranteed \$21.50 and \$31.50 all wool tailored to order suits are \$10 to \$20 cheaper than store prices. Commission in advance. Protected territory. Beautiful assortment 6x9 swatches free. Manager, Dept. 1059, 843 Adams, Chicago.

TAILORING Salesman \$100-\$150 week selling Union hand-tailored made-to-measure suits and overcoats \$23.50-\$29.50. Liberal commissions advanced. Wood & Co., 651 So. Wells, Chicago.

SALESMEN: \$50 and up a week is being made by our men selling Korry Krome Shoes direct to Wearer. Men's, Women's and Children's. Representatives wanted. For information write Dept. M, Korry Krome Shoe Co., Corry, Pa.

AUTO Accessory Salesmen calling regularly on dealers and garages wanted to act as territorial distributors of De Luxe Ford Accessories. Unusual opportunity for right men. For further information write Bronzo Alumina Corporation, 212 Winchester Avenue, Buffalo, N. Y.

NOTION salesmen with established jobbing trade to carry the "O" Boy Curlier as side line on Commission Basis. Steady repeater. Big money to producers. Strictly confidential. Snappy Curlier Company, 2101 Larrabee St., Chicago.

GO Into Business for Yourself. Make storekeepers' profits without storekeepers' troubles or expenses. No investment necessary. We furnish everything and carry all stock for you. We have started hundreds of men who are now making \$4,000 to \$10,000 a year. We can do the same for you. Write for facts at once. Address Dept. 638, Goodwear Chicago, Inc., West Adams Street at Peoria, Chicago.

SALESMEN and District Managers to sell constantly used, repeating building specialties to factories, public institutions and building owners of all kinds. Products established over twelve years among thousands of largest users, including U. S. Government. Immediate big earnings and promotion with \$100,000.00 company to ambitious capable men. Write at once. The Colorcraft Company, 912 W. 70th, Cleveland, Ohio.

VENDING Machine Salesmen: Sensational plan, sells absolutely new machines by thousands. Exclusive slug proof device. Established house. Write us quick, stating experience. Address Hurd Wholesale Dept., Ridge Bldg., Kansas City, Mo.

EASY to Sell Groceries, Paints, Automobile oils, roofing, to consumers from samples. No capital or experience necessary. Profitable, steady, or part-time work. Commission advanced. Satisfaction guaranteed; 53 years in business. Write for particulars. Lovern & Browne Co., Wholesale Grocers, 1775 So. State Street, Chicago, Ill.

SALESMEN—Sell Vacuum Cup Hangers for displaying signs, posters and merchandise. Every storekeeper needs them. 300% profit. Mayer Manufacturing Corp., 1001 Wabash, Chicago.

SALESMEN—Make \$5 to \$10 a day selling our new, unusually beautiful Multi-Light Electric Lamps. Special dimming feature a sales clincher. Write for our money-making offer. Multi-Light Lamp Works, 2604 8th Run, Fort Wayne, Ind.

RESPONSIBLE representatives wanted for new marvelous Pocket Cigar Lighter. Sells on moment's demonstration to consumers and dealers. Big profits and exclusive territory rights. Send for particulars and selling plans. Enclose 50c stamps for sample. E. M. Masterlite Co., 110 East 23rd, New York.

SALESMEN—Sell our latest ballgame machine or buy 50 machines and make \$45 weekly placing them on commission with merchants. Write Blue Bird Vending Co., Ravenswood Station, Chicago.

FREE Sales Outfit—For men who think they can sell a snag, spark, water-resisting, stylish made-to-measure, Suit \$12.50. Earn \$100 next week in advance. No deliveries, no collections. Free outfit worth \$5, absolutely no charge. Simply write. Economy Clothing Mfg. Co., Dept. 1-8, 2035 Charleston St., Chicago.

SALESMAN to sell suits and topcoats tailored by us and direct to wearer at \$23.50; none higher. Sold under positive guarantee of satisfaction or money refunded, with privilege of wearing one week and then returning if unsatisfactory. Easy to sell. Commissions daily. Write for plan, Chain Clothing Stores, 500 Fifth Ave., New York City.

SALESMEN Wanted—We Have It. Something new, different, in demand, repeats, nationally adv., handled by all dealers, used by everybody. Pays big comm. in advance, credits for reorders. Samples easily carried in grip, sideline or regular. A surprise waiting. World's Products Co., Room 65, Spencer, Ind.

\$100-\$200 WEEKLY. Men with slight knowledge of motors who can reach car owners can earn \$200 weekly without making a single sale. If they can also make sales, profits may reach \$15,000 yearly. W. U. Phillips, 235 West 27th St., New York.

SALESMEN for the Fastest Selling Auto Accessory ever invented. No Competition. Exclusive territory to good men. Write or wire for full particulars. H. A. P. Co., 747 McCormick Bldg., Chicago.

DISTRIBUTORS, Salesmen. Agents make 200% profit selling Gas-O-Pep Tablets for automobiles, tractors and oilburners. Guaranteed to remove carbon, increase mileage and power. Big gas saver. Get your territory now. Taylor Products Mfg. Co., 22 West Nighthaven, Columbus, Ohio.

EARN \$18 up daily representing reliable corporation. See advertisement page 158. Write Vit-O-Net Mfg. Co., 4105 Ravenswood Ave., Chicago.

PROTECT Merchants against various evils. Federal Detective Association, New Orleans, La.

SALESMEN—A Salesboard that takes the place of a slot machine. Something new. Write for particulars of this interesting and profitable business of operating and selling salesboards. Square Hole Board Co., 120 Scherer Ave., Newark, N. J.

SELL Men's High Top Boots and High Grade Shoes Factory to Wearer. We are pioneers and leaders in this line. Our men are making \$75 to \$125 weekly everywhere. This proposition is permanent, profitable and worth while. Absolutely the best opportunity in the direct selling field. Carson Shoe Co., Box 123, Essex Station, Boston, Mass.

SUBSTANTIAL Income from Business Concerns. Little Home Work. Cooperation. Dignified, New and Reliable. John Dorey, 1443 Amsterdam Avenue, New York.

SALESMAN, Tailoring: \$65 to \$100 a week. High grade all wool suits made to measure \$25 and \$30. Biggest comm. in advance. Money back guarantee. Free Sample outfit. Write A. M. Ferrin, Mgr., Box 1097, Chicago.

WANTED—Tailoring Salesmen. make \$60 to \$125 per week. Biggest merchants in many towns have started with our line. We are the largest made-to-measure tailoring house in the country, furnishing elaborate sample equipments, including 500 all-wool fabrics. You make your own profits from \$8.00 to \$15.00 on each order. Guaranteed absolute satisfaction, perfect fit, best workmanship, or no sale. Write for line and all accessories to be sent free. Tell us all about yourself. Address N. O. Perry, Sales Manager, Box 483, Chicago, Ill.

MAKE \$100 Weekly in Spare Time. Sell what the public wants—long distance radio receiving sets. Two sales weekly pays \$100 profit. No big investment, no canvassing. Sharpe of Colorado made \$955 in one month. Representatives wanted at once. This plan is sweeping the country—write today before your county is gone. Ozarka, 802 Washington Blvd., Chicago.

SALESMEN—Become Independent. Own your business; experience unnecessary; selling our \$7,500 Accidental Death, \$50 Accident, \$25 Slight Weekly Benefits; \$12.50 yearly; other amounts proportionate. Guaranteed steady income from renewals. \$250,000 deposited Insurance Department, Registration Dept. A, Newark, N. J.

SALESMEN Can make \$5.00 a day selling our Calendars, Pencils, Signs, Advertising Novelties, Yardsticks, Whistles, etc. Liberal terms. Sells entire year. Fine side line. Local and traveling agents. Model Calendar Co., Dept. 226, South Bend, Ind.

A WONDERFUL Seller! Any man, woman, boy or girl can make big wages. Some agents make from \$8.00 to \$20.00 per day. Crimp Grip Clothes Line Fasteners are a simple, time-saving device for holding a rope—also used for many other purposes. It pays for itself quickly in time saved on wash days. No knots—it fastens and releases quickly. Every home a prospect. Every housewife who uses Crimp Grips—and there are thousands of them—is a booster. There is but one Crimp Grip. Write for particulars, or send 50c for one pair and a mounted sample, with full particulars to agents. Crimp Grip Company, Belvidere, Ill.

WERE You Ever Offered a Grocery Store? Our proposition is better. You can handle flour, canned goods, dried fruit, coffee and entire line of groceries as well as radio sets, paints, roofing and automobile oils and tires with no rent to pay; no money invested, take large orders from samples. Goods are guaranteed and proven quality. Selling experience not necessary. Steady, profitable work for "workers." Address Hitchcock-Hill Co., Dept. 226, Chicago, Ill. Reference: Any bank or Express company.

\$75—\$125 WEEKLY, organizing for fastest growing fraternal social society—sick, accident and death benefits. Protected territory. Address, Order of Leaders, Detroit, Mich.

\$50 DAILY Selling Salesboards—Make up to \$33 on single sale, selling largest, lowest priced line; no samples to carry; write for 3-color catalogue and full particulars. Lincoln Sales Co., Dept. E, 212 N. Sheldon, Chicago.

\$60-\$200 A WEEK. Genuine Gold Letters for store windows. Easily applied. Free samples. Liberal offer to general agents. Metallic Letter Co., 458-B North Clark, Chicago.

TRAVELING Salesmen calling on retail stores wanted by large manufacturer to sell unique line of business-boosting articles. Year round, fast selling, main or side line. If not earning \$150 weekly, address Elbasser Works, 222 Charles St., Boscoville, N. Y.

SALESMEN—Sideline pays five to ten dollars a day taking orders for Specialty printed gummed advertising and Match Box Stickers. Write for proposition, samples, etc., today. Beardsley's Printery, Rock Island, Ill.

FOUR \$7.50 sales to merchants net you \$20.00 daily. Sayers Systems, 2843 Sheffield Ave., Chicago, Ill.

\$4.00 PROFIT on Every \$5.00 sale. "Free Sample"—New Specialty. (Money Getter.) Every Storekeeper, Doctor buys quickly. Experience unnecessary. Territories open. Box 595, Hartford, Conn.

CALIFORNIA Roseheads selling like hot cakes. Agents coinng money. Absolutely new. Big profits. Catalog free. Mission Factory 319 No. Halsted, Chicago, Ill.

AGENCIES WANTED

AUSTRALIA. Wanted, agencies' novelties. Household, mechanical, medical, veterinary. Grantley Abbott, Box 749, G. P. O., Sydney, Australia.

HELP WANTED

AGENTS \$5 to \$15 daily easy (Sworn proof furnished). Your Pay Daily. Introducing New Style Guaranteed Hosiery. 57 styles, 37 colors, 7 pairs hose guaranteed 7 months, \$1.75. Neither experience nor capital needed. Just show samples, take orders. We deliver and collect. All transportation charges paid. Monthly bonus besides big cash profits. Complete outfit furnished. All colors, grades, including silks. Marchoes Textile Company, Station 4724, Cincinnati, Ohio.

MEN, women, obtain Government positions. Steady work. Vacations with pay. We show you how. Details free. Chicago Civil Service College, A-71 Kesner, Chicago.

NOTICE! If out of employment try my plan. Particulars free. Tick, 3338 Arkansas St., Oakland, Calif.

BUILD splendid business making chipped glass number and name plates, signs, medallions. Write for particulars. Simplex Utility Co., 1134 Broadway, New York.

SALESMEN cleaning up big profits with most amazing invention of the age. Doubles mileage of any tire. Eliminates 95% of all tire troubles. Unconditionally guaranteed. \$75 to \$125 a week easily made. Permanent business. Free selling outfit. Write today. The Coffield Tire Protector Co., 2801 Coffield Building, Darton, Ohio.

\$133-\$192 MONTH. Traveling. Men, 18 up. Become Railway Postal Clerks. Steady. We train you. Full particulars free. Write immediately. Franklin Institute, Dept. B-19, Rochester, N. Y.

HOTELS Need Trained Men. Nationwide demand for high-salaried men; past experience unnecessary. We train you by mail and put you in touch with big opportunities. Big pay, fine living, interesting work, quick advancement; permanent. Write for Free Book "Your Big Opportunity." Lewis Hotel Training Schools, Suite P-351, Washington, D. C.

MEN, 18 to 55, for post office clerks, carriers, railway mail clerks, customs, and internal revenue employees. \$100 to \$250 monthly. Experience or correspondence course unnecessary. Write B. Bradford, 112 N. 50th St., Philadelphia, Pa.

\$133-\$192 MONTH. Traveling. Railway Postal Clerks. Steady. 25 Trained Free. Write immediately. Franklin Institute, Dept. B-19, Rochester, N. Y.

MAN wanted able to sell men working in Garages, Factories, Workshops, etc. Ironwear Suits that wear like iron, sell on sight, repeat on quality. To make a permanent big income write for Ironwear Agency plan. Ironwear Co., 926 Chauncy, Boston, Mass.

WANTED—Railway mail clerks. Experience or correspondence course unnecessary. Prepare for examination. Complete instructions, \$5.00. United Service Instruction Bureau, B-1, Willow Hill, Ill.

LOCOMOTIVE Firemen for railroads nearest their homes—everywhere; beginners \$150-\$250 monthly; promoted, locomotive engineer, \$3,000-\$4,000 yearly. Best paying positions on railroads. Railway Association, Desk 301, Brooklyn, N. Y.

CONDUCTORS, Sleeping car, Exp. unnecessary. Send for rule book. Railway Sta. C, Los Angeles.

MEN—Women, 18 up. Get Government Jobs. \$95-\$250 month. Full information free. Write immediately. Franklin Institute, Dept. B-19, Rochester, N. Y.

BATTERY Service now in big demand. Complete instructions. Get free particulars. Willett, 5426-C, Broadway, Chicago.

ALL Women, Girls, Men, willing to become "Colorists." \$20.00 week up, send stamp. F. Productions, Box 417, Los Angeles. Colored sample of Film Star Photograph 27c.

EARN \$25 weekly, spare time, writing for newspapers, magazines. Experience unnecessary. Copyright book free. Press Syndicate, 981, St. Louis, Mo.

WHY not sell us your spare time? \$11.80 daily in advance (send for sworn proof) Introducing New Insured Hosiery. 47 styles, 37 colors, guaranteed seven months. All the latest shades, Alredale, Windsor Tan, Picadilly, Beaver, Bamboo, 30 others. No capital or experience required. You simply take orders, we deliver and collect (or you can deliver, suit yourself). Credit given. Pay you daily, monthly bonus besides. We furnish samples. Marchoes Textile Company, Station 2701, Cincinnati, Ohio.

ARE You Old at Forty? See our advertisement on page 175 of this issue. The Electro Thermal Company, 2137 Main Street, Steubenville, Ohio.

YOU Are Wanted, Men—Women, 18 up. Get U. S. Government Life Positions. \$43.00 to \$192.00 month. Steady, sure work. No layoffs. Paid Summer vacations. Pleasant work. Short hours. Pull unnecessary. Common education. Candidates coached without leaving home. Full particulars free. Write immediately. Franklin Institute, Dept. B-19, Rochester, N. Y.

SIGN Men—Handy Men—Make big money with our Gold Window Sign Letters—Easily applied. Get the styles that Sign Painters use. Sign Painters Letter Co., 11416 Forest Ave., Chicago.

GET posted—Good prices paid for butterflies, inserts. See Sinclair display advertisement, page 24.

\$133-\$192 MONTH. Traveling. Railway Postal Clerks. Sample training free. Franklin Institute, Dept. B-19, Rochester, N. Y.

YOUNG men, over 21, of fair education, for service work on adding machines. Later advancement to sales work if qualified. Dalton Adding Machine Company, Cincinnati, Ohio.

FIREMEN, Brakemen, Baggage-men, Sleeping car, train porters (colored), \$140—\$200. Experience unnecessary. 810 Railway Bureau, East 84, Louis, Ill.

WRITERS wanted to edit newspapers for us in small towns everywhere. Experience, capital unnecessary. American Newspaper Syndicate, 290 Broadway, New York.

STOP Daily Grind. Money! Re-Silvering Mirrors, auto-parts, tableware, stoves, Outfits; Plans Free. Sprinkle, Plater, 237, Marion, Ind.

WANTED—Boys—Men. Learn Auto Repairing. \$30.00 week. Sample lessons free. Franklin Institute, Dept. B-100, Rochester, N. Y.

GOVERNMENT Positions, \$1,400—\$2,700 annually. Many splendid opportunities. Common education sufficient. Experience unnecessary. Information booklet free. Chicago Civil Service College, A-41, Kesner, Chicago.

YOUR Opportunity to connect with a strong old line Insurance Company selling their new low cost Health and Accident policy which pays \$5,000 death and \$25 weekly benefit. Total cost \$10 yearly. Our Direct-by-Mail plan makes selling easy. Liberal commission paid immediately. Salary in addition. Address, Underwriters, 702 Bonnell Building, Newark, N. J.

LARGE manufacturer wants agents. Make \$100 weekly. Outfit Free. Sell made-to-measure genuine Crayvette Gaberdines, \$14.50. Whipcords, \$12.50. Reversible Raincoats, \$9.75. Standard Raincoat Co., 131 West 17th St., New York.

MEN to build radio sets in spare time. Leon Lambert, 339-H, Wichita, Kans.

U. S. GOVERNMENT wants men. \$1,400—\$1,600 and up at start. Railway Mail clerk examination coming. Let our expert (former Government examiner) prepare you for this and also Rural Carrier, Post Office, Customs, Internal Revenue, and other branches. Write today for free booklet. Dept. 8, Patterson Civil Service School, Rochester, N. Y.

MEN wanting forest ranger, railway mail clerk and other govt. positions. Write for free particulars. Mokano, Dept. A-12, Denver, Colo.

MEN wanting positions firemen, brakemen, colored train or sleeping car porters, write for application blank; experience unnecessary, first class roads, no strike. Name position wanted. Railway Institute, Dept. 33, Indianapolis, Ind.

MEN—Age 18-40, wanting Railway Station-Office positions, \$115-\$250 month, free transportation, experience unnecessary. Write Baker, Supt., 41 Walnut, St. Louis.

FINGER Print Experts—Excellent paying positions; particulars free. Finger Print Headquarters, 188 East 79th, New York.

SILVERING Mirrors, French plate. Easily learned; immense profits. Plans free. Address, Wear Mirror Works, Excelstor Springs, Mo.

OUR genuine gold window sign letters are an excellent money-making proposition for handy men. Sign Sign System, Bethune Ave. E., Detroit, Mich.

MEN, women, over 18, desiring Government positions, \$133-\$192 monthly, write immediately for full information. Chicago Civil Service College, A-42, Kesner, Chicago.

EARN \$10 daily silvering mirrors, plating and refinishing metalware, autos, chandeliers, bedsteads, headlights. Outfits furnished. E. Derte Laboratories, 1133 Broadway, New York.

MAKE money writing Photo-plays; details free to beginners. No correspondence course. Producers' League, 230 Wainwright, St. Louis.

INVENTORS desiring to secure patents should write for our book "How to Get Your Patent," tells our terms and methods. Send sketch for our examination and instructions without charge. Randolph & Co., Dept. 418, Washington, D. C.

ALL men, women, boys, girls, 17 to 65, willing to accept Government Positions, \$117-\$250 traveling or stationary. Write Mr. Osmont, 101 St. Louis, Mo., immediately.

STORIES, poems, plays, etc., are wanted for publication. Good ideas bring big money. Submit manuscripts or write Literary Bureau, 522, Hannibal, Mo.

INFORMATION

EXPERT information, advice. Any subject. \$1.00. International Information Institute, 15 Moore, New York.

SEND your mechanical problems with twenty-five cents and self-addressed envelope. Bertschy, Plattsburgh, Nehr., U. S. A.

COMPLETE, Accurate, Information on any subject \$2. Prompt Service. National Information Bureau, 1429 Milton St., Grand Rapids, Mich.

COMPLETE information on any book published. Or will supply lists of books that are the best on any subject. Information is free. Room 807, Popular Mechanics Building, Chicago, Ill.

BUSINESS SERVICE

AUTHENTIC information about any Stocks or Bonds. Trustworthy advice concerning investment securities, based on knowledge and experience. As I am not a broker or salesman, I have no "axe to grind." Send name of security with \$3.00 and receive reliable, up-to-the-minute analysis. Individual research—no printed stuff. James A. Crawford, M. Sc. (Financial Expert), 31 Brantford Pl., Buffalo, N. Y.

FORMING a company? Look into the Common Law plan of organizing under a Declaration of Trust. Its economies and advantages are outlined fully in pamphlet (C-53) mailed free upon request. C. S. Demaree, publisher standard legal blanks, 708 Walnut, Kansas City, Mo.

DELAWARE Incorporator. Charters; Fees Small; forms. Chas. G. Guper, 901 Orange St., Wilmington, Del.

AGENCIES wanted. Small expense. Fuller, 107 Massachusetts Ave., Boston, Mass.

MAILING LISTS

NAMES, Indiana, Michigan farmers, \$3.00 thousand. New. E. Moore, 524-56th St., South Bend, Ind.

NAMES, Guaranteed new List. Ruralist. Write for particulars. W. Carthon, Alma, Ark.

WOMEN'S names \$5 Thousand. A. Hund, 204 South Street, Jamaica Plain, Mass.

NAMES—postcard views. Ben Meyer, 35 West 51st, New York.

TYPEWRITERS AND SUPPLIES

UNDERWOOD Typewriters — only \$3.00 down. Easy monthly payments. Low prices at less than manufacturers. 10 days' free trial. Rebuilt, all worn parts replaced. Just like a new machine. 5-year guarantee. Write for big free catalogue C-151. Shipman-Ward Mfg. Co., 1314 Shipman Bldg., Chicago, Ill.

TYPEWRITERS All Makes. Save one-half. Thoroughly rebuilt in our factory by the famous "Young Process." Fully guaranteed. Free Trial. We handle all standard makes. Cash or sold on easy terms. Write for catalog. Young Typewriter Co., Dept. 5754, Chicago, Ill.

TYPEWRITERS \$4.95-\$29.95. Rental \$1.00. Send cash. Buy, Exchange, Knight's, 1512 Locust, St. Louis, Mo.

SIMPLEX Typewriters; Absolutely guaranteed. Large size \$4.25. Small \$2.50. Pay postman on arrival. Smiths Novelty Co., 9145-47 Bishop St., Chicago.

TYPEWRITERS. All makes. \$15 up. Guaranteed. Write for our bargain price list and Free Trial offer. Department 16. Manufacturers Typewriter Clearing House, 193 N. Dearborn Street, Chicago.

PRINTING, ENGRAVING AND MULTI-GRAPHING

CALLING and Business Cards, 100 Calling cards 75c. 200 business cards \$1.25. 500 business cards \$2.50. Carl Hoock, 2526 Warsaw St., Ft. Wayne, Ind.

ALL Printing Prices Smashed. 5,000 Letterheads or envelopes \$13.85. Samples, Quality Printshop, Marietta, Ohio.

YOUR name and address printed on 100 double sheets of high-quality linen-finish correspondence paper and 100 envelopes to match for \$2. Choice of the following colors: Blue, Pink, Gray, Canary or White. Assorted colors if desired. Just send your name and address (twice or print clearly) with \$2. (West of Denver and outside U. S. \$2.10), and this attractive box of personalized stationery will come to you neatly packed, postage prepaid. Your name and address will be printed on each sheet and envelope in steel-faced gothic type in rich dark blue. Money refunded if you are not more than satisfied. Send in your order today. New Method Stationery Shop, Wheeling, W. Va.

\$2.00 FOR 125 Letter Heads, 8 1/2 x 11 and 125 Envelopes. Bond paper. Delivered for cash. Perishing & Co., South Bend, Ind.

100 NAME Cards, handy case free. Old English type. 50c prepaid. Prompt Service. Henry Franks, Southington, Conn.

EXPERT, beautiful mimeographing and typewriting. Samples free. Flajshans', Angola, Ind.

200 BOND Letterheads, 100 envelopes, 100 business cards, all printed, and guaranteed fountain pen, \$2.00 for all delivered. Ables Printing Company, Terrell, Texas.

GUMMED Labels, Name and Address, 500, 2 lines 30c, 3 lines 50c. Catalogue. Eastern Label Co., A, Clintonville, Conn.

YOUR Advertising—Circulars, Booklets, folders, catalogs, prepared and Printed. Estimates cheerfully submitted. National Merchants Company, 4342 N. Robey, Chicago.

EMBOSSED Business Stationery. Samples for Stamps, Daniels Company, Pittston, Pa.

LETTERHEADS, envelopes; Quick service. \$3.00 thousand. Bixler Shop, Frankfort, Ky.

250 EACH — Hammermill Bond Letterheads, Envelopes, \$3.00. Midland Press, 543 West Hickory, Kankakee, Ill.

TRIAL Printing Order—150 8 1/2 x 11 20 lb. Hammermill Bond Letterheads and 150 6 1/2 Envelopes \$2.00 Cash or C. O. D. Race Printing Co., Hudson, N. Y.

DISTINCTIVE Stationery. Samples for Stamp. Franklin Press, B-32, Milford, N. H.

"NEARGRAVURE" Stationery — Unique — 500 Letterheads \$3.50 postpaid. Soliday's, Knox, Ind.

PRINTING 500 Bond Letterheads, \$3.00; Envelopes, \$2.00. Send copy with remittance. Trinkle & Trinkle, Parker, Ind.

200 BOND Letterheads, 200 Envelopes printed, postpaid \$1.50. King's, Warren, Ill.

250 BOND Letterheads, 250 Envelopes, \$3.00. H. M. Walker, R. 3, Crown Point, Ind.

WE print Stationery, Booklets, Catalogs, Circulars. Samples. Commercial Press, Batavia, Ohio.

\$3.00 DELIVERED. 500 Watermarked Bond Letterheads, 8 1/2 x 11, and 250 envelopes, money with order. Job Printing Specialty, National Printing Company, Goshen, Ind.

225 BOND letterheads, envelopes, billheads, cards, \$1.25 each. Combination, \$4.00. Economic Press, Lenoir, N. J.

QUALITY Printing! Reasonable Prices! Send for Free Standardized samples and prices. Folders, Circulars, Catalogs our specialty. Ernest Pantus, 525 South Dearborn, Chicago.

GILT lettered Advertising-Pencils for you. Buy direct; save entire middleman's profit. Samples free (no agents). Address S. Muehl & Co., 10-12 Lincoln St., Yonkers, N. Y.

PRINTING OUTFITS AND SUPPLIES

PRINTING Outfits, hand or power presses, type, cutters, supplies. Lowest prices. Stamps for information. Nicholas, 120 High St., Boston.

COMPLETE printing outfits, presses, type, ink, paper supplies. Write for Catalog. Press Co., C-11, Meriden, Conn.

PRE-USED Printing Presses. Type and supplies. List for stamp. Popular Bargains, Richland, Pa.

PRINTING Outfits—Presses, type supplies, type novelties. Send stamp for catalogue. Model Press, York, Penna.

DUPLICATORS AND DEVICES

STENCIL, Duplicating Outfit — \$2.50, \$3.00, \$4.00 Complete. Typewriting, Handwriting. Returnable. Primos Specialty Co., 3-M, Primos, Pa.

"MODERN" Duplicators save Time, Labor, and Money. Gets business. Reproduces Typewritten or Pencil Letters, Drawings, Lessons, Music, Menus, Bids, Notices, Specifications, Maps or anything in one or more colors. Prints Two per minute. Special Sale On 30 Days' Free Trial, \$6.00 delivered. Booklet Free. J. E. Durkin-Reeves Co., Ridgway, Pa.

YOU can make 50 to 100 copies of a letter, notice, etc., at a cost of three cents on a Hoyer Quality Duplicator. Write for free trial offer. The Hoyer Duplicator Co., 14 S. Wells St., Chicago, Ill.

ADDING MACHINES

NEW \$3.50 Automatic Adding Machine. Adds, Subtracts, Multiplies. Absolutely accurate. Capacity \$999,999.99. Fully guaranteed. 75,000 pleased users. Makes adding easy, positive, quick. Eliminates Mistakes. Saves Time. Postpaid \$3.50. Bassett Co., 1458-C Hollywood Ave., Chicago.

FREE Trial. Marvelous new Adding Machine. Adds, Subtracts, Multiplies, Divides, automatically. Work equals \$350.00 machine. Price only \$15.00. Speedy, durable, handsome. Five-year guarantee. Used by largest corporations. Write today for catalogue and free trial offer. Lightning Calculator Co., Dept. E, Grand Rapids, Mich.

\$100 AMERICAN Listing Adding machine, practically new, only \$37.50. Easy payments. Payne Farms, Shawnee, Kans.

RUBBER STAMPS

RUBBER Stamps; Two line stamp, 50 cents. Atoka Press, Atoka, Okla.

FOR SMOKERS

BEAUTIFUL genuine Diamond set, Roman gold cigarette case, \$1.98. Satisfaction guaranteed. Pay Postman on arrival. Smiths Novelty Co., 9145-47 Bishop St., Chicago.

HOMESPUN Chewing and Smoking Tobacco—5 lbs. \$1.25; 10 lbs. \$2.50; 20 lbs. \$4.50. Farmers Union, Mayfield, Ky.

CHEWING Tobacco, Golden Yellow, good as the best hand-picked, ten pounds \$4.00. Red Leaf, ten pounds \$3.50. Smoking, extra in quality, ten pounds \$2.50. At the price I deliver and Guarantee Quality, and give the Martin Bank Reference. O. D. Collier, Martin, Tenn.

BOATS AND LAUNCHES

"HOW to make your boat leakproof." Send for booklet. L. W. Ferdinand & Co., 152 Kneeland St., Boston, Mass.

BOATS and Engines, Send for Free List. Hunter Boat Factory, McHenry, Ill.

MAKE 16-Foot Rowboat—Blueprint \$0c. Weesho-Uco, 31st Office, Detroit.

BOATS that always go are propelled by Ford Engines. Ford engine booklet free to boat owners. Harry Rider, 201B East Avenue, South Norwalk, Conn.

RAZORS AND BLADES

MASTER Razor Home. Sharpens quickly any safety blade or straight razor. Send one dollar, get two homes for price of one and agency. Wisconsin Abrasive Company, 290 Lake St., Milwaukee, Wis.

WEARING APPAREL

THE greatest men's necktie sale direct to the consumer at wholesale prices. 4 knitted ties for \$1.50. Our ties are of fine quality, heavy weight, new patterns, attractive color combinations and serviceable. Don't miss this bargain. No money in advance. We ship on approval. State colors. Golco Knitwear Company, G. P. O. Box 414, New York.

HOME-MADE Sport Hose, Pure Wool, brown, gray or tan. Plain or striped cuffs, men's and ladies', \$1.25 delivered. Louis Ferreault, Soldier Pond, Maine.

OPTICAL GOODS

BINOCULARS, Binoculars, Binoculars! A glass for every use and every pocketbook. \$12 to \$50. 4 to 20 power. Guarantee of absolute satisfaction or money back. Get the Geneva price list first. Send for descriptive circular today. Geneva Optical Co., 41 Linden St., Geneva, N. Y.

FOR THE HOME

GRANDFATHER Clock Works, \$5.00. Build your own case; instructions free; make good profits selling your friends. Clock works with chimes for old or new cases. Write for full particulars. Clock Co., Ruffner St., Philadelphia.

ROTARY colander for crushing fruit or vegetables. All aluminum. Patented by farmer's wife. A necessary utensil, \$6.00. Western Machine Company, Plattsburgh, N. Y.

LOOMS—Only \$9.90 and up. Big money in weaving Colonial Rugs, carpets, etc., from rags and waste material. Weavers are rushed with orders. Send for free Loom Book; it tells all about home weaving and quotes reduced prices and easy terms on our wonderful new looms. Union Loom Works, 480 Factory St., Boonville, N. Y.

DIAMONDS, WATCHES AND JEWELRY

WATCHMAKERS: Earn highest wages. Understand adjusting thoroughly. Circular free. Write Walter Kleinlein, Publisher, Waltham, Mass.

ANTIQUES, WAR RELICS, AND INDIAN GOODS

RELICS Collected from Europe's Battlefields. Illustrated catalogue and sample war Photographs 25c. Lieut. Welsh, 2117 Regent Pl., Brooklyn, N. Y.

HUNTING bows, relics, minerals, coins, moosehorns, butterflies. Thousand Indian articles. Catalogue 10c. Indiancraft—P—Co., 466 Connecticut, Buffalo, N. Y.

INDIAN Relics—20p. clearing catalog for stamp. Grutzmacher, Mukwonago, Wis.

INDIAN Made Baskets, Blankets, Wampum, Curios. Catalog. Gilham, Kelseyville, Calif.

SEND 5c for fine, new list Indian relics, antique firearms. F. E. Ellis, Webster Groves, Mo.

PHONOGRAPHS AND RECORDS

BUILD Your Own Phonograph with Our Help—Save Half. The Choraleon Aristocratic Phonograph is unexcelled. Plays any record. Finest motors, tone arms, case materials cut to fit, ready to put together and blueprint and full instructions furnished at small cost. Satisfaction guaranteed. Write for catalog. Choraleon Phonograph & Radio Co., 425, 11th Street, Elkhart, Ind.

BUILD your own Phonograph. We furnish everything. Write for Phonograph Radio catalog and free Blue-print offer today. American Phonograph Co., 3752 Belmont, Chicago.

BUILD your own phonographs. We can supply you with motors, tone arms and all accessories at wholesale prices. Write for catalogue AX. Pleasing Sound Phonograph Co., 204 East 113th St., New York, N. Y.

BUILD Your Phonograph. Spring Motors, Electric Motors, Tonearms, Amplifiers, Accessories. Latest Equipment also in Radio Mechanism and Cabinets. Catalog mailed for ten cents. Hooser Mfg. & Supply Co., 313 Baldwin Block, Indianapolis, Ind.

MUSIC AND MUSICAL INSTRUMENTS

PIANO Jazz; Learn to play — Piano Chimes, Negro Ear Harmony, Player Piano Effects, Blue Harmony, Vamping, etc. Write "Piano Bill," 207 Ossington, Toronto, Can.

(PATENT Pending.) Wonder dollar instrument, anybody play, everybody surprised. Imitate orchestra, become professional entertainer; other valuable informations. Multitone Co., 448 C W. 38th, New York.

ENTERTAINING at Piano. Stunts, Hints and Suggestions. \$1.00. Niagara School of Music, Dept. V, Niagara Falls, N. Y.

PLAYER piano, Roll Exchange. Particulars ten cents stamps. New music, month for cost one roll. Van Camp Exchange, Falls City, Nebr.

BAND and Orchestra Instruments—All makes of new and used instruments sold, exchanged and repaired. Standard and popular music sold. Write today for catalog and Free subscription to "Musical Booster" magazine. "Deal with the Professional House," Crawford-Rutan Co., 1051 Grand Ave., Kansas City, Mo.

VIOLINS—I make 'em; sweet, soulful, mellow. Instruments of finest tonal quality since Stradivarius' days. Easy terms. Free trial. John Lehto, 835 14th, San Pedro, Calif.

ENGLISH Saxophone Reeds—Twelve perfect Reeds in every dozen. Each Reed absolutely splendid. Soprano, \$1.65; Alto, \$2.20; Melody, Tenor, \$2.45; Clarinet, \$1.25. Hayes Thomas, 835 Ridge Ave., N. S., Pittsburgh, Pa.

VIOLINS, Deep, Mellow, Soulful—on credit. Easy terms for wonderful instrument. Get details today. Gustav F. Henning, 2424 Gaylord St., Denver, Colo.

I WANT Song Poems. Casper Nathan, 1252 Bryn Mawr, Chicago.

WRITE Songs. Big money and reputation. Write for information. J. Gordon Pub. Co., 201 N. Hoyne Ave., Chicago.

"MUSIC Composed" to words. Bauer Bros., (formerly of Sousa's Band), Oshkosh, Wis.

PATENT ATTORNEYS

PATENTS Procured; Trade Marks Registered—A comprehensive, experienced, prompt service for the protection and development of your ideas. Preliminary advice gladly furnished without charge. Booklet of information and form for disclosing idea free on request. Richard B. Owen, 30 Owen Bldg., Washington, D. C., or 41-R Park Row, New York.

PATENT Procured. Prompt Service. Personal, careful and efficient service. Highest references. Moderate fees. Send sketch or model for actual search and advice. George P. Kimmel, Master of Patent Law, 54 E. Loan and Trust Bldg., Washington, D. C.

STRONGER patents for less money through co-operation. Booklet free. Chartered Association of American Inventors, Barrister Building, Washington, D. C.

PATENTS, Trade marks, copyrights. Prompt, personal, reliable service. Over 36 years' active practice. Write for terms. Book free. Address E. G. Siggers, N. U. Bldg., 918 F St., Washington, D. C.

ESTABLISHED 1894. Milo D. Stevens Company, Free Booklet. Patents, Trade-Marks, Copyrights, Offices, Menadnock Block, Chicago; Barrister Building, Washington, D. C.

MONROE MILLER, Ouray Bldg., Washington, D. C. Patent Attorney; Mechanical, Electrical Expert. Free Blue Book gives candid advice.

INVENTORS—Send for form "Evidence of Conception" to be signed and witnessed. Form, fee schedule, information free. Lancaster and Albino, Registered Patent Attorneys in United States and Canada, 221 Ouray Bldg., Washington, D. C.

PATENTS and Trade-Marks obtained. Prompt service. Write for our new book on patents. Established in 1889. D. Swift & Co., 369 7th St., Washington, D. C.

PATENTS, Trade-Marks, Designs. This firm has 27 years' experience and gives expert personal service at reasonable rates. We properly protect your invention. Write for free information and exact cost of procuring patent before proceeding. John B. Thomas & Co., 992 F St., N. W., Washington, D. C.

MILLIONS spent annually for ideas! Hundreds now wanted! Patent yours and profit! Write today for free book—tells how to protect yourself, how to invent, ideas wanted, how we help you sell, etc. American Industries, Inc., 500 Kresge Bldg., Washington, D. C.

PATENTS—Write for my free Guide Books "How to Obtain a Patent" and "Invention and Industry" and "Record of Invention" blank before disclosing inventions. Send model or sketch of your invention for instructions. Promptness assured. No charge for above information. Clarence A. O'Brien, Registered Patent Lawyer, 5891 Security Bank Building, directly across street from Patent Office, Washington, D. C. See pages 168 and 169.

PATENTS—Write for our Guide Books and "Record of Invention Blank" before disclosing inventions. Send model or sketch of your invention for Examination and Instructions. No charge for the above information. See advertisement on pages 170 and 171. Victor J. Evans & Co., 934 Ninth, Washington, D. C.

LACEY'S Patent Sense. Valuable book free. See ad page 174.

INVENTORS: Send sketch or model for advice and exact cost of patent. Ask for our Free book: "How to Obtain a Patent." Tells what every inventor should know. Established twenty-eight years. Highest references. Prompt service. Reasonable charges. Chandee & Chandee, 474 Seventh, Washington, D. C.

THE PATENTOME, Impartial advice to Inventors and Manufacturers, mailed on request. Anderson & Son, Patent and Trade Mark Lawyers. Established 1865. 635 F St., Washington, D. C.

INVENTOR'S—Universal Educator contains 900 mechanical movements; 40 perpetual motion. Tells how to obtain and sell patents. Suggests new ideas. Explains how to select your attorney and avoid patent sharks. Special price (for a limited time) \$1.00 postpaid. Albert E. Dieterich, 621-B Ouray Bldg., Washington, D. C.

PATENT Application Blanks free to inventors. Patent News-D, Washington, D. C.

PATENTS—Our book "How to Obtain a Patent" sent free upon request. Contains full information about patents, trade-marks and designs. If you will send us a sketch of your invention we will promptly make search of the Patent Office records and advise you as to patentability, our charge for the service being \$5.00. Prompt, efficient service with moderate charges. Over twenty years' experience. Bank and commercial references. Talbert & Talbert, Registered Patent Lawyers, 567 McGill Bldg., Washington, D. C.

PERCY S. WEBSTER, Savings and Loan Building, Stockton, California. Long established organization. Send for free book on Patents.

PATENTS. My fees in installments. Advice book free. Frank Fuller, Washington, D. C.

UNPATENTED Ideas Can Be Sold. I tell you how and help you make the sale. Free particulars (Copyrighted). Write W. T. Greene, 805 Jenifer Building, Washington, D. C.

TRADEMARKS \$35; Design patents \$35; Copyrights \$5; Booklet Free; 20 years' experience. Sanders, Registered Patent Attorney, 7 Rand-McNally Building, Chicago.

INVENTORS—Write for our Guide Book, "How to Get Your Patent" and Evidence of Invention Blank. Send model or sketch of your invention for our prompt examination and instructions free. Randolph & Co., Dept. 430, Washington, D. C.

"INVENTOR'S Advisor," the valuable Patent book with 139 mechanical movements and illustrations, sent free upon request. MM. Labiner, Patent Attorney, 3 Parkrow, New York.

PATENTS. Booklet free. Highest references. Best results. Promptness assured. Send model or drawing for preliminary examination. Watson E. Coleman, Patent Lawyer, 644 G Street, Washington, D. C.

HERBERT JENNER, patent attorney and mechanical expert, 695 F Street, Washington, D. C. I report if patent obtainable and exact cost. Send for circular.

"INVENTOR'S Guide" sent free on request; this book contains illustrations of patented inventions and gives valuable information and advice for all who have original ideas or improvements. Frank Ledermann, Registered Attorney and Engineer, 15-P Park Row, New York.

FOR INVENTORS

INVENTIONS Commercialized on Cash or Royalty Basis. Send us your ideas on anything built of wood, wood and glass, or all glass. In business 20 years. Complete facilities. Send sketch or model. Specialty Display Case Co., Dept. 11, Kendallville, Ind.

PATENTS. If you have an invention which you wish to patent you can write fully and freely to Munn & Co., for advice in regard to the best way of obtaining protection. Please send sketches, or a model of your invention and a description of the device, explaining its operation. All communications are strictly confidential. Our Handbook on Patents is sent free on request. This explains our methods, terms, etc., in regard to Patents, Trade Marks, Foreign Patents, etc. "Scientific American" contains Patent Office Notes, Decisions of interest to inventors and particulars of recently patented inventions. Munn & Company, Solicitors of Patents, 623 Woodworth Building, New York; 524 Scientific American Bldg., Washington, D. C.; 413 Tower Bldg., Chicago, Ill.; 366 Hobart Bldg., 582 Market St., San Francisco, Calif.; 221 Van Nuys Building, Los Angeles, Calif.

PATENTS—Write for my free Guide Books "How to Obtain a Patent" and "Invention and Industry" and "Record of Invention" blank before disclosing inventions. Send model or sketch of your invention for instructions. Promptness assured. No charge for above information. Clarence A. O'Brien, Registered Patent Lawyer, 5891 Security Bank Building, directly across street from Patent Office, Washington, D. C. See pages 168 and 169.

EVERYONE interested in Patents or Inventions, particularly the sale or purchase of same, should subscribe to "Progress and Invention in North America" (International), 391 Donalds Building, Winnipeg, Canada. \$1 yearly. The biggest dollar value yet.

INVENTORS—Write for our Guide Books and "Record of Invention Blank" before disclosing inventions. Send model or sketch of your invention for our free examination and instructions. See advertisement on pages 170 and 171. Victor J. Evans & Co., 157 Ninth, Washington, D. C.

WE Solve your problems on mechanical movements, construction of inventions, buying information. \$1.00. Technical Research Bureau, 377 National Ave., Milwaukee, Wis.

LACEY'S Patent Sense. Valuable book free. See ad page 172.

CHEMICAL Assistance to Inventors. Wolf Kritchevsky, D. Sc., Consulting Chemist, 7049 Chappel Avenue, Chicago, Ill.

OBTAIN your own Patent. We offer you the service of fifteen years' experience. Complete application materials and instructions on procedure \$1. Prompt and personal attention given each inquiry. Inventor's Service Bureau, 189 North Clark, Chicago, Ill.

PATENTS Procured; Trade Marks Registered—A comprehensive, experienced, prompt service for the protection and development of your ideas. Preliminary advice gladly furnished without charge. Booklet of information and form for disclosing idea free on request. Richard B. Owen, 30 Owen Bldg., Washington, D. C., or 41-R Park Row, New York.

SCIENTIFIC Information for inventors. Calculations, designing, scientific books. Commercial lists, patent advice. Write Scientific Information Bureau, Baltimore Bldg., Chicago.

GET your own patents. Legal blanks, complete instructions \$1. Cutting Sons, Campbell, Calif.

INVENTOR'S Universal Educator contains 900 mechanical movements; 40 perpetual motions. Tells how to obtain and sell patents. Suggests new ideas. Explains how to select your attorney and avoid patent sharks. Special price (for a limited time) \$1.00 postpaid. Albert E. Dieterich, 621 Ouray Bldg., Washington, D. C.

MONROE MILLER, Ouray Bldg., Washington, D. C. Patent Attorney; Mechanical, Electrical Expert. Before proceeding, read free Blue Book.

RICHARDSON, Patents; 5 Albee Building, Washington.

MR. INVENTOR: If you have a patent or invention for sale, write Hartley, 44 Central St., Bangor, Maine.

INVENTORS!—Need Money?—I assist worthy inventors. Plajshans, Angola, Ind.

SELL your own invention. Booklet free. Chartered Association of American Inventors, Barrister Building, Washington, D. C.

CASHING In—If you have a sound commercial invention to sell, write promptly American Patents Corporation, Barrister Building, Washington, D. C.

WE Develop your ideas into commercial shape for presentation to purchasers, making working models, drawings, experiments or tests. Courtesy, efficiency, secrecy and ample equipment; 30 years' experience. Ducommun-Rich Engineering Co., 504 Pacific Mutual Bldg., Los Angeles, Calif.

SELL your own patent—successful inexpensive method. Write, Ray Lee, Dowagiac, Mich.

INVENTIONS Developed and Manufactured under royalty. Unpatented ideas protected in your name. Willat Production Company, 1121 Howard St., San Francisco.

PATENTS—Our book "How to Obtain a Patent" sent free upon request. Contains full information about patents, trade-marks and designs. If you will send us a sketch of your invention we will promptly make search of the Patent Office records and advise you as to patentability, our charge for the service being \$5.00. Prompt, efficient service with moderate charges. Over twenty years' experience. Bank and commercial references. Talbert & Talbert, Registered Patent Lawyers, 553 McGill Bldg., Washington, D. C.

I SELL Patents; Established in 1909. Charles A. Scott, 773PM, Garson Avenue, Rochester, N. Y.

PATENTS Sold or placed on Royalties, both U. S. and Canadian. Patented or Pending. For immediate action, write Arthur S. Billings, Suite 401 Debraum Bldg., Portland, Ore.

UNPATENTED Ideas Can Be Sold. I tell you how and help you make the sale. Free particulars (Copyrighted). Write W. T. Greene, 807 Jenifer Building, Washington, D. C.

WILL finance patent (good invention) for interest. F. A., % Patent News, Washington, D. C.

SPECIALIZED service for inventors. You furnish the idea, we'll work it out. Expert machine designing. Drafting. Opinions given on practicality of ideas. Confidential dealings. Your ideas fully protected. Write for full particulars. Otis Engineering Co., Desk C D, Omaha, Neb.

GET Cash for your patent or invention under our new plan. Write at once to Inventors' Syndicate, 61 Palladium Bldg., St. Louis, Mo.

RESPONSIBLE established electrical manufacturer will buy outright or manufacture on royalty new inventions of household utilities or appliances. Details necessary. L. J. Effertz, 6545 Carnegie Ave., Cleveland, Ohio.

HAVE You an Invention? If so, write for our free book, "How to Get Your Patent," tells our terms and methods. Send model or sketch for our free examination and instructions. Randolph & Co., Dept. 144, Washington, D. C.

PATENTS FOR SALE

FOR Sale outright, U. S. and Canadian patent non-rolling and low gravity Plumb Bob adjusted to true position with great rapidity. John A. Moffat, 106 North Bay St., Hamilton, Ont., Canada.

MILLIONS of people wear rubber heels! My invention, "Cashion Heel Plates," will appeal to them. These plates do not impair elasticity of heel. Stamped from steel. Investigate. Wm. A. Morris, 121 So. Roberts, El Reno, Okla.

NEW Hydraulic four-wheel brake for automobiles. Extremely simple, compact and cheap to manufacture. Outright or royalty. Robert Grelland, 2628 Indiana Ave., Chicago.

FOR Sale—Patent No. 1,478,955. "Electric Iron Cord Attachment." Particulars, Simon H. Harrison, 3112 Ellis St., Berkeley, Calif.

RECENTLY Patented. Pneumatic tire valve. Sell outright or royalty basis. Mr. Charles Raymond, 3922 De Tonty St., St. Louis, Mo.

LATEST Smokers' Accessory—Combination Pocket Ash Tray and Match Box. Patent Pending. Dr. Osborn, Port Chester, N. Y.

NEWLY patented Clothesline fastener. Simple, practical, cheap. Copies on request. Wm. E. Menold, 1441 Ellis St. San Francisco, Calif.

VALUABLE basic patent. Finance foreign patents for interest. G. Kjelgaard, Hooksett Falls, N. Y.

FOR Sale—U. S. Patent on pliers. Very Useful Article for Automobiles. Alex Teselsky, Clio, Mich.

PATENT for Sale—Automobile Hood Fastener; raise and lower Hood with one hand; something new. Buford M. McMillion, Rogers, Texas.

OUTRIGHT or Exchange—Patents Motion Picture Fire-Proofing Devices; also apparatus for detecting fractured films. Correspondence solicited. Hulsey Co., Russellville, Ark.

PATENTS and Trademarks. Prompt efficient service guaranteed. Send sketch or model for free opinion. International Patent Bureau, 189 No. Clark St., Chicago.

PATENT for Sale: of Road Building Machine. Nothing Competes in Efficiency, Durability or Price. George Stevens, Ringwood, Ill.

CAR Coupler; Oil Reservoir; Elevator Safety Appliance; Washing Machine; Swimming Pool Platform; Henhouse Release; Poultry Hook; Vehicle Operated Gate; Kitchen Cabinet; Plow Standard; Battery Support; Chalk Holder; Spring Wheel. Talbert & Talbert, McGill Building, Washington, D. C.

YOU have a worth-while patent, haven't you? Why don't you tell our two million readers about it? Most of them are specially interested in patents and new inventions. Ask me to tell you how other inventors successfully sold their patents. Geo. F. Baker, Manager Classified Advertising, Popular Mechanics Magazine, Chicago, Ill.

PATENT for Sale—oil vaporizing carburetor vaporizing kerosene and distillate perfectly, places the carburetor as close to inlet ports as possible; estimated 15% increase in power and 20% saving in fuel. Robert W. Kambak, Ward 5, Battle Mountain Sanitarium, Hot Springs, S. D.

SCREW top fruit jar sealer. Makes every jar air-tight. Patent applied for. Write A. Edge, Quakertown, Pa.

FOR Sale—U. S. patent. Safety pocket device. Fred S. Nelson, Kemmerer, Wyo.

UNITED STATES and Canadian patents on valuable inventions. Water Motor and Locomotive Ash Pan Heater. Outright or Royalty. Write for particulars, George Joranson, 1522 3rd Ave N., Foren, N. Dak.

FOR Sale—to best offer—Patent No. 1,484,775. Small mechanical toy. A stamping job. G. A. Haight, 200 Palmer Ave. E., Detroit, Mich.

NEW, Simple and reliable, automatic signal or burglar alarm; patent just granted. R. B. Isom, Corinth, Miss.

IT'S different. Approved Auto Signal. Not automatic. Makes possible National Standard Safety Signal for Auto traffic. Royalty. P. S. Riggs, Box 594, Marshall, Texas.

PATENT for Sale on newly invented super-heater for feed door of furnaces. Doubles efficiency. Royalty basis. Write for particulars today. Grant Peifer, Watsonville, Pa.

PATENT Pending for sale—lock snap, designed for cattle ties. Elmer Severson, Deerfield, Wis.

ATTENTION, Manufacturers. Patents for sale outright or royalty. Illuminated Automobile License Plate and Holder, Collapsible Camp Table, Illuminated Insert Card Frame for theatre and hotel lobby advertising, Curtain Rod and Bracket, Collapsible Camp Dressing Cabinet and Camp Table, forming suitcase when folded, Window Sash Pulley, Portable Folding Stepladder. M. M. Larsen, Colton, Calif.

FOR Sale—New process moulding presses to make moulds in wax and other substances for the use of electrotypers and others. Take place of hydraulic presses; cost little. Patented. Anthony Soukup, 3639 West 22nd Street, Corner Millard, Chicago.

PATENT For Sale: Headlight Glareshield. Operated by drivers. Shield thrown partly over light. Wm. G. Ruscoe, Box 311, Stamford, Conn.

KITCHEN Article, United States and Canada. Easy and cheap to manufacture. P. G. Bally, 5249 Oak View Ave., Eagle Rock City, Calif.

IMPROVED fruit funnel for home canning. Patent issued Aug. 15, 1924. For putting hot fruit in cold bottles, cold liquids in hot bottles, without breaking. Works perfectly. Canada and United States patent for sale or royalty. C. W. Young, 682 E. Julian, San Jose, Calif.

PATENTS For Sale: To sell, buy or obtain patents, write Patent News-P, Washington, D. C.

MR. MANUFACTURER, Layman or veteran—Side Dump Scraper Hoist, loads wagons, does ditching. E. B. Hawkins, Applegate, Ore.

DRAWING INSTRUMENTS AND DRAFTING SUPPLIES

FINELY made nine-piece German Precision drafting set at \$4.50. Money back if not satisfactory. Bass Camera Company, 109, N. Dearborn St., Chicago, Ill.

SURVEYING INSTRUMENTS

LARGEST stock of new and used surveying instruments in the country direct from factory. Satisfaction guaranteed or money refunded. Wissler, 619 N. Broadway, St. Louis.

MODELS AND MODEL SUPPLIES

PATENTS — Write for my free Guide Books "How to Obtain a Patent" and "Invention and Industry" and "Record of Invention" blank before disclosing inventions. Send model or sketch of your invention for instructions. Promptness assured. No charge for above information. Clarence A. O'Brien, Registered Patent Lawyer, 5891 Security Bank Building, directly across street from Patent Office, Washington, D. C. See pages 168 and 169.

WOOD Models, Patterns. Experimental work. Small wood parts in quantity. W. H. Gall, 616 Dolbee Ave., S. E., Grand Rapids, Mich.

WE make models, dies, tools. All kinds of light manufacturing. Design and build special machinery. Badger Tool & Mfg. Co., 134 So. Clinton St., Chicago, Ill.

SEND Sketch and get lowest prices on Model and Experimental work. Ideal Company, 1635 Spring St., New York.

DIES, Tools and General Manufacturing. Models and Manufacturing of new inventions our specialty. Logan Machine Co., 126 S. Clinton St., Chicago, Ill.

SPECIAL machine builders, tool and die makers, inventors' models, production work of all kinds. Dept. L, Quality Hardware & Machine Co., Ravenswood and Thorndale Avenues, Chicago, Ill.

MODEL steam engine $\frac{3}{8}$ " x $\frac{3}{8}$ " \$8.50. Finished parts for same, \$7.25. Other engines, boilers, blowlamps. Catalog for 10c stamp. Model Machine Shop Co., 417 East 71 St., New York City.

THE Modelmaker. For those interested in making working models. Send 10 cents. Address P. M. 120 Liberty Street, New York.

WE make working models for inventors and do experimental work and carry a complete stock of brass gears and model supplies. Send for catalogue. The Pierce Model Works, Tinley Park, Ill.

WE Build Models, design, develop and manufacture articles in large or small quantities. Homeyer Mfg. Co., 1385 E. 7th St., Cleveland, Ohio.

MANUFACTURING

LET us do your designing and perfecting of inventions or Machines for doing special work. We make working drawings and models. 15 years' experience in designing special Machinery. Expert engineering advice free on all matters before or after Patent. Strictly confidential. Reference on request. Arthur Lansberry, P. O. Box 649, Youngstown, Ohio.

METAL-CRAFT — Eventually — Metal-Craft. Competent Engineers, Designers and Producing Organization await your commands on dies, stampings, die-casting, deep pressing, screw-machine and wire products. Plating, Enameling, Burnishing, Assembling, Wrapping and Packing to your specifications. Large completely equipped plant which guarantees prompt, efficient service. It is not the quality of raw materials alone, nor the precision in manufacture, and not just the service rendered that has given Metal-Craft the good reputation they bear—but all of these, as a constant certainty, in combination. Estimates promptly furnished. Metal-Craft Manufacturing Company, Box 259-W, Chicago.

INVENTORS and Designers will find our engineers able to develop their ideas, make models, dies, stampings and special tools of any description. Let us be your co-inventor. Our charges will please you. Madison Tool & Stamping Works, 1970-84 Helena St., Madison, Wis.

MANUFACTURING space with power for small industries. Write Add Club, Plattsmouth, Nebr.

LET us manufacture it for you. Can quote low prices and can furnish a product you would be proud of. Ideas worked out and simplified. Models made. Metal parts made to drawings or sample. Simplex Tool Co., Woonsocket, R. I.

Our factory will make your models, manufacture your articles as well as build your tools, dies and fixtures. Standard Die & Specialty Co., 1932 W. Austin Ave., Chicago, Ill.

WIRE goods made to order. Cooley Mfg. Co., 530 N. Western Ave., Chicago.

EXPERIMENTS developed, dies, models and manufacturing machine designing. Estimates and information promptly given. Address Schroyer Bros. Machine Works, 2303 Holmes St., Kansas City, Mo.

WANTED—Meritorious articles to manufacture. Dependable Mfg. Co., Streator, Ill.

IF you have acceptable article, inexpensive to manufacture, we'll make and sell. Manufacturer, 614 Park Bldg., Cleveland, Ohio.

PATTERNS, wood and metal. Models, tools and dies. Brass, bronze, aluminum and iron castings. Screw machine work, production work of all kinds. Write Modern Machine & Pattern Co., Terre Haute, Ind.

PATENTED Articles, Models, Brass Work, Machine Construction; Dies Made. Baum's Metal Specialties, Kansas City, Mo.

WE design and build special machinery, make models, dies, stamping tools, do general machine work and light manufacturing. Marshall Mfg. Co., Kansas City, Mo.

IRON, Brass, Aluminum Castings, Models, Patterns, Light Manufacturing. Welch Brothers Co., North Chicago, Ill.

SCREWS, nuts, screw machine products, all metals. Autoscrew Works, 355 West Broadway, New York City.

FOR MANUFACTURERS

MANUFACTURERS—We have a large surplus stock of rivets, bolts, capscrews, screws, welding rod, No. 8, 9, 10 and 12 hard wire, sheet copper, brass pipe unions and fittings, seamless steel tubing. Anxious to dispose of entire surplus stock. Write us your wants. Lincoln Standard Aircraft Corp., Winnebago, Nebr.

MACHINERY, TOOLS AND SUPPLIES

SHAW Garden Tractor does work of five men the year 'round. Besides cultivating, etc., runs belt machinery requiring not much over 1½ H.P. Special Winter Price \$150. Write for particulars. Shaw Mfg. Co., Tractor Dept., Galesburg, Kans.

CONCRETE Building Block Machines and Molds. Catalogue free. Concrete Machine Co., 303 South Third St., St. Louis, Mo.

USED Printing Presses, Type, Supplies. List free. Norfolk Press Works, B1—Baltimore, Norfolk, Va.

ONE 12"x5' LeBlond engine lathe, quick change, \$290. One 15"x5' LeBlond engine lathe, \$375.00. One 24" Metal Shaper, \$390.00. One No. 60 Heald Cylinder grinder, \$850.00. One No. 1½ Cincinnati Milling machine \$275.00. 20" Drill Press, \$55. Terms to suit. Complete line of machinery and supplies. Cincinnati Machinery Supply Co., 215 E. Pearl St., Cincinnati, Ohio.

MECHANICS, Attention: If you desire to start a machine shop we can equip same on an easy time installment plan. Be your own boss and make big profits. Cincinnati Machinery Supply Co., Cincinnati, Ohio.

SPECIAL labor saving machinery designed and built. Punches and Dies and other special tools furnished for manufacturing work. Simplex Tool Company, Woonsocket, R. I.

ENGINES, MOTORS AND DYNAMOS

NEW nine-cylinder Gnome gas engines equipped two magnets, aluminum pistons. \$45.00. Sales Corporation, Alexandria, Va.

MOTORS \$2.98. Good, Practical, twenty-two horsepower, 115-volt alternating, direct current. Order Now. Pay Postman, Perry Trading Co., Dept. M4, 815 Lake, Racine, Wis.

½" PORTABLE Electric drill with stand \$68.00. Western Electric Motorgenerator Battery charging set \$90.00. Floyd Noespel, Bellevue, Iowa.

USED small high-speed motors, suitable for grinder or buffer. \$3.50. Evert Electric Co., Racine Junction Station, Racine, Wis.

STEAM Engines—One H. P. \$18.00; ½, \$12.00. James Chambers, Bessemer, Ala.

GENERAL Electric, new ¼ a.c. motors \$12. Wood, 151, E108, New York.

BATTERY charging pays big. Profits pay for outfit. Easy terms. Hoberth, Troy, Ohio.

BATTERY charging motor generators—Motor 220 V., 60 cycle, 3 phase. Generator 25 V., 8 amp., \$25.00; single phase motor \$37.50. Also special bargains in larger outfits, motors, generators, etc. Queen City Electric Co., 1734 W. Grand Ave., Chicago, Ill.

GOVERNORS to control Auto Engines when used as stationary engines. Circulars. Candee-Smith Governor Co., Springfield, N. Y.

BENDING MACHINES

THE famous Hossfeld Wrenchless Universal Bender is the last word in bending machines; bends metal, cold or hot, into most any conceivable shape, including Eye-bolts and Automobile Spring Eyes. Bends up to 1" bars or 1½" Pipe cold. Used by the largest corporations, yet so inexpensive that even a farm shop need not be without one. Send for circular. Hossfeld Mfg. Co., Box 344, Winona, Minn.

BLACKSMITHS

BLACKSMITHS, Listen! Make more money doing hard jobs easy with Toy's Modern Methods of Master Machine Blacksmithing, Forging and Solid Welding, Tool Dressing and Tempering to a standard with colored tempering charts. All for One Dollar. Samples Free. W. M. Toy, Sidney, Ohio.

FOR SALE—MISCELLANEOUS

WHITE Honey, 60 lbs., \$7.50; 120 lbs., \$14.50. Guaranteed. J. Van Engen, Crawford, Colo.

ADDRESSGRAPHS, Letter Folders, Multigraphs, Envelope Sealers, Duplicators, less than half price. Guaranteed. Fruit Co., 117 N. Market, Chicago.

CARD Case free. 100 business cards printed 85c; 300, 1.65; 50 calling cards 35c; 100, 50c. Postpaid. Woods, 719 St. Charles, St. Louis, Mo.

SUPERIOR Rubber Weld. The only rubber weld on the market. Sample can 85c. No stamps accepted. Agents wanted. R. W. Smith Company, 1874 E. 20th St., Cleveland, Ohio.

252 ORANGES, box \$2.88. Fresh from groves. Southern Warehouses, Rockmart, Ga.

MULTIGRAPHS, duplicators, millimeters, folders, multicolor presses. Printing presses bought and sold. Stamps for information. Nicholas, 120 High St., Boston.

GENUINE Egyptian scarabs for ring mountings—full data; also high-class Egyptian necklaces. Laughlin, 50 Baxter, Chatham, Ontario.

MORRISON'S "Jumbo" Fountain Pen \$4.00. At Jewelers, \$7.50. Guaranteed. George Thurlow, 55 Federal St., Newburyport, Mass.

FOR Sale—Coin Operated Machines. Barr Novelty Works, Shamokin, Pa.

FOR Sale: Watchmaker's Lathes and tools at a bargain. R. Jaegermann, 5815 Easton Ave., St. Louis, Mo.

SWAP!—Buy!—Sell! Anything!—Anywhere!!! 20-Word ad and Six Months' subscription—50c. International-Opportunity, Brookings, S. Dak.

WANTED—MISCELLANEOUS

DO You Write? We are eager to receive in any form Stories, Photoplays and Articles suitable for publication. Send us your manuscript for free criticism. Producers and Publishers Clearing House, Regd. P. O. Box 1182, Montreal, Quebec.

GOT something to swap? Write me, enclosing reply postage. Vitalis Malloy, Dept. 27, Johnsonburg, Penna.

WANTED—Mail Order articles retailing around a dollar. Clarence Fanslow, Yankton; So. Dak.

GOLD, watches, Diamonds, silver, platinum, jewelry, bought. Best prices also for mercury, false teeth, magneto points, bridge-work, jobs, general merchandise, unused stamps, bonds, any valuables. Mail or express in. Prompt, confidential returns. Returnable ten days if unsatisfactory. Ohio Smelting Co., 315 Hippodrome Bldg., Cleveland, Ohio.

MAIL us your discarded Jewelry, Gold, Crowns and Bridges, Watches, Diamonds, Silver, Platinum, and old False Teeth, Money promptly mailed. Goods returned if offer refused. United States Smelting Works, (The Old Reliable), Dept. 71, Chicago.

REAL ESTATE, FARM AND ORCHARD LANDS

20 ACRES or more of our best land in Mich. \$20 per A. 25c per A. down, balance your own terms. 52-page book free. Swigart Land Company, P1259 First National Bank Building, Chicago.

20 ACRES and Crops Only \$900. Buildings Cost \$3,000 to replace; close busy RR. town; lots fruit. Hay, grain, vegetables included. Part cash. Picture and details pg. 19 Illus. Catalog. Free. Strout Farm Agency, 150P Nassau St., New York City.

SEIZED and Sold for Taxes. \$80 for 12 acres, choice lake front; \$72 for 25 acres, Muskoka Lake district; \$50 for 10 acres, hunting camp site; \$92 for 50 acres, mixed farming, good market; \$315 for 160 acres, wheat and dairy farm, Manitoba; \$82 for 50 acres, beautifully wooded; \$216 for large acreage, big game district; \$378 for claim near mines that have paid millions. Also beautifully situated hunting and fishing camps, moose, deer, caribou, ducks, partridge, trout, white fish, bass, etc., best in North America. Splendid improved farms in Western Canada, the Last Great West, dairying, wheat, mixed farming. Summer cottage sites, heavily wooded tracts, easily accessible, situated in Muskoka, Georgian Bay district with its 10,000 islands, Algonquin Park with its 300 lakes, Highlands of Ontario, Lake of Bays, etc. All offered at 10 cents on the dollar of their value, and on easy monthly payments of \$5 and upward. Send for illustrated list describing the above and hundreds of other properties, seized and sold for taxes. Every property is fully described and offered at a stated price. Send no money. Send for list today, so you will have first choice. If you wish you may make your payments to your local trust company. Tax Sale Service, 72 Queen Street West, District 15, Toronto, Ontario, Canada.

PROFITABLE vineyard-homes, on easy payments; fine climate. Splendid living conditions. Standard Vineyard Co., Bentonville, Ark.

WHEAT Land. Reliable information furnished on Kansas wheat land. References. Wheat Land Company, Hutchinson, Kans.

PECAN-ORANGE Groves "On the Gulf" \$10 monthly. Guaranteed care. Soon produce \$300.00 yearly. Suburban Orchards, Dept. M, Biloxi, Mississippi.

\$5.00 DOWN, \$5.00 monthly; 10 acres unimproved poultry, fruit, stock, woodland; \$100; Ozarks, Fishing, hunting, trapping. Alvin Zimmermann, 1800 N. Fifth, Kansas City, Kans.

SELL your property quickly for cash, no matter where located. Don't pay big commission. Particulars free. Real Estate Salesmen Co., Desk B, Lincoln, Nebr.

ATTENTION—"Get acquainted." Cash for your property. Farm, Hotel or Retail Store, no matter where located; confidential service. Hayes' Business Agency, Cincinnati, Ohio.

ROOTS AND HERBS

HERB Doctor Book—10 cents. 250 recipes to make herb medicine. Hazzard Company, Box 1, Vanderveer Park, Brooklyn, N. Y.

DOGS AND PETS

POINTER and Collie Pups—Fashionably bred. Eligible. Winners, hunters. Also Giant Runt and Mondaine Pigeons. Write, Egyptian Farm, Marion, Ill.

NOTICE, Dog Owners—25c brings you a nice nickel-plated nameplate, with your Dog's name and your name and address neatly stamped on it ready for collar. 5 for \$1.00. Wade McDonald, Pyland, Miss.

IMPORTED Pups and grown dogs for sale. Veri-Best Police Dog Kennels, Portland, Ind.

BEAUTIFUL Boston Terrier puppies. Pedigreed. Connell's Kennels, E1018 Courtland, Spokane, Wash.

COLLIES for Sale. Training Book 35c. Sunnybrae Kennels, Bloomington, Ill.

BEAUTIFUL registered bull pups cheap. Bulldogs, 501 Rockwood, Dallas, Texas.

POULTRY

HENRY ACHESON, Breeder, Spencer Turkeys, Jersey Giants, Russian Orloffs and Hatching Eggs, Breeding Fostis. Photo—booklet free. R. 1, Box 144-B, Santa Cruz, Calif.

CHICKS on Low Terms. 20 kinds. Reduced prices. Catalog free. Colonial Farms, Dept. 720, Pleasant Hill, Mo.

PERSONAL

MEN, Do you know why women don't get bald? If your hair is thin and coming out, you can grow it thicker and keep it from ever coming out. You can change that shiny baldness to soft skin. Send \$1.25 Post Office money order for book, "How to Prevent Baldness." L. Frank Robinson, M. D., Greenville, S. C.

ST-STU-T-T-TERING and stammering cured at home. Instructive booklet free. Walter McDonnell, 46 Potomac Bank Bldg., Washington, D. C.

VOCATIONAL Analysis from handwriting. Joseph Pierce, Mission, San Jose, Calif.

SEND 25c and your date of birth for your forecast for 1925. Aryel Synelare, Numerologist, Gen. Del., Redlands, Calif.

YOUR talents and character revealed by your handwriting. Send me a specimen and 25c for analysis. Friend Paul, Stamford, Conn.

HIGH Blood Pressure inexpensively overcome without drugs. Send address. Frank-Ha Stokes, Mohawk, Fla.

YOU can't be a live wire if your vitality is low. Health and Strength for you without drugs. My Illustrated Health Culture course (Nature's Way), only \$1.00; worth \$5.00. Dr. James Piwonka, 5733 Broadway, Cleveland, Ohio.

UNUSUAL Horoscope—Six pages, 2,500 words, consisting of extensive four-page Special Horoscope, Astro-Analysis, and two-page valuable guide giving daily and monthly advice covering entire year. Send 50c and birthdate. Money returned if dissatisfied. Prof. Bolles, Box 125, Cranford, N. J.

FREE—Stop using tobacco. We will give free information how to conquer habit easily and permanently. Results guaranteed. Anti-Tobacco League, Box K, Omaha, Nebr.

TOBACCO Kills manly Vigor. Quit easily. Cigarettes, chewing, smoking, snuff conquered or no charge. Small sum if satisfactory. Stops craving; harmless. Full treatment on trial. Perkins Co., 34-A, Hastings, Neb.

TOBACCO or Snuff Habit cured or no pay. \$1.00 if cured. Remedy sent on trial. Superba Co., TP, Baltimore, Md.

MISCELLANEOUS

STOP Daily Grind. Money! Re-Silvering Mirrors, auto-parts, tableware, stoves, Outfits; Plans Free. Sprinkle, Plater, 288, Marion, Ind.

25 CENTS Brings How to Hunt Pearls in shallow streams and sample pearls. Pearls bought. Investigate that stream. O'Sullivan, O'Neill, Nebr.

KIDDIE Cabinet, Lifetime gift; patterns 25c-50c-\$1.00. Dresser, Desk, Settee, 25c each. Kiddie Cabinet, 305 West 143rd St., New York.

FORMS to Cast Lead Soldiers, Indians, Marines, Trappers, Animals, 151 Kinds. Send 10c for Illustrated Catalogue. Henry Schiercke, 1034 72nd St., Brooklyn, N. Y.

FOR Rent. Building suitable small factory. Inquire W. A. Canfield, Union Mills, Ind.

SEND Radio Applause Cards with your name and address printed in. Show your appreciation. 100, \$1; 200, \$1.75. Blad Printing Company, Box 5, Lamont, Iowa.

SIMPLEX Cigarette machine, guaranteed sample 40c. Box 1177, Pitschey, Okla.

ELECTRIC Stove Polisher. Polishes stoves, Brass, Copper, etc. Grinds valves etc. Write for circular. Sirlanni & Trumbetta, 6 Brown St., Carbondale, Pa.

SIMPLIFIED Photo-Engraving. Line and half-tone cuts. Particulars 2c. Hector & Fisher, Princeton, Ill.

GET posted—Good prices paid for butterfiles, insects. See Sinclair display advertisement, page 24.

LOCKSMITHING, complete 500 tricks of the trade, new edition, many added features. \$1.50, money back if dissatisfied. H. Routsen, 3406 Andover St., Oakland, Calif.

ARE you old at forty? See our advertisement on page 175 of this issue. The Electro-Thermal Company, 2137 Main St., Steubenville, Ohio.

SURPRISE and big mail 10c. F. Doering, Box 494, Berkeley, Calif.

ALPHAGAMS, 30c. Primers, \$1.94. Dictionaries, \$1.98. Languages, 8 West 40th, New York.

TRANSFER prints, patterns, etc. Three Magic Tablets, 25c. Bangert Co., DuBois, Pa.

MINERAL Treasures; how to find them, 10c. Minerals identified, \$1.00. Mineralogist, Joplin, Mo.

ARTIFICIAL Eyes. Booklet free. Denver Optic, 539 Barclay, Denver, Colo.

I CATCH from 45 to 60 Foxes in from 4 to 5 weeks time. Can teach any reader of this magazine how to get them. Just drop me a line for particulars. W. A. Hadley, Stanstead, Quebec, Canada.

CUTS anybody can make. Simple, cheap process, \$1. Specimens, particulars, 2c stamp. M. Day, Windfall, Ind.

HOMEOPATHIC and Biochemic preparations sent postpaid to all parts of the world. Manual and booklets free. Halsey Bros. Co., 111 N. Wabash Ave., Chicago, Ill. Established 1855.



Make Money Drawing Cartoons

It's Easy To Learn When Shown In The Right Way

Some of the cleverest cartoonists and comic artists in America today learned to draw during their spare time by following **CARTOONIST EVANS' SIMPLE AND EASY METHOD**. This school is recommended by foremost cartoonists because they know the students are handled right. If you like to draw, send a sample of your work, either an original or a copy, and we will send you a **portfolio of cartoons and full details**. The course is **NOT EXPENSIVE**.

The W. L. Evans School of Cartooning 821 Leader Building CLEVELAND, OHIO

Whatever Your Question;—be it the pronunciation of Fascista, the spelling of a puzzling word, the location of Esthonia the meaning of soviet, realtor, vitamin, etc., this Supreme Authority—

WEBSTER'S NEW INTERNATIONAL DICTIONARY

contains an accurate, final answer. 407,000 Words 2700 Pages. 6000 Illustrations. Regular and India-Paper Editions. G. & C. MERRIAM CO., Springfield, Mass. Write for specimen pages, prices, etc., and FREE Pocket Maps, per Popular Mechanics.



"THERE'S MONEY IN IT"

LEARN TELEGRAPHY AT HOME

MORSE AND WIRELESS

TEACH YOURSELF

In half usual time, at trifling cost, with the wonderful Automatic Transmitter, **THE OMNIGRAPH**. Sends unlimited Morse or Continental Messages, at any speed, just as an expert operator would. Adopted by U. S. Government, and leading Universities, Colleges and Telegraph Schools. 3 Styles. Catalog free. **OMNIGRAPH MFG. CO., 16-22 Hudson St., NEW YORK**

If you own a Radio Phone Set—and don't know the code—you are missing most of the fun.

LEARN



AVIATION

EARN \$2,000 TO \$10,000 A YEAR

STUDY AT HOME

OPPORTUNITY is at your door. Learn Airplane Engineering now.

Write for Free Catalog

WESTERN AIRPLANE CORPORATION
Dept. M4 Monadnock Block CHICAGO

Tenor Banjo FREE

Worth
18⁰⁰

Read
This Big
Free Offer



Prof. Harry S. Sla, pictured at left, headed the Instrumental Clubs of N. Y. University for 20 years.

Prof. John Martell, pictured at right, is famous as a great tenor banjoist.

The combined efforts of both professors offer you an opportunity to learn to play.

Become Popular Over Night

Thousands flock to New York's many jazz palaces every night, which proves how **magnetic and irresistible** jazz is. You, too, can **become popular, irresistible, magnetic.** We start you by furnishing **free** when you enroll, with a full tone, professional size \$18.00 tenor banjo. **No red tape** or strings to offer—you get tenor banjo immediately when you enroll. The simplest of all to learn to play is tenor banjo, because we have devised a method of instruction so simple, you **quickly learn**, even if you have never had previous music knowledge. Rush coupon and secure our book in colors, "How to Learn To Play Tenor Banjo," and we will also send your **first lesson free.** Act quickly.

Learn to Play Quickly With Our Picture Method

Besides furnishing you with easy-to-understand printed lessons, we also furnish you with **pictures of our professors' playing.** It is easy to imitate pictures and do the right thing. You also get **phonograph records** from time to time of our professors' playing which is really a visit to you. Another exclusive feature is our **Gain-Time Chart** which enables you to play quickly. This chart has been said to be the **greatest discovery** for the teaching of music, and it is being used with our permission by several musical schools throughout the country.

Send No Money—Rush Coupon

Rush coupon. We will send you by return mail our beautiful book in colors, "How to Learn to Play Tenor Banjo," and also your **first free lesson.** We will also reserve for you an \$18.00, full tone, professional size tenor banjo which will be presented to you as a gift when you enroll as a student. Thousands of happy graduates from our Academy today show their diplomas to their friends and are ever increasing their popularity with their tenor banjo education as a stepping stone. You, too, will join this happy army, but you must act—therefore **sign and rush coupon today.**

NEW YORK ACADEMY OF MUSIC
Studio 14, 100 Fifth Ave., New York, N. Y.

Please rush your book in colors, "How to Learn to Play Tenor Banjo," my **First Free Lesson**, and reserve a gift \$18 full tone, professional size Tenor Banjo for me. This obligates me in no way whatever.

Name.....

Address.....

City..... State.....

Note—This Offer Expires in 60 Days.

New York Academy of Music
Studio 14—100 Fifth Ave.
New York—N. Y.

Get Into This



17,000,000
Automobiles in U.S.
85,000,000
Tires to be repaired.
17,000,000 Batteries,
17,000,000 Ignition
Systems and only
50,000 Garages.

Follow the lead of the thousands of "Michigan State" graduates who have taken advantage of the amazing money-making opportunities in the automobile business. **Here is a chart of facts**—authentic figures which point out the opportunities. If you are ambitious and seeking a money-making opening, here's your chance—a chance to cash in to a degree that will satisfy your highest aims.

Thousands of battery shops, auto electrical shops, tire and welding shops are needed now. Only trained men can run them. Good work is what car owners want, and it takes a trained man to do it.



Learn the Auto Business In the Heart of the Industry

Without any previous experience—just a liking for mechanics—you can learn the auto business from A to Z in a few weeks at the Michigan State Automobile School—the factory endorsed school in Detroit—the heart of the industry. Then step out, equipped with knowledge and training, to a future of certain, big money making. You have great advantages, learning the business here. It's the fountain

head of the automotive industry. You are taught under factory endorsed methods. You learn both theory and practice on latest equipment. Go through the great Ford plants. Visit the other auto factories—learn their methods first hand—and it all means greater opportunities and more certain success. The Michigan State Automobile School, in Detroit, the automobile center, is the logical place to learn the auto business.

Endorsed by Big Factories Read These Letters

DODGE BROTHERS

INCORPORATED
DETROIT, U. S. A.

"We believe the Michigan State Automobile School of this city to be an exceptionally high class school, and no doubt a diploma from this school would assist materially in obtaining employment with high class automobile dealers."



BUICK MOTOR COMPANY

"We believe the MICHIGAN STATE AUTO SCHOOL, Detroit, would best meet your requirements, as its course in technical training is most thorough and complete in every detail."

THE STUDEBAKER CORPORATION

OF AMERICA

"We do not know of a better automobile school than the MICHIGAN STATE."

Save Years of Dirty Work

Some men think they can learn the business by starting in green as a helper in a garage. They are wrong. Years of dirty work will be wasted learning wrong methods from poor mechanics. Save all this by coming to the auto center for a few weeks. Learn right, under expert instructors. Learn the short cuts and best ways of doing electrical repairs, engine work, all about autos, trucks and engines.

Start Now A thorough training in Detroit, at the "Michigan State," fattens the pay envelop or starts you in business for yourself. You can take a full Automotive Course in 12 weeks. Or our great Master Course in 30 weeks. Or specialize in any of its money-making branches; be an Auto Electrician, Battery Service man, Engine man, Welder, Tire Expert, or Machinist. All courses include training in Business, Shop Management, Service, Selling, etc., by one of the big men from Detroit's auto plants.

Classes always open. You can start at once. Jump right on the train for Detroit.

MICHIGAN STATE
304 Auto Building Detroit, Michigan

Big Money Business

You Can Have Success Like This. Here is H. A. Bradley—one of the thousands of "Michigan State" students who have achieved success far beyond their fondest hopes. What these men have done you can do. The opportunities now are greater than ever. There are more autos—more trucks—more tractors and every year adds to the money-making possibilities. You have ambition—you want success. Success is certain if you are willing to work for it. You can have independence—be your own boss—**stop plodding and get into work you like.** You can earn big money, be prosperous, happy and independent. Bradley is no exception. We have graduates who have made as high as \$10,000 in less than a year. These records may seem amazing, but they are true. It is all done through head and hand training at the "Michigan State." Decide now to give yourself this training that will pay you big and establish you in a successful life work.

Detroit-Trained Auto Men Earn More Money

Detroit-trained men are preferred. Your diploma from the "Michigan State" is a valuable money-making asset. **The Michigan State Automobile School is known the world over. Wherever autos are used—Detroit-trained men get the best jobs, highest pay.** Auto, truck, tractor factories employ M. S. A. S. graduates. Leading factories, dealers, service stations, garages, shops and farms want men who have trained their heads as well as their hands—the M. S. A. S. Detroit-kind.

Good Positions Open

The demand for men who know automotive mechanics and electricians is greater than the supply. We have more calls than we can fill. The training in **Business Management and Salesmanship** included in our courses makes our graduates especially valuable. The years ahead are predicted to be the biggest years of the industry. That means certain money-making advantages to men who start in the business now.

Life Scholarship

Your enrollment entitles you to life membership, with privilege of our **service any time** you want it. Many students come back to brush up on latest ideas and new equipment. It doesn't cost a penny extra. The position of the Michigan State (The Detroit Auto School) in the heart of this industry, assures most thorough, most practical, systematic training, at a cost so low and terms so easy that any man, anywhere, can afford it.

Earn While You Learn

If necessary we can assist students to secure part time work to earn a small amount each week. Or students who wish to take our evening course will be assisted to full time day jobs. Ask for details, and when writing, please explain your circumstances fully.

Mail This Coupon

Get all the interesting facts. Send for complete information about all courses, illustrated with photos of school, equipment and graduates. It tells you how you can get a good paying job—how you can go into business for yourself with little capital. Let us send it to you **FREE** without obligation. Mail the coupon or send us a postcard today. Write now. (We do not enroll colored students, except for our Home Study Course.)

AUTOMOBILE SCHOOL
3729 Woodward Avenue, Detroit, Michigan

From \$12 a Week to \$500 a Month



H. A. BRADLEY

BRADLEY GARAGE

Cleveland, Ohio.

Before going to your School I was employed as shipping clerk with a well-known concern at the enormous salary of \$12.00 per week. I knew absolutely nothing about an automobile.

After leaving the School I worked as service repairman for the Oakland Motor Company of Pontiac, Michigan. I left the Oakland to accept a position as night service foreman for the Studebaker Company at Detroit and was later connected with such firms as the Northway Motor, and the Continental Motor Manufacturing Company. I have since been service-manager for two large concerns—one in Detroit and one in Cleveland. The salary mounted all the time—the last position paying me \$300 per month.

I, then, went in business for myself, which business I have successfully built and expect to maintain for a long time to come. I estimate the present earnings of my business at \$500 per month clear and growing all the time.

I believe that the M. S. A. S. is by far the best school of its kind in the country. For the man who will apply himself to the work and to the studies I can safely say that the Michigan State Auto School is the best place to learn the automobile business.

Yours very truly,
H. A. BRADLEY.



One of the expert instructors teaching students on a new G.M.C. Truck. Complete equipment in every line is here for you to learn on, and skilled men to guide your practice.

Mail Coupon To Day

Michigan State Automobile School 304 Auto Building
DETROIT, MICH.
Send me **FREE** and without obligation complete information about Detroit-training to make the most money.

Name.....

Street or R. F. D.

City.....State.....

I am interested in Resident Course at your School.
 Home Study Course.

Most Wonderful Musical Instrument

Ever Invented

Play in a Minute!

No Lessons—No Practice

Greatest musical sensation of the age! Never before anything like it. Everybody simply wild about this

20th Century Wonder

No more high cost, hard lessons and long practice. At last a Musical Genius has invented a marvelous instrument that anyone can play who can hum a tune.

It is a big, full-sized musical instrument made of solid brass, polished and finished like the finest Saxophone. You don't need to know a thing about music. You don't have to practice, not a minute.

You Can Play It

Just HUM a tune in it, that's all. And, oh how the music rolls out—sweet and mellow like the dreamy saxophone or loud and clear like trombone or trumpet. Mail coupon for our amazing offer and all the facts about

Play Your Way to Popularity

The Marvelous

Musseh's Slide- Trumpet-Sax

TRADE MARK.

Remember, it doesn't make a bit of difference whether you know one note of music from another or whether you have ever played any kind of a musical instrument. Any man, woman or child can play this wonderful Slide-Trumpet-Sax at once!

FREE We will send you absolutely FREE a phonograph record of a beautiful solo played on Musseh's Slide-Trumpet-Sax. You will be amazed at the sweet, mellow music produced by this wonderful instrument that sounds like a saxophone.

We will also send you our amazing LOW Price Introductory Offer, a price so low that anyone can easily afford it.

Send for **FREE Phonograph Record Today—SURE**

MUSSEHL & WESTPHAL
518 Water St.,
Ft. Atkinson,
Wis.

MUSSEHL & WESTPHAL,
518 Water St., Ft. Atkinson, Wis.

Send me the Phonograph Record of Solo played on Musseh's Slide-Trumpet-Sax and your Low Price Introductory Offer.
Please print or write very plainly.

Name.....

Address.....



I MAKE

\$25
A DAY
with this
Machine

That is what J. W. Fleming, Ind., wrote six months after we started him as an "American Universal" Floor Surfacing contractor, R. E. Waynick, Texas, says, "I made \$30 in 8 hours." Don Arnold, Ind., says, "I have made as high as \$40 a day." Scores of others are doing as well or better. You, too, can make big money

SURFACING FLOORS

The electrically driven "American Universal" Floor Surfacing Machine does the work of six hand scrapers, earns you six men's pay. Field is unlimited, demand tremendous. Every newly laid floor must be surfaced, every old floor represents a resurfacing job. No experience necessary. Work is pleasant, interesting. Small amount starts you. Here's

Your Big Opportunity

to be your own boss, to build a paying business, and make real money from the start. We help you, show you how and where to get work, furnish advertising, stationery, office forms, everything you need.

Write now for free details of this rare opportunity.

The American Floor Surfacing Machine Company
523 S. Saint Clair Street
TOLEDO, OHIO

A Great Book Free with this pay-raising library

For a short time only we will give every subscriber to the New Library of Machine Shop Practice a copy of French's Engineering Drawing—the greatest book on mechanical drawing ever written. This book makes drawing as plain as day—tells you all about instruments, plans and methods—and prepares you to handle any drawing job you will ever have to do. It comes to you absolutely free with

Machine Shop Practice

9 volumes—3065 pages—3608 illustrations
(A combined home study course and reference library)

The New Machine Shop Library is written for practical men. It gives you the best methods for every kind of machine shop work. It explains machine tools and their operation, drawing and design, tool work, gears and grinding, jigs and fixtures, automatic screw machines and their tools and all of the mathematics you will ever have to use. It is plainly written, completely illustrated—the very best kind of help to the machine shop man who wants to advance himself.

FREE Sent **No money down—only 7c a day**



FREE EXAMINATION COUPON

McGraw-Hill Book Co., Inc., 370 Seventh Ave., New York

Send me for 10 days' free examination the New Library of Machine Shop Practice. If satisfactory I will send you \$1.50 in 10 days and \$2.00 monthly until the special price of \$19.50 is paid. If not wanted, I will return the books at your expense.

On receipt of my first payment of \$1.50 it is understood that I am to receive, free of charge, a copy of the second edition of French's Engineering Drawing.

Signed.....

Address.....

City and State.....

Profession.....

Employer..... P.M. 4-1-25

Go to Electrical School AT HOME



CHIEF
ENGINEER
DUNLAP

Mail coupon for the sensational guarantee given by this million dollar Electrical correspondence school. You have a right to ask, "DO YOU GUARANTEE ME A JOB AND A RAISE after I finish your training?" I will answer that in plain English, straight from the shoulder. I will tell you about the opportunities waiting for you in Electricity, and how I prepare you to cash in on them.

I Guarantee



My student of today learns quickly and easily on actual Electrical Equipment which I supply without extra cost



Dunlap-training is so complete and practical that it prepares you for the BOSS jobs at \$60 to \$200 a week

Go Into ELECTRICITY!

\$12,000 a year when you are an ELECTRICAL EXPERT trained to BOSS electrical construction or electrical power plants, to direct the work of ordinary electricians. Prepare for these positions, at home in your spare time, with Dunlap JOB-METHOD training, the complete and up-to-date home instruction in Electricity.

4 Electrical Outfits Given

Dunlap JOB-METHOD training is built around four complete Electrical outfits which I send you without extra charge. With these valuable instruments, tools and materials, you learn by doing actual Electrical jobs.

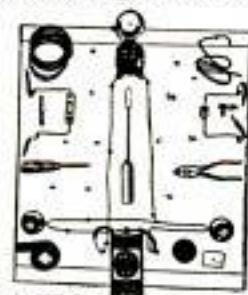

1. Wiring

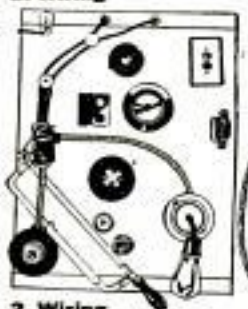

2. Wiring



Make This Training Pay for Itself!

Don't let lack of ready money or anything else prevent you from getting my training. As early as your eleventh lesson I train you to do Electrical and Radio jobs in your spare time—to earn enough money to pay for this course and have some left over.

3. Radio Set



Mail coupon today!

4. Motor and Meter



22 Electrical Engineers

from Westinghouse, General Electric, Commonwealth Edison, Western Union and other great corporations helped me to build this wonderful home-study training. So in every department of Electricity you get your training from a specialist and an authority!

WRITE ME AT ONCE!

The first half of my training is APPLIED ELECTRICITY, a complete course. In the second half I give you Electrical Engineering subjects, doubling the quantity of instruction usually included in home-study training. Get my book, it's free. Get my guarantee and special offers RIGHT NOW. Coupon brings everything quick!

CHIEF ENGINEER DUNLAP

Electrical Division

AMERICAN SCHOOL

Dept. E-474, Drexel Avenue and 58th Street, CHICAGO

What is Your Guarantee?

Chief Engineer Dunlap, AMERICAN SCHOOL, Dept. E-474, Drexel Ave. & 58th St., Chicago
Rush free book, special offers, and your new guarantee. I want complete information on how to become an Electrical Expert at home in spare time.

Name

St. No.

City

State

Great *New* Invention

for seekers of

Health Power Beauty



Elco Health Generators at last are ready for you! If you want more health—greater power to enjoy the pleasures and delights about you, or if more beauty is your desire—write! Ask for the book on these inventions which has just been prepared. It will be sent to you without cost. It tells you how Elco Health Generators aid you in leaving the lethargy and hopelessness of bad health and weakness behind forever. Re-vitalize yourself. Bring back energy. Be wholly alive. Write today!

10 Days Free Trial—Write for FREE BOOK

Elco Electric Health Generators

These great new inventions generate **High Frequency Violet Ray, Mechanical Vibration, Medical Electricity and Ozone.** Combined or separate.

They operate on the electric light in your home or on their own motive power at less than 50 cents per year. Elco Health Generators are positively the only instruments which can give you in one outfit Electricity, Violet Ray—Vibration and Ozone—the four greatest curative agents. Send coupon below. Get the Free Book NOW!



For All These:

Rheumatism	Asthma
Gout	Hay Fever
Lumbago	Sore Throat
Neuralgia	Catarrh
Sciatica	Deafness
Headache	Insomnia
Neuritis	Pain
Nervousness	Development
Circulation	Skin Disease
Weakness	Pimples
Paralysis	Scalp Disorders
Eye Trouble	Obesity

MAIL the COUPON for FREE Book!

Do not put this paper down without sending the coupon. Don't go on as you are with pains and with almost no life and energy. You owe it to yourself to be a better man or woman. You were put here to enjoy life—not just to drag through it. So do not rest another day until you have put your name on the coupon here. That will bring the whole story of these great new inventions. Do it today—now.

Health Power Beauty

Lindstrom & Company
30 W. Lake St. Dept. 13-54 Chicago, Ill.

Please send me your free book, "Health—Power—Beauty" and full information on your 10-Day Free Trial Offer.

Name

Address

For sale in Canada by C. FRASER MACTAVISH
247 Hillsdale Ave. E., Toronto

STOP USING A TRUSS

Do Away With Steel And Rubber Bands



Inner surface is made adhesive to secure the PLAPAO-PAD firmly to the body, keeping the PLAPAO continually applied and the pad from slipping. No straps, buckles or springs attached. Soft as velvet—easy to apply.

FREE to 5,000 Truss Sufferers

To the extent of 5,000 sufferers who may apply I will send, ABSOLUTELY FREE, a sufficient quantity of the Plapao to positively convince them that this is the only logical, common-sense way of treating rupture. Plapao is a highly astringent medication placed within the Plapao-Pad and being absorbed through the skin, creates a wonderful feeling of relief and at the same time tends to strengthen the weakened muscles and thus permanently close the rupture opening. The process of recovery is natural, so you'll have no use for a truss—you can throw it away forever! Old and young have testified under oath that the Plapao-Pads cured their rupture—many of them long-standing, aggravated cases—without delay from work. Patent allowed in U. S. and foreign countries. Awarded Gold Medal at Rome and Grand Prix at Paris.

Send No Money—For a sufficient quantity of the Plapao is sent without charge to enable you to give it a thorough test; you pay nothing for this trial now or ever. Write for it and full information today. Address: Plapao Laboratories, Block 1427 St. Louis, Mo.

Save Your Feet

Stop those aggravating aches and pains. Don't exhaust your energy through hurting feet. Wear our

No Metal Heefner Arch Support
(Fully Patented)

Write for free folder and testimonials from doctors and users.
Heefner Arch Support Co., 552 W. E. Taylor Bldg., Louisville, Ky.



BOW LEGS and KNOCK-KNEES UNSIGHTLY

Send for booklet showing photos of men with and without the **Perfect Leg Forms.** Leg braces for children from 2 to 7 years of age. Corrects bow legs or knock-knees.

PERFECT SALES CO.

140 N. Mayfield Ave., Dept. S, Chicago, Ill.

STOPS FALLING HAIR

ASK YOUR BARBER OR DRUGGIST

Millions of men, women and children have found the secret of hair-health in "**Lucky Tiger**"—the world's greatest remedy for falling hair, dandruff and all scalp disorders. A single application stops that miserable itching. Always sold under a positive Money-Back Guarantee.



LUCKY TIGER

Earn \$50 to \$200 a Week in RADIO

You can! Hundreds of ambitious men are already earning thousands of dollars in this wonderful new industry—you, too, can get your share. Mail coupon below for Free Book which describes fully the amazing money making opportunities in Radio and tells how YOU can earn from \$5,000 to over \$10,000 a year.

THE astonishing growth of Radio has created thousands of big money opportunities. Millions of dollars were spent during the past year on Radio, and thousands of young men are needed right now to meet the ever increasing demand of work.

Men are needed to build, sell and install Radio sets—to design, test, repair—as Radio engineers and executives—as operators at land stations and on ships traveling the world over—as operators at the hundreds of broadcasting stations, and these are just a few of the wonderful opportunities.

Easy to Learn Radio at Home in Spare Time

No matter if you know *nothing* about Radio now, you can quickly become a Radio expert, by our marvelous new method of practical instruction—instruction which includes all the material for building the latest up-to-date Radio apparatus.

Scores of young men who have taken our course are already earning from \$75 to \$200 a week. Merle Wetzel of Chicago Heights, Ill., advanced from lineman to Radio Engineer, increasing his salary 100% *even while taking our course!* Emmett Welch, right after finishing his training, started earning \$300 a month and expenses. Another graduate is now an operator of a broadcasting station, PWX of Havana, Cuba, and earns \$250 a month. Still another graduate, only 16 years, is averaging \$70 a week in a Radio store.

PAY INCREASES OVER \$100 A MONTH



I am averaging anywhere from \$75 to \$150 a month more than I was making before enrolling with you. I would not consider \$10,000 too much for the course.

(Signed) A. N. LONG,
Greensburg, Pa.

DOUBLES SALARY

I can very easily make double the amount of money now than before I enrolled with you. Your course has benefited me approximately \$3,000 over and above what I would have earned had I not taken it.



T. WINDER,
Grand Junction, Colo.

Wonderful Opportunities

Hardly a week goes by without our receiving urgent calls for our graduates. "We need the services of a competent Radio Engineer"—"We want men with executive ability in addition to Radio knowledge to become our local managers"—"We require the services of several resident demonstrators"—these are just a few small indications of the great variety of opportunities open to our graduates.

Take advantage of our practical training and the unusual conditions in Radio to step into a big paying position in this wonderful new field. Radio offers you more money than you probably ever dreamed possible—fascinating easy work—a chance to travel and see the world if you care to or to take any one of the many Radio positions all around you at home. And Radio offers you a glorious future!



The National Radio Institute is America's Pioneer Radio Home Study School—established in 1914. Our course is the absolutely complete one now being offered which qualifies for a government first class commercial license. It gets you the bigger paying jobs in Radio.

Send for FREE BOOK

Learn more about this tremendous new field and its remarkable opportunities. Learn how you can quickly become a Radio expert and make big money in Radio.

We have just prepared a new 32-page booklet which gives a thorough outline of the field of Radio—and describes our amazing practical training in detail. This Free Book, "Rich Rewards in Radio," will be sent to you without the slightest obligation. Mail coupon for it *now!*

For a short time we are offering a reduced rate to those who enroll at once. Act promptly and save money. National Radio Institute, Dept. 15FB, Washington, D. C.



NATIONAL RADIO INSTITUTE Dept. 15 FB Washington, D. C.

Please send me without the slightest obligation your Free Book, "Rich Rewards in Radio," and full details of your special Free Employment Service. Please write plainly.

Name.....Age.....

Address.....

City.....State.....



"Here's an Extra \$50!"

"I'm making *real* money now! Yes, I've been keeping it a secret until pay day came. I've been promoted with an increase of \$50 a month. And the first extra money is yours. Just a little reward for urging me to study at home. The boss says my spare-time training has made me a valuable man to the firm and there's more money coming soon. We're starting up easy street, Grace, thanks to you and the I. C. S."

To-day, more than ever before, money is what counts. You can't get along on what you have been making. Somehow, you've simply got to increase your earnings.

Fortunately for you there is an unfailing way to do it. Train yourself for bigger work, learn to do some one thing well and employers will be glad to pay you real money.

You can get the training that will prepare you for the position you want in the work you like best, whatever it may be. You can get it at home, in spare time, through the International Correspondence Schools.

It is the business of the I. C. S. to prepare men for better positions at better pay. They have been doing it for 33 years. They have helped thousands of other men and women. They are ready and anxious to help you.

INTERNATIONAL CORRESPONDENCE SCHOOLS Box 5503-E, Scranton, Penna.

Without cost or obligation, please tell me how I can qualify for the position or in the subject before which I have marked an X:

BUSINESS TRAINING COURSES

- | | |
|--|---|
| <input type="checkbox"/> Business Management | <input type="checkbox"/> Salesmanship |
| <input type="checkbox"/> Industrial Management | <input type="checkbox"/> Advertising |
| <input type="checkbox"/> Personnel Organization | <input type="checkbox"/> Better Letters |
| <input type="checkbox"/> Traffic Management | <input type="checkbox"/> Show Card Lettering |
| <input type="checkbox"/> Business Law | <input type="checkbox"/> Stenography and Typing |
| <input type="checkbox"/> Banking and Banking Law | <input type="checkbox"/> Business English |
| <input type="checkbox"/> Accountancy (Including C. P. A.) | <input type="checkbox"/> Civil Service |
| <input type="checkbox"/> Nicholson Cost Accounting | <input type="checkbox"/> Railway Mail Clerk |
| <input type="checkbox"/> Bookkeeping | <input type="checkbox"/> Common School Subjects |
| <input type="checkbox"/> Private Secretary | <input type="checkbox"/> High School Subjects |
| <input type="checkbox"/> Spanish <input type="checkbox"/> French | <input type="checkbox"/> Illustrating <input type="checkbox"/> Cartooning |

TECHNICAL AND INDUSTRIAL COURSES

- | | |
|---|--|
| <input type="checkbox"/> Electrical Engineering | <input type="checkbox"/> Architect |
| <input type="checkbox"/> Electric Lighting | <input type="checkbox"/> Architects' Blue Prints |
| <input type="checkbox"/> Mechanical Engineer | <input type="checkbox"/> Contractor and Builder |
| <input type="checkbox"/> Mechanical Draftsman | <input type="checkbox"/> Architectural Draftsman |
| <input type="checkbox"/> Machine Shop Practice | <input type="checkbox"/> Concrete Builder |
| <input type="checkbox"/> Railroad Positions | <input type="checkbox"/> Structural Engineer |
| <input type="checkbox"/> Gas Engine Operating | <input type="checkbox"/> Chemistry <input type="checkbox"/> Pharmacy |
| <input type="checkbox"/> Civil Engineer | <input type="checkbox"/> Automobile Work |
| <input type="checkbox"/> Surveying and Mapping | <input type="checkbox"/> Airplane Engines |
| <input type="checkbox"/> Metallurgy | <input type="checkbox"/> Navigation |
| <input type="checkbox"/> Steam Engineering | <input type="checkbox"/> Agriculture and Poultry |
| <input type="checkbox"/> Radio | <input type="checkbox"/> Mathematics |

Name.....

Street.....

Address..... 3-0-24

City..... State.....

Occupation.....

Persons residing in Canada should send this coupon to the International Correspondence Schools Canadian, Limited, Montreal, Canada.

MUSIC LESSONS FREE

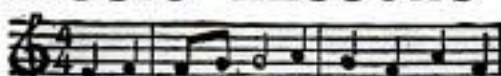

IN YOUR
OWN
HOME

You can read Music like this quickly
Piano, Organ, Violin, Mandolin, Guitar, Banjo, etc.
Beginners or advanced players. One lesson weekly. Illustrations make everything plain. Only expense about 2c per day to cover cost of postage and music used. Write for FREE booklet which explains everything in full.

AMERICAN SCHOOL OF MUSIC, 50 Lakeside Building, Chicago



U. S. Coast Guard Needs More Officers

Pay ranges \$1,700 up to \$7,500 yearly

The U. S. Government pays \$780 yearly to cadets at the U. S. Coast Guard Academy while training to become an officer. This Institute prepares you thoroughly to take the examination during your spare time at home. Age limits are 18 to 24. Write for illustrated booklet to Dept. D-15.

COAST GUARD INSTITUTE, Pa. Ave. Sta., P. O. Box 281, WASHINGTON, D. C.

\$3,000 to \$5,000 a Year

If you want to make at least \$3000 a year, send for our new, big catalogue FREE. Qualify for a big pay job in the automobile business after only 10 weeks' training in New York. Previous experience not necessary. You learn by doing actual work on passenger cars, truck and tractors. Thousands of successful graduates.

FREE BOOK—Write today for large, illustrated catalogue

STEWART AUTOMOBILE SCHOOL
225 West 57th Street Dept. 1754 NEW YORK CITY

LEARN VIOLIN NEW EASY WAY!



VIOLIN FURNISHED! Marvellous new Master Method teaches you by mail in 1/2 time and at 1/50th cost. No numbers or trick music. Play a real piece by note in fifth lesson. Easy as A B C. Diploma awarded. Beginners or advanced players. Money back guarantee. Send today for free booklet. Will be sent in plain wrapper. Write plainly. MASTER VIOLIN SCHOOL, 51 E. 42nd St., Conv. 704, New York, N. Y.



Hotels Start You With Salaries up to \$3,500 a Year —with your living

HOTELS, restaurants, clubs, apartments, everywhere need trained men and women—salaries to start up to \$3,500 a year with your living. Over 70,000 high-class positions paying up to \$10,000 a year are open every year in the hotels of the United States. Today this is the 1st INDUSTRY IN AMERICA—with over 8992,394,968 in new hotels being built in 1924—exceeding by \$200,000,000 the next largest industry. These new hotels, restaurants, etc., will need over 60,000 trained men and women.

You can have one of these high-class big-pay positions, with luxurious meals and apartment and fascinating work. No previous experience necessary. The Lewis Schools guarantee to give you the valuable knowledge that it has taken some of the most successful hotel men years to obtain—men who are now making 25,000 to 50,000 a year. We train you by mail in your spare time at home with the Lewis Simplified Study Plan, and we put you in touch with big opportunities. Our students employed, our methods endorsed by leading hotel men everywhere. Send today for Free Book, "YOUR BIG OPPORTUNITY," showing how we can train you for one of these splendid positions in 20 weeks or less, and explaining our Money-Back Guarantee.

LEWIS HOTEL TRAINING SCHOOLS
Room P-388 Washington, D. C.

***** FREE BOOK COUPON *****
LEWIS HOTEL TRAINING SCHOOLS, Room P-388, WASHINGTON, D. C.
Send me without obligation the Free Book, "YOUR BIG OPPORTUNITY."

Name.....

Address.....

City..... State.....



Every Automobile Man Needs These Auto Books *Yes—That Means You—Mr.*

Garage Owner—Service Station Manager—Repairman
Trouble Shooter — Car Owner — Auto Salesman

2200 pages of money-making automobile ideas. Shop kinks and up-to-the-minute repair methods are all here. Everything made clear and practical by the use of 2400 pictures, diagrams, and charts. From four-cylinder engines to straight-line eights — EVERYTHING ABOUT EVERY AUTOMOBILE IS COVERED—but that is not all—

Four Big New Features

Equipment data and specifications Here at a glance will be found

(A separate sheet for each car)

all of the data covering the car's equipment. Whether you are estimating on a repair job or ordering new parts or doing the actual repair work, the specification sheet will be worth real dollars to you.

Generator output in volts and amperes—when relay should cut-in—distance relay gaps—model number for all units for ordering parts—firing order—ignition timing—breaker contacts—valve tappet distance—size of clutch and brakes—lamps—etc.

Wiring Diagrams A complete diagram of the electrical systems on all standard cars (A separate sheet for each car) shows exact location of generator—starter—distributor—ignition coil—resistance units—ammeter—starting switch—horn—circuit breaker—relay—signals and lights—fuses—battery terminals—etc. Every connection is clearly

indicated. More than one man has built up a paying business because he could not be "stumped" on any ignition or starting job.

Trouble Shooting "What is the matter?" It may be with the ignition—battery—fuel—lubrication—or what not. 58 causes of trouble, how to detect it, and what to do to cure it. 334 definite cures are thoroughly explained with the necessary diagrams and charts. Why the trouble occurred and how to cure it make this service feature worth hundreds of dollars to the trouble shooter or repairman.

Questions and Answers Whether you're stuck on the road or bossing shop repair jobs you have wished for a quick solution of this and that trouble—a solution that is ready-made and does not compel you to read three or four pages of explanation. In the questions and answers section every conceivable automobile trouble has been stated and the right way to correct it given.

Every automobile trouble and its cure indexed for instant reference

FREE—7 days' trial—FREE

Whether you are a garage owner, a service station manager, trouble shooter, repairman, car owner, or auto salesman, I think you will agree that the income of the average man in the automobile game is in direct proportion to his ability to make good—in short, to his knowledge of automobile principles, operations, and repairs. We claim that this work with its four new features will be worth hundreds of dollars to any man thus employed and we want the chance of proving it to you. Let us send you the complete five-volume set of Automobile Engineering for one week's free use—test the books out on any one or on a dozen jobs that have been troubling you—no matter whether on repairs, wiring systems, trouble shooting, or what not. If you do not find just the help that you need in this set, send it back to us at our expense.

Send us the coupon tonight!

American Technical Society
CHICAGO, U. S. A.

American Technical Society
Chicago, U. S. A.

Please send me a set of Automobile Engineering, for seven days' FREE EXAMINATION, shipping charges collect. I will examine these books thoroughly and, if satisfied, will send \$2.80 within seven days and \$3 a month until I have paid the special price of \$19.80. If I decide not to keep the books, I will return them within one week at your expense.

Name.....

Address.....

Reference.....

Please fill out all lines; give local merchant, banker, or employer as reference. A-419

Western Canada is Calling You



Come where rich land is low priced—where virgin soil produces big crops—where you can double or triple your acreage with the same investment, with 35 years to pay.

**Free Use of Land for One Year
Stop Paying the Penalty
of Farming
High-Priced Land**

Canada needs farmers. In return, she offers independence, prosperity and wealth. Canada wants you for a partner—to bring your skill as a farmer to her rich, low-priced soil.

Fertile land sells for an average of twenty dollars an acre. It is near the railroad, stores, towns, churches and schools.
35 Years to Pay—First Year, Free Use of Land

Under our liberal plan, you pay down only 7% of the total purchase price—then use the land a year without even an interest charge, after which the balance of the principal and interest will be amortized on an easy payment plan of 34 equal payments. The second payment does not fall due until two years after purchase. On 160 acres costing \$3,000, you pay down but \$210. Your annual payments will be but \$195.30.

Interest Receipts Are Worthless

Try to buy a mower with your interest receipts. They are worthless! Put your profits back in your pocket—we don't want them. We want farmers—business men farmers—to build the country and fortunes for themselves.

No Taxes on Improvements

Taxes are low. No tax on livestock, buildings, improvements, implements or personal effects. Good markets nearby. Modern schools, churches, roads and amusements make farm life worth while in Western Canada.

Irrigated Farm Lands Also

In sunny Southern Alberta—a district especially adapted to mixed farming—the Company has constructed a vast irrigation system with an unfailing water supply. This insures a crop every year—makes you independent of weather conditions—produces great quantities of coarse grains, pasture, alfalfa, etc. Here the stockman prospers in an industry ultimately more profitable than wheat farming. These lands are for sale on the same easy terms.

We Won't Sell Until You Investigate

You must investigate before you buy. Special inspection trips at reduced fares. We arrange details. Write for information. How about your boys? Where will they find farms if present prices increase further? This is your chance. Don't turn this page until you clip and mail the coupon. Act now.

Send coupon TODAY for FREE booklet

M. F. THORNTON, Supt. of Colonization
Dept. 904 Canadian Pacific Railway Depot
Winnipeg, Manitoba, Canada

M. E. THORNTON, Supt. of Colonization
Dept. 904, Canadian Pacific Ry. Depot
Winnipeg, Manitoba, Canada

I am interested in learning more about:
 Prairie Provinces of Canada.

Irrigation Farming in Sunny Alberta.

Business and Industrial Opportunities in Western Canada.

My Name.....

Address.....

Town.....

State.....



What Shall I Be?

**Can You Answer
This Question and
Be Fair to Yourself?**

ARE you as successful as you could be—if you had some other occupation?

Many a man fights gamely all his life for success—and fails because he has the wrong row to hoe.

Don't make this mistake! If you have been making it—quit! Find out NOW what you can do best and tackle that—before it is too late.

Our expert vocational counselors, employing latest scientific method which eliminates all guess work, will show you what occupation you are best fitted for, and guide you step by step until you succeed.

Write for free information Today

BUREAU OF VOCATIONAL RESEARCH
Dept. 106 530 Broadway New York City

LEARN TO GET DOLLARS OUT OF WATCHES.
WATCH-REPAIRING, ENGRAVING, JEWELRY REPAIRING.
WRITE NOW.
ENICAR TRADE SCHOOL
530 W MONUMENT SQUARE, RACINE, WIS.

Seal Rupture With a Quarter

Now you can throw away forever steel bands, chafing leg straps and other heavy makeshift devices. For a well known American scientist has found a new easy way to support ruptures caused by means of a wonderful little invention weighing less than 1-25 of an ounce. Not only do you do away with the objectionable pressure and tight strapping, but you eliminate the "coming down" of rupture—when running, straining, exercising, sneezing, etc.—which too frequently leads to strangulation. Its great success has been the success of this wonderful device that it is being offered to ruptured people on an absolute guarantee of instant satisfaction or no cost. Simply drop a postcard or letter requesting free literature to:
NEW SCIENCE INSTITUTE 281 Clay Street Steubenville, Ohio



NO MORE BALD HEADS



WHEN our VACUUM CAP is used a few minutes daily. We accept no pay until you have tried the Cap 60 days and are satisfied. The Vacuum Cap is an appliance that draws the blood to the Hair Roots and starts a new healthy crop of hair. It stops Dandruff, stops the hair from falling out.

Bought by Doctors and men who know that it is the only reasonable HAIR GROWER known to science. No Drugs Used. Write for application blank, testimonials and booklet on "HAIR," sent sealed in plain envelope, FREE.

THE MODERN VACUUM CAP CO.
G-559 BARCLAY, DENVER, COLO.

YOU CAN PLAY THIS

Professional Style

HAWAIIAN GUITAR

JUST LIKE THE HAWAIIANS!

FREE!

THIS \$15.00
GENUINE
HAWAIIAN
GUITAR

BECAUSE OUR NATIVE HAWAIIAN INSTRUCTORS WILL SHOW YOU HOW!

Be the Most Popular Member of your Set. Play "What'll I Do", "So This Is Love", "Memory Lane", "Minding My Business", "Fair Lady", "Lazy", "Linger Awhile". All the late song and dance hits. You can play First Selection in Half an Hour and Harmonious Chords at ONCE. Entertain your friends. Play for money. Don't be a wallflower. Be the Life of the Party.

FAMOUS HAWAIIANS TEACH YOU TO MASTER QUICKLY THEIR SECRETS OF THIS FASCINATING MUSIC

The instructions you receive from such world famous experts as Lawrence Kalaiki, Walter Kolesmoku, Frank Ferrer, Carl Seyville and others are invaluable. NO OTHER Conservatory can even begin to give you the expert teaching and knowledge you gain through us. And remember, while it is conceded that the Hawaiian Guitar produces the sweetest music, yet its mastery by you will be simple and quick. We guarantee it.

ONLY 4 EASY MOTIONS—to learn to be able to play any music, popular, dance, classical, native Hawaiian Airs or old time melodies and hymns. Just think of it! You need never have read a musical note in your life. For that matter, even though you haven't the slightest knowledge of any musical instrument, we guarantee to teach you to play just like the native Hawaiians.



NEW INVENTION MAKES IT EASY

Here is your chance to learn to play the most fascinating of all instruments, the Hawaiian Guitar. JUST AS THE HAWAIIANS DO, and in an amazingly short time. Our method is so simple, plain and easy that you begin a piece your first lesson. In half an hour you can play it! Thousands of successful students prove this to be true. No matter how little your knowledge of music may be, you can positively learn to play by our plain, easy picture method.

COMPLETE CONSERVATORY COURSE

You get 52 complete lessons. An entire conservatory course. Nothing is omitted. Success is assured. It is the best course of Hawaiian guitar lessons in the entire world. Real Hawaiians instruct you. This is the only Conservatory teaching Hawaiian Guitar exactly as played by the Hawaiians. It is your good fortune as well as ours, that these Native Masters of Hawaiian Guitar come to this Conservatory to teach. That is why we are the largest and the best known Conservatory of the kind. Your success is assured when you enroll.

ANYONE CAN PLAY

We guarantee it. 40,000 pupils prove it. You don't have to know music. Our picture method makes it easy. Don't be afraid to try it.

WE FURNISH YOU WITH EVERYTHING

When you enroll as a student in this conservatory, you receive FREE a handsome, sweet toned, Genuine Hawaiian Guitar—valued at \$15.00—52 especially arranged lessons, as well as all the necessary Picks, Steel Playing Bar, etc. There is NOTHING extra to buy; everything is furnished.



EXTRA! As a special offer to readers of this magazine, we supply 22 pieces of music as a part of the course of lessons. Study the pictures of the good times you can have at parties, etc. Get in on the fun. Don't pass up this chance. Send the coupon at once for information and proof.

FIRST HAWAIIAN CONSERVATORY OF MUSIC
Dept. 48, 233 Broadway (Woolworth Bldg.) New York, N. Y.

SPECIAL COURSES UNDER FAMOUS TEACHERS, TENOR BANJO, VIOLIN, BANJO-UKULELE AND UKULELE



THIS COUPON MAKES IT EASY



WORTH \$15.00

Yes, that is the price charged in the music stores for these beautiful Hawaiian Guitars. We can afford to give them away free of charge to every pupil because we manufacture them in huge quantities in our own factory, which is the largest stringed instrument factory in the world.

SWEET TONED

You will get the same haunting, soothing, plaintive fascinating tunes that the real native Hawaiians get on these same instruments.

Plays any kind of music. 40,000 satisfied pupils prove all our claims are true.

Yours Free! We mean it. There are no strings tied to this generous offer. You get it absolutely free as soon as you enroll for our course of 52 easy lessons, taught by real Hawaiians. You can't possibly lose, so mail the coupon at once for full information.

Be Popular You'll never be lonesome after you learn to play on this beautiful Hawaiian Guitar. You can be the life of the party. Don't be a wallflower. Use the coupon for complete information. Mail it right away.



Learn in Your Spare Time

TEAR OUT AND MAIL

FIRST HAWAIIAN CONSERVATORY OF MUSIC, Inc.
Dept. 48, 233 B'way, Woolworth Bldg., New York, N. Y.
Gentlemen: Of course I want to get this handsome \$15.00 Hawaiian Guitar free of charge, because I am interested in learning to play it. Please mail full information about your 52 easy lessons under real Hawaiians, and proof that I can play a piece after the first lesson. I am not obliged to enroll unless I want to.

Name.....
Local Address.....
City & State.....

SWEENEY Mechanical

YOU want to do the work you like and make money. For seventeen years I have proved to thousands of young men just like you that the automobile business is the safe, sure way to success, independence, contentment for men mechanically inclined. The big money for you is the automobile business. You know that repair men, mechanics, chauffeurs, welders, garage and tire men are never worried about strikes or lockouts. They are never worried about their job. They can travel anywhere and get a job. You know there are over 17 million cars and tractors running. Somebody has got to repair these cars and keep them running. The demand for trained men is immense. The trained man is king. He is boss. Go where you like in this wide country, there is a real job looking for you. Now suppose you are ambitious. You want a business of your own. The quickest, easiest way to your own business is to start a garage, repair shop, tire shop, welding shop. With Sweeney training you can step out of the ranks of skilled mechanics any time and earn and bank big money. Read Hoffman's letter. How would \$33,000 look to you? Read Klassen's letter. Look at the picture of his garage. Thousands of Sweeney men are living proof that the quick way to success and more money is open to the Sweeney trained man.



E. J. Sweeney,
Kansas City, Mo.

Dear Sir:

When I came to your school I paid my expenses out of my own pocket. I wanted to get my money's worth, and so I kept busy. Have been busy ever since and I found out it pays. I have not toiled in vain for the last eight years, for that's the time I have been in the garage business of my own. I feel satisfied that I could not have done any better anywhere else. I believe everybody that has an opportunity should not delay in getting a good education in the automobile line.

Yours truly,
D. J. KLASSEN.

HERE'S WHAT YOU MUST DO

Whether you want a steady job or a chance to run your own business you've first got to have the right training, and that is the improved SWEENEY SYSTEM, which you can get only at Kansas City, Mo. Over 60,000 Sweeney graduates tell you this is the ONLY WAY to learn. You can't learn working piecemeal around a garage. You can't learn out of books. You've got to come here and work with your hands on over \$200,000 worth of real equipment. Here you learn every detail and angle of the business, step by step under the personal teaching of skilled instructors. We teach you right and in the shortest time and at the least cost. And when you leave here you know your job.

Come Right Now

Every day delay is costing you time and money. You don't need previous experience. You don't need book knowledge or education. I teach with tools, not books. I have even taught deaf and dumb men. Get into overalls and go to work in these healthful, inspiring surroundings. In a marvellous building covering over 12 acres of floor space. Protected by my personal interest in your health, morals, success. What thousands have done you can do. The idea is to start now. The first step is to write me today for my big free catalog and pictures of the school. BEST OF ALL, by quick action you can get my HALF PRICE OFFER. Save money and make money. Come to the BIG SCHOOL, the Million Dollar Sweeney School. Write me today.

Jobs Open

Demonstrator	\$150 to \$500
Garage	\$150 to \$400
Tractor	\$10 a day
Electrician	\$225
Mechanics	\$6 to \$10 a day
Chauffeurs	\$90 to \$150
Truck Drivers	\$125
Tire	\$100 to \$200
Welder	\$140 to \$200
Battery	\$150 to \$200

LEARN
Sweeney
AUTOMOTIVE &
431 SWEENEY BLDG.

There's Only One Sweeney School and That's at Kansas City

Wants Men ly Inclined

How Would You Like \$33,000?

Now I Cut
Tuition $1/2$
Cost 2

My FREE Book
Tells You—

- How to run a garage anywhere.
- How to learn several good trades.
- How to travel and see the world.
- How to fit yourself for prosperity.
- How to get a good mechanical job.
- How to learn to be a chauffeur or truck driver.
- How to learn to repair any make of car.
- How to weld.
- How to learn batteries and auto tires.
- Shows you hundreds of actual photographs of men at work in my big shops. Shows how 60,000 men got their start.
- Shows how easy it is to learn; how much fun you have during recreation hours. Swimming pool, entertainment, band and orchestra, radio broadcasting.
- Answers every question.

Write Me Today The first step is to get my free 64-page book. I will gladly send it to you. And I will make you an amazing offer. I will make it easy for any man to learn the auto business. I will send you this valuable book free—no cost—no obligation. No colored students accepted. EMORY J. SWEENEY, Pres.



Shannon City, Ia.

Dear E. J.:

Since going to your school I have done fine. Started with nothing, and am now worth about \$33,000. I think that is fine, don't you, for a small town of 300 population. I have never been stuck on a job yet, thanks to the Sweeney Auto School. I was a student of the Sweeney School in 1913. W. A. Hoffman.

**Mail the
Coupon
TODAY!**

A TRADE
new
ELECTRICAL SCHOOL
KANSAS CITY, MO.

EMORY J. SWEENEY, President

431 Sweeney Bldg., KANSAS CITY, MO.

Send me, free, 64-page catalog, and how I can get my tuition at Half Price.

Name

P.O.

State..... Age.....

There's Only One Sweeney School and That's at Kansas City



Tobacco Is Hurting You

Look at the facts square in the face, Mr. Tobacco User. You may think tobacco is not hurting you.

That is because you haven't as yet, perhaps, felt the effects of the nicotine poison in YOUR system. For you know that nicotine, as absorbed into the system through smoking and chewing tobacco, is a slow working poison. Slow, yes—but sure.

Tobacco is lowering your efficiency. It slows a man down. Makes it harder for you to concentrate your mind on your work. You haven't near the amount of "pep" and energy you would have if you stopped using it. There's many a man twice as old as you in years who's twice as young in energy, simply because he lets tobacco alone.

Some day you will realize to what an alarming extent tobacco has undermined your system.

When your hands begin to tremble—
and your appetite begins to fail—
and your heart seems to "skip a beat" now and then—
and slight exertion makes you short of breath—
then you have a right to suspect that
TOBACCO is getting the upper hand.

Any well-informed doctor will tell you that these are only a few of many symptoms of tobacco poisoning.

And YOU know that the use of tobacco in any form is an expensive, utterly useless habit. You know you ought to quit.

Tobacco Habit Banished Let Us Help You

It doesn't make a particle of difference whether you've been a user of tobacco for a single month or 50 years, or how much you use, or in what form you use it—whether you smoke cigars, cigarettes, pipe, chew plug or fine cut or use snuff—**Tobacco Redeemer** will positively remove all craving for tobacco in any form in a very few days. Not the slightest shock to the nervous system. Your tobacco craving will usually begin to decrease after the very first dose—there's no long waiting for results.

Tobacco Redeemer contains no habit-forming drugs of any kind and is marvelously quick, scientific and thoroughly reliable.

It is in no sense a substitute for tobacco. After finishing the treatment you have absolutely no desire to use tobacco again or to continue the use of the remedy. It helps to quiet the nerves and make you feel better in every way.

Results Guaranteed A single trial will convince you. Our legal-binding, money-back guarantee goes with each full treatment. We will refund every cent you pay for the treatment if after taking it according to the easy-to-follow directions, it should fail to banish the tobacco habit completely.

SEND Coupon for Free Proof Let us send you our free booklet on the deadly effects of tobacco, together with testimonial letters from men all over the country telling how they have been absolutely freed from the tobacco habit by this simple home treatment. You could not ask for stronger proof that **Tobacco Redeemer** will free you from the habit than the evidence we will gladly send on request. Just mail the coupon—or a postal will do.

NEWELL PHARMACAL CO.

Dept. 300

St. Louis, Mo.



Free Book Coupon

NEWELL PHARMACAL CO.

Dept. 300

St. Louis, Mo.

Please send, without obligating me in any way, your free booklet regarding the tobacco habit and proof that **Tobacco Redeemer** will positively free me from the tobacco habit or my money will be refunded.

Name

Street and No.

Town..... State.....

How "Dad" Records Made His Fortune

The amazing story of how a man, 65 years old, was transformed from a poor, day laborer into a prosperous Real Estate Specialist in less than fifteen months

By WAYNE OVERTON

ALVA C. RECORDS, age 65, of Council Bluffs, Iowa, looked up from the magazine he was reading, with a new light in his eye. Addressing his good wife, he said: "Ma, I'm sick of hard work and poor pay. I'm going to be a real estate specialist and put myself on Easy Street."

When Mr. Records—known to his intimates as Dad—first read about this new system for becoming a real estate specialist, he knew absolutely nothing about the real estate business and was earning exactly \$3.36 a day, which was big pay for him, as he had worked most of his life for \$1.25 a day, and on that small income had raised a family of seven children.

Now, in less than fifteen months after his resolution to become a real estate expert, he has moved into a new home of his own, furnished it with new furniture; he has bought two farms besides his own place; Mrs. Records has a new \$1200 Overland Coupé, and Dad has a Ford that he uses in his business.

And he says he is just getting started!

Are you—like Dad Records—sick and tired of *hard work and poor pay*? Do you want to get into one of the biggest and best businesses in the world—and make more money than you ever made before?

If you do, the coupon at the bottom of this page will bring you *positive proof* of what this system can do for you—how you—too—can become a real estate specialist—right at home—in your spare time—*without capital or experience*—and perhaps make more money than you ever made before in your whole life.

A Successful System

With a brand-new idea—and less than \$5 capital—the originator of this successful system for handling real estate, made



ALVA C. RECORDS, Age 65

over \$100,000 in less than five years. He started in his spare time *without training or experience*, discarded the moss-covered methods of the past and developed a system of handling real estate that is *amazingly simple and remarkably successful*. Write for full information to-day. Let us show you the big profit possibilities in this new kind of real estate business for you.

The Best Business

Here are a few of its many advantages: (1) It is as permanent as the earth itself. (2) It is more healthful than any indoor occupation. (3) It does not require years of study like medicine, pharmacy, dentistry, architecture, law, etc. (4) The business is practically unlimited. There are eight or ten million properties on the market at all times. (5) Beginners receive the same rate of compensation as old-timers. (6) It offers big money to the ambitious. Deals paying \$1000 to \$5000 in commissions are recorded daily in leading newspapers. (7) You can get started at once in your spare time—with little or no capital.

What Others Say

Read the following brief extracts from a few of the many letters received from followers of this successful, scientific system.

"Sold a property yesterday by your plan for \$2500. My commission \$250."—*J. C. K., Curtis Bay, Md.* "I have now a new car, two new typewriters, a stenographer and a dandy office, and money in the bank, all through my own efforts and without any capital to start with."—*P. M., Westport, Conn.* "My success with your system is great, and I have succeeded in my life long dream of establishing a real estate business that is highly promising."—*Mrs. M. L. P., Lead, S. D.*

We haven't room for any more such letters here, but if you want to read more, sign and mail the coupon.

Full Information Free

Send the coupon at once. Let us tell you all about this *quick, easy* system for becoming a real estate specialist—what others are doing with it—and what you—*yourself*—can do. Don't wait. We guarantee you will find this the most interesting, practical, big-money-making opportunity that ever came your way. American Business Builders, Inc., Dept. A-444, 1133 Broadway, New York.

American Business Builders, Inc.
Dept. A-444, 1133 Broadway, N. Y.

Send me—*without cost or obligation*—full particulars about your new System For Becoming a Real Estate Specialist—the history of the man who originated the system and made \$100,000 in five years—the stories of how others are succeeding.

Name

Address

P. M. 4-25



Choose as Your Profession Electrical Engineering

Electricity offers a brilliant future to the young man who is about to choose his career. Never before has there been such wonderful opportunity in this great field. Big paying positions in electrical work the world over are open to trained men—men who possess specialized, practical knowledge. Come to the School of Engineering of Milwaukee—where the Electrical equipment is the best obtainable. Here you are trained in both theory and practice by a faculty of experts. You learn in large, finely equipped laboratories. If you have 14 high school credits or equivalent, you can become an Electrical Engineer with a Bachelor of Science degree in three years. If you lack these credits they can be made up in our Institute of Electrotechnics in a short, intensive course.

A Complete, Practical, Electrical Education

Learn by the thorough approved scientific methods which our twenty years of specializing enable us to give you. In addition to Electrical Engineering, the following complete courses are given: A. C. and D. C. Armature Winding—Wiring and Testing—Practical Electricity—Drafting—Electrotechnics—Commercial Electrical Engineering—Automotive Electrical Engineering and Automotive Electricity.

Earn While You Learn

By our special system you may earn part of your way while learning. Our Employment Department will secure you a position to which you may devote a part of each day, spending the remainder at the school. This plan both solves the students' financial problems and provides splendid experience at the same time. Low tuition fee. Board and room reasonable. Daily Broadcasting WSOE. School Orchestra. Fraternities.

Enter
Any Time

Write for FREE Catalog

Write today for our free, illustrated catalog. Read about this wonderful institution and the great opportunities that lie before you. Find out about our specialized method of training and the details of our Students' Loan Fund and "Earn While You Learn" plan.

SCHOOL of ENGINEERING of Milwaukee

Founded 1905

The Exceptional School That Deserves Consideration.

Dept. P. M. 425, 415 Marshall St., Milwaukee, Wis.

SCHOOL OF ENGINEERING OF MILWAUKEE
P. M. 425, 415-17 Marshall Street, Milwaukee, Wis.

Without obligating me in any way, please mail free 72-page illustrated book, "Electricity and the One Best Way to Learn It," and particulars regarding the course I have marked with an X.

- Electrical Engineering.
- Electrotechnics.
- Commercial Electrical Engineering.
- Automotive Electricity.
- Auto Electrical Service Engineering.
- Radio Sales and Service.
- Armature Winding.
- Light, Motor Wiring and Testing.
- Practical Electricity.
- Home Laboratory Service.
- I am interested in your "Earn While You Learn" Plan.

Name.....Age.....
Address.....
City.....State.....
Education.....

BIG MONEY!

\$3,000 to \$10,000 a year

Want to make big, easy money? Learn how to install, operate, repair, construct and sell Radios. Write now for facts about the amazing opportunities for Radio experts, and our special offer of a FREE 1000-mile receiving set, and how you can quickly train at home by mail.

Be a Radio Expert

No previous experience necessary. Anyone with ordinary education can now learn Radio quickly under our simplified home-study plan. We need men right now to represent our Association. Be the Radio expert in your neighborhood. Get your share of the big profits. Hundreds about you want Radios and advice how to operate. You can earn enough money right from the start to pay for course. Nothing difficult about it. Low cost and easy terms.



FREE 1,000-MILE Receiving Set

Don't miss this big special offer to supply FREE all parts necessary to construct a high-grade 1000-mile receiving set. You can sell this set alone for practically the entire cost of the course. Send for the facts now. Find out all about this big-pay field. Address

Radio Association of America
4513 Ravenswood Ave., Dept. A-4, Chicago, Ill.

WRITE TODAY for Our 168-PAGE FREE BOOK on Deafness

and learn how Perfect Hearing is now being restored in every condition of deafness or defective hearing. Our "Little Wireless Phones for the Ears" require no medicine, but effectively replace what is lacking or defective in the natural ear drums. They are simple devices, which the wearer easily fits into the ears, where they are invisible. Soft, safe and comfortable.

WILSON EAR DRUM CO., Incorporated
771 Inter-Southern Bldg. LOUISVILLE, KY.

"I would not part with it for \$10,000"

So writes an enthusiastic, grateful customer. In like manner testify over 100,000 people who have worn it.

The Natural Body Brace

Comfortable and Easy to Wear

Overcomes Weakness and Organic Ailments of women and men. Develops erect, graceful figure, brings restful relief, comfort, health and strength.

Not Sold in Stores—

Made to Measure—Makes work easy and walking a pleasure; replaces and supports misplaced internal organs; reduces enlarged abdomen; straightens and strengthens the back; corrects stooping shoulders; develops lungs, chest and bust; relieves backache, curvatures, nervousness, ruptures, constipation.

Get Well—Stay Well Write today for illustrated booklet, measurement blank, etc., and read our very liberal proposition.
HOWARD C. RASH, Pres., Natural Body Brace Co.
223 Rash Building • • SALINA, KANSAS



30
Days
Free
Trial

Big Money in Autos



Which School for You?

Yes, You Can Earn \$2000 to \$8000 a Year In Auto Business—BUT You Must Have Practical Training and Experience To Get These Big-Pay Jobs.

Can you learn how to run a locomotive by reading a book? Then how can you expect to become a skilled auto mechanic or electrician by a similar method.

You must have the practical training and experience that is required of the man who "makes good on the job."

The National gives you this training. Twenty-one successful years have proved that our practical system of training will make you a big-pay auto expert. Our million-dollar investment assures you of the newest, most modern, most complete equipment in America. Thousands of successful graduates now earn two, three, four and five times their former salaries, own profitable garage businesses, or operate money-making service stations.

Now we offer you the same opportunity; and give you this advice. You want to earn more money, you want to own your own business, you know you can succeed in the great money-making auto business—NOW CHOOSE the school that will make your success a certainty.

Make More Money Like These National Graduates

Train at National and you can say what these men say: "I have increased my earnings 100%." "I have built a wonderful garage business and owe it all to National." "I am now Assistant Salesmanager and will make \$4000 this year."

Send at once for our big, illustrated auto book. See for yourself what wonderful training advantages you will get at National. Learn firsthand from facts and figures which prove that in California there are more big-pay jobs and more opportunities to make money in your own business than elsewhere.

The coupon below will offer you your greatest opportunity, will show you the way to sure, certain success. Clip it NOW, and mail it. It costs you nothing to learn the facts.

National Automotive School
Los Angeles, California

Free Auto Book

Mail Coupon



National Automotive School
Dept. 63, 4004 S. Figueroa St.
Los Angeles, Calif.

Please send me, absolutely free, your big, 84-page illustrated Auto Book.

Name.....
Address.....
City..... State.....





BE A RAILWAY TRAFFIC INSPECTOR

WE OBTAIN POSITION

Paying at Least

\$110⁰⁰ PER MONTH

and Expenses, Upon Graduation

OR REFUND YOUR MONEY!

Hundreds of successful graduates know our ability to train them thoroughly for the fascinating profession of Railway Traffic Inspection—know our ability to place them in good, congenial positions—know the opportunities ahead of them in this wonderful work.



A SPLENDID FUTURE

R. H. Kruger expresses his gratitude in this way: "Having completed your course in Traffic Inspection, I find that it is very interesting work, also it is one of the most interesting studies of today. The work is very fascinating, and I would be glad to advise anyone wishing to take up this course, as it is sure wonderful work, with a splendid future. Your Diploma means Prosperity."

EARN UP TO \$250⁰⁰ A MONTH

Preparation, easy to understand, requires about three months, in your spare time. Upon graduation, you start in at \$110.00 a month or more. We obtain a position for you or refund your money. Travel or remain near home. Pleasant, out-of-door work; regular hours; splendid opportunities for advancement thru contact with railway officials.

Our Personal Service Appreciated

Claude C. Fay writes: "I certainly wish to thank you for the interest you have taken in me and the many kind favors you have granted me. I can assure you I appreciate it. I think I am doing very well here."



New Profession—Excellent Future

Investigate now; many more trained men are needed. Cost is moderate; easy terms if desired. Send coupon for free booklet No. D-169 giving full particulars, and terms of our strict MONEY-BACK GUARANTEE.

Standard Business Training Institute
Buffalo, N. Y.



STANDARD BUSINESS TRAINING INST.
BUFFALO, N. Y.

Send me, entirely free, Booklet No. D-169 giving full particulars about course in Railway Traffic Inspection.

Name.....

Street.....

City.....

Our Regular \$15.00 Improved
1925 Uni-Hete Burner Outfit

ONLY \$6

For a limited time we offer to send C. O. D. this burner complete, including flexible fuel and supply tubes, regulating valves and galvanized iron tank, ready to install. Fits any stove or range. Fully guaranteed against all defective workmanship and material for one year. Any part that proves defective, if returned, will be replaced free of charge. The Uni-Hete vaporizes kerosene or distillate, mixes it with air, producing an intensely hot, clean, smokeless, silent burning flame. Heat can be regulated to any degree by fuel controlling valves. Improves your stove 100%. Have been manufacturing oil burning devices for thirty-three years. We make this offer for a limited time only. Order today and save \$9. Specify if for range or heater.



ACORN BRASS MFG. CO. 467 Acorn Building,
CHICAGO, ILL.

Beautiful Complexion in 15 Days



Clear your complexion of pimples, blackheads, whiteheads, red spots, enlarged pores, oily skin and other blemishes. I can give you a complexion soft, rosy, clear, velvety beyond your fondest dream. And I do it in a few days. My method is different. No cosmetics, lotions, salves, soaps, ointments, plasters, bandages, masks, vapor sprays, massage, rollers, or other implements. No diet, no fasting. Nothing to take. Cannot injure the most delicate skin. Send for my Free Booklet. You are not obligated. Send no money. Just get the facts.

DOROTHY RAY, 646 N. Michigan Blvd., Suite 225, Chicago

When do Men start to get young?

When they shave with Barbasol. Saves time, looks better, feels like a million. No brush. No rub-in. You just try it—three times—according to directions. 35c and 65c tubes.

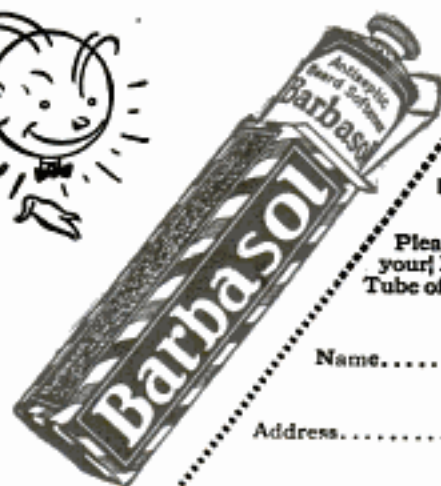

The
Barbasol
Co.
Indianapolis,
Ind.

Please mail me
your Free Trial
Tube of Barbasol.

Name.....

Address.....

P.M. 4-25

For Modern Shaving

Learn Electricity

in Great Shops!

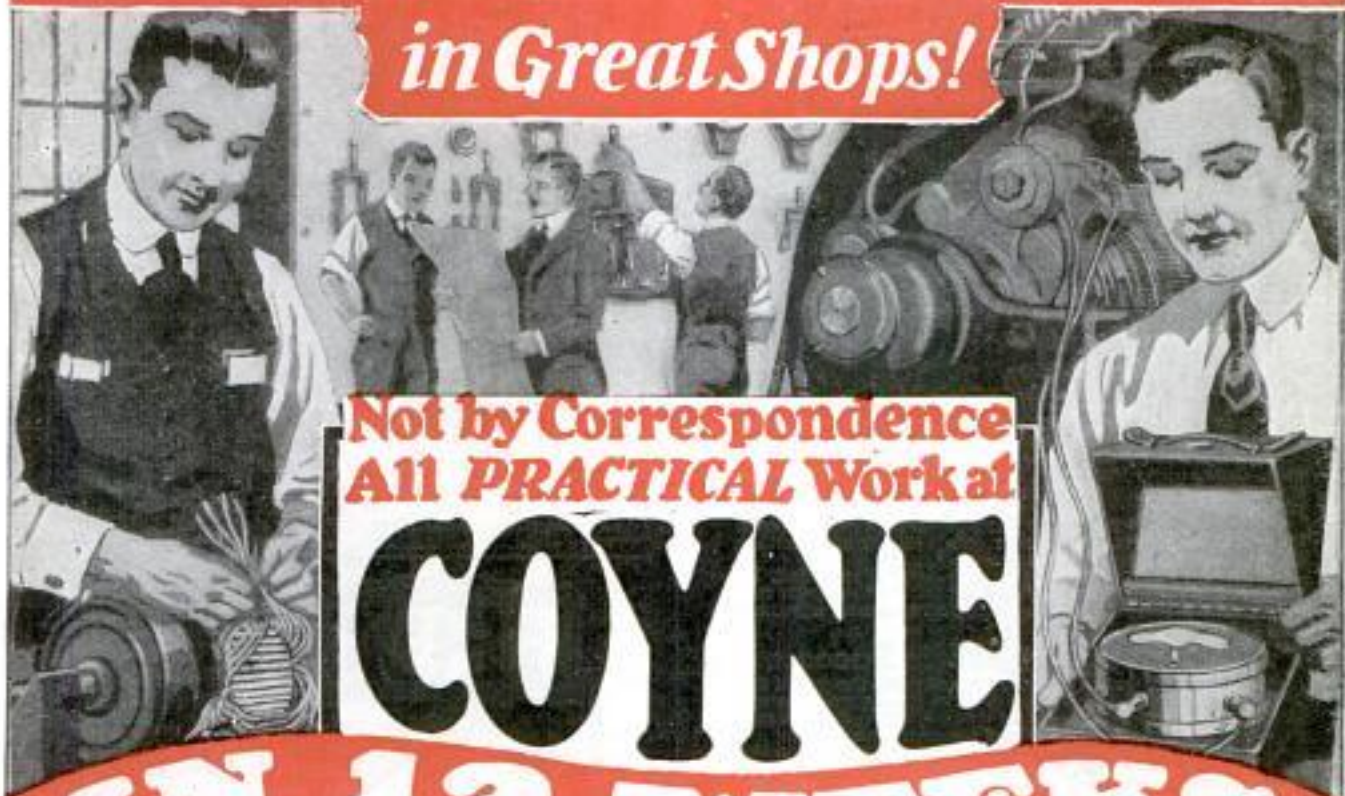

**Not by Correspondence
All PRACTICAL Work at**

COYNE

IN 12 WEEKS

EARN \$60 TO \$200 A WEEK

Why work at dull uninteresting work, at low pay, with no future? In 12 weeks I will train you for a big pay job where you can command \$60 to \$200 a week as a COYNE TRAINED MASTER ELECTRICAL EXPERT or you can go in business for yourself with very small capital and make up to \$15,000 a year. Men trained as I train them are in demand everywhere. The great development of the Electrical Industry makes the demand for trained men tremendous. Big opportunities and advancement for those who prepare now. The Coyne school was founded 26 years ago and my thousands of SUCCESSFUL GRADUATES are living proofs of what my training can do for ANY AMBITIOUS man. Many of these fellows will tell you in my big free book what Coyne has done for them.

COMPLETE ELECTRICAL TRAINING IN 12 WEEKS

I train you thoroughly on ACTUAL ELECTRICAL machinery. You work with your hands on all kinds of Electrical apparatus, door bells, house wiring, armatures, switchboards, dynamos, everything to make you an all around ELECTRICAL EXPERT. This REAL WORK with REAL tools on REAL machinery trains you many times FASTER, many times MORE THOROUGH than trying to learn in the field or by books or lessons.

No Books, No Lessons, No Classes — You Do Actual Work!

I do not attempt to teach you by books or lessons. I train you to work with your head and hands on the same kind of Electrical Machinery used in power houses, industrial plants and on the outside, under actual working conditions, with instructors at your side. I have no classes, every student gets individual training.

Free Radio and Auto Course

For a short time only I am including ABSOLUTELY FREE my big new Radio Course and Auto, Truck and Tractor Electrical Course.

COYNE ELECTRICAL SCHOOL

1300-1310 W. Harrison St., Dept. 935-4, Chicago, Ill.

You Don't Need Education or Experience

You don't need a lot of schooling to master my course. You don't have to be a high school graduate or even a grammar school graduate. My method of instruction is clear and plain, and yet thorough, and if you can understand plain English I will make you an electrical expert even though you haven't a lot of education or any previous electrical experience.

Coyne Trains You for Life

You get a free life scholarship which enables you to stay longer than the required time if you care to, or you may return at any time to take up new work. I am constantly adding to my school to make it the most modern at all times.

Earn While You Learn

My employment department will assist you to a part time job where you can make a few expenses while training.

This big handsome new book just off the press — size 12x15 inches — shows actual photographs of my big shops. Cost me a dollar to print, but it's yours FREE if you mail coupon. You owe it to yourself to get the facts.



H.C. LEWIS, President

good part of your living and they will assist you to get a BIG PAY job on graduation.

Get My Free Book — size 12x15 inches — shows actual photographs of my big shops. Cost me a dollar to print, but it's yours FREE if you mail coupon. You owe it to yourself to get the facts.

H. C. LEWIS
President

COYNE

Electrical School

1300-10

W. Harrison St.

Dept. 935-4

Chicago, Illinois

Dear Sir: — Please send me absolutely FREE your big New Book and full particulars of your Special Offer of Two Extra Courses FREE.

GET MY BIG FREE BOOK NOW!

Name.....

Address.....

Town.....

State.....

MAIL THIS COUPON NOW!

From \$20 a Week To \$4200 a Year in 8 Months

If you are making less than \$50 a week this advertisement will show you how you can earn \$50 to \$300 a week with a chain store organization right in your section of the country.



A bank clerk slaving for \$20 a week, one year later manager of a chain store at \$4200 a year.

Here is the story of Eugene Stockhouse's remarkable success. Read every word of it, for it proves that anyone with average intelligence can earn \$50 to \$300 a week in the chain store field.

Eight months ago Eugene Stockhouse was working in a bank for \$20 a week. The salary didn't satisfy him, neither did the opportunities for advancement.

But Stockhouse was more than merely dissatisfied, he was determined to fit himself for a position that paid real money at the start and where the opportunities for advancement were unlimited.

A Coupon Started His Success

So, one day he mailed a coupon exactly like the one at the bottom of this page. It brought him by return mail my prospectus about my course in chain store technique and some amazing information about the chain store field.

It told him of the enormous growth of chain stores in the last ten years. Of the millions of dollars' worth of merchandise chain stores sell each year. Of the acute shortage of trained executives. Of the wonderful positions at big salaries waiting for men trained in chain store management and administration.

Mr. Stockhouse studied the prospectus carefully and finally convinced himself that I could train him by mail to fill a high salaried position.

He enrolled for the course.

His progress was so rapid that before he had completed the course I got him a position with a chain store company in Mobile as assistant store manager at \$40 a week.

Eight months later he was appointed manager of the company's Baton Rouge store—the best store in the chain.

His earnings this year will be around \$4200, with greater opportunities than ever to double his income.

Mr. Stockhouse's success has been duplicated by hundreds of my students. YOU CAN DUPLICATE IT, TOO.

For chain store organizations all over the country are searching for trained store managers, buyers, district managers, location managers, personal managers, accountants, statistical control men, credit managers, sales and advertising managers, merchandise managers.

And they are willing to pay the price—\$50 to \$300 a week.

I'll train you by mail to fill any one of these positions you desire. My course in chain store technique is based on a life time of experience with the biggest chain store companies such as the Walk-Over Shoe Stores, Federal Clothing stores and many others.

Many of the principles of chain store management that are being used today by chain store organizations and which are incorporated in my course, were originated by me.

I am recognized as one of the leading experts in the chain store field and retained by small and large companies alike for my advice, counsel and experience.

I am not telling you this to boast but simply to show you that you get real, practical experience and first hand authoritative knowledge in my course.

The course requires only one evening a week—one evening of fascinating study that includes the practical application of what I teach you—the working out and solving of everyday chain store problems.

And you earn while you learn for I place you with a chain store company right in your section of the country before you complete the course. Chain store organizations are always glad to employ my students for they know that the men I teach receive the training necessary to fill the responsible, high salaried jobs.

If you are making less than \$50 a week—if your chances for advancement in your present job are slim—

Mail the coupon today for full information about my course in chain store technique. And I'll send you along with the information, convincing proof that I can train you to earn \$50 to \$300 a week.

Mail the coupon regardless of what you are doing now, for you need no previous experience whatsoever to qualify for a big paying job in the chain store field.

Mr. Matthew S. Higgins, The Higgins Institute,
251 Lexington Ave., New York City, Dept. PM-5.

Dear Mr. Higgins:

Send me, absolutely free, full information about your course in chain store technique and proof that you can train me to fill a position paying \$50 to \$300 a week.

Name

Address

City State

Present Occupation

TROUSER TROUBLES



are over

Men who swear at belts and suspenders are swearing by INVISO. INVISO not only keeps trousers and underwear up, but keeps your shirt down, and does it easily, giving you a clean cut, neat, stylish appearance. No more fussing about "pulling" in belt or fixing suspenders.

GOOD BYE
to Suspenders
& Belts

HERE IS SURE RELIEF
from Back Pains and Stomach Pinching

Trial Offer—Send no money—simply forward your measure above hips (right under trousers) and pay Postman \$1.50 plus mailing cost upon receipt of your INVISO. Wear it 10 days. If not satisfied return and your money back.



HIP-FIT COMPANY
12 A East 44th St., NEW YORK CITY
Agents, write for our Special Proposition

FREE Tenor Banjo

BECOME POPULAR

Learn to play at once, your favorite music, at parties, entertainments, etc. Our lessons are so simple everyone can learn in a few hours.

BOTH

Lessons and
\$18.00 TENOR BANJO
Absolutely FREE

For introducing our Famous Normandy Chocolates, RUSH your name for FREE plan to day.

HOME SUPPLY CO.

131 Duane St. Dept. 952 New York City

FREE LESSONS

Make Your Dreams Come True



Join the P. H. Davis
force of profit-making
Tailoring Salesmen

You men who want to realize your ambitions—consider the P. H. Davis tailoring line. Hundreds of salesmen making fine incomes—steadily—taking orders for Davis \$29.50 made-to-measure suits and overcoats. Davis clothes have nation-wide reputation for quality. First sales and repeat orders come easy.

SUCCEED with Davis
\$29.50 Quality Clothes

You can offer finest wools, combined with high grade tailoring. Selling direct from factory to wearer, you save customers \$10 and more on suit or overcoat. Satisfaction guaranteed or money returned. You make big commissions. Also liberal profit-sharing bonus on sales. To men who qualify, we furnish \$40 selling outfit without charge. A chance to go into business for yourself. Write today for free book of facts. Address

**What One
Man Did**

"Earned \$300 fast six days. Moved into my own home bought with Davis profits."
E. A. Stafford,
Ohio.

THE P. H. DAVIS TAILORING CO.

Dept. T-2

Cincinnati, Ohio

MAKES MORE THAN \$86.75 A WEEK



This happy looking young fellow is making good—**big**—because he has Michigan State (Detroit) Auto Training. He writes us: "Made \$86.75 last week and it was a poor week!"

Opportunities are open everywhere to ambitious **trained men**. Over **seventeen million** cars now running. Thousands more good mechanics are needed at big pay. More garages, electric service stations, battery shops, etc., are needed everywhere. Men who know this business, as we teach it to you, are **making big money**.

No Experience Needed With just a liking for Mechanics—you can learn the business in twelve weeks at this great auto trade School in Detroit. **Head and Hand training**, with actual practice in doing the work, makes you an all-around Auto man. Step out now—be a trained man and start to **get ahead**. Read what this man writes of his own success:

"December 21, 1924.

"My wife and I were just counting up last week's receipts and after deducting the rent, light, coal, telephone and mechanics' wages, I cleared \$86.75, clear profit for one week. It is near Christmas and that makes it slower than usual.

"I have now had my own garage for about a year, and am doing fine. Previously I held a position as foreman in one of the garages here in Dayton. There is only one thing that put me here, and that was thirteen weeks in the old M. S. A. S., four years ago, which gave me knowledge that would have taken ten to fifteen years to learn otherwise.

"The practical experience which I received while in your school has made it possible for me to secure the permanent patronage of some of the best people of this city. It has come to the time when the critical auto driver when in trouble does not hesitate to pay the price for good work.

"I have an assistant and am teaching him the methods you taught me. He has been in the Auto game a little over seven years, is good on motor work but the electrical end of it he does not understand. I have seen fellows with over ten years' experience fall down on some simple little thing in the electrical end when there was really "Nothing to it," to one who knows the principles of it. The boss that I worked for last winter had been in it for thirteen years and I have seen him fall down on more than one simple little thing, for he did not know the principles. **But with the short cuts and tests that you taught me I can find the trouble every time.** I will gladly recommend your School to anyone.

"I will close hoping to hear from you soon and wishing you all a Merry Christmas and a Happy New Year.

"EARL HATFIELD,

"319 Nassau Street, Dayton, Ohio."

Below is shown Hatfield's garage at Dayton



Do It Yourself!

Make big money in the auto business. You can, with right training. The training is easy to get. Just a few weeks of real work here at Detroit, the Auto Center. No age limit. No education or experience needed. Jump on the train for Detroit today. Or send the coupon for full facts. Be sure to get **Detroit training** at the factory endorsed School,—the M. S. A. S. Courses are thorough, complete, practical. Best equipment, expert instructors. Come now and start on the road to **Big Money**. Write us fully about yourself. We've helped 20,000 to success and can help you! Write today.

Michigan State Automobile School

1504 Auto Bldg., Detroit, Michigan, U. S. A.

SEND FOR INFORMATION NOW

Michigan State Automobile School 1504 Auto Building
DETROIT, MICH.
Send me FREE and without obligation complete information about Detroit-training to make the most money.

Name.....

Street or R. F. D.....

City..... State.....

I am interested in 12 week Auto Course at your School.
 30 week Master Course.
 Home Study Course.



What Will I Do With These?

TODAY, even the ordinary hammer and saw carpenter is making money. But it's the trained man, the master carpenter who draws the big pay, gets the steady job and becomes the big money contractor. Learn the new short-cuts and methods of modern carpentry. Do better work. Draw bigger pay. Make yourself an expert through spare time reading.

CARPENTRY

Five big volumes—2,200 pages, 1,000 charts, blue-prints and pictures. Big type—easy to read and learn. Covers entire theory and practice of Carpentry, Building, Contracting. Shows how to use tools, draw and read plans, make estimates, figure profits, etc. Practical, simple, complete.



Sent To You FREE

Send no money—just the coupon. Examine set a week with our compliments—then decide. No obligations. Send coupon now and get this master Carpenter Set. Pay only \$3. monthly if you decide to keep it.

American
Technical Society
Dept. G-412
Chicago, U. S. A.

AMERICAN TECHNICAL SOCIETY Dept. G-412, Chicago, U. S. A.

Please send me the 5 volume set of Carpentry and Contracting for one week free examination. If satisfactory I will send you \$2.50 within 7 days, and \$3. monthly until the special price of \$19.50 is paid.

Name _____

Address _____

Reference _____

Build and Fly Model Aeroplanes



Build your own Model Aeroplanes; make trial flights and learn the principles of Aeronautics. IDEAL Scale Drawings and Building and Flying instructions help you build exact 3 ft. duplicates of any of the following well-known Planes. Send 25c now for complete Plans for the one you want to build. Curtiss JN6D-2 Training Plane; De Havilland Gull; Curtiss Military Trainer; Bristol; Sopwith; Peoli Racers; 25 cents each, postpaid. Catalogue IDEAL Model Aeroplanes and Supplies, 5c postpaid.

"EVERY-BOY'S" Airplane clips together without nails, wire or screws. Ready to fly in 2 hours. The newest idea. Send for catalogue and find out about it. IDEAL AIRPLANE & SUPPLY CO., 438 West Broadway, corner Spring St., NEW YORK



Big 3-ft. Telescope

See people and objects miles away on land or sea as if they were close. Perry Wonder Telescope gives new pleasures to home, farm, camp, travel, sport. See moon and stars as never before.

Free

With Perry Wonder telescope this handsome sturdy 12 inch leatherette Carrying Case with strap, absolutely free. Protects telescope from dust and dirt. Telescope opens out over 3 ft. long, in 5 sections; only 12 inches closed. Brass bound slides, powerful lenses.

Send No Money Just send your name and address for telescope and free case. On arrival pay postman only \$1.85 plus a few cents postage. Satisfaction guaranteed or money refunded. Order now while supply lasts. FERRY & CO., Dept. 9774, Chicago, Ill.



Play Tunes in 10 Minutes

or Send It Back!

Now you can learn to play your favorite stringed instrument in 10 minutes with this wonderful new device. No musical knowledge required. No long hours of tiresome practice. Play by numbers instead of notes (or by notes if you wish). As simple as 1-2-3.

Amazing New Invention

The Instant Noteless Player takes all the work out of learning to play. Just attach it to the fingerboard of a Ukelele, Mandolin, Banjo, Mandola or Guitar, press the keys and you are playing tunes. "I learned to play Ukulele in 3 minutes. Never touched a stringed instrument before in my life," says Trina Ferguson (famous vaudeville star). Thousands of others have learned to play with this wonderful new invention. You are always popular and sure of a good time if you can play a musical instrument. Astonish your friends by playing at once.

Send Today for Free Book

Free Book

Explains all about this new invention and how we guarantee that you can learn to play in 10 minutes. Just send your name and address for this Free Book and our big Free Catalog of special prices on musical instruments. No obligation. Write today.

FERRY & CO., Dept. 1774, 3222 No. Halsted Street, CHICAGO, ILL.

FOOT CULTURE AND CORRECTION

I am a Graduate of the Stephenson Laboratories, Boston, Mass.

I give similar courses A. and B. at half the cost, show how to get business. The work is pleasant and very profitable. For full information address J. C. SWINNERTON, NEWARK, N. J., 251 Clifton Avenue.

No Joke To Be Deaf



—Every Deaf Person Knows That

I make myself hear, after being deaf for 25 years, with my Artificial Ear Drums. I wear them day and night. They are perfectly comfortable. No one sees them. They stop head-noises. Write me and I will tell you a true story, how I became deaf and how I make you hear. Address

GEO. P. WAY, Artificial Ear Drum Co. (Inc.) 89 Hoffman Bldg., 2339 Woodward Ave., Detroit, Mich.

Thousands Delighted

"I am delighted with the 'Wonder' telescope. Today I have been watching submarines 3 miles off the coast."—Philip Brush. "I can see across the Mississippi 3 miles and see people fishing."—M. L. Thorn. "I am nearly 80 years old and if I could not get another would not take \$10.00 for it."—A. R. Walker. "I can tell time on the church clock 5 miles away."—Edward Foster. "Could tell color of aeroplane 4 miles away."—Mrs. L. M. Yarbrough. "I saw a Light House 18 miles away."—Clyde Scribner. "Can see men working 7 miles away."—S. M. Genhart.

"I could see windmill more than 4 miles away."—Raymond Cosanova.

Chicago's Finest Office Building

... a triumph in architecture ...
an example to ambitious young men of the
Opportunity in Drafting

by M. L. Straus ... Vice-Pres. S. W. STRAUS & CO.

There are many branches of Drafting ... electrical, machine, architectural. And I have always appreciated the vast field this profession has open for ambitious young men. I have known that great railroads, steel mills, industrial plants ... electrical and building concerns ... employ thousands of men at good salaries for the responsible work of Drafting. But nothing brought home to me the vital importance of this high-class profession as clearly as the building of our new Chicago Home ... the Straus Building, located on the world's greatest boulevard. The architects, Graham, Anderson, Probst and White, told me that for this one job alone they employed 100 Draftsmen ... who made more than 3000 drawings. Here, indeed, is remarkable opportunity for the young man. Proper training in Drafting ... earnest effort ... and thrift ... should put any young man on the highroad to certain success.

FREE TRIAL LESSON Prove your fitness and liking for one of industry's highest paid professions. We want you to know what Drafting is like. How readily you can progress. How we train and teach you by mail. So, before you enroll ... free ... without cost or obligation ... we send you a trial, home-study lesson. This is vocational guidance of the highest order.

In Ten Months' Time \$35 to \$100 a Week

No special training or talent is required. In 10 months' time or less ... we can train you ... at home, in your spare hours ... to be an expert Draftsman.

And remember this: In Drafting a big income is open to every properly trained man. Thousands today are earning \$35 to \$100 per week. The reason is simple: Good Draftsmen are in constant demand... a demand that grows daily with the growth of all industry.

Book of Facts, FREE

We will send you a 40-page Book. It tells you all about Drafting ... and our Drafting courses. What prominent men say ... where Draftsmen are employed ... their salaries ... their opportunities ... what our students have done and are doing ... how many have increased their salaries even before finishing their courses ... how many hold high-salaried executive positions today. Tells how 34 instructors give you from this famous 21-year-old college a practical, short, home-study course. Everything today is built from drawings made by Draftsmen. Industry calls for 50,000

IN CHICAGO Earn While You Learn

Those who can come to Chicago will find opportunity to learn Drafting, Engineering or Architecture, earning expenses in part-time positions outside of school hours.



Chicago Technical College, founded 1904, known as "America's Oldest and Largest School of Specialized Engineering." Over 1000 men enroll in resident day and evening courses yearly. Diplomas in Civil, Mechanical and Electrical Engineering and Architecture granted after two years. Degree of B. S. conferred after three years in the day course. Short courses offered in Drafting, Plan Reading, Estimating, etc. Evening classes for day workers. Write for 52-page Blue Book if interested in Resident Student Courses.

new men yearly. Draftsmen work hand in hand with the architect, the engineer, the designer, the builder. Write for the 40-page book. Its fascinating pages are full of valuable ideas for you.

\$25 Outfit Included

When you enroll, you will need drafting instruments; so included in the cost of the course is a \$25 "lifetime" set. If you have instruments, credit will be allowed. Note that we do not claim to give you these instruments "free." Tuition is low—payments, easy.

Mail Coupon Today

Find out what Drafting may mean to you ... that you like it ... that here is a field in which you can work and win. We make the test easy ... for, with no obligation, we send you a trial lesson, free. Note the fairness of this offer ... the absence of exaggerated promises.

CARPENTERS, BRICKLAYERS and men in BUILDING TRADES—Send for Home-Study Catalog B and Free Book "How to Read Blue Prints." Increase your worth by mastering Plan Reading, Estimating, Superintending and higher branches of building, fully covered in the Chicago Tech. Builders' Course.

Chicago TECHNICAL College

Drafting—Engineering—Electricity—Architecture ... all branches

Dept. 430-B, 118 E. 26th St., Chicago, Ill.

CHICAGO TECHNICAL COLLEGE,
Dept. 430-B, 118 E. 26th St., Chicago, Ill.

Send me, without cost or obligation, your **FREE** Vocational Test Lesson and your 40-page Book of Facts about Drafting.

Name _____

Address _____

City and State _____



Chosen Out of 100 Applicants A Plan That Doubles Salaries

"To LaSalle goes the credit for training me so that I was able to turn a refusal into an acceptance in preference to over one hundred other applicants," writes E. W. DeMotte, a New York man. "I cannot give too much credit to LaSalle and its Placement Department for the success of my application for this very fine position." LaSalle trained him. LaSalle got him the job. "My investment in LaSalle training," writes J. B. Lewels, "has already paid me, during two months alone, an actual cash profit of 300 per cent."

Are you—like DeMotte and Lewels—following a well-organized plan to double—triple—quadruple your salary? Or are you relying for advancement upon business knowledge picked up thru day-to-day experience? LaSalle has added millions and millions of dollars to the earning power of its members. If a successful career is worth 2c and two minutes of your time, check on the coupon the field of advancement that appeals to you, fill in your name and address, and place it in the mail TODAY.

LASALLE EXTENSION UNIVERSITY

The World's Largest Business Training Institution
Dept. 464-R Chicago, Illinois

I would be glad to learn about your salary-doubling plan as applied to my advancement in the business field checked below. Send also copy of "Ten Years' Promotion in One," all without obligation.

- | | |
|---|--|
| <input type="checkbox"/> Modern Salesmanship | <input type="checkbox"/> Modern Business Correspondence and Practice |
| <input type="checkbox"/> Business Management | <input type="checkbox"/> Modern Foremanship and Production Methods |
| <input type="checkbox"/> Higher Accountancy | <input type="checkbox"/> Personnel and Employment Management |
| <input type="checkbox"/> Traffic Management | <input type="checkbox"/> Expert Bookkeeping |
| <input type="checkbox"/> Railway Station Management | <input type="checkbox"/> Business English |
| <input type="checkbox"/> Law—Degree of LL. B. | <input type="checkbox"/> Commercial Spanish |
| <input type="checkbox"/> Commercial Law | <input type="checkbox"/> Effective Speaking |
| <input type="checkbox"/> Industrial Management | <input type="checkbox"/> C. P. A. Coaching |
| <input type="checkbox"/> Efficiency | |
| <input type="checkbox"/> Banking and Finance | |

Name.....

Present Position.....

Address.....

X-RAY. Learn This

fascinating and profitable profession. Start any time. Takes 3 to 9 mos. Graduates now getting big pay.

Write for full particulars to
NATIONAL SCHOOL OF X-RAY, Peoria Life Bldg., Peoria, Ill.

SUBSCRIPTION FREE Three months. The Western Miner, 2541 W. 37th, Denver, Colo.

MAKE THIS CAR YOUR OFFICE

RAILWAY POSTAL CLERKS \$1600 to \$2300 Year

MEN—BOYS 18 UP MAIL COUPON IMMEDIATELY

Steady Work No Layoffs Paid Vacations
Common Education Sufficient

TRAVEL—SEE YOUR COUNTRY



Learn Commercial Art at Home!

Stop working for small pay on a job that offers no chances for advancement. Advertising Agencies, Newspaper and Magazine Publishers, Business Concerns, etc., are always glad to pay anywhere from \$50 to \$250 a week for trained artists. Even if you never touched a drawing pencil before, you can enter this attractive field and make a steady, worth-while income. For through an amazingly easy method you can learn to draw at home in spare time. No wasting of time on unnecessary details. Step by step you progress until soon you can draw pictures that sell. Many earn even while learning.

Send for FREE Book

A new handsomely illustrated book gives complete information on the thousands of wonderful opportunities in Commercial Art and shows how this remarkable method easily enables you to enter this field. Mail postcard or letter NOW. No obligation.

WASHINGTON SCHOOL OF ART
Room 304-C, 1115-15th St., N. W., Washington, D. C.

ELECTRICAL

Condensed course in Theoretical and Practical Electrical

ENGINEERING

including the closely related subjects of Mathematics and Mechanical Drawing taught by experts. Students construct motors, install wiring, test electrical machinery. Course complete

IN ONE YEAR

Prepare for your profession in the most interesting city in the world. Established in 1893. Free catalog.

BLISS ELECTRICAL SCHOOL
214 Takoma Ave. WASHINGTON, D. C.



NOTICE—All men, women, boys, girls, 17 to 65, willing to accept Government Positions, \$117-\$300 monthly, traveling or stationary write Mr Ozment, 111, St. Louis, Mo **AT ONCE**



FRANKLIN INSTITUTE, Dept. B178, Rochester, N. Y.

Bitte: Send me without charge, (1) Specimen Railway Postal Clerk Examination questions, (2) Send List of U. S. Government jobs now obtainable, (3) Send free illustrated book, "How to Get Government Jobs," (4) Send free sample coaching lessons.

Name.....

Address.....

Be a Red-Blooded Man!

GET the joy out of life—win back your health, strength, vigor and vitality—the ability to do what you want to do, enjoy what you wish to enjoy, live as you like to live—it's a joy you never can know while handicapped by miserable ailments or habits that take the tuck out of you and unfit you for both work and play. You can't be welcome among your friends and acquaintances when your breath is bad, your skin blotchy, your temper soured—nobody wants you around when chronic constipation, biliousness, dyspepsia or some other obnoxious indisposition has got you in its grip.

You can't continue to make a success of your business or your work when you wake up headachy, out of sorts, filled with lassitude that makes the tackling of each job a task. You never will be picked out for promotion if you do each day only what you have to do; if you haven't the energy, ambition, mental alertness and physical stamina to make yourself stand out as a man of pep and power.

Get Rid of Your Ailments

You can do it, no matter what your condition is now, if you've got the will to take steps to free yourself from the body and brain destroying ailments that are holding you back, and build yourself up. Any man can, if he only goes about it the right way.

Don't fool yourself with the idea that you will get better—unless you do something—or with the even worse delusion that patent medicine dope will ever bring back the health you have lost. No pill, powder or potion ever put together can build the red blood and physical and mental material that makes a man. It never has been done. It simply can't be done.

Tell All Your Troubles

Tell them in sacred confidence, as you would to a brother or a close friend, and I will show you the straight, broad path back to both physical and mental Health, Strength and Energy. Thousands, in all parts of the world, have found it under my guidance; many who felt, when they came to me, that their lives were almost hopelessly wrecked, are now strong, healthy and vigorous men and women.

STRONGFORTISM

The New Science of Health Promotion

Out of a lifetime of study, investigation and experimentation in Nature's marvelous powers of building up and revitalizing the human organism, this wonderful Science has been built. Through its principles I built myself up into the strongest man in the world. From these Scientific Methods, classified in accordance with the special needs of the individual, I am affording my pupils the one safe, sure method of regaining buoyant health and strength.

Strongfortism will do for you what it already has done for them. There isn't the slightest doubt of it—I **Guarantee It**, if you will follow my instructions for a few months. Back of the Science of **Strongfortism** is **Nature**, and to **Nature** all men and women are alike. With her aid, as explained in my **Free Book**, you can overcome the ailments that are causing your vitality to ebb away. You can enrich your blood, build up the tissues of your body and brain, gain new vigor and make yourself a man your friends, your acquaintances and your business associates will be proud of.



LIONEL STRONGFORT

An athlete of whom Dr. Sargent of Harvard University has said: "He is unquestionably the finest specimen of physical development ever seen."

Send for My FREE Book

"Promotion and Conservation of Health, Strength and Mental Energy." I will give you just the information you want. **It is free.** Just mark the subjects on the free consultation coupon on which you want special confidential information and send to me with 10c (one dime) to help pay postage, etc. You will hear from me at once with a message that will mean more health and strength—more joy and happiness. Send for my Free Book **Right Now—TODAY.**

Lionel Strongfort

Physical and Health Specialist Over 25 Years

Dept. 1768, Newark, N. J., U. S. A.

FREE CONSULTATION COUPON

(Cut Out and Send In)

MR. LIONEL STRONGFORT, Dept. 1768, Newark, N. J.

Please send me your book, "Promotion and Conservation of Health, Strength and Mental Energy," for which I enclose a 10c piece (one dime) to cover mailing expense. I have marked X before the subject in which I am interested.

- | | | |
|------------------|----------------------------|--|
| Colds | Deformity (Describe) | Round Shoulders |
| Catarrh | Short Wind | Poor Circulation |
| Asthma | Stomach Disorders | Tobacco or Other Bad Habits and Weaknesses |
| Obesity | Skin Disorders | Stoop Shoulders |
| Headache | Increased Height | Muscular Development |
| Thinness | Constipation | Weight Lifting |
| Rupture | Biliousness | Great Strength |
| Flat Foot | Torpid Liver | Advanced Course |
| Dependancy | Indigestion | Mary-Weight Barbell |
| Lumbo | Nervousness | |
| Neuritis | Poor Memory | |
| Flat Chest | Rheumatism | |
| Isenemia | | |

Name.....

Age..... Occupation.....

Street.....

City..... State.....

BOYS

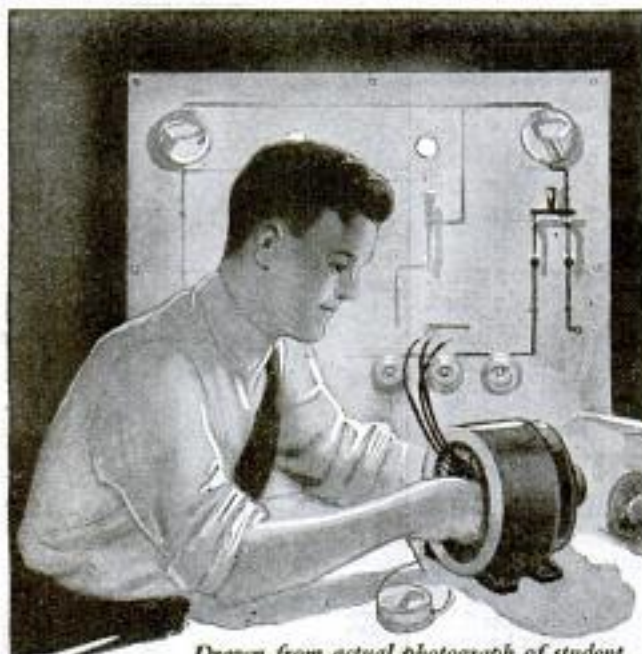

Drawn from actual photograph of student doing spare time electrical work

Learn Electricity Make Big Money

How would you like to earn two or three dollars every evening after school and prepare yourself for a fine big job at the same time? Here's the opportunity of a lifetime for you fellows who like Electricity. Begin right now to prepare yourself for a regular man's size job in this fascinating field. Your chances for a big success are simply wonderful—the pay is big (\$70 to \$200 a week) and advancement comes swift and sure.

I will Train You at Home

With my easily learned, spare time Electrical Course I will train you at home like I have trained hundreds of other boys who are now big successful men. It will not interfere with your school work and you can earn more than the small cost of the course doing odd electrical jobs in your spare time. The Course pays for itself. I will show you how to get this work and how to do it. Some of my boy students make \$30 to \$15 a week this way.

Tools, Apparatus and Radio Course—FREE

Send me the coupon below and I will tell you all about the big outfit of tools, apparatus and instruments and a new Radio Course that I am giving to my students for a limited time. I will send you my big interesting Electrical Book and a sample lesson, too—all Free. You will be tickled with the things I will send you Free. Mail the coupon right now.

L. L. COOKE, Chief Engineer
Chicago Engineering Works

Dept. O-14 CHICAGO

Use This "FREE OUTFIT" Coupon

L. L. COOKE, Chief Engineer,
Chicago Engineering Works,
Dept. O-14 2150 Lawrence Avenue, Chicago

Send me your Free Outfit Offer, your big Electrical Book, Sample Lesson and particulars of your Electrical Course and Free Radio Course. This will not obligate me in any way.

Name.....

Address.....

This Coupon only for use of boys 15 years old or more.

Look What This Boy Is Doing

"Although the School term is coming to a close, and I am pretty busy with my examinations, I manage to keep up with my electrical studies and work.

"I guess I forgot to tell you I am now in business for myself. Am doing fine, but owe it all to you. If it had not been for your Course, I, being under age, could not have secured my license in this town. But I got it, and now have all the work I can do, averaging \$20 to \$30 a week, thru spare time work.

"I went out on a job tonight after school, on which I made \$8 and brought home another on which I made \$2.50—\$5.50, for 4 hours' work and no material furnished by me."

ROGER SMITH,
1218 Chestnut St.,
Greenville, N.C.

\$25⁰⁰ DRAWING COURSE for \$3⁹⁸



Haven't you often wished that you could draw cartoons, illustrate some idea, sketch some pretty face, etc.? You can do all of these things. One of America's most famous Cartoonists and Illustrators has developed a great, simple system for success in all branches of Commercial Art. This system has revolutionized the entire theory of drawing. It means that drawing can be as easy for you as writing—much simpler than learning shorthand, bookkeeping or typewriting. We are now placing this original system for learning Drawing, Art and Cartooning, consisting of 34 lessons with over 500 illustrations, within reach of every one. If you will devote a few hours each week to the Course, WE ABSOLUTELY GUARANTEE that you will learn to draw and draw well before you have half finished the Course. If we fail to make this claim good, we will refund every cent paid us. By eliminating a large office force for answering correspondence, expensive catalogs, etc., we are enabled to make a price of \$3.98, the cheapest price ever known for a high-grade home study course. Many have sent us letters similar to that of Robert P. Davis, of Detroit, who wrote: "I can't see how you ask so little, when others with inferior Courses get from \$20 to \$60 for theirs. It is more than I expected."

Learn to draw. It is a big asset, no matter what field you are in.

SEND NO MONEY

Just order Course and on \$3.98 arrival pay postman only \$3.98 payment in full for the entire Course and Free drawing outfit. If not entirely satisfied, return within five days and we will REFUND MONEY. Address
LEDERER SCHOOL OF DRAWING
Dept. 316-M, Chattanooga, Tenn.

FREE If you order the Course at once, we will include a drawing outfit, consisting of artist's pencils, pens, paper, erasers, thumb tacks, etc., enabling you to go to work without any additional cost.

Cash must accompany orders outside the U. S. A.



BARNEY OLDFIELD'S MECHANICIAN!

Learn no hour a day of your spare time to "Dash," formerly mechanic for Barney Oldfield. His demand for "Dash" trained men. He will put you in the \$100 a week class as Automotive Expert. Learn at Home—Learn by Job-Way Plan. Free tools. Success guaranteed. Free Book gives all details. Write today. No obligation. CHICAGO AUTOMOTIVE INSTITUTE, Dept. 1774, 328 So. Clark Street, CHICAGO

Big Money in Poultry



\$1,000 a Year
Part Time

\$5,000 a Year Full Time

The Poultry Business needs more producers. 85% of the people of this country live in cities. The demand for eggs and poultry is far greater than the supply. You can earn \$1,000 a year in Poultry in spare time—or \$5,000 a year full time. We will show you how.

Our Methods Are Sure

You can't lose. No matter where you live, in the city or on the farm, we can show you how—how to get big hatches; strong, healthy chicks; active, productive fowls—how to get the profits and avoid the losses. Learn at home. Start with just a few hens or with a big flock. Our new book contains valuable poultry information and tells all about our practical, up-to-the-minute, money-making poultry course. Poultry raisers all over the world are using our methods with wonderful success. You can do the same. Our book tells how. Write for it today.



Mail this now

The National Poultry Institute
Washington, D. C. Dept. 151-F

Dear Sir:
I am interested in your plan on "How to Raise Poultry for Profit." You may send me your FREE BOOK. It is understood that this places me under no obligation.

Name.....

Address.....



BE AN ARCHITECT
\$2,000 to \$12,000 a year



BE A BUILDING CONTRACTOR
\$4,000 to \$20,000 a year



BE AN AUTO EXPERT
\$2,500 to \$10,000 a year



BE A CIVIL ENGINEER
\$4,000 to \$12,000 a year



BE AN EXPERT DRAFTSMAN
\$2,000 to \$8,000 a year



BE AN ELECTRICAL EXPERT
\$1,500 to \$12,000 a year



BE A LAWYER
\$1,500 to \$22,000 a year



BE A MECHANICAL ENGINEER
\$5,000 to \$15,000 a year



BE A STEAM ENGINEER
\$2,500 to \$7,500 a year



BE A BUSINESS EXPERT
\$3,000 to \$8,000 a year



BE AN EXPERT ACCOUNTANT
\$4,000 to \$12,000 a year



O. C. MILLER,
Director of Extension

If you're in doubt about what home-training will do for you, my new guarantee measures its benefits in dollars and cents.

MAIL COUPON FOR COMPLETE INFORMATION

"Do You Guarantee me a Job"

"Will you guarantee I will earn more money after I finish your training?" You have a right to ask these questions. When you put your money and time into home-training you are entitled to know what it will do for you. Your whole future success depends on the kind of training you choose now. I WILL ANSWER THESE QUESTIONS—straight from the shoulder, in plain English. For the first time a million dollar correspondence school guarantees its training under head. Copies below bring this unusual guarantee.

Training the quick road to Big Pay!

World's biggest business boom is coming and with it an enormous demand in a dozen industries for EXPERTS at \$50 to \$300 a week! You can't cash in on this opportunity in the old, slow "experience" way. You must TRAIN—you must Specialize! AMERICAN SCHOOL has made it easy for you to get just the training you need to gain promotion and bigger pay QUICK.

Get the Facts—find out what success thousands have gained with AMERICAN Home-Training—why these 13 courses now carry a wonderful, new kind of written guarantee—how AMERICAN SCHOOL has secured over 200 of the leaders in these industries, prominent engineers, educators, and executives, to guide you quickly to the Expert's job and pay.

New Guarantee back of all 13 Courses

Here is the chance you've been waiting for to go into your favorite profession or business. AMERICAN SCHOOL guarantees complete, up-to-the-minute, practical instruction in these 13 great lines. Our NO-PROFIT plan permits very low tuition costs. Easy terms within your reach. Common schooling all you need. You will be astonished at the many features of our student service. While you are training and afterward, we help you at every step.

Train AT HOME!

Business, like Life, is—WAR! You must fight ALONE for every inch of progress. So you need the help our home-training will bring you to meet and beat the competition of your fellow workers. Loan me a part of your spare-time, and right in your own home I will show you how to win your battles for promotion. I will prepare you for the success and prosperity that are now beyond your reach.

ARE TRAINED MEN "LUCKY"?

If you're a \$25 a week man now, you are limited to \$25 a week opportunities. The \$10,000 opportunity is over your head. Only the trained Expert, the specialist, can take advantage of the big-money opportunities. That's all there is to "luck"—being able to grab the big opportunities when they come along. So you see TRAINING must come first.

Mail Coupon Today!

O. C. MILLER, Director of Extension
AMERICAN SCHOOL
Dept. G-474, Drexel Ave. & 58th St., CHICAGO

Earn While You Learn!

Many students report raises, promotions and extra money earned soon after enrolling. AMERICAN SCHOOL "Job-Method" of instruction combines practical experience, home-study, and money-making in a new way. Mail Coupon for complete offers today!

SEND ME FREE BOOK and YOUR GUARANTEE

O. C. MILLER, Director of Extension,
AMERICAN SCHOOL, Dept. G-474,
Drexel Ave. and 58th St., Chicago.
Send me at once your new guarantee and complete information about the home-training marked X below:

- | | |
|---|--|
| <input type="checkbox"/> Architecture | <input type="checkbox"/> Drafting |
| <input type="checkbox"/> Contracting, Building | <input type="checkbox"/> Law |
| <input type="checkbox"/> Auto | <input type="checkbox"/> Mechanical Engineering |
| <input type="checkbox"/> Civil Engineering | <input type="checkbox"/> Business Management |
| <input type="checkbox"/> Structural Engineering | <input type="checkbox"/> Higher Accountancy and C.P.A. |
| <input type="checkbox"/> Electricity | <input type="checkbox"/> Steam Engineering |
| <input type="checkbox"/> High School, 2 Years | |

Name.....
St. No.....
City..... State.....
Age..... Occupation.....

Free *Latest Book*
HEALTH
Beauty
TRIAL
at Home **for Men and Women**



Free trial proves that Wonder Mist revitalizes every cell and works miracles over-coming pain and sickness. Physicians and plain folks explain how "Wonder Mist" has made them well, strong and happy in our 64-page book. Actual photographs, scientific charts and diagrams. It's Free.

Wonder Mist New Improved Violet Ray

"Wonder Mist" works quickly; it's scientific; goes after the cause. That's why results are quick and permanent. Dr. Duncan, Kewanee, Ill., writes, "Wonder Mist" is the finest thing to relieve pain, treatments are so pleasant all my patients like it. "Use it at home. Save doctor bills. Brings the natural magnetic beauty of health, no dieting, exercise or drugs.

SEND FOR FREE BOOK

Explains how Nikola Tesla discovered "Wonder Mist," how it works, why it heals. Tells how to conquer pain, disease and nervous trouble.

Reveals Marvelous Scientific Discovery. Shows charts of human body and explains where pains start, how to banish them. Offered Free for a limited time only to introduce "Wonder Mist." Send for a Free Copy today.

VI-REX CO., 211 S. Peoria St., Dept. 24 Chicago

Mail Coupon—Send No Money

VI-REX CO., 211 S. Peoria Street, Dept. 24 Chicago, Ill.

Please send me without cost or obligation your free 64-page book describing your Vi-Rex "Wonder Mist" outfits, and details of your FREE trial Offer.

Name.....

Address.....

City.....

Start Little Mail Order Business—Free Book

Home employment evenings. Beginners Outfit furnished. Book Free. Pier, 842 Cortland St., NEW YORK

Information on any book free. Write Popular Mechanics Press, Chicago, Ill.

Learn to Mount Birds



Learn at home by mail, to mount birds, animals, game heads; tax furs, make rugs and robes. Complete lessons. Easily and quickly learned by men, boys and women.

FREE Write today for Free Taxidermy Book. Tells all about it. Every Sportsman, Hunter, Trapper and Nature lover should know this wonderful fascinating art. Save your trophies. Big profits. Success guaranteed. Our school is 25 years old—25,000 graduates. Investigate today. Write for Free Book.

Northwestern School of Taxidermy 1774 Elwood Bldg., Omaha, Neb.

THE DRAWING MASTER

All-Metal Adjustable Pantograph
Indispensable wherever a draughting board is used. Quickly enlarges or reduces. Made of the finest materials and absolutely guaranteed.

Best post paid for only \$5.00. Satisfaction guaranteed or your money refunded.

DRAWING-AIDE CO., 308 Carlin Bldg., Cleveland, O.

I Make Champs

Write me what sport interests you. I will tell you how I can pep you up and turn you into a champ, as I did with Tim Jordan, Harry Babcock, and many others. Write today for my book FREE.

Baseball
Tennis
Boxing
Golf

SEIXAS ATHLETIC SYSTEMS, Dept. 4114, 1920 B'way, N.Y.

Comedies, Dramas, Musical Comedies and Revues, Min-strel Choruses, Songs, Blackface plays. Everything for Burnt Cork Shows and All Amateur Entertainments. Monologs, Dialogs, Speakers. CATALOGUE FREE.

PLAYS Vaudeville Acts How to Stage a Play Make-up Goods

T. S. DENISON & CO., 623 So. Wabash, Dept. 9, CHICAGO

Prizes

for Boys & Girls

Send fifteen cents for the fascinating, entertaining, **GRANDDADY** prize-winning **CROSS-WORD Puzzle Book** and how to win Red Injun bicycles, radio sets, wrist watches, cameras, rifles, rings, fountain pens, skates, knives and many other big prizes.

Book contains 5 of our famous Chicago Daily News contest prize-winning puzzles and many others.

LANGDON SPECIALTIES CO.
Department E SAINT PAUL, MINN.



RAILWAY POSTAL CLERK

No strikes. No lockouts. When everybody else is worrying about his job or looking for work, the U. S. Civil Service Employee is earning good, steady pay in a pleasant occupation of his own selection. Earn \$1600 to \$2300. Let me train you to pass the U. S. Civil Service Examination with high rating so you will be eligible for one of the first positions open at \$1600 to \$2300 a year as a Railway Postal Clerk or in Customs, Internal Revenue, Departmental, Immigration, Postmaster, Postoffice and Rural Branches. I have trained thousands to successfully pass the examination. Money refunded if not offered position in one year after receiving rating. Write today. Mail coupon for catalog.

Patterson Civil Service School, Dept. 84, Rochester, N. Y.

Sir: Send me without charge your catalog, describing this and other U. S. Government Positions.

PATTERSON CIVIL SERVICE SCHOOL

Approved as a correspondence school under the laws of the State of New York

Name.....Age.....

Dept. 84

ROCHESTER, N. Y.

Address.....

BARBERING

Now One of the
Highest Paid
Professions!

**\$90 to \$150
Every Week!**



William McClintock, President Master Barbers' Ass'n of Chicago and proprietor of the highest priced rented shop in the world, says, "My son, who learned at Moler's, is top man in my shop every week. I gladly recommend the Moler System as the proper place for men to become successful barbers."
—WM. McCLINTOCK.



"The XXth Century," "Oriental Limited" and other crack trans-continental trains carry barbers.

**BE A "WHITE-COLLAR" MAN—
Earn \$90-\$150 a Week—CLEAN Money!**

What's the use of doing dirty, greasy, *hard* work, when you can *NOW* make TWICE as much money in a manly profession that is CLEAN, profitable and full of opportunities?

**Easy to Learn—
Quick to Earn!**

That's BARBERING for YOU! And the best part of it all is this—scientific barbering, as taught the modern MOLER way, makes YOU a Master Barber in a short course of intensive training, at small expense! You soon step out as your own Boss, if you wish, in your own Shop, which we will gladly help you equip.

See the World, Too!

Or, if you prefer, we will help you step into a real job, with good pay the first day, after you graduate. Ocean Liners, crack trans-continental passenger trains, big luxurious hotels and skyscrapers all over the world, as well as thousands of Barber Shops everywhere, demand MOLER trained men.

**MOLER Graduates
Are Always Busy!**

MOLER trained Men are always given the preference, for they alone possess the valuable, thor-

ough MOLER training in the application of all the latest scientific Barbering methods including the Electric hair cutter, the mechanical massage, and the latest vogues in ladies' hair bobbing. MOLER also gives special training in ladies' marcelling and an easy practical course in the treatment of skin diseases.

**Earn While
Learning!**

"Where there's a Will there's a Way" to earn BIG pay! Write to the nearest MOLER College, there is one near you, and learn how you can earn while you learn the barber trade. Ask for the new FREE MOLER Barbering Booklet B. Find out HOW MOLER helps you help yourself AFTER you graduate, as well as BEFORE! Find out why MOLER Men are making DOUBLE the money others made last year, before Ladies' Shingle Bobbing became so popular. You're NEXT in line for big pay—the MOLER way. Send Coupon TODAY!

MOLER SYSTEM OF COLLEGES

30 Branches in United States and Canada

New York, N. Y.
Chicago, Ill.
St. Louis, Mo.
Kansas City, Mo.
Cincinnati, Ohio.
Cleveland, Ohio.

Detroit, Mich.
Denver, Colo.
Omaha, Nebr.
Milwaukee, Wis.
New Orleans, La.

Atlanta, Ga.
Memphis, Tenn.
Dallas, Tex.
Houston, Tex.
San Antonio, Tex.



The Majestic, Lestath and U. S. Shipping Lines all carry barbers.

**NEXT!
For BIG Pay**

Mail THIS

MOLER SYSTEM OF COLLEGES

← Address Nearest Branch
(Street Address NOT Needed)

Please send me without obligation on my part your Booklet B.

Name.....

Address.....

City..... State.....



ELECTRICAL EXPERTS IN DEMAND

Good positions await trained men. Salaries of \$12 to \$30 a day not unusual.

THE ELECTRICAL field needs men. It needs them badly. Hardly a week or month passes but what some new use for electricity is discovered. Each new use means new positions—*better positions*—for men who have trained themselves as experts in this wonderfully fascinating work.

Why don't you study electricity and prepare for a good position at a good salary?

You can do it right at home in spare time through the International Correspondence Schools. Best electrical home-study courses ever offered. Endorsed by Edison and Steinmetz. Successful students everywhere.

MARK AND MAIL THE COUPON TODAY FOR FREE BOOKLET

TEAR OUT HERE

INTERNATIONAL CORRESPONDENCE SCHOOLS

BOX 5505-E SCRANTON, PA.

Explain, without obligating me, how I can qualify for the position, or in the subject, before which I mark X.

- | | |
|--|--|
| <input type="checkbox"/> ELECTRICAL ENGINEER | <input type="checkbox"/> CHEMICAL ENGINEER |
| <input type="checkbox"/> Electrician | <input type="checkbox"/> Pharmacy |
| <input type="checkbox"/> Electric Wiring | <input type="checkbox"/> SALESMANSHIP |
| <input type="checkbox"/> Electric Lighting | <input type="checkbox"/> Show Card and Sign Painting |
| <input type="checkbox"/> Electric Car Running | <input type="checkbox"/> RAILROAD POSITIONS |
| <input type="checkbox"/> Heavy Electric Traction | <input type="checkbox"/> ILLUSTRATOR |
| <input type="checkbox"/> Electrical Draftsman | <input type="checkbox"/> DESIGNER |
| <input type="checkbox"/> Electric Machine Designer | <input type="checkbox"/> BUSINESS MANAGEMENT |
| <input type="checkbox"/> Telegraph Expert | <input type="checkbox"/> Private Secretary |
| <input type="checkbox"/> Practical Telephony | <input type="checkbox"/> Business Correspondent |
| <input type="checkbox"/> MECHANICAL ENGINEER | <input type="checkbox"/> BOOKKEEPER |
| <input type="checkbox"/> Mechanical Draftsman | <input type="checkbox"/> Stenographer and Typist |
| <input type="checkbox"/> Toolmaker | <input type="checkbox"/> Cert. Public Accountant |
| <input type="checkbox"/> Machine Shop Practice | <input type="checkbox"/> Traffic Management |
| <input type="checkbox"/> Gas Engineer | <input type="checkbox"/> Commercial Law |
| <input type="checkbox"/> CIVIL ENGINEER | <input type="checkbox"/> GOOD ENGLISH |
| <input type="checkbox"/> Surveying and Mapping | <input type="checkbox"/> Common School Subjects |
| <input type="checkbox"/> Reading Architects' Blue Prints | <input type="checkbox"/> CIVIL SERVICE |
| <input type="checkbox"/> METALLURGY | <input type="checkbox"/> Railway Mail Clerk |
| <input type="checkbox"/> ARCHITECT | <input type="checkbox"/> STATIONARY ENGINEER |
| <input type="checkbox"/> Architectural Draftsman | <input type="checkbox"/> Textile Overseer or Supt. |
| <input type="checkbox"/> PLUMBING AND HEATING | <input type="checkbox"/> AGRICULTURE |
| <input type="checkbox"/> Sheet Metal Worker | <input type="checkbox"/> Navigator |
| <input type="checkbox"/> Automobiles | <input type="checkbox"/> Poultry Raising |
| | <input type="checkbox"/> Spanish |
| | <input type="checkbox"/> Math's'ty |
| | <input type="checkbox"/> RADIO |

Name _____

Present Occupation _____ Business Address _____ 3-6-24

Street and No. _____

City _____ State _____

Canadians may send this coupon to International Correspondence Schools Canadian, Limited, Montreal, Canada

BE A Mechanical Dentist^{In Six Months}

Make \$150 a Week

BOTH MEN AND WOMEN IN DEMAND
PERSONAL INSTRUCTION to Each Student



In One Big School for Mechanical Dentists, Students are taught on Patients' work that is actually used. Only Modern Methods Taught. 50,000 Dentists need Laboratory Experts.

Stivison Trained Graduates Always in Demand. Jobs Hunt You. Every Dentist does Laboratory Work that he would gladly have done by an expert and pay Big Prices.

Real Dentist's Tools are furnished and Instructions given by Real Dentists on work that Dentists need. Descriptive Literature Free. We pay your R. R. Fare to Kansas City and assist you in paying your tuition.

GET IN THE BIG PAY CLASS

Write for Special Offer. Delay may cost you a good job and lots of money.
Stivison Dental Institute 11th and Locust Sts. KANSAS CITY, MO.

AGENTS—500% Profit

Genuine Gold Leaf Letters



GUARANTEED TO NEVER TARNISH

Anyone can put them on stores and office windows. Enormous demand, large profits. Paul Clark says: Smallest day \$28.70. R. L. Reel made \$920 in two months. Write today for free sample and liberal offer to general agents.

METALLIC LETTER CO.
433-C N. Clark, Chicago



Music Instructor

These books are illustrated and gotten up to make the method of self-teaching so simple that any one without any knowledge of music could learn to play any of the following:

SAXOPHONE	25c	MANDOLIN	25c
ACCORDEON	25c	PIANO	25c
BANJO	25c	UKULELE	25c
GUITAR	25c	VIOLIN	25c

The above prices are postpaid. :-: Any above 5 titles, \$1.00 postpaid.
J. C. DORN, 725 So. Dearborn St., Dept. 17, Chicago, Ill.

PIMPLY SKIN made WELL

When a few applications of this wonder-working lotion has cleared faces of pimples, **FREE blackheads, acne eruptions** on the face or body, **barbers itch, eczema, enlarged pores, oily or shiny skin**, you can realize why CLEAR-TONE has been tested and approved in over **100,000 Test Cases**. The simplicity of the treatment, and *The Story of How I Cured Myself* are all explained in my free booklet, "A Clear-Tone Skin." Write for your copy today and learn of the results gotten by thousands of men and women.

E. S. GIVENS, 128 Chemical Bldg., Kansas City, Mo.



\$2500 Reward!

For the Capture of an Unknown Man

Twice he had entered the St. Clair Mansion. What was he after? Who? What was in danger?

Berteau, the famous detective, had warned St. Clair that *the mysterious marauder would come again*. And now—a noise in the passage! The creak of an opening door. A shot in the dark! A capture!

Is this wounded stranger the mysterious intruder? Who could tell? Yet Berteau identified the man without hesitation and won the \$2500 reward.

How did he do it? Easy enough for the Finger Print Expert. He is the specialist, the leader, the *cream* of detectives. Every day's paper tells their wonderful exploits in solving mysterious crimes and convicting dangerous criminals.

Course in Secret Service

For a limited time we are making a special offer of a *professional Finger Print Outfit, absolutely Free, and Free Course in Secret Service Intelligence*. Mastery of these two kindred professions will open a brilliant career for you.

Write quickly for fully illustrated free book on Finger Prints which explains this wonderful training in detail. Don't wait until this offer has expired—mail the coupon now. You may never see this announcement again! You assume no obligation—you have everything to gain and nothing to lose. Write at once—address

University of Applied Science

Dept. 13-54, 1920 Sunnyside Ave., Chicago, Ill.

More Trained Men Needed

The demand for trained men by governments, states, cities, detective agencies, corporations, and private bureaus is becoming greater every day. Here is a real opportunity for YOU. Can you imagine a more fascinating line of work than this? Often life and death depend upon finger print evidence—and big rewards go to the expert. Many experts can earn regularly from \$3,000 to \$10,000 per year.

Learn at Home in Spare Time

And now you can learn the secrets of this science at home in your spare time. Any man with common school education and average ability can become a Finger Print Expert in a surprisingly short time.

FREE

UNIVERSITY OF APPLIED SCIENCE

Dept. 13-54, 1920 Sunnyside Ave., Chicago, Ill.

Gentlemen:—Without any obligation whatever, send me your new, fully illustrated, FREE book on Finger Prints and your offer of a FREE course in Secret Service Intelligence and the Free Professional Finger Print Outfit.

Name

Street Address

City and State

Are You Really a Man or Merely a Coat-Hanger?



CHARLES MACMAHON

think that others know no different, so long as you keep under cover. Unfortunately, it is not Halloween all the time and people can judge your physique regardless of your clothes. So

DON'T YOU BE A MASQUERADER

Because the law compels you to wear a man's attire is no excuse for not being one physically. If you possess ailments, minor or major, that are holding you down below the real man class, get started now with me in putting yourself in the best of physical condition. **Waste no further time** in driving, with my methods, these deteriorating ailments from your system. **It can be done** in a short time. **YOU CAN**, with my personal and untiring help, not only become healthy, but as strong, well developed, well proportioned, and full of "pep" and vitality as any real man.

How Would You Like a 15 or 16 Inch Upper Arm

in place of that frail one you now possess? How would an arm of this size look in good, solid muscle instead of flabby fat? You can imagine how you would look with other measurements in proportion to an arm like this. Your friends would soon tell you about the marvelous changes that have come over you. But you will never get anywhere by just wishing. Satisfy yourself that all you need to do is to get started with me NOW. "Make the break," "take the step,"—anything for a start. But just as important as starting is the matter of starting right. **ACTUAL EXERCISE, MUSCLE CONTROL, TUMBLING and HAND BALANCING ARE GIVEN YOU in MY FREE BOOK.**

You Start Right When You Send for My FREE Book

The title of this **ABSOLUTELY FREE BOOK** is, "The Royal Road to Health and Strength." It shows you how to actually perform more worth-while feats than any other book of its kind, besides clearly explaining my Physical Training Methods. Furthermore, it is full of half-tone pictures showing my own physique, as well as a great number of my magnificently developed pupils. There are sixty-four pages of magnificent pictures and desirable instructions for you **FREE**. **DON'T** even send a dime for mailing charges. **YOU'LL ENJOY THIS BOOK, SO MAIL THE COUPON NOW.**

CHARLES MACMAHON

Studio D-11, 180 W. Somerset St., PHILADELPHIA, PA.

Charles MacMahon, Studio D-11
180 W. Somerset St., Phila., Pa.

Please mail me a copy of your valuable book, "THE ROYAL ROAD TO HEALTH AND STRENGTH," which you are to send me without charge in accordance with your special offer.

Name.....
Address.....
City and State.....

Clothes don't MAKE a REAL MAN, but they certainly DO improve the others. Are you one of the "others" who are hiding behind a tailor's handiwork?

If you are one of these you ought to be ashamed of yourself. And I dare say you are ashamed, but the fact that you know your weak and frail or fat body is well hidden by your clothes, gives you a certain amount of misplaced confidence in yourself. You imagine you are a real man and

I will teach you Penmanship by mail

Small Cost, Spare Time, Easy Lessons.

Write for my Book, "How to Become an Expert Penman." FREE

It contains specimens and tells how others became expert writers by the Tevis Method. Your name will be written on a card if you enclose stamp. Write today. T. M. TEVIS, Box 25K, Chillicothe, Mo.

\$100.00 EARNED BY YOUNG ARTIST IN 2 DAYS

Well-trained artists earn splendid incomes. The Federal home-study Course is a proven result-getter. If you like to draw, send 6c in stamps for 56-page book "Your Future." State your age and present occupation.

FEDERAL SCHOOL OF COM'L DESIGNING
503 Federal Schools Building
Minneapolis, Minn.

21 Jewels

Nothing less than 21 Ruby and Sapphire Jewels is good enough for the Burlington masterpiece.

Quality and Style

Adjusted to the second-temperature-isochronism-positions. 20 year Gold Strata Case, in 100 exquisite designs. Only \$1 down. Balance in small monthly payments. Send for free book.

Burlington Watch Company
19th Street and Marshall Boulevard
Dept. 13-54 Chicago, Illinois

MASONS!

Brick - Plaster - Concrete - Tile Workers
Let AUDEL'S NEW GUIDES give you a Helping Hand

Audel's Masons' and Builders' Guides give information in handy form for Bricklayers, Plasterers, Tile Setters and all Cement Workers. Contain best approved outlines of work and materials, including instructions on how to lay out and figure various jobs. A working companion for the journeyman; ready reference for the boss builder; a practical instructor for the house builder.

AUDEL'S MASONS' AND BUILDERS' GUIDES
1100 Pages, 2067 Examples

These Pocket Size Guides cover fully and completely: Brick laying, tools, materials, bonding, mortars, designs, setting frames, foundations. Tile setting, hollow tile, wall, roofing, setting beds, mosaic. Concrete mixing, placing, re-inforced work, stucco, water proofing. Plastering in all its branches, wall board. Stone Masonry and Steel Construction for Masons. Estimating.

4 VOLS. COMPLETE \$6

FREE EXAMINATION COUPON

THEO. AUDEL & CO., Publishers, 65 West 23rd St., New York: Send me for free examination Audel's Masons' and Builders' Guides, 4 numbers, price \$6. If satisfactory, I will mail you \$1 within 5 days and \$1 monthly until paid.

Name.....
Address.....
Occupation.....
Reference.....

Do You Want to Make Big Money?

\$3500 to \$10000 a Year is Easy to Earn in ELECTRICITY!!



**Be a
Cooke Trained
Electrical
Expert**

Read the Proof From My Students

Earns \$800 in 23 Days

Earl R. Montrose, Mono Lake, Calif., gets electrical contract, completes it in 23 days and collects \$800 profit.



**\$7,000 a Year From
Electricity on Farm**



Herbert Dickerson used to earn \$30 a week. Now superintendent of Electrical equipment at North Wales Farm, Warrenton, Va., at \$7,000 a year.

**Makes \$750 in Spare
Time Work**

Before completing course, John J. Burke, 4300 E. Lombard Street, Baltimore, Md., made \$750 doing odd electrical jobs in spare time. Now runs his own electrical business.



**These Are Just a
Few of Hundreds!**

Never before was there such a demand for electricity and *trained* men to handle it as there is now. \$75 a week, \$100 and even \$200 is easy when you are properly trained—trained as I will train you right in your own home. Step out of your small-pay, no-future job. Be a "Cooke" Trained Electrical Expert, and get the big jobs in Electricity.

Big Jobs Open to You

In Radio Work, Power Plants, Contracting, Automotive Electricity—everywhere. The biggest jobs are open to "Cooke" trained men. My employment bureau sees to that. I am actually spending over \$25,000 a year just to get jobs for my students.

I Will Train You at Home

Being a college trained engineer with 25 years of practical experience and now Chief Engineer of the great Chicago Engineering Works, a Million Dollar Institution, I know exactly what kind of training you need to succeed in this big profession. That's what I give you—practical training by a practical man—the kind of training big electrical companies are looking for and are willing to pay for—the kind of training you will need to be successful in business for yourself.

Start Earning Money at Once

You can turn my training into money quickly. I give you FREE a whole outfit of tools and electrical apparatus and show you how to get and how to do spare time jobs. "Cooke" training pays its own way.

**L. L. COOKE, Chief Engineer
Chicago Engineering Works
Dept. 514, 2150 Lawrence Ave., Chicago**

My 16 Big Guarantees

I give you 16 definite guarantees when you enroll for my Course, including a signed bond to return every penny you pay me if you are not satisfied. These guarantees cover FREE Consultation and Employment Service, FREE tools, FREE use of laboratory, FREE Engineering Magazine and other things previously unheard of in home study training. I spare no expense to make you a big, quick success.

Use My Money To Go Into Business For Yourself

Every month I start two of my students in business for themselves. I give them all the money they need, help them get started and help them to a big success. Get the details of this great offer from my big FREE book.

Investigate — Big Electrical Book FREE!

You want proof! You want facts! These I give you in my big book—"The Vital Facts About Electricity"—proof that opportunities more wonderful than you ever dreamed of await you—proof that I will do for you what I say. Send for my new book now. Be a "Cooke" Trained Electrical Expert—Earn \$70 to \$200 a week. Mail the coupon NOW!

**Mail
this
Coupon
for my
FREE
BOOK**

Part of Big Free Outfit



**L. L. COOKE, Chief
Engineer, Chicago
Engineering Works,
Dept. 514
2150 Lawrence Ave.,
Chicago, U. S. A.**
Send me your book, "The
Vital Facts About Elec-
tricity." Full particulars of
your Home Study Course and
your sixteen guarantees, in-
cluding your plan for putting
students in business. This
does not obligate me to enroll
for your Course.

Name.....

Address.....

City.....State.....

The "COOKE" Trained Man is the "Big Pay" Man!



\$20 a Week Clerk
now Auditor
at \$25 a Day

**\$20
A WEEK**

Seven years ago, J. H. Hackney, a Florida man, was employed in a grocery store at \$20 a week.

"Recently," he writes, "the Hackney Audit Company, of which I am president, was employed by the same grocer under contract to make an audit at our regular rate of \$25 a day."

Real progress, that! And how simple his explanation. "Increased efficiency has always meant increased earnings. *Hard work on a LaSalle course in Higher Accountancy will do it.*"

"Within six and a half months after receipt of the first lesson," writes J. B. Lewis, a Missouri man, "your training secured for me a \$25-a-month increase in salary, followed by a second \$25 increase three and a half months later—or a total increase of about \$400 before I had mailed the last lesson of the prescribed course."

You Have the Same Good Opportunity

Is it worth 2c and two minutes of your time to learn in detail of the opportunities that would be yours in the field of Accountancy?

Then fill out and mail the coupon—there's not the slightest obligation—and read how men still in their twenties and early thirties have broken away from the low-pay ranks and today are expert accountants—with incomes ranging from \$3,000 to \$10,000 a year.

Your start toward a bigger salary is as near you as the point of your pencil. For the sake of a brighter future—ACT.

LASALLE EXTENSION UNIVERSITY

The World's Largest Business Training Institution
 Dept. 464-HR Chicago, Illinois

I would welcome copy of "Accountancy, the Profession that Pays," also a copy of "Ten Years' Promotion in One," all without obligation.

Higher Accountancy

Training for positions as Auditor, Comptroller, Certified Public Accountant, Cost Accountant, etc.

Other LaSalle Opportunities

LaSalle opens the way to success in every important field of business. If more interested in one of the fields indicated below, check here:

- | | |
|---|--|
| <input type="checkbox"/> Business Management | <input type="checkbox"/> Modern Business Correspondence and Practice |
| <input type="checkbox"/> Modern Salesmanship | <input type="checkbox"/> Modern Foremanship and Production Methods |
| <input type="checkbox"/> Traffic Management | <input type="checkbox"/> Personnel and Employment Management |
| <input type="checkbox"/> Railway Station Management | <input type="checkbox"/> Expert Bookkeeping |
| <input type="checkbox"/> Law—Degree of LL.B. | <input type="checkbox"/> Business English |
| <input type="checkbox"/> Commercial Law | <input type="checkbox"/> Commercial Spanish |
| <input type="checkbox"/> Industrial Management | <input type="checkbox"/> Effective Speaking |
| <input type="checkbox"/> Efficiency | <input type="checkbox"/> C. P. A. Coaching |
| <input type="checkbox"/> Banking and Finance | |

Name

Present Position

Address

I Pay You While You Learn!

Write immediately for my sensational profit-sharing plan. Let me tell you about my offer to pay you for your work while still a student. Individual, personal instruction makes you an Expert quick. My graduates are successful and in demand.



No books, no classes here. All practical work on actual watch jobs.

Be an

Expert Watchmaker!

Good jobs everywhere for Experts! In my big Chicago School you can learn watchmaking better in a few months than by the old apprentice system in years! 9 successful Jewelers out of every 10 started as watchmakers—so here is your chance to win money and success in the jewelry business!

\$55 TO \$90 A WEEK!

You never see a Trained watch expert out of a job. Get my training and my goodbyes to unemployment and hard times. I will help you find a spare time job while training and an Expert's job and pay when you graduate. For a limited time I give every student Free, courses in Jewelry Repairing, Mounting and Engraving.

THOMAS SWAILEY, Principal,
 Chicago School of Watchmaking,
 Dept. 301
 4844 Lincoln Ave., Chicago

FREE

Complete watchmaker's outfit given free to every student this month. Write immediately for catalog and profit-sharing offer.

Anyone CAN LEARN

No talent or experience necessary. Fascinating work. Pays big money. Complete instruction book tells about: Alphabets, Colors, How to Mix Paints, Stencil Cards, Window Board and Wall Signs, Ready made letters, Gliding, Trivials of the Trade, also gives 100 Alphabets and Designs. Book bound in flexible imitation leather-gold edges, and four half bearing Show Card Pens. Sent postpaid \$3.00, C.O.D. \$1.10c ex. Bellie Pub. Co., 57 Ross St. Dept. 50, N.Y. City

EARN MONEY IMMEDIATELY—
WE FURNISH EQUIPMENT TO START!!

LEARN MECHANICAL DENTISTRY

Earn \$35 to \$125 a week. Taught by actual practice—day or night. Three months' course. Modern laboratories. No previous training required. Established 39 years. For 35-page catalog, write Dept. 2.

NEW YORK 126 W. 52d St. PHILADELPHIA 1306 N. Broad St. BUFFALO 1226 Main St. BROOKLYN 85 Court St.



On the Deagan Xylorimba

Become a crack Xylorimba player right in your own home. Easiest instrument to play. Everyone enjoys it—anyone can learn to play it. We furnish you free 14 complete lessons. Learn to play in a few hours. Earn \$80.00 to \$200.00 a week. Deagan instruments are world-renowned—used extensively in leading dance, theatre and concert orchestras, and for Radio Broadcasting. Yet, the cost of the Deagan Xylorimba is no greater than the cost of any other good instrument.

FREE LESSONS—A YEAR TO PAY Our free trial and easy payment plan make it easy to learn at home. Send coupon below for illustrated literature and details of our special free trial offer.

SEND THIS COUPON

J. C. DEAGAN, Inc., Dept. 1354
 Berteau & Ravenswood Aves., CHICAGO, ILLINOIS
 Gentlemen: Without obligation, please send me literature and full information regarding your Free Trial Deagan Xylorimba offer.

Name

Address

This Success Was Built By Helping Men



**Thousands of Men Now
Earning \$50 to \$200
Per Week in the Auto
Business Owe Their
Success to
GREER TRAINING**

ERWIN
GREER



GREER COLLEGE - 1915 & 1920

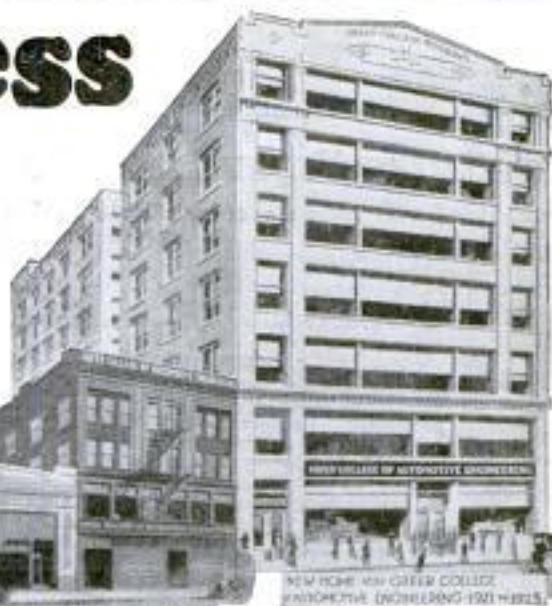

NEW YORK - NEW GREER COLLEGE
AUTOMOTIVE ENGINEERING - 1921 - 1925

GREER COLLEGE TODAY

Heavy Summer Auto Traffic Means CASH to You If You Learn Auto Trade NOW

Men, there's something I want to tell you, based on my own experience, "To succeed you must deliver the goods." You see above how I started 23 years ago. Today, Greer Automobile students are trained in a mammoth 7-story building containing over 3 acres of floor space entirely devoted to my training shops and equipment.

This growth has been based on the successful automobile, truck and tractor training I and my staff of experts have given to over 40,000 men. Over 30,000 of these men have been enabled by my training and assistance to go in business for themselves, making big money. Every man trained here has received his money's worth, and knows it. Increased earning power shows it. Many of the men who constantly come here for training are sent by men I have already trained. That indicates the kind of satisfaction upon which Greer success has been built. Thousands of letters testifying to this satisfaction are in my files. Anyone can examine them.

The Chance For You WRITE FOR FREE BOOK

New Spring Training Class now forming. Get in this class and make the BIG MONEY through the heavy AUTO SEASON and for life. Don't miss this chance! Quick action will pay you well. Mail a card, or the coupon, for Special Training Offer and Free Auto Book.

My Free Employment Department is always at your service to help get you a job during training or after. If you want to go in business for yourself I help you make a start. My training prepares you for the big money in Automobile Repair work, Selling, Shop Management, Electricity, Storage Batteries, Tire Repairing, Vulcanizing, Welding, Driving—every job in the auto business.

My new offer makes it EASY for you to get this training. Requires only few short weeks. Then the big money opportunity is yours for life. Get my free book and special terms. Just say "Send offer" and put your name on a post card, or—

Write for FREE BOOK
and Special Train-
ing Rates

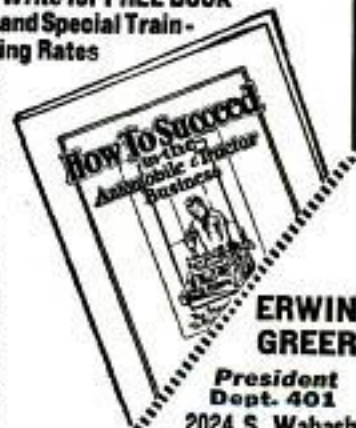

ERWIN
GREER

President
Dept. 401
2024 S. Wabash
Avenue
CHICAGO, ILL.

MAIL THE COUPON
Address me personally

Erwin Greer,
President.

GREER

COLLEGE
**Automotive
Engineering**
Dept. 401, 2024 S. Wabash Ave.
CHICAGO, ILL.

Please send me FREE BOOK "How to Succeed in the Automobile and Tractor Business," and special training offer. This request does not obligate me in any way.

Name.....

Address.....

Two Incomes

Good Salary; Paying Home Work

Read this letter from a successful Dobe student

"As a beginner I am doing fine. Am earning a salary of \$200 a month, besides I made over \$450 at home the last two months. The practical drafting training you gave me by mail put me where I am in less than six months study. Thank you for all your personal interest and help."
(Signed) J. B. (Name and Address upon request.)



Chief
Draftsman
DOBE

I Guarantee:

To train you on practical work under personal supervision until competent as a regular draftsman, and guarantee further to furnish you with draftsman's complete working outfit, a special "Chief's Own" drafting table, and all the instruments you need, just as soon as you become my student—all to be included in the course without extra charge.

You May Earn a \$90 Drafting Course

In addition to my other offers, I have made arrangements whereby you may earn a regular \$90 drafting course while you are my student. I want to offer every inducement to ambitious men anxious to succeed in a big way. Big companies issue calls every day for skilled draftsmen to fill good paying positions. A trained man can be reasonably sure of a good job all the time. Write for details.

Drafting Outfit Drawing Table Included!

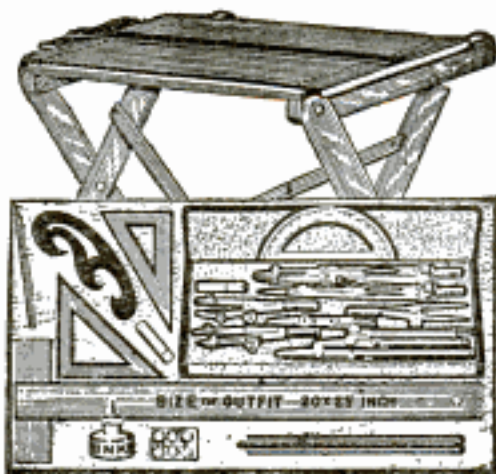

Here is the drafting outfit and drawing table which I send you without any extra charge whatever, the minute you become my student. You get every tool you need. The retail price for these articles is approximately \$28.00.

Read again the letter above. What other students have done, you can do. Write to me. Make your start now.

Write for FREE Book Send Coupon Today

Get this great book—"Successful Draftmanship." Send coupon for free book today.

Chief Draftsman Dobe

1951 Lawrence Avenue, Div. 13-54 Chicago, Ill.

CHIEF DRAFTSMAN DOBE

1951 Lawrence Ave., Div. 13-54 Chicago, Ill.

Without any obligation to me please mail your book, "Successful Draftmanship," and full particulars of your liberal "Personal Instruction" offer to a few students.

Name.....Age.....

Address.....

Post Office.....State.....

Be a Certified MASTER TELEGRAPHER!



EARN \$165 to \$500 EVERY MONTH!

I guarantee to make you a cracker-jack Telegrapher in a few months by famous Dunlop System! No books here. All practical work on actual equipment. Prepares you for big pay jobs with Railroads, Brokers, Telegraph Companies, Newspapers, Broadcasting Stations or great ships.

LEARN QUICK BY DUNLOP SYSTEM!

Write today for confidential offer to ambitious men, women, boys, or girls. I help you earn while you learn—you can work your way thru my school. Big catalog and complete information FREE.

DEL DUNLOP, Chief Dispatcher, Chicago Telegraph Institute
1338 S. Michigan Ave. Dept. 601 Chicago

LEARN

Painting—Decorating

Paperhanging, Marbling and Graining, Sign and Auto Painting, Show Card Writing. All practical courses. Learn in a few weeks by actual work in the world's Largest Painting Shops. Earn \$10 to \$20 a day. Be an expert. No books—no classes—start any time. Write for Free Book and Special Offer.

CHICAGO PAINTING SCHOOL, Dept. 1354

150 West Austin Ave.

CHICAGO, ILLINOIS

Factory to Rider

Saves \$10 to \$25 on the Ranger Bicycle you select. You can have your choice of 44 Styles, colors and sizes. Delivered from on approval, express prepaid, for 30 DAYS' FREE TRIAL. Bicycles, \$21.50 up.

if desired. Possession and use at once on our Liberal Easy Payment plan. Parents often advance first payment.

Best quality, at factory prices, express prepaid. Lamps, horns, wheels and equipment, low prices. Send No Money, do business direct with makers.

MEAD CYCLE COMPANY
DEPT. C CHICAGO

Write today for free Ranger Catalog, factory prices and marvelous loan easy payment terms.



MY U. S. GOVERNMENT JOB

"Yes, dear—I now work for 'Uncle Sam.' Today I received appointment.

Tomorrow, I go out on my first Railway Mail run to Washington, D. C. From now on I will travel on pass and see my country.

"I commence at \$1600 a year and expect to raise to \$2300 within a short time.

"I have a Summer vacation with full pay and very pleasant work."

Thousands of U. S. Government Jobs are obtainable by men and women 18 up. Mail the coupon TODAY SURE. You may then soon find yourself in a well paid U. S. GOVERNMENT JOB.

FRANKLIN INSTITUTE,
Dept. B 150, Rochester, N. Y.

Send me at once, free of charge, (1) List of U. S. Government Jobs obtainable. (2) Full Information regarding salaries, hours, duties etc. (3) Send free sample examination coaching.

Name.....

Address.....

EVEREADY HOUR
EVERY TUESDAY AT 9 P. M.
(Eastern Standard Time)

For real radio enjoyment, tune in the
"Eveready Group" Broadcast through
stations

WEAF	New York	WFI	Philadelphia
WJAR	Providence	WOAE	Pittsburgh
WEKI	Boston	WGR	Buffalo

*Dry "B" Batteries
are an economical,
dependable and
convenient source
of plate
current!*

Satisfaction Reliability Economy

You need three things in radio "B" Batteries—satisfaction, reliability and economy. You get them all in Eveready "B" Batteries. Satisfaction, because they produce all the current needed by your tubes, giving you the maximum results of which your set is capable. Reliability, because you can depend on them to work at full power. Economy, because they long maintain their strength, and because they are low in price.

Advances in the art of battery manufacture make Evereadys last longer than ever. You actually get much longer service for your money.

There is an Eveready Radio Battery for every radio use.

Buy Eveready Batteries.

Manufactured and guaranteed by

NATIONAL CARBON COMPANY, Inc.
New York San Francisco
Canadian National Carbon Co., Limited, Toronto, Ontario

EVEREADY Radio Batteries

-they last longer

Eveready
Columbic
Ignitor
Dry Cell
"A"
Battery
for all
Dry Cell
Tubes
1 1/2-volt



No. 766
27 1/2-volt
Large
Horizontal
Price
\$2.00



No. 772
45-volt
Large
Vertical
Price
\$3.75



No. 771
45 1/2-volt
"C"
Battery
improves
quality
saves
"B"
Batteries
Price 60c

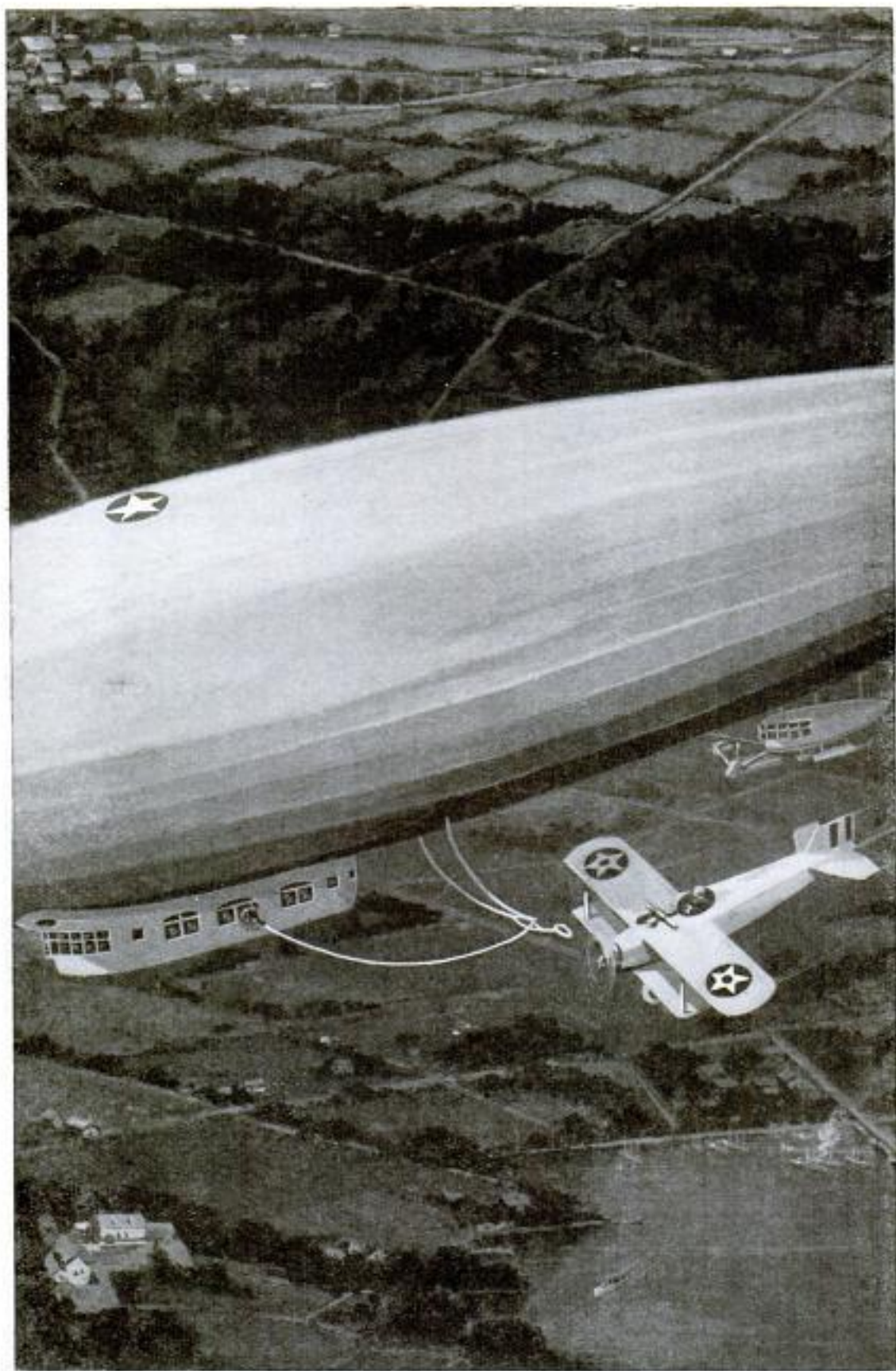

Artist's Conception of Airplane "Hooking On" to Airship, as Successfully Demonstrated by American Army Pilots in Tests at Scott Field—See Page 570

2522

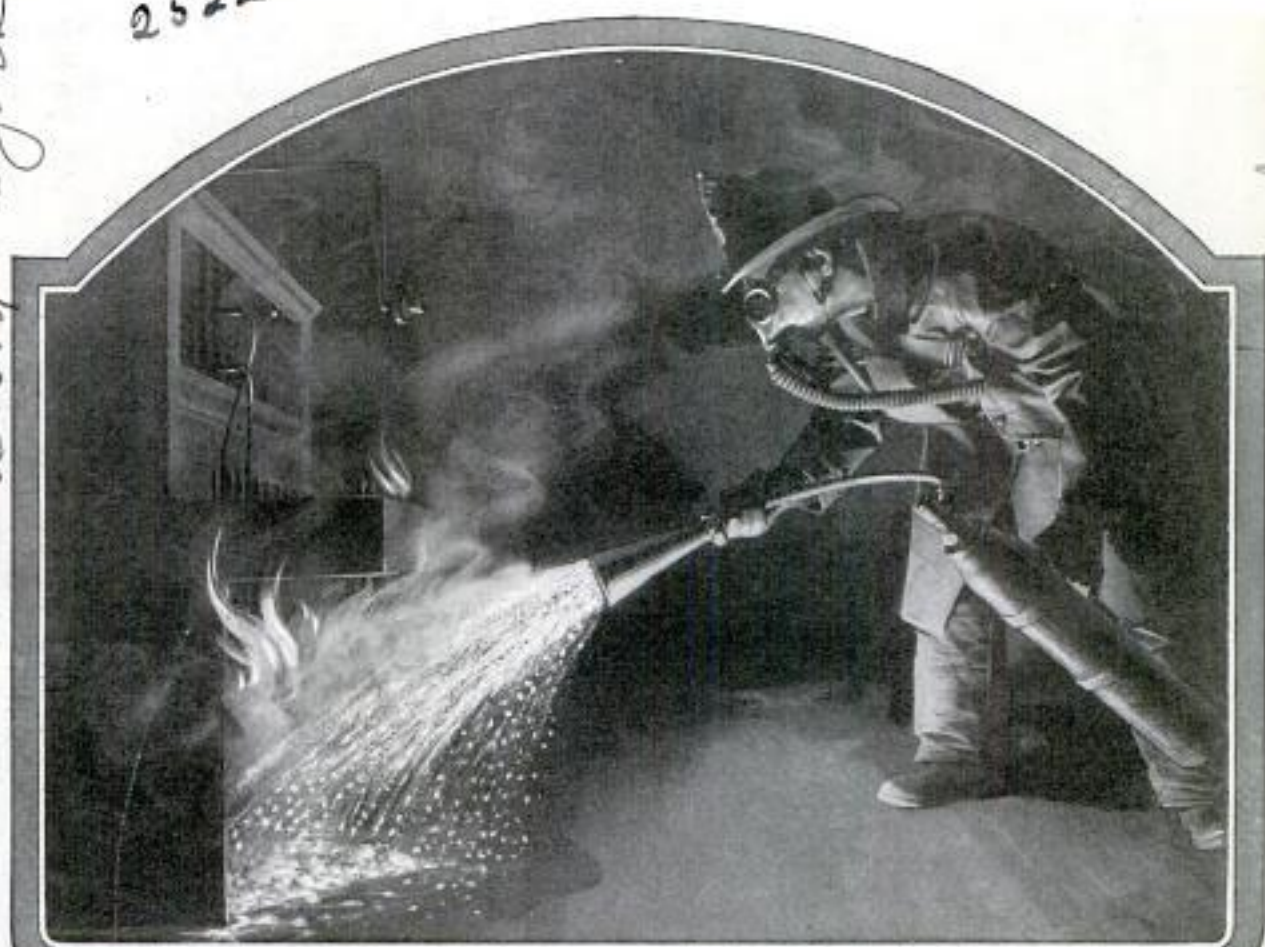

ARTIFICIAL SNOWSTORMS TO FREEZE FIRES

FIRE extinguishers which will literally freeze a fire to death, while covering the burning area with a dense gas, which bars all air and oxygen on which the flames might feed, have been devised for fighting switchboard fires, and also for oil tankers and other ships where fires in the cargo hold present a serious problem.

The extinguishers, which are merely tanks loaded with the carbon-dioxide gas used at every soda fountain to carbonate the soda water, eliminate the water damage which forms one of the greatest losses in ordinary fire fighting.

In the tank in which the soda fountain proprietor buys the gas it is compressed to liquid form, under a pressure of about

900 pounds to the square inch. In that form the contents of the tank retain the temperature of whatever room it may be placed in. But as soon as the valve is opened and the liquid gas is sprayed into the air, it instantaneously drops to a temperature of 110 degrees below zero, and falls as a fine powdery snow. The falling snow is accompanied by clouds of the expanding gas, looking like steam. The gas is so heavy that it falls over the fire surface, displacing all air, and cutting off the supply of oxygen, without which fire cannot exist.

The ability of the gas to put out fire has been known for many years, but the problem has been to design a nozzle which will

Research University of Pittsburgh
 Pittsburgh, Pa.

Liquid Carbon Dioxide Snow - 30 & 40 not St. New York

Developed by Charles B. Jones, Mellon Institute of Industrial

2582



The Gas That Carbonates the Soda Water Is the Same Material Used Now to Extinguish Fires

not freeze up from the intense cold caused by the expansion of the gas. It finally has been solved by making the outlet hole very small, so that contraction of the gas rushing through it offsets the cold, producing expansion outside. The nozzle is supplemented with a megaphonelike horn. The research work was done by Dr. Charles L. Jones, of the Mellon Institute, Pittsburgh, Pa.

Commercial carbon dioxide is made by burning coke. The flue gases contain 18 per cent of carbon dioxide. They are drawn off through superheaters, scrubbing and washing towers, which remove soot and other gases, then through a lye boiler and into an atmospheric cooler, which separates the remaining water vapor from the pure carbon-dioxide gas. It then passes through three compressor stages, with alternating coolers, until it finally passes out as a hot gas at a pressure of 1,200 pounds to the square inch. A final cooler reduces the gas to a liquid, and brings the pressure down to 900 pounds. From the outlet pipes by which the liquid is passed into the soda water fountain tanks and fire extinguishers, the gas can be released into a bucket in the form of snow, with its temperature of 110 below zero, or 142 degrees below the freezing point of water. A bucketful of the

snow dumped out on a table in the sun will last for more than an hour, and when the last bit finally disappears, nothing is left behind, not even water, since it contains no water, and disappears in the form of a gas.

The snow is so cold that a piece held in the hand for more than a second or two will cause a burn, just like a lighted match. Burns are the reaction on the skin of the rush of heat through it, and it makes no difference which way the heat rushes, into or out of the hand, the resulting effect on the skin is the same.

The carbon-dioxide snow is so cold that its temperature cannot be measured with an ordinary mercury thermometer, since mercury solidifies at fifty degrees below zero. This is demonstrated by hollowing out a cup in the top of a pile of the snow and filling it with mercury. In two or three minutes the mercury is a solid lump of metal, firm enough to drive a big spike through a heavy board. A steak placed on the snow will freeze so hard that

when dropped on the floor it will break into a multitude of pieces. One way of testing rubber tubing in the laboratory is to cover it with carbon-dioxide snow, then take it out and break it in pieces in the hands. The frozen tubing snaps like a match stem.

Besides its use in carbonated beverages and for putting out fires, carbon dioxide can be used as a leavening agent in baking bread, for ripening citrus fruits, storing apples, grapes, grain and other crops, for spray painting, operating railway signals, cleaning plumbing, motive power for torpedoes, testing pipes for leakage and inflating automobile tires.

As a low temperature agent it is used in mechanical refrigerators instead of ammonia or other dangerous gases, as a starter for liquid air machines, as a refrigerant and local anesthetic in medicine, for freezing mixtures and testing samples in the laboratory, for humane killing of animals and for invigorating carbonated baths. In chemical industries it plays a part in the manufacture of salicylic acid and aspirin, in boiling out cotton and wool, in the making of white lead, in distilling various products, and the manufacture of pure carbonates. The rubber factories use it in inflating air bags, making cellular products and for atmosphere in dry-cur-

1-11-11
in
1-11-11
1-11-11

*cont. from red lb. Gals...
2560...
Los Angeles*

ing rubber. It will loosen some types of boiler scale and treat water.

Its most spectacular use, however, remains as a fire extinguisher. In a test recently a forty-five-second capacity cylinder was turned on a bonfire built up of wood, old boxes, papers and excelsior, on which had been poured a gallon of fuel oil and a gallon of kerosene. The flames were leaping eight feet in the air, but in three-quarters of a second the fire was out, leaving behind quantities of snow. The snow was so cold it did not melt in the very heart of the fire.

Hero - [unclear]

Seaplane with Hull Like a Boat Has Wheels for Land Use

An airplane of metal, designed for operation over both land and sea, has a boat-like hull instead of pontoons to keep it afloat in the water. The craft carries a crew of three and sufficient fuel for a non-stop flight of 700 miles. In emergencies the gasoline storage can be greatly increased to permit extended cruises. The ship, which is constructed for coastwise or inland service, has been put under tests by the army aviation division. It is also expected this type of flyer might be used for commercial transportation where flights are to be made between seaports or along inland waterways. The motor of the machine is of the inverted model which places most of its bulk below the thrust line of the propeller, materially aiding the progress of the plane.



Getting News of Next Week's Show from Illuminated Sign Carried on Usher's Back

Theater Ushers with Signs on Backs Announce Coming Attractions

Illuminated signs carried on the backs of ushers are being used in a California motion-picture theater to announce approaching attractions. As the attendants reach the darkened aisles, they press an electric switch carried in the hand. A tiny bulb over the sign flashes and persons following have a chance to read the legend on the card before reaching their seats.



Metal Seaplane with Wheels Attached to Boatlike Hull, for Use in Ground Landings, Which Carries a Crew of Three and Fuel for a 700-Mile Non-Stop Flight

*... 420 8.31 ...
Copyrighted material*

James L. Clark Studios
1160 Southern Blvd
New York City

2625

532 POPULAR MECHANICS

Chicago Rev. Post
1/27/25
Airman Knocked Out in Rapid Flight
by Pressure of Wind Past Plane

2553 Dead Animals Made to Look Alive
by Sculptor's Skill

In the heart of New York city is a sort of jungle where wild animals are grouped

Absent-mindedly sticking his head out from behind the windshield while making a record flight at the rate of more than 280 miles an hour. Florentin Bonnet, noted French aviator, was knocked unconscious, he told friends after the accident. The force of the wind, he said, struck him on the side of the jaw with the strength of a boxer's blow and he estimated that he was "out" for twenty seconds. He attempted to lean over the side of the cockpit as he was preparing to bank his plane on a turn.



Putting "Life" into Stuffed Specimens; Artist with a Bear Mounted in Fighting Pose Advancing to Attack

about in lifelike postures, and rare species of birds are poised on the wing as though pausing in actual flight. It is a taxidermist's studio where an expert in the art of stuffing animals has co-operated with a well-known sculptor in achieving realistic poses of specimens killed by big-game hunters for private and public collections. Details, such as the position of the claws and facial expressions of the beasts when fighting, are developed with the same fidelity to nature that the sculptor endeavors to give to his clay when modeling.

2552 Banks for Sale in Vending Machines
Encourage Savings Deposits

Conveniently placed on a window ledge in a Chicago bank, is a vending machine that distributes small pocket savings boxes when a dime is dropped in the slot. This is credited to the depositor when he opens his account. The plan is said to have simplified the task of getting new customers, and serves as a reminder to those who see the machine to save their money.

Autos Are Shipped in Paper Sacks to Keep Out Cinders and Dust

Big paper bags, tightly sealed and fitted, are being used by automobile manufacturers to shield their product from dust and cinders on railroad journeys. They are said to have given better results than cloth containers, are less expensive and keep the autos almost as bright and shiny as they are when they leave the factory. Great care is taken to see that the freight cars are thoroughly cleaned before loading. Water is applied to the roofs to test them for leaks, and the floors are usually covered with dust-proof paper before the automobiles are blocked into place.



Copyright, Underwood & Underwood
Using Savings Box Vending Machine Bank Has Installed on Window Ledge to Attract Customers

Strongheart Co.
2944 W. Lake
Chicago

2601
Lumeta Auto Co.



Copyright, Underwood & Underwood
 Two Leading Varsity Crews of Great Britain with Every Muscle Stressed for a Final Swift Spurt as Their Crafts Approach the Finish Line of a Hard Contest

Oarsmen Are Found More Efficient Than Steam or Electric Motors

In tests to measure the energy used by trained racing oarsmen, at Yale university, it is said by the experimenters that the rowers showed more efficiency than most gasoline and steam engines, since approximately one quarter of the boatman's power goes directly toward propelling his craft. The driving power of the motors generally registers amounts much below this figure. Special apparatus demonstrated that an oarsman will breathe on an average 3,696 cubic inches of air a minute during a contest. One man will produce almost four horsepower in the early part of a race and will consume body fuel equivalent to about half a pound of sugar.

2124.

Signals for Both Ends of Auto Show Stop, Go and Turns

A set of colored lights that may be placed both on the front and rear of the car has been devised for greater safety in driving. Red, yellow and green have been chosen to indicate stops, change and safety

or "go" signs. In addition to these, there is an orange light signifying that the driver intends to turn to the left and a violet one for a right turn. The latter two are controlled by hand switches and the others work automatically. Placed in front of the radiator in a conspicuous position, the battery of lamps is said to be of special value when the driver contemplates a turn. They give approaching auto-

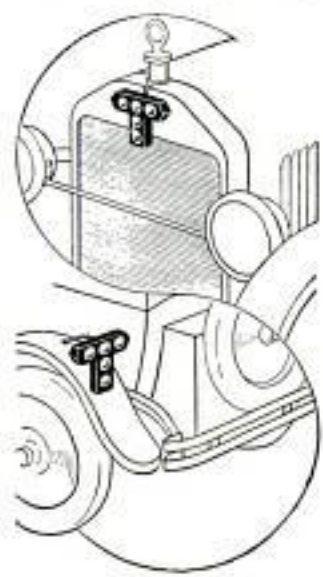

ists a positive signal of the car's intended course in addition to the usual arm signal, and this is an extra safety measure especially for oncoming cars. The lights consume but little current, are easily installed and the color of the lenses may be changed to conform with the traffic system of any locality.

*quit installation
 \$16.50. one end
 where two are used.*

*Woodworkers Hardware Mfg. Co.
 1201 Cortland St. Chicago*

U. W. H. Hartman,

534 1947 Broadway **POPULAR MECHANICS**

Deep-Sea Camera to Reveal Wonders of Sunken Fleets and Cities

2371 Some of Jules Verne's fantastic inspirations of a half century ago may become a

fect a flood of powerful light on the objects to be studied and photographed, while an artificial screen will be created by filtering a chemical down through the water. This background will also serve to reflect

the rays of the light which might otherwise be lost in the dark depths of the sea. Below the main cylinder is suspended a shorter magnetically locked tube containing storage batteries and which is weighted to overcome the buoyancy of the entire structure, causing it to sink. In case of emergency the operator can release and drop this tank, allowing the rest of the apparatus to rise to the surface and safety. The camera, which can take either still or motion pictures, is inclosed in a small water-tight covering and may be moved up and down by means of an electric motor and gear connected to a toothed rail. The occupant of the diving device can turn with the camera in any direction or angle desired. There is practically no pressure on the operator who controls all parts of the machine with electric switches and push buttons. Air is constantly renewed while impurities are absorbed by a special device, and the interior

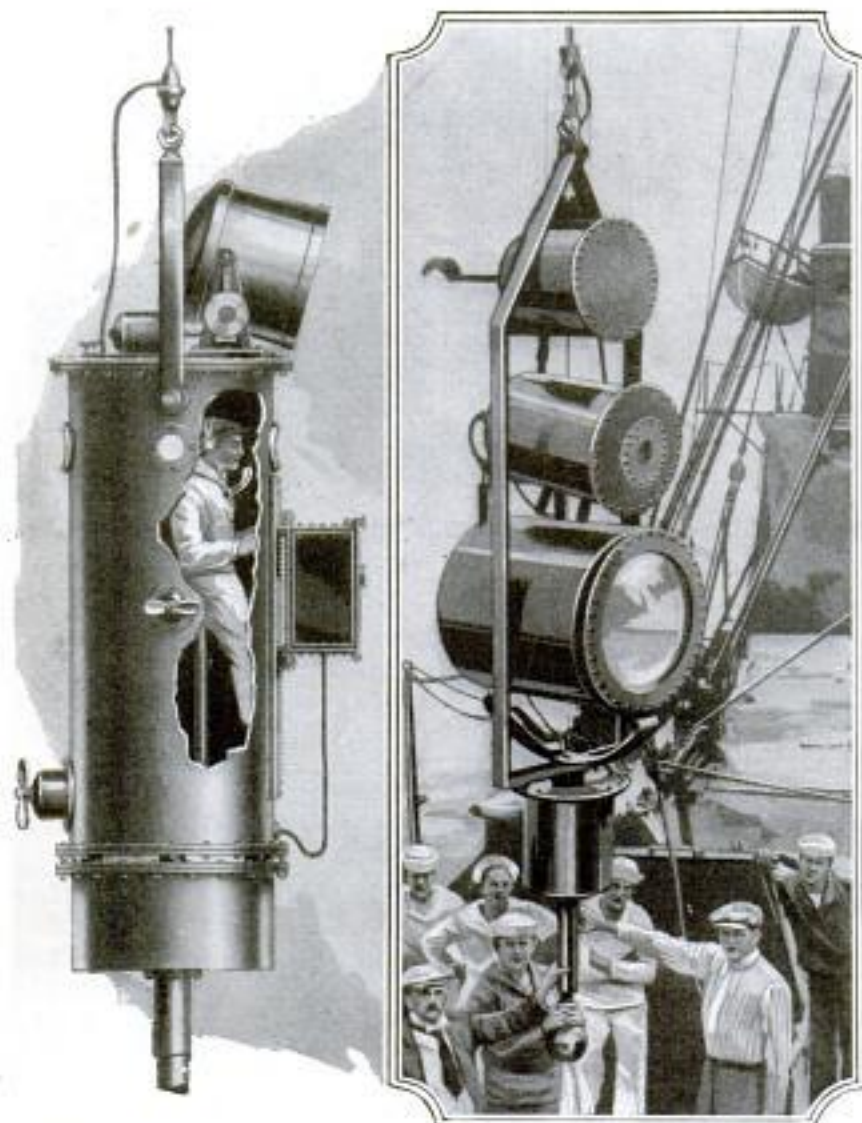

Swinging the Battery Tanks and Lights of the Deep-Sea Camera into Position for an Under-Water Descent; Left, Operator in Projector Chamber

reality through the efforts of a scientific expedition organized to photograph a sunken Roman city discovered at the bottom of the Mediterranean sea and to seek treasures among submerged ruins of vessels wrecked many centuries ago. The submarine camera consists mainly of a steel cylinder, thirty-two inches in diameter, which provides ample space for the operator who occupies a seat in the tube similar to a bicycle saddle. Observations are made through small portholes closed with heavy lenses, and constant telephone communication is maintained with assistants above water for the direction of salvage operations that are carried out with other apparatus. Above the steel cylinder a specially constructed projector will re-

rior of the chamber is warmed by an electric heater. All films will be developed on board the tender ship and examined in a trial projection room before the expedition leaves a particular locality.

262 **Carrier Pigeons and Radio**

Observations of carrier pigeons flying over a radio aerial, seem to indicate that the birds' sense of direction is affected by wireless. A Spanish experimenter noticed that as they flew over the antenna, on their way to the pigeon house, they seemed to falter and more or less "staggered" through this part of the area until clear of the wire and then resumed flight. Variations in the wave length did not alter results.

Auckland News
12/25/24 Copyrighted material

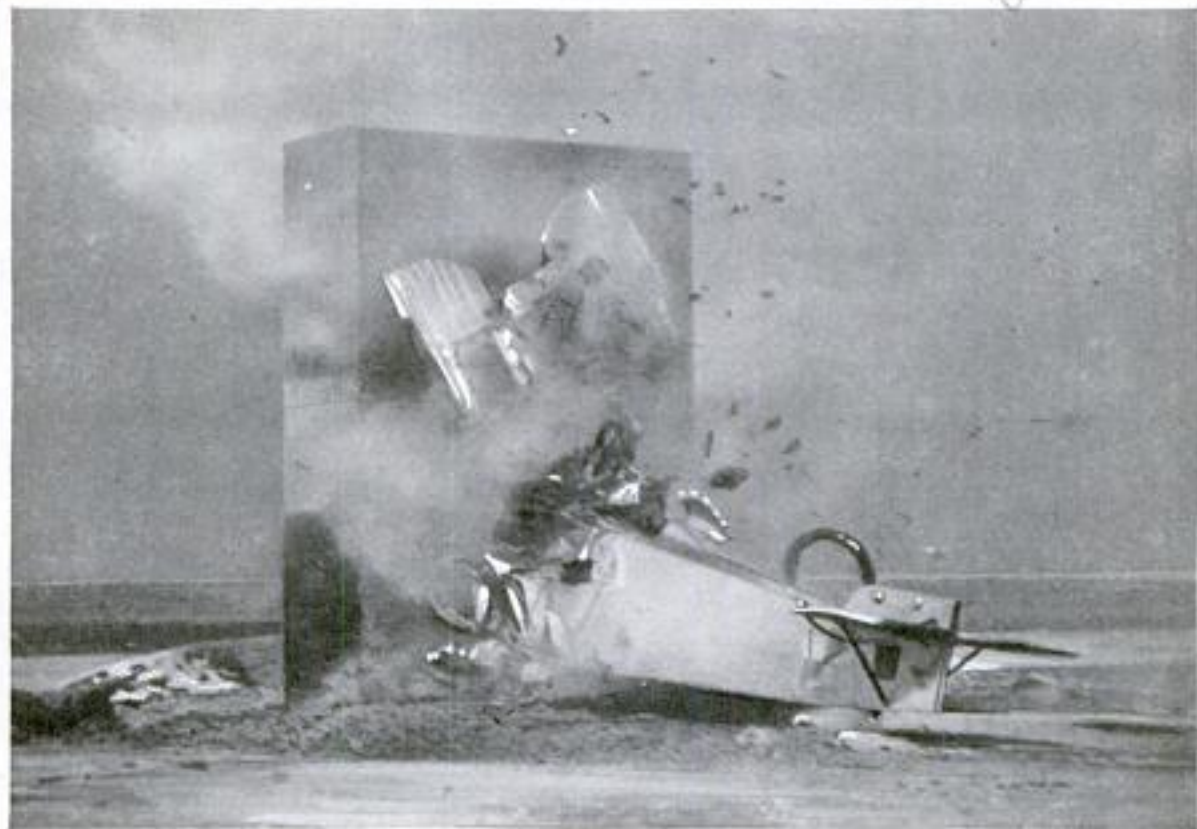

Wrecking an Old Plane against a Concrete Wall at the Army Testing Field to Study Its Weak Points and Determine Dangers of Gasoline Explosion

How Safe Is an Airplane?

Figures Show Air Travel Risk Is Not Much Greater Than That of a Passenger Train, and Less Than Automobile Racing

By MAJOR R. W. SCHROEDER

(Former World's Altitude Record Holder and Ex-Chief Test Pilot, U. S. Army)

MAJOR-General Mason M. Patrick, chief of the army air service, recently told a convention of life insurance presidents that commercial aviation was as safe as railroad travel, and entitled to recognition in the form of more liberal life insurance rates for pilots and passengers. He cited the fact that in three years there was but one passenger fatality on the British and



Major R. W. Schroeder

Dutch commercial airways for every 2,663,000 passenger miles flown. This he compared to the record of the American

railroads over a number of years up to 1913 of killing one passenger for approximately every two million passenger miles.

Civilian aviation is even safer in many instances than life on the ground. I have figures showing eight people lost their lives in the entire United States in civilian aviation in 1921, and during the same year, in the state of Missouri alone, eighty people—just ten times as many—were kicked to death by mules!

The general public is waiting for air travel to be made safe before taking to it as a regular means of getting from one place to another. But the public has quite overlooked the fact that safety has already arrived—sufficient to warrant the general use of commercial aircraft on a large scale. The post office department for months has been maintaining day and night service from New York to San Francisco

and is now extending the night mail service east from Chicago. In 1922, the banner year of the airplane mail service, post office pilots flew 1,756,803 miles with one fatality, a record that compares favorably with the best showing of the railroads and is far better, undoubtedly, than the automobile death toll. In 1923, when the service was being overhauled and expanded, the death toll was six pilots for 1,870,422 miles, or an average of one death for each 311,737 miles. With night flying under way along a well-charted course, and adequate inspection of equipment, the showing was much better in 1924. The figures for the year were three deaths in 2,151,061 miles of flying, or one life lost for each 717,020 miles.

The perfection of the airplane has reached the point that there are pilots in the mail service who haven't had a forced landing in five years. Their planes and motors function perfectly, thanks to systematic and regular care after each trip.

"How does it feel," I asked one of the night mail pilots, "to take off every night, in rain or snow or fog, and start for Omaha with nothing but a string of lights on the ground to guide you?" "Why this is a soft snap," he laughed. "It's easier than daytime flying. Then you are bothered with the haze on the ground and have to keep constant watch to pick up your landmarks. But at night you can sit back in your seat, peep along the side of the ship and just watch your guiding lights pour in over the wing. You can't get off the course; you don't even have to think about it"

Commercial aviation has not developed as fast in this country as abroad for several reasons. One is the abundance of railroads and fast trains. Abroad, the closeness of frontiers and the annoying delays incident to customs inspec-

tions, have helped to make flying popular. The stormy English channel has likewise played a part. Many of the passengers who regularly fly from London to Paris take to the air to avoid seasickness on the channel crossing, as well as to avoid the change from train to boat and from boat to train, with the incidental delays at the customs.

The attitude of the insurance companies, brought out in General Patrick's appeal to their presidents, has also played a part in holding back flying in the United States. Aviation insurance is much farther advanced abroad, though the rates there are still high enough to bring protests from flying men. Lieut.-Col. H. T. Tizard, chairman of the Royal Aeronautical society, in a recent address said: "Flying is unsafe? Here the common-sense view is undoubtedly right. It is unsafe. Not dangerous but unsafe. About as unsafe, let us say, as mountaineering, but hardly as unsafe as motor-car racing."

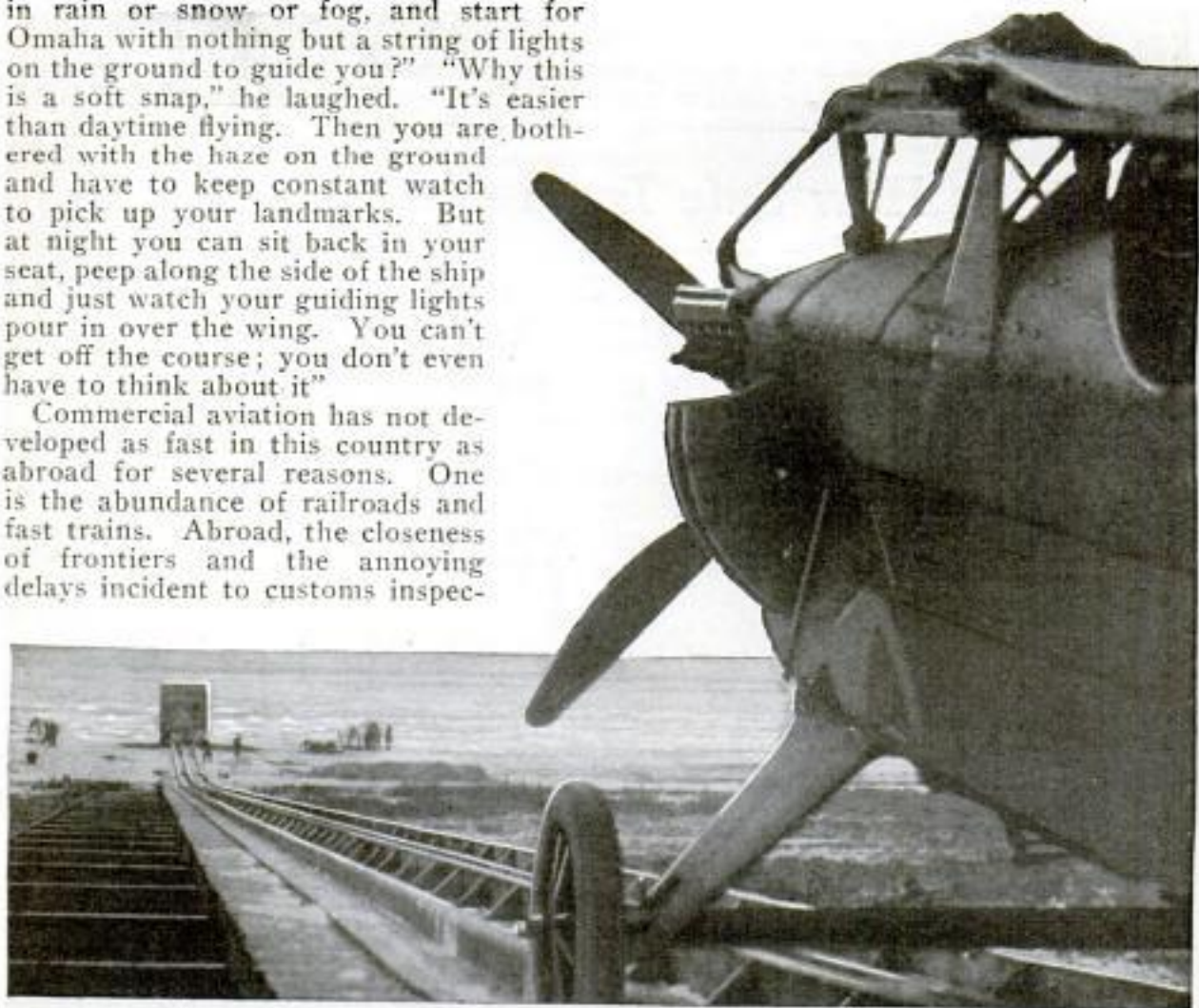

The Airplane, Held to the Monorail Track, Ready to Start Down the Incline under Its Own Power to Be Dashed to Pieces against Wall in Safety Test

Stored Energy in Flywheel Is Used to Crank Airplane Engines 2634. **Springs on Sandals Worn as Skates Add to Children's Sport 2441**

An airplane engine starter, in which energy stored up in a flywheel by revolving it with a hand crank is used to turn over the motor, has been placed on the market. It is claimed to crank an engine of 600 horsepower or less at three or four times the speed of electric starters and from twelve to fifteen times the speed of hand starters. The device gives the engine from three to eight quick revolutions. The principle employed is the same as utilized in toy automobiles and engines, where a heavy flywheel is stored with energy by giving the toy several quick pushes, and then turned loose, the accumulated energy being returned to the wheels to propel the machine. In the airplane starter, a gear train giving a total reduction of 133 to one connects the flywheel with the crank. A few easy turns of the crank will, in from twenty to thirty seconds, set the flywheel revolving at a speed of several thousand revolutions a minute. A clutch is then engaged and the stored energy spins the engine. Ball bearings support all the gears, which are inclosed in an oil-tight casing, while the cranking handle is equipped with a ratchet release to protect the operator.

2400

Pasteboard Suit Box with Handle Eliminates Need of String

Fashioned from a single piece of stout pasteboard, a box for carrying suits and similar articles has a handle at the upper edge. It is part of the container itself, being an extension of the sides of the box with a hole for inserting the fingers. The grip will support from thirty to fifty pounds, it is said, saves the bother and uncertainty of string, and as the box is flat and easy to carry, it is suitable for travelers and may be used as ordinary leather luggage. Metal eyelets inserted when the paper is flat, keep the edges together.



Sandal Springs with Wide Padded Bottom and Support Straps Are Light and Lengthen the Running Stride

tween the bottom and a lower leather-padded sole, are now on the market for boys' and girls' amusement. They are made in five different sizes and stiffness of springs for small and larger children, and the springs are so flexible that there is practically no danger of turning the ankle. Walking or jumping with them is said to strengthen the muscles of the feet and legs, and besides providing healthful sport, the sandals lead to the development of new games for the playground.

Coconut Pulp as Milk Substitute to Be Tried in the Tropics 2604

With the discovery that the pulp of young coconuts contains practically all the nourishing qualities to be found in milk, scientists are experimenting to find out if the substance can be used as a practical substitute for the liquid in the tropics. They plan to extract the moisture from the coconut and mix the dry remainder with milk from the water buffalo, which is said to be more nutritious than cow's milk.

*West. Albert J. Kucheman
 301 Peoples Bank Bldg
 Moline, Ill.*

*Ans. B. J. Clark
 702 N. Halsted
 Chicago*

*(The Hand-Low (Co.)
 Moline, Ill.,)*

*Chicago Evening Post
 Copyrighted material*

The Sphere
12/27/24.
14,371

2455

Climbers Suck Oxygen through Pipe to Keep Alive on Mt. Everest

Something of the hardships that the daring explorers who attempted to climb Mt. Everest were compelled to undergo,



Pose from a Motion-Picture Film Illustrating Oxygen Apparatus and Other Equipment Worn by Mount Everest Climbers

was forcibly impressed upon the public recently in a motion picture illustrating how the adventurers were dressed and how they acted as they fought their losing fight for the summit. One of the most distinctive parts of the equipment was the oxygen apparatus which the men had to use as they neared the summit. The tanks, weighing twenty-four pounds, were strapped to the back. Connected to them was a length of small rubber tubing through which the climber breathed the life-sustaining gas as he struggled upward. Goggles to protect the eyes from the glare of the sun, canvas coats with knitted helmets for the head and heavy mittens were other essentials of the "armor." The warm clothing was absolutely essential, but at times during mid-day when the skies were cloudless, the rays of the sun made the heat almost unbearable in the rare atmosphere, the climbers declared. They failed to reach the summit by less than 2,000 feet.

2581

Eclipse Proves Sun's Effect on Radio Reception

The theory that the extreme increase in range of radio transmitters during the night period, as compared to the day, is

due to the effect of the sun's rays, producing ionization of the atmosphere during daytime hours, is proved, in the opinion of radio engineers, by experiments conducted during the January eclipse. After checking over the reception results it was generally agreed that the reports had yielded valuable data for consideration in designing future radio receivers. The results attained, however, varied considerably in different localities. Tests made from Schenectady, N. Y., on two wave lengths, before, during and after the eclipse, and recorded at New York on an automatic device, showed no appreciable change. On the other hand, an amateur in Argentina picked up forty-one new stations in the United States, Canada and England and one in Holland during the hours

before and after the eclipse. A portable broadcasting outfit set up at Escanaba, Mich., in the path of the total eclipse gave the most complete data on improved reception. It was tested out for three hours each night for three nights prior to the eclipse, and prizes offered for telegrams showing reception from the greatest distance. The results indicated the outfit had an extreme range of 800 miles. On the morning of the eclipse a musical program was started at 3 a. m. and continued without interruption until 9 a. m., while the total eclipse passed Escanaba at 8:02 a. m. During the period before and after the eclipse the extreme range of the set increased from about 800 to 1,800 miles, the reports showed. There is always an improvement in distance just as dawn strikes a transmitting set, but, normally, this improvement lasts but a few moments. Telegraphic reports, however, showed that on the eclipse morning, the dawn effect continued steadily to increase.

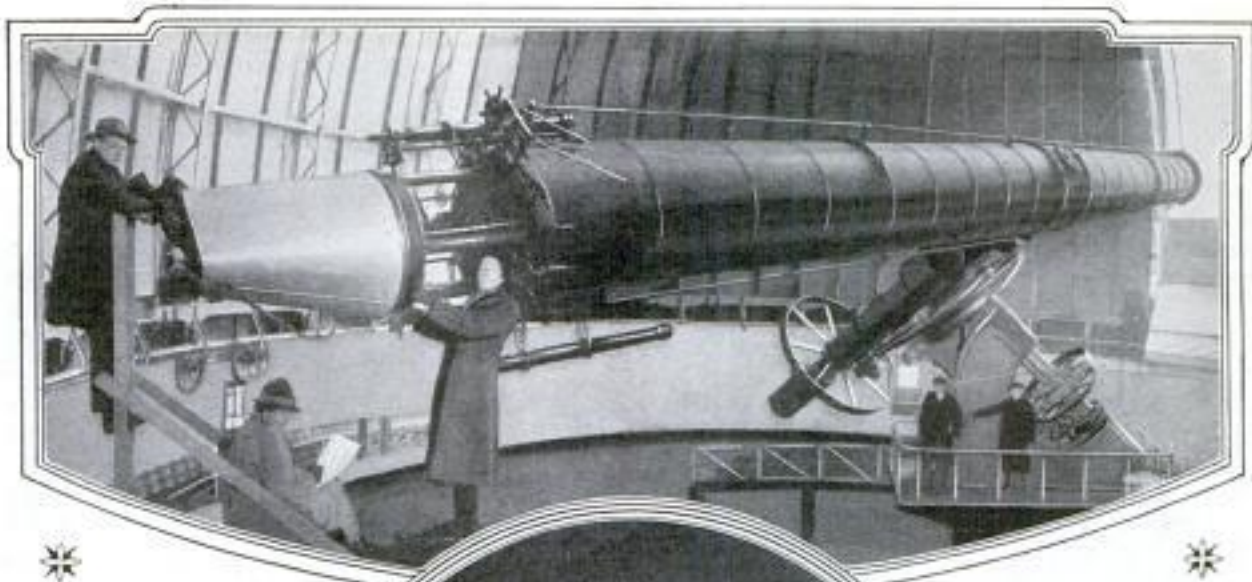

Scientists Training One of the Great Reflecting Telescopes on the Sun's Eclipse, and a Photograph of the Event Taken from the Top of an Army Airplane, One of More Than Twenty-Five Aircraft Which Carried Scientists, Photographers and Reporters High above the Clouds to Witness the Eclipse under Exceptional Conditions; the Picture Shows the Moon at the Exact Moment It Completely Hid the Sun

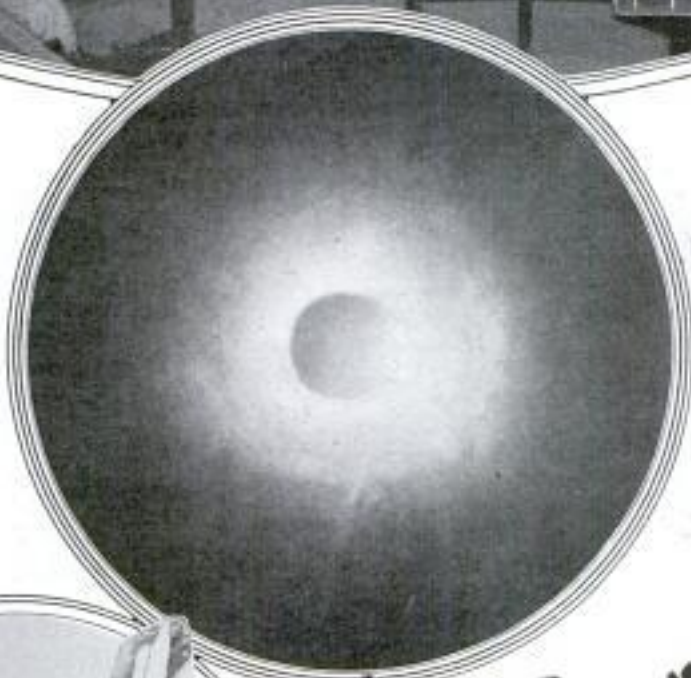

Two Navy Movie Cameramen, Below, with Special Cameras Which They Used to Photograph the Eclipse from the Top of the Giant Gas Bag of the Dirigible "Los Angeles," and, Lower Left, the Recording Tape of an Automatic Radio Receiver Used to Pick Up a Signal Sent Continuously Before, During and After the Eclipse to Determine Whether the Event Would Affect Radio Reception

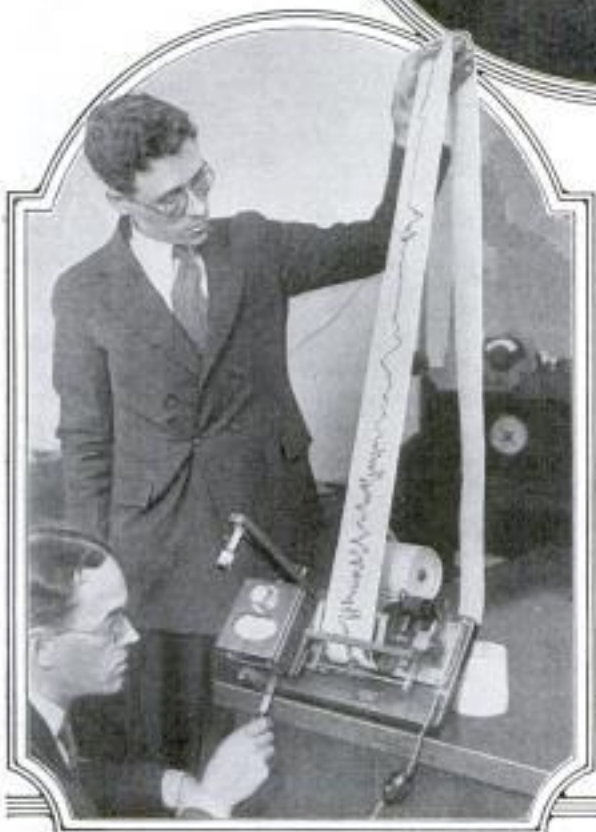

Upper and lower left photos copyright, Underwood & Underwood

Forest Park

**Machine Gun Kept on Guard in Bank
Can Be Fired in Second**

2573

sub-

A machine gun installed by a bank for use against bandits, is capable of firing forty shots in less than a second and can

Firing Forty Shots in Less Than a Second, This Machine Gun on Guard in a Bank Can Be Quickly Trained on Any Target with Deadly Effect

© U. & U.



tear a hole through an ordinary brick wall. The weapon, of .45-caliber, is mounted on a light tripod at a height of about four feet, from which position it can be handled with ease. Always kept ready at a point commanding the interior of the bank, the gun may be quickly brought to bear on a target. The mounting can be adjusted to any elevation, so the rifle may be readily changed to cover any approach or opening to the room. Its operation is such that even a person untrained in the use of firearms can work the weapon after a short instruction.

**Red Tape Yields to White String
to Aid Government Economy**

2633

Red tape, used by governments from time immemorial to tie up packages of official documents has been abandoned by Uncle Sam in favor of plain white string. The change was made in the interest of economy, ordinary twine being much cheaper than tape. The traditional blue and white striped mail bag also has been banished in favor of plain gray canvas.

The striped cloth cost a cent a yard more than the plain color, and the government will save \$40,000 a year as a result of the change. The budget bureau, since its foundation under Charles G. Dawes, has eliminated hundreds of money wasters which existed only because they were customary. One of General Dawes' first acts was to standardize the army and navy brooms. He found each service had its own specifications and bought separate supplies. Now the official brooms are interchangeable, reducing the money tied up in warehouse stocks. Weather bureau reports which have been posted in public places for many years, also have been eliminated because the newspapers and radio give the same information without cost to the government.

**Finger Lamp Throws Light on Work
and Saves Electric Current**

2596

For dentists, artists, watch repairers and others in similar occupations or for use in the sick room, a handy electric lamp that is worn on the finger somewhat like a ring, has been invented. It is so shaped that the light is thrown directly upon the work and may be moved about by means of a convenient holder on which a reflector for the lamp also is mounted. A transformer accompanies the outfit so that the lamp may be used with current from a wall socket. It requires but little electricity, is durably incased in metal and besides affording a bright illumination calculated to spare the eyes, does not bother persons near by, a feature that commends its use for patients in a hospital ward.



For the Sick, Finger Lamp Is Found Convenient When Writing, and Spares the Eyes

Penlux Co., Leipzig, Germany

Christian Science Monitor

1/27/25

Penlux Co., Leipzig, Germany

Copyrighted material

*Avda. No. de Cierwa,
Cuarra, Usinlos*

near Madrid, Spain.
**Airplane with Revolving Wings
Flies Vertically or Level**

**Wireless Sender for the Unskilled
Needs No Knowledge of Code**

An "autogyator," which looks something like a helicopter and can land at very slow speed, overcoming one of the

A simple wireless transmitter with a sixty-mile range, which requires no knowledge of telegraph code and no batteries, has been developed in England, primarily for use on ships' lifeboats. The complete outfit is contained in a cabinet, nineteen by nine by nine inches, and weighs but thirty pounds. A series of rotary contacts, each segment of which represents the Morse signal for a figure or letter, is

see page 1920

*Autogyator Co of
Argentina
1825 Santa Fe
Bldg Chile*



Four Freely Revolving Wings Replace the Usual Upper Surfaces in This Rebuilt Training Biplane

chief difficulties of airplanes, has been successfully tested near Madrid. It is built from an old training biplane, which is retained intact, except for the removal of the upper wings and the substitution of four revolving wings, shaped like propeller blades. Unlike the helicopter, in which the power is transmitted direct to the lifting propeller, the revolving wings of the autogyator are not geared to the engine, but revolve freely in the air like the sails of a windmill. The engine revolves the front propeller in the ordinary way. As the plane starts forward the rush of air sets the revolving wings in motion, and when they have attained a speed of about eighty revolutions a minute they begin to exert a lifting effect. The machine is handled in the air like an ordinary airplane. The chief points claimed in its favor are the low landing speed and the fact that it cannot be stalled in the air. The usual plane must have sufficient speed to permit maneuvering. When its forward movement drops below a certain speed, the plane will go out of control and begin to fall. If it is high enough in the air, the pilot can utilize the falling speed to bring it out of a side slip or tail slip and get under way, but when the trouble occurs near the ground a fatal crash is the usual result.



revolved by turning a crank, and the same crank operates the magneto which generates the sending current. A handful of contact points for the revolving segments is sufficient to give 24,000 code combinations. As long as the handle is turned, the message is repeated over and over. In use on the lifeboat of a wrecked ship, the message could include the SOS call and the boat's longitude and latitude. In addition to the aerial terminal, there are taps from which the masthead light of the boat may be lighted, or radio and light may be worked together. The British Royal air force has adopted the transmitter for use in airplanes.

The motor of boat

2567

Prayer + Atlantic Photos, 25 Park Place, New York City
Kansas City Times 1/12/25

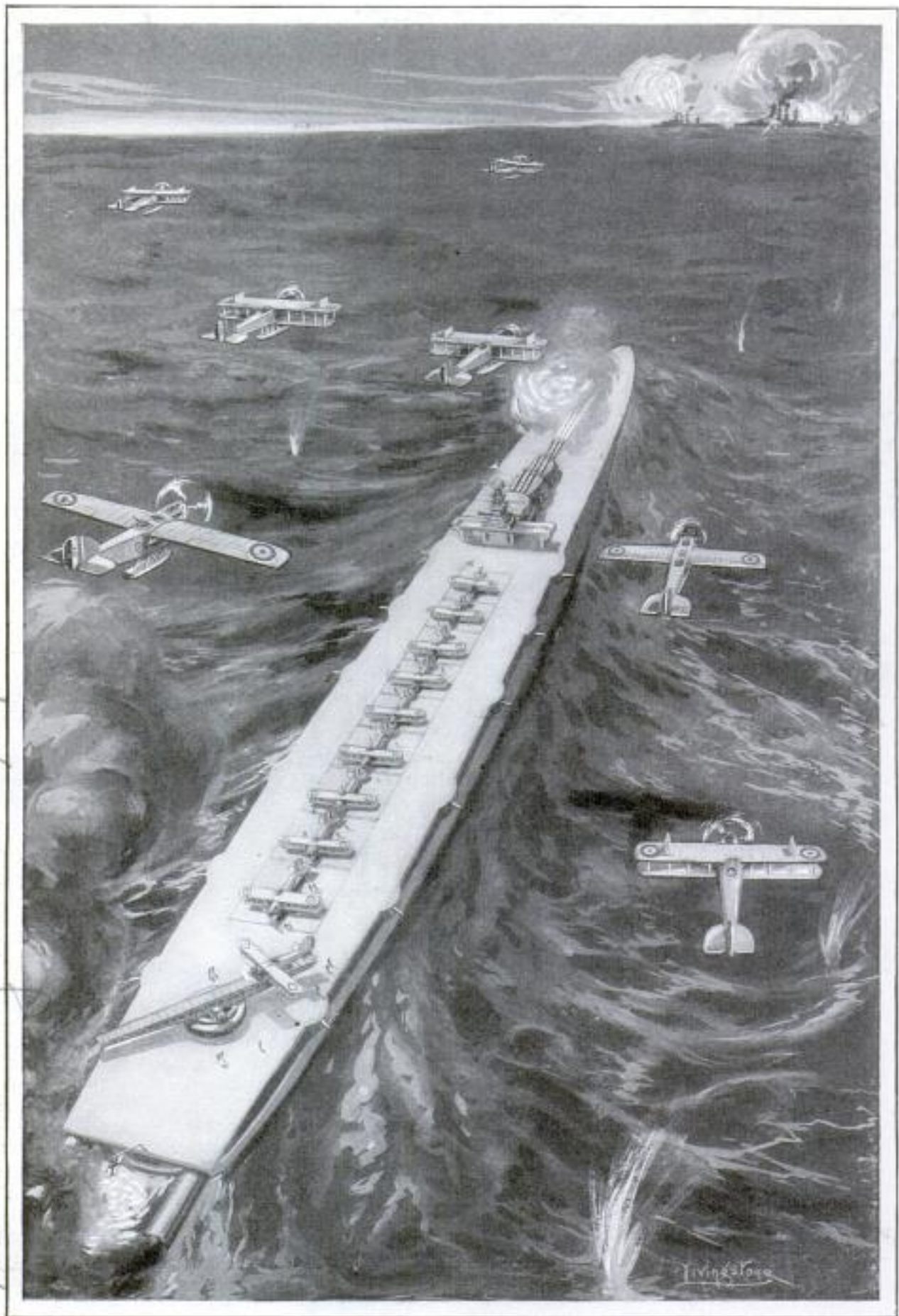

Three Turrets of Nine Guns and a Stumpy Mast and Bridge Will Break the Sweep of the Long Deck on England's New Battleship-Airplane Carrier

2672
544

New Bureau, Niagara Electric Co
Ad. Richard



Niagara at Night, under the Spell of Searchlights Pouring Out of the Darkness Like an Ever-Breaking Wave to Meet Added Brilliance from Batteries of Electric Rainbows

Neutral Gear Control for Small Car
Adds Ease and Safety to Driving

Holding a Ford car in neutral can be done without keeping the foot on the pedal or pulling the emergency brake, by means of an automatic attachment that is put on in place of the metal cup covering the drive on the engine and is entirely concealed under the floorboards. The mechanism consists of a fork which engages the pedal automatically after it is pressed into low gear, returned to high and then put back to the neutral position. A weight on the attachment causes this action without springs or gears, and it is released by simply pressing the pedal in the same manner as when applying the control. Malleable iron, which is claimed to last throughout the life of the car, is the material used for the attachment; it needs no oiling or attention and can be put on in fifteen minutes, as there is no need for boring any new holes.



Magic of Colored Searchlights
to Increase Niagara's Beauty

Twenty-four thirty-six-inch floodlights of many hues with a combined brilliance of one and one-third billion candlepower, are being installed at Niagara to transform the cataract into cascades of liquid color when darkness falls. The project is the result of international co-operation between the United States and Canada, and \$60,000 has been pledged for the installation and the cost of operation for one year. It is planned to have the falls illuminated four hours nightly and color drills will be given on special occasions, such as national holidays and the birthday anniversaries of famous persons. All the lights are to be located on the Canadian side at a point where the beams will penetrate the fine mists, reach the main bodies of falling water and be sent leaping into the heavens where they will be visible at a distance of seventy-five miles. It is estimated that thirty per cent more light than was used in the installation of 1907 will be employed. Only one man will be needed to operate the battery regularly, and one helper will be sufficient on special occasions. The platform holding the lights will be concealed by shrubs so that the beauty of the surroundings will not be marred.

Twenty-five tons of air must be drawn into the cylinder of a Diesel engine to burn one ton of oil fuel.

Auth. 2423
Rudersw, Wilson, Mechanical
Inventor, P. O. Registration, 1154

New York World
1/11/25

Speed of Shooting Stars Estimated at Forty-Five Miles a Second *2806*

Speeds as high as forty-five miles a second are attained by meteors, the "shooting stars" which are drawn into the earth's atmosphere and burn up in a final brief blaze of glory, according to Prof. C. M. Sparrow, of the University of Virginia. The meteors, he says, are small bodies which, entering the upper atmosphere of the earth, are heated to incandescence and remain visible at night until they are completely burned up, or fall to earth. The heights at which they appear lie between fifty and a hundred miles above the earth. At that altitude the atmosphere is believed to be almost pure hydrogen, the gas used in balloons. Hydrogen forms but one ten-thousandth part of the earth's atmosphere at the ground, but being very light, its density diminishes so slowly with increasing height as to outlast the heavier nitrogen and oxygen.

Clown Stilts Have Feet of Sand to Make Walking Easy *2477*

Stilts usually employed by circus clowns to give them gigantic stature during their antics in the rings, have feet of sand to aid the performer in walking and to maintain his balance. The poles are of stout hickory flattened and widened at the tops to fit the wearer's thighs and fitted with straps to hold them in position. Toward the bottom, the props are rounded and tapered, ending in soft shoes filled with coarse sand which are fastened on the sticks so that the heels support the points.

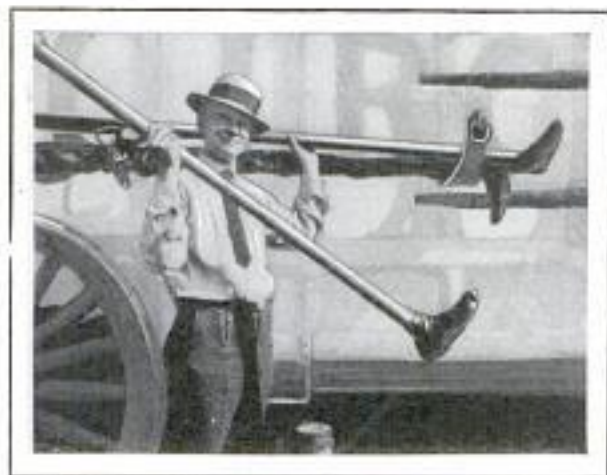

Stilts Used by Circus Clowns to Make "Legs" Which Give Them Gigantic Statures

Wide trousers or other apparel cover the stilts for their full length, and the clowns appear to walk on their heels.

*Cont. Paris, now
Cary + Clinton College Hill,
Cincinnati, Ohio*

Deaf Hear by Touch on Telephone Held in the Hand *2401*

With a telephone whose receiver transmits vibrations to the sensitive palm of



Transmitter by Which Spoken Words Are Converted to Vibrations in the Receiver Above

the hand, it is believed deaf persons can be greatly aided in reading spoken messages through the sense of touch. Words spoken into the mouthpiece of the instrument set up a series of pulsations in the delicate receiver that correspond to the sounds of the voice. These result in a sort of code which the "hearer" may easily learn. Though surrounded by loud noises and other heavy vibrations, the person, while lightly gripping the receiver, can readily distinguish words and sentences coming over the telephone without interference from disturbances and sounds originating on the outside.

2541

Cathedral Saved by Deep-Sea Diver Working Five Years in Dark

One of the most heroic accomplishments in the annals of engineering has come to light in the account of a diver who, working single-handed and in almost complete darkness, saved Winchester cathedral in England by renewing its foundations. The task consumed most of five and one-half years and was performed several feet below the surface, in slimy soil and water. The building was foundering because it rested only on an eight-foot layer of wet peat. The diver removed this material in sections, substituting concrete which he himself brought down and laid on a firm stratum of gravel, flint and chalk below the peat formation.

*Jim Bits
1/3/25*

W. Wilbur A. Salisbury
 546 *Spokane Wash.* POPULAR MECHANICS

Density of Fog Shown by Gauge That Marks Dots on Card

One of the instruments in constant use at the weather bureau station in Kensington,

2327
2458

Meteorological Office

Chicago Daily News
1/9/26



Fog Gauge in Operation, Air from Outdoors Being Drawn In Through Window Tube

London, is a device for measuring the density of fogs. Vapor-laden air is drawn in through a tube inserted in a window and as it passes through the recording apparatus, a scale of dots registered on a card indicates the degree of thickness of the mist. The spent moisture is allowed to pass out through a waste tube, and by examination of the residue left within the instrument, it is possible to measure the amount of foreign matter that is present in the outside air.

Herds of Wild Animals on Increase through Protection of Parks

While big and small game is becoming more scarce each year in almost every part of the country, herds of wild animals are reported on the increase in areas that enjoy the protection of the national parks. H. S. Harris, warden and trail rider in Jasper Park in Canada, reports that a herd of 100 elk brought from the Yellowstone in 1919 has now increased to 700; deer can be counted by the thousand and are seen

every night in the streets of Jasper village within 100 yards of switch engines, and over 9,000 mountain sheep have been counted by a system that allows for duplication. Caribou are now found in most of the valleys, and bears have become so numerous that they are said to be a positive nuisance, breaking into wardens' cabins frequently and stealing provisions. The animals seem to realize quickly that the parks are barred to hunters and migrate to these sanctuaries from great distances.

2327
Portable Electric Steam Radiator Operates from a Light Socket

Combining portability and the convenience of mere attachment to an ordinary electric-light socket, an electrically heated steam radiator devised by a western inventor, appears to have genuine practical value to the home owner. In localities where current is not expensive, it is claimed that the radiator will heat rooms, and even a whole house, at a price within the means of the average wage earner. Steam is generated in a small container made of non-crumbing and heat-resisting clay wound with special wiring to heat a water jacket at one side of the radiator. In about fifteen minutes, the contents in the radiator can be warmed to a temperature of 214 degrees Fahrenheit, it is said. On the other side there is a vacuum attachment which circulates the water by drawing it out of the radiator coils and returning it to the jacket.

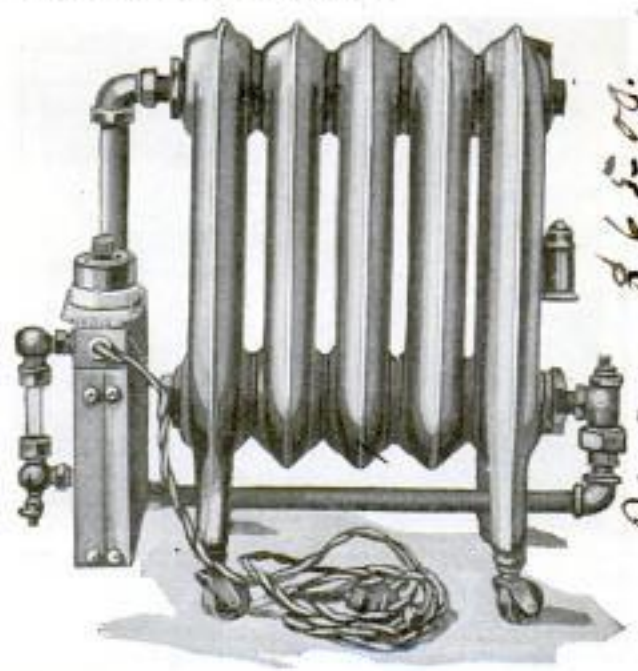

Price - \$65.00

With Water Jacket, Cord and Switch, Electric Radiator Rests on Rollers for Easy Moving

Order of
January 1/4/26

Salisbury Turbine Motor Co., 12 1/2 Lincoln St. Spokane, Wash.



Radio in the Canadian Rockies

By LEWIS R. FREEMAN

*287 E. California St.
Pasadena, Calif.*

TH**ERE** are two fields of adventurous romance into which the pioneer in the development of such modern inventions as the telegraph, telephone, airplane or radio may push his questing way. The first is that of technical improvement. This is essentially the field of trained experts—the Bells, Wrights and Marconis.

The other field might be called that of operative experiment, that in which a new instrument is tried out under novel conditions and in the face of difficulties possibly hitherto reckoned as prohibitive. Here, also, the technical expert has the advantage, but that there are occasional opportunities for the novice to rush in where better trained men have not had the chance to tread, and that such excursions have results, is well proved by my own experiences.

In the summer of 1923, I accompanied the geological survey party through the gorge of the Grand canyon. Experts had been claiming that it would be impossible to receive radio in a deep sheer-walled gorge, and here was an expedition about to endeavor to pass through the most abruptly boxed of all the world's great

gorges. A receiving radio set, specially assembled with dry batteries in a waterproof box, was provided by government experts. The result of the experiment was to establish the entire feasibility of radio reception in the deepest of chasms.

It was our Grand canyon set which disclosed to me for the first time the hitherto unguessed possibilities of the radio for the members of an expedition completely cut off for weeks, or even months, from other communication. Daily news was the greatest boon, with the pleasure of song and music a close second. It was for this reason that I proposed the inclusion of a radio when I was asked, early in the summer of 1924, to join an expedition to explore the barely known region along the Continental Divide called the Columbia ice field.

My relations with the radio set carried through the Grand canyon were confined to stowing the stout yellow box containing it in the forward compartment of my boat and doing my best to keep it from being dumped out into a rapid. Of course, I listened in once the ether had been coaxed into giving up its secrets, but of



Changed in Share by
Rough Pack - Horse
Travel over Rocky
Trails, the Set, Once
Reassembled, Caught
the Drift of Welcome
News and Music
Broadcast by Stations
Thousands of Miles
Distant

the technical side of radio I learned nothing. In spite of this, our Canadian Rockies expedition was destined to prove up the radio receptivity of a very large area which had come to be considered as "dead," to say nothing of giving such a convincing demonstration of the "fool-proofness" and durability of present-day radio sets. The little four-tube set used did not weigh over five or six pounds. Wire and batteries added possibly forty pounds more weight. An outside aerial instead of a loop was decided upon because of its portability, durability and receptivity. Neither New York, Chicago nor Montreal were at all encouraging regarding the prospects of receiving radio in the Canadian Rockies. Furthermore, I was assured that a radio taken to Mount Assiniboine a few weeks previously had

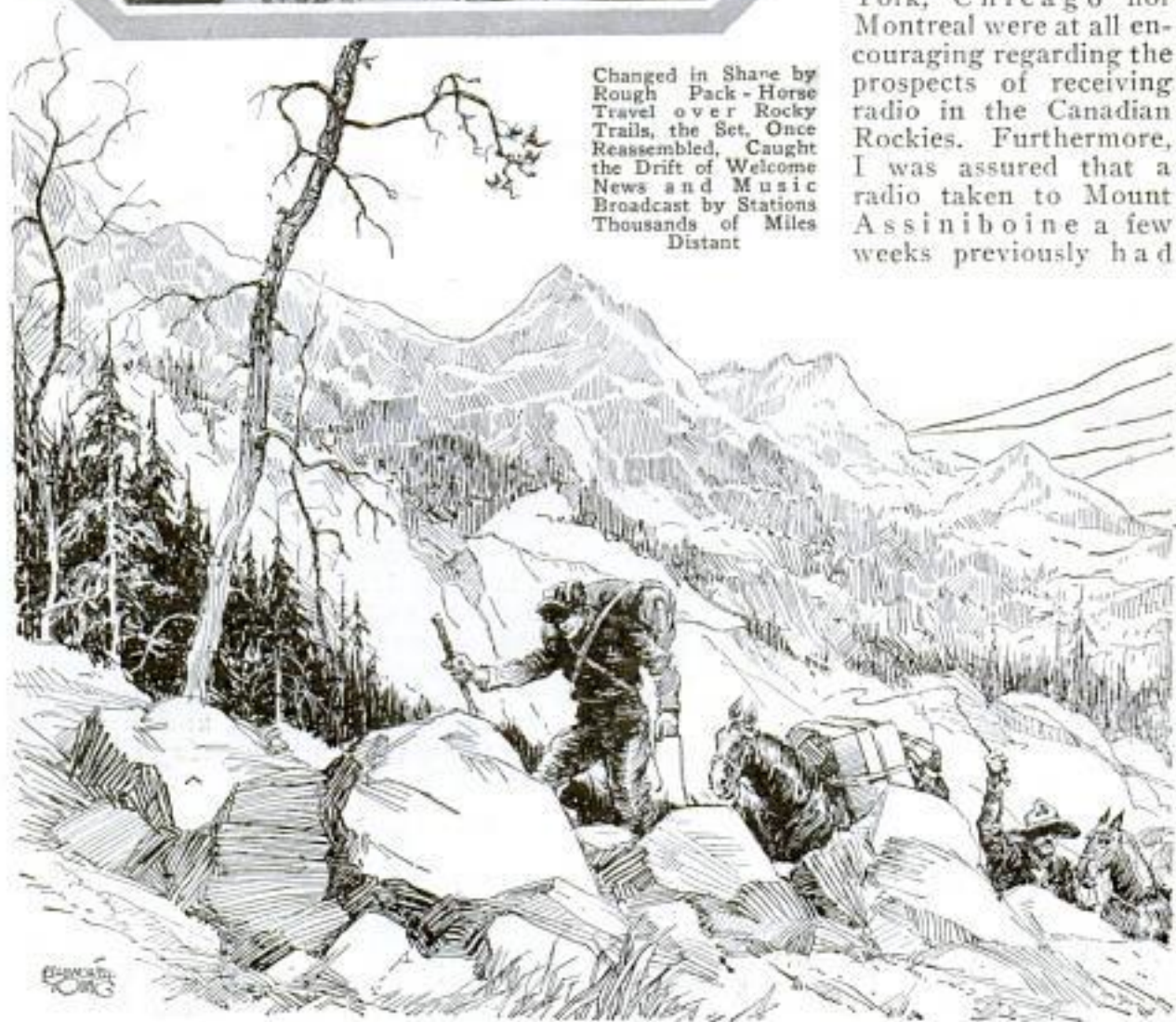

not picked up a single station. Nevertheless, we had a local Banff electrician connect the batteries and tie them into a fairly compact sort of block which fitted into the largest compartment of a cedar pack box for the journey over the Rockies. The radio set itself was wedged into a smaller compartment, while still another received spare tubes and other odds and ends. Spare batteries and wire for antennæ were carried in other packs.

Now of all known methods of transport that by pack horse or pack mule is beyond all comparison the roughest and most destructive. Man back, dog sled, elephant, camel, boat, auto truck or aerial tramway are as nothing compared to it in power to do harm. The crushing with lash ropes and the jolting even along an open trail are punishing beyond description. When, in addition, the pack train is headed into uncut timber, deadfalls, bogs and boulders, the effect may be imagined. Of course, the well-padded pack box was constructed to meet just such conditions, and that is why it only changed shape instead of flying apart the first time the hulking cayuse carrying it was brought up sharp by his pack jamming between two close-growing pines. The case stood that first crash astonishingly

well; also the buffetings of a somersaulting roll down through the shattered rocks. It was even recognizable as a box after it had been on the underside of the pack for ten minutes while its bearer sunk to his ears in a bottomless stretch of muskeg. But when a chafed lash rope parted and let the casket slide down and dangle against "Jerry's" heels, the moment had come when it was no longer possible to follow the expert's injunction as to keeping the set and batteries hooked up exactly as he had left them. Even finding the component parts was hard enough, for "Jerry" had proved his qualifications as a radio horse by "broadcasting" the various

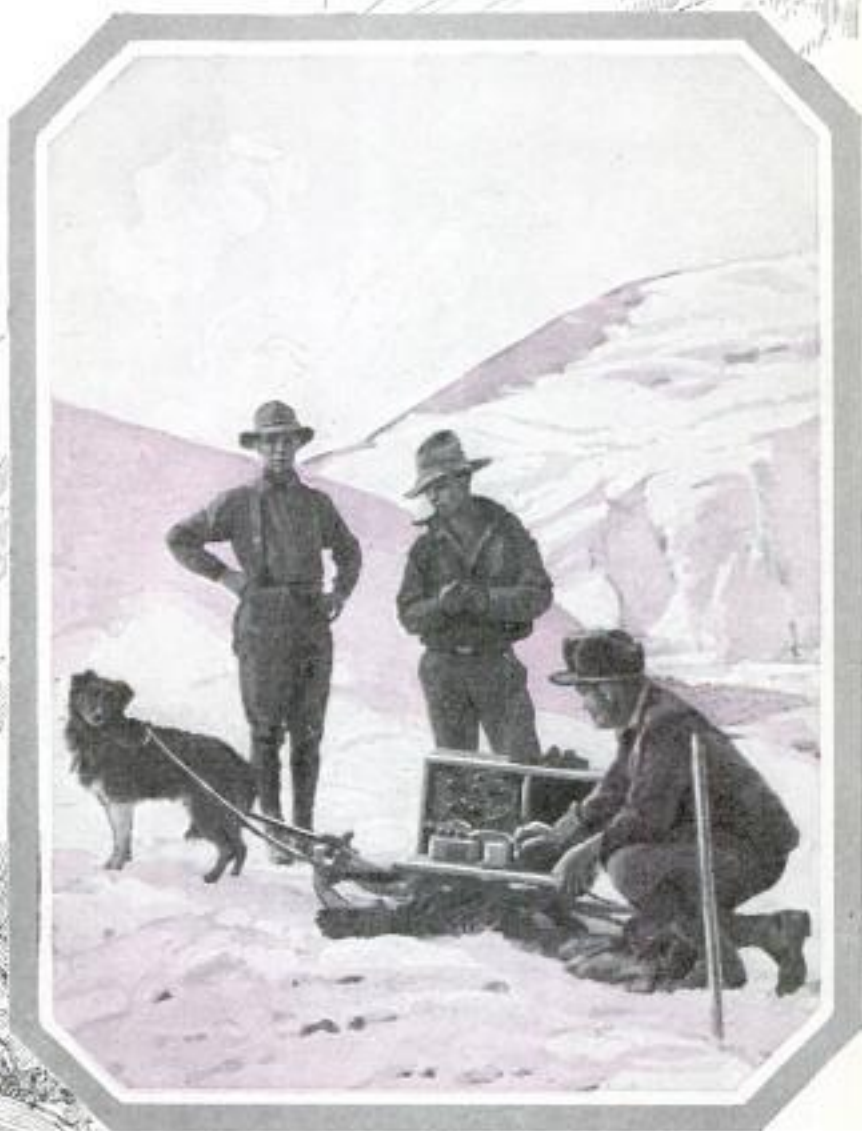

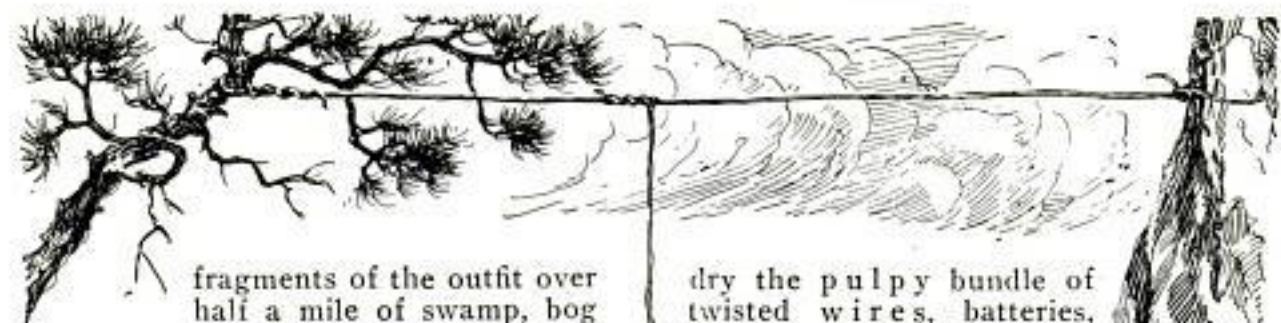

fragments of the outfit over half a mile of swamp, bog and boulder-strewn mountainside. We collected all the pieces we could find and roped them up in the surviving fragments of their carrying case. That they could ever be made to perform their original functions again, no one but our optimistic French-Canadian cook dreamed. When the whole pack train was rolled while fording the torrents of the Saskatchewan and Alexandra, nothing came in for a more prolonged soaking than the radio.

It was in the beautiful Castleguard valley, 8,000 feet above sea level and on the very verge of the great Columbia ice field, that we first rested from our steady grind of trail work, and pitched a four-day camp. Here, for the first time, we had a chance to disentangle, clean and

dry the pulpy bundle of twisted wires, batteries, boxes and packing that was the radio outfit. The box itself, with not a right angle left, gave forth a noise like a child's rattle, from the screws, switches and various odds and ends shaking about inside of it. Once it was trued up and the knick-knacks restored to place, however, it was just about the same as ever, at least so far as looks were concerned. The tubes (there were eight of them including four spares) appeared a total loss. While the outer glass of every one of them, protected by cotton-batting wrappings and a fiber case from breakage, was unshattered, a telltale tinkle from the inside told of something awry.

It was at this juncture that Ule La-Casse, the cook, unearthing a book of



Two Holes for the Headphones Were Cut in an Old Tin Can; Another Can Furnished a Stand, and the Camp Had a Real Loud Speaker!



The World Came to Visit the Explorers by Way of the Little Black Radio Box. They Valued Almost as Highly as the Food Stores

directions in the mud at the bottom of the pack box, made the proposal that we try to restore the radio to life. There was a diagram showing

the proper hook-up, and we already had directions for putting up the aerial. If by any chance the tubes and the batteries still retained a kick, who could say that we should not be bringing the outside world to our tepee door inside of an hour. As it is always good policy to humor a camp cook, we let him have his way.

The batteries spat forth strong, vital sparks, but the real surprise came when each of the tubes, tried out one after the other, responded with a bright red glow to the circulation of the current. Just what was the loose hardware clinking round inside of them we never did learn, but probably a fragment of glass from the collar at the base of the filament.

The aerial, by dint of rough climbing and some clever lassoolike casting of loops of the wire, was finally strung between a ledge of rocks and the last scraggly pine at the timberline. A jiggery of dials and switches along toward the end of the afternoon seemed to reveal restless stirrings of the ether, but not all our cunning could resolve it into anything more coherent than clangs and howls. Further study of the book revealed the various

units of our wiring system as the probable seat of trouble. The radio had been connected to the north rather than the south end of the antenna, while a loose bowknot of insulated wire could hardly have been expected to give as satisfactory outlet for the lead as the soldered joint recommended by the book. All the noises of a busy, booming world seemed to be lying in wait to swoop upon our quiet Alpine valley when reconditioning was complete and we put on the headphones and started jiggerying the dials again. With many stations appearing to want to get to us at once, and with scant cunning of hand or ear in the matter of tuning in or tuning out, it was slow work reducing the chaos to a semblance of order and making the clamoring voices take their turn. The long northern twilight was over and darkness descending upon the ice-bound valley before a plaintive ballad in a cracked soprano was heard, announced as being broadcast by an Oklahoma City station "for the benefit of the auto campers." Following directions still more carefully in restringing the aerial the next afternoon, we were rewarded by picking up Calgary, with a score of stations scattered between Pittsburgh and Los Angeles before it was dark at 8:30. Quality and strength improved after nightfall.

Bothered by snow flurries again, we changed the set-up next day so that the lead ran down into the tepee and we could listen in from the comparative comfort of

our bed rolls and with the light and warmth of a crackling pitch-pine fire. And here it was, for the final two months of the expedition, that the world came to visit us every night by way of the little black box which we had come so near to throwing into complete discard.

Without giving the lengthy list of stations which we had at one time or another, I may say that these included a majority of the high-power ones east of the Missis-

sippi, others as far south as Baton Rouge, high and medium-power stations in California, and practically everything in the Pacific northwest, British Columbia and Alberta. Hastings, Nebr., we picked up first in a rebroadcasting of the Wills-Firpo fight as described from the ringside. The last round of this contest we lost as the consequence of as queer an accident as ever befell a radio. We were clustered around the radio, harkening to a stage of the fight when it appeared that Wills was about to score a knockout.

Suddenly there came a rush and a roar from the outside, and an instant later the headphones were jerked from our ears as the radio box was all but dragged under the side of the tepee. Investigation disclosed that an over-curious bull caribou, venturing close and being chased by our dogs, in his bewilderment had charged right through the camp. His branching horns coming in contact with the lead down to the tepee had been responsible for the disaster.

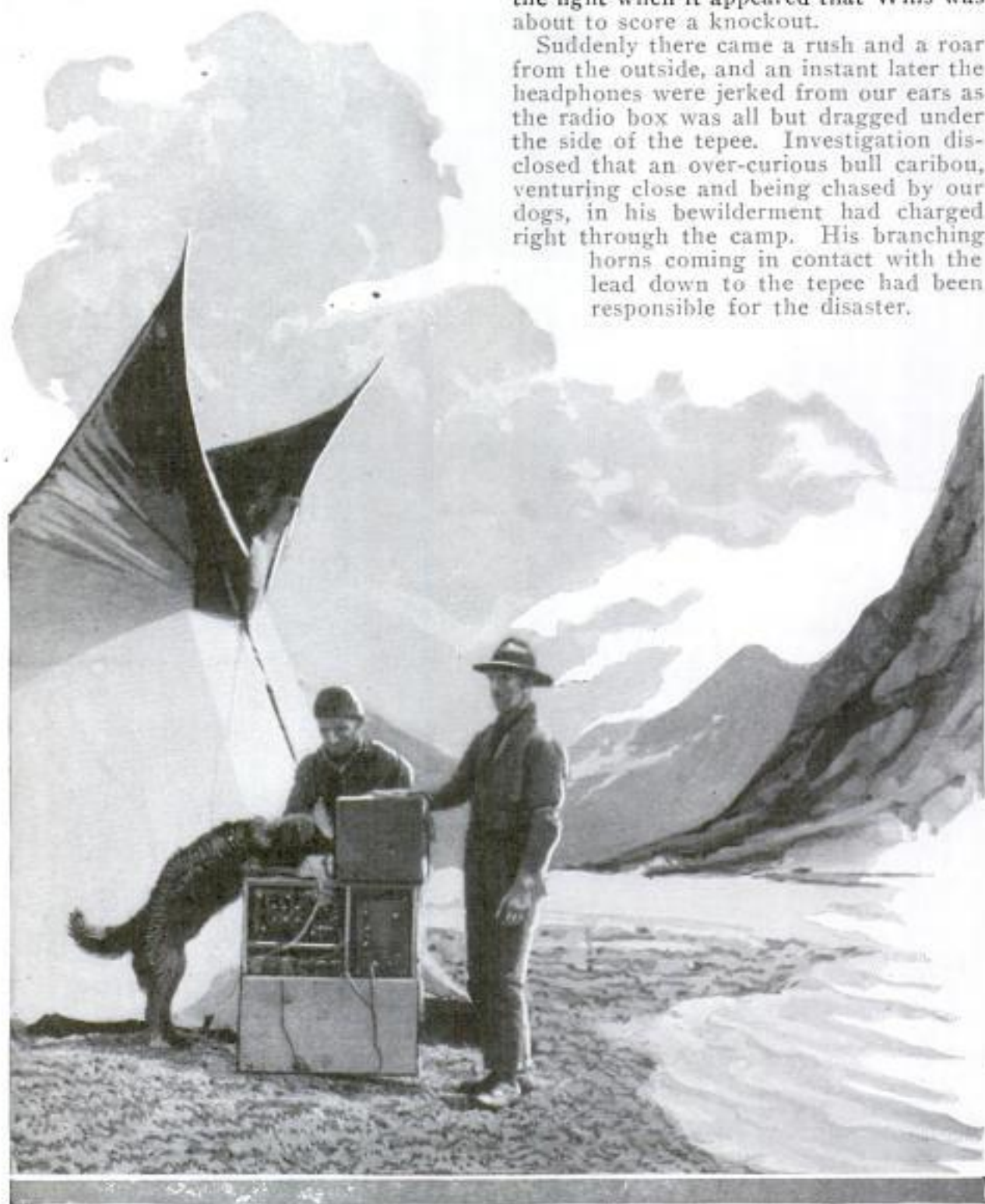

2536

2462

Model Farm Saves Miles of Steps

Designed to eliminate miles of wasted steps, a complete model farm has been designed and built to scale by students at the Nebraska college of agriculture. Working on the theory that every farm is a factory, to which labor-saving schemes should be applied, the students analyzed the ordinary chores of the farmer, grouped them in the order in which they should be performed, and then placed their model buildings accordingly. Fitted to the prairie territory, where the prevailing wind is south and southwest in summer and north and northwest in winter, the farm buildings are placed east of the house, in order that odors will be carried away from the farm home. On the other side, the orchard and a windbreak of trees are arranged to furnish protection from winter winds. Each barn is so placed as to form a windbreak for the adjoining yard. The buildings include a barn, silo, cattle and hog sheds, water tank, granary, implement shed, hay shed and poultry house. In the morning when the farmer leaves the house, he goes first to the barn, tends his horses and cattle, milks, separates the cream and feeds the calves. Then he carries the skim milk to the hogs, passes on to the granary to feed the fattening porkers, and in returning, passes the hay shed and feeds the cattle and poultry. Next he steps into the milk room and gets his cream, returning to the house. Coming in through the lower gate by the hay shed at evening, his course to the barn leads past all the buildings and almost all his chores can be completed while the team is drinking and going on to the barn. On one farm all the chores were done by walking only 750 feet.



Skaters on Stilts Can Cover Great Distances with Fewer Strokes and Maintain High Speeds with Less Effort than Required by Ordinary Blades

Skater on Stilts Glides over Ice in Novel Stunts of Speed

With skate runners attached to stilts, a performer on an ice rink at a Switzerland resort accomplishes feats of grace and speed rivaling those possible with the ordinary blades. Raised almost two feet from the ground, the skater easily swings into long strokes or describes fancy flourishes in small space. For racing, the extensions permit lengthy strides and great rates of speed. The blades which are of the usual size are fastened to shoe-shaped supports while a firmly constructed step holds the performer's foot. Straps keep the standards secured to the skater's legs, leaving his arms free for balancing.

Christian Science Monitor
1/10/25

Auto Bed Camp Mfg. Co.

3120
531

Iritham Road, W.
POPULAR MECHANICS

Kansas City, Mo.

PORTABLE COMFORTS MAKE CAMPS HOMELIKE

2424

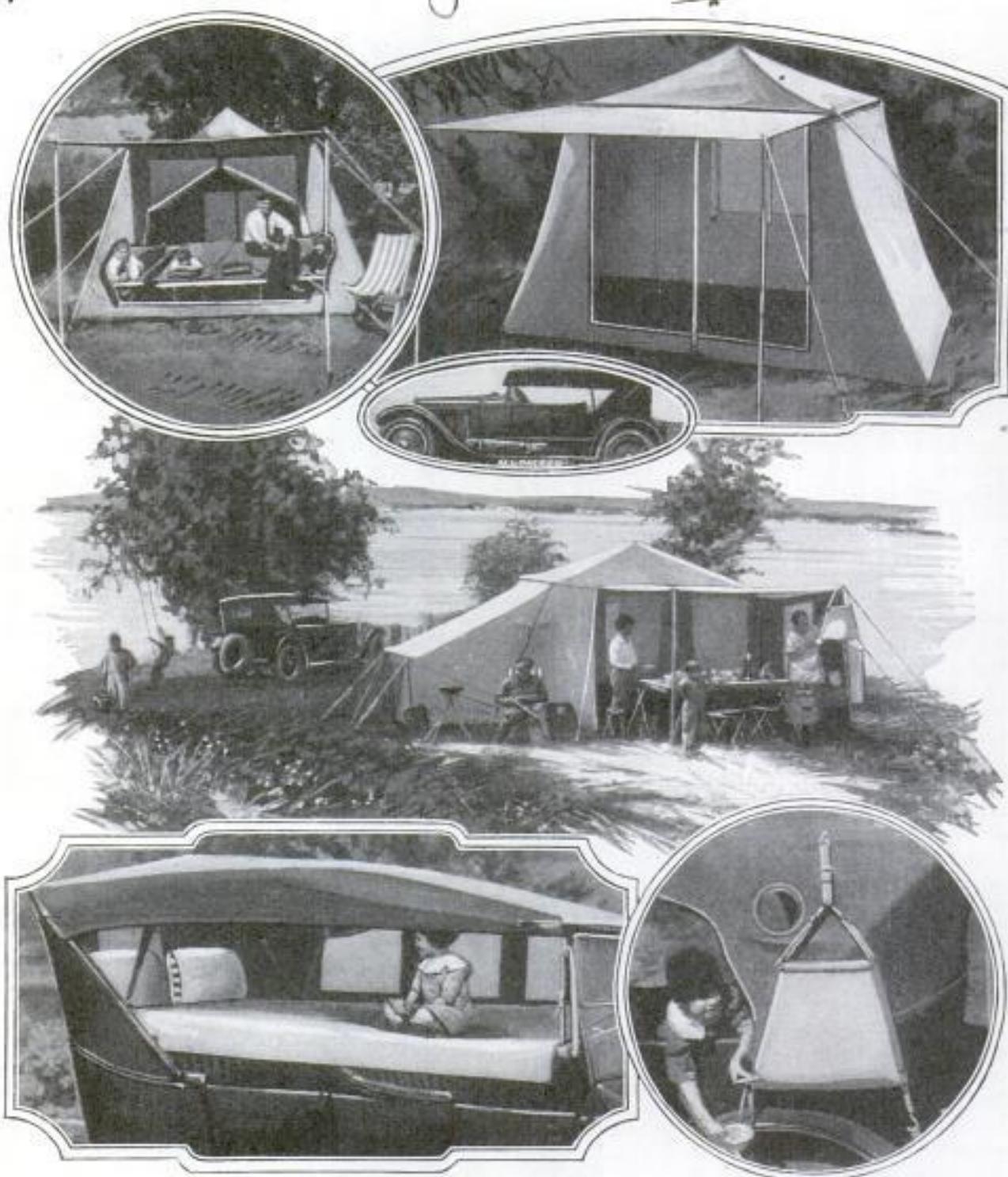

Above, Roomy Tent without Center Pole Which May Be Rolled into Small Parcel; Center, Camp Home with Portable Dining Equipment; Below, Bed Swung in Automobile and an Iceless Water Cooler

Motorists on tours, overland travelers and campers may partake of conveniences rivaling those found in modern homes without adding greatly to the amount of luggage carried or labor necessary to set up such accessories. Roomy shelter to suit almost every need may be provided by a sturdy tent which can be rolled up in a few minutes and packed in a small space on the running board of an auto-

mobile. Readily handled by one man and proof against rains and insects, the canvas house is equipped with a doorway awning as added protection against the sun. The usual center pole is absent, making it more adaptable than ordinary types for the placing of furnishings. A ventilating window of special material, which can be seen through only from the inside, is provided in one wall, while the

Marshall Field, the Fair, etc. handle some of these.

Carry in

floor is of flexible, waterproof fabric and can be quickly cleaned with a sponge. To afford fresh foods and cool water, a combined iceless refrigerator and water container, which operates on the principle of the desert bag of the Orient, is designed to be fastened at the side of an automobile while traveling, or installed in the camp where it can be used as a reservoir or hung overhead and fitted with a shower attachment. Constructed like a canvas bucket, the bag has a faucet at the bottom and can be easily filled or cleaned. For overnight comfort, there is a folding bed which can be hung on the inside of a touring car or put up near the ground at the side. Made to fit almost any make of automobile, it can be placed in position in a short time with the adjustment of but two straps. The frame, made of hardwood, is easily unfolded and assembled, and insures a smooth and comfortable bed that will not sag.

2304.

Candle in Lamp Is Floated in Water to Prevent Fire and Stains

Most of the disadvantages of the ordinary tallow candle are said to be avoided in a lamp-shaped holder which has a shade and a water-filled tube, keeping the stick in an upright position and catching the drippings. As the grease is lighter than water, the candle automatically rises as it is consumed and it can be burned down to the thinness of a wafer before a new one is required. The shade prevents the flame from flickering and gives the lamp an attractive appearance. Besides eliminating the stains from the drippings, the holder is safer than the ordinary kind, as the water would be likely to extinguish the blaze in case the lamp should be overturned by accident.



Messrs. S. A. Lampugh Ltd, King's Road, Dudley, Birmingham, Eng.

Prints of Monkeys' Hands Compared with Criminals' Fingermarks

In an experiment to determine fingerprint characteristics common to criminals



Fingerprint Experts Taking an Impression of a Chimpanzee's Hand While Its Trainer Talks to the Animal to Distract Its Attention

and monkeys, experts at the San Diego, Calif., zoo are taking impressions of the animals' hands for comparison with prints in the files of the police department of that city. The tests are also said to be for the purpose of studying various evolutionary theories. After the investigations, tail prints of the animals are added to the hand marks and distributed to other zoos in remote parts of the country for comparison with those of similar species held in captivity to learn the effects of surroundings and climates on the various kinds of monkeys.

2539

Theater Lends Umbrellas to Patrons Waiting in Rain for Tickets

When showers threaten to disperse crowds waiting in line for tickets at a theater in Portland, Oreg., the management sends a bevy of "usherettes" to the rescue with umbrellas which they distribute and collect later at the entrance. The name of the theater, lettered on all sides of the umbrellas, forms an effective advertising device as well as protection for the property, and the plan has proved an efficient way to prevent decrease in box-office receipts on stormy days.

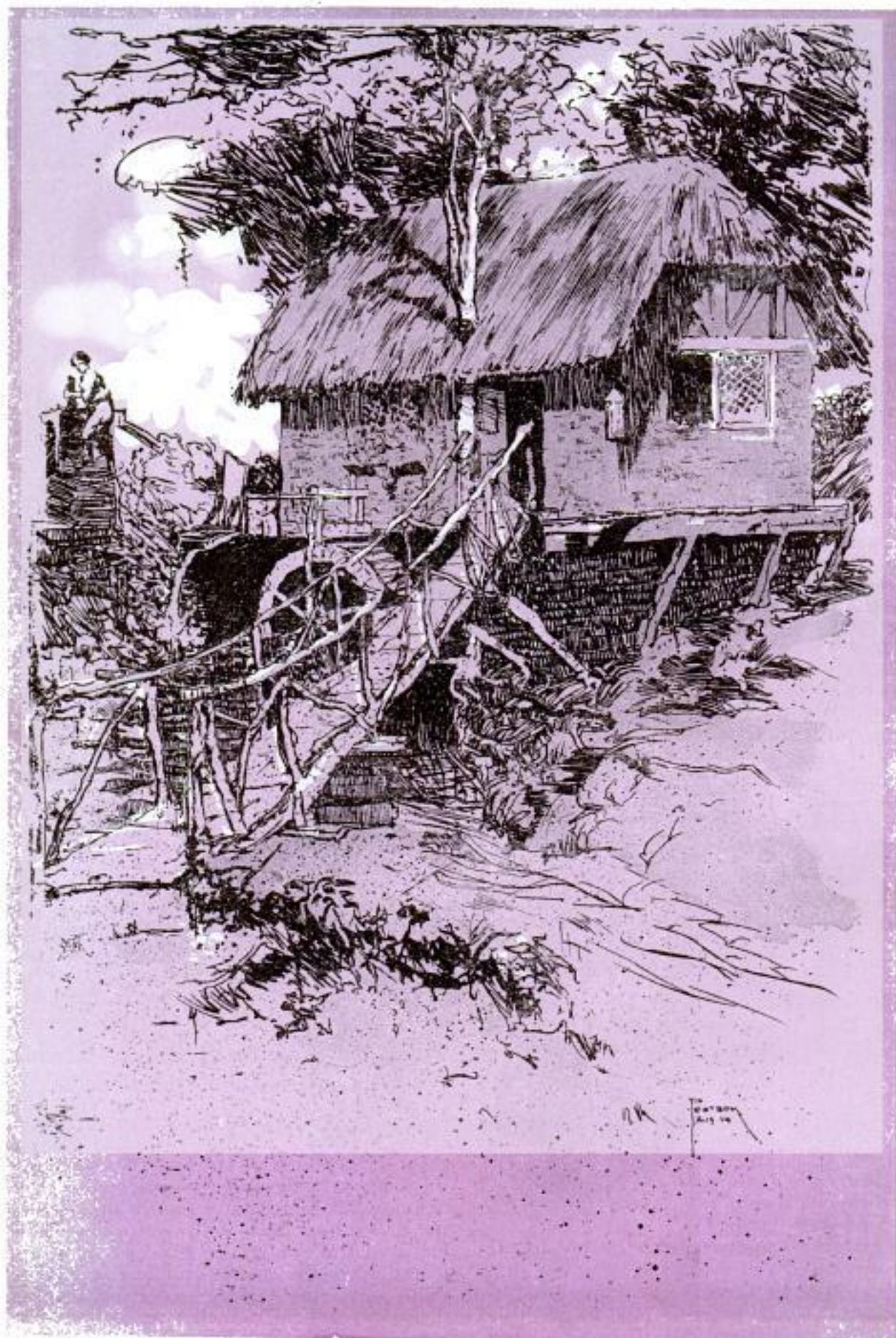

Dard Hunter's Thatched-Roof Paper Mill, with Its Old Water Wheel for Power, from an Etching in Hunter's Book on Old Paper Making

Author Makes Paper and Prints Own Books

Art of Printing and Paper Making, as Practiced in Days of Gutenberg and Caxton, Is Revived by Ohioan in Unique Plant

IN the National Museum at Washington two large cases are filled with punches, matrices, tools, type molds, handmade paper molds and handmade type. They are the nation's permanent record of the world's most unusual book-making venture—Dard Hunter's one-man book plant at Chillicothe, Ohio.

Hunter's work stands alone because he is the only man in the history of book-making who has produced volumes printed on paper which he made with his own hands and from type which he not only designed, but manufactured unaided. From the writing of the book to the last step in its binding no hand but Hunter's touches any of the materials which go into its make-up.

From the cotton and linen rags, beaten to pulp by power from a water wheel of his own construction, in the paper mill which he built with his own hands, Hunter produces the finest of antique hand-laid paper, in molds of his own designing and construction. The watermarks which he designed are works of art and are highly prized not only by book collectors in this country but by great libraries and museums abroad. In his printshop he picks the type from the cases and sets his own manuscripts. The type he designed and then cast in molds of his own construction, was made with tools which he likewise manufactured. Even the metal in which the type is cast is not the common

alloy which may be purchased from type foundries. Instead he bought copper, antimony, steel and lead and mixed his own alloy.

With the type locked in the page forms, Hunter proceeds to print his books on an ancient hand-operated press, and then binds them by hand. His editions average 200 copies each and are so eagerly sought by book lovers, museums and collectors that they command the highest premium of any modern books, even outranking the famous Kelmscott books which were produced in the workshop of William Morris, the great English reviver of the art of fine printing.

The history of Dard Hunter's workshop goes back many years to days when he was a designer of books for the late Elbert Hubbard at the Roycroft shop in East Aurora, N. Y. Hubbard's roycrofters were an aggregation of specialists, each doing one part of the work. Hunter decided that the books lacked individuality because so many hands had a part in their making, so he decided to do the whole work himself. Hubbard's handmade paper was imported from Europe, but Hunter went direct to Italy and studied the art in a mill where hand-laid paper had been made for centuries. Next he went to Vienna and studied type design with the late Rudolph von Larisch and the art of bookmaking in the graphical institute and the artschool. Then he entered the Royal Techni-

cal school in Vienna and studied the art of bookmaking in the graphical institute and the artschool. Then he entered the Royal Techni-



Making Paper by Hand, from a Medieval Print, Showing Methods Used by First Bookmakers



Punches, Ladle and Metal Used by Hunter in Making Type

cal college of Finsbury, London, and studied toolmaking with England's foremost metal worker, Alexander Fisher.

Finally, prepared for his venture, he returned to his old home at Chillicothe, where he lives on a hilltop overlooking the town, his residence being a replica of the Villa Centinale, in Tuscany. It was built by a German political refugee about 1850.

With his own hands he built a paper mill of half-timbered construction, modeled after an old cottage of Devonshire, Eng. He even grew the wheat from which the straw for the thatch roof came. The miniature mill he equipped with paper-making appliances which he had found in an antiquated paper mill at Wiltshire, Eng., which had not been used since the invention of the paper machine more than a hundred years ago.

With the help of power from his creaky wooden water wheel he began making paper, turning out about 200 sheets a day, each sheet being produced from pulp hand laid in molds of his own design. When there was no water to turn the wheel, he turned to toolmaking, and with his tools constructed type molds and mat-



Dard Hunter at His Old Hand Press

rices, using his own type designs for the latter. His methods followed those of the first type makers, the punches being cut by hand and stamped into bars of copper, which formed the matrices into which the type metal was poured.

The type making alone occupied three years, and before he had enough type and paper for his first edition of 200 copies, five years had slipped by, yet when that first book was off the press, in 1915, he sold it at \$5 a copy. The same book now brings as high as \$75 a copy. With the same type and style of paper, he produced a second book in 1917, and in 1923 brought out his famous "Old-Paper Making," a quarto volume of more than 200 pages. The edition, of 175 copies, was two years in the press. The text explains in a comprehensive manner the methods of the old paper makers, with many illustrations in black and white as well as a great number in color—all produced in his one-man shop. The list of clients who

Type Mold and Matrix, and Some "Homemade" Cast Type

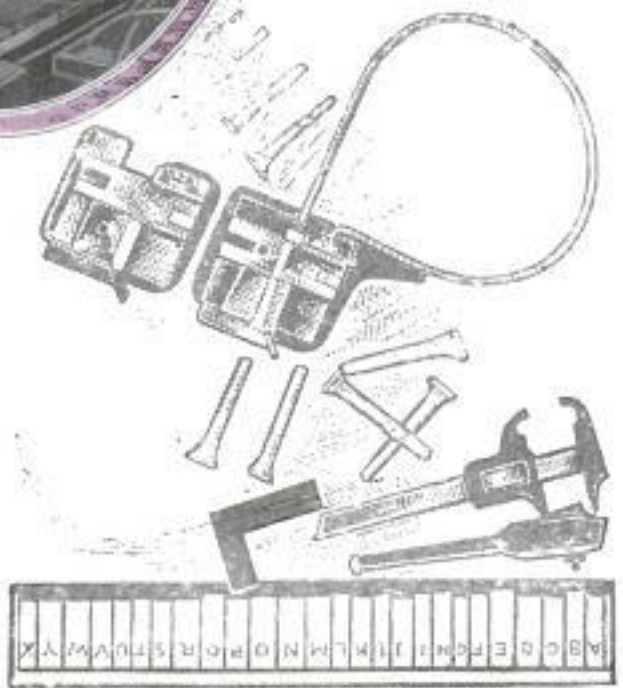

Part of a Font Made by Hunter



The Hunter Watermark, His Name and Bust in a Mold in Which Hand-Laid Paper Is Made by Spreading the Pulp over the Surface; Lettering, Reading Backward on the Mold, Will Be Reversed on the Finished Sheet; Below, One of Hunter's Books, Showing a Page of Ancient "Bull" Watermarks



have purchased his books reads like a "who's who" of the great libraries and museums. In New York they are to be found in the Metropolitan Museum, Public Library, Columbia University library, J. P. Morgan collection and the New York Historical Society. Three foreign museums maintain permanent exhibits of all his books. In Chicago they are owned by the Art Institute, Crerar and Newberry libraries. Nearly all state libraries and the art institutes of San Francisco and other cities have taken copies.

"Typography has always been of vital interest to me," Hunter says. "I was reared in the midst of paper, type and ink. My earliest recollection is watching my father set type, and print on an old Washington hand press. He had a great love for the printing of the early craftsmen, which he said had never been excelled; it was his contention that modern book printers should follow in their footsteps.

"For twenty years I labored to get the quality of old typography into books that I was producing. I used the so-called handmade paper from Italy, my type was of special design, and the printing was executed with care. But my books always lacked the charm of the old volumes. I have seen through the press upward of 200 different books, but none of them ever pleased me. They were just so much paper with a type impression—that was all.

"The Italian book printers of the fif-

teenth and sixteenth centuries have never been excelled. Their paper, even after 400 years, shows a richness in tone and texture which the modern paper makers have never equaled. The type possesses a freedom of stroke unknown today.

"The old books from the presses of Aldus and Nicolas Jenson haunted me. Why could I not, in this age, produce as fine typography as these fifteenth-century artisans? I determined to learn their processes."

A new book, finished during the last year, entitled "The Literature of Paper-making—1390-1800," draws extensively upon his library of early books and prints on the subject of paper making, said to be the finest private collection in the world. His library and workshop are in one, a lofty apartment in his home, with a balcony on four sides. Here he has his old hand presses, fonts of type, and hung from the ceiling rafters, are rows and rows of sheets of handmade paper, drying and seasoning. The process of aging takes several years before the paper is ready for use.

Tricycle Tractor Guided by Reins Can Make Short Turns

245-9 With only three wheels and guided with reins, a tractor of German manufacture is claimed to be adapted to rough



Front and Rear Views of Tricycle Tractor, Showing Reins by Which Driving Wheels Are Regulated

ground and can make exceedingly short turns. Each of the large front wheels is independently geared and can be stopped or started by pulling leather straps attached to a frame in front and held by the driver. By stopping one wheel and leaving the other one in power, the tractor, aided by the small rear wheel which is fixed in a pivot, can turn abruptly about. The big drivers have sectional tires for gripping the surface.

Seagoing Foundry for U. S. Navy to Repair Ships on Voyages

Practical foundry service for ships at sea, including major repair and replacement castings, is to be furnished by a floating foundry designed for the navy. It will be one of a group, the "works" of a fleet when in motion or at rest. The ship is to be more than 400 feet long with a beam of seventy feet and 10,000 tons' displacement. Many smaller shops will be housed on the ship, and a large company

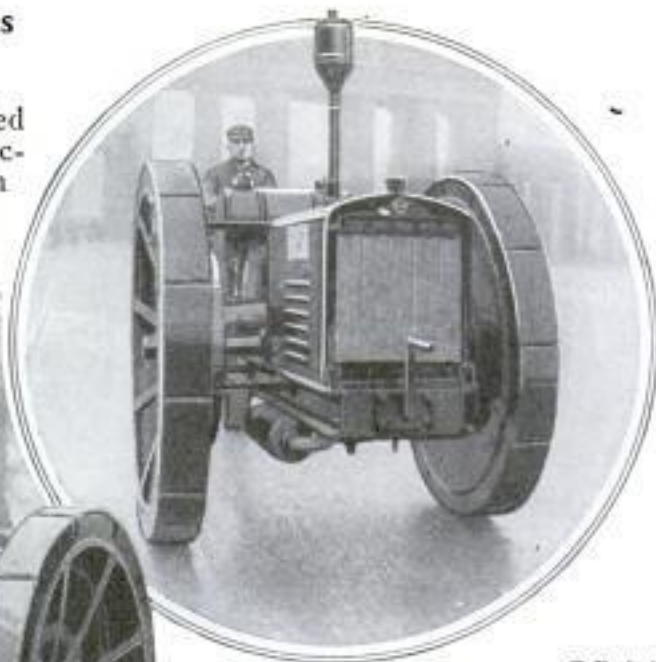

© P. & A.

of workers can be accommodated. The foundry part will have a floor space of forty-eight by seventy feet and be two decks high, that is, twenty feet. By utilizing all of the lower deck and building the upper one in the shape of a gallery, extending around three sides, a total of nearly 5,000 square feet of floor is made available, besides space for storage purposes. Included in the melting equipment, are four 700-pound oil-burning crucible furnaces, a three and one-half and a one-ton cupola, all of which are located on the third deck.

2306 Collapsible Holder for Cigarets Fits into Watch-Charm Case

A collapsible cigaret holder, which is two and a quarter inches long when extended and folds up into a small case that may be worn as a watch charm, has been placed on the market. The carrier is about an inch long, is designed after the pattern of an acorn and has a screw top.



Cigaret Case Extended, and Acorn-Shaped Carrier Which Is Worn as Watch Charm

Empire Patent Co.
72 Madison Ave.
New York City

Brass World 250
12/1924

Tunnel over Thirteen Miles Long Pierces Mountains for Power 2457 **Magnifier for Long or Short Range Is Aid to Weak-Sighted 2530**

Thirteen and one half miles long, fifteen feet in diameter and costing approximately \$17,000,000, the Florence Lake tunnel, piercing the granite of a section of the high Sierras in California, engineers estimate, will provide electricity enough for more than 200,000 homes, pump water to 620,000 acres of farm land and furnish driving power for 5,000 factories. More than five years have been spent on its construction. It is the first of a series of similar tunnels that will have a total length of more than eighty miles and cost about \$375,000,000. One hundred miles from any large town and marooned much of the time by storms, the workers were organized into permanent camps and "grew up" with the job. They bought stock in the company, schools were started for their children, dog teams brought in regular mails, there were daily motion-picture shows and hot meals were served to the diggers far back in the tunnel on specially equipped luncheon cars. Eighteen cook houses with a capacity of 6,000,000 meals a year were required.

A small magnifying glass with a telescope attachment can be used for either



Telescope Magnifier Attached to Head Clip, for Use by Weak-Sighted Person in Reading

Anchor for Fixing Bolts in Concrete Holds Nut in Steel Slot 2349

For attaching shaft hangers, partitions or other objects to concrete, a steel anchor with a slot and hollow chamber for holding the bolt nut has been devised.



It is imbedded in the grout by attaching it to the forms and the insert is so shaped that the nut can be put in place with the finger. The bolt is then introduced and screwed up tight. A shoulder upon which the nut

rests, prevents it from becoming loose or twisting, and additional strength is given to the support by a top flange on the anchor spreading into the concrete. No nails or wire are needed to fix the insert in place, and the use of a steel washer prevents the bolt from sticking. The accessory eliminates the necessity of boring or drilling holes in the concrete and is said to afford a stronger grip than is possible with blocks of wood.

long-distance views or for close-up work by making slight alterations in the position of the lenses. As an aid to weak-sighted persons, it can be carried in the pocket or purse and can be quickly changed to suit the owner's need. To permit of easy support, a loop handle is fastened to the side and to this a bracket or head clip may be attached if the hands are to be left free for other work. A slow-motion adjustment sets the instrument in accurate focus, and a chamber for holding minute objects can be easily inserted.

Autos Use Fuel Wasted on Level in Climbing Moderate Hills 2011

That the motor of an automobile climbing a moderate grade uses no more gasoline than it burns when traveling on the level has been shown in tests recorded by Prof. Thomas R. Agg, of the Iowa State college. Experiments indicated that the engines do not work to capacity on the level, much unconsumed gas being blown out through the exhaust. Operating on medium-steep hills with grades up to seven per cent, he says, motors function with greater efficiency. In moderately hilly country there is hardly any increase in the cost of running automobile engines.

As written in work in book of Morris etc. Ohio

Copyrighted material

Call page 153 W. 23rd St. New York

1/13/25



R.A.

Scenery in the Cavern "Wonderland" and How the Explorers Had to Travel, Creeping along Low Passages and Scaling Heights in the Manner of Mountain Climbers

Cave

Dr. W. Emile Desmas

address unknown 563

New Underground Wonderland Found in Virginia 2566

Species of vegetable and animal life and rock formations, more spectacular than those already known in other parts of the caves are reported to have been found by a party of explorers in a chamber of the Endless Caverns, near Newmarket, Va. They lowered themselves down a steep passage with eighty feet of rope and entered what they describe as a sort of subterranean wonderland where intricate passages, frosted with stalactites glittering in the glare of the flashlights like icicles of rock, stretched away on all sides. To reach some of the small galleries and recesses, the adventurers had to lie flat and push themselves along with hands and knees. The caverns, geologists believe, mark the courses of underground rivers that worked their way through the strata and dried up many years ago.

25-45

High-Pressure Car-Washing Plant Fits Large or Small Garage

Suitable to installation in small as well as large garages, a high-pressure air and water system for washing automobiles has been devised. It can be used wherever water and electric current are available, is simple to operate, and cars can be washed inside and out and under the hood in from eight to fifteen minutes, it is said. After washing, remaining moisture is blown off with a blast of air, and the car wiped with chamois skin. The outfit consists of two high-pressure air and water tanks, a tank for distillate, compressor and motor, mixing chambers, "guns" and nozzles. The tanks are so arranged that while one is used, pressure in the other is being restored. The two working together in this manner, it is possible to use a five-horsepower compressor even for large jobs. Upholstery, rugs and curtains are cleaned by blasts of air, and the distillate mixture applied through special sprays, softens grease and road tar on exposed parts.



Through Long Hose and Nozzle, Spray from Pressure Tank Reaches All Parts of Car



Swimmers Garbed in Unsinkable Bathing Suits Which Are of Great Aid in Teaching Beginners

Bathing Suit Keeps Swimmer Afloat and Helps Beginners Learn 2577

An unsinkable bathing costume which keeps the wearer afloat in water, aids in swimming and helps beginners to master the sport. Fashioned like an ordinary suit, the garment leaves the limbs entirely

free for movement and needs no inflation. In use, it holds the swimmer in a horizontal position and, being light in weight, adds no extra burden to retard progress. It is said to be of great value in developing new strokes or practicing trick feats. The costume is easily put on and is adapted to lifeguards who often support one or more persons in the water at the same time.

National Engineering Co. St. Louis
817 Market St. Mo.



Center Photo © Keystone
 Left, "The Mocker," and Right, "President Wilson," Hero Pigeons of the United States Army Injured While Flying over German Lines with Important Messages; Center, Typical Racing Homer

Pigeon Messengers of Peace and War

Racing Homers Maintain Communications When Other Means Fail and Form Important Link in World's Army Tactics

DESPITE the advances made in scientific methods of communications, homing pigeons, message bearers of the early Egyptians, are still relied on to maintain contact between widely separated places when all other means have failed. Whether the ability of these racing birds to return to their home lofts when released at distant points is due to instinct, intelligence or to some yet unknown power of sense direction has not been definitely established.

Many reasons have been offered, and it has even been suggested that a network of delicate electric forces might be responsible for the pigeons' faculty of finding their ways back home after being carried in masked cages to places hundreds of miles away.

Numbers of these birds are credited with achieving tremendous tasks and heroic services. A short time ago, a fishing party left a Panama port in a stanch vessel, but were not heard from for several days during which a terrific storm raged over that locality. Preparations were being made to institute search for the boat or evidence of its fate, when a homing pigeon that had been taken by one of the crew of the "lost" ship, appeared at the government station, dripping wet and nearly ex-

hausted. It bore a message to the effect that all was well aboard the fishing vessel and gave the location of the craft.

While it is common for homing pigeons to cover courses of 200 or 300 miles, some can fly more than 1,000 miles without apparent harm. Such flights are generally made in a series of "hops," the birds taking to shelter at night and resuming their journeys with daylight. Heavy rain-storms have little effect on them, and many records of fast flying have been made by pigeons forced to go through steady downpours. Nature protects them, covering the wings with a natural powderlike substance which keeps the moisture from penetrating to the skin.

In order to teach the "squeaker," as the youngster is called, a trainer first drills it to "trap" properly. This consists in entering the loft through a swinging-gate arrangement which hangs on a pivoted shaft. Alighting on the landing board, the bird is coaxed by feed within to thrust itself against wire strands which rise upward as it passes and drop into place again to prevent the pigeon's exit. Backward birds are urged by the gentle use of a light whip. After they have learned to trap, they are taken from one to two miles from home and "tossed," or released, to

1924



World's Largest Non-Stop Flight—700 Miles—Manitoba, Canada, to Ft. Worth, Texas

The Mockers, Greatest of Hero Birds, Saved Whole Battalion of American Soldiers

Mobile Pigeon Loft, Used during World War



Message and Metal Container to Be Attached to Bird's Leg

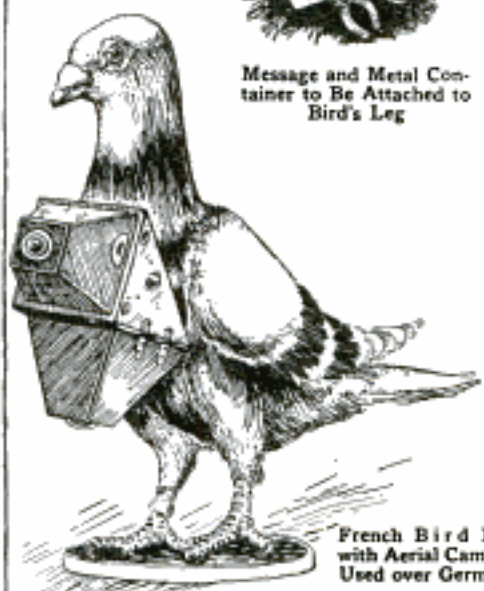

French Bird Equipped with Aerial Camera to Be Used over German Lines



Message Bird Entering Home Loft One-Way Entrance Trap



Cavalryman Equipped with Birds in Basket



President Harding's Official Message Carrier



Ben Bolt, the World's Longest Flier, 3500 Miles. Dayton, Ohio, to Pasadena, Calif.



President Wilson. Many Soldiers Can Thank This Veteran for Saving Their Lives



Spike—Carried 52 Messages through German Lines and Was Never Injured

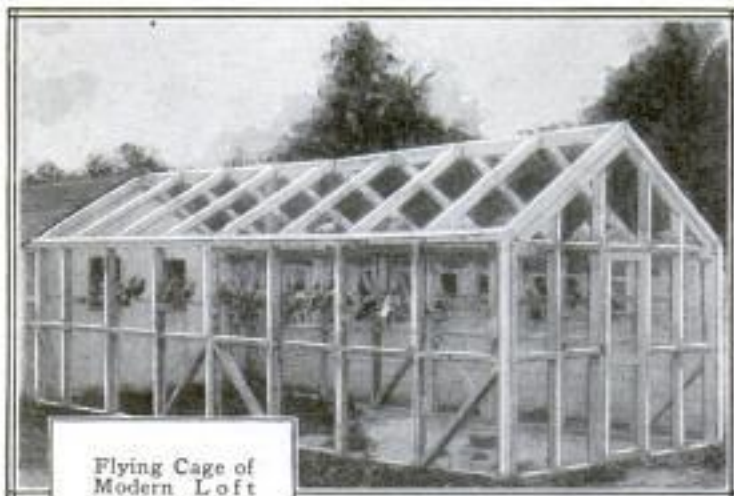

Flying Cage of
Modern Loft
That Insures
Healthy Stock

wonderfully developed branches of this service. The foreign armies had upward of 105,000 birds and 8,000 men each in this service. During the early part of their participation in the war the rapid advance of the Americans found the means of communica-



Setting Clocks to
Time Arrival of
Racing Pigeons at
Home Loft



Placing Bands
from Racers'
Legs in Clock
Safe for Con-
test Judges



fly back. The distance is gradually increased, the trainer purposely keeping the little students hungry to assure their return for food, since a carefully raised homer is not likely to forage for food, especially on short flights. As they progress, courses of 500 or 600 miles become a regular feat for the pigeons. While many records exist of birds flying 1,000 miles, some have gone much farther. And speeds of more than a mile a minute have been maintained by countless homers on ordinary test flights.

The pigeon division of the United States army was not in existence at the beginning of the war, while the French, German, Belgian and English armies had

Sending Pigeon from Airship "Shenandoah" to President Coolidge

whole battalion. When a lone soldier went on reconnoitering duty through the enemy lines, he carried two birds in a small willow basket on his back. Within the basket the birds were placed in small canvas corselets and were suspended by rubber bands so that they would not be injured by the movements of the soldier in walking, falling or running.

Infantrymen were equipped with small silk bags filled with oxygen into which the birds were put when a gas attack came over the lines. At times, the pigeons were with the men in the trenches that were filled with mud and water, and had been without food for days; yet when released, so great was their vitality, they reached their desti-

tions very inadequate. Because of the pounding of the heavy artillery, radio was ineffective and telephone service often impossible. It was then that the pigeon came into its own. "The Mocker," greatest of all hero birds, on the morning of Sept. 12, 1918, arrived at his loft from the Beaumont front with his right eye shot out and his head a welter of blood. He carried messages that gave the exact location of advancing enemy batteries. This information enabled the allied artillery to save a

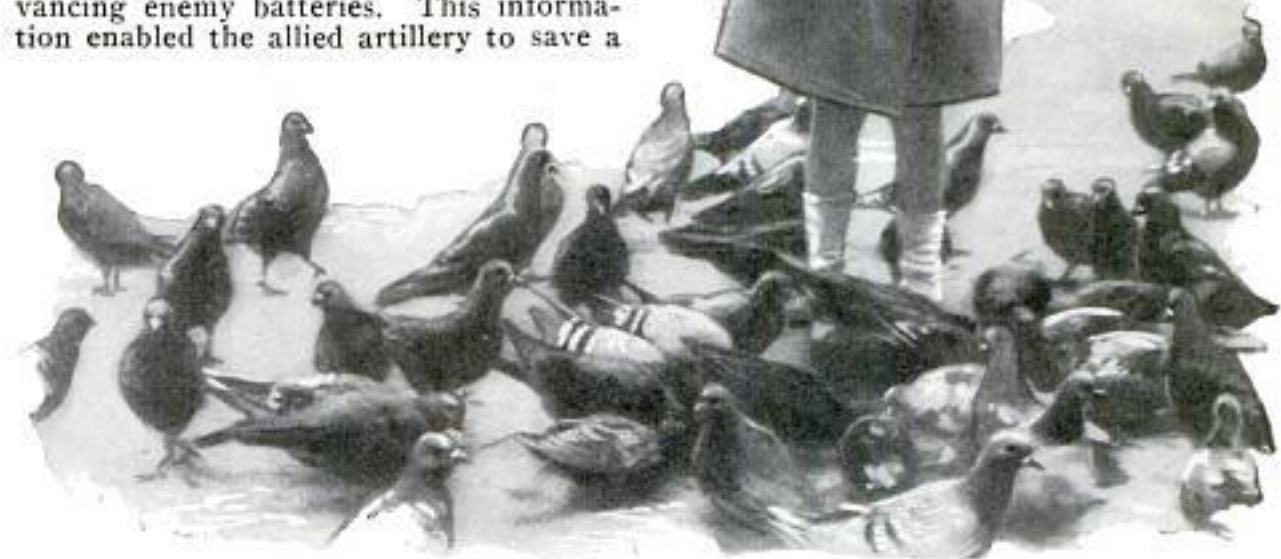

Every Large City Has Its Flocks of Tame Pigeons That Roam the Streets Unclaimed

nations with but few exceptions. Ninety per cent of the messages in France that started out with the birds were delivered.

On the morning of Nov. 5, 1918, "President Wilson" arrived at his loft after a flight of twenty kilometers in twenty-one minutes, with the left leg shot off and hanging to his body by one of the tendons. He lost his leg, but delivered the message in jig time. A more lucky bird was "Spike." He delivered fifty-two messages through all kinds of shell fire and in the worst possible kind of flying weather, and was never injured.

About the year 1916 the French introduced the aerial camera. This little instrument weighed scarce two and one-half ounces and was principally made of aluminum. It was fastened to the breast of the bird with small straps and rubber bands. Each camera had two lenses, one pointing forward and the other downward. Inside was a small rubber ball pierced by a minute hole. This ball was pumped tight with air. After the bird was released, the air slowly leaked from the container and upon complete collapse released the shutter; thus taking the picture.

The bird circled to a height of 100 to 300 feet. It was too small to be hit with bullets and too high for the artillery and gas. The tiny films, when greatly enlarged, gave wonderful information. Often the enemy sent up falcons to kill the allied birds, but the French placed small bowlike whistles on the tails of the birds, and when the wind blew against them, a loud whis-

ting noise issued forth to scare away the falcons. As a pastime and sport, the birds are being raised in practically every country in the world by sportsmen who enter them in contests of speed and endurance. Records are carefully kept of all such performances, and selective breeding has resulted in producing pigeons that can easily fly 500 miles with an average speed of a mile a minute. Probably the longest distance ever covered during a test by racing homers is a flight from Denver, Colo., to Fall River, Mass., in which two birds flew more than 1,800 miles and arrived at their home loft in good form.

Not only are the birds of great value for military and racing purposes, but they have been entrusted with the exchange of news reports, private communications, and have even been sent with the craft taking part in yacht races to keep those at shore informed as to the progress of the run. Laws have been passed in many countries, making it a serious offense to kill a pigeon, in order to protect the homing variety which at any time may be carrying valuable data.

Like race horses, pigeons which prove of great ability to travel long distances swiftly, are used to stock the flying teams.



Messenger-Pigeon Carrier of Argentine Army Going Forward into Line for War Maneuvers

Prices paid for them often reach several hundred dollars. One loft of 150 racing homers, recently sold in England, is said to have brought \$18,000. Private individuals by the thousand give time and effort to breeding and racing the birds. Societies exist in every state of the union for the purpose of promoting interest in the work, and national contests are annually held to encourage the development of the fleetest kinds. As a rule, the racing homer is so highly bred and schooled that it will refuse to occupy a coop which is not kept in the best con-



Inserting Message Tube into Holder Tied to Bird's Leg



Long - Distance Racers of Strong Light Body and Powerful Wings



Leg Bands and Dispatch Holder Usually Employed in Military Services

dition. Their feed is of selected grains, aged for from one to two years before being given the birds. It is with the help of the pigeons' characteristic fondness for

such feed as hemp seed and rice that trainers are able to teach them distance flying while they are still quite young.

While all pigeons at one time were more or less given to homing, most of them have been bred into show and fancy specimens. The racing homer is the result of careful crossbreeding which has produced a pigeon that has strength, intelligence, and a tall graceful form marked by a light body and powerful wings.

In the days when ancient Rome's legions marched forth to battle, carefully guarded pigeons accompanied them. If the passage of foot messengers was prevented by the enemy, the birds were released with messages to fly over the heads of the opposing armies. Rarely did an imperial prince of those times set out on a long journey without the imperial pigeon cote being included in the train of attendants and equipment.



Whistles Are Fixed to Tails of Homing Pigeons to Frighten Off Hawks Bent on Attacking the Flyer

Jellicoe International Co.
Sandwich Co.
 POPULAR MECHANICS
 201 E. Vernon, Los Angeles, Calif.

2380
 540

Slot Machine for Sandwich and Pie Saves Luncheon Time and Cost

At luncheon periods in a western factory, workers find a slot machine that delivers a sandwich or a piece of pie for a



Self-Service at Handy Two-Compartment Slot Machine That Dispenses Sandwiches or Pie

dime, a time and money saver when they do not care to purchase a more elaborate meal. The food is wrapped in stiff-paper packages and fresh supplies are put in each day. Pulling a button rod at the side of the machine releases the purchase and two kinds of sandwiches can be obtained from the same cabinet. The company owning the venders, is thus spared the expense of hiring salesmen for the refreshments.

Also see march. 1926 - 393

Speeding Plane Hooks on Blimp Fifteen Hundred Feet in Air

For the first time in history an airplane flew up from the ground, hooked on to a speeding dirigible, and then cast loose and flew away during recent army aircraft maneuvers at Scott field, Ill. The small messenger plane used in the successful experiment remained attached to the "TO-3," a non-rigid dirigible, for ten minutes, then its motor was started again, the hook released and the airplane flew back to earth. A metal hook fastened over the engine of the plane and a trapeze hanging from the "TO-3" were the only equipment used. The airplane flew at eighty miles an hour, while the big gas bag was jogging along at fifty miles an hour. As the hook snapped into place,

2495

B x A.

the airplane pilot shut off his engine and the plane hung in place. The new army semi-rigid airship "RS-1," now being assembled at Scott field, is being fitted with a similar device, so that it can carry a scoutplane, to be launched and recovered at will. The "RS-1" is the first American-built semi-rigid. It will be 282 feet long, seventy and one-half feet in diameter and have a gas capacity of 719,000 cubic feet of helium. Four 300-horsepower Liberty motors will drive it at a full speed of seventy miles an hour and a cruising speed of fifty-five miles. The navigating cabin, thirty-five feet long, will have sleeping quarters for officers and men, and a trap in the floor, to reach the scoutplane slung beneath.

Steel Houses Built in Single Day Reduce Cost of Construction

To furnish comfortable but inexpensive homes that can be erected in a short time, several types of dwellings built mainly of steel plates have been tested in England. The metal parts and framework are partially assembled at the factories, so that a few men can set the complete skeleton up in an ordinary working day. The frames of some of the structures are of timber, while others consist of light iron-work to which the sheets are attached. When completed, the walls of the houses are hollow, permitting an insulating air space which equalizes temperatures throughout the buildings and aids in keeping out both heat and cold. Inner and outer finishes can be readily placed over the metal, some of which is rust-proof, to prevent staining the covering materials. Some of the models require no exterior stone or cement coatings since the surfaces are decorated and colored in imitation of tile and other effects. Flues are constructed of concrete which in many cases also forms the foundation supports, thus eliminating elaborate preparation for bases. This method is said to prevent dampness and vermin, and reduce the hazards of fire. In the finished state, all the metal work in the houses is hidden, presenting an appearance much like ordinary modern dwellings. With the sections of the buildings ready for assembling on the site, three motor trucks are sufficient to transport the material for an entire structure. Though but a few days are required to erect and complete such homes, they are claimed to last for forty years with little need for repairs and small outlay for resurfacing due to weather.

2571

William Beardmore & Co. Ltd

Glasgow, Scotland

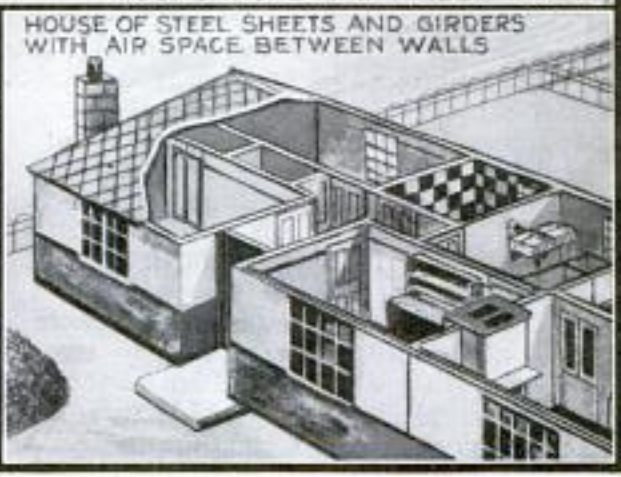
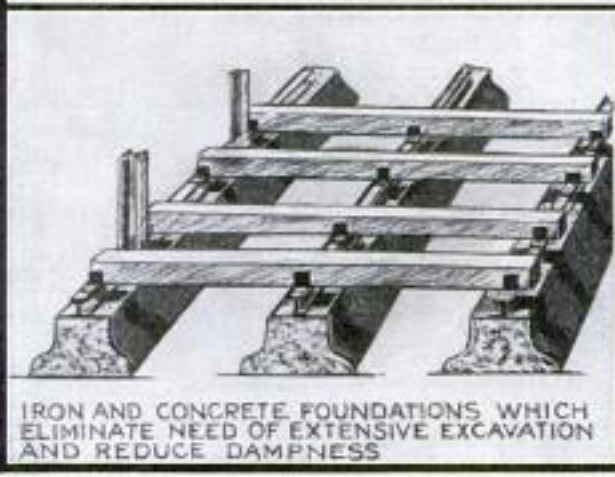
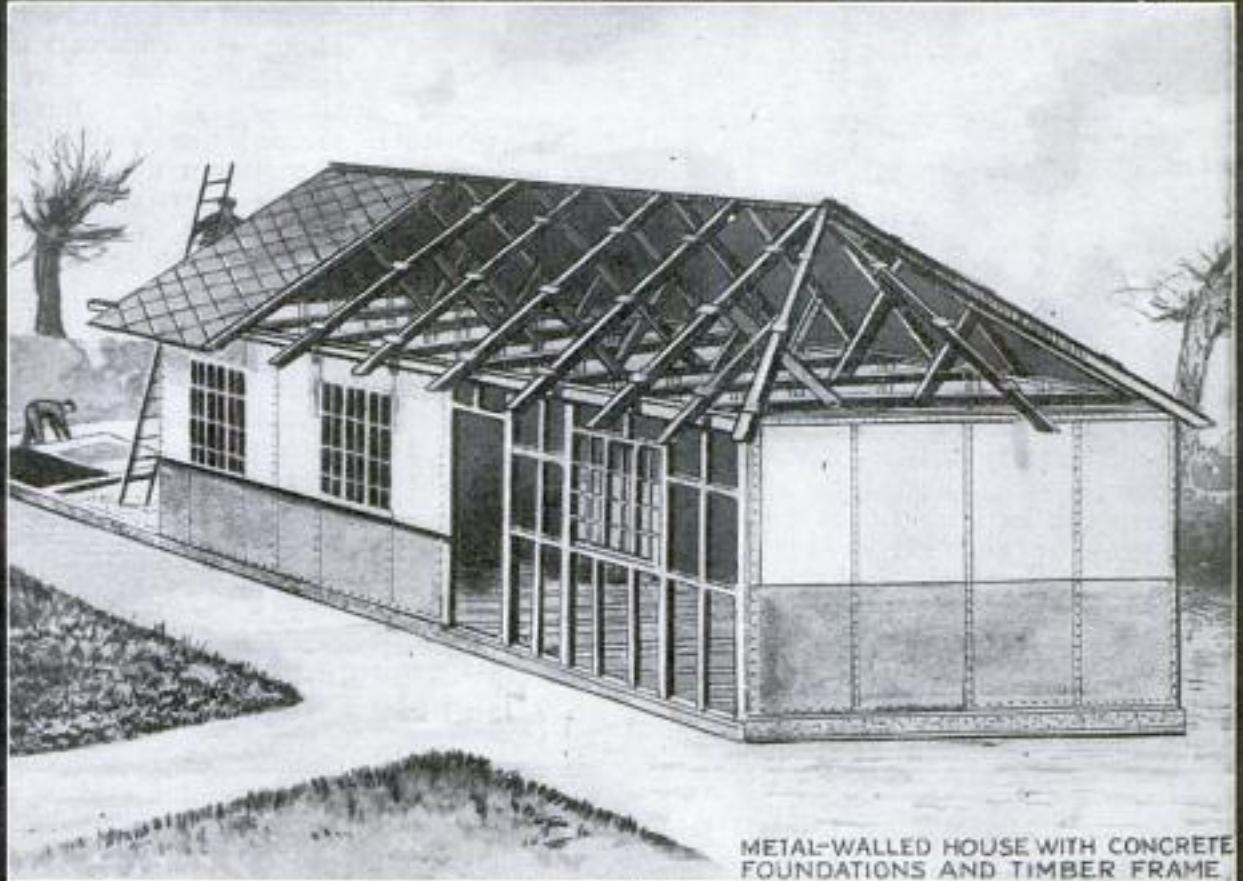
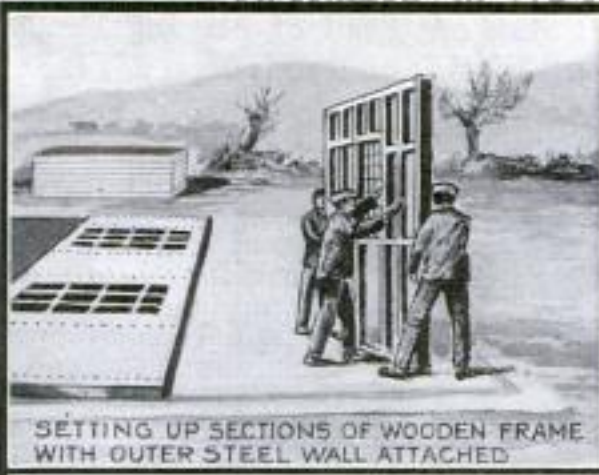

Courtesy, The London Illustrated News

Developments of Steel Dwellings to Solve the Housing Problem Have Resulted in Several Types Consisting of Partially Assembled Sections That Reduce Erection Costs and Provide Cheap Homes

Chicago Evening Post
24, 25
2607

**Green Elephant Carved in Hedge—
by Artist with Shears**

2428

Fashioned from the green foliage of garden bushes, the figure of a large ele-

Charles W. Kimball
Atlanta, Ga.



Lifelike Figure of an Elephant Carved in Thick Foliage of High Hedge by an Artist Who Uses Garden Shears to Do His Sculpturing

phant has been made by an artist to add decoration to a hedge surrounding his house. The leafy statuary, formed in lifelike pose, presents a realistic appearance. To keep the outlines smooth and sharp, new growths and shoots are carefully trimmed. Other animals have been imitated in the same way by the hedge sculptor, who selects subjects according to the grouping and size of the bushes. The elephant is constructed in the familiar attitude of a circus "jumbo" with extended trunk as though in search of food.

**Leaks in Lake Stopped with Plugs
to Check Water Waste**

By plugging holes in the bed of Elk lake in the mountains of Oregon, the flow of large streams issuing from neighboring foothills was checked. During a drought, the springs feeding the lake diminished in volume allowing the level of the pool to fall low enough to expose outlets that were difficult to locate during normal stages. As rapidly as the openings appeared, they were filled with concrete. The outlets ranged from two to twenty feet in width. With the return of the season of rainfall, it was noticed that two rivers several miles from the lake had greatly decreased in depth, and distant springs were reduced to but a small part of their normal flow due, it is thought, to the plugging of the larger pool.

**Police on Trail of Missing Persons
Find Thousands Every Year**

One of the busiest branches of the New York police department, is the bureau that handles reports of missing persons. Last year, of the 8,000 individuals for whom search was made on these reports, only twelve were unaccounted for, and of the 6,000 cases of "absentees"—those away from their homes for indefinite intervals and about whom lawyers and friends wished information—only forty-four remained unsolved. The department draws a distinction between cases that occur in the day's routine, such as those of lost children and the like, and those that have dropped out of sight. Inquiries came to the department from other communities to the total number of more than 3,000 and all but seventy-one were traced. That men are naturally more roving than women was shown by the fact that 1,800 girls under 18 years old were missing as compared with 3,300 boys, and 2,700 adult women against 4,553 adult men.

**Pliers Combine Four Tools in One
and Have Adjustable Jaws**

As a handy implement for the tool chest, pliers designed with adjustable jaws can be used also as a screwdriver, wire cutter, and pipe or nut wrench. They can be made to grip any circular article up to one and one-eighth inch in diameter. A threaded attachment, convenient to the user's thumb, governs the setting of the jaws and permits them to be quickly changed to meet various needs. The device is small enough to be carried in the pocket or stuck in a belt and avoids loss of time often taken up in searching for tools.



2574

249

Chicago Evening Post
21, 25

Copyrighted material

2355 *Arcturus*

New York City

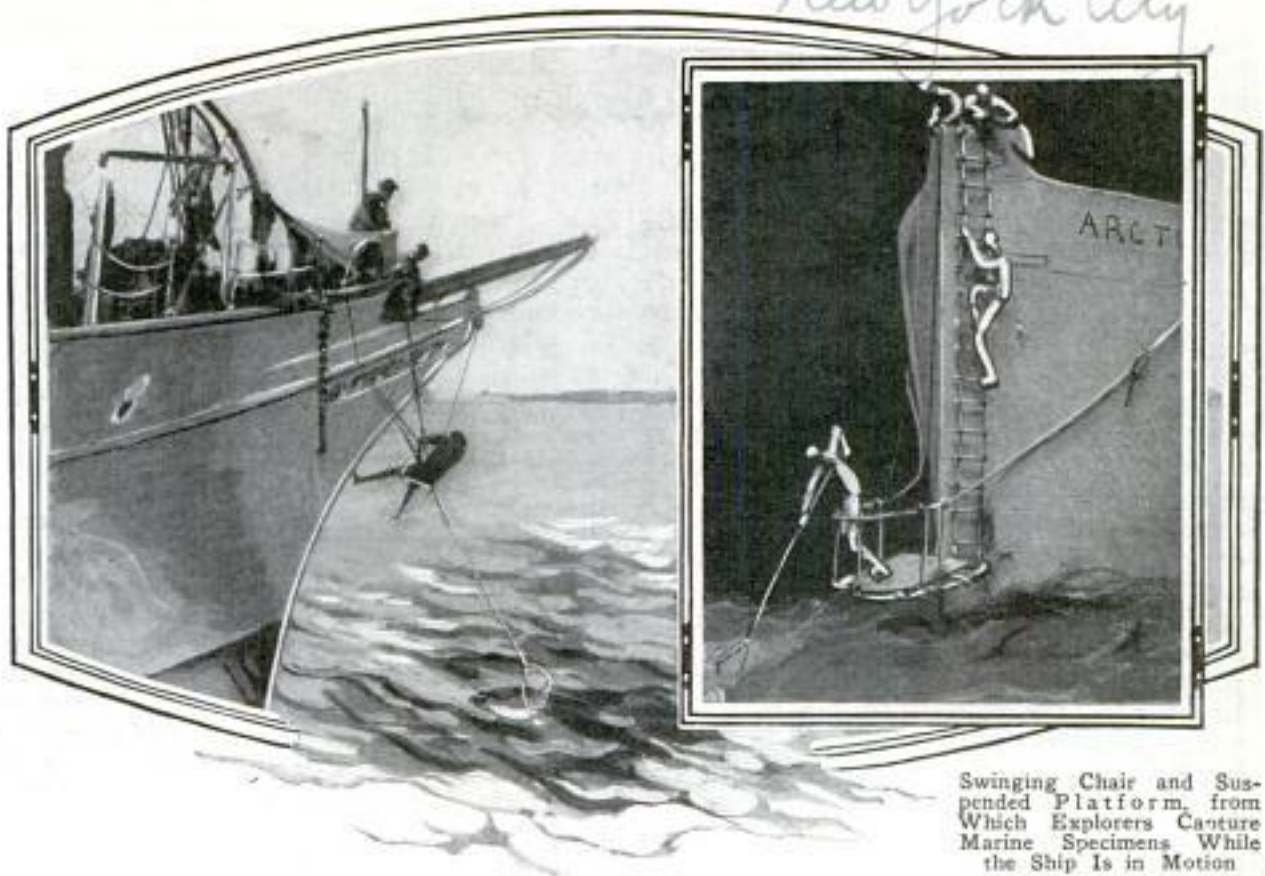

Swinging Chair and Suspended Platform, from Which Explorers Capture Marine Specimens While the Ship Is in Motion

Explorers to Solve Deep-Sea Mysteries

Floating Laboratory to Invade Remote Stretches of Oceans in Search for Specimens of Unknown Marine Life

EQUIPPED for a cruise of 13,000 miles through little-known ocean wastes, the ship "Arcturus," fitted out by scientists of the New York Zoological society for the study of marine life will invade remote parts of the Sargasso sea.

The vessel will include in its furnishings several large aquarium tanks in which specimens of fish and other denizens of the deep can be kept alive for study and examination during the voyage. Dark rooms have been built aboard for the purpose of photographing and spectroscopic investigation of those forms of life taken from great depths. Many of these emit a glow similar to that of the firefly, caused by phosphorescent materials in their bodies. The mysterious sea of floating weeds and drift will be studied with a view to solving some of the questions which have puzzled mariners since the days of Columbus' first voyage, when his fleet of small vessels wandered for two weeks in the patches of vegetation.

As the chief object of the expedition is to devote attention to the study of the

fishes and other organisms that live on and near the surface of the waters and those existing several hundred fathoms down, various arrangements have been provided for securing the required specimens. But all of them will be kept in the aquariums under conditions as near like their native waters as is possible. A number of devices for deep-sea dredging have been installed on the ship and diving apparatus will be ready for use for work in shallow waters near shores.

Special appliances are to be employed for the collection of marine life inhabiting the surface. One of these is a raft-like platform attached to the side of the ship's hull and from which the explorers can gather their quarry while the craft is in motion. Another arrangement will permit a collector to dangle from the side of the vessel, and armed with a long pole and net dip up any specimens within his reach, without slackening the speed of the ship.

Motion-picture machines will be kept busy recording the activities of the party

as well as registering the movements of the interesting fish and animals met with in the search. Ordinary cameras with powerful lenses will be used for still photographs and a complete wireless outfit with which the explorers will be provided will enable them to send reports describing the progress of their work to any point equipped to receive the messages. Thus, more than one log of the journey can be kept up in case accident should befall the expedition.

Although most of the scientists' time will be taken up by work at sea, short trips will be made into western Africa in search of live birds and reptiles for the collections of large museums and zoological gardens. To combat the dangers from savage peoples and wild animals during these incursions, each man will be heavily armed. Medical supplies will also accompany the party as a remedy against the hazards of fevers and jungle sicknesses which often make life unbearable for the hardiest explorers in that section of the world.

Previous expeditions on similar errands traversing neighboring territory to that planned for invasion by the sea hunters,

have added many rare specimens of water and land animals to the collections of the scientific institutions. It is believed that the Sargasso sea alone will reveal many unheard of creatures living in the tangled masses of floating vegetation. This region, which has been described as lying within an area extending from the Gulf of Mexico to Morocco, is dotted with expansive patches of dead seaweed which constantly change position as they are swept about by the ocean currents.

The vessel from which the activities will be carried on is said to be one of the largest ever used for scientific purposes or deep-sea explorations of this nature. It is 280 feet long. When not actually employed in the quest for living subjects for study, the various members of the group will devote their efforts to examining and classifying those already captured, thus saving considerable work at the end of the trip. Comparisons can be made with specimens heretofore recorded, and any that duplicate those known to the scholars might be discarded to again roam the hidden tracts of the sea which once inspired weird tales of derelict ships enmeshed in the mysterious ocean jungle.



Studying Wild Seals at Close Range Where the Animals Have Not Been Harried by Hunters and Remain Unafraid of People Approaching Them with Harmless Intentions

2539



Talking by Radio Telephone from One Ship to Friend on Another

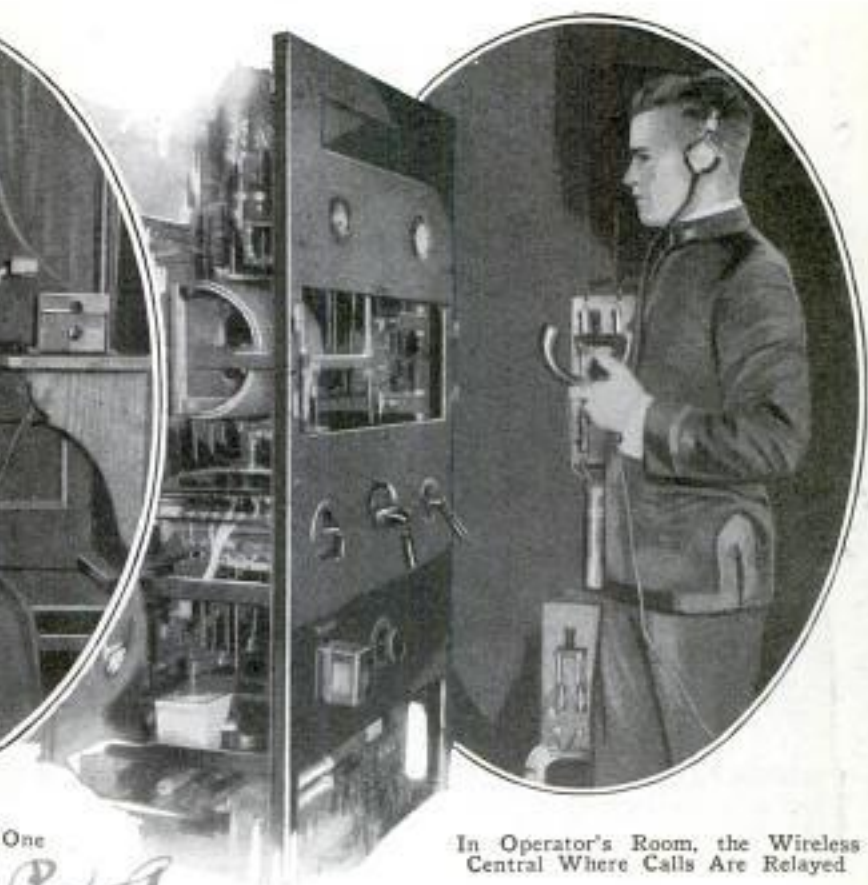

In Operator's Room, the Wireless Central Where Calls Are Relayed

Sea Passengers Telephone by Radio to Persons on Other Ships

Conversation between passengers on different ships while at sea has been made possible with a system of radio telephones that one company has installed on its liners plying between San Francisco and Honolulu. Distances of 500 miles during the day and 1,000 miles at night are covered with little difficulty, it is said. The voice is broadcast through apparatus similar to that of a usual sending station and is picked up on telephones with special tuning apparatus, the talkers wearing regular headphones.

Keeping the Zoo Full 2565

One of the chief items in the upkeep costs of large zoos is the expense of new animals to replace those that die. Proper food and expert care keep the mortality rates within bounds, but monthly purchases for new specimens sometimes amount to hundreds of dollars, and remote parts of the earth are continually being scoured for captives, that empty cages may not greet the visitors. The highest death rate occurs among the birds, next come the mammals with the greatest financial loss. Reptile casualties are the lowest. In a single month at the Bronx zoo, twelve mammals died, including a

New York Times 1/18/25

bonnet macaque and a white-faced sapa-jou, rare kinds of monkeys. A crocodile, two tortoises, fifty-two birds and three snakes died in the same period. Monthly expenditures for new specimens range from twenty-five cents for a box tortoise to \$900 for a pair of baboons.

Shade Snapped on Auto Headlights Stops Glare and Focuses Rays

Glare from small - car headlights equipped with plain glass lenses can be stopped easily and the rays directed upon the road, with a metal cover for the lamp slipped over the rim and held by four tabs that fit about the rivets in the edge. The shield is slotted with a number of apertures, each shaded by a strip reaching across the face of the disk and set at such an angle that the glow of the light is projected downward instead of streaming straight ahead where it is likely to confuse approaching drivers. The attachment costs less than special lenses and can be removed or put in place in little time.



The Surno Mfg. Co. 299 Seattle St. Syracuse, N.Y.

THEATER OF THE STARS TEACHES ASTRONOMY



Nearing completion at the German museum in Munich, is a theater where the heavens and the starry wonders they contain have been reproduced in miniature as an aid to the study of astronomy. It is built in the form of a large dome and across its interior, the movements of 4,500 stars—all that are visible to the unaided eye—the sun, moon and the planets are traced by means of spots of light projected from a telescope arrangement occupying the center of the stage. On the spherical top of this instrument are thirty-one lenses placed like the facets in a fly's eye. They project the little light points from a 200-candlepower lamp on the inside. In addition to these lenses are eleven projectors for marking in dimmer light the misty path of the Milky Way and the planet lights are contained in a cylindrical "tail" at one side of the telescope. The entire apparatus is moved by a small electric motor regulated so that the



Inside the Dome with Its Starry Sky, and Close View of the Projecting Instrument

courses and movements of the heavenly bodies are exactly reproduced. Phases of the moon are shown by means of shades. The names of the constellations and of individual stars flame out in letters of red and white lights at the will of the lecturer or automatically if desired. Summer and winter skies can be represented by adjusting the apparatus and there is a clockwork mechanism to show the year, date and hour. When the spectator enters, he sees the dome lighted to give the appearance of a night sky with its pulsing stars. As the "sun" comes up, colors change and the realistic silhouette of the city of Jena, where the apparatus was designed and constructed, is revealed to increase the illusion. Five years were required to build the apparatus. A considerable number of persons may be accommodated at once inside the theater. With an unobstructed view of the dome they can study regardless of the weather.

Chicago, Rock Island & Pacific

11-25
Railway's War on Mosquitos Costs Nearly a Million Dollars

In the past few years, a western railroad has spent almost \$700,000, not counting screens and the work of physicians, to fight mosquitos along its lines. Not long ago, in a section of Arkansas, the pests became so numerous that they seriously interfered with train service by spreading malaria among workers and train crews, thus making them unfit for work. One hospital, ten years ago, treated 350 cases of mosquito-contracted malaria, and in a hamlet of 300 persons, everyone was suffering from chills and fever. The railway here cuts through lowlands where stagnant pools and similar breeding places for the insects abound. The campaign involved ditching and draining this section, treating the waters with oil and keeping squads of men constantly searching for other places favorable to breeding.

21-21
Front Light Tells if Stop Lamp Is Lit to Prevent Auto Accidents

Attached to the rear of the motor thermometer on the front of a car, a handy light signal has been devised which automatically tells if the stop lamp is working, thus decreasing the risk of rear-end collisions. At the same time the attachment illuminates the thermometer. It also has red and green "courtesy" lights at the side and a front "slow" warning in red letters, to tell approaching drivers that a turn or stop is contemplated. The principle of this lamp is applied in a similar one for the ordinary radiator cap and in a small dash light for the instrument board. They are



Front Light with Side Signals as Seen by Approaching Motorist and from Driver's Seat

easily installed, only simple wiring being necessary, and eliminate uncertainty as to the behavior of the stop signal.

21-25
Chicago, Rock Island & Pacific

Handrail Attached to Stepladder Is Aid to Safety First

Easily attached to any stepladder, a strong handrail, devised by a British inventor, is designed to aid in keeping the



Keeping Balance on High Ladder Is Easy with Handrail Securely Fixed in Sockets

balance and makes it safe to use the top steps, thereby getting greater service from the ladder without extra risk. The rail is simply a stout wooden bar, inserted in a holder on the side and placed through a hole in the top board.

Church Echoes Stilled by Sawdust in Plaster Instead of Sand

By mixing the plaster with sawdust instead of sand, a contractor is reported to have successfully overcome the acoustic problems of a large church auditorium in California. The walls seemed to absorb the sounds instead of reflecting them, as frequently occurs where hard surfaces are used, and noise from the street was also excluded. Corridors, arches and pillars with many curves, had made the interior unusually subject to echoes, but the sawdust apparently silenced them. The builder is said to have adopted the idea from his recollection of a home in the middle west, where the workmen, unable to obtain sand, used sawdust instead.

no information

5-25
Chicago, Rock Island & Pacific

Golf Putter and Strymie Jumper Fits Right or Left Hand

A combined golf putter and stymie "jumper," which can be used for either



Lofting a Golf Ball over Another with Strymie: Side of Putter; Insert, the Adjustable Head

the right or the left hand, has an adjustable head so that it can be made to fit the stroke of almost any player. Near the edge of the green, the stymie can also be employed to pitch the ball toward the cup. Because of the center balance of the haft on the head, the club cannot curve out of line with the ball and hole, it is said, when the player swings back for the putting stroke. Since the implement can be readily adjusted to fit the grip of almost any player, several persons may make use of one club in the same game.

How Weather Affects the Health Shown by Tests at Zoo

Studies of the influence of the weather on men and animals were made not long ago in a series of tests at the zoological gardens in London. As a result of the experiments, it was announced that dry cold is a stimulant, but wet cold profoundly depressing to the system and is really

"bad" weather, although there may be many other times when it is unpleasant. "Rawness" is injurious because it causes a rapid loss of heat from the skin, resulting in chills. To prevent this, the layer of air next to the body should be retained by means of clothing that can be buttoned at the neck to keep the warm air which rises, from escaping. Gloves with gauntlets and coats with sleeves that fasten tightly about the wrists, serve the same purpose. A sheet of cotton wool wound about the chest has been found an excellent air trap, and two light overcoats are preferable to a heavy one if the latter makes the wearer sweat.

Glass Side Curtains for Open Cars Quickly Changed without Tools

Bound in steel strips and inclosed in panels of the same kind of material as the car top, easily adjusted side curtains with glass instead of celluloid have been placed on the market by a western firm. They fit into slotted openings in the side bands, are said not to rattle, and as extra bars and props are eliminated, they open as a unit with the doors. Because of the narrow space between the glasses, the view from the inside of the car is less obstructed than with present styles of inclosures. Each pane is suspended within an inner frame which rests upon the car at only three points, thus decreasing the amount of vibration and guarding against breakage. No tools are needed to put the curtains in place, and when they are not in



Looking into Car with Glass Curtains, and Closer View of Door Panel with Fabric Border

use, they are stored in a handy carrier attached behind the front seat.

2325

Sleuth-Hounds of the Sea



BY HAROLD T. WILKINS

U.S. Navy
THE tropic sun blazes down on the sparkling waters of a far-eastern sea where there is placidly steaming a remarkable vessel whose deck is crammed with buoys and ropes and studded with wonder-working instruments for tearing from old Oceanus the secrets hidden in his bed of slime.

Suddenly a hail comes from the bow to the wheelhouse, and the ship wakes into life, her decks humming with activity. The mirrorlike calm of the sea is slowly breaking before a long, heavy swell traveling from the horizon. A radio message flashes from the ship to a shore station, and in fifty harbors, for a hundred miles around, all work ceases. Vessels riding at anchor at once get up steam to strengthen their moorings; others, too far away to run for port, first heave to for safety, then ascertain in what quadrant of the whirling circle of disturbance they are, and steam swiftly before the storm. The dreaded typhoon is approaching, heralded by the radio message from a United States survey ship on duty in Philippine waters to take observations that may help to predict its path.

But this is only one of her many fascinating activities. The safety of every ship sailing the seas depends upon the accuracy of the charts, the careful soundings of dangerous waters made by her officers. Twenty or more of them and

various launch and shore parties map out the 300,000 miles of shore line and waters adjacent to United States territories. Life on board is strenuous and exciting. The brain of the vessel is the chart room where expert hydrographers and land and marine surveyors daily record soundings of the sea bed taken by various instruments, including a steam winch on the after deck, a graded fathom line read by the leadsmen, and electric machines for sounding depths of hundred fathoms or less.

If the reader glances at a marine chart, he will see that hydrographical surveys are built up on a framework of triangles whose corners are the main points of the chart. Detailed marine surveys, showing the topography of adjacent coasts, are always urgently needed for the great trade routes on the seaways leading to busy ports and harbors. On a coast survey, the charting steamer finds out her position by running out to sea, picking out three fixed objects on shore for signals, and plotting the position with the aid of what are called "two-section angle instruments." But in narrow waters and shoaling channels, or in coral seas where the ship's bottom would be ripped out by one false move, the ship must use the even more accurate three-arm protractor.

This instrument is a graduated circle with one fixed and two movable radial arms. To plot the ship's position, the of-

ficer uses the fixed arm as zero point, and observes the two angles, set by the instrument, between three selected objects on shore or sea. The protractor is then moved over the chart until its three beveled edges pass through the three objects (shown on the chart). The center of the instrument now marks on the chart the ship's position.

Ten miles out from land, the shore signals cannot be seen, and then the ship steams past survey buoys anchored three miles apart and parallel with the shore line. Fixing her position with reference to these buoys, the ship can continue her work six miles beyond the limit of visibility of shore signals. While she is slowly steaming in a straight line, soundings are being taken, and officers mark on a chart a series of parallel lines, a quarter of a mile apart, and showing depths of ten to fifteen fathoms. Beyond these, deep-sea sounding instruments are used to obtain depths up to one hundred

fathoms. The United States survey ship has on board the Sigsbee deep-sea sounding machine in which is used a weight, a cup for obtaining specimens from the sea bed and a thermometer. As soon as the eighty-pound weight strikes bottom, it is automatically released, and the specimen cup and thermometer shoot to the surface. Made to stand enormous pressures, the submarine thermometer is inclosed in a metal jacket attached to a rotating vane. When the bottom is reached, the vane whirls rapidly round, upsets the thermometer and breaks the column of mercury. As it shoots to the surface, reaching water of higher temperature, the expanding mercury overflows into a reservoir. The bottom temperature is found by reading off the length of the mercury column left in the thermometer tube. The work of mapping coast lines and tak-

ing soundings in the near-by waters is divided among expert surveyors who first find a baseline, and then fix, by means of angles, a series of positions far apart, from and to which other angles are measured to fix other stations. These are the main stations or corners of the "triangulation," as it is called. The baseline is obtained

in several ways. Two shore stations, visible from each other, are chosen, with the ship midway between them. At a given signal, a flag is mastheaded and dipped from the ship's truck, and observations of the ship's position are simultaneously made by the shore stations. Another way is to fire guns alternately from both ends of the baseline on shore when the ship dips her flag. Observers record the distance by counting the intervals of seconds between flash and report. Vigilant light-keepers flashing sun signals across the 100 to 150 miles often separating observation stations are a striking feature of the work.

They have to keep their lights directed toward the observers, for which purpose they carry heliotropes—mirrors reflecting the sun in any direction—by day, and electric and acetylene lamps by night. High above trees and houses soar lofty towers to give the observer a clear view many miles across country.

On foreign shores, the nautical surveyor builds stone cairns on cliffs and headlands, sets up a tripod of stakes as a mark, or whitewashes spots on capes. He may also tie canvas to the boughs of trees for the same purpose in the bush or mangrove swamps of equatorial coast lines. Many miles of waters off flat shores are sounded by boats' crews who use as a marker a flagstaff flying neutral emblems. Flags of national significance when flown by survey ships engaged on this duty have been known to cause trouble.



Radio and Depth-Finder Equipment of the U. S. S. "Hannibal," Used in Sounding the Ocean



Storms and an Error in Navigation Wrecked and Beached This Trawler, a Fate That Not Infrequently Visits Ships When Duty Calls to Perilous Waters

Meanwhile, a shore party is landed for the purpose of making a topographic survey. The surveyors ashore have to walk over every inch of land, and use a boat only to round cliffs and headlands or make stations from which to "shoot up" the ship or coast by their instruments. One of the shore party has to wade through swamps and find out, by questioning the natives, if the marshes in the rainy season break their bounds and to what extent. In savage lands, too thick with bush and jungle to walk over, the country is sketched from the ship, stations being made on board and sketches drawn at each station. Angles are then measured from the ship to hill spurs, peaks and ravines, while the officer who has to map the coast line, sketches river entrances.

Soundings and surveys of currents and tides are a very difficult part of the ship's work. A nautical surveyor must have a keen eye to read the signs of danger on the face of waters. A ripple on the surface of a tideway in calm weather is a warning of the presence of a dangerous submerged rock upstream quite close to the nucleus of the ripple. Birds hovering over the water, fish suddenly springing into the air, or discolored patches of sea, tell the mariner of neighboring shoals on which his ship may be driven. In the brilliant sunshine of tropical seas, where coral reefs

abound, the ship must constantly test channels alleged to be safe for deep-draft ships; for, though under-water coral shines in strong light, a steamer may pass, within a mile and with only three fathoms of water under her keel, without detecting the coral from her masthead.

A "submarine sentry" towed at forty fathoms' depth may save many hours of hunting by revealing unsuspected banks and shoals. The submarine sentry is merely a sinker attached to a stout wire. If it strikes the bottom, owing to the water becoming shallower, it at once frees itself and rises to the surface, sounding an alarm on board the ship.

The wire drag is used in searching for submerged ledges and pinnacle rocks in dangerous waters. The drag is suspended horizontally, to any desired depth, by vertical wires leading up to buoys on the surface. It may vary in length considerably and is towed through the sea by launches which sweep an area of water at the depth to which the drag is set. If a rock, sandbar or wreck hits the drag as it is towed along, a horizontal wire catches the obstruction and a buoy bobs up from the water to show the danger zone.

Day and night, along the great transatlantic steamship lanes, coast-guard cutters keep watch for icebergs and icefields drifted southward by the Labrador cur-

rent in April, May and June. They send out daily radio warnings of the whereabouts and limits of the dreaded floes. At night, their three anti-collision lights of green and white, gleaming from the masthead, signal "all's well" to the navigator on the bridge of the liner passing westward along the fairway to Sandy Hook lighthouse.

Every survey ship is now equipped with the sonic depth finder of Dr. Harvey C. Hayes. A few months ago, a cable ship steamed into New York harbor with a thousand miles of cable on board. She reported that, with the help of two destroyers, who made surveys, she laid a cable over a submarine mountain 4,500 feet high in ocean bottom whose every hollow had been sounded by this depth finder. This had been done at a greatly reduced cost, by halving the amount of slack or loose cable payed out to lessen tension. The sonic depth finder is built to stand rough usage. Its sounder emits an electrically regulated sound which penetrates the ocean and the operator regulates the time between each impulse and its successor so as to accord exactly with the time of the returning echo. The human ear can detect a time difference of a very minute fraction of a second, and the depth finder has a possible error of only four feet in a mile of water.

Research is being made to perfect a practical automatic recorder for this instrument, but, at present, any discrepancy in time between the repeated sound and the returning echo is corrected by re-echoing the original sound, which enlarges the time gap and finds and corrects the error.

Some other wonderful devices operated by the hydrographic survey include a portable automatic tide gauge, only ten inches square, but equal to larger instruments in speed and accuracy; an automatic current meter which, for two weeks without attention, makes half-hourly photographic records of ocean currents at a depth of 400 meters or less; and the Wenner apparatus used on board the ice-patrol cutter "Tampa" for finding the salinity of sea water by measuring its electrical conductivity.

It will be a surprise to the landsman to hear that scientists today hold the opinion that currents are caused not by the wind so much as by differences in weight, temperature and salinity of ocean waters. The bureau of standards has perfected an electrical instrument which measures saltness to the fourth decimal place, as the meter is dragged through the water in the ship's wake. Another proposed instrument, a thermometer, will automatically record depth and temperature on a chart.



Looking Down from an Airplane on One of the Trim and Sturdy Survey Ships the Navy Employs, a Service Requiring Special Equipment for Long and Hazardous Voyages

Four Million Dollars from Waste of One Chain of Plants ²⁵²¹

The value of careful reclamation of factory waste is shown by the annual report of the Ford motor-car company, giving sales of by-products from waste as \$4,000,000 in 1924. All told, the company increased its sales by \$13,000,000 by recovering waste and marketing by-products from all its activities. The coke plant turned out \$1,500,000 in gas, benzol and ammonium sulphate. The slag from the blast furnaces was transformed into cement at the rate of 1,000 barrels a day. The body-parts plant returned \$2,500,000 from the reclamation of wood waste, which was converted into crude charcoal, pitch, creosote, ethyl acetate, refined wood alcohol, methyl acetone and acetate of lime. The \$2,500,000 worth of these products sold was in addition to quantities used by the company in its own work. All grades of plate glass made in the glass factory, and too small or otherwise not suited for car work, were sold to mirror companies and various other concerns. A 1,200-acre experimental farm adjoining the wheel factory sold large quantities of farm products and live stock, while surplus electric power from various generating plants added to the by-product total.

Fire Helmet Held by Guard Band Which Protects Face and Neck ²⁴¹

To prevent firemen's helmets from being blown or shaken off, a safety band of leather and cloth has been designed for attachment to the inside of the headpiece and can be adjusted by a drawstring. An apronlike extension of heavy material, which can be removed in hot weather, is provided for protection of the face and neck against cold, water and sparks. The hood is said to make the helmet more comfortable to the wearer by covering its hard rough surface with a soft padding where the rim grips the head. Made of insulating material, the band serves as a safeguard when the fire fighter is working among loose electric wires.



Mirror on One-Man Street Car Helps in Handling Passengers ²³⁴⁶

Street cars with one-man crews are being used in London and to assist the driver-conductor in collecting fares and open-



Front of One-Man Street Car with Mirror above the Motorman's Head

ing the doors, a wide mirror has been placed at the front of the car so that the operator may keep an eye on the passengers without turning around. A ticket punch operated by the foot and an automatic change maker are other appliances which help the motorman. Doors and brakes have been fitted with safety devices to prevent accidents.

Waxer and Polisher Shines Floors without Changing Cloths ²⁵⁰¹

Time and labor in waxing and polishing floors and linoleum are saved with a two-sided moplike tool for the housewife. It has a V-shaped base with flat surfaces covered with cheesecloth. Wax is applied on one side beneath the fabric, which can be lifted off by releasing a spring, and the floor given a thorough treatment with that face of the pad. To polish, the other side of the mop is turned against the wood. The instrument is shaped to reach into corners and will last indefinitely.

*and I saw in the
Laird's magazine 31
Buffalo N.Y. had 1000*

*United States
Banton, Ohio*



Three-Fingered Knives as They Are Attached at the Rear of the Plowshare

Knives Placed at Rear of Plowshare Pulverize and Smooth the Soil

Easily attached to any plow, horse-drawn or tractor, a set of knives has been patented to pulverize the soil as it is broken, eliminating the air pockets that usually form and dry out the ground. Equipped with these blades, the plow practically performs the service of a harrow in addition to its regular function and as the knives move with the share and swing back to allow stones or other obstructions to fall out, they require no attention while plowing. They are curved and reach down to almost the full depth of the furrow and do not interfere with turning under stalks and other litter. They weigh but sixteen pounds to a set of three.

Fruits Coated with Raw Rubber Kept Fresh for Weeks

The most delicate of tropical fruits can be kept fresh and made to retain their flavor and any stage of ripeness by a thin film of raw rubber applied by a method

claimed by Dr. P. J. S. Cramer in a discussion before the Pan-Pacific Fruit conference in Hawaii. When dipped into rubber latex, the scientist said, the fruit will become coated with an air-proof covering permitting shipment of the product as ordinary freight over considerable distances. Even after several weeks, he stated, such articles as strawberries, mangoes, and those so tender they cannot be exported at present from their native lands, remain wholesome and tasty within the latex film. In an experiment, the speaker said, green bananas were coated with the liquid for only half their length with the result that the unprotected portion matured leaving the incased part still unripe. The latex can be easily peeled off and the fruit requires no special cold-storage preparation.

Hand Cleaner for Engine Bolt Holes Eliminates Carbon and Breakage

Operated like a post-hole auger for drilling out the dirt for posts, a hand cleaner for removing carbon from auto engine-head bolt holes has been invented by a Nebraska man. A few turns of the wrist are sufficient to force the tool through the deposit and extract it, thus enabling the mechanic to fit the screw back into place with little difficulty. The process takes only a fraction of the time required to clean the holes with drills, blowpipes and compressed air.

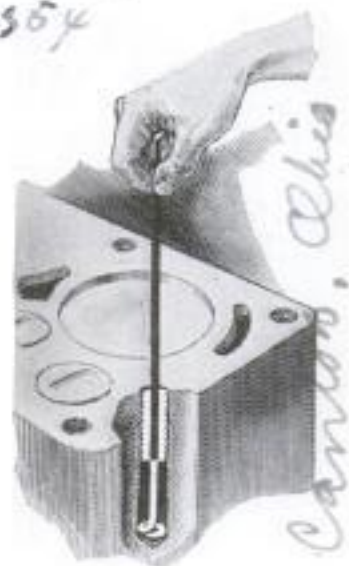

Deep-Sea-Going Log "Submarines" Cut the Cost of Homes

In the wake of puffing tugs, several monster rafts of logs glide out of the mouth of the Columbia river every year and are hauled down the coast to the lumber mills at San Diego, Calif. Tied with 150 tons of one-and-five-eighths-inch anchor chains, each is 900 feet long, sixty feet wide and thirty-eight feet at the center. As they strike the water from the "cradle" in which the logs have been

bound together, they sink deep until only twelve feet of the center part is visible above the water line. Like submarines skimming the surface with only a portion of the hull exposed, the rafts ride smoothly along with rarely a mishap as the logs have been dovetailed with great care so that no two sets of ends come together, giving the chains solid surfaces upon which to play and bind. For eighteen years these rafts have been hauled down the coast, this form of mass shipping having proved a success because of its saving in freight over other ways of transportation. One raft contains about 5,000,000 board feet of lumber, enough to build 300 houses costing about \$7,500 each. It would take 1,200 cars to haul that amount of lumber by rail and the cost for the journey would be about \$15 per thousand feet. Lumber schooners would charge nearly \$6 per thousand, while the raft method costs less than \$3, and besides, bark and waste materials sold at the destination, are said to return more than the towing charges.

Lightweight Rubber Sole with Studs Is Durable and Prevents Slipping

Rubber shoe soles, each with twenty-one protruding studs to afford the wearer a secure footing on slippery surfaces, are being manufactured in England. They are said to be light in weight and durable, and



Edge and Front Views of Thin Rubber-Studded Sole Compared with One of Leather

can be easily attached over the ordinary leather sole. Because of their thinness, they are not conspicuous.

Dustless Vacuum Street Sweeper Cleans without Water

Safeguarding public health by arresting the spread of dust during street-cleaning operations, an automobile sweeper



Dustless Street Cleaner in a Crowded Business District Where It Can Operate without Annoyance to Pedestrians or Vehicle Traffic

equipped with a vacuum arrangement, requires no sprinkling or flushing of roadways to aid its work. Resembling a large delivery truck, the machine is said to pick up anything from a pin to a barrel stave, and as it works without interfering with traffic or scattering particles of dirt among pedestrians, may be manipulated in the daytime on crowded thoroughfares. For residential neighborhoods, its noiseless movements adapt it for night operation. Though firmly lodged bits of dirt are easily removed by the sweeper, its constant use is said to be harmless to any kind of paving material. All litter gathered by the cleaner is collected in a large reservoir in the body of the truck, which can be quickly emptied when filled.

Phone Service from Moving Trains to Aid Travelers on Trips

Passengers on German railroads will be able to order hotel rooms and transact other business by telephone from moving trains, if apparatus constructed in that country fulfills expectations. Technical difficulties are said to have been overcome, and the phones are to be installed on lines from Berlin to Hamburg, Frankfurt and Munich. If they prove popular, further distribution is contemplated.

RADIO REPORT OF SEA-BOMB BLAST TO GUIDE SHIPS

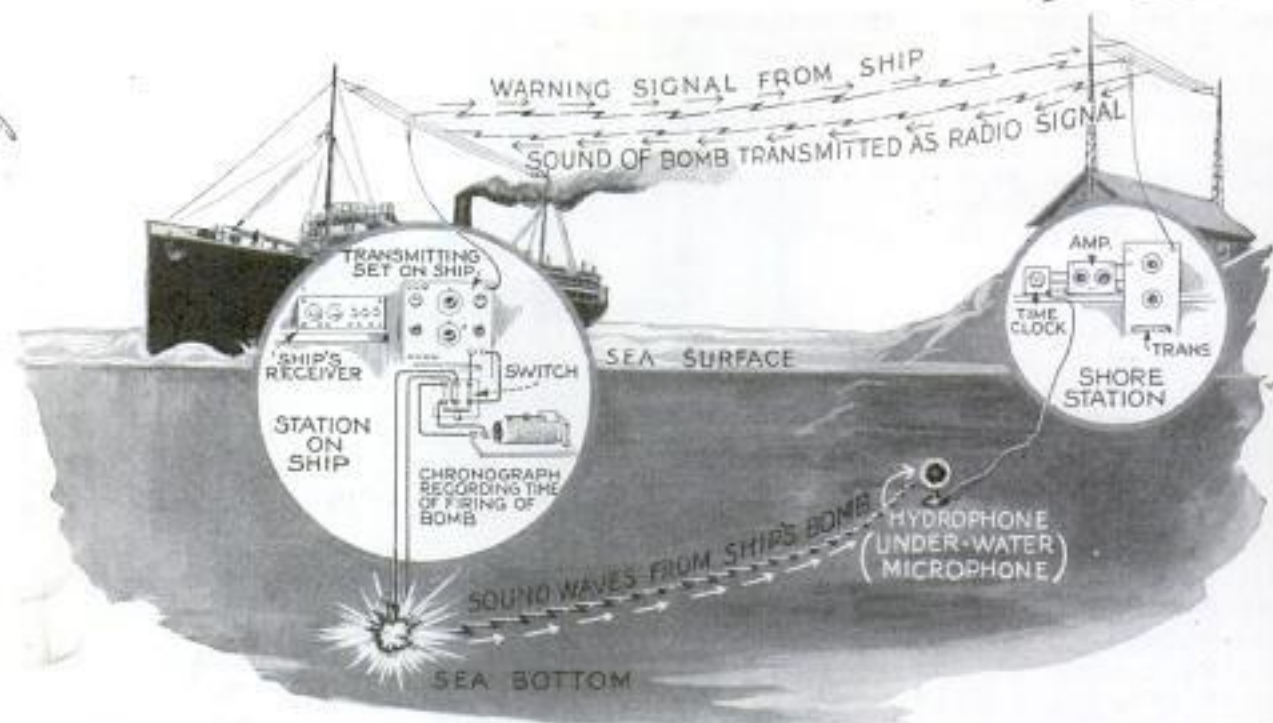

Photodiagram of the Combination Wireless and Under-Water Sound-Wave Device Developed for Use as a Direction Finder for Ships Navigating near Shore

The sound of the explosion of a small TNT bomb, towed along the side of a ship at sea, may be used to give the vessel's exact location, under a new method developed by the Coast and Geodetic Survey and successfully tried out on the southern California coast. Based upon the fact that water transmits sound at a definite speed, the coast-survey apparatus consists of a means by which the bomb may be fired beneath the water alongside the ship, the exact instant of firing being recorded on an electrical clock equipped with a fountain pen. The shore wireless stations are equipped with hydrophones, or under-water microphones, planted on the sea bottom and connected to the wireless transmitting apparatus by cable. The hydrophones pick up the sound waves from the bomb and broadcast them back to the ship, where the electric clock times the return of the signal. As the time taken for the return of the signal is only a fraction of a second, and the speed of the sound through the water is known, the time the round trip consumes can be reduced to miles traveled by the sound waves under water from ship to shore.

The coast-survey steamer "Guide," which used the method in charting the southern California coast, has its wireless apparatus so arranged that when a switch is turned, the electrical impulse which detonates the bomb is sent, and at the

same time a warning signal flashes by radio to the shore stations, while the electric clock records the exact second of time.

Two or more stations on shore are needed to give a cross bearing from which the position of the ship can be calculated, and to prevent their signals returning at the same instant, clogging up the recording clock, time switches are used in the relay between the under-water microphone and the shore station, delaying transmission of the return signal a fixed number of seconds, no two of the clock-driven time switches being timed the same. The number of seconds' delay at each station is known on shipboard, and allowance is made in calculating the time taken by the signal on its round trip.

An entirely different method has been installed by Germany on the Borkum Riff light vessel, in the North Sea, principally for use in time of fog. A submarine sound-broadcasting device transmits the letters BR in Morse code eight times every four minutes, starting six and one-half seconds after every fourth minute of the hour. The radio set of the light vessel at the same time broadcasts the same letters, which in Morse are represented by a dash, four dots, a dash and a dot, but does so only in four-minute periods, starting on the twentieth, thirty-sixth and fifty-second minute of each hour.

The timing is such that the first dash

of the submarine sound signal is transmitted simultaneously with the final dot of the radio signal, but the radio broadcast is then followed by a series of fifteen dots. As a result, if the ship picking up the signal counts the number of dots received by air before the first dash of the submarine signal arrives, the dot on which the two coincide will give the number of miles between ship and light vessel. The time taken by each of the fifteen dots and its interval is 1.253 seconds, approximately the time taken by sound to travel one mile under water. Thus the ship can determine its distance from the light vessel, up to fifteen miles, by merely counting dots. The under-water signals alone will give the receiving ship's position from the light vessel, by means of the direction finder.

Safety Auto Bumper Applies Brakes and Cuts Off Ignition

Automobile bumpers that automatically stop the car by applying the brakes and cutting off the ignition, in case a pedestrian or obstacle is struck, have been demonstrated as an added precaution in the effort to reduce the number of auto accidents. The attachment is placed in about the same position as the usual front bumper and has flexible steel cables connected by crossbars to deaden the shock. The jar of a collision is said to actuate the brake and ignition-control mechanism in such a



Auto Bumper That Keeps Persons from Falling under Wheels and Also Cuts Off Ignition and Applies Brakes

way that the chauffeur need not operate them and the car stops quickly.

no information

Soft Rubber Mattress and Pillows Inflated with Air for Comfort

Rubber-fabric mattresses and pillows that are inflated like tires and can be



Rubber Mattress and Pillow in Use, Showing Corrugated Construction That Adds Strength

washed with soap and water have been devised by a mid-western company under a process which eliminates the use of stitches, stays, metal washers or other attachments that may work loose and cause leaks. They weigh but little, fold up in small space when deflated and are well adapted to camping, or to home and hospital use. During the manufacture, rubber is squeezed into the fabric under pressure, resulting in a flexible material which is said to stand considerable wear.

Farms Devoted to Goldfish Culture Supply Yearly Demand

Goldfish farming is a comparatively little known industry but in a Maryland valley, not far from Washington, thirty-five farms are devoted to culture of the fish, and most of the supply for the whole country is obtained here. Something in the water, the vegetation or the climate—scientists have not yet determined what—seems to produce more brilliant colors in the finny creatures here than elsewhere, and in the last ten years it has become the center of the industry, although there are a few farms in other states. Usually the producers plow up the ponds in the fall and sow grass and other crops that provide suitable "pasturage" for the fish, while some "rest" the ponds every other year and depend on natural growth.

Chicago

1766 W. Superior

Salmon Eggs as Fish Bait Redeem Waste Roe of Canneries

AMONG the industries utilizing what have been considered waste products and converting them into valuable resources is that of the manufacture of salmon roe into fish lures. In the Pacific northwest alone, where the salmon-egg bait industry is centered, more than \$1,000,000 worth of this kind of lures are used each season by sportsmen. On the eastern coast and in England, France and the Scandinavian countries, where many large game and commercial fish are found in both salt and fresh water, tests have

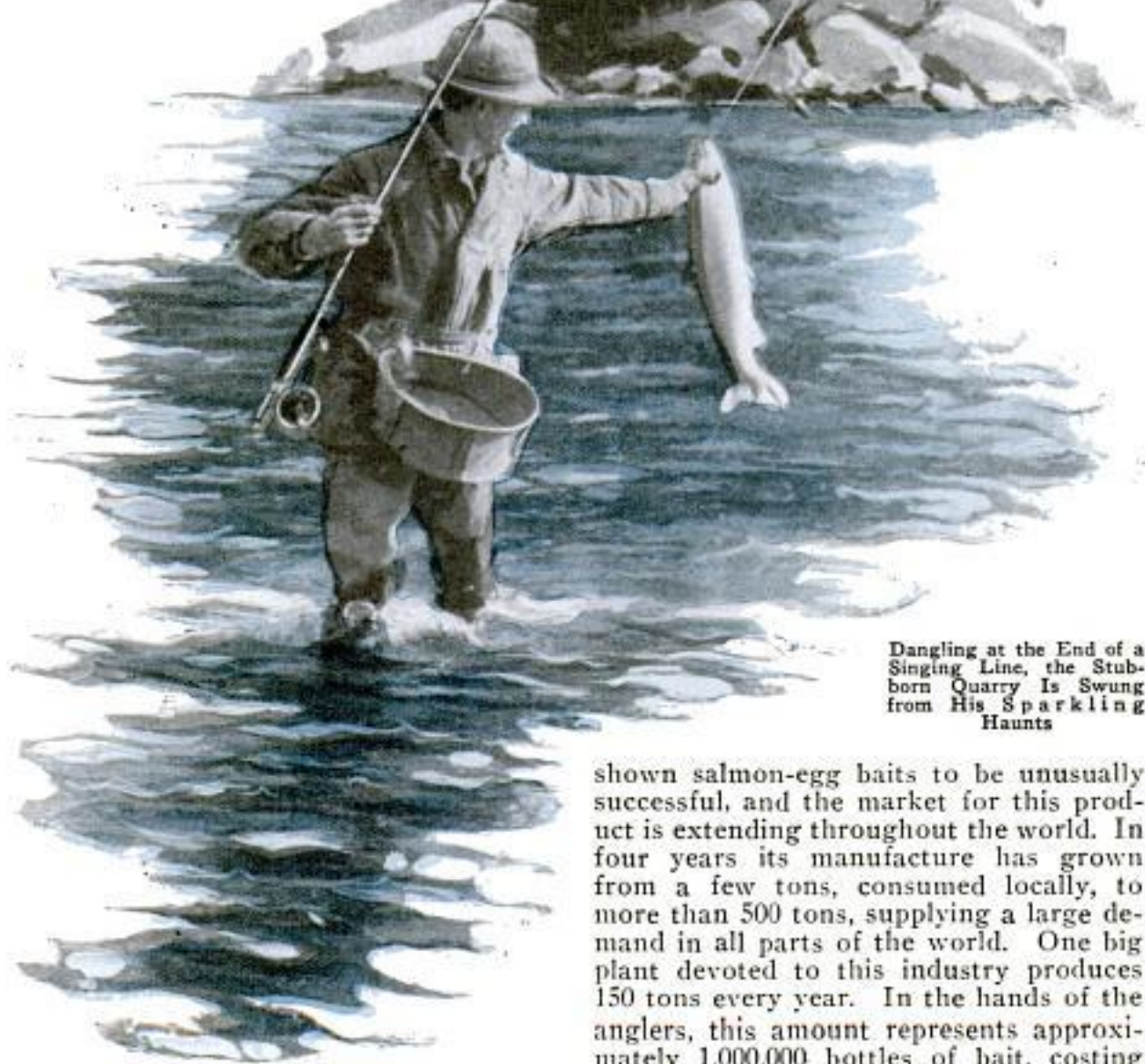

Dangling at the End of a Singing Line, the Stubborn Quarry Is Swung from His Sparkling Haunts

shown salmon-egg baits to be unusually successful, and the market for this product is extending throughout the world. In four years its manufacture has grown from a few tons, consumed locally, to more than 500 tons, supplying a large demand in all parts of the world. One big plant devoted to this industry produces 150 tons every year. In the hands of the anglers, this amount represents approximately 1,000,000 bottles of bait, costing

SALMO

FACTORY AT

Pete's 7

In 3½-Ounce

Pete's Saltr

In 8-Ounce

Pete's Saltr

16-Ounce

Pete's



Above, Labeling and Packing Jars of Salmon-Egg Bait; Insert Shows a Barrel of Roe Resembling Peas but Possessing Shades of Varying Tints of Red; Below, Separating the Eggs Ready for Immersing in Steaming Hot Water Before They Are Worked through a Coarse Screen

the fishermen about \$350,000. Conversion of salmon roe into prepared lures does not interfere with natural or artificial propagation of the fish. The eggs made into bait are obtained from the canneries and the wholesale plants who get their supplies of fish from boats operating in the open seas several miles from the spawning grounds in the rivers. At the Alaska fisheries, where several hundred million salmon are taken each year, only a small part of the roe is saved for fertilizer by the few canneries which have facilities for handling by-products. The larger number of the plants dump the eggs into the sea as the easiest means of disposing of them.

In a general way, the methods of treating the roe for manufacture into bait is the same. In the final preparation, such as preserving, coloring and like operations, each factory has its own secret process. The maker of one of the brands of salmon-egg bait spent several years and experimented with upward of 400 formulas before he obtained a stage of perfection in

manufacture. The finished product must be of natural size and sufficiently tough to stay on a hook without interfering with the ensnaring of the fish. It must also retain the natural oils which exude from it when the bait is dropped into the water. It is the attraction of these oils for the quarry that lure them to the baited hook. Most important of all, the lures are not permitted to contain poison in any form. Strict regulation of this quality is maintained by state game commissions who pass on the legality of prepared baits and their manufacture in accordance with the laws.

Salmon eggs for bait are favored by many fishermen because, differing from most natural lures, they are not difficult to handle. The single bait eggs are canned like peas, and the contents of the packages may be manipulated just as easily. Single bait eggs are used for all kinds of game fish of the salmon and trout species. For the larger specimens, such as steelhead or rainbow, cluster eggs are preferred by many anglers.

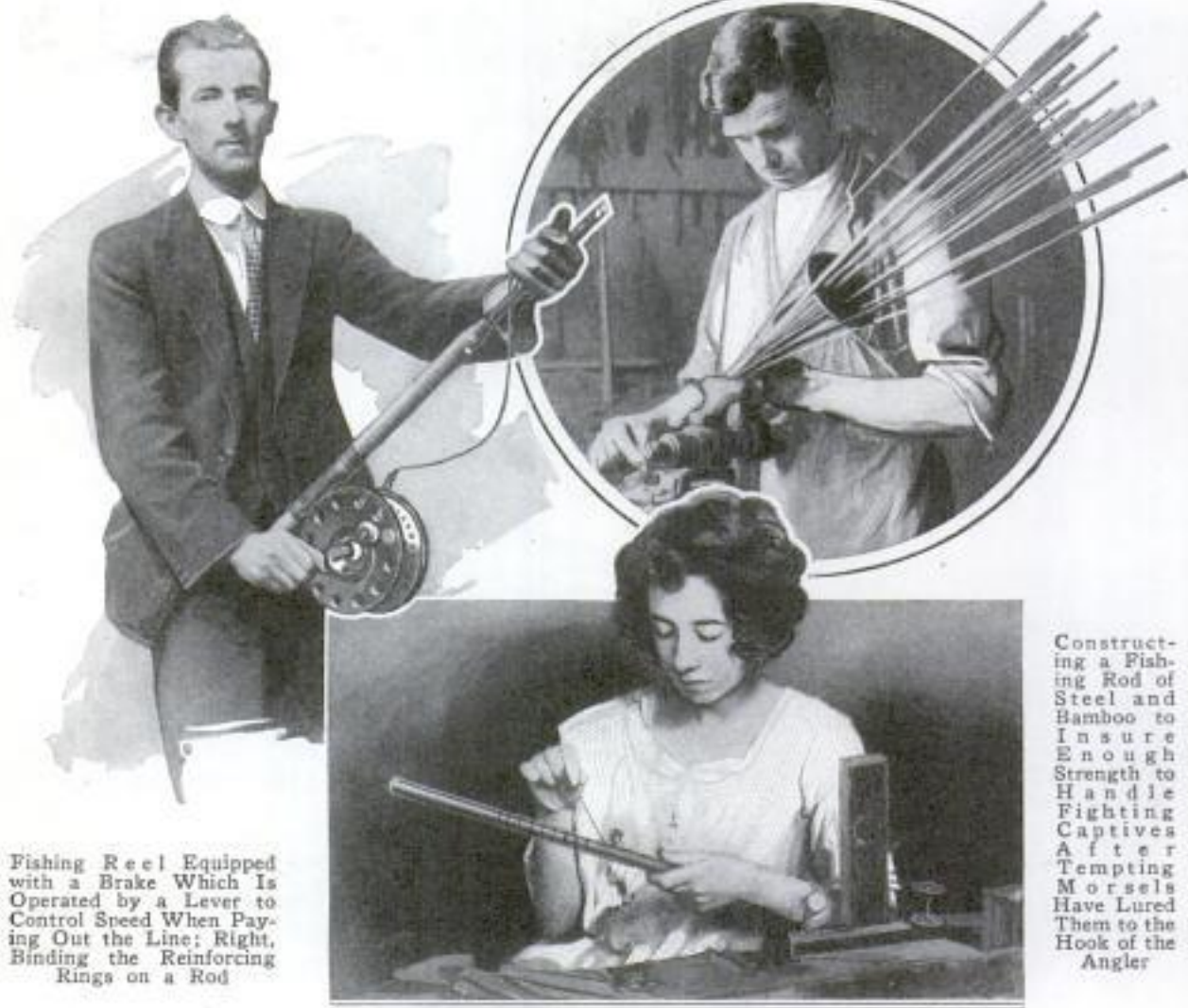

Fishing Reel Equipped with a Brake Which Is Operated by a Lever to Control Speed When Paying Out the Line; Right, Binding the Reinforcing Rings on a Rod

Constructing a Fishing Rod of Steel and Bamboo to Insure Enough Strength to Handle Fighting Captives After Tempting Morsels Have Lured Them to the Hook of the Angler

Battle Between Sound Waves Caused to Silence Loud Noises

On the theory that the waves that carry different sounds could be placed in conflict with each other to silence loud and objectionable noises, Dr. G. W. Stewart, of the University of Iowa, has devised an instrument which he believes may be successful in muffling some of the din that disturbs our daily lives. His apparatus is a sort of sound filter consisting of a number of branching brass tubes, so arranged that the waves are reflected back upon each other, causing a "battle" that halts their progress. He found that a brass cylinder, open at both ends, half an inch in diameter and six inches long, would transmit all the tones of a piano up to a certain note, but above this no audible sound. Another tube of slightly different proportions seemed to refuse all notes below the pitch at which the other stopped. No obstructions are placed in the tubes, the effect apparently being secured wholly through wave reflection.

Parking Lights in Auto Door Handle Eliminate Extra Attachments

A combined door handle and parking light that will fit any make of automobile replaces the ordinary grip. The bulbs in each end of the hand piece project a strong white light forward, red to the rear, on the left-hand side, and green on the right-hand. Wiring is easily installed and is connected to the battery or starter, and to a switch button on the instrument board. As no wires are run under the car, there is less likelihood of the system getting out of order, and no apparatus is added to complicate the task of washing.



Cathedral's Pillars Rival Heights of World's Loftiest Columns

Granite columns supporting a section of the roof of the cathedral of St. John the

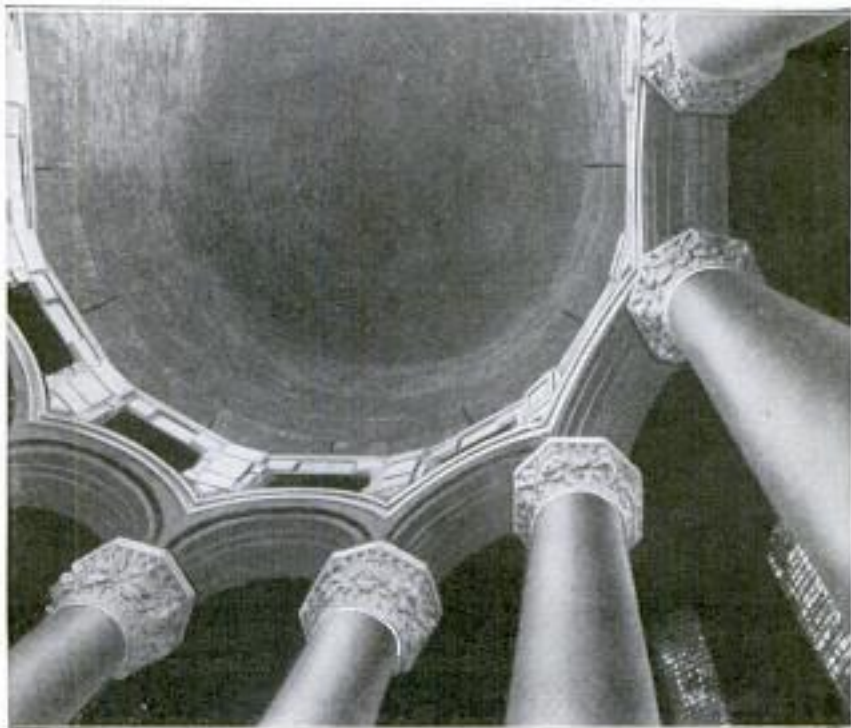

Among the World's Largest Sculptured Shafts of Granite These Imposing Cathedral Columns Seem to Converge at the Roof

Divine, in New York, are so high they appear to converge at the ceiling when viewed from the base of the group. Said to be among the largest stone shafts in the world, the pillars are crowned with sculptured caps of light-colored material, the carved figures of which can be clearly distinguished from the floor. Though many edifices of the old world contain similar lofty specimens produced by handcraft centuries ago, modern machinery makes possible the carving and erection of such great pieces in a small fraction of the time formerly required by the cruder methods.

Subway Cars Joined like Pullmans to Eliminate Noise

Vestibuled subway cars connected in somewhat the same manner as Pullmans have been planned to eliminate noise, carry more passengers and reduce operating costs. The system is expected to take up slack between the cars, thus insuring smoother stopping and starting; the passageway between them is weather and draft-proof and will make walking from one car to another safe. In addition the comfort of the passengers is increased.

including wiring, switch, etc

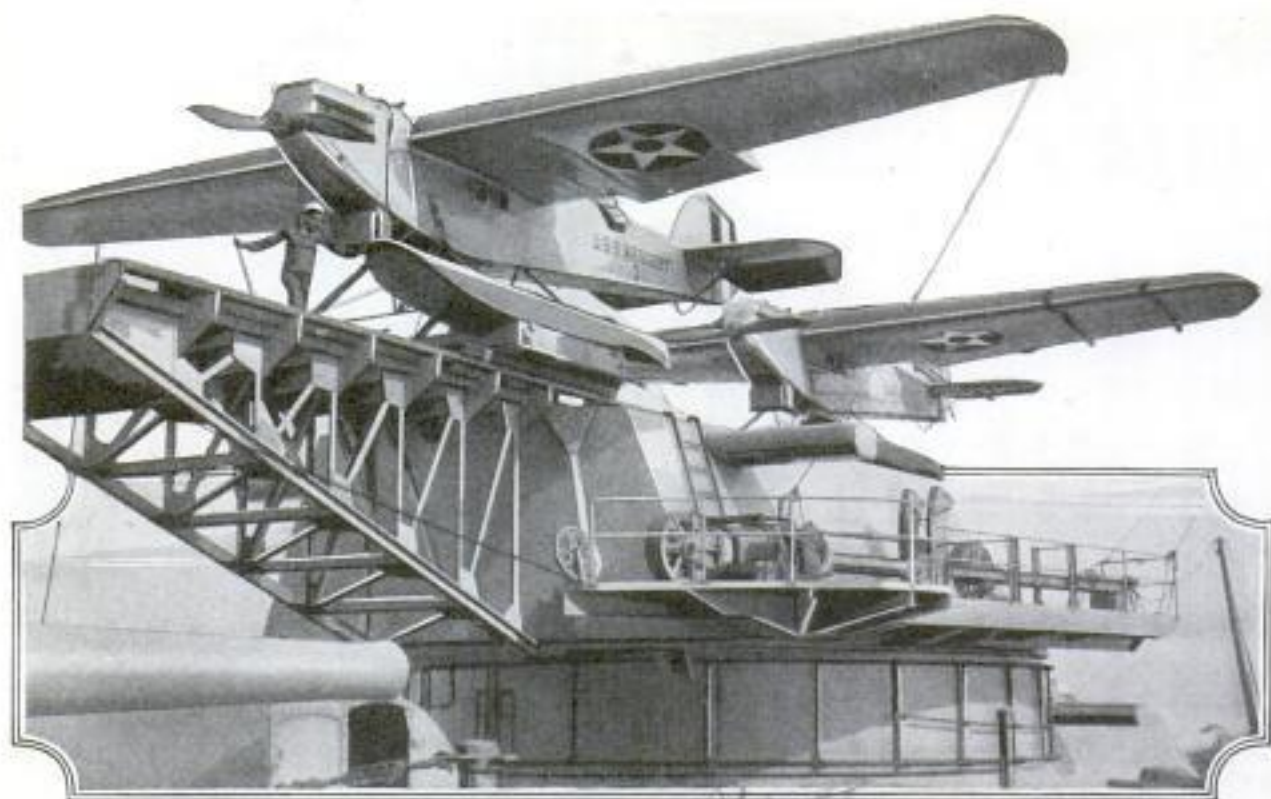

From This Launching Turret on the U. S. S. "Mississippi," Planes Are Sent Skimming Seaward by Firing a Charge of Smokeless Powder, Releasing Apparatus That Acts as a Catapult

Seaplanes Are Shot from Battleships with Smokeless Powder "Gun"

On top of the number three turret of the U. S. S. "Mississippi," a catapult that uses smokeless powder instead of springs and pneumatic pressure has been erected for launching seaplanes from the deck. The entire platform rotates on wheels so that the aircraft can be shot in any direction and the base is large enough to accommodate two planes at one time. Less machinery is said to be required to operate this arrangement than with other types of catapults and the planes receive a powerful flying start the instant the "gun" is discharged.

White Rats Become Puzzle Adepts After Three Months' Schooling

Teaching white rats to work puzzles has been accomplished by Prof. J. F. Dashiell, of the University of North Carolina, by rewarding the victors with food. The experiment, conducted to test the reasoning power of nine rats, was made with a small maze in which three winding paths led from a common starting chamber. Two of the paths were level, but ended in blank walls, while the third was more difficult, leading upward at an angle of thirty degrees, but led to the food. The

position of the three in relation to each other was changed at each experiment, and the tests were made with each rat twice a day for 100 days. Scoring was on the basis of both success in finding the food and the time required to solve the puzzle. At the end of 100 days, three of the nine showed marked progress in picking the difficult, inclined path.

Flat Conduit for Electric Wiring Saves Grooves in Walls

Armored cable conduit for electric wiring with less depth than ordinary tubing is being made in flat form to eliminate the need of grooving brick, tile and concrete walls where it is to be carried under plaster coverings. The conduit is flexible and sufficiently thin to prevent it from



protruding above the finish on the walls. It is claimed it can be bent in much sharper angles without injury than is possible with the other shapes, and can be used to extend old circuits without requiring deep openings to be made in plaster work.

Roaches Guilty of Eating Books Government Scientists Show

Common cockroaches have been found guilty of destroying the bindings of books. The discovery was made by government chemists during investigations in search of more durable bindings. Cloth-covered volumes were found that appeared to have been left near an open window in the rain or splashed when plants were watered, although they were standing on shelves. Watching for an explanation, the chemists found proof that the roaches moisten the cloth and then feed on the starch, flour, casein and other substances that have been put in to give the fabric stiffness. These attacks caused the blisters and marks that at first mystified the scientists. They are now at work on a treatment for the book cloth which will make it distasteful to the pests.

Push-Button Lock for Auto Ignition Prevents Theft of Car

Easily installed with the dash lamp and lighting switches, a push-button lock for the ignition system of a small car has been



invented to afford a certain protection against theft. The attachment is built upon a panel which replaces the standard furnished with the automobile, and the bottom board of the coil box is also to be removed for one with the lock. Pressing the but-

ton, automatically closes the ignition and stops the car. A key is needed only to unlock the switch. The device is also designed to prevent the theft of the coils from the box, the wiring is inclosed in a heavy armored cable so that outside current cannot be introduced, and a special switch has been provided to thwart any such attempts. The lock is so designed that if the button is pushed by accident while the car is in motion, no danger or damage can result.

Wireless seems to be catching up with wire in Great Britain, according to reports, which show that a million radio sets now are in use there and a million and a quarter of telephones.

Portable Electric Blower Cuts Cost of Cleaning Plant Equipment

Keeping motors, textile machinery and other equipment free from dust is simplified by a portable electric blower, at-



Removing Waste and Dangerous Dust from Spinning Machine with Portable Electric Blower

tachable to any convenient electric socket and weighing only seven pounds. The current operates a one-quarter horsepower motor, developing a speed of over 10,000 revolutions per minute, and delivering forty-seven cubic feet of air per minute. Attachments accompanying the cleaner include a suction apparatus, hose and dustbag for other operations. Ridding equipment of dust is an effective way of reducing the fire hazard and lessening wear on machinery, and the portable blower, the inventors claim, provides an economical way of obtaining these results.

Oilcan Fitted with Flow Regulator Prevents Waste and Leakage

Economy and cleanliness are claimed for an oilcan a western man has devised to eliminate the common faults of the ordinary article.

The top has a curved flange and a locking arrangement to prevent leaks, and at the side is a lever so designed that when it is pressed, only a few drops of oil are delivered at one time.

An additional feature is a pin-head valve in the spout to keep the contents from running out should the can be tipped over.



Disabled War Veterans Turn Pioneers

Ex-Soldiers under Training Unite in Clearing Overgrown Lands to Make Way for Their Homes and Farms

WITH the same determination and union of effort that marked their actions on battle fronts, groups of disabled war veterans taking vocational training at a Minnesota school, have established thriving farming communities on tracts of land until recently claimed by impassable underbrush and a wilderness of old tree stumps.

To remove the stumpage, the pioneers use picric acid salvaged from reclaimed war explosives and purchase it in carloads to reduce the cost. Where heavy charges fail to entirely remove the stumps, tractors such as were employed in the artillery complete the work. These powerful machines, furnished by the government, also accomplish the plowing for the entire groups. Clearing operations which heretofore have been stopped for the winter months were carried on despite cold and heavy snowfalls, with the result that each planting time found more than 500 acres of new ground ready for spring cultivation.

Now, less than three years after the veterans bought up the land, more than fifty homes have been established in the two settlements of Veteransville and Silver Star. Roads have been opened up through the wilderness, community houses for social and public gatherings have been erected, and more than a thousand acres of ground cleared and placed under cultivation. Several carloads of cattle, horses and sheep have been purchased and distributed to the individual farmers who

pool their products for ready markets. To provide instruction in agricultural arts for the veterans, special schools have been organized by the government, and experts train the men in dairying, poultry raising and other phases of farming. Supplies and stock animals are purchased together and products are standardized. All have the same breeds of cows and sheep. Butter and eggs are graded and marked with the official labels of the communities. In this way the highest prices are obtainable for them in the markets.

Even when houses are to be put up, the ex-warriors resort to united action, resulting in great savings of time and labor. At first many of the veterans built log cabins from the timber they cut on their own land. These makeshifts were given over to poultry coops the following year and more elaborate houses were built for permanent dwellings. Isolation, which has caused the failure of many lone settlers, is banished by programs of community activities and outdoor sports.

The work of the former soldiers has caused others to adopt their organized methods in clearing ground throughout that section of the state. Additional veterans' communities have been established until now there are estimated to be more than 500 of these intrepid pioneers who



Blast of Salvaged War Explosive That Uprooted Group of Stumps; Left, One of the Powerful Artillery Tractors Going into Action to Aid in Breaking Down Underbrush



Cozy Home Built by a "Vet" from Logs Cut on His Own Land; Below, Chopping Out Young Trees; Insert, Part of Oat Crop Harvested on Soil Cleared and Worked by Disabled Ex-Soldiers

are blazing new trails and building prosperous settlements on territory they wrest from the tangle of abandoned land, all in spite of physical disabilities. Instead of building individual farms, they are erecting entire communities at once by applying modern methods to an age-old task.

Where certain operations are to be carried out, the work is undertaken by squads of four or more men. Everything is planned beforehand and each step of the task handled with precision. Although in the beginning some of the area could

only be reached by narrow footpaths, it was but a matter of days until wagon roads were cut through to accommodate the chugging tractors whose services formed an important part in the uprooting of small trees and the hauling of tools and materials to the scenes of action. If any of the pioneers meet with problems or tasks too difficult for their efforts, a call for aid generally brings a squad of their neighbors to help with the work. And then there is always the tractor to succeed where human energy fails.

Mirror in Flap on Cuff of Glove Latest Fad of Fashion

With a little mirror inclosed under a flap on the cuff of the back of her glove,



Using Make-Up Mirror on Glove Cuff, Where It Is Always Ready and Easily Reached

a woman can arrange her make-up while on the street without having to open a handbag or vanity case. The glass is concealed and protected by the leather tab, which snaps down over it.

Armature for Russian Power Plant Big Enough to Hold Engine

The size of some of the equipment for the light and power plant being erected at Leningrad, Russia, was illustrated when

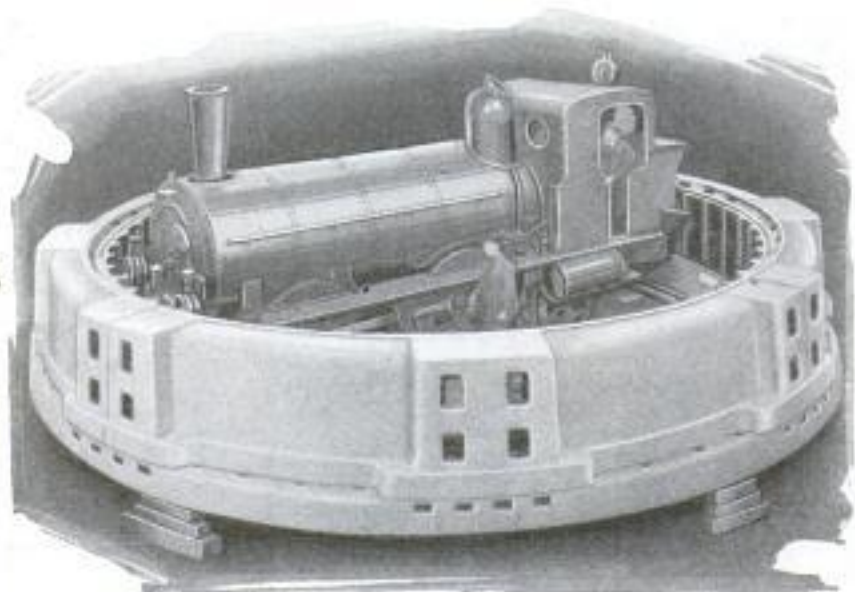

Part of the Plant That Will Have Power of Many Engines, the Giant Armature Holding a Locomotive

a locomotive was fitted inside one of the huge armatures for the dynamos. There was a foot or so of space to spare at each end of the engine. Four large units, each with a capacity of 8,750 kilowatts at 11,000 volts, are part of the installation, which is being made by a Swedish company.

Aero Dynamo Designed to Produce Electricity for Farms

An aero dynamo, driven by a propeller nearly thirty feet in diameter, has been designed by a German officer, who intends it for use on farms or other points far removed from central generating systems. The device is unusual in that the dynamo is concealed in the wind head, which is streamlined like a large raindrop. The four-blade propeller follows the latest practice in aerodynamics, and is so built that it reacts to the slightest wind. The whole plant is portable and can be erected in six hours. The first tests of the machines were very successful, according to reports from Germany.

Elephant's Appetite Calls for Food Twenty-Three Hours a Day

Elephants apparently have appetites in keeping with their size for in India about twenty-three hours out of the twenty-four are consumed in eating and one or more men are employed to keep them in food. This consists of grass, boughs of trees and grain and huge cakes, called "chupatty," each about two and one-half feet in diameter and an inch and a half thick. They are made of coarse ground meal and are relished by the Indian natives themselves. The mahouts become greatly attached to their beasts. They entertain many superstitions regarding their charges and are said to use a special "elephant language." The number of hairs on the animals' tails and the color and position of their toenails are believed to be signs of good or bad luck. In spite of their great bulk, elephants are capable of considerable speed and can carry loads up to 1,000 pounds through the roughest country.

Swedish General
Electric Co.

Wide W

Copyrighted material

German Effort

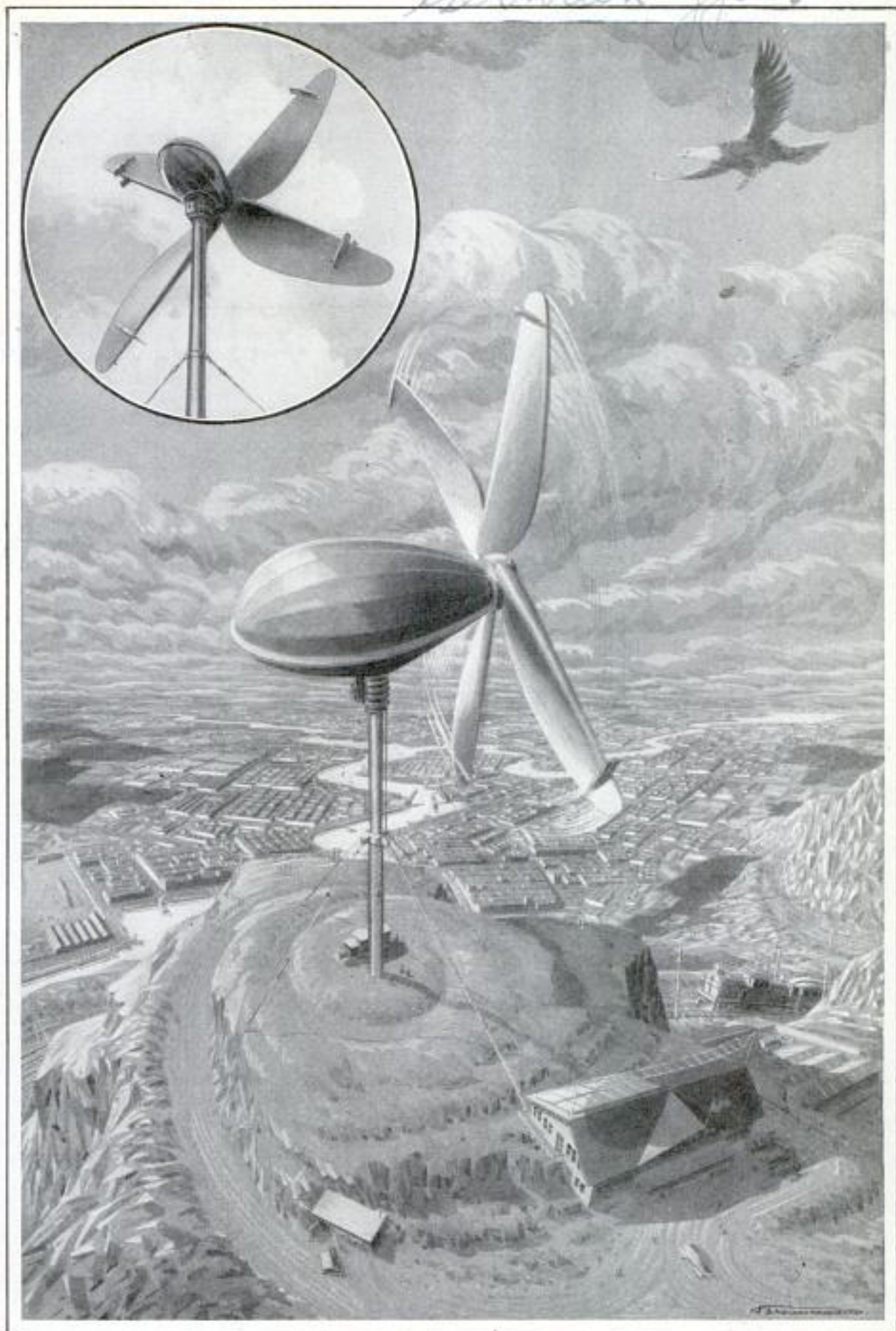

Insert © P. & A.

Four Blades Shaped like an Airplane Propeller Drive This German Self-Contained Aero Dynamo, Designed for Use on Farms; the Dynamo, Direct-Connected, Is Carried in the Egg-Shaped Tail



"Take Chances and Wear These," Said the "Devil,"
Rattling the Eyes and Wooden Leg

"Try a Glass Eye or Wooden Leg," Teaches Safety-First Lesson

"How would you like to wear a nice glass eye and travel around the shop for the rest of your life on a wooden leg?" This question startled workmen at a cement plant as a man, attired to represent the devil and carrying samples of the artificial equipment he referred to, approached them with the query. He rattled the eyes and shook the leg to make his message more forceful. The "stunt" was part of a safety drive the company conducted to decrease accidents, and proved an effective method of teaching the folly of taking chances.

Raw-Rubber Problem Causes Hunt for New Sources of Supply

With a predicted output of 56,000,000 automobile tires for 1925, in the United States alone, government bureaus are striving to find rubber-bearing plants suitable for cultivation in the semitropic soils of this country and its island posses-

sions. All the raw material consumed by the rubber industries now must be imported, and in case of war, the sources might be easily cut off. To replace this great volume, several bureaus are devoting their attention to experimenting with native plants of the south which might offer a means of cultivating a home-grown variety. Various tropical growths of South America have been transplanted to the Panama canal zone where they thrived to such an extent as to make possible the planting of large crops in that region. The Philippine islands are said also to offer suitable land for the raising of different forms of rubber trees. Large sections of several of the southern states are believed to be favorable to the raising of such plants, although the species most fitted for cultivation in these districts may require special processes and machinery to extract the raw product.

Circulator for Warm-Air Furnaces Spreads Heat and Saves Fuel

By increasing the flow of heat from a warm-air furnace, a motor-driven circulator, which can be connected to an electric-light socket, is claimed to greatly aid in its even distribution to all parts of a building. As it is unnecessary to "force" the fire to obtain a heavy volume of draft, it is said a large saving in fuel can be effected. To obtain an immediate flow of warm air, the device can operate with an ordinary amount of heat being produced by the furnace. Where it is desired to start the plant quickly, the circulator can be employed to induce natural draft and switched off when the heater has reached a point of full production. If idle, the apparatus is said to present no ob-

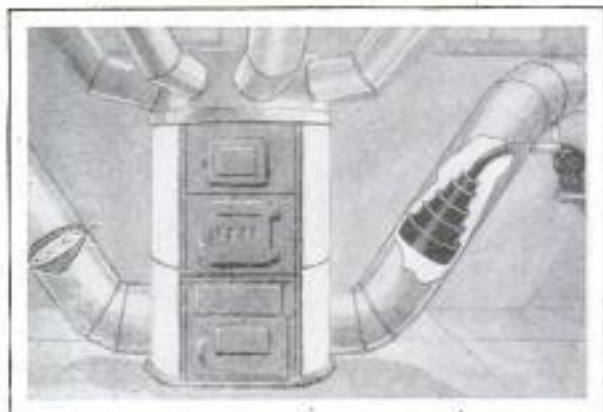

Circulator Installed in Pipe of Warm-Air Furnace to
Induce Draft and Distribute Heat Evenly

struction to the free movement of warm air through that part of the system in which it is installed.



Testing Teletype Printers, with the Entire Battery Writing a Sample Sentence Sent Over and Over Again All Day Long from One Sending Machine

Radio Shoots ^{Message} Typed Words through Space

Automatic Typewriter Delivers Written Message Flashed in Secret through Ether from Keyboard Many Miles Away

SECRET wireless is an actuality, the necessity of learning the telegraph code has been eliminated, and the receiving operator may be dispensed with, as a result of experiments conducted during the last two years by a company manufacturing printing-telegraph equipment for press associations and telegraph companies, and for intercommunication in banks, hotels and other large organizations.

Using the regular typing-telegraph instruments, with radio substituted for land wires, the company's engineers have maintained communication between Chicago and Milwaukee, Wis., Chicago and Indianapolis and Lafayette, Ind., and between Chicago and an experimental laboratory thirty miles west of the city, at Lisle, Ill. At the transmitting station, a message written at an ordinary typewriter keyboard is automatically broadcast by a

continuous-wave tube set, transmitting on a wave length of 1,300 meters, or a frequency of 230.7 kilocycles. At the receiving end, the signals are picked up by a special set and passed through delicate relays to another automatic typewriter printer. The signals which transmit the message resemble telegraph code, if you listen in on them—until you try to decode them. Then they bear no resemblance to any known code system. The system used is a five-unit code. If a given unit of time is divided into five intervals, during which current may or may not be transmitted, it is possible to produce thirty-two code combinations of current and no-current intervals. In one of the telegraph machines used in the radio experiments, pressure on the typewriter keys closes various combinations of five switch fingers in a revolving switch to transmit the code

combinations. In another, and still faster machine, typing of the message punches groups of little holes in a moving tape, which then passes through a transmitter where contact points close circuits through the perforations. Both devices have been used interchangeably in the experiments. The tape transmitter has several other advantages besides greater speed. Tape can be prepared in advance of transmission and run through the transmitter later without the necessity of an operator being present, and tape can be re-run if it is necessary to repeat any part of a message.

Radio fans who have had trouble tuning out interfering stations would find the receiving outfit a joy forever. It has been developed to a point where tuning is so fine that no outside station has been heard for periods of months. In fact, both the transmitting and receiving sets are so perfectly adjusted that they have operated month after month without ever being touched. The engineers simply turn on the current to start and turn it off in the evening. At the transmitting end, a motor generator supplies a 2,000-volt direct current for the plate circuit of the 750-watt transmitting tubes. The filaments of the tubes are lighted by a 12-volt alternating current. The commutator ripple of the direct-current generator is smoothed out by

a filter which gives a pure continuous-wave signal at any distance from the transmitter, with no generator hum noticeable. This purity of signal is one of the important features of the radio typewriter because the relays used at the receiving stations are tuned to the heterodyned note of the sending station. For transmitting at the factory a 256-foot cage aerial, consisting of six phosphor-bronze wires, is suspended eighty feet above the ground. A counterpoise strung below it, and a network of copper ground wires, buried in moist earth, complete the antenna. From the telegraph printer the current passes to a special telegraph relay, with contacts adjusted to carry the heavy broadcasting current. The transmitting equipment itself is practically a standard telegraph outfit, with distributor for sending the signals, tape transmitter, tape per-



Two Radio Typewriters. One Producing a Tape Copy and the Other an Endless Page

forator with keyboard, and tele-type printer, which sends without the tape. In addition there is a Morse key, so that the operator can send the station call letters at intervals, as required by law, to let listeners know who is sending. The set is

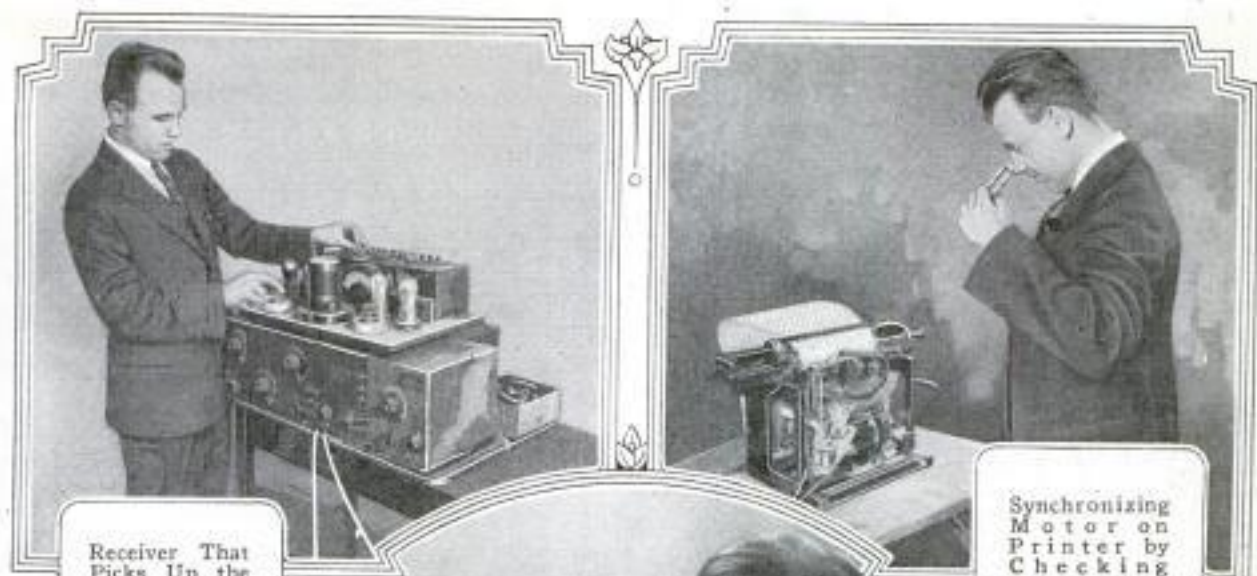

Receiver That Picks Up the Signals and Transmits Them through Relay on Top

Synchronizing Motor on Printer by Checking Spots on Governor with Tuning Fork



Writing Message by Punching the Tape, Which Passes through the Sending Apparatus at Left; Below, Code Tape and Its Message Translated



The Printer at the Receiving End Picks Up the Signals from the Relay of the Receiver and Prints Them on Tape in Plain English

POPULAR MECHANICS MAGAZINE. WRITTEN SO YOU CAN UNDERSTAND IT.

.....

so arranged that when the tape transmitter is sending, the teletype receiving unit makes a copy of the message for the home office, and for comparison with the copy received at the distant radio station.

To radio fans, the chief interest lies in the distant receiver. One of those in use

at present employs a special receiving set, relay and printer. The radio set employs an indoor loop aerial, intermediate circuit tuner, three stages of untuned radio-frequency amplification, detector, two stages of audio amplification and a separate heterodyne. Besides being very stable and requiring no adjustment over long periods of time, the set is not affected by changes in A or B-battery voltages. The signals received are heterodyned to a frequency of 1,200 cycles, and the relay sharply tuned to this audible note, the signal being further amplified

by the tubes of the radio relay, which pass it on to a mechanical telegraph relay, and that in turn actuates a polar relay which finally passes the signal to the selectors of the printer.

A special circuit has been devised which, it is claimed, practically eliminates static or other interference with the receiving set. Tests have shown that static below the intensity that paralyzes the vacuum tubes, even though it is louder than the signal, will not cause the printer to make errors, and that interference and other noises cause correspondingly less trouble. In extended tests, the operation of the radio printer has proved very stable. During eight-hour runs, the accuracy has been close to 100 per cent. One wrong letter in 60,000 letters has been the mark achieved, even under midsummer conditions, while another test gave three wrong letters in 90,000 letters.

In the tests a strip of perforated tape is prepared with a sentence employing every letter of the alphabet, and all the numer-

als. The sentence reads: "A quick movement of the enemy would jeopardize six gunboats, 1234567890." The ends of the strip are then pasted together and it is inserted in the tape transmitter where it goes round and round hour after hour sending the sentence over and over again

all day long. The only break in the routine is to send the station's call letters at intervals.

The company is working primarily to perfect the apparatus for use of newspaper and press associations, and here the element of secrecy which it affords is all-important. Radio has not been generally utilized in news transmission, despite the rigid laws regulating secrecy of wireless messages and court decisions upholding the press associations' property right in their news. It is absolutely impossible to read the signals of the new radio printer by ear, and

the five-unit system offers combinations, which can be changed at will so as to defy even a code expert with a machine that is not set to the same combination.

The task of pirating is further complicated by the fact that the motors operating the sending and receiving printers must run at the same speed, and the listener would not only have to know the code, but have the correct motor speed before his printer could pick up the message. The motor speeds are so exactly adjusted that a tuning fork is used to keep the machines synchronized. Two strips of steel are attached to the prongs of the fork, with a tiny slot in one strip. As the fork is vibrated the slot is alternately exposed and concealed, the rate depending upon the known vibratory rate of the fork. On the governor of the printer motor a row of white dots is painted, and when the operator looks through his vibrating tuning fork the slot is exposed just often enough for the eye to see the dots, provided the motor speed is correct.

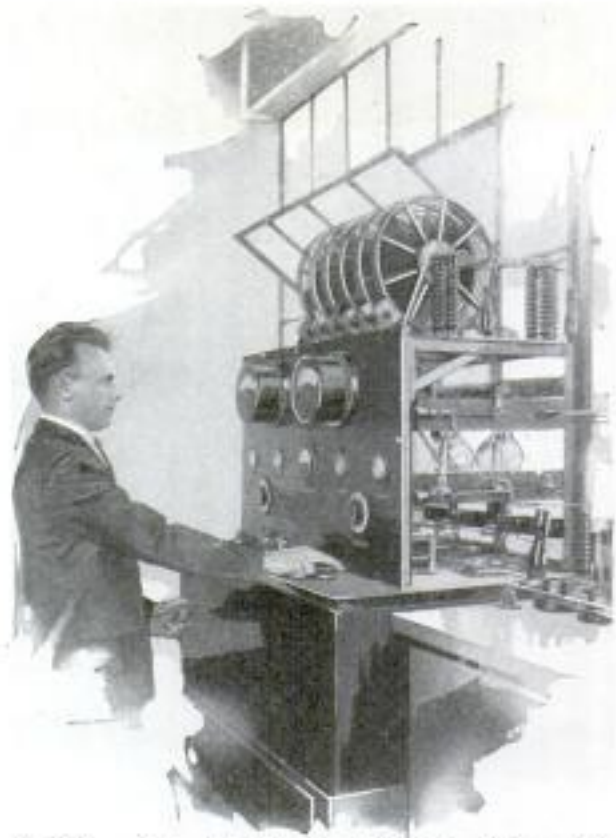

The Transmitter Used to Send Out the Typewritten Message in the Form of Code Dots

Starting Limited Train Requires Effort of Thousand Men

How

With the start of a limited train of the type featured by many of the country's leading railroads, approximately a thousand watchful workers are affected in the routine of duty. Long before the time for departure, hundreds of these are busy preparing cars, engines, and signals, and scrutinizing tracks and switches to insure its unimpeded progress. As the train pulls out on its journey, a wave of orders and information is sent pulsing to stations, offices, towers, roundhouses and even into the homes of those who, several hundred miles in advance, are charged with its care and operation along the way. Equipment is assembled hours before leaving time, and as the limited is made up at its source, directions are sent ahead for various relief crews, diner supplies, and above all to see that powerful engines in perfect condition will be standing at division points ready to take up the race when others are withdrawn. An army of trackmen is constantly on the lookout for defective rails, and roadbeds are continually being repaired and improved to avoid accident and delay to the through-express trains.

Violin Sounding-Board Attachment Produces Rare Tones

Tones of the violin are said to be mellowed and enriched with the aid of a wooden attachment shaped much like the instrument itself and placed on the underside of the top. It is prepared by a special treating process and carefully cut and formed to suit the size and contour of the



Copyright, Keystone View Co.

Violin Sounding Board and How It Is Attached to Underside of Instrument's Top

violin, and is accurately adjusted to give the desired results. Similar boards are made for other stringed instruments.

Seed Planter Operated by Hand Quickly Sows Gardens

To insure accuracy and prevent crowding and choking of growths, a hand-operat-



Sowing a Window-Box Garden with a Hand Planter That Scatters Seeds Evenly

ed seeder devised to save time and labor of measuring and marking when planting a garden, deposits a single seed as a release is touched by the worker's finger. Any-size grain can be scattered with the planter, which is easily guided along marked furrows or used to trace designs in the soil with seeds. The point is constructed for use as a digging tool for soft earth and, where desired, may be employed to make troughs and holes in which the grains are to be placed.

Tilt Battleships to Elevate Guns Is the Plan of Edison

Guns on United States battleships can be elevated without the installation of costly equipment according to Thomas A. Edison, who has announced a substitute for the proposed method for which an appropriation of \$6,500,000 was asked. All that is needed, he says, is a pound of mercury to a ship and an apparatus somewhat like a lateral fin or rudder by which the boat could be tilted to alter the range of the guns. The working principle is similar to that used by submarines in diving or coming to the surface.

**Life Drama of the Bee-Is Filmed
by Cameramen in Masks**

One of the chief difficulties of obtaining realistic motion pictures of bees at work



Using Masks and Extension-Crank Camera While Taking Motion Pictures of Bees at Work

in the hive is that the insects become disturbed at the approach of the camera and their normal activities cannot be studied. To overcome this, a movie camera was devised that could be strapped to the shoulders of one of the operators and held close to the hive while the crank was turned by means of an extension handle intrusted to another. With this arrangement, the bees were not excited by the movements of the arm and hand of the photographer.

**Chinchilla Is Fast Disappearing
as Result of Demand for Fur**

From a supply of 32,000 dozens of chinchilla skins exported by Chile in 1898, the production of this fur has decreased to less than 150 pelts a year, owing to the rapidity with which the animals have been killed off. They are found only at the tops of the highest mountain ranges in South America, where snows and low temperatures prevail the year round, and hunters face extreme hardships to trap the valuable creatures. Less than thirty years ago, a market price of only twenty-five cents each was paid for the hides, but this figure has increased with leaps and

bounds until more than \$90 a pelt is demanded by the trappers fortunate enough to capture a few of the animals. Many attempts to rear them in captivity have failed because of the high altitudes necessary to their life. Two of them, said to be the only pair in captivity, are owned by a governor of a Mexican province who keeps them at a point more than 12,000 feet above sea level. Though the countries in which the chinchilla is found have passed stern laws limiting their capture, ruthless Indian hunters of the Andes mountains seek them sometimes with dogs, braving the worst weather conditions to secure the high prices that are offered for the skins in all the fur markets of the world.

**Supercharger for Racer Motors
Works Like Blower**

Tearing down the course at the rate of 115 miles an hour, with its motor making 5,000 revolutions a minute, a racing automobile may have difficulty in getting a full charge of gas all the time, because the pistons are moving so fast that there is a tendency to create a vacuum in the manifold. To correct this, a supercharger has been invented which operates like a blower and gives the combustion chambers a full dose of fuel by increasing the pressure of the gas at the valves. With this attachment, it has been found unnecessary to introduce a carburetor for each cylinder, a plan that was previously used to obtain high racing speeds. Records made not long ago at Culver City, Calif., were partly due to a blower of this type, experts say.

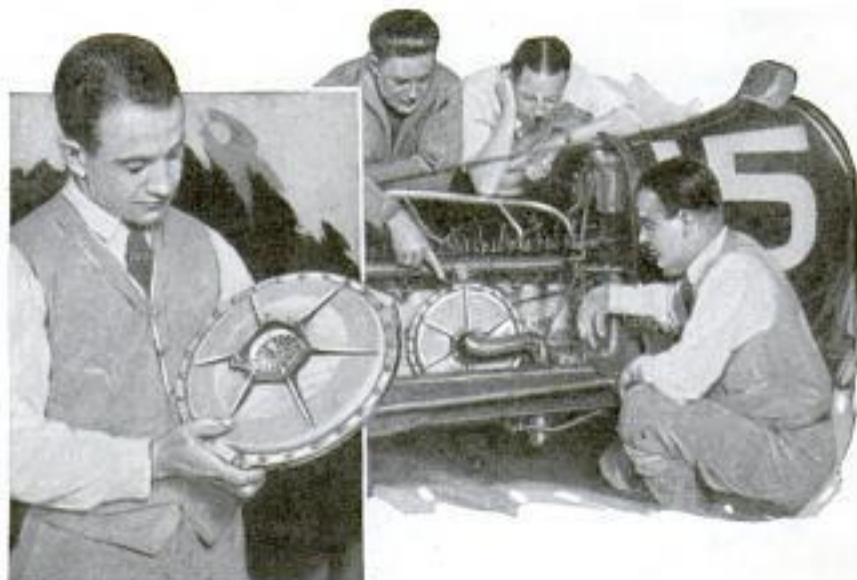

Close View of Supercharger Showing Its Blowerlike Construction, and Position It Occupies When Installed in Racer

Vertical handwritten notes on the left margin:
 "Supercharger works like a blower"
 "The supercharger is a blower"
 "The supercharger is a blower"

Handwritten notes at the bottom:
 "Copyrighted material"
 "W. H. ..."



© U. & U.

Battery of Verifying Counting Devices Which Prove the Figures Computed by the Automatic Calculators

"Steel Brains" Figure Bonus Millions

Battery of Mechanical Calculators Replace Army of Clerks to Compute Accounts for Government Compensation Bureau

"STEEL brains" have been enlisted by the government to do the work of an army of statisticians in figuring the bonus payments due 4,600,000 World War veterans. Facing a problem of staggering proportions, Uncle Sam has devised machines for figuring these allowances—mechanical brains performing the various computing processes from determining the amount of money due each former service man to that of automatically stamping the signature of Major General Robert C. Davis, adjutant general of the army, on the completed certificate. Instead of an army of statisticians and clerks, with reams of paper and pencils by the gross, engaged in making

calculations, a battery of automatic adding and subtracting machines are figuring the precise sum each individual is entitled to. That is, sixty-five of these machines, with as many operators, can handle 40,000 applications a day. Without these

machines the gigantic task would need the services of at least 300 additional clerks in the war department, and the output, even then, would not measure up to the machine production. The various stages of the calculating process are likely to engage the interest of bankers, businessmen, industrialists, merchants, paymasters and statisticians everywhere. If you are entitled to a bonus under the Adjusted Compensation Act and



Close-Up of a Machine with Which Both Home and Overseas Services Are Figured

have filed an application, you will be doubly interested.

Upon receiving your application, it is examined by the department, and if it contains the proper information, receipt is acknowledged. The fingerprints and information on the application are compared with those in the official records of the applicant on file in the department. If any discrepancy between the two is found, the case is referred to the investigation and determination section.

Once the identity and war record of the applicant have been established, the essential facts are entered on a certificate. Then the application and certificate are referred to a reviewer for a second examination, after which the two documents go to the computing section. Here, by means of a simple code and the battery of machines, the amount of each war veteran's compensation is determined. This figuring is done automatically. There are, of course, several types and sizes of machines; some for calculating home service, overseas service, and duty performed upon the applicant's return from overseas, and others that compute home or overseas service only. As fast as these operations are completed, the

printed record of the work accomplished by the machines is torn off and attached to the certificate. Then the total number of days the applicant was on duty and the amount of money due him are entered on the certificate from the printed record. At this stage of the process, all the papers are referred to the verifying section, where the computations and transcribing are again checked for accuracy, and finally the application with attached documents goes to the authentication section where the signature of the adjutant general is affixed automatically. The certificate of application is then ready for consignment to the veterans' bureau where all compensation policies are prepared.

The checking done in the verifying section is also performed by machines, fast-figuring calculators which were specified by the government as necessary in connection with the automatic adding and subtracting machines.



© U. & U.

With the Group of Busy "Steel Brains" Above, the Amounts of Compensation Due World War Veterans Are Determined; Below, Experts Are Comparing Fingerprints to Certify Applications

Heat Radiated by Icebergs Is Used to Warn Ships of Their Approach

Although icebergs seem cold by contrast with the air around them, they nevertheless radiate heat and this is used in an electrical mechanism to warn vessels of the approach of the ice masses. The apparatus is known as the radio micrometer. It consists of a tiny thermocouple inclosed in a vacuum tube and adjusted in the focus of a reflector. The waves of radiant energy from an iceberg as they pass through the instrument, are concentrated in such a way that they are registered upon a delicate galvanometer. By the strength of the current, both the size and the proximity of the berg can be determined. The device is said to be so sensitive that it will show the effect of radiation from the funnels of an ocean liner six miles distant. The old way of detecting the presence of icebergs was to take the temperature of the water, but this proved to be inaccurate because of winds and shifting ocean currents. The electrical method is free from such influences and tests are reported to have shown that the radio micrometer is an effective means for the protection of human life.

Double Tire Carrier for Auto Truck Holds Spares of Different Sizes

Mounted on the sills of a one-ton motor truck now being manufactured, a carrier has been devised to hold two rims and two spare tires of different sizes for the front and rear wheels. It is operated by pushing in two toggle arms to release the tires and closing them somewhat after the fashion of the ribs of an umbrella to lock the spares in place. Nothing touches the rubber.



Toy Castle of Cardboard Masonry Copies Ancient Citadels

A miniature citadel of cardboard, patterned after the feudal strongholds of the

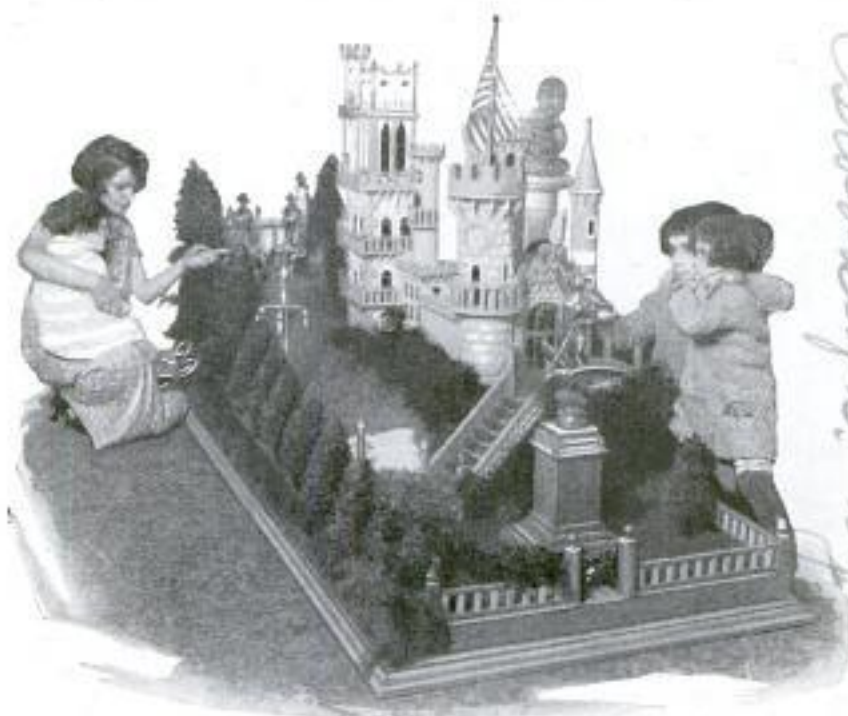

Miniature Castle Constructed from Cardboard and Set in an Artificial Grove Which Is Illuminated by Toy Electric Lights

middle ages and equipped with electric lights to give it a modern finish, has been built by an artist who devoted his spare moments to the task for four years. The framework of the toy castle consists of bits of wood and other light materials, but the walls and turreted towers are formed of pasteboard squares that resemble cut stone. The little structure is surrounded by a grove of artificial trees and bushes, in the midst of which is a small pool of water containing live fishes to add a touch of realism. Toy cannon and a model of an airplane serve to put a warlike appearance on the scene.

Friendly Germs Made into Serum to War on Disease

Germs, too small to be seen even under the microscope, which war on disease-producing organisms, are reported to have been discovered at the University of Minnesota. They are parasites, living on the bacteria that cause pneumonia, typhoid fever, diphtheria, anthrax, chicken cholera and other ailments. These friendly germs have been made into a serum to kill all the bacteria that prey on man or beast except that of tuberculosis.

Discovered by Dr. Arsh. Professor of Bacteriology & Immunology

Memorial Bridge to Span Potomac Will Take Ten Years to Build

One of the most beautiful and costly bridges in the world is reported to be



Architect's Painting of Monumental Memorial Bridge Proposed for Erection across the Potomac between Washington and Arlington

planned to span the Potomac river to connect the Lincoln Memorial in Washington with the Arlington Amphitheater in Virginia. The cost of erecting the gigantic structure is expected to reach more than \$14,000,000, and it will require at least ten years to complete the work. The expense will be borne by the government under whose direction the plans have been made. The bridge, it is said, will greatly reduce the travel distance between the two points, which are centers of interest for visitors and tourists, and the scenes of elaborate patriotic ceremonies conducted by officials of the government.

Motorcycle Taxi-Sleds Solve Northern Snow Problem

Motorcycle taxis, equipped with sidecars and runners, have solved the winter passenger-carrying problem in northern Wisconsin, where the snow lies deep throughout the cold months. Several of the taxi-sleds operated at Barron, Wis., as public conveyances easily earn an average of \$10 a day, while others are supplied to doctors for making their professional



Winter Taxicab in Frozen Northern Wisconsin

calls, and to other business men. The front wheel tire is removed and the rim fitted with a sled runner, which is bolted in place. The sidecar also is fitted with a runner, which is bolted to the frame and set to travel in a sleigh track. Both runners are designed to oscillate freely. The rear tire of the cycle is left in place, and fitted with a heavy, non-skid chain. The final step is to reduce the gear ratio about twenty-five per cent by a simple change of sprockets. Despite the gear reduction, the speed of the taxi-sled is about the same as that of the motorcycle in summer. One hour suffices to make the change from cycle to sled. Wind screens with curtains of leather and glass windows protect both driver and passenger from the worst of the northern weather.

Value of Alaska's Reindeer Herds More than U. S. Paid for Land

The domestic reindeer industry of Alaska is now valued at \$9,750,000, a sum \$1,550,000 greater than the price paid for the territory by this government in 1867. It is estimated that the total stock of the animals on the ranges of breeders is about 350,000, of which more than two-thirds are owned by natives. Not only food and clothing for a large part of the population are furnished from the deer, but their care and marketing afford a means of livelihood for a great army of workers. Efforts are being made to improve the present methods of handling the increasing herds and also to find a cheaper process of marketing the various products. Venison from the reindeer is rapidly becoming a regular item on the menus of restaurants throughout the northwest, and its use as an article of food is becoming quite popular in the larger cities of this country.



Harold Osborne, World's Champion High Jumper, Using the So-Called "Western Roll" to Clear the Bar in the Highest Jump Ever Made by Any Athlete

Science and Sports Records

World's Marks Continue to Fall as Men Master Nature to Improve Form and Technique and Obtain Better Equipment

By CHARLES A. DEAN

(Former President National and Central A. A. U. and Manager of the American Team at the 1924 Olympic Games)

WHEN if ever, will men reach the ultimate limit of physical endurance and cease making new world's records in sports? For two decades records in virtually every field of athletics for both men and women have been broken, in some cases with almost monotonous regularity, and yet the end is not in sight.



Charles A. Dean

That the runners and jumpers, the swimmers and the discus and javelin throwers of the present are produced from better raw material than in the past has not been proved. Instead, the new records may usually be traced to new applications of scientific laws for the improvement of equipment and for better physical training.

The invention of the so-called "lively ball" made Babe Ruth the "King of Swat," because it gave the batter an advantage over the pitcher. Application of science to pitching had in the same way put the batter at a disadvantage for many years. The modern golf ball and improved clubs made golf a popular sport because science had so improved on the old Scottish game that the player got the satisfying thrill of long-distance shots, and similar improvements in tennis racquets have added to the interest in that game.

Since 1895 a fifth of a second has been clipped off the 100-yard dash record, and the mark for 220 yards has been reduced four-fifths of a second. The two records have been tied several times. The last man to do it was Charley Paddock, the California flash, who has devoted his life to sprinting. He has trained himself until he has become a perfect speed automaton, with mind and muscle under absolute control. His movements are worked out with the utmost care, and when he



The Straight Leg and Trick of Raising the Back Knee Have Made Fourteen Seconds Possible for the 120-Yard Hurdlers, Allowing Two Seconds for Jumping Ten Hurdles



Scientific Training, Better Tracks and Improved Shoes Are Aids to Runners

Alfred Leconey, of Philadelphia, Beating Harold Abrahams, British Star



Miss Helen Wills Was a Champion at Seventeen Because of Hard Training and an Improved Racquet

runs, it is with the precision and smoothness of a perfect piece of machinery. In every branch of sport where records are being broken, it is such machinelike precision, or else improvement of equipment, that has made the new marks possible. An English athletic coach is now working on a one-piece, foot-form athletic shoe, which will give both sprinters and jumpers such a prehensile grip upon the ground that it is bound to improve their performance, just as the wide shoe, with slightly curved soles, developed by the Finns, has enabled their javelin and discus throwers to set new world's records.

Bodily performance is largely a question of physical capacity. The jumper has but a certain length of muscle to contract, and the runner only capacity for energy to drive his body along at a certain speed. Yet with better co-ordination of mind and muscle, improved tracks and better shoes, runners are constantly bettering the performances of the past. This increased power of athletes is demonstrated by each succeeding generation of Olympic champions. That these men are able to continue breaking records is due

to greater knowledge of technique, and, consequently, improved methods, more specialized physical development and more scientifically prepared equipment. At the time of the 1908 games in London,

javelins with English ash shafts and unwieldy ringed discuses were used. The world's record for the javelin throw then stood at something short of 180 feet. It has since been increased to over 216 feet, and the increase is largely due to the discovery by the Finns that a stiff-shafted javelin, fashioned from the best outside layer of the sunny side of a Finnish birch tree, will travel some thirty feet farther than will a weapon shafted with English ash. The grain of the ash shaft is subject to considerable vibration while in flight through the air, and this vibration absorbs part of the power which the thrower has put into the weapon. The Finnish birch shaft is not subject to such vibration, and hence all the energy imparted to the javelin is expended in carrying it a greater distance. With the birch javelin the Finnish team won first, second, third and fourth place in the games of 1920, at Antwerp. In 1924, when the Olympic committee specified the kind of shaft to be

used they did not do nearly so well, though still winning first place. The same Finnish method of cutting timber was applied by them also in making discuses and skis, and produced equally remarkable results.

American ingenuity has, in the same way, done much for pole vaulting and hammer throwing.

Originally pole vaulting was a purely British sport, but fell into disuse, first, because poles formed of hickory or ash were liable to snap off transversely, killing or maiming the unfortunate athlete who was impaled on the fractured spike, and, secondly, because a pole long enough to enable a man to clear twelve feet was too heavy. Americans solved both problems by making poles from the strong but extremely light "female" bamboo stalk, which may fracture but never breaks off transversely. The disadvantage of the slippery surface was counteracted by taping a handhold with adhesive tape. In the early days of hammer throwing the blacksmith's twelve-pound sledge was borrowed, but the stiff shaft was found to be a distinct handicap.

Ingenious athletes then utilized cane handles, which were an improvement, but far from perfect because the vibrations were uneven and the handhold unsatisfactory. Then an American invented the modern hammer with stirrup-shaped handle, piano-wire shaft and a spherical, ball-bearing head. With the new device, the record increased from just over seventy-eight feet to a few inches less than 190 feet.

Since the London A. C. met the New York A. C. in New York in 1895, running

records have steadily fallen. Three world's records were broken and one equaled in that match. The half mile was done there in one minute, fifty-five and two-fifths seconds, which was considered a wonderful performance, but an American superman, Ted Meredith, came along

some years later and clipped one and a fifth seconds off that mark, and likewise set a record of forty-seven and two-fifths seconds for the quarter mile. While Meredith is a phenomenon and scientific improvement of the surface of racing tracks has also helped, yet his records have been in good part due to the improvements in training, which reduce a record breaker to perfect co-ordination of movement. Paavo Nurmi, the amazing Finn who startled the Olympic spectators at Paris last summer, has run a mile in four minutes and ten seconds and has done six miles in twenty-nine minutes, seven and four-fifths seconds. He has made a science of distance running, and, incidentally, developed himself after a manner all his own. He has little use for massage and

other refinements of training, but will come in from breaking a record, rub himself down with a towel, dress and be on his way. Nurmi plans every race before he starts, decides what time he must make to win, and then carries a stop watch and checks his time at the end of every lap.

Improvement in field events has been even more marked than in running. Super-style on the track accounts for fractions of seconds, but better equipment and technique clip inches, feet and yards off the field records. Harold Osborne, the



Lee Barnes, of California, Won the Olympic Pole Vault with Bamboo Pole Perfected by American Ingenuity to Eliminate Dangerous Ash Sticks



Left, William T. Tilden, World's Tennis Champion in Action; Right, R. LeGendre, of America, Winning the Broad Jump in the Olympic Pentathlon by Setting a World's Record



F. D. Toote, American Hammer-Throwing Champion, Won the Olympic Championship Using the American-Invented Hammer



Walter Hagen Won the Metropolitan Open Championship with Scientifically Designed Clubs and Balls Plus His Own Skill

twenty-four-year-old farmer-boy school-teacher, has cleared the bar in the highest jump ever made, at six feet eight and one-quarter inches. His record was made possible by the so-called "western roll," introduced by George Horine, which, by the way, is not a roll at all, as was proved to the international judges at the Olympic games, who watched Osborne carefully to make sure that his style was legal under the rules. In this western roll the jumper takes off at an angle of thirty-seven degrees from the line of the crossbar and gives the feet twice the momentum of the head, so that when he crosses the bar his body is parallel to it. As soon as he reaches that height, the lower, or left, arm is dropped down, the under leg is bent at the knee, while the right, or upper, leg is extended. The body gives a violent twist and describes a half revolution, which brings the jumper face downward, so that he has apparently, though not actually, rolled over and away from the bar. The head must be kept back and up during the evolution, as it is illegal to dive over the bar head first and downward.

Broad-jumping shows even greater progress than the high-jump. O. J. O'Connor, a phenomenal Irishman, attained twenty-three feet ten and three-quarter inches from a grass take-off back in the nineties. Next the late W. J. M. Newburn beat twenty-four feet, in 1898, and in 1901, O'Connor brought twenty-five feet in sight, failing to attain it by only a quarter of an inch. The limit to which a man could go by sheer spring appeared to have been reached, so broad jumpers started to work to find some trick of body movement in mid-air which would give added impetus to the jump. Gourdin and Hubbard, two American negroes, solved the problem by introducing a running step

in mid-air, and both succeeded in crossing the twenty-five foot mark. Another American, LeGendre, carried the world's record on to twenty-five feet six inches, in the pentathlon at the Paris games, and did it by a backward lean of the body just prior to the mid-air step, followed by a herculean whip up from the waist in the midst of the mid-air leg movement.

Improvement in hurdling has been brought about by similar changes in technique. The straight-leg method brought fifteen seconds within sight of the 120-yard hurdlers, while a trick of raising the back knee, to bring the rear foot through quickly, has made fourteen seconds possible. Pole vaulters, by a pendulum swing, perfect timing and an upside-down arch of the body, increased their record to thirteen feet five inches, and then a young Norwegian came along with an improvement in the form of a birdlike flight after releasing the pole, and that carried him to within a fraction of an inch of fourteen feet.

The greatest field for breaking records in recent years has been among the swimmers. Many of their marks have been shattered several times a year. At the Illinois Athletic Club, where I am athletic chairman, the swimmers trained by William Bachrach, our coach, and head swimming coach of the American Olympic team, hold about ninety-five per cent of all the world's swimming records.

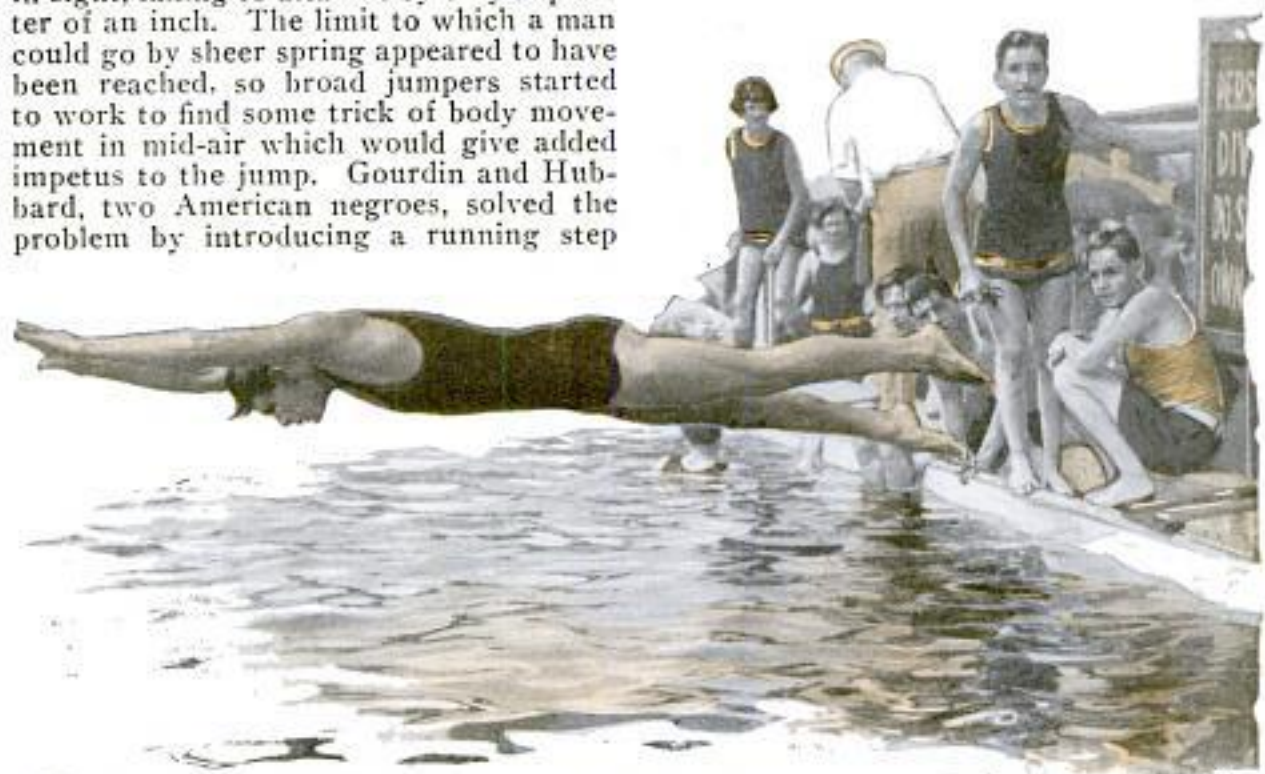

Johnny Weismuller, the Swimming Marvel, Starts His First Kick Here While Still in Mid-Air, a Trick That Has Helped Him Win Many Records

False Eyelashes on Adhesive Tape Worn at Will as Beauty Aid

Women who consider long, curly eyelashes beautiful are spared beading and treating their own by using sets of false



Eyelash Set Turned Sideways to Show Adhesive Strip That Holds It in Place

ones conveniently attached to a small strip of adhesive plaster that cannot be detected when it is stuck to the eyelid. They are made in various lengths and colors and are said not to interfere with the vision.

Two-Mile Dam across Nile River Will Water Parched Sudan

With the completion of the great Sennar dam now under construction across the Nile river in Sudan, a system of more than 9,500 miles of canals and channels stretching like huge veins into virtually desert lands, will be supplied with water for irrigation purposes. If the soil taken from the excavation were made into bricks, it could be built into a wall five feet high and a foot thick long enough to reach around the earth at the equator. It is estimated that when the great storage lake which will form behind the dam has been filled, more than 300,000 acres of barren ground will be brought under cultivation. The gigantic basin will hold sufficient water to supply a community the size of Greater London for two years. The construction of the retaining wall on the eastern half of the dam, developed into a feverish race against time as the period for the annual floods neared. A half-finished structure in the path of such a rush of water as takes place at this time, would

have been destroyed in a few days. The required height of the wall had hardly been attained when the river began to rise. The stone used in the building of the barrier is being quarried within thirty miles of the scene.

Honey Bees Show Sirup Makers How to Improve Product

Once more scientists have gone to the bee to seek knowledge and have come away wiser, this time with a process that promises to improve the quality of sirups. From the honey gatherers, the department of agriculture has learned that a yeastlike substance the insects secrete and mix with the nectar, prevents it from souring or turning to sugar. So they plan to mix with maple, cane and other kinds of sirup what is known as invertase, a ferment made from yeast which is much like the secretion of the bee to keep their products from crystallizing so easily.

Knives and Scissors Are Sharpened by Abrasive in Holder

By placing strips of emery cloth, or other abrasive material, over a flat, steel bar holder and binding them in place with a wooden wedge under a movable brass sleeve, an inventor has produced a simple sharpener for knives, scissors, and other

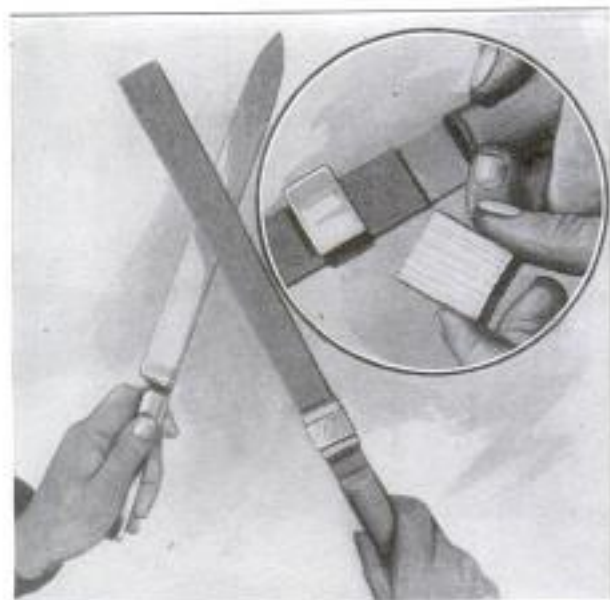

Whetting Knife and Inserting Wedge under Sleeve to Hold Abrasive Strip to Bar

articles. The holder has a comfortable handle and it takes but a few seconds to change the covering.

226
Sole by C. Heston 12 E 49 St
New York

21 1601 25

Copyrighted material
2510 12 10 1000

AIR-PROPELLED BOAT STEERED BY SWINGING MOTOR

Shallow water and quantities of rubbish that made the operation of a screw-pro-

down the course are said to be the usual performance of the engine. The owner is

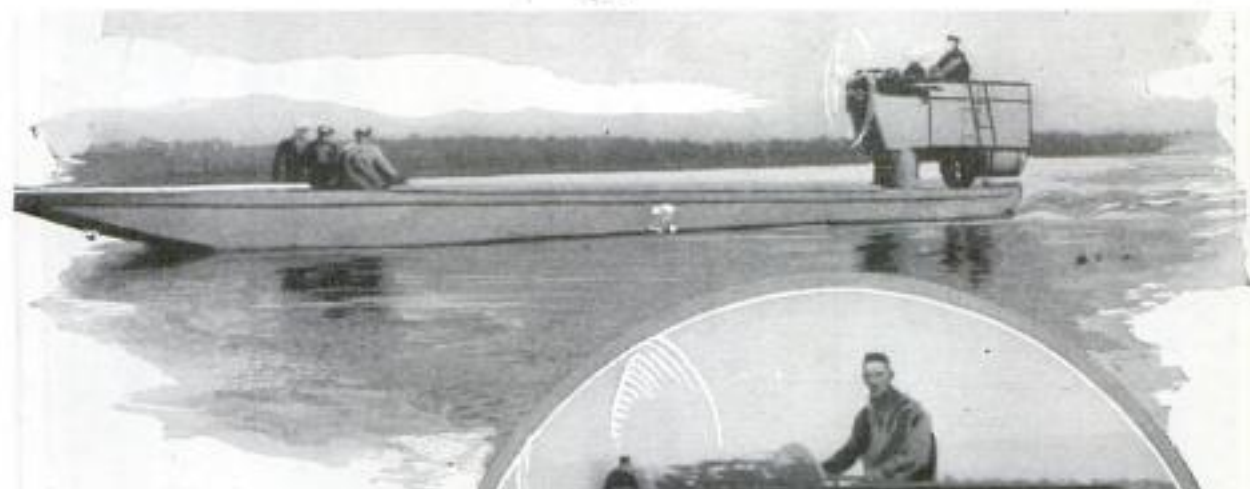

Harnessed to Barge, Airship Motor Speeds Craft Upstream and Pilot Steers by Turning Fuselage and Propeller on Revolving Carriage

elled boat impractical did not defeat a California rancher when he decided to use the Colorado river to haul his produce to market twenty miles from his farm. He built a flat-bottomed, barge-shaped boat, fifty-five feet long, with a beam of nine feet, and at the stern mounted a ninety-horsepower airplane motor and eight-foot propeller to drive the craft. The steering problem was surmounted by placing the engine assembly on a pivot with two pneumatic tires to support the weight of the fuselage and the fuel tank of fifty gallons' capacity. The boat is guided by simply turning the engine and propeller with a steering wheel operated by the pilot who commands an unobstructed view of the river from his seat and is protected by a glass windshield. If the barge gets stuck on a sandbar, the motor can be swung entirely around to pull the boat loose. Speed of from seven to eight miles an hour upstream against a current of six miles an hour and a rate of about twenty-five miles



planning to install a 220-horsepower motor and a larger propeller to reduce the time required to get his goods to the stores. With the smaller outfit, he can carry five tons at once on the barge, in the building of which he spent about two months.

Ⓒ Popular Mechanics Magazine does not publish the name of maker or seller of any device described in its pages, but this information is kept on file and will be furnished free by addressing our Bureau of Information.



Special Lighting Equipment Required to Film a Scene for Government Movie, "When a Man's a Miner,"
Designed to Illustrate Need of Caution in This Hazardous Calling

Uncle Sam as a Movie Producer

Government's Gigantic Studio Annually Turns Out Scores of Reels Portraying Educational Dramas of Safety, Health and Industry

MOVIES, with Uncle Sam as producer and a highly trained staff of directors to stage them, are now a big factor in the government's work of teaching the nation's workers the rules and facts of such everyday subjects as conservation of life, health and industrial progress.

Unlike the theatrical motion-picture makers, the government director generally has the plot already prepared for him and locations are found wherever the interests of any great number of people lie, whether in mines, farms, public parks, bird life, insect pests or many other topics which daily touch the vital social or commercial progress of the nation. Both villains and heroes are furnished by nature in a number of the dramas, and tragedy stalks in the form of destructive pests and diseases of plant life as well as in hazard and danger which are always present

wherever men and machinery combat nature to secure needed minerals and vegetation to supply busy marts and factories.

A great amount of film is also taken up in carefully constructed studies of plant life. Attractive picture stories are built about the doings and habits of small animals, and the pest varieties are all vividly shown in their natural haunts. Their good points are emphasized together with their evil acts against the safety and security of mankind, and as a general rule the best methods of combating or destroying them are detailed.

So widely popular has this manner of educational work become that there is hardly a government department that does not make use of the motion picture for spreading progressive propaganda among those they desire to aid or recruit in the various movements for public good.

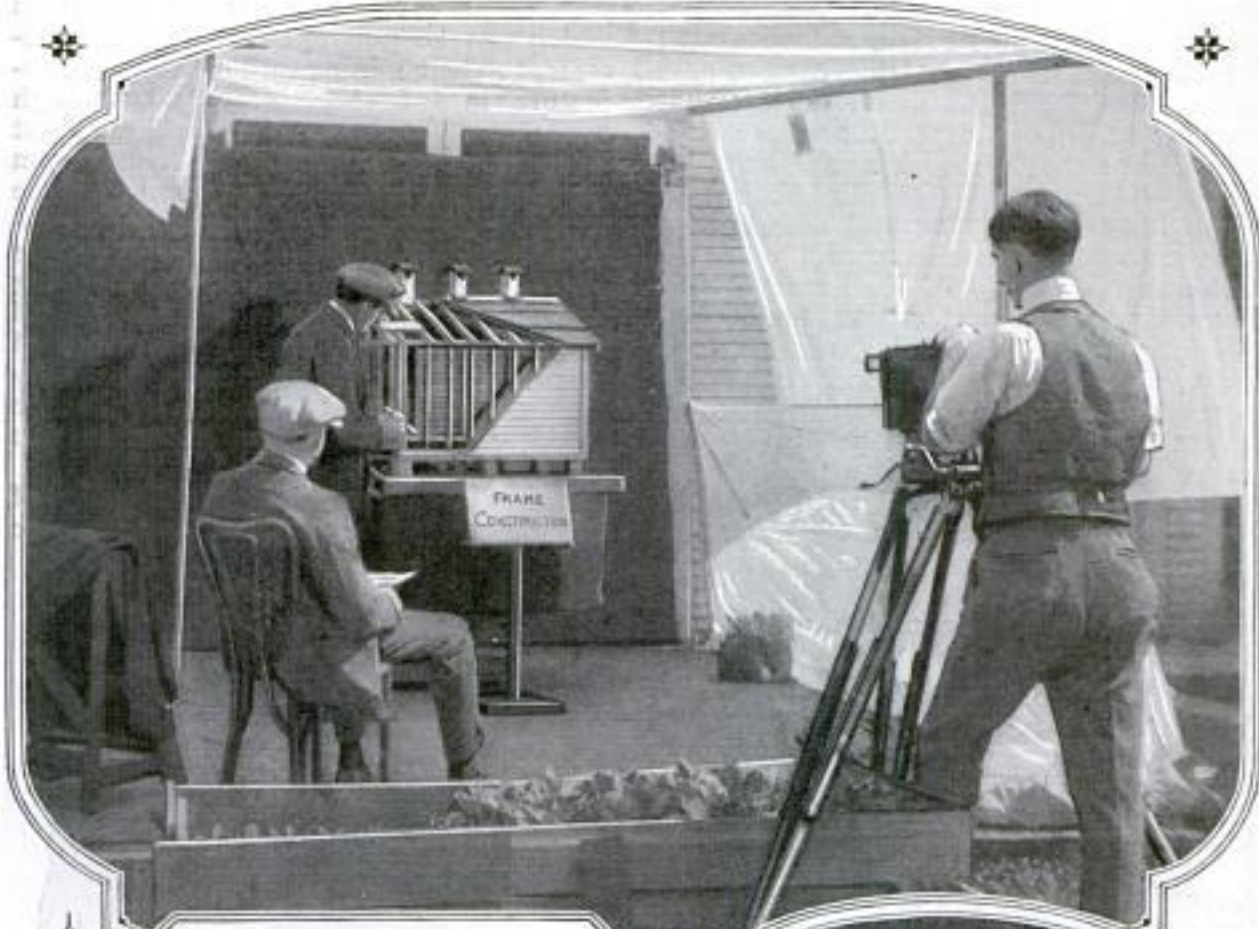

Skeleton Model of a Sweet-Potato Storehouse Which Will Assume Natural Size on the Screen; Below, Bureau of Mines Movie Men Shooting Drilling Operation 3,700 Feet under Ground



Taking Close-Up of Miniature Farm Scene Composed of Grass and Twigs with Painting for Background

It is estimated that the department-of-agriculture pictures alone are witnessed by 25,000,000 people each year. These films are produced with all the art that marks the dramatic reels, and are prepared in a large studio and laboratory equipped with facilities for projecting them for test, printing and distributing. The department has its own high-speed cameras for taking of slow-motion pictures, and special apparatus for microscopic work with seeds, plants and insects. In conjunction with the main studio is a complete animated cartoon department where details that cannot be provided in any other way are added to the pictures to make them even clearer than the most carefully operated camera can take under the best of conditions. Most of the agricultural scenes are photographed on farms and ranches and in forests all over the country and rushed to Washington for development and arrangement into storied form. In the same way safety and efficiency in the numerous mineral industries are preached by the bureau of mines, which is a steady producer of one to seven reel features. Subjects are covered dealing with every step in development

of minerals from their natural formation which can be portrayed by special processes, to their mining and ultimate manufacture into useful materials. Though many of the mining pictures have cost large sums of money, their completion has in several cases been financed by large concerns co-operating with the government in the work of education along these lines. To add reality to a film showing some interesting operations in the oil fields, a big derrick costing thousands of dollars was purposely burned down by the firm which owned it, to create a scene teaching a fire-prevention lesson in this particular industry.

Actors are engaged from all walks of life and rarely is any salary demanded for



Fire Prevention in the Oil Fields Is Aided by Spectacular Films Made by Government Bureau Which Provide All the Thrills and Romance of the Staged Affairs

their services, since the bureaus draw on the workers and officials of the different concerns for their casts of characters. If a number of people are needed, advertisements rarely fail to draw more than enough volunteers from among whom the necessary talent can be selected. One seven-reel picture telling the story of oil from early biblical days to the present, may require many people for the proper action of the piece and these might be secured within a short time from the neighborhoods in which the scenes are staged without any more expense than the cost of a "want ad." There seems to be no difficulty in procuring sufficient volunteers for roles in such productions. Each of the bureaus has its own fields of production from which it does not depart. Health and

these lands and distributes information concerning them, keeps a constant motion-picture service in operation to photograph the interesting things in connection with the resorts, which helps to maintain an almost year-round stream of tourists traveling to the seasonable points for recreation and sight-seeing. Even the army and navy have their propaganda films which are used in aiding the re-

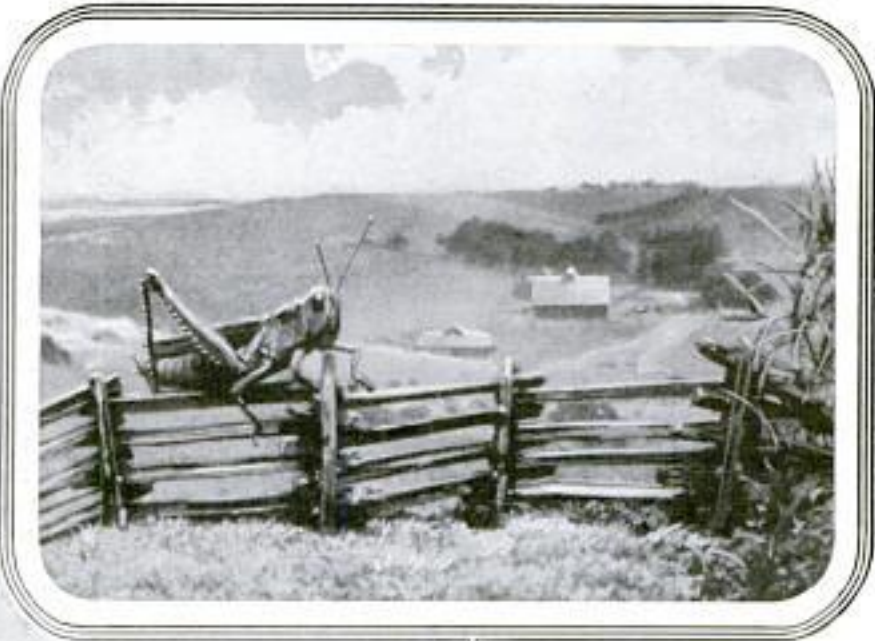

Above, How Grasshopper and Miniature Farm Emphasize Insect Peril; Below, Transporting Movie Apparatus over Arizona Mountains

cruiting services to explain to prospective "rookies" the attractions and advantages of enlistment in these organizations. Entire stories of sea cruises or life in the land arms are arranged in a form which leaves little or nothing to the imagination. Such reels are displayed also for the benefit of patriotic societies and like organizations of citizens in all parts of the country. From the largest

sanitation films are made by the public health service. The bureau of reclamation shows elaborate pictures dealing with the gigantic irrigation systems of the west, while child welfare and women in industry are aided by the department of labor, which offers attractive screen stories furthering the cause of those whose callings are under the supervision of that branch of the government.

battleship designed to protect the nation to the smallest insect which annoys and impedes the farmer or forester, the range of the movie camera reveals in actual scenes the operations of the corps of Uncle Sam's motion-picture producers.

As the gorgeous national parks are set aside as playgrounds for the nation's people, the department which cares for

As in the dramatic studio, miniature settings are often employed. To illustrate graphically the perils of flour-dust explosions in grain mills and storage elevators, a tiny replica of a large grain elevator was built and an explosion imitated by blowing flour out the doors and windows with



Filming the Story of Good Roads by Demonstrating the Qualities of Various Materials with Panels of Paving Surfaces

a bellows. The camera was set in a close-up position so that the finished picture presented a realistic appearance with the effect of a genuine occurrence. Sometimes elaborate outdoor farm scenes are set up and photographed in the studios at Washington to illustrate some particular condition existing in areas thousands of miles away. For these, miniature landscapes are constructed of grass and twigs,

crossed by a network of rail fences made of toothpicks. Against this setting, an ordinary grasshopper looms as large as a dragon, but it serves to show the danger in allowing such pests to roam unopposed over a farming district. Germination and growth of plants are ingeniously photographed by a special camera devised by a member of the government's force. This device is operated by clockwork and takes pictures at determined intervals. Though the exposures may be made weeks apart, when the final reel is shown the entire movement seems to take but a few minutes. In this manner the development of flowers and forage plants can be shown gracefully

unfolding from the tiny seed after bursts in the soil.

Spectacles in the genuine are furnished by the forest-fire fighters who become the principals in the tragedies of the timberlands, filmed as lessons to those working and traveling there. Airplanes are often used to illustrate the precautions taken by the national forestry division for the protection of life and property.



Where a Gasoline Engine Becomes the Subject of a Movie; the Motor Was Actually Sliced in Two to Disclose Construction and Operations of Its Different Parts

Incubators for Raising Oysters to Provide Constant Supply

Natural oyster beds in Chesapeake bay and elsewhere cannot always be depended upon for sufficient harvests because of water pollution, storms and other causes. An incubating process, developed by the bureau of fisheries, is seen as a successful way around these uncertainties. The bivalves are induced to spawn in sunlit tanks. As soon as the eggs have become swimming larvae—a change that takes only six or eight hours—they are removed to rearing basins. By the time they are two days old, they have developed a pair of tiny shells. Then the attendants take ordinary egg-crate partitions, dip them in hot paraffin, cover them with sand and put the sections in the tanks where the baby oysters settle upon them. Flowerpots are sometimes used for this purpose. When the collectors are covered with "spat," as the young are called, they are dropped overboard into the sea at suitable spots, and the little oysters begin to shift for themselves. They grow rapidly, under favorable conditions attaining a length of more than an inch in two months, three inches in a year, and in two years, they may be ready for the half-shell trade.

Plane's Fuel Told by Air in Tank on Dial at Pilot's Seat

The exact amount of fuel in the tank of an airplane can be shown on the instrument board by a gauge dial which operates by the weight of the gasoline on an air cell in the container. It is claimed that with this device, aviators on flights can be kept constantly informed of the condition of their fuel supplies, making the carrying of excess material and forced landings for lack of gas unnecessary. When temperature and altitude cause loss of air in the tank cell, a single stroke of a small pump provided for the purpose replaces the amount, assuring the accuracy of the measurements. The gauge is designed also to indicate the volume of fuel in reservoirs of gasoline-driven vehicles and for similar use on storage tanks.



Works of Watch Run Two-Foot Clock That Folds into Small Box

So finely balanced that it is operated by the works taken from an ordinary watch, a



© U. & U.
Metal Clock, Run by Works of Watch, Which Can Be Folded in Small Box

clock with a dial two feet in diameter has been made to fold up for storing in a box, ten inches long. The entire mechanism of the timepiece weighs only a pound and is said to keep perfect time. To permit easy winding, the stem of the watch has been extended on a long shaft and is also used for setting the hands. The dial is of sheet metal and the large figures are stenciled in the face. The clock may be hung on a wall or installed in a window.

Electric Dredges That Dig for Gold Increase Alaskan Yields

In the footsteps of the prospectors with their picks and pans have come big electric dredges for the gold hunt in Alaskan fields. These powerful outfits can dig down sixty feet deep and scoop out as much as 200,000 cubic yards of material in a month. All of this is sluiced and washed within the dredge itself and nearly every flake of gold extracted. In 1922, dredging accounted for sixty-nine per cent of the volume of placer gold mined in this country, the total from dredging operations in the period from 1896 to 1922 being placed at \$180,800,000.

140 W. 69th St.
New York City

Apartment House Wired for Radio through Wall Plugs in Rooms

Radio is distributed through a New York apartment house, in about the same

report to the American Society for the Advancement of Science by Doctors Max Kahn, William J. Geis and Hattie J. Heft, who have been experimenting for two years with the substance, invented by Dr. Kahn, "Insulin," which preceded it, checks the progress of the disease, though in its advanced stages it still remains incurable. The material was first fed to seven generations of rats, who thrived on it,

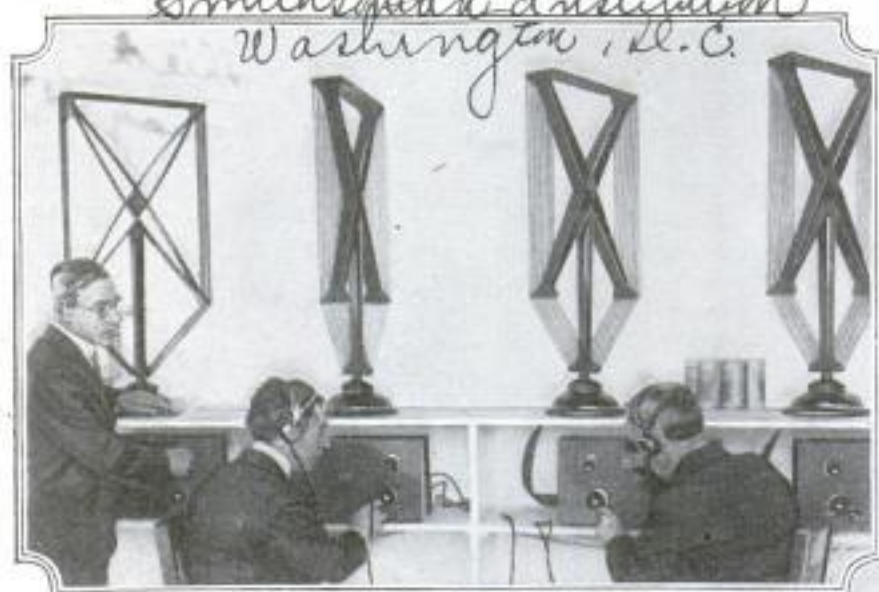

Battery of Radio Sets on Upper Floor; Programs Are Received in Apartments by Connecting the Loud Speaker to a Wall Socket

way as the electric current, by a system of wiring that permits tenants to plug in with a loud speaker through a set of four wall sockets, and receive programs from as many receiving sets located on the top floor. Operators are on duty to tune in on the various stations and fill special requests from the listeners. A transfer of the horn wire brings any one of four programs to the tenant, and families who so desire may have a loud speaker for each socket. As an added attraction, the arrangement, like up-to-date plumbing and the latest electrical conveniences, while increasing the desirability of the rooms from the renter's standpoint, also eliminates disfiguring the outside of the building with an array of aerials, the central receiving sets all employing loops.

Artificial Fat Is Newest Weapon to Fight Diabetes

"Intarvin," an artificial fat made from ordinary beef tallow or steer fat, has been added to the new weapons for the relief of sufferers from diabetes, according to a



and then tried out on diabetic patients. It was found that they gained in weight and lost all sense of undue hunger, while the usual doses of insulin could be reduced.

Portable Cleaner for Old Brick Cuts Cost of Removing Mortar

With a portable outfit that removes the mortar from secondhand brick at the rate of 24,000 or more a day, a great saving over hand methods is effected. Two men are required to operate the machine, which is run by a three-horsepower gasoline engine. As the bricks pass into the cleaner, they are struck successive blows by a hammer that knocks off all the mortar. A conveyor carries the brick to a truck, or they may be piled on the ground. The old mortar falls into a metal trough leading to a waste receptacle.

Arthurian White
1/24, 25

Killing of Flowers by Gas Leads to Valuable Medical Discovery

Discovery of ethylene, a valuable and widely used anesthetic, was due to the investigation of the death of hothouse flowers caused by illuminating gas, according to Dr. William Crocker, of an eastern plant-research institute. Approached by a florist seeking a reason for the sudden killing off of greenhouse carnations, he said, investigation of the air surrounding the growths was made. The presence of a small quantity of gas such as is used for heating and lighting was discovered. Close examination of this showed part of it to be ethylene. Under the influence of a slight mixture of this matter, the flower buds died and fully developed blossoms would close. Air containing a minute percentage of the gas is said to put blooming carnations to "sleep" in about twelve hours without killing them. Further experiments showed that the gas was effective in producing the yellow colors on citrus fruits, when green. Previous to this discovery kerosene stoves were employed in fruit-curing houses to mature the products.

2021

Radiator Screen for Racing Autos Prevents Engine Overheating

Scraps of paper, lodging against the radiators of speeding racers in automobile contests, have compelled more than one driver to abandon the course, due to an overheated engine. The refuse cut off the circulation that helped keep the water's temperature down. To prevent mishaps of this kind, a veteran pilot has invented a screen which fits over the radiator front and can be opened by means of a lever from the driver's seat, throwing the papers to one side. The screen is put back by a reverse move of the lever.

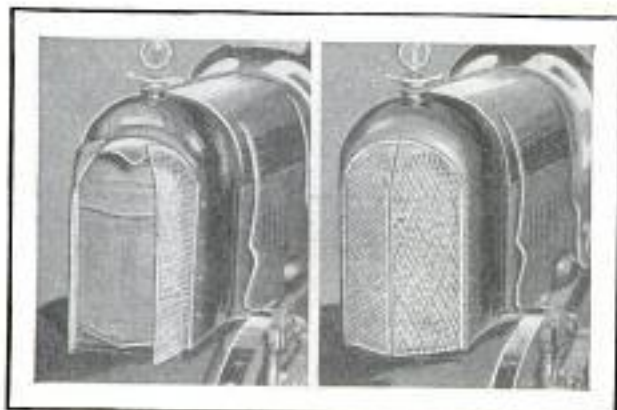

Radiator Screen Open and Closed to Show How Papers Are Caught and Removed

Send request in writing

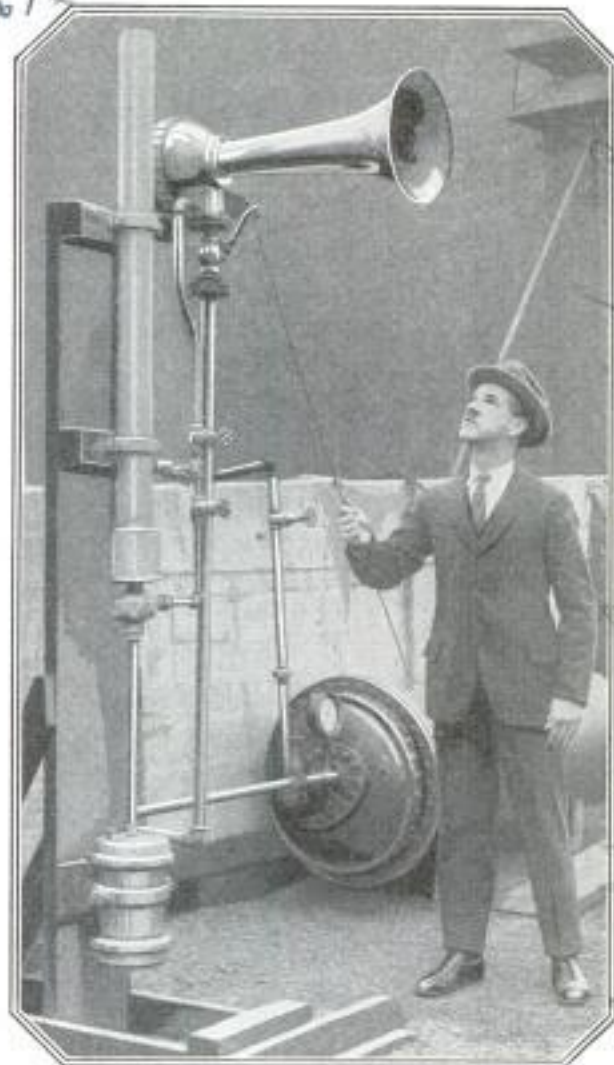

When Whistle Valve Is Pulled, White Cloud of Smoke Appears as Substitute for Steam

Visible Air Whistle on Motorboats Reduces Shipping Hazards

Although some ships driven by Diesel engines have found a substitute for the steam whistle in compressed-air apparatus, this leaves no warning cloud of vapor, a great aid in crowded waters, and installation of steam boilers just to supply the whistle has been exceedingly expensive. To remedy these difficulties, an air signal has been combined with a tank of a liquid smoke-producing preparation in such a way that, when a blast is blown, a cloud of dense white vapor mixes with the air, making a signal of even greater visibility than ordinary steam. One tankful of the preparation is said to last for several months of average operation.

Popular Mechanics Magazine does not publish the name of maker or seller of any device described in its pages, but this information will be furnished free by addressing our Bureau of Information.

*The Sperm Company
40 7 1/2 Lathbury Ave. Extension
Brooklyn, N.Y.*

**Dummy at Auto-Filling Station
Keeps Hose off-Ground**

To keep the air and water hose from being left on the ground and exposed to



White-Clad Dummy Figure That Supports Air and Water Hose at Filling Station

wear and damage, the proprietor of a California filling station fashioned a holder in the form of a dummy attendant, clad in white and wearing a cap, and placed it at a signpost. The shoulder of the figure was fixed to support the lines when customers were through with them and served to remind the users to put the hose back in its proper place.

**Value of Nation's Chicken Output
Quarter of a Billion Dollars**

There were approximately 450,000,000 chickens on the farms of the United States in 1924 with a total value of \$350,000,000, according to the department of agriculture. The egg production was placed at \$600,000,000 for the year. This form of produce, like others, has shared in the rise of prices, advancing from an average of 10.7 cents per pound in 1913 to 44.2 cents at the beginning of 1923. The crop is chiefly produced in the upper Mississippi valley where most of the grain on which the fowls are fed is grown. Poultry has become an important factor in foreign commerce in the last twelve years, ex-

ports for the period totaling more than \$100,000,000, while imports of eggs in various forms, especially from China, amounted to about \$40,000,000 for the same time.

**Queer Cargoes Carried by Ships
Include Walrus Whiskers**

Besides the familiar articles of merchandise arriving on steamers daily, many strange things are to be found among the cargoes. For instance, thirteen tons of dried flies were carried by an English liner arriving at Plymouth from Mexico. They were to be used in making paint. Similar consignments are brought from Brazil for the manufacture of food for poultry. Cases of walrus whiskers are sometimes received, to be turned into toothpicks, and frog skins are imported from India for the bookbinders who find that a delicate leather can be made from them, easy to work and taking soft colors in dyeing. "Twenty-five Tasmanian devils" were included in a shipment of birds and beasts from Australia and the island south. The "devils," savage burrowing creatures though they are, were considered less deadly than a case of "diseases," cultures of malaria, blackwater and other fevers common to the tropics.

**Paper Cones on Plants Repel Frost
and Are Weatherproof**

To protect plants from frost, a weatherproof paper cone has been made. It comes



Early Shoots Saved from Frostbite by Weatherproof Plant Protectors

to the gardener packed flat, with stakes for locking the edges and anchoring it to the ground. The cones also may be used as sun or windbreaks by tilting them sufficiently for proper ventilation.

Miss. State Univ. 1-25-20

Handwritten notes and signatures at the bottom of the page, including 'Copyrighted material' and 'Super Eye'.



Empty Shell of What Was Once an Imposing Bank, the Abandoned "Ghost" City's Center of Finance during a Brief Heyday of Industrial Clamor and Commercial Boom

Ghost Towns of the West

Abandoned Cities, Once Thriving Communities of Eager Toilers, Mark Sites of Mining Tracts Which Failed Hopeful Owners

OF all the "ghost towns" in the west there is one that stands out above all, not only because it once had such a large population, but also because its business district was unusually well built up for a mining community. And when one considers the town was built on nothing more substantial than the most speculative of stocks, it is all the more remarkable that it ever existed at all.

This town, now but a ghost in the desert, is Rhyolite, Nevada, which at the height of its boom had a resident population of six thousand, with transients averaging five thousand, which kept the town well up in the ten-thousand class for some time. And so well established did it seem to be that two railroads entered Rhyolite, one the Las Vegas and Tonopah, covering the 115 miles to Las Vegas on the southeast, while the Goldfield-Bullfrog came down from the north. The Tonopah and Tidewater of today, which operates between Ludlow, California and Goldfield, uses the tracks of the Goldfield-Bullfrog above Beatty, Nevada, which is but four miles from Rhyolite.

Back in 1905, before the railroads had entered, Rhyolite was a booming camp even though everything had to be hauled

in wagons from Las Vegas, with quite a bit of competition between teaming companies for the rich harvest of dollars—and dollars were quite plentiful and freely spent in the boom days. In 1906, the Las Vegas and Tonopah entered, and after that Rhyolite took on a most substantial appearance, two large three-story buildings of reinforced concrete being constructed and later a fine eight-room school building with metal tile roof. The Las Vegas and Tonopah also put up a passenger station which in architecture, material and workmanship would do credit to many an enterprising community of twenty-five thousand—but there it stands, vacant, with all interior woodwork torn out and no rails leading to it. The line was torn up in 1917.

Down in the center of the town, along the main street there now stand a few deserted buildings in all stages of decay. In the whole town there are but a very few buildings now intact, and the reason for their existence is that a few former residents are still paying taxes on their property, though in the last year or two, several have given up all hope of Rhyolite ever being anything but a ghost and have torn down their houses. In the case of



House of Bottles in Forgotten Rhyolite, Grim Reminder of Care-Free Confidence That Kept a Constant Flow of Money Circulating through Stores and Shops Now Marked by Naked Walls

the bank building, it was stripped of all woodwork, including floors, last year, and now it is the turn of the Overbury building, the other three-story edifice.

In the residence section of Rhyolite can still be seen the most perfect specimen of bottle house to be found in the west, a very elaborate affair considering the building material used. The walls are made of empty glass bottles laid in cement with their bases out, making an interesting monument to the roistering days of the wide-open mining town.

With authentic printed information unavailable, the stories of those who lived in Rhyolite at one time or another reveal that there never was any particular reason

for such a large community as Rhyolite once was except that it was a stock proposition. True, the Bullfrog mining district is known to be very highly mineralized, and produced some wonderful ore in small quantities, but not one mine was successful, most of them being total losses, for the simple reason that the rich lead which started the stampede, was badly faulted.

So it was confidence, or hope, that bolstered Rhyolite up, though from 1907 the population rapidly dwindled until in 1922 it had but one permanent resident, J. D. Lorraine, an aged Frenchman, ninety-two years of age, who died early in 1923, thus leaving the town without a single inhabi-

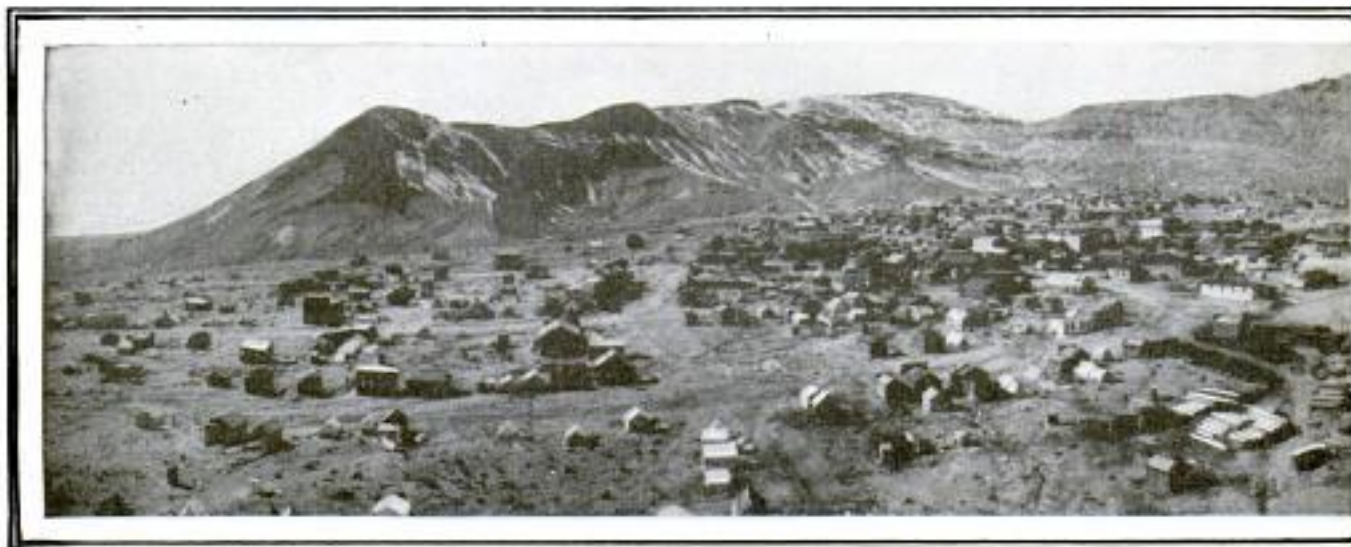

In 1905, This City of the West Lived on Hope, While Its Tireless Workers Feverishly Pierced the Rocks Below for Coveted Minerals That Promised Wealth and Success



Left to the Whims of Time and Weather, the Railroad Station That Welcomed the Hopeful Stranger Registers a Mute Record of Blasted Ambitions and Wrecked Fortunes

tant. In 1922, large numbers of buildings were intact and the aged resident, despite the weight of his years, was still confident that some day some prospector would locate the lost lead, and once again Rhyolite would teem with excitement.

Now, in 1925, the rapid decay is only too evident, much timber being salvaged and the main business street nothing but a memory suggesting, in many ways, a war-born town of 1918. With the exception of the bottle house, which is being maintained as a curiosity, and the station, which is so solidly built, Rhyolite will soon be nothing but a forgotten ruin in a great graveyard of mushroom cities that dot the west. Such is the story of scores of other once promising towns that rose over night on the sites of mythical mineral lodes, only to fade away under tangles of weeds and

dissolve into masses of debris and tumble-down shacks when leads were lost or petered out.

Up and down the whole range of the mining country are still to be seen traces of trails and highways once choked by frenzied gold and silver seekers in days long passed. The fever and excitement following a "find" always brought a motley army of traders, toilers, gamblers and adventurers to the scene, eager to risk their fortunes in the hope of emerging from the feverish contest in possession of great wealth. Now only mute, wind-swept ruins, blackened with age, remain to testify to the enterprises and industry of those who trudged the hills and sun-scorched deserts in the wake of hidden treasure, tempted by thoughts of early rewards in return for long hours of hard labor.

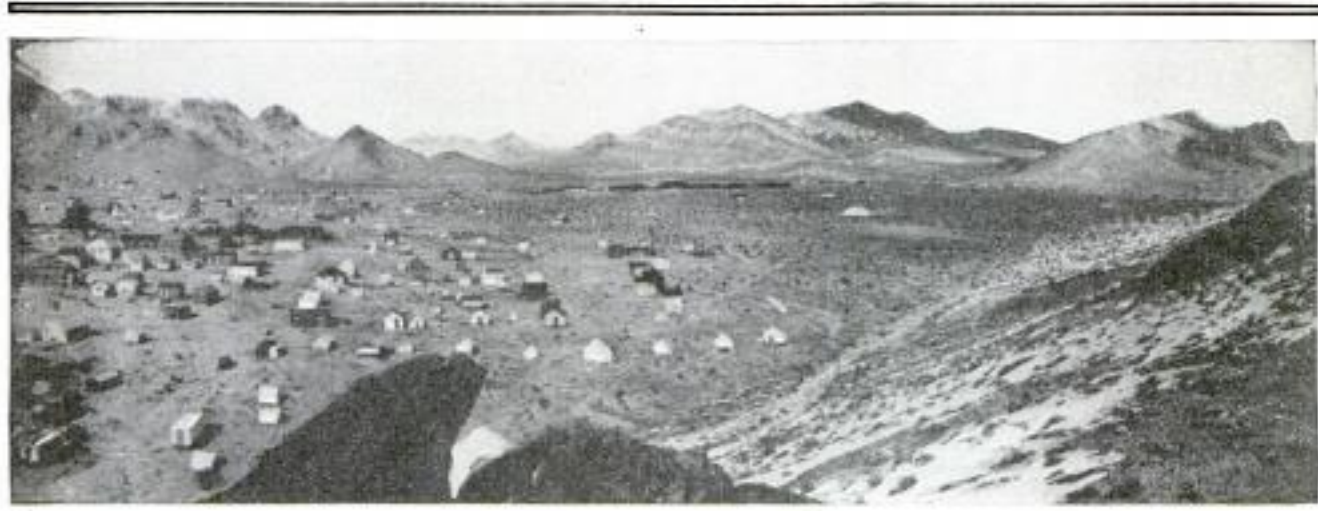

At First but a Scattered Community of Tents and Wooden Shacks Nestling under Surrounding Hills, Rapid Progress Replaced Ramshackles with Architecture of Brick and Stone

227 YOSEMITE MODELED IN CARDBOARD AND CLAY

With a jig saw, modeling tools made from the ivory of a mastodon, bits of cardboard and clay, Ansel F. Hall, chief naturalist of the national park service at Yosemite, has constructed a realistic reproduction of the famous valley,

ten by four and a half feet in size and showing practically every rise and depression molded to exact scale. The remarkable relief map is used to

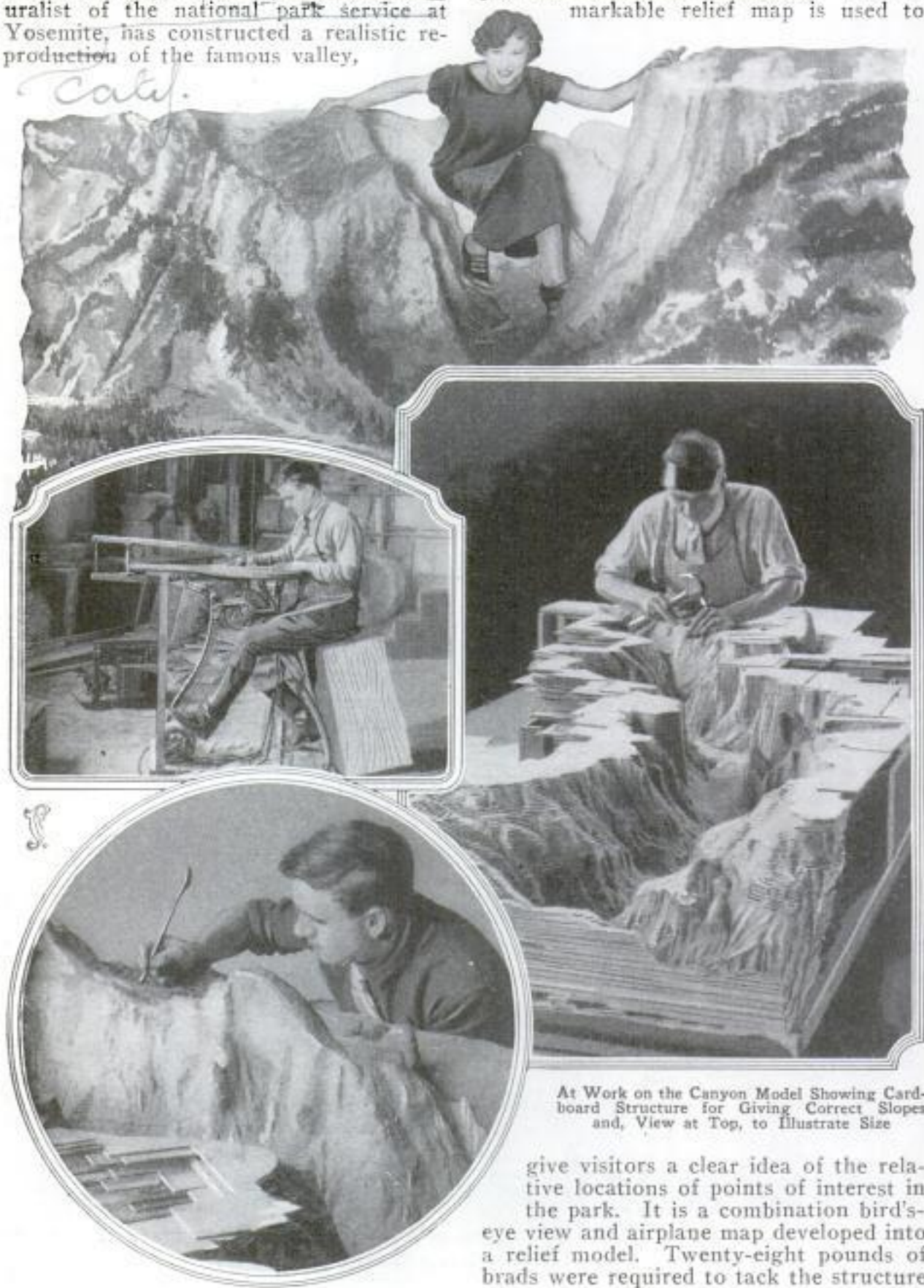

together, and 31,500 square feet of cardboard, cut up into hundreds of pieces, were used in making the foundation for the clay. The naturalist copied his model from contour and relief maps prepared by the government. Each layer of cardboard was cut to one-eighth of an inch in thickness and represented an actual rise of fifty feet in the ground. The strips were cut according to the contours shown on the surveyor's maps and spaced in like manner. The result was a series of cardboard "stair-steps" upon which the clay was spread and molded. For some of the finer details, actual photographs were used.

A. R. Cor
**Sleeper-Hammock Idea Is Traced
 to Indian Papoose Cases** *2011*

The mesh hammocks for wearing apparel seen in berths of Pullman sleeping cars are said to have been modeled from similar woven bags used by Ute Indian mothers to carry babies. It is claimed the inventor of the sleeper, while traveling in the west in 1878, saw many squaws with wool network cases in which the infants were comfortably transported. This material had been substituted for buckskin which had become scarce in certain sections of the country. A few months later, similar hammocklike bags were installed in the railroad coaches.

June 11/25/25 New York
**Automobile Bumper Fitted as Winch
 for Relieving Stalled Car** *2710*

Designed especially for districts where roads are bad, an automobile bumper equipped with a ratchet gear can be quickly changed into a winch for hauling the car out of mud holes and ditches. Without outside help, one man can easily handle the device and produce sufficient pull to move a heavy machine. A lever which fits the ratchet is carried inside the bumper beam, which also holds the rope, neatly reeled around the shaft. In case the car becomes fast in the mud, the cable can be thrown about a tree or post, and by winding it up on the bumper drag the vehicle to safety in a few minutes.



How Combination Auto Bumper and Winch Can Be Utilized to Relieve a Stalled Car

New York Times 10/25
**Writer Pens Six Hundred Words
 on Back of Postage Stamp** *2487*

Without the aid of magnifying glass and using a fine steel pen such as is employed by engravers, an eastern man has



Writer Holding Frame in Which He Has Mounted Stamp Inscribed with 600 Words

written 600 words in ink on the back of a postage stamp. He claims to have surpassed a previous record of an Italian penman who inscribed 11,000 words on a postal card, as the latter feat represents 575 words to the square inch, assuming that the card was of the ordinary size, while the postage-stamp feat necessitated copying the material, two of Lincoln's speeches, at the rate of 734 words to the square inch.

2600
Radio Tubes to Melt Steel

Masses of steel can be melted to white-hot liquid with the aid of tubes such as are used in wireless outfits, according to Dr. C. H. Desch, of the metallurgy university at Sheffield, Eng. Mills there are reported to be installing trial furnaces for testing the efficiency of the tubes in the manufacture of nickel alloys. It is planned to pass alternating current of 200 volts through them at extremely high frequency and then into the metal, which becomes hotter than the crucible containing it.

Cross-Word Pattern Handkerchief Designed for Puzzle Fans

One of the latest novelties arising from the cross-word-puzzle fad is a handker-

Checkerboard - Pattern Handkerchief That Reminds Cross-Word Puzzle Addicts of Their Favorite Sport



chief bearing a checkerboard pattern in the center, suggesting the arrangement of horizontal and vertical squares that perplex the word seekers. The large block of squares is inclosed in a border that further develops the puzzle pattern.

Tool Box Hidden in Step of Auto Locked by Car Door

To save trouble of displacing the seats of automobiles to reach tools needed in an emergency and to permit storage space for extra materials, a chest is now provided which can be placed under the running board. When the car door is opened,



Automobile Tool Box Installed under Step Which Locks with Closing of Car Door

a safety lock on the cover of the container is released, allowing a portion of the step to be raised and the box pulled out. The door can be closed again only after the tool holder has been properly replaced. The box is constructed to fit close under the tread board, so that the step forms a dust and waterproof cover.

Organ of Balance to Guide Airmen Resembles That of Human Ear

Risks of aviators losing their way in heavy fogs and dense darkness may be greatly reduced by aid of a control indicator which detects side slips and false turns of airplanes in flight. Fitted to the instrument board of the machine, the device instantly reveals by means of series of lights the slightest swerve from the straight course. This organ of balance is said to resemble the operation of the balance nerve of the human ear, which, though it immediately warns of any deflection of the body from the perpendicular, must have the assistance of the eyes for the person to estimate the angle of change. It is claimed that where no fixed object is available to the sight, such alterations from a determined course cannot be measured. To provide an indicating method, the control register has two rows of tiny lights which flash up to show the amount of bank or turn an airplane takes. Should the nose of the machine tip in either direction, a speed dial tells whether the rate of travel is increased or lessened, thus indicating upward or downward movement and guiding the pilot's use of elevating controls. The side-slip lamps are governed by a mercury tube and a gyroscope controls those to indicate turn. While the ship is flying a true course and maintaining proper balance, two white lights burn continuously, switching off immediately when the craft leaves the straight path; then colored lamps light up, from the center outward, to whichever side the plane may lean or swerve.

Yearly Cost of Smoke in Big Cities Nearly Eight Dollars per Person

According to the bureau of mines, smoke causes an annual loss of about \$7.66 for each man, woman and child in the larger industrial cities of this country. Philadelphia's yearly smoke bill is placed at \$16,852,000, and this loss, according to experts, could be prevented by the installation of modern stoking devices.

Wapeler Electric Co. (Long Island City, N.Y.)
162 Haverhill Ave.
No information

2447 - [unclear]

2444

3. [unclear] 2012

2556

1/27/28 Copyrighted material

2449

Reid Control Indicator -
 mfr. (?) Vickers, Ltd. Vickers
 POPULAR MECHANICS

633

House, Broadway, Westminster

S.W.1,
 London,
 Eng.

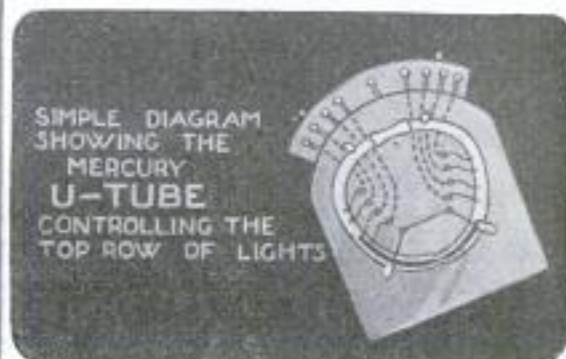
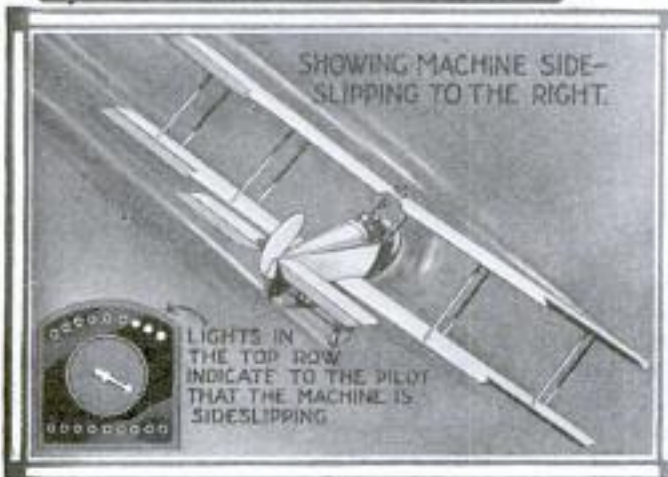
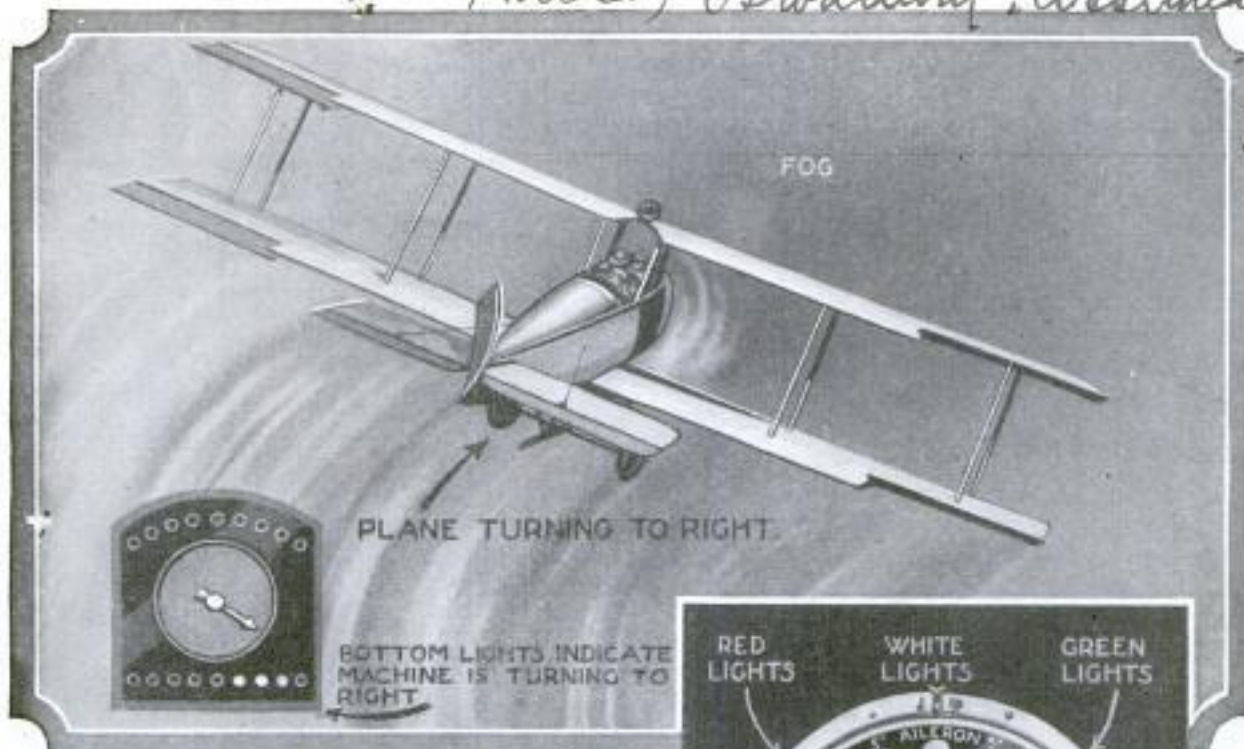

Copyright, The London Illustrated News

Explanatory Drawing of the Reid Control Indicator Which Resembles the Human Organ of Balance and Aids Airplane Pilots to Detect False Turns and Sideslips of Their Machines in Fogs

Copyrighted material

RACING LIGHT BEAMS UPHOLD EINSTEIN'S THEORY

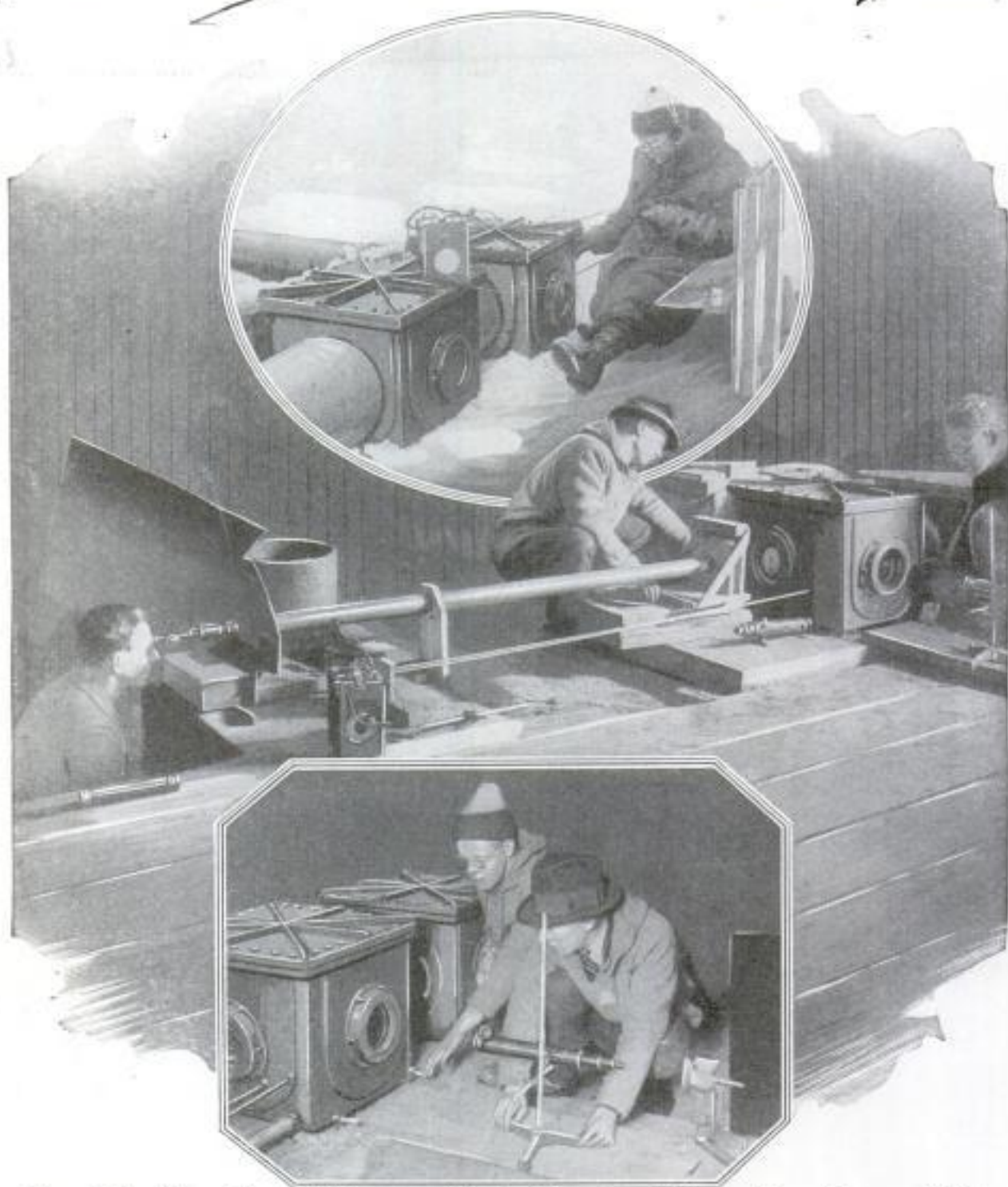

Views of Race Course, Observer's Telescope and Starting Mirror Box, in Center; Above, Assistant with Portable Telephones at Corner of Rectangle, and, Below, Adjusting First Mirror

BY sending small beams of light racing through 7,359 feet of water pipe laid out in the form of a rectangle, scientists of the University of Chicago, headed by Prof. Albert A. Michelson, have obtained further proof of Einstein's theory of relativity. The pipe was twelve inches in diameter and ninety-eight per cent of the air was exhausted so that the light beams would have less interference as they sped

along at 186,000 miles a second. At each corner of the rectangle, the pipes passed through boxes with mirrors so arranged that the beams were directed around the bends. At the starting point, a shaft of light from an electric arc was sent through a round window into one of the mirror boxes, where a glass directed one beam west and another south. The finish was at an observer's telescope arrangement just

a few feet from the starting point. The beams made a complete circuit of the "track," and as they "broke the tape" at the finish, they made curious fringes of alternate light and dark bands. By study of these, the observers were able to determine that the two beams did not arrive home together. There was a difference of a quarter of a fringe or one - two - hundred - thousandth of an inch. It was explained that since the southern side of the rectangle was nearer the equator, it was moving faster than the opposite side because the speed of the world's rotation increases toward its greatest circumference just as a wheel moves faster at the rim than it does at the hub. One of the beams passed through this more rapidly moving side and was going in the same direction that the earth is turning while the other beam was speeding through the slower side and against the earth's movement. The "running conditions" for the two beams, therefore, were not the same. Under the Einstein theory, light is regarded as having a uniform velocity in all directions, but in relation to the earth, it takes a beam longer to go counterclockwise than clockwise. This idea of relativity may be illustrated by a bird and a moving train. If both are going in the same direction and at exactly the same speed, the bird, in relation to the train will appear to a passenger as though it were merely flapping its wings without making an inch of progress. But a stationary observer by the right of way can see that both bird and train are moving, and he will also be able to detect any variations in their relative rate.



weather, concrete can be heated to from seventy to ninety degrees Fahrenheit while in the drum, it is said. At this temperature, it will remain warm for more than fifty hours after pouring. For thawing out



Portable Heater for Thawing Pipes, and Outfit Attached to Concrete Mixture with Flame Directed inside Drum

pipes, cars, switches and similar tasks, a portable torch that operates on the same principle as the concrete heater has been invented. It is also useful in construction work for melting ice and snow from forms, and both outfits are designed to eliminate costly delays in winter seasons.

Universal 2436

**Clock Inclosed in Table-Lamp Stand
— Is Easily Seen and Saves Room**

Two household necessities, a lamp and a clock, have been combined in one decorative article for the desk or library table. The clock is provided with an alarm and silencer, and is so placed that the rays from the light above illumine its face. The stand is of bronze, the shade is trimmed with colors to harmonize, and eight feet of silk-covered cord for insertion into a wall socket are included in the outfit. The idea, said to have originated with a woman, saves table and mantel space.



The idea, said to have originated with a woman, saves table and mantel space.

The idea, said to have originated with a woman, saves table and mantel space.

**Oil Heaters for Concrete Mixing
Prevent Delays in Winter**

Kerosene heaters that shoot a hot, steady flame directly into the concrete mixer while it is turning, have been devised for winter construction work to keep the material in working condition and prevent freezing. A pressure tank operated by a hand pump keeps a constant supply of fuel flowing to the nozzle and forces the flames into the mixer. Even in zero

2531

*Derris, Turner Co
Hudson Ave. 2nd Floor
Hudson, N.J.*

*The International Transportation Co. Supply, N.Y.
2903 Main St.*

Getting the Radio News by Telephone



Concert and Opera Stars in Distant Cities Can Be Brought Home by Telephone; Connecting Land Wires from Other Cities to Local Broadcasting Stations, Center, and, at Bottom, the Radio Station



and fifty loud speakers are connected in Fredonia, while ten miles of iron wire to Altoona is connected in the latter town with forty more.

The telephone-radio system has been growing steadily since January, 1922, when J. A. Gustafson, general manager of the telephone company, purchased a radio-receiving outfit and placed it in his office, with a circuit to a jack on the telephone switchboard. Announcement was then made that any subscriber could call central and be connected with the far-distant broadcasting stations.

Enterprising store owners quickly installed a number of headsets and let their customers listen in. The novelty spread so fast that several merchants asked for loud-speaker service. Gustafson said it was practical, but would

HEARING the best of the middle-western broadcasting stations without even the expense of investing in a receiving set is possible in Fredonia and Altoona, Kans., since the Fredonia telephone company linked wireless with its phone service. Any telephone subscriber can listen in at any time by simply calling the operator and asking to be connected with the radio. The telephone company has even equipped the telephones with headsets so the listener can sit back at ease. There is no charge for the service.

For those who want family radio, the telephone company supplies special wires from the amplifying unit of the receiving set, connected to loud speakers in the subscriber's home or store. Two hundred

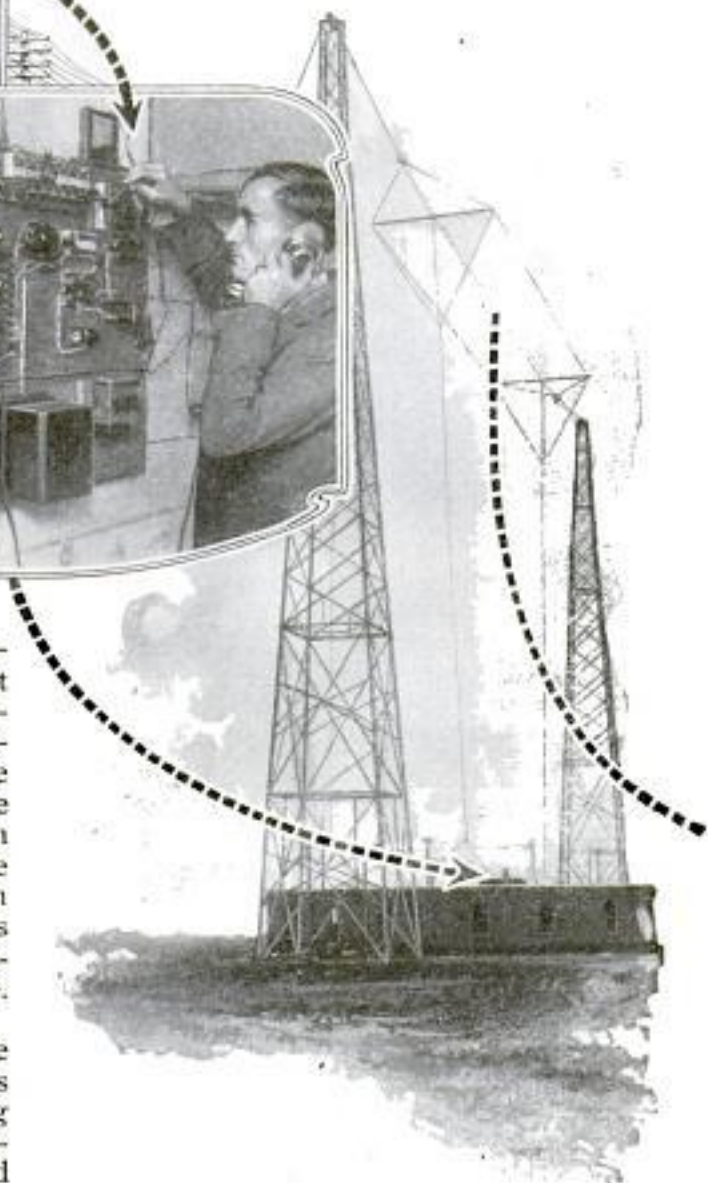

require a special circuit direct from the radio amplifier. Arrangements were made to install the special wires and loud speakers on the same basis as ordinary phone rates. As a result several of the two hundred and ninety homes in the two towns which now have loud-speaker service do not and never have had telephones. They subscribed for radio where they had never cared to have an ordinary phone.

When the first summer of the new service arrived, static frequently interfered with clear reception, so the telephone company bought a microphone and gave local programs when outside broadcasting was not available.

Fredonia ministers quickly saw the value of the microphone, and now a Fredonia church service is sent out by telephone every Sunday morning. Radio does not figure in this service at all, the church service coming through the microphone to the telephone switchboard, and going out through the power amplifiers to the subscribers.

Next, Walter Camp's daily dozen exercises were added to the service, being sent out each morning, then the Wednesday evening chapel services at the high school, and finally all local announcements of general interest were put on the wires. "As a local proposition," says Gustafson, "a system such as we have is a valuable asset to the city. It is different than having a radio set. On this system all can be cut in without any effort on

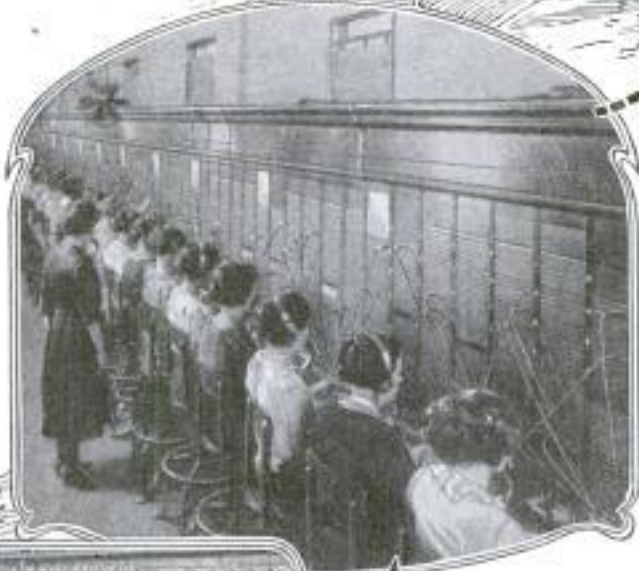

Radio Operator in Fredonia Telephone Office, at Bottom, Tuning in for Phone Subscribers; a City Switchboard, Center, and, at Top, Gov. Ben Paulen, of Kansas, Getting His Election Returns in His Home by Telephone-Radio



their part. With a regular radio set only part of the owners will be tuned in, and then only at the regular hours of broadcasting. With this system they can all be cut in and get all that is put on. It would not even be necessary for us to receive radio from the air, as enough local uses can be found to make the service valuable to the users. If all homes were connected to such a system its benefits would be unlimited. By talking into a single microphone every home could be reached! Think of the educational

opportunity! We would all be as one family gathered around the fireplace.

"As to our equipment: A standard-make receiving set is used and connected to Western Electric power amplifiers. Each power amplifier will operate about seventy-five loud speakers. The input of the amplifiers is connected to the output of the receiving set in multiple. Wires in our regular telephone cable are used for this service. Two wires are run from the cable terminals to a house and the loud speaker connected; at the office end the cable pairs are run to the output of the amplifiers; standard telephone repeating coils are used with each amplifier to divide the number of pairs so as to help overcome the loss from the capacity of the cables."

The service is so effective for broadcasting sporting and election results that on election night last fall, Ben S. Paulen, who was the successful candidate for governor, sat at home with his wife and heard the returns come in, broadcast from Kansas City, picked up at the telephone exchange in Fredonia, and delivered to his home over the loud speaker.

The telephone-radio service has also displaced the ticker in cigar stores as a means of getting the returns on sporting

events. A loud speaker on the counter gives the results to the crowd at the same time the boy at the blackboard posts them.

The telephone company has trained girls as radio operators and they follow the broadcasting programs, pick up the best of those available and keep the set in tune. They also operate the local microphone and make the necessary radio announcements from time to time.

Fredonia and Altoona stand alone as towns where scores of radio fans always listen to the same stations and hear the same things. To the dyed-in-the-wool fan the inability to tune in another station at will would appear to be the chief drawback to the telephone wireless system. Searching for "DX" is an unknown pastime. On the other hand there are no batteries to buy and keep up, no tubes to replace, no aerial to erect and none of the other expenses or vexations of being a radio owner.

The Fredonia system is spreading to some other communities, and likewise is proving popular in large hotels. A Philadelphia hotel has provided similar radiophone service for every room. To listen to what the wild air waves are saying, the guest calls the hotel switchboard by telephone and is connected to the radio.



The Crowd in a Fredonia Cigar Store Listening to Football Returns Broadcast from a Distant City and Received at the Loud Speaker by Telephone from the Central Office

Tame Horses Trained to Be Wild for Rough-Rider Contests

Training horses to be wild is now a craft followed by many ranchers of Texas who find it impossible to supply the demands of circuses and rodeos for "outlaw" animals from the free herds. Cowboys employed for the purpose use the familiar method of "confidencing" a pony to convert it into a bucking bronco. This consists in faking falls from the saddle each time the beast shows the least spirit. In a short time the horse becomes more unruly, until it resorts to rough tactics in order to unseat the rider. With repeated rehearsals, the mustang usually assumes a fierceness equaling that of its wildest brothers of the open plains. When it has been tested by expert horse-breakers and found to be a real outlaw bronco, the once peaceful pony is trussed up, much against its will, and shipped to the market, where high prices are gladly paid by purchasers for such animals.

Geyser Harnessed to Steam Pipes to Turn Electric Dynamos

Natural steam, generated hundreds of feet below the surface, has been harnessed with 200 feet of eight-inch water pipe and the skill of engineers, to turn a thirty-five-kilowatt turbine generator near Healdsburg, Calif. The vapor issues from crevices in the rock of what is called Devil's Gulch, and the subterranean "boiler house" is believed to be a tremendous mass of molten lava beneath strata of spongy formations that allow water to trickle through from the top and reappear as steam. Tests are reported to have shown that there are few impurities, a steady flow at from sixty to seventy pounds' pressure is maintained, with a temperature at the nozzles of 335 degrees Fahrenheit. The pioneer who first attempted to harness the geyser suffered many hardships. He sunk two shafts after a number of explosions had imperiled his life, blowing mud

and rocks 200 feet in the air. One drawback to complete success of the experiment is that various gases, although found in only small amounts, damage the generators. This is said to be the chief diffi-



Roaring Up from Natural Boiler Below, Steam Is Trapped in These Pipes to Turn Dynamos

culty in a similar plant in Italy, where the steam from an old volcano bed is so mixed with vapors injurious to metal that it is used only to heat other water for making steam for the turbines. Engineers are now trying to design machinery that will not be damaged by these gases.

Air-Tight Tins for Auto Tubes Hold Gas That Preserves Rubber

Folded within hermetically sealed tin containers, inner tubes now being supplied by a western company are packed in a



kind of gas which is said to preserve the rubber indefinitely. Moisture is entirely excluded, the tube is prevented from becoming hard and dry in high temperatures, and

hollow paper cylinders are inserted in the loops of the tube to obviate kinking and cracking.

Used in... 22.3' W. 50' py... material

Armor Needed by Modern Workers Rivals That of Feudal Knights

Protective armor as elaborate as any worn by knights of old is now used by industrial workers who face the hazards of furnace flames, dust and gases



Samples of Worker's Armor, Sand-Blaster's Helmet and Furnace Togs

about one and one-half per cent of its weight in one year's handling; hoarding swallows up uncounted millions yearly, especially among primitive races, and vast amounts are lost in fires, shipwrecks and in similar ways. Although the value of gold has long been fixed at \$20.67 an ounce by the government, its purchasing power at present is only about sixty per cent of what it was before the war, and for that reason, gold mining has fallen off in this country because of the high cost of operations. The annual production of the mines of the world is placed at approximately \$370,000,000. Gold bullion priced at \$2,501,000,000 was on deposit in the

vaults of the United States assay office last year. Incoming alloyed gold is put through several refining processes which sometimes yield as much as 1,500 ounces of platinum, quoted at from \$250 to \$300 an ounce. This is "velvet" for the government.

Pneumatic Railroad-Track Greaser Reduces Waste and Work

Inner flanges of rails at curves are greased thoroughly and with considerably less waste and work than with a stick, by using a pneumatic implement a western company has devised. It applies grease, oil or compound



in proper amounts, and in exactly the places where it is needed, by simply holding it against the rail and pressing down with the handle. The flow is shut off automatically as soon as the holder is raised. A shoe which slides on the rail facilitates the task and helps regulate the quantity of lubricant allowed to reach the inside. The time required for the work is also reduced and this is an aid to safety as well as a saving in money.

unknown to toilers only a few years ago. Sandblasting, for instance, has developed a helmet of heavy material, fitting entirely over the head with a window for the eyes and a tightly screened breathing opening. Electrical workers on certain tasks wear rubber suits to guard against deadly shocks; more than twenty different kinds of gas masks are in use in industry today; some fifty varieties of goggles, and leather aprons, suits and gloves are worn in tending some kinds of blast furnaces.

One-Fourth of Gold Mined Used for Making Coins

What becomes of all the gold mined throughout the world is a query that frequently arises. About one-fourth of the annual production, it is estimated, is used by civilized peoples for coins. Much of the remainder is consumed by industrial arts; waste through wear is another source of loss, a five-dollar gold piece losing

24
w.
Refer to George S. Johnston Co. 835
Washington Blvd., Chicago.
R. W. King Optical Co.
Cleveland, Ohio.

Chicago
1/19/25

Econom. Machine Co.
Es. 1570
Chicago. \$16.00

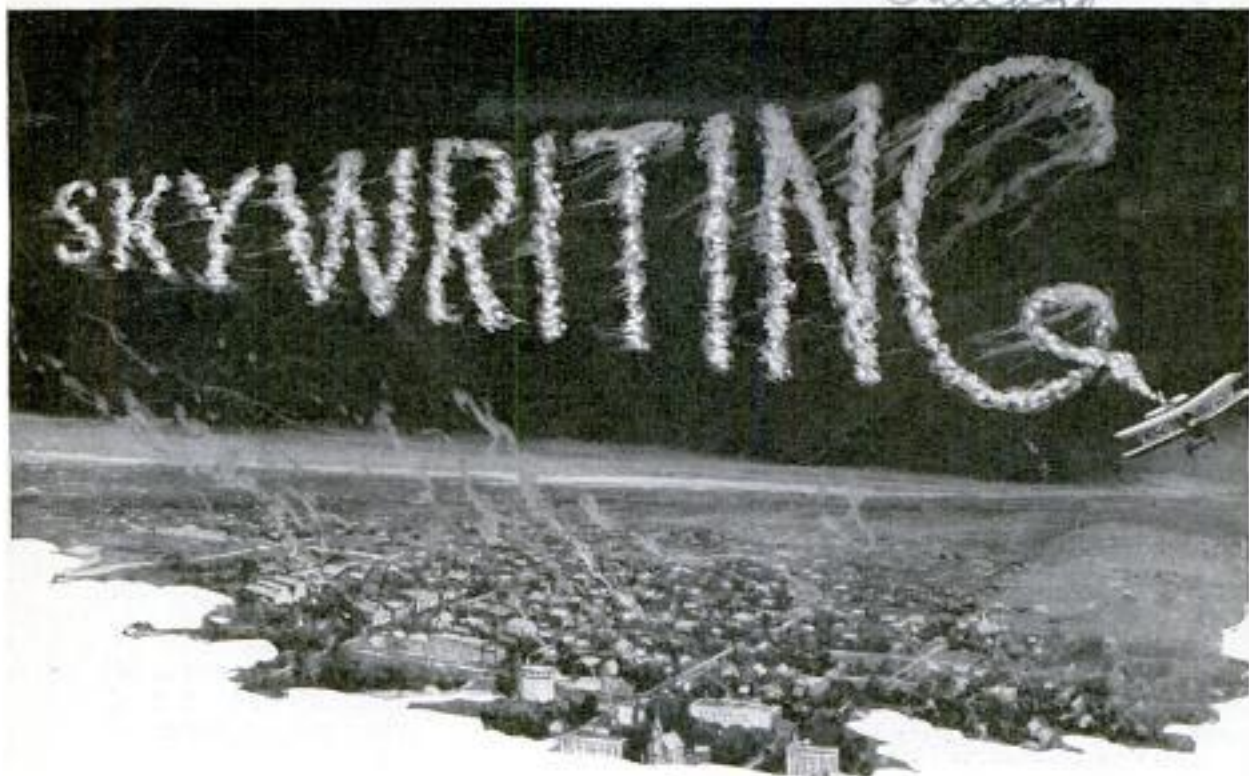

Aerial Penmen Spread Mile-High Words Across the Heavens from Specially Designed Planes Bearing Smoke-Making Equipment

WRITING messages in smoke two miles above the earth, where everybody for 150 square miles around may read them, is one of the novel after-the-war occupations which grew out of military needs.

Designed primarily to throw an aerial smoke screen around ships at sea or troops on land, the war-time smoke apparatus was left idle when peace came, until Maj. John C. Savage, a Royal Flying Corps aviator, conceived the idea of using it to write advertising messages in the sky. Capt. Cyril Turner, on Nov. 28, 1922, wrote "Hello, U. S. A." two miles above the statue of Liberty, and the new business was born in America. The next day he went up again in a seventy-five mile gale and twisted and looped through space to leave a gigantic scrawl across the heavens: "Call Vanderbilt 7100." That was the telephone number of the flyer's hotel and within a few hours orders had been booked for the initial commercial flights, at \$1,000 per flight.

The airplanes used for skywriting are specially built scoutplanes, capable of making a speed of slightly more than two miles a minute. The smoke-carrying ships must have great power, unusual climbing qualities and the ability to be maneuvered rapidly at a height of 10,000

feet without losing altitude. The scout machines have all those qualities and, in addition, are built to a safety factor of eight—eight times as strong as needed to withstand the terrific strains of sharp turns, giddy loops and swooping glides encountered in their work.

Elaborate equipment is necessary to carry out the work of skywriting. The plane carries a load of 2,000 pounds with its intricate smoke-producing gear and the chemicals to make the smoke. Writing is never attempted until an altitude of at least 10,000 feet is reached, in order to insure space in which to glide to a landing field, in event of engine trouble over a crowded city, and likewise because steadier air currents are found at that height. Irregularities in the air, puffs and holes are hard on smoke-written signs, and may, if encountered, dissipate the letters almost as fast as the plane can make them.

In an ordinary airplane of the type used by the aerial penmen, the instrument board is cluttered up with some fifteen controls and recording devices, all of which must be watched by the flyer. Added to these usual instruments, the skywriter has a half dozen dials, levers and indicators, controlling his smoke gear, and besides watching both sets of instruments, he likewise must concentrate on

Skywriting Corp. 608 E. 4th St. New York City

Ed. A. S.

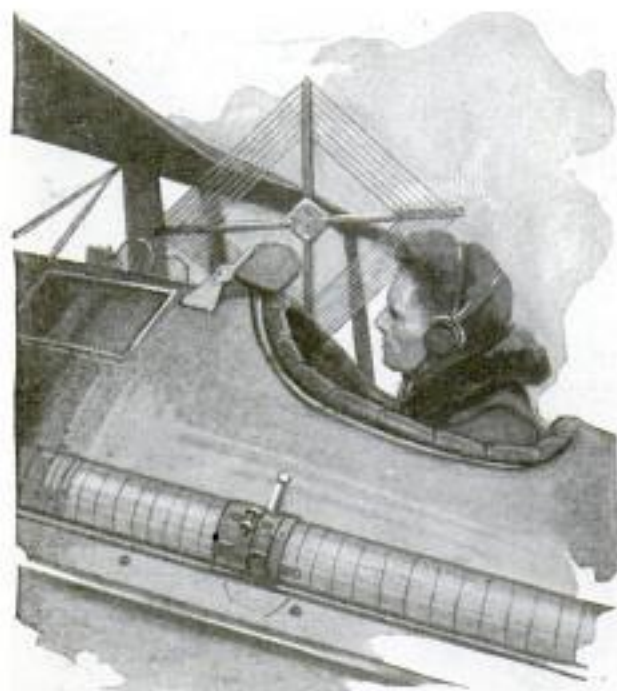

Skywriting Flyer in His Plane with Aerial Set to Receive Instructions from the Ground

the task of spelling his message by maneuvering the plane through space in the intricate formations of spelling — and spelling backward at that, since most sky messages are written that way. There is no chance of correcting an error when going two miles a minute, no going back with an eraser to rub out a smoke column which is already slowly drifting away before the breeze. Once started, the message must be written to a finish without a stop.

Dashing here and there through the air, the plane emits its smoke column at the rate of 250,000 cubic feet a second. In one minute it covers two miles and leaves behind 15,000,000 cubic feet of smoky letters. The best smoke for the purpose is a Persian orange in color. The skywriters hope soon to be able to send up a fleet of three planes and produce an American flag in three colors of smoke. The pilots who qualify for the writing

jobs are all picked men, most of whom made brilliant records during the war. Before a flyer can qualify as an aerial billposter, he is put through a rigorous examination which ranges from mental acquirments to physical tests, and the examinations are repeated at frequent intervals. Besides proving ability as a pilot, he is required to show broad knowledge of navigation and meteorology, of flying by dead reckoning and must be familiar with map reading and general air-traffic rules. His physical examination starts with a lung test with the familiar machine by which lung power is measured by the ability to blow through a rubber tube and lift a weight a certain distance. During the medical examination, a revolver is fired behind his back at irregular intervals to test his nerves, and then he is put to bed in a contraption charged with electricity, while a machine records what has transpired within his heart and other body parts during the experiment as the current is turned on and off. Heart action is registered and respiration studied by the medical examiner before the applicant is finally passed. Altogether these tests consume about three hours.

Maj. Jack Savage, Inventor of Skywriting, Talking to One of His Aviators, 10,000 Feet Above, from a Portable Radio Set



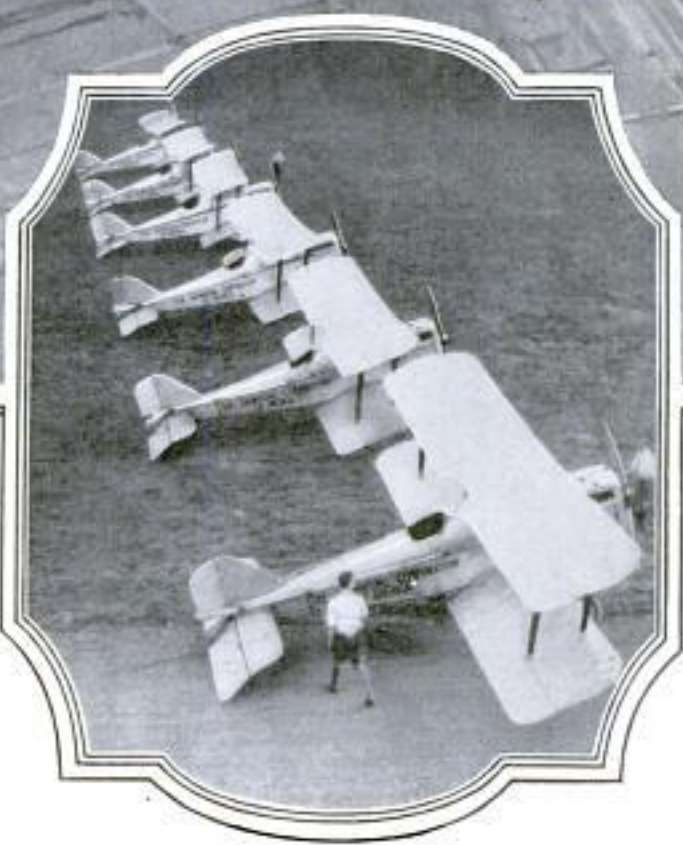

© Fairchild Aerial Camera Co.

Skywriting in Morse Code, (Inset at Top); a Remarkable Aerial Picture of Three Skywriting Airplanes Flying in Formation While Leaving a Trail of Smoke along Their Course, Center; and, at Right, a Fleet of Six of the Aerial Penmen Preparing to Leave the Flying Field at Garden City, Long Island, to Address a Few Aerial Messages to New Yorkers; the Morse-Code Experiment is of Particular Interest to Army Officers Who See in It a Quick and Certain Way of Communicating with Large Bodies of Troops in the Field without the Delay Which Would Follow Transmission of Intelligence by Radio and Its Delivery by Messengers to Each Unit

Scott & Cross, Inc.
 James O'Leary
 644
 New York City

POPULAR MECHANICS

Hydraulic Oil Jack for Automobiles
 Is Worked like Pump

The principle of hydraulic pressure has been applied to an automobile jack that lifts heavy machines with little effort from

Heavy Automobile Can Be Lifted by Child with Long-Handled Pump Jack That Uses Oil as Working Medium



the operator, prevents sudden jars and drops, and affords constant control by simply opening and closing a valve. Oil is forced against a plunger by working the jack handle with a pumping motion. To lower the car, the handle is removed and placed over the valve at the base. By a turn to the left, the oil is released from the plunger chamber and the weight of the car forces it back to the reservoir. Closing the valve halts the car at any desired point.

National Museum for Industries
 to Honor Inventors

As a monument to the nation's inventors and to preserve a record of America's progress in industry and engineering, a huge museum is to be erected in Washington, D. C. It will cost \$4,500,000, have floor space of twenty-seven acres, and a fund of \$5,500,000 is planned as an endowment and to pay for installing the exhibits. To further the project, a corporation composed of representative Americans in the industries and professions already has been formed, and after a year's study of foreign museums, an architect has drafted plans for the building. It will be of Greek design, will occupy a prominent position on the Mall, and provision is made for large storage and workrooms besides the

exhibit areas. A great central rotunda will be designated as the "National Hall of Fame for Engineers, Inventors and Industrialists" wherein busts of famous men will be placed. Relics and inventions now in government departments as well as many in the possession of private companies will be displayed in the museum. Where original models or patterns cannot be obtained, replicas, drawings and illustrations will be used to fill the gaps, so that the exhibits will record not only the growth of American industry but, by comparative displays, will show how various inventions have been developed in other countries. It is planned to have the museum depict the complete story of man's industrial achievements wherever he has labored. Establishment of branch museums in the larger cities, privately endowed and supported, is contemplated.

One-Cup Coffee Percolator Brews
 with Boiling Water Only

To make but a single cup of coffee at a time, a fireless percolator is being manufactured which needs no heat, other than that of boiling-hot water to perform its work. No larger than an ordinary saucer, the utensil requires but a few minutes to brew the liquid. It is of special convenience where only one or two persons are to be served, saving the time and labor necessary to prepare a large pot. Steaming water is poured into the bowl and passed through



Fireless Percolator That Brews Coffee with No Heat Other than That of Boiling Water

finely ground coffee. A filter paper strains the fluid as it drips through the perforated bottom.

The Ericator Co.
 No. 99 Water St.
 New York

2248.
 2-ton capacity
 \$12.00 to 10-ton
 \$20.00 to \$30.00
 \$10-ton

2440

Detroit, Mich.

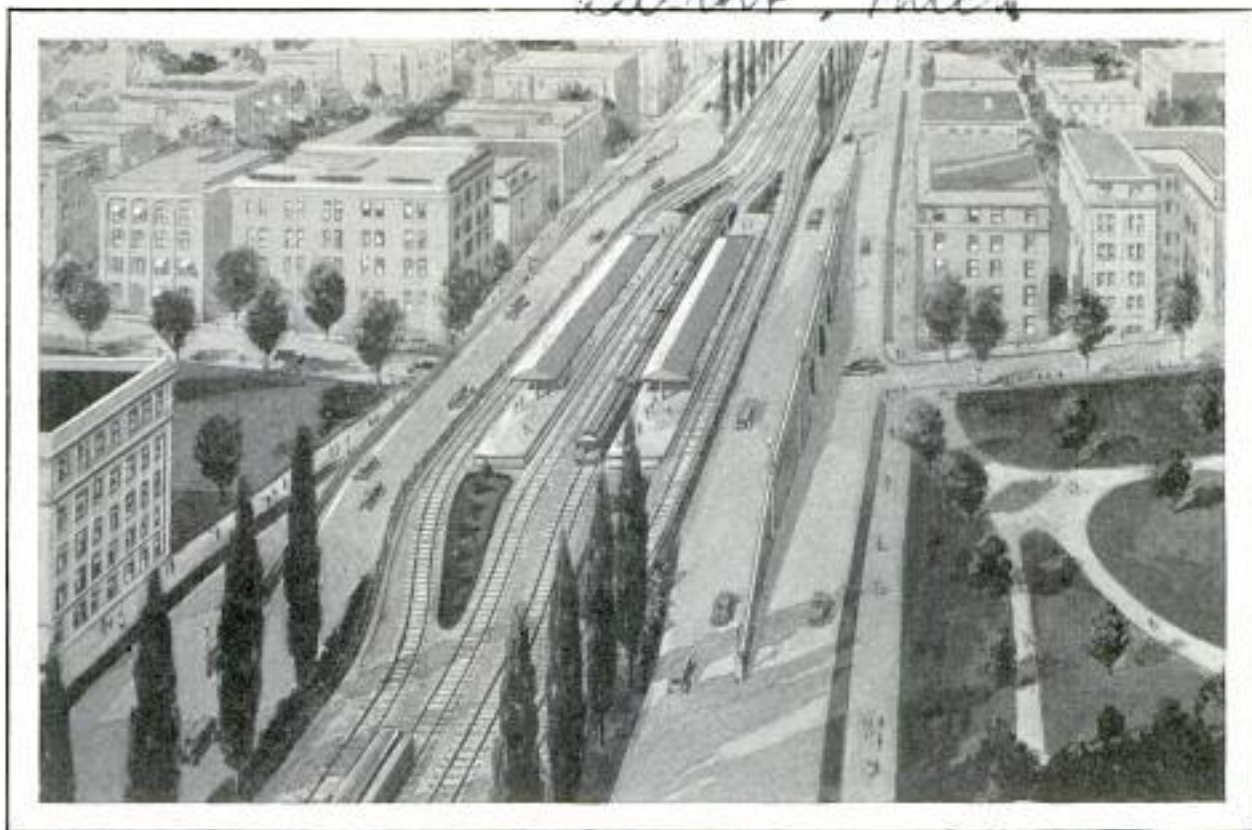

Type of Super-Highway Planned for Detroit, Showing Method of Carrying Express and Through Traffic Overhead at Street Intersections, Where Only Local Vehicle Lanes Connect with Cross Thoroughfares

²⁴²⁶
Super-Highways to Relieve Traffic and Hasten Travel in Detroit

In an effort to relieve present congested traffic conditions and also to provide sufficient travel arteries to care for the community's growth in the next quarter of a century, the city of Detroit is constructing a system of super-highways that will accommodate both electric railways and motor vehicles. On the roads, it is expected a speed of thirty-five miles an hour can be maintained by through traffic at all times and that, on trips now requiring an hour to make, less than twenty-five minutes will be consumed with either automobile or electric car. Twelve travel lanes will compose the road. Four of these will be devoted to tracks for the railway service, and the other eight will be evenly divided between local and through automobile traffic. At intersections with cross streets, only the local lanes of the highway will be built on the level, the express lanes passing over the crossings on raised roadbeds, pierced by archways to permit the intersecting thoroughfares to continue through. All local traffic will be kept in the outside lanes so it can turn off to the street levels where change of direction is to be made. An automatic signal system will control travel at the crossings on the street levels. Where the lim-

its of space will not permit the planned 204-foot width of the highway, the tracks of the railway will be carried underneath by subways, rising to the surface when the road becomes wider. In all, the system is expected to contain 217 miles of highways divided into parallels and radials connected and linked up by a series of circular streets. In this way the city will be divided into areas about three miles square, each bounded on four sides by the super-traffic lanes.

Auto Cigar Lighter and Spotlight 2232 Are Combined in One

Utility of the electric cigar-lighter attachment is practically doubled by the addition of a twelve-foot extension cord, equipped with a detachable bulb that may be slipped into place and used as a trouble lamp for inspecting the car at night. A bracket, placed on the instrument board near the lighter, holds the flashlight when it is not needed, and an ash receiver for the "electric match" box is added if desired.



(Prices in file)

The Euro Engineering Corp., Meriden, Conn.

Copyrighted material

Time and Money-Saving Tools

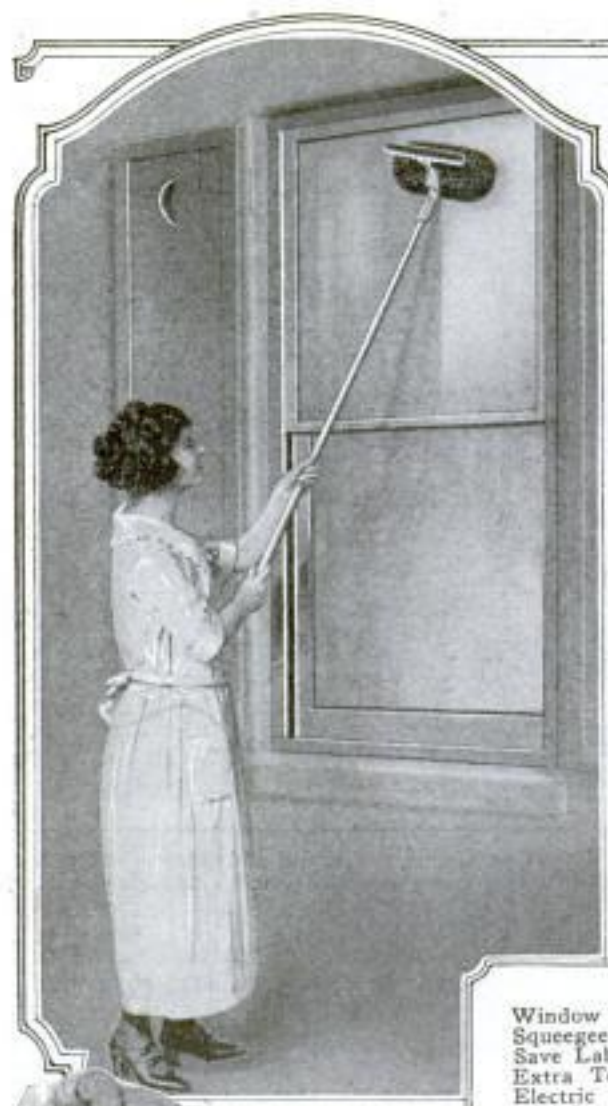

Rotary Cutter Removes
Green Corn from Cobs
Quickly and Easily

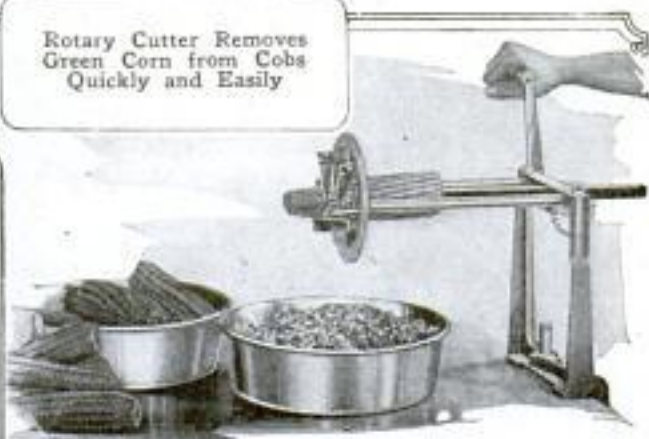

Base for Pots Catches Drrippings and
Keeps Stove Clean



This Whisk
Broom Rotates
in Socket to
Help Get Rid
of Dirt

Window Brush and
Squeegee Combined
Save Labor and Cost of
Extra Tools; Below,
Electric Cabinet for
Light Housekeeping
That Looks
like Phonograph
When Closed



Sanitary Sugar
Shaker with
Rubber Base to
Protect Table



Metal Clothes Hanger
with Six Arms for
Small Space

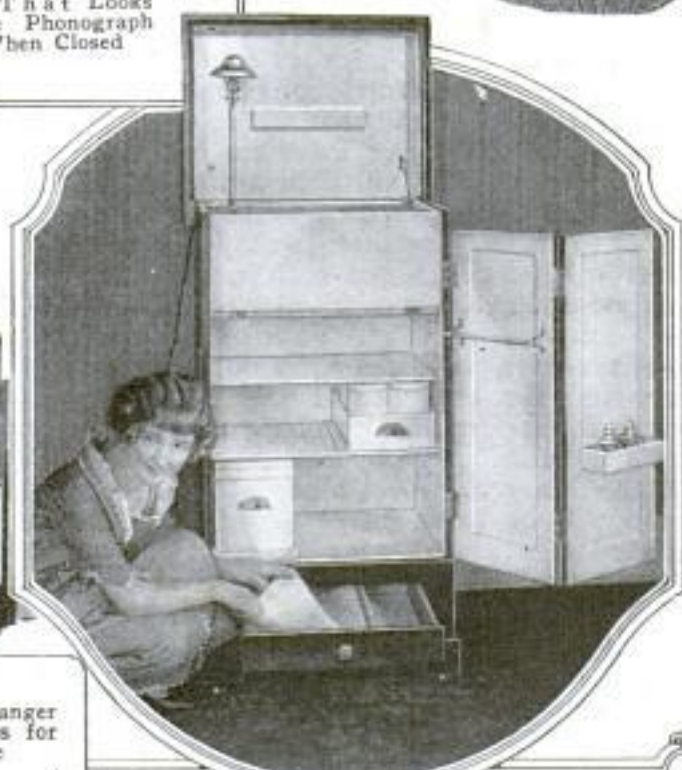

Anyone wishing further information on devices described in the editorial pages can

for Woman's Workshop in Home

Pies Cannot Burn in
Asbestos-Lined Pan

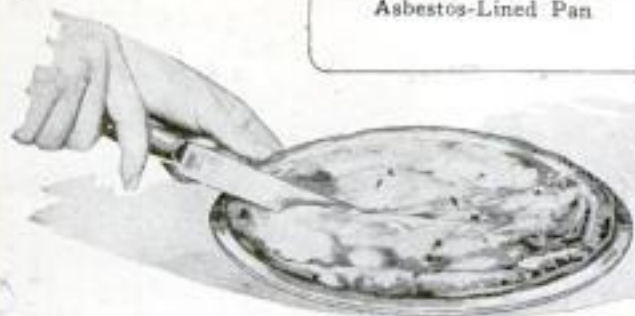

Snapped on the
Faucet, Hook
Helps Hold Pans
for Filling and
Leaves One
Hand Free

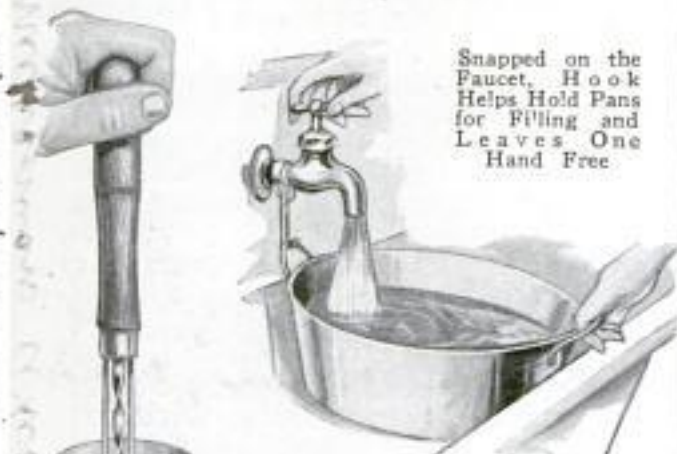

Egg Beater Whips
Them in Ordinary
Tumbler



Washbowl and Shelf
for Any Room Are Entirely
Concealed by Panel Mir-
ror That Slides Down
over Them; Below, at
Left, Is Steam-Cooking
Cabinet Big Enough to
Hold a Whole Meal at
One Time



Glass Cutter, Knife and Scissors Sharpener,
and Can Opener Combined in One



Thirty-Inch Folding
Ironing Board Fits
the Suitcase



obtain it by addressing Bureau of Information, Popular Mechanics Magazine, Chicago.

Originator Dr. J. E. Mackenty
 648 *911 E. 66 St. N.Y.C.*
 POPULAR MECHANICS

Artificial Larynx Restores Speech to Persons Mute from Cancer

Victims of cancer who have been rendered mute by the removal of the larynx



Artificial Larynx in Use, Vibrator in Hand and Tube Leading to Throat Aperture

or other persons who have suffered the loss of this organ of speech through an operation, are now able to talk again with the aid of an artificial larynx devised by Dr. J. E. Mackenty of New York. The instrument consists of a pad strapped over the aperture cut in the patient's throat after an operation for cancer to enable him to breathe, and a rubber tube leading from this opening to a vibrator device shaped somewhat like the bowl of a pipe. This, in turn, is connected with a shorter tube which is held in the mouth. In operation, air passes from the lungs into the vibrator and thence to the mouth where the sound is modulated just as though it had been produced in the normal manner. A test of the laboratory-made larynx showed that persons were easily understood in an ordinary room although they spoke only in a monotone. The invention already has proved a boon to

Developed by scientists of Westinghouse Electric Co. 463 West 41st St. New York.

several persons deprived of the power of speech by operations and has been developed wholly in the interests of science and the welfare of patients.

Richard S. Jackson,

Dahlia Roots as Source of Sugar Seen as Rival to Cane

Scientists are reported to have discovered that there is a cheap and easily acquired sugar supply in the roots of the garden dahlia. The plant is said to store up large quantities of levulose, one of the sweetest and most nutritious members of the sugar group, in the form of inulin, a starchy substance that can be extracted by filtering and treating the juice from the roots. They have been found to contain from ten to fourteen per cent of this material, which is also present in the Jerusalem artichoke. Both of these plants can be made to produce from ten to twenty tons of tubers to the acre.

Portable Electric Heater with Fan Keeps Air in Circulation

Proper circulation of the air as well as a comfortable amount of warmth are claimed for a portable electric heater now on the market. It contains a small fan which draws the air in at the top and expels it through side vents after it has been warmed over heating elements that have a range of from 150 to 165°. Weighing only eighteen pounds and but twenty-one inches high, the heater is attractively made of burnished bronze and is operated either with direct or alternating current supplied from a wall or light socket. Burned steadily, it consumes 485 watts per hour. The coils are so constructed that they do not become red-hot. This keeps the outside from being overheated, preventing burns or fires and making the heater safe even with children about. Larger sizes are made for apartments or small cottages, or for installation in homes up to ten rooms.



Cross-Section Diagram Showing Heating Elements and Fan That Keeps Air in Circulation

The Range Electric Hot Air Furnace Co. Copyrighted material

Scientific American



Finding That Blown Fuse

By E. R. HAAN

WHAT do you do when a fuse blows out? Can you go down into the basement and find the blown fuse at once, or must you laboriously screw out fuse after fuse until you find the right one? The latter is no easy job, as nearly anyone who lives in an apartment house has found by sad experience. It is an easy matter to find a blown fuse, however, if

one goes about the job in the proper way. All that is required is a simple test lamp which can be made in a few moments.

The method of testing a simple fuse block having two screw-plug fuses is shown in Fig. 1. The wires coming in from above represent the supply line and the wires below represent the circuit line. The tips of the test lamp are first touched on ter-

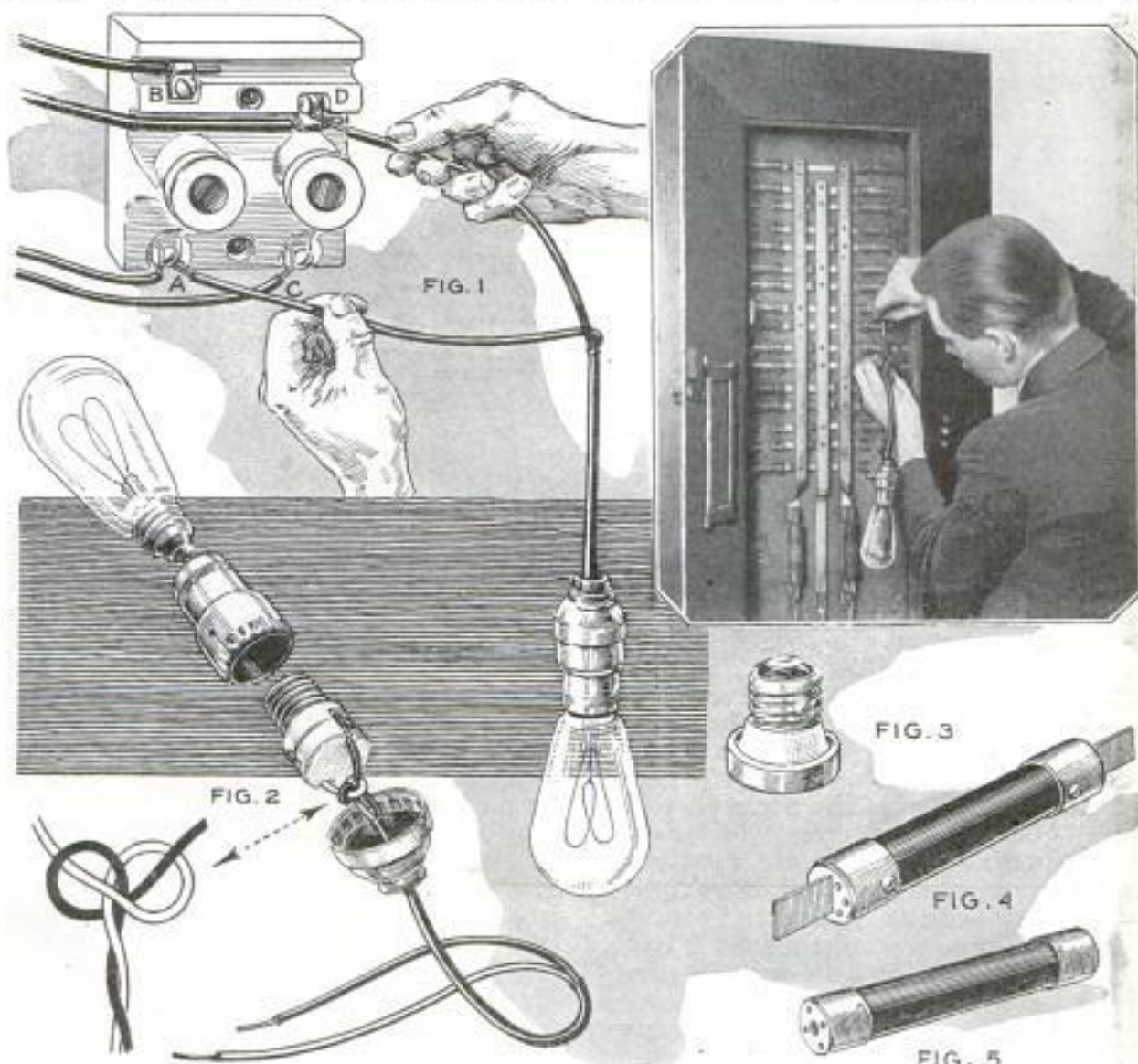

With This Homemade Test Lamp Anyone Can Find Blown Fuses No Matter How Complicated the Fuse Panel May Seem, Eliminating the Expense of Calling an Electrician for Such Simple Jobs

minals A and D to test the left-hand fuse. If the test lamp does not light this fuse is the one that is blown. But if the lamp lights the fuse is in good condition, so

the right-hand fuse is tested by touching the cord tips to terminals B and C. The symptoms just described will also indicate the condition of this fuse. Perhaps the lamp will not light in either case, and this proves that both fuses are blown. The test lamp can be made by anyone from a short length of lamp-cord, a socket and a lamp. The socket is first taken apart by pressing on the shell at the points where it is marked and removing the cap, which is then slipped over the end of the cord. Before baring the ends of the wire a knot of the type shown in the detail is made in it, as

in Fig. 2, to prevent the cord from being pulled out easily. The ends are then bared and connected to the two terminals. The stranded wire should first be twisted together between the fingers and then wound around the screw shank once, in the same direction as the screw is tightened, otherwise the screw will tend to force it out. The parts are then reassembled, and the test cord is complete. The bare tips of the wires may be coated with solder to prevent them from fraying.

In most apartment buildings the three-wire system is used. Such a system is shown in Fig. 6. The supply line comes in from the bottom of the fuse box and is connected to large fuses, which protect

the whole wiring system. From this point three wires or busbars run vertically and the various circuits branching to different parts of the building are

tapped off from these. The branch circuits have only two wires each and are tapped in the following way: One circuit is tapped from the left and center busbars; the second circuit, directly across from the first, is connected to the right and center busbars; the third circuit is connected like the first one and the fourth like the second, and so on. This is evident by carefully studying the connections. The wires on these circuits are protected by small fuses, which are those that usually blow out as soon as the circuit is overtaxed or a short circuit occurs. The types of fuses

most commonly used are shown in Fig. 3, a screw-plug fuse, Fig. 4, a knife fuse, and Fig. 5, a cartridge fuse.

Now, although it is not at all dangerous to test fuses, it is, nevertheless, advisable to refrain from touching bars, wires, or terminals with the fingers, otherwise a very unpleasant shock may result. Of the three wires running vertically the outside ones have a potential of 220 volts while the potential between the center wire and either outside one is 110 volts, on which the house-lighting system is operated. In no case should the test lamp be connected across the 220-volt leads; it would then immediately burn out, as it is made to light at 110 volts.

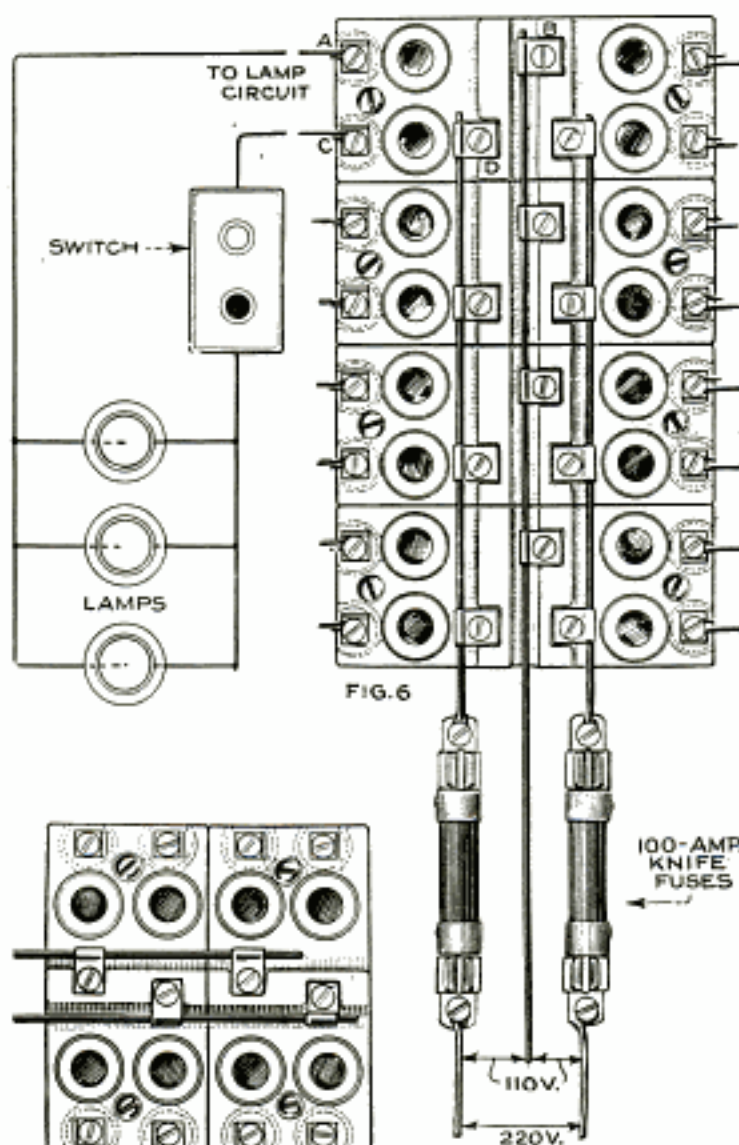

FIG. 6 Three and Two-Wire Porcelain Fuse Blocks Used in Most Apartment Buildings Having Numerous Branch Circuits

When the apartment circuits are not marked between fuses or terminals, as is often the case, it may be necessary to test every fuse on the panel. This seems, at first glance, a difficult job but is really easy. The same method is applied as explained above, no matter what kind of fuses are used. The testing can be followed out easily in Fig. 6, which shows four two-circuit porcelain fuse blocks. The wires leading to a branch circuit with its switch and lamps are shown at the left. Terminals B and D are on the supply line and terminals A and C on the branch circuit. Tests should be made across A and D and across C and B as previously explained. In small towns where the three-wire system is not used extensively, there are only two supply lines, having a potential of 110 volts. They are connected to porcelain fuse blocks, as shown in Fig. 7. The tests on these are made in exactly the same way.

The usual causes of blown fuses are short circuits and overloads of current, that is, more current is used in the circuit than the fuse can carry without melting. Most house fuses are designed to carry 10, 15, and 20 amperes; even 30-amp. fuses are sometimes used. A 60-watt tungsten

lamp takes approximately .6 amp. on 110 volts, so 16 of these lamps can safely be used in a circuit protected by 10-amp. fuses. Electric irons and electric stoves and other heating devices take much more current. The usual types of irons take about 5 or 6 amp., so if a number of lamps consuming about 8 or 9 amp. are lighted, and then the flat iron is plugged in, the fuse will most likely blow out.

Makeshifts, such as coins or pieces of metal, should never be used to connect the two sides of the fuse.

Bathing Pool Built at Water's Edge

A novel and attractive pool has been constructed by a summer resident of an eastern resort, at the edge of the sea, so that his guests may enjoy the invigorating salt water and fresh air, without going to the crowded beaches and safe from rocks and undertow. The concrete of the approach is laid in squares, and the concrete for alternate squares mixed with red dye to give a tile effect. The pool is kept filled by the waves washing over the low wall in front, and pipe rails are set around the pool for additional safety of the users. —Richard C. Tarr, Gloucester, Mass.

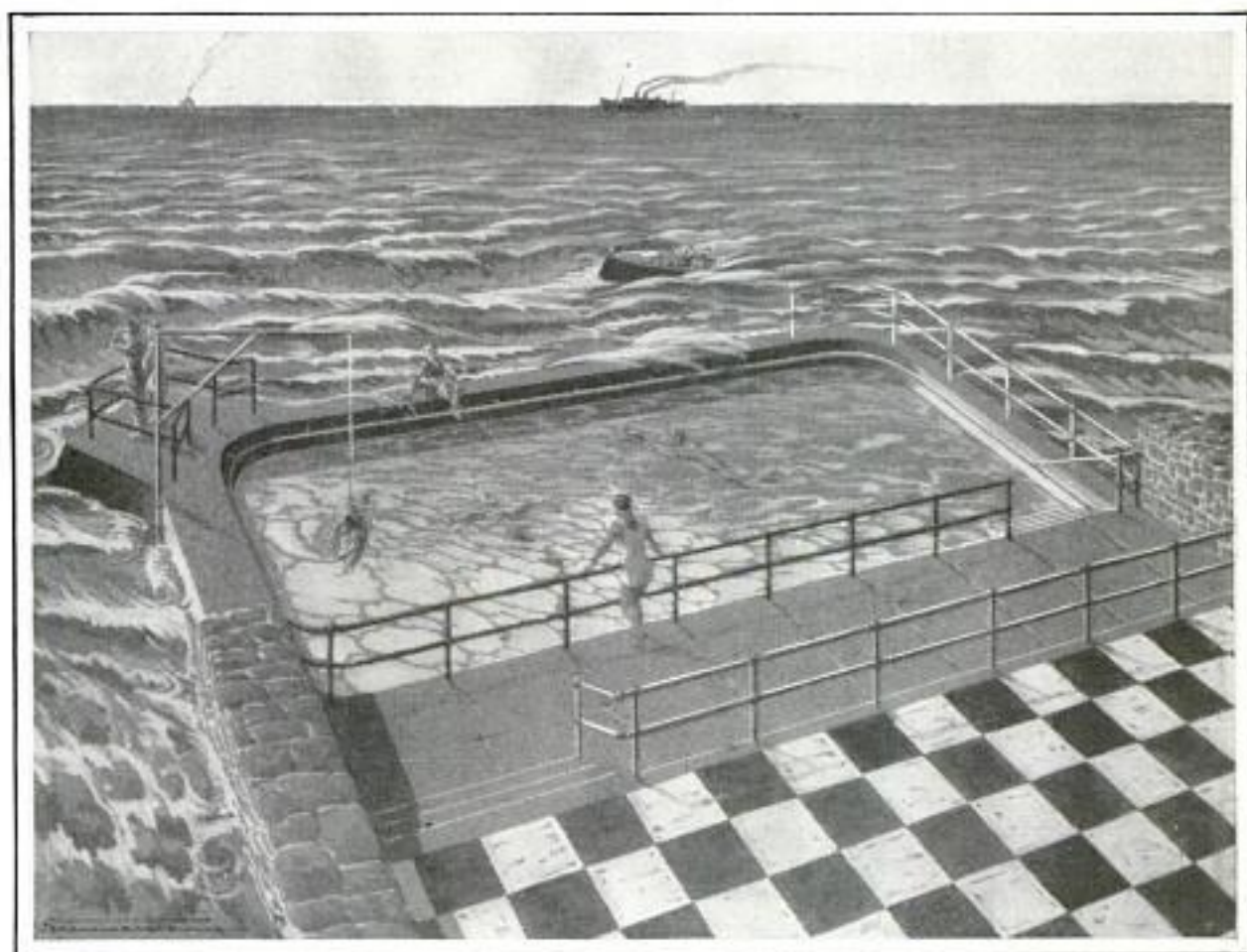

Large Bathing Pool at Water's Edge Provides Comfort, Privacy and Safety from Rocks and Undertow

Portable Picnic Cupboard

For families spending week ends at the lake, the portable picnic cupboard shown in the drawing is just the thing for carrying pies and other provisions that must not be crushed, and it is also useful for storing pies and cakes at



A Portable Picnic Cupboard Is a Convenient Accessory for Picnickers and Can Also Be Used to Advantage in the Pantry

home. It is made of $\frac{1}{2}$ -in. wood, cut as shown. The sides are grooved to receive a sliding door made from a piece of heavy galvanized sheet iron. Holes are drilled through the top of the sides for a length of broomstick, which is used as a handle. The shelves are also made from galvanized sheet iron, having the edges bent over so that they can be screwed to the sides and back. When the cupboard is used for storing provisions at home, a screen door is substituted for the sheet-metal door. This can readily be made by soldering screen to a doubled band of sheet metal or wire, bent to the correct size.—Margaret Vogt Siddall, Moravia, N. Y.

Driving Small Tacks

When using tacks or brads too small to be easily held in the fingers, take a strip of thin cardboard or heavy paper, push the tack through it, and hold the paper with one hand while the tack is started. A slight pull will then tear the paper away. This method may also be used to drive nails in places that are almost inaccessible.—Donald R. Barnett, Missoula, Mont.

Cement for Amber

Amber can be effectively cemented by means of shellac, dissolved in grain alcohol. The parts must be thoroughly cleaned, and after cementing they should be held together in clamps for a few days. The surplus cement is then cut off with a sharp knife and the amber polished with a piece of felt, using dry-lump tripoli and water and finishing the job with a clean rag. Boiled linseed oil can also be used as a cement instead of shellac; it is applied in the same way, but the parts must have more time to dry.

Simple Wooden Jack

An inexpensive rear-end jack, which will be found to be of considerable use around the home garage, especially in winter, when it is often desirable to use a jack in starting the car, can readily be made by anyone. It is made of 2 by 4-in. wood. One piece is about 5 ft. long; a handle is bolted on at one end and two blocks at the other. The blocks are grooved at the top, as shown in the detail, and are separated from each other about 12 in., which can be done by using short pieces of 2 by 4-in. wood between them and the 5-ft. length, the whole assembly being securely bolted together with $\frac{3}{8}$ or $\frac{1}{2}$ -in. carriage bolts about 16-in. long. Flat-iron braces may also be used to hold the blocks more securely. In use, the jack is slipped under the rear axle, as shown in the drawing, and the handle is pushed down to lie flat on the ground, which will raise the rear end so that the wheels clear the floor a few inches.—G. C. Douglas, Raleigh, N. C.

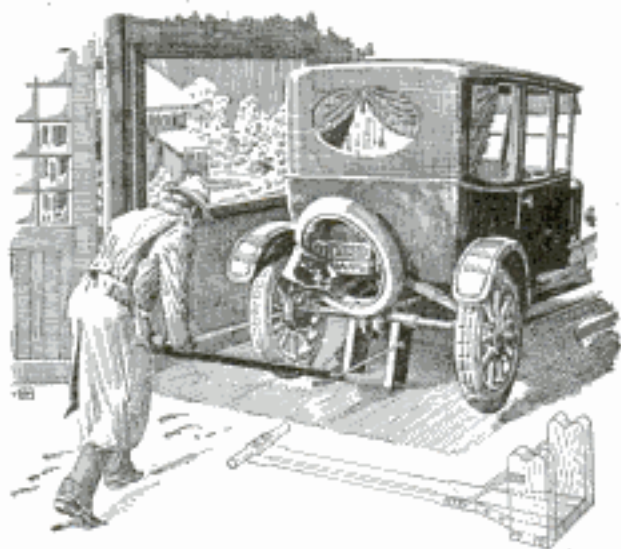

Rear End of Auto Can Be Quickly Raised by Means of Simple Homemade Jack



Making Useful and Attractive Novelties from Odds and Ends with Glue

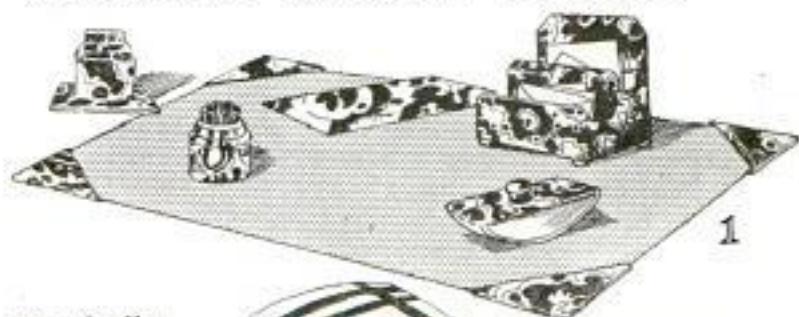

EVEN nowadays, when practically everything from matches to grand pianos is at one's elbow, so to speak, it often seems the hardest thing in the world to discover during a shopping tour just the type of candle shield, wastebasket, wall hanging, dressing-table appointments or desk set that one had in mind when starting out. In spite of the immense variety to choose from, it seems that nothing one sees will harmonize with the furnishings of the particular room in which the things are to be used, or else they are not individual enough to suit the taste. The only thing that is left is to make them at home, and this, to many people, seems an almost impossible task.

There is, however, a simple and easy way to make the many little things so dear to the heart of the housewife, and that without a particle of sewing. The process is called "gluecraft," and, with the aid of a ten-cent tube of glue and some scraps of silk, cretonne, brocade or any other suitable covering, the article can be made in much less time than by sewing. Nor is the process a messy one. With a little care, there need not be a drop of glue on the fingers when the work is finished. The tubes of glue come with a little spreader in the top, with a convenient handle, and the fingers need not come in contact with the glue at all.

Before proceeding with a detailed description of the making of a particular article, the reader's attention is called to the pen-and-ink illustrations on this page, which were all actually made by the method of gluecraft. No. 1 is a desk set, a complete description of which will be given farther on in the article; No. 2 shows a charming jewel case, made from



an old cigar box. Sheets of cardboard are used to cover the top and the inside bottom of the box, and are heavily padded with sheet wadding, then covered with white moire silk. Bands of black silk ribbon, 1 in. wide, are glued over this, and a small black silhouette, which can be obtained at any art shop, glued in one corner. The glue, which is LePage's, is applied very sparingly to this, so that it does not spread. This glue will not stain the most delicate fabrics.

When applying the glue to any kind of cloth, one precaution is necessary. Allow time for the glue to become "tacky"—almost dry—before turning a hem over, or before joining two pieces of cloth together. If this care is taken, the glue will never come through the cloth or spot it.

No. 3 shows how a humble coffee can may be transformed into an attractive wastebasket. Rows of scalloped ribbon are glued onto cretonne, which is then laid in shallow plaits. Glue is lightly and evenly spread directly on the tin, around the top and bottom edges, and the inside ridge of each plait pressed to the tin and held firmly for a few moments. Scalloped ribbon, lightly gathered, is then glued around the rim at the top. In No. 4 is shown a telephone screen that will add a note of color to the nook where the phone usually stands, besides hiding the instrument. It is made of heavy cardboard (part of an old carton will serve nicely) and the edges are bound with seam binding or narrow ribbon, glued on. Cretonne or silk is then stretched over the outside, pressed to glue spread on the cardboard, and allowed to dry. The frame is then lined, and the edges bound with novelty ribbon lightly glued on each edge. A little telephone pad may be covered and lined to match.

An ordinary pair of metal book ends may be covered to match the accessories in any room in the house, as shown in No. 5. A square of cardboard is glued to both sides of the uprights. Then the ends are padded and covered with cretonne or brocade, and a double-edge scalloped ribbon used to bind the edges. When fastening the ribbon, the glue is applied only a few inches at a time. Coverings for flowerpots are easily made as shown in No. 6, with black sateen and novelty ribbon neatly glued to a foundation of cardboard or buckram. A coffee tin also makes an ideal foundation for a flowerpot covering.

A novel and attractive doorstop is that shown in No. 7. Fill a pint bottle with sand, and glue to it a circle of cardboard, 7 in. in diameter; then pad with cotton

to the edge of the circle. Draw black sateen around the foundation and glue a seam at the cat's back. Glue the sateen to the base, tie a cord around the neck, and embroider the features, legs and tail. Glue the edges of the head together; turn it on its side, stuff the head through an opening left in it, and glue to the neck of the bottle. Use green beads for the eyes and tie a ribbon bow around the neck.

No. 8 shows a whisk-broom holder that is decorative as well as useful. It is made by padding a cardboard shield with sheet wadding, then covering it with silk, gluing the raw edges to the back. A band of cardboard, to hold the broom, is also padded, covered with silk, and the ends passed through slits cut in the shield and glued to the back. A piece of silk is glued to the back and all the edges are bound with narrow ribbon. It hangs by a tiny ribbon loop. In No. 9 a little china doll tries to cover the lid of an old cardboard box, converted into an attractive dressing-table box, with her very full skirt. The box is divided into compartments for hairpins, powder, etc., and is lined with glazed chintz. The doll is glued to the cover, and the whole box is covered with silk and novelty ribbon. The tiny sewing kit shown in No. 10 will prove of value to the woman who travels. An empty salt container may be used as a foundation for this. Padding is glued over the container, the inside lined with silk and the outside covered with cretonne. Ribbon is used to trim the finished kit.

To acquaint the reader more closely with the process, the making of a desk set will be described and illustrated, step by step. The "props" are an inexpensive desk pad, inkwell, and paper cutter obtained in a department store, with a paper holder made from an old stationery box and a cardboard pen tray and blotter top. A tube of glue, scissors, a piece of cheesecloth and a little water to keep the fingers clean while working are all the "tools" necessary. The metal spreader that comes with the tube is often the only implement used to spread the glue, although many workers prefer to use the tip of the little finger, or an ordinary nutpick. The most important thing to remember in this work, as previously mentioned, is to use very little glue, merely touching it to the material when partly dry, so that it cannot penetrate or discolor the fabric. To facilitate this, the glue is squeezed out onto a dish, and allowed to dry partly before using.

The leather ends of the desk pad are first covered with brocaded ribbon rich



The Glue Is Squeezed Out onto a Dish or Square Card

A Thin Line of Glue Is Spread on the Ribbon Edge



The Glue Is Spread over the Surface of the Desk-Pad Corners, and Allowed to Set Until It Is "Tacky," or Almost Dry; the Ribbon Is Held Firmly as Shown



When the Glue Has Set Until It Is Partly Dry, the Ribbon Is Pressed Down into Place with the Fingers; the Selvage of the Ribbon Eliminates the Need of Folding



Ready to Commence Operations on the Desk Set



Left, the Ribbon Is Cut to Fit the Inside of the Tray and Glued; Right, the Glue Is Applied Directly to the Inkwell and the Material Stretched Over



Above, Applying the Ribbon to the Blotter Pad; Note the Binding Ribbon on the Edge; Right, the Edges Are Folded over the Back, Glued, and Covered by the Blotter When Glued in Place



Left, Covering the Paper Box; Below, How the Front Is Fitted



Left, the Completed Desk Set, Distinctly Individual and Harmonious

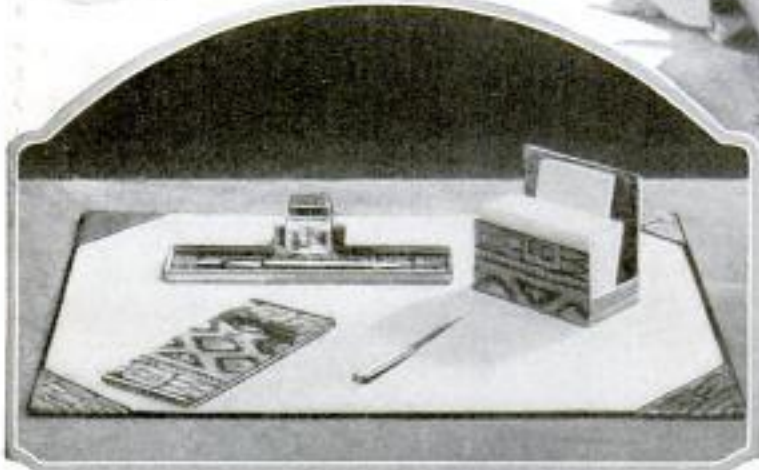

in design; of course, any other suitable material that may happen to be at hand may be used instead. A thin line of glue is applied along the edge of the ribbon as a start; after the glue is partly dry, the ribbon is pressed into place, the ends being glued underneath. The selvage of the ribbon eliminates the necessity of folding it in. Hold the ribbon firmly, and stretch it as shown in the illustration. If

desired, a narrow binding ribbon of suitable material can be applied along the edges.

When covering the pen tray, the ribbon is cut to fit the inside, and binding ribbon applied, as shown, around the rim, both inside and out, covering the raw

edges. In attaching the ribbon to the inkwell, apply the glue directly to the glass in a thin line, and stretch the material into place, mitering the corners carefully. The blotter is next, and if, in making the cover, the ribbon is of the same width as the cardboard, the binding ribbon can be applied first, as shown. The raw edges on the back are covered by gluing the blotter over them as a lining. The paper holder is covered by first lining the inside, front and back. Then dull-gold ribbon is applied to the low sides, inside and out, and the box finished with the outer brocaded

ribbon. When covering the front, it is necessary to slit the ribbon sufficiently to allow it to be turned over the edge and under as a seam when it reaches the side.

The finished set is decidedly individual, and has the added merit of being inexpensive. It demonstrates the versatility and effectiveness of this process.

It is impossible to cover in one article the endless variety of things that can be made in this way. One of our illustrations shows a handsome table runner that was made without a single stitch.

It is made from a strip of black satin, to which 1-in. wide ribbon, with shimmering oblique stripes, is glued as a border. Green and gold metallic ribbon is used as an inside border. A thin line of the glue is applied along each selvage of the ribbon, a few inches at a time, and allowed to become nearly dry before the ribbon is joined to the satin. The brilliant flowers and the slender-tailed bird are applied with the slightest possible touches of glue around the edges. Cut-outs from chintz and cretonne, glued on silk fabrics, are exceedingly effective for this purpose.



A Lamp Shade and a Handsome Table Runner Made Entirely by Means of the Gluecraft, without Any Stitching

Lamp shades, too, are easy to make, and have a very "professional" look when put together with glue. The frame is first wound tightly with seam binding, secured at the ends with a touch of glue. A line of nearly dry glue is next applied along the frame and faille ribbon stretched over it in sections. Gold ribbon covers the upright wire bars, and double-scalloped ribbon with a drawthread running through the center is glued on as a finish. A tray for calling cards is easily made from a shallow cardboard box covered with a scrap of rich brocade ribbon, and lined with a plain

ribbon. An ordinary cold-cream jar takes on a distinct charm when covered with a bit of gold satin, trimmed with black and silver plisse ribbon, and finished with a dainty silhouette of the Marie Antoinette era. Glue in a thin line is spread around the top and bottom of the jar, and the satin stretched over it. The glue is then lightly touched to the ribbon, which, in

turn, is pressed into place. A most useful writing case is made of cardboard and ribbon with the aid of the glue. Two pieces of the cardboard are cut to the

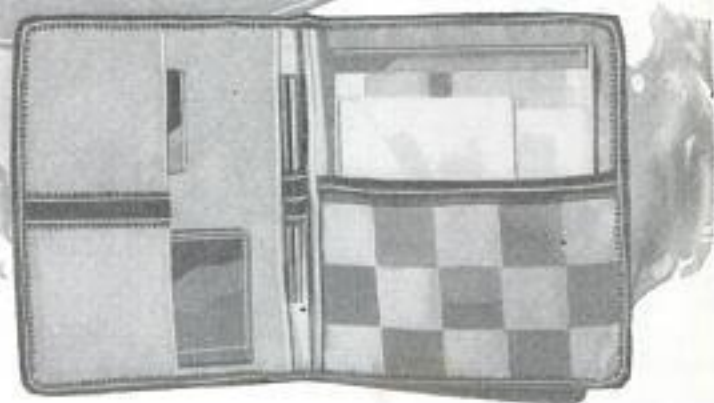

Above, an Easily Made Calling-Card or Pin Tray; Left, a Transformed Cold-Cream Jar, and Right, a Useful and Ornamental Writing Case

desired size and padded with a single sheet of flannel. A heavy and colorful lining ribbon is then stretched over the cardboard at the center, forming a hinge. The two pockets are then glued on. A checked satin ribbon covers the outside, and the whole is finished with a picot-edge ribbon, glued on last.

Turning Wooden Disks on Circular Saw

For the amateur mechanic or woodworker who is not equipped with sufficient funds to provide himself with a lathe, the following method of cutting round disks with a common circular power-driven saw

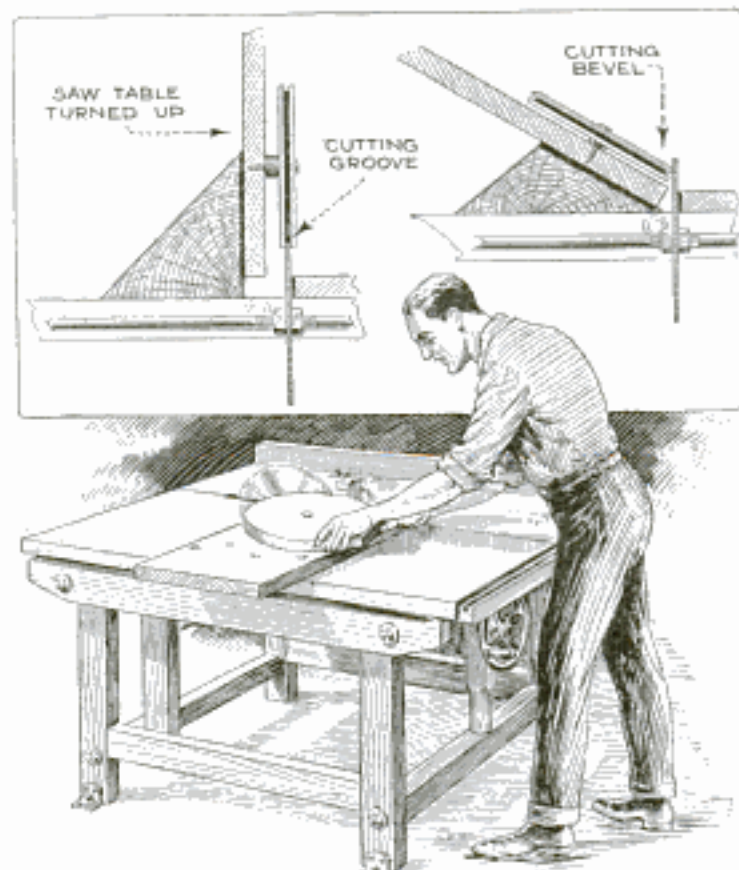

Simple Fixtures That Enable the Amateur Woodworker to Turn and Groove Disks on the Saw

will prove helpful many times in construction and repair work of all kinds. Small pulleys, useful in model making, small wheels, and drums of all kinds can be fashioned without the use of an expensive lathe. If the saw is a homemade affair, the table will probably be of wood, in which case the board carrying the work can be nailed to it. If the table is made of iron it will be necessary to clamp a board a few inches larger than the wheel or pulley to be sawed to the table top in order that a nail may be driven into it. The board should be at right angles to the side of the saw. When the size of the pulley

is determined, a board of the proper thickness should be cut square and the center found by drawing lines from corner to corner. Nail this board to the table or the clamped-on board with one nail. The nail will have to be of sufficient length to hold the board securely in place while it is being rotated and the square board fixed so that the edge just touches the saw as it cuts. To cut the pulley or circle from the square, saw off the corners by pushing the table forward, drawing it back and continuing the procedure until all of them are sawed off. Then the pulley can be rotated on its pivot and the circle will be cut perfectly. If, after the circle is cut, a

groove for a round belt is to be made in the rim, it may be done by constructing a light angle bracket and driving the center nail through the wheel and into the bracket as shown in the diagram at the upper left. The saw is then adjusted so that the desired amount of cut is attained (by lifting the saw table) and the pulley slowly turned until the entire rim is grooved. In making a set of wagon wheels or similar disks, the corners of the circle are cut off after the groove for the tire has been cut in the rim. The circle is pivoted with a nail on a bracket so that it is at the right angle. The drawing shows the angle piece that is fixed to the saw table for the wheel to rotate upon while making the "disk wheel" effect.—Wilbert Whitfield, Fremont, Nebr.

Removing Dents in Fenders

Dents in automobile fenders and body mar the appearance of the car considerably. Some of the dents can be hammered out with a lead mallet, but in many cases this will not entirely remove them. A more effective way is to fill them with solder. The paint is first rubbed off with a piece of emery cloth, and after applying flux, the solder is melted into the depression, the torch flame being played against the underside of the metal, if possible. After enough solder is applied to project a trifle above the surrounding surface, it is allowed to cool and is then filed and sanded down until perfectly flush. It is, of course, necessary to complete the job by repainting the repaired places. The same method can also be used to conceal deep scratches.

Repairing Gasket on Barrel Churn

The cork gasket on the cover of a barrel churn is usually the first part to wear out. This trouble can easily be remedied with a little work in one's spare time by first removing all the iron trim from the wooden cover, which will permit the cork gasket to be removed without any trouble. The iron trim is then replaced and the groove where the gasket was, is filled about one-fourth full of plaster of Paris. The cork gasket is replaced upside down and pressed in so as to make an even job. The soft plaster will fill in all uneven spots that may be left underneath and also make a tight joint.—Adolph Rieter, Marinette, Wisconsin.

Holder for Auto Lamps

Auto lamps can be carried along conveniently and without risk of breaking them in the tin-can holder shown in the drawing. A small can of the kind used for the soft gritty soap used by mechanics, or of similar size, is perforated with a number of holes, just large enough to receive the base of a lamp. Two small slots are cut on opposite sides of each hole to permit the pins on the bases to pass through. The lamps are pushed through the holes from the inside and then given a quarter turn, so that the pins prevent them from coming out. A rubber band cut from an old inner tube is stretched around the outside, as shown, to hold all the lamps still more securely. So supported, the bulbs

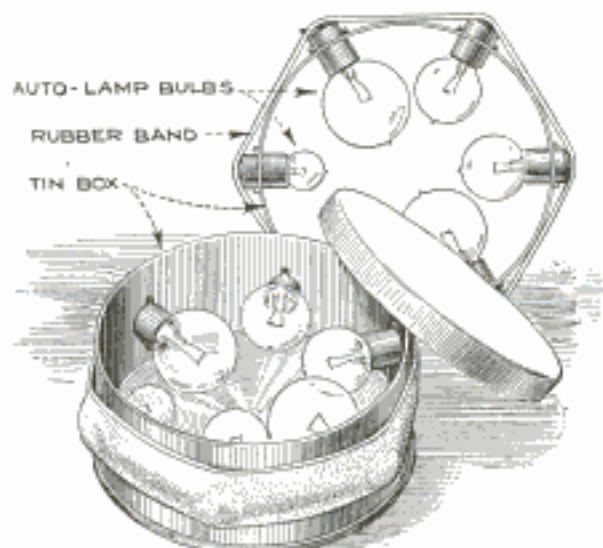

Tin-Can Holder for Auto Lamps Eliminates Danger of Breaking Them

will not touch each other and are practically safe from breakage no matter how rough the roads may be.

Collapsible Seedling Box

With the use of the seedling box shown in the drawing, transplanting to the garden can be done without any interruption

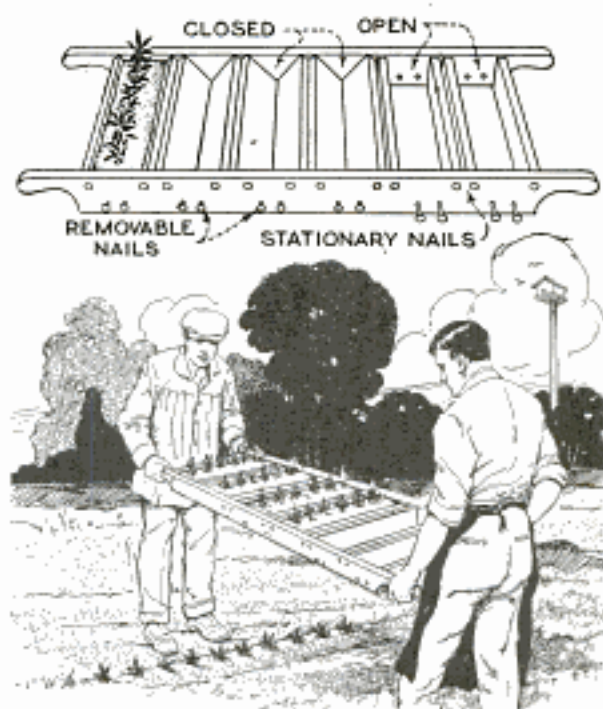

Transplanting Seedlings Grown in Collapsible Box Does Not Affect Their Growth

to the growth of the seedlings. This box consists of a wooden frame, as shown in the detail, with stationary and removable nails driven through the sides to hold a number of boards set with edges together to form V-shaped troughs. The troughs are filled with earth in which the seeds are planted and spaced the same distance apart as they are to be in the garden. The box is then set in a place having the correct temperature for the growth of the plants. When it is time to transfer them, furrows are dug to receive the earth and plants contained in the troughs. The box is then set over the rows and the removable nails pulled out. When the frame is lifted, the boards swing away and the seedlings are neatly deposited in rows. Thus several short rows can be planted at once, or one long row by repeating the operation with one trough of the frame at a time. The roots of the plants will not be loosened and growth will not be affected in any way.—Dale R. Van Horn, Walton, Nebr.

ⓄNo-parking signs to be placed at the entrance of a garage were quickly and cheaply made from a discarded Ford rear-axle housing. Pipes were split at one end to accommodate the signs, and firmly riveted to each half of the housing.

Reel for the Garden Hose

The hose reel shown in the photo was made entirely from parts that are easily

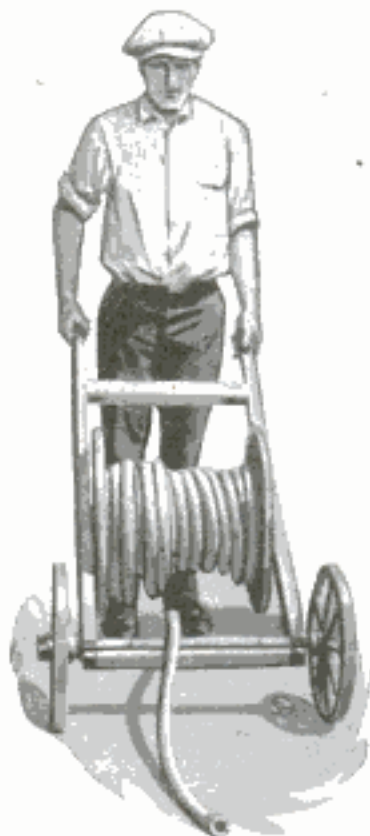

obtainable almost everywhere. The reel, which turns in the frame, consists of two wooden disks, 20 in. in diameter, mounted on a pipe axle, which turns on a long bolt run through the frame. The frame is made of 2 by 2-in. material and the cross-pieces are held in place by flat-iron braces. When the hose is rolled up after use, the reel should be

turned by hand slowly, which will cause all the water to flow out of it, because the hose will not get kinked on the round axle. Thus this reel will double the life of an ordinary garden hose.

Curing Wet-Weather Ignition Trouble on Ford Automobiles

Older models of the Ford occasionally give trouble with the ignition system in wet weather due to water leaking down between the hood and cowl. Some drivers tack rubber covers over the projecting porcelain terminals on the dash, while others cover the joint of hood and cowl with a strip of rubberized fabric in order to protect the ignition during a storm. Neither of these remedies, however, really cures the trouble; the simple method explained below does.

Back of the coil box is the board from which the terminals project. This board becomes wet, and allows the current to leak between the terminals, thus rendering the system inoperative. For permanent relief from this trouble the board should be waterproofed. Detach the ignition wires from the posts, taking care that the battery wire is not allowed to touch any

metal part of the car; to do so would ruin the battery. The four nuts holding the coil box to the dash are removed and the box taken off. The coils themselves are thoroughly impregnated with insulating material and need no attention; so they are taken out and laid aside until the box has been treated. It is best to unscrew all posts and remove the porcelain terminals, so that the whole board can be waterproofed. This is a little difficult with the battery and magneto posts, but by unscrewing the boards from the bottom and sides of the metal box, it can be done without unsoldering the posts.

Put the board in a hot oven while preparing the waterproofing material. This may be ordinary paraffin or melted candles with the wicks removed. When the board is dry, place it in the melted wax and allow it to boil for a short time until it appears to be thoroughly soaked. Then take it out, stand it on edge to drain, and replace the terminals. The coils can now be put in place and the board reinstalled on the car.

This method has been tried on two cars that had given a lot of trouble with ignition in wet weather, even with covers over the hoods. After the treatment no trouble was experienced, although no covers of any kind were used.—R. C. Hitchcock, Manchester, Vt.

Making Pipes "Sit Up"

By flattening the underside of pipe bowls so that they will "sit up" unsupported, the customary trouble of dropping ashes on the table can be eliminated. The work is done with a wood rasp, which is laid on the table or bench, and the pipe is then rubbed over it, holding the bowl in the palm of the hand. Do not bear down on the stem part very much as it is only



Flattening the Underside of the Pipe Bowl Permits It to "Sit Up"

the bowl that has to be flattened. The effect should be to make the stem slightly tilted, to prevent it from leaking when the pipe is set on the table.—Frederick Boesser, Arlington, N. J.

How to Fire the Furnace

MOST domestic furnaces are fired in a haphazard manner, and are not only industrious producers of smoke, but, as a result of this, are not so economical of coal as they should be. It is a very easy matter to fire the furnace properly, and, even if the "lady of the house" must do the job most of the time, it takes but a few minutes to show her how to do it properly, and it is not any harder to fire it correctly than to do it as it is usually done.

A furnace that is producing a quantity of smoke is one that is not completely consuming the fuel. The smoke given off contains tarry

at the left in the drawing. The next time it is fired, the coal is thrown on at the left side. In this way, there is always a bed of burning fuel to one side of the fresh coal, and, as the latter heats, or cokes, and starts to give off vapors, these are ignited and burned as they rise. The

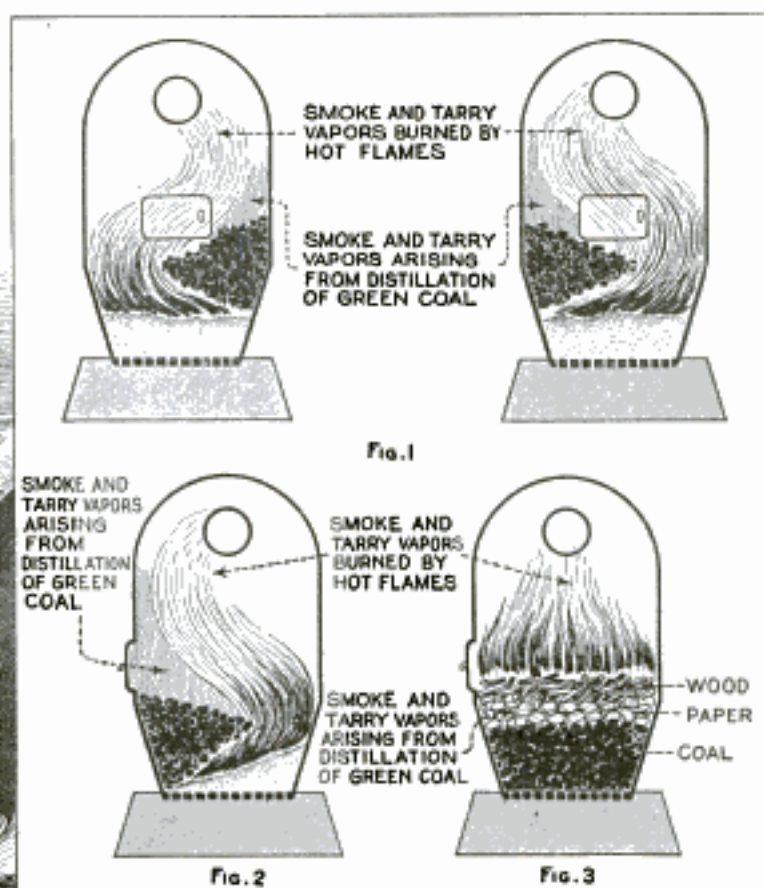
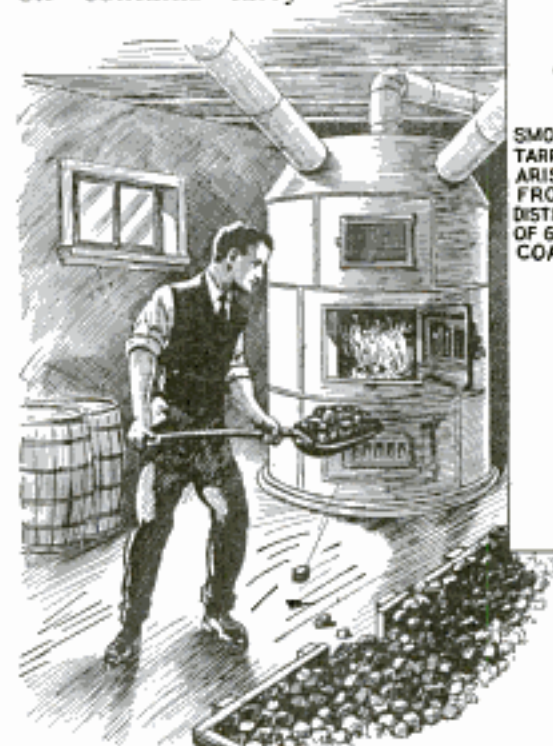

Fig. 1, Firing the Furnace on Either Side Alternately; Fig. 2, Effect of Firing at the Front; Fig. 3, Proper Method of Starting the Furnace Fire

vapors that should be consumed in the firepot; if they are not, the heat contained in them is simply wasted. To consume these vapors, and, consequently, to reduce the smoke given off, it is only necessary to see that the coal is fed to the fire so that there is always a bed of glowing fuel in some part of the firepot. The vapors, in passing over this glowing bed or through the flames arising from it, are ignited and consumed.

There are two simple methods of accomplishing this. The first is shown in Fig. 1, and consists in alternating the feeding of the fresh coal from one side to the other. That is, when the furnace is fired one time, the fresh fuel is thrown on the fire at the right side, as indicated

second method is similar, and is shown in Fig. 2. This shows a side view of the furnace, and in this case the coal is fed to the front of the fire always, the old fire being pushed to the rear of the firepot before the fresh coal is thrown in.

The proper method of lighting fires in furnaces is to place coarse coal on the bottom next to the grate, with paper or other light combustibles on top of the coal and the kindling wood on top of the paper, as in Fig. 3. The light materials on top of the coal almost immediately rise to the proper temperature for complete combustion, and have the effect of consuming the gases distilled from the coal as they rise, with a consequent great reduction in the smoke incidental to starting the fire. The dampers should be adjusted for full draft, and left on until the fire is well under way.

It is the opinion of government experts

that, without changing the furnaces, except as to method of firing, a smoke abatement of from 50 to 75 per cent can be obtained. Smoke abatement is not only beneficial from the standpoint of economy, but as domestic smoke is made in localities where maximum damage to health and furniture results, it is to the advantage of the householder to endeavor to fire the furnace properly.

Revolving Mail-Box Support

To avoid the necessity of crossing a muddy ditch to get his mail, a farmer built the swinging mounting for the mail box



Revolving Mail-Box Support Eliminates Need of Crossing Muddy Ditch to Get Mail

shown in the illustration. The box is supported on an arm made of two 2 by 4-in. pieces, long enough to reach the road across the ditch. These lengths are spaced about 2 ft. apart at one end, where they are bolted to a buggy wheel, and come together at the mail-box end. The wheel is mounted on an axle, set in the ground and braced by a chain running from the top to a stake as shown; a coil spring also connects the wheel rim and the stake. When it is necessary to get the mail, the arm is swung around, bringing the box within reach, and as soon as the arm is released, the coil causes it to swing back to its original position.

Growing Dahlias from Seed

Most people grow dahlias from roots, but they may be grown from seed without much additional trouble. The seed is planted indoors several weeks before the arrival of spring, and the young seedlings are transferred to pots when they are large enough to be handled. As soon as danger from frost is over, they are planted in their permanent places. With good culture, these dahlias will come into full bloom as quickly as those grown from roots. It is

well to remember, however, that dahlias do not come true from seed, and that there is a tendency to revert to semi-double or single forms.

Preventing Spark Plugs from Fouling

Frequently the owner of an automobile or truck finds one or more cylinders of the engine persistently fouling the spark plugs. This condition is usually caused by a too rich mixture of gas in the offending cylinders. Many times it is impossible to adjust the carburetor to serve all cylinders alike because of the shape of the intake manifold. A spark plug fouls in a rich mixture because the electrodes, or points of the plug, become covered with wet gas; this gradually extends up along the porcelain and finally shorts the plug. Having this in mind, an arrangement was provided that caused a charge of hot exhaust gas to be taken in through the spark plug at every suction stroke of the piston. The hot fumes are drawn in around the points of the plug and this evaporates the wet gas that may have collected. In this way it prevents the spark plug from fouling, unless the porcelain cracks or the spark plug is shorted outside of the engine.

To make a spark plug that will not foul, get one with the proper thread to fit the cylinder and which has a priming cup attached. Remove the priming cup and the porcelain and cut a metal disk, about $\frac{1}{8}$ in. thick, then press this into the open end of the plug body. Drill a hole in the center of this disk so that the center electrode will have the proper clearance all around. Now the disk becomes one electrode and the original center point the other. Next obtain a brass ball-check ell, having a $\frac{1}{8}$ -in. thread on one end and some sort of solderless coupling for copper tubing on the other. Screw this ell into the spark

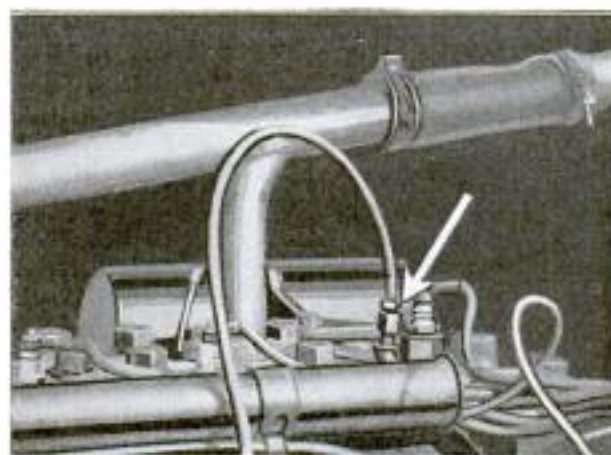

Simple Attachment That Prevents Spark Plugs from Fouling

plug in place of the priming cup. Put the spark plug in the cylinder that is giving trouble. Drill and tap a hole in the exhaust manifold, fit a small shut-off cock into this hole and connect it to the ell on the spark plug with a length of copper tubing. Start the engine and when it is warmed up, open the shut-off cock as much as possible and permit the engine to idle. In assembling the ball-check ell and plug be sure that the check is set so that it closes at each compression stroke. It will be found that an engine having one or more cylinders that get too rich a mixture will run better with this attachment and will give more power. The disk in the end of the plug causes the hot fumes to clean off the electrodes, and it also prevents the wet unexploded gas from getting up around the porcelain. This attachment has been found entirely satisfactory by several car owners.

—Noble D. Gilkison, Kansas City, Mo.

Expanding Brake Shoes

As the shoes of an expanding auto brake become worn and the toes of the operating cam wear off, the effect of turning the latter is lessened so that the brake has very little effect. The trouble can easily be remedied by driving a thimble on the cam to increase its size and this can be done without even removing it from the housing. A short nipple is cut from a length of suitable diameter lap-welded pipe. The nipple is put on the point of an anvil horn and pounded to make it slightly conical in shape, and it is then flattened to fit the brake cam. The sides are filed or ground down until about half has been removed. It is then driven onto the cam, using shims if necessary for a snug fit.

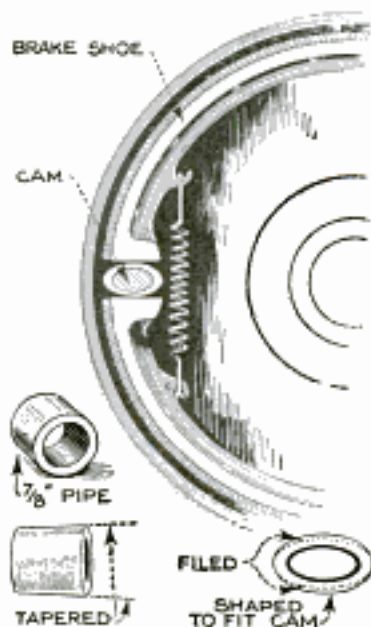

Lantern Trolley for Dairy Barn

Better light distribution is obtained and the danger of fire in the dairy barn, due to upsetting of a lantern placed on the floor,

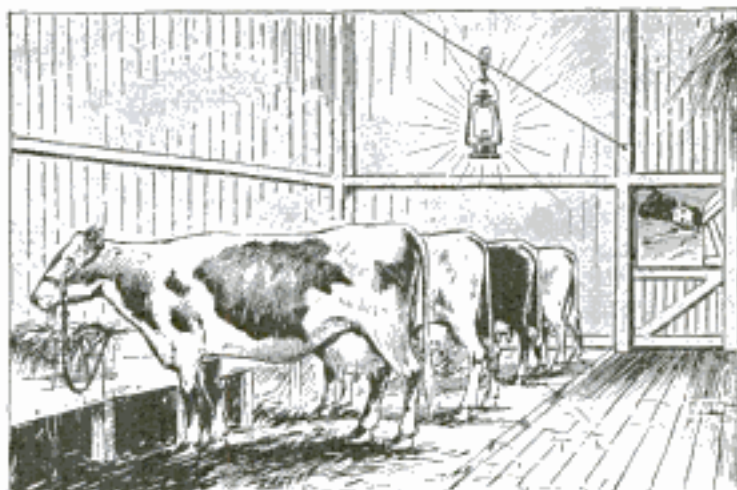

Danger of Fire Is Lessened and Light Is Distributed More Evenly by Hanging a Lantern on Wire Trolley

is lessened, if not entirely eliminated, by the arrangement shown in the drawing. A length of ordinary No. 14 galvanized-iron wire is stretched tightly across the barn, being securely fastened to studdings on opposite sides by means of large screw-eyes; an awning pulley to which a snaphook is fastened is slipped over the wire before it is attached to the wall. The lantern is held by the snaphook so that there is no possibility of its falling, and it can readily be moved along the wire wherever the light is needed. Any slack in the wire can be taken up by driving the screw-eyes deeper into the studs.

Putting a Shine on Windows

Clean and highly polished windows improve the appearance of any store front or home. A good method of doing this is to first wash them on the inside with lukewarm water applied with chamois skin without the use of any soap or other chemical. The outside of the windows should be cleaned with the following mixture: Pulverized whiting, 1 oz.; denatured grain alcohol, 1 oz.; liquid ammonia, 1 oz., and water, 1 pt. This solution is applied with a soft cloth, after the dirt has been removed. It is allowed to dry and is then rubbed off with a polishing motion, leaving the glass extremely brilliant. This method can be used with success on all kinds of windows, although, due to the smoothness of plate glass, a better effect can be produced on it than on ordinary house windows.

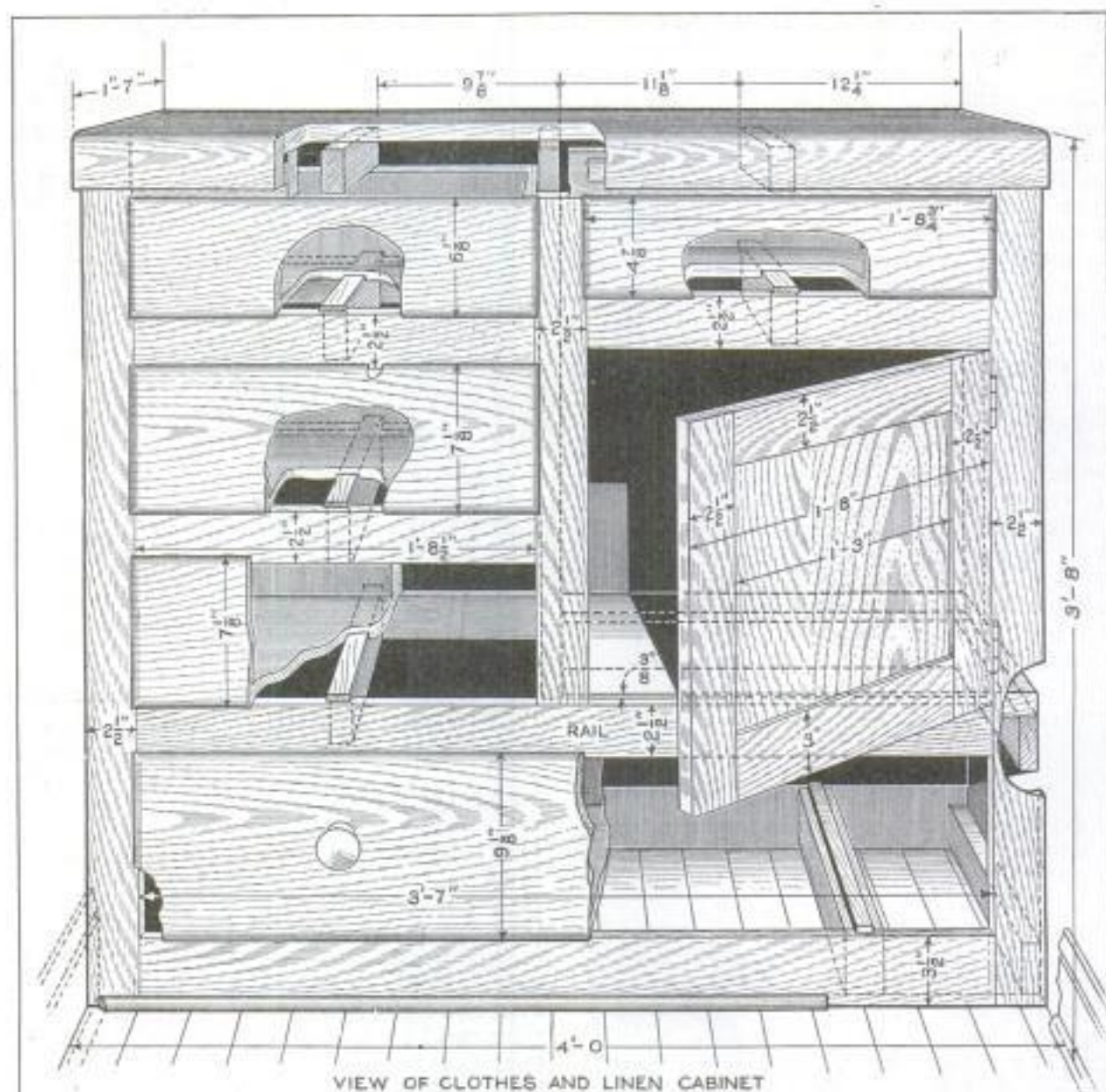

Fig. 1

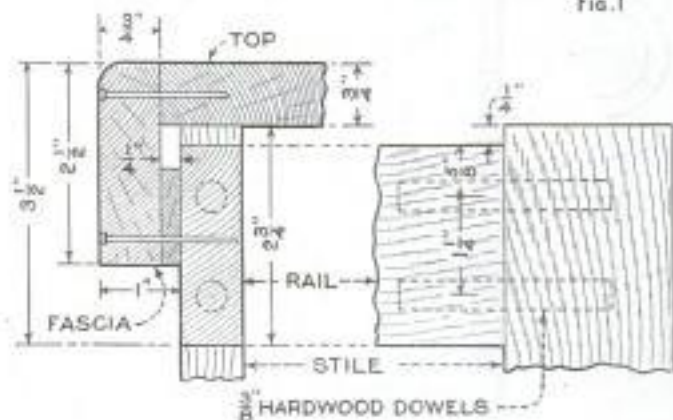

Fig. 2

JOINT BETWEEN
RAIL AND STILE

Fig. 3

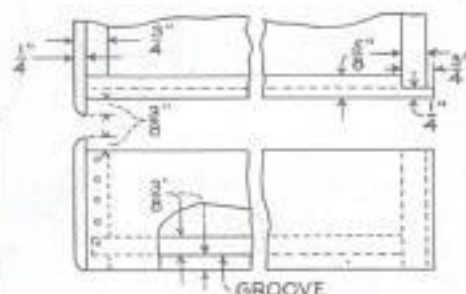
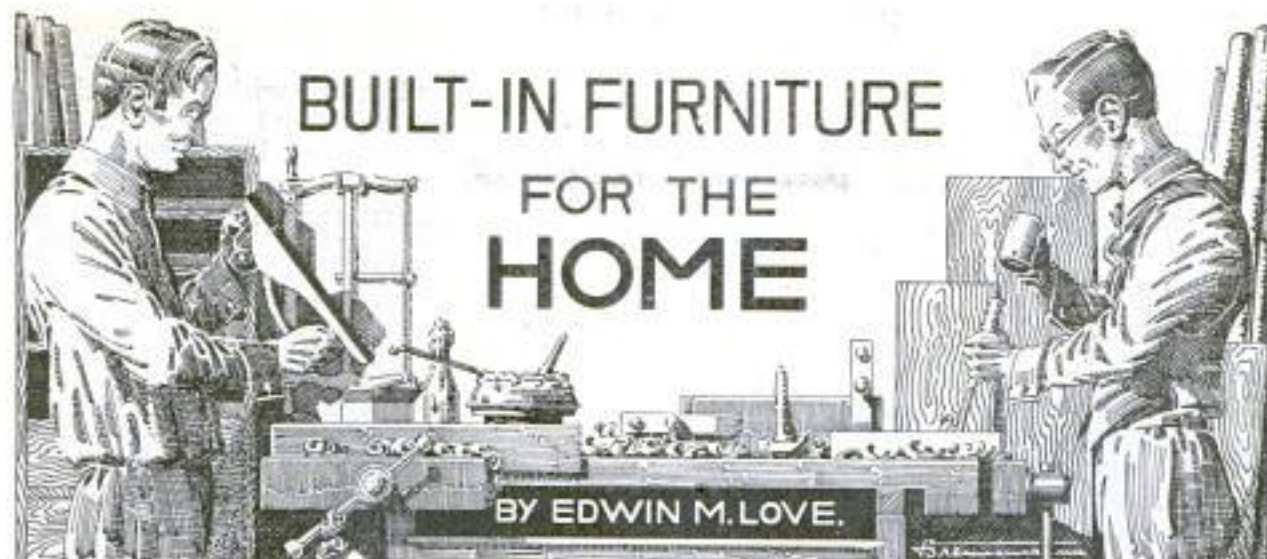

Fig. 4

Fig. 1, Assembly View of Closet, with General Dimensions; Fig. 2, Assembly of Fascia; Fig. 3, Detail of Rail and Stile Joints; Fig. 4, Constructional Details of Drawers



Part V—A Clothes-Closet Linen Cabinet

AN exceedingly useful addition to any fair-sized clothes closet is the simple cabinet illustrated herewith. The cupboard behind the door forms a dust-proof hat box, the large lower drawer a receptacle for shoes, and the other four drawers accommodate the overflow from the bureau in the bedroom. It is easily built, requiring about 20 hours, and if constructed of pine or fir, the material should cost no more than \$8, making it very cheap. This particular cabinet was built at the end of a clothes closet which was 4 ft. wide from plaster to plaster, but by varying the width of the drawers it could be suited to a wider or narrower space, or with the use of a wooden end it would fit nicely in a corner against a side wall. Build the front frame out of $1\frac{1}{2}$ by 3-in. stock, sized to 1 by $2\frac{1}{2}$ -in. net, except for the bottom rail,

which is $3\frac{1}{2}$ in. net in width. All stiles and rails are joined by two hardwood dowels, 3 in. long. Since dressing of the stock by hand, to remove imperfections, is likely to cause slight variations in width, it is well to label each piece when made, to eliminate trouble in assembling. In laying out for dowel holes, be sure to gauge always from the face side, as this

will make the pieces come flush on the good side, regardless of variations in thickness. Glue up the top out of two widths of 1 by 10-in. pine, 4 ft. 1 in. long, either doweling them together or driving clamp nails (corrugated fasteners) in the back. The partition, of the same stock, is finished to a length of 2 ft. 6 in., and the shelf is left roughly to a length of 2 ft. 1 in. When the frame is dry, set it in position in the closet, leveling the rails and locating their levels on the



The Material for This Handy Clothes-Closet Cabinet Costs Only About \$8, and the Work of Construction Requires Only a Few Hours' Time

walls. Notice that, according to the dimensions, the outside stiles are $\frac{1}{4}$ in. higher than the upper rail, and these determine the height of the top cleats above the floor, that is, 3 ft. $7\frac{1}{4}$ in. Set aside the front frame, and level around the walls the lines corresponding to the tops of the cleats, and, using 1 by 3-in. stock, sized to $2\frac{1}{2}$ in. in width, nail up the back cleats, as in Fig. 5, taking care that the ends of the short center cleats are plumb, since the edge of the partition for the hat box must slip in between. Plumb lines on the side walls, 17 in. from the back wall and nail three cleats on each wall, as shown in the detail, keeping the ends very accurately to the line. Also place the two heavy floor cleats of 2 by 4-in. stock, sized to $3\frac{1}{2}$ in. net.

Nail on a wall cleat for the end of the shelf, using stock $2\frac{3}{8}$ in. wide (as is the back-shelf cleat) and scribe the end and back of the shelf to the walls. Plumb up from the end of the back cleat on the wall, place the shelf, and square off the free end from the line just drawn. After cutting, nail into place. It is advisable to put props under all cleats to which shelves are to be nailed so that they will not be driven down. Block the free corner to make the shelf level, and fit the partition so that, when in place, the top

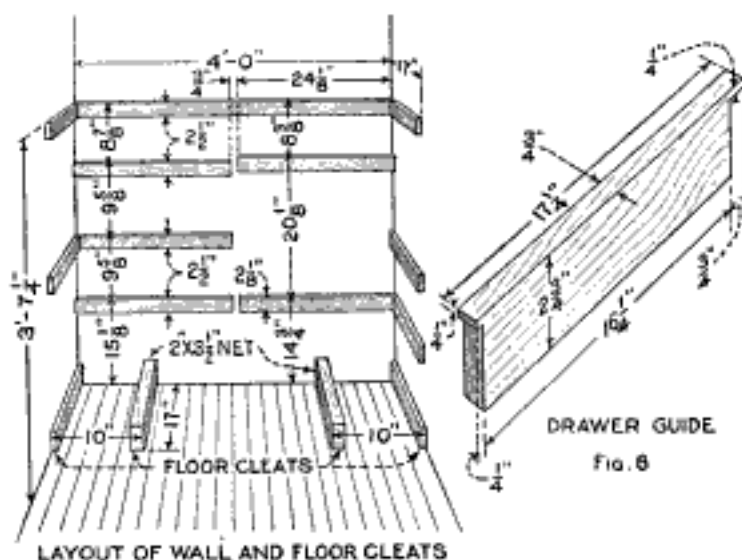

Fig. 5

will be level and in line with the top cleat, while the front edge is plumb and in line with the front edge of the shelf and the front ends of the side cleats.

In setting the front frame, two methods

are available, either to fit the edges snugly against the plaster, or to reduce the width enough to permit the frame to be forced into position, afterward covering the joint with a small quarter-round molding. The latter is more quickly and easily done

than the former. If, however, it is desired to fit to the plaster, slip one edge of the frame into place and push the other stile back as far as it will go; and with a pair of compasses or dividers scribe down the stile. Repeat the process with the other stile, taking care that only enough stock is removed to permit the frame to slide tightly into place. Nail the stiles to the ends of the side cleats, and the lower rail to the floor cleats. Nail through the door rail into the shelf. The $\frac{3}{8}$ -in. projection of the shelf above the rail acts as a stop for the door.

Make drawer guides according to dimensions given in the detail, Fig. 6, and fit between the rails and wall cleats. The lower edges should be flush with the undersides of the rails to hold the drawers level when they are opened. Toenail into the rails from the back so that the nails

MATERIAL LIST

- | | |
|---|---|
| 1 piece, $1\frac{1}{4}$ by 3 in. by 16 ft., pine or fir, S4S, sanded. | 1 piece, 1 by 8 in. by 4 ft., drawer front. |
| 1 piece, $1\frac{3}{8}$ by 3 in. by 14 ft., pine or fir, S4S, sanded. | 1 piece, 1 by 10 in. by 4 ft., drawer front. |
| 1 piece, $1\frac{3}{8}$ by 4 in. by 6 ft., pine or fir, S4S, sanded. | 1 piece, $\frac{5}{8}$ by 6 in. by 4 ft., drawer back. |
| 1 piece, 1 by 10 in. by 8 ft., pine or fir, S4S, sanded. | 1 piece, $\frac{5}{8}$ by 7 in. by 4 ft., drawer back. |
| 1 piece, 1 by 10 in. by 10 ft., pine or fir, S4S, sanded. | 1 piece, $\frac{5}{8}$ by 9 in. by 4 ft., drawer back. |
| 1 piece, 1 by 3 in. by 14 ft., pine or fir, S4S, sanded. | 1 piece, $\frac{3}{4}$ by 7 in. by 6 ft., drawer side. |
| 1 piece, 1 by 3 in. by 16 ft., pine or fir, S4S, sanded. | 1 piece, $\frac{5}{8}$ by 8 in. by 6 ft., drawer side. |
| 1 piece, 2 by 4 in. by 3 ft., pine or fir, S4S, sanded. | 1 piece, $\frac{5}{8}$ by 10 in. by 6 ft., drawer side. |
| 1 piece, 1 by 7 in. by 4 ft., drawer front. | 5 pieces, $\frac{3}{4}$ by 6 by 10 ft., T & G pine drawer bottom, sanded. |
| | 7 $1\frac{1}{2}$ -in. glass drawer pulls. |
| | 1 pair $2\frac{1}{2}$ by $2\frac{1}{2}$ -in. loose-pin latts, to match door hinges. |
| | $\frac{1}{2}$ lb. six-penny finish nails. |
| | $\frac{1}{4}$ lb. four-penny finish nails. |
| | 1 piece, $\frac{5}{8}$ by 16 by 14 in., door panel. |

will not show. Cut in the two top cleats, lining them with a straightedge, and fit the top.

For fitting, the top should be at least $\frac{1}{2}$ in. too long, and more if the plaster corners are much out of square. Lay it in place, one end on its cleat, the other leaning against the opposite wall. Set the dividers for $\frac{1}{4}$ in. and scribe the low end to the wall. Cut off to the mark, beveling under to insure a tight fit on top. Measuring from this out, lay off the exact length of the finished top, and set the uncut end for scribing, this time setting the dividers to the point measured. When cut, slip into place and scribe against the back wall. Naturally the sliding back into place will shift the ends from the exact part of the walls to which they were scribed, but the distance is so slight that the fit should remain good. To get the front edge, allow a projection of $\frac{1}{4}$ in. beyond the stiles and upper rail. Joint carefully, replace and nail to the cleats and partition, and glue and nail on the fascia, which are made of 1 by 3-in. material sized to $2\frac{1}{2}$ in. net in width and rounded off on the top corner, as detailed in Fig. 2.

Build the door next, to the dimensions in Fig. 1, so that it will be dry by the time the drawers are fitted. The stiles and upper rail are of $1\frac{1}{8}$ by $2\frac{1}{2}$ -in. net stock, and the lower of material 3 in. wide net. Plow the inner edges $\frac{3}{8}$ in. wide and $\frac{3}{8}$ in. deep for the veneer panel, which is cut to a width of 1 ft. $3\frac{5}{8}$ in. by 1 ft. $1\frac{1}{8}$ in. in length.

In building the drawers, allow $\frac{3}{8}$ in. in width for clearance and $\frac{1}{16}$ in. in height, and leave a $\frac{3}{8}$ -in. lip, $\frac{1}{4}$ in. thick, on the top edge and ends of the fronts. Place the drawers individually and scribe on the bottom along each side of the guides, using the lines so obtained for the placing of thin strips on the bottom to form a track for the guide.

Surface the door to $1\frac{1}{16}$ in. in thickness. Fit it with a clearance of $\frac{1}{16}$ in. all around, being careful to have enough bevel on the lock stile to clear easily, and line the hinges with the top and bottom rails, in such a way that they will project about $\frac{1}{2}$ inch.

Do not put on the knobs and catches until the painting is complete.

Old Tires Make Boat Fenders

Old automobile tires make splendid fenders for small boats. All that is necessary is to cut the tires into four pieces,

These Fenders, Made from Old Tires, Save One Owner \$100 to \$150 a Year



cut a $1\frac{1}{4}$ -in. hole through one end of each piece for a rope and secure them to the sides of the boat. The iron bead is cut off the tire to prevent it from chafing the boat. To make the fenders more substantial, they can be made in two parts; by using pieces of small tires inside larger ones. I am a ship chandler, and use my boat in all kinds of rough weather, landing against the sides of large ships, and this simple idea saves me from \$100 to \$150 every year.—Capt. Claude Wynne, Norfolk, Va.

Ornamental Brick Well



Disguised as an attractive brick well, which harmonizes with the material of the buildings, an old back-yard cistern is still in daily service. Two oak buckets are attached to the ends of the rope, which is suspended

from the center of the arch as shown in the photo. When not in use, a wooden lid is placed over the top.—Lauree Osborn, Lincoln, Nebr.

☛ Automobiles can be kept looking new by varnishing them every six months.

Making Centerboard Well Splash-Proof

Almost every sailing enthusiast has experienced the annoyance of having water

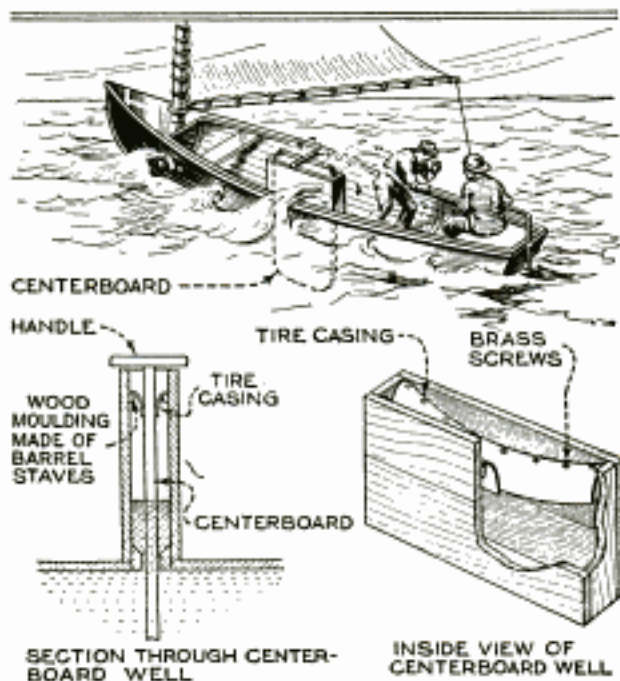

Splash Guards Made from Auto Tire Make Centerboard Well Splash-Proof

squirt up through the centerboard well and drench the occupants of the boat. The usual method of prevention is to cork up the top of the well, but this has the disadvantage of making it impossible to withdraw the centerboard when necessary. One owner fixed his well in the manner shown in the drawing, so that not only was it impossible for water to come through, but the board could be taken out with ease.

The boat was beached and the well taken apart; then to each side was screwed a length of 30 by 3½-in. tire casing, the casing first being split and the beads trimmed off. Under each strip was nailed a molding made from a barrel stave, as shown in the detail. Brass screws were used for attaching the casing to the sides of the well, and the edges were sealed with white lead. These splash guards are completely water-tight.

Bromide-Paper Negatives

While bromide paper, such as is used for making enlargements, does not possess the speed of a photographic plate or film, very interesting pictures of still subjects can be made with it; the results obtained approaching the vague, hazy quality so much sought after by those who use soft-focus lenses. To use bromide paper

in this way, when working with a plate camera, it is only necessary to trim a sheet to the dimensions of the plate and, after sticking it to the glass side of an old negative with a tiny dab of paste at each corner, load in the plate holder in the usual way. For use in film cameras, the process is even simpler, for then a sheet of the paper, trimmed to the right size, can be laid over the opening in the rear of the camera, in the space usually occupied by the film. It is, of course, necessary to do the loading in a dark room by the light of a red or orange-colored light, and to take care that the sensitive side of the paper faces outward. While no definite rules for making the exposure can be given, it is safe to give at least twenty times as much exposure as when using films. This may seem excessively long, but when we consider that twenty times $\frac{1}{25}$ of a second, is approximately one second, and that twenty times $\frac{1}{3}$ of a second is four seconds, it is apparent that the exposures are not so long as one would at first suppose. After the paper has been exposed, develop, fix, wash, and then, before printing, rub vaseline into the back to render it translucent.—John D. Mayer, New York City.

Inexpensive Wall-Light Bracket

Where a number of exterior wall-light brackets must be used the cost of the fixtures is quite an item, being sometimes even more than the cost of the wiring. One building superintendent devised a type of bracket consisting of two lengths

of $\frac{1}{4}$ by 1¼-in. flat iron, bent and riveted as shown in the illustration. This type is just as sturdy as any gooseneck fixture, and although not so neat-looking, serves the purpose just as well. It is attached to the wall with two lag screws and the conduit is brought directly from the junction box to the end of the bracket where it is held with a U-bolt, as shown. This type of bracket makes it possible to extend the lamps at practically any distance from the building and, in addition, the installation is waterproof.

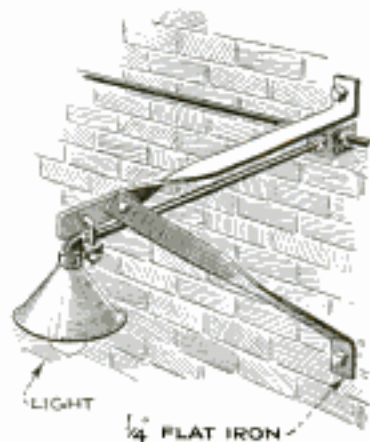

RADIO

The word 'RADIO' is written in large, bold, serif capital letters. On either side of the letters are silhouettes of people. On the left, a man in a suit stands next to a woman who is seated and listening to a radio on a table. On the right, a family scene is depicted with a man, a woman, and a child gathered around a radio on a table.

Loud Speaker and Amplifier for Crystal Set 470.00

THE owner of a crystal receiver who would like to use a loud speaker without going to a great deal of expense will find the instrument described in this article an ideal one for the purpose. It consists of a one-step amplifier built in the same cabinet with the base of a loud speaker, and will amplify local stations perfectly. The instrument shown in the accompanying illustrations was built in Popular Mechanics

radio laboratory, and has given splendid results. It can be built by any fan at a very reasonable cost, and necessitates no change in the receiver. The terminals that are connected to the phones on the receiver are simply connected to a plug; that is all there is to change, and when the plug is shoved into the jack on the amplifier panel and the filament switch thrown on, the instrument is ready for operation. The first requirement is the cabinet. The one shown in the photo was picked up at



This Combined Amplifier and Loud Speaker Will Make the Crystal Set Operate like a Two-Tube Set on Local Stations; Above, Tuning In; Left, Rear View of Instrument, Showing Arrangement of Parts; Right, Front View of Completed Amplifier

MATERIAL LIST

1 3-16 by 6 by $8\frac{1}{2}$ -in. panel.
 1 tube socket for UV-199 or C-299 tube.
 1 tube as above.
 1 audio-frequency transformer, ratio 6 to 1.
 1 filament switch.
 1 open-circuit jack.
 1 phone plug.
 1 rheostat.

1 $4\frac{1}{2}$ -volt C-battery.
 3 $22\frac{1}{2}$ -volt B-batteries, small type.
 2 dry cells.
 1 4-in. stove bolt.
 1 $\frac{3}{8}$ by $\frac{3}{4}$ by 4-in. sheet-metal strap.
 1 small loud speaker with detachable unit.
 1 brass angle, $2\frac{1}{4}$ in. long.
 1 cabinet, 6 by $8\frac{1}{2}$ by $7\frac{3}{4}$ in. inside dimensions.

a radio store for a dollar, and the reader can probably pick up a similar one. The inside dimensions must be at least 6 in. high, $8\frac{1}{2}$ in. wide and $7\frac{3}{4}$ in. deep, in order to accommodate the instruments. If a cabinet of this size is obtained, the layout of the panel will be as shown in Fig. 3; if not, the size of the panel will, of course, be different, but the position of the jack, rheostat and switch can remain

the same. The arrangement of the instruments inside the cabinet is shown in Fig. 1. As a UV-199 or C-299 tube is used, two dry cells are mounted on one side of the cabinet, with the terminals toward the panel. These are held against the side of the cabinet by means of a metal strap and a stove bolt. Three small B-batteries are placed against the other side of the cabinet, with their terminals toward the center, and the $4\frac{1}{2}$ -volt C-battery lies on its side on top of these, its terminals also pointing inward. The B and C-batteries can be taped together if desired, so that they will not shift about.

The audio-frequency transformer, which has a ratio of 6 to 1, is screwed to the bottom of the cabinet, just under the horn, and far enough back so that it will not interfere with the jack when the panel is in place. Soldering lugs should be placed under all terminals on the batteries and the transformer before they are mounted in the cabinet.

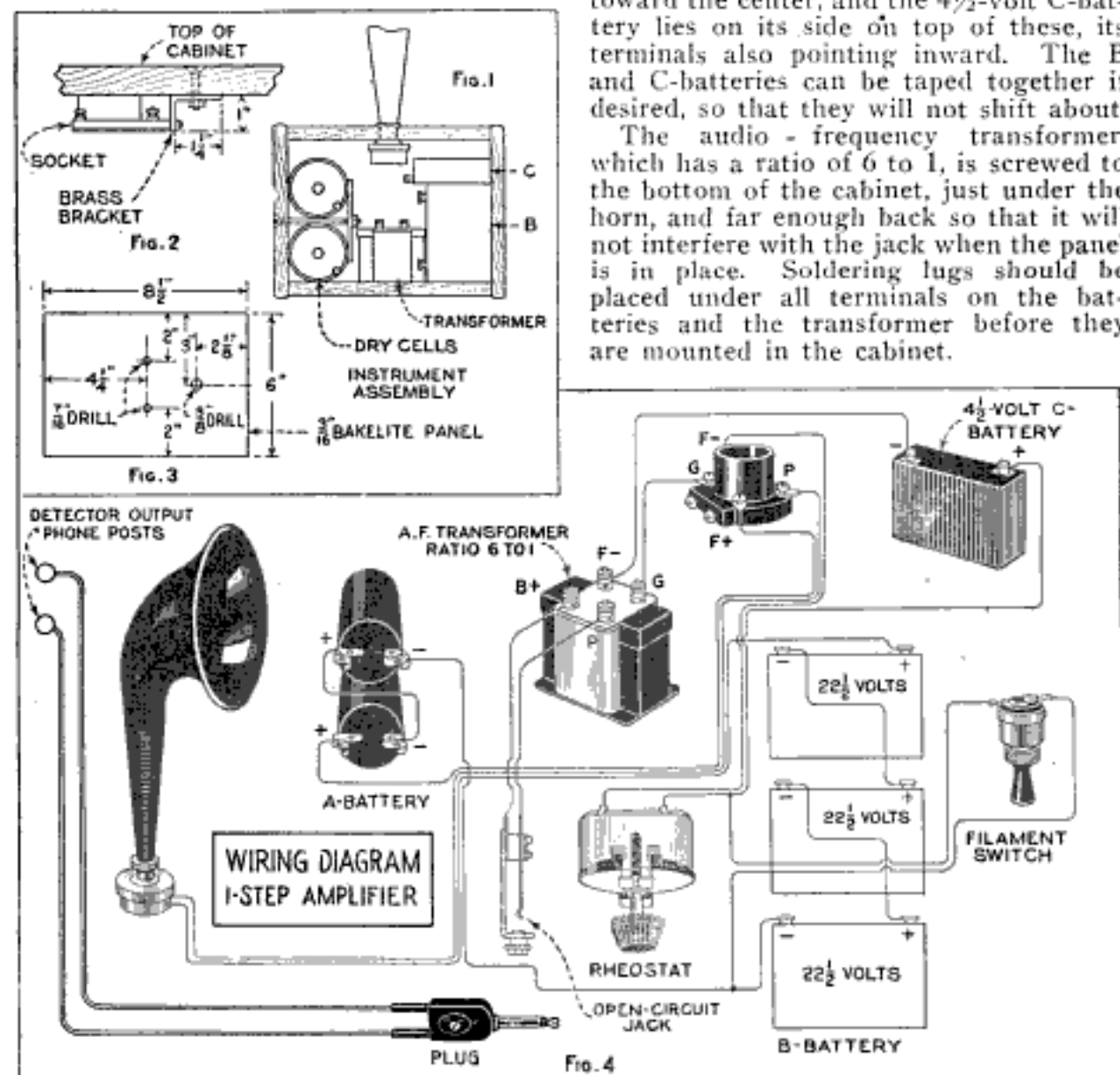

Above, Panel Layout for One-Step Instrument, Mounting of Tube Socket and Arrangement of Components; Below, Wiring Diagram for One-Step Amplifier

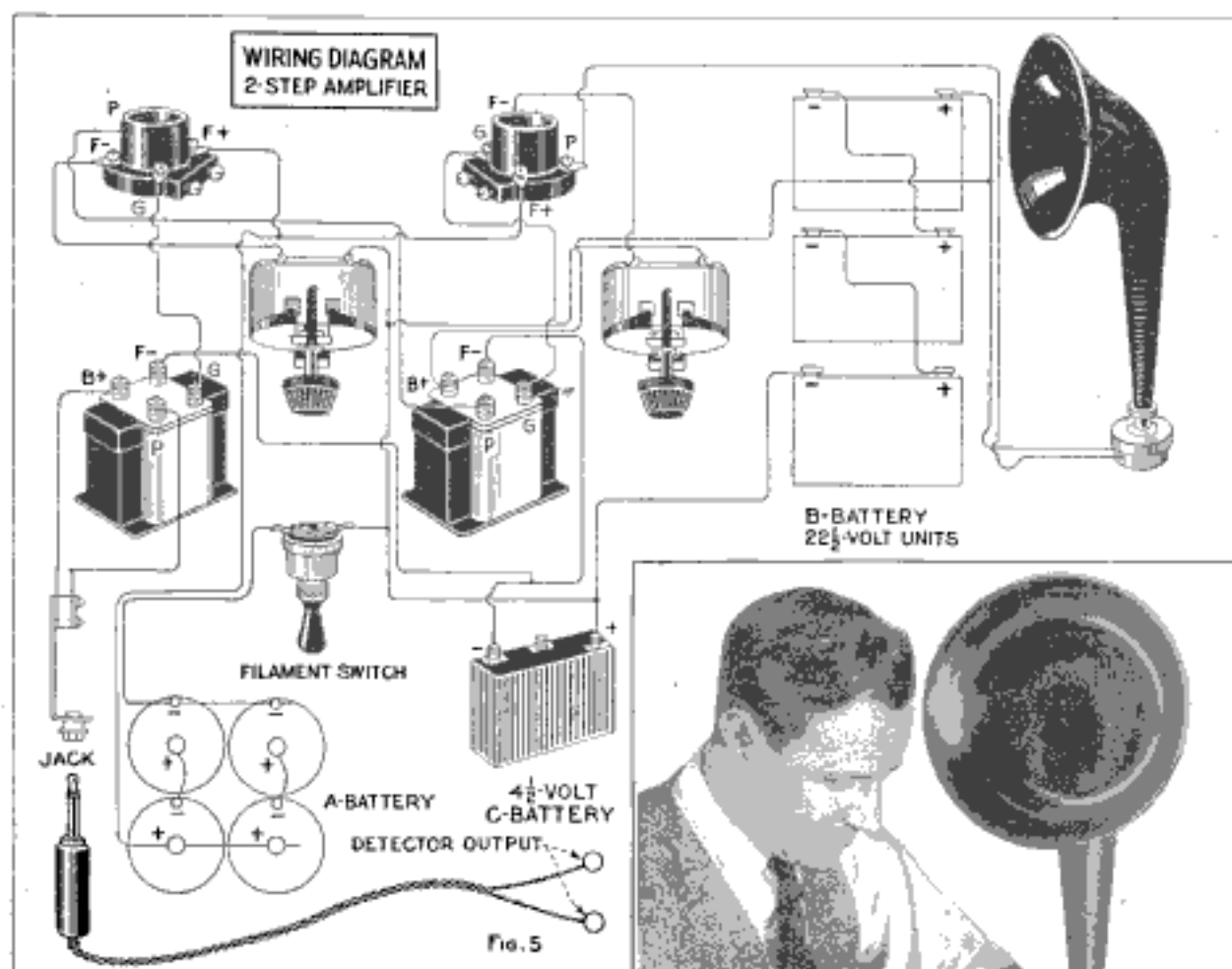

Above, Wiring Diagram for Two-Step Amplifier; Below, Method of Soldering Leads to Instruments on Panel

Any type of horn can be used for the instrument. The base is unscrewed and the loud-speaker unit removed also; the latter is usually screwed to the bottom of the horn. Most loud-speaker horns have a small flange at the bottom that fits against the base, and the remainder of the horn tube, below this, is straight. Bore a hole in the rear of the cabinet top to fit this straight portion of the tube; the hole must be of such a size that the tube will fit tightly. Another hole is bored in the top of the cabinet, at the center and just in front of the horn hole, to clear the body of the tube. The tube socket is then mounted as shown in Fig. 2. The socket used in this instrument is of the panel-mounting type, with tapped holes in the side. A small brass angle is bent and drilled so that it can be bolted to the top of the cabinet by means of a flat-head machine screw and nut. The head of the screw can be colored to match the woodwork of the cabinet so that it will not be noticeable. A screw put through a hole drilled in the vertical leg of the angle bracket fastens the tube socket in place. The bracket should be so bent that the



tube will come exactly in the center of the hole. This arrangement conserves space inside the cabinet, and allows easy access to the tube at all times.

The loud-speaker unit can now be screwed onto the tube of the horn and the batteries hooked up. The reader should study the wiring diagrams carefully before making a single connection. Fig. 4 shows the wiring of the one-step amplifier as built in the laboratory. Fig. 5 shows the hook-up of a two-step amplifier; this can be built in a similar manner, except, of course, that a larger cabinet will be required.

Cut the cord from the horn unit to the proper length, and solder lugs to the ends. This conductor is usually tinsel, and care

must be taken when baring the ends. Solder the connections for the batteries to their lugs, then place the panel in the position shown in the photo accompanying Fig. 5, and solder the leads to the jack, rheostat and filament switch. Keep these leads long enough so that the panel can be removed at any time without disconnecting any leads. Put in the panel and

back, and the instrument is ready for use. This instrument was tested, with a crystal receiver, against a standard two-tube receiver in the Popular Mechanics radio laboratory, and the results obtained with it were fully as good, on local stations, as those obtained with the tube set. The outfit can, of course, also be used as an amplifier on a tube set.

432-R
Aerial Jack Is Mounted in Wall Plate



A special jack for bringing in the aerial, mounted on an insulated brass escutcheon plate, is now available. This plate is 2 3/4 by 4 1/2 in. long, and is screwed to the wall in the same manner as any other electric outlet. A neat nameplate with the word "Radio" completes the

assembly. The wall jack is quite an improvement over the old methods of bringing in the aerial wire, and also automatically grounds the antenna, when the radio set is disconnected from the jack by removing the plug.

426 Q
A Simple Tube Protector

Short-circuiting the B-battery through the tube filaments is an ever-present hazard that the radio enthusiast has to contend with.

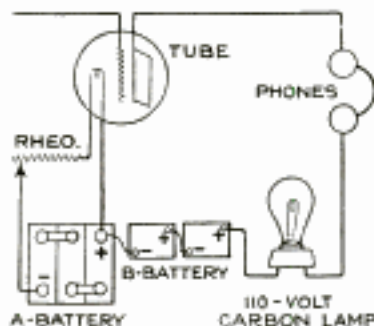

Often one will attempt to tighten a nut or move a wire with a screwdriver, pliers or other metal instrument, and accidentally short-circuit the B-battery

through the tubes, with the result that new tubes will be needed at once. A simple way to guard against such an acci-

dent is to place a 110-volt carbon lamp in the circuit leading from the positive B-battery terminal to the phone post. This acts as a safety device, and any high voltage accidentally placed in the filament circuit of the tube is taken care of by the lamp.

4156-A
Spring Posts for Quick Connections

Neat in design and quick and handy in action, a new binding post recently marketed will appeal to the radio fan. The post is made in two parts, connected by a spring, and fitted so that it cannot come apart. The lower part screws to the baseboard or terminal strip; the upper part has a hexagonal head with a hole drilled through it to take the wire. This is connected to the post simply by pulling the head upward and slipping the wire through the hole. Releasing the head locks the wire tightly and makes a good connection. To disconnect the wire, the head is pulled up and the wire drawn out. These operations can be done in a fraction of the time taken to describe them, thus making the job of hooking up a very fast one. In addition to this, as the head can be swiveled so that the hole faces in any direction, there is no need to be particular about how the posts are mounted on the base or strip. Another type, instead of the hole, has a slot in the side of the head, which in this case is pressed down until the slot lines up with another cut in the lower part of the post, when the wire or terminal can be slipped into place instantly.

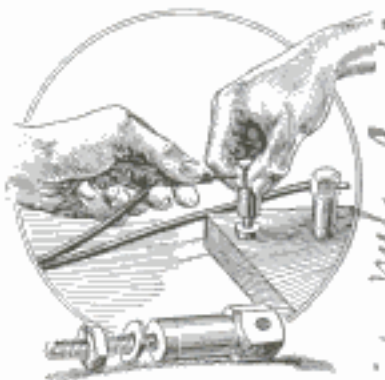

Cores of amplifying transformers should be grounded.

© Snap-on Electrical Co.,
O. B. Norgren, 1456
Rancher Ave., Chicago

Carter Radio Co. Chicago
209 S. State.

Van Dusen, Chicago & W. I. Co., 10 Adams St. Chicago

469. a

Building a Two-Step Cockaday Receiver

By F. L. BRITTIN

THE Cockaday circuit is highly selective, and all authorities agree that it is one of the best types of regenerative receivers. It is not difficult to build and with a little practice in tuning, the results are highly satisfactory. The instrument was built in Popular Mechanics radio laboratory, and the tests for selectivity left little to be desired.

The outstanding feature of this circuit is the arrangement of the four coils. They can be purchased in a complete unit and it hardly pays the builder to wind his own. The antenna loading coil consists of two bank-wound layers, having a total of 43 turns of No. 18 d.s.c. wire, tapped as shown in the diagram; this coil is mounted at right angles to the other coils. The taps are brought out to an inductance switch, so that the primary circuit can be tuned. The primary winding consists of one turn of heavy copper wire. This is wound over the smaller of the two lower coils, as shown in the circuit diagram. The smaller coil on the lower tube consists of 34 turns of No. 18 d.s.c. wire and the larger coil of 65 turns of the same wire. Both of the tubes have a diameter of $3\frac{1}{4}$ in. The panel is bakelite, radion, or formica, $\frac{3}{16}$ by 7 by 18 in. in size. Lay out a template on heavy bristol board for this panel, marking the location of the various holes with a prick punch. Always drill the panel from front to back, so that the holes will be clean-cut. The size and position of the various holes will be noted in the drawing of the front panel. The

two .0005-mfd. variable condensers are mounted at right and left of the panel, in such a position that the rotor plates of these condensers will be toward the center of the panel; this is shown in the wiring diagram. The rheostats are of the carbon-pile type

and are mounted through a single hole on the panel, in the position shown. The inductance switch is self-contained, and is mounted on the back of the panel with a single pole, eliminating the necessity of switch points on the front of the panel. This is a nine-point switch, but only seven

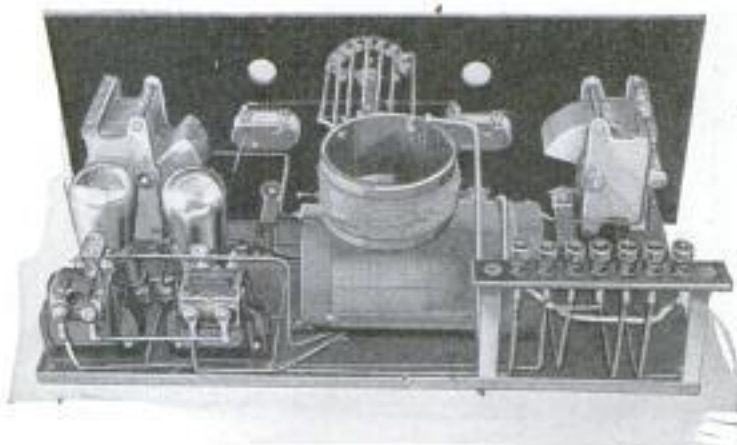

Rear of Cockaday Receiver; Note How the Coil Is Arranged So That the Leads to the Switch Are Straight and Direct

of the taps are used. Directly below the inductance switch, the push-pull filament switch is located. The holes above the rheostats are merely for viewing the brilliancy of the tubes, and also provide a means for air to circulate over the set. The jacks are placed at the lower edge of the panel in the position shown. The detector and first-step amplifier jacks are of the double-circuit type, and the second amplifier jack of the open-circuit type. This completes the front panel.

The baseboard is $\frac{1}{2}$ by $6\frac{3}{4}$ by 17 in. in dimensions, and the instruments are mounted on it in the position shown in the wiring diagram. The coil unit is located toward the rear, with the taps on the upper coil directly opposite those on the inductance switch. The detector-tube socket, grid leak and grid condenser are placed in front of the coil unit. Directly back, and to the right of the coil, two 4-in. brass brackets support a $\frac{3}{16}$ by $\frac{3}{4}$ by 7-in.

bakelite strip on which the terminal posts are mounted. Seven binding posts are used; these posts can be obtained with engraved tops, or the strip itself can be engraved, as



View of Front of Finished Two-Step Cockaday Receiver, Showing Arrangement of Panel

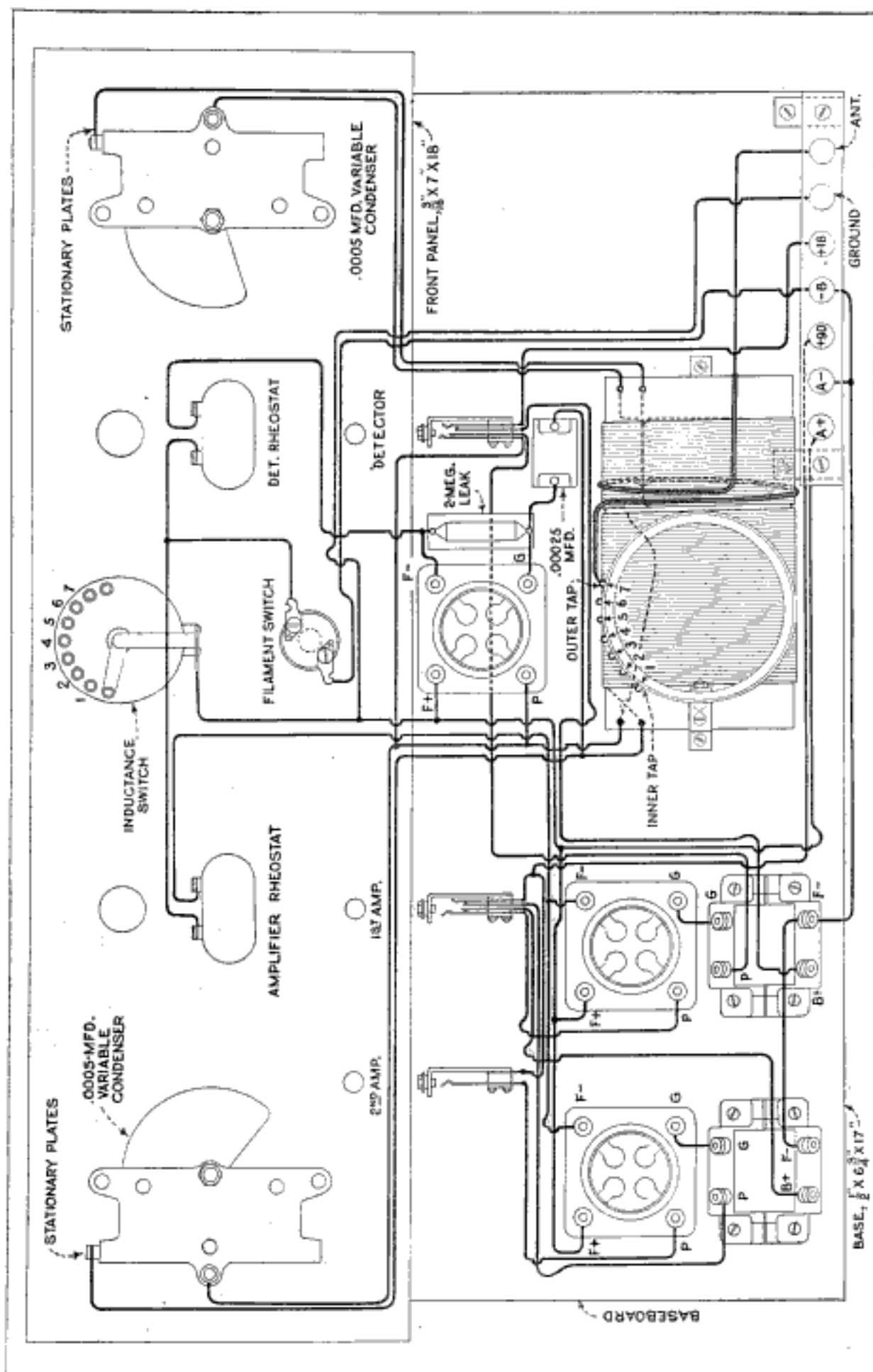

Wiring Diagram for Cockaday Receiver; Every Wire on This Diagram Is Shown in the Position It Should Occupy on the Finished Instrument

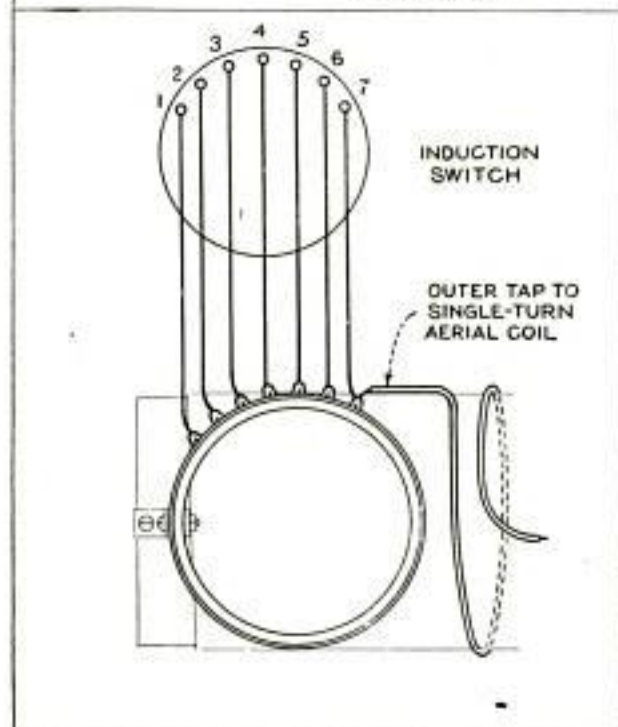
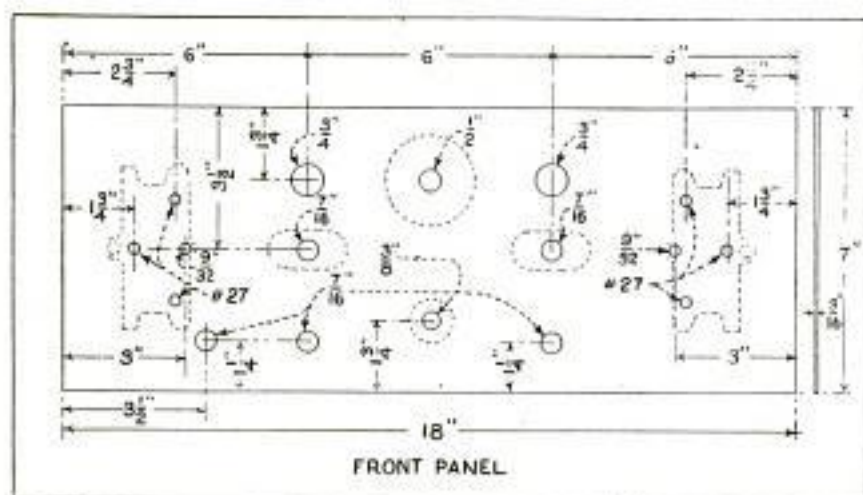

desired. The sockets for the amplifying tubes and the audio-frequency transformers are mounted at the left of the baseboard, as shown in the diagram. The panel is then mounted on the baseboard with three nickelplated oval-head wood screws, driven into the edge of the board through holes drilled in the panel. The instrument is now ready to be wired. Use No. 14 round tinned-copper wire for

this purpose, and cover it with a good grade of black spaghetti tubing. Use solid-wire solder and some good soldering paste; the latter should be used very sparingly, applying a minute amount to the wire and lug to be soldered and then wiping it off. The paste is intended to clean the surface rather than to act as a flux. An inexpensive electric soldering iron is a very handy instrument around the home and almost indispensable to the radio builder. Soldering lugs are used under the terminals of all the instruments to be connected in the circuit. These lugs protect the instruments from the heat given off by the iron.

Care in soldering is a rule that should be

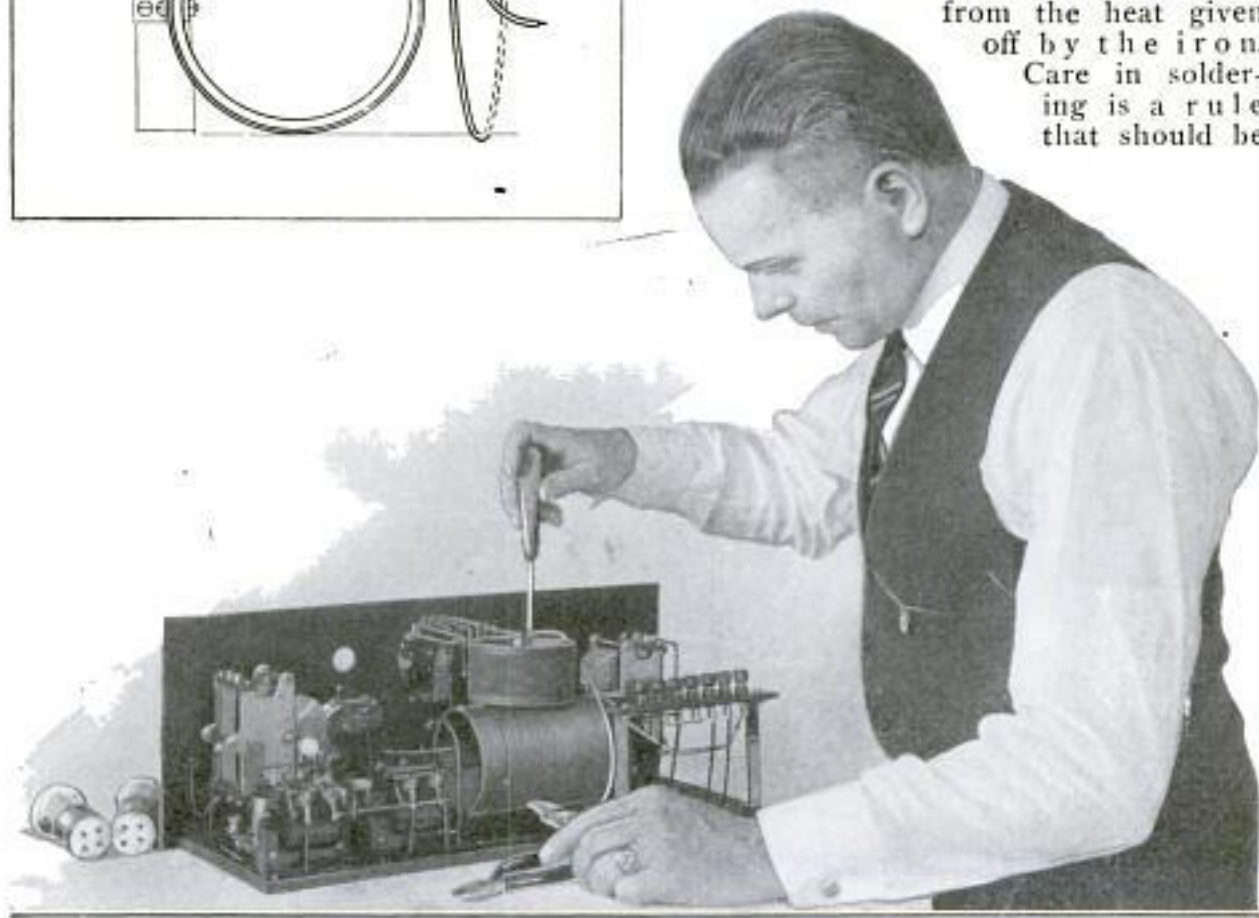

Top, Template for Panel; Center, Connecting Wires from Upper Coil to Switch; Below, Assembling the Set

ever-present in the mind of the radio builder.

Cut the wire for the circuit, after bending it to the proper shape, to make the connections from instrument to instru-

strument, place the inductance-switch lever on any point and rotate the condenser dials slowly until a station is located. If no station is located at this setting, move the inductance switch one

MATERIAL LIST

- | | |
|--|---|
| 1 precision Cockaday coil. | 1 grid condenser, .00025 mfd. |
| 1 bakelite, radion or formica panel, 3-16 by 7 by 18 in. | 10 ft. black spaghetti tubing. |
| 2 audio-frequency transformers, ratio 3 to 1. | 1 lb. coil No. 14 tinned-copper wire. |
| 3 sockets, standard type. | 3 doz. tinned-copper soldering lugs. |
| 1 filament switch, push-pull type. | 1 baseboard, $\frac{1}{2}$ by 6 $\frac{1}{4}$ by 17 in. |
| 2 rheostats, 6-ohm. | 2 3-in. dials. |
| 1 back panel-mounting inductance switch, 9-point. | 7 binding posts. |
| 2 variable condensers, .0005-mfd. capacity. | 1 strip of bakelite, 3-16 by $\frac{3}{8}$ by 7 in. |
| 1 open-circuit jack. | 2 brass brackets, 4 in. long. |
| 2 double-circuit jacks. | 1 UV-200 or C-300 tube. |
| 1 grid-leak mounting. | 2 UV-201A or C-301A tubes. |
| 1 grid leak, 2 megohm. | 2 45-volt B-battery units. |
| | 1 6-volt storage battery. |

ment as direct as possible, taking care not to make any of the grid or plate leads parallel. Where it is necessary to cross these leads, do so at right angles. The reader will note that the grid leak has its individual mounting, owing to the fact that the leak is not used in the usual manner across the grid condenser. The usual grid condenser with the grid-leak clips is, therefore, not used. Soldering lugs are secured to the .00025-mfd. grid condenser by means of two short brass machine screws and hexagon nuts. Never attempt to solder a lead directly to the fixed condenser, as the heat from the iron will ruin it. The safest method is to solder the lugs to the wire first and then attach the lugs to the condenser with the screws. Do not solder the leads to the inductance switch until all other wiring has been completed. Examine the terminals from the upper and lower coils of the coil unit and see that they correspond with the diagram, and follow the leads from the ends of the coils so that the connections to the circuit are the same as those shown in the circuit diagram.

The circuit is now completed and the builder should retrace all of the leads and check them carefully. The single turn of heavy copper wire should fit closely to the end coil on the lower tube and can be adjusted for best results when the set is in operation. The receiver should then be tested.

Connect all A and B-batteries before putting the tubes in the sockets, and also the aerial and ground. Use an ordinary outside aerial, from 75 to 100 ft. long, and a good ground to a cold-water pipe. A UV-200 or C-300 tube is used for the detector and two UV-201A or C-301A tubes for the amplifiers. To tune the in-

point, and rotate the condenser dials as before. Some detector tubes give better results with a 3-megohm grid leak than with the 2-megohm, and it is a good idea to try both. The phones plugged into the detector jack will give sufficient volume on local stations; on more distant stations the first step of amplification will be required with the phones. The second step is for operating the horn or loud speaker, and the volume is too great at this stage to permit the use of the headphones. When selecting the parts to build this receiver, buy the best, as the best is always the most economical in the long run, and this applies to any type of radio receiver. A 7 by 18-in. cabinet can be obtained from any dealer in radio supplies, and the appearance of the panel can be improved by engraving it to suit the needs of the builder. The reader will note in the photo of the finished receiver that special vernier dials were used. These dials are not absolutely necessary, but they do aid in the tuning of the instrument because they afford a means of very fine control of the condenser.

Aerial Insulator of Special Glass

45% Efficient and Clean

A special pyrex glass insulator for aeri- als with a high surface finish that does not tend to accumulate soot and atmospheric dust has lately appeared on the market. The insulator has very high insulating properties, and does not absorb moisture. These insulators are made in three types, for commercial transmission, for amateur transmission, and a smaller type for broadcast reception. All three types possess the same characteristics, the difference being in size only.

The Corning Glass Works, Corning, N.Y.
Copyrighted material

Radio

471-A

Tools That Aid in Building Sets

SET building is a pleasure when the proper tools are used, but when the amateur attempts to build a set with a screwdriver, a pair of pliers and an ice pick, he is apt to run into difficulties. Not that the last-mentioned tool isn't useful—it is—but the job is so much easier with the tools that have been developed to help the radio fan in his work, that he should be familiar with them.

Two excellent tools are shown in Figs. 1 and 2. The first is a cutter for making peepholes in panels. It is made in three sizes, $\frac{3}{4}$, 1 and $1\frac{1}{2}$ in. in diameter. All are fitted with $\frac{7}{16}$ -in. pilots, and all that is necessary is to drill a hole of this size at the proper location on the panel,

put the cutter in a brace, insert the pilot in the small hole and proceed to cut out the hole. The larger sizes are useful for cutting holes in the subpanel for tube sockets. Fig. 2 shows a tool that will put a professional finish on the peephole. It is made in two sizes, $\frac{3}{4}$ and 1 in., to suit the cutters mentioned above. The beader, as the tool is called, finishes the edge of the hole as shown in the photo.

In Figs. 3 and 4 is shown a tool that will appeal to every builder who has tried to lay out the holes for a condenser or other part without a template. The three arms can be adjusted so that the points fit the mounting holes in the instrument. The shaft of the latter is put through its

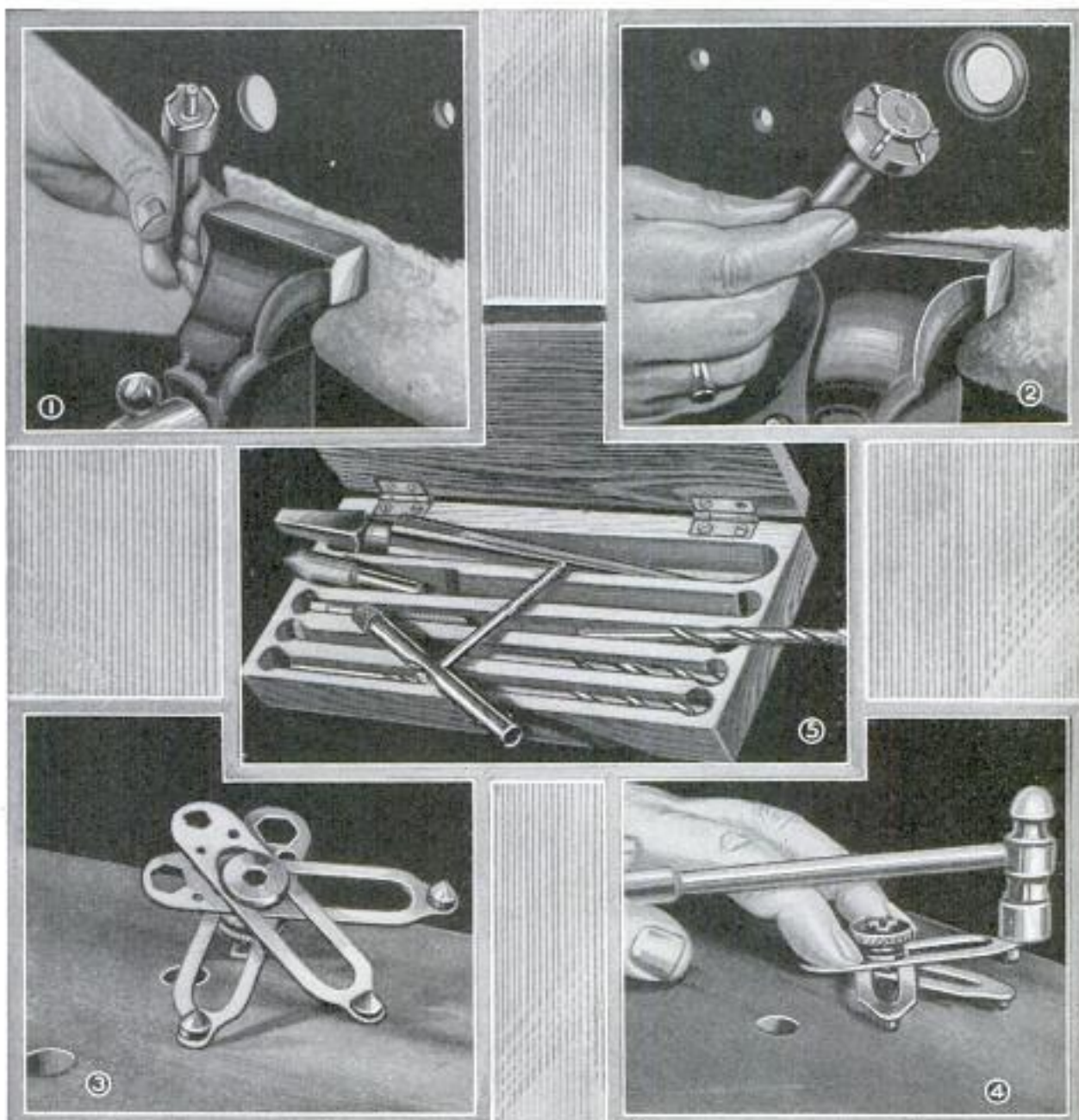

5. Butterfield & Co., Liberty Line, U.S.

Clever Tools for the Radio Builder That Aid in Drilling and Finishing Peepholes and Socket Holes; Drilling and Tapping Panels, and Marking Off for Various Instruments

1 + 2 Stevens & Co., 375 Broadway, New York
3 + 4 Service Radio Appliance Co., 541 W. Superior, Chicago

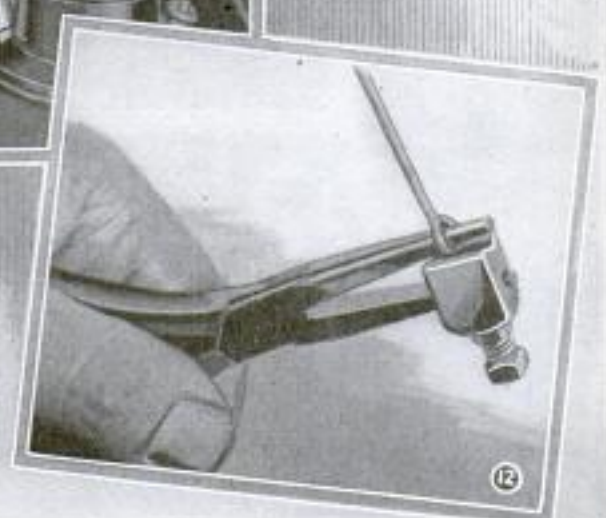
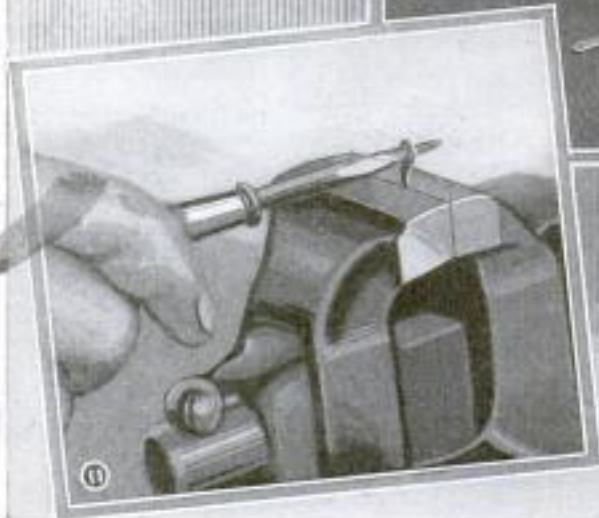
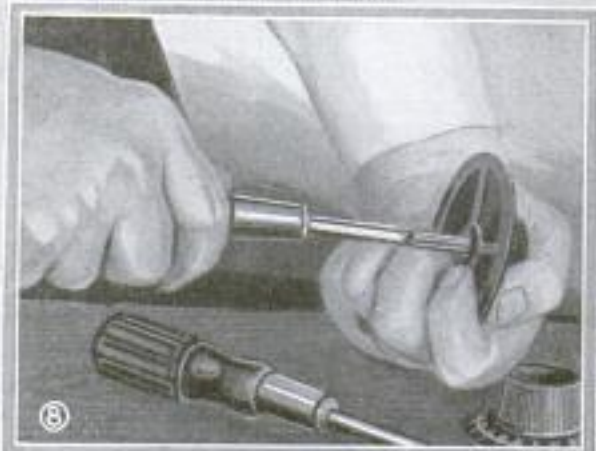
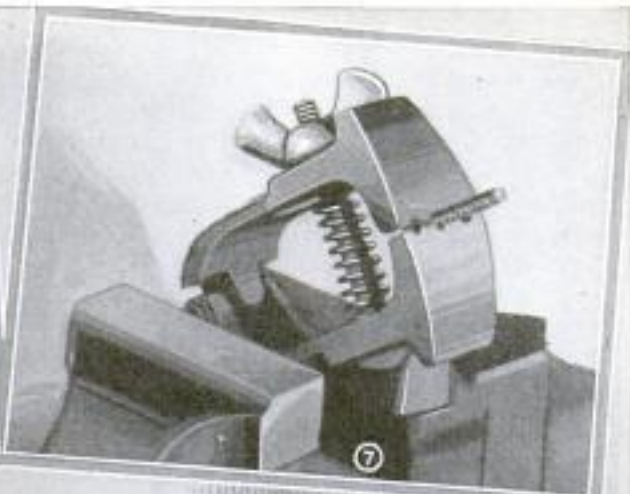
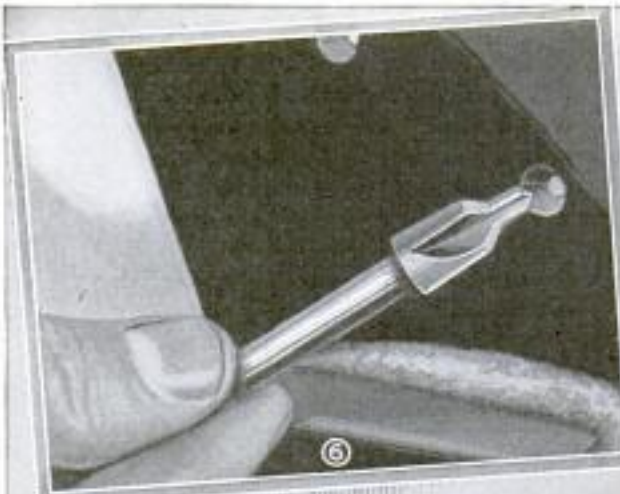

Tools for Drilling and Countersinking in One Operation; for Holding Screws to Be Cut to Length; Reaming D's and Panels; Tightening Socket and Similar Screws; Reaming Small Work to Size; Bending Loops and Special Perms in Wire, and Many Other Operations

All Stevens & Co.
137 50 Broadway
New York

Copyrighted material

hole, the tool slipped over it, and, with three taps of the hammer, the holes are marked exactly. The arms also have holes that serve to gauge drills for clearing holes for various sizes of taps and the tapping sizes. Hexagonal holes in the ends of the arms form convenient wrenches for various standard nuts on radio instruments. A convenient screw plate is shown in Fig. 5. The set contains No. 6-32 and 8-32 taps, tapping and clearing drills for these sizes, a small tap holder, a countersink to fit flat and oval-head screws, and a taper reamer, and will prove a worth-while addition to the tool kit.

A tool that drills a hole for a No. 6-32 machine screw and countersinks it in one operation is shown in Fig. 6. The tool shown in Fig. 7 will appeal to the fan who has ever tried to cut off a small screw that was too long for his purpose. It is a small vise with three tapped holes in the jaws. The screw to be cut or filed is held in the proper hole and cannot slip or be marred in any way. It fits No. 6, 8 and 10 screws, 32-thread, and the hardened jaws may be used as rethreading dies, if necessary. Figs. 8 and 9 show tools for which there is constant use. The first is a small parallel reamer that is used to clear out holes in dials to the proper size for the instrument shafts, and also to ream holes in jacks that are too tight for the plugs. The second is a taper reamer with a

helical cutting edge that produces a true round hole in metal, bakelite, hard rubber, wood, etc., without digging in or chattering. A reamer of this type should be in the kit of every radio builder.

It is quite a job, in many sets, to tighten or loosen the binding-post nuts on transformers, tube sockets and other instruments. If pliers are used they are apt to slip and mar the nuts and, besides, the instruments are many times mounted in such a position that the pliers cannot be applied. In such cases the socket wrench shown in Fig. 10 will prove of value. This is made like a screwdriver, and the sharp teeth of the socket are spiraled and tapered so that they take a firm grip on the round nuts. They are made in three sizes to take all types of round radio nuts.

Another simple, but very handy reamer is shown in Fig. 11. This is square in shape and tapered so as to form four cutting edges. It can be used for reaming holes in lugs and washers, starting screws in hardwood, and as a scribe, to mention only a few of its possibilities. Equally handy is the attachment shown in Fig. 12. This is a little tool intended for forming loops on busbar and similar wires. In use, it is simply slipped over one jaw of a pair of round-nose pliers, and it will form eyes of any desired size in the wire. It will also bend special forms in the wiring of the set quickly and easily.

420-R

Radio Receiver Has Remote Control

A receiver with remote control has made its appearance in England. This arrangement permits the operator to control the volume of the loud speaker while seated at a distance from the instrument.

A flexible cord leads from the set to the control device, which is held in the operator's hand; by turning a knob the volume of sound can be increased or decreased. The device consists of a rheostat which controls the filament of the detector tube, no other rheostat being

used on this tube, and the control unit at the same time actuates a relay, inside of the receiver, which completes the circuit to the other tubes. The receiver has seven tubes and uses three steps of radio-frequency, detector and three steps of audio-frequency amplification.

As soon as the lever of the device is moved from the zero position, it completes the circuit to all the seven tubes and when further rotated increases the filament current to the detector tube only. The other six tubes are controlled by separate rheostats, after the circuit is completed.



Remote Control Permits Adjustments from Any Part of Room; Insert, Control Unit

Cont. A. R. Aldroyd, 127 Abbey Road
Barrow-in-Furness, England

469.2

Cont. Will H. Bates
5544 W. 1st St. Chicago

A Selective Crystal Receiver

By WILL H. BATES

THE crystal receiver described in this article can be built for less than \$5, not including the cost of the phones. A good pair of 2,000-ohm phones, however, can be obtained for from \$3 up. This circuit gives excellent volume and has exceptional selectivity. The lack of selectivity in ordinary crystal receivers is well known to those who have built them, and this circuit is an agreeable surprise. During the test, in Popular Mechanics laboratory, this little set demonstrated its ability to tune out any of the Chicago stations at will. This is unusual, and offers a basis for further experimentation. When used with the one-tube amplifier and loud-speaker unit described and illustrated in the first article in this section, the volume on local stations was sufficient to fill a large room. The panel can be of any insulating material and is $\frac{3}{16}$ by 7 by 8 in. in size. The center of the panel is drilled to receive

board and the other to a small wood block fastened to the back of the panel, at a point just at the rear of the crystal detector. The block is fastened to the panel of the detector-mounting screws, and the brass strip is screwed to the block.

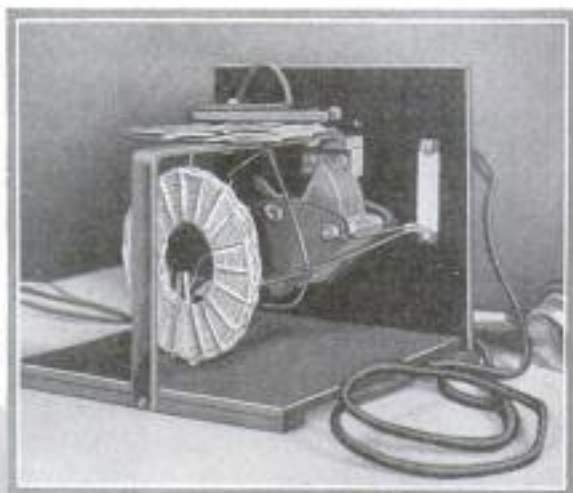

A wiper arm is mounted on the brass strip just in front of this block; the arm consists of a tapered strip of wood, $\frac{3}{16}$ in. thick by $3\frac{1}{4}$ in. long. A hole is drilled in the small end and another near the front to permit a short length of No. 18 insulated wire to be threaded through the arm. The wire is bared

at the end of the arm and doubled over to form a smooth wiping contact. This is shown in the sketch. The other end of the wire is connected to the aerial binding post, leaving sufficient slack to permit the arm to move freely. A hole is drilled in the front end of the arm and the assembly mounted on the brass strip by means of a small brass machine screw and two fiber washers; a locknut is placed on the mounting screw. This method of mounting the arm permits the wiper contact to be moved across the wires of the coil.

The coils are homemade, the upper coil being wound on a fiber form, $4\frac{1}{2}$ in. in diameter. This form can be cut from heavy cardboard if desired. No. 22 cotton-covered wire is used for this coil and 60 turns are wound on the form. Leave a

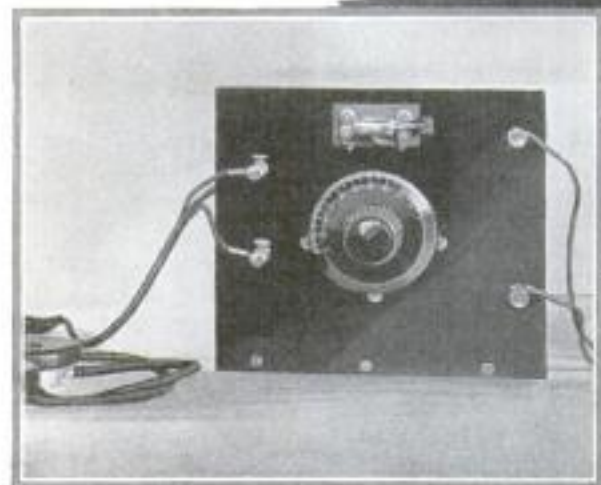

Above, Rear View of Completed Set, Showing How the Coils Are Mounted; Below, Front View of Set

the shaft of the 21-plate variable condenser, the screws of the crystal detector, and the binding posts for the phones, aerial and ground. The baseboard is $\frac{3}{8}$ by 8 by 8 in., and is fastened to the panel by means of three oval-head wood screws. A brass strip, $\frac{1}{8}$ by $\frac{5}{8}$ in., is used to mount the upper coil and also strengthens the panel and baseboard assembly; this strip is drilled at each end for the mounting screws. One end is screwed to the base-

6 or 8-in. length of wire, when starting to wind the coil, and wind the wire over and under each segment of the form. The finishing end of the wire is fastened to the outer edge of the form by passing it through a small hole. The coil is then mounted on the strip by means of a small brass machine screw and fiber washer, in the position shown in the photo. The insulation is then bared across one arm of the coil for the wiper arm.

The lower coils are wound on a different type of form, and in a slightly different manner. The method of winding these coils will be seen in the illustration. A large wooden spool is used, the spool is cut in half, and the flange is drilled to take 19 twelve-penny nails, the holes being just large enough to take the ends of the nails snugly. Both of the lower coils are wound on this form and No. 22 cotton-covered wire is again used. The 10-turn coil is wound on the form first; be sure to leave an end several inches long on starting the coil, then wind the wire on clockwise, running it under two nails, then over two, and so on. After the 10 turns are wound, leave an end 8 or 10 in. long and cut the wire. The second coil of 60 turns is then wound in the same direction on the same form, leaving a starting end of the same length as before. After the 60 turns are completed, cut the wire, leaving a loose end several inches in length. Now press the coils firmly together on the nails, and carefully remove all of the latter. Lay the coils flat on a table, and with a large darning needle, threaded with heavy white cotton thread, bind the

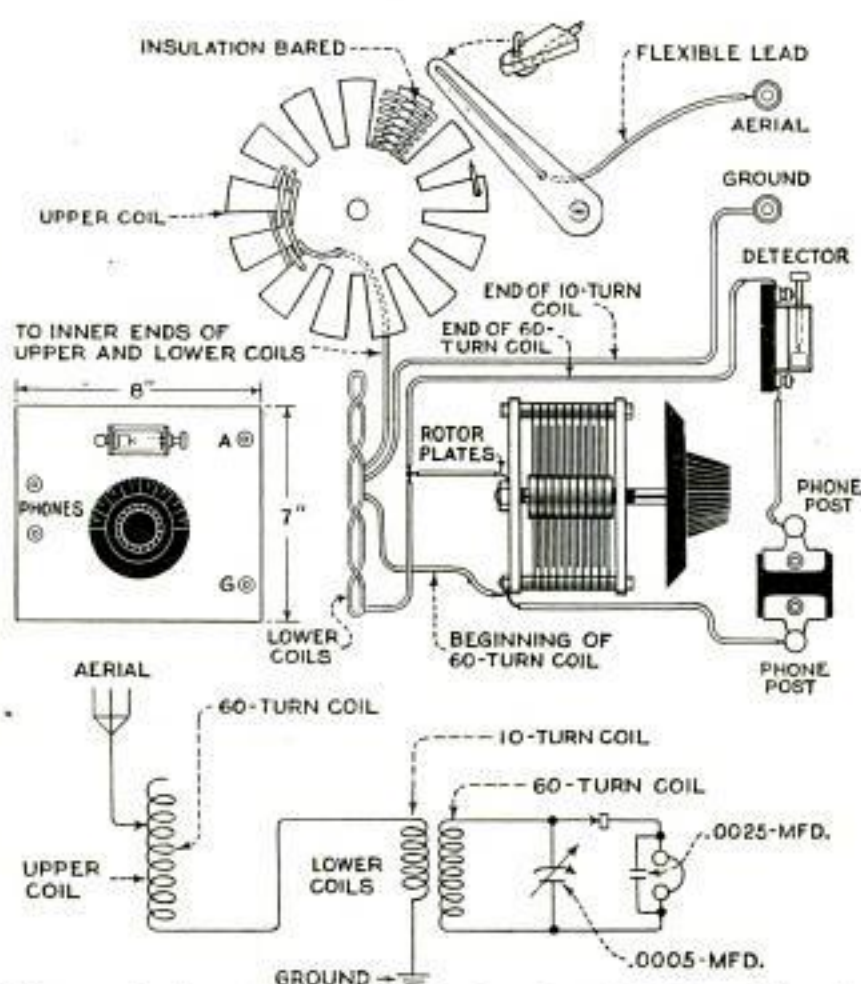
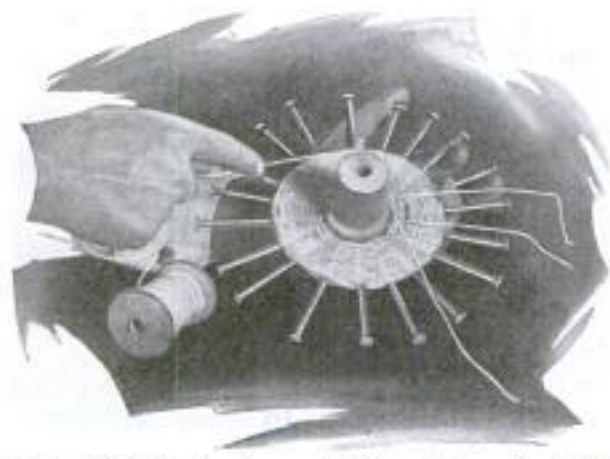

Diagram of Connections of the Selective Crystal Receiver; Schematic Diagram and Panel Template

coils together. This is done by running the needle through each section of the coil, bringing the loop of thread to the top, cutting it off, tying a knot in the thread, and clipping off the ends. This holds the coils in position. The finished coil has a neat appearance, and is fairly strong.

A small wooden dowel pin of the same diameter as the nails is used to hold these coils upright on the baseboard, under the upper coil. The wooden pin is fitted in a hole in the baseboard, and the coil is mounted on the pin. The position of the lower coils is shown clearly in the photo of the completed set. The .0025-mfd. fixed condenser is then mounted on the back of the panel across the phone binding posts, and the set is ready to wire.



Method of Winding Lower Coils on Form; the Nails Are Removable

The first turn of the upper coil is connected to the first turn of the 10-turn coil below. The other end of the 10-turn coil is connected to the ground binding post. The first turn of the lower 60-turn coil is taken to the stationary plates of the variable condenser and also to the phone post. The end of this coil is connected to the rotor plates of the variable condenser, and to the catwhisker of the crystal detector. The other side of the detector is connected to the remaining phone post, and the set is ready for operation.

To operate, use an ordinary outside aerial and a good ground to a water pipe.

Connect a pair of 2,000-ohm phones to the phone posts. The stations are located by moving the wiper arm across the upper coil, and tuning in the station with the variable condenser.

The following materials are needed:

- 1 bakelite panel, 3-16 by 7 by 8 in.
- 1 baseboard, $\frac{3}{8}$ by 8 by 8 in.
- 1 brass strip, $\frac{3}{8}$ by $\frac{3}{8}$ by 15 in.
- $\frac{1}{2}$ lb. No. 22 cotton-covered wire.
- 1 crystal detector, panel-mounting type.
- 1 .0005-mfd. variable condenser.
- 1 3-in. dial.
- 1 .0025-mfd. fixed condenser.
- 4 binding posts.
- 1 fiber disk or spider-coil mounting, $\frac{1}{2}$ in. in diameter.
- 1 large spool.
- 19 twelve-penny nails.

Automatic Radio "Switchboard"

A new automatic switchblock, that provides series connections for five sets of headphones, is now available.

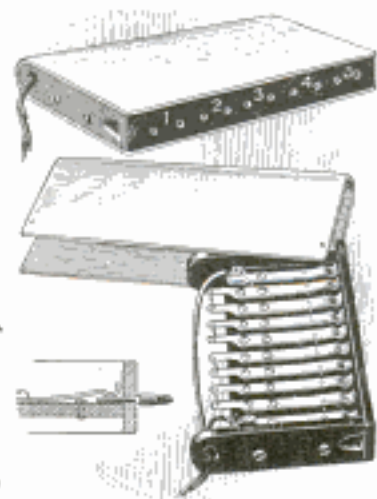

Two terminals in the switchblock are connected to the plug or phone-post leads from the receiver, and the tips of the headset are inserted into the jacks. The two jacks for each set of phones are indicated by numbers on the block.

Headsets can be connected or removed at will, and the action of the switches automatically keeps up the series connection. The block is fitted with a heavy aluminum cover. It is claimed that five sets of phones can be used with very slight reduction in the volume of reception. The terminals of the switchboard permit any type of cord tips or bare wire ends to be connected.

Hot Iron Shorts Fixed Condensers

A common source of trouble encountered by the radio experimenter lies in short-circuited fixed condensers. As a rule trouble shooting in a receiver begins at the larger instruments, such as the transformers, variable condensers, tube sockets, and jacks. Much time can be saved by first examining the fixed condensers. These are very delicate and will not stand excessive heat from the soldering iron. If lugs are not provided with

the condenser they should be supplied by the builder, and the connecting wires soldered to the lugs. Use short 6-32 machine screws for attaching the lugs to the condensers.

"Spaghetti" in Liquid Form

Put on with a brush like paint, a new liquid "spaghetti" dries quickly and forms an excellent insulation. It has been found well adapted for covering soldered joints to prevent corrosion, and is also claimed to be superior to varnished-cambrie tubing for covering wires, as it prevents condensation on the wire and does not deteriorate with age. It can be used for cementing wire in forms, and for coloring small electric lamps.

Portable Lamp Illuminates Radio Set

A portable lamp that can be quickly attached to any radio set, eliminating all shadows and glare, is now available.

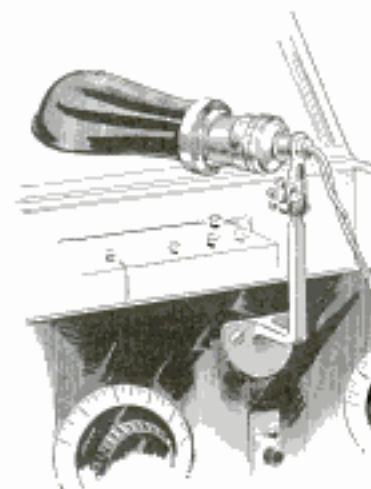

Exact dial settings are somewhat difficult with ordinary room lighting, and this little lamp is therefore a welcome addition to the modern radio receiver. The ball joint affords easy adjustment and permits the operator to turn the lamp so as to illuminate the interior of the set if he desires. The small thumbnut allows the light fixture to be detached.

*The C. P. White Co.,
19 Kerman St.
Worcester, Mass.*

*464-02
453-05
466-11
475-01
Sunter Radio Mfg. Co.
S. C.*



All Shop Notes published in 1924, in book form—Fifty Cents—from our Book Department

Trailer Hoist for Contractors

By G. A. LUERS

THE trailer hoist described in this article has been built by an eastern contractor, who uses it for two purposes. Attached to the rear of a tractor, the base affords a small trailer on which materials may be carried to and from the job; once at the place where the work is to be done, the load is removed, and the hoist is available for work.

The wheels were taken from an old horse-drawn truck and are made of steel, with broad tires. The whole space inside the tires is filled with concrete, to add to the strength. The wheels are mounted on a substantial steel axle, which is bolted to the underside of the triangular frame

of the trailer. The rear member of this frame, to which the axle is bolted, is built up of flat steel, and the front members are also bolted to it; the latter are made of wood, as indicated in the drawings, and are fitted with a simple coupling, so that the trailer may be attached to the drawbar of the tractor by means of a pin.

The wooden mast is pivoted on a steel plate at the center of the rear member of

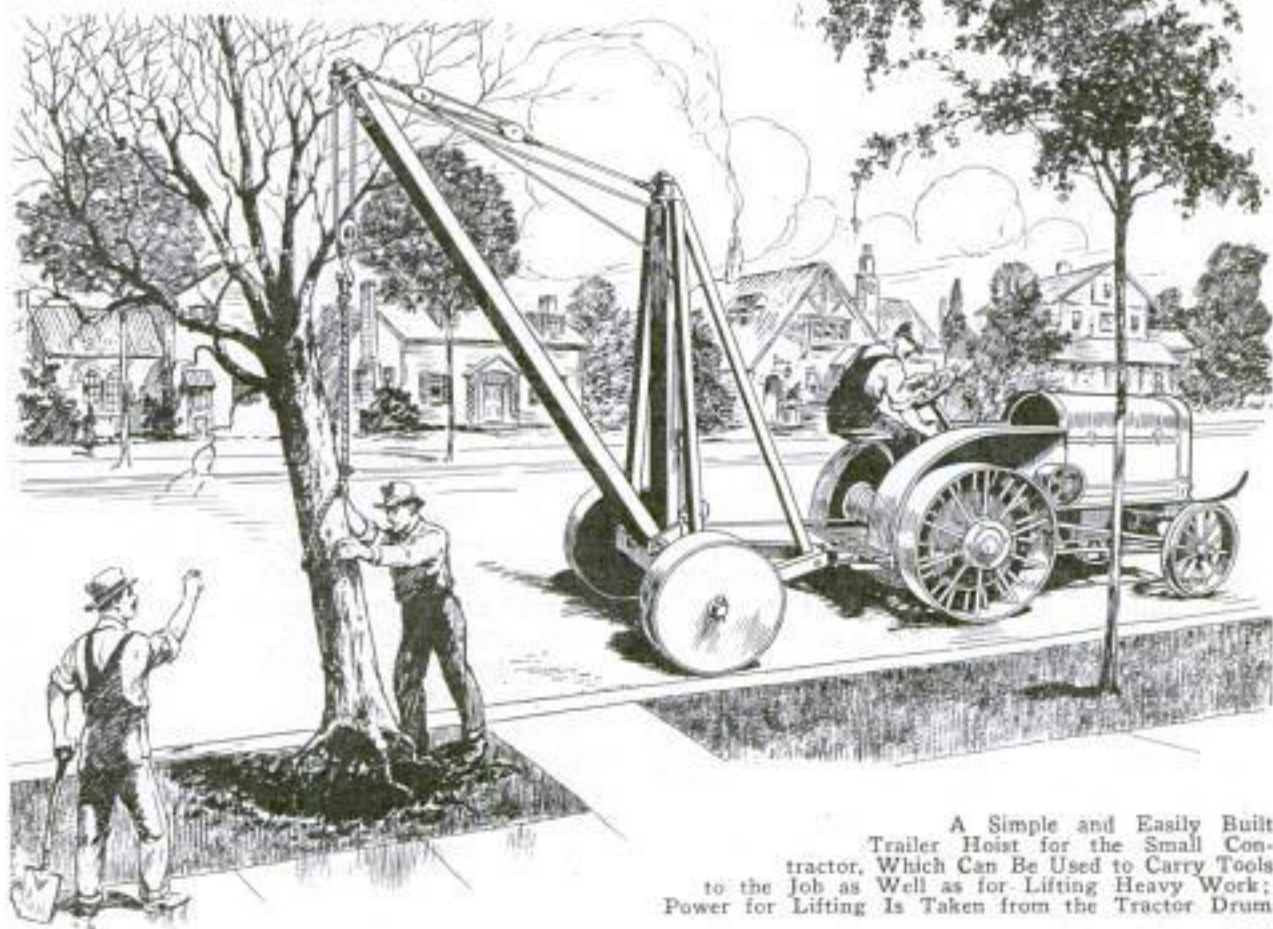

A Simple and Easily Built Trailer Hoist for the Small Contractor, Which Can Be Used to Carry Tools to the Job as Well as for Lifting Heavy Work; Power for Lifting Is Taken from the Tractor Drum

the frame, and is stayed by means of a length of structural iron on each side. These are bolted to the frame at the bottom, and are bent and bored at the top to rest over the upper pivot of the mast. Another stay runs from the top of the mast to the front of the frame. The mast is slotted near the top to take a pulley, mounted by means of a pin driven through a hole bored in the mast. A small pulley is fastened to the side of the mast a little below the large pulley, and on the same side, near the bottom, a rope cleat is screwed. At the bottom of the mast, on the front side, a large pulley with a swivel mounting, is mounted. The top and bottom of the mast are rounded, and iron bands are shrunk over the rounded portions, to prevent the mast from splitting. The pivots are of steel, driven into holes in the mast ends.

The boom is pivoted between two flat steel plates bolted near the bottom of the mast. The boom also has two steel plates bolted on each side at the bottom, to strengthen it and to prevent wear at the

pivot. The upper end of the boom is rounded like the ends of the mast, and an iron ring shrunk on to prevent splitting. It is also slotted for a pulley, as shown.

One end of the fall is fastened to the top of the boom; the other end is rove through the tackle block, through the pulley slot in the boom, over the pulley in the top of the mast and under the swivel pulley at the bottom; thence it runs to the winding drum on the tractor. The tackle for adjusting the height of the boom is rigged as shown in the drawing, and the end of the fall from the tackle is fastened

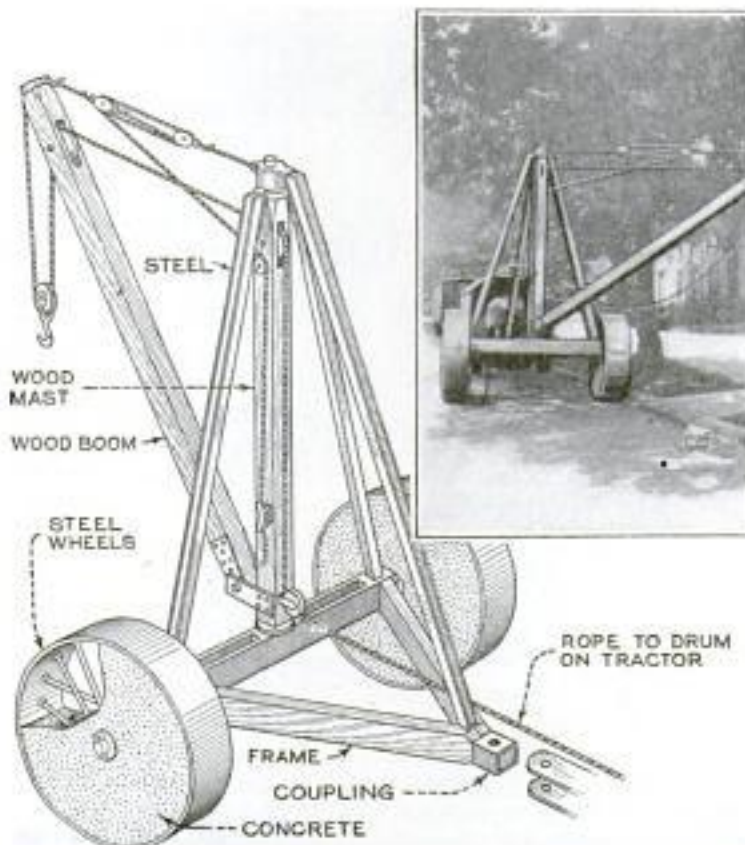

Above, Photo of the Trailer Hoist on the Job; Below, Perspective View of the Hoist, Showing the Lifting and Boom Tackles

around the cleat on the mast. The boom is raised and lowered by hand, although it can be done by power from the tractor if desired, in the same manner as the load is lifted.

The entire construction is simple, as the parts are easily assembled, and the hoist is capable of a wide range of work. It will form a useful piece of equipment for the small jobbing contractor in a variety of lines.

Mixing Soils

The best soil for agricultural purposes is one that has approximately equal proportions of clay, silt, sand and humus, and if a smaller amount of any of these constituents is present the value of the soil is correspondingly less. In many cases soils that are deficient in one or more of these constituents can be improved by the addition of other soils having an oversupply, but this method of improvement cannot always be adopted, as the cost is sometimes so high as to make it prohibitive.

It would seem, at first sight, that clay

and peat soils could be improved considerably by the addition of sand. Clay is cold and cannot be penetrated easily by air or water, a quality that sand would tend to correct. Peat and muck soils are subject to great extremes of temperature, that is, they warm up rapidly by day and cool off rapidly by night, and the addition of sand seems to be the proper remedy. Application of moderate amounts of sand does not produce permanent results, as the clay and muck seem to swallow up the sand within a short time after it is applied. Only the application of considerable amounts of sand is helpful, and this is in

most cases too expensive a solution, as the transportation of sand is very costly, which makes it impracticable for most farmers. If a bank of sand is close at hand so that a large quantity can be easily obtained, this method of improvement will give satisfactory results. Sometimes, however, the value of the land is so great that it pays to spend a large sum to cover it with sand. This usually holds true in the case of a productive cranberry bog, for example, which should be covered with a layer of sand, 3 or 4 in. thick. In this case the sand should not be mixed with the soil of the bog.

Soils that contain too much sand can be bettered by the addition of clay, and it has been found that this method of improvement is, on the whole, much more practical than sanding; it requires far less clay to improve a sandy soil than it takes sand to improve a clay soil, 40 to 60 loads of clay per acre being enough to improve light, sandy soils permanently.

Humus or organic matter can be supplied to soils deficient in this constituent by the addition of peat or muck, or by green manuring, that is, growing a crop and plowing it under. Applying peat and muck is preferable if a supply is close at hand and it can be obtained conveniently. Besides improving the soil physically the addition of muck and peat, which contain a considerable amount of nitrogen, also improves it chemically by enriching it with this element. The muck or peat should be thrown in piles so that the water will evaporate. The material can then be distributed.

Using Jack for Vise

Simple repair jobs on the road are usually easy for motorists having elaborate repair kits, but even these do not always include a vise, which is so often needed. It will be useful, therefore, to know that the jack can be made to serve as a substitute. It is set up under the running board, and the work to be repaired held between the two by raising the jack, as shown.—W. M. Wailes, Jr., Washington, D. C.



Checking Railroad-Section Gangs

Daily activities of railroad-section gangs are rather difficult to check, but with the aid of the peg post shown in the photo, which serves as a sort of daily time clock, this difficulty has been overcome by a Mexican railroad. The posts are located at the division point between two sections and the numbers of these are painted on a metal plate fastened to the top of the post. Seven holes are drilled on each side of the post to represent the days of the week, the top one representing Sunday, the second Monday, and so on, and two black pegs, one for each side, are provided to fit the holes. When a gang has completed its work on the section and arrives at the post marking the end, it is the duty of the foreman to place a peg in the hole representing the day that the work was completed. Similarly, he places a peg in a hole on the other side, representing the next section, when the work is begun here. The posts are painted white so that the black pegs show very distinctly, enabling trainmen, division superintendents and other railroad officials to keep a constant check on the section gangs.—J. E. Hoag, Los Angeles, Calif.



Filing without Scratching

When filing, small particles of metal adhering to the file cause scratches on the work. This trouble can be prevented by chalking the file after cleaning it. Powdered chalk may be used and rubbed on with the fingers or a large piece of lump chalk rubbed over the file.—Dominic G. Kollros, St. Mathews, Ky.

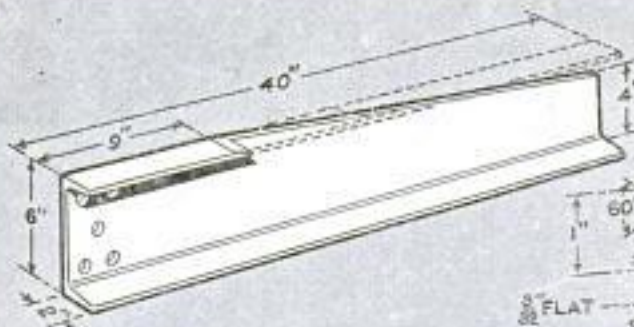

DETAIL OF ARM

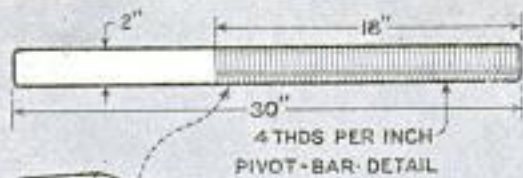

PIVOT-BAR-DETAIL

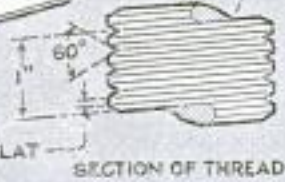

SECTION OF THREAD

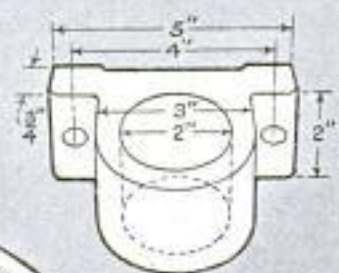

PIVOT BEARING, CAST IRON, 2 REQUIRED

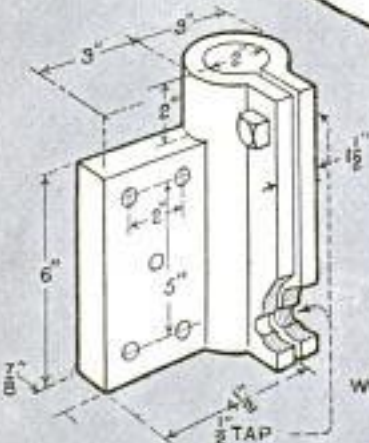

ARM BEARING, CAST IRON

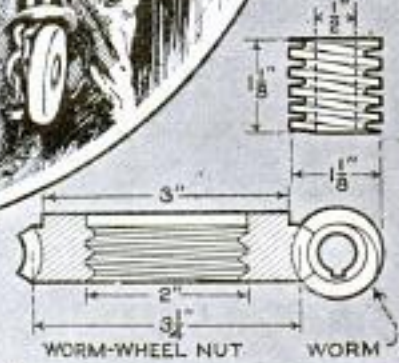

WORM-WHEEL NUT WORM

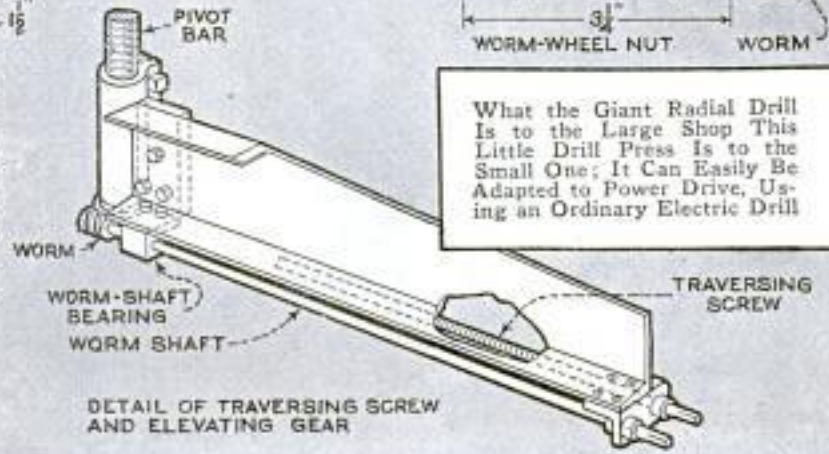

DETAIL OF TRAVERSING SCREW AND ELEVATING GEAR

What the Giant Radial Drill Is to the Large Shop This Little Drill Press Is to the Small One; It Can Easily Be Adapted to Power Drive, Using an Ordinary Electric Drill

A Radial Drill Press for Small Shop

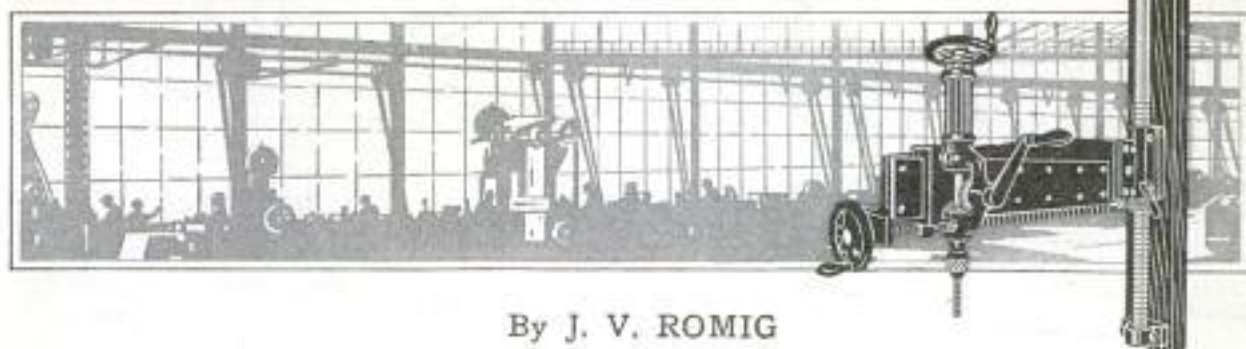

By J. V. ROMIG

MOST mechanics, while appreciating the value of the radial drill press in the large shop, and realizing what a help such a tool on a smaller scale would be in the small experimental shop, look upon its construction as beyond the scope and capacity of the small shop. Such is not the case, however, as a glance at the accompanying drawings will prove. In this design, the machine work necessary has been reduced to the minimum, and all of it is within the capacity of a shop equipped with a good lathe. A drill press of this type is capable of a much wider range of work than the ordinary post drills and bench drill presses found in the small shop. As it can be swung back against the wall when not in use, it can be used where bench room is limited; it will drill holes anywhere within a 38-in. radius from the pivot bar, and thus is of special advantage on sheet-metal work, on heavy jobs that cannot be handled easily on account of their weight, and where holes

must be drilled in the center of pieces of large diameter.

The arm is made of 6-in. channel iron, cut to the length shown in the drawing, and with one flange cut away for a portion of its length. To the rear end is bolted a casting that forms the pivot bearing; the dimensions of this bearing are given in a detail, and it is split and fitted with capscrews and a clamping lever. The slide for the drill head is made of a 36-in.

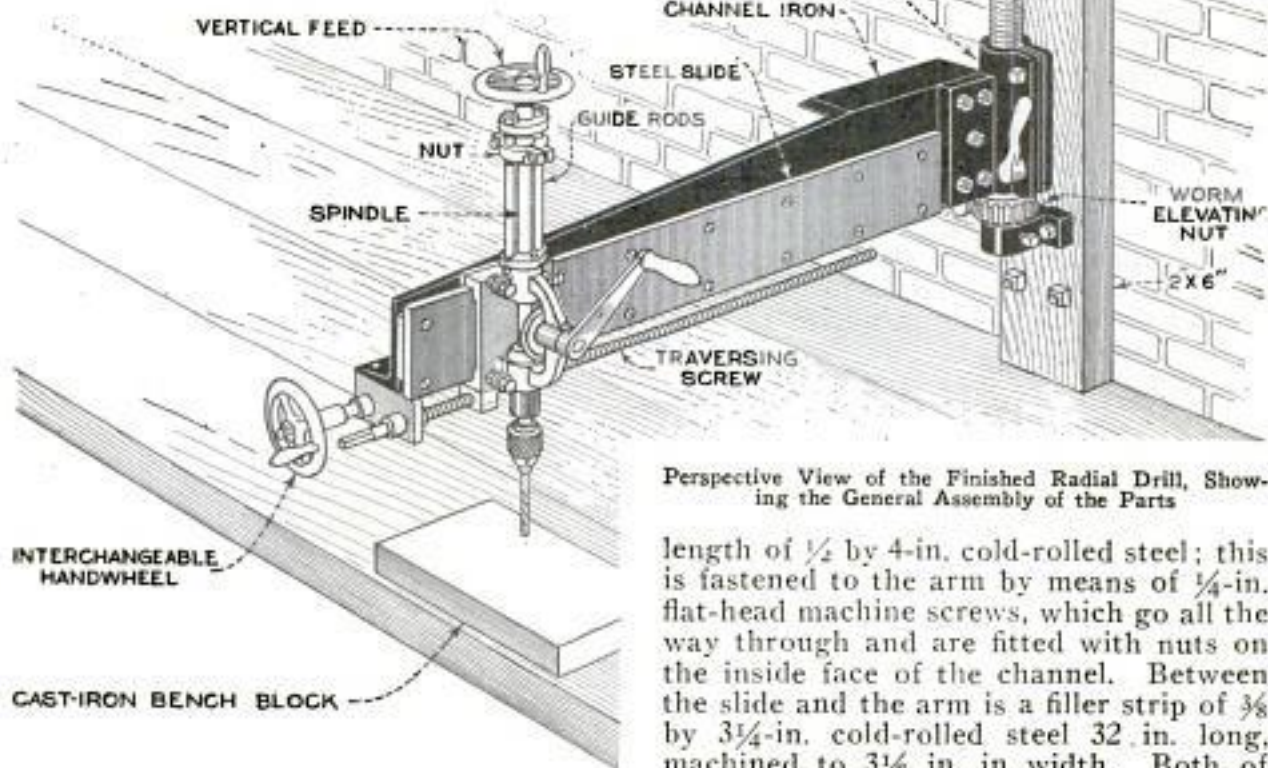

Perspective View of the Finished Radial Drill, Showing the General Assembly of the Parts

length of $\frac{1}{2}$ by 4-in. cold-rolled steel; this is fastened to the arm by means of $\frac{1}{4}$ -in. flat-head machine screws, which go all the way through and are fitted with nuts on the inside face of the channel. Between the slide and the arm is a filler strip of $\frac{3}{8}$ by $3\frac{1}{4}$ -in. cold-rolled steel 32 in. long, machined to $3\frac{1}{8}$ in. in width. Both of

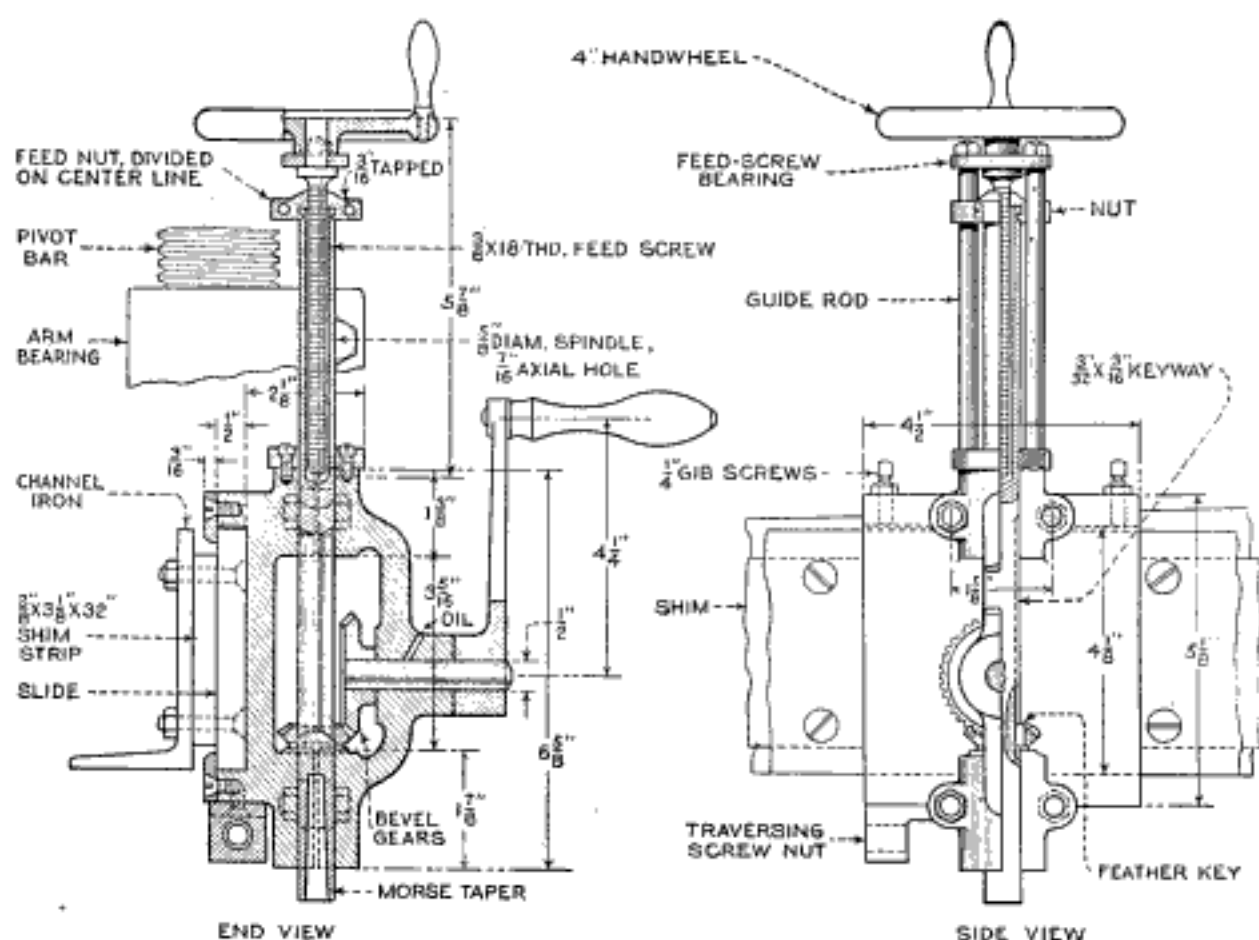

DRILL-HEAD AND SADDLE DETAILS

Details of Construction and Assembly of the Drill Head or Saddle; Bronze Bushings May Be Fitted to the Spindle Instead of the Plain Bearings Shown

these cold-rolled pieces must be very carefully straightened and the edges scraped true. It is also necessary to take care that the slide and the pivot bearing are square with each other.

The pivot bar is made of 2-in. cold-rolled steel, threaded for 18 in. of its length. The thread is of sharp V-form at the bottom, but flattened on top, as shown in the detail; this provides a surface for the bearing, while not interfering with the function of the screw. The worm wheel is used to elevate the arm to the desired height; it is made of bronze to the dimensions given, and is actuated by a steel worm on a shaft extending to a bearing on the front of the arm. The pivot bar is held against the wall by pinning it in bearings at each end, which, in turn, are bolted to a stout stringer fastened to the wall by lag screws or expansion bolts. A plumb bob is used to set the bar exactly vertical on the wall. When in use, the arm may be held fast in any position on the pivot bar by means of the clamp screws.

The drill head, or saddle, is a casting, machined to fit on the slide and drilled and bored for the drill and hand-crank

spindles. The bearings are split; the front half of the casting also has the bearing for the crank spindle. A suitable pair of bevel gears, of 1 to 1 1/2 ratio, are purchased, and the larger gear is pinned to the crank spindle, as also is the crank handle; the spindle is 1/2 in. in diameter, and the bearing is drilled for an oil hole as in the drawing. The small gear is fitted with a feather key, and, when in place on the spindle, rides on a fiber washer. The spindle is turned from good machinery steel, and is bored at the lower end to No. 1 Morse taper. A groove is turned in the upper end to take the feed nut, and a 7/16-in. hole bored axially to clear the feed screw. The groove is highly finished. The feed is effected by means of a split nut of novel design, which is a nice running fit in the groove in the spindle and is threaded internally to fit the feed screw. It is prevented from turning by two guide posts, one on either side, the posts also supporting the top bearing of the feed mechanism. The nut must slide freely on the posts, and is provided with an oil hole. The posts are screwed into a steel collar which is fastened to the top of the upper spindle bearing; a similar collar forms the

upper feed-screw bearing, and to the top of the screw is pinned a small handwheel. The spindle bearings can be fitted with bronze bushings if desired; and this is, in fact, preferable, as it will add to the life of the machine.

The top of the upper saddle slide, bearing on the rail, is tapped for two $\frac{1}{4}$ -in. set-screws, which are used to adjust the gib to the slide. The gib is made of sheet brass, bent up at each end to prevent it from coming out, and both the upper slide and the gib should be drilled for oil holes. A brass or bronze nut for the traversing screw is screwed to the lower surface of the saddle, and a bearing for the screw and the worm shaft is fastened to the front of the arm. The ends of both the screw and shaft are squared to fit an interchangeable handwheel.

A good table or faceplate can be made from an iron bench plate, and care should

be taken to see that the press and the top of the plate are square with each other in every direction. The best location for the drill is near the end of the bench, so that the drill can be swung over the end of the latter for work that cannot be raised to the bench. A drill chuck of $\frac{1}{2}$ -in. capacity is fitted to the spindle; although the gears are strong enough to drive drills larger than $\frac{1}{2}$ in., it is seldom, in the small shop, that larger drills will be used in the machine. Larger holes, however, may be bored with a boring bar held in the chuck.

The head may be modified with very little trouble to make the tool power-driven, by using an electric drill and mounting it on a saddle designed on the same lines as the one shown, but modified to suit the drill. If this is done, the tool would be an ideal one for the garage or woodworking shop as well as the small machine shop.

Machining and Finishing Ebonite

Ebonite, which is sometimes called vulcanite and hard rubber, and which is largely used for electrical purposes, is also of great use in the chemical industry, owing to the resistance it offers to chemical reagents. It is stable toward air, light, and changes in temperature up to about 175° F. It can be softened in boiling water and then bent and shaped as desired; the shape or impression is retained on cooling, but if the material is subsequently softened by heat it will return to its original form. In machining it, the tool must be sharp, and to prevent overheating, the cut must not be too heavy. If the tool and the work are not kept cool, the former will rapidly lose its edge and the work will be burnt. In polishing ebonite, the surface should be rubbed smooth with powdered pumice and then buffed, using a tripoli compound, and running the cloth polishing wheel at high speed, the

work being held lightly against the wheel. In making ebonite, sheet-metal foils are used as a backing for the plastic material during the process of vulcanization, and this gives the finished sheets their well-known glazed appearance.

Replacing Ford Crankcase Cover

Repairmen are familiar with the difficulty experienced in replacing the cover under a crankcase on Ford cars and trucks as the cover and gasket are assembled first and then held up against the

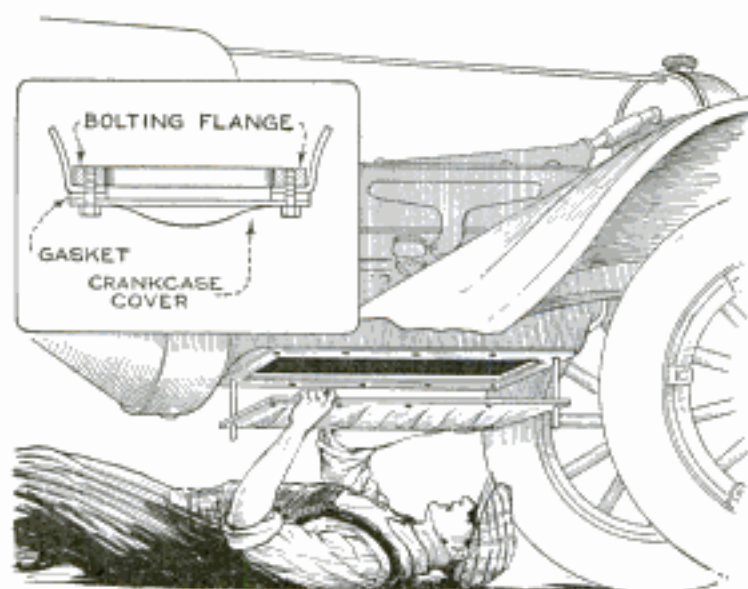

Guide Studs Provide Easy Method of Replacing Crankcase Cover

crankcase while the bolts are inserted into a loose flange resting on a lip on the crankcase. A good method of overcoming the difficulty is to screw two threaded studs into the bolt holes in the flange at opposite corners, as shown. The corresponding holes in the cover can readily be brought over these studs and it is then an easy matter to hold the cover up with one hand while replacing the bolts with the other.

Carrying Brackets for Touring Car

By H. H. PARKER

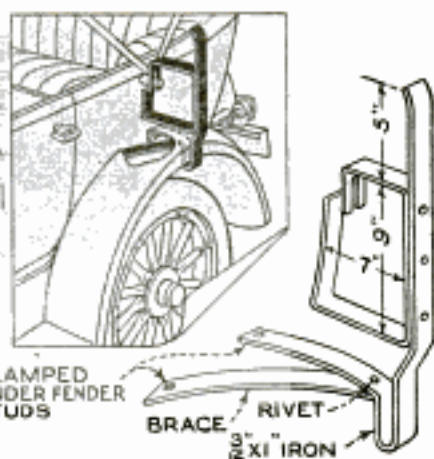

DETAIL OF REAR BRACKET

Auto Owners Who Are Frequently Obligated to Carry Long Pieces of Material Will Find These Brackets of Great Convenience

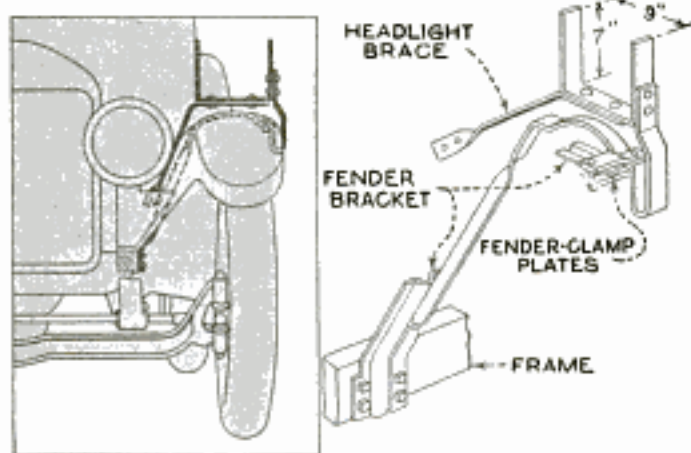

THE automobile owner who has frequent occasion to haul timbers, iron pipe or other long material uses much time in trying to lash these to the car, and unless about half-a-dozen blankets are used as cushions, the fenders and the body of the car are sure to be scratched or otherwise marred. Besides, the material usually loosens and slips before being carried very far. The fender brackets described in this article were designed with the idea of providing substantial carriers that could be attached without drilling holes in the fenders or body, in fact, but one extra hole or fastening was used. It is impossible, of course, to show brackets that will answer for every car, but the reader will gain a good idea of the construction from the illustrations, and can easily adapt them to his own car.

The forward fender of the car to which the brackets were fitted was strengthened by a pressed-steel brace, which was fastened to the frame by four bolts, and run up under the lower side of the fender. As the frame bolts extended about $\frac{3}{8}$ in. beyond the nuts, it was decided to clamp the lower end of the bracket under the rear pair of bolts, then carry it up parallel with the fender brace, under the edge of the

fender and up outside. To this upright projection a U-shaped iron was bolted; bolts were used, as it would have to be removed to get the lower brace into place; another strap was then riveted to the bottom of the U-piece and bent down with a right-angle twist, then bolted to the headlight bracket, under the head of the headlight clamping bolt. All the pieces were of $\frac{3}{16}$ by 1-in. iron, bent cold. The upper end of the brace under the frame needed fastening in some way, and investigation showed that a $\frac{1}{4}$ -in. space between the lower side of the fender and its bracket, would be wide enough to admit a length of the iron-bar stock. A piece about 6 in. long was used, and one end offset about $\frac{3}{16}$ in. so that the brace could fit over it, between the brace and the lower part of the fender. A second piece was bent to fit under the fender bracket, and the two pieces drilled for a $\frac{3}{16}$ -in. capscrew, which was put through them and tapped into the bracket. The ends of the pieces on the other side of the bracket were also drilled and a similar screw used to bolt them together, thus clamping the whole to the bracket and making the carrier secure. In fitting, care must be taken to get the parts well up under the fender, else the tire may strike them when running over a rough road.

Unless the rear carrier is allowed to project beyond the fender its capacity will be limited. This particular one was made large enough to carry a 2 by 8-in. piece, or a 4 by 4-in. one; others may be carried by lashing them to the first, all resting on the forward bracket. One

piece of the bar stock was bent around to fit under the rear fender, just below the pivot of the top bows, and clamped under the $\frac{3}{8}$ -in. stud that bolted the fender to the car body. To prevent the bracket from working sidewise, a second brace was riveted to it, near the outer end of the fender, and the other end of this was clamped under a stud to the rear of the first one. The projecting part of the bracket was run vertically about 14 in. above the fender, and to it another piece, bent in the shape of an open rectangle, was riveted. One arm of this piece extended parallel with the body (about $\frac{1}{2}$ in. away from it, to protect the side), while the other end was bent down and forked to fit over the $\frac{3}{8}$ -in. top-bow pivot stud, and was clamped between the head of the bolt and the sleeve. The pieces to be carried can either be put through the rectangular bracket or rested on top of it, as the vertical projection holds them in place in the latter case.

The brackets were attached to the left side of the car so as to be under the eye of the driver. A second pair can be placed on the right side if desired, and the carrying capacity thus doubled.

Production Methods on Connecting Rods

Production of connecting rods has been increased to a considerable extent by a Canadian manufacturing concern, in both milling and drilling operations, by employing the simple yet effectual methods shown in the photographs.

To speed up the operation of milling the faces to size, a number of V-shaped



The Work Is Mounted on the Table and Both Ends Are Faced at Once

locating blocks are fastened on the revolving table of the milling machine, so that 10 connecting rods can be loaded at the same time, in the manner indicated. As the milling machine is equipped with

two spindles, and each spindle is equipped with double cutters, it is possible to face both ends of a connecting rod in one operation. The process of milling is a continuous one, as the attendant substitutes

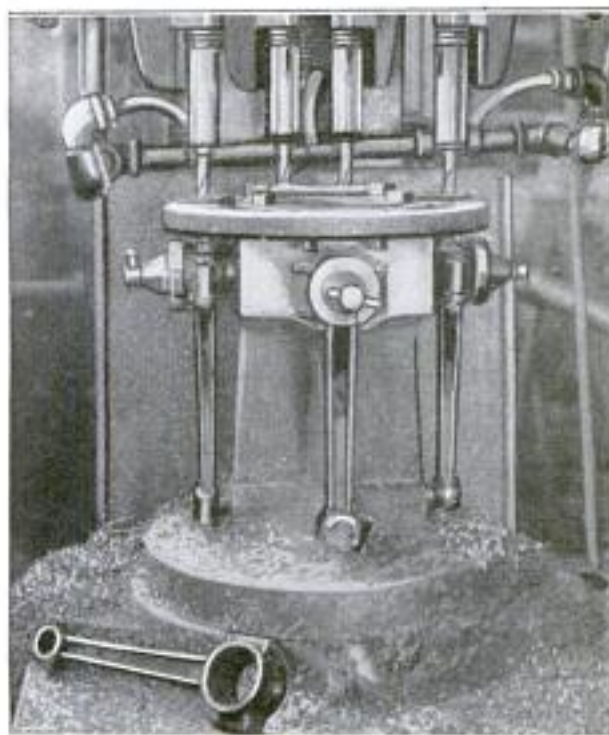

Four Spindles Each Drill a Hole, While the Completed Work Is Removed and a New Part Loaded

unfinished connecting rods for the finished ones, immediately after the latter have passed the cutters, and while the table is revolving.

The arrangement of the drill press is somewhat similar to that of the milling machine, the work being mounted on a stand that can be revolved by hand, and can be locked at each quarter revolution. The front station is the loading one; the others are for distinct drilling operations. The connecting rods are mounted on two studs and clamped in place, after which they are swung into the drilling position. All four spindles are lowered at the same time and work simultaneously on different connecting rods.

Dressing Poultry

By dusting powdered rosin into the feathers of each fowl before scalding, dressing of poultry is made a much easier and less disagreeable job. The rosin melts as soon as the scalding water comes into contact with it and causes the feathers to stick together so that they may be rolled off, almost in a mass. The pin feathers of chickens and the down of geese and ducks are removed at the same time.

Cooling and Ventilating Farm Cellar

Nearly every farm has a well or creamery near the house that can be used to advantage for cooling the cellar. A simple method of doing this, using water to cool the air, which is drawn through an underground pipe into the cellar, is shown in the illustration. In the upper figure fresh air enters the well and is cooled by the water before entering the pipe, and an electric blower sucks the air

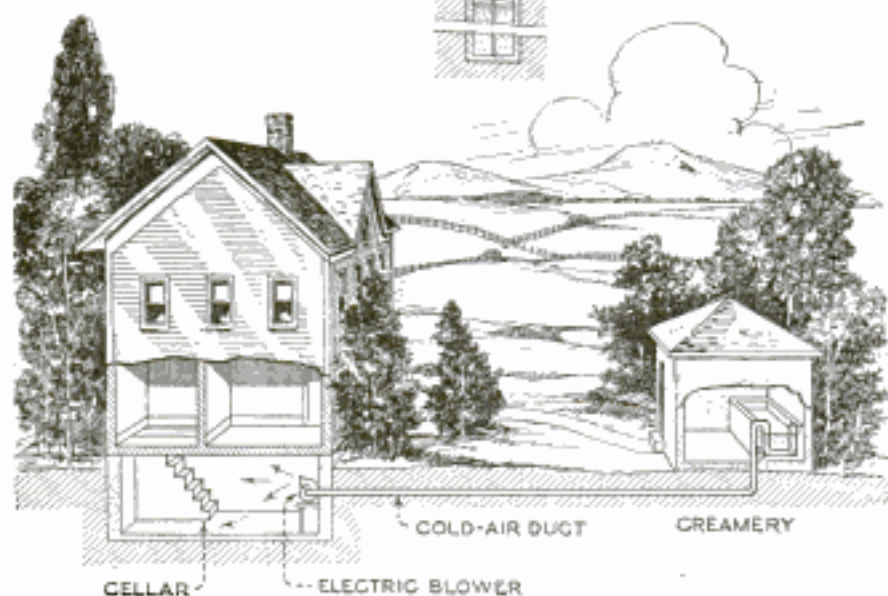

Novel Method of Cooling and Ventilating Farm Cellar with Air Cooled by Contact with Water and Drawn through an Underground Duct

through the pipe and into the cellar. The humidity of the air is also increased by passing over the water. If this method is not possible, a similar cooling system shown in the lower detail can be made to work in connection with the water tank in the creamery, if this is not too far away from the house. The duct, through which the cold air is drawn, is run through the water tank as indicated.

Soldering Jewelry

It is of first importance that soft solder be avoided as far as possible in repairing articles of gold and silver, and even filled and plated jewelry can be repaired with hard solder. To repair a ring, the shank of which requires soldering, bury the setting in a crucible of wet sand, place a small piece of charcoal against one side, and coat the break, previously cleaned by

scrapping or filing, with borax; charge with solder and blow a flame against the ring until the solder runs in.

Articles that require protection against discoloring in the process of soldering,

should be coated with a mixture of burnt yellow ochre and borax, adding a little gum to make it cover the article completely. Allow it to dry, charge with borax, solder, and boil in a weak pickle composed of nitric or sulphuric acid in water. One important point is to wash the piece well in hot water, with a little ammonia added, to remove any dirt and grease, before undertaking any repairs.

If the article is made of colored gold, boil out in a pickle of muriatic acid and water, but never coat with any protecting mixture. To repair gold-filled work, melted solder is required; this may be made in the proportion of 1 oz. fine silver, and 10 dwt. hard brass wire, to which 2 dwt. of zinc is added just before pouring. Or, for strong silver use only the silver and brass.

For repairing most bright gold work, use an alloy composed of 3 dwt. fine silver, 3 dwt. gold, and 2 dwt. fine copper.

A good solder for soldering spectacle frames, or other steel parts, is made by melting together equal parts of silver and copper.—Geo. M. Millard, Toronto, Ont.

☞ Sometimes the dash light on an automobile causes eye strain because of its glare. This can be prevented by slipping a piece of green or blue celluloid inside of the cover.

Tinning Small Work

The work to be tinned is placed in warm water, to which a little sulphuric acid has been added, to clean the pieces of grease and dirt. Some powdered sal ammoniac is then added to the water and vigorously stirred until entirely dissolved. The work is then removed, washed in clean water, and placed near the fire to dry. A shallow pan, such as a frying pan, is obtained, and the bottom perforated. This pan should be small enough to allow it to be dipped into the pot of melted tin. The work is placed in the bottom of this perforated container, and a little sal ammoniac is sprinkled over the surface of the melted metal; then, after all smoke from the metal has disappeared, dip the pan containing the articles into the tin, lift it out, and shake well to get rid of the excess metal, at the same time sprinkling a little sal ammoniac over the work to prevent too thick a coating. The articles are cooled quickly by dumping them into water, which also produces a bright finish.

Lapping Pistons

Lapping pistons by hand is a job that requires considerable effort, but much of the hard work can be eliminated by using a fixture of the kind shown in the illustration. It consists of a simple lever arrangement in which a pivoted, flat-iron connecting rod is fastened to a wooden lever. This lever has a slot cut at one end to permit pivoting the lever on a bolt, which is held in a U-shaped bracket, bolted

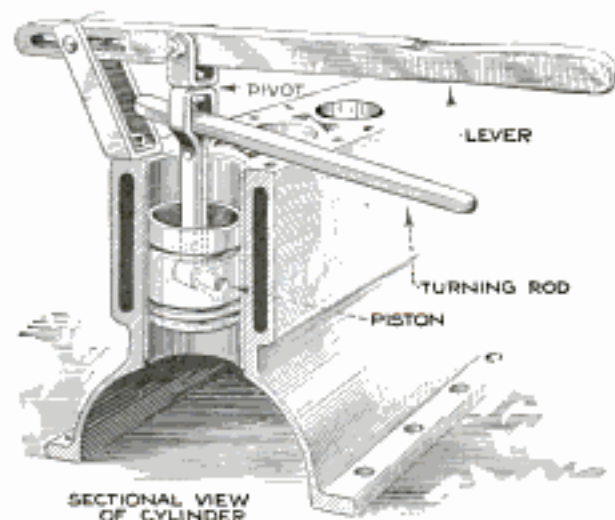

Handy Lever Arrangement Reduces Work of Lapping Pistons

down on the block as shown. An extra handle is provided to turn the piston during the lapping process.

Double-Capacity Tool Box

For auto mechanics, carpenters and others whose work makes it necessary for them to carry a tool box around continually, the type shown here will be found very convenient. Although small,



Portable Tool Box Is Compact and Has Double Capacity

its two compartments will hold as many tools as are ordinarily stored in a much larger box. The bottom compartment is made very similar to those of conventional style, only that it is not so deep and the ends extend higher. The upper compartment is of the same shape and also shallow. It is not quite so long as the lower section and the ends are slotted so that it can be hung on the handle. In use, the top compartment can readily be swung sideways to permit one to reach into the lower one, or if desired, it can be removed entirely. Both compartments may be divided into sections for holding small articles.—C. C. Brabant, Detroit, Mich.

Securing Ford Dust Rings

The dust ring in the front hub of Ford cars sometimes shakes out of place even if new and well hammered in. In such cases, it is often helpful to solder the ring to the hub casting. The ring should, of course, be removed and all grease cleaned out thoroughly before soldering.

Refuse Chute for the Store

Instead of disposing of the dirt and rubbish swept from the floor in a refuse can,

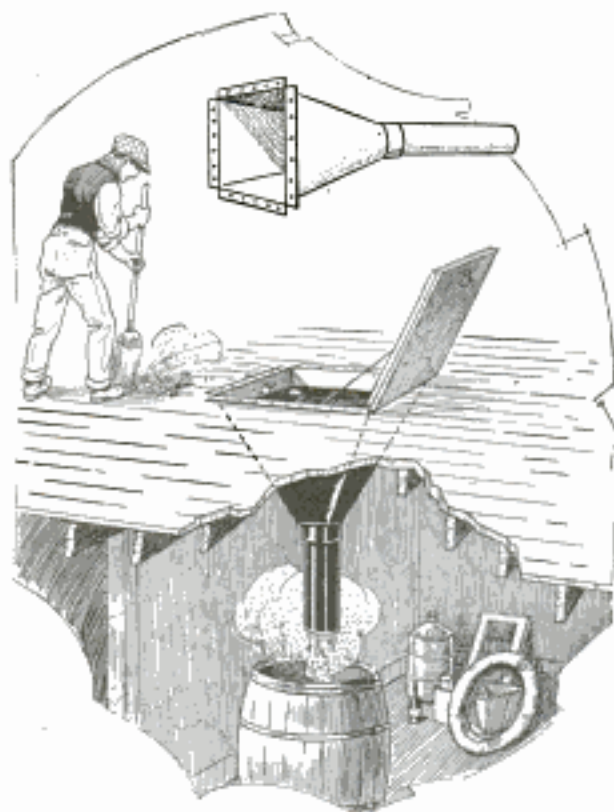

Galvanized-Iron Chimney Cowl Makes Handy Dirt Chute in Store

as is usually done, a storekeeper sweeps it into a chute, which leads to a barrel in the cellar. By using this method many steps are saved, as the barrel need not be emptied as often as a small can. The chute consists of an ordinary sheet-iron chimney cowl, which any tinsmith can make. It is arranged as shown in the illustration, a rectangular hole being cut in the floor for the wide end of the cowl, and a trapdoor provided to close the hole.—Frank Harazim, New York City.

Safety in Handling Dynamite

From time to time one hears the observation that "dynamite won't explode from heat—one can burn it without its exploding." This is true in probably 95 per cent of cases, but in the other five dynamite does explode from heat or fire, and hence frozen dynamite should never be thawed in front of a fire, in the bake oven, or on a boiler. Another bad method of thawing is to place the dynamite directly in hot water; this causes the nitroglycerin in the dynamite to come out into the water. The strength of the explosive is lost, and an accident may occur from

nitroglycerin sticking to the empty pail. One of the simplest and safest methods of thawing frozen dynamite consists in burying the box in a manure pile and allowing it to remain overnight. If this method is impracticable, a tub may be half filled with warm water, not so hot that the hand cannot bear it, and the dynamite placed in a dry pail, or deep pan, which is set in the water and covered with a piece of old carpet. Always remember that the rules given in the original container are based on a thorough investigation of all accidents. Dynamite is not "fool-proof," and the fact that someone else has taken some "fool" chance in handling this capricious explosive and got away with it, is no assurance that one can do the same thing without being blown to pieces.

Handy Auto Trouble Mirror

The little mirror shown in the accompanying illustration was devised by an auto mechanic to enable him to see around corners when making repairs on auto engines in places difficult to get at. A cross was made by soldering two short strips of flat metal together; a pocket-size mirror was laid over the

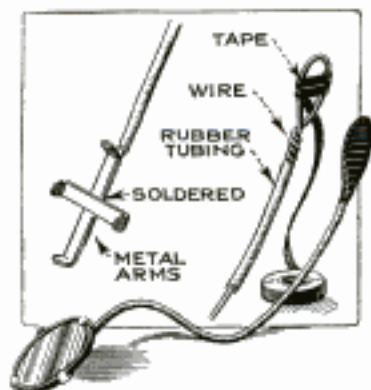

cross, and the ends of the strips bent over the edge of the mirror to hold it in place. A handle consisting of a length of wire solder was soldered to the back of the cross, and a rubber tube slipped over it for insulation. The end of the handle was enlarged to make it easier to hold; this was done by twisting the solder wire to form a loop and then winding several layers of tape over it. The handle can be bent in any way required to insert the mirror in places otherwise inaccessible. The rubber tube protects the user from receiving shocks when the handle comes in contact with the ignition wire.—L. B. Robbins, Harwich, Mass.

☞ When buying a lighting plant and engine for the farm, get an engine large enough to use for power when not charging the storage batteries.

Using Wood Alcohol

Great caution should be observed in the use of any mixtures containing wood alcohol. This is the most deadly poison used in daily commerce; one teaspoonful has been known to cause blindness, and one ounce, death. The poison may be absorbed into the body through the nose, mouth or skin, so that even the inhalation of the fumes, or the contact of the liquid with the hands, or any other part of the body, may cause poisoning just as though the alcohol were taken into the system through the mouth.

Sudden blindness, with vomiting and abdominal pain, should always cause suspicion of wood-alcohol poisoning, and no time should be lost in having the patient treated by a physician.

Lettering Show Windows

Although distemper lettering on windows has found favor with merchants, it has the disadvantage of being readily damaged by showers and by accidental contact with the clothes of passing pedestrians. This trouble may be eliminated by painting the lettering on the inside of the glass; this, of course, necessitates reversed lettering, and unless the painter is expert a mussy sign may result. To do the job neatly, the letters should be outlined on the outside first, and then traced on the inside, the preliminary lettering on the outside being removed as soon as the inside lettering has been completed. Wedge-shaped pieces of soap are often used for



Lettering on Inside of Store Window Is Protected from Rain and Passing Pedestrians

this kind of lettering, being applied just like crayons.—Philippe A. Judd, Portsmouth, Ohio.

Counterweight for Electric Hand Drill

When using an electric hand drill on the workbench a counterweight will be found convenient. The weight should be about



Counterweight for Electric Hand Drill Facilitates Handling It

equal to that of the drill; it can be arranged on a length of sash cord, run over two pulleys in the ceiling, as shown. After use the drill can be pushed up out of the way and held suspended by the weight. Such an arrangement makes it much easier to handle the drill and causes less wear on the extension cord.

Substitute for Brass Castings

Purchase $\frac{1}{2}$ pt. of muriatic acid and make a saturated solution of zinc chloride. The manner of preparing this solution is to drop particles of zinc into the acid from time to time until no more zinc will be taken up in the solution. Do not inhale the fumes from the acid while it is working. Procure a quantity of brass filings—not spelter—and cleanse them thoroughly in the solution. Melt 8 parts of lead and 2 parts of solder together and, while molten, stir the brass filings in until the mass appears to be all brass; the more brass filings the better. The proportions should be about 8 parts filings to 1 part of the lead and solder.

This metal is especially adapted to work of inventors and can be used in making name plates, brackets, and kindred articles. For molds, either use sand or plaster of paris. If plenty of filings are added to the melted lead it will be hard to detect the finished casting from brass.

Handy Wire-Fence Unwinding Rack

By J. R. KOONTZ

THE job of fencing—a slow and laborious one—can be made easy and much time saved by the use of the horse-drawn unwinding rack shown in the photos and drawings. Most farmers build some wire fence every year and will appreciate such a rack. It can be built of material found on nearly every farm, and it will not take more than a few hours to make it.

The following materials are used in its construction:

- 2 pieces 4 by 5 or 4 by 4 in. by 12 ft.
- 1 piece 4 by 4 by 38 in.
- 1 piece 2 by 4 by 46 in.
- 1 piece 2 by 4 by 38 in.
- 2 pieces 2 by 4 by 56 in.
- 2 pieces 2 by 4 by 50 in.
- 2 pieces 1 by 8 by 20 in.
- 1 piece 1 by 8 by 42 in.
- 1 piece 1 by 4 by 45 in.
- 2 5-in. clevises.
- 30 4-in. spikes and a handful of eight-penny nails.

The two 12-ft. lengths of 4 by 4 or 4 by 5-in. material are laid down and the 4 by 4 by 38-in. piece spiked to the front end. The 2 by 4-in. crosspieces are then spiked

on, the two 50-in. lengths nailed about 28 in. apart and the 56-in. lengths spiked to the ends of these, as shown in the drawing. Two spikes are driven at each joint. The seat and its support are made from the 1 by 8-in. pieces, braced with the 1 by 4-in. piece, and securely nailed to the rack near the front end as indicated. About 3 in. from the rear ends of the two 56-in. lengths of the 2 by 4-in. frame, holes are drilled to receive clevis pins. The clevises are then attached and through these a 5-ft. length of iron pipe or a round piece of shafting is passed; hardwood may be used if nothing else is available.

After completing the rack, it is loaded on a wagon chassis. Place the 46-in. length of 2 by 4-in. wood just in front of the rear wagon stakes to keep the rack from slipping back when loading the roll of fencing or when the roll is being unwound. Back the wagon to the roll of fencing and raise the front end of the rack to lower the rear end, which will make it an easy matter to slip the pipe through both clevises and through the roll of fencing. If the roll is not very large, the weight of the front end of the rack will raise it, and the driver may comfortably take the seat. However, if the roll is large and heavy it may be necessary to pull the front end down to the wagon and tie it with a rope. When the wagon has been driven to the place where the fencing is to be used, one end of the roll is staked to the ground, or fastened in any other suitable manner, and the team

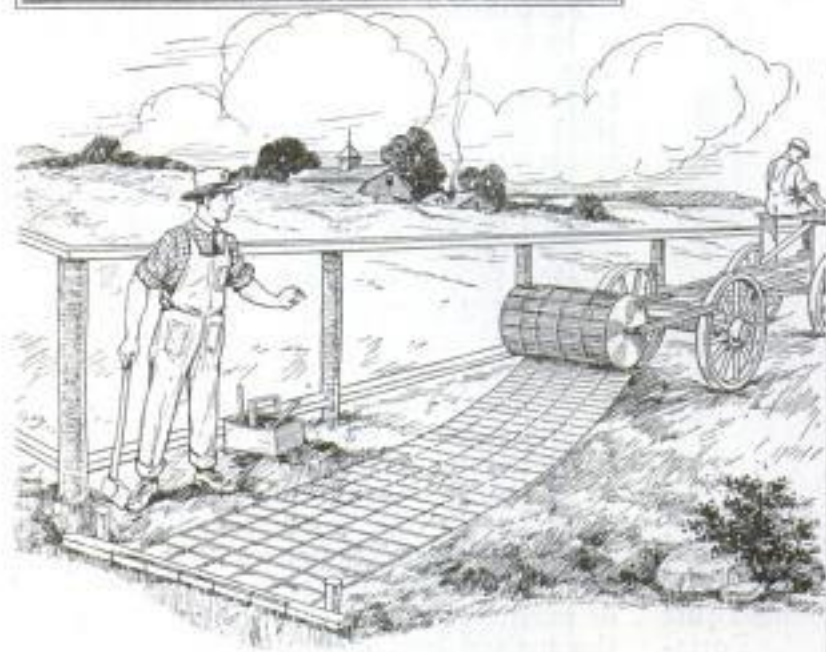
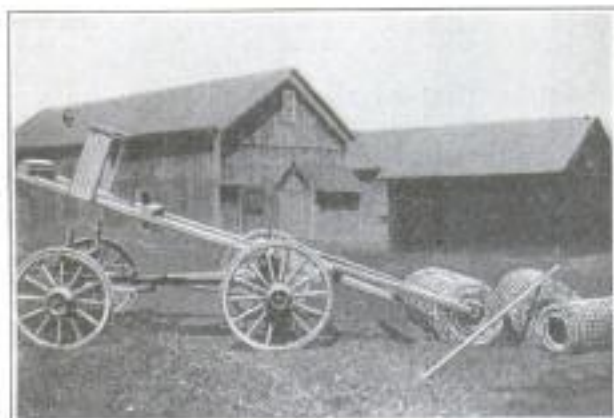

Convenient Fence-Unwinding Rack, Attached to Wagon Chassis, Reduces the Time and Eliminates the Hard Work of Unwinding Fencing by Hand

driven forward. The roll will unwind as fast as the team walks.

When a barb-wire fence is put up, the same method can be used to unwind two or three rolls at once. If desired, a frame of this kind can be permanently mounted on a two-wheeled rig, built especially for the purpose, and it can be

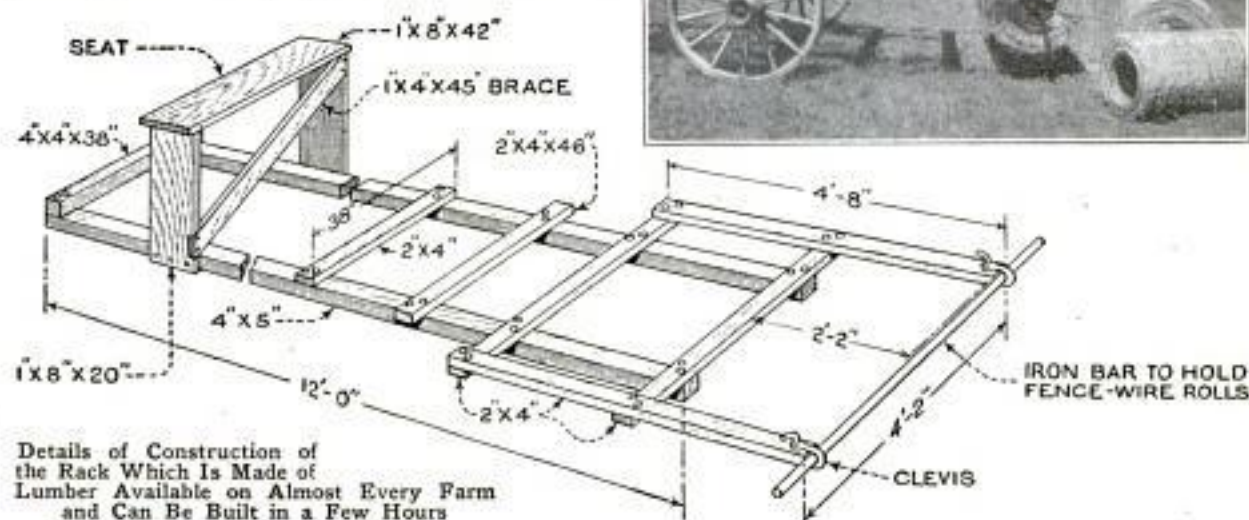
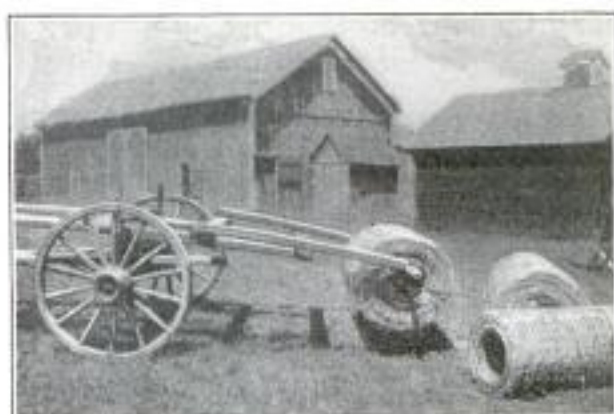

Details of Construction of the Rack Which Is Made of Lumber Available on Almost Every Farm and Can Be Built in a Few Hours

pushed along by hand, which will eliminate the need of using a team of horses. If this is done, it is necessary to change

the construction of the device accordingly. When once made, a rack of this kind will give several years of service.

Cutting Woodruff Keyways in the Lathe

The drawing gives a general idea of a special attachment made for cutting keyways for Woodruff keys in the lathe, the cutter being held in the lathe headstock and backed by the tailstock when necessary. The actual construction of the attachment depends on the type of lathe to which it is fitted, and it may be built up from stock materials or from special castings, as convenient. A base, preferably made of cast iron, is clamped to the lathe bed, the base being planed to fit on the ways. The base has a split boss at each end, with vertical holes and clamp bolts; through the holes are fitted two steel columns, one of

which has a hinge joint at the upper end, while the other is bored and threaded for a feed screw. The base also has two upright guides, the inside surfaces of which are machined parallel. Hinged to the rear adjustable column is a long cast-iron V-block or guide, the vee being planed the full length; this is to hold the shaft

or work being key-seated. The feed screw merely rests against the lower end of the V-block, which drops by its own weight as the screw is turned down. Two or more C-clamps hold the work firmly in the block while the keyway is being cut. Various sizes of work and cutters are accommodated by adjusting the columns so that the work will sit just below the cutter before the feed screw is operated.

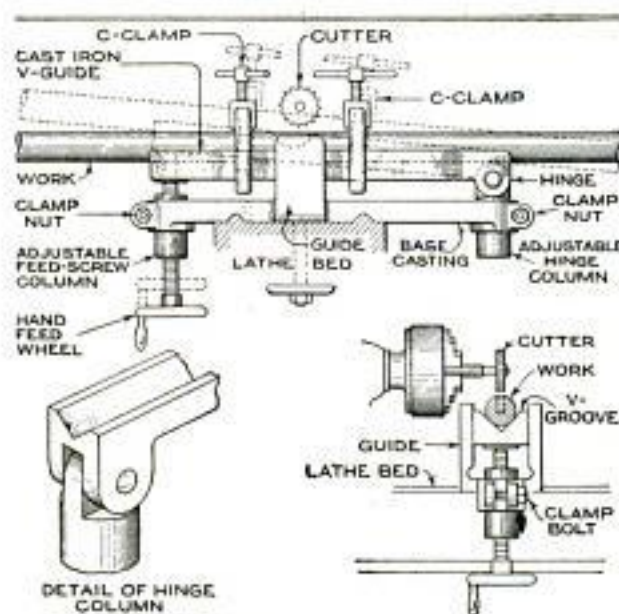

Attachment for Cutting Woodruff Keyways in the Lathe, Which May Be Built from Stock Parts

Filling Cylinder Score without Removing Motor from Auto

On a newly overhauled car a piston was broken and the side of the cylinder was slightly scored. This would, normally,



Novel Method of Filling Cylinder Score Saves Considerable Time Dismantling Engine

have meant the removal and dismantling of the whole engine. However, it was suggested, jokingly, that the car be stood on end and the score filled, and the joke was developed into a practical scheme for raising the car and holding it in upright position by means of the rigging shown in the drawing. The air vent in the gasoline tank was plugged, the front dustpan was removed, and a short, stout iron bar was placed between the front springs and the nose of the frame, so that a tackle could be attached. The tackle was suspended from the ridgepole of the roof, which was braced in a suitable manner. The rear wheels were blocked up as indicated, to keep the fenders and gasoline tank from touching the floor. When nearly per-

pendicular two smaller tackles were arranged horizontally as shown, and the car thereby prevented from tipping sideways. A board was placed across the windshield on which the workman stood to fill the score. It took about an hour for two men to raise the car to this position, but at least two days' labor was saved for one man. The same method can be employed if the score is on the front side of the cylinder, but the car must then be held with the front end down.

Hanging Metal Molding

Electricians have difficulty at times when putting up metal molding on account of the springiness of the strips, particularly with the coping. I have discovered that if the lips of the coping are slit with a hacksaw every few inches, this difficulty is overcome.—P. J. Alart, New York, N. Y.

Clamp for Flexible Tubing

On machines using cooling liquids or cutting compounds, flexible tubing, on account of its pliability, is often used to convey the fluid to the work or tool. However, some difficulty is encountered when it is desired to hold the tubing in a fixed position so that the spout delivers the spray directly on one spot. Machine vibration usually makes it necessary to adjust the spout continually or resort to makeshift methods such as tying the tubing

with string. A much better method of holding it is shown in the drawing. Two clamping pieces to fit the tubing are made of thin sheet metal. These are placed at either end, and both are clamped on with nuts. Two lengths of thicker sheet metal are drilled at each end so that they can be passed over the clamping pieces and held in place behind the nuts. A thumbnut and screw are used to bind the two pieces together in the middle.

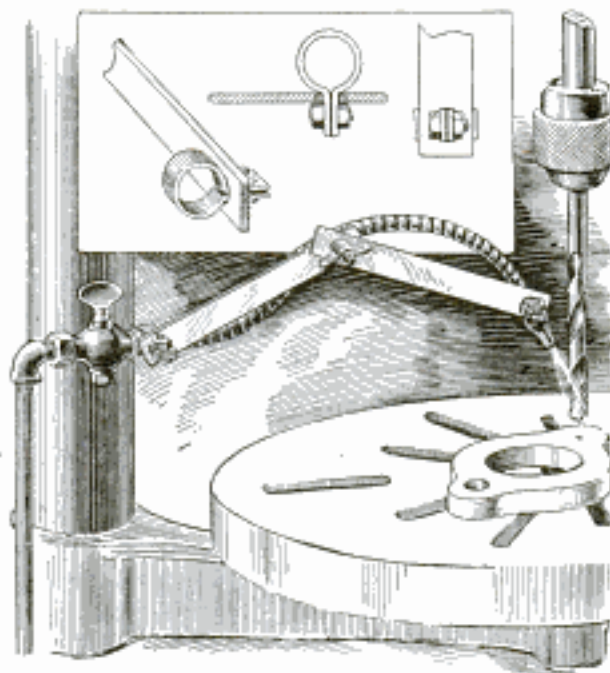

Convenient Clamp Holds Flexible Tubing in Any Position

Homemade Boat Railway for Small Yacht Repairs

By J. A. STEVENS

MANY times the small-boat or yacht owner would like to haul up his own boat for repairs, overhaul or winter storage. This is difficult without special equipment; the accompanying drawings, however, show a simple railway that will enable the job to be done easily. Such a railway is of use not only to the individual

owner, but to the small repair yard, the owner of which does not wish to go to very great expense in installing a marine railway. The first thing to consider is the form of the boat and its weight. The writer has taken as an example a short-hull, deep-draft boat, as this is the most difficult type to handle. First the arrange-

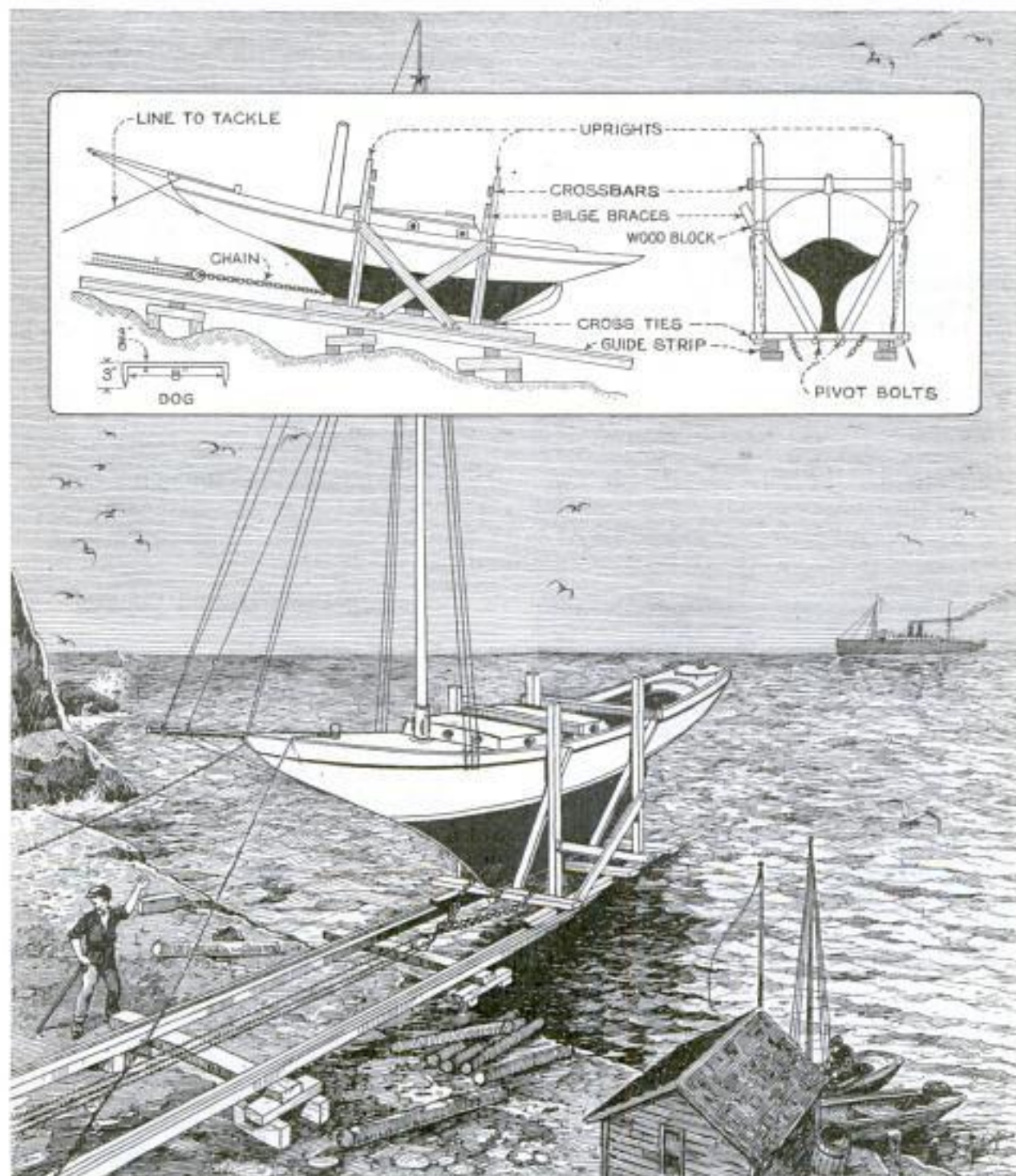

To the Small Repair Yard as Well as the Individual Yacht or Small-Boat Owner, This Homemade Marine Railway Will Prove of Value; the Underwater Shape of the Boat Need Not Be Known

ment must have suitable launchways; these must be run from the place where the work is to be done, or the boat is to be stored, a sufficient distance into the water so that the boat can be floated into its cradle at high water. The ways must be substantially blocked, and must be so laid that they cannot spread. On the outer edges of the ways 2 by 3-in. guide strips are nailed.

The slide pieces of the cradle are now placed on the ways, with about $\frac{1}{2}$ in. clearance between the edges of the slides and the guide strips, and cross ties are spiked to the slides. The length of the slides and the number of cross ties must, of course, be determined by the length of the hull that bears on the ties. After the ties are in place, the uprights are spiked to the end ties, as shown in the drawing; 2 by 6-in. planks are suitable for the uprights. These are braced fore and aft with $\frac{3}{8}$ by 6-in. boards, taking care to keep these clear of the hinged bilge braces. The latter are made of $2\frac{1}{2}$ by 6-in. spruce, if the boat is not over 30 ft. long; a $\frac{5}{8}$ -in. hole is bored in one end of each, and they are then bolted to the end cross ties as shown in the end view, far enough apart to allow the keel of the boat to drop between them. Washers are used under the bolt heads, and the bolts screwed tight enough to hold the braces firmly, while allowing them to be swung up under the bilge of the boat at the proper time. For

a longer craft, heavier braces should be used. The cradle is now ready to be placed on the ways, which, of course, is done at low water. It is fastened to the ways by means of dogs made as shown in the detail, to keep it from floating until the boat is in position. These are pulled out when the boat is ready to be started up the ways. The boat should be placed in the cradle just as soon as there is depth enough of water over the cross ties to float it there. Care should be taken that it is upright fore and aft on the ties. Nail some small blocks on the uprights, and bearing against the hull, to take up any side play, and spike crosspieces across the tops of the uprights. Swing up the bilge braces until they bear against the hull, and fasten them securely to the uprights.

Now make a couple of lines from the boat fast to the tackle to keep the cradle from being pulled from under the boat when it is first started. The boat is then ready to be hauled ashore. For a heavy 30-ft. boat a double-block tackle, with a double and single-block tackle for a luff, will easily do the job with three men hauling. Use plenty of grease on the ways, and be sure that everything is strong enough for the boat; be sure also to keep it on an even keel.

The writer has used this method with the best results, and has found it especially useful where the exact underwater shape of the boat was not known.



Cleaning Underground Conduit

In the underground conduits of the St. Louis water-purification plant a novel method was used to break up the hard deposits of lime, which had formed during seven years of service. A disk harrow was lowered into the conduit and runners were substituted for the tongue. The harrow was pulled through the conduit by teams of horses on the street above; a long rope, arranged on pulleys, which were attached

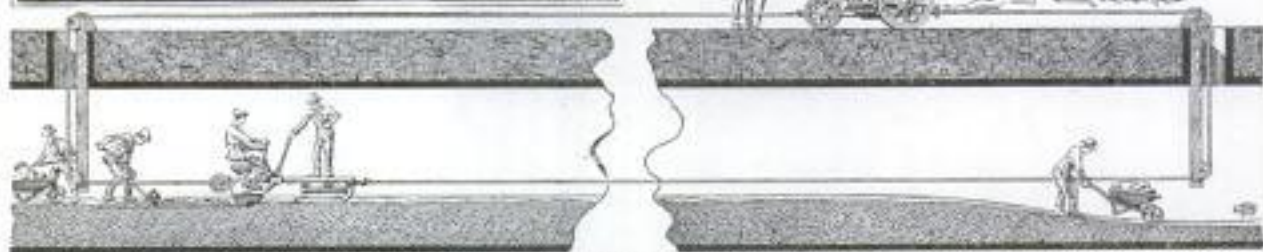

Above, Old Method of Removing Lime Deposits, with Pick and Shovel; Below, Diagram Showing Improved Method, Using a Disk Harrow to Break Up the Deposits

to frames at each end of every 410-ft. division of the conduit, was connected to both harrow and team. A tag line served as the pulling line on the return trip. Two men rode the harrow and adjusted the disks to suit the hardness of the lime deposit. When the deposit had been broken up thoroughly the conduits were flushed out by running 12 in. of water through them at a velocity of about 4 ft. per second. Obviously, the cost of this method was much less than if men had been employed to do the work with pick and shovel. A tractor could be used instead of horses, as suggested in the drawing, and would probably decrease the time required.—Martin Bunn, Babylon, N. Y.

Protecting Eccentric on Cement Mixer

The plunger that feeds the cement to our concrete mixer was driven by an eccentric on the main shaft from the belt wheel, and the particles of cement that got under the strap on the eccentric soon wore down the guiding ring, letting the strap and rod fall off. This was remedied in the following way: A piece of 30 by 3-in. auto casing, long enough to encircle the strap and overlap an inch or so, was wrapped around it. This brought the bead down over the rim of the eccentric about 2 in. A slot was cut in the casing at the place where the eccentric rod passed through and another hole at the bottom so that particles working in might readily fall out. The overlapping ends of the casing were then

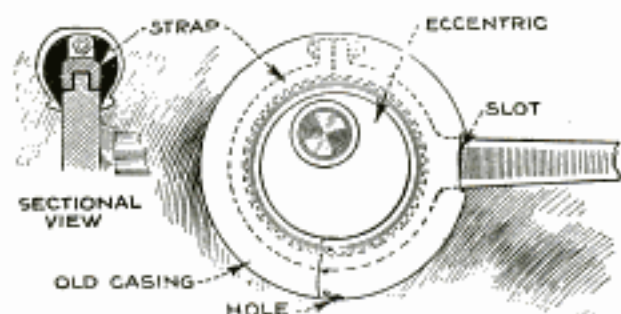

Old Auto Casing Prevents Cement from Getting under Strap on Eccentric of Concrete Mixer

riveted together, allowing its inner surface to rest on the lugs of the strap. The tube of the compression grease cup was lengthened so that it extended to the outside, a hole being provided in the casing for this purpose. Springs of heavy wire were forced over the casing at intervals of about 4 in. to hold it close to the sides of the eccentric. The protection thus given was found effective and no further trouble was experienced.—Geo. G. McVicker, North Bend, Nebr.

A Device for Covering Up Seeds

Every home gardener has found that the apparently simple task of covering up seeds is really rather troublesome. A



Simple Homemade Garden Implement Covers Rows of Seeds Quickly

simple device, which will do this quickly and thoroughly, is shown in the accompanying illustration. All that is necessary is to set the device over the seeds and pull it backward. It consists of two wings of galvanized iron or heavy tin, about 3 in. wide at one end and 8 in. at the other, and 12 in. long. These are fastened together with an iron band, 6 in. long, bolted to the wings, as shown, about 3 in. from the narrow end. The parts are held together with $\frac{3}{16}$ -in. stove bolts. The whole frame, which holds the blades, can be made of one long piece of flat iron, heated and bent to the shape shown. An ordinary broomstick can be used as a handle.—Bessie O. Johnson, Belton, Tex.

Testing Lumber Waterproofing

Lumber treated with waterproofing compound can readily be tested by taking four pieces of treated stock, about 1 by 1 by 2 in. in dimensions, and nailing them to strong crosspieces at each end so that there will be a space between them about equal to the thickness of a hacksaw blade. The wood is submerged in water for 24 hours. If in that time the strips have swelled so that they fit tightly together, the waterproofing compound is worthless.

Sensitive Drill-Press Handle Attachment

Every shop is not equipped with a sensitive drill press and consequently it is often difficult to bore small holes without breaking the drill, as the operator is un-

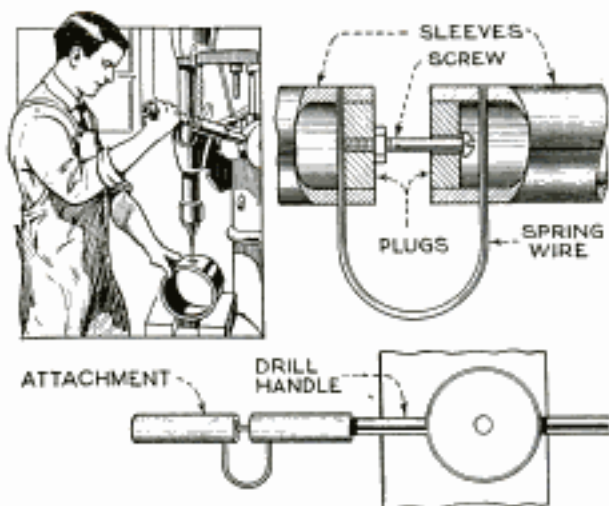

Spring Attachment on Handle Makes Ordinary Drill Press Sensitive

able to tell when the pressure is becoming too great. The trouble can easily be remedied by providing a spring attachment on the handle, as shown in the drawing. It is made of two short lengths of steel tubing having an internal diameter equal to that of the machine handle, on which one of these pieces is wrung. The adjacent ends of the pieces are plugged, one plug being drilled and tapped for a small machine screw and the other drilled an easy sliding fit on the shank of the screw. The tubes are linked together with the screw, as indicated, so that there will be a little space between them. Holes are drilled through both tubes near the ends and a piece of light spring wire is inserted, as shown, leaving a little play between the screw head and the plug in the tube that is slid over the drill-press handle. This arrangement provides a means for more sensitive feeding and will prevent much lost time due to broken drills.—Harry Moore, Montreal, Can.

Lathe-Bed Brackets

A small screw-cutting lathe that was supplied with a milling and grinding attachment had two cast-iron brackets made and fitted so as to be clamped to the bed as shown in the drawing, and these proved to be of great convenience in many ways. The pattern is simple, the hole being made tapered so that a green-sand core may be used, and no machining is required. Hand filing only was required to fit the brackets

to this type of bed; a $\frac{3}{8}$ -in. length of flat steel was filed on one edge to a 60° angle and held to the underside of the bracket by a $\frac{3}{8}$ -in. capscrew. This clamped the bracket firmly to the bed when the screw was drawn up.

The eye of each bracket was drilled and tapped for four $\frac{3}{8}$ -in. setscrews, one pair of holes being drilled and tapped from the top and the others from the rear to allow working room for the tap wrench; these setscrews are used to clamp a cold-rolled steel mandrel and for accurately adjusting it parallel to the travel of the lathe carriage, as determined by a dial indicator clamped to the tool slide and bearing against the side and top of the mandrel.

In use, the mandrel, which is set several inches to the rear of the lathe center line, had clamped to it various pieces of work, the surfaces of which pointed to the front and were to be milled or ground by attachments on the tool side; if clamped between centers the work would project too far forward and the milling cutter would not have room to work. The work is readily blocked up from the bed, if additional support is necessary.

Another use is that of an emergency steady rest, a hardwood board, drilled and reamed to take the work, or bushed with metal, being bolted or clamped to the bracket as shown in the left-hand detail. If two such rests are used and the work adjusted parallel to the carriage travel,

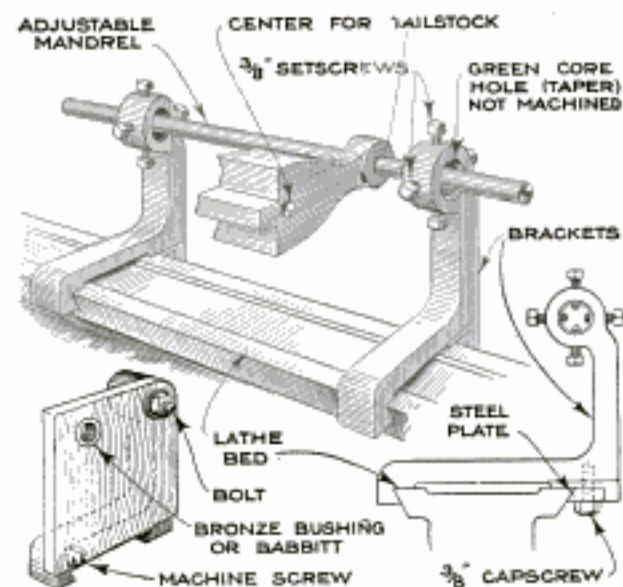

Brackets for the Lathe Bed Make It Possible to Use Milling and Grinding Attachments with a Minimum of Difficulty

and there is no play between the work and steady-rest bearings, the work will run absolutely true, provided a flexible connection is used for driving.

Prize Offers and Announcements

\$150—Best New Uses for Stop Watch

In two awards of \$100 and \$50; also ten additional awards of one stop watch each. These offers are made for the best lists of uses for the Pastor stop watch, which is an accurate instrument consisting of a time-piece and a stop watch in one. Particular value is placed by this concern on uses promising great savings to the user. Leading engineers claim that in the industries millions of dollars are wasted owing to lack of attention to the time element in operations. The Sterling Watch Company, Inc., wishes to learn all the uses to which the Pastor stop watch may be put. The larger one of the cash offers will be paid for the best list, the smaller sum for the second best and a Pastor stop watch, valued at \$7.50, will be given for each of the next ten best series of uses received. The instrument can be examined by entrants at practically any local watch dealer's establishment. Each use should be stated briefly and simply and numbered according to its place on the list. Write on one side of the paper only, with name and address on each sheet. Address all replies to Industrial Award, Sterling Watch Company, 15 East Twenty-Sixth Street, New York, N. Y. Offer closes May 1, 1925.

\$1,000—Adjustable Miter Box

The sum of \$1,000 in cash and a satisfactory royalty will be paid by Roche and Moore for a suitable miter box for carpenters, to be employed with the ordinary handsaw. The design must be such that it can be easily and quickly adjusted to any arc of a half circle. It should be one inexpensive to manufacture, should be light in weight and preferably planned to be constructed of either wood or steel. No models of suggested designs should be submitted until after the drawings or sketches have been sent to the donor. This concern reserves the right to be the sole judge of the merits of all ideas submitted and their availability for adoption by our organization. Address Roche and Moore, Cochran, Pa. This offer expires May 1, 1925.

\$100—Eliminating Radio Interference

The Saranac Lake Radio Club will pay the sum of \$100 to anyone submitting a successful device for the elimination of interferences to radio reception set up by electric heating pads. The pads are widely used by outdoor resorters and as each heater is equipped with a thermostat regulator they cause serious interruption to the operation of radio receiving sets. The eliminator must be available for practical application to such heating pads as are now in use and causing the trouble. Detailed information on the subject will be sent to anyone on request. This organization or its representatives will act as judges of the merits of any plans, methods or inventions submitted. Address Interference Committee, Saranac Lake Radio Club, Saranac Lake, New York.

\$1,000—Article to Increase Brass Uses

With the person who designs some acceptable article which is composed of considerable brass in the form of sheet, rod or tubing, and which can be protected by patent, or with anyone who develops an acceptable plan wherein brass can be successfully and usefully substituted for a competing material now used in established articles of commerce, the Bridgeport Brass Company will enter into an agreement to pay royalties on the basis of such an invention, plan or suggestion, up to \$1,000. The Bridgeport Brass Company will be the sole and final judge in reaching a decision regarding the commercial value of the invention, plan or suggestion, but if the company approves and enters into such an agreement in any instance, and reward is paid up to an aggregate of \$1,000, payments shall then cease and the Bridgeport Brass Company shall become proprietor of all rights, privileges and returns from the promotion, manufacture or sale of any such patent, plan or suggestion the Bridgeport Brass Company adopts under this offer. May 1, 1925, is closing date for this offer. Address Bridgeport Brass Company, Bridgeport, Conn.

OFFERS ANNOUNCED IN PREVIOUS ISSUES

All of These Offers Expire May 1, 1925

FOR THE BEST SUGGESTED IMPROVEMENT on a gasoline-heated blowtorch and soldering and branding iron combined an award of \$500 will be paid by the Everhot Manufacturing Company.
Maywood, Ill.

AWARDS OF \$500 EACH WILL BE PAID for a waterproofing process for a library paste and a method that will produce increased sales of this product. John J. Harris and Company.
Chicago

\$2,000 WILL BE PAID BY THE NORTH Shore Food Products Company for a method of processing or preserving cottage cheese to keep it fresh for at least two weeks.
Chicago

THE SUM OF \$25 WILL BE PAID BY CELLO Products, Inc., for suggested new uses for its product. Information from the concern on request.
Chicago

FOR NEW WAYS OF USING BUTTON molds \$500 will be paid by donor in Problem HA-1, and the same concern will pay \$500 for new uses for button-mold machines as stated in Problem HA-2.
Chicago

THE SUM OF \$50 IS OFFERED BY THE Parsons Manufacturing Company for the best plan they receive for uses of ground slate.
Chicago

ELECTRIC HEATING ELEMENT WHICH will operate and interchange with base and cover of Imperial self-heating gasoline iron, \$500. Imperial Brass Company.
Chicago

DISCOVERY OF NEW USES FOR CARBON-dioxide gas or improvements to present uses. Award \$1,000. Liquid Carbonic Company.
Chicago

Full Details Regarding the Previous Offers Listed Above, May Be Obtained by Addressing the Bureau of Information, Popular Mechanics Magazine

NATIONAL BRASS COMPANY WILL PAY \$300 for design of key guide that can be made of sheet metal and which will properly fit cutcheon plate of similar material.
Grand Rapids, Mich.

TO ANYONE WHO WILL PRODUCE FOR them a saxophone reed to satisfactorily replace the present reed, the Buescher Band Instruments Company will pay the sum of \$1,000.
Chicago

THE PHENIX RADIO CORPORATION WILL pay the sum of \$1,000 for the design of a new form of condenser for radio reception.
Chicago

FOR A SATISFACTORY HAMMER-BLOW arrangement for portable hammer drill, the Woodack Electric Tool Corporation will pay \$500.
Chicago

FOR SEVROCKET STICK HARMLESS IN descent, \$1,000; bombshell with illuminated flag, \$250; chemical combinations to produce smokeless fireworks colors, \$250. The Castle-Drumfield Fireworks Company.
Chicago

MOTOR-OPERATED HANDSAW FOR MANUFACTURE and sales; award, \$10,000 in royalties. E. L. Barker and Company.
Chicago

TO THE PERSON SUBMITTING TO THEM an article which they can make in their machine and electrical shop, the Guyan Machine Shops will pay \$250 over and above its royalties or sales price.
Chicago

GRANITE STATE MOWING MACHINE COMPANY offers \$500 in cash and royalties for satisfactory working drawings for gasoline-motor lawn mower they accept for manufacture and marketing.
Chicago

Radio Questions and Answers

Q. I would like to build a five-tube neutrodyne receiver. Can you furnish me with diagrams and building instructions? I live close to the Mexican border, but would like to get the broadcasting stations in the northern states. I now have a one-tube set and cannot reach very far. **A.** We published the complete working details for the construction of this receiver in the February and March, 1924, issues. You can obtain these back numbers from our subscription department at the usual price. We can also supply you with a large blueprint of the circuit if you wish.

Q. I have a three-tube regenerative set, using three UV-199 tubes. How can I make it more selective? **A.** Place a .0005-mfd. variable condenser across the secondary of the variocoupler, and another variable condenser of .001 mfd. capacity in series with the aerial or the aerial and ground. This will give you very selective results.

Q. My two-step amplifier does not seem to have enough volume. Does it make any difference which side of the filament the secondary of the transformers are connected to? **A.** It is very important that the secondary terminal of the transformer at the lower end is connected to the negative side of the filament. Most transformers are marked P- at this point.

Q. I have a two-tube receiver, a detector and one step of amplification. How far should I be able to hear with this set using a good pair of ear phones on "silent night"? **A.** This depends on the type of receiver you have, the condition of the batteries, the efficiency of the aerial and ground, your location, atmospheric conditions and, last but not least, your ability to tune the instrument. Remarkable distances have been covered with two-tube receivers under good conditions, but no one can tell you just how far you will be able to receive, as there are too many angles to be considered. A conservative range would be from 500 to 1,000 miles.

Q. What do you consider the best crystal? I have tried several kinds and cannot find a good one. **A.** Galena is a very good crystal. There are also many synthetic crystals now on the market that are very good. The best way is to get several, as they are low in price, and try them out. A large piece of galena can be purchased, broken up small, and each piece tested. Handle the crystal with a small pair of tweezers, as the surface should not be touched with the fingers. If you have crystals that have been handled, wipe them off with a little benzine; you will find that it will then be easier to locate the sensitive spot.

Q. I would like to connect a number of phones to my receiver. Should I connect them in series or parallel? **A.** The phones should be connected in series.

Q. Can I use a loud speaker with my two-tube receiver? It is a one-step spider-coil set that you described in the February, 1923, issue. **A.** This instrument was not designed to be used with a loud speaker; it would be necessary for you to add another step of audio-frequency amplification to the instrument to enable you to use a loud speaker on distant stations. However, for local stations, a loud speaker may be used with fairly good results.

Q. I have been given an old set of the homemade type. The circuit seems good, but many of the connections are corroded; how can I put it in shape? It is a two-step regenerative receiver. **A.** Copy the circuit carefully for reference, then take off all the wiring, and place new soldering lugs under the terminals of all the instruments. If the rheostats are loose and make poor contact, get new ones. Clean all dust and dirt from the blades of the variable condensers, using a common pipe cleaner for this purpose. See that the sockets are in good condition, and that the clips make good contact with the prongs on the tubes. If there are any pigtail connections, such as are commonly used on variometers and condensers, see that these are not broken. Rewire the set carefully, soldering each joint. See that the jacks are not shorted by corrosion. To test the transformers, use a pair of phones with a dry cell in series and test each primary and secondary; if they are in working condition, you will get a click in the phones, if not, put in new ones.

Q. Will you please tell me if I can use a storage A-battery on my UV-199 tubes. **A.** Yes; there are several 4-volt storage batteries on the market for this purpose.

Q. I am having difficulty in soldering the connections on my set. The flux runs under the instrument terminals. I am using wire solder with the flux in the core, and it does not seem suitable for this kind of work. **A.** Use a solid-wire solder, get a small tin of soldering paste and use the paste sparingly on the lugs to be soldered. Use the paste more to clean the terminal than to act as a flux. If tinned-copper wire is used for the circuit very little flux is required.

The Radio Department is willing and anxious to serve you. If you contemplate buying or building a set, we will be glad to advise you in selecting the proper instrument to suit your purpose, furnish you a circuit, or tell you where to get the best parts. When you run into trouble in building or operating your set, tell us about it, and we will endeavor to clear it up for you.

Address all inquiries to the Radio Editor, Popular Mechanics Magazine, 200 E. Ontario St., Chicago.

Q. What is the difference between audio-frequency and radio-frequency transformers? This point has never been explained to me. **A.** Radio-frequency transformers are used before the detector tube to amplify the weaker signals to a point where they will actuate the detector. Audio-frequency transformers are used after the detector to amplify the signal at frequencies that can be heard.

Q. How many turns of wire should I place on my loop? I have made the frame two feet square. What kind of wire should I use? **A.** Wind 12 turns

of No. 18 flexible rubber-insulated and braided wire on the frame, spacing the turns $\frac{1}{2}$ in. apart. Lampcord can be used if this wire is unobtainable, but it does not make as neat a job.

Q. Should I shield my superheterodyne receiver? Some say to shield, other not to. Do shields cut down volume? **A.** Shielding is necessary in superheterodynes between the various stages. A well-shielded set will tune more closely and body capacities will be eliminated; this offsets any loss of volume, as you usually have more volume than you know what to do with in any case. Volume can always be sacrificed for clarity in a multi-tube receiver.

Q. How can I make a tube-protecting device? I have burnt out several tubes and hesitate to buy more until I can find some means of protecting the filaments. **A.** To protect your tubes place a 110-volt carbon lamp in series with the B-battery so that the current must pass through this lamp before going to the set. This protects your tubes in case of a short circuit.

IN accordance with the editorial policy of this magazine never to accept compensation in any form for what appears in our reading pages, and also to avoid all appearance of doing so, we are obliged to omit the name of the maker or the seller of any article described. This information, however, is kept on file and will be furnished free, by addressing Bureau of Information, Popular Mechanics Magazine, Chicago. [Editor.]

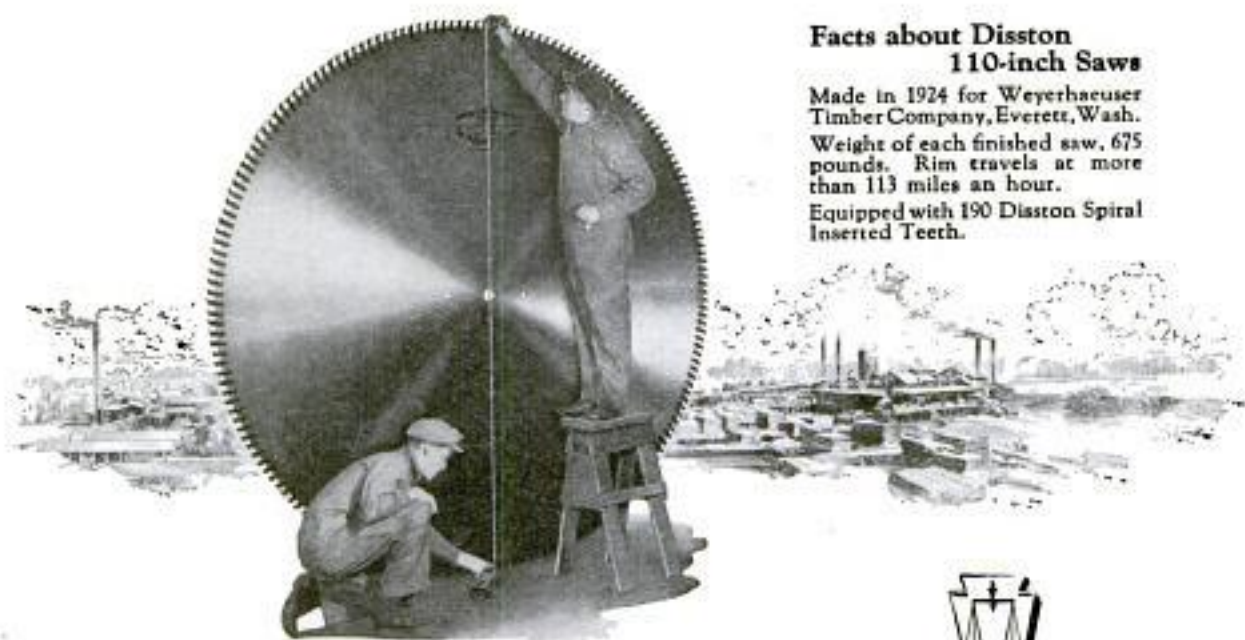

Facts about Disston 110-inch Saws

Made in 1924 for Weyerhaeuser Timber Company, Everett, Wash. Weight of each finished saw, 675 pounds. Rim travels at more than 113 miles an hour. Equipped with 190 Disston Spiral Inserted Teeth.



The skill of three generations —and the World's Biggest Saws!

BIG logs were coming down from the West Coast forests!

Logs calling for saws bigger than any that had ever been made.

The Weyerhaeuser Lumber Mills turned to Disston:

—And Disston made their big saws for them; 9 feet and 2 inches across—almost half a ton of Disston Saw Steel in each—the largest saws in the world!

There were no standards for saws in 1840, when Henry Disston began to make them.

Saw Steel from the best makers was never twice alike. And the best of workmanship can not make a good saw from poor steel.

So Disston mastered the methods of steelmaking.

At last he found ways to roll, harden, and temper saw-steel so that it will always have life and spring and hold its cutting edge.

Saw-makers he had trained took this Disston steel and made such saws as never were made before.

Disston's little cellar workshop has grown into the biggest saw plant in the world; 68 buildings housing 3600 busy workmen—

Carpenters and mechanics, as well as men who use a saw only once in a while, have spread the fame of the Disston Hand Saw everywhere.

Any hardware man will show you the Disston Hand Saw.

You can try its balance right there at the counter. You can observe its spring and life. You can read Henry Disston's promise etched on the shining blade—"For Beauty, Finish, and Utility this Saw can not be excelled."

Later, when you saw with it, you will discover why it is the choice of the carpenter. For here is an edge that keeps its keenness, a blade that works with you. This is the saw that is through the cut first!

So, when you choose your saw, do as the experts do, the men who make their living working with tools.

Say—"I want a Disston Saw!"

Ask Disston

Tell us what kind of work you are doing, in wood, metal, stone, ivory, rubber, leather, cloth, fibre or other material, and we will tell you what types of saws to use to do your work better and easier. Disston issues many books to aid the user of saws and tools.

HENRY DISSTON & SONS, INC.
Philadelphia, U. S. A.

Hardware dealers the world around sell Disston Saws, Tools, and Files

DISSTON

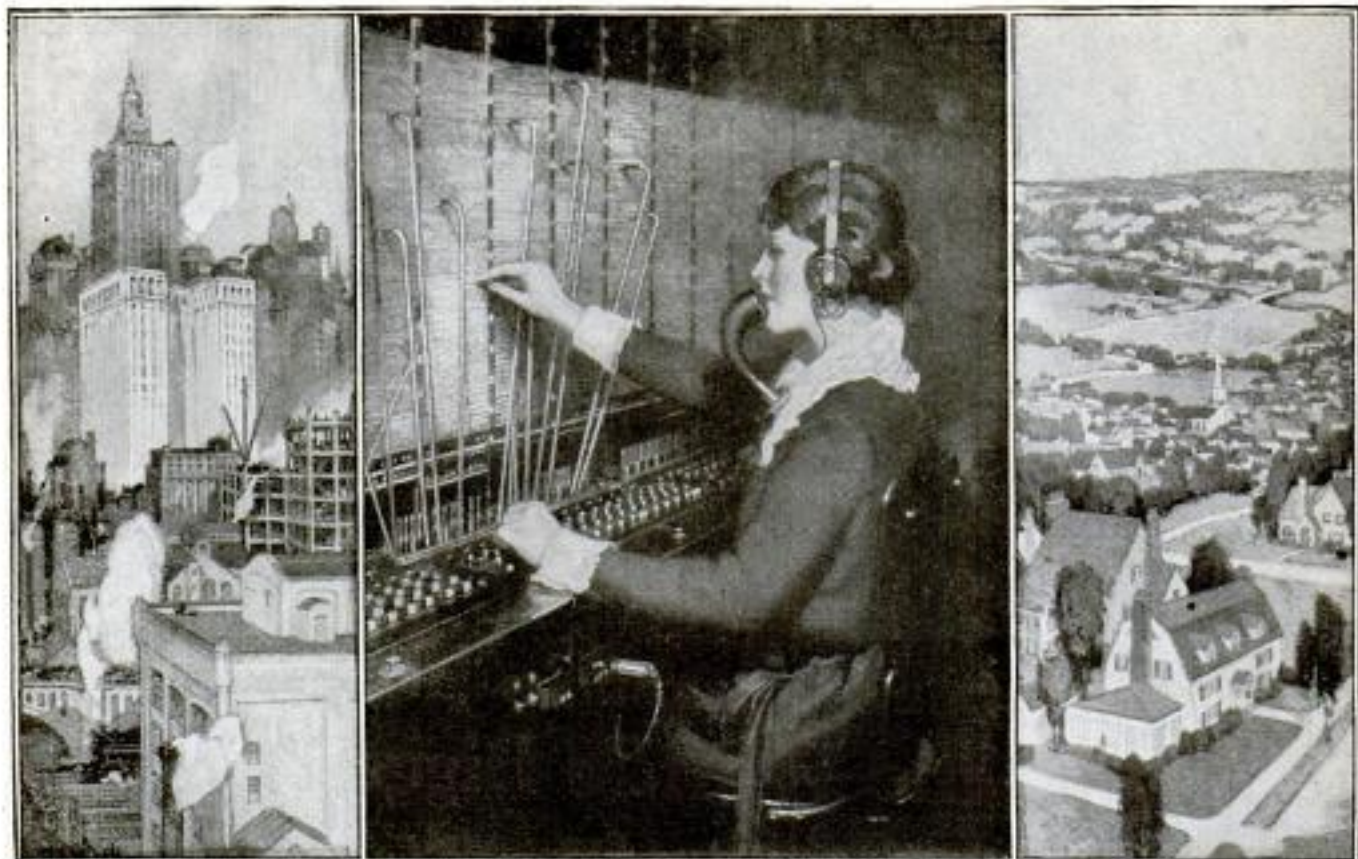

At your service

The courteous girl at the switchboard speaks the first word in more than two million conversations an hour. Presiding day and night at the busy intersections of speech, she is always at the call of the nation's homes, farms and offices.

Out of sight, and most of the time out of hearing of the subscribers, little is known of the switchboard girl—of her training and supervision under careful teachers, and of her swift and skilful work. Likewise, little is known of the engineering problems necessary to bring the terminals of fifteen million

telephones within the reach of a girl's arm, or of the ceaseless work of maintenance which in fair weather and storm keeps the mechanism fit and the wires open.

America's millions of people must have at their command means of direct and instant communication, and the Bell System must ever be in tune with the demands of national service.

These are the components of America's system of telephony: The best of engineering, of manufacture, of facilities—and a personnel trained and eager to serve.



**AMERICAN TELEPHONE AND TELEGRAPH COMPANY
AND ASSOCIATED COMPANIES**

BELL SYSTEM

One Policy, One System, Universal Service

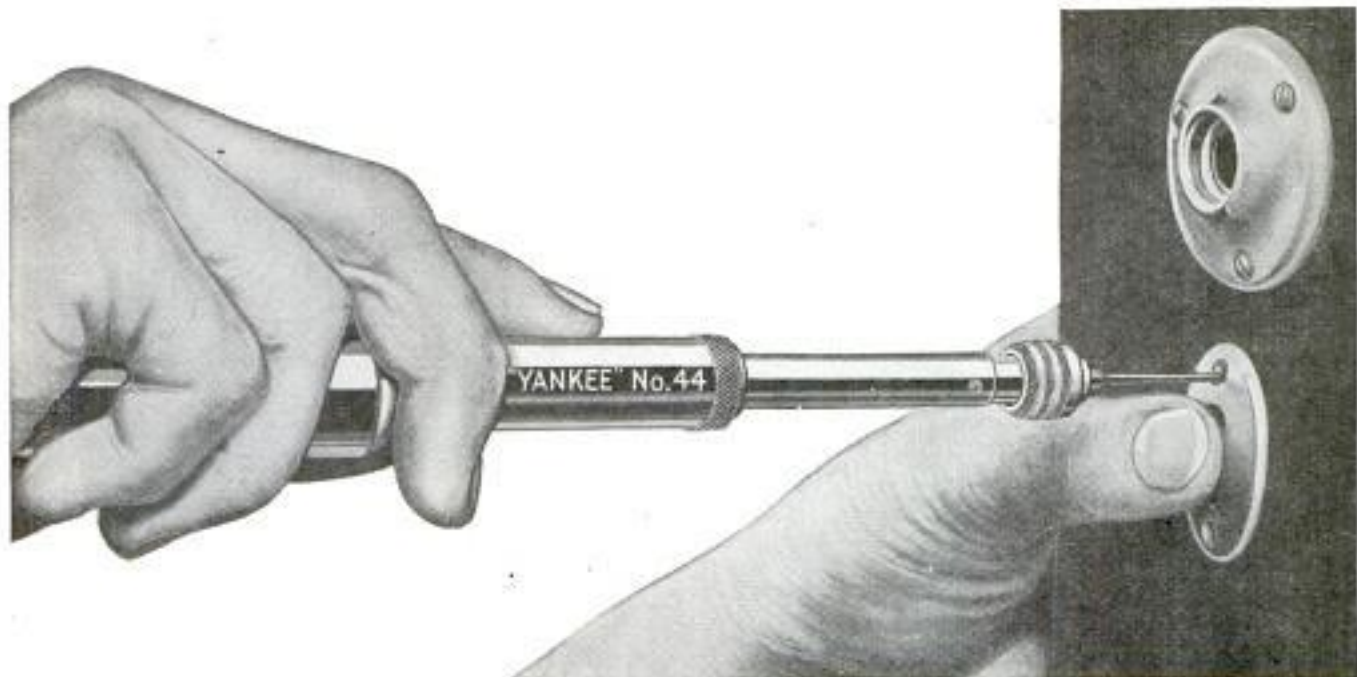

From tiny holes to large ones The exact tension for each job

You don't have to guess at the right pressure if you use a "Yankee" Automatic Push Drill No. 44.

Seven adjustable tensions enable you to change the pressure to suit small drills, large drills, soft wood, hard wood. Using an 11-64" drill in hard wood, you turn cap on handle to right, increasing tension. With a small drill in soft wood, turn cap to left to lessen tension.

"YANKEE" Automatic Push Drill No. 44

is practically a special tool for each job. Saves drill points. Saves time. Saves labor. Eight drill points, 1/16" to 11/64" in magazine handle, that opens up toward chuck, for quick, easy selection.

No. 41 is another automatic push drill, without adjustable tension, for those who do not require this feature.

These tools are just as valuable for jobs about the house, as they are to skilled mechanics.

Some other "Yankee" Tools

Spiral Screw-drivers
Quick Return Spiral
Screw-drivers

Ratchet Hand Drills
Ratchet Breast Drills
Push Braces

Dealers everywhere sell "Yankee" Tools

"Yankee" on the tool you buy means the utmost in quality, efficiency and durability

NORTH BROS. MFG. CO., Philadelphia, U. S. A.

"YANKEE" TOOLS

Make Better mechanics



This FREE Tool Book will interest you.

Every "Yankee" Tool is illustrated and described. Write for your copy.

SARGENT

PLANES



The beauty of Sargent Planes is not in their looks alone

SARGENT Planes are beautiful tools—in design, materials and fineness of construction and finish. But the beauty of them that's most appealing is in the way they do their work. Always smooth and clean-cutting, with never a murmur! And "murmur" isn't simply a figure of speech.

As you undoubtedly know, the important part of any plane is the cutter, and the next thing is to make sure that it will not chatter or murmur when going across or against the grain.

SARGENT & COMPANY, *Mfrs.*

Here are two of the advantages you get in Sargent Planes: 1—a cutter of finest chromium steel, tough, wear-resisting, edge-holding. 2—absolute rigidity when the cutter is in place.

Of course there are other points that will interest you—points that make these two moderate-priced planes most desirable for every home and school work-bench. See Sargent Planes at your hardware dealer's and write us for booklet, which gives detailed information about them.

49 Water St., New Haven, Conn.

Scientists and experimenters choose Eveready Columbias

EVEREADY COLUMBIA Dry Batteries

-they last longer



Popular uses include—

gas engine
ignition
telephone and
telegraph
doorbells
buzzers
motor boat
ignition
heat regulators
tractor ignition
starting Fords
ringing burglar
alarms
protecting bank
vaults
electric clocks
calling Pullman
porters
firing blasts
lighting tents and
outbuildings
running toys
radio "A"



FOR home or factory electrical experimental work, Eveready Columbia Dry Batteries are supreme. They give experimenters power of known and dependable quality. Famous scientific and industrial laboratories everywhere use them for delicate work in preference to other sources of electricity. When not in use they rest quietly, renewing their strength for further experiments or tasks of utility and convenience. For every dry battery use, select Eveready Columbia Dry Batteries—they last longer.

Manufactured and guaranteed by

NATIONAL CARBON COMPANY, INC.
New York San Francisco

Canadian National Carbon Co., Limited, Toronto, Ontario

Fahnestock
spring clip bind-
ing posts on the
ignitor at no ex-
tra cost to you.

Ask for
them by
name at

electrical
hardware
radio
automobile
marine supply
implement and
general stores



What a whale of a difference
just a few cents make

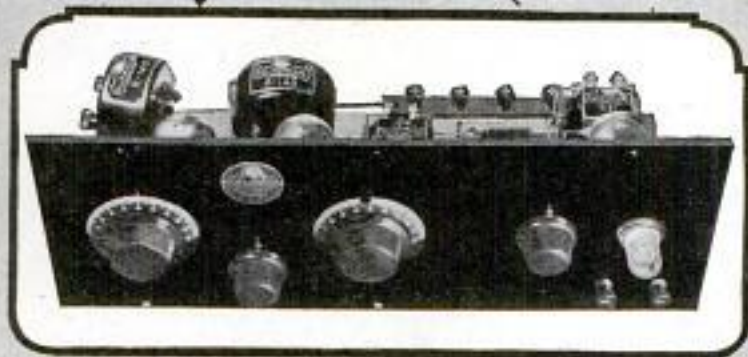

Now You Can Afford —
a modern precision-made
set which "cuts through"

☞ Tuned radio frequency for distance and selectivity, reflex for economy, the unequalled loudspeaker tone quality and volume which comes with ALL-AMERICAN precision manufacture—all are present in this *non-radiating* three-tube receiver. ☞ And, owing to the economy of "wiring it yourself," ALL-AMAX SENIOR costs less than a finished one-tube set of equally high quality. **Price \$42.**

The RADIO KEY BOOK is a radio education in itself. Send ten cents, coin or stamps, for your copy.

ALL-AMERICAN RADIO CORP
PIONEERS IN THE INDUSTRY
2656 Coyne Street Chicago

ALL-AMERICAN
Largest Selling Transformers in the World

ALL-AMERICAN Guaranteed Radio Products

Standard Audio Transformers
3 to 1 Ratio, type R-12... \$4.50
5 to 1 Ratio, type R-21... 4.75
10 to 1 Ratio, type R-13... 4.75

Power Amplifying Transformers
(Push-Pull)

Input type R-30... \$6.00
Output type R-31... 6.00

Rauland-Lyric

A laboratory grade audio transformer for music lovers. R-500... \$9.00



Universal Coupler

Antenna coupler or tuned r. f. transformer. R-140... \$4.00

Self-Tuned

R. F. Transformer
Wound to suit the tube. R-199 \$5.00. R-201A \$5.00



Long Wave Transformer
(Intermediate Frequency)
(15-75 kc.) R-110... \$6.00

10,000 Meter (30 kc.)

Transformer
Tuned type (filter or input). R-120... \$6.00



Radio Frequency Coupler
(Oscillator Coupler). R-130 \$5.00

Super-Fine Parts
Consisting of three R-110's, one R-120 and one R-130... \$26.00

The ALL-AMAX Sets

This shows how they come to you—mounted complete on panel and base-board, with full photographic wiring instructions.



All-Amax Junior



A one-tube reflex set that brings in the locals on the loudspeaker, with wonderfully clear tone quality, or tunes them out and gets real distance. *Non-Radiating.*
Price \$22.00



Starrett

*Why do the
Crack Machinists
Advise
the Apprentice
to start with
Starrett Tools*



Apprentice Set No. 901

You'll use the Starrett Tools you buy today for the rest of your life. Ten years seems like a reasonable length of service for a Precision Tool, yet any veteran machinist will show you Starrett Tools which he has used twice and three times ten years. It's all in the way Starrett Tools are made. Parts are correctly proportioned. The finest steel the market affords goes into

these lifetime tools. The workmanship is unequalled—a characteristic of a Starrett which is obvious when you examine the tool and is always evident in its lasting accuracy.

Starrett Apprentice Sets (Nos. 900 and 901) give you the tools you need to start—and tools you'll *always* need. Sold by first-class hardware stores everywhere at a price you can afford to pay.

Write for Starrett Catalog No. 23 "AP" describing the uses of 2200 Fine Precision Tools. FREE.

THE L. S. STARRETT CO.

*World's Greatest Toolmakers
Manufacturers of Hacksaws Unexcelled
ATHOL, MASS.*



The Starrett Set for Apprentices and Students comprises the following Precision Tools neatly cased in a substantial and nicely finished wood tool box: 6-inch Combination Square No. 11 complete, 6-inch Flexible Steel Rule in Pocket Case No. 320, Center Punch No. 117-B, Center Gage No. 390, 5-inch Divider with Spring Nut No. 77, 6-inch Outside Caliper with Solid Nut No. 79, 6-inch Inside Caliper with Solid Nut No. 73. And the Starrett Book for Machinists' Apprentices (Vol. I), 184 pages that show "how to do it."

7550



\$3
DOWN

and it's YOURS

The Greatest Typewriter Bargain Ever Offered

Right now we are making you the greatest typewriter offer you ever dreamed of—an eye opener. This wonderful standard Shipman-Ward Rebuilt Underwood only \$3.00 down. Ten days' free trial and the easiest monthly payments, shipped direct to you from our big factory.

10 Days' Free Trial From Factory to You

Yes, only \$3.00 down puts this genuine late model Shipman-Ward Rebuilt Underwood in your home. You can try it, test it, and then decide. See for yourself how new it is, how it writes. You must be satisfied. Your \$3.00 unconditionally returned if at the end of ten days you are not satisfied. The entire transaction will not cost you one cent.

EASY Monthly Payments

Little more than rental. Balance of payments so small you will hardly notice them, while you enjoy the use of this wonderful machine. You don't have to scrimp and save to pay cash. All at a big saving to you.

5 Year Guarantee

With every typewriter we give a written guarantee. These machines are rebuilt like new by the famous SHIPMAN-WARD PROCESS. Equipped with late improvements. You can't tell them from a new machine. The world's standard typewriter, the same models as sold by the Underwood Typewriter Company today, at a big saving to you. Act now! Get this splendid offer and save money.

These machines are shipped direct from our factory—the largest typewriter rebuilding plant in the world. They are rebuilt by the famous SHIPMAN-WARD PROCESS. Developed through 30 years in the typewriter business. Through our money saving methods of rebuilding and elimination of a large expensive sales force we are able to make this wonderful money saving offer to you. ACT TODAY, take advantage of it and you will SAVE MONEY.

ACT NOW! Mail this coupon today.

Free Book of Facts

Write for this free book of facts explaining Shipman-Ward's wonderful system of rebuilding typewriters. We show you exactly how it's done. How you are able to buy them. Complete and valuable information about the typewriter industry, both instructive and educational.

FREE with Every Typewriter

A complete course in touch typewriting. You don't have to know how to operate a typewriter. You can learn to operate this machine in one day. We also give free a waterproof cover and all tools that come with a typewriter.



All Shipments made direct to you from our modern factory—the largest typewriter rebuilding plant in the world.

FREE BOOK COUPON

SHIPMAN-WARD MFG. CO.
2124 Shipman Bldg.
Montrose and Ravenswood Aves.
CHICAGO

Send by return mail your wonderful offer of Shipman-Ward Standard Rebuilt Underwood, also your book of facts. (This is not an order and does not obligate me in any way.)

NAME.....

STREET.....

POST OFFICE.....STATE.....

SHIPMAN-WARD MFG. CO.

2124 Shipman Bldg., Montrose and Ravenswood Aves., Chicago

The Fine Finish of
Brown & Sharpe
Tools
Is Part of Their Quality
—An Indication of Excellence

High accuracy, together with superiority in every point of tool design, are basic qualities in Brown & Sharpe Tools. Fine finish is one of these qualities. Just examine closely any Brown & Sharpe Tool. Its fine finish is an indication of its excellence—an excellence which can be had only in Brown & Sharpe Tools.

Have you seen the new Brown & Sharpe Small Tool Catalog No. 29? Let us send you a copy.

BROWN & SHARPE MFG. CO.
 Providence, R. I., U.S.A.

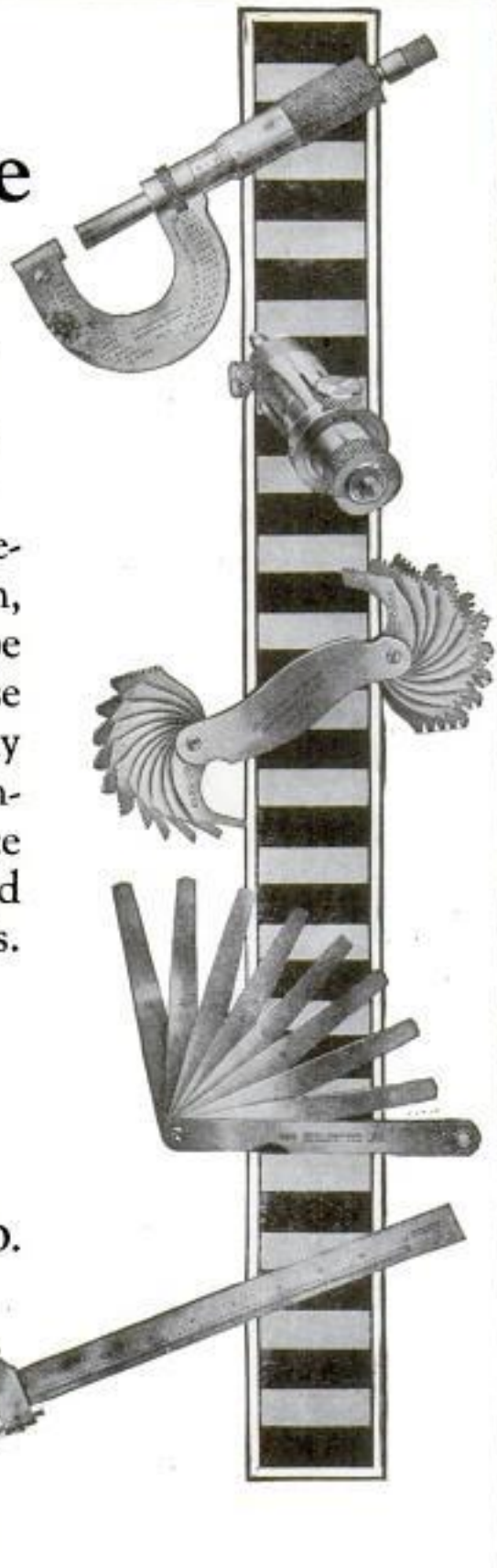

BROWN & SHARPE TOOLS

“Standard of the Mechanical World”

500 PUNCTURES Yet Leaks No Air



We Want Agents

A new Puncture Proof inner tube has been invented by Mr. H. F. Milburn of the Milburn Puncture Proof Tube Company, Chicago. In actual test it was punctured with 500 nail holes without the LOSS OF AIR. This amazing new inner-tube increases mileage from 10,000 to 12,000 miles; eliminates changing tires and makes riding a real pleasure. Many users have run over 20,000 miles without removing a tire from the wheel.

These wonderful, no-trouble, puncture proof inner tubes cost no more than ordinary tubes and Mr. Milburn wants agents everywhere to help him introduce them.

CAR OWNERS WANTED

To sell and demonstrate this wonder tube. Interests everyone immediately. Automobile owners buy on sight. It makes no difference what car they drive or what tires they use. Our salesmen are coining money on our "DIRECT FROM FACTORY" scheme of selling. Absolutely no competition. We control all basic patents. No capital required to start. Previous selling experience not necessary.

EARN \$5,000 to \$10,000 A YEAR

Read What These Men Say

J. D. Cooper—"I have made 30,000 miles with my Milburn Puncture Proof Tubes and have not as yet removed a rim or casing and my casings are still in excellent condition."

J. C. Jerves—"I sold 50 Milburn Tubes in the first three days."

Chas. Cayton—"I sold twelve tubes yesterday in ten minutes."

L. S. Knapp—"My first few hours out I sold eight tubes, no trouble at all to sell them. The most wonderful tube on the market today, I think. I am hoping you will give me the agency for a big territory."

D. Edeler—"I have driven seventy-five miles in one of the 30x3 tubes and twenty were spike nails. It has gone above the test that you recommended to me it would do."

Earn \$5,000 to \$10,000 yearly or more. Get into business for yourself. Sell Milburn Puncture Proof Inner Tubes. Every car owner is a prospect. Your field is unlimited. Get in while it is good. Be independent. Find out all about it now and get started at once. Then you will be ready to make big money when the heavy spring selling season starts.

FREE TUBE SPECIAL FREE TUBE OFFER

Send coupon or write today for special free tube offer and further details. References, Industrial State Bank of Chicago, National Bank of the Republic, Chicago, Baker State Bank of Chicago. Don't hesitate. Fill out the coupon and send it in or write and send name and we will send you all details. This is your opportunity so don't delay. Address

H. F. MILBURN, Pres.
**Milburn Puncture
Proof Tube Co.**
331 West 47th Street
CHICAGO, ILLINOIS

MILBURN PUNCTURE PROOF TUBE COMPANY
331 West 47th Street, Chicago, Illinois

If the money-making opportunity is as big as you claim, I am interested in writing the facts so that I can get a share of the profits selling Milburn Puncture Proof Tubes. Without obligation, send me the material about commission and FREE TUBE OFFER TO AGENTS.

Name.....
Address.....
City.....
State.....



The whole world in your hands

General Electric motors enable one great mill to produce paper enough in a day to cover a 13-foot road from New York to Chicago. Other G-E motors run the huge presses which can print as many as 300,000 newspapers an hour.



Rivers that now furnish power for great mills once ran wastefully away. Not in the United States alone, but all over the world, equipment made by the General Electric Company is transforming idle rivers into hard-working servants.

So, served by electricity, you breakfast like a king—an electric percolator and an electric toaster on your table, and the world's news in your hands!

GENERAL ELECTRIC

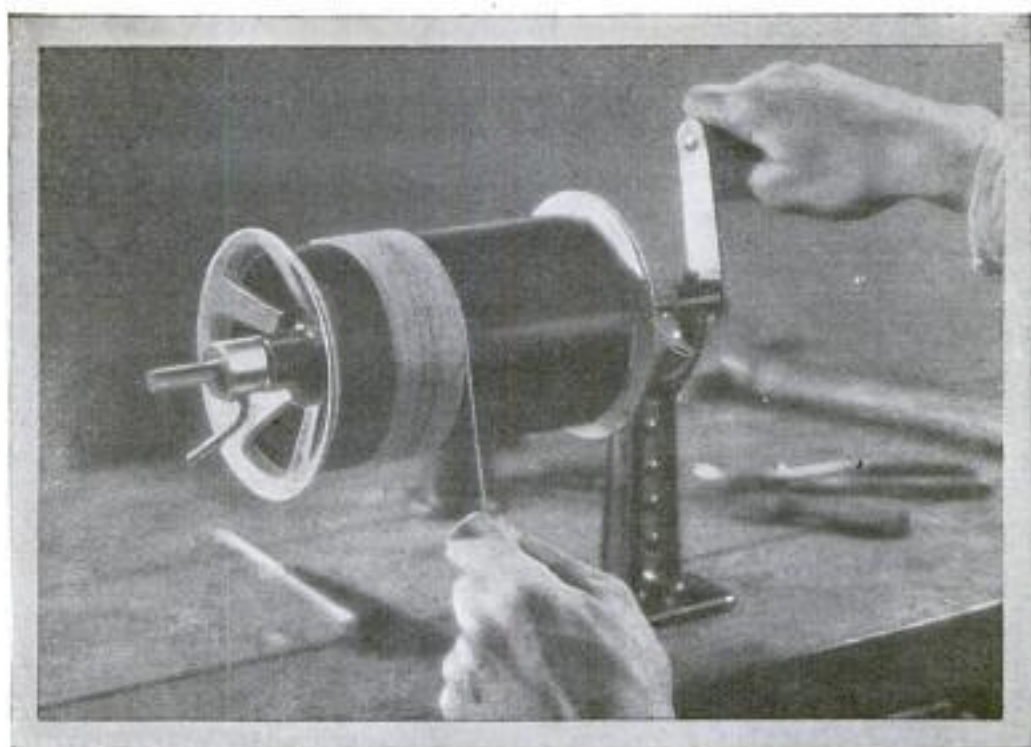

A new tool that radio fans have been waiting for

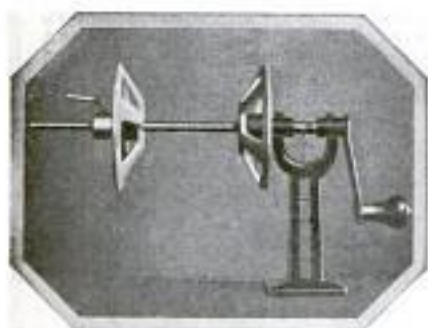

No. **695**

Coil Winder

NOW the radio amateur can "wind his own" as quickly and as expertly as any professional coil winder—and at one-tenth the cost. This Goodell-Pratt Coil Winder is a new tool made especially for winding tubular coils, inductance coils and transformers for superdyne and neutrodyne circuits.

Holds any cylinder of cardboard, bakelite or fibre up to $4\frac{3}{4}$ inches in diameter and 7 inches in length. The outer aluminum driving disc is adjusted to the cylinder length by a sliding collar which can be locked at any point on the spindle with a thumb screw. The outside face of this collar is cut at an angle, affording a cam action against the button on the disc hub, which exerts a continual tightening effect on the cylinder. And because both discs are cone-shaped, the cylinder is centered automatically.

The spring wound around the spindle prevents it from turning backward and releasing the tension on the coil wire. If unwinding becomes necessary, merely raise the loop end of the spring.

Nicely finished in red and black enamel and natural aluminum, with all exposed steel parts well polished. Length over all, $14\frac{1}{2}$ inches; weight, 3 pounds.

Other tools for radio builders. Write for special radio tool folders, which show all the Goodell-Pratt radio tools, many of which are new and exclusive Goodell-Pratt inventions.

GOODELL-PRATT COMPANY, Greenfield, Mass.
Makers of Mr. Punch

GOODELL-PRATT

1500 GOOD TOOLS

*Combines distance, selectivity, power,
deep full tone, beauty and simplicity!*

Looks like—and performs
like—a \$200 radio set



BUILT TO GIVE
LOUD SPEAKER
ENTERTAINMENT
FROM STATIONS
THOUSANDS OF
MILES DISTANT
WHILE LOCAL
STATIONS ARE
BROADCASTING

A real entertainer that will fill your home with friends!

**MIRACO
RADIO
GETS 'EM
COAST TO
COAST**

West Virginia
Hears
Australia
Got 2-XB
Wellington,
Australia,
plain last night
at 12:45 A. M.

over the Miraco. I am delighted and would not trade for any instrument in town.—Geo. B. Lancaster, Glenn Ferris, W. Va.

Indiana Hears England

During the International Test, was successful in bringing in 2-LO, London, also Manchester, England, on my Miraco.—H. R. Royer, Servia, Ind.

Using Miraco, I get 'em all from coast to coast. Also picked up London, England.—E. O. Wachter, Hammond, Ind.

Iowa Hears Coast to Coast
I can say Miraco is a wonder. We have received stations from coast to coast and also Canada.—O. E. Puderbaugh, Lacona, Ia.

Ohio Hears 104 Stations
Miraco very successful, having gotten 104 stations so far, California to New York, Canada to Texas. Also heard piano solo Nov. 24th from Wales.—H. S. Owen, Columbus, Ohio.

Wisconsin Hears France
Have received over 60 stations with the Miraco, San Francisco to New York City—also Sheffield, England and Paris, France.—Carl H. Dettmann, Waukesha, Wis.

Illinois Hears Cal. to N. Y.
Miraco works fine. I have Los Angeles, Cal., and several New York stations on my list.—W. W. Worrell, Carthage, Ill.

Texas Hears All Over U. S.
I have heard stations all over the United States and Havana, Cuba. Think Miraco as good as can be bought.—Thos. Peyton, Parker, Texas.

Pennsylvania Hears Germany
During International Radio Test we received Germany. Also San Juan, Porto Rico.—F. G. Kaminsky, Mildred, Pa.

South Dakota Hears Coast to Coast
Received Miraco a few days ago and it is a wonder. Have heard from Coast to Coast.—Dewey Grabinski, Rockham, South Dakota.

New York Hears California
Miraco received O. K. and am well pleased with results. Concert from Oakland, Cal., came in clear—and it's a long way from New York to California.—E. M. Davis, Waverly, N. Y.

—costs only \$ **75**
The Marvelous
MIRACO
Ultra 5

Send for
free bulletins
and
SPECIAL OFFER
today!

[FIVE TUBE OUTFIT IN BEAUTIFUL SOLID MAHOGANY CASE]

Completely built, thoroughly tested and factory guaranteed by one of America's oldest and most reliable manufacturers of quality sets! Years of experience and quantity production explain its almost incredible price. Users say that friends who see and hear it are amazed that it sells for less than \$150 or \$200. Radio experts, who know good construction and quality parts, are equally astonished. You, too, will be delighted, thrilled, amazed with your big five-tube Miraco Ultra 5 in its beautiful hand-rubbed solid mahogany cabinet!

Imagine getting all this for \$75—a beautiful sweet toned "coast to coast

loud speaker" set, composed of finest parts, equipped with the latest improvements, refinements and features found on costliest sets. An instrument approved by radio's highest authorities! A set anyone can connect and operate. Even beginners learn quickly to cut through the "locals," get distant stations loud and clear, log stations and return to them at will. (Full directions with each set.) It is non-radiating, non-distorting, non-howling. Has cut-out switch—and a first stage phone jack for tuning—on Bakelite panel. All wiring concealed under Bakelite sub-base. Works on storage battery or dry cells. Literature describes other newest features.

Other Miraco Long Distance Sets \$ **14³⁵** up



Miraco Model R justly deserves its title, "Radio's finest low priced quality receiver." One tube sets as a tuned radio frequency amplifier and detector combined. A great distance getter. Easy to

operate and log. Covers all wave lengths 150 to 625 meters. Like all Miraco sets, it operates on a storage battery or dry cells. Never such value before at only \$14.35. Send coupon today!

This wonderful new Miraco Model R-3 is the three-tube, long distance, loud speaker set that has created such a sensation. Easy to tune and log. Covers wave lengths 150 to 625 meters. Detector acts also as a tuned radio frequency amplifier. 2 stages audio frequency amplification. Has no equal for simplicity, volume, range or clearness at anywhere near its price of \$29.50. Use coupon!



All the Proof you want is waiting for You!

Reports from the many users in every state prove Miraco Tuned Radio Frequency Receivers—at rock bottom prices—have efficiency of sets costing up to three times as much. Remember that Miraco Sets are the product of a long established, reputable manufacturer—pioneer builders of sets. Send for further evidence that they are Radio's finest moderately priced receivers. All Miraco sets bear the endorsement of radio's highest authorities. Mail coupon now for latest bulletins, SPECIAL OFFER and plenty of additional testimony from users leaving no doubt that "Miraco Radio Gets 'em Coast to Coast."

Dealers! Jobbers!

Write for the new Miraco proposition.
Agents!

The wonderful tone, volume and distance-getting ability of Miraco Sets makes them easy to sell. Send coupon for proposition and territory open.

Send coupon
for
free bulletins
or order
direct from
this ad!

MIDWEST RADIO CORPORATION
Pioneer Builders of Sets, 407-2 E. Eighth St., Cincinnati, O.
Send free literature, SPECIAL OFFER and all particulars regarding Miraco Sets. () Jobber () Dealer () Agent () User

NAME.....
ADDRESS.....

Only

 DOWN

**SILENT
MODEL
NO. 8**
*for this
Long Wearing*
**BALL
Bearing**

Honor Built L.C. SMITH

HAVE YOU a good typewriter in both your home and office? If not, you are running the risk of costly errors, misunderstandings and criticism—no matter how well you write. All business and personal letters and invoices should be typewritten. It is the method used by all modern men and women, old and young, and anyone can afford a machine on our plan. We will send you one of these wonderful typewriters with no obligation to you whatsoever. Send no money. Just fill out and mail the coupon. This brings full particulars of our Free Trial Plan made by special arrangement with the express company. Take advantage of our Remarkable New Special Low Price Offer which makes it so easy for you to own this handsome full size machine with all late style features and modern operating conveniences.

10 DAYS FREE TRIAL!

We want you to give this wonderful typewriter bargain the most thorough test in your own home or office. You cannot imagine the perfection of this beautiful machine until you have seen it and used it. You send no money. When the typewriter arrives, you deposit only \$3 with your local express agent. Test it thoroughly for ten days. Then if you are not satisfied it is the greatest bargain—the very finest typewriter you have ever seen, just return it to your express agent and he will promptly return your \$3 to you. If you decide to keep it, you make monthly payments so small you will never miss them—just like rent—and then this wonderful typewriter is yours. No "red tape"—no annoyance—no delay. Five-year written guarantee with every machine.

A LIFETIME BARGAIN!

We are giving you the lowest price ever made on this wonderful machine—late style models—up-to-date—just like new—absolutely highest quality rebuilt, perfect adjustment and fully guaranteed. The world famous ball-bearing L. C. Smith has set the standard of quality and long service for over 20 years. It is the easiest running and longest wearing typewriter ever built. The choice of largest and discriminating users all over the world. Over half a million sold. No machine leaves our factory unless it is 100% perfect in every detail. Our prices are so low because we are the world's largest exclusive

dealers in L. C. Smith Typewriters. You cannot buy a typewriter at anywhere near our price that will give you as many years of satisfactory service.

FREE TO YOU NOW!

A Complete Course of Lessons on Touch Typewriting; Tools; and Waterproof Cover; Complete Operating Instructions; all given with your machine. This is the easiest typewriter to operate and learn. Anyone can use it. Send the coupon now before this offer is withdrawn.

SMITH TYPEWRITER SALES CORP.
300-360 E. Grand Ave., Chicago, Ill.

FREE TRIAL COUPON

SMITH TYPEWRITER SALES CORP.,
300-360 E. Grand Ave., Chicago, U. S. A.
 Send me your New Special Offer; Free Booklet of Valuable Typewriting Information; Your Catalog; and Free Trial Plan with no obligation to me.

Name

Address

CIR-KIT



More Power per Tube brings Greater Radio—Economically

Triple power is the basis of Erla Supereflex records. Tubes, as used in Supereflex, simultaneously amplify received radio frequency currents, reflexed radio and reflexed audio frequency currents. So 1-tube Supereflex rivals the power of conventional 3-tube circuits. And 3-tube Supereflex readily outclasses the ordinary five! Only such power can give you the thrill of Supereflex distance and volume; always with Erla crystal-pure tone—and with uncanny selectivity that gets what you want when you want it.

This finer radio is brought within the reach of all by Erla Supereflex *CIR-KIT*, the factory-sealed carton of genuine Erla apparatus for building Supereflex yourself. Anyone can follow the *CIR-KIT* assembly plan to perfection, using only screwdriver and pliers, without the risk of drilling or soldering.

Pride of workmanship, extreme economy, priceless radio performance, are yours in Erla Supereflex *CIR-KIT*. Select your model at the Erla store. 1 to 5 tubes, antenna and loop types.

ELECTRICAL RESEARCH LABORATORIES
Department J, 2500 Cottage Grove Avenue, Chicago

SEE ERLA RECEIVERS

Inherent Erla advantages in power, tone and selectivity are now available in beautiful complete Erla receivers. Retail prices range from \$67.50 to \$225. Both price and performance place Erla receivers among the sensations of radio history.

ERLA

Nine Months of merciless drubbing!



*A popular athletic-trim Keds model
—built to stand the hardest wear*

A National Handball Champion gives astonishing demonstration of Keds long-wearing quality

FIVE hours a week of driving play in one of the fastest sports known. That's the pace kept up by one of the greatest handball players in the world—winner of many championships.

A pair of Keds stood this grilling day after day, week after week, month after month—for a total of nearly nine months!

Records like this have made Keds the standard sports shoes today. Keds are worn by leading athletes everywhere—not only because they are tough and durable, but also because they give the maximum of ground-grip, comfort and speed.

These same qualities make Keds ideal for all summer outdoor uses—for outings, games, hikes, camping, canoeing—and for hard everyday wear.

Keds come in many styles and at prices from \$1.25 to \$4.50—according to grade, size and style.

Every real Keds has the name Keds on the shoe. It will pay you to look for the name.

Our Keds Hand-book for Boys is full of interesting information on camping, sports, rules for games, how to make things, etc. Sent free if you address Dept. 170, 1790 Broadway, N. Y. City.

United States Rubber Company

Keds

Trademark Reg. U. S. Pat. Off.



A Crepe-Sole Keds model—remarkable for lightness, floor-grip and long wear.

THEY ARE NOT KEDS UNLESS THE NAME KEDS IS ON THE SHOE

The Aladdin Combination!

"BACKED BY A \$200,000 CORPORATION"

"Absolutely the Greatest Radio Value on the Market Today"
**A 5-Tube Balanced Radio Frequency Receiver
 COMPLETE WITH ALL ACCESSORIES**

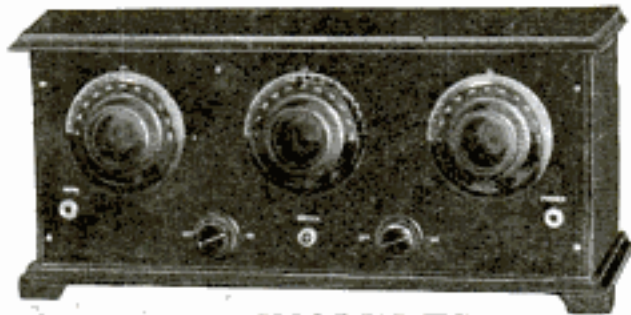
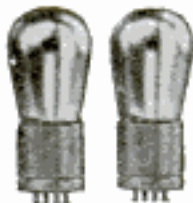

INCLUDES:

The Aladdin Receiver
 Five Aladdin Vacuum
 Tubes—6 Volts—
 Type 401A
 Loudspeaker

Storage Battery
 2-45 Volt "B" Batteries
 Aerial Equipment
 Ground Equip-
 ment

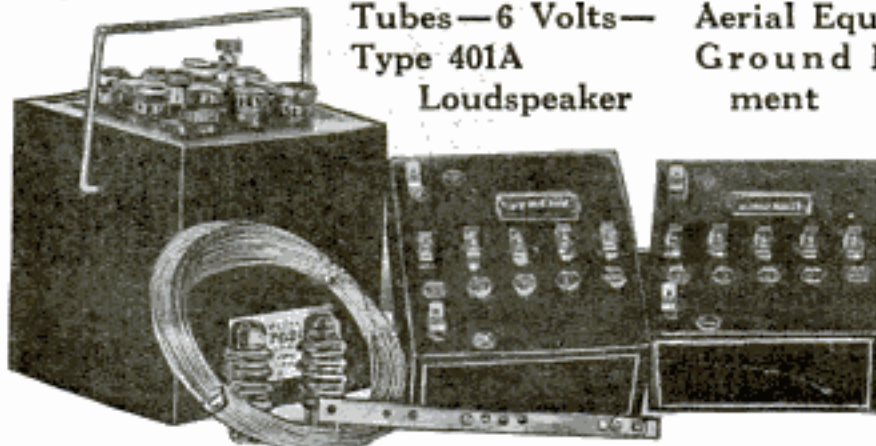

\$60.00

COMPLETE
 Nothing else to buy

The ALADDIN
 Vacuum Tube—Bakelite Base
 —Tipless

An improved, accurate instrument, built to precision and minute, scientifically gauged specifications. Can be used in any set, from the smallest one-tube receiver to the finest and most intricate multi-tube set. Economical in current consumption. Impregnated thorium filaments (not thorium-coated).

List Price \$3.00

Every tube furnished with the ALADDIN RECEIVER has been individually matched and bears an identification mark for easy insertion in their proper sockets.

Dealers! We have a wonderful tube proposition for you. Write for our exceptionally generous range of discounts.

Unbeatable Value

5 Matched and Tested Aladdin Tubes—Type 401A.

Solid Mahogany Cabinet—Lustrous Piano Finish.

Standard Low Loss Parts Throughout.

Skillfully Constructed—Scientifically Tested.

From Bus Bar to Cabinet—The Finest Quality Procurable

The ALADDIN employs the most efficient principle known to RADIO science today—TUNED RADIO FREQUENCY! With this recently perfected circuit, sharp and selective tuning, long distance reception and remarkable ease of control are actual realities. The usual stray capacities inherent with the ordinary radio frequency circuits are entirely eliminated, insuring remarkably clear, undistorted reception, volume and mellow tonal qualities.

The ALADDIN is conscientiously built—under the personal supervision of skilled radio engineers. An inspection of this receiver will immediately convince you that only the finest and most efficient LOW LOSS parts have been incorporated in its construction.

The position of the radio frequency transformers and condensers has been scientifically and minutely adjusted for the permanent and exact capacity balance of the receiver. This circuit is self-neutralizing—troublesome neutralizing condensers are entirely eliminated!

The ALADDIN is FOOL-PROOF!—exceptional results are obtained by the non-technical users.

ALADDIN RADIO CO.,
 156 Fulton Street, New York City

Gentlemen:

Kindly ship the items checked below, for which I am enclosing.....dollars:

- The ALADDIN Combination
 The ALADDIN Tube

Name.....

Address.....City.....

PM

Satisfaction Insurance Each and every one of these receivers is carefully and conscientiously tested under actual conditions. Therefore, we have no hesitancy in issuing our iron-bound guarantee of uniformly high quality results.

The Aladdin Radio Co.

Originators of Radio Apparatus

156 Fulton Street, Dept. PM
 NEW YORK CITY

MAIL ORDER DIVISION

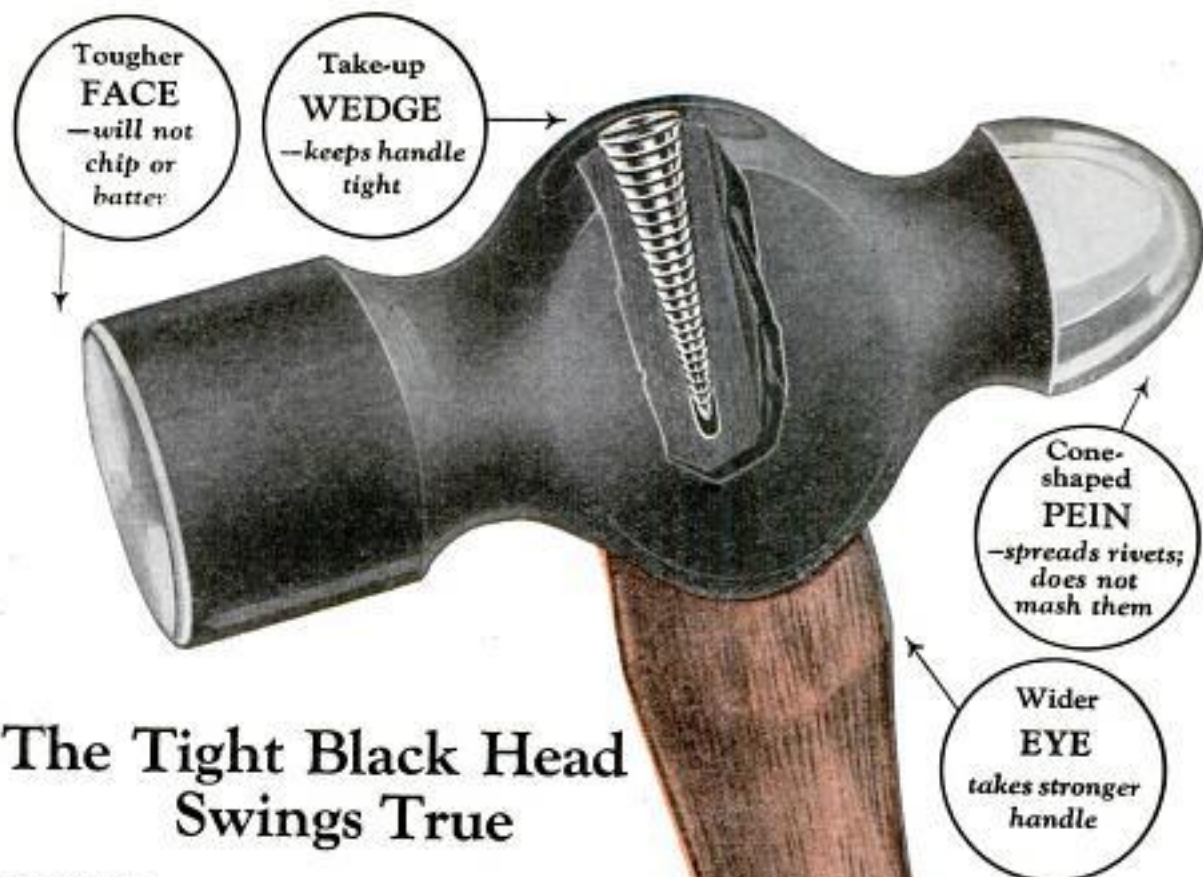

The Tight Black Head Swings True

WHEN you spread a rivet, when you cut a gasket, when you drive a cold chisel—the Plumb machinists' hammer swings true.

Balanced, it sure is. The off-center head adds power. The wider, stronger handle spells longer life. Every line of this hammer speaks of the practical suggestions of the working mechanics who helped us shape it.

Swings true! At first, and always. For with a turn of the Take-up Wedge (exclusively Plumb), you keep the black head always tight on the red handle. Thus you preserve its original hang and balance.

Try the Plumb. See what has been done to give the mechanic a better hammer!

(1 lb., \$1.00; 1½ lb., \$1.25; 2 lb., \$1.30; except in the Far West and Canada.)

Fayette R. Plumb, Inc.
Philadelphia, U. S. A.

LOOK FOR THE
Red Handle
WITH THE
Black Head
(Color Combination
Registered as Trade
Mark, U. S. Pat. Off.)
PLUMB



PLUMB TAKE-UP WEDGE
DOUBLE LIFE
FAYETTE R. PLUMB, INC. PHILADELPHIA, U.S.A.
A TURN OF THE SCREW TIGHTENS THE HANDLE

Patented Aug. 15, 1922. The cone shape of wedge expands handle against all sides of eye all the way to. Groove threads prevent wedge from flying out.

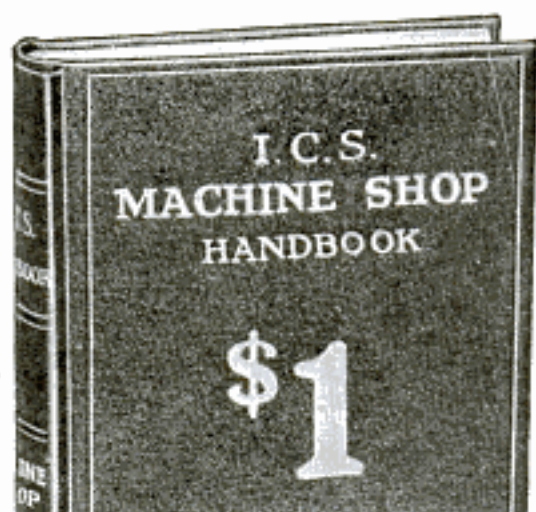

MACHINE SHOP HANDBOOK

335 Pages—282 Illustrations

THIS I. C. S. MACHINE SHOP HANDBOOK is a wonderful bargain at \$1. Contains more common sense, practical information than any other book of its kind ever published. Pocket size. A book that you will find invaluable in your daily work.

PRICE ONLY



Useful tables, mensuration, trigonometry, properties of materials, drilling, reaming, tapping and threading, lathe work, threads and thread cutting, measuring and testing, milling-machine work, indexing, helices and spirals, key work, gearing, planer work, shaper work, slotter work, broaching, grinding and polishing and lapping, jigs and fixtures, punch and press work, die casting, gauges, micrometers and vernier instruments, lubricants, temperature indicators, metals, heat treatment, chilled iron, welding and brazing and soldering, coating and protecting, filing, stock estimating, etc.

Just mark and mail the coupon—enclose the necessary amount of money—and we'll send you a copy of this Machine Shop Handbook, or any other book or books you want, by return mail. Money back if not satisfied.

INTERNATIONAL CORRESPONDENCE SCHOOLS

Box 5506-E, Scranton, Penna.

I am enclosing _____ for which please send me the books I have checked below—

- | | |
|--|--------|
| <input type="checkbox"/> Machine Shop Handbook—335 pages | \$1.00 |
| <input type="checkbox"/> Patternmaking—420 pages | 3.00 |
| <input type="checkbox"/> Foundry Work—368 pages | 4.00 |
| <input type="checkbox"/> Lathe Work—312 pages | 3.00 |
| <input type="checkbox"/> Gauges, Jigs, Dies, Tempering, Heat Treatment—347 pages | 3.00 |
| <input type="checkbox"/> Drilling, Boring, Bench Work, Erecting—385 pages | 3.00 |
| <input type="checkbox"/> Automobile Handbook—345 pages | 1.00 |
| <input type="checkbox"/> Electricity Handbook—414 pages | 1.00 |
| <input type="checkbox"/> Chemistry Handbook—348 pages | 1.00 |
| <input type="checkbox"/> Pharmacy Handbook—324 pages | 1.00 |
| <input type="checkbox"/> Traffic Handbook—386 pages | 1.00 |
| <input type="checkbox"/> Radio Handbook—514 pages | 1.00 |
| <input type="checkbox"/> Mechanic's Handbook—330 pages | 1.00 |
| <input type="checkbox"/> Building Trades Handbook—400 pages | 1.00 |
| <input type="checkbox"/> Advertising Handbook—445 pages | 1.00 |
| <input type="checkbox"/> Salesman's Handbook—352 pages | 1.00 |
| <input type="checkbox"/> Civil Engineer's Handbook—411 pages | 1.00 |
| <input type="checkbox"/> Steam Engineer's Handbook—298 pages | 1.00 |

Name.....

Address.....

30 Days FREE TRIAL

NO MONEY DOWN



Your request to try this engine is all we ask. You do not send a penny down—you try your engine first. After you have tried your OTTAWA Engine right at your own work for THIRTY DAYS, send us the small payment of \$4.95 a month. SOLD DIRECT FROM FACTORY TO YOU.

\$4.95 OTTAWA ENGINES

MONTHLY

Smallest monthly payment ever made on a 1½ H-P. engine—other

sizes 2¼ to 22 H-P. at proportionally low monthly payments—a whole year to pay if you want. No interest; no C. O. D.; no tiresome red tape. Use kerosene or gasoline without changing. New patented Venturi makes starting easier. Throttling governor. WICO Magneto ignition.

FREE BOOK Send your name and address on a post card for new OTTAWA Catalog. Get this book before you test any engine. Find out about this trial offer now. WRITE TODAY.

H. C. OVERMAN, President

OTTAWA MFG. COMPANY
530-E King St., OTTAWA, KANSAS
Desk 530-E Magee Bldg., Pittsburgh, Pa.

How to KNOW BETTER ENGINES

Measures ANYWHERE!

Inside or Outside—quick and accurate—the rule for you. Sliding action for speed and durability. Any length 2 to 8 ft., 20¢ per linear foot. At dealers or sent postpaid.

Dealers and Agents request attractive proposition

Interlox

MASTER SLIDE RULE

Master Rule Mfg. Co.
813 East 136th Street, NEW YORK



MOTORIST PROTECT YOURSELF FROM ACCIDENTS

My Safety Signal shows both direction signals, has a park, stop and tail light, carries the license. Complies with safety laws; guaranteed. Price \$12.95. Write today for Free Booklet. Discount to Agents. Address G. VEYMEIER CO., 395-24th St., Milwaukee, Wis.

AGENTS HOT SELLER JUST OUT

STOPS HEADLIGHT GLARE OF APPROACHING AUTOS

A simple, inexpensive device called "Glaroff" protects auto-drivers from the blinding headlights of the other fellow's car or a low, direct sun. Prevents serious accidents. Applied to inside of windshield instantly; held fast without bolts or screws; will not work off on rough roads. Try one on your own car a week; if it does not make driving easier, safer, trial costs you nothing.

SPECIAL OFFER TO AGENTS to use and introduce Glaroff. Enormous, uncrowded field. Sells like wild fire—every car owner buys.

\$25 A DAY up to \$10,000 a year to agent who gets your county. Territory going fast. Write for SPECIAL FREE GLAROFF OFFER and further details. This is a big opportunity, so don't delay, write today. **GLAROFF MFG. CO., 167 Plumbers Bldg., SIOUX FALLS, S. DAK.**

21 Jewel STUDEBAKER

The Insured Watch

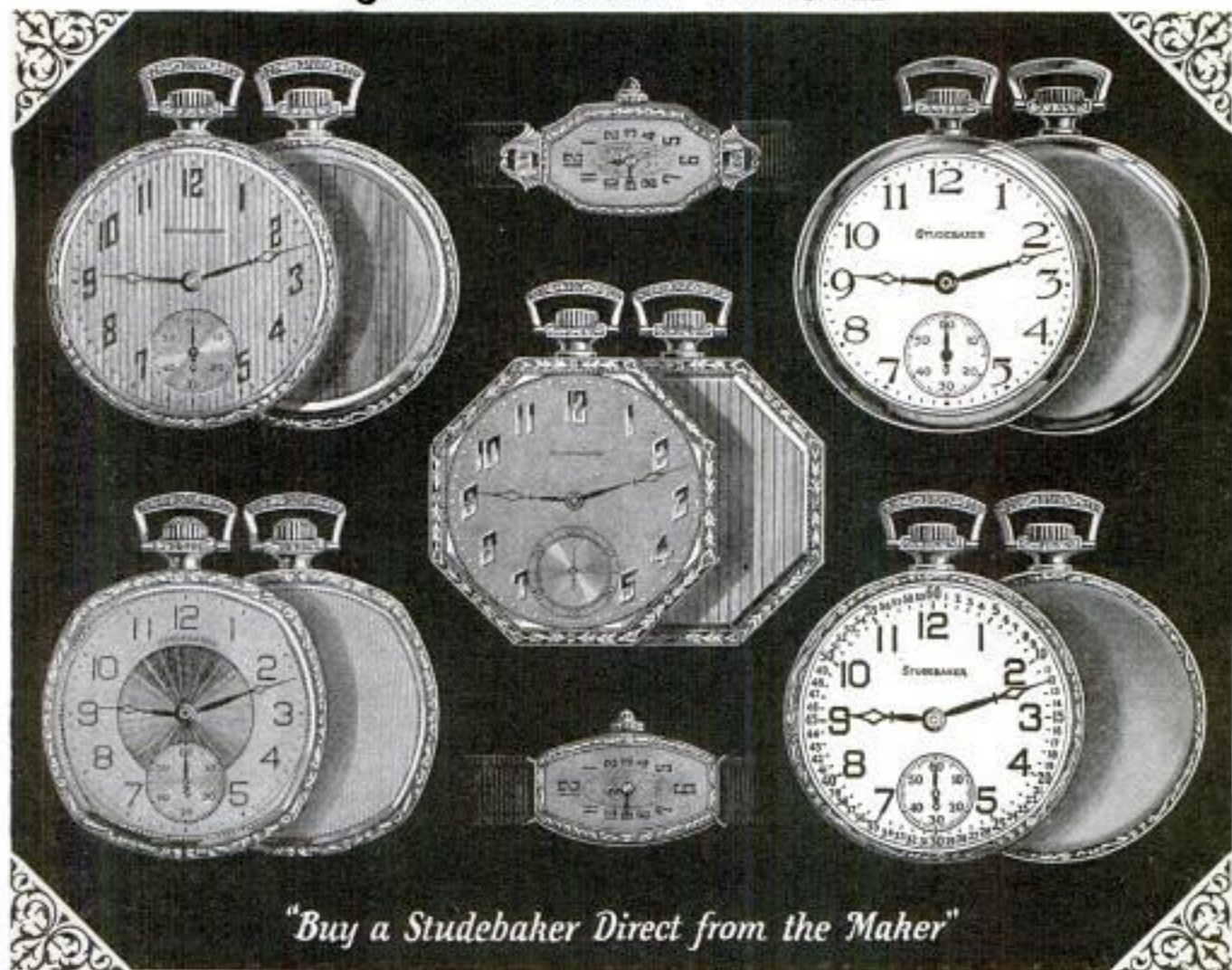

"Buy a Studebaker Direct from the Maker"

Only \$1.00 Down

CHAIN FREE!

Limited offer. Write at once for details.

Only \$1.00! The balance on credit, payable in small monthly installments—buys the magnificent 21 Jewel Studebaker Watch—insured for a lifetime—direct from the factory at a big saving—at the lowest factory price. Without doubt America's greatest Watch value. Mail Coupon for Book of Advance Watch Styles—beautiful new designs shown in full colors.

WRITE for the wonderful Studebaker Watch Style Book. See the stunning, latest thin-model Studebaker Art Beauty Cases in 54 different styles in yellow gold, white gold and green gold effects. 8 artistic Dial designs. Newest case shapes.

Read why the famous Studebaker Watch has 21 Jewels—why it has 8 adjustments—why it is adjusted to the second in 5 positions and for heat, cold and isochronism. Read why these things mean best time-keeping quality—the finest Watch movement.

For a limited time we are offering a beautiful Watch Chain FREE. Write for details. Send coupon—at once—for Style Book and free Watch Chain Offer.

STUDEBAKER WATCH CO., Dept. K22 South Bend, Indiana
Ask for Ladies' Bracelet Watch Folder. Ask for Jewelry Folder.

**MAIL THIS
For FREE Book**

STUDEBAKER WATCH CO.
Dept. K22 South Bend, Indiana

Please send me your Free Book of Advance Watch Styles and particulars of your \$1.00 down offer.

If you live in Canada send your inquiry to our Canadian office: Windsor, Ontario

Name.....

Address.....

City..... State.....

Check here for Ladies' Watch Folder Check here for Jewelry Folder

Build a Big Business



Selling Harley-Davidsons — we'll help you!

YOUNG men have a real opportunity right in their own home towns selling Harley-Davidsons. We furnish live "leads" and real help.

We receive many inquiries in response to our advertising. Those from your territory we'll turn over to you, and help you close them into real sales. Before long you'll have a permanent, growing business *all your own*, earning a real profit every month in the year.

We want responsible men with real ambition and enthusiasm. Very little capital required.

Don't pass up this opportunity to start a high-grade business with our help. Send the coupon for full information.

Harley-Davidson The Motorcycle

CLIP THIS COUPON

Harley-Davidson Motor Co.
Dept. P, Milwaukee, Wis.

Tell me how I can get into the profitable motorcycle business with your help. Also send free, illustrated booklets.

Name.....

Address.....

City.....

SELL EUROPEAN BONDS and MONEY

BY MAIL! THRO' AGENTS! DIRECT!
Big Profits. Big Sales. We start you. Lowest prices.
Write for Rock-Bottom Price List. \$1.00 brings sample outfit. 100 Pieces. Contains Bonds, Money, Coins.

HIRSCH EXCHANGE, 70 WALL ST., NEW YORK

ADDING MACHINE VEST POCKET SIZE



**ADDS
SUBTRACTS
MULTIPLIES
DIVIDES**

\$ 2⁵⁰

NEW Does Work of \$100 Machine.
Total Visible at all Times.

FREE TRIAL—Send No Money

Anyone Can Operate It. *Guaranteed for Life*
Just write "Send me a Baby Calculator" and give your name and address. We will ship it immediately, all charges prepaid. On delivery pay postman \$2.50. You can return it after 10-day trial for full refund if the Baby Calculator is not the greatest time and labor saver you ever used. *This is the lowest priced practical calculating machine made.* Order today.

BABY CALCULATOR SALES CO.
P. O. Box 1115, Dept. 5, Chicago, Illinois

AGENTS
Every business firm, man or woman, will buy the Baby Calculator on sight. **BIG COMMISSION**

PATENTS PEND.

TRADE MARK REG.

Husky

Common Sense Wrenches



600 PRACTICAL COMBINATIONS

Built From the Above Illustrated

No. 986—HUSKY STANDARD SET

ONLY \$13.15 COMPLETE IN TOOL BOX

(Slightly Higher West of Denver and Canada)

Write to

HUSKY WRENCH CO.

929-16th Avenue

Milwaukee, Wis.

Export Office: 280 Broadway, New York City

Suit of Clothes \$12⁵⁰

Make \$22.00 a day selling 4-square suits. Five patterns.

Profits in advance. \$3.00 to \$5.50 each sale. Complete line coat, vest, pants, riding pants, women's knickers, slip-ons, caps, jiffy snap-ons. 24-hour delivery. Write today.
**Stone-Field Corporation, Dept. 47,
2556 Wabash Avenue, Chicago, Ill.**



Send No Money

\$200

**DOWN
10 MONTHS
TO PAY**

Just send your name and address — we'll send this 18K White Gold ring set A-1 quality blue-white Diamond for **FREE EXAMINATION**. If satisfied, pay only \$2 upon acceptance—then only \$4.30 a month. **Satisfaction Guaranteed or Money Refunded.**

**No Red Tape—No Delay
Transactions Confidential**

Free—A complete catalog of Diamonds, Watches, Jewelry. 10 Months to Pay on Everything. Send for it.

AUTHORIZED CAPITAL \$1,000,000.

L.W. SWEET INC.

Dept. 65-J 1660 BROADWAY, NEW YORK



In fairness to your family and yourself

OF course you want your family to enjoy all of the advantages of modern living. But, have you provided them with the modern way of writing?

Have you considered what a wonderful help a Remington Portable will be to that boy of yours, and what an invaluable training it will give him for his life's work—whatever it may be? Do you realize the many precious hours it will save for everybody in the home?

Wouldn't it be worth a great deal to you to have this always ready helper on hand to take care of your personal writing?

Countless homes now find the Remington Portable indispensable, and we are sure that yours is no exception.

The Remington Portable is the choice of most people the world over, because it has every feature common to the big machines, is easy to operate, does beautiful work always, is compact, and carries its table on its back.

Sold everywhere. Easy payment terms, if desired. Write today for illustrated "For You, For Everybody."

Address Department 12
 REMINGTON TYPEWRITER COMPANY
 374 Broadway, New York

Remington Portable

THE RECOGNIZED LEADER IN SALES AND POPULARITY

Diamonds

Here at 60% of Market Price

Never in three quarters of a century have we offered such amazing bargains. Hundreds of money-saving opportunities in latest Diamond Bargain List, equalling those shown here.

Here's why we can offer such remarkable values: This 15 year old firm—rated at over \$1,000,000.00 capital—the largest and oldest diamond banking institution of its kind in the world has made loans on Diamonds, Watches, and other Jewels in excess of \$25,000,000.00.

Why Pay Full Prices Costs Nothing to See

Thousands of unpaid loans. Must sell now. Diamonds, Jewels, Watches and other Gems of unusual quality—at an entirely different price basis—viz: loan values not market values. At our risk we send you any bargain you wish for absolutely free examination. No red tape. No obligation. Don't buy unless satisfied you can not match the bargain at 50 per cent more. Diamonds of desirable quality at \$125 per carat. Yes, some even lower priced—also, finest gems obtainable at higher per carat—but proportionately low bargain prices. Our bargains have guaranteed loan values also, unlimited exchange privilege at full prices.

Latest List Diamond Loans

Send at once for latest list. Thousands of unpaid loans and other special advantage bargains. Many from big cash deals direct with European diamond cutters. Every gem described in full detail with exact weight, color, quality, etc. Get details of Free Examination offer. No obligation. List is free.

MAIL COUPON NOW

Only Opposite Post Office
Without obligation, send me free, your latest Bargain List of Diamonds, Watches and other jewelry.

Name.....
Address.....
City.....State.....

Jos. DeRoy & Sons,
1931 DeRoy Bldg., Pittsburgh, Pa.







Our Wonderful Plan Means SURE Success!

Make \$10 to \$20 a Day

Our plan puts you in business for yourself, starts you off successfully, makes big money for you the very first day. No other proposition like it. No "hard sledding" to begin with. Ours is the largest organization in the world selling shoes Direct to Wearer. Matchless quality at remarkably low prices—and a sales plan that works wonders.

Two Hours Daily

of your spare time will convince you our money-making plan is without an equal. Prove it at once. No need to quit your present work until you know our proposition is absolutely right. Start on full or part time. Write at once for unusual offer.

DOUBLEWEAR SHOE CO.
318 E. Lake St. Minneapolis, Minn.

Makes Autos Go 49 Miles on One Gallon of Gas

James A. May, of 7432 Lacotah Building, Sioux Falls, S. Dakota, has perfected an amazing new device that cuts down gas consumption, removes all carbon, prevents spark plug trouble and overheating. Many cars have made over 49 miles on a gallon. Anyone can install it in five minutes. Mr. May wants



agents, and is offering to send one free to one auto owner in each locality. Write him today.—*Adv.*

"DARN-IT-ALL"

The Magic Mender

Darns stockings, mends clothes, patches all fabrics, rubber and leather. Does away with drudgery of darning and mending. Does the work cheaper, easier, quicker. Stands repeated washings. Send 50c for full size tube. Money back if not satisfied.

Agents Get our generous offer.

DARN-IT-ALL COMPANY
4040 Cottage Grove, Dept. P. M., Des Moines, Ia.



Buy Now Pay Later

Let Boice Help You Build It!

No matter what you want to build, Boice can help you. He'll send you the

Boice-Crane Junior Saw

or any other Boice-Crane machine on monthly payments. He gives you unsurpassed values at lowest prices with a positive money-back guarantee. Machine grows will saw, bark, grind, mill, rabbit, tenon, etc. Steady, accurate, economical. Saws 1 1/2" stock. Sold with or without motor.

Write today for Descriptive Catalog of Bench Saws, Drills, Jointers and Hand Saws and the Boice E-E-Pay Plan.

W. B. & J. E. BOICE
Dept. P. M. 4-A, TOLEDO, OHIO
"World's Largest Makers of Small Bench Machines"



Pay a few cents a day the Boice way

Electric Welding Simplified



Regardless of the size of the job or its location, you can easily handle it. Get an "ALTERNARC," which cannot be beaten for portability, flexibility and durability. Stop turning down jobs. An Alternarc will soon pay for itself. Endorsed by thousands of satisfied users. Not an experiment, but a proven necessity in any repair or metal production shop.

Get An ALTERNARC—It's Portable

Welds cast iron, steel and malleable iron, also copper, bronze, lead and monel metal and good for boiler work. Also for score filling by the arc or Nickel Flash or semi-arc process; for attaching nails and bolts to sheets; for lead burning—either sheets or battery terminals, and many other uses. Particularly useful for welding Cracked Water Jackets, Furnace Sections, Crank Cases or Rear Ends without dismantling. Not good for thin sheet metal or brazing except in special cases.

Standard for

110 and 220 volts A. C., but can be made for any voltage, phase or frequency, or combination thereof. Popular universal model 150, 220, 440, 550 volts A. C. and 110, 220 D. C. in one unit.

Write for FREE Book

Send today for particulars and our free book, "ALTERNARC" which contains 52 pages of practical welding ideas. — It's FREE and no obligation of any kind. (Licenses under Pat. 1305362, June 3, 1919.)

THE ELECTRIC ARC CUTTING & WELDING COMPANY

152 Jelliff Avenue NEWARK, N. J.

I Want 700 Agents At \$90.00 a week



Men and Women! Write me today and by this time next week I can place you in a position to make \$2.00 to \$5.00 an hour in your spare time, up to \$15.00 a day full time. Thousands of our representatives are making that and more with our New Plans. Simply introduce and take orders for famous World's Star Hosiery and Underwear sold direct from mill to home—a complete line for whole family. Permanent customers and repeat orders make you steady, big income. No delivering or collecting. No capital required.

Write Quick It's a chance to make thousands of dollars. Your profits begin at once. Exclusive territory. No experience needed. Write today and I'll send all facts and tell how to start free. (Established 29 years.)

World's Star Knitting Co.
274 Lake Street Bay City, Mich.



FROST-RADIO MUNETTE

Phonograph Attachment
CONVERTS your present phonograph into loud speaker. Pure, clear tone, and faithful reproduction of voice and music insured. Order from your dealer.

MEMBER
R.M.A.



List price, complete with cord as shown... **\$5.50**

HERBERT H. FROST, Inc.
314-324 WEST SUPERIOR STREET, CHICAGO
NEW YORK CITY CLEVELAND KANSAS CITY LOS ANGELES



My Life Work

The finest shaving cream you will ever know

Let me send you a tube to try

By the Chief Chemist

GENTLEMEN:

One of our creations is Palmolive Soap—the world's leading toilet soap. Now in less than 4 years, Palmolive Shaving Cream, too, has gained top place.

Will you do us the courtesy of trying it?

We asked 1,000 men what they most desired in a Shaving Cream.

We made up 130 formulas which we discarded.

Then we attained, by many times over, the best Shaving Cream in existence. Today Palmolive Shaving Cream is winning men by the millions as they try it.

Don't change from the cream you like now until you see what Palmolive Shaving Cream does. But make this test. Try ten shaves, and let the results show if we have excelled the rest.

- 5 New Delights**
- 1—Multiplies itself in lather 250 times.
 - 2—Softens beard in one minute.
 - 3—Maintains creamy fullness 10 minutes.
 - 4—Strong bubbles hold hairs erect for cutting.
 - 5—Fine after-effects, due to palm and olive oil content.

We have also created Palmolive After Shaving Talc—especially for men. Doesn't show. Leaves the skin smooth and fresh, and gives that well-groomed look. Sample free with the tube of shaving cream. Clip coupon now.

THE PALMOLIVE COMPANY (Del. Corp.), Chicago, Ill.

PALMOLIVE SHAVING CREAM



10 SHAVES FREE

and a can of Palmolive After Shaving Talc

Simply insert your name and address and mail to Dept. B-973. Address for residents of Wisconsin, The Palmolive Company (Wis. Corp.), Milwaukee, Wis. Address for residents other than Wisconsin, The Palmolive Company (Del. Corp.), 3702 Iron St., Chicago, Ill.

2735

"Tuning up" for Spring

SPRING says: "A busy season ahead! Now is the time to get things in proper shape for real work." Cars, farm machinery, motorcycles and home jobs of one sort or another offer plenty to do. Crescent Wrenches, Pliers, and Screwdrivers offer the sort of help that gets things done quickly, easily and thoroughly. Sizes for a wide range of uses. Your hardware or accessory dealer has them.

CRESCENT TOOL COMPANY

210 Harrison St., Jamestown, N. Y.

Originators of the Crescent Wrench

CRESCENT TOOLS

Crescent Wrenches, 4 to 18 inches, of drop-forged special steel. Powerful jaws. Smooth, accurate adjustment.

Crescent slip-joint pliers in straight or bent thin-nose types, specially hardened bolt and nut.

Crescent all-steel T-type screwdrivers. Handle turns at right angle giving extra turning power. A heavy duty tool.

\$47²⁵ Profit in 4 Hours



Doughnut Making business has wonderful possibilities. "Snow-Flake" Doughnuts have taken the country by storm. Enormous demand. \$25.00 to \$75.00 a day.

Capacity 500 dozen a day. Makes plain, chocolate and coconut doughnuts. 200% profit. No experience needed. Put dough in hopper—turn crank—out drop sweet, savory, golden doughnuts.

AMAZING PROOF FREE

Money-making possibilities unlimited. Put this Automatic Doughnut Machine in display window. Attract crowds. Exciting odor whets appetite. You take in money fast. Pay for the machine the first week. Earnest & Wells, Pa., say: "Sold 200 dozen first day." Others report earnings equal or better. Big money wholesaling.

WRITE NOW Get in on the ground floor—act quickly before others start. These machines pay for anywhere—no town too small. Get full details of this new profitable business—costs nothing to investigate. Write today.

Delicious Potato Chips can be made with special attachment we supply.

BUTLER & BUTLER, Dept. 43, 5945 W. Chicago Ave., Chicago



GEARS ALL KINDS SMALL

The most accurate made and prices reasonable. We carry a complete line of gears in stock for immediate shipment. Can also quote on special gears of all kinds. Send us your inquiries.

WRITE FOR CATALOGUE.

CHICAGO STOCK GEAR WORKS
105-109 S. Jefferson St., CHICAGO



Comfort for tired feet!

WORK or pleasure may bring suffering—even torture. But a few drops of Absorbine, Jr. quickly brings relief and makes feet fit for another day.

\$1.25 a bottle at your druggist's
W. F. Yeatz, Inc. Springfield, Mass.

Absorbine Jr.
THE ANTISEPTIC LINIMENT

Sells for \$1.25. Agent's Sample 65c!

Guaranteed for 1 year
"It makes Carbon Copies"
Hustlers Making \$20 Daily

Money refunded if you don't think it's the best pen you ever wrote with. Just out price list and distributing plans.



Comes in beautiful brown trimmed in black. Send for wholesale quantity
F. SPORS & CO., 337 Main St., Leasew Center, Minnesota



FREE

140-page Book full of life-size ruled forms, each one completely filled in. The answer to problems of accounting and record keeping for any business or profession.

Send for this FREE Book today
John C. Moore Corporation
(Established 1839)
2196 Stone St., Rochester, N. Y.

MOORE'S LOOSE LEAF SYSTEMS
In Use In More Than
300,000 Offices

SELL BY MAIL

Mall Order Men, send for our Dollar Making Circular Service. Circulars with your imprint furnished at one-fourth original cost. Make 92 cts. profit on each dollar order. Add our service to your regular line and watch profits grow. PARTICULARS FREE!

D. B. ELFCO, 525 S. Dearborn, Chicago



The Newest Sport

Play Tenikoits

Deck Tennis Brought to Land

The fastest, swiftest game ever played. Speed like Lawn Tennis—only a few rules to learn. No racket required; singles or doubles; indoors or outdoors, at home, club or factory. Draw any game for \$25.00. A fascinating sport, all the rage on the big Ocean Liners. Newly invented, self-collapsing Tenikoits makes a lot of fun, even on a yacht porch. For young folks or grown-ups. Only Tenikoits needed. Send for complete set with 10-ten sets. Tenikoits and book "How to Play Tenikoits" 75c postpaid.

DEK SALES CO.
340 Sutter Street, San Francisco

Do You Really Want Money?



Do you really want to make from \$75 to \$100 a week? Would you like to do as well as S. W. Allen of California who made \$40.80 in one day's joyful work? Then you will never find a better opportunity than this wonderful Hand Tailored RAIN-PROOF Cap!

Wear this Fine Cap

Show it to your friends. Every man you know will want one like it. It's guaranteed RAINPROOF—moisture can't soak in! Choice of finest wools and latest styles. Far superior to store caps. \$10 a day extra in spare time is easy. No experience is needed. Write at once for our FREE Selling Outfit.

TAYLOR CAP MANUFACTURERS, Dept. 8-D, Cincinnati, Ohio



She hated to tell him

OF late her brother seemed much discouraged. He was being left out of things—dances, dinners—and somehow "the girl" never had an open date. His sister knew the cause.

She hated to tell him, because it was such a personal thing. ✓ ✓ ✓

Nearly all young men are inclined to have a grimy-looking skin, spotted with blackheads and dull in appearance. Few realize that this hinders their success in life. Pompeian Massage Cream helps you overcome this handicap by giving you a clean, ruddy complexion. ✓ ✓ ✓

Clears the Skin: Pompeian Massage Cream thoroughly cleanses the pores. It helps clear up blackheads and pimples by stimulating healthy circulation, and by keeping the skin clean and the pores open.

Easy to Use: Rub it in; rub it out. After shaving or washing rub it in gently. Continue rubbing and it rolls out, bringing with it all the dirt and skin impurities. Result—a clean, healthy skin with clear, glowing color.

Your drug store has it.
Use it regularly at home.

SPECIAL OFFER

$\frac{1}{3}$ of 60c jar for 10c

For 10c we send a special Trial Jar containing one-third of regular 60c contents. Contains sufficient Pompeian Massage Cream to test thoroughly its wonderful benefits.



Pompeian Co., Cleveland, Ohio, Dept. 21

Gentlemen: I enclose a dime (10c) for trial jar of massage cream.

Name _____

Address _____

City _____ State _____

Orlando is Calling You

Do you want to get away
From the grind of every day—
From the drudgery of things you have to do?
Do you want to settle down
Near a lively, busy town,
Where the joy of living will appeal to you?

Do you want to scent the breeze
Coming through the orange trees?
Do you want to hear the birds call—loud and clear?
Are you seeking perfect health
That's combined with certain wealth
And an income from an orange grove each year?

Do you want a piece of land
That will grow to beat the band
All the different garden crops that you enjoy?
Do you want to make a "Nest,"
And a permanent bequest
For the future welfare of each girl and boy?

Do you want a sunny clime
Where there's fishing all the time?
Where there's ducks and deer and quail and other
game?
Where the summer climate's cool,
And within each lake and pool,
You can swim in January—just the same?

Do you want to buy this land
On an easy-payment plan,
With about your monthly outlay for cigars?
Do you want to read a book
That will make you want to look
On the finest land that lays beneath the stars?

Send a letter right away;
Put it in the mail today,
We will send this Booklet absolutely FREE.
After you have read it through,
If a thought occurs to you—
Just address another letter here to me.

We will answer, straight and true,
Questions that occur to you.
We have nothing to evade or to conceal.
On an Orange County Farm
Life will take on added charm,
And you'll never lack a dollar—nor a meal.

Send for our Big, FREE Illustrated Book—
"TWENTY ACRES AND PLENTY." It tells of
almost unbelievable profits made from trucking and
fruit-growing in our part of FLORIDA. Also about
sick-and-out-of-work Clauses, and other protective
features of our contract. Address *Sylvester E.
Wilson, Dept. U-3, Orlando, Florida.*

**Bronze Signs, Numbers, Letters,
Tablets, Honor Rolls and Memorials**



For Banks,
Public
Buildings,
Stores,
Homes and
Doctors

Sun Dials, Ornaments, Life Size Portraits and Busts
High grade, solid cast bronze. Will last forever. Write for prices.
Chicago Architectural Bronze Co., 4742 N. Clark St., Chicago

MAKE \$20 DAILY **TAKING ORDERS for PATENTED GARMENTS**

Different! New!
Salesmen! Agents! Join our selling staff. Write quickly for this newest and greatest money-making line. Permanent work. Big profit paid daily in advance. No competition. Easy to sell our

LESS THAN STORE PRICES

PATENTED WORK SHIRT
PATENTED FLANNEL SHIRT

PATENTED OVERALLS

PATENTED FLANNEL SHIRT

Patented Work Shirts, Patented Flannel Shirts, Work Pants, Overalls, Work Coats and other work clothes. Also wonderful line of high grade dress shirts.

Direct from factory to wearer. We deliver and collect. You take orders from sample book. Starting Outfit Free. Write for complete proposition at once!

HANDY SAMPLE KIT WEIGHS 12 OZ.

PATENT SHIRT CO.
39 W. Adams St. Dept. 227 CHICAGO, ILL.

Large Profits—Easy Sales

Handling "VAPO" Vaporizers

To Distributors and Agents selling the "VAPO" Vaporizer—a unique, automatic, patented device that gives greatly increased motor power, reduces gas consumption 25% to 40% (guaranteed) and WILL remove carbon by a simple operation. Installed on any motor without expense in a few minutes—no holes to drill. Money back guarantee. Very attractive sales proposition. Write for details and samples.

"VAPO" Specialty Company

P-450 North 12th St.

Philadelphia, Pa.

YOU will make REAL MONEY selling Boys' Suits at \$6.85. Big commission. The only proposition of its kind in the country. No competition. Also Men's Suits at \$12.50. Selling outfit FREE. Write at once.

"JIM" FOSTER
2250 S. Spaulding Ave. CHICAGO, ILL.

\$14.95 Suit
Made to Order Now

SEND NO MONEY

To introduce unbeatable values, classy style, perfect fit of PROGRESS tailoring we offer, for \$14.95 tailored to measure any style suit of your choice, delivered post-paid. We Guarantee Satisfaction or Money Back. Other wonderful values up to \$39.50.

AGENTS WANTED

Earn \$9 to \$18 Daily spare time showing our samples to friends and neighbors, we explain how, no experience needed. Big Outfit, agent's wholesale prices, real wool pieces, fashion styles, tape measure, etc. Complete outfit and simple directions FREE, write at once. **SAMPLES FREE**

The PROGRESS TAILORING CO. Dep. D-216 CHICAGO



Make BIG MONEY! IN RADIO

We Need Men—Can You Qualify?

Ozarka representatives make real money because they give real values and deliver a real service. For instance, there is a 4-tube Ozarka Instrument for loud speaker operation giving wide range of reception, at \$39.50. Our men demonstrate Ozarka Instruments and install. The instrument makes the sale easy by its performance. We train you to know radio and our methods, make you worthy to wear the Ozarka button as our accredited representative. Previous experience is not necessary. In fact, we prefer to do our own educating. If you have a clean record, are industrious, and have saved up a little cash, here's a real opportunity, if you can qualify for an exclusive territory. We already have 2247 representatives. Territory going fast.



FREE, LARGE Illustrated BOOK

WRITE Today for illustrated book No. 100 that gives the entire Ozarka Plan. Don't fail to give the name of your county.

OZARKA, Inc.
851 Washington Blvd., CHICAGO

4-Tube Sets as Low as \$39.50

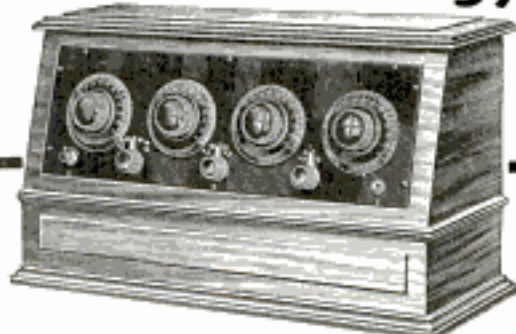

STOP FORD CRANKSHAFT END-PLAY!

C-A ADJUSTABLE BEARING corrects and prevents end-play without removing motor. Eliminates many troubles. Easy to install—simply drop pan. Only \$3.75. Ask your dealer or mail prepaid to **ADJUSTABLE BEARING CO.** Dept. P **BRAZIL, IND.**

What Will Rogers



does
between acts.

When he's not amusing folks on the stage of The Follies, Will Rogers has other ways of turning minutes into money.

With his Corona, in his dressing room, he turned out his famous book, "The Illiterate Digest"—the best selling book of humor of the year.

That's the advantage of owning a Corona. You can use it anywhere, any time—make something of the spare moments most people squander.

By the way, have you seen the New Corona Four? It has a full-size standard keyboard, the same as big office machines, yet it is portable.

Corona Four costs only \$60. Easy terms if desired. Look for Corona in your phone book or write Corona Typewriter Co., Inc., 108 Main St., Groton, N. Y.



CORONA



A \$2840
HOUSE FOR
\$1891

WE PAY THE FREIGHT

\$478
5-ROOMS



FREE CATALOG
with many other beautiful homes at \$478 to \$4,797—all at big savings. Garages \$73 and up.

LET us ship you direct from our mill all the materials complete for a **Sterling cut-to-fit home**, (not portable) and save you **four big profits** on lumber, hardware, mill-work and labor, besides a **proved 20% saving** in waste. Substantially built and lasting. **Satisfaction Guaranteed or Your Money Back!**

Buying Direct Saves 1/3

ABOVE prices include everything complete—all lumber cut-to-fit (highest grade only), windows, doors, flooring, everything easily assembled according to drawings we furnish.

\$1891 House includes double walls and floors. **\$478 five-room house** includes single walls and floors; for double add \$90.

International Mill & Timber Co.
2223 South Wenona Ave.
Bay City, Mich.

FREE CATALOG



LUMINOUS PAINT

Make Your Watches, Clocks, Etc., Visible by Night

The very latest discovery in the scientific world, HILBERT, practically unobtainable except at an exorbitant price, we have at last succeeded in producing this remarkable LUMINOUS PAINT, which, applied to the surface of any article, emits rays of white light, rendering it perfectly visible in the dark. THE DARKER THE NIGHT, THE MORE BRILLIANT IT SHINES. Quite simple to use. Agree—your own do it. A little applied to the dial of your watch or clock will enable you to tell the time by night. You can coat the push buttons or switch plates of your electric lights, watch boxes, and innumerable other articles; make your own Luminous Crucifixes, Luminous Rosaries, etc. Small bottle, price 25c. Larger sizes, 50c and \$1 postpaid. **JOHNSON SMITH & CO., Dept. 341, RACINE, WIS.**

Serpent's Eggs Exploding Cigarettes

Box contains 12 eggs. When lit with a match, each one gradually hatches itself into a snake, several feet long, which curls and twists about in a most lifelike manner. Price per box, 10c postpaid, 3 for 25c.



CIGARETTE MAKER



Roll your own and save money. Makes them better and quicker besides saving more than half. Use your favorite brand of tobacco. Neat, useful and handy. Pocket size, weighs 1/4 oz. Made entirely of metal, nickel-plated. Price 25c postpaid.

MIDGET BIBLE

GREAT CURIOSITY Smallest Bible in the World. Size of a postage stamp. 200 Pages. Said to bring good luck to the owner. A genuine work of art. Must be seen to be appreciated. Makes good money selling them to friends, church organizations, etc. PRICE 15c each, 3 for 40c, 12 for \$1.35, 100 for \$7.50. Also obtainable in Leather Binding, with gold edges. Price \$1.00 each, 3 for \$1.25, \$4.50 per doz. Magnifying Glass for use with Midget Bible, 15c.



STAGE MONEY

With a bunch of these bills, it is easy for each person of limited means to appear prosperous by flashing a roll of these bills at the proper time and peeling off a genuine bill or two from the outside of the roll, the effect created will be found to be all that can be desired. Prices, postpaid: 40 Bills 20c, 125 for 50c, or \$3.50 thousand postpaid.

Wonderful X-Ray Tube

A wonderful little instrument producing optical illusions both surprising and startling. With it you can see what is apparently the bones of your fingers, the lead in a lead pencil, the interior opening in a pipe stem, and many other wonderful illusions. A mystery that no one has been able to satisfactorily explain. Price 10c, 3 for 25c, 1 doz: 75c. **JOHNSON SMITH & CO.**



Good Luck Ring

Quaint and Novel Design

A VERY striking and uncommon ring. Silver finish, skull and crossbones design, with two brilliant, flashing gems sparkling out of the eyes. Said by many to bring Good Luck to the wearer, hence its name, Good Luck Ring. Very unique ring that you will take a pride in wearing. ONLY 25 CENTS.

Address orders for all goods on this and opposite page to

JOHNSON SMITH & CO.

Dept. 341 RACINE, WIS.

A DeLuxe Edition of our new 1925 CATALOG mailed on receipt of 25c. Handsome cloth binding. Only book of its kind, 420 pages of all the latest tricks in magic, the newest novelties, puzzles, games, sporting goods, interesting books, curiosities in seeds and plants, etc., unobtainable elsewhere.

BLANK CARTRIDGE PISTOL

Protection against Burglars, Thieves & Dogs

Price \$1.00 Post-paid

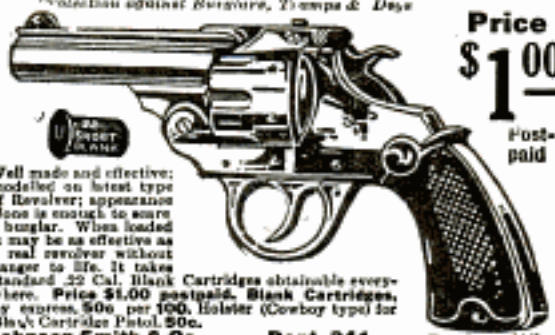

Well made and effective; modelled on latest type of Revolver; appearance alone is enough to scare a burglar. When loaded it may be as effective as a real revolver without danger to life. It takes standard 32 Cal. Blank Cartridges obtainable everywhere. Price \$1.00 postpaid. Blank Cartridges, by ounces, 50c per 100. Holster (Cowboy type) for Blank Cartridge Pistol, 50c. **JOHNSON SMITH & CO., Dept. 341, Racine, Wis.**

DANCING BEAUTIES

Get a Kinetograph and see the picture move. France's latest sensation. A great surprise. Is worth twice what they cost. Are made of solid brass, highly nickel-plated and very durable. Satisfactory or your money back. Price 50c. **JOHNSON SMITH & CO., Dept. 341, Racine, Wis.**

BOYS!

BOYS!

BOYS!

THROW YOUR VOICE

Into a trunk, under the bed or anywhere. Lots of fun fooling the teacher, policeman or friends. **THE VENTRILO** a little instrument, fits in the mouth out of sight, used with above for Bird Calls, etc. Anyone can use it. Never Fails. A 32 page book on ventriloquism, the Ventrillo, ALL FOR 10 CENTS

1000 Silk Remnants

For patching Crazy Quilts, Sofa Cushions, Head Rests, Pin Pads etc. Large pieces, all colors and shades. Sure to delight you. **For 10 Cents** stamps, we send a large package and book of quilt designs. 8 packages, 25c. 1 pound makes a lovely large quilt. Price 15c postpaid. Our silk is the best. **JOHNSON SMITH & CO., Dept. 341, RACINE, WIS.**

LOOK 35 Look

Wonderful instrument. Greatest thing yet. Nine separate articles in one. Everybody delighted with it. Odd, curious and interesting. Lots of pleasure as well as very useful. It is a double Microscope for examining the wonders of nature. It is also an Opera Glass, a Stereoscope, a Burning Lens, a Reading Glass, a Telescope, a Compass, a Pocket Mirror, and a Laryngoscope—for examining eye, ear, nose and throat. It is worth all the cost to locate even one painful cinder in the eye. Folds flat and fits the pocket. Something great—you need one. Don't miss it. Sent by mail, postpaid. **Only 35c or 3 for \$1.00**

Resurrection Plant

One of the most wonderful plants known. Possesses the strange power of turning in a few minutes from an apparently lifeless, dry herb to a beautiful living fernlike plant of a dark green color. Simply place the plant in saucer of water, it will open up and start to grow in 30 minutes. When taken out it will dry up and go to sleep until placed in water again. Fine house plant—summer or winter. 10 cents each or 3 for 25c, post paid. **AGENTS WANTED** **JOHNSON SMITH & CO., Dept. 341, RACINE, WIS.**



JUST LIKE ORDINARY CIGARETTES. BUY SUCH REAL STARTLERS! The box contains ten genuine cigarettes of excellent quality. They appear so real, but when each cigarette is about one-third smoked, the victim gets a very great surprise as it goes off with a loud BANG! A great ninth revolver yet entirely harmless. Price 25c per box.

Popular Watch Charms

Very pretty little curiosities and decidedly novel. Fitted with Magnifying Lenses that enlarge the picture to a very surprising degree; in fact, it appears almost incredible that a clear picture could be possible in such a small compass, and how sharp and distinct they show up when you look through. Come in assorted views—Actresses, views of Panama Canal, Lord's Prayer in type, etc.

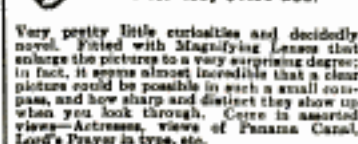

Mystic Skeleton

A jointed figure of a skeleton 14 in. in height, will dance to music and perform various gyrations and movements while the operator may be some distance from it.

NEW BOOK ON ROPE SPLICING

Useful Knots, Hitches, Splices, etc. A most practical handbook giving complete and simple directions for making all the most useful knots, hitches, rigging, splices, etc. Over 100 illustrations. All about wire rope attachment, lashing, blocks, tackles, etc. 37 Heraldic Knots illustrated. Of great value to mechanics, riggers, carpenters, boatmen. Price 20c postpaid.

MAGIC FLUTE

Wonderfully Sweet Toned and Musical The Magic Flute, or Humanator, is a unique and novel musical instrument that is played with nose and mouth combined. There is just a little knack in playing it which, when once acquired after a little practice will enable you to produce very sweet music that somewhat resembles a flute. There is no fingering, and once you have mastered it you can play all kinds of music with facility and ease. When played as an accompaniment to a piano or any other musical instrument, the effect is so charming so it is surprising.



JAPANESE ROSE BUSHES

The Wonder of the World

Japanese Rose Bushes bloom all the year round. Just think of it. Six weeks after planting the seed, the plants will be in full bloom. It may not seem possible, but we positively guarantee it to be so. They will bloom every ten weeks, Summer or Winter, and when three years old the bush will be a mass of roses, bearing from five hundred to a thousand roses on each bush. The flowers are in three shades—white, pink, and crimson. The plants will do well both in and out doors. We guarantee at least three bushes to grow from each packet of seed. Price, 10c packet, 3 pkts. for 25c postpaid.



10 Cts.

Chinese Fragrant Tree Fern

Just introduced; noted for its rapid growth. An exceptionally pretty ornamental plant. Foliage is rich dark green. Forms grand pyramidal bushes about 5 feet high. Branches very desirable for decorative purposes, wreaths, etc. Seeds 15c pkt., 3 for 40c.



Shoo Fly Plant



A very remarkable botanical curiosity you should have. Though quite odorous it is said flies will not remain in a room where it is grown. Bears very pretty blossoms, blooms summer and winter. Grows rapidly from seed. SEEDS 15c pkt., 3 for 40c, postpaid.

Gigantic New Butter Beans

The New Edible Vegetable Wonder. Grows to an astonishing size, the Beans measuring from 3 to 6 feet long, and weighing anything from 10 to 16 lbs. and even more. One bean is sufficient for a family for several meals. Very palatable and rich in nutritious materials. The delicate luscious flavor is much appreciated. The Vines are easily grown, very prolific, and a most welcome and valuable adjunct to your garden. Try them; you will find them the most delicious vegetable you have ever tasted. Imported direct. Unobtainable elsewhere. Sample package of Seeds with full directions for cultivating and cooking. 25c, postpaid.



Perfume Plant

Blooms only at night, giving forth the most delightful scented fragrance for quite a distance. Grows in house or garden. Also valuable because of rare perfume made from it. SEEDS, 10c pkt., 3 for 25c.



Weather Plant

NATURE'S WEATHER PROPHECY. By mysterious changes that take place, this remarkable plant accurately forecasts the weather many hours in advance. Will grow anywhere all the year around. An interesting house plant. Bears large, fragrant, pink, butterfly shape flowers. SEEDS, 15c packet, 3 for 40c, postpaid.



GROUND ALMONDS

Amazingly Prolific—Easily Grown From Seed. The Ground Almond has a flavor that is MOST EXCELLENT, resembling the coconut. The meat is snow white, covered with a shell or skin of brown color. It grows close to the surface and anything from 200 to 300 Almonds may be expected from a single nut. There is no trouble whatever in growing anywhere and in any kind of soil. May be planted any time, and in eight or ten weeks from time of planting you will have an ENORMOUS CROP of the MOST DELICIOUS ALMONDS YOU EVER TASTED. SEEDS 15c Pkt.



The Great Wonderberry

A luscious berry that may be grown and ripened from seed in any soil or climate in 3 months. The berries have a fine and un surpassed for eating raw, cooked, canned or preserved in any form. The fruit is blue-black in color, and tastes like a luscious, rich blueberry. One bush will produce an enormous amount of fruit, yielding great masses of rich fruit all Summer and Fall. Packet, 10c, 3 pkts. for 25c, postpaid.



Bush Musk Melon

A vineless Musk Melon, grows in bushes, and thus can be cultivated in the smallest garden. The fruit is of the popular "Jenny Lind" type, but larger, averaging 4 inches in diameter. The flesh is very deep, edible almost to the rind and is colored light green, flushed with a salmon toward the center. The quality is superb, lusciously sweet and juicy. Packet of seeds, with full directions for culture, 15 cents, 3 packets for 40 cents, p.p.d.



TREE OF HEAVEN

This splendid ornamental tree is a native of China, and is called the Tree of Heaven, on account of its great beauty. Very hardy, thrives in any soil, no matter how poor, and grows from 6 to 10 feet high from seed the first summer. The leaves are from 5 to 6 feet in any length, giving it a grand appearance. Nothing outside the tropics can rival it for lawn decorations. Large panicles of blossoms, followed in season by great clusters of colored seed pods, make it the most beautiful of beauty. Price, 15c, 3 packets for 40c.



THE REMARKABLE

FIREFLY PLANT

A Vine that Blooms at Night. Fills the Atmosphere with Fragrant Aromas. One of the most rapid growing vines known. Under favorable conditions this vine has been known to grow OVER 25 FEET IN A SINGLE WEEK. In a very short space of time indeed the vine has climbed to a great height, and is covered with IMMENSE FLOWERS, from 5 to 7 inches in diameter. It is, indeed, a great novelty, for, unlike other plants, the flowers OPEN IN THE EVENING, and remain open until about noon the following day. In full weather they will remain open all day. It is a most INTERESTING SIGHT to watch the opening and closing of the flowers as the clouds appear and disappear. As the flowers open they give forth the most DELIGHTFUL AROMA and the whole atmosphere around is full of scented fragrance. It is always the object of favorable comment, and much curiosity is aroused by people passing at night time as to the cause of the charming aroma, frequently stopping in an endeavor to satisfy their curiosity. PRICE, 19 CENTS packet, two packets for 35 CENTS, POSTPAID.



Seed remittance (Postage Stamps accepted) for all articles listed on above and previous page to

THE EXPO WATCH CAMERA



The most wonderful and ingenious Camera made. It is but little larger than a watch, which it closely resembles. You can carry the Expo about in your pocket and take pictures without any one being the wiser.

Less Than 2 Cents a Picture

The Expo loads in daylight with 10 or 20 Exposure Films, costing 25c and 35c respectively, and thus the picture taking part of a whole day's outing may be had for a very nominal sum—Little more than one cent a picture.

Easy to Manipulate

It is simplicity itself to operate. Takes pictures through the lens, where the Rapid Fire Lens is located. The photos (2-8x-8) may be enlarged to any size.

Operated as Quick as a Flash

Time and instantaneous shutters; weighs but 3 ounces; nickel plated. Endorsed by amateurs and professionals the world over. Thoroughly practical—printing and developing of films just the same as ordinary cameras—in daily use by the police, newspaper reporters, detectives, and the general public. Important events have been secured with the Watch Camera by enterprising reporters. Produces clear, sharp negatives indoors or outdoors equal to any camera on the market, size or price notwithstanding.

Expo Watch Camera \$3.60 FILMS, 10 Exposures 25c, 20 Exposures 35c
Price Post Paid Leather Pocket Carrying Case, 35c
JOHNSON SMITH & CO., Dept. 341, Racine, Wis.



RING 25 CENTS TANK



BABY TANK Goes backward or forward by its own power. Nothing to wind. What makes it go is a mystery. It crawls along, overcoming obstacles just like the larger Tanks. Performs dozens of most amazing "stunts." Runs ten times longer than most mechanical toys. Handsomely finished and constructed in natural colors. 25c postpaid.

NOVELTY PHOTO RING

Very great curiosity in Rings. Has microscopic view which is enlarged to an almost incredible degree of size and clearness by the powerful little lens. Obtainable in several pictures, views of well known buildings and scenes, Panama Canal, Actresses and even the Lord's Prayer, every word of which can be plainly read. Ring is made of its platinum, with one karat blue white sparkling imitation diamond. Price \$1.00 postpaid.

INVISIBLE INK

The most confidential messages can be written with this ink, for the writing MAKES NO MARK. Cannot be seen unless you know the secret. Invaluable for many reasons. Keep your postals and other private memorandums away from prying eyes. Great fun for playing practical jokes. Only 15c Bottle.



Everything about the Ku Klux Klan told in a clear, fearless manner. Book tells all—How it started and was suppressed in 1871—The New Ku Klux Klan—How organized—How members are enrolled—Oath of the Klan—Questions for Candidates—Creed—Objects of the Order—Obedience—Fidelity—Pledge of Loyalty—Ku Klux Klan and the Masons—The Jews—The Masons—Real K. of C. Oath—The Negro Ku Klux Klan, etc., etc. Latest and most complete book on the Klan published. Price, 35c, Postpaid.

Female SEX Indicator 25c Male SEX INDICATOR



Hold the MAGIC INDICATOR over a man's hand—instantly it moves to a straight line backward and forward. Hold it over a woman's hand and it describes a complete and continuous circle. The same action can be obtained over a letter written by a man or woman, etc.

It is fascinating; baffling. We have never been able to figure out how it's done—but we've never seen it fail. Many novel and entertaining tests may be performed with the Sex Indicator. For example, similar results can be obtained with animals, cats, dogs, rabbits, over birds, chickens, canaries, etc. Also used to predetermine the sex of chickens and birds, etc. In fact it is sold as a patented egg tester in Europe. Price 25c, or 3 for 65c, postpaid.

All the Latest Surprising and Joke Novelties

- Misture Water Pistol . . . 10c
- Cleopatra's Snake (very lifelike) . . . 15c
- Fake Mustache . . . 10c
- Pocket Detective (see behind you) . . . 15c
- Great Mind Reading Mystery . . . 10c
- Thornton's Mysterious Trick Cards . . . 10c
- Fighting Roosters, pair . . . 10c
- Hoopit Ring 25c Trick Panel . . . 15c
- Mosses' Fantasy . . . 25c
- Magic Plate Litter . . . 25c
- Imitation Gold Teeth . . . 3 for 10c
- Barking Dog (imitates dog bark) . . . 25c
- Great Fire-eating Trick . . . 25c
- Magic Ball and Vase Trick . . . 25c
- Naked Tooth Joke (Magic Card) . . . 15c
- Chicken Inspector Badge . . . 10c
- 10c's License, 1st . . . 10c
- 10c's License, 2nd . . . 10c
- Surprise Machine, per box . . . 10c
- Emulating Writing Pad . . . 15c
- Shimshie Dancer . . . 15c
- Perfume Telling Cards, per deck . . . 25c
- 3-Real Moving Picture Machine . . . \$2.00
- Excelsior Solar 4-Lens Telescope . . . 1.50
- Revolver Combination Padlock . . . 25c
- Rubber Dagger (very deceiving) . . . 25c
- Boys' Book "How to Make Toys" . . . 10c
- Invisible Ink, per bottle . . . 15c
- Magic Nose Blower . . . 10c
- Dying Pig Balloon . . . 15c
- Imitation Red Hot . . . 10c
- Kissing Permit Badge . . . 10c

JOHNSON SMITH & CO. Dept. 341, Racine, Wis.



"Been on a vacation, Bill?"

"No, Jim — I've stopped smoking.

Gained six pounds in a week. You know how I used to smoke—a package of cigarettes and a cigar or two a day—it sure had some hold on me. But I'm cured—took a scientific home tobacco treatment—fixed me up in two weeks.

"Wasn't hard on me at all—noticed improvement the first day—I feel like a new man. It didn't interfere with my work—didn't leave any druggish after-effects—the money I saved in the last two weeks has paid for the treatment alone.

"Why don't you take it? It has cured men like you and me for over forty years—it is a doctor's individual prescription that sure fixes you up. Just send the coupon for full information NOW. No obligation. All correspondence is strictly confidential."



A Doctor's Prescription

The Keeley Institute, Dwight, Ill.

Please send me, without any obligation on my part; your free booklet which will tell me how to rid myself of the tobacco habit.

Name

Town

Street.....State.....PM-4

HOW THE ARTEX DIAMOND LOOKS IN A BEAUTIFUL MOUNTING

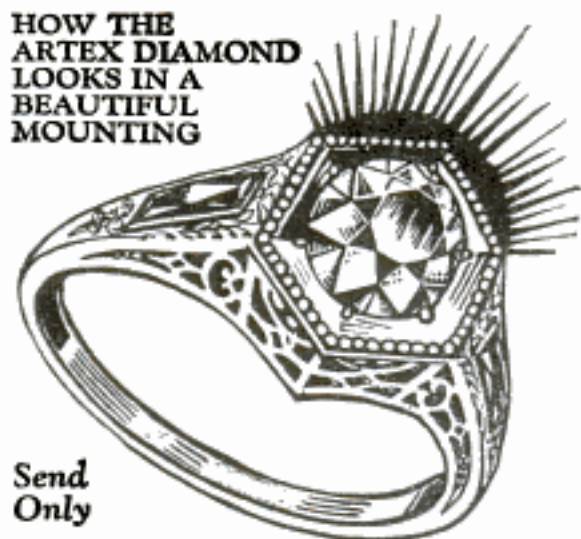

Send Only

10¢

To Help Cover Cost of Handling and We Will Send You a Full Cut One Carat

"ARTEX DIAMOND" Nothing More to Pay

Nothing to Sell—Nothing to Buy No Red Tape Attached to This Offer

We want Thousands of new owners and boosters of ARTEX DIAMONDS and we will distribute these gems FREE to the readers of this magazine.

ARTEX DIAMONDS are full 24 facet cut and are of such radiant beauty that even experts are astonished at their likeness to the genuine.

WE ARE MAKING this unusual offer only to get ARTEX DIAMONDS into the hands of appreciative friends.

SLIP your name and address with 10¢ in stamps or coin (to help cover cost of handling) in an envelope and get it right off to us. Your ARTEX DIAMOND will reach you by return mail fully prepaid.

R. C. ARTEX CO., 530 Broadway, N.Y.C.



BOW LEGS?

OUR GARTER (Pat'd)

Makes Trousers Hang Straight

If Legs Bend In or Out. Self Adjustable. Free Booklet — Plain Sewed Elastic.

The T. GARTER CO. Dept. 2, New London, New Hampshire

LYON BODIES

Send For Our 1925 **FREE BOOK OF BARGAINS**

Containing a full line of bodies and accessories at exceptionally low prices. Buy direct from the factory.



\$2490 AND UP

LYON TIRE SALES CO.

Bdly Division Dept. F-31

1344 S. Michigan Ave., Chicago

Different from all others—the NEW BENJAMIN

AIR RIFLE

Made on a different principle from all other Air-Rifles. The Benjamin is really a strong air-pump used to compress the air in the air chamber to any degree of power desired. From one to six strokes of the pump give all the force necessary. Each additional stroke gives increased power. The Benjamin works on the same principle as all air-drills and air-hammers—with this difference:

You control the shooting force as you desire. Look at this block of hardwood. It shows how Benjamin power is regulated at your wish.

You can't have accidents with a Benjamin. It's safe, always, because you control the power. The Benjamin never loses shooting force, and has no springs to get out of order or shake your aim. Write us for an interesting folder about this wonderful air-gun.

If your dealer does not handle same, send direct to factory:

**(PRICE \$5)
POSTPAID**

BENJAMIN AIR-RIFLE & MFG.
CO., 615 N. Broadway, St. Louis, Mo.

Pacific-Coast
Representatives
THAYER &
BOWER
Los Angeles
Calif., and
San Francisco
Calif.

Ask your
dealer for
demon-
stration.

CAMERAS

Over a Hundred Styles and Sizes
Send for new illustrated catalog showing latest reduced prices. It's Free.
10 days' trial given

SENECA CAMERA MFG. COMPANY
300 Central Avenue Rochester, N. Y.

Self-Filler DE LUXE Style Pen

"INDEPENDENT"

All the best features of a Fountainpen. Lasts longer. Writes smoother. Improves handwriting. Eliminates fatigue. GUARANTEED.

\$2.00

By Mail

14 Kt. White Gold Point.
Chased Rubber Holder.
Lever Filler. Pocket Clip.

Your Name in Gold Inlay, 25c.

Write for Pen Catalog. Agents Wanted.

J. C. Ulrich & Co., 151 Washington St., New York

Known the World Over for 40 Years.

SEND NO MONEY 2 Genuine Diamonds
4/100 Each
Cut Stones, No Chips

SOLID GOLD \$25

Terms if desired (6 mos. to Pay)

14 kt. White gold top.
Gold Emblem (any Lodge)
or any Initial (Old English)
Inlaid in Genuine

HOPE RUBY

Also, in Black Onyx

Send size of finger and ring This  Reg. Trade Mark
will be sent for inspection. guarantees you genuine diamonds.

Send for Free Catalog  Any Letter

BUFFALO JEWELRY MFG. CO., "THE MAIL ORDER HOUSE"

Dept. P, Brisbane Bldg. Buffalo, N. Y.



Good Times Waiting



—when you
pass this
Free, New

**Holton
TALENT TEST**



GOOD times, new friends, big pay—how do you know they couldn't be yours? Hidden to thousands—to you, most likely—is an unsuspected gift for music, waiting only for something to call it forth. That you have hesitated, wondering if you had talent, does not mean that a life-long ambition to play yourself cannot now be turned into delightful, endless hours of reality.

Now is provided, by the Holton Talent-Test, a new free method by which thousands are proving they can play this easiest-to-learn of all saxophones, the



Holton
New Revelation
SAXOPHONE

The Talent-Test is Frank Holton's personal and climaxing contribution in a lifetime of service to music-loving America. In just a few interesting minutes it reveals any hidden talent—measures your musical ability. No obligations, no responsibilities—you determine everything to your own satisfaction.

Your request for booklet brings you appointment card entitling you to the Talent-Test in the privacy of any Holton dealer's studio, or in your own home with the aid of a Holton Saxophone and our copyrighted record on which the Talent-Test is given.

FRANK HOLTON & CO.
ELKHORN, WIS.

FREE BOOK

—tells how
Talent-Test
is given



Frank Holton & Co., Elkhorn, Wis. 

Without obligation, I want to determine my talent for the easy-to-learn Holton New Revelation Saxophone. (Check below if interested in any other instrument.)

Cornet () Trombone () Baritone () Trumpet ()

Name _____

Street Address _____

Town _____ State _____ (S)

Red Devil Tools Better Made

**You May Pay More
But You'll Never
Buy Better Tools!**



Combining a quarter century's drop forging experience and expert workmanship, "Red Devil" Tools give unsurpassed value, dollar for dollar.

The "Red Devil" trade mark means all there is in tools.

Just a few tools shown here—send for free copy of the "Red Devil" Mechanic's handy tool booklet, showing many more.

"Red Devil" Slip Joint Plier

Practically all your radio repairs and adjustments can be made with this tool. Combines a side cutter, wrench and flat nose plier. No. 850, 5½-inch size, \$1.35 each.

"Red Devil" Circular Glass Cutter



For the man who wants to replace his own automobile headlights. Also ideal for making lampshades, table tops, glass curves, circles, etc. No. 263, \$1.25 each.

On sale at all dealers; or if not in stock, order from our factory.

Smith & Hemenway Co., Inc.

Manufacturers of "Red Devil"
Tools for Over a Quarter Century

260 Broadway New York, N. Y.

ZIP!! and the glass is cut clean and sharp. "Red Devil" Glass Cutters—the glaziers' standard of the world. No. 024 shown here. 20 cents each.



Please Mention Popular Mechanics

For your home shop!

PARKS Cabinet Shop Special

\$225.00

with all attachments
and motor



Here's an all-round woodworker for the small shop. Sturdy, fast

and true. The biggest little woodworker ever built. Saw table has 8-in. rip and cross-cut saw, and 4-in. jointer and borer. You can choose from these extra attachments: band saw; shaper; sander; lathe; and motor.

Send for Bulletin C-S and complete Parks catalog

The Parks Ball Bearing Machine Company
1500-1540 Knowlton St. Cincinnati, Ohio
Canadian Factory: 200 Notre Dame East, Montreal, Can.

PARKS WOODWORKING MACHINES



CALCULATIONS

in Office and Shop can be instantly made with the Midget Slide Rule. It gives the answer to any problem involving fractions, mixed numbers, decimals, whole numbers, roots, powers, Logs, and Trig. Functions. Thousands of these rules are used by Accountants, Engineers, Clerks, Students, etc. It is the most versatile calculator ever invented. If you have any learning to do, order a Midget Slide Rule on trial. Made of aluminum with figures on white celluloid. Size 4".

Price with Instruction Book, \$1.50. Leather Case, 50c extra. Catalogue Free. Sent C. O. D. if desired.

Your money back if you are not satisfied.
GILSON SLIDE RULE CO., Niles, Mich.



Saw Books FREE

"Saws in the Shop," "Saw Sense," "Saws on the Farm"; just send your name and address, and say which of these helpful books you want—and we will send it FREE.

E. C. ATKINS & CO., Dept. P, Indianapolis, Ind.

BURN YOUR NAME ON TOOLS

WITH THE ARKOGRAF

PROTECT YOUR TOOLS FROM THEFT

Write with electricity any name or design on the hardest and finest tools and instruments, or any metal, like writing on paper with pen or pencil. Complete Outfit \$3.50—Pozoid Anywhere. Interesting illustrated circular free. Write today. Agents wanted.

ARKOGRAF PEN CO., 1171 E. Stark St., Portland, Oregon



DYNA-MOTOR

As a dynamo it will operate induction coils, light lamps, charge storage batteries, electroplating, etc., makes an ideal machine for experimenting. As a motor they will operate heavy models, every wheel, and other appliances.

16 Watt \$6.50 25-Watt \$8.00

Dyna-Motor Dyno-Motor
64 to 200 Watt Dynamos, Armatures, Commutators, Pulleys, Parts for Schools and Students.

Send 6c for Catalog to cover cost of mailing, etc.
LOOMIS ELECTRIC COMPANY
1427 N. Artesian Ave. CHICAGO, ILL.



\$542⁰⁰ Earned IN ONE MONTH

A NEW BUSINESS—BIG BUSINESS

A Business to Enthuse Over—The "IDEAL" Lawn Mower Sharpener

A wonderful invention that sharpens lawn mowers scientifically—quickly—perfectly; does the work as nothing else can.

Fred Milkert, Roselle, Ill., writes:
"Last June I sharpened 254 lawnmowers for which I received \$542.00."

W. F. Kendt, Buffalo, writes:
"I sharpened 934 lawnmowers last season, and the receipts were nearly \$2100.00 which is not bad for a side line."



Fred C. Milkert of Roselle, Ill., writes: "The Ideal Lawnmower Sharpener put me in business, starting in the basement of my home and forcing me now for the third time to move into bigger quarters. Today the dream of my life—a shop of my own—is realized. With a machine like yours and a little hustle any man can have a business of his own and be independent."

D. H. Noakes, Milford, Ohio, writes: "Several years ago I started sharpening lawn mowers in a 10x10 shed. Today I own a store of my own on Main Ave., No. 212, valued at \$8,000.00. The 'Ideal' Grinder did it all."

You Start Now No town too small. Lawn mowers are dull—owners don't know where to get them sharpened. Mowing the lawn dreaded because of dull or improperly sharpened mower. Lawn mowing healthful, invigorating and pleasant when mower is "ideally" sharpened. You do the work scientifically—you are in big demand.

Lawn Mowers Sharpened to Razor Edge—

People glad—owners delight in mowing lawn with mower sharpened on an "Ideal." Mower runs light—click-click-click and the grass is cut. Build permanent business for yourself. Start now!

USE THIS—Mail it Today

The Fate-Root-Heath Company
Bell and High Streets, Plymouth, Ohio

Please mail at once free illustrated Catalog and booklet "Let George Say It."

Write Today—FREE

Detailed illustrated catalog and booklet "Let George Say It."

Write Today!

Name _____

The Fate-Root-Heath Company
Bell and High Sts., Plymouth, Ohio

Address _____



CRESCENT Wood Working Machines

continue to steadily increase in popularity. Tell us just what you are interested in and we shall be glad to mail circular. Hand Saws, Jointers, Saw Tables, Planers, Planers & Matchers, Hollow Chisel Mortisars, Boreas, Disk Grinders, Swing Cut Off Saws, Cut Off Table, Universal Wood Workers, Shapers, Single End Tenoners.

THE CRESCENT MACHINE CO.
93 Columbia St. Leotosia, Ohio, U. S. A.



Gerstner TOOL CHESTS

are made so well, finished so beautifully, and are such splendid values that Toolmakers and Machinists everywhere are more than pleased with them. *Catalog free.*

Gerstner Sons

416 Columbia St., Dayton, Ohio



SERVISTEEL TAP AND DIE SET

WORCESTER STEEL PRODUCTS CO.
WORCESTER, MASS. U. S. A.

SERVISTEEL TAP AND DIE SET, ONLY \$3.75

FOR THE HOME—THE FARM—THE WORKSHOP

Our No. 32 Automobile Set furnished in our highly finished chestnut box contains 5 each taps and dies (1-4, 5-16, 3-8, 7-16 and 1-2"), in the S. A. E. thread, 1 die stock, and one tap and reamer wrench.

Our No. 31 Set is the same as No. 32 except that the thread is U. S. S. instead of S. A. E. You are purchasing a splendid set at a very low figure.

Send your order at once and be one of our many satisfied customers. Let us also send you our circulars illustrating our full line of tools. Worcester Steel Products Co., Dept. 40, 25 Union St., Worcester, Mass., U. S. A.

MARVELOUS Hand Made Tools

Try This Test Yourself

Lock any other wrench with a Cornwell wrench of equal size and exert pressure until one of them breaks. **No wrench made will break a Cornwell.** These tools, including complete line of chisels, bolt and rivet busters, punches, wrenches, screw drivers, pliers, etc., are made of finest Swedish Charcoal Process Molybdenum Steel, from our famous Cornwell secret formula. They are forged, heat treated, and hardened and tempered in oil. **All tools made by hand, NOT drop forged and case hardened.**

LET US DEMONSTRATE CORNWELL TOOLS

Ask for salesman to call and show you many startling demonstrations that **no other tools in the world will stand.** Or send for free descriptive booklet, order tools and make these demonstrations at our risk.

Money Back if Not Satisfied

If you ever saw tools as good as these, return your order and get your money back. Guaranteed finest tools made in the world. Any tools not standing amazing tests described instantly replaced or money refunded.

Amazing Booklet—FREE

CORNWELL QUALITY TOOLS CO.

Dept. H, Cayahoga Falls, Ohio

Send me illustrated booklet with prices on Cornwell Secret Formula Hand Made Tools.

.....Occupation
Name,
Address
City,State.....

Make Your Roofs Last a Lifetime!

Positively that! The wonderful Seal-Tite method renews, preserves, and makes your old, wornout roofs watertight. One application lasts 10 years. Write today for this great money-saving roofing offer.



NO Money Asked

We send you everything you need to stop all roof leaks without asking you to send a single penny. No C. O. D. No notes. Pay four months later if our material proves to be exactly as represented.

Write! Don't put off another day finding out all about this wonderful way of solving all your roof problems. We'll make you an offer so liberal, so clear, so suprisingly unprecedented that you simply **MUST** take advantage of it at once. Don't wait for rain to remind you that your roof leaks. Write **TODAY!**

Monarch Paint Co. *Established 1903* Cleveland, O.
Dept. 13-54

AMERICAN BOY SCROLL SAW

It's Easy to Build Things When You Use This Saw



You will like its sturdy, mechanically correct construction; the ease of operation; the smooth, absolutely square cut. Cuts fibre, bakelite, wood up to 1" and metal up to 1/8" thick. A real tool to make your radio sets, accessories, cabinet, experimental work and lots of useful things around the house, etc. An ideal gift any time.

It's a Regular Tool
And the Price Is Right

To get complete details, write your name plainly on this ad, clip and mail to

Delta Specialty Co., 858-K Third Street, Milwaukee, Wis.

TURN WASTED TIME INTO MONEY!

Every Purchaser Finds Numerous Uses for the **Torit Acetylene Torch No. 13**

Uses acetylene only. No oxygen or air pressure is required. Tips suck in air. Simply connect to Presto auto tank, light gas, and the outfit is put to work.

Beats anything you ever tried for soldering, heating or light brazing. Outfit consists of 4 tips for different kinds of work, soldering copper, 5 feet tubing, tank connection, and full instructions.

ST. PAUL WELDING & MFG. CO., 177 W. 3rd St., St. Paul, Minn.



Sure I'll Fix It!

Nothing could be simpler with these Klein Pliers. Fact is, I'm glad to get my hands on them again. I guess every man feels that way about good tools.

Yessir, most men *do* feel that way. That's one reason why Klein Pliers have been the favorites for 68 years. You'll notice that most hardware stores feature them. Electrical companies *specify* them. Treat yourself to a pair today.

Mathias **KLEIN** & Sons
Established 1851 Chicago, U.S.A.

21 Jewels
Nothing less than 21 Ruby and Sapphire Jewels is good enough for the Burlington masterpiece.

Quality and Style
Adjusted to the second-temperature-temperature-position. 25 year Gold Strata Case. In 100 exquisite designs. Only \$1 down. Balance in small monthly payments. Send for free book.

Burlington Watch Company
19th Street and Marshall Boulevard
Dept. 13-54 Chicago, Illinois

Only \$5.69 a month for a few months—easy to own the famous standard **WITTE** Engine. Uses Kerosene, Gasoline, Distillate or Gas. Equipped with celebrated Troubleproof **WICO** Magneto. Simplest and cheapest to operate. **New device makes starting easy.** 50% surplus power. Sizes 2 to 25 H-P—all styles. Sold direct from factory to you on **FREE BIG NEW NINETY DAYS' FREE TRIAL.** Write today for my new illustrated engine book—sent absolutely Free. No obligation to you.

WITTE ENGINE WORKS
1748 WITTE BUILDING, - - - KANSAS CITY, MO.
1748 EMPIRE BUILDING, - - - PITTSBURGH, PA.
1748 WITTE BUILDING, - - - SAN FRANCISCO, CALIF.

Save Time and Money
Get a **SHAW GARDEN TRACTOR**

Now you can get a better power Garden Tractor at less cost. Amazingly Low Price on the SHAW. Just the thing for Truck Gardeners, Small Farms, Estates, etc.; Low Cost; Simple to operate.

SPECIAL OFFER
Write at once for Special Offer.
Address Dept. P. M.
SHAW MFG. CO.
GALESBURG, KANSAS

2 1/2 H-P FULL PARTICULARS FREE Write Today

STOP LEAKS! REPAIR BREAKS! MAKE LOOSE PARTS STAY TIGHT!

Smooth-On No. 1

STOPS leaks and repairs breaks in pipes, furnaces, radiators, tanks, bursted water jackets, etc., with one simple application.



Keeps bolts, nuts, grease cups, etc., from loosening and dropping off—makes loose handles tight—joins wood, metal or glass to each other tightly—holds on iron, brass, lead, aluminum, etc.

For quick, cheap, lasting joints and repairs and stopping many nuisances in every home, automobile and workshop, Smooth-On is in a class by itself.

144 pages
This Book
FREE

**SMOOTH-ON
REPAIR
BOOK**

Get Smooth-On No. 1 in 6-oz., 1-lb. or 5-lb. tins at any hardware store.

SMOOTH-ON MFG. CO.
574 Communipaw Ave., Dept. 37
JERSEY CITY, N.J.

MAKE MONEY SELL MADISON SHIRTS

Direct from our factory to wearer. Easily sold. Over one million satisfied wearers. No capital or experience required. Large steady income. Many earn \$100. to \$150. weekly. Territory now being allotted. Write For Free Samples. Madison Shirt Mill, 511 B'way, New York

ADDING MACHINES

Your choice of Burroughs, Dalton, Wales and all standard makes often at less than one-third regular price! All sizes and styles. Every machine guaranteed A-1 condition. Rebuilt by experts. **1/3 PRICE**
SOLD ON INSTALLMENTS
You can buy a regular \$50 machine for as low as \$5 down. Why pay big prices? Hundreds of well-known firms our customers. Write for FREE list of models and bargain prices that save you money. Do it NOW.
RELIABLE ADDING MACHINE CORP. Dept. 107
168 W. Washington Street CHICAGO, ILL.

TYPEWRITER PRICES REDUCED

ON ALL STANDARD MAKES
Big bargains, easy payments on safe model Underwoods, Royals, L. C. Smiths, Remingtons, etc.—perfect machines expertly re-manufactured by the "Young Process" guaranteed like new for five years. Shipped direct from our factory to you at big saving. Our big illustrated catalog sent free and without obligation to buy. Write for yours today.
Young Typewriter Co., Dept. 1004
654 W. Randolph St., Chicago, Ill.



Swinging, Swaying Tantalizing Tunes

The lure of jazz is yours with a Buescher True-Tone Saxophone. Young folks are enamored by these tantalizing tunes. They love that syncopation.

If you want to be popular—if you want to be admired—favored, get this wonderful instrument. At home, at parties, everywhere, the Saxophone player is the center of attraction.

BUESCHER

TRUE-TONE Saxophone
Easy to Play
Easy to Pay

You don't have to "study" the Saxophone as you do other instruments. There is no practice drudgery. You don't have to be "talented." Three lessons sent free with the instrument start you. In a week you can play popular airs. No teacher needed.

It's all fun, and even though you're only out for pleasure now, you can, in 90 days' time, if you wish, join a band or orchestra.

First class Saxophonists make big money. Try it out free for six days in your own home.

Free Saxophone Book

Send the coupon! Or a postal for full particulars and copy of Saxophone Book! Mention any other instrument in which you may be interested. No obligation. Do this today. (112)

BUESCHER BAND INSTRUMENT CO.

Everything in Band and Orchestra Instruments
804 Buescher Block Elkhart, Ind.

Buescher Band Instrument Co.,
804 Buescher Block, Elkhart, Ind.

Gentlemen: I am interested in the instrument checked below:

Saxophone..... Cornet..... Trombone..... Trumpet.....
(Mention any other instrument interested in)

Name.....

St. Address.....

Town..... State.....

"Sells like Hot Cakes"

writes Supt. of Schools in Georgia

MR. J. O. RODGERS, a county Superintendent of Schools in Georgia, bought a Fil-Gage for his own car. Shortly after, he wrote us: "The people here are just carried away with it. They want to give me orders for it. You have a product that will sell 'like hot cakes' and I want the agency for it here"—and so Mr. Rodgers became our salesman and now covers seven counties in Georgia.

Hundreds of others are increasing their incomes as Fil-Gage salesmen. Lefan (Texas) made \$713.80 in one month. You, too, can make more money with the

Kirstin Fil-Gage for Fords

Fills the tank, gauges the gas
—without lifting cushion!

Just what every Ford owner wants. It clamps into the regular tank opening—installed in ten minutes. The gas gauge is read from the driver's seat.

Write now for new copyrighted Sales Plan—and exclusive territory—they mean sure success.

A. J. Kirstin Co.

401 1st Street,

Escanaba,
Michigan

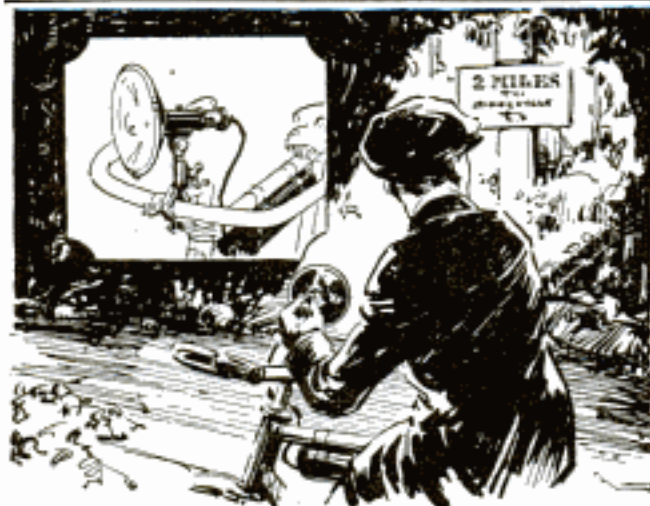

DELTA

No. 37 BICYCLE SPOTLIGHT

A STRONG BEAM OF LIGHT WHERE THE RIDER WANTS IT WHEN HE WANTS IT

A Bike Light that equals a good auto spotlight. The only truly Bicycle Spotlight on the market. Strictly high powered. Not a common Bicycle light or marker, but a spotlight equal to a good auto spotlight. Throws powerful beam of light in any direction at will of rider. Head 4 1/2 inches in diameter. Improved bracket, fits any handlebar. Operates on two dry cells. At your dealer or sent prepaid for \$3.75 complete (less batteries). In Canada \$5.00.

DELTA ELECTRIC COMPANY, 100 Delta Block, MARION, IND.

Standard makers of Electric Bicycle Spotlights and Lamps, Motorcycle Spotlights, Auto Spotlights, Auto Air Receivers, Electric Hand Lamps, Radio Head-Phones, Flashlights and Flashlight Batteries.

New York
EXPORT DEPT.
30 Water St.

Chattanooga
FAUCETTE-NUSTON CO.

San Francisco
SANFORD BROS.
331 Mission St.

Roofing Book

FREE

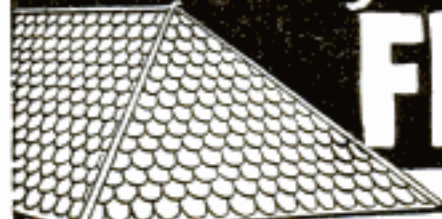

World's

Best Roofing at Factory Price

Don't buy Roofing of any kind until you get our big Free Roofing Book, describing full line of Edwards Famous "Tightcoats" Galvanized Roofings, Sidings and Ceilings, and our lowest factory prices. Then see for yourself how much we save you by selling direct and saving you all in-between dealers' profits.

EDWARDS "REO" Metal Shingles

Absolutely rust proof. By our patented "Tightcoats" process, edges as well as sides of metal sheets are heavily coated with zinc—not a space the size of a pin point exposed to weather. Fire and lightning proof. Outlasts three ordinary roofs. Forever wind and weather proof. Need no repairs—end all roofing expense. Patent INTERLOCKING DEVICE makes water tight seams—all nail heads covered—no chance for rust or leaks.

EDWARDS Galvanizing Test



Edwards "Tightcoats" Galvanized Roofing can be bent, twisted or struck by lightning, and the galvanizing will not crack or flake. Bend it or hammer it—you can't loosen or scale the galvanizing. No other galvanized roofing can withstand this test.

Low Priced Garages

Wide variety of styles, all sizes of Portable Fireproof Metal Garages. Lowest prices ever made. Postal brings Big Garage Catalog free.

Write Today for free samples and proof that we can save you a lot of money on any kind of roofing siding or ceiling you may need. Ask for Roofing Book No. 100.

THE EDWARDS MFG. CO.,
400-450 Pike St., Cincinnati, O.

FREE
Samples &
Roofing Book

RADIO SETS—AUTO BODIES



SEND FOR THE
INTERNATIONAL
CATALOG

Our net price list. Full line of Radio Sets, and auto bodies for Fords at Wholesale Prices. Save big money by buying direct from factory.

INTERNATIONAL BODY WORKS, 914 W. Ohio Street, Dept. 7, CHICAGO, ILL.



Catch Fish

Eels, Mink, Muskrats and other animals in large numbers, sure with our new folding, Galvanized Steel Wire Traps. They catch them like a fly-trap catches flies. Write for our FREE TRAP offer, bargain catalog of Fishermen's Supplies and Recipe for making best lure known for catching fish. Agents Wanted.

WALTON SUPPLY CO., Dept. A, ST. LOUIS, MO.

MOTORCYCLE BARGAINS

Save 25% to 65%

on Slightly used and Rebuilt Motorcycles, Side Cars, Johnson Motor Wheels, Evans Power Cycles, Bicycles. Send for Free Bargain Bulletin and Money Saving Message, listing hundreds of Bargains in used, rebuilt and new machines, supplies, accessories, etc.

AMERICAN MOTOR CYCLE CO. CHICAGO
Dept. 429, 2047 W. Chicago Avenue.

30 Days' Free Trial

Select from 44 Styles, colors and sizes, famous Ranger bicycles. Delivered free on approval, express prepaid, at Factory Prices. You can easily save \$10 to \$25 on your bicycle. Prices \$21.50 and up.

\$5 a Month often advance first deposit. Boys and girls can easily earn small monthly payments. Pay as you ride, best quality, at factory prices, express prepaid.

Tires, Lamps, wheels and equipment, low prices. Send No Money, do business direct with makers.

Mead CYCLE COMPANY
DEPT. C- CHICAGO

Write today for free Ranger-Catalog, factory prices and marvelous easy payment terms



This New Way To Iron Cuts Ironing Time In Half



New Invention Ends Forever Ironing Day Drudgery

Now, once and for all, you can do away with the hardest part of ironing day. No more need you keep a roaring hot fire to do your ironing. No more need you trot back and forth from ironing board to stove. No heavy back-breaking, hot-handled flat irons to carry. No tiring, tedious, drudgery in a sweltering, smothering kitchen, but instead, you can make ironing day delightfully easy, cool and comfortable with the new **Diamond Self-Heating Iron**. You can do your ironing—all of it with one iron—in any room—out on the porch—out-doors in the shade. No wonder housewives are delighted—amazed at its convenience, and pronounce the Diamond Self-Heating Iron the greatest labor-saving invention for housewives of the age.

Beats Electricity or Gas

Cheaper to Operate No home need be without the labor-saving advantage of the Diamond Iron. Gives all the conveniences of the electric or gas iron without the danger or annoyances. Has no hose attachments to break or leak—no cords, tubes or wires to bother with or replace. Costs only one cent to do the average weekly ironing. Retains its heat—quickly regulated to right heat for any class of ironing. Ready in a minute—simply turn a valve. Absolutely dependable. Lasts a life-time. **Guaranteed.**



What Users Say:

"I am pleased with the Diamond Self-Heating Iron. It surely saves lots of steps, and it is much more pleasant to use."
Mrs. Freeman Crippen, Mich.

"I have used the Diamond Self-Heating Iron for the past eight months, and find it saves steps, does better work in half the time."
Mrs. P. H. Danaker, Conn.

"I bought a Diamond Iron and I will say every woman should have one. I would not sell mine for \$50.00 if I could not get another one."
Mrs. Wm. J. DeShano, Mich.

FREE Trial Special Advertising Offer

Try this Iron 30 Days FREE, use it for 4 weekly ironings without risk or obligation. See for yourself how easy ironing is done this new way. Send at once for Special Free Offer and descriptive circular—"A New Way To Iron"—tells all about this invention and how it works. Act now and you will be in time to receive special free trial advertising offer. Write today. Your name and address on a postcard will do.

THE AKRON LAMP COMPANY
34 Iron Street AKRON, OHIO, U. S. A.

AGENTS, \$1200 A Day

If you are making less than this, the position I have open in your town will interest you. Moyer, Pa., made \$164 in one week. Wonderful opportunity. New plan. Simply accept orders. Work is pleasant and dignified. No experience nor capital required. If you cannot work full time I will pay you well for your spare time. Outfit Free to workers. Exclusive territory. Address me personally—say, "Send Agent's Free Outfit Offer."
J. C. STEESE, President.

SHAW MOTOR ATTACHMENT MAKES YOUR BIKE A MOTORCYCLE!

A high grade 2½ H. P. motor attachment quickly clamped on any bike frame. Speed 4 to 40 miles an hour. 90 to 125 miles per gallon of gas. **Special Low Price Now!** Write today for Complete Description and Special Low Prices on SHAW Motor Attachments and the SHAW Complete Motorcycle.
SHAW MANUFACTURING COMPANY
Dept. 37 Galesburg, Kansas



MOTORCYCLES



RELIABLE STANDARD MAKES that you can **DEPEND** on. Enjoy the glorious experience of going wherever you like—when ever you like. The price is within your means—25% to 50% less than others. These machines are **absolutely** **thoroughly** overhauled or rebuilt. Send for catalogue.
MYEROW BROS.,
15 Berkeley St. Boston, Mass.



RECOVER IT YOURSELF

\$3.85 AND UP Custom Made Make your car look like new and save a big labor bill. We have been making top recoveries, side curtains and seat covers for 15 years. We have patterns for all makes, no model too old for us. Easy to apply, simple instructions given. Write for our big money saving catalogue with samples.

THE LIBERTY TOP & TIRE COMPANY, Dept. E-7 Cincinnati, Ohio

You and This New Machine Can Earn \$500 a Month

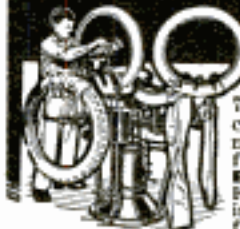

Operate a Tire Repair Shop

70,000,000 Tires in use. America's greatest opportunity for men with small capital. We furnish everything—\$100 and up. **Easy payments.** We train you **FREE** right at home. Start making money at once. Write today for **Free Book of Opportunity.**
Haywood Tire Equipment Co., 1344 S. Oakley, Chicago

Tire AGENTS WANTED

Use and Introduce **MELLINGER CORD TIRES 15,000 MILES GUARANTEED** Lowest Wholesale Prices in America. Shipped prepaid on approval. Make big money all or part time. No capital or experience. Sample sections furnished.

YOUR TIRES FREE! Simply send name today for valuable **FREE BOOK**, tells how thousands have gone into big business. **SPECIAL AGENTS OFFER** Wholesale Prices and **FREE SAMPLE KIT.** Write nearest address.
MELLINGER TIRE & RUBBER CO.,
Philadelphia, Pa. Dept. 1915 Kansas City, Mo.



Let us recommend the best books to study on any subject. Popular Mechanics Press, Chicago, Illinois.

MAKE YOUR FORD INTO THIS SPORT CAR—SAVE \$50 to \$150 WITH **Red-i-Kut** Life-Size Patterns \$6.40

Famous **Red-i-Kut** life-size patterns and pleasure-it instructions show you how you can easily convert your Ford into this Fast, Saucy, Sport Car as thousands have done, with easily obtained materials. No need to lay up the car, **LOOK AT WILLFRED ECK'S PAL**—Eck says, "Total material cost with steel and paint for my Pal only \$11.57. It took me just 3 Sundays to build it and I am sure am proud to hear them say, 'He built that snappy sport car.' I never cut any steel or did any woodwork before but she can't go wrong with Kuempel patterns." (Overland City) St. Louis, Mo. The "Pal" with pressed metal streamline rear.

Life-size patterns for each part of the body so you can't go wrong. picture instructions and **CONICAL DISK WHEEL PATTERNS** Only \$6.40 delivered. Order now while we can make good delivery, and really enjoy the wonderful spring days in your "Pal." Keen, Classy, Up-to-the-minute. You can build it. Over \$11,000 in use. Don't hesitate. "Swing Low" Underling Irons, no frame cutting kind. \$6.99. Only \$4.99 when ordered with Pal patterns. Send 5c coin for new manual of other distinctive sport body patterns from \$5.50 up—"RKO," Steel "Sport-Lo" Irons, "Jiffy," Tops and "Gears" Wheelwells. **ORDER RIGHT NOW.**
KUEMPFL CO., 53 Kuempel Bldg., Galtiesburg, Iowa



38-inch Easy riding seat

CLASS SWAP



NOW—the Caille 5-Speed Motor in a Light Weight Twin

Raising and lowering steering handle changes pitch of propeller blades giving variable speeds forward, reverse and neutral in addition to spark and throttle control. (See cut below.) Motor has twin cylinders—no vibration. Light weight. Rope starter. Send for our free book on Rowboat Motors.

THE CAILLE PERFECTION MOTOR CO.
6318 2nd Boulevard Detroit, Michigan



2 Speeds Forward—Neutral—2 Speeds Reverse
Note Change in Pitch of Blades

Drive This Beautiful Raceabout Instead of your OLD FORD



Choice of Four Colors: Fiat or the Bullet Nose Radiator Shell. Send for 1925 Free Catalog of New Auto Acces., Bodies and Speed Equipment. Direct from Factory.

AMERICAN TOP AND BODY CO., Park Ave., DELPHI, IND.

SWEATERS Any Style or Design for Men, Women, Boys, Schools, Clubs, Teams. Order direct from mill. Save 20% to 30%. Any style, color or size, from stock or to order. Finest virgin wool. Send now for free catalog of big bargains. Special offers to schools, clubs, teams.

AMERICAN KNITTING MILLS, 1538 Clybourn Ave., Dept. 44, CHICAGO

10 DAYS TRIAL
\$2 Brings You
this Genuine
DIAMOND



Lady's wide top solitaire. Latest Style 18 K. white gold hand engraved and pierced ring gives the blue white, perfect cut diamond extra brilliance and large appearance.
Regular price \$85—special bargain price only \$62.50

A few cents a day will pay for this handsome ring. Simply send \$2 to us today. Wear ring for 10 days' trial.

GUARANTEE

Absolute satisfaction: If you don't agree this ring is an amazing bargain, we will refund your money. If satisfied, pay balance in 10 equal monthly payments.

Free Catalog showing bargains in Diamonds, Watches and Jewelry from \$10 to \$1000. Cash or liberal credit terms. WONDERFUL VALUES.

Write Dept. 426

BAER BROS. CO.
6 MAIDEN LANE - NEW YORK

"Old Town Canoes"



Days that merit fond reflection

DAYS when the lake is crystal clear and the sky is cloudless overhead—these are such days as vacation dreams are made of.

Get an "Old Town." Here is a sturdy canoe of unusual beauty. "Old Towns" are low in price. \$64 up. From dealer or factory.

The 1925 catalog shows all models in snappy colors. It is free. Write for your copy today. OLD TOWN CANOE CO., 1564 Middle St., Old Town, Maine, U. S. A.

Get this BOOK



HILDEBRANDT'S NEW HINTS about fishin' is brimful of ideas and baits and things. Not a dry line in it! For all kinds of game fish. YOUR copy is ready. Send for it.

The John J. Hildebrandt Co. FREE
549 High St., Logansport, Ind.

A REAL BOY'S ROOM

His walls are filled with pictures, pennants, drawings, held up with

Moore Push-Pins

Glass Heads—Steel Points

Moore Push-less Hangers

"The Hanger with the Twist"

The points do not mar wall paper

10c pkts. Everywhere

MOORE PUSH-PIN CO., Philadelphia, Pa.

Safe in Rough Water!

The wide "Tumble Home" makes the KENNEBEC best in all weathers. Select a KENNEBEC for your fishing trip. Paddles easily. Light, graceful, beautiful in finish. 15th season. Also rowboats. FREE CATALOG IN COLORS. Please mention dealer's name.

Kennebec Boat & Canoe Co.
Dept. PM-2
Waterville, Maine



FREE
CATALOG

KENNEBEC

**Imperial
Sanitary
Floor**Base
and Floor
one solid piecePut on like Plaster
Wears like Iron
-waterproof
fireproof
resilient
noiseless
dust-
less

A composition material easily applied in plastic form over practically any kind of floor. Laid about 1/4 inch thick. Imperial floor does not crack, peel or come loose from foundation. A continuous, fine-grained, smooth, non-sliping surface. No crevices to gather grease, dirt, dust, disease germs or moisture.

Ideal Floor for Kitchen, Pantry, Bath Room, Laundry, Porch, Garage, Restaurant, Theatre, Hotel, Factory, Office Building, Railroad Station, Hospital—wherever a beautiful, substantial floor is desired. Several practical colors. Full information and sample FREE of your first and second choice of colors.

Imperial Floor Co., 377-379 Halstead St., Rochester, N.Y.

A Success for 15 Years

**AGENTS 500%
GENUINE GOLD LEAF LETTERS PROFIT**

S guaranteed to never tarnish. Anyone can put them on stores and office windows. Enormous demand, large profits. Paul Clark says: Smallest day \$28.70. H. L. Reel made \$920 in two months. Write today for free sample and liberal offer to general agents.

METALLIC LETTER CO., 433-B N. Clark St., CHICAGO

Oh
How
Lovely!**AGENTS**

Saleswoman—Salesmen!
Make big money taking orders for our beautiful Dress Goods, Silks, Wash Fabrics and General Yard Goods. Large Book of Fabric Samples furnished to Agents. Write today.
National Imp. & Mfg. Co.
573 Broadway, Dept. 6, N.Y. City

1000 ACTUAL
FABRIC SAMPLES**AGENTS EARN A
GOOD INCOME**

You can sell Premier Knife Sharpeners to housewives, restaurants, stores, etc. \$9 out of 10 will buy. Sells for 50c. Write today for attractive offer. PREMIER MFG. CO.
Dept. 29 Detroit, Mich.

**LARGE
PROFIT
for you****RAISE BELGIAN HARES**

NEW ZEALAND REDS—Chinchillas—Flemish Giants
MAKE BIG MONEY!—We supply stock and pay you following prices for all you raise: Belgian Hares \$2 each—New Zealand \$3 each—Chinchillas \$4 each—Flemish Giants \$5 each. 32-page illustrated book, catalog and contract, also copy of Fur Farming magazine, tells how to raise skunk, mink, fox, etc., for big profits, all for 10c. Address

OUTDOOR ENTERPRISE CO., Box 25, Holmes Park, Mo.

Make Big Money!

Everybody likes hot peanuts and popcorn—and that's your big opportunity. With one of our machines you can simply coin money. Clear Profit on every dime you take in. Many men make

\$10 TO \$30 A DAY!

Get into business for yourself—we help you. Send for FREE illustrated catalog and full information on our 30 different models.

KINGERY MFG. CO.
ROOM 101 CINCINNATI, O. KINGERY BLDG

**no
freezing no
boiling!**

An absolutely genuine article, prevents freezing or boiling in any climate, running or standing. The system has no moving parts, requires no attention; installed like a motometer—outlasts your Ford. The sensation of the year.

AIRLOCK PRODUCTS CO.
Box 703A, Willow St., Long Beach, Cal.

Send me () Literature. () One AIRLOCK C. O. D. \$6.50 on 30 Days' Free trial, under money back guarantee. () Agent's proposition.

Name.....
(Print name plainly)

Address.....

No need for winter fronts or summer pumps
AIRLOCK Does Both

**SALESMEN—
SALESWOMEN**

Exclusive or Sideline

\$12.00 to \$25.00 daily easily made selling **MAYER'S DOUBLE SUCTION VACUUM CUPS** for displaying signs, posters, merchandise and many other items in windows and show cases.

- (1) You make 150% to 300% Profit
- (2) Spring and summer are best seasons
- (3) Price low, easy to sell—no competition
- (4) A proven necessity—not an untried novelty
- (5) Every storekeeper needs them—unlimited uses

Get our big special free goods offer now

Mayer Manufacturing Corp., 1606 Wabash Ave., Chicago, Ill.

**THE TOOL OF A \$100
THOUSAND USES**

More Than a Wrench. Better than Pliers.

Does the work of both. Instant adjustment. Unbreakable Drop-forged steel. Saves time and trouble for mechanics, plumbers, electricians, farmers, automobilists, housewives. Grips, holds or twists anything round, square, or hexagon up to one inch. Order your Plier-Wrench now.



AROUND AUTO

LOOSENING CAPS

STOPPING LEAKS

BENDING WIDE

MONEY-BACK GUARANTEE

If a dealer cannot supply you, order direct.

Noble & Westbrook
Mfg. Co., Hartford, Ct.

FOR HARD-TO-REACH PLACES

Sales Agents Write for Special Discount

OXO-GAS

OIL BURNERS

OXO-GAS oil burner for ranges One of 20 types for all purposes.

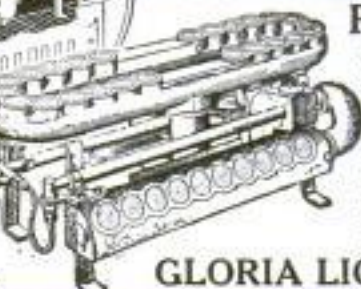

For Furnaces, Ranges, Heating Stoves, Etc.

OXO-GAS, the cheapest, cleanest, most efficient fuel known to science, is made from kerosene or distillate, and air, mostly air. Burns with a pure blue flame of high heating intensity, as silently as city gas. Over a million in use. Manufactured by the oldest (est. 1906), highest rated and most responsible corporation. Ask any bank. Send for Catalog illustrating and describing twenty different, distinctive designs of oil burners for Furnaces, Cook Stoves, Heating Stoves, Base Burners, Hot Water Heaters, etc.

Agents Wanted Some choice territory for OXO-GAS agencies still open to thoroughly responsible parties. Your own locality may yet be unassigned.

GLORIA LIGHT COMPANY, 111-4 N. May St., Chicago, Ill.

YOU can make **\$100.00** a week **and Be Your Own Boss!**



Salesmen and saleswomen are not born—they are made. We have proven this and can make a salesman out of you. We put you in business for yourself—no investment. Build permanent trade selling our nationally known silk hosiery—profits begin immediately. We not only give you a very fine line of hosiery to offer customers, but also free training in salesmanship by mail that you can master overnight. We have taken men and women who have never sold a thing in their lives, or failed at other selling jobs and taught them to become real order getters. Representatives make \$60 to \$125 a week and more.

FREE! It will pay you to write for full particulars—sent free—and learn all about our new plan for getting out of the rut and earning \$100 per week. Costs only one cent for a post card to learn how—

Write Now! **SOLIDSILK HOSIERY CO.**, Dept. 402, 315 Fourth Ave., New York

10 DAYS FREE TRIAL - MONEY BACK IF NOT SATISFIED

THE NEW INKOGRAPH SELF FILLER
GREATEST VALUE EVER OFFERED

The Perfect Writing Instrument

Writes with ink easy as a lead pencil. Won't skip, blot, scratch, leak or soil hands in each uniform flow of ink by pressure loads writing.

Makes three carbon copies with original in ink. Guaranteed—Send No Money. Pay postman \$1.50 plus postage.

INKOGRAPH CO., Inc.
161-29 Centre St., New York City

A hard, round, smooth ball—the 3641 Gold Point.

\$25 A DAY
Selling Suits

Fifth Ave. New York Custom Tailors

want agents to sell advertised brand all wool tailored to measure suits and overcoats direct to wearer. **Lowest Prices in America.** Fell on sight. No capital or experience required. Big line swatch samples Free. **Biggest Commissions** paid daily. Permanent positions \$75 to \$100 weekly. Auto Free to Agents.

MONARCH TAILORING CO., 100 Fifth Ave., Dept. E-51, NEW YORK

NEW VEST POCKET ADDING MACHINE

Adds as rapidly and accurately as a \$300 machine, yet fits the vest pocket. Mechanically perfect. Easy to operate. Everyone who uses figures should own one.

COUNTS UP TO 999,999,999

\$2.95



Total visible at all times. A pull of the finger clears it. Don't carry a pocket full of pencil stubs and scrap paper to do your figuring. Carry a Ve-Po-Ad.

10 DAYS TRIAL SEND NO MONEY.

Just name and address and we will send machine postpaid. Pay postman on delivery \$2.95. Use it for 10 days to prove it does all we claim. If not perfectly satisfied we will refund your money. Limited supply. Order today.

RELIABLE ADDING MACHINE CORP., Dept. 69

170 West Washington Street, CHICAGO, ILL.

AGENTS

Here's a money maker for you. Everybody wants one. Splendid profit. Write for special offer. **DO IT NOW.**

I Offer You
\$8.00 a Day and a **DODGE TOURING CAR**

Write quick for new proposition. We offer \$8.00 a day and new Dodge touring car, for demonstrating and taking orders for Comer Topcoats and Raincoats. Spare time. No experience required. Sample outfit free. Write now.

COMER MFG. CO., Dept. W-5106, Dayton, O.

WE PAY CASH

CASH SENT IMMEDIATELY for old gold, silver, platinum, diamonds, genuine pearls, watches, gold crowns, bridge work, old false teeth, magneto points and other valuables. If you think the money you receive is not enough, write us within fifteen days and we will return your goods. Satisfaction guaranteed.

BUSCH PRODUCTS, Dept. 50
2360 Eighth Ave., New York City, N.Y.

WHAT HAVE YOU?



"If I hadn't been all through it myself, I wouldn't have the assurance to say to you 'cheer up.'"

ERICKSON.

Those who wear them say:
ERICKSON LEGS are Wonderful
because they do not chafe, overheat or draw end of stump.



If you have had a recent amputation send for new booklet on **TEST LEGS** for beginners.

E. H. ERICKSON CO.
38-A Washington Av. N.
MINNEAPOLIS • MINN.

play your way ahead

LEADING professionals, like Carroll Martin, famous trombonist of Isham Jones' Orchestra choose Conn instruments because of Conn supremacy in tone, tune, mechanism and easy playing qualities. You'll get ahead faster with a Conn, socially or professionally — win new friends, make big money if you choose.



Carroll Martin

Cultivate Your Musical Bump

Conn is the only maker of every instrument for band; saxophones, trombones, cornets, etc. Write now for Free Book "Success in Music and How to Win It," by Sousa and other artists, and details of Free Trial offer. Mention instrument.

C. G. Conn, Ltd., 431 Conn Bldg., Elkhart, Ind.



CONN

BAND INSTRUMENTS
GIBBY LARSEN MANUFACTURERS

Beautiful HOUSES \$900 and BUNGALOWS CAN BE BUILT FOR AND UP

This and many others in my new book, Building Plans for Modern Homes, will save you hundreds of dollars. One of the most complete and comprehensive books of plans ever published by any architect. New edition just off the press. Nearly 500 floor plans and photographs of bungalows, Colonial houses, etc., costing from \$200 up; gives sizes and cost to build. Sent postpaid for \$2.00.



FREDERICK H. GOWING
ARCHITECT
101 Tremont St., BOSTON, MASS.

DEAFNESS IS MISERY



I know because I was Deaf and had Head Noises for over 30 years. My invisible Antiseptic Ear Drums restored my hearing and stopped Head Noises, and will do it for you. They are Tiny Megaphones. Cannot be seen when worn. Effective when Deafness is caused by Catarrh or by Perforated, Partially or Wholly Destroyed Natural Drums. Easy to put in, easy to take out. Are "Unseen comforts." Inexpensive. Write for Booklet and my sworn statement of how I recovered my hearing.

A. O. LEONARD, Suite 226, 70 5th Avenue, New York City

Clear-Tone FOR

PIMPLES

Your skin can be quickly cleared of Pimples, Blackheads, Acne Eruptions on the face or body, Enlarged Pores, Oily or Shiny Skin. \$1,000.00 Cold Cash says I can clear your skin of the above blemishes. WRITE TODAY for my FREE Booklet—"A Clear-Tone Skin"—telling how I cured myself after being afflicted for fifteen years.

E. S. GIVENS, 129 Chemical Bldg., Kansas City, Mo.

\$11,275.65 IN THREE MONTHS SO REPORTS V. A. MARINI

of Santa Cruz, Cal., (Nov. 1924.) J. Gordon, of New Jersey, says \$4000 profit in two months. Alexander, of Penn., \$3000 profit in four months. Ira Shook, Flint, \$365.75 in one day. Bram, bought one outfit, then 10 more within a year. Mrs. Lane, Pittsburg, sold 8000 packages in one day. J. R. Bert, Ala., "only thing I ever bought that equaled advertisement." Patallo, Ocala, writes: "Crispettes all you claim and then some." John W. Culp, South Carolina, writes, "Every thing going lovely. Crispette wrappers lying all over. It's a good old world after all."



WE'LL START YOU IN BUSINESS

Furnish secret formulas, raw material, and equipment. Very little capital required; no experience needed.

Build Paying Business of Your Own

No limit to the sale of Crispettes. Everybody likes them. It's a delicious food confection made with or without sugar. Write me for facts about a business that will make you independent. Start now, in your own town.

Profits \$1,000 a Month Easily Possible

Send postal for illustrated book of facts. In contains enthusiastic letters from others—shows their places of business, tells how and when to start, and all information needed. Free. Write now!

LONG-EAKINS COMPANY

428 High Street

Springfield, Ohio

MOVIES In Your Home



Our marvelous, practical Movie Machines sell as low as \$3.75 postpaid, and use same size film as big theatres. We also have wonderful films at lowest prices—with a new film exchange service. Don't Miss This!

Write NOW for Free Catalogue

PARAMOUNT MFG. COMPANY Dept. M7
Boston, Mass.

FREE Selling Outfit and \$40 to \$60 Weekly

also extra bonuses and special prizes. Though inexperienced, you can have a permanent, ever increasing business in protected territory.

Our tailored-to-measure suits and overcoats, at wholesale prices of \$18.50 and \$28.50, thoroughly satisfy the customer. And he recommends them to others. All-wool fabrics; 125 distinctive patterns; "Larvex" bonded process of moth-proofing; absolute "pop-pulling-out" hair cloth fronts; pocket labels; satin linings; 8-day service.

Write today for Free Outfit Offer.

WHOLESALE DIRECT TAILORS
Dept. 505, 83-89 Ellicott St.
Buffalo, N. Y.



TAILORED
Suits and Overcoats
\$18.50—\$28.50

WEAR ONE 7 DAYS FREE

A \$352
B \$384
C \$393
D \$284
E \$348
F \$418

If You Can Tell It From A Genuine DIAMOND

SEND IT BACK These Amazingly Beautiful **CORODITE** Gems match the scintillating beauty of GENUINE DIAMONDS in every way. They have the same gorgeous blazing flash and dazzling play of living rainbow fire. Standing the terrific Acid Test of direct comparison. Lifetime experts need all their experience to see any difference. Prove this yourself.

MAKE THIS TEST Wear a Genuine CORODITE and a Diamond side by side on the same finger. for SEVEN days. If you and your friends can tell the difference send it back, you won't be out a single penny. That's fair enough. If you keep the ring the price printed here is all you pay. No installments. Remember CORODITEs alone have the same facet cutting as Genuine Stones.

A. Ladies Hand Carved Basket Ring, Platinum effect \$3.52
B. Ladies Pierced Filigree 4 Post Ring, Platinum effect \$3.84
C. Ladies Filigree Ring, Blue Sapphire Set Sides, \$3.93
D. Ladies Bridal Blossom Hand Chased Solitaire \$2.84
E. Mens Heavy Belcher 14K Gold Filled Ring \$3.48
F. Mens Massive Carved Hexagon Gyzer, Sapphire Sides \$4.18
Carat Size Gems Beautiful Hand Carved and Engraved Rings reproducing in exact and faithful detail the most modern high priced and fashionable Platinum Diamond Creations.

SEND NO MONEY Keep your money right at home. Just send name and address stating which ring you want and size as shown by slip of paper fitting snugly around finger joint and your ring will come by return mail. Deposit amount shown above with postman. You do not risk a penny as our binding legal guarantee to refund your money in full is attached to every ring we sell. **SEND TODAY.**

E. RICHWINE CO., Dept. 362 19 West Jackson Blvd. CHICAGO, ILLINOIS
Original and Sole Importers of Genuine CORODITE GEMS

5-Room \$498
ALADDIN
WE PAY THE FREIGHT

You can buy all the materials for a complete home direct from the manufacturer and save four profits on the lumber, millwork, hardware and labor.



6-Room \$648
ALADDIN



Living room, dining room, 2 bedrooms, kitchen, bath. Four other plans, some with pantries and dining alcoves. Get Free Aladdin Catalog.

7-Room \$799
ALADDIN

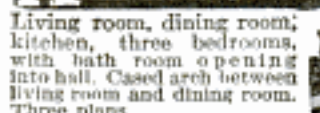

Living room, dining room, kitchen, three bedrooms, with bath room opening into hall. Casse arch between living room and dining room. Three plans.
Price includes all lumber cut to fit; highest grade interior woodwork, siding, flooring, windows, doors, glass, paint, hardware, nails, lath, roofing, with complete instructions and drawings. **Freight paid** to your station. Permanent Homes—NOT PORTABLE. Many styles to choose from. Write nearest mill today for **FREE Money-Saving Catalog No. 915.**

The ALADDIN Co. MICHIGAN
Wilmington, North Carolina; Portland, Ore.; Toronto, Ont.

Only 97 Motors

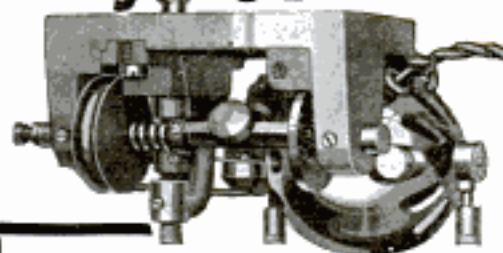

Left at
\$10

Each

Ideal for home-made phonographs, experimental purposes and combination **phonograph-radio** sets.

We have 97 small motors which are greatly under-priced for quick clearance. You will never again equal this low price, when this lot is sold.

They are **universal motors**, 110 volts, 60 cycle single phase, complete with turntable, cord and socket for immediate use. 1400 R. P. M. Motor has 1" pulley with flange for 1/4" flat belt. Housed in highly polished, nickel-plated shell.

Don't lose out on this remarkable offer. Order your motor today. Tomorrow may be too late. **DO IT NOW!** Price, **\$10.00** f.o.b. Steger, Illinois.

Industrial Division

Steger & Sons Piano Manufacturing Company
Dept. 50, Steger Building CHICAGO, ILLINOIS



A & H Auto and Furniture Cleaner
(Not a Polish)

Leaves a hard dry finish with less labor and better results than polish.

AGENTS WANTED

Price \$1.00

BATTERY EXCHANGE, INC., 2115 Olive St., ST. LOUIS, MO.

AGENTS SELL PANTS
HAND TAILORED

At Lower Prices Than Ready Made Pants
Big Money Making all year round proposition. Every man is your prospect.

FREE SALESMAN OUTFIT
250 Different Patterns of the highest grade wools. No selling experience required. Commissions paid in advance. Write for our line today. No deposit required.
WASHINGTON SQUARE TAILORING CO., Inc.
Dept. 150 832 Broadway NEW YORK CITY

Forming a Company?

If starting a new business or reorganizing one you may find it expedient to organize on the Common Law plan under a Declaration of Trust. The economies and advantages are set forth in "D-53"—a pamphlet mailed free upon request. C. S. Demaree, publisher of legal blanks, 708 Walnut, Kansas City, Mo.

Free Mailing Lists

Will help you increase sales
Send for FREE catalog giving counts and prices on thousands of classified names of your best prospective customers—National, State and Local—Individuals, Professions, Business, Contractors.

99% Guaranteed
by refund of 5¢ each

ROSS-GOULD CO. 301 N. 10th St. St. Louis

Sell Foxes

A permanent lifetime proposition for you in a substantial, unlimited industry.

**Big Pay Jobs
for Producing
SALESMEN**

Our men have made from \$200 to \$1,000 a month and more. Our national magazine ads produce live leads for you. WRITE TODAY for full particulars and our FREE selling outfit of photos and profit charts on

Windswept Silver Foxes

Customers need have no previous fox experience or own any land—we ranch foxes for them—they reap the animal increase and pelt profits. A yielding investment for their dollars now. A steady income for the man who intends to retire. Field unlimited—sell prospects with \$5 or \$5,000. Many selling plans—full or part ownership, whole or time payment. Costs nothing to get full particulars. WRITE TODAY.

Windswept Farms

3761 Windswept Building
HENDERSON, Jefferson Co., NEW YORK



BIG MONEY for YOU!

Be the Tanner's representative in your district. It means a permanent weekly income and a sure future. Write today for particulars.

TANNERS SHOE MFG. COMPANY, 41-3 6 St., Boston, Mass.

Mr. Brush Salesman

Unusual opportunity is offered for aggressive, ambitious, hustling men to represent an old established manufacturer of high grade, guaranteed, fastest selling line of Sanitary Twisted in Wire Brushes, sold direct to the Home. We have openings for experienced brush men as managers in all territories. We want live wire, energetic Go-Getters. We pay larger commissions than any other Brush House in the Country. If you want to earn some real money, it will pay you to write us immediately for our proposition.

WIRE GRIP SANITARY BRUSH CORP., 15 MERCER STREET, NEW YORK CITY

SQUAB BOOK FREE!

Squabs are selling at highest prices ever known. Greatest market for 20 years. Make money breeding them. No mixing food, no night labor, no young to attend. Start small, grow big. Start now. Read how our customers sell squabs for \$12 a dozen. We have been established for 24 years. Better look into this. Let us send you, at no cost to you, our big, illustrated free book telling how to make money breeding squabs. Address

Plymouth Rock Squab Co., 634 H. St., Melrose Highlands, Mass.

Ranger \$5 a Month

Finest bicycle built—44 Styles, colors and sizes. Factory-to-Rider prices. FREE delivery, express prepaid on 30 Days Free Trial. Cash or easy payments. Bicycles, \$21.50 and up.

Tires lamps, wheels and equipment at half usual prices. Send no money. Write today for big catalog, special factory prices, free trial plan and marvelous offers.

Mead CYCLE COMPANY
DEPT. C-CHICAGO 108

Write today for free Ranger Catalog, factory prices and marvelous easy payment terms.



A Keener Edge...

For jungle undergrowth, sugar-cane—perhaps even tropic politics—cutting tools must be razor sharp and shaped just so. It's the file that keeps them properly edged, adding impetus to even primitive industry.

From the gold mines of Alaska to rubber plantations on the Amazon—wherever tools need sharpening and files must render constant and faithful service—NICHOLSON FILES are preferred.

In your home, too, you can quickly sharpen every cutting edge with a NICHOLSON FILE—one of the many reasons why they belong in your tool equipment.



NICHOLSON FILE CO.
Providence, R. I., U.S.A.

NICHOLSON FILES

~ a File for Every Purpose

Please Mention Popular Mechanics

LOFTIS
BROS. & CO. 1818

DIAMONDS WATCHES

Genuine Diamonds Guaranteed
CASH OR CREDIT



"Sylvia" Diamond Ring
Blue white, radiant, perfect cut Diamond. The ring is 18-k solid White Gold \$100

Loftis Carved "PERFECTION" Ring
Blue white Diamond \$1.75 A WEEK

"No. 1 Special" Diamond Ring
Brilliant Diamond, blue white and perfect cut. Ring is 18-k Solid White Gold \$50

\$10 Down, \$2.50 a Week

\$5.00 Down, \$1.25 a Week

Loftis Carved "Perfection" Ring. Special at \$75. Terms: \$7.50 with order or on delivery, then \$1.75 a week. Also up to \$2,500.

WEDDING RINGS
Platinum, Solid White Gold, Yellow Gold, and Green Gold; also Diamond-set Platinum and White Gold, at all prices from \$5.00 to \$200.

SEND FOR CATALOG
High-grade Railroad Watches
Guaranteed to Pass Inspection
HAMILTON No. 992, 21 Jewels, Adjusted \$55
to 2 Positions, Gold-filled 25-Year Case
ILLINOIS "BURN SPECIAL," 21 Jewels, \$50
Adjusted to 2 Pos. Gold-filled 25-Year Case
ELGIN'S LATEST RAYMOND, 21 Jewels, \$55
& Adjustments. Runs 40 hours one winding

Rectangular Wrist Watch
18-k White Gold, 17 Jewels, \$27.50; 14-k, 15 Jewels, \$21.50.
Yours for \$2.75 down then \$1 a week until paid.

17-Jewel ELGIN
No. 15—Green Gold, engraved, assorted patterns, guaranteed 25 years, \$30
12 Size, gilt dial
Terms: \$5.00 Down, then \$1.00 a week.

Money Back if not Satisfied
LOFTIS BROS. & CO.
National Jewelers
DEPT. M894
108 N. State St., Chicago, Ill.
Stores in Leading Cities

AGENTS—100 Per Cent PROFIT
New Household Device

Washes and dries windows. Sweeps better than a carpet sweeper. Cleans walls and ceilings. Scrubs and mops. Complete outfit only \$2.95. Over half profit. Write
HARPER BRUSH WORKS, 214 Third Street, Fairfield, Iowa

Build Robust Health and Vitality!



Vit-O-Net Magnetic Health Blanket a reservoir of energy

Be in topnotch physical condition—and stay there! You can now have a tremendous reserve of real vitality. No longer will you feel nervous, fagged out or dull. The Vit-O-Net Magnetic Health Blanket gives you new life—new power. Eliminates disease-breeding poisons thru the pores and other waste channels. Write for facts.

VIT-O-NET HEALTH BLANKET

Eliminates More Poisonous Waste than Any Other Method

Successfully used for treatment of Colds, Catarrh, Pneumonia, Rheumatism, Neuritis, Kidney troubles and scores of other ailments. Magnetic warmth of Vit-O-Net soothes and strengthens. Improvement is noticed immediately. Endorsed and used by prominent physicians and leading health authorities. In daily use in scores of America's greatest hospitals. Whether you are in good or poor health you need a Vit-O-Net—the best insurance against sickness you can purchase. Pays for itself over and over again.

Get Free Health Document! Tells why 90% of diseases are caused by improper elimination. Reveals valuable health secrets you ought to know. Write for your copy today!

VIT-O-NET MFG. CO.
Desk 545, 4105 Ravenswood Ave., Chicago, Ill.
Representatives Wanted

Buy Direct from Factory



Ranges Buy direct from factory! Save $\frac{1}{4}$ to $\frac{1}{2}$ on your stove, range or furnace. Take advantage of the biggest SALE in our 25 years. Kalamazoo quality is the highest; prices are at bedrock. This is the

year to buy. Send for our big, new catalog—it's full of new ideas, new features, new models. 200 bargains in heating stoves, gas ranges, combination ranges, coal ranges, furnaces, both pipe and pipeless, and household goods. Cash or easy payments. 30 days' trial. Money-back guarantee. Quick, safe delivery. 530,000 pleased customers.



Furnaces \$59.95 Up

Write today for Your FREE Book Now Ready
KALAMAZOO STOVE CO., Mfrs.
391 Rochester Avenue
Kalamazoo, Michigan



A Kalamazoo Direct to You

WE PAY \$50 Every Week
Some Make \$200

Big commissions and extra bonus checks for introducing the Simpson plan in every community. Super tailored to measure suits and overcoats at \$31.50 sell easily, and repeat.

FREE Simpsonmen are given complete ease of gorgeous woollens and outfit, sales helps of many kinds, valuable territory; write for new, illustrated book, The Simpson Plan—tells what you can earn, how to start, etc. **FREE** on request to—
J. B. SIMPSON, Inc., Dept. 1100, CHICAGO



Do Your PRINTING



Cards, stationery, circulars, labels, paper. Complete Outfits \$8.85 up, Rotary Jobber, \$150, Card Cutters \$3 Save Money. Print for others, big profit. Easy with rules sent. Write for catalog presses, type, paper, cards ink, etc. **THE PRESS CO., L-37, MERIDEN, CONN.**

fishermen



Fishing facts and hints. Tells how to compete in our annual \$2,000 Fish-Photo contest. A postal gets it FREE!

get this book

SOUTH BEND BAIT COMPANY
3579 High Street South Bend, Ind.

Agents Make \$200 to \$500.00 Per Month

INSTANT WELD. Welds Rubber Instantly. Better, quicker, and easier than vulcanizing **ONCE ON—ALWAYS ON.** No Heat or Cement required. Repairs blow outs, punctures, rubber boots, shoes, etc. Guaranteed to out wear article repaired.

Agents, Salesmen and Distributors Wanted.
TOURIST PRIDE MANUFACTURING CO.
DESK 40D MINNEAPOLIS, MINN.



good tubes
for a
good set



MAGNATRON have reached that degree of excellence where the mere name is synonymous with the very best in vacuum tubes. You have but to use **MAGNATRON**s to form the same opinion.

MAGNATRONs are made in three types: the DC-201A, the DC-199 with large base, and the DC-199 with miniature base.

All Types \$3.00

Connewey Electric Laboratories
309 Fifth Ave. New York City

MAGNATRONS

Cut Prices on Radio

Save 25 to 50 per cent. Standard Sets, all types, \$5.00 to \$79.00. Everything in accessories. Wiring diagrams and estimates free. 150,000 customers. Money-back guarantee. Immediate delivery. Illustrated catalog on request. Special proposition to community agents.

Radio Dept. 108

IMPERIAL LABORATORIES, Coca Cola Bldg., KANSAS CITY, MO.



The Triple Duty Charger

Charges radio 2, 4 or 6 volt "A" battery, radio "B" battery up to 125 volts and auto batteries from lamp socket. Average cost per charge about a nickel. Solidly built—will not get out of order. Fool-proof and simple. The first successful charger—introduced over ten years ago. Type A, B., price \$20; West of Rockies, \$25. Type 6 for 6 volt "A" or auto batteries, price \$18; West of Rockies, \$16.50. "B" factory charging attachment, \$2.50 extra. Write for literature and name of dealer who will supply you with the genuine FF charger.

FRANCE MFG. CO.

10424 Brees Road CLEVELAND, OHIO

FREE RADIO CATALOG

Sent You Every Month

ALL the latest improved apparatus is listed in our monthly bulletin: "The American Radio Transmitter." If it's new we have it.

Lowest Prices in U. S.

Our prices to deal rs are the lowest in the United States. All nationally advertised goods at discounts that make you real money. Dealers, get your name on our mailing list. Simply send name today for latest, big monthly bulletin, showing 75 nationally advertised factory lines and 4,500 items.

AMERICAN RADIO MFG. CO. 6 W. 14th St. Dept. O, Kansas City, Mo.



YOUR CRYSTAL SET

will work 400 to 1000 miles if made by my plans. No tubes or batteries. Copyrighted plans \$1.00; or furnished FREE with complete parts for building set, including special coil and panel correctly drilled, for only \$5.00. Satisfaction guaranteed or money refunded. Satisfied customers everywhere. Particulars free.

LEON LAMBERT, 539 Kaufman Building, Wichita, Kansas

Direct Tuning!



Point record a station on the dial—thenceforth simply turn the slider to your pencil-mark to get that station instantly. Eliminates fumbling, guessing.

1. This alignment is the gauge for penciled station records.
2. Operates vernier for hair-splitting adjustment.
3. Takes standard condenser shaft lengths—easy to mount.
4. Penciled station records easily erased from silver dial.

Designed by R. E. Lacault, inventor of the famous Ultradyne circuit. This monogram seal (R.E.L.) is your assurance of Lacault's design. Details at

\$250

ULTRA-VERNIER
TUNING CONTROL
PHENIX RADIO CORPORATION
3 Beckman Street New York City

A New Socket that means Better Reception!

After exhaustive research, our engineers have developed **Viralon**, a special glass, processed for 100% efficiency. Sturdy and rugged, absolutely heat and moisture proof, and unaffected by those influences that commonly make rubber, rubber derivatives, porcelain or vitreous products so inefficient.



Other exclusive features are Eazyklean Contacts (proof against corrosion) — One-Piece Contact Strips — Handy Soldering Terminals, etc. Price \$1.25 standard size.

Write for interesting pamphlet

If your dealer cannot supply you, send us \$1.25 and parcel post to cover each socket.

DURAY
ALL-GLASS
VIRALON
SOCKET

DURAY RADIO CORPORATION
Dept. 16, 263 Washington Avenue
NEWARK, N. J.

Ask your Radio Dealer

to show you these

KELLOGG PARTS:

Audio Frequency Transformers

New-Type Low-Loss Variable Condensers

Radio Frequency Transformers

Write today for free 5-tube
radio frequency circuit diagram

KELLOGG

Kellogg Switchboard & Supply Co.
Chicago, Illinois

AGENTS Some Seller at
\$200

Looks Like \$5.00 Worth
Gives You \$1.10 Profit!



This is
What
Gets
the Coin
Investment—no delays. You bank immediate profits, also a winning plan, a premium
to each sale. Write today for illustrated circulars explaining our unique plans. Act Now.
E. M. DAVIS CO.

You should see our Nifty Nine Package. Our Representatives introduce our products with a first sale of beautiful combination sets of Toilet Articles, Soaps, etc., at half store prices. No fancy talk—they sell on sight. Make twenty to thirty sales a day, with \$1.10 profit on each.

**EASY TO AVERAGE
\$100.00 A WEEK**

Could you ask more while introducing line establishing a permanent business for yourself? Another plan calls for no deliveries—no investment—no delays. You bank immediate profits, also a winning plan, a premium to each sale. Write today for illustrated circulars explaining our unique plans. Act Now.

Dept. 5628

CHICAGO

Radio Inventors!

If you have a marketable idea, we have the necessary plant and facilities. Either royalty or outright purchase. Write us at _____ once.

**Inventor—Room 513, 217
Broadway, New York, N. Y.**

**RADIO TEXT BOOK
& CATALOG
FREE**



Contains—
75 Radio "Hook-Ups"
300 Illustrations
556 Articles
84 Pages

"Build Your Own with RASCO Parts"

RADIO SPECIALTY CO.
98-E Park Place, NEW YORK, N. Y.

ALUMINUM SOLDER

SOLDERS ALUMINUM of any description. NO ACIDS OR FLUX NECESSARY. For home, shop and garage use. Your tool kit is not complete without HAMILTON LEAD CO. ALUMINUM SOLDER. (Name on every bar.) Send 25c for 2 six inch bars, post paid.

HAMILTON LEAD CO., HAMILTON, OHIO

LATEST WHOLESALE RADIO CATALOG

FREE Simply send name
TODAY for big
48 - page catalog
of latest radio goods at Wholesale.
Live dealers and agents wanted.
STANDARD RADIO CO., 102 East 13th, Kansas City, Mo.

Mohawk Radio

5 TUBES—JUST ONE DIAL TO TUNE



Buchstein's Fibre Limb

is soothing to your stump—strong, cool, neat, light. Easy payments. Braces for all deformities.
D. BUCHSTEIN CO.
610 2nd Ave., So., MINNEAPOLIS, MINN.

Come On, Boys! **FREE SALES KIT!**

SELL \$12.50 **MADE TO MEASURE SUITS**

FREE Complete Selling Outfit!
Earn \$150 a week, regular line, or \$75 a week, side line. Commission in advance. No delivery. A KNOCK-OUT—SELLS ON SIGHT.
Our \$12.50 Superkloak suits resist water, sparks, snags. Quality union tailoring. Experience unnecessary.

ECONOMY CLOTHING MFG. CO. Dept. 1-17
2035-49 CHARLESTON ST.
CHICAGO ILLINOIS

FREE

Economy Sales Kit

The LARGEST RADIO STORES in AMERICA

THE PERIOD OF QUALITY AND SERVICE

RADIO Catalogue

Hook-ups!
All the latest and best Kits in our new
RADIO CATALOG

FREE

JUST OUT! Our new 1925, ninety-six page Radio Catalog including all the best and latest Kits, Parts and Accessories. Also our new 32 page bargain section—Write for your FREE copy today!

SAVE MONEY! We buy up manufacturers' jobber, and dealer surplus and bankrupt stocks—but only brand new fully guaranteed, nationally advertised apparatus. Our enormous buying power permits us to pay spot cash and get rock-bottom prices—even way below manufacturer's costs. That's why our catalog is crammed with thousands of wonderful Radio Bargains.



509 So. State St., CHICAGO, ILL., Dept. PM6

THE NEW **PARAGON**
RADIO RECEIVERS



Introducing the new non-radiating Paradyne Circuit, new simplified tuning, and new low prices. Write for Folder

ADAMS-MORGAN CO., Inc.
5 ALVIN AVE., UPPER MONTCLAIR, N. J.

WRITE FOR FREE BOOKLETS describing and illustrating complete line of IVER JOHNSON Bicycles, Velocipedes, Revolvers and Shot Guns. IVER JOHNSON'S ARMS & CYCLE WORKS 4 River Street FITCHBURG, MASS.

SOLDERALL
METAL IN PASTE FORM

The Only Convenient metal solder

Every Electrical Connection needs Solderall for perfect reception

25¢

The **SOLDERALL CO., NEWARK, N.J.**

The Traffic Cop of the Air



Add a Ferbend Wave Trap to your Radio Set and "Police" your reception. Regulate traffic. Guaranteed to tune out any interfering station. Widely imitated but never equalled. The original and only successful WAVE TRAP. Now in its third year. Sent Postpaid upon receipt of \$3.50 or C. O. D.

plus postage. Send for Free Booklet
FARBEND ELECTRIC CO.
18 E. So. Water St. Chicago

FARBEND
Wave Trap

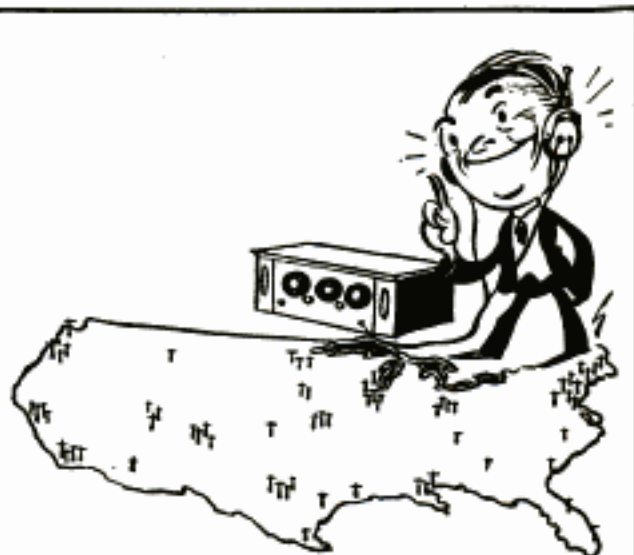

We've mapped the air for Radio explorers!

Get your copy of this great new map today.

TWIST the dials until you catch a faint hum. Nurse it carefully and it becomes a murmur of distant music. Then a moment of silence. "This is station KFAP, Denver,"—and you add another station to your list.

But how far away was it? What sort of a country did the message flash over? You want to visualize your exploit and mark it for future reference.

You can—with the New Collier radio map of the United States and Canada. It's beautifully printed in three colors. Every station is clearly marked and the time zones outlined.

Instantly you can tell how many miles away a station is. Cut out the scale of miles provided and paste it on cardboard. Put a pin through one end at the point where you are located. Swing the other end across the country until you reach the station you are after.

Here are some more points worth noting:

1. If you use a directional aerial, you can pick out any station you want to get on the map, and point the loop towards the exact point where the station is located.
2. Around the map there is an alphabetical list of all stations which also gives the name of the operator of each. If you miss the letters given by an announcer, you often catch the name of the operator of a station which can then be located by referring to the index.
3. The map outlines the boundaries of the radio districts, identifying them by number. This will be a help in locating amateur stations.

There's a lot of satisfaction in radio exploring with this great new map. And it costs only a quarter. Get your copy at your news stand, bookstore or radio dealer's tonight. Or just mail 25 cents in coin or stamps with your name and address to us direct.

P. F. Collier & Son Co.

Dept. R. M.

250 Park Ave. New York City

Please Mention Popular Mechanics

Copyrighted material



FRED W. STEIN

Steinite

LOW LOSS

Interference Eliminator

What Radio Users Have Been Looking For

For those who have had Interference Troubles this new auxiliary tuning device will trap out the undesired stations.

Select Your Stations at Will

The air is so crowded with music and voices that the average set fails to bring in the desired stations properly. The Steinite Interference Eliminator shuts out local and other interference. You get one station at a time, whatever one you want, and can tune it in loud and clear.

Improved Results with Tube or Crystal

Try for yourself entirely at my risk the wonderful improvement this inexpensive little device will make in the reception of your set. Sold on absolute guarantee of satisfaction or money back and the greatest dollar's worth ever offered the radio public. Improves results on both crystal and tube sets that use an indoor aerial, outdoor aerial or light socket; but will not help a set using loop antenna. Clears up reception wonderfully and partially absorbs static.

Mfrs. Famous 1,500 Mi. Steinite Tube Sets, \$12; Long Distance Crystal Sets, \$6; De Luxe Crystal Set, complete with headphones, aerial and ground, \$10; 2 Tube Set, \$16; 2 Tube Amplifier, \$15. FREE descriptive literature on request.

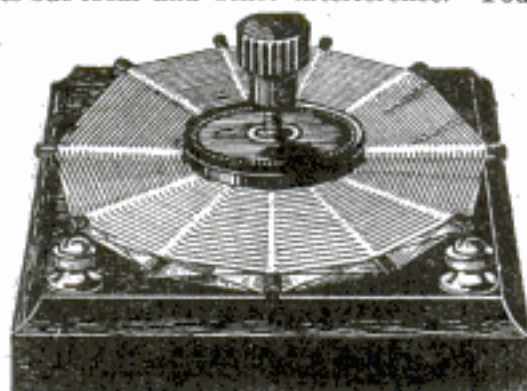

\$1.00 Amazing Satisfaction or Money Back

Put this interference eliminator on your set and note amazing improvement. No tools needed and but a moment's time required to install. Full directions with each instrument. Simply connect with set and follow instructions. Requires no additional tubes or batteries. You must be pleased and delighted or you get money back promptly on your say so. \$1.00 postpaid anywhere in U. S. when cash accompanies order. These two big Atchison banks will testify to my reliability: Exchange National Bank, Atchison Savings Bank. Order today—a dollar bill will do.

STEINITE LABORATORIES, 1021 Radio Bldg., Atchison, Kansas

Books on all subjects are sold by Popular Mechanics Press, 200 East Ontario Street, Chicago, Illinois.

Licensed by
Independent Radio Manufacturers, Inc.
NEUTRODYNE
Reg. U.S. Pat. Off.
Pat. March 27, 1923 and April 1, 1924
Machine Pats. Nos. 1,450,000 and 1,469,229
Other Patents Pending

HOWARD 5 Tube Neutrodyne in Chicago successfully brought in European Stations on recent Trans-Atlantic tests. If your dealer cannot demonstrate them to you, write for information, giving dealer's name.

Howard
Mfg. Co. Inc. **Chicago, U.S.A.**
GUARANTEED PRODUCTS

469 East Ohio Street

FREE This Radio Book of Bargains



Big Money-Saving Radio Catalog
Save about half on Everything in radio. Assembled sets and parts for complete sets. Spare Parts, Accessories. Valuable radio data. Write today.
RANDOLPH RADIO CORP.
199 N. Union Avenue, Dept. 433, Chicago



Save **\$1.25** ON COST OF NEW TUBES

BY HAVING YOUR OLD TUBES REBUILT AT **\$1.75 Each**

Guaranteed equal to new. Send us your tubes by parcel post. We return parcel post, C. O. D. and try to maintain 24 hour service.

Harvard Radio Laboratories
204 Old Colony Ave., So. Boston, Mass.



FREE BIG CATALOG
Thousands of Radio Bargains!

Contains interesting Radio information. Complete list of U. S. Broadcasting stations with space to log station. All booklets. How to operate sets. Construction of aerial. Write today.

STANDARD RADIO CORP.
227 WEST MADISON ST. Chicago

You cannot buy
these features
in any other
Bltorch

Only Turner "Master Line" Bltorches have the burner baffle and heater plug which gasifies present-day gasoline or kerosene—400 degrees more heat!—automatic safety valve and air release eliminates excess tank pressure. **No danger**—separate needles for adjusting and shut-off eliminates orifice troubles. **No enlarged orifice** (a common nuisance with ordinary torches)—one opening in tank prevents leaks from soldered connections. **No opening below fuel line**—pistol-grip handle fits any hand. **No strain**. Get a Turner NOW—**FEARLESSLY GUARANTEED**. If your dealer cannot supply you, write direct

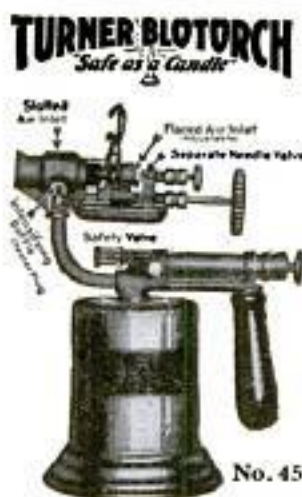

Capacity 1 Quart

\$8²⁵

THE TURNER BRASSWORKS
Industry Ave., Sycamore, Illinois
The World's Largest Exclusive Manufacturers
of Blow Torches, Fire Pots and Brazers

MINSTRELS Musical Comedies and
Revue, with full in-
structions for staging.
You can stage your own show with our books. Full line
of plays, stage songs, crossfire, monologues, afterpieces,
vaudeville acts and make-up. CATALOGUE FREE.
T. S. DENISON & CO., 623 So. Wabash, Dept. 19 Chicago

the best four tube set that you can build?
Do You Know The Browning-Drake Receiver
Using the
National Regenerator, Dials, and Condensers,
designed by Harvard experts. Simple, easy
to build—wonderful results. Bul. 105 P. M. describes it.
NATIONAL COMPANY, INC., CAMBRIDGE, MASS.

Como Duplex Transformers
(Push Pull Power Type)



Price
\$12⁵⁰
Per Pair

The Como Duplex system of audio frequency amplification (push-pull) gives the maximum volume without distortion and tube noise. There is a combined filtering action which assures perfect results when ordinary amplification transformers fail. Can be used as a single-stage, two-stage, or a three-stage amplifier.

The World's Standard Push Pull Transformer
Send for copy of "How to Build a Power Amplifier."

COMO APPARATUS CORP.
MANCHESTER NEW HAMPSHIRE



**"I selected it for its high
insulating qualities
It cuts down the losses
in the circuit"**

THOSE were the exact words of a prize-winner in a radio set-building prize contest, when asked why he used a Radion Panel. Like thousands of others, he had found by experience that there is nothing quite like Radion for real results.

Our engineers developed Radion Panels especially to order for radio. Losses from surface leakage and dielectric absorption are exceptionally low. And low losses mean clearer reception, more volume and more distance.

Radion is easy to cut, drill and saw. You need not have the slightest fear of chipping. It resists warping. It's strong. It's moisture proof. Comes in eighteen stock sizes and two kinds, black and mahogany.

Radio dealers have the exact size you want. The use of Radion by the manufacturer of ready-built sets is almost invariably a sign of general good quality in that set.

Send for booklet,
"Building Your Own Set"

Our new booklet, "Building Your Own Set," giving wiring diagrams, front and rear views, showing new set with slanting panel, sets with the new Radion built-in horn, lists of parts and directions for building the most popular circuits—mailed for ten cents.

AMERICAN HARD RUBBER COMPANY
Dept. K4 11 Mercer St., New York City
Chicago Office: Conway Building
Pacific Coast Agent: Goodyear Rubber Co.,
San Francisco—Portland

RADION

The Supreme Insulation

PANELS

Dials, Sockets, Binding Post
Panels, etc.

AMERICAN HARD RUBBER CO.,
Dept. K4, 11 Mercer St., New York City.
Please send me your new booklet "Building Your Own Set," for which I enclose 10 cents (stamps or coin).

Name.....

Address.....

You Can Play a Hohner Harmonica!

This FREE Instruction Book Will Teach You How



Millions of happy people of all ages are now playing Hohner Harmonicas for entertainment, education and popularity. Anyone can quickly learn to play a Hohner with the aid of the Free Instruction Book.

This interesting and instructive book contains a series of easy lessons, charts and pictures which will enable you to quickly master the harmonica and play operatic, classical and jazz selections.

Even though you have had no previous musical training, you can learn to play a Hohner Harmonica. And when you do learn, you will have mastered the first principles of a musical education.

Don't hum or whistle—play it on a Hohner. Ask your dealer for the Free Book today. If he can't supply you, write to M. Hohner, Inc., Dept. 181, New York City.

Leading dealers everywhere sell Hohner Harmonicas—50¢ up.



HONEYCOMB COILS

The Universal all-wave inductance. Back and front panel mountings. Send 25c for Super Het., R. F. and Honeycomb Coil Circuits and Complete Catalog.

Chas. A. Branston, Inc.
853 Main St. Buffalo, N. Y.
Chas. A. Branston, Ltd., Toronto

DON'T WEAR A TRUSS

BE COMFORTABLE—

Wear the Brooks Appliance, the modern scientific invention which gives rupture sufferers immediate relief. It has no obnoxious springs or pads. Automatic Air Cushions bind and draw together the broken parts. No salves or plasters. Durable. Cheap. Sent on trial to prove its worth. Beware of imitations. Look for trade-mark bearing portrait and signature of C. E. Brooks which appears on every Appliance. None other genuine. Full information and booklet sent free in plain, sealed envelope.

BROOKS APPLIANCE CO., 215-A State St., Marshall, Mich.



MR. C. E. BROOKS



Why pay a high price to have a New Top put on your car? Recover it yourself very easily, and save \$15.00. Just send name, year and model of car. We make Top to order and send it to you with complete simple instructions. It's a snap and will

Make Your Car Look New

Improves appearance of car 100%. Greatly increases its value. No middleman's charges—that's why we can ship direct to you at an amazing saving.

Write for FREE Style Book

showing money-saving prices on tops and other Auto accessories. Samples free.

RUOB & SCHEU, Dept. A-4, CINCINNATI, OHIO



(11)



Canoes



Rowboats



Outboard Motor Boats



Motor Boats

BETTER BOATS At Lower Prices

**CANOE
ROWBOATS
FISH BOATS
HUNTING BOATS
OUTBOARD MOTOR BOATS
V-BOTTOM MOTOR BOATS**

Two Factories
Write to either one,

Catalog Free—Save Money—Order by Mail

State kind of Boat in which you are interested.

THOMPSON BROS. BOAT MFG. CO.

423 Ellis Ave.
Peshtigo - Wis.

1223 Elm St.
Cortland - N. Y.

AGENTS WANTED—To Sell HUGHES VALVE CAPS

Fastest selling article on the market today. Big profits with a minimum of effort. Retail price \$1.25 per set of five.

Write at Airlox Rubber Co., 2512 W. Monroe Street, Chicago

RADIO ENCYCLOPEDIA



FREE! Thousands of radio catalogs, standard sets, standard parts for sets, vacuum tubes, etc., at one-third less than regular prices, also latest information on all aspects, complete list of broadcasting stations and other valuable data. Send name and address, we'll send you 50c book FREE!

FREE SERVICE DEPARTMENT. Mr. Deane of N. Y. Box World will help you solve your radio problems, and furnish up-to-date information on set construction, operation, improvement. This service FREE to our customers. Write today!

NORWALK RADIO CORP

Dept. 58C 66 READE ST., NEW YORK

DEMONSTRATORS WANTED For 5-Tube Neutrodyne Set

Live young man in every town and neighborhood, to own, operate and take orders for the licensed, standard, ed, synchronous "De Luxe 5-Tube Coast-to-Coast Neutrodyne" made famous in "The Radio Digest." Complete assembly retails only \$34.49. Thousands sold. Furnish you at discount. Liberal financial arrangements. Write us at once all about yourself. Ask for plan. Also illustrated description of set. **Be First.**

The Radio Shack America's LARGEST Radio Dealers
Dept. D200, 55 Vesey Street, New York City



BUILD YOUR OWN PHONOGRAPH

WITH OUR HELP—SAVE HALF

Choraleon Aristocrats are unexcelled. Play any record. Finest motor, tone arm, case materials, blueprint, full instructions at LOW COST. Write for catalog and FREE Blueprint offer.

Choraleon Phonograph & Radio Co.
425-1st St., Elkhart, Ind.

I MAKE

The "American Universal" Way

\$150.00 A WEEK SURFACING FLOORS

says Brooks, Okla. "My profits run from \$35.00 to \$50.00 a day and I have cleared as high as \$180.00 in 17 hours," says Gieseking, Ill. "I make at least \$20.00 a day," says Phillips, Ohio. "I have made \$30.00 in 8 hours," says Waynick, Texas. Hundreds of other fellows who have become "American Universal" Floor Surfacing Contractors, are doing as well, some even better.

More Good Men Needed

The field is unlimited, the demand for "American Universal" work tremendous in villages, towns and cities the country over. Every new floor must be surfaced, every old floor represents a resurfacing job. "American Universal" (electrically driven) Floor Surfacing Machine does work of six hand scrapers, costs six men's pay. Work is pleasant, interesting, requires no experience, no special training. Small amount starts you. Here's Your Big Opportunity to get into something for yourself, be your own boss and make real money. We help you get started, show you how and where to get work, furnish other forms, stationary, advertising, everything you need. It's the big chance you've been looking for—Grab it.

Write now for free details of this rare opportunity

The American Floor Surfacing Machine Company
523 S. Saint Clair Street
TOLEDO, OHIO



Saws Logs—Falls Trees—
Buzzes Branches—
Does Belt Work
10-Year Guarantee—Cash or Easy Terms.

One Man Saws 15 Cords a Day!

—Easy with the OTTAWA Log Saw! Wood selling for \$3 a cord brings owner \$45 a day. Use 4 H. P. Engine for other work. Wheel mounted—easy to move. Saws faster than 10 men. Shipped from factory or nearest of 10 Branch houses. Write for FREE Book—"Wood Encyclopedia"—today.

OTTAWA MANUFACTURING CO.
1741-T Wood Street Ottawa, Kansas
Room 1741-T Magee Bldg., Pittsburgh, Pa.

TRY 30 DAYS



DIAMONDS

FOR A FEW CENTS A DAY

Don't send a single penny. Ten days Free Trial. When the ring comes, examine it—if you are not convinced it is the Greatest Bargain in America, send it back at our expense. Only if pleased, pay 20% as first payment—then send \$1.50 weekly—at the rate of a few cents a day. This Bargain Cluster Ring with 7 Blue-White Perfect Cut Diamonds can be yours. No red tape. No risk.

Million Dollar Bargain Book FREE Send for it today. It pictures thousands of Bargains. Address Dept. 1774

Million Dollar Bargain Book

FREE

J.M. LYON & CO.
2-4 Maiden Lane N.Y.

MONEY BACK GUARANTEE



WURLITZER

Couldn't Play a Note

Now Makes \$100 a week!

"Bill Carola"
Laudaus Serenaders

Read the story in his own words—

"When I sent for your catalog, I wanted a Tenor Banjo, but I hesitated a long time as I didn't know a note of music. I finally decided to try it a week, as you offered, and at the end of that time I found I could pick a few notes. Then I started the correspondence course you furnished, and in seven months, even before the final payments on the Banjo were due, I had taken my place in a professional orchestra. Now I am making \$100 a week, three times what I made as a clerk. Two of my friends made money with their instruments after five months practice, one a drummer and the other a saxophonist, and neither could play a note when he started. I wish everybody knew how easy it is—anyone who can whistle a tune can learn to play a musical instrument."—Bill Carola



New Offer

Learning to Play Made Easy

FREE We now furnish with every instrument a Free Scholarship Certificate. This scholarship entitles you to free tuition in one of the foremost correspondence schools of music in the country. Whether you want to learn to play for profit or only for pleasure, this Free Scholarship will make it surprisingly easy for you.

Free Trial

You may have any Wurlitzer instrument for a week's free trial in your own home. No obligation to buy. Payments are arranged in small monthly sums, a few cents a day will pay for your instrument. Wurlitzer instruments are the result of 200 years' experience in musical instrument building. Famous for artistic quality, rich tone value and fine workmanship. Used in the finest bands and orchestras throughout the world.

Free Book

Illustrates and describes every known musical instrument—over 3000 articles. Special offers on complete outfits. Special prices direct to you. We also give you our Free Trial, Easy Payment Plan and special Free Scholarship Offer. No obligation.

Send Coupon Today

The Rudolph Wurlitzer Co., Dept. 1774
117 E. 4th St., Cincinnati 329 So. Wabash Ave., Chicago
120 W. 42nd St., New York 250 Stockton St., San Francisco

Send me your Free Book on Musical Instruments. Also your Free Trial Easy Payment Plan and Free Scholarship offer. No obligation.

Name.....
Address.....
City..... State.....
Instrument.....
(State instrument in which you are interested)

Copyright 1934, The Rudolph Wurlitzer Co.



For
Your
Boat



Elto

Ole Evinrude's
New Quick Detachable
ROWBOAT MOTOR

Get more fun out of your vacation this year. Take the thrill of motor boating with you wherever you go. Elto attaches instantly (without tools) to any boat. This wonderful little 3 H. P. Motor is—

**FAST—POWERFUL
EASY TO CARRY**

Weighs less than 17 lbs. per H.P. Has these exclusive features—Propello Pump, Instant Easy Starting, an Extra Horse Power, Much More Speed, Safe Rudder Steering, Fits Carrying Case without taking apart.

Write for FREE Catalog See how easily you can own an Elto. See why it is the safest Motor for all the family—the fastest on the water, and the easiest to start. Write today.

ELTO OUTBOARD MOTOR CO.
Manufacturers' Home Bldg.
Dept. AA Milwaukee, Wis.



The Motor that Starts with a Touch

Fire Impossible with My Formula

Every home and others should know how to make fire and blaze proof all kinds of wearing and decorating material, silks, satins, cottons, curtains, tissue paper to wallboard, without injury to material, for \$1.00. I will send this formula, with guarantee to do all claimed, or money back. **T. R. WOODARD, HYDE PARK, VERMONT**

66 Miles on 1 Gallon

Wonderful Vapor Humidifier

1 FREE TO INTRODUCE

BIG PROFITS Showing to Autoists

CRITCHLOW, PM-A-111, WHEATON, ILLINOIS

FORD Owner's Look Here!



Every Ford owner looks when you show him how a

NEW-RODE WATER PUMP for FORDS

forces a big stream of water so fast it ends over-heating, prevents freezing, makes engine work better, saves oil, reduces repairs. Our men are making **BIG MONEY** equipping Ford cars with these fast selling Pumps at \$8. Put on in a few minutes. Get agency, equip your car, lift hood, draw crowds, make quick sales for cash. Keep big share for your work. Exclusive territory. Good men wanted everywhere. Write now. **JENKINS VULCAN SPRING CO., 514 North 6th Street RICHMOND, INDIANA**

Motor to Work or Sport— at 1/3¢ per Mile!

SAY goodbye to crowded trains and trolleys. Motor to work or sport for less than carfare. The New Indian Prince, the Personal Motor, goes 90 miles on a gallon. Light—safe—clean.

Only half the weight of an ordinary motorcycle. You learn to ride it in 5 minutes. Costs less than any other high-grade machine. Write today for illustrated booklet containing full information about this new Indian Prince, the Personal Motor, and how easily you can buy it.



Indian Motorcycle Co.
Dept. P4, Springfield, Mass.

FORD RUNS 57 MILES ON A GALLON OF GASOLINE

A New Automatic Vaporizer and Decarbonizer which in actual test has increased the power and mileage of automobiles from 25 to 50 per cent, and at the same time removes carbon from the cylinders, is the proud achievement of John A. Stransky, 216 Fourth St., Pukwana, South Dakota. A remarkable feature of this simple and inexpensive device is that its action is governed entirely by the motor. It can be installed by anyone in five minutes. With it attached, automobiles have made from 30 to 57 miles on a gallon of gasoline. Mr. Stransky wants distributors for his marvelous invention and is willing to send a sample at his own risk. Write him today.—*Adv.*

Buy SPORT BODIES for FORDS AT FACTORY PRICES!



This Model in Grey Prime **39.50**

Write for Circular B-1 Showing Other Models.

Sport Body Sales, Aurora, Illinois

Try This on Your Hair 15 Days



Then let your mirror prove results. Write for FREE Trial Offer.

Your hair need not thin out, nor need you become bald, for there is a way to destroy the microbe that destroys the hair. This different method will stop thinning out of the hair, lifeless hair, remove dandruff, itching, darken gray hair and threatened or increasing baldness, by strengthening and prolonging life of the hair for men and women. Send your name now before it is too late for the 15 days' free trial offer.

AYMES CO., 3932 N. ROBEY ST., M-390, CHICAGO, ILL.



Hy-Power 60 DAY TRIAL OFFER

REG. U.S. PAT. OFF.

TIMER FOR FORDS

You take no chances when you buy a HY-POWER Timer. Order one today. If after using it 60 days you feel that it is not the best timer you have ever used, we will gladly refund your money. No quibbling. Can you ask more? Send no money—pay postman \$1 plus postage, Act today. Average life will over 10,000 miles. (\$1.25 West of the Rockies, \$1.50 Canada and Foreign Countries.) **\$1**

HY-POWER MANUFACTURING CORP'N, Dept. P, Mt. Vernon, N.Y.



A 3-PLY BARGAIN

Here is one of the biggest offers we have ever made. Read it carefully. Remember it is limited to a short time—send in your order NOW.

(1) The famous little Hustler Motor—known and used in every part of the world. 3 1/2" high, three pole armature, 3/8" pulley, runs on a single 6"x2 1/2" dry cell or 110 volts a. c. through a transformer.

(2) Specially equipped for this offer with a 4 inch nickel plated fan—see illustration.—*Makes a real electric fan.* Tremendous speed, wonderful breeze. Fan detachable.

(3) Fascinating book, illustrated with photographs and engineers drawings, diagrams etc., on the nature and kinds of Electricity. Contains complete illustrated directions for building a real motor yourself, AT A COST OF ONLY \$1.50.

This is a special offer, limited to a short time only. Send us no money. Simply tell us to send you this outfit and when it arrives pay postman \$2.00 plus a small postage fee.

ONLY \$2.00 FOR A SHORT TIME ONLY.
KNAPP ELECTRIC CORPORATION, Port Chester, N. Y., Dept. 25

Special Offers

As exclusive violin experts, buying personally direct from individual European violin-makers, we offer you a selection of special values in both moderate and higher priced violins. Every instrument the work of an artist in the craft. Tone quality and workmanship that will appeal to those who want and appreciate true musical character. We also have a large collection of old violins at a wide range of prices. Liberal examination privilege—extended terms if desired. Special service on orders by mail.

Send for Catalog

New illustrated catalog shows our exclusive selection, with prices and details of our special offer to out-of-town customers. Also contains information and help to purchasers of violins as to origin, methods of production, etc., on medium and high grade instruments, as well as valuable hints on care and use. Sent free. Write for it now.

WM. LEWIS & SON
(Largest Exclusive Violin House)

225 South Wabash Avenue Suite 1774 Chicago, Illinois

Teachers Professionals

Enclose your professional card or letter head for our special proposition



"Lighting Fixtures" READY TO HANG

(Direct from Manufacturer)

Completely wired, including glassware. Send for Catalogue No. 26. Just Off the Press. Special proposition to DEALERS.

ERIE FIXTURE SUPPLY CO.
STA. A ERIE, PA.



Taxidermy
Book
FREE

Mount Birds

We teach you by mail to stuff and mount all kinds of Birds, Animals, Game Heads. Also to tan skins and make rugs. Be your own taxidermist. Decorate your home with your beautiful trophies or increase your income selling specimens and mounting for others. Easily, quickly learned in spare time by men and women. Highest endorsements by thousands of students. Write today for our great free book "How to Mount Birds and Animals" Free—write today, N. W. School of Taxidermy, 9774 Elwood Bldg., Omaha, Neb.

FISH WILL BITE

INDIAN FISH LURE Guaranteed Fish Bait Assures fishing luck. 25c a box. Free catalog of Atomatic Hooks and Supplies, also Dough Bait Recipe Free. SPORTSMEN SUPPLY CO. Dept. D, Louisville, Ky.



BEAUTIFY YOUR CAR

PROMANCO Auto Frames all the rage! Adjustable. Add 100% to appearance of any car. Order TODAY. Postpaid \$1.00. Money returned if not satisfied. DISTRIBUTORS. Fortune right now! Demand spreading like wildfire! Exclusive territory now. Write Dept. 9.

PRODUCTS MANUFACTURING CORP.
168 DARTMOUTH ST., BOSTON, MASS.

Western Canada is Calling You



Come where rich land is low priced—where virgin soil produces big crops—where you can double or triple your acreage with the same investment, with 35 years to pay.

Free Use of Land for One Year Stop Paying the Penalty of Farming High-Priced Land

Canada needs farmers. In return, she offers independence, prosperity and wealth. Canada wants you for a partner—to bring your skill as a farmer to her rich, low-priced soil.

Fertile land sells for an average of twenty dollars an acre. It is near the railroad, stores, towns, churches and schools.

35 Years to Pay—First Year, Free Use of Land

Under our liberal plan, you pay down only 7% of the total purchase price—then use the land a year without even an interest charge, after which the balance of the principal and interest will be amortized on an easy payment plan of 34 equal payments. The second payment does not fall due until two years after purchase. On 160 acres costing \$3,000, you pay down but \$210. Your annual payments will be but \$195.30.

Interest Receipts Are Worthless

Try to buy a mower with your interest receipts. They are worthless! Put your profits back in your pocket—we don't want them. We want farmers—business men farmers—to build the country and fortunes for themselves.

No Taxes on Improvements

Taxes are low. No tax on livestock, buildings, improvements, implements or personal effects. Good markets nearby. Modern schools, churches, roads and amusements make farm life worth while in Western Canada.

Irrigated Farm Lands Also

In sunny Southern Alberta—a district especially adapted to mixed farming—the Company has constructed a vast irrigation system with an unending water supply. This insures a crop every year—makes you independent of weather conditions—produces great quantities of coarse grains, pasture, alfalfa, etc. Here the stockman prospers in an industry ultimately more profitable than wheat farming. These lands are for sale on the same easy terms.

We Won't Sell Until You Investigate

You must investigate before you buy. Special inspection trips at reduced fares. We arrange details. Write for information. How about your boys? Where will they find farms if present prices increase further? This is your chance. Don't turn this page until you clip and mail the coupon. Act now.

Send coupon TODAY for FREE booklet

M. E. THORNTON, Supt. of Colonization
Dept. 504 Canadian Pacific Railway Depot
Winnipeg, Manitoba, Canada

M. E. THORNTON, Supt. of Colonization
Dept. 504, Canadian Pacific Ry. Depot
Winnipeg, Manitoba, Canada

I am interested in learning more about:

- Prairie Provinces of Canada.
 Irrigation Farming in Sunny Alberta.
 Business and Industrial Opportunities in Western Canada.

My Name.....

Address.....

Town..... State.....



PATE

TRADE MARKS

Any new article, machine, design or improvement thereof, or any combination of parts or improvements in any known article which increases its efficiency or usefulness, may be patented, if it involves invention.

IF YOU HAVE ANY NEW IDEAS

which you feel are useful, practical and novel, **take prompt action to protect your rights.** If you have invented any new machine, or new combination of parts or improvement, or any new design or process, **SEND DRAWING, MODEL OR DESCRIPTION** of it for information as to procedure to **secure protection.**



DRAFTING and SPECIFICATION ROOM of CLARENCE A. O'BRIEN, Registered Patent Lawyer, Washington, D. C.

All Communications are held in strict confidence. My personal, careful and thorough attention is given to each case. I offer you efficient, reliable and prompt service—based upon practical experience. **Highest references.**

NO CHARGE FOR ABOVE INFORMATION

Clarence A. O'Brien

REGISTERED PATENT LAWYER

Member of } Court of Appeals, District of Columbia, United States Court of Claims;
Bar of } Supreme Court of United States, Supreme Court, District of Columbia

Practice Confined to Patents, Trade Marks and Copyrights

NTS

-COPYRIGHTS

PROTECT YOUR IDEAS

Write Today for FREE BOOKS,

"How to Obtain a Patent"

and

"Invention and Industry"

and **BLANK FORM,**

"RECORD OF INVENTION"

These books will give you valuable information, and they may save you much time and effort. **Send for them, NOW.** My practice is devoted **exclusively** to United States and Foreign Patents and Trade Marks. Write me freely, frankly and with full confidence; it is very probable that I can help you.

Use the Coupon Attached

and immediately upon its receipt I shall send you the form, Record of Invention, to be returned to me with drawing, description or model of your idea; promptly upon receiving your idea I shall write you as to procedure and costs.

FREE COUPON

CLARENCE A. O'BRIEN, Registered Patent Lawyer

709 1/2 Security Savings & Commercial Bank Bldg., Washington, D.C.
Directly Across Street from Patent Office

Please send me your free books, "HOW TO OBTAIN A PATENT" and "INVENTION AND INDUSTRY," and blank form "RECORD OF INVENTION," without any obligation on my part.

Name

Address

IMPORTANT—WRITE OR PRINT NAME CLEARLY.

FREE

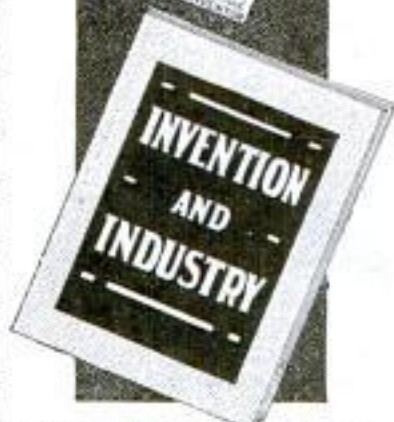

These Books Free



Our New York Office
5th 1007 Woolworth Bldg.



Our Philadelphia Office
5th 714-15 Liberty Bldg.



Our Washington Office
Victor Building

PATENTS TRADE-MARKS AND COPYRIGHTS

Have You An Idea?

Our Offer: FOR THE PROTECTION OF YOUR INVENTION YOUR FIRST STEP

Before disclosing an invention the inventor should write for our blank form

"RECORD OF INVENTION"

This should be signed and witnessed and returned to us together with model or sketch and description of the invention for instructions. **No Charge for the Above Information.**

Our Four Books Mailed Free to Inventors

Our Illustrated Guide BOOK

HowtoObtainA Patent

Contains full instructions regarding U. S. Patents. Our Methods, Terms, and 100 Mechanical Movements illustrated and described.

Our Trade Mark Book

Shows value and necessity of Trade Mark Protection. Information regarding *Trade Marks and unfair competition in trade.*

Our Foreign Book

We have Direct Agencies in Foreign Countries, and secure Foreign Patents in shortest time and lowest cost.

Progress of Invention

Description of World's Most Pressing Problems by Leading Scientists and Inventors.

We Regard a Satisfied Client as our best advertisement, and furnish anyone, upon request, lists of clients in any state for whom we have secured patents.

**Highest References—Prompt Attention
—Reasonable Terms**

VICTOR J. EVANS & CO.

PATENT ATTORNEYS

Main Offices: 956 9th St., N. W., Washington, D. C.

Opposite U. S. Patent Office

PATENTS TRADE-MARKS AND COPYRIGHTS

IMPORTANT

Do not submit your invention to anyone before you furnish proof that the invention is patentable or application has been filed. IN ORDER TO HAVE YOUR CASE MADE SPECIAL TO AVOID DELAY YOU SHOULD TAKE THE PRECAUTION OF HAVING YOUR CASE MADE SPECIAL IN OUR OFFICE to secure protection, save correspondence and secure early filing date in Patent Office. To secure special preparation of your case send \$25.00 on account with model, sketch and description.



MAIN OFFICE, VICTOR J. EVANS & CO.—VICTOR BUILDING, WASHINGTON, D. C.

All Communications and
Data Strictly Confidential.
Interference and Infringe-
ment Suits Prosecuted

OUR ORGANIZATION OFFERS
PERSONAL SERVICE
By Experienced Patent
Solicitors and Draftsmen

**FREE
COUPON**

**VICTOR J. EVANS & CO.
PATENT ATTORNEYS**

NEW YORK OFFICES
1097 Woolworth Bldg.

CHICAGO OFFICES
1114 Tacoma Bldg.

PHILADELPHIA OFFICES
714-715 Liberty Bldg.

PITTSBURGH OFFICES
514 Empire Bldg.

SAN FRANCISCO OFFICES
Hobart Bldg.

MAIN OFFICES: 956 9th Street, N. W., WASHINGTON, D. C.

Gentlemen: Please send me *Free of Charge* your books as described on preceding page.

Name

Address



Our Chicago Office
Suite 1114 Tacoma Building



Our Pittsburgh Office
Suite 514 Empire Building



Our San Francisco Office
Suite 1010 Hobart Building

PATENTS

TRADE MARKS · DESIGNS · FOREIGN PATENTS

MUNN & CO. PATENT ATTORNEYS

Associated since 1846 with the Scientific American

672 WOOLWORTH BUILDING
New York City

523 SCIENTIFIC AMERICAN BLDG.
Washington, D. C.

412 TOWER BUILDING
Chicago, Ill.

365 HOBART BUILDING
San Francisco, Cal.

220 VAN NUYS BUILDING
Los Angeles, Cal.



Books and Information on Patents and Trade Marks by Request. Associates in All Foreign Countries.

PATENTS

To the Man with an Idea

I offer a comprehensive, experienced, efficient service for his prompt, legal protection and the development of his proposition.

Send sketch, or model and description, for advice as to cost, search through prior United States patents, etc. Preliminary advice gladly furnished without charge.

My experience and familiarity with various arts frequently enable me to accurately advise clients as to probable patentability before they go to any expense.

Booklet of valuable information and form for properly disclosing your idea free on request. Write today.

Richard B. Owen, Patent Lawyer
9-303 Owen Building, Washington, D. C.
41-E Woolworth Bldg., New York City

Mason, Fenwick & Lawrence
Patent and Trade Mark Lawyers
Washington, D. C. New York Chicago
Established over 60 years Write us
Inventions Protected Trade Marks Registered

PATENTS
REGISTERED PATENT ATTORNEY SINCE 1905
CHARLES W. LOVETT SECURITY BLDG. LYNN MASS.
(SEND FOR FREE BOOKLET)

INVENTORS who derive largest profits know and heed certain simple but vital facts before applying for Patents. Our book *Patent-Sense* gives those facts; sent free. Write **LACEY & LACEY**, 646 F St., Washington, D. C. Established 1889.

Have You An Invention?

If so the **WORLD PROGRESS** will show you how to **PROTECT AND PROFIT FROM YOUR IDEAS**
Sample copy free. One year's subscription \$1.00.
Send for free book,

"WHAT TO INVENT"

containing **SUGGESTIONS TO INVENTORS** as to Inventions Needed. We invite manufacturers to source us regarding inventions they want.

WORLD PROGRESS PUB. CO., Inc.
Room 203 Victor Bldg. WASHINGTON, D. C.

PATENTS

Booklet Free Highest References Promptness Assured Best Results

Send drawing or model for preliminary examination

ALL BUSINESS GIVEN PROMPT AND PROPER ATTENTION

Listed Patent Lawyer in the latest editions of the Rand-McNally Directory of Bankers and Attorneys, published by Rand-McNally & Co., Chicago, Ill.; The Baggott & Ryall Directory of Attorneys, published by the Ryall Legal Directory Company, New York City; the United Lawyers' List of Attorneys, published by the United Lawyers Association, Chicago, Ill.; The Lawyers and Bankers Quarterly, published by the Legal Directory Publishing Co. of St. Louis, Mo.; the American Lawyers Annual, published in Cleveland, Ohio; and Snow-Church Directory Co. Lawyers List, published in New York City.

WATSON E. COLEMAN, 644 G Street, N. W., Opp. U. S. Pat. Office
REGISTERED PATENT LAWYER WASHINGTON, D. C.

Models and Experimenting

Let Us Design and Build Your Models Complete

**WOOD—METAL PATTERNS
 CASTINGS—MACHINE WORK**

Established 25 Years

McDERMOTT PATTERN AND MODEL WORKS
 231-233 West Grand Ave. CHICAGO, ILLINOIS

1000 NEEDED INVENTIONS!

Here is the most remarkable book ever offered to inventors. One Thousand needed inventions listed and described. Arranged as follows: General Problems; Automotive; Mechanical; Electrical; Chemical; Radio; Marine; Separate chapter on the Ten Most Needed Inventions. This book may give you one idea that will win you a fortune. Nothing else like it has ever been published. Compiled at enormous expense. Edited by Raymond Francis Yates, formerly Managing Editor of a leading scientific magazine. Over 100 pages, durably bound. Send no money. Pay postman only \$1.00 plus postage on arrival. Money back after 10 days examination if desired. Limited edition. Write NOW.

BUREAU OF INVENTIVE SCIENCE

Dept. 34

ROCHESTER, NEW YORK

PATENTS

C. L. PARKER
 Formerly Member Examining
 Corps, U. S. Patent Office
PATENT LAWYER
 MCGILL BLDG.
 WASHINGTON, D. C.

Patents, Trade Marks, Copyrights, Patent Litigation

Handbook for Inventors, "Protecting, Exploiting and Selling Inventions," sent free upon request.

INVENTORS PROTECT YOUR IDEAS

Send for our Guide Book, **HOW TO GET A PATENT**, and Evidence of Invention Blank, sent Free on request. Tells our terms, methods, etc. Send model or sketch and description of your invention for **INSTRUCTIONS**. No charge for the above information.

RANDOLPH & CO.
 300 Victor Bldg., WASHINGTON, D. C.

NAME

STREET

CITY STATE

\$2 Brings This Genuine DIAMOND RING

SIMPLY send \$2.00 for the most sensational, price-smashing diamond ring offer ever made.

A perfectly cut, guaranteed, blue white, fiery diamond is set in an 18 Karat white gold cup; 5 Karat size. Latest design, hand engraved mounting.

10 DAYS' FREE TRIAL

We take all chances—if you are not satisfied at the end of ten days for any reason whatsoever, return the diamond ring to us and your deposit will be refunded to you. Send only \$2.00, and receive this genuine steel blue white diamond ring exactly as illustrated; in a handsome gift box charges paid. A legal guarantee bond as to quality and value accompanies each ring. After ten days' trial pay balance \$6.46 a month for twelve months. Price only \$79.50.



NO RED TAPE—NO DELAY

Order Now! This offer is limited. It may never appear again. Don't delay. Just send \$2.00 as a deposit. If you wish to return the diamond ring after trial, your deposit will be refunded.

FREE BOOK OF GEMS

Most complete Jewelry Catalog ever issued of Diamonds, Watches and Jewelry—newest designs at lowest prices.

A full year to pay on everything you order from our TWO MILLION DOLLAR STOCK.

Address Dept. 1312. Est. 1895

ROYAL DIAMOND & WATCH CO.
35 Maiden Lane - New York

U.S. PATENTS



SEND FOR THIS FORM

DON'T LOSE YOUR RIGHTS TO PATENT PROTECTION

Before disclosing your invention to anyone send for blank form "EVIDENCE OF CONCEPTION" to be signed and witnessed. A sample form together with printed instructions will show you just how to work up your evidence and establish the same before filing application for patent. As registered patent attorneys we represent hundreds of inventors all over the United States and Canada in the advancement of inventions. Our schedule of fees will be found reasonable. The form "Evidence of Conception," sample, instructions relating to obtaining of patents and schedule of fees sent upon request. Ask for them—a post card will do.

PATENTS AND TRADE MARKS

LANCASTER & ALLWINE

Registered Patent Attorneys In U. S. and Canada.
480 Ouray Bldg., WASHINGTON, D. C.
Originators of forms "Evidence of Conception."



PATENTS

Send us sketch or model for advice and exact cost of patent. Our book "How to Obtain a Patent" sent free. It tells how to apply for Patents, Trade Marks, Foreign Patents, Copyrights, etc.; gives information on Patent Procedure; tells what every inventor should know. Thousands of Inventors, who are our clients, are our reference.

CHANDLEE & CHANDLEE, 25 Years' Experience
473 7th St. Washington, D. C.

Inventor's Universal Educator

Contains 900 mechanical movements; 50 perpetual motions. Tells how to obtain and sell patents. Suggests new ideas. Explains how to select your attorney and avoid patent sharks. Special price (for a limited time) **\$1.00 Postpaid**

ALBERT E. DIETERICH, 621-A Ouray Bldg., Washington, D. C.

BLUE BOOK ON PATENTS

gives instructive information and candid advice.
MONROE E. MILLER, PATENT LAWYER
411-2 Ouray Building WASHINGTON, D. C.
ELECTRICAL AND MECHANICAL EXPERT



Catch Fish, Lobsters, Eels, Mink, Muskrats and many fur-bearing animals, in large numbers with my latest improved Folding, Galvanized **STEEL WIRE TRAPS**. They catch them like a fly-trap catches flies. Strongly built. In all sizes. Write today for **Descriptive Price List**, and my Special **Free Trap and Bait offer**. Best bait known for attracting all kinds of fish. In fresh or salt waters. **J. F. GREGORY, Dept. 26, Lebanon, Mo.**

Drive 100 Tacks and Save \$25

on your next Top or Seat covering. Fords \$3.65 to \$10. Chevrolets—\$7.95 to \$15. All other cars \$9.95 to \$25. Our Plate Glass Lights enhance the value of your car. Side Curtains \$5.95 up. Seat Covers \$2.50 to \$35. Quality and fit the best. Our instructions make it easy to apply. Send for samples. Our prices include delivery at your door. Eastern orders shipped from Ohio.
AUTO EQUIPMENT CO., 106 E. 11th St., Los Angeles, Calif.



\$365 up

Delivered

FREE 1000 Illustrations ELECTRIC FIXTURE CATALOG!



Write today for your copy. Save 50% direct from Manufacturer. No Middleman's Profit. OUR SPECIAL \$8 Room Electric Set, ready to hang, \$24.50—other bargains.

UNITED LIGHTING FIXTURE CO.
280 Bowery Dept. H New York



SPORT BODIES for FORD and CHEV. 490 at \$34.50

Life-size paper patterns—You can build your own body at small cost. **\$8 UP**



UNDER SLUNG PARTS
Per Set **\$6.75**

We are manufacturers and our quantity production enables us to quote exceptional low prices. Our unique shipping methods save you 73% in FREIGHT CHARGES. Send at once for free particulars on Central Bodies. Our Book: "HOW TO BUILD A FORD RACER" sent anywhere on receipt of 25c in cash or stamps. **WRITE TODAY!**
Central Auto Supply Co. Dept. 120 Louisville, Ky.



WADE BENCH LATHE

AMATEUR MECHANICS, MODELMAKERS, INVENTORS, STUDENTS
A real machine tool for the home work bench—capacity 4" dia. x 12" length. For Metal—Wood—Composition Materials—Turning—Facing—Boring—Drilling—Winding—Thread Cutting. **Accurate—Strong—Quiet—Compact.** Slide-rest has travel entire length of bed. Leadscrew inside bed. Send for literature—Price \$28.00. **THE GEROLD CO., Dept. P-9, 120 Liberty St., New York**

SANDS LEVELS



Plumb Right

Window frames, doors, walls, foundations are plumb when you use a Sand's! Sand's accuracy is built-in by factory experts. It's permanent.

Strong and Light

Greater strength with less weight—lenses of non-brittle glass that withstands rough usage. You can use a Sand's Level overhead and at arm's length without fatigue.

The Choice of Master Craftsmen

At Good Hardware Stores Everywhere

SANDS LEVEL & TOOL CO.

5881 Fischer Ave., DETROIT, MICH.



CAMERA OWNERS
EXTRA SPECIAL
ENLARGEMENT
HAND COLORED
AND FRAMED
FOR ONLY
\$1.25

TWO SIZES—
4x6—6x10
MADE FROM YOUR
CELLULOID OR
SEND FILM.
SEND NO MONEY!
BY POSTAL CHECK OR
CASH TO SMALL ORDER. FRAMES
AND POLISHED. WE DO NOT
WARRANT. REGULAR \$3.50 VALUE. THIS SPECIAL
SERVICE. MONEY REFUSED TO BE PAID. COMPLETE
AGENTS WANTED. NOW

PHOTO FINISHING COMPANY
3265 S. MICHIGAN BLDG. CHICAGO.

Limbs & Braces

\$35 to \$175. Easy Terms. 5 Year Guarantee.

Great Invention for Cripples. BE OUR AGENT
SEND BUYERS' NAMES TO **WORMAN CO.** 252-P HENNEPIN AVE. MINNEAPOLIS, MINN.

A Test Every Man Past 40 Should Make

Medical authorities agree that 65% of all men past middle age (many much younger) are afflicted with a disorder of the prostate gland. Aches in feet, legs and back, frequent nightly risings, sciatic pains, are some of the signs—and now, a member of the American Association for the Advancement of Science has written a remarkably interesting Free Book that tells of other symptoms and just what they mean. No longer should a man approaching or past the prime of life be content to regard these pains and conditions as inevitable signs of approaching age. Already more than 10,000 men have used the amazing method described in this book to restore their youthful health and vigor—and to restore the prostate gland to its proper functioning. Send immediately for this book. If you will mail your request to the Electro Thermal Company, 2144 Main Street, Steubenville, Ohio—the concern that is distributing this book for the author—it will be sent to you absolutely free, without obligation. Simply send name and address. But don't delay, for the edition of this book is limited. Western Office, Dept. 21-J, 711 Van Nuys Bldg., Los Angeles, Cal.

WANTED!

Men Who Want to Sell and Make Money Doing It

So as to cut out the necessity of a lot of correspondence, I'm going to tell you right here just what the proposition is that I have to offer. Take five minutes and read it over—then after you have read it, give it plenty of thought because I don't want a man to be with me a short time and then chat his mind. When you've made up your mind, apply for our application blank so you can get busy in your home neighborhood.

For years, I've been manufacturing roofing and waterproofing materials. My factories have grown so big that I want to sell my products through men that are directly responsible to me so that the users of Leitch Products will have the kind of service and interest that only dealing direct with the manufacturers can give.

There are over twenty million dwellings, over twenty-five million farm buildings and over a million factory buildings in the United States, and when you figure the cost of a new roof, you can realize the tremendous market there is in each locality for a product like mine. Every home is a prospect—every factory—every garage—in fact, every building with a roof on it.

Our composition fibre roof covering can be applied to over 95% of the roofs in common use. A roof never wears out—it always dries out.

Are YOU One of the Men We Want?

We need hustling men in every section of the country to represent us in their home neighborhoods. The opportunity for making money is unlimited, but the chance of joining me is limited to real men who intend to give their customers attention and to sell the goods on an honest basis, as well as giving their time to building up a big volume for themselves.

"Succeed with Leitch."

Write today for particulars of our whole proposition. Get the facts. Territories are now being assigned in the order in which applications are received. To get the territory of your choice, you must write us at once.

C. A. Leitch, Pres.

C. A. LEITCH MFG. CO.
342 Madison Ave., Dept. M, New York

FREE Book of Newest Styles just out. Women's, men's, children's clothing on credit and at bargain prices, less than cash prices everywhere. Very latest fashions; best materials. Open a charge account with us. Buy on credit and save money! Dress in newest styles. Send for Style Book absolutely FREE today! Elmer Richards Co., Dept. 1774, W. 35th Street, Chicago

ENJOY THE GLORIOUS SPRING WEATHER

In a snappy, distinctive Ford speed "bug."

8 model bodies \$35 up. Speed and power equipment.



Understand Fix
on! Write for catalog and attractive prices. Attractive Dealer's Proposition
U. V. FORDSPEED BODY MFRS., 250 W. 54th Street, NEW YORK

I'll teach You How to Earn \$100 a Week



Selling This New Indexed BIBLE

During the last 15 years I have specialized in training salesman how to make big records. There is nothing magical about my methods—I simply teach you how to apply a few simple rules in the art of scientific salesmanship. If you have average ability and initiative I can help you earn from \$100 to \$200 a week from the start.

G. C. BUXTON

A beginner, A. B. Little, averaged over \$120 a week in net commissions for 14 consecutive weeks. Others doing just as well.

Most Salable Bible Ever Published

No matter how many Bibles there may be in a home, there is a real demand for the New Indexed Bible. Combines 3 translations; compressed digest and encyclopedia. No other Bible like it. Makes every Bible subject clear for home reading. No other book presents the entire Bible and gives so much valuable additional information. Indispensable to Ministers, S. S. Teachers, and homes where there are children.

Write today for all the facts about our wonderful selling plan and proof of the big money salesmen are making. This is your opportunity to establish yourself in a profitable business.

G. C. BUXTON, Sales Manager.

BUXTON-WESTERMAN CO.
36 So. State St., Dept. 51, Chicago



12 Books in One



Wonderful New Shoe

fits and feels like a glove. Will help your foot troubles like no other. Must be seen to be appreciated.

Send for Catalogue on foot troubles and their cures. Heavy duty sole elk upper **Guaranteed** to give wear and comfort and to be satisfactory. **DISTRIBUTERS WANTED.**

GREYHOUND SHOE CO.
120 Boylston St., Boston, Mass.

Collect Postage Stamps

FOR PLEASURE AND PROFIT

Take Advantage of this Special Bargain Offer

For less than 1/4 of the catalog value of the stamps which we send you, you can own a COMPLETE outfit, including foreign postage stamps, a fine album and accessories.

Read this Offer (1) 300 foreign postage stamps. Many unused, from all parts of the globe, including the new European Post War Countries. Guaranteed genuine or money back. (2) The Imperial Postage Stamp Album. More than 100 pages—spaces for 4000 stamps. Profusely Illustrated. Blue Board Covers—the Standard beginner's album. (3) 1000 mounts for placing stamps in album. (4) "Standard Guide to Stamp Collecting," 40 page illustrated book, used by thousands. Explains every phase of stamp collecting. Alone worth the price of the combination.

For a short time only, to Popular Mechanics readers the entire outfit for only \$1.00. Start being a collector now. A fascinating, educational and profitable pastime. **Free Price List on request.**

Dept. **SCOTT STAMP & COIN CO.** 33 West 44th Street
New York, N. Y.

Hand Forged Razor Steel Blades, No. 57



A GENUINE \$2 KNIFE FOR \$1.18 POST PAID

Direct at Factory Prices

This \$2 KNIFE \$1.18 Postpaid Hand Forged Razor Steel Blades Handy shaped Blade makes this knife best for mechanics, sportsmen and farmers; light but strong; re-sharpened easily. Stag handle. German silver finish; blades file tested, hand forged from razor steel and warranted.

Sample \$1.18 3 for \$3.00 Postpaid.

Send for our 100-page List and "HOW TO USE A RAZOR" **FREE**

MAHER & GROSH CO., 106 A St., Toledo, Ohio



Just 17c a Day Pays for This Beautiful Chair

Over 1000 other bargains, Furniture, Rugs, Lamps, Silver,

China, Blankets, Stoves, etc. **Save Big Money** at our Factory-to-Family prices. Pay as little as \$3 down; up to a year and a half to pay balance. Get all your Furnishings at once—pay as you use. Thousands buying this new way.



Big Catalog FREE

New Spring "Larkin Book of Better Homes." Shows everything for parlor, porch, dining-room, bedroom, kitchen. **Bargain Prices** on famous Symphonola Phonographs; also Symphonola Pianos, Player-Pianos in genuine Mahogany, Walnut, Fumed Oak. Free trial. Up to four years to pay. Satisfaction or money back. Check below article interested in.

- Home Furnishings
- Pianos or Players
- Phonographs

Cut out this Adv.—Write TODAY for FREE Book.

Larkin Co. Inc.

Dept. 439 • BUFFALO, N. Y.
Peoria, Ill. Chicago, Ill.

AN OPPORTUNITY

Responsible Middle Western Manufacturing Institution desires to get in touch with inventors or small manufacturers with view to buying outright or manufacturing on royalty basis. Brass, bronze, iron, steel or aluminum preferred, but will consider any article having merit. Address

MANUFACTURER, Box 300, Popular Mechanics

I ASK ALL FORD OWNERS:

Do you know how much oil is in your crankcase? Not until you crawl under your car, a dangerous chatter is heard, or you install a

DASH OIL INDICATOR

The INDICATOR always tells you when you are short of oil. Price \$3.00 Post Paid. Your money refunded if not satisfied.

Send money today to

General Machinery & Mfg. Co., 4824-28 W. Kinzie St., Chicago

SHOW IT—and IT'S SOLD



The Handy Knife Sharpener is the fastest selling home necessity ever offered.

Everyone a prospect. Sells for \$1.00, your profit 65c. Free deliveries. Guaranteed.

Morgan Mfg. Co., Dept. G, 443 S. Dearborn, Chicago

DOUBLE TIRE MILEAGE

PROTEX TIRE SAVER

Increases Tire Life 10,000 to 15,000 Miles

SEE FOR YOURSELF



Before Protexed



After Protexed

Protex is to an old tire casing what a gland operation is to an old man. It renews the vigor and youth of a tire, makes it go twice as far, last twice as long. Rubber is the toughest, most durable flexible material we know. It is practically impossible to wear it out. Tires do not wear out, they ROT. Protex forms a protective film that prevents rotting. Protex gives a perfect, sleek-looking, black gloss finish to tires that spruces up appearance of your car. Results are fully guaranteed. You must be thoroughly pleased, or your money will be refunded.

Fills Up Tiny Holes that Cause Trouble

Look through the magnifying glasses above. See for yourself what Protex does to a tire. It fills up all the cuts and crevices, fills up the pores where rotting has set in. Protex makes new tires out of old ones. Rubber tires rot because the rubber used in them is compounded with other chemicals that are affected by the free chemical elements in the air, in water, and those picked up from road surfaces. Protex prevents this rotting because it protects against these harmful chemicals.

Easy to Apply

It takes less than a half hour to apply Protex to tires. A few minutes spent monthly will save you a hundred dollars yearly. Full directions and all equipment are furnished with Protex. Nothing more to buy. All is easy. Do not have to be a scientist or mechanic to apply Protex. Anyone can do it.



COMPLETE TIRE RENEWER OUTFIT

SPECIAL INTRODUCTORY PRICE

Be My Agent



I will show you how you can make from \$100 to \$200 a week selling Protex Tire Saver to motorists. Other men are making even more. You cannot help but make money the Protex way. We show you how, give you full instructions that point the way to big money. Order a sample outfit using the coupon, and check second paragraph if you wish to become my personal representative.

A. G. HANSEN, Manager.

Regular price for the Protex Tire Saver is \$8.35. To quickly introduce this marvelous new discovery, we have made a special introductory price of \$3.65. This special price may be withdrawn at any time. Send your order for sample outfit now to insure that you get the special low price.

START NOW TO SAVE YOUR TIRE DOLLARS

Take advantage of our special offer, and start now to add years of service to your tires. Remember, if you are not completely satisfied, if you do not believe that Protex does everything we claim, you may return it and get your money back.

Protex is the result of years of scientific research by two of America's foremost chemists. It reinforces tire walls, binds casings together firmly, makes shabby old tires look like new, and protects them from rotting. There is nothing else like it on the market. Protex saves its costs 10 to 100 times over. Send for your outfit today.

SEND ONLY \$1⁰⁰

to pay packing and shipping expense. Pay for Protex products when delivered. Shipped express C.O.D., subject to your inspection. Or send money order in full if you wish, deducting 5 percent cash discount. Remember, your satisfaction is guaranteed or money refunded. Send for full details of our agent proposition. You make \$100 to \$200 weekly by the Protex plan. SEND COUPON TODAY!

PROTEX PRODUCTS, Dept. M, 100 W. Chicago Ave., Chicago, Ill.

PROTEX PRODUCTS, Dept. M, 100 West Chicago Avenue, CHICAGO, ILL.

Please send me one complete tire renewing outfit. I am enclosing \$1.00 to cover packing and shipping expense, and I will pay \$3.65 to expressman when it is delivered. It is understood that you ship subject to my inspection and that I am to be satisfied or you will return my money.

Please give me all details of your agent proposition.

Name _____
Address _____
City _____
State _____

WINDOW SIGNS



AGENTS—500% Profit Genuine Gold Leaf Letters GUARANTEED TO NEVER TARNISH

For Store Fronts, Office Windows, Bank Windows, Office Doors, Panels, Board Signs, Trucks, Automobiles and Glass Signs of all kinds. No experience necessary. Anyone can put them on and make money right from the start. All you have to do is to show your samples, the letters are very attractive and easy to sell. Letters costing 4c sell for 25c. One agent says: "Your letters are the best thing I have seen in years. I have made \$125.00 the first week and still going strong." Paul Clark says: "Smallest day \$28.70." H. Gilder made \$835.00 in six weeks.

\$60 to \$200 a Week—Now Is the Time

General Agents It is easy to appoint sub agents for this line. We pay you 20% cash commission on all orders we receive from local agents appointed by you anywhere. We allow you 50% discount on your own orders. You can sell to nearby trade or travel all over the country as you please. Large demand for window lettering everywhere. WRITE TODAY for free sample, full particulars and liberal offer to general agents.

METALLIC LETTER CO., 400-A, North Clark Street, CHICAGO, U. S. A.

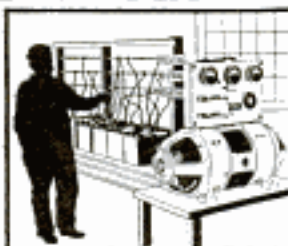

\$150 to \$300 MONTHLY PROFITS EASILY MADE WITH ONE DAY BATTERY CHARGING

Here's your **BIG CHANCE** to add \$1500 to \$3000 a year to your income. An HB One Day Battery Charger recharges auto and radio batteries in one day or less. Requires no expert attention. Thousands in use endorsed by leading battery makers. Just \$35 cash puts an HB One Day Battery Charging outfit in your shop, complete ready to operate. 30 days free trial on money back guarantee. Long easy terms on balance, more than paid by your big monthly battery charging profits. HB users everywhere making big money—you can, too. Write today for free bulletin.

HOBART BROS. CO. Box M425 TROY, OHIO

ONE DAY BATTERY CHARGING MAKES YOUR SHOP PAY FOR PROFITS

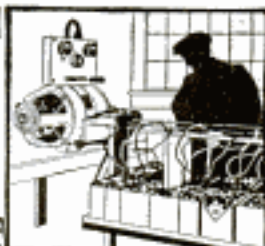

Write
today

MAKE
\$250.00
A WEEK

It's Easy!
It's Sure!

BEGIN NOW! A few dollars starts you making hundreds! "Krispy" Potato Chip Machine. Sure shot money maker. 80 CENTS OUT OF EVERY DOLLAR YOUR PROFIT. May sound impossible, but it's TRUE! Write us. We'll prove it to you. Time is precious. Don't let easy money escape you. Make "Krispy" Chips for 10 cents a pound. Sell for \$1.00 in 5c and 10c bags. Tremendous market. Your step up into money is at hand. Potato chips are the lunch of the hour. Everybody is eating them. One stand in small building sells \$100 worth in a week. Think of it! Grocers, druggists, pool rooms, cigar stands, tourist's counters, parks—all sell thousands of packages. Supply them. Get the big profits. Biggest little money maker you ever saw. Machine, simple, perfect, guaranteed. Chips easily, quickly made at home. No experience necessary. Sign and mail coupon now. Get in a big profit, fast going business now!

SERVICE & EQUIPMENT CO.

905 HOAG ST., TOLEDO, OHIO

Krispy Potato Chips
THE LUNCH OF THE HOUR EVERYBODY'S EATING THEM

21 Jewels Santa Fe Special Sold Direct

SAVE YOU MONEY

My sole aim during the year 1925 is to place as many standard, dependable watches, as I can, in the hands of men throughout the land, REGARDLESS OF PRICE OR PROFITS. To do this, I have cut the prices to ABSOLUTELY ROCK BOTTOM. I know that if I can distribute 5,000 "Santa Fe Specials" this year on this CUT-PROFIT PLAN, that every watch will sell another. I am making this STARTLING OFFER to those who will tell their friends of this remarkable watch value, if they find the watches all and more than I claim for them.

Alouys Thomas

Pres. Santa Fe Watch Co.

21 Perfect Ruby and Sapphire Jewels.
Adjusted to Positions. Adjusted to Temperature.
Adjusted to Isochronism. Adjusted to the Second.
25 Year Gold Strata Case.
Your Choice of Dials (Including Montgomery R. R. Dial).

New Thin Models. All Sizes.

Guaranteed to last a lifetime and give satisfactory service.

No Money Down—Sent on Approval

In addition to our Cut-Profit Special Offer, we will send this famous watch, express prepaid, for you to examine, to inspect, to admire, to approve without one penny advance payment. Examine the watch and be convinced it's the best watch buy you ever saw, just a small payment down, the balance in easy MONTHLY payments. You use the watch while paying for it.

Save $\frac{1}{3}$ to $\frac{1}{2}$ of Your Money

By purchasing this Famous Santa Fe Special Watch. Not only are you saving money from the present day prices of watches, but you can still secure the "Santa Fe Special" Watch at the same low prices and terms that have made our watches famous.

Ladies' Wrist Watches—The "New Elite"

This Artistic dependable Ladies' Wrist Watch, fitted with genuine Illinois Springfield movement. A perfect timepiece. Beautiful 14 Karat white or green solid gold cases. Ask for New Watch Book showing New Cases in all the new shapes and designs. Watch sent on approval and sold on payments.

Send for Free Watch Book

Clip the coupon, fill out and receive the FREE WATCH BOOK. All the newest watch case designs in white or green gold, fancy shapes and thin models are shown. Read our easy payment offer. Wear the watch 30 days FREE. Watch sent for your examination and approval without a penny down. Nothing to risk. See the watch before you buy. Write for FREE Book Today and Select Your Watch—Mail Coupon.

SANTA FE WATCH COMPANY

46 Thomas Building TOPEKA, KANSAS
The Home of the Great Santa Fe Railway

SANTA FE WATCH CO.

46 Thomas Bldg.
Topeka, Kan.

Please send prepaid and without obligation your Watch Book Free, explaining your "No Money Down" Offer on the Santa Fe Special Watch.

Name.....

Address.....

State.....



The greatest Evinrude ever built—and that means the world's finest outboard motor. Not built for speed alone, for power alone, nor just for lightness. Created, instead, to perfectly combine these three ideals. A revelation in eager power and smooth speed; an achievement in handy operation—quick to start, reverses instantly, easily set for slow trolling or racing speed to and from the fishing grounds. Light weight, too—yet not at a single sacrifice of strength.

The key to new pleasures in Vacationland—the new Evinrude Sport Twin. A true "1925 Champion"—named so because it is.

Automatic Instantaneous Reverse. Exclusive Evinrude feature. Just a lift of the tiller sends your boat astern. You don't take your eyes off the course ahead—you don't swing the motor even a fraction of an inch—you don't have to stop it and crank it backwards.

Automatic Tilt-Up. Another exclusive Sport Twin feature. When the propeller strikes an obstruction the motor tilts automatically—snubbing the shock and preventing damage to the boat, motor or propeller. *Yet motor locks rigid for starting.* No wobbling—no side-sway—just a straight line pull on the Easy-Starter and away you go.

Five more exclusive and "Champion" features—Super-Power Magneto, Power-Focus Drive, No-Clog Pump, Easy Portability and Auto-type Carburetor.

Write for copy of new 1925 "Evinrude Year Book." Know why more Evinrudes are in use than all other makes combined.

EVINRUDE MOTOR COMPANY
328 Evinrude Building, Milwaukee, Wisconsin

The New 1925 Champion
EVINRUDE
Sport Twin

Use RayCoils for Results

Designed to give Volume, Distance, Clear Reception and Selective Tuning. Five Continental Stations heard during the test week.

RayCoils "A" for the Reinartz Circuit . . . **\$2.50 Each**

RayCoils "D" for Radio Frequency Circuits . . . **\$2.00 Each**

Blue Print Diagram with all Coils

Write for Folder showing how to improve your set

Manufactured by

R. C. SCHOONHOVEN, Major Q. M. R. C.
306 Seneca Street ELGIN, ILL.



AT LAST! DIAMOND RIVAL DISCOVERED

Amazing blue white RAJAH GEM astounds jewelry world! Deceives experts! Beautiful Sample Case FREE!

AGENTS!

\$100.00 weekly introducing these beautiful stones! Greatest all-the-year proposition ever offered salesmen and agents! No room to tell our story here! Write Quick!

RAJAH CO., Inc.
Dept. 70, Salisbury, N. C.

FOR YOU
\$2000 to \$5000
Extra Annual Income
No competition
This Change-Ad Clock in your town can earn it.
No Experience Needed

A few hundred dollars and a little spare time effort means \$40 to \$100 weekly profit in your own exclusive advertising business. Needn't interfere with present occupation. Territory closing fast. Write today.
KEI-LAC COMPANY, 314 N. 19th St., St. Louis, Mo.

AGENTS—\$1000 a Day Up

And just as much more as you want. Exclusive territories are now being allotted, so if you want to represent a good, fast, easy seller (it's going like wild fire), get a post card off to us right now and we will send you full information. Be the first in your territory to secure this valuable, exclusive, money-making agency. Many of our agents are making from \$20 to \$35 a day. Hurry your name for particulars before it is too late.
SPAD Manufacturing Co., Dept. 100, 215 W. 40th St., New York, N. Y.

SAW FILING PAYS

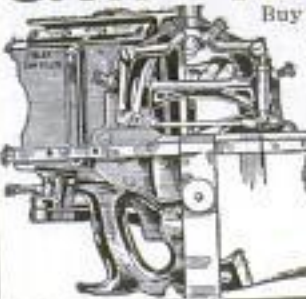

Buy a Foley Automatic Saw Filer and Setter and establish an independent, profitable business.

Mr. W. J. Adams, Colesburg, Pa., writes: "Received your Saw Filer in good shape and it works perfectly. Enclosed is my check for two more machines that I just sold; please rush them, as they are needed badly."

Prices and catalog on request. Territory open to interested parties.

FOLEY SAW TOOL CO.
914 E. Lake St. Minneapolis, Minn.

Handbook for Farmers

861 discoveries by practical farmers, telling how to make, repair or improve the various devices and machines used about a farm or garden. 683 illustrations. "The Most Remarkable Book Ever Published for Farmers," says one authority. **Send No Money.** When the postman delivers the book to you, hand him \$1 plus the few cents postage.

POPULAR MECHANICS PRESS
Popular Mechanics Building, Room 711, Chicago, Ill.

UTAH

Made In Salt Lake City

\$25⁰⁰

Phono-Speaker \$10.00

GUARANTEE

Buy a UTAH and use it for two weeks. Compare its tone with the best others are able to produce. If the UTAH does not give at least 50% better reception, return it to your dealer and he will cheerfully refund your money.

SPECIAL!!

The Utah is particularly suited as a perfect companion for Popular Mechanics Superheterodyne Eight.



- here make your own test at no risk

Try the Utah in your own home—in your own way. Compare it with any loud speaker regardless of price, make or name. Note how clearly the UTAH preserves the overtones and delicate tonal shadings with all of the beauty of the original.

Consider the absence of the rasping howl of nearby stations, while DX comes in full toned and colorful. When you have made this test you will know why the UTAH has attained leadership among all loud speakers. You will realize how such a liberal, prove-it-to-yourself guarantee can be offered and lived up to.

Go to any Utah dealer and arrange to make this test. If there is none near you mail us the coupon and \$25 and we will send you a Utah—all charges prepaid.

Don't wait. Get a Utah at once.—It will reveal new delights which your radio has so far concealed.

TEST COUPON

UTAH Radio Products Co.
Dept. 504
Chicago, Illinois

Name

Address

If your dealer cannot supply you, send us \$25 and we will send a Utah under our money refund guarantee.

UTAH Radio Products Co.
Dept. 504, 1427 Michigan Ave., Chicago

\$1250.00 Month for a Man in Your Community



READ—don't stop until you finish—then act. Get **exclusive rights** in your community for making "Tater-Flakes" Then start in this new dignified business. Retail and wholesale at big profits. You can be enthusiastic over this business.

You be the "Tater-Flakes" man in your locality. Send for details.

Earnings Amazing

\$1250.00 monthly is conservative estimate. Many exceed that amount. Ranson, Ill., takes in **\$1000 weekly**. Nuestr, Ill., runs around **\$850 weekly**. Gass, Pa., averages **\$100 daily**. All in small towns. Brook's Chicago store with high rent approximates **\$700 clear profit month**. This "Tater-Flake" business succeeds everywhere. Machine works automatic. **No experience needed.**

So simple boy or girl can operate. Feeds, slices, cooks and delivers mechanically. Produces wonderful potato chips. Makes crisp, golden-brown flakes supreme in flavor and superior in quality.

Wholesale and Retail

Field for "Tater-Flakes" practically unlimited. **Market tremendous.** Retail to thousands over your counter. Wholesale to hundreds of stores. **Big profits both ways.** Hustlers make sensational money. One hour's capacity of "Tater-Flakes" machine brings in **\$25.** Cost of operation and materials only **\$6.**

Exclusive Rights

Write or wire for **15-day option** on your community. We protect your territory while you investigate. Option blank and full particulars forwarded by return mail. Rights being snapped up fast. **Act quickly.** Write or wire.

The Tater-Flakes Company, Inc.
Dept. 414
20 E. Jackson Blvd., Chicago, Ill.



KING

Band Instruments

WHETHER you are just learning to play or are a finished musician you will find "King" Saxophones, Trumpets, Trombones and Horns, easier to play than any other make.

Every "King" Instrument has the latest improvements—is built by experts and is laboratory-tested before being shipped. Every "King" is fully guaranteed.

It is easy to own a "King" Instrument. They are sent on trial and sold on easy payments.

"King" Band Instruments and Saxophones are fully described in beautifully illustrated catalogs. Send for free copy.

Write for list of bargains in rebuilt instruments.

THE H. N. WHITE CO.
5211-62 Superior Avenue, Cleveland, Ohio
Please send me free, your latest catalog on

..... Instrument.
Name ..
Address ..
City .. State ..

Make
**BIG
PAY**

SELLING SHIRTS

\$20 a Day Easy!

That's the average of our men selling elegant, individual, distinctive, tailored shirts. Exclusive patterns. "Tailored on Honor to Honor Their Maker." Direct from our large, airy mills to wearers. Out of ordinary values. Tremendous demand. Big repeat business. We deliver for you. Not sold in stores. No capital or experience required. Write

J. W. HEITJAN, Gen. Mgr., CHICAGO SHIRT COMPANY
114 Chicago Shirt Building, Chicago, Ill.

Tires Can't Stick to Rims

J. B. S. Rim Compound prevents tire from adhering to rim—overcomes creeping of tire—eliminates rim-cutting. Makes both tires and tubes last longer. With J. B. S. Compound on the rim you can remove a tire 6 months or a year later as easily as the day you put it on—and without damage to tire. Get J. B. S. Rim Compound and stop "cussing" when removing tires. Also a rust preventer. Use it on bolts, brake rod couplings, radiator cap, body and fender dents where enamel gets knocked off. Carry in car. Two years' supply, \$1.00, postpaid. Money back if not satisfied. Circular free.

J. B. SCOTT MFG. Co., Freeport, Ill.

RADIO CATALOG AND HOOK-UPS FREE

Our great new catalog, fresh from the press, contains the very newest in complete sets, parts and accessories—hundreds of amazing bargains. **250,000** customers testify to our wonderful values and reliability. Complete instructions with diagrams for making most practical popular sets **FREE.** **SEND QUICK** for your copy. (Please include name of friend who is interested in Radio.)

THE BARAWIK CO.
Dept. 302 32-40 So. Clinton Street

Chicago

THE LARGEST RADIO STORES IN AMERICA

Hookups!

All the latest and best "Kits" in our new

RADIO CATALOG



JUST OUT! Our new 1925, ninety-six page Radio Catalog showing all the best and latest Kits, Parts and Accessories. Also includes our new 32 page bargain section—Write for your **FREE** copy today.

An Unequaled "Kit" Service

All parts for each "KIT" have been carefully selected and tested by our staff of graduate Radio Engineers—satisfactory results are guaranteed.

Completely drilled and engraved panel included with each "KIT." Makes set building easy and sure. No other concern gives this **FREE** service.

Easy to understand **Instruction Book** and **Blue-Prints** included with each Outfit. No technical knowledge required to build your radio set.

Save Money On GUARANTEED APPARATUS

We buy up manufacturers' jobber, and dealer surplus and bankrupt stocks—but only brand new fully guaranteed, nationally advertised apparatus. Our enormous buying power permits us to pay spot cash and get rock-bottom prices—even way below manufacturer's cost. That's why our catalog is crammed with thousands of wonderful Radio Bargains.

**Dealers!
Jobbers!
Manufacturers!**
ATTENTION!

We will pay you spot cash for your surplus stocks—brand-new apparatus only! Write and tell us what you have.



Remember our motto: **Salvage means—
SAVE, SERVICE, SATISFACTION**

RADIO CHICAGO SALVAGE STOCK STORES
509 S. State Street, Dept. P. M. 6, Chicago
Write for your **FREE** copy of our new catalog today—just your name and address on a post-card will do. Please add the names of any of your friends interested in Radio.

Only \$10_{Down} Buys

This Fully Guaranteed Used Burroughs Adding Machine

Balance in
easy
Payments

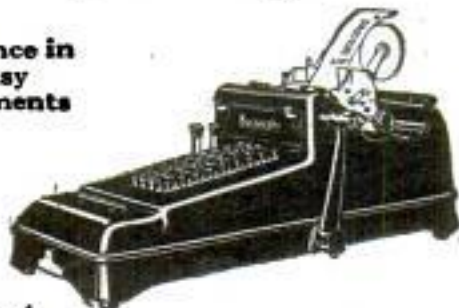

This is a standard Burroughs Machine used in banks, offices and stores everywhere. It has been completely overhauled and worn parts replaced. It is guaranteed for the same period as a new machine.

Take advantage of this remarkable offer today—pay only \$10 down and let the machine pay its way in your business. Total cash price only \$100.

Mail
This
Today

Other styles and sizes in leading makes of figuring machines.

General Adding Machine Exchange
6827 Second Blvd., Detroit, Michigan

Please send me information about this special guaranteed Burroughs Adding Machine.

Name _____

Business _____

Address _____

Exceptional Values

The Finest line of small Gasoline and Steam Engines on the American market. 1/10 H. P. to 10 H. P. Catalogue free.

Dynamic Manufacturing Co.
First National Bank Building
Dept. 4 CHICAGO



BUILDERS' HARDWARE—1/2 PRICE

Write for our Net Price Builders Hardware Catalog

PAUL J. DEVITT 1101-1107 S. 2nd St. PHILADELPHIA, PA.

QUICK, ACCURATE SAWING done with the CLEAN-CUT BENCH SAW

A glance is all that is necessary to convince you of the large range of usefulness this machine covers. **SPECIFICATIONS:** Weight 110 lbs., saw size 8", table 16x16, base 13x14, table height 8", sanding disk 9" dia., saw shaft 1/2" dia., running on ball bearings, idler pulley with spring tension, a permanent fixture on base, table is hinged for cutting grooves, tenons, and rabbets. Guides and sanding disk removable and adjustable for cutoff, rip, and miters. **MOTOR:** High grade 1/2 h. p., 110 V., 60 cycles, 1750 R. P. M., current A. C., guaranteed 20% overload. Our bulletin No. 12 will give you complete information. May we send it? **NORTH SHORE MACHINE WORKS**
1135-41 Catalpa Avenue CHICAGO, ILL.



All Parts for Popular Mechanics Superheterodyne 8

Be sure to use only tested and approved parts—in constructing this set. Certainty of success depends upon the use of standard parts, tested and specified by Popular Mechanics. Remember, the more powerful the set, the more sensitive it is. Don't take chances with unproven parts; get the standard and tried ones. It pays!

Absolutely Guaranteed

We guarantee that each and every part shipped will be exact ones ordered. No substitution in any case.

Special Discount to Superheterodyne Builders

Save money by getting our special discount from regular prices. Write for our prices and see the difference.

Every Standard Set, Kit and Part

Our extensive stock can supply you with any standard set, kit, battery, loud speaker, tube, or any article known in radio. And we can supply them to you at less than regular prices. Write to us for any nationally advertised radio set or part and you will be sure of getting it. All our radio supplies are guaranteed to be genuine—all can be had at less than regular prices.

Write for Our Special Prices Today

RELIABLE RADIO RETAILERS

128-A S. Clark St.

Chicago, Ill.

YOU CAN USE BALLOON TIRES

And Drive WITHOUT EFFORT

If You Install SUPERIOR C P C

Only \$16.50

(West \$17.50)



Write for Agency Plan Good Line for Specialty Men Calling on Garage Trade.

A REAL STEERING GEAR FOR FORDS

Notice worm cut right in LOWER END OF MAIN SHAFT. THIS SOLID BAR OF STEEL EXTENDS RIGHT THRU TO THE STEERING WHEEL.

C. P. C. PRODUCTS COMPANY

1934 Ferry Park

Detroit, Mich.

THE BUSINESS SAXOPHONIST—

20 lessons by J. Beach Cragun, teach you the "tricks of the trade" which have made the great professional players earn \$20,000 to \$75,000 a year. \$1.00 with order, \$9.00 C. O. D. Total \$10.00. Money Back if not satisfied.

FINDER & URBANEK, 1322 W. Congress St., Dep. 301-4, Chicago

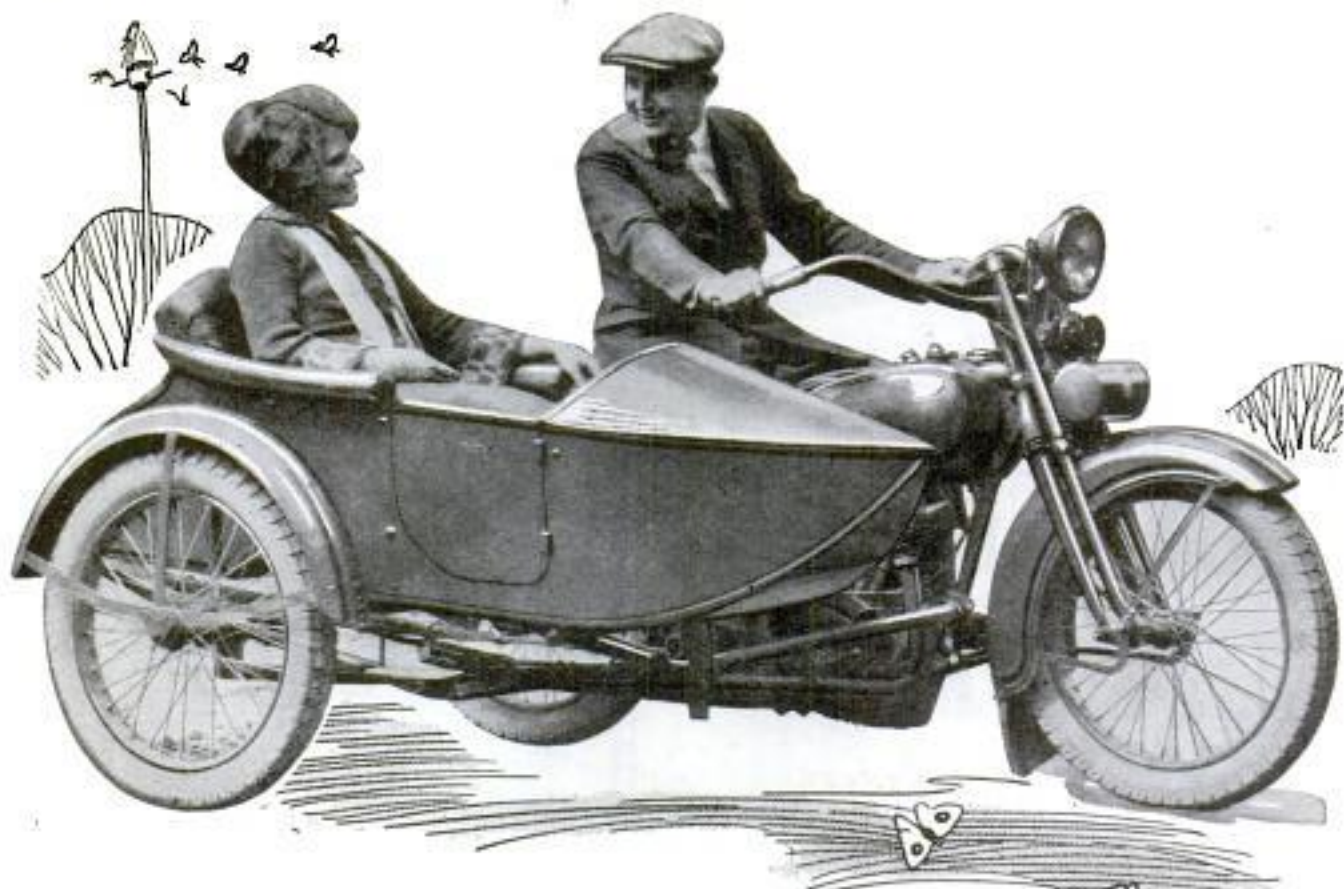

Where'll We Go?

Head for pleasure land with the 1925 Harley-Davidson "Stream-Line." Go anywhere—get away from the dust and bother of crowded highways—follow side roads and by-paths—enjoy Spring! New 1925 "Stream-Line" model—27 big improvements that mean new speed—new comfort—new economy (50 miles for a dollar—gas, tires and all)—and *new low prices!*

See your Harley-Davidson dealer. He will give you a free demonstration ride entirely without obligation. He will point out the features that make this the motorcycle you want. *Send the coupon for free, beautifully illustrated booklet showing the new Harley-Davidsons in full colors.*

Just a small down-payment and you begin riding your Harley-Davidson. Ask the dealer about the easy terms of his Pay-as-You-Ride plan.



See our other ad in this issue (page 134) about big business opportunities selling Harley-Davidsons.

Harley-Davidson

The Motorcycle



It's Easy to Get a
Harley-Davidson

Harley-Davidson Motor Co., Dept. P, Milwaukee, Wis.

Send me free literature showing the new "Stream-Line" Harley-Davidson in actual colors.

Name.....

Address.....

City.....

The TOSTWICH is the most delicious sandwich ever made



One of the sixty beautiful Mac Diarmid's stores in Michigan and Ohio.



Salesmen

An attractive proposition to experienced high-grade salesmen. You get full cooperation from us and our distributors. Leads furnished promptly. Every sale brings another in an endless chain of enthusiastic customers.

Distributors

Some desirable territory is open to active, responsible concerns or individuals on an exclusive distributor's contract.

Here is the amazing sensation in fast, repeat-selling, appetizing food. The minute you taste a TOSTWICH you will know why. You will want another and another and then come back day after day for more. Why? Because you never ate anything so thoroughly good and satisfying. There is nothing like the TOSTWICH. Both the TOSTWICH process and name are fully protected. This is a new process. It improves sandwiches, America's favorite food—fully 100%, and it is remarkable but true that the cost is actually less. A TOSTWICH is a toasted sandwich (not a sandwich made of toast). You can use any kind of filling—meat, jam, cheese, salad, peanut butter, etc.—all taste 100% better in a TOSTWICH.

Doubles the Profits in Your Store

The TOSTWICH brings tremendous profits and increased sales wherever installed. Hundreds of letters from all over the country prove this fact. The first day you put a TOSTWICH machine on your soda fountain counter, your sales will increase tremendously—regardless of whether you now sell lunch or not. Everyone likes the TOSTWICH. The daintiest boulevard restaurants, soda fountains everywhere, lunch rooms, billiard halls, roadside stands—all sell TOSTWICHES by the thousands. THE TOSTWICH brings new customers to your store and they keep coming. It's the greatest advertising feature of the day. It brings you big profits and helps sell your other merchandise. The TOSTWICH can easily double the entire profits of your store as it is doing for others. It's a complete lunch department and yet it occupies only three feet of counter or floor space. The first TOSTWICH in your locality will clean up enormous extra profits.

Make \$3,000.00 to \$15,000.00 Per Year WITH A TOSTWICH SHOP

Anyone can start a TOSTWICH SHOP and make money. The profits will simply amaze you if you get an unusually good location near a school, on a busy street, a well traveled automobile highway, or a pleasure resort. The price of the TOSTWICH machine and outfit is very reasonable. Easy terms are made to all responsible people. We supply everything complete, including posters, advertising material, etc. All you need is bread, butter and the kinds of filling your customers prefer. The machine operates on an ordinary electric light socket. It is brilliantly illuminated and has a large, electric-flash, globe sign that attracts the customers. A TOSTWICH SHOP makes more money than a store in which ten to twenty times as much is invested. Your machine pays for itself in no time and gives you a steady income all-the-year-round.

A Big Advantage to Those Who Start Now

Hundreds of TOSTWICH machines are now making large incomes for their owners. The TOSTWICH will eventually be one of the most widely used food articles in America. You are very fortunate if it has not yet been introduced in your locality. Passes prices and a gold mine in profits come to the first TOSTWICH store in every city or locality. Send for our complete TOSTWICH proposition at once. This is an unusual opportunity. Full information given without any obligation to you. Write today.

Address the Office Which Covers Your Location

THE TOSTWICH CORPORATION

EASTERN OFFICE
19 W. 44th St., New York City
(For New England States, Eastern N. Y., N. J., and Eastern Pa.)

WESTERN OFFICE
646 N. Michigan Ave., Chicago
(For all states not covered by Eastern office and Western Pa. and Western N. Y.)

Fill out coupon or pin to your letterhead

Tostwich Corp. Send me complete TOSTWICH proposition without obligation to me.
Name.....
Address.....
City..... State.....

A Real OPPORTUNITY

Agents-Salesmen-Distributors

WANTED To use and introduce attachment that makes Fords run on 94% air. THERMOSTAT on exhaust automatically turns needle valve on carbureter up and down as engine warms and cools, exactly as Ford Manual says do by hand.

BLANCKE THERMOSTATIC CARBURETER

CONTROL increases mileage on your Ford Car and Truck 50% to 100%. Makes Fords start easier, winter or summer — eliminates carbon formation — prevents dilution crankcase oil — greatly reduces repair bills. Motor runs smoother — makes overheating impossible. Faster acceleration. Lower speeds possible in high gear.

Easily and
Quickly
Installed

**BLANCKE THERMOSTATIC
CARBURETER CONTROL**
AN AUTOMATIC CARBURETER CONTROL
for FORD CARS and TRUCKS



Thousands in Use

Sells on sight to every Ford owner as easily as giving him \$100 bill, because it saves \$100 every 10,000 miles. Saves its cost (\$5.00) in gas and oil within 30 days. This way the Control actually costs the buyer nothing. After this the Blancke Control saves \$5.00 in gas and oil every 500 miles. Sold on 30 Days' Trial.

Blancke Plan Starts You Without Capital

You can make Big Money selling this wonderful proven device. Experience not necessary. Our plan starts you without capital in a business of your own that makes you from \$250 to \$2000 a month profit. Write for free circulars and our fast money-making proposition NOW.

A. C. BLANCKE & CO., Dept. 1164, 602 W. Lake St., Chicago, Ill.

Cadillac
now uses as
standard
equipment
Thermostatic
Carbureter
Control
under
Blancke
license



WE WANT AGENTS AT \$75 TO \$100 A WEEK

New Invention—Sensation of 1925. Just out. Every car owner buys on sight. "FIXIT" Rubber Repair for tires and tubes. Vulcanizes without heat or tools. Seals punctures and blowouts. Saves tire repair bills, increases mileage on castings.

FREE OFFER Retail price \$1.00 per can. Send us \$1.00 today and get TWO cans and exclusive territory offer. Sell one to a neighbor and get yours FREE. Act Quick. Circulars sent on request.

MARQUETTE RUBBER COMPANY
2923-2327 Wolfram St. Dept. P CHICAGO, ILL.

MODELS AS LOW AS \$2750 SPEED BODIES for FORDS

\$2750



Add class to your Ford with a snappy "sassy" speed body. Best body bargains on market. Write for fully illustrated catalog showing different models and all Ford accessories.

PARTS-A-FORD CO. 4414 S. Michigan Ave. CHICAGO, ILLINOIS



\$150 to \$300 PROFIT MONTHLY FROM HB ONE DAY BATTERY CHARGING

Be Independent! Own your own moneymaking battery charging business and add \$150 to \$300 every month to your income. Thousands of HB owners with no previous experience now own the big battery service station of their city. You can do it, too. Only \$35 cash brings a complete HB One Day Battery Charging Outfit, ready to use. Your monthly profits easily carry the small monthly payments. 30 days free trial on money-back guarantee. The best and lowest-priced complete outfit on the market. Write for free bulletin. Start your own money-making business.

HOBART BROS. CO. Box M4 TROY, OHIO

MORE HB ONE DAY BATTERY CHARGERS ARE IN USE THAN ANY OTHER MAKE

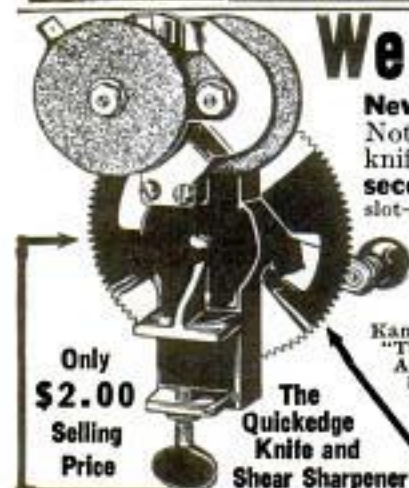

We Want Agents at \$50 to \$90 a Week

New Invention—Just Out. Needed in every home every day. Patented. Nothing else like it. Low priced—Sells on sight. Sharpens any kitchen knife, paring knife, carving knife, bread knife, or shears and scissors in ten seconds. Mechanical masterpiece. A child can use it. Just put knife in slot—turn crank—sharpens both sides at once automatically. We want representatives at once—men and women hustlers. Get this position where profits start first day.

No Experience Necessary—200% Profit

Make as much money next week as these men are making now. J. C. Lewis, of Kansas, says: "I have sold one hundred sharpeners in four days." Hobart Kerr, of Md., writes: "The women can hardly wait till they get them." Herbert Cain, of Ky., sold nine after supper. At the end of the first day, J. W. Gordon, of Pa., writes: "I sold two dozen and I sold to everyone I saw." Wm. G. Hall, of N. J., says: "I think it is great. I sold six in about one-half hour. The machine is a mighty fine proposition. I am a mechanic and I know what I am talking about." You can make this money. WRITE TODAY. TERRITORY FREE. Get busy at once.

QUICKEDGE SHARPENER CO. 104 Sharpener Building JACKSON, MICH.



Big
Radio
Book

Send
For it
At Once

Send For This Sensational Radio Bargain Book-FREE

Order Direct from This Page! Save About One-Half!

Compare our prices with others. Only highest grade nationally known GUARANTEED parts. OUR GUARANTEE PROTECTS YOU. Money cheerfully refunded if you are not satisfied. Be sure to write your order and state prices plainly. Send post office or express money order or bank draft for total amount to insure prompt shipment. ALL PRICES ON THIS PAGE INCLUDE SHIPPING CHARGES RIGHT TO YOUR DOOR. Refer to any bank or commercial agency regarding our reliability. If your favorite circuit is shown here, order direct from this ad. No skill required to build your own radio with Randolph parts. Panels are all drilled. Instructions are simple and complete. Everything comes ready to assemble. Order direct! All shipping charges prepaid.

THIS 5-TUBE SET, \$39.50

FULLY BUILT AND WIRED COMPLETE IN DARK HEAVY-MAGNIFICENT CABINET OF BEAUTIFUL DESIGN

The Biggest 5-Tube Value on the Market

which will bring in all distant stations on the loud speaker in clear loud tones. A value of three times the price. Shipped on a guarantee of satisfaction or money back. A wonder set constructed on the new principle that requires no neutralizers and is self-balanced. Special features are low-loss coils, engraved bakelite panel, distortionless transformers and pure bakelite sockets. Wiring of the latest safety type. Perfect logging of stations. The set alone, shipped prepaid, is



\$39.50

This Set with All Accessories, Including American Bell Loud Speaker, with

adjustable unit, 5 R. C. A. UV201-A Tubes, 2 45-volt "B" batteries, 1 6-volt 90 amp. hour storage battery, complete antenna equipment, including approved lightning arrester, shipped prepaid, east of the Rocky Mountains.....

\$81.30

Genuine Radio Corporation Tubes UV201-A	\$ 3.55
UV199, WD12 or WD11	12.95
Home Charger, 6-volt	.95
Soldering Iron	.19
Solderall Tube	.35
Approved Lightning Arrester	1.59
Cockaday Coils	.59
Balancing Condensers, per pair	1.95
Harkness Coils, per set	.44
Hydrometer, Best Quality	.89
Battery Meters, 0 to 50 vlt.	\$20.95
Magnavox, M4, Loud Speaker	19.95
Baldwin Loud Speaker	8.45
Branded Table Talker	21.95
Atlas Loud Speaker	.89
Multiple Four Phases Plug	.24
Two Phase Plug	2.59
Complete Antenna Outfit, including Lightning Arrester	3.25
Bakelite Molded Variometer	
Low Loss Condensers:	
11-plate	\$1.25
24-plate	2.05
44-plate	2.85
Bakelite Rheostats:	
6-ohm	0.35
30-ohm	.38
Apperites:	
For all tubes	\$0.94
Bakelite Dials:	
2-inch	\$0.26
3-inch	.35
4-inch	.48
Composition Dials:	
2-inch	\$0.13
3-inch	.17
4-inch	.29
Accurate Dials	3.14
Audio Transformers	
Theodores:	
3 1/2 to 1	\$3.25
6 to 1	3.65
Arms	3.95
Columbia:	
3 1/2 to 1	\$3.79
6 to 1	3.89
American Bell:	
3 1/2 to 1	\$2.45
6 to 1	2.79
Randolph Specials:	
3 1/2 to 1	\$1.89
6 to 1	2.16
Randolph Specials:	
Headphones	\$2.24

COMPLETE PARTS FOR
ACME 1-TUBE REFLEX \$17.45
ACME 4-TUBE REFLEX 39.85

with Genuine Arma parts as specified, drilled bakelite panel and full wiring diagram.

COMPLETE PARTS FOR
REINARTZ
1-TUBE REIN-ARTZ SET \$10.45
3-TUBE REIN-ARTZ SET 17.55

COMPLETE PARTS FOR
2-TUBE HARKNESS SET
including Licensed Harkness Coils, Drilled Panel and wiring diagram. Easy to build. Wonderful results..... \$16.95

Our GUARANTEE

Every article exactly as represented. Every article is tested before shipping. Complete satisfaction guaranteed or money will be cheerfully refunded.



COMPLETE PARTS FOR 3 AND 5-TUBE NEUTRODYNE RECEIVING SET
Genuine Hazeltine Licensed Neutrodyne Parts Furnished.

PARTS FOR 5-TUBE SET

1 7x24x1/4 Drilled Panel	1 .001 Condenser
2 Thordarson or Columbia Audio Transformers	1 .006 Mica Condenser
3 4" Bakelite Dials	35 feet Hook-up Wire
2 Precision Jacks	1 Kit consisting of 3 Hazeltine Licensed Neutrodyne Transformers and 2 Neutrodons
1 Bakelite Rheostat, 30 ohm	1 Baseboard
1 Bakelite Rheostat, 6 ohm	3 Bezels
1 Bakelite Binding Post Strip	Complete blue-prints and working diagrams.
7 Marked Binding Posts	
1 Grid Leak and Condenser	
5 Bakelite Sockets	

\$33.45

Easy to build your own radio set. All complete parts for sets consist of standard advertised guaranteed parts and include drilled bakelite panels and wiring diagrams for easy set construction. Everything guaranteed on money-back basis. All transportation charges paid.

FREE — BIG MONEY SAVING RADIO CATALOG containing a thousand bargains of everything on radio—parts, supplies, complete parts for sets, complete sets, etc., also a mine of very latest information on all different circuits, complete list of broadcasting stations, and other valuable, up-to-the-minute radio data. Send your name and address on a card or letter. We will send catalog free.

FREE Service Department
Our radio engineers will help you solve all your radio problems, and furnish up-to-date information on set construction, operation and improvement. This service is free to our customers.

Complete Parts
Cockaday Receiving Set

1-Tube Set \$10.10
3-Tube Set \$18.55
5-Tube Improved Cockaday Receiving Set .. \$39.65



COMPLETE PARTS SUPER-HETERODYNE FOR 5-TUBE

2 23-Plate Bremer-Tully or Duplex Low Loss Condensers	1 .006 Mica Condenser
3 Remier or Columbia Intermediate Frequency Transformers	1 .0005 Mica Condenser and 2 megohm Grid Leak
1 Remier or Columbia Tuned Circuit Transformer	3 .0025 Mica Condensers
1 Special Oscillator Coupler	10 Binding Posts
1 Midget Condenser	1 .00025 Mica Condenser
8 Bakelite Sockets	1 Bakelite Terminal Strip for Binding Posts
2 Thordarson or Columbia A. F. Transformers	1 Multicoed cable for connecting batteries
1 Connecticut Filament Switch	1 7x30x1/4 Drilled Bakelite Panel
2 Bakelite 6-ohm Rheostats	1 Baseboard
1 Bakelite 30-ohm Potentiometer, 400 ohms	35 ft. Hook-up Wire
1 Carter Double Circuit Jack	2 4 in. Bakelite Dials
1 Dubilier 1 mfd. Condenser	2 4 1/2 volt C Batteries

\$52.75

RANDOLPH RADIO CORPORATION
159 N. Union Ave. Dept. 439 Chicago, Illinois

CROSLEY 1 TUBE-50

\$14⁵⁰



*The Little
Giant of Radio
Coast to Coast Reception
with phones frequently
reported.*

This Little Giant of Radio, the Crosley one tube 50, has everywhere astounded people with the distant stations that it brings in, on ear phones of course. All parts of the United States report European stations were heard with it during international test week. It is the radio with which Leonard Weeks of Minot, N. D., kept in constant touch with the MacMillan expedition at the North Pole. All other makes of receivers failed. For true radio value, it is excelled

Prices quoted are without accessories.

only by the other larger Crosley Radios. Stations may be easily logged and always located at the same place. For the beginner in radio, the Crosley 50 is ideal. For sale by good dealers everywhere. Other models priced from the two tube 51, at \$18.50 to the Trirdyn Special with sloping panel, at \$65. All Crosley Radios are licensed under Armstrong Regenerative U. S. Patent 1,113,149. Write for Catalog.

Prices West of Rockies—add 10%

THE CROSLEY RADIO CORPORATION

Powel Crosley, Jr., President

415 SASSAFRAS STREET

CINCINNATI, OHIO

Crosley owns and operates Broadcasting Station WLW

60 MILES ON A GALLON OF GASOLINE

TESTS SHOW FORD CAN RUN 60 MILES ON A GALLON

The amazing fact that a Ford can run 60 miles on 1 gallon of gasoline was recently brought to light through tests conducted by America's foremost engineers, where it was shown that a gallon of gasoline contains sufficient heat units which if properly atomized and mixed with air would give this additional mileage. Great strides have already been made in this direction by the recent invention of a simple attachment which can be installed in a few minutes without any alterations to the motor. It is common for Ford Owners to make from 40 to 44 miles per gallon after this marvelous device is attached.

MOST WONDERFUL INVENTION TODAY BRINGS JOY TO FORD OWNERS

Starts Ford Instantly

Starting a Ford Car in cold or zero weather is something every Ford Owner dreads—everybody realizes that difficult starting is an abuse on the starter and battery. Thousands of Ford Cars are "laid up" during the Winter just for these reasons. This great difficulty has been overcome. "The SUPER positively starts a Ford Car instantly in the coldest weather."

Marvelous Device

The SUPER is no trick affair—requires no mechanical adjustments and contains all the scientific principles of carburetors costing \$20 to \$35 and in its natural action uses up every particle of unused gasoline and breaks it up into a perfect vapor. The hitherto impossible is now realized by the SUPER.

Everybody Satisfied

Saves 3 to 7 Dollars Per Month

The best investment I ever made. The SUPER is saving me from three to seven dollars each month, besides putting new life into my motor.

A. H. WORRA, Iowa.

Makes 44 Miles Per Gallon

I have tried the SUPER and the results of the experiment are satisfactory. One quart of gasoline run my Ford 11 miles over improved roads which is just about again as far as I could run with the plain Ford Carburetor.

G. E. YODER, Penn.

Finds That Our Claims Are Correct

I find that your claims for increased mileage are correct and that a big saving is made by your SUPER. In fact, the best device I have met with in that line.

M. J. VAN LEEUWEN, Mass.



The Heart of the Motor

Eliminates Oil Pumping in Front Cylinder

What a wonderful relief to Mr. Ford Owner when he realizes that he can run his car without the motor pumping oil in the front cylinder. Sounds like an awful lot to expect of any device, but that is what the SUPER does and this is only one of its many advantages because it puts real efficiency into any Ford Car.

Complete Combustion

The SUPER is so designed that it takes advantage of the present Ford Carburetor and properly atomizes the light as well as the heavy elements of the fuel, converting every atom of gasoline and kerosene into power preventing liquid fuel from passing into the cylinders, thus avoiding carbon formation and oil dilution.

Easy to Sell

Sells Like Hot Cakes

This is a recent letter from one of our distributors: "Enclosed find draft for 200 more SUPERS, rush as I need them badly. I sold and banked \$104.00 in one day. Hope to sell 1000 SUPERS next month."

A. W. LEONARD, Penn.

Making Big Profits Every Noon

I have been working the SUPER at noon only. Yesterday noon I made more money with the SUPER than I did all my 11 hours' hard work in the factory all day.

J. L. LEHNER, Wis.

Had No Previous Selling Experience

This letter shows what ambition does: "I sold six SUPERS in less than 2 hours tonight. I think it's a pretty good start—for it's the first thing I ever sold."

E. MANGOLD, Ind.

\$60.00 TO \$150.00 PER WEEK EASY

You just can't help making Big Money selling the SUPER because a trial sells itself and soon everyone in the neighborhood get talking about this marvelous device. Men like Leonard, Shaw, Manner, Kinsley, Peters, Sands, Beck and Hall are not exceptional salesmen, but just the type of men that saw an opportunity and were quick to grasp it when within reach. No previous selling experience is necessary, just a little ambition on your part to make money is all we ask and we will extend the same opportunity to you. Spare time will pay you well. If you can devote your entire time so much the better, because the SUPER is a whirl-wind seller and takes hold in a locality like wildfire.

Men Wanted Everywhere To Introduce

We want distributors in all parts of the country to take orders and deliver the SUPER and to look after the repeat business that is bound to follow and to such distributors we are willing to assign territory. You do not have to own a Ford to take up this proposition but if you have a Ford it is easier to explain its many advantages. However a trial of the SUPER convinces the most doubtful person and tells a wonderful story.

A REAL FUTURE HERE

WEEKS SUPER CARBURETOR CO.
426-783 Eleventh St., Milwaukee, Wis.

MAIL TODAY
WEEKS SUPER CARBURETOR CO.
426-783 Eleventh Street, Milwaukee, Wis.
GENTLEMEN: Please mail me full free particulars about your wonderful invention.

Name

St. or R. F. D.

Town

County

State

How to Finish Furniture— New and Old

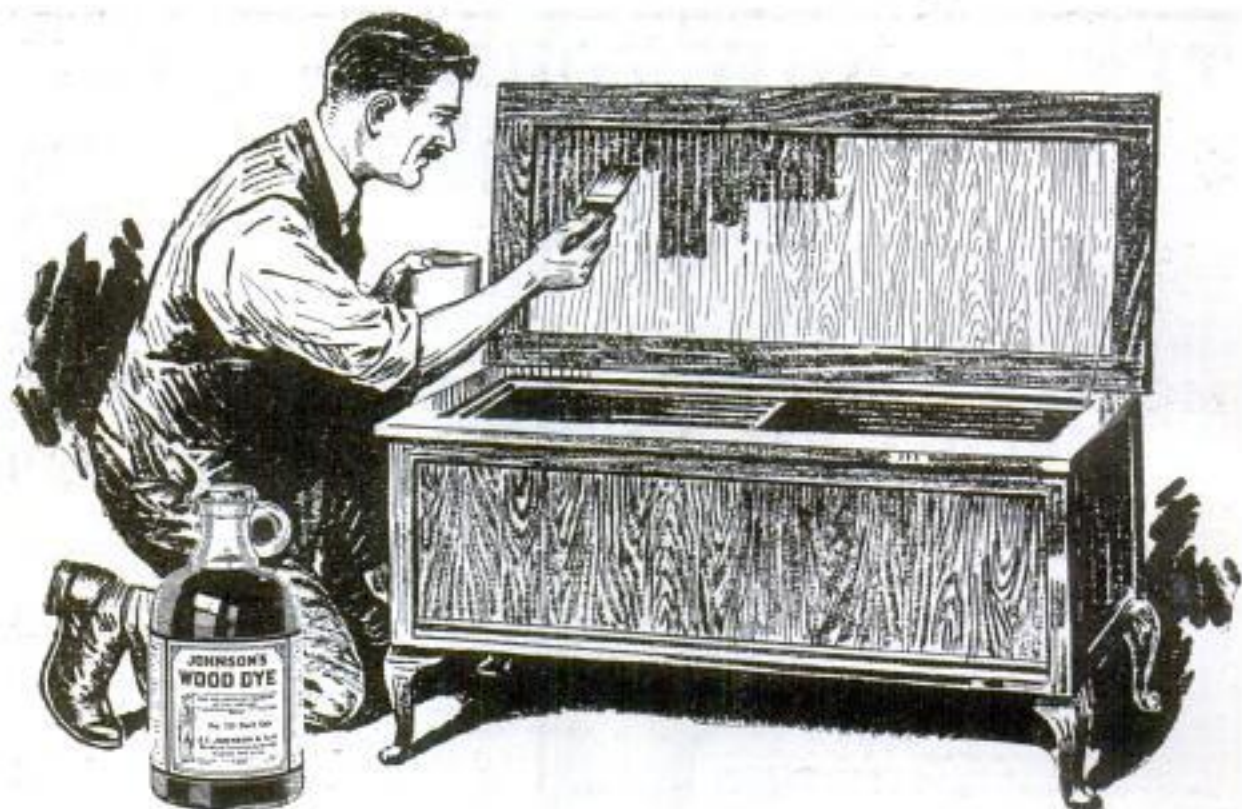

Johnson's Wood Dye

(PENETRATING)

If you have a hobby for making chests, cabinets, furniture, radio boxes, etc., you will find our book on Wood Finishing invaluable. For, naturally, you want to give your handiwork a beautiful finish. Our Book gives complete instructions for finishing new and old wood—soft or hard. It tells how to stain wood artistically—how to secure a beautiful enamel finish, etc.

Johnson's Wood Dye is for the artistic coloring of all wood. It is easy to apply—dries in four hours and will not rub off or smudge—penetrates deeply. Made in 17 beautiful shades, among the most popular of which are:

123—Dark Oak 131—Walnut
129—Dark Mahogany 126—Light Oak
127—Brown Mahogany 124—Golden Oak

Order Johnson's Wood Dye from your dealer by name and number.

FREE—25c BOOK ON WOOD FINISHING—



Ask for a FREE copy of the Johnson Book at stores displaying the sign shown at right. These stores carry Johnson's Artistic Wood Finishes and will be glad to show you wood panels—and answer questions on how to properly finish wood. If no store in your locality can supply the Johnson Book—mail this coupon for a FREE copy.

YOUR DEALER'S NAME.....
Your Name.....
Your Address.....
City and State.....

Mail to:
S. C. JOHNSON & SON, Dept. P.A.4, RACINE, WIS.
"The Wood Finishing Authorities" (Canadian Factory: Brantford)



SAVE HALF-INSTALL YOUR OWN PLUMBING AND HEATING BY OUR *New Easy Method*



Get This Big Book

Any Handy Man can install his own plumbing and heating by our new easy method and save half. During the last 50 years, we have saved our customers a hundreds of thousands of dollars in the cost of

Plumbing Goods
Pipeless & Warm
Air Furnaces
Steam Boilers
Hot Water Boilers
Water Supply Systems
Water Heaters
Bath Rm. Outfits
Pipes, Radiators
Valves & Supplies

You Save Half

BIG HANDY MAN BOOK

Tells the whole story. Shows the Hardin-Lavin New Easy Method. Send copy on with 25c (regular price 50c, refunded on first order) for your copy today. This Big, Instructive, Well-Bound "Handy Man" Book-Catalog shows 10,000 items in latest style, highest quality Plumbing and Heating Fixtures and supplies at Wholesale Prices.

A HUNDRED TRADE SECRETS

The "Handy Man" book catalog shows many valuable diagrams and plans and elevations of simple installing systems. Also trade secrets and money, time and labor saving links. No expense has been spared to make this book the most useful and valuable of its kind ever published. Send for your copy TODAY.

CHICAGO HIGHEST GRADE BATHROOM OUTFIT, COMPLETE \$59.95

Fixtures furnished with our Chicago bathroom outfit are built along practical and attractive lines, are perfect and of the highest-grade that it is possible to MAKE. Shows that FIRST quality Hardin-Lavin products can be had at low costs

White Enamelled Bathtub



Tub is cast iron, heavy white porcelain, enameled inside and over the 3 1/4 inch turned-over rolled rim; outside of tub is painted. This is our newest design having a pleasing appearance and is the highest-grade leg tub manufactured. Fitted complete with heavy brass nickel-plated compression bath faucet, with china indexed handles, nickel-plated heavy brass adjustable waste and overflow and supply pipes to floor; width 30 1/2 inches, length 4 1/2 or 5 feet, weight 300 pounds.

Chicago A-10—Bathtub complete as shown with iron-pipe connections. **Special \$31.10**

Chicago A-13—Bathroom Outfit, complete as shown and described. **Special \$59.95**

All shipped out of our Chicago plant same day order is received. Order today and save. You cannot see.

ASK FOR ESTIMATE—FREE—NO OBLIGATION

Send us a rough sketch of the arrangement of your rooms and we will figure the wholesale cost of your heating plant or plumbing system. We will show you many wrinkles where you can make savings that will surprise you. You get from us a simplified, cut-to-fit system that exactly meets your needs. You save waste, unnecessary material and expensive labor with free, easy, installing plans. Our Bonded Guaranty covers every purchase. Behind our Guaranty stands our million dollar plants and our record of 50 years' service to economy buyers.

Pipeless Furnace

MAIL THE COUPON TODAY! →

OUR BONDED GUARANTY and LABEL PROTECTS YOU

We guarantee that every watersupply system, plumbing outfit, heating plant or any article that you buy from us, from the smallest fitting to a complete installation, is perfect and exactly as shown and of the HIGHEST GRADE possible.



We further guarantee that if for any reason you are dissatisfied you can return any goods bought from us and we will immediately refund your money plus freight charges you have paid. *Could Anything Be Fairer!* (Signed) **HARDIN-LAVIN CO.**

HARDIN-LAVIN CO.

ESTABLISHED 1876

When in Chicago Visit Our New Plant at 107-17 West Pershing Rd., CHICAGO

SUPER-IMPROVED AUTOMATIC ELECTRIC WATER-SUPPLY SYSTEM, Complete

One of the most carefully designed, substantially constructed Automatic Electric Water Supply Systems on the market. Absolutely reliable, fool-proof and simple. Can be depended upon to give lasting service with practically no attention. (A letter outfit is not made.) FOR SHALLOW WELLS OR CISTERNS WHERE WATER IS NOT OVER 22 FEET BELOW SURFACE

\$98.50



NOISELESS PUMP Runs in Oil

Our pump is noiseless, double acting, brass fitted throughout and fully enclosed and lubricated by the "New Splash System." All moving parts run in oil bath, which insures lasting service. Latest type oversize 1/6 Horse Power electric motor, operates economically and is thoroughly reliable; surplus power to drive pump under all conditions.

Outfits Complete—No Extras

System consists of pump with automatic air valve, oversize 1/6 Horse Power repulsion induction motor, automatic switch set at 40 pounds, relief valve, shut-off valves, necessary pipe and fittings, as shown; 1 galvanized heavy pneumatic tank with pressure gauge, 1 1/2 inch galvanized foot valve and strainer. Pump has 3/4 inch suction and discharge. Outfit equipped with 60 cycle, 110-220 volt, single-phase alternating current motor. If you have other current, state voltage, phase, etc.

No. A-100 Water Supply System with 42 Gallon Tank, shipping weight 300 pounds, price complete....

No. A-101 Water Supply System with 80 Gallon Tank, shipping weight 340 pounds, price complete....

No. A-102 Water Supply System with 100 Gallon Tank, shipping weight 380 pounds, price complete....

Systems shipped out of our Chicago Plant same day order is received. Order TODAY and SAVE

Special \$98.50

Special \$110.50

Special \$122.50

Deep Apron Lavatory

Late design, white porcelain enameled, cast-iron drop apron lavatory, supported on concealed wall hangers; new low design, china indexed compression faucets, heavy brass nickel-plated adjustable supply pipes and trap to floor or wall, size 17 x 19 1/2 inches, weight 120 pounds.

Chicago A-11—Lavatory, Complete as shown with Iron-Pipe Connections. **Special \$11.75**

White Closet Outfit

Improved, snow-white composition China closet tank, (beautiful and indestructible); fitted with solid brass elevated noiseless valves and improved china flushing handle. Highest-grade white vitreous china syphon washdown bowl. Highly polished, reinforced birch mahogany seat, with heavy brass, nickel-plated bur hinges, flushing ell, supply pipe, closet bolts, etc., weight 125 pounds.

Chicago A-12—White Closet Outfit, complete as shown, with iron-pipe connections. **Special \$19.95**

Special \$59.95

All shipped out of our Chicago plant same day order is received. Order today and save. You cannot see.



Hot Water Boiler

Hardin-Lavin Co., 107-17 W. Pershing Rd., Chicago, Ill.

Geneless: Enclosed please find 25c (1/2 regular price) for which send me your Big Complete "Handy Man" Book-Catalog with special wholesale discount sheets and Free Bulletin Service. I am interested in:

Water Supply System Plumb. Fixtures Steamheat Plant
 Bathroom Outfit H.W. Heat Plant Pipeless Furnace.

Note: "Handy Man" Book is FREE if order accompanies coupon.

NAME.....

ADDRESS.....

P. O..... STATE.....



*Paul Whiteman
and his famous
Concert Orchestra*

*Such popularity
must be deserved*

*Neither this famous orchestra nor this
famous cigarette have found success by
mere luck. Both have had to show cause.*

