

FEBRUARY

ACROSS OCEAN RADIO

N.S.E.  
25 CENTS

# POPULAR MECHANICS

## MAGAZINE

WRITTEN SO YOU CAN UNDERSTAND IT

REG. D. TRADE MARK GREAT BRITAIN No. 410428

REG. U.S. PAT. OFF.

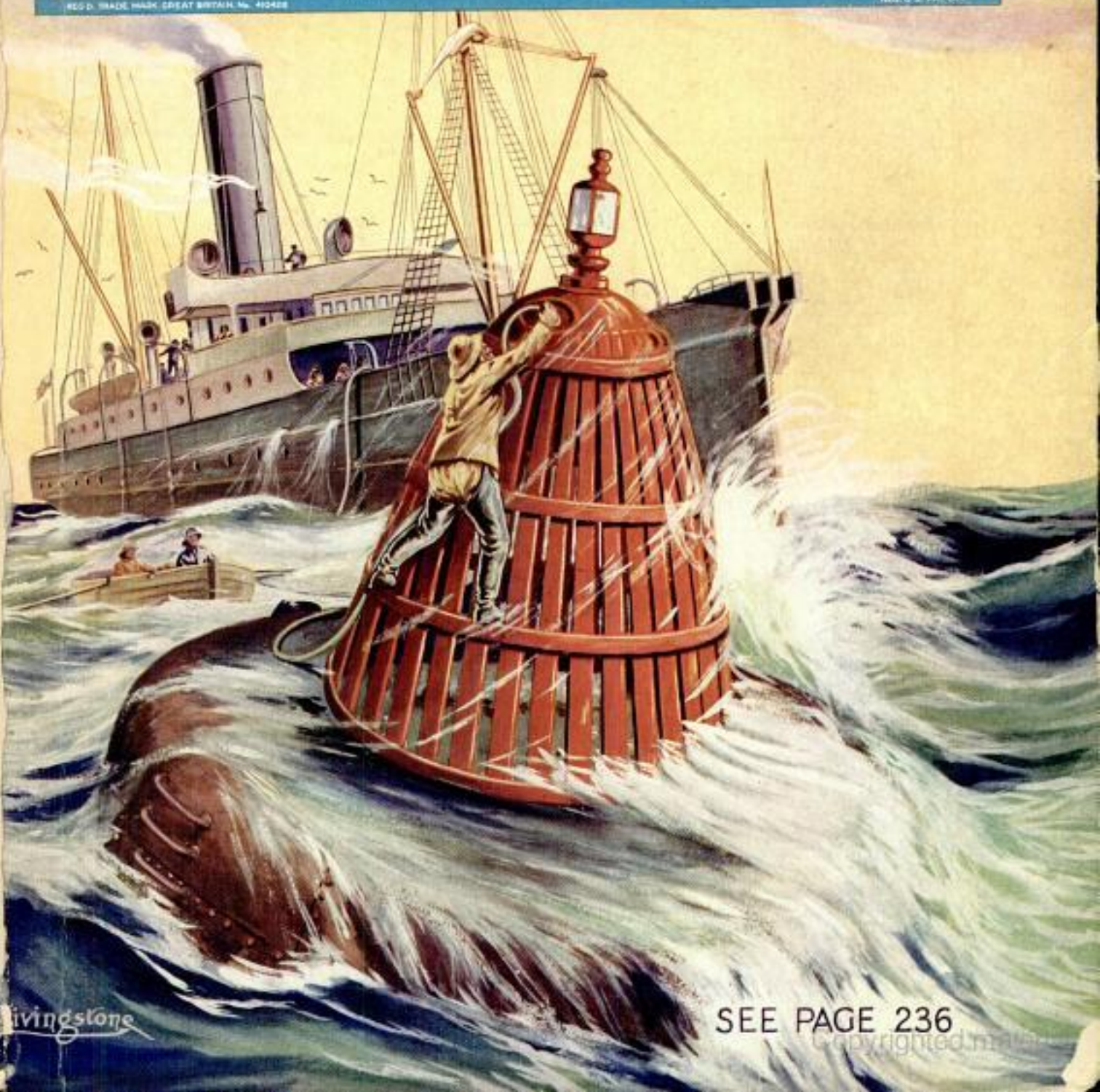

Livingstone

SEE PAGE 236



# BE AN AUTO, TRACTOR, AND ELECTRICAL EXPERT!



**I**F YOU are earning less than \$50 a week, read every word. Why stay in the old job, with no future—no chance of ever earning much more than you are now? The Auto, Tractor and Electrical business offers thousands of **BIG-PAY JOBS**—jobs where you are the **BOSS**. Get out of the rut—be independent—be an Auto Expert.

**J. H. McSweeney, Operator of Three Auto Schools, Will Train You!**

I operate Auto, Tractor and Electrical Schools in Cincinnati, Chicago and Cleveland. Think a moment what it means to be trained by McSweeney—think of the prestige—the case of getting a big job when you can say, "McSweeney trained me!" That's the magic phrase that has opened the doors of thousands of big pay jobs to my students.

**Be an Auto Expert** **Coupon** **McSweeney Trained Men Make GOOD**

Ordinary garage mechanics make good money. After 8 weeks in any of my schools, you'll be in a position to boss ordinary mechanics, and to make more money than you ever dreamed of before you read this announcement.

**Decide TODAY**

Now is the time to train yourself—now during the Winter months—so that you will be able to take your place with the other McSweeney Trained Big Pay Experts. Send the coupon—Now—TODAY—this minute.

A. J. Beall, Jr., Morgantown, W. Va., made \$85,000.00 last year from his garage and Chevrolet Agency.

George Smith, W. Alexandria, Ohio, makes over \$800.00 a month clear with his garage.

Thousands of other students are now making from \$50 to \$150 a week. Before they came to school, they knew nothing about automobiles—now they are successful men. You, too, can have the same success—all you need is the Training—McSWEENEY Training.

**FREE R. R. FARE and FREE BOARD!**

For a very limited time, I am going to pay your railroad fare to my nearest school—to board you absolutely free—and in addition make you a very special tuition offer.



**Just One of the Big Jobs Open**

A job like this—a "bossing" job with a future—this is what you can expect after 8 weeks in any of my schools.

**an AUTO GET THIS FREE BOOK!**  
**EXPERT**  
**Send it TODAY**

My big 64-page, beautifully illustrated catalog tells the whole story—I send it free if you act at once.



**McSWEENEY AUTO, TRACTOR & ELECTRICAL SCHOOLS**

**Operating Completely Equipped Schools in Three Leading Cities**

9th and Walnut Streets [Dept. 1415] 515-521 So. Laflin St. Cincinnati, Ohio Chicago, Ill.  
1815 East 24th Street, Cleveland, Ohio

See My Other Announcements on Pages 50, 51 and 131

**USE THIS COUPON FOR MY SPECIAL OFFER**

Send this coupon to the school nearest you.  
J. H. McSWEENEY, Pres., Dept. 1415  
**McSWEENEY AUTO, TRACTOR AND ELECTRICAL SCHOOLS**  
9th and Walnut Streets, CINCINNATI, OHIO  
515-521 South Laflin Street, CHICAGO, ILL.  
1815 East 24th Street, CLEVELAND, OHIO

Dear Mac: Let me have the full details of your special offer.

Name.....  
Address.....  
(No facilities for colored students.)





## The "Super-Het" brings home the fun!

### Radiola Super- Heterodyne

— gets distance  
with no antenna  
— no ground wires  
— no connections.  
Once mark the  
stations on the  
dials, and you can  
turn to the mark-  
ed spots and tune  
in—clear—true—  
real!

Operates entirely  
on dry batteries.

With 6 Radio-  
trons UV-199  
and Radiola  
Loudspeaker.  
With compart-  
ments to hold the  
batteries. Entirely  
complete except  
batteries . . . \$269

Extra  
Radiola Loop,  
Model AG-814,  
\$12



This symbol  
of quality  
is your  
protection

Where's the fun today? At home, where-  
ever there's a "Super-Het"! City home  
and farm home hear the same good music  
— laugh at the same good comedy — thrill  
to the same big games!

At the family dinner table, there's the  
dinner music of the greatest hotels. For  
home parties, famous orchestras play their  
best dance music. So many of the things  
that folks once went out of the home to get,  
come into the home now—with a Radiola  
Super-Heterodyne.

*"There's a Radiola for every purse"*

Radio Corporation  
of America  
Sales Offices: Suite No. 512  
233 Broadway, New York  
10 So. La Salle St., Chicago, Ill.  
28 Geary St., San Francisco, Cal.

# Radiola

REG. U. S. PAT. OFF.

This One



DBDH-EYN-TESR



# I Guarantee

**To Make You  
A Public Speaker  
or I Won't Take  
A Penny**

**I'll Show You How  
to Control One Man  
Or a Big Audience—  
How to Conquer  
Stage Fright—How  
to Increase Your  
Earnings—All By  
The Power of Ef-  
fective Speech**



## Give Me 15 Minutes a Day

That's all I want, 15 minutes a day, to prove to you beyond a shadow of a doubt that I can do for you what I have done for other men—**increase your income, make you a leader, make you successful.**

C. F. Bourgeois, President of Robison and Peckham, says: "The lesson on 'How to Develop Personality' is alone worth the entire cost of the course. It has been of real practical help to me."

Walter O. Ford of the Ford Manufacturing Company writes: "Was always considerably flustered when called upon to speak. Now, thanks to your course, I feel perfectly at home and confident. Every man who wants a strong personality and the power of effective speech should take your course."

H. B. McNeal, President of the Telephony Publishing Company, says: "It should appeal to every man and especially to young men who are ambitious for rapid promotion."

### Get Big Money Jobs

These men write us do hundreds of other successful men concerning this amazing new method of making you a forceful, fluent, convincing speaker. The world is at the feet of the man who can hold others by the sheer power of speech. Powerful speech brings success. Leadership depends on the ability to talk forcefully. Why do salary increases and the big-pay jobs seem to come naturally to one man when all about him are men of equal ability in other respects? Why in social life does one man hold the center of interest when others are ignored? The answer is

#### What This Amazing Course Teaches You

- How to make after-dinner speeches.
- How to write better letters.
- How to sell more goods.
- How to have a good memory.
- How to enlarge your vocabulary.
- How to make political speeches.
- How to develop self-confidence.
- How to have a winning personality.
- How to be master of any situation.

obvious. The successful man has the knack of making every word he says or writes count in his favor. He is never at a loss for the right word and he presents his ideas in clear, forceful language—with the result that he gets what he goes after.

### Sway Others At Will

The powerful speaker is welcomed everywhere and listened to with deep respect. How many men can address a dignified board of directors and have their plans and ideas approved? How many men can appear at a moment's notice before an audience and create enthusiastic notice? Not many. And yet there is no reason why any man should not be able to do these things.

### Easy For Anyone

I don't care how embarrassed you now are when asked to speak; nor how timid. I can show you how to rise quickly above the mass in business, how to step to promotion, how to be a leader, with poise and the assurance to plunge right into any subject and convince others. By this amazing new method, evolved by Professor R. F. Pattison Kline, formerly dean of the Public Speaking Department of the Columbia College of Expression, being a powerful speaker is easy and simple.

### Free Self-Test

To convince you fully that you can become a powerful and convincing speaker by giving me only fifteen minutes a day right in the privacy of your own home, I will send you a remarkable FREE self-test. I want to prove free that you can have this power of speech that men envy and women applaud. Also, because I know that you will be so delighted that you will tell others of this amazing method, I will send you a SPECIAL OFFER if you fill in the coupon and mail at once. You, like thousands of others, can quickly and easily learn the secret of achievement both in position and salary and all this without leaving your present position. Mail at once.

**NORTH AMERICAN INSTITUTE**  
Dept. 1382, 3601 Michigan Ave., Chicago

North American Institute,  
Dept. 1382, 3601 Michigan Ave., Chicago, Ill.  
I am interested in your Course in Effective Speaking and your  
Free self-test and special offer. Please send me full particulars.  
This request places me under no obligation of any kind.

Name.....  
Address.....  
City..... State.....



Popular Mechanics Magazine

200 E. Ontario Street, Chicago, U. S. A.

H. H. WINDSOR, Founder

H. H. WINDSOR, Jr., Editor and Publisher

London: Hachette & Co.,  
16-17 King William Street, Charing Cross, W. C. 2

Paris: Hachette & Co.,  
111 Rue Reaumur

Melbourne: Gordon & Gotch  
509-513 Little Collins St.

ISSUED MONTHLY

SUBSCRIPTION:

SINGLE COPY, 25 CENTS

In United States and its possessions, also Canada, Cuba, and Mexico, per year, postpaid - \$2.50

To all other countries in the Postal Union - 3.00

All subscriptions are discontinued at expiration. Please examine the date printed on your wrapper.

Entered as Second Class Matter Sept. 15, 1905, at the Post Office at Chicago, Illinois, under Act of March 3rd, 1879.

Entered as Second Class Matter at the Post Office Department, Canada.

Published monthly by POPULAR MECHANICS CO.

Copyright, 1925, by Popular Mechanics Co.

Copyright in Australia. Copyright in France

Vol. 43

Contents for February, 1925

*Substitute for glass No. 27*

Advertising—store front built of glass.....	180	Food—plant hunters search world for new food.....	218
Aerial Photography—looking down on us.....	226	Forest Fires—airplane and radio patrols to fight.....	233
Aeronautics—airplane transports for soldiers.....	255	Forests and Forestry—school for lumbermen.....	216
Airplanes		Fountain Pens—and pencil in one.....	216
"Flying bathtub" wins air meet race.....	188	Gas	
in moving pictures.....	285	socket with removable key.....	233
Airships—"ZR-3" engines stop when oil gets low.....	235	to be fuel of the future is prediction.....	287
Archaeology—buried Indian city found.....	283	Glass—plate glass blown in tubes.....	292
Automobile Touring—auto tops make ferryboats for explorers.....	142	Glider—miniature, stays up ten minutes.....	201
Automobiles—Equipment and Supplies		Gold—output of British South Africa.....	243
auto-cleaning brush fitted on hose.....	199	Guns—where guns for Uncle Sam's navy are made.....	209
autos "coined" in press to speed production.....	233	Hair—remover worked as scissors.....	209
bed with springs built in auto.....	284	Handle—vanishing, on traveling bag.....	180
valve levers.....	247	Household Devices.....	230
ventilating eaves for closed cars.....	250	Houses—of metal built in day.....	201
Automobiles—Fuel—fuel valve controlled by button.....	223	Insects—do they give off rays?.....	242
Automobiles—Ignition—spark plug grounds static.....	192	Irrigation—"inverted wells" dug in rivers.....	256
Automobiles—Lighting—safety light on rear fender.....	266	Islands—how floating are formed.....	182
Aviation—aerial traffic claims six lives in five years.....	206	Jacks—rolling auto jacks move car sideways.....	201
Bakers and Bakeries—15,000 needed to supply New York.....	249	Ladders—extension leg for.....	256
Bears—capture of brown-eyed white bear.....	215	hand, with direct gear drive.....	242
Bees—nature's cleverest mechanic.....	259	that cut lines in banknote plates.....	209
Berries—cranberry picker run by tractor.....	234	with circular bed.....	256
Billiards—pocket, played in home with pneumatic cues.....	191	Locks (Hydraulic)	
Boats and Boating—collapsible three-passenger boat.....	224	carrying ships over locks in Gota canal.....	223
Brakes—efficiency of brakes shown by tester.....	206	lift canal boats.....	200
Building—of church in bone.....	292	Lubrication—airplane oil made from locusts.....	258
Chair—ancient Chinese, for bride.....	249	Lumber and Lumbering—big trees cut by old-time buckers.....	235
Chewing Gum—value of products of factories.....	248	vacuum drying process.....	193
Cleanliness—invisible glove for workers.....	279	Magnetism—audible by aid of loud speaker.....	283
Clocks		Marker—rubber, for tennis balls.....	244
big clock's hands and face washed.....	258	Marking Machine—traffic marker does work of many men.....	273
tells time of tides.....	225	Merry-Go-Round—and teeter in one.....	206
Coin—electric coin sorter saves time.....	189	Mines and Mining—poison gas revealed by color change.....	207
Conveyance—road boat propelled by levers.....	256	Moose—pulls boat while swimming.....	273
Crime—death ray gunners in rubber suits for safety.....	191	Moths—furniture fumigated in vault.....	234
Cross—electric lighted.....	199	Motor Busses—six wheel double deck.....	257
Cycling—sidecar rider risks life to win race.....	244	Motorcycle—canoe as sidecar.....	179
Desk—combination pupil's desk and chair.....	202	Mower—electric lawn trimmer cuts edges.....	288
Disabled—artificial mouth of rubber aid to dumb.....	215	Muff—and handbag combined.....	216
Diving Bell—electric lighted diving chamber permits work in deep water.....	192	Musical Instruments	
Dog—mascot "Stubby" decorated by Pershing.....	209	aluminum for banjo head.....	218
Drydock—blocks tested in press for safety of ships.....	202	harmonica and trumpet combined.....	210
Dynamometer Car—reveals force of train shocks.....	265	Navigation	
Efficiency—Industrial—how heat affects.....	245	charts show rise and fall of ocean bottom.....	193
Electric Cooking—cooker cover browns food on top.....	278	derelict's wanderings aid charting of ocean's currents.....	249
Electric Lighting		night watchmen of the sea.....	237
material for electric lamps.....	180	Numbers—nine, the handiest.....	243
mercury arc lamp to protect eyes.....	204	Ocean—depth of six miles found.....	242
Electric Motors—in logging camps.....	205	Office Supplies	
Electricity—higher voltages possible by better insulation.....	256	c copyholder for typist.....	210
Elephants—scrubbed with bricks in India.....	201	letter sealer and automatic stamping device.....	233
Elevators—automatic, for skyscraper.....	248	Packing Industry—wanted: a use for the pig's squeal.....	267
Energy—Marconi sees new source of.....	288	Paint—mixer with adjustable paddle.....	198
Fans—fan run by rocking-chair provides breeze.....	284	Pearls—that grow in coconuts.....	225
Fingerprints—enlarged, help identify criminals.....	208	Penknife—1,800-bladed.....	191
Fire Engine—like limousine auto.....	289	Pests—earthworms feel light through skin.....	198
Fireplace—portable, burns oil.....	193	Petroleum—romance of pipe line.....	219
Fish—that sing found in Ceylon.....	257	Piano	
Fishing—keeping anglers supplied with lures.....	185	player piano rolls made from master record.....	183
Fogs—toll of London's.....	250	produces tones of flute.....	224

*Bank in Waller [Continued on Page 4]*  
*Rolling Jacks Inv car for Parking 284 2811*

*Discharge Meter*







# DRAKE'S PRACTICAL MECHANICAL BOOKS

## THEY WILL RAISE YOUR PAY—

### ORDER ON 5-DAY TRIAL

The books listed below will perfect you in your chosen trade—pave the way to the big positions. Written in non-technical language—easy to read and understand. **Every book covers its subject completely. An entire course of instruction condensed into one volume.** Your choice sent postpaid—you benefit 5 days—money refunded in full if not entirely satisfactory. Order direct from this page.



### Automobile Books

Automobile Starting, Lighting and Ignition, by Manly. 700 pp. . . . .	Leatherette	\$3.00
Brookes' Automobile Handbook, 1924 Edition. . . . .	Leatherette	\$2.00
Ford Motor Car, Truck and Tractor, by Manly. . . . .	Cloth	\$1.50
Starting and Lighting Troubles, Remedies and Repairs, by Manly. . . . .	Leatherette	\$3.00
Automobile Battery, Care and Repair, by Manly. . . . .	Leatherette	\$2.00
Automobile Catechism and Repair Manual. . . . .	Leatherette	\$1.50
Tires and Vulcanizing, by Tufford. . . . .	Cloth	\$2.00
Gas and Oil Engine Handbook. . . . .	Cloth	\$1.50
Automobile Upkeep and Care, by Manly. . . . .	Cloth	\$1.50
Motorcycle Handbook, by Manly. . . . .	Cloth	\$1.50

### Shop Practice Books

Sheet Metal Workers' Manual. . . . .	Leatherette	\$2.00
Oxy-Acetylene Welding and Cutting. . . . .	Cloth	\$1.25

## ORDER DIRECT FROM THIS PAGE—ON OUR MONEY-BACK PLAN

The books listed above are only a few of the many in our catalogue, which you will receive promptly after filling out and mailing us the attached coupon. For quick action order direct from this page—cross name of each book wanted and send in with price quoted. We prepay postage and send the books on our money-back plan.

**FREDERICK J. DRAKE & CO.**  
PUBLISHERS

1008 Michigan Ave., Chicago  
Drake Books Are For Sale at All Book Stores

Mail Coupon For Free Catalogue  
Your Guide to Home Study

Slide Rule and Logarithmic Tables. . . . .	Leatherette	\$2.00
Handbook for Millwrights. . . . .	Cloth	\$2.00
Modern Blacksmithing. . . . .	Cloth	\$1.25
Machine Shop Practice. . . . .	Cloth	\$2.00
Mechanical Drawing and Machine Design. . . . .	Cloth	\$2.00
Pattern Making. . . . .	Cloth	\$1.50

### Carpentry Books

Modern Carpentry, 2 vols. . . . .	Cloth Binding	\$3.00
The Steel Square, 2 vols. . . . .	Cloth	\$3.00
Wooden Boat and Shipbuilding. . . . .	Cloth	\$1.50
Modern Estimator. . . . .	Cloth	\$1.50
Timber Framing. . . . .	Cloth	\$2.00
Builder's Architectural Drawing. . . . .	Cloth	\$2.00
Concretes. . . . .	Cloth	\$1.50
Practical Bungalows. . . . .	Cloth	\$1.00
Low Cost Homes. . . . .	Cloth	\$1.00
Roof Framing, by Van Gusbeek. . . . .	Cloth	\$1.50
Stair Building and Hand Railing. . . . .	Cloth	\$1.50

### Electrical Books

Telephony, Including Automatic Switching, by Smith. 450 pp. . . . .	Leatherette	\$2.50
Practical Applied Electricity. . . . .	Cloth	\$2.00
Alternating Current. . . . .	Cloth	\$1.50
Electric Motor Control Systems. . . . .	Cloth	\$1.50
Wiring Diagrams and Descriptions. . . . .	Cloth	\$1.50
Electrical Tables and Data. . . . .	Cloth	\$1.50
Armature and Magnet Winding. . . . .	Cloth	\$1.50
Modern Electrical Construction. . . . .	Cloth	\$1.50
Modern Electric Illumination. . . . .	Cloth	\$1.50
Electricians' Operating and Testing. . . . .	Cloth	\$1.50
Motion Picture Operation. . . . .	Cloth	\$1.50
Drake's Electrical Dictionary. . . . .	Cloth	\$1.50
Electric Motors, D. & A. . . . .	Cloth	\$1.50
Electrical Measurements and Meter Testing. . . . .	Cloth	\$1.50
Drake's Telephone Handbook. . . . .	Cloth	\$1.25
Easy Experiments. . . . .	Cloth	\$1.25
Wireless Telegraph and Telephone Handbook. . . . .	Cloth	\$1.25
Telegraphy Self-Taught. . . . .	Cloth	\$1.25

### Steam Engineering

Swingle's Handbook for Steam Engineers and Electricians. . . . .	Leatherette	\$4.00
Examination Questions and Answers for Marine and Stationary Engineers. . . . .	Leatherette	\$2.00
Steam Boilers. . . . .	Leatherette	\$2.00
Swingle's Catechism of Steam, Gas and Electrical Engineering. . . . .	Leatherette	\$1.50

### Painting Books

Interior Wall Decoration, by Vanderwalker. . . . .	Leatherette	\$4.00
The Mixing of Colors and Paints, by Vanderwalker. . . . .	Cloth	\$2.00
Scene Painting and Hobbies Art. . . . .	Cloth	\$4.00
A Show at Show Cards. . . . .	Cloth	\$4.00
Sign Painting. . . . .	Cloth	\$4.00
Strong's Book of Designs. . . . .	Leatherette	\$4.00
Strong's Art of Show Card Writing. . . . .	Cloth	\$4.00
Sigmis's Alphabets. . . . .	Cloth	\$1.50
Modern Painter's Cyclopedia. . . . .	Cloth	\$2.00
Automobile Painting. . . . .	Cloth	\$1.50
Estimates, Costs and Profits, Painting and Decorating. . . . .	Cloth	\$1.50
New Hardwood Finishing. . . . .	Cloth	\$1.50
The Amateur Artist. . . . .	Cloth	\$1.50
New Stencils. . . . .	Cloth	\$1.25
Chalk Talk and Crayon Presentation. . . . .	Cloth	\$1.25

### Farm Books

Farm Mechanics. . . . .	Cloth	\$1.25
Farm Buildings. . . . .	Cloth	\$1.25
Farm Engines. . . . .	Cloth	\$1.25
Traction Farming. . . . .	Cloth	\$1.50

### Business and Reference Books

Better Business Letters. . . . .	Cloth	\$1.00
Better Business English. . . . .	Cloth	\$1.00
Better Advertising. . . . .	Cloth	\$1.00
Finger Prints Simplified. . . . .	Cloth	\$1.25
Practical Bricklaying. . . . .	Cloth	\$1.25
Practical Instruction for Detectives. . . . .	Cloth	\$1.00
Practical Plumbing. . . . .	Cloth	\$1.50
Hot Water Heating. . . . .	Cloth	\$1.50
Elementary Chemistry. . . . .	Cloth	\$1.50
Courses in Civil Service. . . . .	Cloth	\$1.50
Cyclopedia of Recipes. . . . .	Cloth	\$1.50
American Star Speaker. . . . .	Cloth	\$1.50

### Modern Languages

By Prof. P. S. Allen, U. of Chicago		
French without a Teacher. . . . .	Cloth	\$1.25
Spanish without a Teacher. . . . .	Cloth	\$1.25
German without a Teacher. . . . .	Cloth	\$1.25
Everyday French. . . . .	Cloth	\$1.25
Everyday Spanish. . . . .	Cloth	\$1.25

FREDERICK J. DRAKE & CO.  
1008 Michigan Avenue  
Chicago, Ill.

GENTLEMEN:—Please send me free, postage paid, your illustrated catalogue which lists and describes over 100 Practical Mechanical Books for Home Study.

My name is .....

and my address .....





## From \$100 a Month to \$8,000 a Year —and just beginning to grow!

Only one hundred a month—that was what Charles S. Jones, a Texas man, was drawing when he first took up home study training under the LaSalle Problem Method.

Three years later comes a letter from "Henry & Jones, Certified Public Accountants," and bearing the address of Jones' home city. "My income is a trifle in excess of \$8,000 a year," writes Jones, "and I am just beginning to grow. I can hardly find words to tell you of the inspiration that the course has given me. I have recently enrolled for your full Law course and expect to complete my business education with LaSalle."

### *His Chance is Yours!*

A practical and remarkably interesting method of business training—the LaSalle Problem Method—and it gets results!

A. V. McDuffie, for example, writes that in six years' time his training in Higher Accountancy lifted him from a bookkeeper's job, at \$15 a week, to full partnership in a firm of Certified Public Accountants, with an income better than \$10,000 a year. Arthur J. Hammerl writes that LaSalle training increased his income 70 per cent in eight months. Other LaSalle members, thousands of them, tell of incomes doubled, tripled, even quadrupled thru home study training under the LaSalle Problem Method. During a period of only three months as many as 1193 members reported definite salary increases totalling \$1,248,526. *The average increase per man was 89 per cent.*

If you are in earnest when you say you want to make more money, check the training that interests you, sign and mail the coupon NOW. It will

bring you full particulars of the LaSalle Problem Method, together with details of our convenient-payment plan; also your copy of "Ten Years' Promotion in One." "Get this book," said a prominent Chicago executive, "even if you have to pay five dollars for it." We will send it free.

Make your start toward that bigger job TODAY.

## LaSalle Extension University

The World's Largest Business Training Institution  
Dept. 264-HR Chicago, Illinois

Please send me catalog and full information regarding the course and service I have marked with an X below. Also a copy of "Ten Years' Promotion in One," all without obligation to me.

### Higher Accountancy

Training for positions as Auditor, Comptroller, Certified Public Accountant, Cost Accountant, etc.

### Other LaSalle Training Courses

LaSalle is the largest business training institution in the world. It offers training for every important business need. If more interested in any of these courses, check here:

- |  |  |
|--|--|
| <input type="checkbox"/> Business Management                         | <input type="checkbox"/> Banking and Finance                       |
| <input type="checkbox"/> Modern Salesmanship                         | <input type="checkbox"/> Modern Foremanship and Production Methods |
| <input type="checkbox"/> Traffic Management                          | <input type="checkbox"/> Personnel and Employment Management       |
| <input type="checkbox"/> Railway Station Management                  | <input type="checkbox"/> Expert Bookkeeping                        |
| <input type="checkbox"/> Law—Degree of LL. B.                        | <input type="checkbox"/> Business English                          |
| <input type="checkbox"/> Commercial Law                              | <input type="checkbox"/> Commercial Spanish                        |
| <input type="checkbox"/> Industrial Management Efficiency            | <input type="checkbox"/> Effective Speaking                        |
| <input type="checkbox"/> Modern Business Correspondence and Practice | <input type="checkbox"/> C. P. A. Coaching                         |

Name.....

Present Position.....

Address.....



# CARPENTERS

## GUIDES THAT SOLVE PROBLEMS

A Complete Course in Practical Carpentry and Building Work

POCKET SIZE—  
FLEXIBLE  
COVERS—  
3100 ILLUSTRATIONS  
—1600  
PAGES

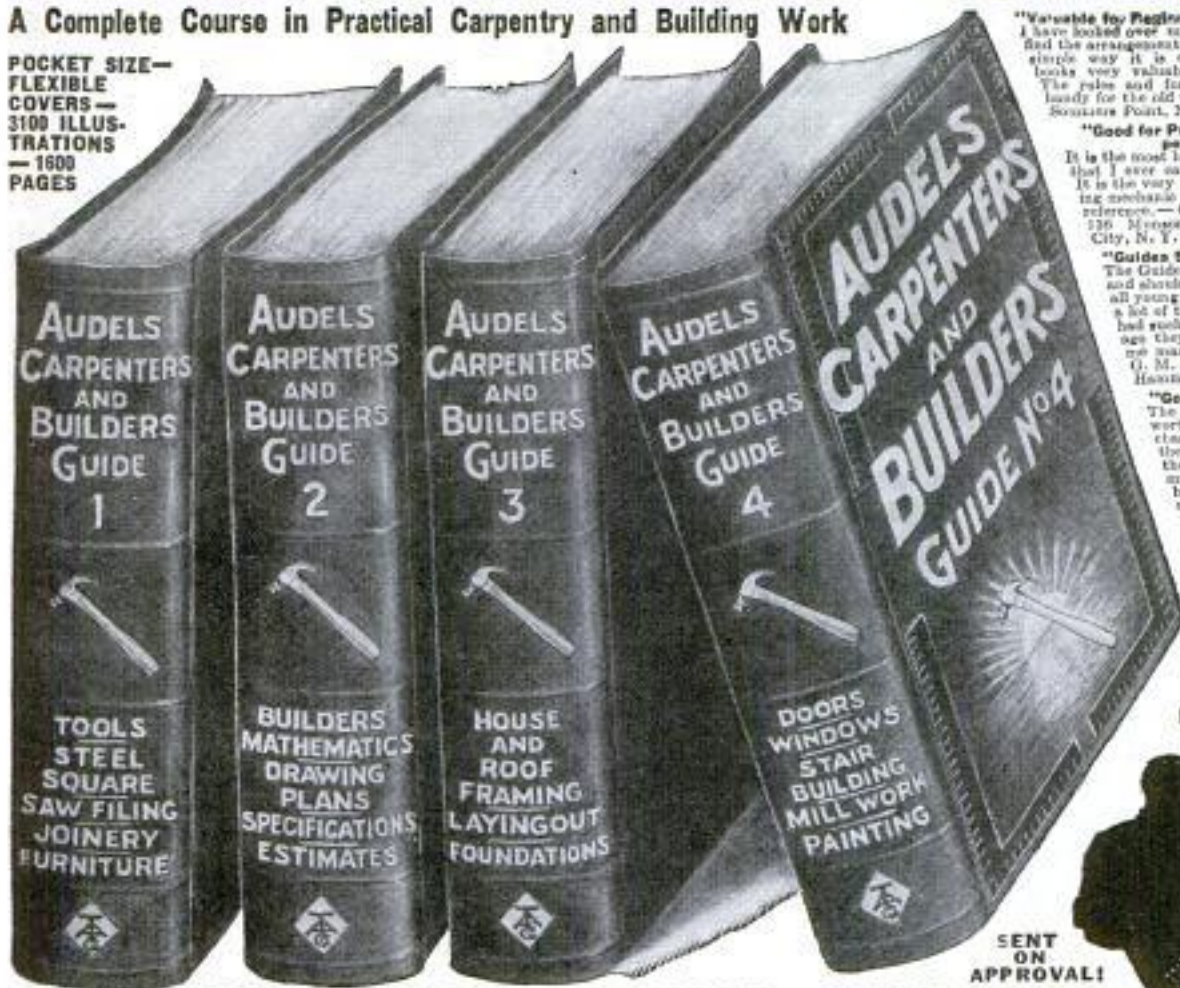

**"Valuable for Beginners or Old Timers"**  
I have looked over my Audel Guides and find the arrangement of subjects and the simple way it is explained make the books very valuable for the beginner. The rules and formulas are neatly handy for the old timers.—Hess Smith, Sloatsburg, N. J.

**"Good for Professional Carpenters"**

It is the most handy reference work that I ever came in contact with. It is the very thing that the building mechanic needs every day for reference.—George H. Watson, 126 Morgan St., Long Island City, N. Y.

**"Guides Save Hard Knocks"**

The Guides are truly wonderful and should be in the hands of all young carpenters as well as a lot of the older ones. If I had such information 20 years ago they would have saved me many a hard knock.—O. M. McJohnston, E. H. L. Hammond, Ind.

**"Good for Amateurs"**

The books are surely worth more than the purchase price, especially as they serve as a guide to the nonprofessional like myself who is trying to build himself a house at the least expense.—O. F. Schum, P. O. Box 142, Westmont, Ill.

**\$1**  
PER MONTH



SENT ON APPROVAL!

### NEW IDEAS—MODERN METHODS—SHORT CUTS

This course, "Audel's Guides for Carpenters and Builders," consists of 4 handy volumes of over 1600 pages with thoroughly illustrated charts, diagrams, graphs, pictures with calculations for every job from making the excavation to constructing the entire building. You will find these new Guides most complete and comprehensive in addition to being both timely and practical. There are 3700 actual examples of efficient construction work with new, methods, ideas, solutions, plans, systems, short

cuts, time and labor saving suggestions, new ways that cover the entire theory and practice of the subject illustrated by sketches and forms all specific and practical. Audel's Guides give you the short cut, professional information you want. No need to guess or take chances. Every day you have before you in this set the exact, practical, useful information that will help you with every job that comes up in your daily work.

### HOW To Handle the Job That Puzzles YOU

There are thousands of examples of modern construction and building work—new methods, new ideas, proved efficiency plans, short cuts, time saving suggestions, new ways that cover the entire theory and practice of modern carpentry. Every point is easy to read and understand and clearly illustrated with sketches and forms. Inside Trade Informa-

tion for Carpenters, Builders, Joiners, Building Mechanics and all Woodworkers on—Care and Use of Tools—How to Use the Steel Square—File Saws—Make All Kinds of Joints—Draw and Read Plans—Write Specifications—Make Estimates—How to Frame Roofs and Houses—Lay Out Work—Put in Foundations—Full Instruction on In and Outside Building Work—Stair Building—Saw Mill Work—Practical Painting—Thousands of Short-Cuts that save time and money—Information usually obtained only by hard experience.

**NO MONEY!**  
MERELY SEND COUPON AND LOOK THE SET OVER AT AUDEL'S RISK

# FREE

### EXAMINATION

Not a cent to pay until you see the books. No obligation to buy unless you are satisfied. Fill in coupon in pencil. Send now—today—get this great help library for carpenters and builders.

**THEO. AUDEL & CO., 72 5th Avenue, NEW YORK CITY**  
I will send you \$1 worth of guides and mail \$1

Send me for free examination **AUDEL'S CARPENTERS AND BUILDERS GUIDES** if I return the coupon within 5 days and mail \$1

Send me for free examination **AUDEL'S CARPENTERS AND BUILDERS GUIDES** if I return the coupon within 5 days and mail \$1

Name.....  
Address.....  
Occupation.....  
Employed by.....  
Reference.....

S-T-20



**Be a B.W. Cooke-Trained Auto EXPERT!**

**I WILL TRAIN YOU AT HOME**

**\$3,500. to \$10,000. A YEAR**

### Clip Coupon Now for My Free Auto Book

The world's biggest, most fascinating business needs you! Why slave away at small pay when there are unlimited opportunities as a *Cooke-trained* Auto Expert waiting for you? Mail coupon and I will tell you how I train you at home in your spare time for AUTO EXPERT'S big-pay position.

### Earn \$75 to \$200 a Week!

When you read that there are now 15 MILLION autos, trucks and tractors — that car owners are paying out SIX THOUSAND MILLION DOLLARS A YEAR for upkeep, you will realize here is the business to get into! Enormous demand for *Cooke-trained* Auto Experts. My training includes Garage management, automobile salesmanship and advertising—many other special features — how to go into business for yourself and make a success of it.

**FREE**

**2**

TWO BIG REPAIR and TESTING

**OUTFITS!**

Costly testing and repair outfits free to every student for a limited time. Coupon brings special offer.

### No Other Training Like Mine!

As Directing Engineer of the great Chicago Auto Shops I know what training you need to make big money, and I GIVE YOU THAT TRAINING! Right in your own home, I make you MASTER of every branch of Auto, truck and tractor work. I train you with JOBS—not books. I give you complete and practical instruction in every detail of Mechanical and Electrical work, Battery, Ignition, Farm Power Plants, Welding, Brazing, Vulcanizing, etc., and my Employment Department helps you to Position.

### Go Into Business!

W. J. Morrision, without previous experience—now in business for himself—and only half-way through Cooke JOB-WAY training, writes: "I would not take \$500 for what I've already learned. Am already in business and clearing over \$50 a week, with wonderful prospects." Hundreds others have done it. Mighty little capital needed. I'll train you, too, to do it.



W. J. MORRISON  
Parkersburg, W. Va.

### FREE! AUTO BOOK

**B. W. COOKE, Directing Engineer**  
CHICAGO AUTO SHOPS, Dept. 216  
1916 Sunnyside Avenue, CHICAGO, ILL.

Send me FREE Auto Book and proof that I can become an Auto Expert at home in spare time. Also send your special offers of 2 FREE outfits.

..... Name

..... Address

..... City..... State

..... Occupation..... Age

### Earn While You Learn!

Get my big Auto Book— it's FREE—see what others have done after only a few months of my JOB-WAY training. In this book I prove to you under a written Money Back Guarantee that you will find your success as a *Cooke-trained* Auto Expert. Almost at the start I train you to do actual jobs and make extra money doing it. 82 out of 100 of my students report that they are doing practical work, many of them are already making more money than the entire cost of "JOB-WAY" training!

**Big Auto Book FREE!** I don't care how old or young you are, how much or little education you have, this training will make you a successful Auto Expert. Special inducements and many EXTRA features right now. Easy terms and low cost. Coupon brings free book and complete information. *Mail it today!*

**B. W. COOKE, Directing Engineer**  
CHICAGO AUTO SHOPS, Dept. 216  
1916 Sunnyside Avenue Chicago, Illinois





## The letter that saved Bob Johnson's job —and paved the way for a better one!

**I**T WAS written to his employer by the International Correspondence Schools. It told how "Robert Johnson had enrolled for a course of home-study and had received a mark of 94 for his first lesson."

Bob answered the summons to the Chief's office with just a little fear and trembling, for a lot of men were being dropped—a lot more were having their pay reduced.

But as Bob came in, his employer did a surprising thing. He got up quickly from his desk and grasped Bob warmly by the hand.

"I want to congratulate you, young man, on the marks you are making with the I. C. S. I am glad to see that you are training yourself not only for your present job, but for the job ahead.

"We're cutting the pay-roll. Until I received this letter, I had you in mind as one of the men to be dropped. But not now. Keep on studying—keep your eyes open—and pretty soon there'll be a still better job for you around here. We're always looking for trained men."

Won't you let the I. C. S. help you too?

Won't you trade a few hours of your spare time for a good job, a good salary and the comforts that go with it? Then mark the work you like best on the coupon below and mail it to Scranton today. That doesn't obligate you in the least, but it will be your first big step towards success. *Do it now!*

### Mail the Coupon for Free Booklet

INTERNATIONAL CORRESPONDENCE SCHOOLS  
Box 5673-D, Scranton, Penna.

Without cost or obligation, please tell me how I can qualify for the position or in the subject before which I have marked an X:

#### BUSINESS TRAINING COURSES

- |  |   |
|--|---|
| <input type="checkbox"/> Business Management                     | <input type="checkbox"/> Salesmanship                                     |
| <input type="checkbox"/> Industrial Management                   | <input type="checkbox"/> Advertising                                      |
| <input type="checkbox"/> Personnel Organization                  | <input type="checkbox"/> Better Letters                                   |
| <input type="checkbox"/> Traffic Management                      | <input type="checkbox"/> Show Card Lettering                              |
| <input type="checkbox"/> Business Law                            | <input type="checkbox"/> Stenography and Typing                           |
| <input type="checkbox"/> Banking and Banking Law                 | <input type="checkbox"/> Business English                                 |
| <input type="checkbox"/> Accountancy (including C.P.A.)          | <input type="checkbox"/> Civil Service                                    |
| <input type="checkbox"/> Nicholson Cost Accounting               | <input type="checkbox"/> Railway Mail Clerk                               |
| <input type="checkbox"/> Bookkeeping                             | <input type="checkbox"/> Common School Subjects                           |
| <input type="checkbox"/> Private Secretary                       | <input type="checkbox"/> High School Subjects                             |
| <input type="checkbox"/> Spanish <input type="checkbox"/> French | <input type="checkbox"/> Illustrating <input type="checkbox"/> Cartooning |

#### TECHNICAL AND INDUSTRIAL COURSES

- |   |  |
|---|--|
| <input type="checkbox"/> Electrical Engineering | <input type="checkbox"/> Architect                                   |
| <input type="checkbox"/> Electric Lighting      | <input type="checkbox"/> Architects' Blue Prints                     |
| <input type="checkbox"/> Mechanical Engineer    | <input type="checkbox"/> Contractor and Builder                      |
| <input type="checkbox"/> Mechanical Draftsman   | <input type="checkbox"/> Architectural Draftsman                     |
| <input type="checkbox"/> Machine Shop Practice  | <input type="checkbox"/> Concrete Builder                            |
| <input type="checkbox"/> Railroad Positions     | <input type="checkbox"/> Structural Engineer                         |
| <input type="checkbox"/> Gas Engine Operating   | <input type="checkbox"/> Chemistry <input type="checkbox"/> Pharmacy |
| <input type="checkbox"/> Civil Engineer         | <input type="checkbox"/> Automobile Work                             |
| <input type="checkbox"/> Surveying and Mapping  | <input type="checkbox"/> Airplane Engines                            |
| <input type="checkbox"/> Metallurgy             | <input type="checkbox"/> Navigation                                  |
| <input type="checkbox"/> Steam Engineering      | <input type="checkbox"/> Agriculture and Poultry                     |
| <input type="checkbox"/> Radio                  | <input type="checkbox"/> Mathematics                                 |

Name.....  
Street.....  
Address.....

3-6-24

City..... State.....

Occupation.....

Persons residing in Canada should send this coupon to the International Correspondence Schools Canadian, Limited, Montreal, Canada.



# \$90 Drafting Course Free

## Mail the Free Coupon Below

There is such an urgent demand for practical, trained Draftsmen that I am making this special offer to deserving, ambitious men. You get your course FREE for getting two additional students. I will teach you to become a Draftsman and Designer, until you are drawing a salary of \$250.00 a month. You need not pay me for my personal instruction or for the complete set of instruments.

## \$250 a Month

Starting salary according to my agreement and guarantee. Draftsmen's work is pleasant and profitable. Positions are open paying \$3,600.00 a year in the best surroundings. They are open everywhere. Thousands of men are needed who have just the kind of training I will give you. You can get this training during spare time in your own home.

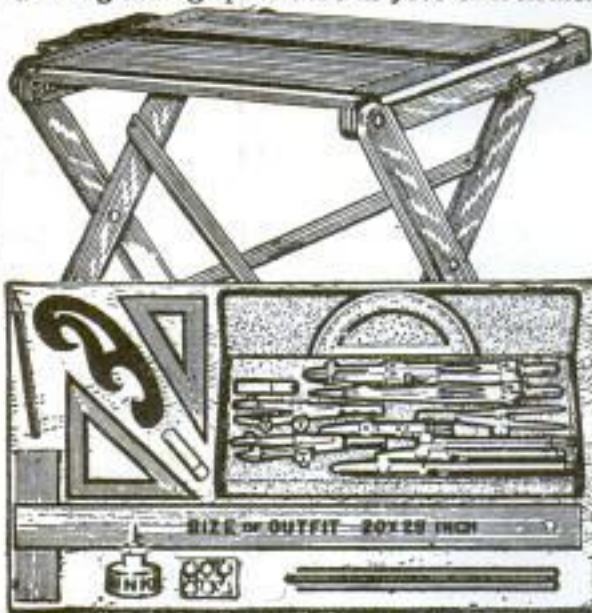

### Free Course Offer Coupon Chief Draftsman Engineers Equipment Co.

1951 Lawrence Ave. Div. 13-52 Chicago  
Without any obligation to me please mail your book, "Successful Draftsmanship" and full particulars of your liberal "Personal Instruction" offer to a few students. It is understood I am obligated in no way whatever.



Name .....

Address .....

Age .....

## Chief Draftsman Will Train You Personally

on practical Drafting-room work Until you are competent and Until you are in a permanent position at a salary paying at least \$250 per month. This is an exceptional opportunity for a few selected ambitious men, between the ages of 16 and 50 whom I will train personally.



## I Guarantee

To instruct you until competent and in a permanent paying position at a regular Draftsman's salary of at least \$250 per month and guarantee to furnish you free complete Draftsman's Working Outfit at once from the start.

## Free Drawing Instruments Free Drawing Table

These are the regular working instruments and the kind of table I use myself. I give them free to you if you enroll at once. Send the Free Coupon Today.

## Earn While Learning

You can be earning a handsome income while learning at home. This is a special offer I am making. Absolutely no obligations of any kind in sending coupon. But you must write at once, as I limit the number of my students.

Mail the **FREE Coupon** at once for my book—"Successful Draftsmanship," also list of open positions and for the free offer to be earning good money at once while learning at home. This offer is limited and in order to benefit thereby — act at once.

**Chief Draftsman  
Engineers Equipment Co.**  
1951 Lawrence Ave., Div. 13-52 Chicago, Ill.



# We Will Make You An Electrical Expert In 12 Weeks At Coyne



Students Doing Actual Work On  
Power Transmission Apparatus



Students Working on Massive  
A. C. Control Equipment.



Students Practicing House-wiring  
In Skeleton Houses

Not by Correspondence — All PRACTICAL Work  
**IN GREAT SHOPS!**

Clip that Coupon Right Now! Get my Big New Book—IT'S FREE! It points the way to Success for you. Crammed full of hard, dependable, proven Facts. Shows the way to Big Pay in the Largest, Most Interesting Money-Making Field—ELECTRICITY! Find out how a world of Opportunities can be opened up for you as a Coyne-Trained Electrical Expert. See what my PRACTICAL TRAINING has done for others. Read what they say about Coyne.

**Earn \$60 to \$200 a Week!**

Yes, sir, I train you for the BIG JOBS in ELECTRICITY! Coyne IS NOT A CORRESPONDENCE SCHOOL! I train you—thoroughly—on Thousands of Dollars' worth of Electrical Apparatus. You do ACTUAL WORK on REAL EQUIPMENT—the kind you use out on the job. That's why my students MAKE GOOD. That's why you can Master Electricity in 3 MONTHS!

#### Coyne Trains You for Life

It makes no difference how much or how little Education or Electrical Experience you have had. I'll make you an Electrical Expert through Coyne LEARN-BY-DOING METHOD! I have done it for thousands. I will do it for YOU! At Coyne you get a Life Scholarship. You can stay longer than the required time if necessary. You can return any time later to take up new work I am continually adding to keep my course up-to-date at all times.

#### HERE'S THE BOOK!

FREE! Send for it now. It's a book worth having. Handsomely bound. Beautifully illustrated. Size 12x15 inches. Shows dozens of actual photographs of Coyne Students working in my BIG SHOPS. Gives others' experiences. Shows what you can do. Cost me a dollar but it's yours FREE if you mail coupon. Do it now.

Absolutely no obligation on your part.

Get my  
Big Free  
Book



#### Radio and Auto Course FREE

Special Offer right now! I am including Absolutely Free my Big New RADIO COURSE and AUTO, TRUCK and TRACTOR ELECTRICITY. Coupon brings full details.

#### EARN While You LEARN

I back my students up. My Employment Dept. will assist you in getting a part time job to make a good part of your expenses while training. And it will help you get a BIG PAY JOB on graduation.

#### For 26 Years We Have Been Training Men for BIG PAY JOBS

Remember Coyne is a School with an established REPUTATION. Endorsed by Electrical Industry. Over a QUARTER OF A CENTURY of Success—Success that was earned by the BIG SUCCESSSES Coyne Students have made. You owe it to yourself to find out what I can do for you. Clip the Coupon Now!

H. C. LEWIS,  
President.

Send For Free Book

H. C. LEWIS,  
President

**COYNE**

26th Year  
Founded 1899

**ELECTRICAL SCHOOL**

1300-10 W. Harrison St., Dept. 135-2, Chicago, Ill.

**MAIL THIS COUPON!**

H. C. LEWIS, President  
COYNE ELECTRICAL SCHOOL, 1300-10 W. Harrison St., Dept. 135-2, CHICAGO, ILLINOIS

Dear Sir:—Please send me, absolutely FREE, your big New Book and full particulars of your Special Offer of Two Extra Courses FREE.

Name .....

Address .....





### THE HOP-OFF

Round-the-World flyers  
leave at Clover Field,  
Santa Monica, Cal., on  
30,000 mile trip.  
(Wide World Photo)

# Daring Young Men Needed in Aviation

**T**HERE is no field of work in the world today which offers such amazing opportunities to young men of daring and who love adventure as does Aviation. Although still in its infancy, there is a crying demand in Aviation for young men with courage, nerve and self-reliance. For those who can qualify there will be thousands of highly paid jobs which will lead quickly and surely to advancement and success.

## Big Opportunities Await The Trained Man

Look over the fields of work which are open to the young man today. You will find that Aviation is the ONE FIELD that is not overcrowded—the ONE FIELD in which there is plenty of room at the top. Think of it! Only 21 years ago Orville and Wilbur Wright made the world's first airplane flight. Now airplanes fly around the world. Yes, Aviation offers the same wonderful opportunities today that the automobile and motion picture industries did 15 and 20 years ago. Men who got in on the ground floor of those industries made fortunes before others woke up. AVIATION IS NEW! It clamors for nifty young men—and the trained man has the world before him in Aviation.

## Easy to Become an Aviation Expert—\$50 to \$100 a Week

You can qualify now quickly for one of these exciting highly paid jobs through a new, sure, easy method of training. The study of Aviation is almost as interesting as the work itself. Every lesson is fascinating and packed full of interest. That's why Aviation is so easy to learn—you don't have to

force yourself to study—once you start, you can't get enough of it. Only one hour of spare time a day will give you the basic training in an amazingly short time.

One student, S. F. McNaughton, Chicago, says: "Your lessons are like a romance, and what is more, after one reading, the student gets a thorough understanding. One never tires of reading them." James Powers, Pa., another student says: "I am indeed surprised that such a valuable course can be had from such practical men for so little cost."

## PREPARE For One of these POSITIONS

Aeronautical Instructor  
\$60 to \$150 per week  
Aeronautical Engineer  
\$100 to \$300 per week  
Aeronautical Contractor  
Enormous profits  
Aeroplane Repairman  
\$60 to \$75 per week  
Aeroplane Mechanician  
\$40 to \$60 per week  
Aeroplane Inspector  
\$50 to \$70 per week  
Aeroplane Salesman  
\$5000 per year and up  
Aeroplane Assembler  
\$40 to \$65 per week  
Aeroplane Builder  
\$75 to \$200 per week

## Personal Instruction by Experienced Men

Men who have had actual experience in Aviation give you personal attention and guide you carefully through your training. They select the lessons, lectures, blueprints and bulletins. They tell you the things that are essential to your success. Every lesson is easy to read and quickly understood.

## Big Book on Aviation FREE

Send coupon below for New Free Book, just out, "Opportunities in the Airplane Industry." It is interesting and instructive and will show you many things about Aviation which you never knew before. Only a limited number offered—get yours before the edition is exhausted.



American School of Aviation

Dept. 1352

3601 Michigan Ave., Chicago, Ill.

AMERICAN SCHOOL OF AVIATION,  
3601 So. Michigan Ave., Dept. 1352, Chicago, Ill.  
Without any obligation, send me your Free Book, "Opportunities in the Airplane Industry," also information about your Course in Practical Aeronautics.

Name.....

Street.....

City..... State.....





Chief Engineer  
Dunlap

You Get  
4 Electrical  
Outfits

Dunlap JOB-METHOD training is built around four complete Electrical outfits which I send you without extra charge. With these valuable instruments, tools and materials, you learn by doing actual Electrical jobs. You get the theory while getting the practice. My JOB-METHOD of instruction makes it easy for you to understand the most difficult subjects.

If you are now earning less than \$40 a week, I will guarantee you an Electrical job after you finish my training—guarantee you at least 50% more pay under bond, or refund every cent you pay for tuition. You can get this guarantee only from AMERICAN SCHOOL, the 27 year old, million dollar educational institution.

## Go Into ELECTRICITY!

The world's greatest, fastest growing, most fascinating industry will pay you \$3500 to \$12,000 a year when you are an ELECTRICAL EXPERT trained to BOSS electrical construction or electrical power plants, to direct the work of ordinary electricians. Prepare for these positions, at home in your spare time, with Dunlap JOB-METHOD training, the most complete and up-to-date home instruction in Electricity.

### 22 Electrical Engineers

from Westinghouse, General Electric, Commonwealth Edison, Western Union and other great corporations helped me to build this wonderful home-study training. So in every department of Electricity you get your training from a specialist and an authority! Those executives know what training you need to hold down the BIG-PAY positions in Electricity, and they give you just that training.

### BOSS Electrical Jobs at \$70 to \$200 a Week!

New projects in Electricity total hundreds of millions of dollars. No other industry offers such a golden future to trained men, trained as I train you. Electricity rewards not only the occasional genius like Edison and Steinmetz. This giant business also pays rich prizes to thousands of men who master electrical principles as I help you master them in my JOB-METHOD instruction.

Only a  
Part  
of  
Outfits

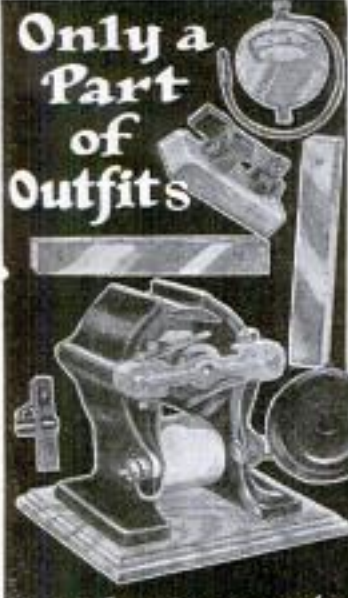

Dunlap Guarantees You a Job And a Raise!

## Mail Coupon for FREE Book Today!

AMERICAN SCHOOL organized NOT FOR PROFIT, gives you the benefit of royalties, profits and other savings. Write me at once for confidential money-saving offer. Get the facts and take advantage of my GUARANTEED JOB and RAISE offer. Get the facts about your chances in the Electrical business. Get my big, free catalog, see for yourself how quickly and easily you can get ready for BIG PAY!

CHIEF ENGINEER DUNLAP  
Electrical Division

**American School**  
Dept. E-274, Drexel Av. and 58th St.  
CHICAGO

### Make This Training Pay for Itself!

Don't let lack of ready money or anything else prevent you from getting my training. As early as your eleventh lesson I train you to do Electrical and Radio jobs in your spare time—to earn enough money to pay for this course and have some left over.

Chief Engineer Dunlap  
American School, Electrical Division  
Dept. E-274, Drexel Av. and 58th St.  
CHICAGO

Please rush free book, guarantee of a job and 50% raise, and complete information.

Name .....

St. No. ....

City ..... State .....



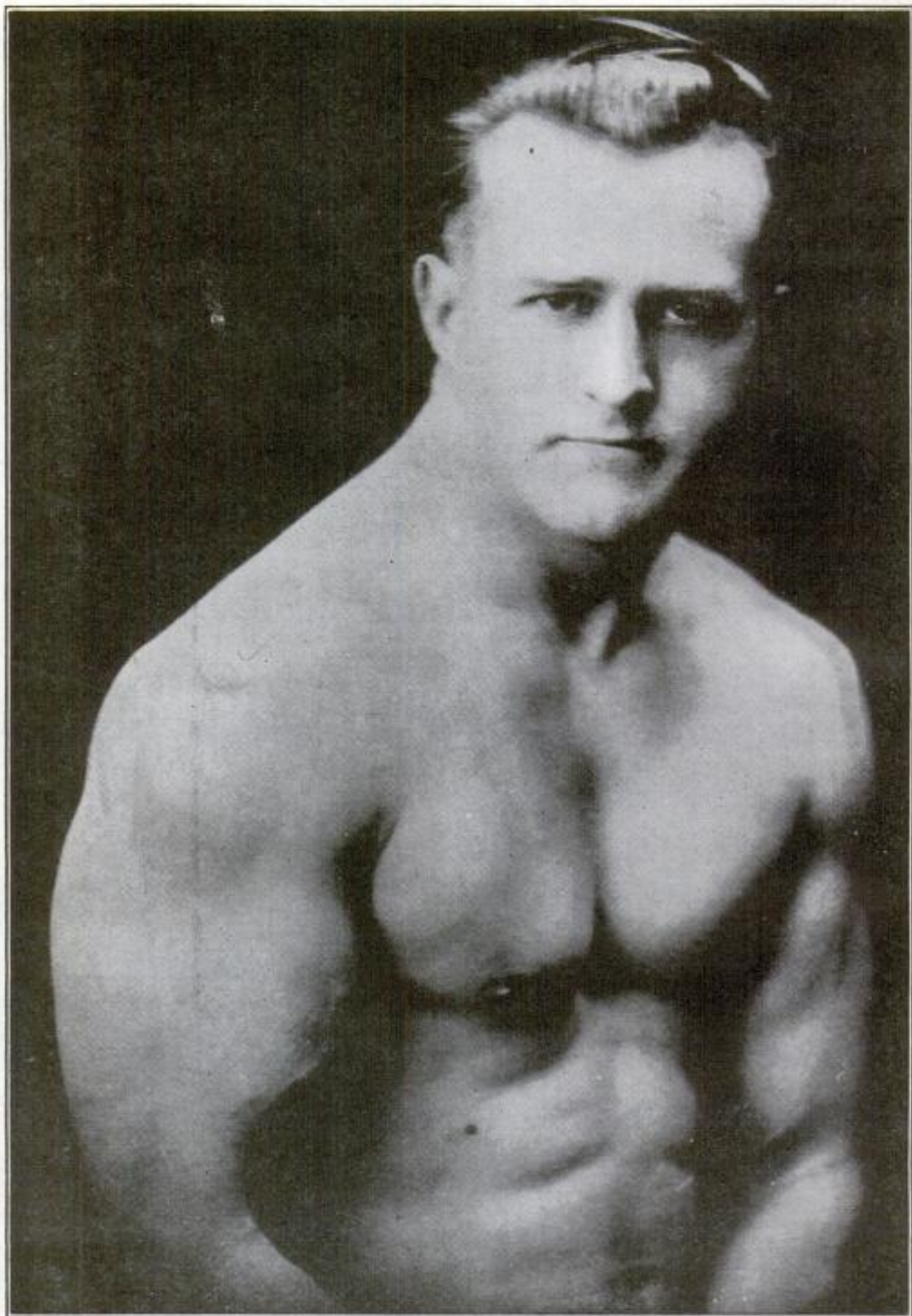

**EARLE E. LIEDERMAN, *The Muscle Builder***  
*Author of "Science of Wrestling", "Muscle Building", "Here's Health", etc.*



# A Wart on Your Nose

would not be noticed nearly as much as a frail, weak body. Yet, if you had a wart on your nose, you would worry yourself sick—you would pay most any price to get rid of it. But what about that body of yours? What are you doing to make people admire and respect you? Wake up! Come to your senses! Don't you realize what a strong, robust body means to you? It makes no difference whether it be in the business or social world—everybody admires the strong, robust fellow—everyone despises the weakling.

## I Will Transform You

I make weak men strong. That's my job. That's why they call me "The Muscle Builder". I never fail. A bold statement, but true. I don't care how weak you are, I can do the trick. The weaker you are, the more noticeable the results. I've been doing this for so many years, it's easy now. I know how.

In just thirty days, I'm going to put one full inch on those arms of yours. Yes, and two inches on your chest. But that's nothing. I've only started. Now comes the real work. I'm going to broaden your shoulders and strengthen your back. I'm going to deepen your chest so that every breath will literally penetrate every cell of your lungs, feeding them with rich, life-giving oxygen. You will feel the thrill of life glowing throughout your entire system. I'm going to tighten up those muscles in and around your heart, kidneys and stomach. I'm going to shoot a quiver up your spine so that you will stretch out your big, brawny arms and shout for bigger and harder tasks to do. Nothing will seem impossible.

Sounds good, doesn't it? You can bet your Sunday socks it's good. It's wonderful. And the best of it is, I don't just promise you these things—I guarantee them. Do you doubt me? Come on, then, and make me prove it. That's what I like.

Are you ready? Atta boy! Let's go.

Send For My New  
64 Page Book

# "Muscular Development"

IT IS FREE

It contains forty-three full-page photographs of myself and some of the many prize-winning pupils I have trained. Many of these are leaders in their business professions today. I have not only given them a body to be proud of, but made them better doctors, lawyers, merchants, etc. Some of these came to me as pitiful weaklings, imploring me to help them. Look them over now and you will marvel at their present physiques. This book will prove an impetus and a real inspiration to you. It will thrill you through and through. All I ask is ten cents to cover the cost of wrapping and mailing and it is yours to keep. This will not obligate you at all, but for the sake of your future health and happiness do not put it off. Send today—right now, before you turn this page.

**EARLE E. LIEDERMAN**

Dept. 2002 305 Broadway, New York City

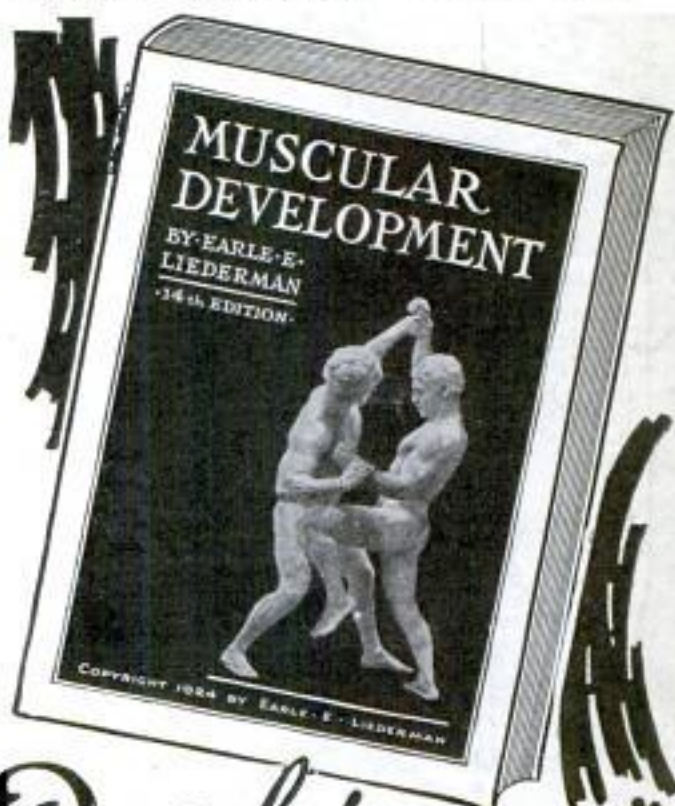

**EARLE E. LIEDERMAN**

Dept. 2002, 305 Broadway, New York City

Dear Sir:—I enclose herewith 10 cents for which you are to send me, without any obligation on my part whatever, a copy of your latest book, "Muscular Development." (Please write or print plainly.)

Name .....

Street .....

City ..... State .....





### I GUARANTEE

to give you personal, individual training in every branch of Dental Laboratory work, to make you expert in a few months!

# Be a Dental Laboratory EXPERT!

\$3.00 an Hour  
 \$20.00 a Day  
 \$125.00 a Week  
 \$500.00 a Month  
 \$6000 to \$10,000 a Year

## Get ready for these Jobs!

Where else can you earn such large salaries after only a few months of training? My training is the quickest way to BIG PAY. At my schools you become Expert in EVERY BRANCH of Dental Laboratory work, not merely skilled in some one part of it. That is why you will read letters in my book from McCarrie graduates telling of winning wonderful successes and enormous salaries.

## Open a Laboratory!

That's the big thing my students and graduates aim for—a business all their own! Remember when you are a McCarrie-trained Dental Laboratory Expert IT TAKES VERY LITTLE CAPITAL to open a Laboratory of your own. So I say to my students and to you—train at my schools as the shortest road to a business of your own, good for profits of \$6,000 to \$10,000 a year.

## Get This Book Quick!

It will show you how to pull yourself out of the rut, how to lift yourself out of small pay, hard work into the fascinating, professional life of the well paid Dental Laboratory Expert. You need this book if you are earning less than \$75 a week and want to make something of your future. Coupon brings it, mail it today!



H. A. McCarrie, Director, McCarrie Schools of Mechanical Dentistry.

1338-1340 S. Michigan Ave., Dept. 1801-B, Chicago

Send me your two free offers and your Book without cost or obligation. Tell me about the Dental Laboratory business and the training you give at your schools.

I attach letter stating the kind of work I am interested in while training at your schools.

..... Name

..... St. No.

..... City ..... State

With my training any fellow with a little mechanical ability can become a Dental Laboratory Expert in a few months! Here is a growing, uncrowded business calling for more experts than it can find—men trained as I will train you to make Crowns, Plates, Bridges, etc., for Dentists. This work is interesting, clean, easy. Salaries \$75 to start up to \$125 and more per week for EXPERTS. Why don't you investigate the wonderful opportunities of this profession and break away from poorly paid *harder* work?

## "Work your way thru McCarrie School"

In Chicago (and Detroit) any ambitious fellow can with my help find a well paid position which will enable him to attend my schools evenings. Hundreds now at my schools, hundreds who have graduated have done this. Others go to my schools days and work evenings.

### Day or Evening Instruction

Don't let lack of ready money keep you back. I will help you. When you mail coupon for complete information, be sure and tell me what kind of work you are interested in, so I can arrange to place you at once when you arrive.

This picture shows how I train my students. No classes, no text-books. You learn on actual "cases" from ethical practical Dentists, you learn with standard instruments on actual materials at my schools. Individual, personal instruction, intensive methods, enable you to become expert in every branch of Dental Laboratory in only a few months. My schools at Chicago and Detroit are the largest and best equipped Dental Laboratory schools in the world, and my graduates are the most successful.



This is Not a "Correspondence" School. You Learn Here by Doing Actual Dental Laboratory Jobs.

**FREE** 1. R. R. FARE TO CHICAGO OR DETROIT  
2. COMPLETE OUTFIT

In order to encourage more men to go into Dental Laboratory work and meet the big demand from Dentists and Laboratories I am making extraordinary inducements right now! Even if you have only common schooling, no matter what your age, get all the facts about this wonderful business and my remarkable offers quick.

Coupon brings complete information, mail it or write immediately.

Address, H. A. McCARRIE, Director

## McCarrie Schools of Mechanical Dentistry

Dept. 1801-B, 1338-40 So. Michigan Ave., Chicago



# NOW FREE!

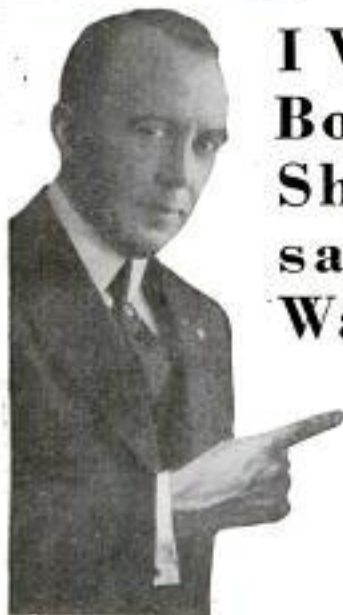

I Will Give You the  
Book That Has  
Shown Thou-  
sands the  
Way to

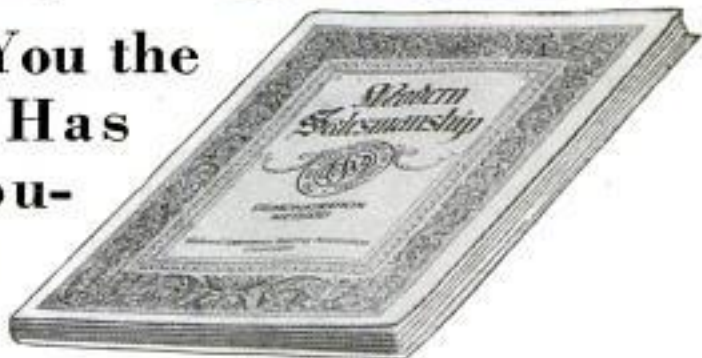

## AMAZING SALARY INCREASES!

TAKE this situation. A man who had worked all his life in a routine job at low pay suddenly surprises his friends by moving into a better neighborhood, taking a big house, buying a car and blossoming out as a well-to-do and influential citizen in his new community. How did he do it? What is the secret that he used? Simple enough. He knew that the biggest money in business is in selling; and though he felt that he couldn't sell a thing, he learned the secrets that make Master Salesmen, and then began to make big money.

If only one man had found inspiration enough in this remarkable book to make a brilliant success in the Selling field—in a job paying him many times his former salary—then you might call it luck. But thousands have done it.

### Your One Chance to Make the Biggest Money of Your Life

Not one of the men whose names appear at the right had ever sold a thing before—not a dime's worth. If you had told one of them that he could sell, he would have laughed at you.

They were frankly skeptical. Yet every one of these men, through reading this book, discovered the fallacy of this vicious old idea that Salesmen are "born." They learned that Master Salesmen are made! And in this book they found an easy way to go from low pay to big earnings.

### Simple as A B C

Sounds remarkable, doesn't it? Yet there is nothing remarkable about it. There are certain ways to approach different types of prospects to get their undivided attention—certain ways to stimulate keen interest—certain ways to overcome objections, batter down prejudices, outwit competition and

make the prospect act. If you will learn these principles, there is awaiting you a brilliant success and more money than you ever thought of earning. This book, "Modern Salesmanship," tells exactly how the National Salesmen's Training Association will make you a Master Salesman.

As soon as you are qualified and ready, the Employment Service of the National Salesmen's Training Association will help you to select and secure a selling position as city or traveling salesman.

### Now Free to Every Man

We are not making any extravagant claims about what we will do for you. We don't have to. The records of the real successes for which we are responsible are so overwhelming a testimonial of the fact that any man of average intelligence can become a Master Salesman that we are willing to leave the decision entirely up to you. All of this proof and many important features about Salesmanship are contained in "Modern Salesmanship." It is yours—FREE. Send the coupon for it today. It will show you how you can quickly become a Master Salesman—a big money-maker. It will tell you about the National Salesmen's Training Association system of Salesmanship Training that has meant prosperity to so many thousands of men—about the National Demonstration Method that gives you actual experience while studying—and all about the fine opportunities that await you in the selling field. Mail the coupon NOW.

### READ!

*Charles Berry, of Winterset, Ia., stepped from \$18 a week as a clerk to a position making him \$1,000 the very first month. J. P. Overstreet, of Dewison, Tex., read this book, left a job on the Capital Police Force, and in six weeks earned \$1,800. F. Wynn, Portland, Ore., an ex-service man, earned \$554.37 in one week. George W. Kearns, of Oklahoma City, found in this book a way to jump his earnings from \$60 a month to \$524.00 in two weeks, and C. W. Campbell learned from it how he could quit a clerking job on the railroad to earn \$1,632 in thirty days.*

**National Salesmen's Training Association**  
Dept. 12-B, N. S. T. A. Bldgs., 1139 N. Dearborn, Chicago

National Salesmen's Training Association, Dept. 12-B,  
N. S. T. A. Buildings, 1139 N. Dearborn, Chicago, Ill.

I simply want to see the facts. Send me FREE your Book, "Modern Salesmanship," and Proof that I can become a Master Salesman.

Name.....

Address.....

City.....State.....

Age.....Occupation.....





## An Easy Way to Learn PHARMACY AT HOME

Graduate pharmacists are always in demand. The work is interesting and pleasant and salaries are good. Many young men open drug stores of their own and become independent.

There's an easy way to learn pharmacy right in your own home in spare time, without losing a day or a dollar from your present work.

The International Correspondence Schools course in Pharmacy supplies the knowledge which it will be necessary for you to have in order that you may pass your State Board Examination.

Just mark and mail the coupon printed below to the International Correspondence Schools, Box 5677-D, Scranton, Pa., and full particulars about the Pharmacy Course or any other work of your choice will come speeding to you by return mail.

### INTERNATIONAL CORRESPONDENCE SCHOOLS Box 5677-D, Scranton, Penna.

Without cost or obligation, please send me full information about the subject before which I have marked an X in the list below:

#### TECHNICAL AND INDUSTRIAL COURSES

- |  |   |
|--|---|
| <input type="checkbox"/> PHARMACY                | <input type="checkbox"/> Civil Engineer                                     |
| <input type="checkbox"/> Chemistry               | <input type="checkbox"/> Surveying and Mapping                              |
| <input type="checkbox"/> Automobile Work         | <input type="checkbox"/> Mine Foreman or Engineer                           |
| <input type="checkbox"/> Navigation              | <input type="checkbox"/> Steam Engineer                                     |
| <input type="checkbox"/> Agriculture and Poultry | <input type="checkbox"/> Gas Engine Operating                               |
| <input type="checkbox"/> Mathematics             | <input type="checkbox"/> Wireless <input type="checkbox"/> Airplane Engines |
| <input type="checkbox"/> Electrical Engineering  | <input type="checkbox"/> Architect  |
| <input type="checkbox"/> Electrician             | <input type="checkbox"/> Contractor and Builder                             |
| <input type="checkbox"/> Mechanical Engineer     | <input type="checkbox"/> Architectural Draftsman                            |
| <input type="checkbox"/> Mechanical Draftsman    | <input type="checkbox"/> Concrete Builder                                   |
| <input type="checkbox"/> Machine Shop Practice   | <input type="checkbox"/> Structural Engineer                                |
| <input type="checkbox"/> Railroad Positions      | <input type="checkbox"/> Plumbing and Heating                               |

#### BUSINESS TRAINING COURSES

- |   |   |
|---|---|
| <input type="checkbox"/> Business Management                              | <input type="checkbox"/> Salesmanship                                     |
| <input type="checkbox"/> Industrial Management                            | <input type="checkbox"/> Advertising                                      |
| <input type="checkbox"/> Personnel Organization                           | <input type="checkbox"/> Better Letters                                   |
| <input type="checkbox"/> Traffic Management                               | <input type="checkbox"/> Foreign Trade                                    |
| <input type="checkbox"/> Business Law                                     | <input type="checkbox"/> Stenography and Typing                           |
| <input type="checkbox"/> Banking and Banking Law                          | <input type="checkbox"/> Business English                                 |
| <input type="checkbox"/> Accountancy (including C.P.A.)                   | <input type="checkbox"/> Civil Service                                    |
| <input type="checkbox"/> Nicholson Cost Accounting                        | <input type="checkbox"/> Railway Mail Clerk                               |
| <input type="checkbox"/> Bookkeeping                                      | <input type="checkbox"/> Common School Subjects                           |
| <input type="checkbox"/> Private Secretary                                | <input type="checkbox"/> High School Subjects                             |
| <input type="checkbox"/> Business Spanish <input type="checkbox"/> French | <input type="checkbox"/> Illustrating <input type="checkbox"/> Cartooning |

Name.....  
Street.....  
Address.....  
City..... State.....

Occupation.....  
Persons residing in Canada should send this coupon to the International Correspondence Schools Canadian, Limited, Montreal, Canada

## We Teach COMMERCIAL ART

Meyer Both Company, the largest Commercial Art Organization in the World offers you a practical training based upon twenty-five years of success. This nationally known organization each year produces and sells to advertisers over 15,000 commercial drawings. This well paid profession equally open to men and women. Home study instruction.

### Get Facts Before You Enroll in Any School

Ask the Advertising Manager of the leading newspapers in your city about Meyer Both Company—let them tell you about us. Send four cents in stamps for illustrated book telling of the success of our students.

### MEYER BOTH COMPANY Department of Art Instruction

CHICAGO, ILLS.

Michigan Ave. at 20th St. Dept. 16

Note—To Art and Engraving Firms: Secure artists among our graduates. Write us.

## MUSIC LESSONS FREE

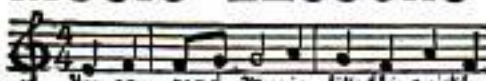





## Men who "know it all" are not invited to read this page

**T**HIS page is not for the wise young man who is perfectly satisfied with himself and his business equipment, who believes that the only reason he is not paid twice as much is that he has never been "given a chance."

This page is a personal message to the man who has responsibilities, who feels secretly that he ought to be earning several thousand dollars more a year, but who simply lacks the confidence necessary to lay hold on one of the bigger places in business. We would like to put into the hands of every such man a copy of a little book that contains the seeds of self-confidence. It is called "A Definite Plan for Your Business Progress" and is sent without obligation.

We have in mind, for example, a certain man who is now auditor of a great corporation in the Middle West. Until he was thirty-one years of age he was a bookkeeper. His employers had made up their minds that he would always be a bookkeeper. His wife was beginning secretly to wonder. Worst of all, he himself was beginning to lose faith.

He investigated the Alexander

Hamilton Institute; without any great hope in its results, he enrolled for the Modern Business Course and Service. The first few months of his association with the Institute were a revelation to him. He found himself being initiated into departments of business that had hitherto been a mystery to him. He was learning the fundamentals of purchasing, of merchandising, of advertising, of office and factory management, and corporation finance.

He began quietly to make suggestions to the officials—suggestions that surprised them, because they had ceased to expect anything from him. They revised their estimate of his capacities; when the position of auditor became vacant, he was given his chance. And recently, on an important financial problem, he argued against the position of the company's own attorneys—basing his argument on principles which the Institute had taught—and by proving his point succeeded in saving the company \$60,000.

The self-confidence which the Institute gave him has transformed that man. He will be a vice-president of that great cor-

poration; and at 31 he was condemned to be a bookkeeper for life.

For the man who is perfectly content with himself and his job the Alexander Hamilton Institute can do nothing. But there are thousands of men who could double their incomes in one year if they believed in themselves and had the solid business knowledge to back up their belief.

To such men the Institute offers "A Definite Plan for Your Business Progress"—a book with power in every page, and which also describes clearly and interestingly what the Alexander Hamilton Institute can do for you. Thousands of successful men regard it as one of the most valuable little books they ever sent for. May we send it to you? The coupon is for your convenience.

Alexander Hamilton Institute  
244 Astor Place, New York City

Send me the book, "A Definite Plan for Your Business Progress," which I may keep without obligation.



Name.....  
*Please write plainly*

Business Address.....

Business Position.....

Alexander Hamilton Institute, Limited, C. P. R. Building, Toronto  
Australian Address, 11c Castlereagh Street, Sydney





## High School Course in Two Years!

### You Want to Earn Big Money!

And you will not be satisfied unless you earn steady promotion. But are you prepared for the job ahead of you? Do you measure up to the standard that insures success? For a more responsible position a fairly good education is necessary. To write a sensible business letter, to prepare estimates, to figure cost and to compute interest, you must have a certain amount of preparation. All this you must be able to do before you will earn promotion. Many business houses hire no men whose general knowledge is not equal to a high school course. Why? Because big business refuses to burden itself with men who are barred from promotion by the lack of elementary education.

### Can You Qualify for a Better Position

We have a plan whereby you can. We can give you a complete but simplified high school course in two years, giving you all the essentials that form the foundation of practical business. It will prepare you to hold your own where competition is keen and exacting. Do not doubt your ability, but make up your mind to it and you will soon have the requirements that will bring you success and big money. **YOU CAN DO IT.**

Let us show you how to get on the road to success. It will not cost you a single working hour. Write today. It costs you nothing but a stamp.

### American School

Dept. H274, Drexel Ave. and 58th St., Chicago

### American School

Dept. H274, Drexel Ave. and 58th St., Chicago

Send me full information on the subject checked and how you will help me win success.

- |                             |                           |
|-----------------------------|---------------------------|
| ....Architect               | ....Business Law          |
| ....Building Contractor     | ....Lawyer                |
| ....Automobile Engineer     | ....Machine Shop Practice |
| ....Automobile Repairman    | ....Mechanical Engineer   |
| ....Civil Engineer          | ....Shop Superintendent   |
| ....Structural Engineer     | ....Employment Manager    |
| ....Business Manager        | ....Steam Engineer        |
| ....Cert. Public Accountant | ....Foremanship           |
| ....Accountant and Auditor  | ....Sanitary Engineer     |
| ....Bookkeeper              | ....Surveyor (& Mapping)  |
| ....Draftsman and Designer  | ....Telephone Engineer    |
| ....Electrical Engineer     | ....Telegraph Engineer    |
| ....Electric Light & Power  | ....High School Graduate  |
| ....General Education       | ....Wireless Radio        |
| ....Vocational Guidance     | ....Undecided             |

Name .....

Address .....



## THERE IS A Master Key

Which can unlock the secret chambers of success; can throw wide the doors which seem to bar men from the treasure house of nature; it is for those only who are wise enough to understand, broad enough to weigh the evidence and firm enough to follow their own judgment. This may seem too good to be true, but when you remember that by the touch of a button or the turn of a lever science has placed almost infinite resources at the disposal of man, it is evident that there may be other resources not generally known, but which contain even greater possibilities. One writer says:

"I have found the Master Key and with it each day am unlocking the storehouse of wisdom and success of which I was heretofore utterly ignorant." A Master Key will be sent to any address without cost or obligation. Send for one.

MASTER KEY INSTITUTE, 214 Howard Bldg., St. Louis, Mo.



## "BECOME A LIGHTNING TRICK CARTOONIST"

MAKE MONEY CHALK TALKING. SEND \$1.00 FOR SNAPPY RIDGEMAN OF TRICK DRAWINGS WITH INSTRUCTIONS BY A PROFESSIONAL CARTOONIST. SATISFACTION GUARANTEED. CIRCULAR FREE. BALDA ART SERVICE, Q1, 05H HOSH, WIS.

## "STAMMERING Its Cause and Cure"

You can be quickly cured if you stammer. Send 10 cents, coin or stamps, for 288 page cloth bound book on Stammering and Stuttering. It tells how I cured myself after Stammering and Stuttering for 20 years. BENJAMIN N. BOGUE 6918 Beque Building, 1147 N. Ill. St. Indianapolis

## LEARN ENGINEERING

Great Demand for Practical-Technical Engineers. Big Salaries. Wonderful Opportunities. Thousands of our graduates holding responsible high-salaried positions. Practical-Technical Courses from 3 Months to 2 Years in Electrical and Mechanical Engineering. Simple and Condensed Method. Faculty of Trained Experts. New Building. Extensively Equipped Laboratories and Shops. Department of Architecture. Structural and Mechanical Drafting. Degrees Awarded. Positions Secured. Day and Night Sessions. Catalog D. FREE. Ask about our Earn While You Learn Plan.

FINLAY ENGINEERING COLLEGE, Kansas City, Mo.

## LEARN WATCHMAKING

and become independent. Good-paying positions secured.

Easy to learn. Send for FREE CATALOG.

ST. LOUIS WATCHMAKING SCHOOL, Dept. 5, ST. LOUIS, MO.

MAIL ORDER \$ Start Little Mail Order Business—Free Book Home employment evenings. Beginners Outfit furnished. Book Free. Pier, 842 Cortland St., NEW YORK

NOTICE—All men, women, boys, girls, 17 to 65, willing to accept Government Positions, \$117-\$300 monthly, traveling or stationary write Mr Ozment, 111, St. Louis, Mo AT ONCE



**INFORMATION**

On every electrical subject arranged in **HANDY FORM** under these **CHAPTER HEADINGS**

Electro-Therapeutics  
 Electric Shocks  
 X-Rays  
 Welding  
 Brazing  
 Soldering  
 Heating  
 Motion Pictures  
**RADIO**  
 Radio Hook-ups  
 Telephone  
 Telegraph  
 Electric Bells  
 Cranes  
 Elevators  
 Pumps  
 Electric Ship Drive  
 Electric Railways  
 Electric Vehicles  
 Automobile Starting and Lighting Systems  
 Ignition  
 Generation & Transmission  
 Electric Tools  
 Plant Management  
 Power Station Plans  
**ARMATURE WINDING**  
 Armature Repairing  
 A. C. Motors  
 Alternator Construction  
 Alternators  
 D. C. Motors  
 Dynamos  
 Magnetic Induction  
 Wiring  
 Wiring Diagrams  
 Electric Lighting  
 Sign Flashers  
 Cable Splicing  
 Power Wiring  
 Underground Wiring  
 Outside Wiring  
 Wiring Finished Buildings  
 Tests  
**A. C. Apparatus**  
 (Switch Devices)  
 (Current Limiting)  
 (Lightning Protection)  
 Rectifiers  
 Converters  
 Transformers  
 Power Factor  
 Alternating Currents  
**D. C. Apparatus**  
 (Switches)  
 (Fuses)  
 (Circuit Breakers)  
 (Rheostats)  
 (Watt Hour Rules)  
 Electro Plating  
 Electrolysis  
 Storage Batteries  
 Magnetism  
 Electrical Energy  
 Mechanical Energy  
 Conductors  
 Insulators  
 Static Electricity  
 Dynamic Electricity  
 Magnetic Electricity  
 Radio Electricity  
 Recent Applications  
 Ready Reference  
 Index on all subjects

**FREE EXAMINATION.**  
**PRICE, COMPLETE, \$4**  
**PAYABLE \$1 MONTHLY**

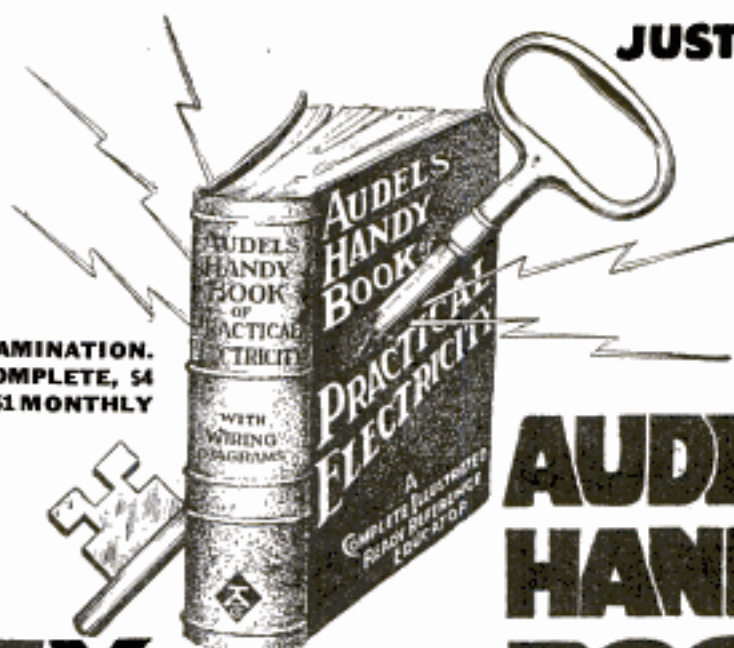
**JUST OUT!**

# KEY to a PRACTICAL UNDERSTANDING of ELECTRICITY

## Audels Handy Book of Practical Electricity, \$4

Here is an up-to-date, quick Ready Reference. It gives complete instruction and inside information on every electrical subject. Every point clearly explained in plain language and diagrams that are easily understood. Handy to use. Easy to learn from. Subjects arranged in progressive manner for the student and with complete index which gives information instantly to professional workers. A time saver, money saver, and a helping hand for Engineers, Professional Electricians, Students and all interested in electrical work.

### Valuable and Helpful Information

Audels Handy Book contains important and valuable wiring diagrams and calculations, machine sketches; instructions and helps on operation, maintenance and repair; outlines showing the entire theory and all modern, practical applications of elec-

tricity; and a big lot of good and useful **RADIO** information and diagrams. The use of Audels Handy Book of Practical Electricity will make you familiar with many time-saving, short-cut, profitable suggestions. As this handy, pocket-size volume covers the entire field of electricity in such convenient form it will prove to be a practical daily helper to both student and professional worker.

### Handsomely Bound in Flexible Red Leather

Audels Handy Book is a magnificent volume that you will be proud to own and carry with you. Gilt Edged. Durable real leather binding. 1040 pages of strong white paper. Large Type. 2600 illustrations and diagrams. A mine of information and a most unusual value at only \$4.

**FOUR DOLLARS COMPLETE**  
**\$4 1040 PAGES \$1 PER MO.**  
**2600 ILLUSTRATIONS**  
**LEATHER BOUND-POCKET SIZE**

Send no money. Pay nothing to postman. Examine book absolutely free. No obligation to buy unless satisfied. If you want to keep the Handy Book, send \$1 within 7 days and \$1 monthly until \$4 is paid.

**FREE  
 EXAMINATION  
 COUPON**

Theo. Audel & Co., 65 W. 23rd St., N. Y. City  
 Please send me AUDELS HANDY BOOK OF PRACTICAL ELECTRICITY for free examination. If satisfactory, I will send you \$1 in 7 days, then \$1 monthly until \$4 is paid.

Name.....

Address.....

Occupation.....

Employed by.....

### FREE EXAMINATION

For the past 40 years we have rendered a specialized educational book service—We accept payment for our books only after **examination** has proven to the purchaser that the books are worth the money. Use this valuable coupon now to take advantage of our free offer in securing **AUDELS Handy Book of Practical Electricity.**





# Learn By Doing!

Every phase of all branches of

## ELECTRICITY

Taught By Actual Practice

In America's foremost institution for trade training.

Established 1902

### No Books Used

Individual Instruction

Start Any Day

A SPECIAL and SEPARATE Course in Ignition, Auto Lighting and STARTER Systems.

Write for FREE 64-Page Catalog

**THE NEW YORK ELECTRICAL SCHOOL**  
44 West 17th Street NEW YORK CITY

Learn to **PAINT SIGNS and SHOW CARDS**

Big field—unlimited possibilities—increasing demand for men with creative ideas. Our course develops ability and originality. Work is—**extremely interesting.**

**EARN \$25 TO \$75 WEEKLY**

You can do it if ambitious. Successful graduates everywhere. Our course thoroughly covers every phase of work. Our graduates command big salaries. Write for catalog, samples, guarantee and Free Credit Offer.

Detroit School of Lettering, Dept. P. M., Detroit, Mich.

**PIANO JAZZ**

By Note or Ear. With or without music. Short Course. Adult beginners taught by mail. No teacher required. Self-Instruction Course for Advanced Pianists. Learn 67 styles of Bass, 180 Syncopated Effects, Blue Harmony, Oriental, Chime, Movie and Cafe Jazz, Trick Endings, Clever Breaks, Space Fillers, Sax Sturs, Triple Bass, Wicked Harmony, Blue Obligato, and 247 other Subjects, including Ear Playing and Musical Invention. 110 pages of REAL Jazz, 25,000 words. A Postal brings our FREE Special Offer.

Waterman Piano School, 293 Superio Theatre Bldg., Los Angeles, Cal.

**"THERE'S MONEY IN IT"**

**AT HOME LEARN TELEGRAPHY AT HOME**

**MORSE AND WIRELESS**

**TEACH YOURSELF** in half usual time, at trifling cost, with the wonderful Automatic Transmitter, **THE OMNIGRAPH**. Sends unlimited Morse or Continental messages, at any speed, just as an expert operator would. Adopted by U. S. Government, and leading Universities, Colleges and Telegraph Schools. 3 Styles. Catalog free. **OMNIGRAPH MFG. CO., 16-22 Hudson St., NEW YORK**

If you own a Radio Phone Set—and don't know the code—you are missing most of the fun.

**YOUR OWN BUSINESS**

**EARN \$40 to \$200 WEEKLY**

Finishing Kodak Pictures. I teach this fascinating, profitable work by mail. Furnish everything to start. Give second advice. Booklet on request.

**CHIPMAN SYSTEM, 104 MITCHELL BLDG., SYRACUSE, N. Y.**

**MINSTRELS** Musical Comedies and Revues, with full instructions for staging. You can stage your own show with our books. Full line of plays, stage songs, crossfire, monologues, afterpieces, vaudeville acts and make-up. **CATALOGUE FREE.**

**T. S. DENISON & CO., 623 So. Wabash, Dept. 19 Chicago**

**WANTED**

**RAILWAY POSTAL CLERKS**

**\$1600 to \$2300 Year**

**MEN—BOYS 18 UP MAIL COUPON IMMEDIATELY**

*Steady Work No Layoffs Paid Vacations*

*Common Education Sufficient*

**TRAVEL—SEE YOUR COUNTRY**



**FRANKLIN INSTITUTE, Dept. W176, Rochester, N. Y.**

Send me without charge, (1) Specimen Railway Postal Clerk Examination questions. (2) Send List of U. S. Government jobs now obtainable. (3) Send free illustrated book, "How to Get Government Jobs." (4) Send free sample coaching lessons.

Name.....

Address.....



# How I Found a Short-Cut to Popularity

When they called me a back number something within me rebelled. My pride, perhaps. Then it dawned upon me! At first I didn't believe that anyone could become popular quickly. And yet—here's what happened.

I NEVER was much of a dancer. But when our club gave a dance, I couldn't very well stay away. Besides—how could I ever learn to dance if I didn't get some experience?

I discovered, though, that no one wanted to dance with me. The boys knew I was a poor dancer and they warned the girls to keep away from me. "Jim?" I heard one of the boys say. "Oh, Jim's all right, but he doesn't know a waltz from a fox-trot." The girls laughed. It made me want to chuck it all and never go to another dance again.

But something within me rebelled. My pride, perhaps. "Show them you can do it!" it whispered. "Show them you can dance as well as they!" But how? I asked myself. I really couldn't dance. I had no confidence in myself. I certainly couldn't go to a dancing school, and I couldn't afford a private teacher. What *could* I do?

Suddenly I had an idea. Yes, I'd do it! I'd astound them! I'd become the best dancer of them all!

That evening I wrote to Arthur Murray, world-famous dancing master. I knew that he charged \$10.00 a lesson in his studio, but I knew also that he had five lessons in dancing that he offered free. I asked him to send these five lessons to me.

When they came, I followed the simple directions and diagrams, practising before a mirror. Before I knew it, I had mastered a fascinating fox-trot step! I learned how to follow, how to lead, how to be perfectly at ease and have poise of manner in the ballroom. It was wonderful! In one evening I learned to dance.

And then I astounded everyone! I went to a dance (no one expected me to accept the invitation) and I deliberately asked the best dancer there to be my partner. It was a fox-trot. We began to dance, and others stopped to watch us. They expected me to be the goat again—but they were disappointed.

We danced that fox-trot perfectly together. We did all the latest steps like professionals. I was absolutely at ease, never felt so comfortable and poised before. It was wonderful! *They'll never laugh at my dancing again.*

Arthur Murray will be glad to send his five free lessons to anyone who is interested in becoming an accomplished dancer. These lessons prove better than anything he can say that through his method anyone can learn to dance at home, without music and without a partner. These lessons teach you how to lead and follow, how to waltz and fox-trot, how to have poise and confidence. Send for them today—they are yours to keep without obligation. This coupon brings them promptly.

**ARTHUR MURRAY**

**Studio 404 801 Madison Ave., N. Y.**



Posed by  
Edna  
Murphy,  
"Pathe  
FilmStar,"  
and  
Arthur  
Murray

Arthur Murray, Studio 404  
801 Madison Ave., New York

To prove that I can learn to dance at home in one evening you may send me the FIVE FREE LESSONS, which are (1) The Secret of Leading; (2) How to Follow Successfully; (3) How to Gain Confidence; (4) A Fascinating Fox-trot Step; (5) A Lesson in Waltzing. I enclose 10c to pay for the postage, printing, etc.

Name.....

Address.....

City.....State.....





## Men Needed in Electricity

**NO PROFESSION** offers greater opportunity to-day than Electricity. Salaries of \$12 to \$30 a day are not uncommon and the opportunity for advancement is unlimited.

As Forrest Crissey said recently in *The Saturday Evening Post*—"The demand for electrical work is increasing immensely and electrical contractors assert that the supply of electrical workers cannot overtake the demand for several years."

Now is the time to prepare for a good position in this profitable, interesting profession. You can study right at home in spare time through the International Correspondence Schools—just as so many other men have done. The I. C. S. Electrical Courses have been endorsed by Thomas A. Edison and Charles P. Steinmetz—the late electrical wizard of the General Electric Co.

Just mark and mail the coupon printed below and full information about Electrical Engineering, Electric Lighting, Electric Wiring, Electric Railways, Radio or any other work of your choice will come to you by return mail.

Mail the Coupon To-day

### INTERNATIONAL CORRESPONDENCE SCHOOLS

BOX 5674-D SCRANTON, PA.

Explain, without obligating me, how I can qualify for the position, or in the subject, before which I mark X.

- |  |   |
|--|---|
| <input type="checkbox"/> ELECTRICAL ENGINEER             | <input type="checkbox"/> CHEMICAL ENGINEER                              |
| <input type="checkbox"/> Electrician                     | <input type="checkbox"/> Pharmacy                                       |
| <input type="checkbox"/> Electric Wiring                 | <input type="checkbox"/> SALESMANSHIP                                   |
| <input type="checkbox"/> Electric Lighting               | <input type="checkbox"/> Show Card and Sign Painting                    |
| <input type="checkbox"/> Electric Car Running            | <input type="checkbox"/> RAILROAD POSITIONS                             |
| <input type="checkbox"/> Heavy Electric Traction         | <input type="checkbox"/> ILLUSTRATOR                                    |
| <input type="checkbox"/> Electrical Draftsman            | <input type="checkbox"/> DESIGNER                                       |
| <input type="checkbox"/> Electric Machine Designer       | <input type="checkbox"/> BUSINESS MANAGEMENT                            |
| <input type="checkbox"/> Telegraph Expert                | <input type="checkbox"/> Private Secretary                              |
| <input type="checkbox"/> Practical Telephony             | <input type="checkbox"/> Business Correspondent                         |
| <input type="checkbox"/> MECHANICAL ENGINEER             | <input type="checkbox"/> BOOKKEEPER                                     |
| <input type="checkbox"/> Mechanical Draftsman            | <input type="checkbox"/> Stenographer and Typist                        |
| <input type="checkbox"/> Toolmaker                       | <input type="checkbox"/> Cert. Public Accountant                        |
| <input type="checkbox"/> Machine Shop Practice           | <input type="checkbox"/> Traffic Management                             |
| <input type="checkbox"/> Gas Engineer                    | <input type="checkbox"/> Commercial Law                                 |
| <input type="checkbox"/> CIVIL ENGINEER                  | <input type="checkbox"/> GOOD ENGLISH                                   |
| <input type="checkbox"/> Surveying and Mapping           | <input type="checkbox"/> Common School Subjects                         |
| <input type="checkbox"/> Reading Architects' Blue Prints | <input type="checkbox"/> CIVIL SERVICE                                  |
| <input type="checkbox"/> METALLURGY                      | <input type="checkbox"/> Railway Mail Clerk                             |
| <input type="checkbox"/> ARCHITECT                       | <input type="checkbox"/> STATIONARY ENGINEER                            |
| <input type="checkbox"/> Architectural Draftsman         | <input type="checkbox"/> Textile Overseer or Supt.                      |
| <input type="checkbox"/> PLUMBING AND HEATING            | <input type="checkbox"/> AGRICULTURE <input type="checkbox"/> Spanish   |
| <input type="checkbox"/> Sheet Metal Worker              | <input type="checkbox"/> Navigator <input type="checkbox"/> Math'm's    |
| <input type="checkbox"/> Automobiles                     | <input type="checkbox"/> Poultry Raising <input type="checkbox"/> RADIO |

Name \_\_\_\_\_ 3-6-24  
 Present Occupation \_\_\_\_\_ Business Address \_\_\_\_\_  
 Street and No. \_\_\_\_\_  
 City \_\_\_\_\_ State \_\_\_\_\_

Canadians may send this coupon to International Correspondence Schools Canadian, Limited, Montreal, Canada

## CAN YOU DRAW THIS?



Learn to draw. It is a big asset, no matter what field you are in.

### SEND NO MONEY

Just sign your name and address on blank line below, tear out and mail to us. Upon arrival of **\$3.98** Course pay postman only \$3.98 payment in full for the entire Course and Free drawing outfit. If not entirely satisfied, return within five days and we will REFUND MONEY. Address **LEDERER SCHOOL OF DRAWING Dept. 674-F, Chattanooga, Tenn.**

**FREE** If you order the Course at once, we will include a drawing outfit, consisting of artist's pencils, pens, paper, eraser, thumb tacks, etc., enabling you to go to work without any additional cost.

Name \_\_\_\_\_ Address \_\_\_\_\_  
 Cash must accompany orders outside U. S.

## Learn to Mount Birds



Learn at home by mail, to mount birds, animals, game heads; tax furs, make rugs and robes. Complete lessons. Easily and quickly learned by men, boys and women.

**FREE** Write today for Free Taxidermy Book. Tells all about it. Every Sportsman, Hunter, Trapper and Nature lover should know this wonderful fascinating art. Save your troubles. Big profits. Success guaranteed. Our school is 20 years old—5,000 graduates. Investigate today. Write for Free Book.

Northwestern School of Taxidermy 9772 Elwood Bldg., Omaha, Neb.

## \$1000 REWARD!!

Big rewards like this are being made every day to the trained Finger Print Expert. Share in these rewards. There is a wonderful opportunity for the trained Finger Print man. Besides, high grade secret service men are usually Finger Print Experts. Enroll now under my personal training and I will give you a fine professional Finger Print Outfit and a valuable course in Secret Service Intelligence—both **FREE**

I will send you Free Secret Service Reports and tell you about the five jobs waiting for the trained Finger Print Expert. Write Today.

**U. S. SCHOOL OF FINGER PRINTS**

7003 North Clark Street, Dept. 13-52, Chicago, Illinois

## LAW STUDY AT HOME

Become a lawyer. Locally trained men win the highest positions and biggest success in business and public life. Be independent. Greater opportunities now than ever before. Big corporations are headed by men with legal training. Earn **\$5,000 to \$10,000 Annually**. We guide you step by step. You can train at home during spare time. Degree of LL. B. conferred. LaSalle students practicing law in every state. We furnish all text material, including fourteen-volume Law Library. Low cost, easy terms. Get our valuable 100-page "Law Guide" and "Evidence" books free. Send for them NOW. LaSalle Extension University, Dept., 256-L Chicago. The World's Largest Business Training Institution

## AGENTS—500% Profit

### Genuine Gold Leaf Letters



### GUARANTEED TO NEVER TARNISH

Anyone can put them on stores and office windows. Enormous demand, large profits. Paul Clark says: Smallest day \$28.70. R. L. Reel made \$920 in two months. Write today for free sample and liberal offer to general agents.

**METALLIC LETTER CO.**  
 433-C N. Clark, Chicago



# What Do You Want to Play- Jazz?-Ballads? -Classics?



What makes a party a success?  
What's always in demand?  
What's the centre of attraction?  
Who's the popular person?  
Who gets all the invitations?  
Who makes things hum? .

} Music  
} The  
} Musician

**W**HAT'S the use of sitting by and listening to others entertain when you, yourself, can get up and start things going? If you can play any kind of an instrument—piano, banjo, violin, cornet, saxophone—you'll have a good time wherever you go. Your friends will be eager to hear you, anxious to have you join them, and ready to admire and acclaim your talent. Musicians are never neglected—they are always in demand, sure to be included in the fun.

## Learn to Play in a Few Months

**You Can Play!** And you can learn to play anything you want—popular and sacred songs, dance music, ballads, jazz, opera. Not only that, but you can play them like an expert.

It doesn't make a bit of difference if you don't know one note from another—you can now progress with your music in an easy, rapid manner!

This remarkable new method of learning to play completely does away with dull, monotonous finger exercises! Right from the beginning you learn to read notes and to play simple little tunes—a hymn, a lullaby, a song. And within a short time—you'll be playing many of the familiar airs you have always loved.

## Play Any Instrument You Want

Suppose you want to play the cornet, or the violin, or the saxophone, and there's no one near to teach you. You have to give up the idea! Or suppose the teacher's fee is too high. You have to do without the lessons! Yet all the time you're longing to know how to play.

The U. S. School of Music has solved this problem for 350,000 others and brought them joy and happiness by satisfying their desire for music. This simple Print-and-Picture method of teaching music

has positively done away with all need for years of study, long hours of tiresome practice and expensive teachers. You can actually save enough money, through this course,

to enable you to learn to play a second instrument!

All you need do is read the list of instruments in the panel, decide which one you want to play, and let the School teach you! No tricks—no stunts! You learn to read notes and play from regular music. All the hard, complicated "mysteries" of music have been reduced to an amazingly simple system. Every step of this method is as clear as A, B, C. Children as young as 7 years old have taught themselves how to play. If they can do it—surely you can!

## Send for Complete Details—Booklet Free

Whether you are a beginner or an advanced student you'll want to read all about this wonderful method. And you'll find complete description and full details of the courses clearly described in a wonderfully new interesting book, "Music Lessons In Your Own Home." Just mail the coupon and the book will be sent by return mail.

You place yourself under no obligation whatever. The booklet is FREE.

It is so difficult to properly describe a Home-Study method of teaching, that we are sending free with the booklet, an illustrated Print-and-Picture lesson which will give you a clear idea of how thousands of others have learned to play. If you want to have a good time wherever you go—if you want to make yourself popular—send for this booklet and sample lesson before this offer is withdrawn. U. S. SCHOOL OF MUSIC, 72 Brunswick Bldg., New York City.

Be sure to write name and address plainly so book and lesson will reach you.

U. S. SCHOOL OF MUSIC, 72 Brunswick Bldg., New York City

Please send me your free book, "Music Lessons In Your Own Home." Illustrated folder and particulars of your special offer. I am interested in the following course:

.....  
Have you above instrument.....  
Name.....  
(Please write plainly)  
Address.....  
City.....State.....

### LEARN TO PLAY ANY INSTRUMENT

Mandolin	Saxophone
Drums and Traps	Piano
Harmony and Composition	Organ
Banjo	Violin
Sight Singing	Clarinet
Ukulele	Flute
Piccolo	Harp
Guitar	Cornet
Hawaiian	Cello
Steel Guitar	Trombone
Voice and Speech Culture	Automatic Finger Control



# The Mighty Stories of History

Told in Fascinating Story Form

**T**HINK of being able to read — in easy story form — about all the stirring events that have made the world's history. Dr. Ridpath's eminent position as an historian is due largely to his wonderful flowing style, a style no other historian has ever equalled. Ridpath, the profound scholar, the authority among authorities, has written history so that it reads like a great novel. He takes you with him through the life of the past. Pick up Ridpath's History at any point and you will find a thrilling story — an account of some great historical occurrence that seems to happen before your eyes.

6000 Years of History



Joan of Arc Burned at the Stake



## Ridpath's History of the World

Including a Full Account of the World War

has long been recognized as standard authority. Ridpath is endorsed by Presidents of the United States, practically all college presidents, by a quarter of a million Americans who own and love it. **New Edition** of nine handsome Octavo volumes just off the press contains complete and accurate account of the World's history from the dawn of time through the great World War to the administration of President Coolidge. Ridpath covers every race, every time and holds you spellbound with his wonderful eloquence.

**HISTORY BOOK FREE** Send now for beautifully illustrated 46-page history book. Contains actual sample pages and pictures of Ridpath's History. Also we shall send you complete details of manufacturer's unusual direct low price offer and convenient easy terms. Learn about the special on approval offer. No obligation. Book is free. Tear off the coupon. Write your name and address plainly and mail now while you are thinking of it.

**Ridpath Historical Society,**  
1772 United Bank Bldg., Cincinnati, Ohio.

Please mail, without cost to me, the 46-page history book containing sample pages and pictures of Ridpath's History of the World. Also write me full details of your special low price and easy payment offer to readers of Popular Mechanics

Name.....

Address.....

## Learn to Write

### I Teach by Mail

I can make a good penman of you at your home during spare time, no matter where you live or how poorly you now write. My simplified system has shown thousands the way to good penmanship during the past twenty-five years — it CAN and WILL do the same for YOU.

My beautifully illustrated 32-page Book:

**"How to Become a Good Penman" FREE!!**

It contains many beautiful specimens of penmanship showing what others have accomplished by the Tamblin System, with testimonials and general information about our courses. (Your name elegantly written on a card if you enclose stamp for postage.) Ladies taught as successfully as men. Write Today. Address:

**F. W. TAMBLIN**  
418 Ridge Bldg. Kansas City, Mo., U. S. A.

*F. W. Tamblin*

## Wanted Men and Women to Learn Photography!

Photographers and Photo-Engravers earn \$200 to \$500 a month. The field is uncrowded. Learn these profitable and fascinating professions. Taught by largest and best college of its kind in the world. Established over 30 years. Demand for our graduates far exceeds supply. Good positions secured. Tuition and living expenses low.

**Get this FREE Book!** Write today for free book describing wonderful opportunities in this field.

Illinois College of Photography, Box 425, Effingham, Ill.

## Anyone CAN LEARN

No talent or experience necessary. Fascinating work. Pays big money. Complete instruction book tells about: Alphabets, Colors, How to Mix Points, Show Cards, Window Board and Wall Signs, Ready made letters, Gilding, Trade of the Trade, also gives 100 Alphabets and Designs. Book bound in flexible imc. leather-bound edges, and four full bearing Show Cards. Form. Sent postpaid \$3.00, C.O.D. 10%.

Galvin Pub. Co., 57 Race St. Dept. 53, N.Y. City

**EARN MONEY IMMEDIATELY— WE FURNISH EQUIPMENT TO START!!**

## Factory to Rider

Saves \$20 to \$25 on the **Ranger** Bicycle you select. You can have your choice of **44 Styles**, colors and sizes. Delivered free on approval, express prepaid, for **30 DAYS' FREE TRIAL**. Bicycles, \$21.50 up. **\$5 a Month** if desired. Possession and use at once. Payments often advanced on our Liberal Easy Payment plan.

**Tires** best quality, at factory prices, express prepaid. Lamps, wheels and equipment, low prices. Send **NO MONEY** to business direct with makers.

**Mead CYCLE COMPANY**  
DEPT. 108 CHICAGO

Write today for free Ranger Catalog. Factory prices and marvelous easy payment terms.

## I Guarantee You Can Play Any String Instrument in 1 Minute

Most remarkable music invention of the century. Any novice can now play any string instrument—INSTANTLY! A child can play without hesitation. No notes to learn—no ear for music needed. The only color system on the market. Full production by U.S. patents. Pronounced marvelous by nationally known musicians.

**\$2000 VALUE FREE!**

Beautiful instrument given with each color number course. Rich, mellow tone.

**Money Back Guarantee**  
Your money back if it fails.

Get full details and free instrument offer. Write Today!

**Schneider School of Music**  
230 Vermont St., Dept. 8-7, Blue Island, Ill.



# \$3500 to \$5000 a Yr.

## Begin NOW to Make 1925 Count for PROGRESS!

Take the First Step Today! Send at once for complete details of how to qualify in Three Months for Success and Professional Earnings in the most rapidly growing Professional Trade—

### MECHANICAL DENTISTRY

The very best opportunity for men who like to use tools. There is need right now for 2500 more Dental Mechanics and the demand is rapidly growing. There are now approximately 56,000 practicing Dentists in the U. S. and only about 4000 full-fledged Dental Mechanics! At the present time the shortage of Mechanical Dentists runs into the thousands with no immediate prospects of this demand being filled. Unequaled opportunity—pleasant, dignified work—steady income—rapid advancement—no "slack seasons" as in most other trades.

### You Learn by Doing

We train each student individually—no classes whatever. Instruction is practical from the very beginning. From the start you use the tools and instruments of the trade and work on practical dental work. But we do not make the serious mistake of depending on practical work alone as some schools do. You are given a definite theoretical training as well, so that you become familiar with both the theory and the practical working methods of Mechanical Dentistry used throughout the Dental Profession.

### Unequaled Curriculum

All phases of Vulcanite Denture construction, with clasp technique, bars, and patented attachments. Occlusion of teeth and anatomical articulation. Crowns of all types—Seamless, Two-piece, Darby, Richmond, Telescope, Carmichael, etc. Fixed Bridges—with and without interchangeable teeth; Sanitary Bridges; Dummy Bridges. Removable Bridges—Nesbit and Bonwell styles; Peso, Brown-Mayer and Gollobin attachments using the Parallelo-meter. Metal Plates—Bodee Span Swedged Plate with attachments, partial rim and full upper swedged Plate, Partial rim Plates with tagged tooth and metal dummy, etc. Casting—every phase of this branch including crowns, bridges, saddles, clasps, plates, etc. Both direct and indirect methods used. Also the technique of carved teeth.

### Why Bodee-Trained Men Lead the Field

The Dental Profession recognizes the Bodee course as the highest standard of efficiency. This institution has maintained its leadership for over 30 years and is the oldest and largest school of Mechanical Dentistry in the world. It is and always has been the chief source of supply for competent dental mechanics. Compare the cost of our course with the charges of other schools offering to teach Mechanical Dentistry. Ask your own dentist to examine the course we give and tell you just how thorough and valuable it is.

### FREE PARTIAL SCHOLARSHIPS

In order to meet the urgent demand for the men we train, we are offering for a limited time Free Partial Scholarships. Be sure to ask immediately for this exceptional offer. It will very much reduce the cost of your training. Remember, this offer will be discontinued soon—so act NOW while it is still in effect.

### SEND FOR CATALOG AND SCHOLARSHIP OFFER

Catalog No. 2 fully describes the field and why the demand. Shows how students "Learn by Doing" actual work through practical, individual instruction, day or evening sessions. Shows how you can "Earn while Learning." This catalog is your First Step to Success in Mechanical Dentistry. IT IS FREE. SEND THE COUPON TODAY.

### BODEE DENTAL INSTITUTE

136 West 52d Street, New York  
1305 No. Broad St., Philadelphia  
1226 Main Street, Buffalo  
85 Court Street, Brooklyn



The Shortest  
Way to  
Professional  
Earnings

**WE  
DO  
NOT**

1—Offer "Free" Railroad Fare—  
*It is plain that any such expense would have to be added to charges for tuition.*

2—Offer "Free" Sets of Tools—*Our regular tuition covers the cost of a Complete Set of Standard Tools of the trade. (See catalog page 25.)*

—BUT—

### HERE'S WHAT WE DO

We give the Most Thorough Course in the Most Practical way. Ask your Dentist about the High Standing of the School and the Quality of the instruction given.

### SEND THIS COUPON

BODEE DENTAL INSTITUTE:  
Without obligation to me send me a Free Copy of your catalog and complete details of the Free Partial Scholarship Plan No. 2.

Name.....

Address.....





## Hotels Start You With Salaries up to \$3500 a Year — with your living

**HOTELS; restaurants; clubs; apartments, everywhere need trained men and women—salaries to start up to \$3500 a year with your living. Over 70,000 high-class positions paying up to \$10,000 a year are open every year in the hotels of the United States. Today this is the 1st INDUSTRY IN AMERICA—with over \$292,394,968 in new hotels being built in 1924—exceeding by \$200,000,000 the next largest industry. These new hotels, restaurants, etc., will need over 60,000 trained men and women.**

You can have one of these high-class big-pay positions, with luxurious meals and apartment and fascinating work. No previous experience necessary. The Lewis Schools guarantee to give you the valuable knowledge that it has taken some of the most successful hotel men years to obtain—men who are now making \$5,000 to \$10,000 a year. We train you by mail in your spare time at home with the Lewis Simplified Study Plan, and we put you in touch with big opportunities. Our students employed, our methods endorsed by leading hotel men everywhere.

Send today for Free Book, "YOUR BIG OPPORTUNITY," showing how we can train you for one of these splendid positions in 20 weeks or less, and explaining our Money-Back Guarantee.

**LEWIS HOTEL TRAINING SCHOOLS**

Room M-388 Washington, D. C.

\*\*\*\*\* FREE BOOK COUPON \*\*\*\*\*

LEWIS HOTEL TRAINING SCHOOLS, Room M-388, WASHINGTON, D. C.

Send me without obligation the Free Book, "YOUR BIG OPPORTUNITY."

Name .....

Address .....

City .....

## How To Speak and Write Masterly English

Every time you speak or write you show just what you are. Mistakes in English reveal you as a person who lacks education and refinement. Lack of language power prevents you from presenting your thoughts in the strongest possible way. No matter what you do, real command of English will help you to your goal. Stop making mistakes in spelling, punctuation, pronunciation. Increase your vocabulary.

### WONDERFUL INVENTION

Only 15 minutes a day with Sherwin Cody's new invention—and you can actually SEE your English improve. It teaches by HABIT—makes it easier to do the RIGHT way. Wonderful self-correcting lessons include Spelling, Punctuation, Grammar, and Expression.

**FREE BOOK ON ENGLISH AND 15 MINUTE TEST** Lack of language power may easily be costing you thousands of dollars every year. See what Mr. Cody can do for you. It costs nothing to find out. Mail a postal card or letter this very minute for free book "How to Speak and Write Masterly English," and 15 Minute Test, which you can take in your own home. It will prove a revelation to you. **WRITE NOW!** Address

Sherwin Cody School of English, 52 Searle Building, Rochester, N. Y.



**LAW IN YOUR SPARE TIME**  
Same course by correspondence as given for 15 years at classes of this college. **LL. B. DEGREE CONFERRED.** 3 year university course prepares for bar exam. Money back guarantee. Low fee, many lessons, includes 1124 12 volume library, lectures, lessons, all expenses. Write for **FREE BOOK.**  
HAMILTON COLLEGE OF LAW, Dep. G-2 431 S. Dearborn St., Chicago



**WANTED!**  
**U. S. RAILWAY MAIL CLERKS**  
**STEADY WORK—NO LAYOFFS—PAID VACATIONS**  
**TRAVEL—SEE YOUR COUNTRY**  
Common Education—Mail Coupon Today—SURE



## This Marvelous Selling Outfit enabled S. C. Snodgrass to make \$225.00 in 7 days

If you are now selling or thinking of selling, investigate this wonder-working sales outfit showing America's greatest line of tailoring for men, in the most powerful order-getting display outfit ever put into the hands of a salesman. With this great line more than 3,000 men are now making \$5.00 an hour and up. If you are ambitious and anxious to get ahead and make money and are willing to work and follow instructions, we'll take you whether or not you have had experience, whether you can give full time or only part of your time. Write today for the full facts about this proposition and its money-making possibilities. Address Dept. 553,

**GOODWEAR Chicago, Inc., 844 W. Adams St., Chicago**

SEND FOR .....

## Art-LIFE MAGAZINE

Art, Nature, Sports, Mental and Physical Culture. For artists, students, thinkers. Stands for **The Body Beautiful** Mind Intellectual, Soul Intentional. Drawings and photos. Animals, birds, designs, cartoons, comics, etc. Art lessons, criticisms, amusements, inspiring articles and poems. Nothing like it. Must be seen. Will help you gain health, wealth and happiness.

**CUT THIS OUT** send with \$1 now for 5 mo. trial sub. (no free samples) O. K. or refund.

**ART and LIFE, Dept. 25-45, KALAMAZOO, MICH**

## LAW High-Grade Instruction

**By Correspondence Prepares You for the Bar—Est. 1892**

University Methods. Standard Text-Books. Approved by Bench and Bar. Graduates practicing in every state. Send today for Free Catalog and Rules for Admission to the Bar.

**CHICAGO SCHOOL OF LAW, 502 Reaper Block, Chicago, Ill.**

## LEARN PIANO TUNING AT HOME

With our TUNE-A-PHONE, Action Model, tools, charts and lessons you can learn quickly and easily and be prepared to make big money. Estb. 1888. Money-back Guarantee. Diploma given. Amazing Surprise in our free book, "Winning Independence." Write for it today.

**Niles Bryant School of Piano Tuning, 40 Bryant Bldg., Augusta, Mich.**

## WHY NOT

spend Spring, Summer and Fall gathering butterflies. I buy hundreds of kinds for collections. Some worth \$1 to \$7 each; simple outdoor work with my instructions, pictures, price-list. Send 10¢ (not stamps) for my Illustrated Prospectus before sending butterflies.

**Mr. Sinclair, Dept. 6, Box 1424, San Diego, Calif.**

## \$1600 to \$2300 Year

**Men—Boys 18 Up. Hundreds Gov't Jobs Obtainable**

**Franklin Institute, Dept. W 178, Rochester, N. Y.**  
Sirs: Send me, without charge: (1) Specimen Railway Mail Clerk Examination questions and free sample coaching lessons; (2) tell me how to get a U. S. Government job; (3) send list of places at which examinations will be held; (4) send copy of illustrated book, "How to Get Government Jobs."

Name .....

Address .....



# Learn Cartooning at Home

## Earn \$100 a Week In This Fascinating Business

**C**ASH in on the amazing ever-increasing popularity of cartoons! Thousands of cartoonists are needed to draw the vast number of political, religious, international, seasonal and human-interest cartoons. There is a crying demand too for men able to produce humorous cartoons, comic strips and sport cartoons. Advertising and animated cartooning offer two wonderful new and almost untouched fields. Never before have the opportunities in cartooning been so many or so varied. Never have cartoonists had such a wonderful chance to make big money. Now indeed is the time to study cartooning!

### New Method Makes Cartooning Easy To Learn

Regardless of how little ability you have in drawing, you can now easily qualify for this attractive highly-paid business. Through a wonderful new method you can learn right at home in your spare time. Learning this way is more than easy—it is actually as fascinating as a game.

First you learn the important fundamental principles of cartoon-making. Then you learn the little secrets of originating ideas, of action, exaggeration, and expression—the little tricks which make cartooning easy to those who know

them. Step by step you advance through every branch of cartooning until almost before you realize it you are drawing cartoons that **SELL**. Many of our students have sold enough work while studying to pay for the course many times over.

Just think of earning a splendid salary for such pleasant work. Successful cartoonists earn from \$3,000 to over \$100,000 a year. Yet enough cartoonists cannot be found to meet the tremendous demand. Right now there is a wonderful opportunity for you in this fast-growing uncrowded field.

### Send for FREE BOOK

Find out more about the wonderful opportunities open to you in this attractive field. Learn more about this easy home-study method of learning cartooning. A handsome booklet has just been prepared

which is crammed full of interesting information about cartooning, and describes in detail this remarkable method. It will be sent to you without cost, without obligation. Mail coupon for it **TO-DAY!**

### Washington School of Cartooning

Room 302C, 1113-15th St. N. W., Washington, D. C.

#### WASHINGTON SCHOOL OF CARTOONING

Room 302C, 1113-15th St. N. W., Washington, D. C.

Please send me without obligation your illustrated booklet on cartooning.

(Print Name Plainly)

Name.....

Address.....

City.....State.....

If under 16 years, please give age.....







## "Send for Andrews —he knows!"

"Seems to me that every time a tough problem comes up around here we always send for Andrews.

"Do you know why? It's because he doesn't guess at a thing—he *knows!* He studies those I. C. S. textbooks every chance he gets, and I want to tell you it has made him a valuable man for this firm.

"This is the last time I'm going to 'send for Andrews.' For when he comes in to-day, he's going to stay in. From now on he's going to sit right in this office as my assistant. I wish I had more men like him."

**H**OW do you stand in your organization? Are you a guesser? Or do you *know!* Make up your mind, to-day, that you, too, are going to get the special training that you must have to get a better job and a larger salary.

One hour a day, spent with the International Correspondence Schools, in the quiet of your own home, will prepare you for the position you want in the work you like best.

Yes it will! Put it up to us to prove it. Without cost, without obligation, mark and mail this coupon and find out what the I. C. S. can do for you!

### INTERNATIONAL CORRESPONDENCE SCHOOLS Box 5670-D, Scranton, Penna.

Without cost or obligation, please tell me how I can qualify for the position or in the subject before which I have marked an X:

#### BUSINESS TRAINING COURSES

- |  |   |
|--|---|
| <input type="checkbox"/> Business Management                     | <input type="checkbox"/> Salesmanship                                     |
| <input type="checkbox"/> Industrial Management                   | <input type="checkbox"/> Advertising                                      |
| <input type="checkbox"/> Personnel Organization                  | <input type="checkbox"/> Better Letters                                   |
| <input type="checkbox"/> Traffic Management                      | <input type="checkbox"/> Show Card Lettering                              |
| <input type="checkbox"/> Business Law                            | <input type="checkbox"/> Stenography and Typing                           |
| <input type="checkbox"/> Banking and Banking Law                 | <input type="checkbox"/> Business English                                 |
| <input type="checkbox"/> Accountancy (including C.P.A.)          | <input type="checkbox"/> Civil Service                                    |
| <input type="checkbox"/> Nicholson Cost Accounting               | <input type="checkbox"/> Railway Mail Clerk                               |
| <input type="checkbox"/> Bookkeeping                             | <input type="checkbox"/> Common School Subjects                           |
| <input type="checkbox"/> Private Secretary                       | <input type="checkbox"/> High School Subjects                             |
| <input type="checkbox"/> Spanish <input type="checkbox"/> French | <input type="checkbox"/> Illustrating <input type="checkbox"/> Cartooning |

#### TECHNICAL AND INDUSTRIAL COURSES

- |   |  |
|---|--|
| <input type="checkbox"/> Electrical Engineering | <input type="checkbox"/> Architect                                   |
| <input type="checkbox"/> Electric Lighting      | <input type="checkbox"/> Architects' Blue Prints                     |
| <input type="checkbox"/> Mechanical Engineer    | <input type="checkbox"/> Contractor and Builder                      |
| <input type="checkbox"/> Mechanical Draftsman   | <input type="checkbox"/> Architectural Draftsman                     |
| <input type="checkbox"/> Machine Shop Practice  | <input type="checkbox"/> Concrete Builder                            |
| <input type="checkbox"/> Railroad Positions     | <input type="checkbox"/> Structural Engineer                         |
| <input type="checkbox"/> Gas Engine Operating   | <input type="checkbox"/> Chemistry <input type="checkbox"/> Pharmacy |
| <input type="checkbox"/> Civil Engineer         | <input type="checkbox"/> Automobile Work                             |
| <input type="checkbox"/> Surveying and Mapping  | <input type="checkbox"/> Airplane Engines                            |
| <input type="checkbox"/> Metallurgy             | <input type="checkbox"/> Navigation                                  |
| <input type="checkbox"/> Steam Engineering      | <input type="checkbox"/> Agriculture and Poultry                     |
| <input type="checkbox"/> Radio                  | <input type="checkbox"/> Mathematics                                 |

Name.....  
Street.....  
Address..... 3-6-24

City..... State.....

Occupation.....  
Persons residing in Canada should send this coupon to the International Correspondence Schools Canadian, Limited, Montreal, Canada.



## Get Ready to fill a BIG JOB

LEARN at HOME in TEN MONTHS spare time

EARN \$3000 to \$10000 a year as a motor designer

EASY to LEARN by Our NEW SYSTEM of Personal Instruction by Mail

No previous experience or knowledge of drafting required. No text books needed. We start you drawing motor details at once and furnish a complete set of drawing instruments and drafting board FREE. All you need is ambition to succeed in life and a determination to invest your spare time evenings into building a future for yourself. The Automotive industry needs thousands of engine draftsmen and motor designers. Hundreds of jobs open in Michigan alone. In only ten months time we guarantee to fit you for a BIG PAY Position. Pay as you learn—a little each month. Send for literature, describing our course and easy payment plan.

Michigan School of Motor Design and Drafting  
331 North Third Street Saginaw, Michigan

## ELECTRICAL ENGINEERING

Course for men of ambition and limited time. Over 4000 men trained. Condensed course in Theoretical and Practical Electrical including the closely related subjects of Mathematics and Mechanical Drawing taught by experts. Students construct motors, install wiring, test electrical machinery. Course complete

### IN ONE YEAR

Established in 1893. Prepare for your profession in the most interesting city in the world. Free catalog. **BLISS ELECTRICAL SCHOOL**  
104 Takoma Ave. WASHINGTON, D. C.

## BE AN ARTIST

WE CAN TEACH YOU DRAWING in your own home during your spare time. Twenty-five years of successful teaching proves our ability. Artists receive large salaries.

Write Today for Art Year Book

**SCHOOL OF APPLIED ART**  
ROOM NO. 2 BATTLE CREEK MICH.



## BE A JAZZ MUSIC MASTER



### PLAY PIANO BY EAR

Play popular song hits perfectly. Hum the tune, play it by ear. Self-instruction—no teacher required. No tedious ding-dong daily practice—just twenty brief, entertaining lessons which you master

At Home in Your Spare Time Send for FREE BOOK. Learn many styles of bars 2-4 4/4 6/8 3/4—trick endings, etc. In stamps brings interesting LIBRARY to test your ability.

NIAGARA SCHOOL OF MUSIC  
Dept. 128, Niagara Falls, N. Y.

Send for this Free Book



# FREE Lesson and Book

## How to Play Hawaiian Guitar

These Professors  
Want to Prove They  
Can Teach You  
by Mail

Learn the Keynote  
to Popularity  
.. and ..  
Social  
Success



Large photo shows our group of native Hawaiian instructors. They are known as Clark's Hawaiians. Photo No. 3 is Meade, DeBarn and Howard broadcasting from W.E.A. Radio station, N.Y. Picture No. 5 is the pair of them all, Harry J. Clark, chief instructor.

THESE native and American Hawaiian Guitar professors under the auspices of the New York Academy of Music, seek the opportunity to prove to you that you can learn how to play Hawaiian Guitar quickly with our short cut method of instruction—you can learn at home in spare time, regardless of the fact you never had musical training.

To prove we can teach you, we will send without obligation your first lesson free and our book, "How to Learn Hawaiian Guitar." We will also furnish free when you enroll, a beautiful, genuine, professional size \$18 Hawaiian Guitar. This is your opportunity to gain popularity and social success. You will soon play as well as native Hawaiians. Play quickly from notes.

With our staff of nine experts as your personal teachers, you are sure to get on, because they have perfected a course for our Academy so simple that it is as easy as learning ABC's.

Free  
\$18  
Hawaiian  
Guitar

### Picture Method Easy

Besides furnishing you with thorough, easy to understand printed lessons, we supply many photographs of our professors' playing. With our professors in action as your guide, it is easy to imitate these pictures. Besides this, you receive diagrams, charts and phonograph records of our instructors' playing which practically brings our professors from our studio to your home.

### Popularity Is Yours We Start You With \$18 Hawaiian Guitar Free

We start you on the road to social success. It's great to be invited to parties where young folks gather to have good times. This popularity will be yours. Immediately when you enroll as a student, you get absolutely free, a beautiful, full tone, genuine \$18.00 Hawaiian Guitar. We also furnish every bit of equipment so that it is not necessary for you to spend an extra penny outside of the cost of our course.

Hawaiian Studio No. 522  
of New York Academy of Music  
212 Fifth Ave., New York, N.Y.

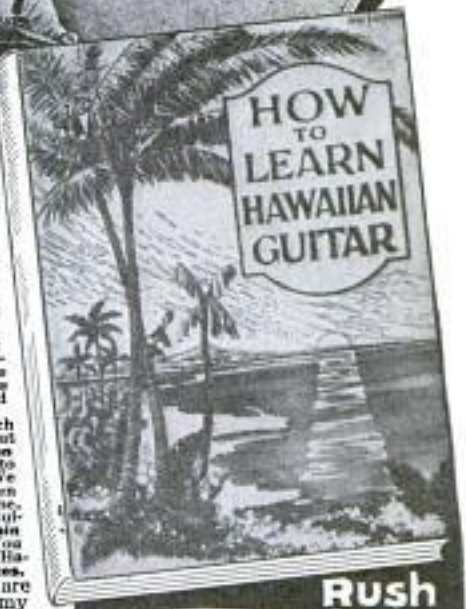

Rush  
Coupon

### Rush Coupon for Free Book & Lesson

So positive are we that you will become one of our students and a booster for our course, that if you write at once, we will send you absolutely free, without any obligation on your part, our first lesson which will enable you to see just what you can expect when you enroll. You will also receive our big book which gives full particulars about our course. Write for your free book and your free lesson today.

Be one of the lucky ones to have a free Hawaiian Guitar reserved for you—write at once, because the number of gift Hawaiian Guitars is limited. Sign coupon and mail now, before you forget.

HAWAIIAN STUDIOS No. 522  
of New York Academy of Music  
212 Fifth Avenue, NEW YORK

Please rush your book, "How to Learn Hawaiian Guitar" and my first free lesson. Also reserve a gift Hawaiian Guitar for me. This obligates me in no way whatever.

Name .....

Address .....

City.....State.....



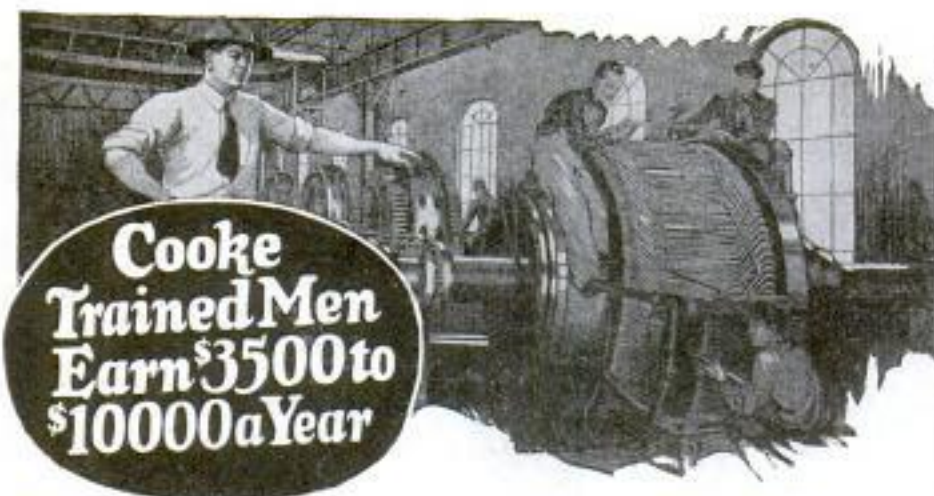

**Cooke  
Trained Men  
Earn \$3500 to  
\$10000 a Year**

## Electricity Needs You I Will Train You at Home



L. L. COOKE,  
Chief Engineer

### Earn Extra Money While Learning

YOU can turn my training into money quick. In a few weeks after you enroll for my course I show you where and how to get spare time electrical work and teach you how to do it. I give you a complete outfit of tools and apparatus to work with. My training pays for itself many times over, even while you are learning. Hundreds of my students earn \$25 to \$35 a week in their spare time, while they are getting ready for a big job—all without losing a single hour from their regular work.

Administration Building of the Chicago Engineering Works, the Million Dollar Institution which stands behind my guarantees. My Electrical Laboratory occupies another big building similar to this.

**GET INTO ELECTRICITY.** The world's biggest and most fascinating business needs you. Ordinary electricians earn \$8 to \$10 a day, but thousands of the biggest jobs—the ones that pay \$12 to \$30 a day, are going begging for want of trained men to fill them. Why stick to your small-pay, no-future job? In a few short months time with my training you can be an Electrical Expert earning \$70 to \$200 a week and not work half so hard as you do now.

### Why Trained Electrical Men Are Needed

Thousands of new power stations—millions of automobiles—the wildfire spread of Radio and an undreamed-of demand for electric light and power—all these things demand more and more trained men. The industry will be sadly crippled without these men—they must be had at any cost. That's why salaries are high and why they will stay high in Electricity.

### I Can Train You Best

I am an engineer with college training and 20 years of practical experience. I have employed and directed the work of thousands of electrical men. I know what a man needs, to be a big success in Electricity. That's what I give you in my course—20 years of practical experience simplified, and made easy for you to understand. My course is the recognized best and most successful training of its kind in America.

### JOBS—How I Get Them For My Students

I am spending over \$25,000 a year to get jobs for my students. This money is actually spent on Employment Service alone. And I do get jobs for my students, even before they finish my course. They don't have to wait until they graduate. It is easy for me to do this because employers of electrical help know that "Cooke" Trained Men KNOW Electricity. They know that "Cooke" Trained Men are the best men they can get.

### My 16 Big Guarantees

I don't promise you anything—I guarantee it with a signed bond backed up by a Million Dollar Institution. It says, "you get your money back if you are not satisfied." There are no strings to this guarantee—you alone are the judge. Among the things I guarantee besides Free Employment Service are—use of my big Laboratory—Accommodations when you visit Chicago—Lifetime subscription to monthly Engineering Magazine—Consultation and Vocational Service—a big outfit of Tools and Apparatus—all FREE. Most of these things are exclusive with my training—you can't get them anywhere else.

### Investigate! Get the Proof! Big Electrical Book FREE!

You want proof? You want facts? These I give you in my big book—The "Vital Facts" about Electricity—Proof that opportunities more wonderful than you ever dreamed of await you—Proof that "Cooke" Trained Men do get the big jobs in Electricity and that I can do more for you than anyone else. Send for my book now. Be a "Cooke" Trained Electrical Expert—Earn \$70 to \$200 a week. Mail the coupon NOW.

L. L. Cooke, Chief Engineer

### CHICAGO ENGINEERING WORKS

Dept. 12  
2150 Lawrence Ave.,  
CHICAGO



The Cooke Trained Man is the "Big Pay" Man

## My Boys Get the Big Jobs in Electricity

**\$800 to \$1000 a  
Month for Jirinec**



In business for himself doing electrical work, John Jirinec, 1133 Fourth Ave., Astoria, L.I., New York, makes over \$10,000.00 per year. He says "Cooke" Training alone is responsible for his success.

**Pence Earns Over  
\$750 Every Month**

W. E. Pence of Albany, Oregon, specializes in Auto Electricity and makes \$750.00 a month. Was formerly a mechanic earning \$30.00 a week. The Auto Electrical Experts have the "white collar" job in Automobile work.



**Jumps from \$5 a  
Day to \$5000 a Year**



This is the 18 months' record of A. F. Kiens, 25 Chass Block, Saginaw, Mich. Now State Superintendent for Miller York Construction Company. Kiens handles big jobs and directs hundreds of men. "Cooke" Training made this possible.

My Free Book contains letters just like these from over 100 other big successful "Cooke" Trained Men.

Mail  
this  
Coupon  
for my  
FREE  
BOOK

L. L. COOKE,  
Chief Engineer,

Chicago Engineering Works, Dept. 12  
2150 Lawrence Ave., Chicago

Send me your book "The Vital Facts About Electricity," full particulars of your Home Study Course, and your 16 guarantees including your plan for helping me earn extra money while learning and details of your Free Employment Service. This does not obligate me to enroll for your course.

Name.....

Address.....

City..... State.....

Occupation.....



# Classified Advertisements

## WORLD'S BEST WANT AD MEDIUM

Advertisements in this section, 25 cents per word, each insertion, minimum 10 words, payable in advance.  
To be inserted under proper classification in March issue, copy should be in our office January 18th.

### ADVERTISING AGENCIES

FOR individual newspaper, magazine advertising analysis, together with copy expertly written or revised, remit \$5.00 and outline proposition. Satisfaction guaranteed. Martin Agency, 1402A Broadway, New York.

25 WORDS, 75 Country Town Newspapers, only \$3.40. Shaw, 221A Northeast, Washington, D. C.

TO secure agents or salesmen or for selling farms and reaching investors, use classified (want) ads in largest newspapers and magazines. Price list No. 30 sent free. Ankrum Advertising Agency, 20 W. Jackson Blvd., Chicago, Ill. The largest classified advertising agency in the U. S.

25 WORDS—355 Rural Weeklies \$14.20. Ad-Meyer Agency, 4112-M Hartford, St. Louis.

### FOR ADVERTISERS

SHOWCARD Writing Made Easy. Complete Outfit and Instructions \$1.00. D. Gale, 618 Madison Ave., Albany, N. Y.

REACH 100,000 for ten years in our cook book; only 1c per page per family; use entire edition, any part. Representatives wanted; send postage. Meador Publishing Co., Box 224, Quincy, Mass.

CLASSIFIED seventy magazines, 2c word; three 8c. Smith's Service, 1194, Wenatchee, Wash.

IMMEDIATE Results or two extra weeks free. Advertisement 21 leading newspapers two weeks only 35c word. Affiliated Newspapers, Bedford Bldg., Chicago.

ADVERTISING Cuts! Your 1x2" ad. Hand Lettered—Illustrated—Engraved, \$1.25. Proofs 2c. Greenbald, 3009 Kenwood, Indianapolis, Ind.

"ADVERTISER'S Guide" Contains latest mail order news and advertising information. Three months 25c. Smith's Service, Wenatchee, Wash.

ADVERTISE in 24 Big Sunday Newspapers, 24 words \$15.00. Catalog listing 1,000 leading Dailies, Weeklies, Magazines, 4c stamps. Union Advertising, Baltimore Bldg., Chicago.

ADVERTISE, hundred magazines, three issues, 10c word. Pennell-Company, Covington, Ky.

### SALES PROMOTION

\$50 to \$10,000 Daily Sales developed during 36 years for clients by my direct-mail plans, copy, campaigns. A \$25,000 annual volume increased ten-fold in twelve months. Another, from an initial expenditure of \$720 developed in four years sales by mail of half million yearly. Ten years Sales Promotion Manager Larkin Co. Submit sales problems for free diagnosis. James C. Johnson, 118A Woodbridge Ave., Buffalo.

### AUTOMOBILE SUPPLIES

\$250.00 TO \$200.00 profit monthly easily earned with One Day Battery Service. It costs only \$20 monthly. Send postal to Wilhobart, Troy, Ohio.

SAVE—deal with us. Pistons \$2.00. Hammered Rings 20c. Piston Pins 50c each; any size, any make. Also Valves, King Bolts, Shackie Bolts, Timing Gears, and all kinds of gears. No catalog issued. Mention Model. Lawrence Company, 6529 Euclid, Cleveland, Ohio.

POCKET Knives \$1.30, Open Razors \$1.20. Side Cutters \$1.15. Filers, 45c. Made in Germany and guaranteed World's finest; cannot be duplicated anywhere at any price. International Importers, 4819 W. Harrison St., Chicago, Ill.

AUTOMOBILE and Truck Parts at a saving to you of from 25 to 75% off the factory list prices, on Reclaimed parts for nearly all makes and models, from 1914 to 1924. State parts wanted, and send for free parts list on your make of cars. "The largest stock of Reclaimed parts under one roof." Send us your parts orders. Auto Parts Co., Boyle & Papin, St. Louis, Mo.

AUTOMATIC Air Compressor, complete with motor, only \$16.50 monthly. Quickly builds your business. Send postal for particulars. Hobart, Troy, Ohio.

AUTOISTS. Make sure your Head-Lights are on. Our "Is-It-Lit" Testlites at \$1.25 will advise you. Out of Gas? Our Siphon Pump costing \$2.50 will enable you to borrow gas from the next passing car and get home. Handy Specialty Co., Somerville, Mass.

VULCANIZING Auto Tires is a Paying Business. We have Plants near you from \$100 Up. We save you 50%. Catalog Free. Instruction Book \$1. Equipment Exchange, 108 East 11, Los Angeles, Calif.

SWEETER and more mileage with "Trick" Valve Adjusters and Silencers; new; one-piece. No tools required. 24 for \$1.00. C. E. Richardson, Albee Building, Washington, D. C.

AUTO Parts at cut prices! All kinds of new and used, for all cars. Engines, Clutches, Transmissions, Axles, Radiators, Magnets, Generators, Batteries, Shafts, Gears, Bearings, Springs, etc., etc. If you have never known the house of Warshawsky, you had better write us and get acquainted. Think of buying the Shaler lens for 85c a pair, and rims for any car at \$2.00 each. Windshields from \$8.00 to \$10.00. Spotlights \$1.75. Welding outfits at a low price. Specify make and model of car when writing. "Ask for Bargain List." Warshawsky & Co., 1935 S. State St., Chicago, Ill.

BARGAINS—Radiators—Sport Bodies built to order—send sketch. All standard makes radiators furnished at bargain prices. State make and model. We guarantee satisfaction. Independent Radiator Co., 1119 Wabash Ave., Chicago.

MILERITE-KHYL-Super-Fuel Ingredient for Gasoline. Increases Power and Mileage—Saves Gas. Make it yourself by my simple Formula and clean up five to fifty thousand a year. This and eighteen other High Class Automobile Specialties described in the valuable literature I'll send you upon request—Hurry! Exclusive Territory!! Miller, Chemist, 1109-1111 Grand Central, Tampa, Fla.

RIM Cut Tires repaired quickly, effectively, with Rim Cut repair clamps; for straight side rim, style S; for clincher rim, style C; per set of 10—\$1.00. Each set covers 7 1/2-inch Cut. Sent Parcel Post prepaid. Rim Cut Clamp Co., P. O. Box 12, Station A, Elizabeth, New Jersey.

AUTOMOBILE Parts—Used parts for most any car at half factory list prices. Allen, Beirson, Buick, Cadillac, Chalmers, Chevrolet, Dodge, Ford, Grant, Hudson, Humobile, Oakland, Overland, Oldsmobile, Reo, Studebaker and many others. Send list of parts wanted. Century Auto Parts Co., 4106 Olive St., St. Louis, Mo.

ONYX Gear Shift Balls made from Arizona Onyx; sells on sight for \$2.50 each, special to agents at \$1.25. Write for exclusive territory. Phoenix Onyx Co., Box 888, Phoenix, Ariz.

### AUTOMOBILE SUPPLIES, ACCESSORIES AND HOUSEHOLD SPECIALTIES WANTED

PENNSYLVANIA Distributor reaching more than one million automobile owners will consider meritorious automobile supplies and accessories. If you desire such representation submit description, sample and best-rock prices. James C. Johnson, 118B Woodbridge Ave., Buffalo.

### AUTOMOBILE ARMATURES

LET us rewind your Automobile Armatures. We guarantee to make them as good as new. Fords \$2.00 each. Most any other two unit armature \$1.00. Single unit Buick, Dodge, etc., \$12.50. Send no money; all work sent out C. O. D. Jones Electric Company, Charlotte, N. C.

### AUTOMOBILES

\$300.00 TO \$500.00 profit monthly in One Day Battery Service. Easy monthly payments allowed. Hobburts brings particulars without obligation. Hobburts, Troy, Ohio.

PATENTS—Write for our Guide Books and "Record of Invention Blank" before disclosing inventions. Send model or sketch and description of your invention for our free Examination and Instructions. Highest references. Reasonable terms. See advertisement on pages 156 and 157. Victor J. Evans & Co., 185 Ninth, Washington, D. C.

AUTO Tourist's Handbook—An indispensable help for those who wish to make a motor trip. Tells how to prepare your car for the long grind to avoid trouble, how to make and use camp equipment, how to cook on the road and how to make comfortable sleeping quarters. Will reduce your touring bill many dollars if you follow the ideas presented. Only 50 cents. Popular Mechanics Press, Room 867, Popular Mechanics Building, Chicago, Ill.

PATENTS—Write for my free Guide Books "How to Obtain a Patent," "Invention and Industry" and "Record of Invention" blank before disclosing inventions. Send model or sketch of your invention for instructions. Promptness assured. No charge for above information. Clarence A. O'Brien, Registered Patent Lawyer, 589-B Security Bank Building, directly across street from Patent Office, Washington, D. C. See pages 154 and 155.

DYKE'S Automobile Encyclopedia, 13th edition, new, greater than ever, entirely rewritten and rearranged. Contains greatest array of automobile facts ever published in one volume. Separate books containing same information cost \$21. Over 1200 pages and 4100 illus. Cloth \$6. Flex. Amer. Morocco \$7.50 postpaid. Popular Mechanics Book Dept., 206 E. Ontario St., Chicago.

### FOR FORD OWNERS

FORD Parts—Save from 40 to 50% from the factory list price on guaranteed Reclaimed Ford Parts. Reclaimed Ford Motor, Starter and generator, running condition guaranteed, \$60.00. "The oldest, established parts house in the country." Send us your orders for parts on any car. Auto Parts Co., 904 S. Boyle, St. Louis, Mo.

ONE Day Battery Service pays big in smaller Shops. Only \$16.50 monthly. Hobartco brings particulars. Hobartco, Troy, Ohio.

UNDERSLING with "RKO" Spring Lo Irms. See "Red-1-Kut" ad page 149.

FORD sport, speed bodies and specialties. See Ad. Page 162.

WRITE for free Motor Light or Cigar Lighter. Minute installation. Very useful. Koester, 440 VanCortland Park Ave., Yonkers, N. Y.

MAKE your old Ford start like a new one these cold mornings. Don't jack up hind wheel. Install Adjustable Bronze Bearings in thirty minutes. Takes out all end-play. Guaranteed to last life of car. \$1.95 postpaid. The George Bearing Co., Tulsa, Texas.

AUTOMATIC Hot Coil. Guaranteed instant starting, \$1.75. Roy Hancock, Portsmouth, Va.

CALIFORNIA Tops for Ford Roadster and Touring. Stylish—Noiseless. Cool in Summer. Warm in Winter. Easily Installed. High Quality. Low Prices. Write Factory Today. Koupet Auto Top Company, Belleville, Ill.

### MOTORCYCLES, BICYCLES AND SUPPLIES

GOOD Used Motorcycles Indians, Harley-Davidson, Ace, Henderson and Clevelands. Price \$10 and up, purchased through our Cooperative Plan for as low as \$1.00 down and \$1.00 a week. "Motorcycles shipped to all parts of the world." Walker Indian Co., 188 Mass. Ave., Boston, Mass.

SEND for our Bargain Bulletin and Money Saving Message. It will save you money on Motorcycles, Side Cars, Motor Wheels, Repair Parts and Accessories. Some used parts at less than half. Cleveland and Ace Motorcycles our specialty. See our ad on page 150. American Motor Cycle Co., 2043-5-7 W. Chicago Ave., Chicago.



NEW and used parts for Motorcycles and Bicycles. Get our prices on parts needed. Kingshighway Motor Co., 1166 N. Kingshighway, St. Louis, Mo.

USED parts for all motorcycles, cheap. State wants. Schuck Cycle Co., 1922 Westlake, Seattle, Wash.

USED Motorcycle Bargains: Lists free. Secher-Hoffbeins, Buffalo, N. Y.

1922 HARLEY-DAVIDSONS, \$135; 1921, \$117; 1920, \$85; 1919, \$65; 1917, \$50; 1916, \$45; 1915, \$40; 1914, \$35. Guaranteed. Money refunded if not satisfied. Circular free. Wisconsin Cycle Sales Co., 725 National Ave., Milwaukee, Wis.

DON'T buy a Bicycle Motor Attachment until you get our new catalogue and prices. Also runs washers, pumps, and shop machinery. Shaw Mfg. Co., Dept. 27, Galveston, Kans.

OVERSTOCKED—240 Used Motorcycles. Must be sold at once. We have Harley-Davidsons, Indians, Hendersons, Excelsors, Cleveland. Write for our Bargain List. Myerow Brothers, Dept. B, 15 Berkeley St., Boston, Mass.

SEND for big list of slightly used motorcycles on the easy payment plan. Howard Cycle Co., Trenton, N. J.

#### AVIATION

BOYS! We have everything for aircraft. Let us furnish you material. Special prices to builders of small planes. Write your wants. Lincoln Standard Aircraft Corp., Lincoln, Neb.

SEND 10c for our latest aeronautical catalogue, listing a complete line of airplane goods at reduced prices; also special bargain sheet on overstocked material. Ford and Motorcycle airplane circular to each. Heath Airplane Co., Chicago, Ill.

FREE Flying Scholarships. Our new course prepares you for a big future in aviation. We give you a chance to learn to fly free. Write for our folder. Chicago Aviation Company, 73E Auditorium Building, Chicago, Ill.

THE Lincoln Standard Aircraft Corp., largest builders of commercial aircraft in the U. S., offer a practical, up-to-date, seven-lesson Home Study Course in aeronautics at \$5.00. Lay your foundation by obtaining this course at once. It has no competition for five times the money. Address 2409 O St., Lincoln, Neb.

PATENTS—Write for my free Guide Books "How to Obtain a Patent" and "Invention and Industry" and "Record of Invention" blank before disclosing inventions. Send model or sketch of your invention for instructions. Promptness assured. No charge for above information. Clarence A. O'Brien, Registered Patent Lawyer, 589-B Security Bank Building, directly across street from Patent Office, Washington, D. C. See pages 154 and 155.

OPPORTUNITY is at your door. Learn Airplane Engineering Now at Home. The World Flyers were Airplane Engineers. Write for free catalog. Western Airplane Corporation, Dept. K-2, Menadnock Block, Chicago.

LEARN to fly this winter. Special Course! Special Price! Get free catalog. Varney Aircraft Co., Peoria, Ill.

TEN lessons in the air of twenty minutes each will make you a pilot by our advanced method of training. This together with our five week shop course at \$100.00 makes America's oldest aircraft factory the most popular flying school. Work after class hours guaranteed. Heath Airplane Co., Chicago, Ill.

SPORT Plane; particulars and specifications ready for you. America's latest in light sport plane, just finished and tested. High speed 90 miles per hour. Write now. Lincoln Standard Aircraft Corp., Lincoln, Neb.

"TWO-SEATER Sportplane." Ford or air-cooled motor used. Complete planes and parts for builders. Blueprints and Instructions, \$5. Monoplane Plans, \$2.50. Circular Free. Aviation Engineering Co., Lawrence, Kans.

THE American School of Aviation announces a new correspondence course in Mechanics of Aviation. A thorough training in Practical Aeronautics. American School of Aviation, Dept. 1861, 3601 Michigan Ave., Chicago, Ill.

COMPLETE Scale Plans, with Building-Flying Instructions for following 3-ft. Model Aeroplanes, 25c each postpaid; JN4D-2; DeHavilland; N.C.-4; Curtiss Tractor; Bleriot; Nieuport or Taube Monoplanes; Cecil Peck Racer. Complete 48 pp. catalog, 5c. Ideal Aeroplane Co., 165½ Spring Street, New York.

HEATH propellers represent the most efficient method of aerial drive. Each propeller individually designed for the particular work to be done, as laid out by America's oldest aeronautical engineers. Propeller catalog 4c; Sled blueprints \$2.00; Jersey aviator helmets 95c; Resistor goggles \$2.90. Heath Airplane Co., Chicago, Ill.

AIRPLANE Wheels, 20x3 ball-bearing, wire type. Just right for small autos, wagons, or scooters. Only \$2.50 each. Lincoln Standard Aircraft Corp., Lincoln, Neb.

#### WELDING AND SOLDERING

ACETYLENE Brazing and Soldering Torches, \$2.00. Light welding and lead burning torches, \$7.00. Postage prepaid upon receipt of price. Marshall Mfg. Co., Kansas City, Mo.

#### BOOKS AND PERIODICALS

BE a Laboratory Expert. Earn \$300 to \$500 monthly. Study Microbiology, Sanitation. Day, Evening Classes. Diplomas, Degrees Granted. Free 71 Piece Outfit to Students. Write for Free Prospectus Today. International College of Microbiology, 2126 Lincoln Ave., Chicago.

PERSONAL Advancement—The new magazine published by Popular Mechanics Press for all who want to get ahead. Inspiration, education, entertainment, advice. Will help you to decide upon a vocation, to get help in preparing yourself for that vocation, to get the best books on travel, mechanics, and on related subjects. One year free. Send your name and address on a postal to Popular Mechanics Press, Room 807, Popular Mechanics Building, Chicago, Ill.

DIRECTIONS for Building Imitation Marble Front Houses and for Manufacturing Tomb-Stones and Monuments from White Cement. Read my book on Fancy Concrete. Price \$1. Peter De Linde, Zion, Ill.

BOOK—"Poems of Inspiration and Action." (was \$1.00)—now, only 25c postpaid! Hansen Company, Brookings, S. Dak.

COMPLETE, easy self-instructors—Spanish, Italian, German, French, Square Dancing, Boxing, Etiquette, Violin, Piano, Drums, Accordion, Harmonica, Ocarina, Ukulele, Saxophone—25c each; any five, 97c. G. Elser, Bowling Green, Ohio.

HOW To Run a Lathe, a new 160-page book containing 250 illustrations. Price 25c. postpaid. See our Advertisement on page 165 for Easy Payment Plan on Lathes. South Bend Lathe Works, Dept. C, South Bend, Ind.

HYPNOTISM—Thorough course with illustrations. Scientific, complete. Price only 25c. Astrolite Company, Sharpsburg, Pa.

NEW Book—"Where To Buy Ten Thousand Things At Wholesale." (No Catalog.) Everyone wants this book. 75c postpaid. G. O. Shaver, Publisher, Norphlet, Ark.

SEND 10c for copy of my best article opposing Evolution. Stephen O. Bryant, Bethany, Mo.

ELIMINATE Shaving Troubles. Booklet shows how to acquire a barber's skill and lightness of touch. 25c. James Neary, 28 Flora St., Brookline, Mass.

LAFFALOG is a Monthly Magazine Devoted to Wit and Wisdom, Poems, Formulas and Plans. Sample Copy 10c. W. H. Gilbert, Publisher, Box 25, Milford, Conn.

FARMER'S Handbook—Filled with discoveries made by farmers who have found ways to save time and labor. 270 pages, containing 881 discoveries on all phases of farm work. 683 illustrations. Only \$1. Popular Mechanics Press, Room 807, Popular Mechanics Building, Chicago, Ill.

"33 CARD Mysteries." New Copyrighted Book tells how to mystify your friends. No skill. Anyone may learn. Postpaid 10c. Lyle Douglas, Station A, Dallas, Texas.

LAFFALOG is a monthly devoted to Wit, Wisdom, Essays, Poems and Formulas. Sample copy 10c. P. M. Lutz Printing Co., York, Pa.

HYPNOTISM easily learned. Lessons guaranteed. Postpaid \$1.10. Smith Pub. Co., Dept. 3, Springfield, Mass.

PRACTICAL Psychology Teaches Hypnotism, Personal Magnetism, Magnetic Healing, Auto-Suggestion, Cure Habits and Disease. Easy Lessons. Send for Booklet, 4c. cents stamps. Fernando, Dept. M, Springfield, Mass.

WRITERS—Study at home; 30 text books; criticism and advice regarding markets for manuscripts. Catalogue free. Correspondence invited. James Knapp Reese (former editor The Editor), 50 Alexander Bldg., Franklin, Ohio.

EDUCATIONAL Books. Bargain prices. Bulletin free. Instruction Correspondence Exchange, 1266 Broadway, New York.

INDUSTRIAL Alcohol. Wright's book. Full directions for making drawings. \$2.50. Spun & Chamberlain, 120 P. M. Liberty Street, New York, N. Y.

FREE—Send for my Newthought, Self-Culture, Occult, Mystic and Scientific book literature. Martens Publisher, Burlington, Iowa.

"NATURE'S Finer Forces"; Vibrations; Lights; Color-tones; Electromagnets; Occultisms; Radio; Coldlights; Inventions; Wonderful Opportunities; Fifty Lessons; Marvelous Cures; Illustrated. Satisfaction Guaranteed. 270 pages, \$2.00. DeLuxe \$3.00. M. Stevens, 242 Powell, San Francisco, Calif.

176 PRACTICAL Subjects, how to master any of them. A new booklet giving reliable advice on how to study 176 subjects at home is free. Write your name and address on a postal and say, Send me "An Easy Way to Master 176 Practical Subjects" and mail to Popular Mechanics Press, Room 807, Popular Mechanics Building, Chicago, Ill.

#### PICTURES AND POSTCARDS

HEADQUARTERS for hot-air (comic) cards—55 all different. 25c. Square Deal Press, 142 Crafton St., Pittsburgh, Penn.

JOIN Live Postcard Club; Membership Lists including Catalog, 10c. Harvey Teeple, Decatur, Ind.

PHOTOS of all kinds. Samples for \$1.00. Photocraft Co., Lebanon, N. H.

FREE: 20 Beautiful girl pictures. Smith's Novelty, 89143-47 Bishop St., Chicago.

TRIAL offer 5x7 enlargement 20c. 6 for \$1.00. Rod Wagon, Wis.

TWENTY Beautiful "Colorview" post cards 15c and full particulars how to get others free. Mutual Supply Co., Bradford, Pa.

75 BEAUTIFUL Art Pictures and Bathing Beauties 25c (each). Photo Sales Co., 6975 Pingree, Suite 301, Chicago, Ill.

EXCHANGE Postcards! Extremely entertaining, fascinating, instructive pastime. Year's membership \$1. Six months, 50c. List 10c. Join now. Popular Exchange, Windsor, N. C.

#### GAMES, ENTERTAINMENTS AND PLAYS

MYSTIFY your friends. Great fun. Ventriloquism made easy by new Scientific Method. Write today for free information. White Institute of Ventriloquism, Dept. 68, Bloomfield, N. J.

CAN You Draw? Make Money Giving Chalk-Talks, Particulars. Truman's Studio, Box 585, Perryville, Ohio.

VENTRILLOQUISM taught almost anyone at home. Small cost. Send 2c stamp today for particulars and proof. George W. Smith, Room M-931, 125 N. Jefferson Ave., Peoria, Ill.

100 LIGHTNING Chalk Talk Stunts \$2.00. Cartoonist, 2925 Euclid, Kansas City, Mo.

BE a Wizard! Amaze your friends. New book, "33 Card Mysteries," tells how. Postpaid 10c. Lyle Douglas, Station A, Dallas, Texas.

PLAYS, musical comedies and revues, minstrel music, blackface skits, vaudeville acts, monologs, dialogues, recitations, entertainments, musical readings, stage handbooks, makeup goods. Big catalog free. T. S. Denison & Co., 623 So. Wabash, Dept. 11, Chicago.

#### NOVELTIES, CURIOS, ETC.

EUROPEAN Novelties, Tricks and Puzzles. Complete Catalog and book of "33 Card Mysteries" postpaid 10c. Lyle Douglas, Station A, Dallas, Texas.

MYSTERIOUS Novelties, when dropped into water, expand twice original size, turning into fish, flowers, animals. Pretty Package twelve, assorted, 15 cts. Heilmann, 7242 Pingree, Chicago.

#### MAGIC TRICKS, BOOKS AND JOKER NOVELTIES

LATEST Magical Effects, Gazing globes. List free. Waldmann, 1450 First Ave., New York.

10-CENT Bargain Offer. Pack of mysterious mind-reading cards; six Japanese water flowers bloom instantly; one magic needle threader; all for 10c. Catalog free. Astrolite Company, P-19, Sharpsburg, Pa.

MAGIC goods, cards, books, novelties, tricks. Catalogue free. C. Fenner, 2401 Jefferson, Louisville, Ky.



"33 CARD Mysteries" 10c: New Book just published. Amaze and mystify your friends. Easy to learn. Big 1925 Catalog of Magical Apparatus—Imported "Novelties"—Puzzles—Jokes—Pocket Tricks—Magic Books—Mind-reading Effects—Escapes—and Stage Supplies included. Largest assortment in the South. Both for 10c silver. Send today! Lyle Douglas, Station A, Dallas, Texas.

**DIMINISHING** Billiard Ball, 50c. Secrets, Pocket Tricks, Small Magic, Lowest Prices. Catalogue free. C. Pentz, Minneapolis.

**FUN** Creating Novelties, Tricks. Catalogue Free. Mystic Chelsea, 382 East 144th, New York.

**FREE**—Our puzzle, trick, game, joke, Novelty Catalog. Wright & Son, 601-G Ind. Ave., Peoria, Ill.

**CURIOUS** Books—Rare, Scarce, Valuable. Catalogue 10c. (50 books.) L. Rinker, 296 Broadway, New York.

**25 PUZZLES** 25c. The Tweedle Club, 190 Lancaster Street, Albany, New York.

**TRICKS**, puzzles, jokes, magical apparatus, plays, stage supplies, mind-reading, sensational escapes, large illustrated professional catalog, 10c. Oaks Magical Co., Dept. 548, Oakbrook, Wis.

**SEVEN** Magic Effects, Four Catalogs—25c. Gilmaglio, Morgan Park, Ill.

**MAGIC**—Tricks, Books and Supplies. For Amateurs as well as the great professionals. Anyone can learn through our instructions. Feature Acts in Mind Reading, Spiritualism, Rope Ties, etc. Large illustrated Professional Catalog, 20c. Chicago Magic Co., 140 S. Dearborn St., Dept. B, Chicago, Ill.

#### STAMP COLLECTING

**START** a Stamp Collection—70 different stamps from 70 different foreign countries, including Africa, Asia, Australia, Europe, West Indies, etc. Our pamphlet which tells "How to make a collection properly," and price list of albums, packets and sets all for only 16 cents. Queen City Stamp Co., Room 26, 604 Race St., Cincinnati, Ohio.

**FAMOUS** Fenway Outfit—2 triangle stamps, small album, 5 blank approval sheets, 250 hinges, perforation gauge, 5 large French Colonials, 2 special deliveries, animal set, red cross set, packet 55 different, including Abyssinia, Azores, Cape of Good Hope, Bosnia, Crete, Congo, etc., 16-page price list, all for 12c to new approval applicants. Fenway Stamp Co., 161 Massachusetts Ave., Boston, Mass.

**STAMP** Collectors' Outfit only 20c, includes Big 32-page book, "How to Collect Stamps," Illustrated Album, 100 different foreign stamps, 250 hinges, gauge, "Free Stamps," Coupon, etc. Trial approvals with each order. Harry Inor, 801 State Life Bldg., Indianapolis, Ind.

**NYASSA** Triangles! Complete unused set 9 varieties, animals, ships, etc. Special Price to approval applicants only 89c; singles 10c per copy; also free premium sent with each selection. Westland Stamp Co., 70 Westland Ave., Boston, Mass.

**EXCEPTIONAL** Edgewood Outfit! Contains (1) small stamp album; (2) 250 peelable hinges; (3) perforation gauge, millimetre scale and ruler; (4) large illustrated price list; (5) fine pocket book for duplicates; (6) 5 blank approval sheets; (7) 25 all diff. Hungary; (8) 10 diff. Czechoslovakia; (9) triangle stamp; (10) 55 all diff. from Egypt, Africa, Argentina, Cuba, Dominican Rep., etc. This complete outfit—16 big articles—for only 12c to approval applicants. Edgewood Stamp Co., Milford, Conn.

**10 DIFFERENT** Iceland—all fine stamps—for 12c; 6 Epirus, Nos. 5-10 (catalogue 40c), only 10c; 8 other Epirus, Nos. 15-22 (Cat. 75c), 16c; 12 diff. Cape Verde and Mozambique for 6c. These only to approval applicants, and if you tell size of your collection you get 6 diff. Guinea Free. Fred Jackson, Box 116, Montara, Calif.

**ANCHER'S** Net Approvals. To get you acquainted with our approvals, we are offering the following: 500 different, all countries, 27c; 50 different Greece, 21c; 100 different Germany, 12c; 50 different French Colonies, 12c; 50 different Portuguese Colonies, 15c; 50 different Czechoslovakia, 12c; 100 different Poland, 22c, to approval applicants only. Ancher Stamp Co., 148½ Clerk St., Jersey City, N. J.

**20 INDIAN** States, 10c. 3 Hejaz, 9 Georgia, 10 Persia, 8 Iceland, 15 Ceylon, 35 French Colonies, 30 Portuguese Colonies, 17 China, 50 Poland, 10 Siam, 16 Tunis, 100 Austria, 10c each. Postage extra under 50c. Rowland Hill Stamp Co., 3675 Washington St., San Francisco.

**MYSTIC'S** "Mysterious" Packet! Contains stamps from the lands of cannibals, heathens, sun worshipers, and wild savages. Included are Kenya and Uganda, Persia, Africa, Dutch Indies, Gold Coast, Federated Malay States, Abyssinia, Nyassa, Travancore, Siam, Congo, etc. This wonderful packet containing 105 all different (mostly unused) for only 8 cents to approval applicants. Mystic Stamp Co., Dept. 8, Camden, New York.

**BOYS!** Have you ever owned a nice, shiny, new pair of steel stamp tongs? Lakeriew offers: Famous "Conflated" set of Bulgaria (stamps that nearly started a war); set of new Germany with (prewar) face value over forty million dollars; perforation gauge; small album; packet 100 different from Argentine, British Guiana, etc., etc.—and last but not least, a dandy pair of stamp tongs! The entire big outfit only 15c to approval applicants! Lakeriew Stamp Co., 328 Columbia Street, Toledo, Ohio.

**BOYS!** Bet you haven't got a single stamp from the Irish Republic! We offer this month only to approval applicants: Packet of 100 different from Cape of Good Hope, San Marino, Fiume (triangle), Travancore, Malay (tiger), Guatemala, Congo (Savage), etc., etc.; also a fine set of 5 diff. Ireland, Perforation gauge and mm. scale, and 250 peelable hinges—all for eight cents! Supply limited, order at once. Paul Revere Stamp Co., Watertown, Mass.

**NYASSA** Giraffes and packet of 52 different scarce stamps. Fiume Triangle, large \$1.00 U. S. Rev., millimetre scale, perforation gauge and ruler for only 9c. To introduce our Sudden Service approvals, Fennell Stamp Company, Dept. P, Fullerton Bldg., St. Louis, Mo.

**100 STAMPS** from 30 different countries, perforation gauge, pocket album, and 250 hinges, 15c. A. S. Griffith, Wasco, Calif.

**BEST** one-cent approvals in America. F. P. Hand, 1117 So. 60th St., Philadelphia.

**200 DIFFERENT** European stamps free with three months' subscription McKee's Stamp Weekly, Beverly, Mass. Remit 25c.

**50 DIFFERENT** Hungary to approval applicants giving references. J. A. Flaten, Fertile, Minn.

**100 STAMPS** free to new approval applicants. Sam Josephson, Bremerton, Wash.

**1,000 MIXED** 20c, 200 Var. 25c. Charles Pough, Elma, Wash.

**300 DIFFERENT** stamps 20 cents to approval applicants. Odd Stamp Co., 261 W. Dakota, Pasadena, Calif.

**ROUMANIA**—50 Different 15c. Browne, 90 Kemper St., Wollaston, Mass.

**BEST** one-cent approvals. Marko, 2027 Logan Blvd., Chicago, Ill.

**TWO** U. S. Rev., 100 diff., a stamp from each South American country, all for 25c to new approval applicants with references. Magnolia Stamp Co., 4338 Newton St., Dallas, Tex.

**10 MADAGASCAR**, 12 Malta, 20 Serbia, 10 Monaco, 20 Nicaragua. Each 17c. Michael, 3250 Calumet, Chicago.

**FREE**—50 varieties to approval applicants sending 2c. Richard P. Lamprecht, Valparaiso, Ind.

**100 DIFFERENT** Stamps, many unused, high values, free to collectors requesting our Net Approvals. Postage 2 cents. Christensen, Milwaukee, Wis.

**STAMPS** sent on approval at 70% discount. Reference required. Emory Remoll, Hanover, Pa.

**500 FOREIGN** stamps 25c; 50 Foreign coins \$1. A. McCreery, Chatham, Ont.

**FREE** premium of four early Ukraine surcharged on Russia to approval sheet applicants. Sheets contain stamps priced ¼, ½, ¾, 1c, and up. Herbert Kelgwin, Middletown, N. Y.

**1,000 DIFFERENT** stamps \$1.00, 100 different Germany, all mint, 15c. 100 different Austria, 10c. Claud Denney, Box 315, Dallas, Texas.

**FREE!** One penny British Empire Exposition to approval applicants. Reference necessary. Royal Stamp Co., Grimsby, Ontario.

**SPECIAL** 1925 Packet—128 diff. stamps, from Sudan, Azore Islands, etc., including complete sets from Nyassa, Belgium and Germany, and 500 hinges—only 37c. Mountain City Stamp Co., Box 325, Mannington, West Va.

**100 DIFFERENT** foreign, 4c. Walter Oliver, 813 Richmond, Buffalo, N. Y.

**4 MINT** sets, including "Prisoners of War," hinges, 300 different, premium, French colonies, 25c. Deering, Newton St., Marlborough, Mass.

**FREE!** Scarce set of Azerbaijan to approval buyers who want good stamps. Our specialties: fine sets, British Colonials, Latin Americans. Penna. Stamp Co., Manor, Pa.

**1,000 DIFFERENT** Stamps \$1.00; Approvals 60%. Martel, 306 Station "C," Montreal, Canada.

**100 DIFFERENT**, South and Central American, 45c; 200 \$1.10; 500 \$4.50. Fred Onken, 630 79th Street, Brooklyn.

**FREE**—3 Abyssinia to approval applicants sending 2c. F. H. Marsh, 524 N. Hamilton Ave., Indianapolis, Ind.

**CONTINENTAL** Packet, 250 varieties, all over the world, 15 cents. Covert Stamp, 39 State, Rochester, N. Y.

**FINEST** one-cent approvals. Boehm, 401 W. 19th St., New York.

**MORE** advanced approvals. Discounts to 80%. Reference. International 2117 Regent Pl., Brooklyn, N. Y.

**GOOD** approvals. Free premium. Reference. Postage 2c. Penn Stamp Co., 3620 Colfax St., Minneapolis, Minn.

**HEJAZ** (Arabia)—3 fine varieties, 10c postpaid. Allion, Angola, Ind.

**BOYS!** Packet of 108 Stamps, including Tehad, Congo, etc., 5c to approval applicants. If you will write at once we will include a stamp album, perforation gauge and a big list of bargains without extra charge. Hill Stamp Co., Leonard St., Waltham, Mass.

**100 RARE** Stamps, all different, bargain list, Stamp Magazine, everything 7c. Stanton, Niantic, Conn.

**500 MIXED** U. S. and Foreign stamps 10c. R. H. Carlton, 266 W. 80. Temple, Salt Lake, Utah.

**BORNEO** Rhinoceros, Australian Kangaroos and 100 Different Foreign, Hinges, Etc., to Approval Applicants for 10c; 50 Different U. S. 10c. Mosley, 225 South Taylor, St. Louis, Mo.

**250 MIXED** stamps and souvenir photo, 10c. Phil Lamsed, Cape Cottage, Maine.

**FREE**—50 diff. stamps free to approval applicants only. Rubin Hoffman, 405 Pennsylvania Ave., Brooklyn, N. Y.

**104 DIFFERENT**, including German 200 Million mark and Turkish Picture Stamps, 10 Cents, Sonnee Stamp Co., 675 Ivy, St. Paul, Minn.

**FIFTY** British, French and Portuguese Colonials only fifteen cents to not approval applicants. Davies Stamp Co., Box 108, Toledo, Ohio.

**SUPERB** Newfoundland Stamps sent on approval. References please. Rev. Butler, St. George's, Newfoundland.

**100 NEW** Europe, All Different, a wonderful collection cataloguing several dollars, free to collectors requesting our Net Approvals. Postage 2 cents. Badger Stamp Co., Milwaukee, Wis.

**35 DIFF.** Neurope free to request for my 1, 2, and 3c approvals, and also my 50% discount. Chas. W. Schmidt, 3227 Benner St., Wissinoming, Philadelphia, Pa.

**FREE**—Two Sets Nyassa. Also 20 diff. British Colonies, Barbadoes and Jamaica pictorials and packet of hinges for a request for my 1, 2, 3c net approvals. None better. Charles T. Egner, 4821 Frankford Avenue, Frankford, Phila., Pa.

**BARGAINS!** 100 unused all different stamps, only 5 cents, another 1,000 mixed stamps from Europe, Asia, Africa, etc., 20 cents. Nielsen, 3244 Whipple St., Chicago, Ill.

**105 CHINA**, etc., stamp dictionary, list, 2c. Album (500 illustrations), 3c. Bullard, Sts. A, Boston.

**BIG** Variety Packet Foreign Stamps Free for 2c postage. Gray Stamp Company, Station E10, Toronto, Canada.

**BIG \$4.00** outfit and premium to approval applicants 10c. Bucky, 712 Bowen, Dayton, Ohio.

**FRENCH** Colonies Free.—Pretty Picture Set, Native Chiefs, Tigers, 2c Postage. Empire Stamp Company, 342 Lippincott, Toronto, Canada.

**20 UNUSED** stamps free. All different. Postage, 2c. P. M. Fisk Stamp Co., Toledo, Ohio.

**DANZIG** Free—Nice Set Danzig Stamps with Biggest Lists Issued, 2c. postage. Midland Stamp Co., Station E2, Toronto, Canada.

**HAVE** you an Abyssinia in your collection? 3 varieties 5c. 1,000 all different stamps \$1.00. Approvals sent upon request. Edgewood Stamp Co., Milford, Conn.



24 VARIETIES Cuban stamps, 10 cents. List of 6,000 low-priced stamps free. Address: Chambers Stamp Co., 111P, Nassau St., New York City, N. Y.

STAMPS, 100 all different. Postage 2c. Lists free. P. M. Quaker Stamp Co., Toledo, O.

158 GENUINE Foreign Stamps. Mexico War Issues. Venezuela, Salvador and India Service. Guatemala, China, etc., only 5c. Finest approval sheets 50 to 60%. Agents Wanted. Big 72-p. Lists Free. We Buy Stamps. Estab. 20 years. Hussman Stamp Co., Dept. 54, St. Louis, Mo.

FOREIGN Stamp Collection Sent Free. Cornish Co., Schenectady, N. Y.

FREE! Loose Leaf Postage Stamp Album at rate of 8 pages each month given with subscription to monthly Journal. Send 2c stamp for prospectus. United Stamp Co., Marquette Bldg., Chicago, Ill.

STAMPS. 50 varieties. Africa, Brazil, Peru, Cuba, Mexico, etc., 10c. 50 different U. S., 25c; 1,000 mixed, 40c; 1,000 hinges, 10c. List free. C. Stegman, 5948 Cote Brillante, St. Louis, Mo.

ZAMBESIA, Zanzibar, Abyssinia, Herzegovina, Alienstein stamps, menagerie collection, album, 10c. Liberty, 3974 Arsenal, St. Louis, Mo.

PACKET of 23 stamps, no two countries alike. Packet hinges. Set of \$1 and \$2 U. S. Rev., all for 5c. P. M. Miami Stamp Co., Toledo, Ohio.

#### RARE COINS

OLD Money Wanted. We paid \$2,500.00 for one silver dollar to Mr. Manning of Albany, N. Y. We buy all rare coins and pay highest cash premiums. Send 4c for large Coin Circular. May mean much profit to you. Numismatic Bank, Dept. H, Fort Worth, Texas.

U. S. COINS for Sale. Ebery Fleming, Box 2025, Palm Beach, Fla.

CALIFORNIA gold Quarter, 27c; Half, 52c; 1831 cent, 20c; 1837 5c, 20c; Confederate \$50, 20c. A. Wylie, Wheaton, Ill.

OLD Coins, Large Spring Selling catalogue of coins for sale free. Catalogue quoting prices paid for coins, ten cents. William Heaslett, 101A Tremont Street, Boston, Mass.

PRICE Lists and Wild Cat Bill, 6c; Gold 1/2, 27c; 3/4, 53c; 10 Foreign Coins, Copper, Different, and German Script, 25c; Nickel 3c and 2c, 15c; 100,000 German Mark, 10c. A. V. Bonnell, Richmond, Ind.

44 DIFFERENT Foreign Coins \$1.00, postpaid. Otto Oddehon, Independence, Mo.

50 OLD coins, all different, \$1.00. 50 coins from 50 countries, \$2.00. List Free. Claude Denney, Box 315, Dallas, Texas.

EMERGENCY coin 5c. 4 European 15c. Russian coin 10c. 3 Central America 15c. 2 Scandinavian 12c. J. Murphy, 510 So. Canal, Holyoke, Mass.

GENUINE Roman coin, 1,600 years old, 25c. Durso, 25 Mulberry, New York City.

\$1.00 BRINGS pound European Money, Bonds, Coins. Tremendous Profits. Circulars Free. Hirschel, 70 Wall St., New York.

U. S. FLYING Eagle Cent with Price List for 10c. Fred Greenday, Box 1715, Telluride, Colo.

\$2 TO \$500 Each paid for hundreds of Old or Odd Coins. Keep all Old Money; it may be very valuable. Send 10 cents for Illustrated Coin Value Book, 4 x 6. Get Posted. Guaranteed Prices. Clarke Coin Company, C. St., LeRoy, N. Y.

CALIFORNIA gold, 3/4 size, 27c; 1/2 size, 53c; three-cent-piece and catalogue, 10c. Norman Shultz, Colorado Springs, Colo.

GET Profit and Pleasure in collecting Old Coins. Send 10c for Sample Old Coin, together with my Large Illustrated Coin Catalogue. You'll be delighted with it. Send for it right now. B. Max Mehl, Professional Numismatist, Mehl Bldg., Dept. P, Fort Worth, Texas. Largest Rare Coin Firm in U. S.

#### FOR BOYS

MOUTH - ORGAN Instructor (18 big pages), 25c. Eighteen good selections of music, including "Mocking Bird," with complete instructions for playing immediately. Thousands sold. Order today—become popular. Boxing Instructor, Illustrated, 25c; Etiquette Guide, 25c. Hunters-Trappers Guide, 25c. 150 Parodies, 10c. All for \$1.00. G. Elsen, Bowling Green, Ohio.

200 FEET Fine Film with 2,000 Theatre Tickets \$1.65 Postpaid. Northern Theatre Supply, Duluth, Minn.

JUST Out—A New Boy Mechanic Book No. 4—1309 Articles, 1320 Pictures. Tells how to make such things as Radio Receivers, Toy Airplanes, Pushcycles, Camo Postions, Diving Rafts, Electromagnets, Wind Wagon and Ice Boat, Catamaran, Motion-Picture Camera, Sidelwheel Motorboat, Motor-Driven Sleds, Camp Equipment and hundreds of other interesting devices. Price \$2 postpaid. Popular Mechanics Book Dept., 290 E. Ontario St., Chicago.

BOYS, earn money. Sell our notions. Universal Sales Company, Dept. D, Box 152, Springfield, Ill.

BE a Wizard! Fool your friends. New Magic Book tells how. Postpaid 10c. Lyle Douglas, Station A, Dallas, Texas.

OUTDOOR Sports—How to make devices for sports the year round. Kites, airplanes, wind wagons, swimming accessories, and dozens of other things every live boy wants. A 150-page book, jammed with ideas. Instructions are complete and can be followed by any intelligent boy. Only \$1. Popular Mechanics Press, Room 807, Popular Mechanics Building, Chicago, Ill.

#### CAMERAS AND PHOTO SUPPLIES

PHOTOGRAPH sent in with \$2.00 will be made into hand-painted picture 8 x 10. State color of hair, eyes and clothes. Starkey, 13452 17th St., Springfield, Long Island, N. Y.

PHOTOGRAPHIC equipments and accessories of every description are listed and illustrated in our 228-page catalogue. It will pay you to secure a copy which is issued free, as our prices are low. We also deal in used goods which are sold under the same guarantee as new goods. Ask for our Bargain Book. Central Camera Co., Dept. E-96, 112 S. Wabash Ave., Chicago, Ill.

POCKET Photo Outfit! Cute; Interesting; full outfit prepaid 10 cts. Warfel, Photographer, Cadiz, Ohio.

SUPERIOR quality finishing. Trial offer: Any size 6 exposure roll developed and printed, 25 cents. One only 8x10 enlargement unmounted from negative, 35 cents. Carlsbaff Photo Finishing Co., 2129 W. Van Buren St., Chicago, Ill.

FILM developed, 5c; Glossy prints 3c. 7x11 enlargements, 50c—3 for \$1. Ashton Photo Works, Ashton, Ill.

ART-KRAFT Prints from your favorite film. Something different in Finishing. Send negative and 25c (silver) for trial print. Klinkner Film Service, Dyersville, Iowa.

MODERN Photography in all its branches now taught by mail. New Successful Method. Students earning \$300.00 while learning. Big opportunity. Write for particulars and unusual offer open for short time. Dept. 1351, International Studios, Inc., 3601 Michigan Ave., Chicago.

SIX 5 x 7 enlargements from your favorite negative for \$1.10 C. O. D. Mounted in Art Folders \$2.00. Sample enlargement, mounted, 25c. David N. Essick, Ankeny, Iowa.

FILMS Developed Free on trial roll. Prints 3c each. Desk E, The Camera Co., Oklahoma City, Okla.

POCKET Kodaks \$2.50 to \$8. Reflex Speed Camera, F 4.5 lens, 25c. Kodaks exchanged. Write for bargain price list. H. Ray, 324 Fifth Ave., New York.

ENORMOUS Profits from Small Camera. Write for Details. Press Studio, Box 132, Lincoln, Nebr.

HAVE You a Camera? Write for Free sample of our big magazine showing how to make better pictures and earn money. American Photography, 116 Camera House, Boston, 17, Mass.

FILMS Developed. Special Trial Offer. Any Size Kodak film developed 5c, prints 3c each. Trial 6x10 Enlargement in handsome folder 48c. Overnight Service. Roanoke Photo Finishing Co., 209 Bell Ave., Roanoke, Va.

BIG Money Saved on Photographic Lenses and Apparatus—goods exchanged; repairing done. Ralph J. Golsen, 1128 Argyle St., Chicago, Dept. P.

KODAK Films—Special trial offer: your next kodak film developed, 5c—prints, 2c each. Moser & Son, 1917 St. James Ave., Cincinnati.

#### MOTION PICTURES

BARGAINS—Machines, Films, Supplies, Stereoscopes. National Equipment Company, Duluth, Minn.

MOVIE Films 1c foot; 130 feet \$1; Reels \$3. Send stamp for list. X. Sales Company, West Haven, Conn.

TOY Films—1,000 ft. westerns, comedies, Scenics and others, \$3.00. La Vere Film Exchange, 808 So. Wabash Ave., Chicago, Ill.

FILMS rented and sold. Moving Picture Projectors sold at lowest prices. Movie Cameras \$40.00. Triped \$20.00. New Motor Driven Suit Case Projector \$75.00. Write for Bargain Price-List. A. Ray, 324 Fifth Ave., New York.

FILM—Million Feet for Sale. Cowboy—Drama—Comedy and Feature Specials. Mix—Hart—Chaplin and best Movie Stars. \$2.00 per reel up. Genuine List Free. We Supply the World. Dept. G, Monarch Films, Memphis, Tenn.

OH! Boy, Toy Films, westerns and comedies 1,000 ft. only \$2.00. Diamond Film Company, 806 So. Wabash Ave., Chicago, Ill.

BIG Money Nightly—Good assortment. Complete Outfits, installment plan. Splendid Home Outfit, \$25.00. Good Movie Camera, \$25.00. Ralph J. Golsen, Dept. M, 1128 Argyle St., Chicago.

DON'T fail to send for the big Free Bass Book of Cinema Apparatus. The Encyclopedia of M. P. Cameras and Projectors. Get in the game that has made thousands independent. Write or wire for your copy. Bass Camera Company, 105 N. Dearborn St., Chicago, Ill.

WONDERFUL Opportunities for Making Fortunes in this Business. No Experience needed. Complete Theatre Outfits sold on Easy Terms. Free Catalog. Monarch Theatre Supply Co., Dept. P, Memphis, Tenn.

\$25.00 PROFIT nightly. Small capital starts you. No experience needed. Our machines are used and endorsed by government institutions. Catalog free. Atlas Moving Picture Company, 482 Morton Bldg., Chicago.

\$\$\$ FOR Ideas. Photoplay plots accepted any form; revised, criticized, copyrighted, marketed. Advice free. Universal Scenario Corporation, 206 Security Bldg., Santa Monica and Western, Hollywood, Calif.

AMERICA'S Greatest Fortunes made in the Motion Picture business. We furnish complete theatre equipment on easy payments. Openings everywhere. Catalog free. Monarch Theatre Supply Co., Dept. A, 724 So. Wabash Ave., Chicago, Ill.

MAKE money writing photoplays; details free to beginners. No correspondence course. Producers League, 230 Wainwright, St. Louis.

ELECTRICITY—Make it yourself with our auto generator. Write for particulars. Monarch Theatre Supply Co., Dept. 7, 724 So. Wabash Ave., Chicago.

#### SCENERY TO RENT

SETTINGS for Opera, Plays, Minstrels. Push drops. Address Amelia Grain, Philadelphia.

#### EDUCATIONAL AND INSTRUCTION

USED educational matter bought, sold, exchanged. Bulletin free. Instruction Correspondence Exchange, 1968 Broadway, New York.

HOW TO Run a Lathe, newly revised 160-page book, 250 illustrations, over 1,000,000 copies now in use. Price 25 cents postpaid. See advertisement page 185 for Easy Payment Plan for South Bend Lathes, South Bend Lathe Works, Dept. C, South Bend, Ind.

ARTHOL Shorthand learned in four evenings. Full course seven dollars. Used everywhere. Sent on approval. Particulars, Hollefreund's Arthol Institute, Stratford, Ontario, Canada.

LEARN Sign Painting in two days. New System makes big money. Samples 10c stamps. Gilmer Service, Lock Box 208-D, Chicago.

USED educational matter sold at lowest prices, easy terms, bought for cash. Catalog Free. Economy Educator Service, 442-A Sansome, San Francisco.

EARN \$25 weekly, spare time, writing for newspapers, magazines. Experience unnecessary. Copyright book free. Press Syndicate, 981-A, St. Louis, Mo.

VIC'S Selfwriter wonderful asset in teaching writing. \$1. Vic Hansen, Wallace, Idaho.

WORLD-ROMIC System, Masterkey to All Languages. Primers, \$1.94; Chinese, French, Spanish, Pronunciation-Tables, 30c. Dictionaries, \$1.98. Languages, 8 West 40th, New York.



USED educational matter bought, sold, exchanged. Handling, 799 Broadway, New York.

**PERSONAL** Advancement tells how to decide upon a vocation, how to plan a course of home study, how to avoid duplication in the books you buy, how to secure the best books on any subject. And it's free for a year. Send your name and address on a postal today to Popular Mechanics Press, Room 807, Popular Mechanics Building, Chicago, Ill.

**RAILROAD** Postal Clerks start \$133 month, railroad pass. Send stamps for questions. Columbus Institute, E-2, Columbus, Ohio.

**YOU** can have a business profession of your own and earn big income in service fees. A new system of foot correction; readily learned by anyone at home in a few weeks. Easy terms for training; openings everywhere with all the trade you can attend to. No capital required or goods to buy, no agency or soliciting. Address Stephenson Laboratory, 1 Back Bay, Boston, Mass.

**CARTOONISTS**—Improve your style by following the work of the greatest cartoonists found in the bound volumes of Cartoons Magazine. Three volumes, each covering six months, Jan.-June 1919 to Jan.-June 1920, inclusive, 1200 cartoons, 900 pages to a volume, 7 by 9½ in., 3 in. thick. New books, durable and attractive binding. Sold separately at \$2 per vol. postpaid. Supply limited. Send at once. Popular Mechanics Book Dept., 206 E. Ontario St., Chicago.

USED educational matter, books, etc., bought, sold, rented and exchanged. Big list free. Lee Mountain, East Chattanooga, Tenn.

**ARTIFICIAL** Marble sanitary flooring instructions, ornamental casting, concrete, plaster, papier-mache decorations, garden furniture, statuary, Rubber-moulds. 15 years' instruction the public, particulars and 200 illustrations free. Chris Mahler, Huntington, N. Y.

**STUDY** Patent Solicitation. Become Patent Attorney. Full particulars, Patent Law, Jordan, Minn.

"WHAT to Invent for Profit" free. Patent News-N, Washington, D. C.

**DOUBLE** Entry Bookkeeping mastered in 60 hours with 8 keys; guaranteed; diplomas. International Bookkeeping Institute, Dept. 8, Springfield, Mo.

**BOPP'S** Calculator and Short-cut Arithmetic shows the answer as quickly as a watch shows the time to all problems likely to occur in office, store, shop, bank, farm or factory. Price, pocket size, paper 35 cents; cloth 50 cents; leatherette \$1. Desk size, cloth \$1.50 postpaid. Popular Mechanics Book Dept., 206 E. Ontario St., Chicago.

USED Educational Matter; save over half. Bargain catalogue 1,000 courses free. Used courses bought. Students' Exchange, Dept. A, 47 West 42nd St., New York.

#### RADIO OUTFITS AND SUPPLIES

**RADIOTRON** or Cunningham tubes \$3.25. Send for price list. Radio Engineering Co., Box 197, Berkeley, Calif.

**THOUSANDS** of Bargains in Radio Supplies and Sets. Write for Free Complete Catalog. Stone Electric Company, Dept. P, 714 Pine St., St. Louis, Mo.

**RADIO** Tubes guaranteed, new and re-filled direct from factory, information free. Agents Wanted. Radio Tube Outlet, 207 Market Street, Newark, N. J.

**IF** you want the most from your set, use good tubes. Tritone type 201-A and 199, detector-amplifier will equal any tube on the market. Satisfaction guaranteed or money refunded. Special introductory offer \$2.35. Tritone Sales Co., 1004 Union St., Brooklyn, N. Y.

**WONDERFUL** Discovery—build this Radio Apparatus—it's easy; light your home free. Produce Electricity from water and air; book and 30 years' experience—it's \$1.00 Postpaid. Spark Co., Monongahela, Pa.

**RADIO** Builders: Order a set of Nine Standard Radio Drills in Canvas Tool Roll for One Dollar. Postage Prepaid. South Bend Sales Company, South Bend, Ind.

**CRYSTAL** Radio Set \$2.98. Complete parts for one-tube famous Pingree set and instructions for assembling, \$10.00. Send check or money-order. Nicholas, 120 High St., Boston.

**RADIO** tube sets, 2,000 mile radius easily. Sacrifice. Complete with tube \$15, worth \$35. Write: H. Vail, 1761 State, Schenectady, N. Y.

**BIJUR** Generators, new 6-volt maximum output 22 amp., 2,000 r. p. m., with cutout suitable charging A-battery. Government surplus, \$10.00. Cook County Sales, 2456 Calumet, Chicago.

**RADIO** Shock Absorber. If bothered with vibration or body capacity send \$1.00 for a set of four Herbert Insulators. Hard rubber base with sponge rubber cushion. Give type and finish of cabinet. Green Rubber Co., Box 208M, Greensburg, Pa.

**ELECTRIC** Soldering Iron. \$1.50 postpaid. Satisfaction guaranteed. Mayvin, Medina, N. Y.

**PATENTS**—Send for booklet. Contains valuable information for inventors. Bank and commercial references. Prompt service, twenty years' experience. Talbert & Talbert, Registered Patent Lawyers, 573 McGill Building, Washington, D. C.

**CABINETS** and Panels at lowest prices. Foxon, 1065 Third Avenue, New York.

**SET** Builders, Attention! Thousands making big money. Get dealers' discounts on standard parts or kits ready to wire. Guaranteed merchandise. Write North Shore Radio Works, 813 Mulford St., Evanston, Ill.

**GREATER** volume and distance on crystal or single tube sets. Write Theodore Barwell, Middletown, N. Y.

**LOUD** Speaking Crystal Set. Broadcastings heard throughout house. Easily constructed. Book, diagram, 25c. Catalog free. Steinmetz Wireless Mfg. Co., Eastend, Pittsburgh, Pa.

**2,650 MILES** Distance with one tube. Any novice understands our Simplified Instructions, including Panel Layout and Photo 25c. Vesco Radio Co., Box PM-117, Oakland, Calif.

**DICTIONARY** of Radio words and terms, electrical symbols, wiring diagrams, radio diagrams and complete electrical dictionary; new up-to-the-minute, just published. 188 pages, cloth cover, vest-pocket size. 35c postpaid. Popular Mechanics Book Dept., 206 E. Ontario St., Chicago.

#### TELEGRAPHY

**TELEGRAPHY**—Both Morse and Wireless—taught thoroughly and quickly. Tremendous demand. Big salaries. Wonderful opportunities. Expenses low; chance to earn part. School established fifty years. Catalog free. Dodge's Institute, H St., Valparaiso, Ind.

#### TRADE AND TECHNICAL SCHOOLS

**EARN** from \$10 to \$25.00 per day. You can learn in a few weeks at low cost to be a Sign, Auto and Pictorial Painter—Decorator, Paperhanger, Showcard Writer, Grainer and Marble. No books used, all practical work. Send for Free Catalog. Chicago Painting School, Dept. 9352, 150 West Austin Ave., Chicago.

**BE** a Bricklayer. Attend a School conducted by building contractors, who are interested in increasing the number of bricklayers. Day course is four months and for which student pays \$100.00. Night class is six months for which student pays \$80.00. This Association helps students get work after they finish course. Send for catalogue. Associated Building Employers of Michigan, 112 A. B. E. Building, Grand Rapids, Mich.

**GET** a Foreman's Job in any trade. Train yourself to earn more money. Become an expert Blue Print Reader. You can do it in spare time. My training will give you advancement in a few weeks. Write now—tell me what trade you want—I will send my plan at once. Carroll Rumsey, 165 Drexel Bldg., Philadelphia, Pa.

**NO** Matter What Trade you are interested in, you can get help from Personal Advancement magazine, published by Popular Mechanics and sent free to all who request it. Will help you decide upon a vocation. Send your name and address on a postal to Popular Mechanics Press, Room 807, Popular Mechanics Building, Chicago, Ill.

#### BUSINESS OPPORTUNITIES

**BRANCH** Manager Wanted—\$75 to \$100 weekly; repeat mechanics necessity; must handle mail sales, agents, trade; \$100 capital gets quick results. Clean-It Products Co., 1608 E. 66th St., Cleveland, Ohio.

**MONEY-MAKING** Business in your own home. This Plan Practical and Positive. Send fifty cents for sample and instructions. P. O. Box 127, Ottumwa, Iowa.

**MANUFACTURING** and Electric Lawn Mower Sharpening at Home. Investigate. 415 South Lawndale, Kansas City, Mo.

**120** MONEY-MAKING Plans Free! Wolverine Bureau, G-11, Muskegon, Mich.

**START** a business of your own. Sell goods under your own private brand. Toilet articles, food products, household specialties. Tremendous profits. Big repeat business. We supply everything needed. Write for our attractive proposition. National Scientific Laboratories, 298 Monroe, Richmond, Va.

**POPULAR** Scherer, Alliance, Ohio, teaches mail-order business and prints big profit schemes; one subscriber making \$25,000 from three; another \$10,000 from one. Try your luck. Year, 12 copies, 384 pages, only \$1; 3 months, 30c.

**MAKE** toys and novelties at home. Big profits. Instructions and 200 illustrations, 25c. Astrolite Company, Sharpshurg, Pa.

**START** a small Magazine and Mail Order Business. Sample, Plan, free. Harvey Teeple, Decatur, Ind.

**AGENTS:** \$11.80 daily in advance (send for sworn proof). Introducing New Insured Hosiery. 47 styles, 35 colors, guaranteed seven months. 1925 line now ready. No capital or experience required. You simply take orders. We deliver and collect (or you can deliver, suit yourself). Credit given. Pay you daily, monthly bonus besides. We furnish samples, spare time will do. Maccohee Textile Company, Station 2582, Cincinnati, Ohio.

**START** Mail Order Business. New, Simple, Economical Plan. Positively Gets Money Steadily. Surely Without Fail. Sworn Proof Free. Gerald Hinds, Monticello, Ill.

**GO** into the Crispettes business. Everybody likes Crispettes. You can make a lot of money. We start you. Write for facts. Long Eakins, 1939 High St., Springfield, Ohio.

**GOOD** Money easily earned at home spare time Silvering Mirrors. Glass Embossing, Chipping, Frosting, Gold Leafing, etc. Patterson & Co., Brooksville, Ky.

**I** MADE \$100,000 as Real Estate Specialist. Free booklet tells how. American Business Builders, Inc., Dept. AA-442, 1133 Broadway, New York.

**A** MAIL-ORDER business of your own, selling movie patrons all year anywhere, free circulars. Wondo, M 31 Times Plaza, Brooklyn, N. Y.

**SPECIAL** Free Offer: One Billion (1,000,000,000) German Marks, 5,000 Polish Marks and 10 Russian Czar Pre-War Roubles Absolutely Free with every 25c order for 100 Kronen Hungarian Government 5½% Bonds. Interest coupons attached. Send 25c order today and receive latest quotations. Public State Bank, Dept. 608A, Chicago.

**BE** your own boss. \$100 sufficient. Handle your own cash. Dept. M, Paul Kaye, 149 Broadway, New York.

**MAKE** Money Silvering Autolights, Radiators, Mirrors, tableware, stoves. Outfits. Methods Free. Sprinkle, Plater, 127 Marion, Ind.

**WANTED**—One reliable high class salesman in each state to sell Skilaw, the wonderful new labor saving tool; no competition, unlimited market. Practical mechanics preferred. Substantial interest may be obtained by right party. References. Michel Electric Hand Saw Company, Chicago, Ill.

**BUILD** splendid business making chipped glass number and name plates, signs, medallions. Write for particulars. Simplex Utility Co., 1133 Broadway, New York.

**FORMULAS**, Processes, Trade-Secrets. Different, dependable, guaranteed. Catalog free. B. Thaxly Co., Washington, D. C.

**GOLD** Window Sign Letters. Manufacture them at home. Unlimited profits and business opportunities. Complete instructions and patterns. No experience required. Particulars, Witterding, 1144 Pleasant Street, Oak Park, Ill.

"SIGN Painting Self Taught." Samples 5c Stamps. Healy Sign Co., 21 Old Colony Ave., Wollaston, Mass.

**FORMULAS:** New. Different. Guaranteed. Make your own extracts, flavors, syrups, beverages, etc. Valuable information free. The Formula Co., 122 W. Howe, Seattle, Wash.

**SAWDUST** and Chemicals make imitation marble flooring. Profitable business. Formula \$1.00. Universal Supply Co., 119, Auburn, N. Y.

**START** Mail Order Business. Watch Yourself Grow. Cost 5c—Sell by Mail for \$1. Particulars Free. Tick, 3338 Arkansas St., Oakland, Calif.

**25** MAILORDER Magazines and Papers 50c. Hansen Company, Brookings, S. Dak.

**START** Wonderful Business. Plan To Quickly Raise Cash Free! Goldberg's, Rockville, Conn.



**\$100 TO \$200 a Week Easy**—New Gasoline Tonic. Perfected by inventor of Klaxon Horn. Removes carbon—increases mileage—makes starting easy in freezing weather—cuts down deadly carbon monoxide gas. Called Hutch-Olene. Comes in 16 oz. cans—good for 40 gallons of gasoline. Salesmen cleaning up! Spare time—full time. Big money—easy sales—repeat orders. Free auto. Send for Big Free Offer. Hutch-Olene Company, Dept. BR, 234 Fifth Avenue, New York.

**START** mail order business of your own. Send \$1.00 for 22 good workable plans. Lloyd Steele, Aurora, Ill.

**A WORTHWHILE** Mail-Order Business of Your Own, by new methods; up-to-date, quick, sure, positive and big is yours if you want it. Get the latest information while it is new. Circular free. Marion Mac Rae, Publisher, 623-P Washington St., Portland, Oreg.

**A GOLD Mine** of Mail Order Information—Plans, Formulas, magazines, bargain offers, money-making propositions, Realize 10c. Opportunity Publishers, Dunkirk, N. Y.

**COMPANIES** organized. Capital furnished. Write: Official, 296 Broadway, New York.

**FREE** booklet, "How to Become Successful in Real Estate." MacDonald Cooperative Realty, San Diego, Calif.

**AGENTS' Names** one day old. Realize Co., 58 W. Washington, Chicago.

**LEARN** Sign Painting in two days. New System makes big money. Samples 10c stamps. Glimmer Service, Lock Box 208-C, Chicago.

**INCH** Display Advertisement 166 Magazines Year \$50. Wood's Popular Services, Atlantic City (N. J.)

**MAIL** Order. Agents' Supply Houses. Dry Ink. Ideal specialty. Triangle, 125 Tremont, Boston.

**PATENTS**—Write for our Guide Books and "Record of Invention Blank" before disclosing inventions. Send model or sketch and description of invention for examination and instructions. No charge for the above information. See advertisement on pages 154 and 157. Victor J. Evans & Co., 192 Ninth, Washington, D. C.

**PATENTS**—Write for my free Guide Books "How to Obtain a Patent" and "Invention and Industry" and "Record of Invention" blank before disclosing inventions. Send model or sketch of your invention for instructions. Promptness assured. No charge for above information. Clarence A. O'Brien, Registered Patent Lawyer, 589-B Security Bank Building, directly across street from Patent Office, Washington, D. C. See pages 154 and 155.

**\$1.00 BRINGS** sound European Money, Bonds, Coins. Tremendous Profits. Circulars Free. Hirschbonds, 70 Wall St., New York.

**PATENTS** procured; trade marks registered. A comprehensive, experienced, prompt service for the protection and development of your ideas. Preliminary advice gladly furnished without charge. Booklet of information and form for disclosing idea free on request. Richard B. Owen, 39 Owen Bldg., Washington, D. C., or 2274-R Woolworth Bldg., New York.

**\$5,000-10 YEARLY.** Start Painting—Interior Decorating Business. Millions of Homes, Automobiles, Garages need this Service. Easily Learned at Home. Sound, helpful advice given. Sold on Money-Back Basis. DeWilde, Sheboygan, Wis.

**\$5,000 TO \$8,000 Yearly.** Want it? Others are making it. Send check or money order today for our invaluable books "How to Sell Real Estate," \$3.00—and "How to Conduct Real Estate and Insurance Business," \$1.50. Absolute satisfaction guaranteed. Free catalogs. Realty Book Co., Dept. 52, Cleveland, Ohio.

**SIGN** work made easy with "Perfect" letter patterns. Over 40 styles. Cut from Aluminum, Celluloid, or Oil-board. Beautiful and exact gold-leaf lettering on glass now easy. Instructions free with order for patterns. Write for samples and prices. Ross System, 4794 Vincennes Ave., Chicago.

**\$2.50 BUYS** 1,000,000 mark, German Government 1923 Bonds. We offer \$1,500.00 for 1,000,000 marks. German Government 5% Bonds. All foreign bonds and currency dealt in. Frank H. Everett & Co., 35 Wall St., New York.

**\$10,000 YEARLY** easy, doing professional work you'll like. Leaders, 129 N. State, Suite 1105, Chicago.

**EARN** money at home spare time or evenings. No peddling. Permanent. Work in your own home. Write Downs Co., 2323 Myrtle, St. Paul, Minn.

**CHEMICAL** Expert furnishes Manufacturing Formulas and Processes with complete working directions. Reliable individual service only. No lists. Charges reasonable. Correspondence invited. Dr. VanHeeden, 508 South Oakley, Chicago.

**"HOW to Sell Patents"** free. Patent News-H. Washington, D. C.

**FREE** Book. Start your own little Mail Order business; home employment evenings. Beginner's Outfit furnished, including 500 circulars, samples, things to sell; you deal with Manufacturers. Also tell easy way to get Agents by mail to sell your novelties. Instructive Book free. Plier, 865 Cortland Street, New York.

**LEARN** Tartaric Mirror Silvering. It Pays Big! Long, closely guarded secret. Particulars free. Wm. Barstow, 514 23d St., Oakland, Calif.

**EARN** \$25 weekly, spare time, writing for newspapers, magazines. Experience unnecessary. Copyright book free. Press Syndicate, 981-B, St. Louis, Mo.

**3,784 MONETARY** Plans, Formulas, Trade-Secrets. "Encyclopedia Business Opportunities," 3 Volumes 98c. "Ideal," 5501-PM, North Robey, Chicago.

**HOW to Start** Mail Order Business \$1. Information free. F. Fischer, 902 7th, Oakland, Calif.

**MONEY-MAKING** Business Chances—Write. Pruitt Publishing Co., 734-F Cherry, Kansas City, Mo.

**ENTER** a new business. Earn \$3,000 to \$6,000 yearly in professional fees making and fitting a foot specialty, openings everywhere, with all the trade you can attend to; easily learned by anyone at home in a few weeks, at small expense; no further capital required, no goods to buy, job hunting, soliciting or agency. Address Stephen Laboratory, (1) Bark Bay, Boston, Mass.

**MANUFACTURE** Millerite! Ethyl-Super-Fuel Ingredient for Gasoline. Increases Power, Mileage—saves gas—easily mixed—profits great—valuable Formula Literature of this. Lightning Electrolyte, Kor-Kit, Pro-Tex-U, Amazon Rubber Repair, and fifty other Biggest selling Specialties in all lines will be sent on request. Miller, Chemist, 1115 Grand Central Ave., Tampa, Fla.

**MAKE** money with your camera. Lancaster-B. Box 428, Los Angeles.

**MANUFACTURE** fast selling necessities; particulars, samples, 10c stamps. Glimmer Service, Lock Box 208-A, Chicago.

**ATTENTION!** You can have a business of your own. Establish and operate New System Real Estate Business, brokerage and insurance agency in your community. Office at home. Earn \$5,000 year. Representatives wanted everywhere. Send stamp free booklet. Hayes Realty Association, Cincinnati, Ohio.

**INVENTORS**—Write for our Guide Book, "How to Get Your Patent" and Evidence of Invention Blank. Send model or sketch of your invention for our free Examination and Instructions. Randolph & Co., Dept. 435, Washington, D. C.

**EXCEPTIONAL** Opportunity for Sales Manager capable of handling state distribution. Marvelous new Adding Machine. Retails \$15. Free equals \$350 machine. Tremendous possibilities. Unlimited Profits. Write quick for details. Lightning Calculator Co., Dept. B, Grand Rapids, Mich.

**MAIL** Order Business is your opportunity. Brenner's Famous Handbooks teach how to start small, grow big. Sell merchandise, service, ideas; enormous profits. Spare time to begin. Get complete set, 11 books, \$3.00, and be posted. Brenner, 335 Walnut, Philadelphia. Descriptive Catalog and big batch interesting mail order information. 25c. None free.

**CHEMICAL** Expert will furnish Formulas and Trade Secrets. All lines. Lists Free. W. L. Cummings, Ph. D., 228 Gordon Ave., Syracuse, N. Y.

**UNPATENTED** Ideas Can Be Sold. I tell you how and help you make the sale. Free particulars (Copyrighted). Write W. T. Greene, 810 Jennifer Building, Washington, D. C.

**I MADE** \$30 a Week Home. French Breadmaking. 15 years' experience; Free booklet tells. Ashbrook 67, Marengo, O.

**LEARN** the collection business. Good income, quick results. Interesting booklet, "Skillful Collecting" free. National Collectors Assn., Long St., Newark, O.

**PATENTBOOK**, 139 mechanical movements and illustrations, sent free. Labiners, 3 Parkrow, New York.

**"WHAT to Invent for Profit"** free. Patent News-C, Washington, D. C.

**WE Start You in Business**, furnishing everything; men and women, \$30.00 to \$100.00 weekly operating our "New System Specialty Candy Factories" anywhere. Opportunity lifetime; booklet free. W. Hillyer Bagdale, Drawer 4, East Orange, N. J.

**DOLLARS** Yearly in your Backyard. No mushroom dope. Particulars free. Meta, 313 East 89th, New York.

**EARN** \$10 daily silvering mirrors, plating and refinishing metalware, autos, chandeliers, bedsteads, headlights, Outfits furnished. E. Decle Laboratories, 1133 Broadway, New York.

**MARBLE** mixing instructions, covering wood or cement flooring 1/2 in. thick. Fire-proof, waterproof, low cost, sanitary, all colors. Particulars, 200 illustrations free. Chris Mahler, Box 122, Huntington, N. Y.

**EVERYONE** knows of the remarkable success of the 10c Stores. Now comes the 25c and 50c Mail Order Business. Write for free circular. Taber Bros., 311 Fifth Avenue, New York.

#### WANTED—BUSINESSES FOR SALE

**IF** You Want to Sell Your Business for Cash quickly and privately, we take the prospective buyer directly to you at our expense, no matter where located. We specialize in selling out-of-town businesses. If your business is worth \$5,000 or more, write us The Mutual Security System, 68 W. Washington St., Chicago.

#### CHEMISTRY

**YOUR** chemical problem solved. Formulas and processes for every business and for any purpose. Practical working formulas a specialty. Write me. W. Steadman Richards, Consulting Chemist, Box 2402, Boston, Mass.

**CHEMICAL** Processes, Analysis, Information. Robert Henderson, Consulting Chemist, Madison, Maine.

**TECHNICAL** information, analyses, formulas, trade secrets. Jacob Sluyter, Chemist, 2525 East St., Davenport, Iowa.

**WORKING** Formulas, Five Dollars. Analysis, Research. R. J. Noble, Chemist, 133 Mt. Vernon St., Malden, Mass.

#### FORMULAS AND TRADE SECRETS

**WHAT** do you want to manufacture? \$2 will bring guaranteed formula for any product; complete instructions. Consulting Chemists Bureau, Box 1709, Boston, Mass.

**BIG** Demand Basic Chemical, handsomely packed, for twelve 35c packages, used daily by millions; with permanent, profitable Mail Selling plan \$1. Formula alone 25c. All with expert revision your individual sales letter \$2. 2% reservations monthly; be quick. Write, Box 163, Joplin, Mo.

**ARTICLE** costs 50c to make, sells for \$8.00; repeater, sells the year around. Sample 25c. Mitchell-Ames Co., Effingham, Ill.

**500 SUCCESSFUL** money-making Formulas and trade secrets 25c. C. H. Dymms, 705 E. 12th St., Muncie, Ind.

**25,000 TESTED** formulas at \$1.00. International Information Institute, 17 Moore, New York.

**RESTALL** Chemical Wood Stone—For public building, kitchen and bath room flooring. Can be molded into innumerable souvenirs and ornamental novelties. Formula \$5.00. Maxin Chemical Company, Maxin Building, New Castle, Ind.

**BEVERAGES**, Etc. Reliable Formulas. Valuable information. The Formula Company, Ber. Dep't., 122 West Howe St., Seattle, Wash.

**500 VALUABLE** Formulas 25c. Literature Free. Harry Teepie, Decatur, Ind.

**ATTENTION**—Plumbers, Stop Leaks permanently; Boilers, Radiators, Pipe, Castings, Etc. 15c at the Drug store, enough for average job. Several Formulas instructions \$1.00. Plumbers, 3553 N. Aldrich Ave., Minneapolis.

**VALUABLE** collection of 550 high-grade formulas and manufacturing secrets, including successful selling methods, 50 cts. Pentland Service, Norwalk, Conn.

**ANY** formula, One Dollar. Satisfaction guaranteed. Manufacture your own goods. Tell what you want to make. We send one or more formulas. Stamp brings list of profitable preparations. Barton, South Whitley, Ind.

**500 FORMULAS**, including Luminous Paint—Renewing Dry Batteries—Mechanics' Soap—Gas Tonic—25c. Catalog Free. Ideal Book Shop, 5501-PM, North Robey, Chicago.

**ELECTRIC** Inhaler—Quick Relief for all aches and pains. Great winter seller. Guaranteed formula, \$1.00. Elm Supply Co., Rockville, Conn.



1,000,000 FORMULAS, 1,016 pages, \$1.98. 500 Formulas Free if you order quick. Ideal Book Shop, 5501-P.M. North Robey, Chicago.

**FORMULAS** The best Chemical Science can devise—Guaranteed Reliable Processes in all lines. Stamp brings big bunch valuable literature. Interesting lists. Don't buy till you see what I can give you. 27 years supplying the best. Miller, Chemist, 1113 Grand Central, Tampa, Fla.

**BLUE-FINISH** guns, rifles, etc., at small cost. Make them look new again. Guaranteed formula \$1.00. E. J. Simon, Dane, Wis.

10,000 **SELECTED** chemical, technological and practical recipes and processes, including hundreds of so-called trade secrets for every business, alphabetically arranged in one large volume of 800 pages. Price \$4 postpaid. Popular Mechanics Book Dept., 286 E. Ontario St., Chicago.

#### AGENTS WANTED

**NO Dull Times in the Food Business.** Selling Federal Pure Food Products is the greatest, surest and safest business in the world today, and here is your opportunity to get into it. You can make \$3,000, \$5,000, \$10,000, or more per year—the only limit is your ability to take care of the business. You will need no experience or money to get into this business as we send you our handsome \$15.00 Sample Case on Trust and teach you everything you need to know. No Dull Times, for the People Must Eat, and our food products are the fastest selling, surest and quickest repeat order goods in the world. Sell on sight in every home where food is used—repeat orders immediately and every week thereafter. A real big business all your own. Every new customer adds a great deal to your weekly income. Your business once established, has a market value just like a store and can be easily sold. The greatest money making opportunity of your lifetime because you risk absolutely nothing as we guarantee your sales, and we will not let you fail. Remember! Guaranteed! Best products, biggest sellers, surest repeat orders. No capital or experience is required. We furnish capital and everything necessary for you to become a Federal Distributor. Exclusive territory will be given honest men or women who write at once. Federal Pure Food Company, 2389 Archer Avenue, Dept. A, Chicago, Ill. Largest packers of Pure Food specialties in the world. Reference, any bank, Dun or Bradstreet rating agency, Express or Railway Company in America.

**WE want one ambitious man in each county as Sales Representative.** Our salesmen make big money taking orders for the Cole Visible Gasoline Gauge. Only scientifically accurate gasoline gauge that fits on instrument board—always in sight—prevents short measure—stops running out of gas—low price—in class by itself—sells on sight. \$10 to \$20 a day for six to eight hours. You get your pay in advance. We deliver and collect. Commissions paid on repeat orders. Exclusive territory. Capital not necessary. Write The Stemo Engineering Co., 208 Webb St., Dayton, Ohio.

**MILLERITE:** Here it is! You've read about this New Wonderful Ethyl-Super-Fuel Ingredient for Gasoline—Increases Mileage—Saves Gas—Knocks Carbon—Easily Mixed from my simple Formula—profits great—\$5,000.00 to \$50,000.00 for you if you hurry!! Don't pass this by you'll be sorry—but send today for full descriptive literature of this and other valuable Formula Lists describing latest, biggest selling specialties in all lines as Mendit, Fabric Mending Cement, Marcel Permanent Hair Curling Fluid; Denta-pearl Tooth Whitener; Balloons and other thin dipped rubber goods; Flynox—few drops kills roach flies; Amazon Self Vulcanizing Repair; Pro-Tex-U only Guaranteed Fire Extinguisher; Pure Food Products; Toilet, Medical, Household, Automobile Office Specialties—latest in all lines. 27 years supplying the best in Formulas and manufacturing information. Highest References. Miller, Chemist, Tampa, Fla.

**GENUINE Gold Leaf Letters** anyone can put on Store windows. Guaranteed to never tarnish. Large Profits. Enormous Demand. Free Samples. Write today. Metallic Letter Co., 428-A North Clark, Chicago.

**DUSTLESS Sponge Cloth.** New Invention. (1) Rub—Dusts, Cleans and Polishes Automobiles, Furniture, Pianos, Retail (50c)—Costs (16c). "Sample Free." NuLife (E) Sponges, Hartford, Conn.

**CALIFORNIA Roseheads** selling like hot cakes. Agents selling sooner; new stuff. Big profits. Catalog free. Mission Factory PM, 519 No. Halsted, Chicago, Ill.

**START a business of your own.** Sell goods under your own private brand. Toilet articles, food products, household specialties. Tremendous profits. Big repeat business. We supply everything needed. Write for our attractive proposition. National Scientific Laboratories, 251 Monroe, Richmond, Va.

**300% PROFIT:** Whitewash Seller. Tremendous repeater. "Kleanrite." Marvelous Discovery. Washes clothes without rubbing. Premiums for customers. Free samples make easy sales. Write quick. Bestever Products Co., 1941-K-2, Irving Park, Chicago.

**CLOTHING Sensation!** New line of men's clothes. All-wool suits and topcoats all at the one low price of \$23.50. Nothing higher. We pay biggest commissions cash with order, supply finest selling outfit and give powerful co-operation. 3 to 6 orders a day gives income of \$30.00 to \$125.00 a week. We have men who earn even more and can prove it. If you're looking for a real proposition and a money maker, write us at once. Experience isn't necessary. If you're honest, earnest and willing to work, we'll train you. Write at once to Dept. 268, William C. Bartlett, Inc., 850 W. Adams St., Chicago.

**SALESMEN Cleaning Up with New Gasoline Vitalizer.** Amazing new super-fuel perfected by inventor of Klaxon Horn brings \$100 to \$200 weekly to salesmen. Motorists wild about it! Removes carbon—increases mileage 20%—makes starting easy in frosty weather—gives more pep on hills—cuts down deadly carbon monoxide gas in exhaust. Called Hutch-Olene—3 oz. good for 5 gals. of gas. 16 oz. can good for 40 gals. of gas. No capital to invest—no experience needed. Write now for exclusive territory and big free offer. Address Hutch-Olene Company, Dept. B, 334 Fifth Avenue, New York.

**WHY not sell us your spare time?** \$11.80 daily in advance (send for sworn proof). Introducing New Insured Hosiery. 47 styles, 37 colors, guaranteed seven months. Spring line now ready. All the latest shades—Airedale, Tan Bark, Pica-dilly—30 others. No capital or experience required. You simply take orders. We deliver and collect (or you can deliver, suit yourself); credit given. Pay you daily. Monthly bonus besides. We furnish samples. Macches Textile Company, Station 2562, Cincinnati, Ohio.

**AGENTS—Best seller;** Jem Rubber Repair for tires and tubes; supercedes vulcanization at a saving of over 800 per cent; put it on cold. It vulcanizes itself in two minutes, and is guaranteed to last the life of the tire or tube; sells to every auto owner and accessory dealer. For particulars how to make big money and free sample, address Amazon Rubber Co., Philadelphia, Pa., Dept. 505.

**AGENTS, Salesmen—Sell New Thermostatic Automatic Carburetor Control Attachment for Fords.** Big Profits, full or part time. Burns 95% air. Doubles Mileage. Attached in 2 minutes. No drilling. Does automatically exactly what Ford manual says do by hand. Cadillac now using Thermostatic Carburetor Control under Blanche license. Write today. A. C. Blanche & Co., Dept. 250C, 602 Lake St., Chicago.

**TAILORING or Raincoat Agents:** Free—Raincoat—Free! Something new; Suits made-to-measure \$25.50, with raincoat free. Our men already making \$75.00 to \$150.00 weekly on this new plan. Also big raincoat sellers \$3.95. Satisfied customers everywhere. Commissions paid daily. Biggest outfit now ready. Get busy. Offer will soon be withdrawn. Elliott Bradley, Inc., 241 W. VanBuren, Dept. 1001, Chicago.

**AGENTS, Salesmen, Demonstrators,** you will have the devil's own time trying to find a better seller than "Zippo." If there was such a thing we'd have it. Splendid profit on 50c "Go Getter" repeat article that sells on ten second demonstration. Works While You Watch It. Demonstrates value, while others waste time making claims. New discovery! Greatest Scientific Triumph of the age. It's the berries. Haven't room to tell our story here. Write immediately. Karam-Smith Co., 602 Bozart St., Ft. Wayne, Ind.

**AGENTS—\$15 a day.** Easy, Quick Sales. Free auto. Big weekly bonus. \$1.50 premium free to every customer. Simply show our beautiful 7-piece solid aluminum handle cutlery set. Appeals instantly. We deliver and collect. Pay daily. New Era Mfg. Co., 803 Madison St., Dept. 21-BK, Chicago.

**AGENTS wanted** entirely new patented domestic article, sells for 50c; 200% profit. Write for particulars. Acme Products, 903AA Broad Street, Newark, N. J.

**\$50,000 PICTURE Man Friedman** made can-assing. Beginners can make \$100.00 weekly with my sales talk. Experienced men make more. Free book "Profits in Portraits" explains. Samples Free. Picture Man Friedman, Dept. 8-D, 541 W. Lake, Chicago.

**GOODYEAR Mfg. Co.,** 1742 Goodyear Bldg., Kansas City, Mo., is making an offer to send a handsome raincoat free to one person in each locality who will recommend it to friends. Write today.

**WONDERFUL** invention eliminates needles for phonographs. Preserves records. Abolishes scratching. Day's supply in pocket. \$20 daily. Sample on approval if requested. Everstar, Desk B-2, McClurg Bldg., Chicago.

**EARN \$15 daily** showing famous Style-Arch shoes. No experience needed. Attractive outfit. Style-Arch Shoe Company, Dept. 302, Cincinnati, Ohio.

**EARN \$45 to \$85 extra a week.** Selling beautiful Shirts. Commission in advance. We deliver and collect. Write quick. Fashion Wear Shirts, Dept. 462, Cincinnati, Ohio.

**PORTRAITS,** photo pillow tops, frames, sheet pictures, medallions, merchants' signs, food products, rubber aprons, guaranteed hood, toilet requisites, luminous crucifixes. Catalog 50 specialties free. 30 days credit. Jas. C. Bailey Co., Desk A-2, Chicago.

**WE'LL make a classy suit** for well dressed man over 25 who will wear and show to friends and help us introduce. Write for order blanks, etc. Chicago Tailors' Ass'n., Dept. 685, Sta. C, Chicago.

**SALESMEN and Agents—Make \$8.00—\$15.00 per day** selling men's Guaranteed shoes from factory to wearer. Complete sample case furnished upon good references. A business of your own, exclusive territory. Perry Shoe Company, 709-709½ E. Lake St., Minneapolis, Minn.

**\$3.00 AN Hour For Your Spare Time.** New discovery. Proven success. Particulars Free. K. Bothe, 3949 Metropolitan, Chicago.

**HAVE You Seen the New BeeGeo Line?** Get our 1925 Catalogue and stop worrying about what to sell. You'll be satisfied with what you make. B. & G. Rubber Co., Dept. 767, Pittsburgh, Pa.

**START in a permanent business** of your own selling guaranteed Hosiery and Underwear direct from mills. No capital or experience is needed; many representatives make \$3,000 to \$5,000 per year. Become our district manager—get others working for you. Write for details to Malloch Knitting Mills, 552 Grant St., Grand Rapids, Mich.

**AGENTS Wanted:** \$10 a Day Easily Earned taking orders for our big line quality soaps, perfumes, toilet goods, extracts, spices, foods, towels, jewelry, remedies, novelty needle books, rubber goods, etc. Men and women write for big offer. Catalogs free. Western Products Co., Dept. 156, 606 N. Oakley, Chicago.

**\$100 WEEKLY—Pleasant Work:** Appointing local agents to introduce Mother Hubbard Foods; no canvassing; no delivering; no money invested. Adam Inghout, 556 Congress, Chicago.

**AGENTS—Make \$20.00 to \$30.00 a day.** Live, keen house to house men wanted for new territory to introduce home specialty that sells on sight. My old Dad sold seven-teen the first day; made \$25.50 in six hours. Big profits, exclusive territory. Write today. A. B. Bradshaw, 227 W. Huron St., Chicago, Ill.

**AGENTS—To sell St. Christopher Shrine** in Catholic homes. Wonderful proposition and a new article. Write for territory. United Religious Goods Co., Covington, Ky.

**EARN \$40 to \$45 extra** every week taking orders for our high-class tailoring—made-to-measure suits from \$14.95 to \$39.50. Your own clothes at low wholesale prices. No experience necessary. Write for our Big Free Sample Outfit. Progress Tailoring Company, Dept. B-217, Chicago, Ill.

**WILL \$60.00 weekly** income satisfy you? Best proposition with surest results ever offered solicitors. No selling, delivering or showing samples. Field Manager, Room 343, Wells Bldg., Quincy, Ill.

**PAINTERS, carpenters, handymen,** start furniture refinishing, job painting and handyman business on nearly nothing. Winter money-maker; mostly all profit; winning plan brings customers quickly. John Brace-land, 1457 So. Ninth, Philadelphia, Pa.

**EXCLUSIVE line of "Well Finished"** Children's Garments direct from Factory. Underhill stores. Your profit daily. Wm. Freedman, Dept. M, 560 Broadway, New York.



**THE Clothing Business** is the second largest business in the country. Men have made fortunes in it. So can you if you go into it right. We'll put you into it right without one penny of expense to you, supply everything you need to get into the business and clear from \$100.00 to \$200.00 a week, right from the start. This is a wonderful opportunity, for the right man. If interested, write at once. Address Dept. 552, Goodwear, Chicago, Inc., West Adams Street at Peoria, Chicago.

**START** a business of your own. Sell goods under your own private brand. Toilet articles, food products, household specialties. Tremendous profits. Big repeat business. We supply everything needed. Write for our attractive proposition. National Scientific Laboratories, 251 Monroe, Richmond, Va.

**AGENTS:** Men and women, in spare or full time, make big money selling household necessities. Every home a prospect. Quick sales, big profit. Territory open. Write for particulars. Judd & Leland Manufacturing Company, Box 21, Clifton Springs, N. Y.

**AGENTS—Get** the ace of money makers. Sell every home and have big repeat business. Specially liberal proposition. Devo Brush Works, 550 Harrison, Chicago.

**MOST** Wonderful Seller. 96c profit every dollar. No stock to carry. License unnecessary. Sample free. Mission Factory PM, 519 No. Halsted, Chicago, Ill.

**\$50-\$200 A WEEK.** Genuine Gold Letters for store windows. Easily applied. Free samples. Liberal offer to general agents. Metallic Letter Co., 438-D North Clark, Chicago.

**EVERYBODY** Needs and Buys the "Business Guide." Wells cleared \$1,150 in 35 days. Send for sample. It's Free. Nichols Co., Dept. 4B, Naperville, Ill.

**FREE** Sample. "Rain Shield Wiper." Retail \$1.00—costs (25c). Just Invented. No Cloth—No Paste—No Attachment. Sold Clear and Rainy Days. (1) Rub keeps Windshield Clear (24) hours. Automobiles buy quickly. Riley made \$198 three days. Experience unnecessary. Wonderful Sellline. NuLife Corporation, Hartford, Conn.

**AGENTS—\$240** a month. Take orders for well known line of household specialties, food flavors, toilet preparations, etc. Full or spare time. Build a big permanent business. Must satisfy or money back. Write for free sample outfit and offer. C. H. Stuart & Co., 5367 Spring St., Newark, New York.

**AMERICAN** Woolen Mills Co., Dept. 5992, Chicago, are making a free suit for one agent in each community to introduce their fine tailored to order suits at \$18 and up. Write them today for their offer.

**MARVELOUS** Radio Gas Lighter—lights instantly, sells instantly, easily demonstrated, good for 10,000 lights; retails 25c, costs \$10 gross, \$26 profit. Send \$1.00 for sample dozen with self-selling plans. W. Masterlite, 110 East 23rd, New York.

**LIBERAL** commission; credit repeat orders; protected territory agents selling Helmitz Health Biscuits. Helmitz Food Co. (Est. 1902), 5638 Lake Park Ave., Chicago.

**WE** pay \$50.00 weekly for a few hours spare time work, calling on drug, department, general stores in your section. Dental-Drug Association, 2566 Lincoln Ave., Chicago, Ill.

**IMPORT** Your Own Goods. Big German Export Magazine, published in English, offers thousands of bargains in latest novelties. Sample copy 50c. Abca Specialty Co., E-283 Fifth Ave., New York.

**AGENTS,** \$20 daily easy selling household necessity every woman wants. New invention reduces price. Big profit. Fagley & Halpen, 303 Cherry Street, Dept. 5, Philadelphia, Pa.

**FOUNTAIN** Automobile Washers and other new specialties. Live sellers. Liberal profits. Get particulars. Hanson Mfg., 4121 Lake, Chicago.

**IF** you want to distribute free samples, circulars, etc., in own locality, write quick. Absolutely no selling. Excellent pay. Mutual Advertising Association, Dept. 488, Zanesville, Ohio.

**AGENTS—Big** Profits Selling Our Broom. Big Repeater. Let Us Show You What Others Are Doing. Write Now. Weaver Broom Co., Dept. B, Jonesville, Mich.

**BIG** Money. Enamel Automobiles; Formula, Instructions, one dollar. Guy Finch, Newton, Iowa.

**AGENT'S** complete outfit 25c—Stropper and Home for sharpening all makes of safety razor blades. Radio Stropper Co., 65 West Chicago Ave., Chicago, Ill.

**AGENTS** Make Big Money selling new auto invention. Hoffenberg's sold 900 in 2 months. Profit \$2,700. For full particulars write Stransky Co., Dept. W-13, Pukwana, S. Dak.

**"EIGHTEEN** calls, sold forty 20c boxes Owl Self-Shining (Oriental) Stone Polish. Made \$4.80." Amazes, delights; permanent business; friendly customers; sells itself. Scranton Glass Co., Jefferson Avenue, Scranton, Penna.

**MAKE** Money Silvering Autolights, Radiators, Mirrors, tableware, stoves. Outfits. Methods Free. Sprinkle, Plaster, 128, Marion, Ind.

**HAVE** agents work for you! See Big Demand Chemical ad under Formulas. Write Box 162, Joplin, Mo.

**BIG** Profits with Exclusive Territory—\$50 to \$100 weekly easy. More has often been made in one day's work. A hot or cold running water bath equipment for any home at only \$7.50. No plumbing or water works required. Investigate. Send no money. Write today. Sanitary Supply Co., 735 Allen Building, Toledo, Ohio.

**TAILORING** Salesmen: Our guaranteed \$21.50 and \$31.50 all wool tailored to order suits are \$10 to \$20 cheaper than store prices. Commission in advance. Protected territory. Beautiful assortment 6x9 sweaters free. Manager, Dept. 1060, 813 Adams, Chicago.

**WE** pay \$18 a week, furnish auto and expenses to introduce our Soap and Washing Powder. Buss-Beach Company, A42, Chipewa Falls, Wisconsin.

**AGENTS,** Mail order men: Valuable tips, inside information; also 17 automobile specialties. 300% profit. Particulars. Nite Mail Order & Supply Co., 609 27th St., Denver, Colo.

**NEW** \$1.00 Article Sells 1 out of 10 housekeepers. Your profit 65c. Morgan Mfg. Co., 443 So. Dearborn, Chicago.

**A** REAL Opportunity. A crackerjack seller and big profits. Agents wanted everywhere. Act Now, we will forward a sample for 25c. Howard E. Kirk Co., 66 Vernon St., Springfield, Mass.

**SELL** Books by Mail. Use Our Money making circulars at one-fourth cost; enormous profits on sales; particulars free. Peifro, 523 South Dearborn, Chicago.

**AGENTS—I** want hustling young men to take charge of my business in their home neighborhoods. \$1.25 an hour for spare time. Permanent positions. Dignified work. No experience or capital required. Costs nothing to start—I furnish everything. Answer quick. Harley Co., B-2011 Harley Bldg., Dayton, Ohio.

**AGENTS—Steady** Income. Large manufacturer of soaps, perfumes, toilet articles and pure food products, etc., wishes representatives in each locality. Manufacturer direct to consumer. Big profits. Honest goods. Whole or spare time. Cash or credit. Send at once for particulars. American Products Co., 2329 American Bldg., Cincinnati, Ohio.

**SELL** Mayneda pure rubber aprons. Many styles. Dainty colors. Baby goods. Sanitary necessities. Big profit. Mayneda Co., Dept. 136, 39 Murray St., New York.

**RAZOR** Blade Knives, take used safety razor blades; every man a prospect; brass, durably nickel-plated for vest pocket and heavier model, thirty cents each, postpaid. Burleigh Brooks, 136 Liberty St., New York.

**COMPLETE** line Hosiery, Underwear and New Art Silk Lingerie, rear's greatest selling sensation. Jacobs, Snider, others make \$150 a week. Free Samples to full or spare time workers. Write Wearplus Co., Dept. 361, Bay City, Mich.

**AGENTS** Wanted. Your chance in life to own dignified profitable business. We teach you practical insurance. Earn \$5,000.00 yearly. No capital required. Office at home. Dept. M, Room 215, 75 Montgomery St., Jersey City, N. J.

**AGENTS—Make** a dollar an hour. Sell Mendets, a patent patch for instantly mending leaks in all utensils. Simple package free. Collette Mfg. Co., Dept. 404, Amsterdam, N. Y.

**AGENTS!** Profit with first order selling shirts. Factory to Wearer. \$50 to \$100 weekly. Write Swanson Sales Co., Dept. 12, 1276 Broadway, New York.

**CAN** you sell? Suits and overcoats tailored-to-measure at \$19.75! Universal Tailors, H-99 Bedford Street, Boston.

**AGENTS,** both sexes; we manufacture and control new household article. Fast seller. Big profits. Exclusive territory. Write now. Connolly, 123 Liberty St., New York.

**STUDENTS—Agents,** Sell College Sport-Souvenir Pennants. Hutter Specialties, Saugerties, N. Y.

**GET** posted—Good prices paid for butter-fles, insects. See Sinclair display advertisement, page 28.

**ARE** you old at forty? See our advertisement on page 163 of this issue. The Electro Thermal Company, 2137 Main St., Steubenville, Ohio.

**PATENTS—Write** for my free Guide Books "How to Obtain a Patent," "Invention and Industry" and "Record of Invention" blank before disclosing inventions. Send model or sketch of your invention for instructions. Promptness assured. No charge for above information. Clarence A. O'Brien, Registered Patent Lawyer, 589-B Security Bank Building, directly across street from Patent Office, Washington, D. C. See pages 154 and 155.

**MARVELOUS** New Invention — 400% Profit. Johnson's Liquid Quick Mend. Tremendous demand. Plan unique. Act quick. Over hundred other fast-selling specialties. J. E. Johnson & Co., Dept. 52, 321 W. Chicago Ave., Chicago, Ill.

**AGENTS** Wanted—Something New—Fyr-Fyter sells easily. Makes a spectacular demonstration; car owners, homes, factories, stores, practically buy on sight. Our men make \$10.00 to \$30.00 a day. If you wish to establish a business of your own with unlimited possibilities for making big money, write us today. Fyr-Fyter Co., 684 Fyr-Fyter Bldg., Dayton, Ohio.

**YOUNG** Men who want to make their spare time pay from \$20 to \$50 a week are offered an opportunity to sell an article which every man buys on sight, made by Ingersoll, the dollar watch man; retails for \$1; you don't need to be a salesman; merely to show is to sell; big profits, quick sales and constant repeat business. Write today. Robt. H. Ingersoll, 476 Broadway, Dept. 260, New York.

**AGENTS—Ten** dollars daily, steady year round. Samples and particulars free. Waychoff, Loveland, Colo.

**AGENTS:** Sell two shirts for price of one. Walton Duplex shirts are reversible. Make \$15—\$25 daily. We deliver, collect. Write for "Your Opportunity." Walton-Duplex Co., 122 Brooks Bldg., Chicago.

**AGENTS:** \$15—\$30 daily selling "Swing-up," the great accident preventer. Every auto driver wants one. 100% profit. Free offer. Industrial Development Corp., Dept. 22, Bridgeport, Conn.

**AGENTS,** Sell our new Liquid Face Powder; enormous profits and fast sales. Sta-On Liquid Powder Co., 75 Broadway, Asheville, N. C.

**BIG** Mills, doing international business, seeks representative for distinctive C. S. C. tailored shirts. "Built on Honor to Honor Their Maker." Direct to wearer \$20 daily easy. Tremendous demand. Big reseller. Outfit and samples free. Act Quick. Chicago Shirt Co., 205, Chicago Shirt Bldg., Chicago, Ill.

**AGENTS** handling La Fleur Perfume Tablets are reaping immense profits, costing six cents and selling for twenty-five. Sales repeated promptly, with a permanent clientele. Do not miss this wonderful opportunity. Great for lady agents. Free terms. Sample ten cents. Triumph Mfg. Co., Fox Chase P. O., Philadelphia, Pa.

**NEW** Specialty costs 10c. Sells for 50c. Read \$1.00 values. 30 other wonderful sellers. New inventions, all household necessities. Sample outfit free. Write Quick. General Products Co., Dept. 7, Newark, N. J.

**WILLIAMS** No Water Hand Soap, in tubes, has taken Auto owners by storm; washes dirtiest hands perfectly clean without water. Easy demonstration makes quick sales; 150% profit. Williams Co., Box 205, Montclair, N. J.

**AGENTS** to sell Power, the universal cleaning fluid. Removes dirt, spots and grease from wearing apparel without injury to fabric or color. Send 25 cents for sample and particulars. Power Laboratories, 941 Greenfield Ave., Pittsburgh, Pa.

**YOU** can sell every merchant in town our changeable signs. Large profits; easy sales. Write for territory now. Changeable Sign Co., 581 East 192nd, Cleveland.

**SELL** guaranteed spark plugs \$12.00 per hundred. Send \$2.00 for 12 samples, order blanks, etc. Kelly Lamp Works, Oak Park, Ill.

**AGENTS—Something** absolutely new and novel in signs. Every office, store and private family a prospect. Make 'em yourself. We sell you materials and letters ready to mount. No. not tinful. Mounted sample 10c. Ross System, 4704 Vincennes Ave., Chicago.



**BROWN** Earned \$987.00 in 60 days selling Automatic Kuff Buttons, the Greatest Convenience of Ages. Demand unlimited for capable salespeople. Sold on Money-back Basis. Flexo, Sheboygan, Wis.

**START** a business of your own. Sell goods under your own private brand. Toilet articles, food products, household specialties. Tremendous profits. Big repeat business. We supply everything needed. Write for our attractive proposition. National Scientific Laboratories, 251 Monroe, Richmond, Va.

**AGENTS** Koining money selling Klan Jewelry. Dime brings lucky Kluxer pocket-piece and Katalog. Box 524-PM, Omaha, Nebr.

**AGENTS**, \$45 a week—Finest line of silk hose you ever saw. All styles and latest shades. Also other kinds for men, women, children. Must give satisfaction or new hose free. No collections or deliveries. Pay you daily. Write for samples. Parker Mfg. Co., Sample 1978, Dayton, Ohio.

**AGENTS**: Make \$1 to \$5 an hour selling the Famous Bamboo Self-Filling Fountain Pens. Write for Wholesale price list. Cordell McDaniel, Salisbury, N. C.

**AGENTS**—Big Money Maker. Miracle Mixer. Absolutely new idea using faucet water power, labor-saving device. Beats eggs, cream, batters, etc., from 15 to 30 seconds. Housewives buy on sight. Agents cleaning up; territory going fast. Send \$1.00 for machine and proposition. Miracle Manufacturing Company, Dept. E, Flatiron Bldg., San Francisco.

**CHEAPER** To Make Your Own Auto Polish. Top Dressing. Carbon Solvent. Radiator Cement. The four formulas \$1. Jo-La-Ko, Box 842, Station C, Los Angeles, Calif.

**\$100 WEEKLY** easy selling Oriental perfumes and cosmetics; 100 per cent profit. Sample case absolutely free. Write for catalog. Rosola Parfumerie, Inc., Woodlawn, Chicago.

**BUILD** splendid business making chipped glass number and name plates, signs, medallions. Write for particulars. Simplex Utility Co., 1133 Broadway, New York.

**FORMULAS**. Processes. Trade-Secrets. Different, dependable, guaranteed. Catalog free. B. Thaxly Co., Washington, D. C.

**PUMPS**. The fastest selling product on the market. Nothing else like it. Something entirely new. Make Big Money. Used by every auto-driver, mechanic, and necessary to every household. Repeat orders. A twenty-five cent article. Quick sales. Big Profits. Pumse Manufacturing Company, 128 West 75th St., New York City.

**WE** are now selling the Great Dane shoes for men and boys direct to wearer. Agents wanted, whole or part time. Hamlet-Mooney Co., 35 Lincoln St., Boston, Mass.

**MANUFACTURE** fast selling necessities; particulars, samples, 10c stamps. Gilmer Service, Lock Box 208-B, Chicago.

**LATEST** French Advertising Novelties, Pencils and Watch Chains, with Microscopic Snaggy Views Enlarged 500 Times. 25c Seller. Three samples sent for 25c with list. Grandfield, 1538 Theriot Ave., Bronx, New York.

**I PAY** Men \$100 a week, selling our fine made-to-measure, all-wool suits—Direct to Wearer—All one price, \$31.50. Biggest values. Highest commissions in advance. We deliver and collect. 629 swatch samples furnished. Write today. State selling experience fully. W. Z. Gibson, Inc., 161 W. Harrison St., Dept. B-517, Chicago.

**EXCLUSIVE** territory to desirable agents to sell beautiful Onyx Gear Shift Balls. fit all cars, retails \$2.50, wholesale \$1.25. Send \$1.25 for sample. Phoenix Onyx Company, Box 888, Phoenix, Ariz.

**AGENTS** get Klosswik, the newly invented door spring. Whirlwind seller. Retails for 50c. You make 100% or more. Sell 50 to 80 a day easy. Write for 45c sample and easy starting offer. Klosswik Mfg. Co., Dept. A, Bible House, Astor Place, New York.

**RESPONSIBLE** representatives wanted for new marvellous Pocket Cigar Lighter. Sells on moment's demonstration to consumers and dealers. Big profits and exclusive territory rights. Send for particulars and selling plans. Enclose 50c stamps for sample. W. Masterlite, 110 East 23rd St., New York.

**AGENTS**—Men and Women. 35 Million women are anxiously waiting to buy the 3-in-1 Hot Water Bottle—Icebag—Fountain Springs combination. Commissions daily. No delivering. Write for startling money making plan. Lobi Manufacturing Corporation, Middleboro, Mass.

**AGENTS**: Part time, \$25.00 to \$10.00 week extra. Sell Longworth all-wool suits to your friends and fellow workers. Real \$40.00 values \$23.75. You get your commission in advance. No delivering—no collecting. Guaranteed all wool, perfect fit. Old house established 1882. Sample outfit. Full particulars what to do and what to say free. Write today. John G. Longworth & Sons, 1301 W. Congress St., Dept. CC 18, Chicago.

**GOLD-LEAF** Sign Letters; make and sell; 1,000% profits. Particulars, Johnston Co., Quincy, Ill.

**BIG Money** Selling New Household Cleaning Set. Washes and dries windows. Sweeps, scrubs, mops. All complete only \$2.95. Over half profit. Write Harper Brush Works, 132 3rd St., Fairfield, Iowa.

**10** secure agents or salesmen or for selling farms and reaching investors, use classified (want) ads in largest newspapers and magazines. Price list No. 39 sent free. American Advertising Agency, 20 W. Jackson Bldg., Chicago, Ill. The largest classified advertising agency in the U. S.

**WE** pay \$200 monthly salary, furnish car and expenses to introduce our guaranteed poultry and stock powders. Bigler Company, X368, Springfield, Ill.

**NEW** spark plug invention, the Beacon Lite; visible flash from each explosion in cylinders; big gas savers; sell on sight. Write today for special proposition. Dept. 160, Central Petroleum Co., Cleveland, Ohio.

**BRING** Home the Baron—selling Stuart's Stain Remover. Removes ink, iron rust, grass and fruit stains. Write for free samples and terms today. C. H. Stuart & Co., 5947 Spring St., Newark, New York.

**WANT** Money? Lots of it! Sell Perry Photo Medallions and Lykoll Paintings of loved ones. Novel. Appealing. Easy to sell. \$15 to \$40 a day. Advance commissions. Write, Perry Photo Novelty Corp., 1795 Jerome Ave., New York.

**AGENTS**—Our gold-eyed needle case proposition is positively good for \$50 to \$300 weekly; proof and particulars free; sample outfit 15c; factory prices. Paty Needle Co., 231 Davis Sq., Somerville, Mass.

**MAN** in each town to plate auto parts, reflectors, bathroom fixtures, refinish bed, mirrors, chandeliers; by new method. No capital or experience required. Simple plan of manufacturing at home starts you in big money-making business. Outfit furnished. Free particulars and proofs. Gun Metal Co., Ave. H, Decatur, Ill.

**AGENTS**—\$9.00 Profit every sale of a Print-Ad Machine—used by merchants to print their wrapping paper. Fast seller. Every storekeeper interested. Automatic Print-Ad Machine Co., Dept. 10, Reading, Pa.

**WE** Pay \$50 a Week and expenses and give a Ford Auto to men to introduce poultry and stock compounds. Imperial Co., D-23, Parsons, Kans.

**MAKE** \$25.00 showing "Consumers All-Weather Coats." Special introductory price \$2.95. Complete outfit free. Consumers Manufacturing, 728 Rosseret, Chicago.

**AGENTS**—Make big money selling Sharp-Easy and other new household necessities. Premier Mfg. Company, Dept. 813, Detroit, Mich.

**\$5.00 HOUR** taking orders for Jackson "29.95 Combination Coat." Demonstrating coat selling outfit free. Jackson Raincoat, 720 Rosseret, Chicago.

**KU KLUX** Klan Pocketpiece; Free sample to Agents; send dime for postage, wrapping and Klan Katalog. Box 524-PM, Omaha, Nebr.

**AGENTS**—Make \$150 weekly. Our new household specialties sell like wildfire. Build business your own. You can't afford to pass this up. Knights Manufacturing Co., 37 Hamilton Blvd., Buffalo, N. Y.

**WASH** Clothes the new way. Use the Torent Automatic Washer. You will be delighted. Special offer to one in each locality. Stern Royalty Co., 3619 Enright Ave., St. Louis, Mo.

**AGENTS**. At Last, Livest Supply house, wholesale druggists, extracts, medicines, perfumes—everything. Sales for every home. The Jet. Pharmacal Co., Allentown, Pa.

**BIG** Profits. New \$3.50 Automatic Adding Machine. Quick Sales. No competition. Ten daily easy. Absolutely accurate. Fully guaranteed. Pocket size. Business people everywhere positive customers. Exclusive territory to workers. Act quick. Bassett Company, 1458-A Hollywood Ave., Chicago.

**IF I** Send You a Suit made in the latest style from the finest goods, will you keep it, wear it, and show it to your friends as a sample of my sensational \$23.50 all-wool suits guaranteed regular \$50.00 values? Could you use \$3.00 an hour for a little spare time? If so, write me at once for my wonderful new proposition. Just write your name and address on a card and mail to Dept. 314, A. M. Ward, 852 West Adams St., Chicago.

**\$5 STARTED** me earning \$200 weekly with Mail-Order business. Anyone can do the same. Outfits furnished. Particulars free. Peerless Service, 447 Waterville, Me.

**AGENTS** and Side Line Salesmen wanted to sell the Easy Fill Gasoline Tank Cap and Gauge for Fords. A big proposition for live men. Write today. Easy Fill Cap Co., 929 Lawrence Ave., Chicago.

**EARN** money at home spare time or evenings. No peddling. Permanent. Work in your own home. Write Downs Co., 2323A Myrtle, St. Paul, Minn.

**AGENTS**—Coin money selling our new fabric table cover; needs no laundering, housewives wild about them; send for free offer. Mfg., Box 67, Medford, Mass.

**SELL** every merchant Embossed Display Signs. 500% Profit for you. Means a fortune for workers. Write today for territory. Details free. Sample free. Artistic Sign Works, 799 Broadway, New York.

**\$300.00 A MONTH** to distribute everyday household necessity in rural and small town districts. No money needed. Million dollar firm behind it. Write for particulars and state territory desired. B. M. Johnson, 611 W. Lake, Chicago.

**A BUSINESS** of Your Own—Make and Sell Chipped Glass Name and Number Plates, Checkerboards, Signs. Large Booklet Free. E. Palmer, 512, Wooster, Ohio.

**TURN** your spare time into dollars selling Polmet Polishing Cloth that cleans all metals without liquid, paste or powder. Retails 25c. Our agents say it sells like "hot-cakes." Prove it yourself with free sample sent on request. F. C. Gale Co., 122 Edinboro St., Boston.

**AGENTS**—Something new. Wonderful invention. Ford Owners wild over it. Distributors profit 300%. Thirty-day trial offer. Write K. Super, 1304 Fondulac, Milwaukee, Wis.

**AGENTS**—N-R-G Laundry Tablets, the old reliable moneymaker for live agents. Millions sold—200% profit—sales waiting for you. Clothes washed spotlessly clean in 10 minutes without rubbing. Free samples. N-R-G Company, 732-B, N. Franklin, Chicago.

**MAIL** order business; big profits; no stock to carry; we furnish everything; particulars free. J. M. Hunt Company, Morrisville, Pa.

**LIVE** Agents Make \$10 Day selling Eureka Strainer and Splash Preventer for every water faucet. Takes on sight. Widely advertised and known. Get details today. A. B. Seed Filter & Mfg. Company, 73 Franklin, New York.

**"HOW** to Sell Patents" free. Patent News-O, Washington, D. C.

**\$200 FIRST** Two Weeks—made by Wetland, Johnstown, Pa., selling "Slide-O-Graf Jr." Novel, effective—sidewalk advertisement projector. Sells fast, big non-competitive field. \$14 Profit every sale. Standard Slide Corp., 207 W. 48th St., New York.

**ANY** man can easily make big money by addressing Consolidated Co., 632 South Dearborn, Chicago.

**AGENTS** Wanted. Men and Women. Exclusive territory. Marvellous new camera takes and finishes pictures inside camera in one minute. Wonderful opportunity. Crown Co., 909 Romax Bldg., New York.

**\$20 PROFIT** daily selling needlebooks; costs 3c-5c each; sells 25c, value 50c; Three samples 2c. Catalogue Free. Needlebook Specialty Co., 661 Broadway, New York.

**AGENTS**: 500% profit. "Happy Home Maker Shampoo" builds your own big business. Martin of Indiana made \$750.00 one month. Exclusive territory. Geo. A. Schmidt & Co., 236 W. North Ave., Chicago.

**CAN** you sell to colored people? Write, Eton Co., Dept. 101, 2500 Second Ave., Birmingham, Ala.

**ABSOLUTELY** free box Bassett's Native Herbs sent to introduce. For Constipation, indigestion, headache, rheumatism. Big money selling, all or part time. Established 1878. Bassett, Dept. 8, Columbus, Ohio.



**START** a business of your own. Sell goods under your own private brand. Toilet articles, food products, household specialties. Tremendous profits. Big repeat business. We supply everything needed. Write for our attractive proposition. National Scientific Laboratories, 251 Monroe, Richmond, Va.

**AT Last! Diamond Rival Discovered!** Amazing blue white Rajah Gem astounds jewelry world and deceives experts! Beautiful Sample case Free! \$100 weekly! Write Quick! Rajah Diamond Co., Dept. F-7, Salisbury, N. C.

**MAIL-ORDER** Houses and Distributors: We pack French made beauty creams, face powders, perfumes, toilet preparations with your label. Chemist, 944A North Clark, Chicago.

**SELL** Beautiful \$7.99 Red and Black Oversized hand made Fountain Pens for \$2.50. Cost you \$1.75. With bonus \$1.55. Post card brings full details, or C. O. D. sample, at wholesale price. Johnson Pen Co., 117 So. First St., Rockford, Ill. Dept. P.

**AGENTS—Be** independent, make big profit with our soap, toilet articles and household necessities. Get free sample case offer. Ho-Ro-Co., 2725 Dodder, St. Louis, Mo.

**\$5.00 TO \$20.00** per day. A wonderful seller. Any man, woman, boy or girl can make big wages Selling Crimp Grip Clothes Line Fasteners. It is a perfect rope holder and can be used for many purposes. Crimp Grips are a simple, time-saving device. They last a life time and will not rust; it holds the line tight, and saves time on wash days. Every buyer is a booster. Send 50c for Mounted Sample and one pair of Crimp Grip Clothes Line Fasteners. Write for particulars. Crimp Grip Company, Belvidere, Ill.

**\$25.00 A DAY** Easy! Best Line of Brushes on the market. 90 varieties. Including famous Auto Fountain Washer. Excellent territory available. Write immediately. Philadelphia Brush Co., Dept. 25, Vineland, N. J.

**AGENTS—Make** \$25.00-\$100.00 weekly selling Comet Sprayers and Autowashers to Farmers and Autoists. All brass. Throws continuous stream. Established 30 years. Particulars free. Busler Co., Johnstown, Ohio, Box C46.

**AGENTS** clear \$50.00 weekly selling Opaline Portraits. Expense money advanced. Credit given. Big line now ready. Samples and Catalog free. Consolidated Portrait Co., Desk 2, Chicago.

**AGENTS—Steady** income. Large manufacturer of handkerchiefs and dress goods, etc., wishes representative in each locality. Factory to consumer. Big profits, honest goods. Credit given. Send for particulars. Freeport Mfg. Co., 39 Main St., Brooklyn, N. Y.

**SELL** Shirts and Overalls direct to wearer. Big profits. Work full or spare time. No experience required. Big variety dress shirts with splendid line Union-made work and flannel shirts, overalls, coveralls and khaki pants. Write today for free selling outfit. The Nimrod Shirt Co., Dept. 8, 4712 N. Kedzie Ave., Chicago.

**SELF - THREADING** Needles. Needle Books. Machine needles, find sales in every home. Fine side lines, easily carried, big profits, sample and catalogues free. Prentice Lee, 145 East 23rd St., New York.

**AGENTS** make 500% profit handling auto monograms, window letters, transfers, novelty signs. Catalog free. Hinton Co., 1153 N. Wells St., Chicago.

**MAKE** \$10.00 to \$25.00 daily selling our Standard Books, Bibles and Testaments. Easy to sell. Big profits. Permanent position for responsible producers. Write National Book & Bible House, Desk 1, 36 S. State, Chicago, Ill.

**BIG** Money Selling Gold Initials. Quick Sales. Every Car Owner Buys. You Charge \$1.50—Make \$1.44 Every Sale. Your Profit \$20 Daily. No License. No Experience. "Samples Free." NuLife (4) Monogram Company, Hartford, Conn.

**AGENTS—Write** for Free Samples. Sell Madison "Better-Made" Shirts for large Manufacturer direct to wearer. No capital or experience required. Many earn \$100 weekly and bonus. Madison Mills, 564 Broadway, New York.

**GET** Our Free Sample Case—Toilet articles, perfumes and specialties. Wonderful profitable. La Derma Co., Dept. A, St. Louis, Mo.

**EASY**, pleasant work for Mechanics, Shop Men, Clerks, during spare hours; will add many dollars to their salaries. Also want persons who can give full time. Big wages assured. Novelty Cutlery Co., 67 Bar St., Canton, Ohio.

**POLMET—The** Wonderful Polishing Cloth that cleans all metals without liquid, paste or powder. Approved by "Good Housekeeping" and "Modern Priscilla"—sells fast at 25c. Sample free. Gale & Co., Inc., 15 Edinboro St., Boston.

**AGENTS—Clever** invention! Inkspoon makes every pen a fountain pen. Fast office seller; big profit, demand increasing everywhere. Exclusive territory offered. Sample free. H. Marul Company, Tribune Bldg., New York, N. Y.

**AGENTS—Stamping** names on Pocket Key Protectors; sample Check with your name and address, 25c. Stamping Outfits, Emblem Checks, Check Fobs, Name Plates. Hart Mfg. Co., Desk 2, 303 Degraw St., Brooklyn, N. Y.

**MAKE** \$17 daily—Finest Extracts, Food Products, Toilet Preparations, Household Necessities. Credit: Sample Case Free. Write for amazing offer. Perkins Products, B-6, Hastings, Neb.

**AGENTS: Big** Money Monogramming by Transfer Method. Catalog Showing Over 50 Styles and Particulars Free. Motorists' Accessories Co., Mansfield, Ohio.

**AGENTS: Big** Profits. Best and cheapest window letters made. Easily applied. Dime brings five samples. Particulars free. Stalbritte Co., 1115 Second Ave., New York.

**MAKE** \$25 to \$30 Week, representing Clow's Famous Philadelphia Hosiery, direct from mill—for men, women, children. Every pair guaranteed. Prices that win. Free book "How to Start" tells the story. George Clow Company, Desk 31, Philadelphia, Pa.

**YOU** can be your own boss with our Key-Check outfit. Good for \$5 a day stamping names on pocket key checks, fobs, etc. Sample check with your name and address, 29 cents. Pease Die Works, Dept. M, Winchester, N. H.

**INSTANT** Weld. Repairs largest punctures without cement or heat. Lenn's profit one day, \$56. Write quick. Free sample; territory going fast. Tourists' Pride Mfg. Co., Desk T, Minneapolis, Minn.

**EARN** \$10 daily silvering mirrors, plating and refinishing metalware, autos, chandeliers, bedsteads, headlights. Outfits furnished. E. Dele Laboratories, 1133 Broadway, New York.

**AGENTS** sell Wolverine Laundry Soap. Wonderful reputer and good profit maker. Free Auto to hustlers. Wolverine Soap Co., Dept. B37, Grand Rapids, Mich.

**EVERYBODY** uses extracts. Sell Duo Double Strength Extracts. Complete line household necessities. Big repeaters. Write today. Duo Co., Dept. El, Attica, N. Y.

**PATENTED** Cigar Lighters with Glass Advertising Front. Also Electric Cigar Moisteners. Wonderful Sellers. No Competition. Big Steady Profits. Proof, Cuts, Sales Plan Free. Drake Mfg. Co., Dept. M, Milwaukee, Wis.

**BIG** Money and Fast Sales. Every owner buys Gold Initials for his auto. You charge \$1.50; make \$1.35. Ten orders a day easy. Write for particulars and free samples. American Monogram Co., Dept. 40, East Orange, N. J.

**IF** you want good live agents—fellows who can get the business—ask me how others are doing it. I'll gladly render the necessary assistance. Geo. F. Baker, Mgr. Classified Advertising. Popular Mechanics Magazine, Chicago.

**AGENTS—Send** for free sample "Frenot"—washday wonder. You can clear at least \$20 to \$100 weekly, according to spare or whole time. You don't have to talk; if she doesn't buy at sight, leave sample; she will be looking for you long before you are able to make the rounds again. Samples furnished free. Premiums for your customers. Exclusive territory. Credit given. Empire Specialties Co., 1549 N. Wells, Dept. 101, Chicago.

**BUILD** permanent business. Men's, Women's, Children's guaranteed shoes direct to wearer. A. P. Condon, Sales Manager Allen Shoe Co., 110 Summer, Boston.

**WE** Start You Without a Dollar. Soaps, Extracts, Perfumes, Toilet Goods. Experience unnecessary. Carnation Co., Dept. 201, St. Louis.

**BIG** profits selling our practical patented specialties. Write for particulars. Welch Brothers Co., North Chicago, Ill.

**EVERYBODY** Buys new, instant stain and rust remover. For clothing, table linen, etc. Fine premium with every sale. Big, Quick Profits. Free Outfit. Write today. Christy, 51 Union, Newark, New York.

**10,000,000** FORDS need "Teuscher" fan belts. 50% profit selling dealers; 250% selling owners. Write quick. Teuscher Belting Co., St. Louis.

**AUTO** owner tire agent wanted each locality to use and take orders for handmade Mellinger fabric and cord tires; guarantee bond \$,000 and 12,000 miles (no seconds); shipped prepaid on approval; get your tires free; no capital or experience required; make \$100 to \$300 weekly. Write for wholesale prices and sample kit. Address, Mellinger Tire Co., Dept. 200, Kansas City, Mo.

**AGENTS—Good** salary and commission selling "Ratskyl" new rat and mouse exterminator; ready for use; no bait required; non-poisonous; rodents die outside premises; no odor. Empire Specialties Co., 1549 N. Wells, Dept. 301, Chicago, Ill.

**AT Last—World's** Greatest Adding Machine. Almost human. Retail \$15; work equals \$200 machine. \$300 monthly easily made, demonstrating to stores, offices, garages, factories. Simple, easy; adds, subtracts, multiplies, divides automatically. Speedy, accurate, durable, handsome. Five year guarantee. Tremendous demand, amazing profits. Liberal trial offer. Protected territory. Write quick. Lightning Calculator Corp., Dept. F, Grand Rapids, Mich.

**AGENTS—Men** and Women. Establish permanent business. 34c money order brings can of Gray Crystals, a wonderful Gray and Steel Improver. Try it and convince yourself. Every Store and Home a prospect. New product with big future. Exclusive territory to live representatives. Smith & Gray, Manufacturers, Guinda, California.

**WONDERFUL!** Startling! Amazing! Our Ex-Cel Luminous Crucifix and Magical (Luminous) Necklace shine brilliantly in the dark. Sell on first demonstration. Big profits to you. Write for further particulars, or better still, send for sample and territory protection immediately. Crucifix \$1.50, Necklace \$1.00, postpaid. W. G. Hannan Co., Dept. B, 57 E. 18th St., Chicago.

**SELL** the Livest, Quickest Selling Specialties Ever Known—Famous "Hawkey" self-lighting pocket Cigar Lighters and Gas Lighters. Low Prices. Easily Demonstrated. Sell to Dealers, Employ Sub Agents. Exclusive Territory. Make over 100% Profit. P. Bernhardt, 148 Chambers Street, New York.

**EARN** big money fast applying gold initials to autos. Every owner buys—\$1.35 profit on \$1.50 sale—particulars and samples free. Write quick. Lithogram Co., Dept. 17, East Orange, N. J.

#### HIGH GRADE SALESMEN WANTED

**WRITE** for Free Selling Outfit. Earn \$140 next week. Tailored to fit suits \$12.50, \$13.50. Stand water, fire, smog tests. Earn bigger money selling SuperKloth Economy Clothes. Experience unnecessary. Union Made. Commission to \$8.25 per sale in advance. Quality sells on sight. Also Famous IronKloth boys' line. Free Outfit. Economy Clothing Mfg. Co., Dept. D-65, 2035-49 Charleston St., Chicago, Ill.

**SALESMEN** Distributors wanted. Ours is an exceptionally lucrative proposition—a permanent and profitable business connection, not a job. Product nationally advertised—easy to sell. Generous profits. One sale a day produces income of \$5,000 a year. Let us put the facts before you. Write CFSCO., 15 N. 10th St., Richmond, Ind.

**ARE** You the Man? We must have more representatives—at once! Style-Center Suits and Topcoats are sweeping the country—and our biggest year is just ahead. If you want a better job than any you have ever had—a steady job—a job that will pay you just as much as you want to earn—write us today! No matter what your previous experience, you can sell these splendid all-wool, tailored-to-measure garments at the attractive price of \$23.50. Hundreds of beginners have made \$75-\$150 a week, easy—right from the start. Scores of Style-Center salesmen are averaging more than \$10,000 a year. Write us today! The Style-Center Tailoring Co., Dept. P2, Cincinnati, Ohio.

**DISTRIBUTORS—Screw** holding Screw Driver. Handiest Tool ever invented! Unlimited Market. Tremendous demand! Big repeat earnings! Write Coburn Tool, 7381, Boylston, Boston, Mass.



**DISTRICT Salesmen with Ford Cars.** Sell Kirtin Fil-Gages, direct to Ford Owners working with local dealers; exclusive territory. Capable man can earn \$10.00 a day and up. Build a permanent business of your own. Fil-Gage Hills Ford Tank without lifting seat cushion, and shows how fall tank is! No competition. Patented. Write for Dealer-Representative Plan. Pays you a profit on every Fil-Gage sold in the district. A. J. Kirtin Co., 201-A Kirtin Bldg., Escanaba, Mich.

**SALESMEN—\$20 daily** calling on merchants; staple guaranteed product used by millions. Elicor Aspirin Tablets sell on sight to general merchants everywhere. Most attractive "Silent Selling" Counter Display Cabinet on market. Retail 12 tablets for 10c; meets all competition. 100% profit each for merchants and salesmen. The largest seller in years; enormous repeat business. Permanent employment or side line. Elicor Products Corporation, Department 121, Washington, D. C.

**SHOE Salesmen:** Our new "Everybuddies" moccasin shoe is now ready for your distribution. Agents and district managers wanted everywhere to sell direct from our factory to wearer. Shoes leaders on market for thirty years. Immediate service and cooperation our standard. Send inquiries, references and experience direct to factory. Freeman Shoe Co., Manufacturers and Distributors, East Boston, Mass.

**WANTED:** District salesman for large mfg. selling union made, hand tailored all wool suits for \$23.50. Prefer married man with sales experience, who has lived at least 5 years in his territory. Apply A. G. Harvey, Mfg., Box 90, Chicago.

**CAR Owners Wanted.** Confidential spare-time work \$10.00 to \$75.00 a week easy and steady, utilizing an hour or two daily. Answer—C. C. C., 170 Second St., Cambridge, Mass.

**BIG chance for mechanic with selling ability.** Wonderful universal socket wrench that every garage mechanic wants. Most every demonstration means a sale. Send for booklet. York Wrench Mfg. Co., 2419 N. Ashland Ave., Chicago.

**SALESMEN:—Sell Four Square Suits** \$12.50—guaranteed two years. All wool overcoats \$19.50, five different patterns. \$3.90 to \$5.50 each sale. Profits in advance. Complete line, coat, vest, pants, riding pants, overcoats, slip-ons, caps. One day delivery. District territories open. Stone-Field Corporation, X2556 South Wabash, Chicago.

**TAILORING Salesmen:** Our guaranteed \$21.50 and \$31.50 all wool tailored to order suits are \$10 to \$20 cheaper than store prices. Commission in advance. Protected territory. Beautiful assortment 6 x 9 swatches free. Manager, Dept. 1059, 843 Adams, Chicago.

**SELL Men's Highest Grade Shoes and High Top Boots** Factory to Wearer. No competition on this line. Shoes that are entirely different and have extremely strong selling appeal. Best and only permanent proposition in direct selling field. Our men are making \$85 to \$125 weekly in every part of the country. You will miss a real opportunity if you fail to write for details to-day. Carson Shoe Co., Box 123, Essex Station, Boston, Mass.

**SALESMAN to sell suits and overcoats** tailored by us and direct to wearer at \$23.50; none higher. Sold under positive guarantee of satisfaction or money returned and with privilege of wearing one week and then returning if unsatisfactory. Easy to sell. Commissions daily. Write for plan. Chain Clothing Stores, 560 Fifth Avenue, New York City.

**WE Will Make You Prosperous and happy.** Selling Alexander Film Publicity to merchants is congenial and vastly profitable. Average profit per sale \$50. Sales average one or more daily. No investment. We teach you free. Write today and get in right with Alexander Film Co., 3389 S. Broadway, Denver, Colo.

**BEATS a Gold Mine—Electric Sign.** Sells \$15.00. Commission \$5.00. Easy to sell 100 to 1,000 at once to manufacturers of autos, ice cream, etc., for distribution to their dealers or agencies, or several an hour from store to store. Write while its new. Flash-tite, 2131 Hudson, Chicago.

**SELL Superior Rubber Weld** for tires and tubes. New invention. Best rubber repair on the market. Supersedes vulcanizing. Quick seller—money maker. Sample furnished. R. W. Smith Co., 1874 E. 20th, Cleveland, Ohio.

**\$75—\$125 WEEKLY,** organizing for fast-growing fraternal social society—sick, accident and death benefits. Protected territory. Address, Order of Leaders, Detroit, Mich.

**A WONDERFUL Seller!** Any man, woman, boy or girl can make big wages. Some agents make from \$8.00 to \$20.00 per day. Crimp Grip Clothes Line Fasteners are a simple, time-saving device for holding a rope—also used for many other purposes. It pays for itself quickly in time saved on wash days. No knots—it fastens and releases quickly. Every home a prospect. Every housewife who uses Crimp Grips—and there are thousands of them—is a booster. There is but one Crimp Grip. Write for particulars, or send 50c for one pair and a mounted sample, with full particulars to agents. Crimp Grip Company, Belvidere, Ill.

**WERE You Ever Offered a Grocery Store?** Our proposition is better. You can handle flour, canned goods, dried fruit, coffee and entire line of groceries as well as radio sets, paints, roofing and automobile oils and tires with no rent to pay; no money invested, take large orders from samples. Goods are guaranteed and proven quality. Selling experience not necessary. Steady, profitable work for "workers." Address Hitchcock-Hill Co., Dept. 226, Chicago, Ill. Reference: Any bank or Express company.

**WANTED—Tailoring Salesmen,** make \$60 to \$125 per week. Biggest merchants in many towns have started with our line. We are the largest made-to-measure tailoring house in the country, furnishing elaborate sample equipments, including 500 all-wool fabrics. You make your own profits from \$8.00 to \$15.00 on each order. Guaranteed absolute satisfactory perfect fit, best workmanship, or no sale. Write for line and all accessories to be sent free. Tell us all about yourself. Address N. O. Perry, Sales Manager, Box 483, Chicago, Ill.

**MAKE \$100 Weekly in Spare Time.** Sell what the public wants—long distance radio receiving sets. Two sales weekly pays \$100 profit. No big investment, no canvassing. Sharpe of Colorado made \$955 in one month. Representatives wanted at once. This plan is sweeping the country—write today before your county is gone. Ozarka, 802 Washington Blvd., Chicago.

**SALESMEN—Become Independent.** Own your business; experience unnecessary; selling our \$7,500 Accidental Death, \$50 Accident, \$25 Sick Weekly Benefits; \$12.50 yearly; other amounts proportionate. Guaranteed steady income from renewals. \$270,000 deposited Insurance Department. Registration Dept. A, Newark, N. J.

**SALESMEN and District Managers** wanted, to sell auto accessory, an item carried in stock by every garage, and all year round seller. Only 7 States now being covered by our salesmen, selling the garage trade. Ample territory available for hustlers. Salesmen earning from \$60.00 to \$150.00 a week. Jiffy Manufacturing Company, Huron, S. Dak.

**SALES Representative** wanted for well-known specialty; prefer man experienced in selling mill superintendents and factory executives. Olmsted, 95 Commercial, Boston, Mass.

**\$15.00 DAILY** securing memberships: General Protection Service, Federal Detective Association, New Orleans, La.

**START a business of your own.** Sell goods under your own private brand. Toilet articles, food products, household specialties. Tremendous profits. Big repeat business. We supply everything needed. Write for our attractive proposition. National Scientific Laboratories, 298 Monroe, Richmond, Va.

**DISTRICT Manager—Fine opportunity;** sell guaranteed nursery stock, appoint agents. No capital necessary. Right type man can make big money. Every co-operation from home office. Write at once for details. Genesee Nurseries, Dept. P, Rochester, N. Y.

**NEW Map Calendar and Automobile** pocket map line worth \$100 to \$150 a week. Can use few additional salesmen. Write for particulars. The Geographical Publishing Co., 621 Plymouth Court, Chicago.

**\$50 DAILY Selling Salesboards—**Make up to \$33 on single sale, selling largest, lowest priced line; no samples to carry; write for 3-color catalogue and full particulars. Lincoln Sales Co., Dept. E, 212 N. Sheldon, Chicago.

**SALESMEN—Agents,** Two or three hours of your spare time pays \$60 weekly. Call on drug, department, general stores. Protected territory, answer quick. Waddell Co., 2568 West Lincoln Ave., Chicago, Ill.

**AUTO Accessory salesmen** wanted to sell De Luxe Ford Accessories to dealers and garages. Complete fast-selling advertised line. Liberal commission. Write for particulars. The Bronze Alumina Corporation, 210 Winchester Ave., Buffalo, N. Y.

**SELL Greeting Cards.** Unusual opportunity to earn \$300.00 to \$500.00 monthly selling Business Greeting Cards. Side line or full time. Weekly payment. Samples Free. Selling experience unnecessary. Get details. Dept. H, John A. Hertel Co., 318 W. Washington St., Chicago.

**ARE you contemplating permanent sales** position for 1925? The proper man can secure territory representing a house handling first-class specialty merchandise. Our organization has had excellent reputation for thirty years. Give full particulars. The Ad-Lee Company, 821 Wabash Ave., Chicago.

**SALESMEN interested in a Real Proposition** with Big Pay, write for Free booklet entitled "New Way to Buy." Dept. F, Taylor Wells & Company, Chicago.

**SALESMEN—Electric.** We can offer a good opportunity to men experienced in selling lighting fixtures to stores and factories. Missouri Illuminating Co., 411 Olive, St. Louis, Mo.

**SALESMEN—Automobile and truck tire** chains, clamps, 22% to 30%. Commission advanced weekly. Inside discount gets orders. Herman Chain Co., 1312 Ninth St., Washington, D. C.

**SALESMEN—Collection service contract.** Will pay \$4,000 to \$6,000 annually; extra bonus. Home territory. Write National Credit Protection Service, Inter-Southern Bldg., Louisville, Ky.

**THREE Brite Lites Cleaningdom:** Rusticide—Chemical Rust Destroyer; Farnstone—Tones Woodwork; Glasobrite—Cleans Glass Right. Complete Line—Bigger Sales—More Profits. Rusticide Co., 412 Frankfort, Cleveland, Ohio.

**SALESMEN sell sales and order books,** auto, reg. rolls and bill ladings. Large demand. Liberal commission. Wirth Sales Book Co., Dept. PM, Chicago.

**\$60-\$200 A WEEK.** Genuine Gold Letters for store windows. Easily applied. Free samples. Liberal offer to general agents. Metallic Letter Co., 438-B North Clark, Chicago.

**ASTOUNDING invention.** For use kerosene, start instantly. Mileage doubted. Big profit. Super, 1366 Fondulac, Milwaukee, Wis.

**THE Jackson Mfg. Co., 1331 16th St.,** Denver, Colo. has salesmen clearing as high as \$85.00 daily selling their newly patented auto specialty. Write them for free sample and particulars.

**FOUR \$7.50 sales to merchants** net you \$20.00 daily. Sayers Systems, 2803 Sheffield Ave., Chicago, Ill.

**BEST Seller.** Jam Rubber Repair for tires and tubes; supersedes vulcanization at saving of over 80%; put it on cold, vulcanizes itself in two minutes, guaranteed to last life of tire or tube; sells to every auto owner and accessory dealer. Get particulars how to make big money and free sample. Amazon Rubber Co., Philadelphia, Pa., Dept. 510.

**TRAVELING Salesmen** calling on retail stores wanted by large manufacturer to sell unique line of business-boosting articles. Year round, fast selling, main or side line. If not earning \$150 weekly, address Elaser Works, 222 Charles St., Bonville, N. Y.

**SALESMEN—Sideline** pays five to ten dollars a day taking orders for Specialty printed gummed advertising and Match Box Stickers. Write for proposition, samples, etc., today. Beardley's Printery, Rock Island, Ill.

**\$4.00 PROFIT on Every \$5.00 sale.** "Free Sample"—New Specialty. (Money Getter.) Every Storekeeper, Doctor buys quickly. Experience unnecessary. Territories open. Box 596, Hartford, Conn.

**SALESMEN Can make \$5.00 a day** selling our Calendars, Pencils, Signs, Advertising Novelties, Yardsticks, Whistles, etc. Liberal terms. Sells entire year. Fine side line. Local and traveling agents. Model Calendar Co., Dept. 226, South Bend, Ind.

**CALIFORNIA Rosebuds** selling like hot cakes. Agents gaining money. Absolutely new. Big profits. Catalog free. Mission Factory SP, 519 No. Halsted, Chicago, Ill.

#### HELP WANTED

**LOOKING for a Job?** If you are out of work or not it will pay you to get my four master letters of application, the ones that bring home the bacon; how many have you written without getting a reply? Copy one of mine, send to employer or prospect and see the results. A big value and may be best money ever spent. Four letters \$1 Bill. A. H. Dencon, 1781 East 31st Street, Cleveland, Ohio.



**YOU Are Wanted.** Men—women, 18 up. Get U. S. Government Life Positions. \$95.00 to \$192.00 month. Steady, sure work. No layoffs. Paid Summer vacations. Pleasant work. Short hours. Full particulars free. Common education. Candidates coached without leaving home. Full particulars free. Write immediately. Franklin Institute, Dept. W-3, Rochester, N. Y.

**MEN:** We will establish you in a permanent business paying big income. Your credit is good for merchandise people must buy every day. No special experience necessary. Write today for free booklet "Mc-Coman's System." McComan & Co., Factory M18, Winona, Minn.

**FIREMEN,** Brakemen, Baggage-men, Sleeping car, train porters (colored) \$140—\$200. Experience unnecessary. 810 Railway Bureau, East St. Louis, Ill.

**HOTELS** Need Trained Men. Nationwide demand for high-salaried men; past experience unnecessary. We train you by mail and put you in touch with big opportunities. Big pay, fine living, interesting work, quick advancement; permanent. Write for Free Book, "Your Big Opportunity." Lewis Hotel Training Schools, Suite M-351, Washington, D. C.

**U. S. GOVERNMENT** wants men. \$1,400—\$1,600 and up at start. Railway Mail clerk examination coming. Let our expert (former Government examiner) prepare you for this and also Rural Carrier, Post Office, Customs, Internal Revenue, and other branches. Write today for free booklet, Dept. 8, Patterson Civil Service School, Rochester, N. Y.

**MAKE Money Silvering Mirrors, Auto-lights, Radiators, tableware, stoves, Outfits, Methods Free.** Sprinkle, Plater, 287, Marion, Ind.

**WANTED—Boys, men.** Learn Auto Repairing. \$30.00 week. Sample lessons—free. Franklin Institute, Dept. W-469, Rochester, N. Y.

**GOVERNMENT** positions. \$1,400—\$2,700 annually. Many splendid opportunities. Common education sufficient. Experience unnecessary. Information booklet free. Chicago Civil Service College, A-41 Kesner Building, Chicago.

**BUILD** splendid business making chipped glass number and name plates, signs, medallions. Write for particulars. Simplex Utility Co., 1133 Broadway, New York.

**MONEY** Polychroming, also Silvering Mirrors. Samples and Particulars free. Polychrome Works, 2694 East 40th, Kansas City, Mo.

**LOCOMOTIVE** Firemen for railroads nearest their homes—everywhere; beginners \$150—\$250 monthly; promoted, locomotive engineer, \$3,000—\$4,000 yearly. Best paying positions on railroads. Railway Association, Desk M1, Brooklyn, N. Y.

**AGENTS:** World's greatest Accident and Health Insurance Policy. \$5,000 death; \$25 weekly benefit; premium \$10 yearly. \$300 a month easily made. Permanent renewal income guaranteed. Easy to sell with our "Direct-by-Mail" Plan. Write quick for territory. Address Underwriters, 702 Bonnell Bldg., Newark, N. J.

**MR. BRUSH** Salesmen:—Old Established New York Brush Manufacturers requires the services of men in all territories to sell their extensive line of Sanitary Twisted Wire Brushes. We pay larger commissions than any other Brush House in the country. Write immediately for proposition. Wire Grip Sanitary Brush Corp., 15 Mercer St., New York.

**\$117.00—\$192.00 MONTH.** Government Postal Jobs. Candidates coached. Particulars Free. Franklin Institute, Dept. W-19, Rochester, N. Y.

**SALESMEN—A** salesboard that takes the place of a slot Machine. Something new. Write for particulars of this interesting and profitable business of operating and selling salesboards. Square Hold Board Co., 120 Scheerer Ave., Newark, N. J.

**MEN:** Make 1,000% profit in your own business, resilvering mirrors, plating auto parts, chandeliers, tableware. Refinishing Beds, etc. Experience unnecessary. Get "The Road to Success" free. Atlas Works, 22-A Quincy, Chicago.

**LARGE** manufacturer wants agents. Make \$100 weekly. Outfit Free. Sell made-to-measure genuine Cravanne Gaborlines, \$14.50. Whipcoats, \$12.50. Reversible Raincoats, \$9.75. Standard Raincoat Co., 121 West 17th St., New York.

**MEN** to build radio sets in spare time. Leon Lambert, 539-H, Wichita, Kans.

**YOUNG** Men who want positions abroad send 30c in stamps for list of 375 firms employing men in South America. Mr. Thomas, 612 Finance Bldg., Kansas City, Mo.

**AGENTS:** \$11.80 daily in advance (send for sworn proof). Introducing New Insured Hosiery, 47 styles, 35 colors, guaranteed seven months, 1925 line now ready. No capital or experience required. You simply take orders. We deliver and collect (or you can deliver, suit yourself). Credit given. Pay you daily, monthly bonus besides. We furnish samples. Spare time will do. Marchose Textile Company, Station 2692, Cincinnati, Ohio.

**MEN, 18 to 50,** to qualify for U. S. Mail Service. \$1,400 to \$2,600. Experience or correspondence unnecessary. Write today. B. P. Bradford, 112 N. 56th St., Philadelphia, Pa.

**SELL** Dollar-Martin "Ruff Proof" work clothes to workers. Earn \$75 to \$100 weekly. Free outfit. Dollar-Martin Corporation, 127 West 17th Street, New York.

**\$133.00—\$192.00 MONTH.** Government Railway Postal Clerks. Men, 18 up. Steady. Common education sufficient. Candidates coached. Particulars free. Write immediately. Franklin Institute, Dept. W-19, Rochester, N. Y.

**MANY** excellent opportunities, \$1,400—\$2,700, with United States Government. Write immediately for free information. Chicago Civil Service College, A-41 Kesner Building, Chicago.

**ARE You Old at Forty?** See our advertisement on page 163 of this issue. The Electro Thermal Company, 2137 Main Street, Steubenville, Ohio.

**GET posted—Good prices paid** for butterflies, insects. See Sinclair display advertisement, page 28.

**MEN** wanting forest ranger positions, \$1,500—\$2,400 year. Write for free particulars. Mokane, A70, Denver, Colo.

**CLERKS:** Railway Mail. Other good Government postal positions. \$1,400—\$2,300 yearly. Experience unnecessary. Full particulars free by writing G. W. Robbins, Civil Service Expert, 411 Burchell Bldg., Washington, D. C.

**EARN \$25** weekly, spare time, writing for newspapers, magazines. Experience unnecessary. Copyright book free. Press Syndicate, 981, St. Louis, Mo.

**25c BRINGS** samples and full information of Cooperators' Service, assuring work that pays Home Magazine, Nashville, Tenn.

**MEN** wanting forest ranger, railway mail clerk and other good positions. Write for free particulars. Mokane, Dept. A-12, Denver, Colo.

**\$133.00—\$192.00 MONTH.** Men, 18 up, Railway Postal Clerks. Candidates coached. Particulars free. Franklin Institute, Dept. W-19, Rochester, N. Y.

**BECOME** a Landscape Architect. Uncrowded profession of wonderful opportunity for money-making. Easily mastered by mail. Earn while you learn. Write for book. American Landscape School, 56-E, Newark, N. Y.

**MEN** wanting positions firemen, brakemen, colored train or sleeping car porters, write for application blank; experience unnecessary, first class roads, no strike. Name position wanted. Railway Institute, Dept. 25, Indianapolis, Ind.

**MEN—Age 18-40,** wanting Railway Station-Office positions, \$115—\$250 month, free transportation, experience unnecessary. Write Baker, Supt., 41 Wainwright, St. Louis.

**FINGER** Print Experts—Excellent paying positions; particulars free. Finger Print Headquarters, 188 East 78th, New York.

**SILVERING** Mirrors, French plate. Easily learned; immense profits. Plans free. Address, Wear Mirror Works, Excelsior Springs, Mo.

**OUR** genuine gold window sign letters are an excellent money-making proposition for handy men. Shann Sign System, Bethune Ave. E., Detroit, Mich.

**MAKE** money writing Photo-plays; details free to beginners. No correspondence course. Producers' League, 230 Wainwright, St. Louis.

**INVENTORS** desiring to secure patents should write for our book "How to Get Your Patent," tells our terms and methods. Send sketch for our examination and instructions without charge. Randolph & Co., Dept. 43, Washington, D. C.

**ALL** men, women, boys, girls, 17 to 45, willing to accept Government Positions, \$117—\$250 traveling or stationary. Write Mr. Ozment, 101 St. Louis, Mo., immediately.

**STORIES,** poems, plays, etc., are wanted for publication. Good ideas bring big money. Submit manuscripts or write Literary Bureau, 522, Hannibal, Mo.

**GOVERNMENT** Jobs. You Are Wanted. \$95.00—\$192.00 month. Steady. Sample coaching lessons free. Write immediately. Franklin Institute, Dept. W-19, Rochester, N. Y.

**EARN \$10** daily silvering mirrors, plating and refinishing metalware, autos, chandeliers, bedsteads, headlamps, Outfits furnished. E. Deice Laboratories, 1133 Broadway, New York.

#### INFORMATION

**CONSULTING** and Designing. Specializing in Production Problems. Special Machinery. Development of Invention. Drafting. Tools, Jigs, Fixtures, etc. Industrial Engineering Ser./ot. 191 Burwood Building, Washington, N. J.

**MEXICO—Accurate,** reliable reports on mines, conditions, etc. Investigate before investing. Twenty years' residence. One dollar. Engineer, Apartado 33, Chihuahua, Mexico.

**EXPERT** information, advice. Any subject. Confidential. \$1.00. International Information Institute, 15 Moore, New York.

**PRACTICAL** information on Mechanical Movements, construction, materials for inventions. Also where obtainable. \$1.00. Technical Research Bureau, 377 National Ave., Milwaukee, Wis.

**I WILL** solve your electric and hydraulic problems. Send \$1.00 with problem for solution. Extra fees for problems requiring special drawings, design or research. John P. Garvin, E. E. 290 Colliart, Pittsburg, Pa.

**COMPLETE** information on any book published. Or will supply lists of books that are the best on any subject. Information is free. Room 897, Popular Mechanics Building, Chicago, Ill.

#### BUSINESS SERVICE

**INCORPORATE—**Delaware, Palmer, 110 West 46th Street, New York City.

**DELAWARE** Incorporator. Charters; Fees Small; forms. Chas. G. Guyer, 901 Orange St., Wilmington, Del.

#### MAILING LISTS

**RANCHMEN,** stockmen. Buy Everything. 1,000 names \$5. James Mathews, Twin Falls, Idaho.

**AMERICAN** Novelty Buyers \$5 thousand. Cross, Box 47, Branford, Ontario.

**NAMES—**postcard views. Ben Meyer, 35 West 31st, New York.

#### TYPEWRITERS AND SUPPLIES

**UNDERWOOD** Typewriters—only \$3.00 down. Easy monthly payments. Low prices at less than manufacturers. 10 days' free trial. Rebuilt, all worn parts replaced. Just like a new machine. 5-year guarantee. Write for big free catalogue C-151. Shipman-Ward Mfg. Co., 1512 Shipman Bldg., Chicago, Ill.

**TYPEWRITERS** All Makes. Save one-half. Thoroughly rebuilt in our factory by the famous "Young Process." Fully guaranteed. Free Trial. We handle all standard makes. Cash or sold on easy terms. Write for catalog. Young Typewriter Co., Dept. 5752, Chicago, Ill.

**TYPEWRITERS—\$20** up. Easy payments. Free trial. Payne Company, Rosedale, Kans.

**TYPEWRITERS,** All makes, \$15 up. Guaranteed. Write for our bargain price list and Free Trial offer. Department 16. Manufacturers Typewriter Clearing House, 193 N. Dearborn Street, Chicago.

**TYPEWRITERS,** all standard makes, \$10 up. Fully guaranteed. Free trial. Write for complete illustrated lists. Northwestern Typewriter Exchange, 121 N. Francisco Ave., Chicago.

**MULTIGRAPHS,** Multicolor Presses, Addressographs, Printing Presses, Folders, Mollometers, Duplicators, Paper Cutters, Dictaphones, Low prices; stamp for information. Nicholas, 120 High St., Boston.

#### PRINTING, ENGRAVING AND MULTIGRAPHING

**FOOTE** prints anything. Mail copy for estimate. Free samples; price list. Large variety cuts; no extra charge. Foote Printing, Dept. G, 5702 Halmoth, Cleveland, Ohio.

**\$2.00 FOR** 125 Letter Heads (8 1/2 by 11) and 125 Envelopes printed with not over 5 lines. First-class stock. Cash with order. Delivered prepaid. Low prices in lots of 500 and 1,000 on all office stationery. Samples free. Pershing & Co., South Bend, Ind.



250 LETTERHEADS and Envelopes neatly printed, \$2.50. 500—\$4.50. Cole Bros., 400 South Halsted, Chicago.

250 CARDS \$1.25. Edward Schwer, 318 Bush St., Covington, Ky.

250 FINE letterheads, 250 envelopes, \$3.00. Todd, 19 East Second, Cincinnati, Ohio.

2,000 LETTERHEADS or Envelopes \$6.25 prepaid. 3rd zone. Samples Free. Quality Printshop, Marietta, Ohio.

DISTINCTIVE Stationery! Samples Free. Franklin Press, B-33, Milford, N. H.

COMMERCIAL Printing. Get our prices before ordering. Estimates furnished free. No obligation. National Merchants Co., 4342 No. Hobey, Chicago.

PRINTING Bargains—5,000 Typewriter Letters, \$16.00; 5 1/2 x 8 1/2 Circulars \$9.50; Envelope Slips \$4.75. All printing low prices. Samples—List Free. Good's Printery, Harrisonburg, Va.

PRINT Your Own Circulars, Letters, Announcements. Make own Press for \$1.00. Uses Printer's Type. Illustrated instructions 10c. Greenhagh, 2909 Kenwood, Indianapolis, Ind.

ENVELOPES, Letterheads. Fast service. Thousand—\$3; Five Thousand—twelve fifty. Bixler Shop, Frankfort, Ky.

200 PRINTED 3 1/2 x 11 Hammermill Letter-heads, Envelopes, Billheads or business Cards \$1.00. Postpaid. Race Printery, Hudson, N. Y.

1,000 LETTERHEADS \$2.50—5,000 \$10.00—10,000 \$17.50 Prepaid. Samples Free. John Sprinkle Company, Martinsburg, W. Va.

1,000 LETTERHEADS and Envelopes \$9.99. Ewan, 49 Pearl, Jersey City, N. J.

SOLLIDAY'S — "Neogravure" — Knox, Indiana. "Letterheads today. No comparison between your work and ordinary printing. Wagner Sales Co., Davenport, Iowa."

250 BOND Letterheads, 250 Envelopes, \$2.00. Samples. Midland Press, 543 West Hickory, Kankakee, Ill.

EMBOSSED Business Stationery. Samples for Stamps. Daniels Company, Pittston, Pa.

WE print Stationery, Booklets, Catalogs, Circulars. Samples. Commercial Press, Batavia, Ohio.

225 BOND letterheads, envelopes, billheads, cards, \$1.25 each. Combination, \$4.00. Economic Press, Levonia, N. J.

QUALITY Printing! Reasonable Prices! Send for Free Standardized samples and prices. Folders, Circulars, Catalogs our specialty. Ernest Fantus, 525 South Dearborn, Chicago.

GILT lettered Advertising-Pencils for you. Buy direct; save entire middleman's profit. Samples free (no agents). Address S. Musial & Co., 10-12 Lincoln St., Yonkers, N. Y.

#### PRINTING OUTFITS AND SUPPLIES

COMPLETE printing outfits, presses, type, ink, paper supplies. Write for Catalog. Press Co., C-11, Meriden, Conn.

PRINTING Outfits, Presses, Type, Supplies. Stamp for information. Nicholas, 120 High St., Boston.

PRINTING Outfits—Presses, type supplies, type novelties. Send stamp for catalogue. Model Press, York, Penna.

#### DUPLICATORS AND DEVICES

STENCIL Duplicating Outfit — \$2.50, \$3.00, \$4.00 Complete. Typewriting, Handwriting. Returnable. Primos Specialty Co., 3-M, Primos, Pa.

"MODERN" Duplicators save Time, Labor, and Money. Gets business. Reproduces Typewritten or Penned Letters, Drawings, Lessons, Music, Menus, Bids, Notices, Specifications, Maps or anything in one or more colors. Prints Two per minute. Special Sale On 30 Days' Free Trial. \$6.60 delivered. Booklet Free. J. E. Durkin-Rooves Co., Ridgway, Pa.

YOU can make 50 to 100 copies of a letter, notice, etc., at a cost of three cents on a Heyer Quality Duplicator. Write for free trial offer. The Heyer Duplicator Co., 14 S. Wells St., Chicago, Ill.

#### ADDING MACHINES

FREE Trial. Marvellous new Adding Machine. Adds, Subtracts, Multiplies, Divides, automatically. Work equals \$350.00 machine. Price only \$15.00. Speedy, durable, handsome. Five-year guarantee. Used by largest corporations. Write today for catalog and free trial offer. Lightning Calculator Co., Dept. E, Grand Rapids, Mich.

NEW \$2.50 Automatic Adding Machine. Adds, Subtracts, Multiplies. Absolutely accurate. Capacity \$999,999.99. Fully guaranteed. 75,000 pleased users. Makes adding easy, positive, quick. Eliminates Mistakes. Saves Time. Postpaid \$3.50. Bassett Co., 1458-B Hollywood Ave., Chicago.

\$100 AMERICAN Listing Adding machine, practically new, only \$37.50. Easy payments. Payne Farms, Shawnee, Kans.

#### FOR SMOKERS

ATTENTION, Smokers: Stop wasting matches; Send 50c to-day for a vest-pocket gasoline lighter. It is a wonder. 3 for \$1.00. Specialty Sales Company, 102 Pioneer Trust Building, Kansas City, Mo.

CIGAR Smokers! Factory to Smoker System Saves You Half; write for particulars and special offer. Montrose Cigar Factory, Dept. F, 4901 Montrose Ave., Chicago, Ill.

#### BOATS AND LAUNCHES

BOATS that always go are propelled by Ford Engines. Ford engine booklet free to boat owners. Harry Rider, 201B East Avenue, South Norwalk, Conn.

#### RAZORS AND BLADES

NEW discovery! Get 3 times more shaves from each blade—Blade-Tone—Guaranteed. Postpaid, 25c. Lark Laboratory, Sta. 12, Houston, Tex.

25 NEW, American-made guaranteed Gillette style blades \$1. Johnson Specialty Co., Box M183, Clereland, Ohio.

GUARANTEED American-made Gillette style double-edge blades for Gillette holders. 3 dozen \$1.50 postpaid. 1 dozen 50c. Money back guarantee. Prompt service. Peter G. Wetterquist, 1635 13th Ave., Dept. P, Rockford, Ill.

BLADES for Gillette razor 35c per dozen. Brand new. Live agents wanted. Razorblade Co., 2743K Broadway, New York.

#### OPTICAL GOODS

BINOCULARS, Binoculars, Binoculars! A glass for every use and every pocketbook. \$12 to \$60. 4 to 20 power. Guarantee of absolute satisfaction or money back. Get the Geneva price list first. Send for descriptive circular today. Geneva Optical Co., 41 Linden St., Geneva, N. Y.

#### FOR THE HOME

A WARMER home at less cost. To get quick, steady heat and plenty of it on less coal, attach the Crown Fuel Saver to feed door of your heating plant. Users guaranteed 20% fuel saving or money refunded. Write for details of this amazing heat producer, coal-saver and smoke consumer. CFSCo., 15 N. 10th St., Richmond, Ind.

HOME - MADE Furniture — Popular Mechanics Mission Furniture Library tells how to make all kinds of furniture in the easiest way. It is not only cheaper to make your own furniture, but you have a lot of fun making it. The library consists of three cloth-bound volumes and the entire library is only \$1.50. Popular Mechanics Press, Room 807, Popular Mechanics Building, Chicago, Ill.

LOOMS—Only \$9.90 and up. Big money in weaving Colonial Rugs, carpets, etc., from rags and waste material. Weavers are rushed with orders. Send for free Loom Book; it tells all about home weaving and quotes reduced prices and easy terms on our wonderful new looms. Union Loom Works, 480 Factory St., Bensenville, N. Y.

#### DIAMONDS, WATCHES AND JEWELRY

WATCHMAKERS: Earn highest wages. Understand adjusting thoroughly. Circular free. Write Walter Kleinlein, Publisher, Waltham, Mass.

#### ANTIQUES, WAR RELICS, AND INDIAN GOODS

FOR Dens, Relics collected from Europe's Battlefields. Illustrated Catalogue and Sample War Photos 25c. Lieut. Welsh, 2117 Regent Place, Brooklyn, N. Y.

INDIAN Made Baskets, Blankets, Wampum, Curios. Catalog. Gilham, Kelseyville, Calif.

SEND 5c for fine, new list Indian relics, antique firearms. F. E. Ellis, Webster Groves, Mo.

#### PHONOGRAPHS AND RECORDS

BUILD Your Phonograph. Spring Motors, Electric Motors, Tonaroms, Amplifiers, Accessories. Latest Equipment also in Radio Mechanism and Cabinets. Catalog mailed for ten cents. Hooser Mfg. & Supply Co., 313 Baldwin Block, Indianapolis, Ind.

BUILD Your Own Phonograph with Our Help—Save Half. The Choraleon Aristocratic Phonograph is unexcelled. Plays any record. Finest motors, tone arms, case materials cut to fit, ready to put together and blueprint and full instructions furnished at small cost. Satisfaction guaranteed. Write for catalog. Choraleon Phonograph & Radio Co., 225 11th Street, Elkhart, Ind.

BUILD your own phonographs. We can supply you with motors, tone arms and all accessories at wholesale prices. Write for catalogue AX. Pleasing Sound Phonograph Co., 204 East 113th St., New York, N. Y.

SAVE money; Finest quality Phonograph Builders' Equipment. Instructions, Catalogue. Superior Phonographs Co., Erie, Pa.

BUILD your own Phonograph. We furnish everything. Write for free catalog. American Phonograph Co., 3732 Belmont, Chicago.

#### MUSIC AND MUSICAL INSTRUMENTS

BAND and Orchestra Instruments Exclusively. We sell and exchange Buescher Saxophones and other instruments, Vega Banjos, Ludwig Drums and supplies, Penzel Clarinets, Violins and Supplies. We do repair work on all band and orchestra instruments. Write today for complete Free Catalog and list of used and rebuilt instruments, including free subscription to Musical Booster Magazine. "Deal with the Professional House." Crawford-Rutan Co., 1051 Grand Ave., Kansas City, Mo.

VIOLINS—I make 'em; sweet, soulful, mellow, yet powerful. Instruments of rare quality. Get details now. John Lehto, 935 14th St., San Pedro, Calif.

PIANO JAZZ; Learn to Play—Piano Chimes, Negro Harmony, Ear Playing, Player Piano Effects, Blues, Harmony Runs, Chording, etc. Particulars Free. Write Will Mulveney, 207 Ossington Ave., Toronto, Canada.

FEW easy-playing Hohner Saxes, polished brass, \$5.80 postpaid. Wm. Bogar, Lykens, Penna.

NOTICE—Music Lovers—send for free bargain list of quality Musical Merchandise and save money. Hobson's Music House, Chillum, Ohio.

WONDER dollar instrument. Anybody play, everybody surprised. Imitate orchestra, become professional entertainer. Particulars: Multitone, 448 W. 38th, New York.

SONGWRITERS. We advance \$250.00 Royalty upon publication of songs found suitable. Settlements quarterly thereafter. Send us your compositions based on popular sentiments or novel ideas for immediate consideration. Free booklet, "Writing the Popular Song," sent on request. Equitable Music Corporation, 1638-B Broadway, New York.

VIOLINS, Deep, Mellow, Soulful—on credit. Easy terms for wonderful instrument. Get details today. Gustav F. Henning, 2424 Garfield St., Denver, Colo.

MUSICAL Glasses. The most wonderful pure and beautiful tones can be produced by a touch of the finger. Send for Catalogue, Al. Braunfels, 9512 100th St., Richmond Hill, N. Y.

I WANT Song Poems. Casper Nathan, 1232 Bryn Mawr, Chicago.

WRITE Songs. Big money and reputation. Write for information. J. Gordon Pub. Co., 291 N. Hoyne Ave., Chicago.

"MUSIC Composed" to words. Bauer Bros., (formerly of Sousa's Band), Oshkosh, Wis.

#### PATENT ATTORNEYS

PERCY S. WEBSTER, Savings and Loan Building, Stockton, California. Long established organization. Send for free book on Patents.

PATENT Procured, Prompt Service. Personal, careful and efficient service. Highest references. Moderate fees. Send sketch or model for actual search and advice. George F. Kimmel, Master of Patent Law, 54 C. Loan and Trust Bldg., Washington, D. C.

INVENTORS, Write for valuable information. Suite 2522, Park Row Building, New York.

PATENTS, Trade-Marks, Designs. This firm has 27 years' experience and gives expert personal service at reasonable rates. We properly protect your invention. Write for free information and exact cost of procuring patent before proceeding. John B. Thomas & Co., 202 F St., N. W., Washington, D. C.

ESTABLISHED 1854. Milo D. Stevens Company. Free Booklet, Patents, Trade-Marks, Copyrights, Offices, Leader Building, Cleveland; Menadnock Block, Chicago; Barrister Building, Washington, D. C.



**PATENTS**—"How to Obtain a Patent" is the name of a book which every inventor should have. It will be sent free upon request, and will tell you what you want to know about patents. It contains the whole story. It describes the different parts of the application and explains in simple language the prosecution before the Patent Office. It tells about joint applications, reissues, agreements, assignments, licenses, interferences, process and design patents, trade-marks, and prints and labels. If you are interested in patents, either as an inventor, manufacturer or owner of a patent, you will enjoy reading this book. If you have an invention and will send us a sketch, model or photograph of it, we will promptly make search of the Patent Office records and advise you whether or not, in our opinion, your invention is patentable, our charge for this service being \$5.00. Prompt, efficient service with moderate charges. Over twenty years' experience. Bank and commercial references. Talbert & Talbert, Registered Patent Lawyers, 561 McGill Building, Washington, D. C.

**STRONGER** patents for less money. Booklet free. Chartered Association of American Inventors, 635 F Street, Washington, D. C.

**PATENTS.** My fees in installments. Advice book free. Frank Fuller, Washington, D. C.

**EDWARD C. SASNETT**, formerly a Principal Examiner U. S. Patent Office, 516 McGill Building, Washington, D. C.

**MILLIONS** spent annually for ideas! Hundreds now wanted! Patent yours and profit! Write today for free book—tells how to protect yourself, how to invent, ideas wanted, how we help you sell, etc. American Industries, Inc., 500 Kresge Bldg., Washington, D. C.

**MONROE MILLER**, Ouray Bldg., Washington, D. C. Patent Attorney; Mechanical, Electrical Expert. Free Blue Book gives candid advice.

**PATENTS, Trade-Marks, Copyrights, and Patents Litigation.** Write for advice and instructions how to proceed, costs, etc. Hand Book with Illustrations of 100 Mechanical Movements sent free on request. Albert E. Dieterich, Patent Lawyer and Solicitor, 621-B Ouray Bldg., Washington, D. C.

**THE PATENTOME** Impartial advice to Inventors and Manufacturers. Mailed on request. Anderson & Son, Patent and Trade Mark Lawyers, Established 1895, 635F St., Washington, D. C.

**INVENTORS**—Send for form "Evidence of Conception" to be signed and witnessed. Form, fee schedule, information free. Lancaster and Albaine, Registered Patent Attorneys in United States and Canada, 221 Ouray Bldg., Washington, D. C.

**PATENTS and Trade-marks** obtained. Prompt service. Write for our new book on patents. Established in 1889. D. Swift & Co., 398 7th St., Washington, D. C.

**HIGHEST** price promptly realized for sound commercial inventions. American Patents Corporation, Barrister Bldg., Washington, D. C.

**PATENTS** procured; trade marks registered. A comprehensive, experienced, prompt service for the protection and development of your ideas. Preliminary advice gladly furnished without charge. Booklet of information and form for disclosing idea free on request. Richard B. Owen, 39 Owen Bldg., Washington, D. C., or 2276-R Woolworth Bldg., New York.

**LACEY'S Patent Sense.** Valuable book free. See ad page 158.

**PATENTS**—Write for our Guide Books and "Record of Invention Blank" before disclosing inventions. Send model or sketch of your invention for examination and instructions. No charge for the above information. See advertisement on pages 156 and 157. Victor J. Evans & Co., 934 Ninth, Washington, D. C.

**PATENTS.** Write for my free Guide Books "How to Obtain a Patent" and "Invention and Industry" and "Record of Invention" blank before disclosing inventions. Send model or sketch of your invention for instructions. Promptness assured. No charge for above information. Clarence A. O'Brien, Registered Patent Lawyer, 589-B Security Bank Building, directly across street from Patent Office, Washington, D. C. See pages 154 and 155.

**H. F. LOWENSTEIN**, Registered Patent Attorney. Technical expert. McLachlin Building, Washington, D. C.

**PATENTS** for inventions. Long experience, highest grade work, rates reasonable, best references. Advice as to patentability. Wm. Ashley Kelly, 41 Park Row, New York.

**PATENT** Application Blanks free to inventors. Patent News-D, Washington, D. C.

**UNPATENTED** Ideas Can Be Sold. I tell you how and help you make the sale. Free particulars (Copyrighted). Write W. T. Greene, 896 Jenifer Building, Washington, D. C.

**INVENTORS:** Send sketch or model for free opinion concerning patentable nature and exact cost of patent. Book "How to Obtain a Patent," sent free. Tells what every inventor should know. Established twenty-eight years. Highest references. Prompt service. Reasonable charges. Chandler & Chandler, 474 Seventh, Washington, D. C.

**TRADEMARKS \$35; Design patents \$35; Copyrights \$5; Booklet Free; 20 years' experience.** Sanders, Registered Patent Attorney, 7 Band-McNally Building, Chicago.

**INVENTORS**—Write for our Guide Book, "How to Get Your Patent" and Evidence of Invention Blank. Send model or sketch of your invention for our prompt examination and instructions free. Randolph & Co., Dept. 430, Washington, D. C.

**"INVENTOR'S Advisor,"** the valuable Patent book with 139 mechanical movements and illustrations, sent free upon request. M.M. Labner, Patent Attorney, 3 Parkrow, New York.

**PATENTS.** Booklet free. Highest references. Best results. Promptness assured. Send model or drawing for preliminary examination. Watson E. Coleman, Patent Lawyer, 644 G Street, Washington, D. C.

**PATENTS, Trade marks, copyrights.** Prompt, personal, reliable service. Over 36 years' active practice. Write for terms. Book free. Address E. G. Siggers, N. U. Bldg., 918 F St., Washington, D. C.

**HERBERT JENNER**, patent attorney and mechanical expert, 606 F Street, Washington, D. C. I report if patent obtainable and exact cost. Send for circular.

**"INVENTORS' Guide"** sent free on request; this book contains illustrations of patented inventions and gives valuable information and advice for all who have original ideas or improvements. Frank Ledermann, Registered Attorney and Engineer, 15-P Park Row, New York.

#### FOR INVENTORS

**PATENTS.** If you have an invention which you wish to patent you can write fully and freely to Munn & Co., for advice in regard to the best way of obtaining protection. Please send sketches, or a model of your invention and a description of the device, explaining its operation. All communications are strictly confidential. Our vast practice, extending over a period of seventy-eight years, enables us in many cases to advise in regard to patentability without expense to the client. Our Hand-Book on Patents is sent free on request. This explains our methods, terms, etc. In regard to Patents, Trade Marks, Foreign Patents, etc. "Scientific American" contains Patent Office Notes, Decisions of Interest to Inventors and particulars of recently patented inventions. Munn & Company, Solicitors of Patents, 623 Woolworth Building, New York; 524 Scientific American Bldg., Washington, D. C.; 413 Tower Bldg., Chicago, Ill.; 365 Hobart Bldg., 582 Market St., San Francisco, Calif.; 221 Van Nuys Building, Los Angeles, Calif.

**PATENTS**—"How to Obtain a Patent" is the name of a book which every inventor should have. It will be sent free upon request, and will tell you what you want to know about patents. It contains the whole story. It describes the different parts of the application and explains in simple language the prosecution before the Patent Office. It tells about joint applications, reissues, agreements, assignments, licenses, interferences, process and design patents, trade-marks, and prints and labels. If you are interested in patents, either as an inventor, manufacturer or owner of a patent, you will enjoy reading this book. If you have an invention and will send us a sketch, model or photograph of it, we will promptly make search of the Patent Office records and advise you whether or not, in our opinion, your invention is patentable, our charge for this service being \$5.00. Prompt, efficient service with moderate charges. Over twenty years' experience. Bank and commercial references. Talbert & Talbert, Registered Patent Lawyers, 545 McGill Building, Washington, D. C.

**MARKET** your own invention. Booklet free. Chartered Association of American Inventors, 635 F Street, Washington, D. C.

**GET** Cash for your patent or invention under our new plan. Write at once to inventors' Syndicate, 61 Palladium Bldg., St. Louis, Mo.

**SELL** your own patent without expense; same, suitable plan, free details. Lee, 610 Ashland Bk., Chicago.

**INVENTORS' Educator:** 900 Mechanical Movements. 50 Perpetual Motions. How to procure and sell patents. Mechanical Movements greatly assist inventors, suggest new ideas. Explains how to select an attorney and avoid Patent Sharks. Price \$1.50. Postage Free. Albert E. Dieterich, 621 Ouray Building, Washington, D. C.

**MONROE MILLER**, Ouray Bldg., Washington, D. C. Patent Attorney; Mechanical, Electrical Expert. Before proceeding, read free Blue Book.

**HIGHEST** price promptly realized for sound commercial inventions. American Patents Corporation, Barrister Building, Washington, D. C.

**INVENTORS:** Original Manufacturer of Nationally Famous article offers valuable suggestions and information regarding profitable handling of inventions patented or pending. Will advise best method of selling or marketing your invention to make it commercially successful and profitable. Stamp for details. No obligation. Floyd Clymer, Denver, Colo.

**LACEY'S Patent Sense.** Valuable book free. See ad page 158.

**INVENTORS**—Write for our Guide Books and "Record of Invention Blank" before disclosing inventions. Send model or sketch of your invention for our free examination and instructions. See advertisement on pages 156 and 157. Victor J. Evans & Co., 157 Ninth, Washington, D. C.

**PATENTS**—Write for my free Guide Books "How to Obtain a Patent," "Invention and Industry" and "Record of Invention" blank before disclosing inventions. Send model or sketch of your invention for instructions. Promptness assured. No charge for above information. Clarence A. O'Brien, Registered Patent Lawyer, 589-B Security Bank Building, directly across street from Patent Office, Washington, D. C. See pages 154 and 155.

**WHY** not have a lathe of your own? See description of our Easy Payment Plan on page 165 of this issue. South Bend Lathe Works, South Bend, Ind.

**PATENTS** Procured; Trade Marks Registered — A comprehensive, experienced, prompt service for the protection and development of your ideas. Preliminary advice gladly furnished without charge. Booklet of information and form for disclosing idea free on request. Richard B. Owen, 39 Owen Bldg., Washington, D. C., or 2276-R Woolworth Bldg., New York.

**I SELL** Patents (Ask Mr. James J. Earley, 443 Lincoln Place, Brooklyn, N. Y.) Estb. in 1890. The Oldest Exclusive Patent Sales Business in America. Charles A. Scott, 173PM Garson Avenue, Rochester, N. Y.

**PATENTS** Sold or placed on Royalties, both U. S. and Canadian. Patented or Pending. For immediate action, write Arthur S. Billings, Suite 401 Dekum Bldg., Portland, Ore.

**UNPATENTED** Ideas Can Be Sold. I tell you how and help you make the sale. Free particulars (Copyrighted). Write W. T. Greene, 897 Jenifer Building, Washington, D. C.

**WILL** finance patent (good invention) for interest. F. A., % Patent News, Washington, D. C.

**SPECIALIZED** service for inventors. You furnish the idea, we'll work it out. Expert machine designing. Drafting. Opinions given on practicality of ideas. Confidential dealings. Your ideas fully protected. Write for full particulars. Otis Engineering Co., Desk C D, Omaha, Neb.

**RESPONSIBLE** established electrical manufacturer will buy outright or manufacture on royalty new inventions of household utilities or appliances. Details necessary. L. J. Efferth, 6545 Carnegie Ave., Cleveland, Ohio.

**WE** Develop your ideas into commercial shape for presentation to purchasers, making working models, drawings, experiments or tests. Courtesy, efficiency, secrecy and ample equipment; 30 years' experience. Duccorron-Rich Engineering Co., 594 Pacific Mutual Bldg., Los Angeles, Calif.

**GET** your own patents. Application blanks, complete instructions \$1. Cutting Sons, Campbell, Cal.

**HAVE** You an invention? If so, write for our free book, "How to Get Your Patent," tells our terms and methods. Send model or sketch for our free examination and instructions. Randolph & Co., Dept. 144, Washington, D. C.



## PATENTS FOR SALE

**FOR Sale—Patented Prison Bar:** Cannot be cut (Proven). Particulars given on application. Chas. Carter, 4907 North Broadway, St. Louis, Mo.

**INVENTION** for laying heavy tile, for sale. Takes place of two men. Write for particulars. T. M. Farnsworth, 23 Cuyler St., Newark, Wayne County, N. Y.

**PATENT—Only practical Stop Direction Signal** on automobiles. Sale or royalty. F. Cox, 27 West Ohio St., Chicago.

**PATENT for Sale—Combination Hand Saw.** Louis Rothbauer, 2148 W. 23d St., Chicago.

**PATENT for sale, on scoop** containing weighing device. Every grocer a prospect. Outright or royalty. Harry Fine, 1435 Ogden Ave., Bronx, New York.

**IMPROVED fruit funnel** for home canning. Patent issued Aug. 16, 1924. For putting hot fruit in cold bottles, cold liquids in hot bottles, without breaking. Works perfectly. Canada patent applied for, United States patent for sale or royalty. C. W. Young, 425 S. 4th St., Corvallis, Ore.

**SIGN-MAKING Device:** For the painting of all kinds of signs. Work done quickly and neatly. No experience required. Handy for professionals also. Big demand. Patent pending. Will sell outright. Full particulars. J. Kall, 378 Powell St., Vancouver, B. C., Canada.

**FOR Sale—Patent No. 1,397,670.** Garment Holder. Manufacturers interested in wire goods, write for copy and particulars. Inventor, D. W. Y., 3 Temple St., No. Abington, Mass.

**PATENT for Sale on improved crate** for ringing hogs. Easily manufactured and exceptionally efficient in use. Write for particulars. Frank L. Overton, Odon, Ind.

**UNITED STATES and Canadian Patent.** Stamped steel steering column support for Fords. Good seller, sideline or specialty. Outright. Fred H. Foster, Oxford, Ind.

**PATENT:** Basic unit for factory. Five foremost kitchen necessities into one. Simple, attractive. 3 1/2 to 5 to 8 ft. x 2 1/2. Iron, wood. Bid with royalty. 2110-10th, Wichita Falls, Tex.

**INVENTORS:** Valuable information every inventor should have. Details for stamp. No obligation. Floyd Clymer, Denver, Colo.

**UNITED STATES Patent for Railway Crossing signal.** Patent No. 1,477,697. Robert J. Dougherty, Canton, Ill.

**FOR Sale:—Newly Devised Rule;** patent pending. 6119 Ellis Ave., Chicago.

**SHOE-SHINING Machine.** Private Use. Box 77, Sioux City, Iowa.

**PLANING machine,** return carrier. Sell outright or royalty. Cheap to manufacturer. Big market. August Heinzelring, 1607 19th Street, Detroit, Mich.

**FOR Sale—Patented Prison Bar:** Cannot be cut (Proven). Particulars given on application. Chas. Carter, 4907 North Broadway, St. Louis, Mo.

**PATENT pending.** Reversible electric camp lantern, outright or royalty. For particulars address, Samuel Chase, Box 1027, Long Beach, Calif.

**PATENTS For Sale:** To sell, buy or obtain patents, write Patent News-P, Washington, D. C.

**MR. MANUFACTURER,** Layman or veteran—Side Dump Scraper Hoist, loads wagons, does ditching. E. B. Hawkins, Applegate, Ore.

**YOU have a worth-while patent,** haven't you? Why don't you tell our two million readers about it? Most of them are specially interested in patents and new inventions. Ask me to tell you how other inventors successfully sold their patents. Geo. F. Baker, Manager Classified Advertising, Popular Mechanics Magazine, Chicago, Ill.

## DRAWING INSTRUMENTS AND DRAFTING SUPPLIES

**IMPORTED Drawing Instruments—Slide Rules.** Highest Quality—Lowest Prices. Circulars free. Automotive Engineering Co., Transportation Bldg., Indianapolis, Ind.

**FINELY made nine-piece German Precision** drafting set at \$4.50. Money back if not satisfactory. Bass Camera Company, 109 N. Dearborn St., Chicago, Ill.

## SURVEYING INSTRUMENTS

**LARGEST stock of new and used surveying instruments** in the country direct from factory. Satisfaction guaranteed or money refunded. Wissler, 619 N. Broadway, St. Louis.

## MODELS AND MODEL SUPPLIES

**PATENTS.** Write for my free Guide Books "How to Obtain a Patent" and "Invention and Industry" and "Record of Invention" blank before disclosing inventions. Send model or sketch of your invention for instructions. Promptness assured. No charge for above information. Clarence A. O'Brien, Registered Patent Lawyer, 589-B Security Bank Building, directly across street from Patent Office, Washington, D. C. See pages 154 and 155.

**DIES, Tools and General Manufacturing.** Models and Manufacturing of new inventions our specialty. Logan Machine Co., 126 S. Clinton St., Chicago, Ill.

**SPECIAL machine builders, tool and die makers, inventors' models, production work** of all kinds. Dept. L, Quality Hardware & Machine Co., Ravenswood and Thorndale Avenues, Chicago, Ill.

**PATTERN Making.** Wood Models. Fourteen Years' Experience. My Personal Attention. M. Herbert Heighon, Hypoxo, Fla., Box 47.

**WE Build Models, design, develop and manufacture articles** in large or small quantities. Homsey Mfg. Co., 1385 E. 17th St., Cleveland, Ohio.

**MODEL steam engine 3/4" x 3/8" \$8.50.** Finished parts for same, \$7.25. Other engines, boilers, blowlamps. Catalog for 10c stamp. Model Machine Shop Co., 417 East 71 St., New York City.

**WE make working models for inventors** and do experimental work and carry a complete stock of brass gears and model supplies. Send for catalogue. The Pierce Model Works, Tinley Park, Ill.

**THE Modelmaker.** For those interested in making working models. Send 10 cents. Address P. M. 120 Liberty Street, New York.

## MANUFACTURING

**IDEAS are of no value unless they are developed into practical and commercial possibilities.** We have a completely equipped plant for developing and perfecting inventions and the economical production of automobile, electrical and mechanical devices, radio specialties, dies, tools, jigs, fixtures, screw machine work, brass finishing, punch press and sheet metal work. Metal finishing and assembling, a single part or a complete unit. References, Dun's and Bradstreet's, Berkman Manufacturing Company, 625 West Jackson Boulevard, Chicago, Ill.

**GET down to Wire Facts.** Send us your inquiries on special or standard Wire products. Forming, splitting, pointing, welding, etc. Increased facilities make double present production possible. We know our quotations will be of interest to you. Metal-Craft Manufacturing Company, Box 259-W, Chicago.

**PATTERNS, wood and metal.** Models, tools and dies, Brass, bronze, aluminum and iron castings. Screw machine work, production work of all kinds. Write Modern Machine & Pattern Co., Terre Haute, Ind.

**PATTERNS, Wood and Metal, Models and Experimental Work, Brass-Aluminum Castings, Machine Work, Light Manufacturing Complete.** The Reliable Pattern & Castings Co., Cincinnati, Ohio.

**PATENTED Articles, Models, Brass Work, Machine Construction; Dies Made, Baum's Metal Specialties, Kansas City, Mo.**

**WE design and build special machinery, make models, dies, stamping tools, do general machine work and light manufacturing.** Marshall Mfg. Co., Kansas City, Mo.

**SPRINGS made to order.** Wright Bros., 5616 Haron St., Chicago.

**Our factory will make your models, manufacture your articles as well as build your tools, die and fixtures.** Standard Die & Specialty Co., 1832 W. Austin Ave., Chicago, Ill.

**WIRE goods made to order.** Cooley Mfg. Co., 530 N. Western Ave., Chicago.

**WE design and build special machinery, tools, dies, jigs, and fixtures.** Experimental work. Reliable Machine Co., 400 W. 23rd St., New York City.

**WE develop models, make dies and stampings; prices reasonable.** Rapid Manufacturing Company, Pittsburgh, Pa.

**METAL-CRAFT — Eventually — Metal-Craft.** Competent Engineers, Designers and Producing Organization await your commands on dies, stampings, die-casting, deep pressing, screw-machine and wire products. Plating. Enameling. Burnishing. Assembling. Wrapping and Packing to your specifications. Large completely equipped plant which guarantees prompt, efficient service. It is not the quality of raw materials alone, nor the precision in manufacture, and not just the service rendered that has given Metal-Craft the good reputation they bear—but all of these, as a constant certainty, in Combination. Estimates promptly furnished. Metal-Craft Manufacturing Company, Box 259-W, Chicago.

**IRON, Brass, Aluminum Castings, Models, Patterns, Light Manufacturing.** Welch Brothers Co., North Chicago, Ill.

**SCREWS, nuts, screw machine products, all metals.** Autocrew Works, 355 West Broadway, New York City.

## MACHINERY, TOOLS AND SUPPLIES

**YOU can install a lathe in your shop now** under our Easy Payment Plan. See page 165 for details. South Bend Lathe Works, South Bend, Ind.

**ONE 12" x 6" LeBlond quick change lathe,** \$200.00. 1 12" x 6" Reed lathe, \$115.00. 1 No. 60 Head cylinder grinder, \$700.00. 1 14" Jungst crank shaper, \$185.00. One 16" x 48" Metal Planer, \$275.00. One 15" Drill Press, \$25.00. Terms to suit. Complete line machinery. Cincinnati Machinery & Supply Co., 218 E. Pearl St., Cincinnati, Ohio.

**LIGHT Power Transmission Machinery, Grooved and Flat Pulleys, Bearings, Reducing Gears, Revolving Display Tables, Arbor Presses, Motors.** Free Catalogue. Electric Machine Co., 438 Monticello Ave., Norfolk, Va.

**MECHANICS Attention.** For a time, set of serviceable twist drills. Postpaid, 1 to 60 with accurate metal stand \$5.00. Also Files and Hack Saws cheap. W. E. Whittier, 751 Putnam Ave., Brooklyn, N. Y.

**SHAW Garden Tractor** does work of five men the year 'round. Besides cultivating, etc., runs belt machinery requiring not much over 1 1/2 H.P. Special Winter Price \$150. Write for particulars. Shaw Mfg. Co., Tractor Dept., Galesburg, Kans.

## ENGINES, MOTORS AND DYNAMOS

**ONE Lockwood Ash outboard boat motor;** One Smith Motor Wheel; One 30 lb. U. S. Welding generator; Two 7 H. P. Focs gasoline engines; Two Sets Ford Wire wheels; Two Buffalo Blacksmith forges; One Surface grinder. Samuel Kerslake, Paris, Ky.

**MOTORS \$2.98.** Practical, twentieth horsepower, alternating-direct current. Order Now. Par Postman, Perry Trading Co., Dept. M2, 815 Lake, Racine, Wis.

**BATTERY charging motor generators—Motor 220 V., 60 cycle, 3 phase. Generator 25 V., 8 amp., \$25.00; single phase motor \$27.50.** Also special bargains in large outfits, motors, generators, etc. Queen City Electric Co., 1734 W. Grand Ave., Chicago, Ill.

**GENERATORS, with propeller, \$10.** Battery charging \$8. Wood, 151 E. 108th, New York.

**GOVERNORS to control Auto Engines** when used as stationary engines. Circulars. Candee-Smith Governor Co., Springfield, N. Y.

**SMALL Gasoline, Steam Engines, Dynamos, Motors, Storage Batteries, etc., new and secondhand.** New Catalogue free. Dynamic Manufacturing Co., First National Bank Bldg., Chicago.

## ELECTRICAL

**30-FT. Extension Cords complete with plug and socket \$1.50.** James, LaBlanc, 5216 Republic Ave., Racine, Wis.

## BENDING MACHINES

**THE famous Hossfeld Wrenchless Universal Bender** is the last word in bending machines; bends metal, cold or hot, into most any conceivable shape, including Eye-bolts and Automobile Spring Eyes. Bends up to 1" bars or 1 1/2" Pipe cold. Used by the largest corporations, yet so inexpensive that even a farm shop need not be without one. Send for circular. Hossfeld Mfg. Co., Box 344, Winona, Minn.

## BLACKSMITHS

**BLACKSMITHS, Listen!** Make more money doing hard jobs easy with Toy's Modern Methods of Master Machine Blacksmithing, Forging and Solid Welding, Tool Dressing and Tempering to a standard with colored tempering charts. All for One Dollar. Samples Free. W. M. Toy, Sidney, Ohio.



## FOR SALE—MISCELLANEOUS

**SWAP!**—Buy!—Sell! Anything!—Any-where!!! 20-word ad and Six Months' subscription—50c. International Opportunity, Brookings, S. Dak.

**FOR Sale**—Rebuilt fifteen-dollar France Chargers—eight dollars while available. These machines were taken in trade on larger apparatus. Factory guaranteed. Send for bulletin. France Mfg. Co., 16312 Borea Rd., Cleveland, Ohio.

**WONDERFUL Bargains**—Typewriters, Adding Machines, Multigraphs, Mimeographs, Printing Presses. See Typewriter Co., Ada, Okla.

**FOR Sale**—Coin Operated Machines. Barr Novelty Works, Shamokin, Pa.

**ADDRESSOGRAPHS.** Letter Folders, Multigraphs, Envelope Sealers, Duplicators, less than half price. Guaranteed. Pruitt Co., 170 N. Wells, Chicago.

**BUY—Exchange—Sell!** Many of our readers have for sale or exchange the article you are looking for—and lots of them are looking for the very items you want to turn into cash. Get together! Let our two million readers know your wishes—they'll help you! Send your ad today to Geo. F. Baker, Manager Classified Advertising, Popular Mechanics Magazine, Chicago.

## WANTED—MISCELLANEOUS

**WANTED**—10 to 13 inch, foot power, screw-cutting, compound rest lathe. Also Shepard hand power planer. Cash for bargain. For Sale—Good Grammes' lathe cheap. Harry Fessenden, Black Earth, Wis.

**GOLD, watches, Diamonds, silver, platinum, jewelry, bought.** Best prices also for mercury, false teeth, magnets points, bridge-work, jobs, general merchandise, unused stamps, bonds, any valuables. Mail or express in. Prompt, confidential returns. Returnable ten days if unsatisfactory. Ohio Smelting Co., 315 Hippodrome Bldg., Cleveland, Ohio.

**Do You Write?** We are eager to receive in any form Stories, Photoplays and Articles suitable for publication. Send us your manuscript for free criticism. Producers and Publishers Clearing House, Regd. P. O. Box 1182, Montreal, Quebec.

**MAIL us your discarded Jewelry, Gold, Crowns and Bridges, Watches, Diamonds, Silver, Platinum, and old False Teeth, Money promptly mailed. Goods returned if offer refused.** United States Smelting Works, (The Old Reliable), Dept. 71, Chicago.

## REAL ESTATE, FARM AND ORCHARD LANDS

**SEIZED and sold for Taxes, \$89 for 12 acres, choice lake front. \$73 for 25 acres, Muskoka Lake District. \$50 for 10 acres, Hunting camp site, \$92 for 50 acres, mixed farming, good market. \$315 for 160 acres, wheat and dairy farm, Manitoba. \$82 for 50 acres, beautifully wooded. \$216 for large acreage big game district. \$378 for claim near mines that have paid millions. Also beautifully situated hunting and fishing camps, moose, deer, caribou, ducks, partridge, trout, whitefish, bass etc., best in North America. Splendid improved farms in Western Canada, the Last Great West dairying, wheat, mixed farming. Summer cottage sites, heavily wooded tracts, easily accessible, situated in Muskoka, Georgian Bay district with its 10,000 islands. Algonquin Park with its 300 lakes, Highlands of Ontario, Lake of Bays, etc. All offered at ten cents on the dollar of their value, and on easy monthly payments of \$5.00 and upwards. Send for illustrated list describing the above and hundreds of other properties, seized and sold for taxes. Every property is fully described and offered at a stated price. Send no money, send for list to-day so you will have first choice. If you wish you may make your payments to your local trust company. Tax Sale Service, 72 Queen Street West, District 15, Toronto, Ontario, Canada.**

**LATE Opening Oregon Homesteads offer exceptional opportunities, map and details, \$1.00.** F. G. Thompson, Sheridan, Oregon.

**PECAN-ORANGE Groves "On the Gulf"** \$10 monthly. Guaranteed care. Soon produce \$500.00 yearly. Suburban Orchards, Dept. M, Biloxi, Mississippi.

**\$10.00 DOWN, \$10.00 monthly;** Entire 10-acre tract Oklahoma prospective oil, gas and mineral land \$150. No misrepresentations. "A-1" Bank References. D. G. Williams, 6436 University Avenue, Chicago, Ill. Phone Midway 6221.

**FOR Sale**—Three full sections in McKenzie County and two sections in Billings County, North Dakota. Each section contains land suitable for crops, balance for cattle. Each section has valuable deposits of lignite which some day will alone be worth many times the present value of the land. This part of the state is developing very rapidly with good schools within easy access. As owner cannot use this land himself, will sell one or more sections at a price which almost anyone can afford to pay. Address W., care Popular Mechanics, 290 East Ontario St., Chicago.

**FARMS wanted** by cash buyers. Describe, give lowest price. R. McNow, 312 Wilkinson Bldg., Omaha, Nebr.

**WANT to hear from owner** having farm for sale; give particulars and lowest price. John J. Black, Chippewa Falls, Wis.

**\$500 FULL Price Secures 20-acre Farm.** Furniture, Crops, Potatoes, turnips, cabbage, etc.; near village; cozy 5-room house, piped water, 40-ft. barn. All \$550, part cash. Details pg. 28 big illus. Bargain Catalog. Free. Strout Farm Agency, 1507 Nassau St., New York City.

**\$5.00 DOWN, \$5.00 monthly;** 10 acres unimproved poultry, fruit, stock, woodland; \$100; Ozarks. Fishing, hunting, trapping. Alvin Zimmermann, 1809 N. Fifth, Kansas City, Kans.

**CALIFORNIA**—Half Acres in Southern California \$50.00 Total Price. Easy Terms. \$5.00 Starts You. Write for Details. "Thorneland," 4628 Hollywood Blvd., Los Angeles, Calif.

**ATTENTION**—"Get acquainted." Cash for your property. Farm, Hotel or Retail Store, no matter where located; confidential service. Hayes' Business Agency, Cincinnati, Ohio.

**SELL your property quickly** for cash, no matter where located. Don't pay big commission. Particulars free. Real Estate Salesmen Co., Desk B, Lincoln, Nebr.

## SEEDS, PLANTS, TREES, ETC.

**WANTED**—Everyone interested in gardening to write for free copy of our beautiful Seed and Plant Guide. Our new specialties will interest you. H. W. Buckbee, Rockford Seed Farms, Dept. 901, Rockford, Ill.

## ROOTS AND HERBS

**HERB Doctor Book**—10 cents. 250 recipes to make herb medicine. Hazard Company, Box 1, Vanderveer Park, Brooklyn, N. Y.

## DOGS AND PETS

**COLLIES for Sale.** Training Book 35c. Sunnybrae Kennels, Bloomington, Ill.

**RAISE guinea pigs.** Pay better than poultry or rabbits; easy to raise; little space required. We guarantee market. Particulars and booklet how to raise free. Cavies Distributing Co., 3192 Grand Ave., Kansas City, Mo.

**BEAUTIFUL registered bull pups cheap.** Bulldogs, 501 Rockwood, Dallas, Texas.

## POULTRY

**HENRY ACHESON, Breeder,** Spencer Turkeys, Jersey Giants, Russian Orloffs and Hatching Eggs, Breeding Poultry. Photo—booklet free. R. 1, Box 144-R, Santa Cruz, Calif.

**CHICKS on Low Terms.** 20 kinds. Reduced prices. Catalog free. Colonial Farms, Dept. 720, Pleasant Hill, Mo.

## PERSONAL

**50 ART Cards \$1; Membership Friendship Exchange 25c.** A. McCreery, Chatham, Ont.

**INFORMATION, advice.** Any subject. \$1.00. International Information Institute, 16 Moore, New York.

**SEND 25c and your date of birth** for forecast of your vibrations for 1923. Arzel Synclare, Numerologist, Astoria, Ore.

**FREE**—Stop using tobacco. We will give free information how to conquer habit easily and permanently. Results guaranteed. Anti-Tobacco League, Box K, Omaha, Nebr.

**KNOW Thyself**—and become a success! Know your character, talents, possibilities in business, love, marriage and future enterprises. Send your full birth date, specimen of your handwriting and 10c for your wonderful Three-Page Horoscope of surprising indications of your life. Write at once: Gargilla, Box 2771-DD, Boston, Mass.

**TOBACCO Kills manly Vigor.** Quit easily. Cigarettes, chewing, smoking, snuff conquered or no charge. Small sum if satisfactory. Stops craving; harmless. Full treatment on trial. Perkins Co., 34-A, Hastings, Neb.

**TOBACCO or Snuff Habit cured** or no pay. \$1.00 if cured. Remedy sent on trial. Superior Co., TP, Baltimore, Md.

**FREE**—Information of a scientific nature that has brought happiness through perfect health to thousands. No charge, no obligation. Enclose stamp for reply. Fair Sales Co., Dent 248-O, Colorado Springs, Colo.

## MISCELLANEOUS

**ARE You Old at Forty?** See our advertisement on page 163 of this issue. The Electro Thermal Company, 2137 Main 27, Johnstown, Penna.

**GET posted**—Good prices paid for butterflies, insects. See Sinclair display advertisement, page 28.

**MINERAL treasures.** How to find them? 10c. Minerals identified, \$1.00. Mineralogist, Joplin, Mo.

**GOT something to swap?** Write me, enclosing reply postage. Vitalis Malloy, Dept. 27, Johnstown, Penna.

**TATTOO marks removed easily and painlessly** with the new scientific preparation "Tattoo-Off." Complete \$3. R. Vestvold, 4011 Sixth Ave., Brooklyn, N. Y.

**LOCKSMITHING,** complete 500 tricks of the trade, new edition, many added features. \$1.50. money back if dissatisfied. H. Runtson, 3408 Andover St., Oakland, Calif.

**MAKE Money Silvering Mirrors Auto-lights, Radiators, tableware, stoves.** Outfits, Methods Free. Sprinkle, Plater, 288, Marton, Ind.

**KIDDIE Cabinet, beautiful toy; patterns,** 25c, 50c, \$1.00. Dresser, desk, settee, 25c each; others. Kiddie Cabinet, 305 West 143d St., New York.

**LUCKY**—If not send for wondrous lucky stone to carry for luck. \$1.00 each. Pay postman. L. Rinker, 296 Broadway, New York.

**ECONOMY Cigarette Making Machine,** 40 cigarettes made for ten cents. Rolls and gives cigarettes for future use. Select your own brand of tobacco. Postpaid on receipt of \$2.50. Economy Machine Works, 4816 Kenmore Ave., Chicago, Ill.

**PHOTO-ENGRAVING** Easily learned at home. Samples 3c. J. P. White, 1037 E. 47th St., Chicago, Ill.

**ROCKS and Minerals for sale**—Hundreds of varieties—Price List 5c. Peter Zedac, 157 Wells St., Peekskill, N. Y.

**NEW Mail Order Plan Brings quick, steady income,** spare time or full time. Permanent, positive and profitable. Details complete, \$2. Circular telling all about it free. W. H. Blair, Box 5, Lamoni, Iowa.

**I CATCH from 45 to 60 Foxes in from 4 to 5 weeks time.** Can teach any reader of this magazine how to get them. Just drop me a line for particulars. W. A. Hadley, Stanstead, Quebec, Canada.

**FORMS to cast Tin Soldiers, Indians, Marines, Trappers, Animals.** Send 5c for Catalogue. Henry Schiercke, 1034 72nd St., Brooklyn, N. Y.

**ARTIFICIAL Eyes, \$3. Booklet free.** Denver Optic, 559 Barclay, Denver, Colo.

**CUTS anybody can make.** Simple, cheap process, \$1. Specimens, particulars, 2c stamp. M. Day, Windfall, Ind.

**HOMEOPATHIC and Biochemic preparations sent postpaid** to all parts of the world. Manual and booklets free. Halsey Bros. Co., 111 N. Wabash Ave., Chicago, Ill. Established 1855.

**MECHANICS!** You will seldom if ever get stuck on a job if you keep on hand for quick reference a 14-volume set of Popular Mechanics Shop Notes. At the price of 50 cents a volume, any one of the several thousand time and labor-saving kinks may save you the cost many times over. Any of the volumes may be purchased separately at the same price. Popular Mechanics Book Dept., 296 E. Ontario St., Chicago.

**JUST Out!** Shop Notes for 1923, comprising the articles that have appeared in the Shop Notes section of Popular Mechanics during the past year. Bigger and better than ever. 519 articles, 296 pictures. 50 cents postpaid. Popular Mechanics Book Dept., 296 E. Ontario St., Chicago.



# FREE LESSON & BOOK

*Positive Proof that you can Learn to play the TENOR BANJO at home*

Professor Harry S. Siz for 28 years head of the Glee and Instrumental Clubs of N. Y. University. His method enables you to play first day.



MR. OTTO H. KAHN, the chairman of the Board of Directors of the Metropolitan Opera Company, in a speech here in New York on November 11th,

paid a great tribute to jazz. He said, "It is vigorously alive, characteristically novel and distinctly its own."

You unquestionably agree with Mr. Kahn, because there is no music so **captivating, energetic and thrillingly full of excitement** as jazz. The very fact that many thousands of people flock to New York's many jazz palaces every night is evidence of not only the **popularity of jazz**, but it also proves how **magnetic and irresistible** it is.

You, too, can become **popular, irresistible and magnetic**. The simplest of all jazz instruments to play is the Tenor Banjo, because we have devised a method of home instruction so simple, that you can **quickly learn to play**, even if you have never had any previous musical knowledge. The Tenor Banjo plays the leading part in every successful orchestra.

You can learn it home in your spare time and we **guarantee to teach you**. We don't ask you to take our word for a single thing. So positive are we you will become one of our students, if you will **write at once**, we will send you **absolutely free**, without any obligation, your first lesson and our beautiful book in colors, "How To Learn To Play The Tenor Banjo." Read about our **FREE Tenor Banjo** offer below.

**FREE TENOR BANJO worth \$18.00**



## Professional Size

### Tenor Banjo FREE

When you enroll in our academy as a student, we furnish you, free, with an \$18.00 full professional size Tenor Banjo which is like the one pictured here. There are no extra charges of any kind and you always have the privilege of writing to our professors for special information which is furnished without cost. You get **six months' free service** and consultation after you graduate.

### Learn Quickly with Our Picture Method

Besides furnishing you with easy-to-understand printed lessons, we also furnish you with pictures of our professors' playing. It is easy to imitate pictures and do the right thing. You also get **phonograph records** from time to time of the professors' playing, which is really a visit to you. Another exclusive feature is our **Gain-Time Chart** which enables you to play quickly. This chart has been said to be the greatest discovery for the teaching of music, and it is being used with our permission by several musical schools throughout the country.

### When Lights Are Low

When the time, the place and the mood suggest music, you will most enjoy the fascination of your Tenor Banjo. The Tenor Banjo will always be at your service, either accompanying voices or blending with other instruments that warm the heart and bring cheer and joy.

No matter whether the occasion demands a soothing melody of love, or an exciting, entrancing, magnetic jazzy hit, you will always be prepared as a good tenor banjoist.

Rush coupon today and receive your first free lesson and our book, and you can learn these facts for yourself. Act at once in order that your request will be received in time for us to reserve a free Tenor Banjo for you.

**New York Academy of Music, Studio 12, 212 Fifth Ave., New York, N. Y.**



Professor John Maril is another of our professors. He is known all over the country as a Great Tenor Banjoist. He wants to welcome you as one of his students.

*The Art of Playing the Tenor Banjo*

*How to learn to play the TENOR BANJO*

**RUSH THIS COUPON FOR FREE BOOK AND LESSON**

**NEW YORK ACADEMY OF MUSIC, Studio 12, 212 Fifth Ave., New York, N. Y.**

Please rush your book in colors, "How to Learn to Play the Tenor Banjo," my First Free Lesson, and reserve a gift \$18.00 full-size, professional size Tenor Banjo for me. This obligates me in no way whatever.

Name .....

Address .....

City ..... State .....

(Note—This Offer Expires in 30 days.)



**You Can Be  
One of These  
Big Pay  
Auto Experts**

# Join these on their march

THEY have completed their course of training in the big McSweeney Shops and are on their way to the best jobs in the field they have picked out—automobiles, tractors, battery or ignition repairs. They'll find the doors of the big jobs open to welcome them—and they will get the big money—they are McSweeney Trained men! The big and small employers alike all over the country know what that means—it means that they know their stuff! They have to before they get their diplomas.



**Pick Out  
Your Job—  
it's waiting  
for you**

There is always room for McSweeney Trained Men. Pick out the job you want—automobile mechanic, tractor mechanic, battery expert, ignition expert—it makes no difference, I'll train you and you'll get started in the biggest paying game there is.



**BIG SPECIAL OFFER—Including  
Free Board and Free Railroad Fare**

This offer I am making for a limited time is within the grasp of every man who wants to safeguard his future. Let me tell you all about it—send the coupon for my special offer.



**Greatest Home Study Offer  
Ever Made**

If you cannot get started at once you can begin your training at home. I have been three years in preparing this Home Study Course. It is backed by years of experience in teaching in not only one—but three schools.

**McSweeney** **Auto, Tractor  
& Electrical**  
**Three Big Schools**

See my announcements on  
page 131 and on the inside  
front cover

**Cincinnati, Ohio** **Chicago, Ill.** **Cleveland, Ohio**  
**9th and Walnut Sts.** **517-21 S. Laflin St.** **1015 E. 24th St.**



# Successful men to big pay auto jobs

## I Have Brought An Auto School To Your Door

I have built the largest chain of Auto Schools in the country. No longer is it necessary to go a long way from your home and friends. I have brought a school to your door. The location of my schools, Cincinnati, Chicago, Cleveland, completely cover the richest, most densely settled part of the country. No matter where you live—there's a McSweeney School within comfortable traveling distance from your home. My schools are nearest to the most automobiles. That's what you are interested in. I have built this chain for you with your interest always uppermost in my mind.

## It's Easy When You Know How

There's nothing mysterious about being successful in the automotive business—all you have to do is to know how. I don't care if you have never seen an automobile or tractor before. I don't care if you can't even read or write—if you have the determination to earn more money—I can make an expert mechanic of you in eight short weeks! Then you'll know what it means to receive a heavy pay envelope—real money to do the things you've always wanted to do.

## Get This 64 Page Book

**FREE!** 64 pages crowded with information about my schools, showing you all of the departments and telling you more than I possibly could in such little space.



Send  
the  
Coupon  
To-day—  
It Means More Money for You

## Schools

Send the Coupon to the School  
Nearest You

See other announcements on page 131  
and on the inside front cover



## USE THIS COUPON FOR MY SPECIAL OFFER

**J. H. McSweeney, Pres., Dept. 1416  
McSweeney Auto, Tractor & Electrical Schools**

9th & Walnut Sts., Cincinnati, Ohio } Address school nearest you.  
517-21 South Laflin St., Chicago, Ill. }  
1815 East 24th St., Cleveland, Ohio }

Dear Mac: Send me your 64-page catalog and full particulars of your special offer.

Name.....

Address.....

City..... State.....

I am interested in the  Resident Course  
 Home Study Course  
(Check the one you are interested in)



# Will you give me 6 Months to Increase YOUR PAY?

Your name on the coupon means "Yes"



## What I Give You

**Free Book.** Send in the coupon today. I will immediately send you our book "Drafting—Your Success" which tells about Drafting and its opportunities and contains proof that I can raise your pay.

**Free Subscription to Drafting Publication "The Compass."** I will give you free a subscription to our helpful, inspiring publication "The Compass."

**Practical Problems.** You will be carefully coached in practical Drafting work.

**I Help You Get a Job.** I will help you get a position as a practical Draftsman and will give you real, personal help, such as I have given to thousands of others.

**Personal Instruction and Supervision,** throughout the Course. You will receive the personal instruction and help of Roy C. Claflin, President of the Columbia School of Drafting and a practical Draftsman of many years experience.

**Draftsman's Equipment.** I will furnish you with a full set of first class drawing equipment and Drafting Instruments, as shown in the picture below, when you enroll. You keep both sets on completing the course.

**Consultation Privileges.** You are free to write me at any time for personal advice and suggestions regarding your progress.

**Diploma.** The diploma I will give you on completing the course attests to your proficiency as a Draftsman. It is an entering wedge to success.

**Advice Regarding Government Positions.** The following are a few of the many positions open in the Government Departments from time to time. The salaries are starting salaries, subject to increase:

Architectural Designer — \$4,000 a year.

Chief Draftsman, Naval Aircraft Factory — \$15.04 a day.

Aeronautical Draftsman, Field Service Navy Department — \$5.20 to \$12.50 a day.

We will advise you as to other government openings from time to time.

No, I am not a wizard. I don't claim to have a "corner" on success, but here's a fact.

For fourteen years I have been helping men just like you to make more money, not just a few men here and there, but thousands of men.

Think these facts over—in just a few months time I boosted one man's pay from \$2.00 a day to over \$300 a month—another now makes as high as \$27.00 a day—another man, after securing my help, went into business for himself and, while he now hires his drafting done, he makes over \$50,000 a year.

## \$275 Extra in Three Days

One man saw an ad like this—Sent in the coupon—Enrolled for the Columbia Course—and shortly after he received \$275 for one drawing that he made in his spare time in three days.

Do you make money like these men do? Does the money in your pay envelope get you the things you really want or just enough to make you wish you, too, could have the good things of life that other men have—money, independence, success, happiness?

### MAKE \$50 TO \$100 A WEEK

Columbia will train you to be an expert Draftsman in your spare time at home by mail. There's a lot of room for you if you set now. This doesn't mean that you will be just an ordinary Draftsman, but a finished, Professional Draftsman, able to hold your place among the highest paid Draftsmen in the land.

### PROMOTION IS QUICK

We'll qualify you for a high salaried position in the Drafting field and keep you in touch with openings for Draftsmen in the big machine shops, industrial plants and United States Government departments. Men who start as Draftsmen are often advanced to Chief Draftsmen, Chief Engineers, Production Managers, and so on. Many of my graduates are today holding such positions as a result of my help. These positions pay big money and lead on to executive positions of the highest type. Thousands of men have found Drafting to be the stepping stone to some of the biggest positions in American industry.

### GET THE RIGHT TRAINING

I started this school years ago. Today it is a solidly established nationally known institution, with graduates all over the world. I stand personally in back of the Columbia School of Drafting and back of every promise, every state-

ment we make. You get the right training when you enroll at Columbia. You spend no time on long winded theories. You start on actual drawing work the day you receive your first lesson. You get right down to brass tacks and there is no lost motion, no waste time or effort at any stage of the course. From the very beginning you can feel yourself making progress, the kind of progress that makes you confident of yourself and sure of your success.

### YOU NEED NO PREVIOUS TRAINING

This course of mine is easy to understand and easy to follow. It is designed for men who must have the best and who must get the right training quickly, so as to be able to make more money as soon as possible. Many of my students are qualified, even before they complete the course. Many a man has increased his pay so soon after enrolling that his course has actually cost him nothing.

### SUCCESS CALLS MEN OF ACTION ONLY

If you are a man of action—if you want success bad enough to reach out and grab it, clip the coupon now and show me that you are a man of action. Keep right on top of this opportunity to make real money. Don't go looking for a pair of scissors, tear the coupon off and mail it right away. Get started now.

## COLUMBIA SCHOOL OF DRAFTING

ROY C. CLAFLIN, President

Dept. G-108, 14th & T Sts., N. W.,

WASHINGTON, D. C.



### FREE DRAFTING OUTFIT

We give you free with our course this professional Drafting outfit. It is yours to keep when you complete the course.

### FREE BOOK COUPON

**COLUMBIA SCHOOL OF DRAFTING**  
Dept. G-108, 14th and T Sts., N. W., Washington, D. C.

Please send me without charge your free illustrated book on Drafting, telling me how I can secure your help in securing a position as Draftsman. Also enter my name for free subscription to "The Compass."

Name.....

Address.....

City.....State.....





Unholz and Farina, once common laborers, now have their own electrical company.

G. Fields jumped from \$35 a month to superintendent of a big electrical plant with two big salary increases to date.

G. Melrose now makes \$400 a month because S. & H. and Lincoln Tech. trained him right.



# Only 20 Weeks Then You'll Be Ready for These Big ELECTRICAL JOBS

Just 20 weeks! Think of it. And yet in this short time you now can receive the amazing training of the S. & H. Engineering Company and Lincoln Institute of Technology and be ready to step into big jobs like Unholz and Farina, or G. Melrose, or G. Fields and hundreds of others. And yet this remarkable course takes only 30 minutes a day. No matter what your experience or education, this is an amazing opportunity for you.

## S. & H. Fits You for Jobs Like These

Jobs like these above can be yours, so thorough is this training. After many years' study and experimental work there has been developed this remarkable way of teaching electricity right in your own home. This shop type home training is an exclusive copyrighted feature. You can get it nowhere else. And remember! You receive a diploma actually certified and endorsed by the Lincoln Institute of Technology. This is something you receive nowhere else. You not only get theoretical knowledge of electrical principles that is taught in technical universities, but you get the practice that a man gets only from doing practical work. This makes this amazing training the quickest and yet the simplest training in electricity ever devised.

And electricity needs you. Right now hundreds of big-pay jobs want men. But you must be trained right. The experts of this great institution know exactly what you need to fit you for these jobs. And you get it right in your own home, so simple and easy to grasp is this amazing training. You can soon be

equipped to demand and get the high salaries this profession pays. All you need do is to take the first step.

## Send for Big Book FREE

If you want to be an electrical expert send the coupon at once. All who send immediately will receive an amazing free offer of a complete outfit of electrical apparatus, instruments and appliances for experimental and practical home shop work. Also our big catalog gives you full information about this amazing rapid and easy course. Learn what electricity holds for you. Find out what the S. & H. Training will do for you. Also about our big free Employment Bureau. But do not delay. Mail the coupon now.



## S. & H. ENGINEERING CO.

In Affiliation With Lincoln "Tech"

Dept. B-1, 1422 W. Monroe St., Chicago, Ill.

Chief Engineer, S. & H. Engineering Co.  
1422 W. Monroe St., Dept. B-1, Chicago, Ill.

Please send me catalog and full information about the remarkable S. & H. Course, your FREE Outfit, your Employment Bureau, etc. This information is free and does not obligate me in any way whatsoever.

Name.....

Address.....

City..... State.....





## "I'm making real money now"

"SEE that coupon? Remember the day you urged me to send it to Scranton? It was the best thing I ever did. Mr. Carter called me in to-day. Said he'd been watching my work for some time—ever since he learned I was studying with the International Correspondence Schools.

"Then he asked me if I thought I could take over Bill Stevens' job. I told him I was sure that I could—that I had had that goal in view ever since I started my I. C. S. course.

"I start to-morrow, Mary, at an increase of \$60 a month. It's wonderful how spare-time study helps a man to get ahead."

FOR thirty-three years, the I. C. S. has been helping men to win promotion, to earn more money, to get ahead in business and in life.

You, too, can have the position you want in the work you like best. Yes, you can.

All we ask is the chance to prove it. Without cost, without obligation, just mark and mail this coupon.

### INTERNATIONAL CORRESPONDENCE SCHOOLS Box 5678-D, Scranton, Penna.

Without cost or obligation, please tell me how I can qualify for the position or in the subject before which I have marked an X:

#### BUSINESS TRAINING COURSES

- |  |   |
|--|---|
| <input type="checkbox"/> Business Management                     | <input type="checkbox"/> Salesmanship                                     |
| <input type="checkbox"/> Industrial Management                   | <input type="checkbox"/> Advertising                                      |
| <input type="checkbox"/> Personnel Organization                  | <input type="checkbox"/> Better Letters                                   |
| <input type="checkbox"/> Traffic Management                      | <input type="checkbox"/> Show Card Lettering                              |
| <input type="checkbox"/> Business Law                            | <input type="checkbox"/> Stenography and Typing                           |
| <input type="checkbox"/> Banking and Banking Law                 | <input type="checkbox"/> Business English                                 |
| <input type="checkbox"/> Accountancy (including C.P.A.)          | <input type="checkbox"/> Civil Service                                    |
| <input type="checkbox"/> Nicholson Cost Accounting               | <input type="checkbox"/> Railway Mail Clerk                               |
| <input type="checkbox"/> Bookkeeping                             | <input type="checkbox"/> Common School Subjects                           |
| <input type="checkbox"/> Private Secretary                       | <input type="checkbox"/> High School Subjects                             |
| <input type="checkbox"/> Spanish <input type="checkbox"/> French | <input type="checkbox"/> Illustrating <input type="checkbox"/> Cartooning |

#### TECHNICAL AND INDUSTRIAL COURSES

- |   |  |
|---|--|
| <input type="checkbox"/> Electrical Engineering | <input type="checkbox"/> Architect                                   |
| <input type="checkbox"/> Electric Lighting      | <input type="checkbox"/> Architects' Blue Prints                     |
| <input type="checkbox"/> Mechanical Engineer    | <input type="checkbox"/> Contractor and Builder                      |
| <input type="checkbox"/> Mechanical Draftsman   | <input type="checkbox"/> Architectural Draftsman                     |
| <input type="checkbox"/> Machine Shop Practices | <input type="checkbox"/> Concrete Builder                            |
| <input type="checkbox"/> Railroad Positions     | <input type="checkbox"/> Structural Engineer                         |
| <input type="checkbox"/> Gas Engine Operating   | <input type="checkbox"/> Chemistry <input type="checkbox"/> Pharmacy |
| <input type="checkbox"/> Civil Engineer         | <input type="checkbox"/> Automobile Work                             |
| <input type="checkbox"/> Surveying and Mapping  | <input type="checkbox"/> Airplane Engines                            |
| <input type="checkbox"/> Metallurgy             | <input type="checkbox"/> Navigation                                  |
| <input type="checkbox"/> Steam Engineering      | <input type="checkbox"/> Agriculture and Poultry                     |
| <input type="checkbox"/> Radio                  | <input type="checkbox"/> Mathematics                                 |

Name.....  
Street..... 3-6-24  
Address.....

City.....State.....

Occupation.....

Persons residing in Canada should send this coupon to the International Correspondence Schools Canadian, Limited, Montreal, Canada.

**YOU CAN PLAY IT IN 30 MINUTES**  
40,000 successful students back up our guarantee that you can play a piece in 30 minutes by following our printed instructions. You get this \$18.00 TENOR BANJO, FREE, as soon as you enroll for 32 easy lessons. New low prices and easy terms!

**PICTURE LESSONS MAKE IT EASY**  
You can't fail to learn because the pictures explain every move. You don't have to be able to read notes. Better than oral instructions. We teach you in the largest conservatory, by mail.

**PLAY FOR FUN OR MONEY**  
Don't be a wallflower. Get in on parties. Entertain your friends. Be popular. Play for dances, etc. Form an orchestra. Our 32 lesson course will make you an expert. Earn money in spare time.

**WRITE FOR SPECIAL FREE OFFER**  
Famous teachers will explain how we can positively teach you to play. You get the free \$18.00 Tenor Banjo with the first lesson. Play while you play. Write for other special courses under famous teachers for Hawaiian Guitar, Violin, Banjo Ukelele, Ukelele.

**FIRST HAWAIIAN CONSERVATORY OF MUSIC, Inc.**  
Woolworth Bldg., Dept. 60 New York, N. Y.

## 10 CTS. WILL BRING YOU—

A WONDERFULLY INTERESTING BOOK, written by the Trainer of Many of the World's Greatest Strong Men. It tells you—How to Develop—Vitality, Energy, Endurance, Muscle and Nerve Strength, Perfect Physique—It tells the weak, How to grow strong—It tells the strong, How to grow stronger—It tells how to develop strong Lungs and Heart—It tells how to gain powerful muscles and vigorous digestion—It is a PRACTICAL GUIDE TO GOOD HEALTH, STRENGTH AND VIGOR—It tells in plain language, SIMPLE METHODS that ANYONE can easily follow—It contains 60 Half-tone illustrations of Giants of Strength—ALL FOR ONE DIME. Send stamps or coin today for a copy of this marvelous Book revealing my astonishing discoveries about rebuilding the Human Body, during more than 25 years' experience as America's Foremost Physical Culture Instructor.

PROF. H. W. TITUS, 105 East 13th Street, N. Y., Dept. A8



## "I WANT YOU"

MEN—BOYS, 18 UP

\$1140 to \$3000 A YEAR

Many U. S. Government Jobs now obtainable. Steady work. Write today sure, for FREE list of positions and free sample coaching lessons.

FRANKLIN INSTITUTE  
Dept. W-198 Rochester, N. Y.

# PIMPLY SKIN made WELL

When a few applications of this wonder-working lotion has cleared faces of pimples, FREE blackheads, acne eruptions on the face or body, barbers itch, eczema, enlarged pores, oily or shiny skin, you can realize why CLEAR-TONE has been tested and approved in over 100,000 Test Cases. The simplicity of the treatment, and The Story of How I Cured Myself are all explained in my free booklet, "A Clear-Tone Skin." Write for your copy today and learn of the results gotten by thousands of men and women.

E. S. GIVENS, 128 Chemical Bldg., Kansas City, Mo.



**TOM BROWN** of *Brown Brothers* says: I find that "Business Saxophonist" provides just the stimulus—just the necessary material—just the brass tacks, the "how-to-do-it" information that I must have to keep going a step further each day. It will actually make fine players out of the ordinary—and do it quickly.

## LEARN

the "tricks of the trade" that make Saxophone EXPERTS!

**KATHRYNETHOMPSON** says: Since I've had "Business Saxophonist," believe me, my friends "sit up and take notice," because I find I can easily do most of the tricks and stunts they do on the records. And they are so easy to learn! Truly, I would not take a hundred dollars for the course.

# MAKE MORE SAXOPHONE MONEY!

**ARTHUR DAVIS, Sousa soloist, says:**

Anybody who can read plain English surely can improve his playing 100 per cent in a short time with "Business Saxophonist" to guide him. It teaches what all other books leave out, and explains what I have always thought were "secrets" of just a few players.

**TOM THATCHER** of *Chapman's Orchestra* says:

I'm a fellow who dislikes to practice dreary, tiresome "exercises," but I certainly get fun out of practicing the interesting things in "Business Saxophonist." One feels like he has really learned something when he finds he can do the laugh, slap tonguing, flutter tonguing, glissandos, vibratos, etc.

**WORTH ITS WEIGHT IN GOLD** says **ED. BARROLL**

(Teacher, composer, magazine writer, director of *Sopranos* has heard—praise from *Barroll* in review indicates)

The *Business Saxophonist* is worth its weight in gold. I never imagined anyone could put down on paper how to make the Saxophone talk, laugh—how to slap-tongue, glissando, vibrato, how to improvise, "break," transpose. You have done the IMPOSSIBLE, yet here it is before my eyes, simple enough for a school boy to savvy, easy enough for any rank amateur TO DO! In my day it was a fair life-time job for a professional to develop a tenth part of what the great CRAGUN has actually condensed between the covers of a single volume! I will look for a whole crop of Tom Browns, Paul Bieses, Isham Joneses, now. Any ordinary Saxophone player can now wrap himself around your 20 lessons and climb to important Dollars and Places in one jump!

**CLARENCE McCREERY, solo saxophonist, Ralph Williams' actor Record Artists.**

In "The Business Saxophonist" I find reduced to comprehensible form the practical, necessary procedures, tricks and methods by which, nowadays, the skill of a player is universally judged. The embellishments, the beautifying adornments of playing MUST be learned—and outwardly,

"Business Saxophonist" is the first work yet to appear that covers them all, and covers them thoroughly.

## For Beginners!

To make quickest progress on the Saxophone, learn at home with *Crugun's CONSERVATORY Method*. Illustrations show how to finger every note correctly. Crugun knows how to make the "Sax" easy for the beginner. In two volumes, containing hundreds of exercises, 118 duets and trios. Correct breathing, tonguing, tone and technic explained by a master so you can understand and do them. Only \$2.50, plus a few cents postage. Finder & Urbaneck publications handled by all good dealers. Ask for Big FREE Catalog.

### FINDER & URBANEK

World's largest exclusive SAXOPHONE publishers  
1322 Congress St., Dept. 101A, CHICAGO



J. Beach Crugun, A. S., Mus. B.

World's greatest Saxophone teacher. For nine years instructor in music and bandmaster at the University of Chicago. Author of Crugun's Conservatory Method—most successful Saxophone home-study instruction for beginners. Now presents his "BUSINESS SAXOPHONIST"—the sensational new "professional" training.

### Advanced Professional Training Adopted by 500 "Sax" Artists!

Hailed by great Saxophone soloists as the most valuable aid to professional results ever produced. Read a few of thousands of Artist endorsements shown here. They agree you cannot master the Saxophone without this training. They insist you must master "THE BUSINESS SAXOPHONIST" if you would earn BIG MONEY with your "Sax." In loose-leaf form.

### Sent On Approval

Every cent of your money refunded if after examination and 5 days' study you return THE BUSINESS SAXOPHONIST. We can safely guarantee money back on the greatest advanced Saxophone instruction that ever came from the brain and pen of man. Mail coupon and only \$1.00 now. Pay balance \$9 when delivered.

We pay postage. Enormous demand may exhaust the first edition. To avoid disappointment order today!



### YOU NEED

## "The Business Saxophonist" in Your Business!

Why do Tom Brown, Paul Biese, and Isham Jones each make \$20,000 to \$75,000 a year with their Saxophones? And why does the ordinary Saxophonist only earn one-tenth as much? After you know how to play ON the Saxophone, get this wonderful course by CRAGUN, and learn how to play the Saxophone for BIG MONEY.

### Trains You How!

Master the 20 easy lessons of the BUSINESS SAXOPHONIST and earn REAL money as a top-notch! Crugun has exposed the secrets of the world's most successful Saxophone Soloists. Here are some of the things he shows you how to do:

**THE LAUGH**  
Explicit directions and instructions.

**HIGH TONES**  
Exactly how to GET THEM and in tune.

**SLAP TONGUING**  
Simple instructions that assure a perfect result.

**DOUBLE and TRIPLE TONGUING**  
Flutter-tonguing, new jazz-effects, etc.

**GLISSANDO**  
Brass tacks information that enables YOU to DO IT.

**VIBRATO**  
Methods of doing it correctly and easily.

**TALKING**  
How to make your sax "say" almost anything you please.

**BREAKS**  
Several dozen of the best breaks, copied directly from the originators. Makes it easy to have a "world of stuff" available in your playing.

**RHYTHM**  
This one lesson is worth the entire price of the course.

**IMPROVISE**  
When and how to "fill in."

**FOX TROT**  
What you can do with it and how. Invaluable to you.

**ONE STEP**  
New ideas to get away from the "same old stuff."

**WALTZ**  
New beauties and delights brought out.

**TRANSPOSITION**  
Practical, easy, understandable directions for doing the transposition a business player must know. ALL about it. Nothing left for you to "guess at."

**"BUSINESS STUFF"**  
SCORES of other important methods, tricks, embellishments and practices that Make You More Money. 20 Lessons in all.

## Mail Coupon And Only \$1

FINDER & URBANEK, Dept. 101A,  
1322 Congress St., Chicago, Ill.

Please send SAXOPHONE home-study courses marked X, subject to Money Back Guarantee:

THE BUSINESS SAXOPHONIST, \$1 now, \$9.00 C. O. D. (Total \$10.00).

CRAGUN'S CONSERVATORY METHOD for beginners, \$1 now, balance \$1.50 and postage C. O. D.

Name.....

Street No.....

City.....State.....



# BOYS

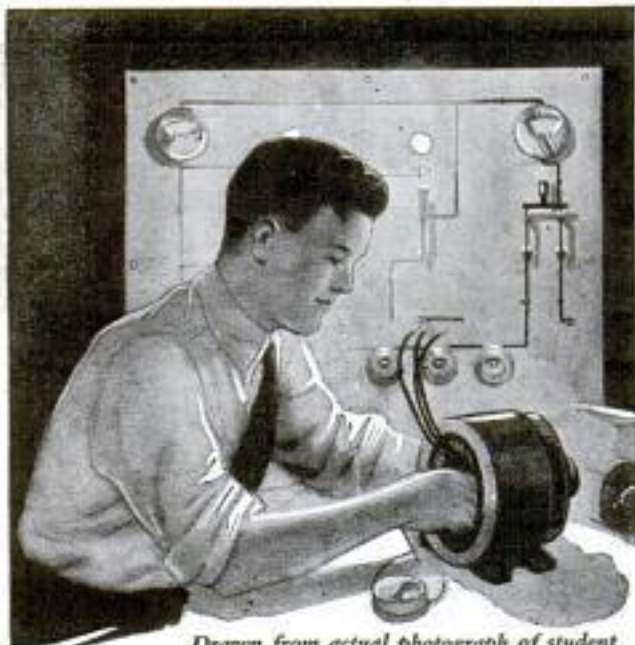

Drawn from actual photograph of student doing spare time electrical work

## Learn Electricity Make Big Money

How would you like to earn two or three dollars every evening after school and prepare yourself for a fine big job at the same time? Here's the opportunity of a lifetime for you fellows who like Electricity. Begin right now to prepare yourself for a regular man's size job in this fascinating field. Your chances for a big success are simply wonderful—the pay is big (\$70 to \$200 a week) and advancement comes swift and sure.

### I will Train You at Home

With my easily learned, spare time Electrical Course I will train you at home like I have trained hundreds of other boys who are now big successful men. It will not interfere with your school work and you can earn more than the small cost of the course doing odd electrical jobs in your spare time. The Course pays for itself. I will show you how to get this work and how to do it. Some of my boy students make \$10 to \$15 a week this way.

### Tools, Apparatus and Radio Course—FREE

Send me the coupon below and I will tell you all about the big outfit of tools, apparatus and instruments and a new Radio Course that I am giving to my students for a limited time. I will send you my big interesting Electrical Book and a sample lesson, too—all Free. You will be tickled with the things I will send you Free. Mail the coupon right now.

L. L. COOKE, Chief Engineer  
Chicago Engineering Works  
Dept. O-12 CHICAGO

### Use This "FREE OUTFIT" Coupon

L. L. COOKE, Chief Engineer,  
Chicago Engineering Works,  
Dept. O-12, 2150 Lawrence Avenue, Chicago

Send me your Free Outfit Offer, your big Electrical Book, Sample Lesson and particulars of your Electrical Course and Free Radio Course. This will not obligate me in any way.

Name.....

Address.....

This Coupon only for use of boys 15 years old or more.

### Look What This Boy Is Doing

"Although the School term is coming to a close, and I am pretty busy with my examinations, I manage to keep up with my electrical studies and work.

"I guess I forgot to tell you I am now in business for myself. Am doing fine, but owe it all to you. If it had not been for your Course, I, being under age, could not have secured my license in this town. But I got it, and now have all the work I can do, averaging \$20 to \$50 a week, three spare time work.

"I went out on a job tonight after school, on which I made \$3 and brought home another on which I made \$2.50—\$5.50, for 4 hours' work and my material furnished by me."

ROGER SMITH,  
1212 Chestnut St.,  
Greenville, N.C.

## Make Money Taking PICTURES



### Get \$100 for Flood Pictures

"I took pictures of a flood and sold them for \$100. I have been able to buy my home and lot from the sale of pictures."

C. M. COLE,  
Washington.

### \$97 in Two Days!

"I made \$295 in December. Went out two days last week on home portrait work and made \$97."

A. G. HUNNIS,  
Kentucky.

Tremendous, big-paying opportunities are open for ambitious men in Modern Photography. This is the picture age. Magazine and newspaper publishers buy thousands of photographs each year. Every manufacturer sends out high priced pictures of his products. Every home wants portraits. Photography is a business running into millions of dollars each year. And there is a great shortage of trained photographers.

### EARN \$3,000 to \$10,000 a YEAR

Hundreds of men are earning big money and establishing their own businesses. Even during spare time, while training,

you can make \$75 a week easily—no matter where you live!

### Amazing New Easy Method

I show you, at home, how to do the kind of work turned out by the big studios in New York and Chicago! I show you how to make big money within 30 days! C. M. Cole bought a home with money he had made when only half way through his training. So well do I know what I can do for you that I guarantee under bond to return every cent of your tuition if you are not thoroughly satisfied.



### Professional View Camera FREE!

Write at once for Free Camera Offer—I give you free, a splendid professional view camera. You will be astonished and delighted. This offer open for short time only—so act quick! No obligation.

INTERNATIONAL STUDIOS, Inc.  
Dept. 1372 3601 Michigan Ave., Chicago, U. S. A.



### Stop Forgetting

Make Your Mind an Index from which you select facts, figures, names, faces. Develop concentration, self-control; overcome bashfulness, forgetfulness.

Write today for FREE memory and concentration test and illustrated booklet, "How to Remember."

PROF. HENRY DICKSON  
Dept. 7052 Evanston, Ill.



## MUSIC LESSONS FREE

IN YOUR OWN HOME  
You can read music like this quickly.

Piano, Organ, Violin, Mandolin, Guitar, Banjo, etc. Beginners or advanced players. One lesson weekly. Illustrations make everything plain. Only expense about 2c per day to cover cost of postage and music used. Write for FREE booklet which explains everything in full.

AMERICAN SCHOOL OF MUSIC, 50 Lakeside Building, Chicago

## Learn Watchwork, Jewelrywork and Engraving.

A fine trade commanding a good salary, and your services are always in demand. Address **Horological**,

Dept. P, Bradley Institute, PEORIA, ILL., for our latest catalog.

## I'll Make You an Auto Expert

### I Will Teach You at Home

by a simple new system to be an Expert Auto Mechanic, so you can hold the better positions paying

\$200 to \$400 a Month

Thousands of men I have trained are today holding good jobs as garage mechanics or foremen or are in business for themselves. Others are making \$8 to \$10 a day in spare time doing repair jobs for their neighbors. I place my graduates in good jobs. Money back if you're not satisfied. This is your chance. Write today for free book. E. J. Stas, Pres. Lincoln Engineering School, 2428 O St., Lincoln, Neb.





# New Method Makes Learning to Draw Actual Fun!

Anyone can now learn to draw with this startling new home-study method. Why don't you become an artist in your spare time? Good artists earn from \$50 to far over \$300 a week.

**M**ILLIONS of dollars are being spent this year for Advertising and Story Illustrations, Commercial Designs, and Cartoons. Single drawings are bringing as high as \$1000! Commercial Art has become one of the world's best paid businesses—besides the most attractive.

And now you can easily become an artist—with just a few minutes' study a day—a few minutes of real pleasure! You don't need previous training. You don't need any mysterious talent. No matter how poorly you draw now, you can learn right at home in spare time how to illustrate, design and make cartoons of every description.

## New Easy Way To Become An Artist

Become an artist this new easy way. Thousands who never dreamed they could draw are now good artists. Many of our most successful students never touched a drawing pencil before starting.

It's real fun learning to draw this way—at home during convenient moments. All your work receives through the mail the individual attention of trained instructors and the personal criticism of one of America's most successful artists. It's like studying directly under a famous instructor. Almost before you realize it, you will be able to make professional drawings—the kind that are in big demand in the field of commercial art.

Good artists are in tremendous demand. The newspaper *want ad section* is about always filled

with calls for trained artists. Big money is gladly paid. And now you can learn to draw and can get your share of the big money in commercial art.

## Send for FREE BOOK on Commercial Art

Why work at uninteresting poorly-paid work, when you can become an artist and get into work that you can put your heart into? Commercial Art offers opportunities beyond your wildest imagination. Learn more about these opportunities and how you can take advantage of them. Get full details on this wonderful new method which makes learning to draw real fun.

The attached coupon will bring you a newly published book on commercial art, which gives all the most up-to-date information on this fascinating field. It describes in full this startling new easy way of learning to draw. It tells all about our graduates—their successes—what they say about their training—actual reproductions of their work and how many of them earned far more than the cost of their training while taking it.

If you are the slightest bit interested in drawing, you will want to see this handsomely illustrated new book on art. It will be sent to you without cost or the slightest obligation. Send for it—today. Cut out the coupon and mail it *now*.

The Washington School of Art, Inc.  
Room 302-C  
1115-15th St., N. W., Washington, D. C.



WASHINGTON SCHOOL OF ART, Inc.  
Room 302-C, 1115-15th Street, N. W.  
Washington, D. C.

Please send me without cost or obligation your handsome new illustrated booklet "New Easy Way to Become An Artist," and details of your special Free Offer. Please write plainly.

Name.....  
(Mr., Miss or Mrs.)  
Address.....  
City..... State.....



**Free** *Latest Book*  
**HEALTH**  
*Beauty*  
**TRIAL** *for Men*  
*and*  
**at Home** *Women*



Free trial proves that Wonder Mist revitalizes every cell and works miracles over-coming pain and sickness. Physicians and plain folks explain how "Wonder Mist" has made them well, strong and happy, in our 64-page book. Actual photographs, scientific charts and diagrams. It's Free.

## Wonder Mist New Improved Violet Ray

"Wonder Mist" works quickly; it's scientific; goes after the cause. That's why results are quick and permanent. Dr. Duncan, Kewanee, Ill., writes, "Wonder Mist" is the finest thing to relieve pain, treatments are so pleasant all my patients like it. "Use it at home. Save doctor bills. Brings the natural magnetic beauty of health, no dieting, exercise or drugs.

### SEND FOR FREE BOOK

Explains how Nikola Tesla discovered "Wonder Mist," how it works, why it heals. Tells how to conquer pain, disease and nervous trouble.

**Reveals Marvelous Scientific Discovery.** Shows charts of human body and explains where pains start, how to banish them. Offered Free for a limited time only to introduce "Wonder Mist." Send for a Free Copy today.

**VI-REX CO., 211 S. Peoria St., Dept. 22 Chicago**  
*Mail Coupon—Send No Money*

**VI-REX CO., 211 S. Peoria Street, Dept. 22 Chicago, Ill.**  
Please send me without cost or obligation your free 64-page book describing your Vi-Rex "Wonder Mist" outfits, and details of your FREE trial offer.

Name.....  
Address.....  
City.....

## LEARN Painting Paper Hanging and Decorating

### Marbling and Graining—Auto Painting—Show Card Writing

Learn any of these big paying trades in a few weeks by practical work under competent instructors. No books—no classes—start anytime. No previous experience or education necessary. Working conditions exactly the same as "out on a job". Largest and best equipped painting shops in America—the only industry endorsed school.

### Make \$10 to \$20 a Day

Or, go in business for yourself and make \$5,000 to \$15,000 a year. We train you to become an EXPERT, not an ordinary "brush hand". There are not enough trained men to go around. Be an EXPERT and get the big money.

### Send for Free Book

Take the first step today and send for Free Book and Special Offer. No obligation. A few weeks practical training will fit you for this big paying trade.

**CHICAGO PAINTING SCHOOL**  
150 W. Austin Ave., Dept. 1352 CHICAGO, ILL.

## I PAY \$100 a week MEN

Make \$100.00 a week and up selling our fine made-to-measure, all-wool suits, direct to wearer. **Biggest values—positively sell on sight.** Biggest commissions paid in advance. We attend to delivery and collections. 6x9 swatch samples—over 100 styles all one price—furnished FREE. Part or full time men write at once.

W.Z. GIBSON, Inc., 161 W. Harrison St., Dept. 516 Chicago

## NO MORE STAMMER

Kill the fear of stammering. Re-education the key. The widely famed Hatfield Method fully outlined in an accurate, dependable, worthwhile book—"HOW TO STOP STAMMERING." It has inspired thousands. Free copy today.

THE HATFIELD INSTITUTE, 109 N. Dearborn, Chicago, Ill.

*Whatever Your Question;*—be it the pronunciation of Fascista, the spelling of a puzzling word, the location of Esthonia the meaning of soviet, realtor, vitamin, etc., this Supreme Authority—

## WEBSTER'S NEW INTERNATIONAL DICTIONARY

contains an accurate, final answer. 407,000 Words 2700 Pages, 6000 Illustrations.  
Regular and India-Paper Editions. G. & C. MERRIAM CO., Springfield, Mass.  
"The Magic of Words" and Pocket Maps FREE if you mention Popular Mechanics.



## WANTED

RAILWAY POSTAL CLERKS  
**\$1600 to \$2300 Year**  
MEN—BOYS, 18 UP

Steady work. No layoffs. Paid vacations.

Travel—See Your Country

Common education. Mail coupon today—SURE



FRANKLIN INSTITUTE, Dept. W-177, ROCHESTER, N.Y.

Sirs: Send me without charge, (1) Specimen Railway Postal Clerk Examination questions; (2) List of other government jobs now obtainable; (3) Send list of examination places; (4) Send free sample coaching lessons.

Name.....  
Address.....



# BARBERING

Now One of the  
Highest Paid  
Professions!

**\$90 to \$150  
Every Week!**



William McClintock, President Master Barbers' Ass'n of Chicago and proprietor of the highest priced rented shop in the world, says, "My son, who learned at Moler's, is top man in my shop every week. I gladly recommend the Moler System as the proper place for men to become successful barbers."  
—WM. McCLINTOCK.



"The XXth Century," "Oriental Limited" and other crack trans-continental trains carry barbers.



**NEXT!  
For BIG Pay**

**Mail THIS**

**MOLER SYSTEM OF COLLEGES**

← Address Nearest Branch  
(Street Address NOT Needed)

Please send me without obligation on my part your Booklet B.

Name.....

Address.....

City..... State.....

**BE A "WHITE-COLLAR" MAN—  
Earn \$90-\$150 a Week—CLEAN Money!**

What's the use of doing dirty, greasy, hard work, when you can NOW make TWICE as much money in a manly profession that is CLEAN, profitable and full of opportunities?

**Easy to Learn—  
Quick to Earn!**

That's BARBERING for YOU! And the best part of it all is this—scientific barbering, as taught the modern MOLER way, makes YOU a Master Barber in a short course of intensive training, at small expense! You soon step out as your own Boss, if you wish, in your own Shop, which we will gladly help you equip.

**See the World, Too!**

Or, if you prefer, we will help you step into a real job, with good pay the first day, after you graduate. Ocean Liners, crack trans-continental passenger trains, big luxurious hotels and skyscrapers all over the world, as well as thousands of Barber Shops everywhere, demand MOLER trained men.

**MOLER Graduates  
Are Always Busy!**

MOLER trained Men are always given the preference, for they alone possess the valuable, thor-

ough MOLER training in the application of all the latest scientific Barbering methods including the Electric hair cutter, the mechanical massage, and the latest vogue in ladies' hair bobbing. MOLER also gives special training in ladies' marcelling and an easy practical course in the treatment of skin diseases.

**Earn While  
Learning!**

"Where there's a Will there's a Way" to earn BIG pay! Write to the nearest MOLER College; there is one near you, and learn how you can earn while you learn the barber trade. Ask for the new FREE MOLER Barbering Booklet B. Find out HOW MOLER helps you help yourself AFTER you graduate, as well as BEFORE! Find out why MOLER Men are making DOUBLE the money others made last year, before Ladies' Shingle Bobbing became so popular. You're NEXT in line for big pay—the MOLER way. Send Coupon TODAY!

**MOLER SYSTEM OF COLLEGES**

**30 Branches in United States and Canada**

New York, N. Y.  
Chicago, Ill.  
St. Louis, Mo.  
Kansas City, Mo.  
Cincinnati, Ohio.  
Cleveland, Ohio.

Detroit, Mich.  
Denver, Colo.  
Omaha, Nebr.  
Milwaukee, Wis.  
New Orleans, La.

Atlanta, Ga.  
Memphis, Tenn.  
Dallas, Tex.  
Houston, Tex.  
San Antonio, Tex.





## "There's One Man We're Going to Keep"

"Ed Wilson, there, is one of the most ambitious men in the plant. I notice that he never fools away his spare time. He studies his International Correspondence Schools Course every chance he gets.

"It's been the making of him, too. He hasn't been here nearly so long as Tom Downey, who was laid off yesterday, but he knows ten times as much about this business.

"I'm going to give him Tom's job at a raise in salary. He's the kind of man we want around here."

HOW do you stand in your shop or office? Are you an Ed Wilson or a Tom Downey? Are you going up? Or down?

No matter where you live, the International Correspondence Schools will come to you. No matter what your handicaps or how small your means, we have a plan to meet your circumstances. No matter how limited your previous education, the simply-written, wonderfully-illustrated I. C. S. textbooks make it easy to learn.

This is all we ask: Without cost, without obligating yourself in any way, put it up to us to prove how we can help you. Just mark and mail this coupon.

### INTERNATIONAL CORRESPONDENCE SCHOOLS Box 5678-D, Scranton, Penna.

Without cost or obligation, please tell me how I can qualify for the position or in the subject before which I have marked an X:

#### BUSINESS TRAINING COURSES

- |  |   |
|--|---|
| <input type="checkbox"/> Business Management                     | <input type="checkbox"/> Salesmanship                                     |
| <input type="checkbox"/> Industrial Management                   | <input type="checkbox"/> Advertising                                      |
| <input type="checkbox"/> Personnel Organization                  | <input type="checkbox"/> Better Letters                                   |
| <input type="checkbox"/> Traffic Management                      | <input type="checkbox"/> Show Card Lettering                              |
| <input type="checkbox"/> Business Law                            | <input type="checkbox"/> Stenography and Typing                           |
| <input type="checkbox"/> Banking and Banking Law                 | <input type="checkbox"/> Business English                                 |
| <input type="checkbox"/> Accountancy (Including C.P.A.)          | <input type="checkbox"/> Civil Service                                    |
| <input type="checkbox"/> Nicholson Cost Accounting               | <input type="checkbox"/> Railway Mail Clerk                               |
| <input type="checkbox"/> Bookkeeping                             | <input type="checkbox"/> Common School Subjects                           |
| <input type="checkbox"/> Private Secretary                       | <input type="checkbox"/> High School Subjects                             |
| <input type="checkbox"/> Spanish <input type="checkbox"/> French | <input type="checkbox"/> Illustrating <input type="checkbox"/> Cartooning |

#### TECHNICAL AND INDUSTRIAL COURSES

- |   |  |
|---|--|
| <input type="checkbox"/> Electrical Engineering | <input type="checkbox"/> Architect                                   |
| <input type="checkbox"/> Electric Lighting      | <input type="checkbox"/> Architects' Blue Prints                     |
| <input type="checkbox"/> Mechanical Engineer    | <input type="checkbox"/> Contractor and Builder                      |
| <input type="checkbox"/> Mechanical Draftsman   | <input type="checkbox"/> Architectural Draftsman                     |
| <input type="checkbox"/> Machine Shop Practice  | <input type="checkbox"/> Concrete Builder                            |
| <input type="checkbox"/> Railroad Positions     | <input type="checkbox"/> Structural Engineer                         |
| <input type="checkbox"/> Gas Engine Operating   | <input type="checkbox"/> Chemistry <input type="checkbox"/> Pharmacy |
| <input type="checkbox"/> Civil Engineer         | <input type="checkbox"/> Automobile Work                             |
| <input type="checkbox"/> Surveying and Mapping  | <input type="checkbox"/> Airplane Engines                            |
| <input type="checkbox"/> Metallurgy             | <input type="checkbox"/> Navigation                                  |
| <input type="checkbox"/> Steam Engineering      | <input type="checkbox"/> Agriculture and Poultry                     |
| <input type="checkbox"/> Radio                  | <input type="checkbox"/> Mathematics                                 |

Name.....  
Street.....  
Address..... 3-6-24  
City..... State.....

Occupation.....  
Persons residing in Canada should send this coupon to the International Correspondence Schools Canadian, Limited, Montreal, Canada.

# Play a SAX!

## Have Fun

Nothing will bring you so many friends or make you so popular as being able to play a saxophone. The new York Saxophone is easier to finger, easier to blow.

**6 DAYS FREE TRIAL**

**YORK**  
Nothing to Pay for but Quality



With our free lessons you can be playing popular tunes in a short time. You can get this wonderful instrument, with its superb tone and perfect workmanship, on six days' free trial in your own home. Then if you decide to keep it you can take ten months to pay. Write at once for free saxophone booklet. Other York Band Instruments sent on the same easy terms.

Free literature upon request.

**J. W. YORK & SONS**  
Dept. 125-B Grand Rapids, Mich.

## STUDY AT HOME

Directed by

### The University of Chicago

Courses in English, History, Chemistry, Business, Education, Mathematics, Psychology, and 35 other subjects command credit toward a Bachelor degree. Begin any time. Address 15 EIHs Hall, University of Chicago, Ill.

### GIVEN

**22 RIFLE** This Fine 22 Cal. Sure Shot HAMILTON Rifle or Genuine American Stem Wind & Set Watch. Just what you need. We give them Free, postpaid, for selling our large colored Art and Religious Pictures at 10c each. Send No Money. Just your name & address. We will send you 24 Pictures promptly. When sold choose your price according to Big Prize List. **HOME ART CO., 428 W. 59th St., Dept. 664, Chicago**



### BARNEY OLDFIELD'S MECHANICIAN!

Loan an hour a day of your spare time to "Dash," formerly mechanic for Barney Oldfield, big demand for "Dash" trained men. He will put you in the \$100 a week class as Automotive Expert. Learn at Home—Learn by Job-Way Plan. Free books. Success guaranteed. Free Book gives all details. Write today. No obligation. **CHICAGO AUTOMOTIVE INSTITUTE, Dept. 1772, 538 So. Clark Street, CHICAGO**



### LEARN TO GET DOLLARS OUT OF WATCHES.

WATCH-REPAIRING, ENGRAVING, JEWELRY REPAIRING. **WRITE NOW.** **MECHANIC TRADE SCHOOL** 530 W. MONUMENT SQUARE, RACINE, WIS.

## STRENGTH

Let the world's strongest man give it to you. Have vigorous Health, powerful Strength, bulging Muscle. My original methods pulled me out of weakness. I can do the same for you. It's put brawn and muscle on weaklings. Three months and you'll be saying, "Hello, stranger" to yourself. Send for my wonderful book, "Muscular Power." It's free.

**FREE** Send for my muscle meter and book. Enclose a dime to help pay mailing expense and you'll receive the most remarkable book on physical culture published. Wonderfully illustrated. Write now. **BREITBART, Dept. F-9, 1819 Broadway, NEW YORK CITY**



# Learn Electricity

*in Great Shops!*

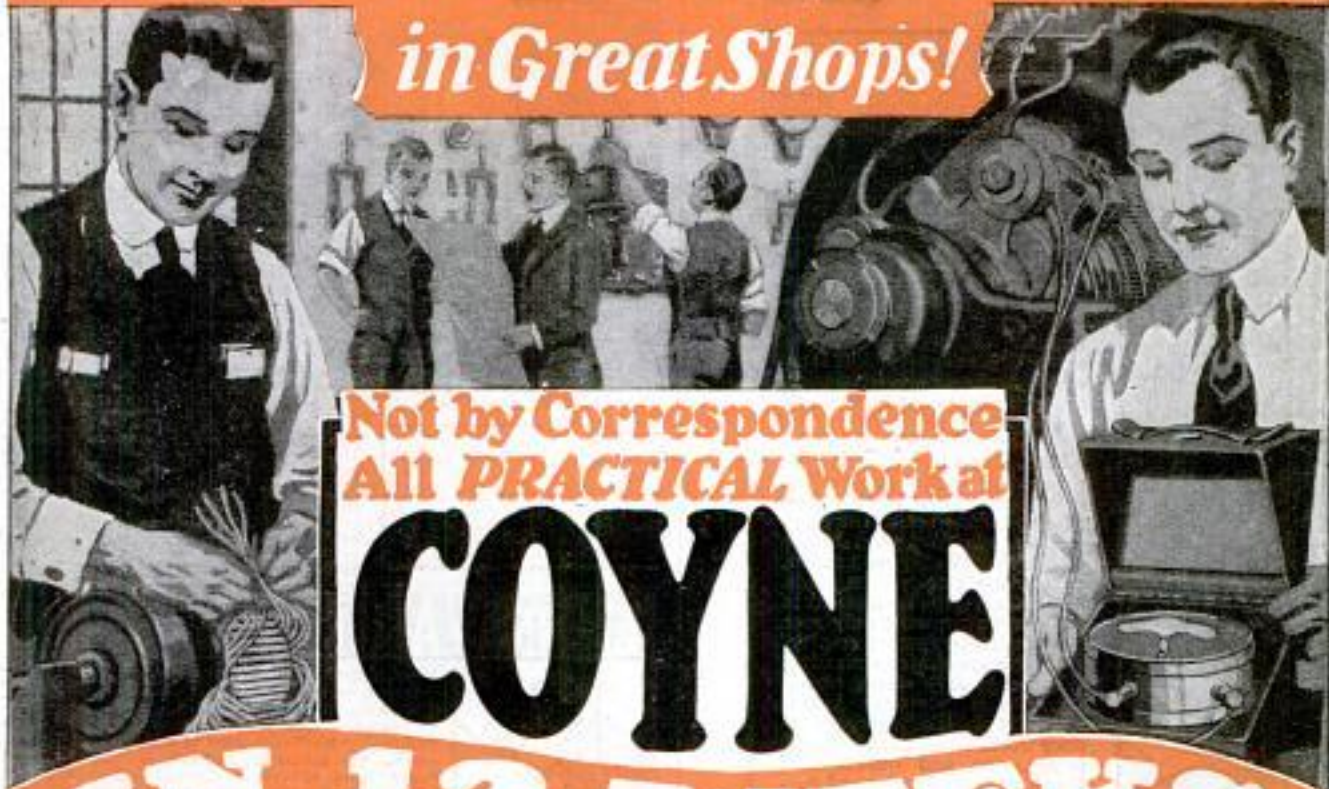

**Not by Correspondence  
All PRACTICAL Work at**

# COYNE

## IN 12 WEEKS

### EARN \$60 TO \$200 A WEEK

Why work at dull uninteresting work, at low pay, with no future? In 12 weeks I will train you for a big pay job where you can command \$60 to \$200 a week as a COYNE TRAINED MASTER ELECTRICAL EXPERT or you can go in business for yourself with very small capital and make up to \$15,000 a year. Men trained as I train them are in demand everywhere. The great development of the Electrical Industry makes the demand for trained men tremendous. Big opportunities and advancement for those who prepare now. The Coyne school was founded 25 years ago and my thousands of SUCCESSFUL GRADUATES are living proofs of what my training can do for ANY AMBITIOUS man. Many of these fellows will tell you in my big free book what Coyne has done for them.

#### COMPLETE ELECTRICAL TRAINING IN 12 WEEKS

I train you thoroughly on the greatest outlay of ACTUAL ELECTRICAL machinery ever assembled in any school.

You work with your hands on all kinds of Electrical apparatus, door bells, house wiring, armatures, switchboards, dynamos, everything to make you an all around ELECTRICAL EXPERT. This REAL WORK with REAL tools, on REAL machinery trains you many times FASTER, many times MORE THOROUGH than trying to learn in the field or by books or lessons.

#### No Books, No Lessons, No Classes —You Do Actual Work!

I do not attempt to teach you by books or lessons. I train you to work with your head and hands on the same kind of Electrical Machinery used in power houses, industrial plants and on the outside, under actual working conditions, with instructors at your side. I have no classes, every student gets individual training.

#### Free Radio and Auto Course

For a short time only I am including ABSOLUTELY FREE my big new Radio Course and Auto, Truck and Tractor Electrical Course.

## COYNE ELECTRICAL SCHOOL

1300-1310 W. Harrison St., Dept. 935-2, Chicago, Ill.

#### You Don't Need Education or Experience

You don't need a lot of schooling to master my course. You don't have to be a high school graduate or even a grammar school graduate. My method of instruction is clear and plain, and yet thorough, and if you can understand plain English I will make you an electrical expert even though you haven't a lot of education or any previous electrical experience.

#### Coyne Trains You for Life

You get a free life scholarship which enables you to stay longer than the required time if you care to, or you may return at any time to take up new work. I am constantly adding to my school to make it the most modern at all times.

#### Earn While You Learn

My employment department will assist you to a part time job where you can make expenses while training,

**BIG PAY** job on graduation.

This big handsome new

book just off the press

—size 12x15 inches—shows actual photographs of my

big shops. Cost me a dollar to print, but it's yours

**FREE** if you mail coupon. You owe it to yourself

to get the facts.



H.C. LEWIS, President

good part of your living

and they will assist you to get a

**Get My Free Book**

—size 12x15 inches—shows actual photographs of my

big shops. Cost me a dollar to print, but it's yours

**FREE** if you mail coupon. You owe it to yourself

to get the facts.

H. C. LEWIS

President

**COYNE**

Electrical School

1300-10

W. Harrison St.

Dept. 935-2

Chicago, Illinois

Dear Sir:—Please send me absolutely FREE your big New Book and full particulars of your Special Offer of Two Extra Courses FREE.

Name.....

Address.....

Town.....

State.....

## MAIL THIS COUPON NOW!



## Young outdoor men wanted



To a few sturdy young men—lovers of fresh air and sunshine—who want to get away from the grind of indoor work—John Davey's national organization, The Davey Tree Expert Company, offers an exceptional opportunity. Constantly increasing demand will create a limited number of openings. Those young men selected will be thoroughly trained by the company and given a permanent position if they make good. If you are single, between 20 and 30 years of age, free to travel, healthy, industrious, having a high school education or its equivalent, and able to furnish satisfactory references, you have good chance to qualify. Pay is good at start, advancement assured on merit. We make a large investment in training so we want only men who desire permanent employment in a growing organization. We accept only clean, sturdy young men, thorough Americans, not afraid of vigorous outdoor work. Write for additional information and qualification blank to serve in place of personal interview. The Davey Tree Expert Company, Inc. 25 Federal Bldg., Kent, Ohio.



## Sell Men's Clothes

and make big money doing it with our line of all-wool suits and topcoats at \$23.50. Our tremendous values at the sensational low price is what does the trick. It makes no difference who you are or what your previous experience has been, you can make from \$250.00 to \$600.00 a month and more as our sales representative in your town. But you must be honest and have a clean record. If you are such a man, let us hear from you at once. Sign the coupon and mail today. Address Dept. 269.

**Wm. C. Bartlett, Inc., 850 W. Adams St., Chicago**

Gentlemen: I'm looking for just such an opportunity as you describe and think I'm the man you want. Let me have the facts please by return mail.

Name.....

Address.....

Town..... State.....



## Do People Admire Your Figure

and envy your strength! All your acquaintances would like to look upon you as a man who possesses great strength of will and physique, which you can bring into use whenever the occasion arises. They may not demand that you occasionally perform feats of strength to prove it, but they do demand that you look the part. Unless you have great strength and a fine physique, you can neither impress those around you nor be sure of your own ability to make good in life.

Your health and strength must come first. And if you will but follow my instructions, I will give you the health, strength, energy, will-power and appearance that will lift you out of the commonplace and put you in the class with the great.

### One Type of Person I Can't Help

is you who sit there month after month reading what I have to offer and haven't the energy, the determination, the will-power to get up on your feet and mail the coupon at the bottom of this page. And if you continue to sit there, you are most likely excusing yourself by saying, "But I'm not interested—I don't need exercise." To this I say, "If you are not interested in your appearance, your own health and happiness, why have you read this far?"

Don't fool yourself—time will tell. You won't feel as good at thirty as you did at twenty or as good at forty as you did at thirty, unless you dig a few minutes a day into the only Fountain of Youth that ever existed—Good Physical Exercise. Try the first plunge anyway by sending for

### MY BOOKLET, WHICH IS ABSOLUTELY FREE

It does not obligate you in the least. The title is, "The Royal Road to Health and Strength." This booklet gives you more real physical culture pointers than any other booklet of this class. There are many new pictures of myself and my pupils; a thorough explanation of my methods; and actual description of hand-balancing, tumbling and muscle-control feats. These last feats are just some of the extra service I give along with my body-building and muscle-developing course. I not only give you a fine body, but I teach you how to use it. If you haven't gotten up before this, see if you can't do it now and send in to me for this booklet.

**CHARLES MACMAHON**  
Studio D-5, 160 W. General St., Philadelphia, Pa.

### IMPORTANT

My New Leaflet, "Your Muscles, Where They Are and What They Do," will be sent with my Booklet, and it is also free. Every person contemplating physical culture should get this Leaflet first. Then you will really know what you are doing. Get one of them by return mail.

## LEARN WATCH REPAIRING



You can learn by our modern and original system of instruction every part of the Watch Repairing Trade at home as good or better than at a shop. You can earn money while learning and secure a well paying position or start in business after completing our course of instruction. Good watch repairers are always in demand and earn from \$30 to \$70 per week. For particulars apply to the Wisconsin School of Watch Repairing 166 Mason St., MILWAUKEE, WIS.

## I Made \$100,000

in less than five years as a

### REAL ESTATE SPECIALIST

Started during my spare time, with no experience and less than \$5 capital. If you want to learn the secret of my success and follow my money-making method, send your name and address at once to American Business Builders, Inc., Dept. A-442, 1133 Broadway, New York. They send full information free, telling you how you can build up an independent, profitable business of your own by using my amazingly successful system.



## ANY BOOK IN PRINT

Delivered at your door. We pay the postage. Standard authors, fine editions, new books, all at biggest savings. Be sure to send postal for Clarkson's catalog. **FREE** Write for our great book catalog. This catalog is a short course in literature and is so used by some of America's leading universities; 300,000 book lovers buy from it. Free if you write now.

**DAVID B. CLARKSON** THE BOOK BROKER  
221 CLARKSON BUILDING, CHICAGO, ILLINOIS



Wonderful, new device, guides your hand; corrects your writing in few days. Big improvement in three hours. No failures. **Complete outline FREE.** Write C. J. Ozment, D-34, St. Louis, Mo.



# YOU CAN PLAY THIS

Professional Style

# HAWAIIAN GUITAR

JUST LIKE THE HAWAIIANS!

## BECAUSE OUR NATIVE HAWAIIAN INSTRUCTORS WILL SHOW YOU HOW!

Be the Most Popular Member of your Set. Play "What'll I Do", "So This Is Love", "Memory Lane", "Minding My Business", "Fair Lady", "Lazy", "Linger Awhile". All the late song and dance hits. You can play First Selection in Half an Hour and Harmonious Chords at ONCE. Entertain your friends. Play for money. Don't be a wallflower. Be the Life of the Party.

## FAMOUS HAWAIIANS TEACH YOU TO MASTER QUICKLY THEIR SECRETS OF THIS FASCINATING MUSIC

The instructions you receive from such world famous experts as Lawrence Kalaluki, Walter Kolomoku, Frank Ferrera, Carl Seville and others are invaluable. NO OTHER Conservatory can even begin to give you the expert teaching and knowledge you gain through us. And remember, while it is conceded that the Hawaiian Guitar produces the **sweetest music**, yet its mastery by you will be simple and quick. We guarantee it.

**ONLY 4 EASY MOTIONS**—to learn to be able to play any music, popular, dance, classical, native Hawaiian Airs or old time melodies and hymns. Just think of it! You need never have read a musical note in your life. For that matter, even though you haven't the slightest knowledge of any musical instrument, we guarantee to teach you to play just like the native Hawaiians.



## NEW INVENTION MAKES IT EASY

Here is your chance to learn to play the most fascinating of all instruments, the Hawaiian Guitar. JUST AS THE HAWAIIANS DO, and in an amazingly short time. Our method is so simple, plain and easy that you begin a piece your first lesson. In half an hour you can play it! Thousands of successful students prove this to be true. No matter how little your knowledge of music may be, you can positively learn to play by our plain, easy picture method.

## COMPLETE CONSERVATORY COURSE

You get 52 complete lessons. An entire conservatory course. Nothing is omitted. Success is assured. It is the best course of Hawaiian guitar lessons in the entire world. Real Hawaiians instruct you. This is the only Conservatory teaching Hawaiian Guitar exactly as played by the Hawaiians. It is your good fortune as well as ours, that these Native Masters of Hawaiian Guitar come to this Conservatory to teach. That is why we are the largest and the best known Conservatory of the kind. Your success is assured when you enroll.

## ANYONE CAN PLAY

We guarantee it. 40,000 pupils prove it. You don't have to know music. Our picture method makes it easy. Don't be afraid to try it.

## WE FURNISH YOU WITH EVERYTHING

When you enroll as a student in this conservatory, you receive FREE a handsome, sweet toned, Genuine Hawaiian Guitar—valued at \$15.00—52 especially arranged lessons, as well as all the necessary Picks, Steel Playing Bar, etc. There is NOTHING extra to buy; everything is furnished.



**EXTRA!** As a special offer to readers of this magazine, we supply 52 pieces of music as a part of the course of lessons. Study the pictures of the good times you can have at parties, etc. Get in on the fun. Don't pass up this chance. Send the coupon at once for information and proof.

FIRST HAWAIIAN CONSERVATORY OF MUSIC  
Dept. 48, 233 Broadway (Woolworth Bldg.) New York, N. Y.

**SPECIAL COURSES UNDER FAMOUS TEACHERS. TENOR BANJO, VIOLIN, BANJO-UKULELE AND UKULELE**

**THIS COUPON MAKES IT EASY**

# FREE!

THIS \$15.00  
GENUINE  
HAWAIIAN  
GUITAR



## WORTH \$15.00

Yes, that is the price charged in the music stores for these beautiful Hawaiian Guitars. We can afford to give them away free of charge to every pupil because we manufacture them in huge quantities in our own factory, which is the largest stringed instrument factory in the world.

## SWEET TONED

You will get the same haunting, soothing, plaintive fascinating tunes that the real native Hawaiians get on these same instruments.

Plays any kind of music. 40,000 satisfied pupils prove all our claims are true.

**Yours Free!** We mean it. There are no strings tied to this generous offer. You get it absolutely free as soon as you enroll for our course of 52 easy lessons, taught by real Hawaiians. You can't possibly lose, so mail the coupon at once for full information.

**Be Popular** You'll never be lonesome after you learn to play on this beautiful Hawaiian Guitar. You can be the life of the party. Don't be a wallflower. Use the coupon for complete information. Mail it right away.



## TEAR OUT AND MAIL

FIRST HAWAIIAN CONSERVATORY OF MUSIC, Inc.  
Dept. 48, 233 B'way, Woolworth Bldg., New York, N. Y.  
Gentlemen: Of course I want to get this handsome \$15.00 Hawaiian Guitar free of charge, because I am interested in learning to play it. Please mail full information about your 52 easy lessons under real Hawaiians, and proof that I can play a piece after the first lesson. I am not obliged to enroll unless I want to.

Name.....  
Local Address.....  
City & State.....





## "I'm Going to Send It in To-night"

"I'VE been drifting too long. . . . Two years ago, when Tom Adams took up an I. C. S. course, I determined to study too. But I put it off—and off—and off—"

"Tom's manager of the department now and earning twice as much as I am. It isn't because he has more natural ability than I have, but because he's trained! That's it—he's trained!"

"Me? Why I'm just one of a score of routine workers. Tom gets the big salary because the firm knows he's trained himself to handle work that I can't do."

"I've wasted two years, but it's not too late. This time I'm really going to send in that I. C. S. coupon too. The sooner I send it in, the sooner I'll be promoted like Tom."

**Mail the Coupon To-day!**

### INTERNATIONAL CORRESPONDENCE SCHOOLS Box 5675-D, Scranton, Penna.

Without cost or obligation, please tell me how I can qualify for the position or in the subject before which I have marked an X:

#### BUSINESS TRAINING COURSES

- |  |   |
|--|---|
| <input type="checkbox"/> Business Management                     | <input type="checkbox"/> Salesmanship                                     |
| <input type="checkbox"/> Industrial Management                   | <input type="checkbox"/> Advertising                                      |
| <input type="checkbox"/> Personnel Organization                  | <input type="checkbox"/> Better Letters                                   |
| <input type="checkbox"/> Traffic Management                      | <input type="checkbox"/> Show Card Lettering                              |
| <input type="checkbox"/> Business Law                            | <input type="checkbox"/> Stenography and Typing                           |
| <input type="checkbox"/> Banking and Banking Law                 | <input type="checkbox"/> Business English                                 |
| <input type="checkbox"/> Accountancy (including C.P.A.)          | <input type="checkbox"/> Civil Service                                    |
| <input type="checkbox"/> Nicholson Cost Accounting               | <input type="checkbox"/> Railway Mail Clerk                               |
| <input type="checkbox"/> Bookkeeping                             | <input type="checkbox"/> Common School Subjects                           |
| <input type="checkbox"/> Private Secretary                       | <input type="checkbox"/> High School Subjects                             |
| <input type="checkbox"/> Spanish <input type="checkbox"/> French | <input type="checkbox"/> Illustrating <input type="checkbox"/> Cartooning |

#### TECHNICAL AND INDUSTRIAL COURSES

- |   |  |
|---|--|
| <input type="checkbox"/> Electrical Engineering | <input type="checkbox"/> Architect                                   |
| <input type="checkbox"/> Electric Lighting      | <input type="checkbox"/> Architects' Blue Prints                     |
| <input type="checkbox"/> Mechanical Engineer    | <input type="checkbox"/> Contractor and Builder                      |
| <input type="checkbox"/> Mechanical Draftsman   | <input type="checkbox"/> Architectural Draftsman                     |
| <input type="checkbox"/> Machine Shop Practice  | <input type="checkbox"/> Concrete Builder                            |
| <input type="checkbox"/> Railroad Positions     | <input type="checkbox"/> Structural Engineer                         |
| <input type="checkbox"/> Gas Engine Operating   | <input type="checkbox"/> Chemistry <input type="checkbox"/> Pharmacy |
| <input type="checkbox"/> Civil Engineer         | <input type="checkbox"/> Automobile Work                             |
| <input type="checkbox"/> Surveying and Mapping  | <input type="checkbox"/> Airplane Engines                            |
| <input type="checkbox"/> Metallurgy             | <input type="checkbox"/> Navigation                                  |
| <input type="checkbox"/> Steam Engineering      | <input type="checkbox"/> Agriculture and Poultry                     |
| <input type="checkbox"/> Radio                  | <input type="checkbox"/> Mathematics                                 |

Name.....  
Street.....  
Address..... 3-6-24

City..... State.....

Occupation.....

Persons residing in Canada should send this coupon to the International Correspondence Schools Canadian, Limited, Montreal, Canada.

# & Music Lessons

WITH AN ACCREDITED SCHOOL

## At Home

### A Complete Conservatory Course By Mail

Wonderful home study music lessons under great American and European teachers. Endorsed by Paderewski. Master teachers guide and coach you. Lessons a marvel of simplicity and completeness.

**Any Instrument** Write telling us course you are interested in—Piano, Harmony, Voice, Public School Music, Violin, Cornet, Mandolin, Guitar, Banjo or Reed Organ—and we will send our FREE CATALOG with details of course you want. Send NOW.

University Extension Conservatory, 80 Siegel-Myers Bldg., Chicago, Ill.



## Learn How to WRESTLE

In Your Own Home  
By Mail

Yes, learn to wrestle right in your own home, by mail, from the greatest wrestlers the world has ever known. Be an athlete, be strong, be healthy. Learn how to throw and handle big men with ease. Learn to defend yourself. All taught in our course of lessons, and illustrated with hundreds of charts and actual photographs by

### Farmer Burns and Frank Gotch

Farmer Burns, "the grand old man of the mat," taught Frank Gotch, the World's Champion, all he knew about wrestling, so Gotch said. He will now teach you Scientific Wrestling—Physical Culture—Jiu-Jitsu—Self Defense. Every man and boy in America, no difference what age, needs this wonderful course of lessons. Write today—your name, age and address on a postcard or letter brings you our fine book absolutely free, no obligation of any kind. A splendid book on wrestling and physical culture. Write today stating your age.

Farmer Burns School of Wrestling 1772 Range Bldg., Omaha

This Wrestling Book FREE

Can you afford to

## STAMMER?

OR STUTTER?

It ruins many chances for promotion. Send postage for large free book "The Correction of Stammering and Stuttering." Methods successful for over a quarter-century. THE LEWIS INSTITUTE, 33 Lewis Bldg., 155 Stimson Av., Detroit, Mich., U.S.A.

## If I Send You A Suit



made to your measure, in the latest style, would you keep and wear it, show it to your friends,

let them see our beautiful samples and splendid new styles? Could you use \$3.00

an hour for a little spare time? **Every tailoring agent, send for our wonderful new proposition.** Just write a letter or postal or fill out and mail coupon below.

I will send you our big new book of samples and styles to pick from and my new, special offer, **all free.** Even if you don't care to be agent, send anyway, and learn how to get all your own clothes FREE.

Send Name and Address on This Coupon.

To L. E. ASHER, President  
BANNER TAILORING CO., Dept. 424, Chicago, Ill.

DEAR SIR: Please send me your new special offer, all FREE.

Name.....

R. F. D..... Box..... Postoffice.....

St. and No..... State.....



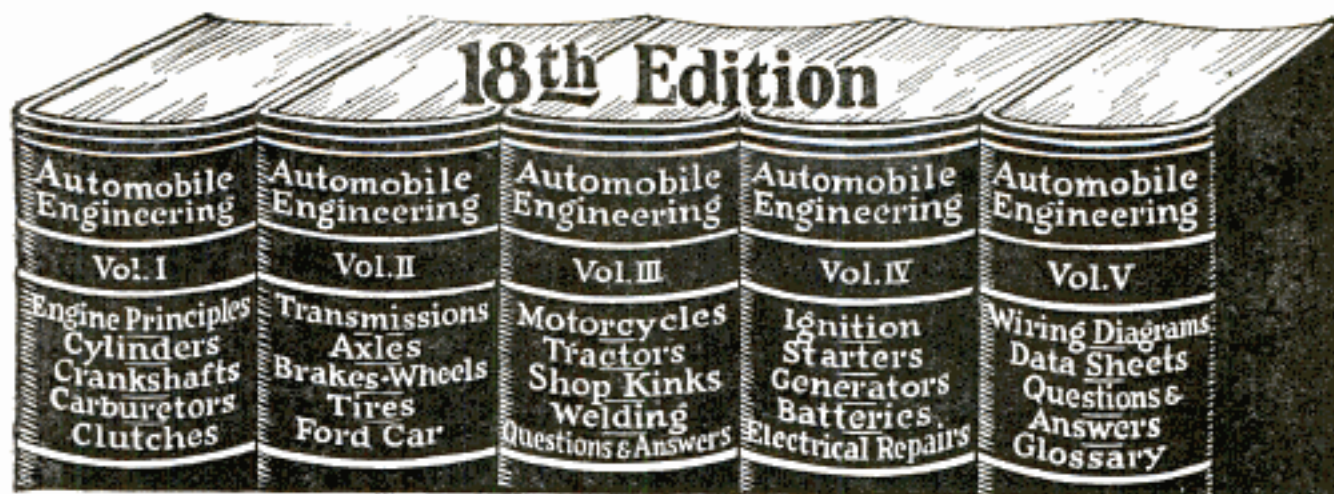

# Every Automobile Man Needs These Auto Books *Yes—That Means You—Mr.*

**Garage Owner—Service Station Manager—Repairman  
Trouble Shooter — Car Owner — Auto Salesman**

2200 pages of money-making automobile ideas. Shop kinks and up-to-the-minute repair methods are all here. Everything made clear and practical by the use of 2400 pictures, diagrams, and charts. From four-cylinder engines to straight-line eights—**EVERYTHING ABOUT EVERY AUTOMOBILE IS COVERED—but that is not all—**

## Four Big New Features

**Equipment data and specifications** Here at a glance will be found

*(A separate sheet for each car)*

all of the data covering the car's equipment. Whether you are estimating on a repair job or ordering new parts or doing the actual repair work, the specification sheet will be worth real dollars to you.

Generator output in volts and amperes—when relay should cut-in—distance relay gaps—model number for all units for ordering parts—firing order—ignition timing—breaker contacts—valve tappet distance—size of clutch and brakes—lamps—etc.

**Wiring Diagrams** A complete diagram of the electrical systems on all standard cars *(A separate sheet for each car)* shows exact location of generator—starter—distributor—ignition coil—resistance units—ammeter—starting switch—horn—circuit breaker—relay—signals and lights—fuses—battery terminals—etc. Every connection is clearly

indicated. More than one man has built up a paying business because he could not be "stumped" on any ignition or starting job.

**Trouble Shooting** "What is the matter?" It may be with the ignition—battery—fuel—lubrication—or what not. 58 causes of trouble, how to detect it, and what to do to cure it. 334 definite cures are thoroughly explained with the necessary diagrams and charts. Why the trouble occurred and how to cure it make this service feature worth hundreds of dollars to the trouble shooter or repairman.

**Questions and Answers** Whether you're stuck on the road or bossing shop repair jobs you have wished for a quick solution of this and that trouble—a solution that is ready-made and does not compel you to read three or four pages of explanation. In the questions and answers section every conceivable automobile trouble has been stated and the right way to correct it given.

**Every automobile trouble and its cure indexed for instant reference**

**FREE—7 days' trial—FREE**

Whether you are a garage owner, a service station manager, trouble shooter, repairman, car owner, or auto salesman, I think you will agree that the income of the average man in the automobile game is in direct proportion to his ability to make good—in short, to his knowledge of automobile principles, operations, and repairs. We claim that this work with its four new features will be worth hundreds of dollars to any man thus employed and we want the chance of proving it to you. Let us send you the complete five-volume set of Automobile Engineering for one week's free use—test the books out on any one or on a dozen jobs that have been troubling you—no matter whether on repairs, wiring systems, trouble shooting, or what not. If you do not find just the help that you need in this set, send it back to us at our expense.

**Send us the coupon tonight!**

**American Technical Society**  
CHICAGO, U. S. A.

**American Technical Society**  
Chicago, U. S. A.

Please send me a set of Automobile Engineering, for seven days' FREE EXAMINATION, shipping charges collect. I will examine these books thoroughly and, if satisfied, will send \$2.80 within seven days and \$3 a month until I have paid the special price of \$19.80. If I decide not to keep the books, I will return them within one week at your expense.

Name.....

Address.....

Reference.....

Please fill out all lines; give local merchant, banker, or employer as reference. **A 219**



## *A Sensation of the Chicago Radio Show*

### Popular Mechanics Superheterodyne Eight

*The Last Word in Radio*

# YOURS WITHOUT COST

Designed in Popular Mechanics Laboratory by our Radio Engineers—a Hookup that Experts agree is far in advance of anything yet produced in Radio.

We want all of our Subscription Representatives to own one of these MARVEL sets, and we will furnish a full set of blue prints and every part necessary to hook up the instrument—cabinet, loop aerial, highest grade standard parts, lugs, screws, shields—*everything—without cost!*

It will amaze you to know how easily you can get this wonder Superheterodyne, having a possible range of 4000 miles. No outside aerial or ground necessary. Just a few hours of your spare time and the set can be yours—all charges prepaid.



WRITE TODAY for full details. Name two references in coupon below

#### POPULAR MECHANICS MAGAZINE

Room 408, 200 E. Ontario Street, Chicago, Illinois

Please send me, without obligation, full details of your Superheterodyne offer.

Name .....

Street .....

City ..... State .....

#### MY TWO REFERENCES ARE:

1. Name ..... 2. Name .....

Street ..... Street .....

City ..... State ..... City ..... State .....



# This Year, Thousands of Men Will Succeed in Drafting

## —Will You Be One of Them?

### FREE Trial Lesson Points the Way

TEN months from today you can be an expert draftsman. If you are making less than \$200 per month with limited prospect for advancement . . . these facts are addressed to you.

More than 50,000 draftsmen are needed every year. That is what makes drafting . . . when the man is properly trained . . . one of the surest and shortest roads to increased income. In a letter to Mr. Charles W. Morey, President of the Chicago Technical College, Mr. George W. Hand, Assistant to the President of the Chicago and Northwestern Railway, writes:

"Good draftsmen are hard to find and they experience no difficulty in obtaining remunerative employment."

#### Short Home-study Course

We have been teaching drafting for 21 years. Our instructors are practical engineers. They train you with practical jobs. Rates are low . . . payments easy. When you enroll, we include a \$25 "lifetime" drawing outfit.

#### The Trial Lesson Idea

We send you without obligation a trial lesson in drafting. We want you to see what drafting is like . . . we want you to know our method of teaching by mail. Our course has been simplified and perfected through 21 years of teaching experience, but we want you to

judge for yourself whether you will like this fascinating, well-paid work.

**40-page Book, free!** We send you also a book of interesting facts on the field of drafting. This book gives you in complete outline our courses in structural, architectural, electrical and machine drafting. It introduces you to our instructors; tells you what prominent men say about drafting . . . where draftsmen are employed . . . and at what salaries . . . what a draftsman's opportunities are . . . it tells you how . . . and why . . . many of our students have increased their salaries even before finishing their courses.

Most men at the top in engineering started as draftsmen. Many of our students who learn drafting in spare time through Home-Study come to Chicago and secure positions at greatly increased salaries as draftsmen in engineering construction, railroad, architectural firms, etc. Then . . . evenings in the college classroom . . . they continue their study of engineering or architecture. Many of them rise quickly to positions paying \$300, \$350, \$400 per month. Many enter their own business. Others become chief draftsmen and executives. The

field of progress opened up to them in this way is really limitless.

#### Send Coupon Today

Thousands of men will succeed in drafting this year. Will you be one of them?



Chicago Technical College, founded in 1904, enrolls over 1000 men each year in resident day and evening courses.

Diplomas in engineering and architecture are granted at the end of two years. The Degree of B. S. is conferred at the end of three years in the day course. Short courses, also, in Drafting, Plan Reading, Estimating, etc.

From this famous College of Engineering come these Home-Study courses in Drafting.

#### Opportunities in Chicago

For those who can come to Chicago, there is a splendid opportunity to learn drafting while earning expenses in part-time positions. If interested, write for 52-page Blue Book.



## Chicago TECHNICAL College

Chicago Tech Building, Dept. 230-B, 118 East 26th Street, Chicago

Chicago Technical College,  
Dept. 230-B, 118 East 26th Street,  
Chicago, Ill.

Gentlemen: Send me, without cost or obligation, your Trial Lesson and your 40-page Booklet of Facts About Drafting.

TRIAL  
LESSON  
FREE

Name.....  
Address.....  
City.....  
State.....



#### How big a field is DRAFTING?

A structure like the Temple Building, recently completed in Chicago, requires approximately 3000 mechanical drawings to guide its builders. Every floor, every girder, every stone must first be "laid out on paper." Every cottage and every skyscraper must be drawn . . . mechanically and to scale . . . before the builder can interpret the ideas of the architect . . . every country highway and city street, every engine and machine . . . wherever anything is built, there the draftsman is essential.

Send the Coupon



# Be an Auto Expert

EARN FROM \$2000.00 UP

## Be the Boss!

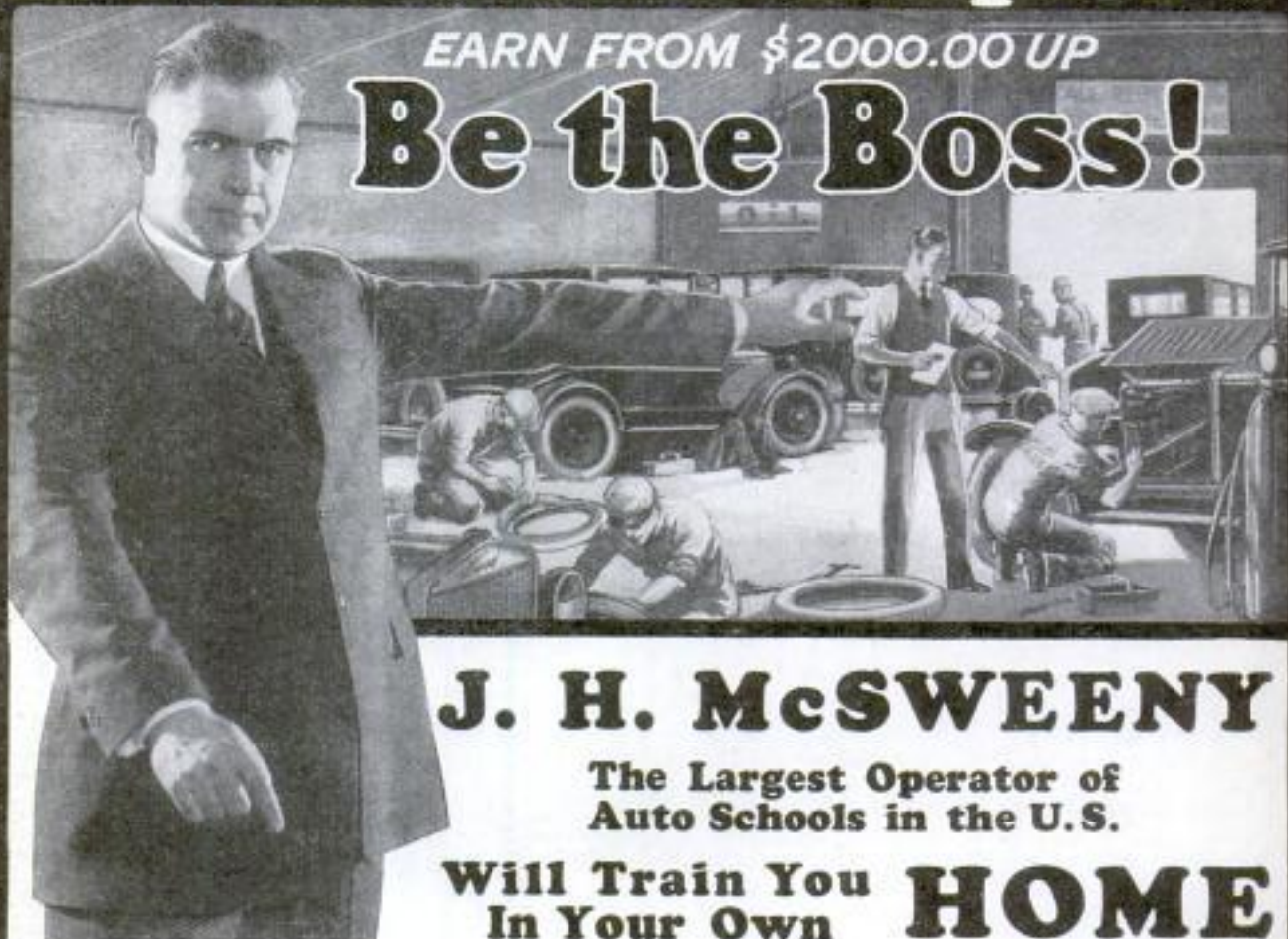

### J. H. McSWEENY

The Largest Operator of  
Auto Schools in the U. S.

Will Train You **HOME**  
In Your Own

### Earn While You Learn

You don't have to wait until you finish my course before you begin earning money. McSweeney Training gives you almost immediate action. You can soon begin to earn real money.

### Satisfaction Guaranteed

I guarantee that you will be satisfied. When you enroll you are given a Guarantee Bond behind which is the tremendous organization of the largest operator of Automotive Schools in the U. S.

### Special Limited Offer

To those who write at once I am going to make what I believe is the lowest offer ever made in the history of the Automotive Schools.

## McSweeney Auto, Tractor & Electrical Schools

The Largest Operator of Auto Schools in the U. S.

Dept. H-1418

Cincinnati, O. Chicago, Ill. Cleveland, O.  
9th and Walnut Sts. 517-21 So. Laflin St. 1815 East 24th St.

Get out of the small pay, no advancement jobs. The largest industry in the United States—the Automotive Industry—needs trained men. You can take your place beside men who are making from \$2,000 a year up. I can train you in a few months. Almost from the start you can be making big money doing spare time jobs.

### My Course is Practical—Interesting—Simple

I am the largest operator of auto schools in the United States. I have trained thousands of Automotive Experts—men who are making up to \$85,000 a year! I know how. You won't find a lesson that you can't understand. Everything is most minutely explained—hundreds of illustrations make everything clear. My FREE Consultation Service will answer immediately every question you ask, even after you have finished the course.

### No Age Limits—No Experience Necessary

It makes no difference if you have had no experience, many of my most successful graduates had never put a screw driver to a car before they enrolled with me. I have successfully trained boys of sixteen as well as men of sixty. If you can read and write the English language you will have no trouble mastering the lessons.

### Big Free Book

I will send my big book explaining everything FREE, if you send the coupon at once.

**J. H. McSweeney, Pres.**  
Dept. H-1418, Home Study Division  
McSweeney Auto, Tractor and Elec. Schools  
9th and Walnut Sts., Cincinnati, Ohio  
DEAR MAC: Send me your big free book and your special proposition at once.

Name.....

Address.....

City..... State.....

See other important announcements on Pages 50, 51, 131 and on the inside Front Cover



# OH, YOU MISFIT!

**S**AILING under the name of man. You know the truth if no one else does—you know what you lack—what you need.

You may hide it from others in a way, but you can't hide it from yourself. Have you a spark of ambition left to be the man you ought to be? Are you an easy victim of every little ailment that comes along, going around without snap or ginger, losing ground when you ought to gain it? Then wake up and be a man, not a misfit. Deserve the name of man; be vigorous; be strong; be vital. It makes no difference if you are a physical wreck, if you join hands with me, I'll make you the kind of man that's wanted, the kind of man needed, the kind of man looked for, sought for, bid for all the time, and it will be done without drugs, or tonics, or stimulants.

**You business man**—overworked, did you say? You are not doing half as much as you ought with your experience. Never mind, there is a way to get back your aggressiveness, to be right in the fight and enjoy it. Along your line of work, you need concentration and connected thought—you must apply yourself—the more healthy and strong your physical form, the more active will be your brain—the more clear your reasoning. You can double your percentage of real worth as a man, and enjoy life as you ought to be able to do.

**If you are losing** vim, vigor, vitality, have no snap, no inclination to hustle—and if you do hustle for a minute, you flop like a fish the next—you feel languid, indolent, always out of sorts. Get the pep and ginger and tingle of life into you. You are not living for yourself alone; you need dash, spirit, the enterprise you used to have. Regain and maintain your health; I'll show you how.

**You young man**—think of your future—how about it—are you qualified—do you feel it in your soul—are others sliding by you, doing more, getting more than you are? You know that a weak body is the greatest handicap in life. To succeed you must be strong, full of life and energy. This is easy to accomplish if you will let me help you. I have helped thousands; physically, mentally, morally. I will make you the kind of man that is a credit to any community. I will make you so that your progress in any undertaking will be easier. I will guide, direct and point the way; the natural way for you to achieve what I have said—nature's way. You can gain muscular tissue, be strong, erect in carriage, courageous and likeable to all you meet.

Let me be your guide, your teacher. I have pupils all over the world, learning a system of Health, Strength, moral courage building, known as

## STRONGFORTISM

### The New Science of Health Promotion

Under it, **you men** can build your body up in symmetrical proportions as nature intended you to be. You will gain greater confidence in yourself, and compel others to have more confidence in you—you can win success, capped with the glow of health and the supreme joy of living. You can keep your youth with you, no matter what your present physical condition is, or what ailment or disorder you have. See the coupon attached, check what troubles you have, mail and I will send you a practical talk on that subject and a copy of my book, "**Promotion and Conservation of Health, Strength and Mental Energy.**" Just enclose a 10c piece (one dime) to cover mailing expenses—that's all.

# Lionel Strongfort

Physical and Health Specialist Over 25 Years  
Dept. 1742, Newark, N. J., U. S. A.



**LIONEL STRONGFORT**  
An athlete of whom Dr. Sargent of Harvard University has said: "He is unquestionably the finest specimen of physical development ever seen."

#### FREE CONSULTATION COUPON

(Cut Out and Send In)

MR. LIONEL STRONGFORT, Dept. 1742, Newark, N. J.

Please send me your book, "**Promotion and Conservation of Health, Strength and Mental Energy,**" for which I enclose a 10c piece (one dime) to cover mailing expenses. I have marked X before the subject in which I am interested.

- |                            |                         |                        |
|----------------------------|-------------------------|------------------------|
| ..... Colds                | ..... Insomnia          | ..... Lung Troubles    |
| ..... Catarrh              | ..... Short Wind        | ..... Heart Weakness   |
| ..... Asthma               | ..... Stomach Disorders | ..... Poor Circulation |
| ..... Obesity              | ..... Skin Disorders    | ..... Tobacco or Other |
| ..... Headache             | ..... Increased Height  | ..... Bad Habits and   |
| ..... Thinness             | ..... Constipation      | ..... Weakness         |
| ..... Rupture              | ..... Biliousness       | ..... Stoop Shoulders  |
| ..... Flat Feet            | ..... Torpid Liver      | ..... Muscular         |
| ..... Dependancy           | ..... Indigestion       | ..... Development      |
| ..... Lumbago              | ..... Nervousness       | ..... Weight Lifting   |
| ..... Neuritis             | ..... Poor Memory       | ..... Great Strength   |
| ..... Neuralgia            | ..... Rheumatism        | ..... Advanced Course  |
| ..... Flat Chest           | ..... Gastritis         | ..... Many-Weight      |
| ..... Deformity (Describe) | ..... Round Shoulders   | ..... Barbell          |

Name.....

Age..... Occupation.....

Street.....

City..... State.....



# GOV'T JOBS OPEN

Railway Postal Clerks, City Mail Carriers, Rural Carriers,  
City Postal Clerks, Clerks at Washington, D. C.  
INCOME TAX AUDITORS

**\$1140 to \$3000 a Year** STEADY, SHORT HOURS  
Long Vacations With Pay  
**MEN—BOYS 18 OR OVER**

Mail coupon immediately for full list of positions now  
obtainable. Don't delay.

Franklin Institute, Dept. W180, Rochester, N. Y.

Gentlemen: Kindly send me, at once, and entirely with-  
out charge or any obligation on my part, list of U. S. Gov-  
ernment big paid positions obtainable. Advise me also re-  
garding the salaries, hours, work, vacation and tell me how I  
can get one of these jobs. Send me also free sample coaching  
lessons.

Name.....

Address.....

## TELEGRAPHY

(Morse and Wireless) and RAILWAY ACCOUNTING taught thoroughly. Big  
salaries; great opportunities. Oldest, largest school. Endorsed by Telegraph,  
Railway, Radio, and Government officials. Expenses low—opportunities to earn  
large portion. Catalog free. DODGE'S INSTITUTE, Jones St., Valparaiso, Ind.

Comedies, Dramas, Musical Comedies, Vaudeville Acts  
and Revues, Min- How to Stage a Play  
strel Choruses, Songs, Blackface plays, Everything for  
Burnt Cork Shows and All Amateur Entertainments,  
Monologs, Dialogs, Speakers. CATALOGUE FREE.  
T. S. DENISON & CO., 623 So. Wabash, Dept. 9, CHICAGO

## LEARN



## AVIATION

**EARN \$2,000 TO \$10,000 A YEAR**

**STUDY AT HOME**

OPPORTUNITY is at your door.  
Learn Airplane Engineering now.

Write for Free Catalog

**WESTERN AIRPLANE CORPORATION**

Dept. M2      Monadnock Block      CHICAGO



## Make Money Drawing Cartoons

*It's Easy To Learn When Shown In The Right Way*

Some of the cleverest cartoonists and comic artists in America today learned to draw during their spare  
time by following **CARTOONIST EVANS' SIMPLE AND EASY METHOD**. This school is recom-  
mended by foremost cartoonists because they know the students are handled right. If you like to draw,  
send a sample of your work, either an original or a copy, and we will send you a **portfolio of  
cartoons and full details**. The course is **NOT EXPENSIVE**.

**The W. L. Evans School of Cartooning** 821 Leander Building  
CLEVELAND, OHIO

## "THE SAWING QUARTETTE"

American  
Legion of  
Wisconsin  
—Paul  
Florine  
Post No. 166

Start a  
Saw Club  
in Your  
Town

# Play a Saw

With Our Free Course of Instruction You Can **Play in 3 Days**

We positively guarantee that you can play our Musical Saw (using both bow and hammer) within  
three days by following our simple and easy Course of Instruction. The "Musical Saw" is the  
easiest to play musical instrument ever invented. No knowledge of music or note reading  
required. If you have heard our Musical Saw in Vaudeville, cover the Radio or Green Victor  
Record 18281, Columbia Record 8707 or Vocalion Record 14166, you are familiar with the  
soft, mellow tones produced from our musical saws.

The "novelty" of producing such beautiful music from "a saw" makes this  
instrument "THE HIT" on any program entertainment.

**Start A Saw Quartette** in your Lodge, Legion Post or Club. A novelty  
organization of this kind will be the talk of the  
town. Put "saw" into your meetings, make it a feature advertising card  
at your entertainments, parties, etc.

**Send No Money** Simply fill out the coupon and mail today. We  
send you the special tempered, tenor (solo)

Musical Saw, Soft Hammer and complete Course of Instruction  
C. O. D. \$4.85 plus the postage. Try out the instrument for three  
days. If not satisfied with the tone or its easiness to play, return  
and we will refund your money. No strings to this offer, **YOU  
ARE THE SOLE JUDGE**. You will be the one to furnish  
the big surprise at your next Club or Lodge meeting. Then,  
start a Sawing Trio or Quartette. Complete information on  
this subject will be mailed to you with the instrument.

**Mussel & Westphal** FT. ATKINSON,  
WISCONSIN



Now  
Only

**\$4.85**

**Mussel & Westphal**  
723 West Water Street  
Ft. Atkinson, Wisconsin

You may send me the Musical Saw, Soft Hammer  
and Free Course of Instruction. I will deposit with  
postman \$4.85 plus postage. If not entirely satisfied I will  
return the shipment within three days and you will refund  
my money.

Name.....

Address.....

The cost of our special "Saw Bow" is \$2.25 extra.  
check here if you wish Bow sent with instrument.

Copyrighted material



# Your Chance to Make

## \$3000<sup>00</sup>

to

## \$5000<sup>00</sup>

### a Year

### after Training in New York

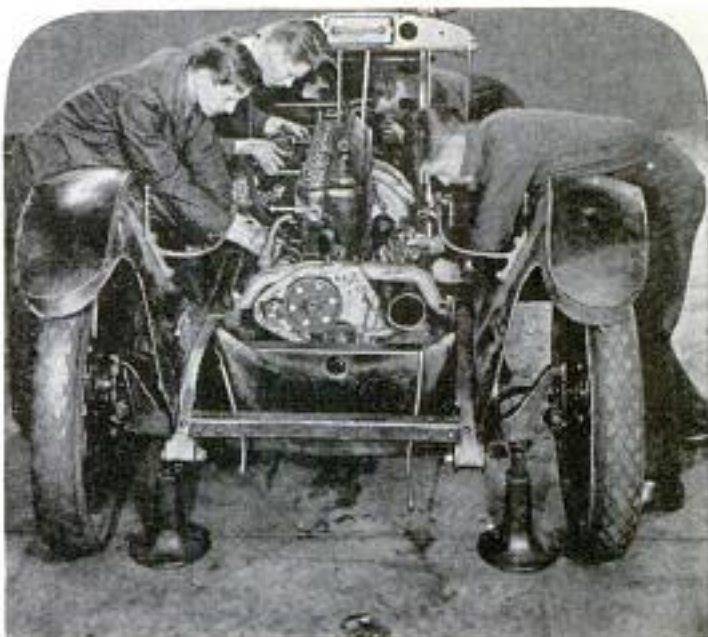

**S**UCCESS comes from making the most of the chances we have. Get out of the rut of indecision and doubt. "Take the bull by the horns" and determine now to learn how to do something just a little better than the other fellow. Be a specialist, for this means success, big pay and power. All you need is the proper training backed by decision and determination.

If you are not earning at least \$50 to \$75 or more a week—with a business of your own in sight—this message is intended for you. It is now possible for any average man, regardless of education or experience, to be trained at the Stewart Auto School for a big pay job in a few weeks. There is a crying demand for good men right now—But you must act quickly.

#### *You Can Now Learn the Auto Trade in Ten Weeks in New York*

In the big, splendidly-equipped shops of the Stewart Automobile School you can master all kinds of repair work in only 10 weeks' time. Here you can lay the foundation for a successful career in the world's largest industry. You can learn how to be your own boss—and can step right into a big pay job soon after you graduate.

There is no mystery—it is not difficult in any way—as you will see in our catalogue. You can do it easily. The Stewart Automobile School has thousands of successful graduates.

#### *The Stewart System Makes Learning Easy*

Stewart Instructors—all hand picked men—have perfected the "personal instruction" policy of this school. Each beginner is studied—his individual characteristics noted—then he receives his instruction in the way that will be most valuable to him and easiest to grasp.

The course of training is thorough—no one is rushed and every point is driven home. The complete catalogue (which

you will receive as soon as you send in the attached coupon) contains a guarantee that you can remain until you are entirely satisfied.

#### *Earn While Training in New York*

If you have a clean record and can furnish satisfactory references our Employment Department will help you meet expenses by rendering valuable assistance if you want to earn while training. Graduates can also obtain excellent positions in this way.

#### *FREE BOOK—Send for It*

You can open up the way to newer and better things by a mere scratch of the pen or pencil. You can take advantage of the great opportunities in the rapidly expanding automobile business. Investigate now. It costs you nothing and does not obligate you to buy anything. But find out—investigate—take a new lease on life. Send the coupon for our new big FREE book which explains all details. Here is the coupon. Send it now!



**STEWART AUTOMOBILE SCHOOL**  
225 W. 57th St., Dept. 1752, New York, N. Y.

Please send me your free book that describes your school and the opportunities in the Automobile Business. I am under no obligation.

Name.....

Address.....

City.....

State.....



# Learn Cartooning



*BRANNER*

**WINNIE WINKLE**  
When I consider the small investment I made in taking your course and the enormous profits I am making now I feel like a proffter.

*M. M. Branner.*



*Gene Byrnes*

**REG'AR FELLERS**  
I attribute my success to the thorough and highly competent course I received from you.

*Gene Byrnes.*



*Diller*

**FRECKLES**  
More words cannot express my appreciation of the course of lessons I received from the Landon School.

*Merrill Blosser.*



*Edwina*

**"GAP" STUBBS**  
No one could take your course and regret it—your instructions made it possible for me to do the work.

*Edwina Dumm.*

At Home in Your  
Spare Time by the  
World Famous  
Landon Picture  
Chart Method

**YOU** can learn to make original drawings with the aid of this remarkable method, just as easily as you learned to write. A series of big picture charts with each lesson of this great course, explains step by step, just how to proceed in making original drawings of your own. Every detail of cartoon drawing is fully covered throughout this complete course. Instructions on originating cartoon ideas are also included. A complete criticism service gives you the full benefit of the experience of one of America's foremost newspaper artists.

Newspapers want more cartoonists and comic artists trained to do snappy or iginal work. That's why they are constantly employing Landon-trained cartoonists, who are now earning from \$50 to \$200 and more a week.

## RESULTS TELL THE STORY

Here are four of the famous characters created by Landon students who have attained national reputations as Comic Strip Cartoonists. Hundreds of former students of this School are producing cartoons on political and national affairs, sports, comic strips, etc., for leading newspapers and syndicates all over the United States and Canada. Many newspapers now employ from two to five students of this School; one big newspaper employs nine. Many successful students who prefer to work at home are selling their drawings by mail. The record of results produced by this school is evidenced in the increasing demand by newspaper Editors for Landon graduates.

Send NOW for complete information and sample Picture Chart to test your ability. Please state your age.

**The Landon School**  
1238 National Bldg., CLEVELAND, O.

**\$700**  
**a week**  
from his own  
**Photograph Studio**



"My income now averages from \$700 to \$1000 a week," writes Michael Gallo, who owns his own photographic studio on fashionable Fifth Avenue, New York. He adds, "My portrait studies bring me as much as \$250 a dozen."

Hundreds of others are earning big money everywhere. Amazing growth of Professional Photography offers chance of a lifetime; high salaried position or your own business. \$20 to \$75 a week in spare time!

### LEARN AT HOME

No previous experience or special ability needed. New easy method makes you a Professional Photographer in spare hours at home. Famous experts of New York Institute of Photography train you by mail. All branches: Motion Picture, Portraiture, Commercial, News Photography. Earn while learning.

### MOTION PICTURE CAMERA FREE OR 5x7 VIEW

Your choice absolutely free. Motion Picture Camera takes real Motion Pictures on standard professional film used by all theatres—View Camera is latest professional model for all still photography; contains smallest lens.

### WRITE FOR BOOK

Handsome big new book explains wonderful opportunities; positions paying \$50 to \$250 a week, how to start your own business, how to earn money in spare time. Send postcard or letter today for FREE BOOK and free Camera offer.

**New York Institute of Photography, Dept. 492,**  
143 West 36th Street NEW YORK, N. Y.



### NOTE

If you prefer to come to our New York or Chicago Studios for personal instruction, day or evening classes, write for Catalogue B-49 to nearest address: 141 W. 36th St., New York, N. Y., or 630 S. Wabash Avenue, Chicago, Ill.

## Government Positions

Those who wish to secure life positions in the United States Civil Service at from \$1,400 to \$2,500 a year, should write for the catalogue of the oldest Civil Service School in America, the  
**COLUMBIAN CORRESPONDENCE COLLEGE,**  
WASHINGTON, D. C.

\$

DOWN

### 21 Jewels

Nothing less than 21 Ruby and Sapphire Jewels is good enough for the Burlington masterpiece.

### Quality and Style

Adjusted to the second-temperature—soother—position. 25 year Gold Strata Case, in 100 exquisite designs. Only \$1 down. Balance in small monthly payments. Send for free book.

**Burlington Watch Company**  
19th Street and Marshall Boulevard  
Dept. 13-52 Chicago, Illinois

### Artificial LIMBS and BRACES

Limb Prices \$85 to \$175. Easy Terms. 5Yr. Guarantee

Great Invention for the Needy. AGENTS WANTED

FREE Fibre Sample. DESCRIBE STUMP TO

**WORMAN CO.** 252-P HENNEPIN AVE. MINNEAPOLIS, MINN.

## Music Instructor

These books are illustrated and gotten up to make the method of self-teaching so simple that any one without any knowledge of music could learn to play any of the following:

SAXOPHONE	25c	MANDOLIN	25c
ACCORDEON	25c	PIANO	25c
BANJO	25c	UKULELE	25c
GUITAR	25c	VIOLIN	25c

The above prices are postpaid. 1-: Any above 5 titles, \$1.00 postpaid.

**J. C. DORN, 725 So. Dearborn St., Dept. 17, Chicago, Ill.**





# \$2500 Reward!

## For the Capture of an Unknown Man

Twice he had entered the St. Clair Mansion. What was he after? Who? What was in danger?

Berteau, the famous detective, had warned St. Clair that the mysterious marauder would come again. And now—a noise in the passage! The creak of an opening door. A shot in the dark! A capture!

Is this wounded stranger the mysterious intruder? Who could tell? Yet Berteau identified the man without hesitation and won the \$2500 reward.

How did he do it? Easy enough for the Finger Print Expert. He is the specialist, the leader, the cream of detectives. Every day's paper tells their wonderful exploits in solving mysterious crimes and convicting dangerous criminals.

## Course in Secret Service

For a limited time we are making a special offer of a professional Finger Print Outfit, absolutely Free, and Free Course in Secret Service Intelligence. Mastery of these two kindred professions will open a brilliant career for you.

Write quickly for fully illustrated free book on Finger Prints which explains this wonderful training in detail. Don't wait until this offer has expired—mail the coupon now. You may never see this announcement again! You assume no obligation—you have everything to gain and nothing to lose. Write at once—address

University of Applied Science

Dept. 13-52, 1920 Sunnyside Ave., Chicago, Ill.

## More Trained Men Needed

The demand for trained men by governments, states, cities, detective agencies, corporations, and private bureaus is becoming greater every day. Here is a real opportunity for YOU. Can you imagine a more fascinating line of work than this? Often life and death depend upon finger print evidence—and big rewards go to the expert. Many experts can earn regularly from \$3,000 to \$10,000 per year.

## Learn at Home in Spare Time

And now you can learn the secrets of this science at home in your spare time. Any man with common school education and average ability can become a Finger Print Expert in a surprisingly short time.

# FREE

UNIVERSITY OF APPLIED SCIENCE  
Dept. 13-52, 1920 Sunnyside Ave., Chicago, Ill.

Gentlemen:—Without any obligation whatever, send me your new, fully illustrated, FREE book on Finger Prints and your offer of a FREE course in Secret Service Intelligence and the Free Professional Finger Print Outfit.

Name .....

Street Address .....

City and State .....



# FEAR

## Is Your Worst Enemy

I MEAN BY THIS FEAR OF SELF. If you are troubled with any of the following weaknesses you may be sure that the above statement is true in YOUR case. Do you lack SELF CONFIDENCE—SELF RELIANCE—or INITIATIVE? Do you indulge in WORRY—SELF DEPRECIATION—SELF CONSCIOUSNESS—APPREHENSION—OVERANXIETY—DOUBT or OVERSERIOUSNESS? If so, you are limiting yourself mentally, physically, socially and financially.



Such mental states mean unhappiness, general weakness—nerve supersensitiveness and an inferiority complex which develops physical weakness—neurasthenia—and may even lead to suicide or insanity. ALL SUCH FEARS CAN BE REMOVED.

### A FREE Preliminary Psychological Analysis of Your Case

I will mail to those who purchase my wonderful 90 page book, SELF MASTERY THROUGH UNDERSTANDING, one of my complete case sheets to be filled out and returned to me. Upon receipt of this history I will send you a scientific FREE ANALYSIS, without any obligation to you in any way. This will simply be giving yourself a fair chance and you cannot afford to let this opportunity pass by. I have successfully helped thousands during the seventeen years I have been in this work. I am a pioneer in the field of Psychology. Sit down and send for the book NOW.

The Cost of this Book is 25 Cents

**C. FRANKLIN LEAVITT, M.D.**  
Suite 746, 14 W. Washington Street, Chicago, Illinois

# Big Money in Poultry



**\$1,000 a Year**

Part Time

**\$5,000 a Year Full Time**

The Poultry Business needs more producers. 85% of the people of this country live in cities. The demand for eggs and poultry is far greater than the supply. You can earn \$1,000 a year in Poultry in spare time—or \$5,000 a year full time. We will show you how.

### Eggs are in Big Demand

You can't lose. No matter where you live, our course will show you how to make big money from poultry—how to feed for eggs in winter when eggs are high in price—how to keep your flock in healthy, paying condition—how to get the profits. Learn at home—start with just a few hens or with a big flock. In either case, we will make you succeed. Our course is endorsed by over 30 leading Agricultural Schools. It has brought success and independence to thousands. It will do the same for you. FREE BOOK tells everything. Mail the coupon now!



**Mail this now**

**The National Poultry Institute**  
Washington, D. C. Dept. 151D  
Gentlemen!

I am interested in your plan on "How to Make Poultry for Profit." You may send me your FREE BOOK. It is understood that this places me under no obligation.

Name .....

Address .....

## Be a Certified MASTER TELEGRAPHER!



### EARN \$165 to \$500 EVERY MONTH!

I guarantee to make you a cracker-jack Telegrapher in a few months by famous Dunlop System! No books here. All practical work on actual equipment. Prepares you for big pay jobs with Railroads, Brokers, Telegraph Companies, Newspapers, Broadcasting Stations or great ships.

### LEARN QUICK BY DUNLOP SYSTEM!

Write today for confidential offer to ambitious men, women, boys, or girls. I help you earn while you learn—you can work your way thru my school. Big catalog and complete information FREE.

DEL DUNLOP, Chief Dispatcher, Chicago Telegraph Institute  
1338 S. Michigan Ave. Dept. 401 Chicago

*I will teach you penmanship by mail*



Small Cost, Spare Time, Easy Lessons. Write for my Free Book, "How to Become an Expert Penman." It contains specimen and tells how others became expert writers by the Tevis Method. Your name will be written on a card if you enclose stamp. Write today. T. M. TEVIS, Box 25H, Chillicothe, Mo.

## Free Book for Auto Mechanics

Henry Rahe, who has trained more than 50,000 Auto Mechanics, has just published a new illustrated study course of immense value to the home mechanic. You can obtain a copy free by writing him at 1751 Rahe Building, Locust Street, Kansas City, Mo.

# MECHANICS' HANDBOOK



330 PAGES

HANDIEST book of its kind ever written. Prepared by experts under the direction of the International Correspondence Schools. Note this partial list of subjects:

Hydro-mechanics; Strength of Materials; Boiler Design; Care and Inspection of Boilers; Horsepower of Boilers; Chimneys; Exhaust Heating; Machine Design; Horsepower of Engines; Boilers and Pumps; The Slide Valve; Belt Pulleys; Rope Belting; Cylinders and Steam Chests; Electricity; Currents; Wiring; Dynamos and Motors; Batteries; Compass Surveying; Curves; Leveling; Etc.

Just fill out and mail the coupon with a dollar bill, and this 330-page I. C. S. Mechanics' Handbook will be sent to you by return mail.

Only \$1

TEAR OUT HERE

INTERNATIONAL CORRESPONDENCE SCHOOLS  
Box 5681-D, Scranton, Penna.

I enclose One Dollar. Please send me—post-paid—the 330-page I. C. S. Mechanics' Handbook. It is understood that if I am not entirely satisfied I may return this book within five days and you will refund my money.

Name .....

Address .....



# Train at Home For Big Money in RADIO!



**Earns College Education**  
I entered the maritime service of the Radio Corporation of America and served several months on board ship. I not only had the advantages of visiting foreign countries at no cost to me but I was also able to save enough money to pay for my tuition to college.  
**G. E. Rogers,**  
Troy, N. Y.



**Earns \$50 to \$83 a Week**  
I enjoyed every one of your lessons and had no trouble whatever. I earn \$50 to \$83 a week beside a commission on sales.  
**Michael De Marco,**  
Boston, Mass.



**Doubles Salary**  
I can very easily make double the amount of money now than before I enrolled with you.  
**T. Winder,**  
Grand Junction, Colo.



**Pay Increases Over \$100 a Month**  
I am averaging anywhere from \$75 to \$150 a month more than I was making before enrolling with you. I would not consider \$10,000 too much for the course.  
**A. N. Long,**  
Greensburg, Pa.

**Thousands earning \$50 to \$200 a week in easy, interesting work. You can do it!**

Radio just teems with money making opportunities. Every Radio set which is sold means profit in somebody's pocket. Every broadcasting station erected means big pay for Radio Engineers, Radio Mechanics, Operators, etc. Thousands are "cleaning up," fortunes are being made almost overnight in this fascinating business. Big salaries, interesting, easy work, short hours, and a wonderful future are offered to ambitious men who get into Radio now!

One of our recent graduates is making over \$400 a month in his own business. Another has increased his pay \$1,300 a year. Still another writes, "I made \$3,500 in one year working for myself."

## Easy to Learn Radio at Home in Spare Time

Right now Radio is the fastest growing industry in the world. Thousands of Certified Radio-technicians are wanted to design Radio sets; to make new Radio improvements; to manufacture Radio equipment and install it; to maintain and operate great broadcasting stations and home Radio sets; to repair and sell Radio apparatus; to operate aboard ships and at land stations. Employers write and telegraph us continually, seeking to employ our graduates at splendid salaries.

You, too, can easily and quickly qualify in your spare time at home through the help of the National Radio Institute—America's first and biggest correspondence radio school. No matter how little you know about electricity or Radio, we will guarantee to prepare you thoroughly for one of the big jobs in a few months. One of our recent graduates, Bert Roodzant, writes, "I now have a license and a good job, altho' I did not know the difference between a volt and an ampere before enrolling."

## You Learn by Doing

All materials required for practical instruction are furnished you free of charge. This is an absolutely complete course now being offered which prepares you for a Government First Class Commercial License and the really "big-pay" jobs in Radio.

## Send for Free Book and Special Offer

No other field today offers such great opportunities as Radio. Take your choice of the wonderful openings everywhere. Prepare now to step into the most fascinating and best paid profession today. Read about the opportunities open now—the different kinds of work—the salaries paid. Write today for 32-page book, "Rich Rewards in Radio," that tells how prominent Radio experts can teach you to become a Certified Radio-technician in your spare time.

**Important**—those who act immediately will also receive the details of our Special Reduced Rate. Mail the coupon or write a letter Now.

**National Radio Institute**  
Dept. 15DB Washington, D. C.



**\$405 in One Month**  
I cleaned up \$405 in one month recently. Not so bad—is it—for a fellow who just completed your course a short time ago.  
**Emmet Welch,**  
Peculiar, Mo.



**Tripled Salary**  
I am earning three times as much as before enrolling.  
**Arthur Herke,**  
Vancouver, B. C.



**From \$15 to \$80.00 a Week**  
Before I enrolled I was making \$15 a week. Now, I earn from \$2,080 to \$4,420 a year. I believe the course will be worth at least \$100,000 to me.  
**George A. Adams,**  
Tamaqua, Pa.



**NATIONAL RADIO INSTITUTE, Dept. 15DB,**  
Washington, D. C.

Without obligation send me your book, "Rich Rewards in Radio," which tells all about the opportunities in Radio, how spare time study at home will qualify me quickly as a Certified Radio-technician so I can get one of these splendid positions, and how your Employment Service helps me to secure a big pay job.

Name..... Age.....  
Street.....  
City..... State.....



# THESE MEN BUILT - ON "MICHIGAN STATE"



F. E. DULYEA

MARTIN VANDER BIE

Are **you** looking for something better in life? Opportunity? A better job? A business of your own? **More Money?**

The opportunities are waiting everywhere around you! Where? **In the automobile business.** In this great business with its 16,000,000 machines in use the year around. Thousands more skilled mechanics are needed at big pay. More garages, electric service stations, battery shops, etc., are needed everywhere. Men who really know this business right, as we can teach it to you, **make money.**

Here are two examples. These two men did not know a thing about repairing cars. Look at the business they have now. They are just plain ordinary fellows—no smarter than you or thousands of other men all over this country who are wondering how to make more money. But these men found the key to success—which is just picking out a good business and getting the **best** training for it that can be gotten—then going to it with hard work.

Read for yourself what they say—their letter tells you, in plain words, how to succeed:

## WOLVERINE GARAGE

Michigan State Automobile School,  
3729 Woodward Ave., Detroit, Mich.

Holland, Mich., Dec. 3, 1924.

Dear Friends: Just a few lines to let you know we are living and in good health, and as it is about the close of another successful year in the automobile business, we thought we would let you hear from us. We now have five mechanics in our shop and keep them very busy. Two of them are "Michigan State" graduates, like ourselves, so with 4 out of 7 men the School is well represented. In fact, WE HAVE NOT RUN UP AGAINST ANYTHING THAT COULD BE REPAIRED, THAT WE HAVEN'T MADE GOOD ON. We also sell Star, Flint and Durant Cars.

Our business has been steadily on the increase since we started. The first year's business was \$70,000 and 1924 IS \$150,000 so far, with prospects better yet for 1925. In a town of only 15,000, that looks pretty good to us.

Neither of us had any experience whatever in auto work before we took your course, but the thoroughness of your training certainly started us right, to success.

Yours truly,

F. E. DULYEA  
MARTIN VANDER BIE

These two men are not unusual. They are just ordinary fellows—like you. Thousands of "Michigan State" graduates are now enjoying good jobs or shops of their own.

## The Same Opportunities Are Open to You!

You can see, as well as they did, that there are millions of automobiles to be repaired—over 16,000,000 now. Many millions more to be built and sold. Think of this huge business. Get into it yourself. Get in with proper training. The untrained man gets nowhere. The trained man gets to the top.

## LEARN THE AUTO BUSINESS RIGHT— AT DETROIT, THE HEART OF THE INDUSTRY

Put this down—you **must** learn the business **RIGHT**. Get a thorough course. Your training is not a passing matter of a few weeks—it is an investment for your whole life. "Michigan State"

Detroit Training is what gets the good jobs. It's what gives you the ability to repair cars right and to make money in a business of your own.



You can learn the auto business in 12 weeks (from A to Z) here at Detroit—the **Heart** of the industry. Then step out, equipped with knowledge and training, to a future of certain, big money making. You have big advantages, learning the business here. It's the fountain head of the auto business. You are taught under factory endorsed methods. You learn both theory and practice on latest equipment. Go through the great Ford plants. Visit the other auto factories—learn their methods first hand. The Michigan State Automobile School, in Detroit, the auto center, is the logical place to learn the auto business.

## MICHIGAN STATE

302 Auto Building Detroit, Michigan

BE A DETROIT TRAINED MAN -



# A \$150,000 BUSINESS

## AUTO TRAINING



Here's Dulyea and Vander Bie's Garage and Salesroom

## No Experience or Education Needed

With just a liking for mechanics—you can learn the business here at this great auto trade School. **Head and Hand Training.** You learn the why of everything, with actual practice on fine equipment, new cars, engines, electric systems. The best of everything. And real service of expert instructors. It is this quality training which has given the "Michigan State" its high reputation. Your tuition fee here all goes for training, not for so-called inducements. The U. S. Government has given approval to this school to admit students from foreign countries, under special arrangements outside of immigration quotas, to take courses here. Auto factories also endorse our courses. *Hudson Motor Car Company* says: "You will make no mistake in attending M. S. A. S." *Packard* says the same. *Studebaker*—"We know of no better school." *Maxwell*—"The School is very fine." *Dodge* says: "The M. S. A. S. is an exceptionally high class School." *Buick* says: "Course thorough and complete in every detail."

**Government, factories and graduates unite to point your way to the "Michigan State" at Detroit, the Auto Center**

### Practice On Fine New Cars

Equipment includes new machines, all types of cars, engines, electrical systems. New cars such as Packard Eight, Oakland Six, Buick Six (all with 4-wheel brakes), Hupp, Olds, Reo, Gray, G. M. C. Truck, Hudson, Overland, many others.

### Real Training

This thorough training fattens your pay envelope if you work for others, or puts more profit in business for yourself. **You can take a full Automotive Course in 12 weeks. Or our great Master Course in 30 weeks, including autos, engines, electricity, batteries, welding, brazing, vulcanizing and machine shop.** Or take any part of this training that you need. Write for full details.

### FREE Business Course Included

Special Course on shop systems, management, banking, selling, to all students. This is conducted by a service manager of one of the leading auto companies of Detroit. It is just the training you need to put you head and shoulders above other garage men in your town.

*(Colored students may enroll for our Home Study Course only.)*

## AUTOMOBILE SCHOOL

3729 Woodward Avenue, Detroit, Michigan

**EARN BIG MONEY**

### Unconditional Guarantee

Our reputation is our best guarantee. But we add to that this positive agreement: A graduate of any course will be qualified to fill the position for which he is trained or we will refund his tuition fee in full.

### Earn While You Learn

We assist students to secure part time work to help pay expenses while in School. Or work days and take our evening course; many do this. It starts them to success. Ask for details, and explain your circumstances fully. We are here to help you succeed.

**Start any day.** Jump on the train for Detroit and begin at once. Or mail this coupon for further information.

**Home Study Course FREE.** If you can't start at once you can begin to learn at home by our fine Home Study Course. Then come here later. No extra charge for the Home Study training. Get the facts.

## Mail Coupon To Day

Michigan State Automobile School 302 Auto Building  
DETROIT, MICH.

Send me FREE and without obligation complete information about Detroit-training to make the most money.

Name.....

Street or R. F. D.....

City..... State.....

I am interested in  Resident Course at your School,  
 Home Study Course.



# Free Trial!

## In your own home—

Think of it! Our free trial offer makes it possible for you to become a crack Xylorimba player right in your own home. Easiest instrument to play. In addition, we furnish you free, 14 complete lessons. Learn to play in a few hours. With a little practice you can play jazz accompaniments. Be the life of the party—anywhere. Earn \$80.00 to \$200.00 a week with a

## DEAGAN Xylorimba

With this instrument you can play either for profit or for fun. Deagan Instruments furnish the "spice" of the music. Used exclusively in recording studios for phonograph records.

### Free Lessons—Easy Payments

Our free lessons and easy payment plan make it easy to learn at home, with the phonograph, radio, or other instrument. Send coupon below for illustrated literature and details of our special free trial offer.

### Mail Coupon Today!

J. C. DEAGAN, Inc., Dept. 1352  
Berteau and Ravenswood Avenues, Chicago, Ill.

Gentlemen: Without obligation please send me full information regarding your Free Trial Deagan Xylorimba offer.

Name .....

Address .....



## New Way to Make Money at Home

Send 2c now for postage on FREE BOOK-LET giving full details

We have openings for a few new members in Fireside Industries, a national organization of artistic home-workers. No experience needed. We teach you just what to do and furnish outfit to members without extra cost. Satisfaction guaranteed.

### FREE BOOK Tells How

You can easily make extra money, in spare hours or full time, without leaving home. Fascinating work, decorating beautiful art novelties to supply big demand. Read experiences of successful members.

**FIRESIDE INDUSTRIES**  
Dept. 662 ADRIAN, MICH.

## Make Champs

I give individual coaching by mail in your favorite sport. Twenty-eight champs to my credit. Let me make you one. My system never fails.

Write me what sport interests you. I will tell you how I can pep you up and turn you into a champ, as I did with Tim Jordan, Harry Babcock, and many others. Write today for my book FREE.

**SEIXAS ATHLETIC SYSTEMS, Dept. 2114, 1920 B'way, N.Y.**



## RUBY FREE

To introduce our imported Mexican **BLU-FLASH GEM**, the only low priced gem exactly matching genuine diamonds, with same blue-white brilliancy and rainbow fire, guaranteed 20 years, we'll send free this beautiful, flashing fiery red Mexican Ruby. Just clip out this ad, mail with your name, address and 10c to partly cover handling cost and we'll mail FREE, with catalog of gems and special half price offer. Write today.

Mexican Gem Importing Co., Dept. P-5, Meadville Park, N. Mex.

# STOP USING A TRUSS

## Do Away With Steel And Rubber Bands

## FREE TRIAL

TRADE MARK  
STUART'S ADHESIVE  
PLAPAO-PAD

Inner surface is made adhesive to secure the PLAPAO-PAD firmly to the body, keeping the PLAPAO continually applied and the pad from slipping. No straps, buckles or springs attached. Soft as velvet—easy to apply.

PAT'D  
APRIL 6  
1909

It's the Non-Slipping, yet Non-Rigid Pad and What is Within It That Counts

### FREE to 5,000 Truss Sufferers

To the extent of 5,000 sufferers who may apply I will send ABSOLUTELY FREE, a sufficient quantity of the Plapao to positively convince them that this is the only logical, common-sense way of treating rupture. Plapao is a highly satrington medication placed within the Plapao-Pad and being absorbed through the skin, creates a wonderful feeling of relief and at the same time tends to strengthen the weakened muscles and thus permanently close the rupture opening. The process of recovery is natural, so you'll have no use for a truss—you can throw it away forever! Old and young have testified under oath that the Plapao-Pads cured their rupture—many of them long-standing, aggravated cases—without delay from work. Patent allowed in U. S. and foreign countries. Awarded Gold Medal at Rome and Grand Prix at Paris.

**Send No Money**—for a sufficient quantity of the Plapao is sent without charge to enable you to give it a thorough test; you pay nothing for this trial now or ever. Write for it and full information today. Address - Plapao Laboratories, Block 1427 St. Louis, Mo.

# Electrical Course

In  
Book  
Form

Here is the quickest, easiest, cheapest way to learn electricity. Think of it! A complete electrical course in book form. No tiresome lessons with a lot of mathematics. Just plain everyday electrical facts—the very things and the only things you need know to hold down a good paying job. Written and simplified by 27 of the biggest men in the electrical field. 8 big books—4100 pages and 3300 pictures.

## Electricity Means Success

—Good Pay and a Good Job. You can succeed in electricity. It's one of the best paying fields open to young men who know.

You do not have to give up your present position, just a few pleasant hours spent in the evenings on this subject, and success is yours.

### FREE TRIAL!

Just mail the coupon—don't send a cent. We send books for a week's free use. Look them over yourself, and see how thoroughly and completely everything about electricity is explained in them.

**American Technical Society**  
58th St. & Drexel Ave. Dept. E-219

American Technical Society, Dept. E-219, Chicago

Send me your 8-volume set of Electrical books for a week's free use. I will either return the books in 7 days or remit \$2.50 and pay you \$2.50 each month until a total of \$25.00 is paid.

Name .....

Address .....

Employed by .....

Copy this coupon on larger sheet if more convenient



# Look Here!



Earnings up to

**\$500**

a month!

Get into the Easiest, Finest,  
Most Fascinating, Big-Pay  
Work in the World!

Be **DRAFTING**  
a **EXPERT**

From \$120 to

**\$250**

a month through

"Job-Method"

S. Novak, 977 Walnut  
Street, Freeland, Pa.,  
writes as follows:

"I will write you a few  
lines to tell you how you  
have given me a trade  
and made a Draftsman  
out of a Laborer at \$4.50  
for ten hours. Now it is  
\$10 for eight hours' easy  
work.

"Your training has  
helped me 100 per cent  
—more pay—less hours  
—and easier work.

"S. NOVAK."



**Big Pay—Great Opportunities**

**Now You Can Get PRACTICAL Training  
FROM PRACTICAL ENGINEERS**

If you're earning a cent less than \$50 a week, clip coupon now! Send for FREE BOOK. Be a DRAFTING EXPERT. Positions everywhere. Easiest, most fascinating work in the world. Short hours. Big Pay. Unlimited Opportunities. Drafting Experts are in contact with BIG MEN—in line for promotion—BIG PAY. Amazing Careers built on Drafting. President greatest Railway System in America and President Million Dollar Corporation, started as Drafting Experts.

**Great Association Brings Famous "Job-Method" Training RIGHT TO YOUR HOME!**

Get that FREE Book. Find out about this Thorough, Easy, Simplified, Money-making Training. Common schooling all you need. We guarantee to train you successfully—AT HOME, with actual Drafting Jobs. Also Professional Instruments FREE! Personal and Individual lifetime Consultation Service from Accredited Engineers FREE to you. Famous "Job-Method" not narrow, one-man viewpoint but the result of the combined effort and years of practical experience of these famous Engineers. FREE EMPLOYMENT SERVICE. POWERFUL ASSOCIATION BACKS YOU UP. Drafting Expert's Outfit FREE. Many other big features special for limited time. ACT NOW.

**Big Outfit FREE!**

To help you get started for Big Pay. Limited time only. Same Instruments Engineers use. Valued at \$15. Absolutely Free. Write quick. Clip Coupon Now for Special Offer and full information.

Address Chief of Staff  
**ASSOCIATED  
DRAFTING ENGINEERS**  
1920 Sunnyside Ave.  
Dept. 219 Chicago, Ill.

**FREE DRAFTING BOOK!**

Chief of Staff  
**ASSOCIATED DRAFTING ENGINEERS**  
Dept. 219, 1920 Sunnyside Ave.,  
CHICAGO, ILL.

Without obligating me in any way, please send me your book, "Drafting, the Foundation of Industry" absolutely free. Also complete information of your rapid "Job-Way" home-study Drafting course, free instruments and special offer.

Name .....

Address .....

FREE!



**MAIL COUPON TO-DAY!**



# If you make less than \$75 a Week don't turn this page



If you are making less than \$75 a week—  
If you have reached the limits of advancement in your present job—

Read every word of this advertisement before you turn the page.

For it tells about the amazing opportunities offered by chain organizations to men trained in chain store management and administration.

These organizations are constantly searching for trained store managers, district managers, location managers, personnel managers, accountants, statistical control men, buyers, merchandise managers, sales and advertising managers.

And they are glad to pay the price—\$75 to \$300 a week.  
If you are ambitious and possess average intelligence I will train you by mail to fill any one of these positions. And after you have passed my course in chain store technique with credit I'll place you with a chain store organization, right in your own section of the country.

## Read These!

My dear Mr. Higgins:—

As per conversation with you, one of our big problems has been getting suitable men to act as managers of our stores.

Since we understand that you are conducting a school for training chain store executives we should be pleased to interview such men as you recommend.

Yours very truly, (Signed)  
Joseph M. Sydeman,  
Vice-President.

Dear Mr. Higgins:

I am leaving tonight for the position in Mobile, Ala., that you secured for me and I want to thank you for the assistance that you have given me, and to say that I am finding your course in Chain Store Technique very practical and I know that when I have completed it I shall be ready to make good in a position of even greater responsibility.

I am glad to commend the course to other young men seeking a business career. I feel that in this course I have found something that I have been looking for for years.

Respectfully yours (Signed)  
Eugene Stockhouse.

Mr. Matthew S. Higgins,  
111 East 10th Street, New York City, Dept. PM3.

Dear Mr. Higgins:  
Send me, absolutely free, full information about your course in chain store technique and proof that you can train me to fill a position paying \$75 to \$300 a week.

Name.....  
Address.....  
City.....State.....  
Present Occupation.....

## Be an EXPERT Watchmaker! Earn \$55 to \$90 every week



Make money while learning.  
Write for my "Profit-Sharing plan."



View in my school. Day or night instruction. Earn while you learn here!

J. Kate Smith, Tiffin, Ohio, one of the most successful jewelers in that part of the state, writes, "Strictly square dealings and the excellent training I received at your hands have made this possible."

Louis C. Rathbun, Colwyn, Iowa, "Swearer Trained," started in a very small way now doing over \$20,000 a year.

### Big pay only 7 months away!

You don't have to put in 3 years as apprentice at starvation wages to learn watchmaking. In my big School at Chicago I train you in a few months to repair any make of watch, clock or chronometer, to make parts, etc. Jewelry repairing and engraving courses free to every student of watch-making for a limited time.

### Go into business—be your own boss!

Jobs are plentiful, but go after the big game—a business of your own. I help you find a location, help you run your repair shop and jewelry store, help you succeed. Little capital needed when you get my training.

### WRITE ME TODAY!

My students learn on actual watch-repair jobs and I pay them while learning. Get my free book and offers quick!

**CHICAGO SCHOOL OF WATCHMAKING**  
Thomas Sweazey, Prin., Dist. 101, 4845 Lincoln Ave., Chicago

## STEAM ENGINEER'S HANDBOOK



### 298 PAGES—50,000 SOLD

Handiest book of its kind ever written. Prepared by experts under the direction of the International Correspondence Schools. A valuable reference book worth many times its small cost of one dollar. Note this partial list of contents:—

Mathematics, Mensuration, Useful Tables, Weights and Sizes of Material, Chemistry, Heat, Mechanics, Work and Power, Belting, Hydraulics, Steam, Steam Boilers, Boiler Feeding, Boiler Management, Boiler Inspection, Hydraulic Test, Boiler Explosions, Steam Engines, Measurements and Steam Consumption, Condensers, Engine Management, Steam Turbines, Propulsion of Vessels, Engineers' License Laws, States and Cities having License Laws, License Laws for Stationary Engineers, Abstracts of City Engineers' License Ordinances, United States Marine Law, etc.

Just fill in and mail the coupon with a dollar bill and this 298-page I. C. S. Steam Engineer's Handbook will be sent to you by return mail. Money back if not satisfactory.

Only  
\$1

TEAR OUT HERE

INTERNATIONAL CORRESPONDENCE SCHOOLS

Box 5683-D, Scranton, Penna.

I enclose One Dollar. Please send me—post-paid—the 298-page I. C. S. Steam Engineer's Handbook.

Name.....  
Address.....





# Electricity Needs You

## I WILL TRAIN YOU AT HOME

### Cooke Trained Men Get the Big Jobs in Electricity

They get the big jobs because they are trained to fill big jobs, by a practical man who has been through the hard mill of experience himself. Here are some of the things that my "Boys" get when they enroll for my course—The lowest priced, and very best available home-study Course in Electricity ever offered. You must get all these things if you want a complete course.

1. Practical instructions by a practical engineer—a college trained man backed up with many years of practical experience.

2. Simplified instruction—Lessons so easy to master that lack of education or experience is no drawback.

3. Free employment service, supervised by an expert employment man, that actually gets you the job you want.

4. Special instruction that helps you earn extra money in your spare time right from the start.

5. Free complete outfit of tools and electrical apparatus—not toys but real honest-to-goodness equipment that you can use in your work.

6. Free Unlimited Consultation Service that helps you with unusual problems while you are studying and afterward.

7. Free Subscription to monthly Engineering Magazine which keeps you posted on all new developments in electricity.

8. Free use of Electrical Laboratory where you can come for actual experience or to develop an idea of your own.

9. Free Accommodations for visiting students while working in laboratory.

10. Free special courses on Radio, Auto Electricity, Electrical Drafting and a splendid Business Course for men who want to go into business for themselves.

11. Guarantee of absolute satisfaction or your money refunded.

**S**TOP right here. This is YOUR BIG OPPORTUNITY. Electricity is calling you. The Electrical Industry is the fastest growing thing in the world. It is expanding at the rate of a billion dollars a year. But it needs more trained men—big-pay men. With My Home Study Course in Practical Electricity I can quickly fit you to fill one of these big-pay jobs.

## EARN \$70 to \$200 a WEEK

You've always had a liking for Electricity and a hankering to do electrical jobs. Now is the time to develop that talent; and make big money out of it. Even if you don't know anything at all about Electricity you can quickly learn it through my simplified and practical method of teaching. I have trained thousands of men and put them in big pay jobs, in all parts of the country. I can place thousands more in similar positions. As Chief Engineer of the great Chicago Engineering Works, a million dollar Institution, I know where the big jobs are and what you must know to fill them—that's what I give you in my Course. Get ready now—let me train you to earn \$3,500 to \$10,000 a year.

## Be a Big Paid Electrical Expert

What are you doing to prepare yourself for a real success? At the rate you are going where will you be in ten years from now? Have you the specialized training that will put you on the road to success? Have you ambition enough to prepare for success, and get it?

You have got the ambition and I will give you the training, so get busy. I am offering you success and all that goes with it. Will you take it? I'll make you an ELECTRICAL EXPERT. I will train you as you should be trained. I will give you the benefit of my advice and 20 years of engineering experience and help you in every way to the biggest possible success.

## Valuable Book FREE

My book, The "Vital Facts" about Electricity, has started many a man on the way to fortune. It shows how you too, can quickly become a highly paid Electrical Expert. I will send a copy, free and prepaid, to every person answering this advertisement.

**Act Now!** Good intentions never get you anywhere. It is action, alone, that counts. NOW IS THE TIME TO ACT. Mail the Coupon NOW.

L. L. COOKE, Chief Engineer

**CHICAGO  
ENGINEERING  
WORKS**

2150 LAWRENCE AVENUE  
Dept. 512, Chicago, U. S. A.

**Chief Engineer Cooke  
Chicago Engineering Works  
Dept. 512, 2150 Lawrence Avenue  
CHICAGO, ILL.**

Dear Sir:

You may send me, entirely free and fully prepaid, a copy of your book, The "Vital Facts" about Electricity, and particulars about your Home Study Course in Electricity and your special free features.

Name .....

Address .....

City ..... State .....

**The "Cooke" Trained Man is the "Big Pay" Man**



## The Most Astounding Announcement ever made to Boxing Fans by JIMMY DeFOREST

*World's Greatest Trainer and Boxing Instructor*



I have adapted the complete system of training and boxing instruction with which I developed Jack Dempsey, Firpo, Joe Gans, Pal Moore, and a score of other famous fighters, to a *course of training and boxing instruction by mail*. This course will teach you all that I taught these champions, *right in your own home and at very slight cost*. Every six months I will select the men in each weight class who make the best showing on my course, and *Tex Rickard will stage them in star bouts at Madison Square Garden, New York*.

I have developed more champions and great fighters in every class, and introduced more new punches, principles of footwork and defense and tricks of ring strategy than the rest of the trainers put together. *And my wonderfully comprehensive course will make you master of them all in twenty short weeks*.

I personally designed and wrote this course, and it is profusely illustrated with practical diagrams, many of which I personally posed for. To take my course from beginning to end is to prepare yourself fully to enter and succeed in a profession which affords even mediocre talent more money, glory and independence than even the leaders of other professions can command.

### SEND FOR MY BOOK "The Golden Age of Boxing"

Send ten cents to cover cost of mailing and postage, and I will send you my big, brilliant, 56-page book, which fully describes my course, and is also the most meaty message ever written about the great opportunity for the lads of today to win fame and fortune in the ring. It is crammed with pictures, many of which are from my own private collection and not to be duplicated. Send for this great book TODAY SURE!

*Jimmy DeForest*

Box 612, 347 Madison Avenue  
New York City



## HOW MUCH do ARTISTS EARN?

WOULD you like to earn \$100 a week as a commercial artist? If you like to draw, you should develop your talent, for well-trained artists earn \$75, \$100, \$150 a week, and often-times much more. Beginners who can do practical work soon command \$50 a week. The Federal home-study course develops your talent on a sure foundation by the **quickest possible method**, and makes the work truly a pleasure. It is the **original, practical** course in commercial art, created by men with more than 25 years' experience in the field, and after 11 years of unequalled success today stands supreme as America's Foremost Course in Commercial Designing. It contains **exclusive** lessons from leading American artists, gives you individual personal criticisms on all lessons and teaches you the methods that make your drawings worth real money.

### Send Today for "YOUR FUTURE"

If you are in earnest about your future, send 6c in stamps today for this book. It is beautifully illustrated, tells every detail about the Federal Course, gives you convincing proofs of its merits and shows work done by Federal Students. Fill out and mail the coupon NOW, kindly stating your age and present occupation.



## Federal of School Commercial Designing

601 Federal Schools Bldg., Minneapolis, Minn.  
Gentlemen: Please send me "YOUR FUTURE," for which I enclose 6c in stamps.

Name.....

Present Occupation.....

Age.....

Write your address plainly in margin.



# Take Your Choice—Any One FREE

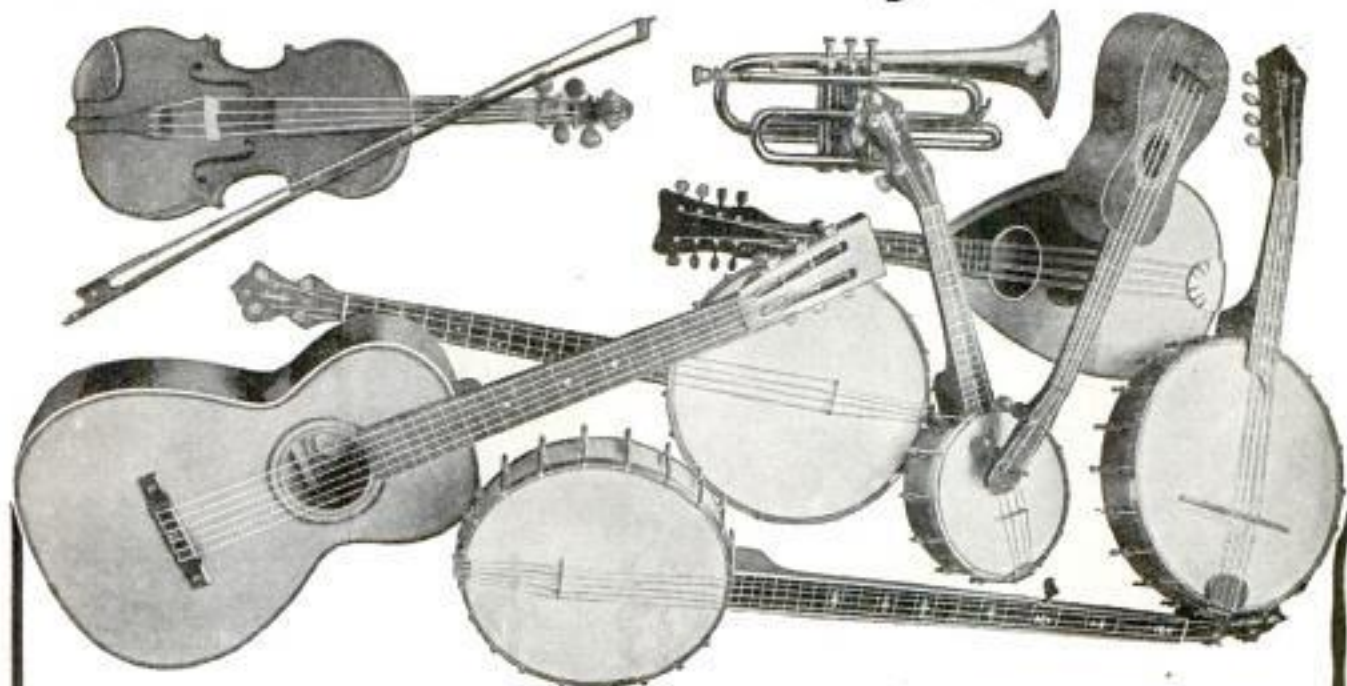

**\$20 VALUE** VIOLIN, MAN-  
DOLIN, GUITAR,  
UKULELE, HAWAIIAN GUITAR,  
BANJO, BANJO MANDOLIN, TENOR  
BANJO, CORNET or BANJO UKULELE

**FREE**

## And Learn to Play AT HOME in Your Spare Time for Profit or Pleasure

These high-class instruments are actually given away. They are free to pupils. Which one do you want? Which instrument do you want to learn? Send no money—just the coupon.

### Everyone Loves Music

Our wonderful new system enables everyone to learn to play their favorite instrument in a few easy lessons. You can learn to play any of the instruments shown in a remarkably short time. Your spare time will do and it **only costs a few cents a week**. No charge for the instrument, just the lessons. That is your only expense. Why not mail the coupon today? You can be playing real music BY NOTE in a few short months if you do.

### Play by Note in 4 Lessons

This new system is very simple. Anyone can understand it. You can be playing standard note music in 4 lessons. We guarantee this. You pay nothing if you fail and only a few cents a week for the lessons while learning, nothing for the instrument you want. Every lesson is complete; you go along in easy steps. Learn to play either for your own pleasure or for profit. Do not wait longer to become a musician and be popular among your friends.

**Slingerland's Correspondence School of Music**  
Dept. 2 Lincoln Park P. O., Chicago, Ill.

### Your Success Guaranteed

This is the most remarkable offer you ever read. Just think—the instrument FREE, only a few cents a week for the lessons and your success guaranteed or money back. Why should you delay? You have everything to gain and nothing to lose. Send the coupon now while the Free Instruments Offer is good. We reserve the right to withdraw it at any time without notice. You may never have the same chance again. **Send the Coupon.**

*If you own a piano, organ or other musical instrument and want to learn to play it, write for special booklet and terms.*

#### COUPON

**Slingerland's Correspondence School of Music**  
Dept. 2, Lincoln Park P. O., Chicago, Ill.

I want a \_\_\_\_\_ FREE and learn how to  
play it by your easy method. Please send me full particu-  
lars and detailed information. This request does not ob-  
ligate me in any way.

Name \_\_\_\_\_

Address \_\_\_\_\_

City \_\_\_\_\_

State \_\_\_\_\_





## Out of the Crowd Into a \$7500 Job Electricity

Do you realize that there is a crying and insistent demand for men who are fitted to accept important positions? Think of it! Positions that pay anywhere from \$3500 to \$10,000 a year which means \$70 to \$200 per week are actually going begging because there are not men enough to step into the shoes of these big jobs. You can get out of the crowd and out of the rut and fill one of these big jobs—electrical training will put you there, and do it quickly. Our master teacher, Mr. H. George Streuber, has perfected a system of home instruction which will enable you to master electrical engineering in ten, easy-to-understand short lessons. Even if you never had any previous electrical knowledge whatsoever, you are sure to get on, because Mr. Streuber's method is so simple.

### Working Outfit and Motor FREE

Besides furnishing you with easy-to-understand lessons, diagrams and drawings, we will present to you free when you enroll, a working outfit of great value which includes a motor. Our free working outfit offer is limited. Be one of the lucky ones. Act at once. Receive by return mail our book, "How to Learn Electricity." Don't get off until tomorrow. You might forget and miss this opportunity which can be the turning point in your career.

WORLD TECHNICAL INSTITUTE, Class 2002,  
1 Montgomery St., JERSEY CITY—N. J.  
Please send me by return mail your book, "How to Learn Electricity." Also receive a free working outfit for me. This obligates me in no way whatsoever.

Name.....

Address.....

City..... State.....

Write for  
**FREE  
BOOK**

How to  
Learn  
Elect

## A Great Book Free with this pay-raising library

For a short time only we will give every subscriber to the New Library of Machine Shop Practice a copy of French's Engineering Drawing—the greatest book on mechanical drawing ever written. This book makes drawing as plain as day—tells you all about instruments, plans and methods—and prepares you to handle any drawing job you will ever have to do. It comes to you absolutely free with

## Machine Shop Practice

9 volumes—3065 pages—3608 illustrations  
(A combined home study course and reference library)

The New Machine Shop Library is written for practical men. It gives you the best methods for every kind of machine shop work. It explains machine tools and their operation, drawing and design, tool work, gears and grinding, jigs and fixtures, automatic screw machines and their tools and all of the mathematics you will ever have to use. It is plainly written, completely illustrated—the very best kind of help to the machine shop man who wants to advance himself.

Sent **FREE** No money down—only 7c a day



### FREE EXAMINATION COUPON

McGraw-Hill Book Co., Inc., 370 Seventh Ave., New York  
Send me for 10 days' free examination the New Library of Machine Shop Practice. If satisfactory I will send you \$1.50 in 10 days and \$2.00 monthly until the special price of \$19.50 is paid. If not wanted, I will return the books at your expense.

On receipt of my first payment of \$1.50 it is understood that I am to receive, free of charge, a copy of the second edition of French's Engineering Drawing.

Signature.....

Address.....

City and State.....

Position.....

Employer..... P. M. 2-1-75

## I'll Pay You \$150 A Week



Introducing my amazing new Super-Automatic Washer. Fits in any wash boiler—washes large family washing in 30 minutes; creates its own power—shoots 64 jets of hot, soapy, steady water constantly through the clothes. No work or rubbing. No electricity, gas engine or hand power. Greatest invention of age. Costs only a few dollars complete. Fully guaranteed. Sells like wildfire.

### FREE OUTFIT

to workers—No capital or experience necessary. Full or spare time. Cash profits daily. Schalk made \$24.50 first two days—Bryce made \$645 in one month. You can do the same. No charge for exclusive territory. Write for Free Outfit Offer today. MERLE MFG. CO., Dept. 1-19, Aurora, Illinois.

## LEARN VIOLIN NEW EASY WAY!

**VIOLIN FURNISHED!** Marvellous new Master Method teaches you by mail in 1/2 time and at 1/10th cost. No numbers or trick music. Play a real piece by note in fifth lesson. Easy as A B C. Diploma awarded. Beginners or advanced players. Money back guarantee. Send today for free booklet. Will be sent in plain wrapper. Write plainly. **MASTER VIOLIN SCHOOL**, 52 E. 42nd St., Conv. 704, New York, N. Y.

## Free Auto Book

\$40 to \$100 weekly pay check is yours if you become an auto mechanic, electrician, etc. Learn by tested training methods at National, million dollar training headquarters for auto experts. We guarantee to qualify you. Earn while you learn. Big 84-page book with 150 illustrations explains everything. Send **FREE**—write to-day. **NATIONAL AUTOMOTIVE** Dept. 317, 4004 South Figueroa LOS ANGELES, CALIFORNIA

Our BUREAU OF INFORMATION will answer all questions regarding articles in this magazine. Address Popular Mechanics Magazine, Chicago.



## U. S. Government Needs Men!

Wonderful opportunities in Civil Service. Thousands of men and women appointed every year as Income Tax Auditors, Bookkeepers, Railway Mail Clerks, Postmen, Deputy Collectors, etc. Generous salaries, short hours, liberal vacations. Positions open in Washington and in other cities.

Mail the Coupon for Free Booklet  
on Civil Service

INTERNATIONAL CORRESPONDENCE SCHOOLS  
Box 5680-D, Scranton, Penna.

Without cost or obligation, please send me a copy of your 48-page CIVIL SERVICE BOOKLET, which tells how I can secure a good-paying position with the U. S. Government.

Name.....

Address.....



# I Guarantee You a JOB

## and a 50% Raise!



My student of today learns quickly and easily on actual Electrical equipment which I supply without extra cost

Dunlap-training is so complete and practical that it prepares you for the BOSS jobs at \$60 to \$200 a week



If you are now earning less than \$40 a week, enroll for my home-training in Electricity, and I will guarantee you a job and a 50% raise in writing under bond after you finish, or I will refund every cent of your money!

### World's greatest business needs you!

While you're at it, while you're spending time and money to be a success, train for boss-jobs in world's biggest, fastest growing industry. Millions of men now employed, but millions more will be needed to build Electrical machinery, operate power plants, manufacture Radio and Electrical appliances, run the telephone and telegraph systems, make and install and repair automotive electrical equipment, etc.

Write me today!

Mail coupon for ALL the facts. Get my guarantee of a job and a raise. Get my new, big free book. Get my surprise offer to ambitious men.

Mail coupon today!

## \$60 to \$200 a Week for

### ELECTRICAL EXPERTS!

Enormous demand for Power Plant Superintendents, Chief Electricians, Foremen of Construction, Electrical Contractors, Electrical Stores, shops and businesses of all kinds. Actually millions of opportunities. Big-pay Jobs waiting, and thousands of opportunities to go into business with small capital. But first you need my training. Without it these opportunities mean nothing to you.

### 22 Noted Electrical Engineers

This is no one-man, one-idea school. 22 famous Engineers and Executives of the following great corporations and universities helped me make Dunlap training the most complete and up-to-date:

- |                                       |   |
|---------------------------------------|---|
| 1. General Electric Co.               | 8. Underwriters Laboratories, Inc.        |
| 2. Commonwealth Edison Co.            | 9. Columbia University                    |
| 3. Crocker-Wheeler Co.                | 10. Dartmouth College                     |
| 4. Cutler-Hammer Mfg. Co.             | 11. Massachusetts Institute of Technology |
| 5. American Telephone & Telegraph Co. | 12. Lehigh University                     |
| 6. Westinghouse Electric & Mfg. Co.   | 13. University of Vermont                 |
| 7. Western Electric Co.               | 14. Armour Institute of Technology        |
|                                       | 15. University of Kansas                  |

AND MANY OTHERS

## I give you 4 Electrical Outfits

Dunlap "Job-Method" training makes it easy for you

to understand Electrical theories and laws. With this complete valuable equipment which I send you without extra charge, you can master Electrical principles and practice instantly. Dunlap-trained Electrical Experts do not need any post-graduate Laboratory practice—they get it all at home with these 4 outfits.

CHIEF ENGINEER DUNLAP  
AMERICAN SCHOOL

Dept. EA-274, Drexel Ave. & 58th St., Chicago

Earn while you learn

As early as your eleventh lesson, I give you special training in wiring, radio, repair jobs, etc. Many students easily earn cost of training in spare time. You too, too.

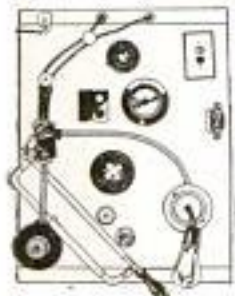

Mail coupon today!

## JOB and RAISE COUPON

AMERICAN SCHOOL  
Dept. EA-274, Drexel Av. & 58th St., CHICAGO

Send me at once, free book, complete information, guarantee of a job and a 50% raise and your confidential surprise offer.

Name.....

St. No. ....

City..... State.....



# POSITION *Expenses Paid* GUARANTEED *To Graduates or Money Refunded*



## BE A RAILWAY TRAFFIC INSPECTOR

### Chances For Rapid Advancement Unlimited

You travel, you see the country, you come in contact with high railway officials in this important confidential work—or you can remain near home, if you prefer. The work is pleasant, with no monotony and the hours are not long.

### EARN Up To \$250.00 Per Month Expenses Paid

Prepare in three months' spare-time study at home. Any average man can qualify. Advancement rapid with experience, starting at not less than \$110.00 per month and often running up to \$250.00 per month and more. Hundreds of successful graduates everywhere—and yet **many more trained men are needed.**

YOU CAN SUCCEED and enjoy this fascinating work, without risking a penny during preparation. Our guarantee is that we will place you in a position paying at least \$110.00 a month and expenses upon graduation or we will refund all that you have paid. **We stake our business reputation upon the honesty of our guarantee.**

Standard Business Training Inst.  
Buffalo, N. Y.

**Mail  
Today**

#### These Men and Hundreds of Other Graduates Have Proven It



A. A. Quintana

A. A. Quintana, a graduate, says: "I have been working in my present position for over a year and the manager is well satisfied with my work and I have already received an advancement in salary."

J. W. Mensinger states: "My work must be satisfactory as my wages have been increased. There are great opportunities for first-class inspectors and my advice to anyone wishing such a position is that he will make no mistake in securing a training in your school."



J. W. Mensinger



Stanley W. Dress

Stanley W. Dress writes: "There is no other work that gives more opportunities to travel than that of a Traffic Inspector and at the same time is interesting and instructive. **There is no end of advancement to the person who sticks to it.**"

## Don't Delay

Send for details of this real opportunity. Cost is moderate and easy terms may be arranged. Get our free Booklet No. D-63. Send coupon, **now**, while you think of it.

### Organized in 1918— Seventh Year

Standard Business Training Inst.,  
Buffalo, N. Y.

Send me, entirely free, Booklet No. D-63, giving full particulars about course in Railway Traffic Inspection.

Name.....

Street.....

City.....





## Which One Has Personal Magnetism?

**Y**OU can tell at a glance, of course. There is no mistaking the man, or the woman, whose very manner radiates personal attraction, whose very presence is a magnet that draws and holds the attention of others.

How much personal magnetism have you? Do you find it easy to mingle with strangers, making friends as you go? Do you find it easy to mix with people at a dance or at a party, feeling thoroughly poised, calm, sure of yourself? Do you find it easy to win the confidence of people in business, impressing them instantly, commanding their attention, swaying them to your way of thinking?

You have the magnetic attraction you need, but you are not using it! Learn the secret of magnetic control, and it is inevitable that you will be popular wherever you go, with whomever you happen to be. You can be popular in social life, successful in business. You can be strong, healthy, powerful—confident of yourself—conscious of your powers—*successful!* Here's how!



### What Is Sex Magnetism?

What is that powerful magnetic influence that draws one man to one woman—forever, irresistibly? What is that strange, never-failing spark that awakens love? What is it, in man or woman, that seems to draw and fascinate—the hypnotic power that no one can resist?

You have it. Everyone has it. *But do you use it?*

magnetism, your sex magnetism, your emotional magnetism, your passional magnetism, your aggressive magnetism. You can sway and control others. You can command success. You can influence people to do the things you want them to do. You can overcome nervousness, worry, ill health.

All these are but the first and most conspicuous results of magnetic control. The great, fundamental change is in your own personality. Release the magnetic influence of your nature—and feel instantly conscious of a new power surging through you, a new confidence in yourself, a new poise and self-assurance!

### An Interesting Booklet Sent Free On Request

We will be glad to send you, absolutely without cost or obligation, our fascinating new book called "Your Magnetic Powers" which explains in detail what personal magnetism really is, why only one person in a thousand uses this amazing natural power, and what it can do for you throughout life once you

release it through the remarkable Shaftesbury system.

You must have a copy. Send your name and address so that we can forward it to you at once. No obligation.

### RALSTON UNIVERSITY PRESS

Dept. 13-B

MERIDEN, CONN.

Ralston University Press, Dept. 13-B, Meriden, Conn.

I'd like to know a little more about Personal Magnetism, and about the famous Shaftesbury system that develops mental and personal magnetism. Send me your interesting free book called "Your Magnetic Powers" and remember that there is not the slightest obligation of any sort to me.

Name.....

Address.....

City.....State.....

### The Shaftesbury System for Cultivating Personal Magnetism

Edmund Shaftesbury, famous scientist and psychologist, has perfected a simple system based upon the one great fundamental principle of magnetic control. It is the same amazing principle that Shaftesbury has been quietly teaching to a select group of people who were able to pay hundreds of dollars for the privilege. Now anyone, at trifling cost, can come into possession of this extraordinary secret of magnetic control that has made Shaftesbury one of the leading scientists of our age.

Through this simple system you can become a new, dominant, powerful, magnetic personality. You can release at once all the subtle magnetic influence of your nature—your imprisoned mental





# Sweeney To Make

**Accept my amazing offer—Tuition at HALF COST—and come to Sweeney Auto School, Kansas City, Mo., the only place in the world where you can get the “Sweeney System of Training”**



**Auto Mechanics \$125 a Month and Up**

**There's Only One SWEENEY SCHOOL. It's at Kansas City, Mo.**



I want you to succeed, and I know you can. I am doing my part by making my tuition price so you can come right now—You've long wanted to come to this Million Dollar School, but you just couldn't see how you could make it. NOW IT WILL BE EASY and I am sure you are going to come. I've raised the salaries of thousands of other fellows—I can do it for you, and if you decide now to come here, spend a few weeks in actual “Learn by Doing” training, there's a good job paying big money ready for you.

If you are mechanically inclined COME RIGHT NOW TO THE MILLION DOLLAR SWEENEY SCHOOL. I teach you by doing actual work. No books are used. You'll wear overalls, get your hands and clothes dirty and greasy. BUT YOU'LL LEARN EVERYTHING about all kinds of automobiles, tractors, oxy-acetylene welding, vulcanizing, battery work, electrical work, building and repairing radio sets and in a few weeks be able to cash in on your time. No previous experience or education is needed.



**Battery Experts \$150 Month and Up**

**You Cannot Get the “Sweeney System of Training” Anywhere Except at the Sweeney Auto School, Kansas City, Mo. Now I Cut the Tuition Price One-Half to Make It Easy for You to Come Now**

**Mail The Coupon Right Now Or Wire Me When You Will Be Here.** I want to prove that you can do what thousands of men in just your position have done as a result of SWEENEY TRAINING. Take up the Auto Business now. LEARN IT AT SWEENEY'S. Ask any Sweeney Man. They are in good positions all over the country, repairing and selling Autos, driving cars and trucks, mechanics running garages, tire shops, battery stations, welders, handling radio supplies.

**Get the BEST and  
Get It for LESS**

The Million Dollar Sweeney School Building is just across the Plaza from the Union Station, and stands at the foot of beautiful Memorial Hill upon which a \$2,000,000 building is being completed. It is 10 stories high and covers 12 acres of floor space. Every foot is devoted to practical instruction and floor after floor filled with the very latest gas engine, electrical and radio equipment for you to work on. Scores of expert instructors all trained under the Sweeney System to work with you. The Sweeney School is a small city in itself.

**LEARN**  
**Sweeney**  
**AUTOMOTIVE &**  
**231-A SWEENEY BLDG.**

**SEE SWEENEY DOUBLE-PAGE AD ON NEXT TWO PAGES**



# Trains Men Big Money!

And Now Cuts **1/2** So You Can Start Your  
The Tuition Training At Once

IF YOU WILL COME RIGHT NOW I WILL CUT THE PRICE JUST EXACTLY ONE HALF. I further guarantee you the same high class practical instruction under skilled instructors that has made the Sweeney Automotive and Electrical School World Famous. Over 60,000 graduates, and I estimate of that number 20,000 of them are making big money in their own business.

I know there are thousands of you fellows right now ready to take the first step towards independence. NOW I AM MAKING IT EASY FOR YOU—JUST HALF PRICE. You must ACT NOW, not NEXT WEEK or NEXT MONTH. I've got everything here you want—Expert Instructors—the best available equipment—over \$200,000 invested—over \$50,000 invested in my big Radio Station WHB.



Welding Experts \$150 a Month and Up

## LEARN A GOOD TRADE



Electrical Experts \$175 Month and Up

Look at the views of my students doing actual work. These boys know they will soon be ready to take positions in any part of the country paying from \$150 to \$500 a month and more, or owning their own business. YOU CAN DO IT TOO. DECIDE NOW TO LEARN A TRADE. There's ONLY ONE WAY to learn if you want to save time and money and be properly trained—THE SWEENEY SYSTEM OF PRACTICAL INSTRUCTION. You get this at the World Famous Trade School, the Million Dollar Sweeney School, and you get it nowhere else.

## MY FREE BOOK TELLS YOU—

- How to get a good mechanical job.
- How to be a chauffeur or truck driver.
- How to repair any make of car. How to weld.
- How to make batteries and auto tires.
- Shows you hundreds of actual photographs of men at work in my big shops.
- Shows how 60,000 men got their start.
- Shows how easy it is to learn; how much fun you have during recreation hours. Swimming pool, entertainment, band and orchestra, radio broadcasting.
- Answers every question.

**WRITE ME TODAY** The first step is to get my free 64 page book. I will gladly send it to you. And I will make you an amazing offer. I will make it easy for any man to learn the auto business. I will send you this valuable book FREE—no cost—no obligation. No colored students accepted. Answer this now and get my book and Special Offer.  
EMORY J. SWEENEY, Pres.

Do Not Confuse The SWEENEY SCHOOL, KANSAS CITY, MO., with any other school. I have no branch schools.



MAIL THE COUPON TODAY!

**A TRADE**  
*Sweeney*  
**ELECTRICAL SCHOOL**  
**KANSAS CITY, MO.**

**Send-this NOW**

EMORY J. SWEENEY, President  
231-A Sweeney Bldg., Kansas City, Mo.  
Please send me your Free 64-page catalog and how I can get my tuition at Half Cost.

Name.....

P. O.....

State..... Age.....

SEE SWEENEY DOUBLE-PAGE AD ON NEXT TWO PAGES



# There's Only One And Now The

**NOW I WILL CUT COST OF TRAINING  
1/2 IF YOU WILL COME RIGHT NOW**

**SWEENEY Trains You to Make Big Money**

If you are mechanically inclined, here is your opportunity. There is a fine job in the auto business for you.

**Do you want a sure trade that pays  
\$50 a Week and UP?**

Then write me today. Do you want a driving job, run a garage, be an auto repair man? Do you want to travel or open your own repair business? Tell me what you want. Sixty thousand Sweeney men say "Tell it to Sweeney." These men are now doing work they like for good pay. I figure 20,000 of them are owning their business. Now listen, no experience is needed. I teach with tools, not books. Sweeney men are sure of jobs because they have learned by doing with their hands.

**There's Only One Sweeney Auto School—It's at  
Kansas City, Mo. The Only School in the World  
Where THE SWEENEY SYSTEM is taught**

In just a few weeks you learn everything about all kinds of automobiles, tractors, oxy-acetylene welding, vulcanizing, battery work, electrical work, building and repairing radio sets. You need no special education—you don't spend hours over dry books—you learn by actually doing the work with your own hands on the most complete equipment in any school in the world. You must decide now—today, to get this practical training and save one half cost on your tuition. I advise you to get on a train today—wire me you are coming, or write me for my big Free 64-page book

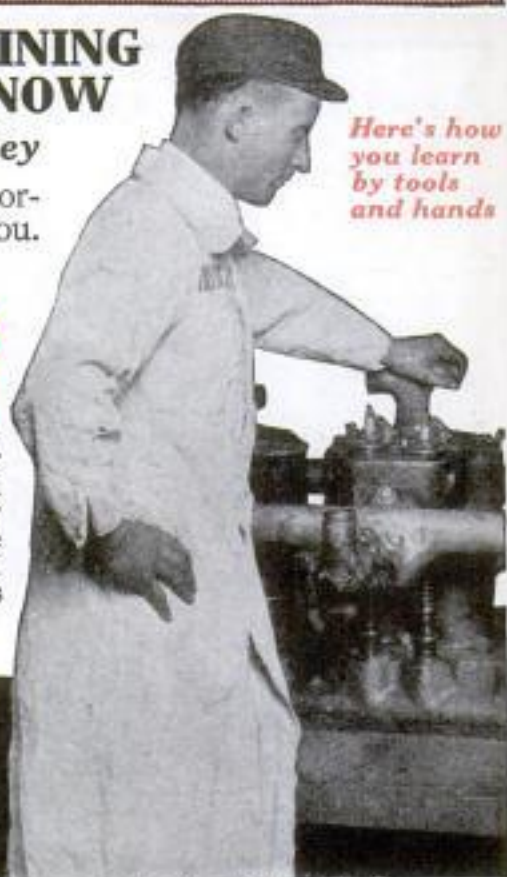

*Here's how  
you learn  
by tools  
and hands*

**An Engine Being Rebuilt**

**FREE** Sign and mail the coupon today, or a post card will do. I'll send you my wonderful 64-page book without cost or obligation. It takes you on a sight seeing trip through this magnificent Million Dollar Auto School—shows how Sweeney Students learn by the "Sweeney System." You'll want to join the boys right now and I am offering the opportunity to come right away—get your training in a few weeks at just half price. I urge you to act at once—you must either come now or lose this opportunity, and with it probably your chances for success and prosperity in 1925.

E. J. SWEENEY, Pres.

**LEARN**  
**Sweeney**  
**AUTOMOTIVE &**  
**231 SWEENEY BLDG.**

**SEE SWEENEY DOUBLE-PAGE SPREAD ON TWO PRECEDING PAGES**



# Sweeney School Cost Is Cut $\frac{1}{2}$

**I CUT THE COST OF TUITION TO MAKE IT EASY  
FOR YOU TO COME TO THIS MILLION  
DOLLAR SCHOOL RIGHT NOW**



*Under Personal Instruction*

If you have **just enough** determination to better yourself to clip the coupon or send a postcard and do it now. It will be your first step toward a big paying job or a business of your own.

**My Amazing Offer** Never before have I ever made such an offer. I want you to write me quick. You won't need to wait any longer. I further guarantee you the same expert practical instruction under skilled instructors that has made the Sweeney School World Famous.

## The Sweeney System of Practical Instruction

Is the **ONLY WAY** to learn if you want to save time and money and be properly trained. You get this at the **WORLD'S** famous trade school, the **Million Dollar Sweeney Auto School** and you get it nowhere else. I want you to read letters from hundreds of men just like you, without experience, but with **ENERGY**, who prepared themselves by a few weeks intensive training at the **MILLION DOLLAR SWEENEY SCHOOL**, for the big opportunity afforded by the automobile and electrical business. But you must **act now** if you want to save one half on cost of your training.

**There Is Only One SWEENEY  
SCHOOL — It Is at  
KANSAS CITY, MO.**

*Write for  
this  
Free  
Book  
To-  
day*

## The first step is to send for this FREE Book

Just send me your name and I will send you a 64-page big illustrated book. I have put into this fascinating book a lifetime of mechanical experience. It is full of real pictures—shows how mechanics do all kinds of expert jobs. Lists the opportunities in the business. Explains step by step how to learn and be a skilled mechanic. Answers every question. Many a mother and father reading this book have been inspired to make sacrifices and help their sons out. Tells all about the world famous Sweeney System—adopted by U. S. GOVT. during the war to intensively train soldier motor mechanics. Shows how easy it will be for you to **FIT YOURSELF** for a real job at big pay or own a business of your own. I will send this to you free—no cost, no obligation. Write for it today. No colored students accepted. Answer this **NOW** or better still wire me when you will be here.  
E. J. SWEENEY, Pres.



**EMORY J. SWEENEY, President**  
231 Sweeney Bldg., KANSAS CITY, MO.

Send me, free, 64-page catalog and how I can get my tuition at Half Price.

Name.....

P. O.....

State..... Age.....

**A TRADE**  
*Sweeney*  
**ELECTRICAL SCHOOL**  
**KANSAS CITY, MO.**

**SEE SWEENEY DOUBLE-PAGE SPREAD ON TWO PRECEDING PAGES**





# Choose as Your Profession Electrical Engineering

Electricity offers a brilliant future to the young man who is about to choose his career. Never before has there been such wonderful opportunity in this great field. Big paying positions in electrical work the world over are open to trained men—men who possess specialized, practical knowledge. Come to the School of Engineering of Milwaukee—the largest and best equipped electrical school in America. Here you are trained in both theory and practice by a faculty of experts. You learn in large, finely equipped laboratories. If you have 14 high school credits or equivalent, you can become an Electrical Engineer with a Bachelor of Science degree in our Institute of Electrotechnics in a short, intensive course.

**B.S. Degree  
In 3 Years**

## A Complete, Practical, Electrical Education

Learn by the thorough approved scientific methods which our twenty years of specializing enable us to give you. In addition to Electrical Engineering, the following complete courses are given: **A. C. and D. C. Armature Winding—Wiring and Testing—Practical Electricity—Drafting—Electrotechnics—Commercial Electrical Engineering—Automotive Electrical Engineering and Automotive Electricity.**

## Earn While You Learn

By our special system you may earn part of your way while learning. Our Employment Department will secure you a position to which you may devote a part of each day, spending the remainder at the school. This plan both solves the students' financial problems and provides splendid experience at the same time. Low tuition fee. Board and room reasonable. Daily Broadcasting WBOE. School Orchestra. Fraternities.

**New Term  
Begins Feb. 16**

## Write for FREE Catalog

Write today for our free, illustrated catalog. Read about this wonderful institution and the great opportunities that lie before you. Find out about our specialized method of training and the details of our "Earn While You Learn" plan.

# SCHOOL of ENGINEERING of Milwaukee

Founded 1905  
Dept. P. M. 225, 415 Marshall St., Milwaukee, Wis.

SCHOOL OF ENGINEERING OF MILWAUKEE  
P. M. 225, 415-17 Marshall Street, Milwaukee, Wis.

Without obligating me in any way, please mail free 72-page illustrated book, "Electricity and the One Best Way to Learn It," and particulars regarding the course I have marked with an X.

- .....  Electrical Engineering.
- .....  Electrotechnics.
- .....  Commercial Electrical Engineering.
- .....  Automotive Electricity.
- .....  Auto Electrical Service Engineering.
- .....  Radio Sales and Service.
- .....  Armature Winding.
- .....  Light, Motor Wiring and Testing.
- .....  Practical Electricity.
- .....  Home Laboratory Service.
- .....  I am interested in your "Earn While You Learn" Plan.

Name.....Age.....

Address.....

City.....State.....

Education.....

**Ludwig**  
TRADE MARK

**Trap Drummers!** With one of the new Ludwig Trap Drum outfits you will be able to make from \$75 to \$200 a week. Nearly all famous drummers use Ludwig equipment. Write today for full information on all outfits. **LUDWIG & LUDWIG, The World's Largest Manufacturers of Percussion and Rhythmic Instruments.** *Evans Makers of the Professional* 1631 N. Lincoln St., Dept. 1352, Chicago, Ill.

**Be An Officer  
in the U. S. Coastguard  
\$1700 Up to \$7,500 Yearly**

You get \$780 yearly at the U. S. Academy while training. You rank Ensign to Captain in service. We Guarantee to prepare you in time for Academy Examinations. Age requirements 18 to 24. Write Dept. B-15 for free information.

Coastguard Preparatory School, 1653 Pa. Ave., N. W., Washington, D. C.

## Popular Mechanics Library of Newest Books

This library consists of the eight books listed below, which have been published by Popular Mechanics Press in recent months:

- Lathe Handbook
- Handbook for Women
- Concrete Handbook
- Auto Owner's Handbook
- Home Mechanics Handbook for Farmers
- Boat Book
- Auto Tourist's Handbook

The regular price of these books when bought separately is \$4.50. To those who order the complete Library of Newest Books at one time, the special price of \$4 will be allowed. **SEND NO MONEY**—Simply write a postal asking that the library be sent C.O.D. When the postman delivers the books at your door, hand him the \$4 and the few cents postage.

POPULAR MECHANICS PRESS, Popular Mechanics Building, Room 711, CHICAGO



# BUILDING TRADES BOOKS

## "ESTIMATING BUILDING COSTS AND SPECIFICATION AND CONTRACT WRITING"

One of the best books of its kind ever written. Prepared from the lessons of the International Correspondence Schools and used by leading colleges and technical schools. A pocket encyclopedia that will save you many times its small cost. 344 pages. Only \$3.

## "BUILDER'S BLUE PRINTS"

Tells you how to read blueprints. A practical book for practical men. Written by W. S. Lowndes in language that you can understand. Profusely illustrated with actual plans of buildings (10 full-size blueprints included). A real bargain at \$3.

## "PLASTERING AND STUCCO WORK"

Tells all about Furring, Grounds, Corner Beads, Wooden Lath, Metal Lath, Plaster Boards and Wall Boards, Plaster Plastering, Plasterers' Tools, Lime Plaster, Gypsum Plaster, Keene's Cement, Portland Cement Plaster, Caen Stone Cement, Ornamental Plastering, Stucco Materials, Preparation and Application, Stucco Finishes, Stucco Color Effects, Waterproofing of Stucco, etc. Price only \$1.50.

## "BUILDING TRADES HANDBOOK"

An indispensable book for every man in the building trades. Takes up roofing, shingles, sheet metal, plumbing, drainage, architectural and structural design, strength of materials, water supply, fire-proofing, retaining walls, plastering, lathing, etc. 495 pages. 174 illustrations. The best building trades handbook ever sold for \$1.

INTERNATIONAL CORRESPONDENCE SCHOOLS  
Box 5682-D, Scranton, Penna.

I am enclosing \$..... for which please send me the books I have checked below:

- Estimating Building Costs, Specification and Contract Writing
- Builder's Blueprints
- Plastering and Stucco Work
- Building Trades Handbook

Name.....

Address.....



# WANTED

at \$3,000 to \$10,000 a year



Yes—\$3,000 to \$10,000 a year! These are the opportunities that exist everywhere today for big, easy money in Radio. Radio is the fastest growing industry in the world. If you are in a routine job with poor pay and no future, here's the chance of a lifetime. Investigate! Look into the amazing money-making possibilities of Radio. In a few short months of training at home by mail, we can make you an expert representative of our Association. Learn to install, repair, build and sell high-grade radio sets. Become the Radio expert of your neighborhood. Find out how the Radio Association of America now makes all this easy for you. Radio offers not only big-salary jobs, but is a business you can easily get into for yourself.

## Become a Radio Expert

**Train at Home in Three Months** Get your share of the big money being made in Radio.

Mail the coupon for free information. Find out how in your spare time at home, without giving up your present position or losing a dollar of pay, you can become a Radio Expert in a few short months. No previous experience is necessary. For the man who prefers a salary, big-pay jobs are waiting with the U. S. Government, Steamships, Railroads, and thousands of corporations and business houses. For the man who wants to get into business for himself and be independent, Radio offers unlimited possibilities—either on a spare or full time basis. In no other line can ambitious men find the opportunities that Radio now offers. You can train under one of America's leading Radio authorities. Read Mr. A. G. Mohaupt's offer to train you personally in everything about Radio—construction, installation, repairing and selling. By enrolling with us now you get the benefit of the direct personal guidance of this well-known expert.

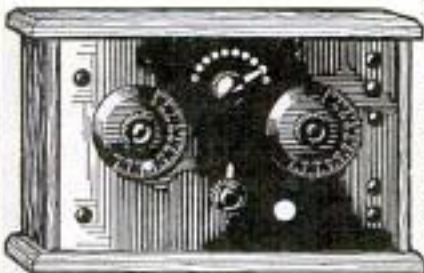

### FREE—1000 MILE RADIO OUTFIT

This set when completed has a range of over 1000 miles. Right now we give it free to each member taking our course of training. Mr. Mohaupt's clear, simple instructions will show you how to build similar sets to sell at a big profit. When you have finished the course, you can sell this free set at a price that will practically pay the cost of your training.



A. G. MOHAUPT, B. A., M. S.

Head of the Radio Association of America, Graduate Electrical Engineer, University of Wisconsin. Former Radio Instructor for U. S. Government. Author of "Practical and Theory of Modern Radio."

"I give my personal attention to every student taking my course. Your individual problems and questions are answered by myself. I work with you at every stage of the course, guiding you, directing you to your goal to be a Radio Engineer in the big-pay class. My course prepares you to successfully pass Gov't examination for Operator's License."

## Get The Facts—Mail Coupon

Radio knowledge is not only interesting and the means to the greatest form of entertainment the world has ever known, but is the most cashable knowledge a man can possess. Let us prove to you that there is nothing difficult about Radio—that any intelligent person can easily learn it right at home by mail under our simplified and approved methods. Mail the coupon now for all the facts. Let us prove that Radio is easier to learn and offers bigger money than any other business or profession you can get into. Don't wait—act while our Free Offer of a 1000 mile radio outfit is still in effect.

A. G. MOHAUPT, Radio Engineer  
RADIO ASSOCIATION OF AMERICA  
4513 Ravenswood Avenue Chicago, Ill.

Radio Association of America,  
Dept. A2  
Chicago, Ill.

Please send me details regarding your Expert Home Training Plan and offer to representatives, also your offer of a 1000 mile Radio Set FREE.

Name.....

Address.....

City..... State.....



# BE A BIG MAN

## In The Auto Business

### Make \$5,000 To \$10,000 A Year



A.G. ZELLER  
PRESIDENT

Do you want to get into the auto business in a way that will bring you to independence quickly? Or are you already an auto mechanic and looking for a way to get into a bigger job? My big "Master Course" (thirty weeks or more of thorough training) will put you where you can tell the world you are a real automobile man, and prove it.

Training for business comes down to this—the more you know the quicker you succeed. A doctor or lawyer goes to college for years, but he gets a foundation for a whole life work. The same in business. With a real foundation such as this long course of mine will give you, you are fitted for a high-grade, well-paid position; to be a service manager or to

run a garage or salesroom of your own. The investment of time and money will pay you big dividends, and bigger every year.

## Take MASTER MECHANICS' Course

### THIRTY WEEKS' TRAINING in All Branches of Auto Work Unlimited Time Life Membership

Come to this great school at Detroit. Make up your mind you are going to get this training right. Then go after the big job or start your own business. You will be your own boss because you can get a job anywhere.

The fourteen years of experience of this great School (at Detroit, the Auto Center of the World) have been put into this Master Course. No auto training course even approaches it in completeness. It covers every branch of auto service completely, and there is no limit on your time. Thirty weeks is the average. You need have no experience, to learn auto work thoroughly in this course. We start you at the beginning and give you both head and hand training. Auto dealers send their men to take this course, to fit them for big positions. Foreign governments send officials here to take it, to prepare them for handling their auto industries.

Complete equipment is here for you to learn on. All types of engines, electrical systems, new cars. Instructors are experts, each a specialist in his line. In addition to this 30-week course, we have a number of shorter courses. Write for outline.



### 16,000,000 Cars — A World-Wide, Wonderful Business

Think what opportunities are open in the servicing of over fifteen million cars in the U. S. A. alone. Men who know the business can get a job anywhere in the world.

Write Me Today. Send for the details of our great Master Course (and our other courses). Use the coupon, or write. I will answer you personally. Every student here gets personal attention and is a Life Member. Write me today.

A. G. ZELLER, President

**MICHIGAN STATE AUTOMOBILE SCHOOL**  
1502 Auto Bldg., 3729 Woodward Ave., DETROIT, MICH.

### J. R. NAVARRE SAYS:

"Three years ago when I left your school I was nearly broke and a single man. Now I have a fine job, wonderful wife and comfortable home. Mechanics think I must have had twenty years' experience."

M. S. A. S. gave me all I needed." (He is Service Manager of Dodge Station at Carrolltown, Ohio.)

All over the world M. S. A. S. graduates have fine jobs or shops of their own.



## Mail Coupon To Day

Michigan State Automobile School 1502 Auto Bldg. DETROIT, MICH.

Send me FREE and without obligation complete information about Detroit-training to make the most money and your 30 weeks' Master Course.

Name.....

Street or R. F. D.....

City..... State.....





*Dry "B" Batteries  
are an economical,  
dependable and  
convenient source  
of plate  
current!*



No. 770. 45-volt extra large vertical. For heavy duty only. The ideal "B" Battery for use on multi-tube sets. Price \$4.75.

## *Scientists constantly improve battery quality*

EVEREADY "B" Batteries today contain more electricity, more service, more satisfaction than ever before.

Processes evolved by the scientists of the Union Carbide and Carbon Research Laboratories, Inc., when put in effect in the Eveready factories, are responsible for this great accomplishment.

At the same time the factories have effected a still higher standard of workmanship. A system of inspection that is a marvel of efficiency was inaugurated. The results, gratifying beyond measure, were accomplished with a speed and completeness that have few

parallels in industry. The final tests showed more electricity, more battery service, greater Eveready satisfaction without increasing battery sizes and with a substantial reduction in price. "B" Battery operating costs, using the new Evereadys, in most cases show a reduction of at least one-half.

There is an Eveready Radio Battery for every radio use.

Insist on Eveready "B" Batteries.

Manufactured and guaranteed by  
NATIONAL CARBON COMPANY, Inc.  
Headquarters for Radio Battery Information  
New York San Francisco  
Canadian National Carbon Co., Limited, Toronto, Ontario

EVEREADY HOUR  
EVERY TUESDAY at 9 P. M.  
(Eastern Standard Time)  
For real radio enjoyment, tune  
in the "Eveready Group." Broad-  
cast through  
WEAF New York WJAR Providence  
WEEI Boston WFI Phila.  
WGR Buffalo WCAE Pittsburgh

# EVEREADY

## Radio Batteries

*- they last longer*



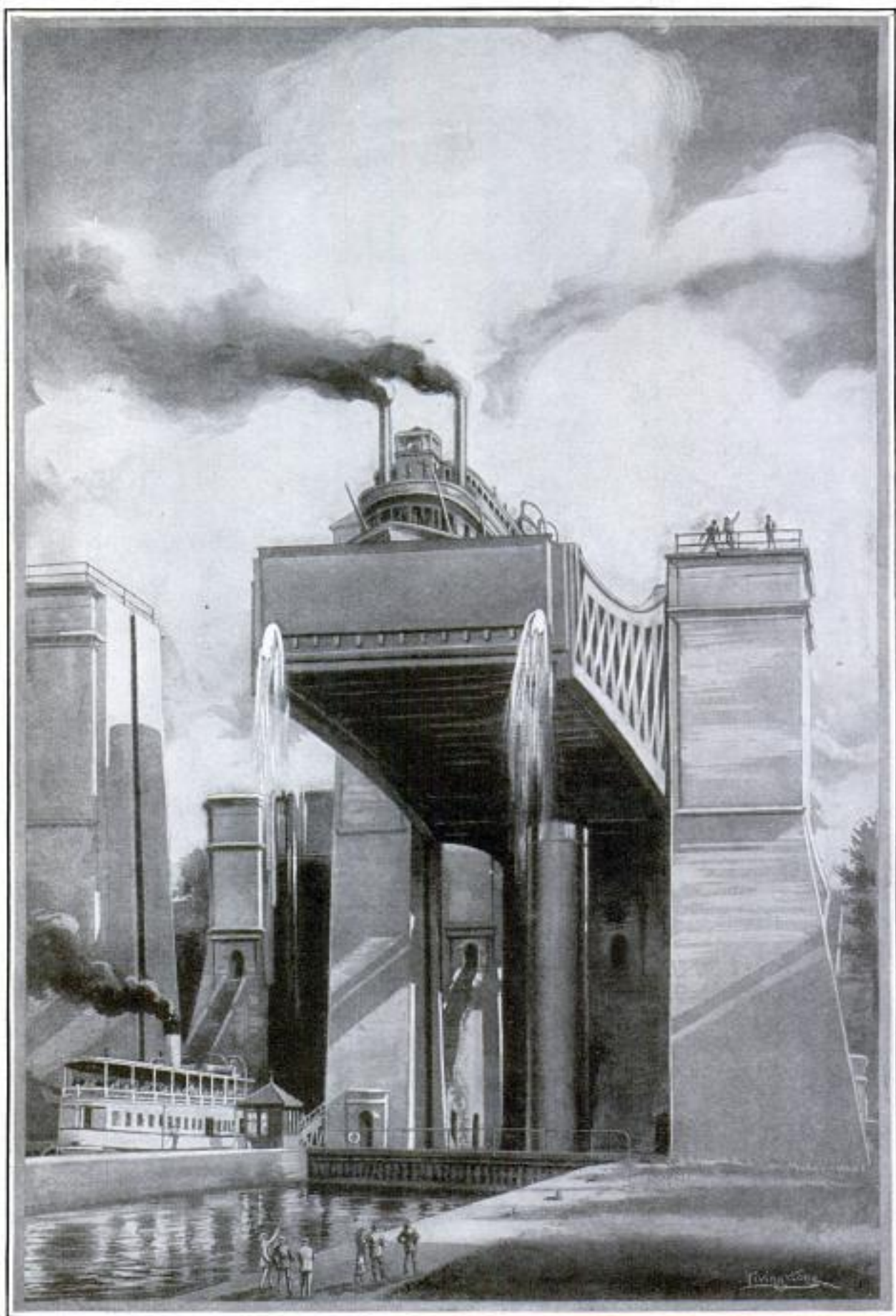

Hydraulic Lift Locks Transferring Steamboats between Water Levels Sixty-Five Feet Apart, Using the Descending Load to Aid the Upward Movement of the Other Chamber—See Page 200



*Cooper Hewitt Electric Co  
Stoneck Bldg., Hoboken, N.J.*

# Popular Mechanics Magazine

REGISTERED IN U. S. PATENT OFFICE

WRITTEN SO YOU CAN UNDERSTAND IT

Vol. 43

FEBRUARY, 1925

No. 2

*2062*

## The Sun as Your Doctor

### Clear Quartz Windows Promise to Cure Diseases Caused by Lack of Ultraviolet Rays in Filtered Sunlight

**A**NNOUNCEMENT recently that a way has been found to produce clear fused quartz glass in commercial quantities at a reasonable cost, followed by word that Johns Hopkins hospital had installed the world's first quartz window, disclosed a new chapter in the use of natural agencies to fight disease.

The value of clear fused quartz lies in the fact that it affords ready passage to the ultraviolet rays which glass turns back. It is the absence of ultraviolet rays that causes children kept indoors in wintry climates to develop rickets and other diseases. Besides the seven colors of the spectrum — red, orange, yellow, green, blue, indigo and violet — sunlight contains another "color" which is not visible to the eye, and which lies beyond the violet range of the spectrum. This is known as ultraviolet. Not only are the eyes insensible to its presence, but the pigment in the skin is ordinarily proof against it. When the unpigmented portions of the skin are exposed to the ultraviolet rays sunburn develops. In the extremely rare cases known to science where people have been born without any pigment in the skin, it has been necessary to keep

them out of the sun to save their lives. Ordinary window glass is opaque to ultraviolet rays, and now science has discovered that to this fact rickets, a disease of undeveloped bones in children, is due.

The discovery was made by Dr. William T. Bovie, professor of bio-physics at Harvard university, with the co-operation of President C. C. Little, of the University of Maine. They used chickens for the experiment, and produced ultraviolet rays with an ordinary mercury lamp, using a quartz globe. Two chickens were raised in a greenhouse, under the same conditions, with identical food, the same dust bath, and the same-size pens. The common glass of the greenhouse kept out the ultraviolet rays. One chicken was exposed to the rays of the mercury lamp for fifteen minutes each day. It developed much faster than its unexposed mate, and at the end of the experiment X-rays showed the bigger chicken had well-developed bones, with plenty of calcium and phosphorus salts in them, while the small chicken had poor bone structure, and died shortly after the pictures were taken. The chicken exposed to the rays for fifteen minutes a day also showed

*Made in Thomson  
Research  
General  
Schenectady  
N.Y.*

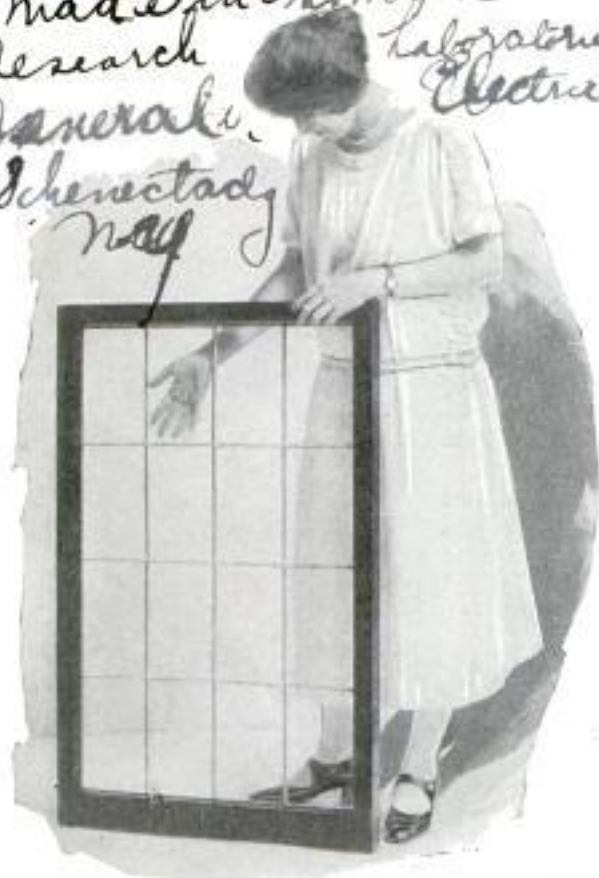

Window of Fused Quartz, the First of Its Kind, Which Has Been Built for a Hospital

*Quartz - American Window Glass Co, Farmers Bank Bldg. Pittsburgh, Pa.  
Quartz - American Window Glass Co, 50 E. 42nd St. New York*

*Quartz glass window made in Thomson Research Laboratories, Schenectady, N.Y.*

*Patent + other (Photo)  
25 - 1924 Copyrighted material  
New York*





Exposure under Ultraviolet Rays from Quartz Lamp Made Bigger Chicken Outstrip Mate

better development and weighed more than chickens of the same brood which had been permitted to run at large under natural sunlight. That fact has raised the interesting question of whether longer exposure to the rays might cause the bones to develop too fast, and hence produce a dwarf chicken. Scientists believe the experiment indicates that the prevalence of pigmy races in the tropics, with their development to maturity taking place much earlier in life than in more temperate climes, may be due to an excess of ultraviolet rays from the intense tropical sunlight. In its application to humans, as planned at Johns Hopkins hospital, the new quartz glass is expected to open a new field of therapeutic treatments. The formation of the bones, which is affected by the rays, involves a series of chemical changes which physiologists call "calcium metabolism." Besides rickets, there are other diseases caused by the absence of calcium, such as otosclerosis, or hardening of the eardrum, and osteomalacia, a chronic progressive adult disease marked by softening of the bones. A bowlegged child is a victim of rickets.

"The disease records of every city," Dr. Bovie said in announcing his discovery, "show that from ninety-seven to one hundred per cent of all the babies raised in

the northern countries, where it is necessary to keep children indoors and to use window glass to shut out the cold, have rickets when examined in the spring. Undoubtedly many other physiological processes are involved. We may expect to find the same factors influencing the growth rate of children as have been found in this experiment with the chickens. The results of the experiments are of great economic value because it is a common experience of chicken growers that the death rate of chickens at the age of four and five weeks is very high. The experiments show that this death rate can be reduced by supplying ultraviolet light to the chickens. Chickens receiving this treatment are not only larger, but are livelier and more vigorous in every way than are those which did not receive it. The secondary sex characters did not develop in the chickens which were deprived of the ultraviolet light. These characters were fully, if not excessively, developed in the chickens which did receive the ultraviolet radiation. It should be added that the illustrations do not tell the whole story because all of those chickens in the group treated with ultraviolet light lived, except a few killed by rats. About seventy-five per cent of the chickens from the pen of the smaller chick pictured, that is, those receiving filtered sunlight, died from a disease known as 'weak legs.' This disease in mankind is called rickets."

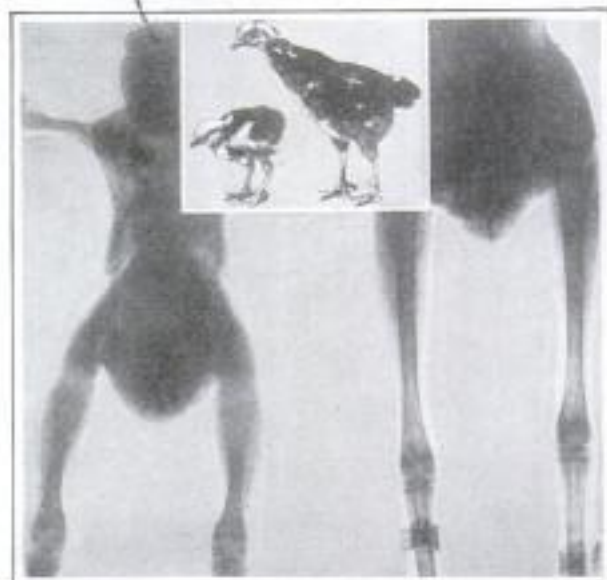

The Two Chicks at Age of Four Weeks, and X-Ray Showing Better Bone Development of the Larger





Halted at Water's Edge. Canoe That Has Served as Sidecar Is Quickly Launched from Motorcycle without Disturbing Passenger

### Canoe as Sidecar for Motorcycle Is Detached for Floating 2202

A motorcycle exhibited during a London exposition has a canoe fastened to the frame like a sidecar, which can be dismounted from the wheel and launched in forty seconds. The craft is held in place by a series of straps which may be quickly loosened. After a cruise on the water, the lightly made boat can be set on the cycle frame and used as a comfortable compartment for one or two passengers. For long overland trips, the boat may serve as a carrier for provisions and other materials as well as a roomy seat for the occupant. Although the canoe is fourteen feet long, it does not interfere with the handling of the motorcycle.

### Voice Amplified Fifty Billion Times through Radio Microphone 2148

Power of the human voice in loud speech or song is estimated at only one one-hundred-millionth of a watt. A radio-broadcasting station using 500 watts, "steps" this sound up to the equivalent of almost a full "horsepower voice," which means that the original tone has been am-

plified about fifty billion times. Measured in this way, the vibrations that leave the station's wires, are far more powerful than the noise that would be produced if all the people in the world could unite in one mighty shout.

### Sources of Platinum Ore 2142

Platinum ore and its associated metals, contrary to popular impression, are widely distributed over the earth, but thus far have been worked in paying quantities in only a few regions. More than ninety per cent of the world's supply has come from the Ural mountains, but conditions in Russia in recent years have almost closed this source. Next to Russia, Colombia, in South America, which also produces most of the world's emeralds, is the biggest producer of platinum. Traces of the ore have been found in California, Oregon, Alaska, Canada and Mexico, and in Brazil and other parts of South America, as well as Australia, Tasmania, Dutch East Indies and Papua. Crude platinum is usually found in the form of rounded or flattened grains of "sand," occasionally in irregular lumps the size of a pea, and but seldom in nuggets, though one has been discovered weighing twenty-one pounds.

*J. S. Keatinge*



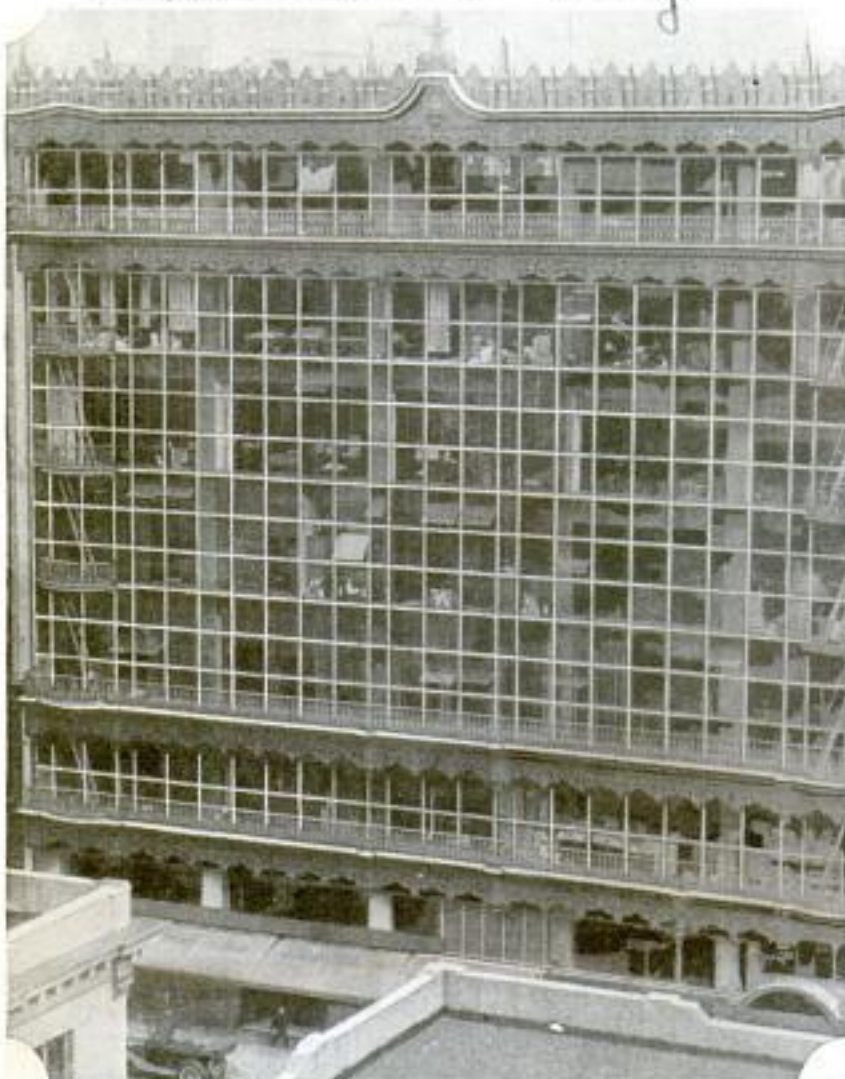

Like One Big Window with Many Panes, This Store Front Affords Excellent Light and Show Space on Every Floor

**1948 Entire Store Front Built of Glass Provides Better Light**

Modern building construction, whereby the outer walls of a steel and concrete building are carried by the pillars, and serve no purpose except to inclose the structure, has made possible a remarkable department-store front in the far west. It is of glass, with the exception of three rows of ornamental trim. The unusual front not only admits more daylight, but makes possible window displays on the upper floors.

**Whole World Contributes Material for Making Electric Lamps**

Ships must sail the seven seas to gather materials for the 1,000,000 electric lamps that the United States uses every day. In the simple-looking filament, bulb and base, countries from Greenland to Australia

South America insulate them and protecting material is also made from rice paper brought from Japan, "kraft" paper from Sweden and burlap from Scotland.

**1982 Vanishing Handle on Traveling Bag Protects Owner against Theft**

As a safeguard against theft of luggage, steel loops for the traveling-bag handle



that permit it to be swung down and locked securely inside when the grip is closed, have been placed on the market. They can be fitted to any style of bag in a few minutes and are said to be stronger than the fastenings usually furnished with equipment of this kind.

*New Bulletin 11/17/24*

*New England Bureau of Public Service Information 24 North St Boston, Mass*

*Milwaukee Sta copying Co., Westfield, Wis.*



Wide World Photos  
229 W. 43rd St  
New York City

New York Times  
11/16/24

## World's Tallest Building Planned for Rome

2059  
Topping the Woolworth building by 408 feet, the Mole Littoria, a gigantic skyscraper tower being planned for Rome, will rise 1,100 feet into the air. Designed as a center for all sport associations and the scientific training of champions for international and local contests, the huge tower, if plans are carried out, will be a unique monument to athletics. The architect's plans call for 4,500 rooms, 100 assembly halls, a huge theater, a concert hall, swimming pool, libraries, and large gymnasiums for each class of sports. Compared to the proposed 4,500 rooms, the Hotel Pennsylvania, New York's giant hostelry, has but 2,200. The structure will be built of reinforced concrete, with stone trimming. The plan for the building, which is credited to Mussolini, the Italian dictator, has provoked a storm

of criticism from artists and architects, who say the grandeur of the ruins of ancient Rome will be dwarfed and spoiled by such a skyscraper.

## Sugar from Artichoke May Reduce Cost of Sweets

2199  
By a process discovered by experts of the government bureau of standards, sugar one and a half times as sweet as the cane and beet varieties may be extracted from artichokes. The refining treatment necessary so simple that, it is said, the cost of manufacturing the product can be greatly reduced. Because of the low expense in cultivating the vegetable and its heavy yield when compared to other sugar-bearing plants, it is believed the artichoke may be extensively employed to provide a great part of the future crops. Lack of means of crystallizing the extract has been a bar heretofore.

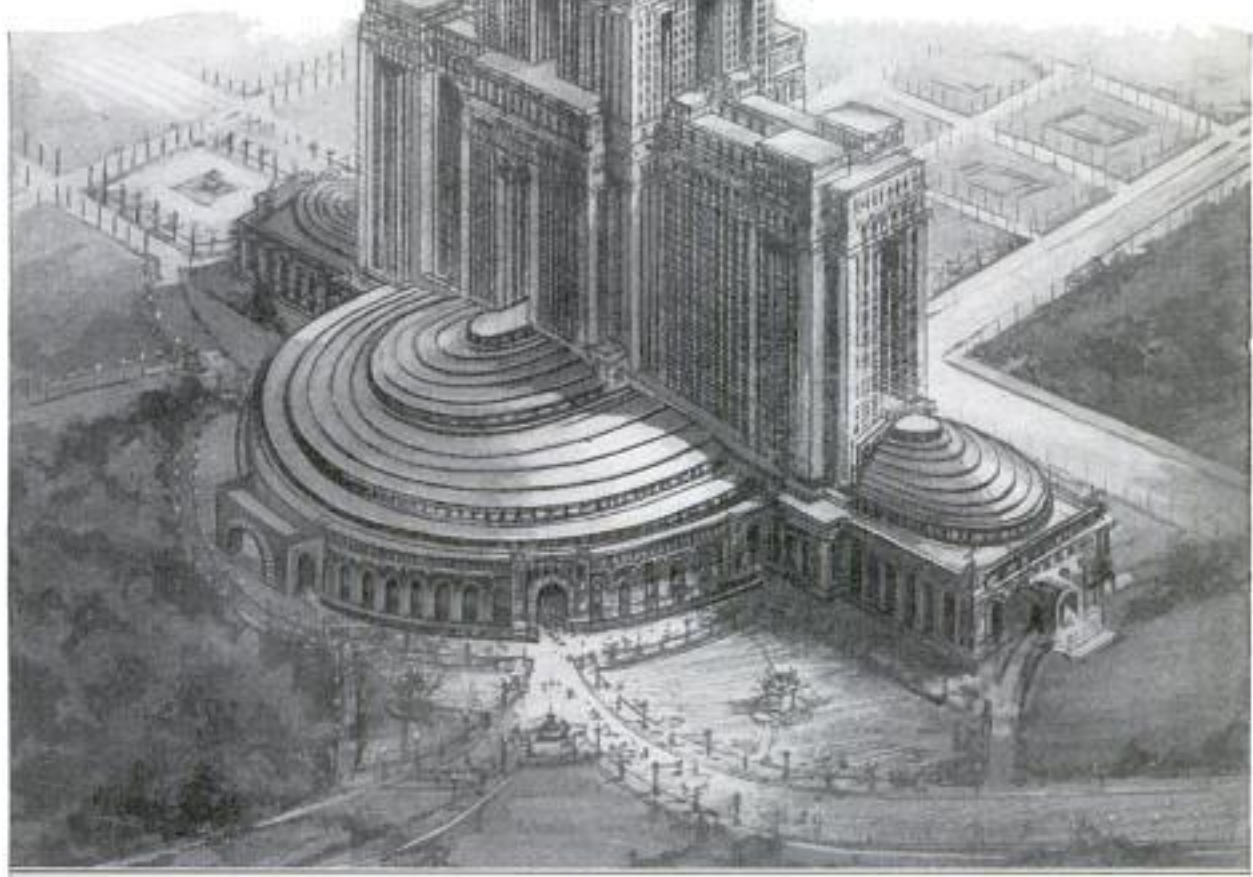

Architect's Design of Lofty Skyscraper Mussolini Plans for Rome; Motifs of Both the Coliseum and the Modern Tower Are Combined in the Structure Which Is Intended as an Exhibition, Training and Living Center for Sports Associations and Athletes



Carl. E. A. Aldroyd Esq.  
127 Abbey Road

*Larrow, in. Urnes, Lancs, Eng.*  
**AUTO TOPS MAKE FERRYBOATS FOR EXPLORERS**

2130

*Crosley Motors, Ltd. Leiston, Manchester, England.*

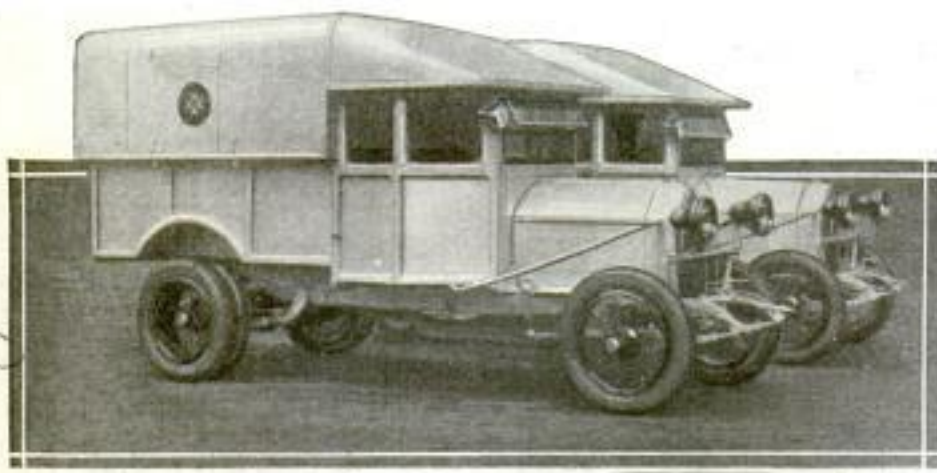

Motor Transports for the African Expedition with Metal Tops in Normal Traveling Position; Putting the Boat Together, and Ferrying a Car over a Stream in It; Double-Tired Rear Wheels, Wire Spokes Throughout and Capacious Drinking-Water Tanks Are Included in Equipment to Aid in Blazing 7,000-Mile Motor Trail through Wilderness

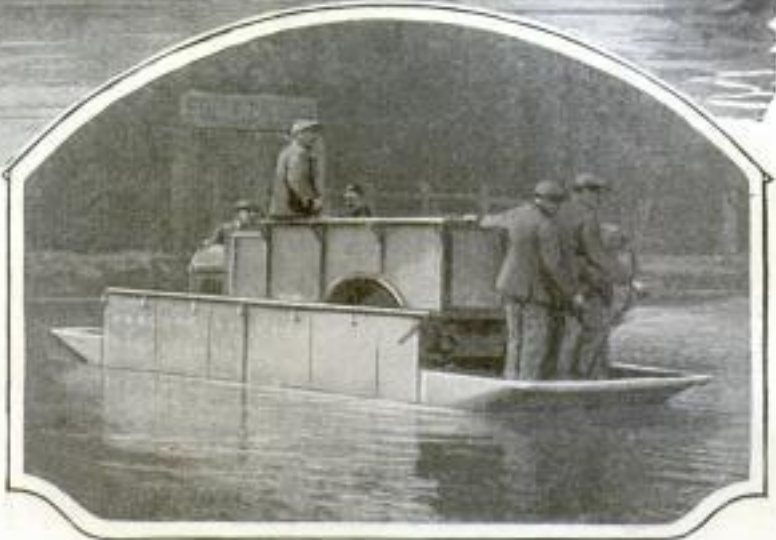

Motor conquest of the wilds of Africa is contemplated in an expedition of English explorers, setting out from Capetown with Cairo, Egypt, 7,000 miles away, as their objective. The purpose of the journey is to determine if automobile roads can be built through the wildernesses as feeders for existing railway lines. In order that they may cross lakes and streams the cars have been constructed with metal tops that may be detached and bolted together to form pontoons on which one automobile at a time can be ferried over. The sloping ends of the boat permit running them well up on the banks so that a machine can cross the bridge with little difficulty under its own power. Other equipment for the journey includes mosquito-proof netting for all openings of the cars and specially large drinking-water tanks

for the long treks over barren wastes. At times, the party, which is led by Maj. C. Court-Treant, will be thousands of miles from civilization and will be left to their own resources.

**How Floating Islands Are Formed**

Floating islands are not fantasies from the pens of imaginative fiction writers but scientific facts as real as anything in nature and sometimes capable of blocking



Abstract News  
11/14/24

Pacific + Atlantic Photos  
25 Park Place  
New York City

ivers. They are formed by accumulations of soil and various growths about reeds and grasses that push their way over the normal bank line of streams and oceans. When high water comes, the floating mass rises, and if the pull is strong enough, breaks away from the main land. One of these wandering islands, or "rafts" as they are called, in less than forty years became ten miles long, 600 feet wide and eight feet thick in a lower area of the Mississippi river and required four years of labor before it was removed. Another blocked the channel of the Red river for about forty-five miles.

### Thousands of Player-Piano Rolls Made from Master Record 1996

Perforating strips of paper so that when placed upon player pianos, they will reproduce with startling fidelity the touch and expression of skilled musicians, is a mechanical marvel of the modern musical age. In one large factory, with a capacity of 30,000 records a day, a pneumatic machine is used that makes 128 duplicate rolls at once. The paper passes from the reels at the rate of 170 feet a minute, receiving punctures from batteries of small punches. These are operated by compressed air, the different bars striking with a quick downward motion that sends them through sixteen thicknesses of paper. They are moved as a master handmade record passes over a diaphragm like the one on the player piano itself. The master roll really "plays" itself upon every one of the 128 strips of paper. Instead of the music made by the hammers striking the strings, the sound is the steady drone of the punches as they bore through the paper under seventy pounds' air pressure. The words are then put on the record. This is done by a single impression from a stamper bar, thirty-six feet long, set with rubber type, arranged in proper order and glued to metal slides that can be removed in an instant. One turn of the bar inks the letters from a long pad; another sends them forcibly against the paper. Thirty-two records a minute is the ca-

capacity of this machine. The strips are then spooled, labeled, tagged and inspected, and boxed for shipment.

The master records are punched by special apparatus as the musician himself



At Work on Master Player-Piano Record with Musical Score as Copy Guide

plays the keys or are copied from the score by experts. They receive many alterations and corrections before they are finally released, and are made on heavier paper than the others, and larger. Thousands of duplicates can be taken from a single original.

### Defects in Speech Are Used as Clue 2082 to Diagnosis of Disease

By recording the vibrations of a patient's voice on a strip of smoked paper on a revolving drum, physicians in an English hospital endeavor to diagnose certain nervous diseases and determine methods of treatment. The theory is that various defects in the speech indicate corresponding ailments in the nervous system. These peculiarities of the voice or pronunciation are recorded on the paper, the vibrations being registered in an irregular line. The method is said to have proved valuable in paralytic and epileptic cases.



When Dictating May Reveal Disease: Talking into Voice-Vibration Recording Apparatus in Hospital

West End Hospital  
Copyrighted material





Assembling-Bench, Where Jointed Bamboo Rods Are Fitted with Grips and Reel Seats



Inspecting and Adjusting Reels before Mounting on Rods



Machines Which Set Tiny Screws into Ready-Drilled Holes



Glass Eyes for the Wooden Minnows Are Put on Like Tacks



2108 James Heddon's Sons,  
Lowagere, Mich.

## Keeping Anglers Supplied with Fish Lures

Industry Producing \$7,000,000 Worth of Tackle Each Year Equips Sportsmen with Rods and Baits to Trap Finny Game

**I**MITATING bright-colored bugs, silvery minnows and other favorite prey of game fish is the task of an industry which annually supplies about \$7,000,000 worth of tackle to enthusiastic followers of Izaak Walton who angle the lakes and streams of this country for sport.

Few factories make complete assortments of these products. While some specialize in rods and reels alone, others manufacture artificial flies, grasshoppers, gaudily decked hooks, baits and similar lures. One concern makes more than a million flies a year, and a rod manufacturer turns out about 50,000 such articles in the same time, in addition to nearly 500,000 wooden minnows.

Rods are constructed of bamboo or steel and as a rule consist of several sections or joints so they can be taken apart and carried easily. For the manufacture of the elastic wood varieties, the bamboo is imported from the Orient and each stem is split into many pieces, which are shaped into tapered triangular sections. Six of these are glued firmly together to form

what is known as a split-bamboo rod. After cementing, the shafts are seasoned for several years when they are inspected and tested for strength. The ones selected for finishing are then scraped and sanded until the surfaces become smooth as glass.

In the mounting room, cork grips are fitted to the butts and reel seats are put on. A protective metal ferrule is forced over the thin end and the guides are wound on with silk, an operation so delicate that the entire process must be done by hand. Girl workers with long experience at such tasks are charged with the winding, which requires close application to avoid uneven coils. Several coats of elastic waterproof varnish are applied to the rods before they are permitted to be equipped with reels. All coats are applied with camel's-hair brushes and each one is allowed to dry thoroughly before the succeeding application is put on.

Reels are made with accurate machinery built for precision work, and the best of care is exercised in assembling the products. In some factories, each reel is con-

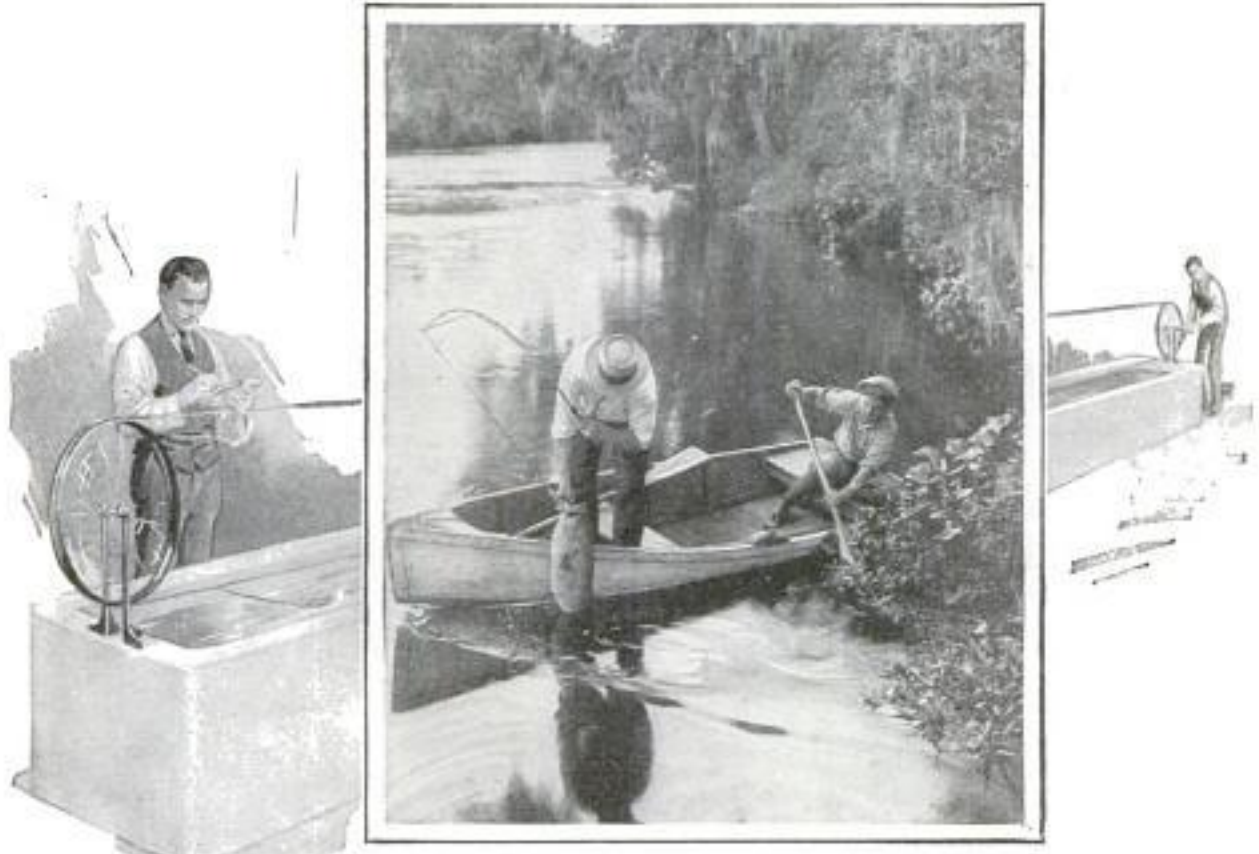

Lured by a Wooden Minnow, a Prize Catch Being Taken In by an Angler; and Test Tank Where Artificial Baits Are Tried Out for Action in Water



2108

structed as a separate article and all pieces are manufactured as for an individual machine. Although this method is sometimes costly, it generally insures a smooth-running reel which will not readily give trouble to the user. Values of these tiny pieces of mechanism are frequently so high that the stocks are kept in fire and burglarproof vaults.

The manufacture of feather lures is almost entirely done by hand. Many varieties of feathers dyed in various colors are used. Those most commonly found in the factories are from the necks of chickens, known as chicken hackle, although feathers of geese, ducks, peacocks, ostriches and wild fowl are required in great quantities. On lures for trout, bass, and muskies, deer tails are often employed, and it is estimated that more than 10,000 of these are annually bought from hunters and fur dealers who gather them. About 35,000 of such lures are produced by one factory each year, calling for more than 150 different shades of feathers and like materials. At the same factory, a yearly supply of three carloads of white cedar is consumed in the production of wooden minnows for the floating and diving types of baits. For the heavier, sinking varieties, red gum from the gumwood swamps of the Gulf states is employed. The lumber is first cut into small blocks, about two inches square and five inches long, and turned in lathes to a rough shape of the tiny fish. They are then carved to the proper outlines, weighted with lead when desired, and enameled in the required finish. After being bored for hooks, screws

and eyes, painters apply natural colors with air brushes, the fumes of the sprayed paint being carried off by blowers to protect the workers.

Some of the baits have a fish-scale effect, which is put on by spraying the colors through a fine netting. Glass eyes are made similar to tacks and must be carefully matched by the operator who hammers them in with a wooden mallet. No detail is overlooked to make the imitations as near like the originals as possible, since defective baits are rarely successful in performing their purposes.

To fasten the hooks and other materials on the wooden bodies of the lures, small power-driven screwdrivers are used. The holes are all bored before the articles reach the machines. For a wooden minnow at least sixty operations are necessary at the screwdrivers before the product is completely decked with its garb of feathers and hidden hooks. Inspectors finally pass on the quality of the baits, and send them to the shippers. Here each one is wrapped in a tissue-paper cover and packed for storage or shipment.

In the basement of a Michigan factory there is a forty-foot tank with testing and measuring devices for scientific bait development. It is used for trying out the various lures to determine their action in water. The baits are attached to a belt of cord passing over a wheel at each end of the tank. As the line is drawn rapidly through the water, the movements of the lures can be studied and any corrections necessary to make them more lifelike noted.



Courtesy of James Hedden's Sons  
Winding Guides on Fishing Rods with Tough Silk Thread, an Operation Which  
Is Entirely Achieved by Hand to Assure a Smooth Finish





Above Is the Packing Table Where Various Forms of Baits Are Wrapped in Tissue, Stamped, and Boxed for Shipping; Right, Painting the Decoys with Natural Colors; the Fumes of the Chemicals Are Drawn Off by Suction Blowers to Protect the Operators; in the Insert Is Shown Group of Artificial Baits Designed to Attract Different Kinds of Fish



Excelsior Motor Rep & Supply Co  
3701 Cortland St.  
Chicago, Ill.

POPULAR MECHANICS

Buider. E. Stormay, Mc Cook, Field  
Dayton, Ohio

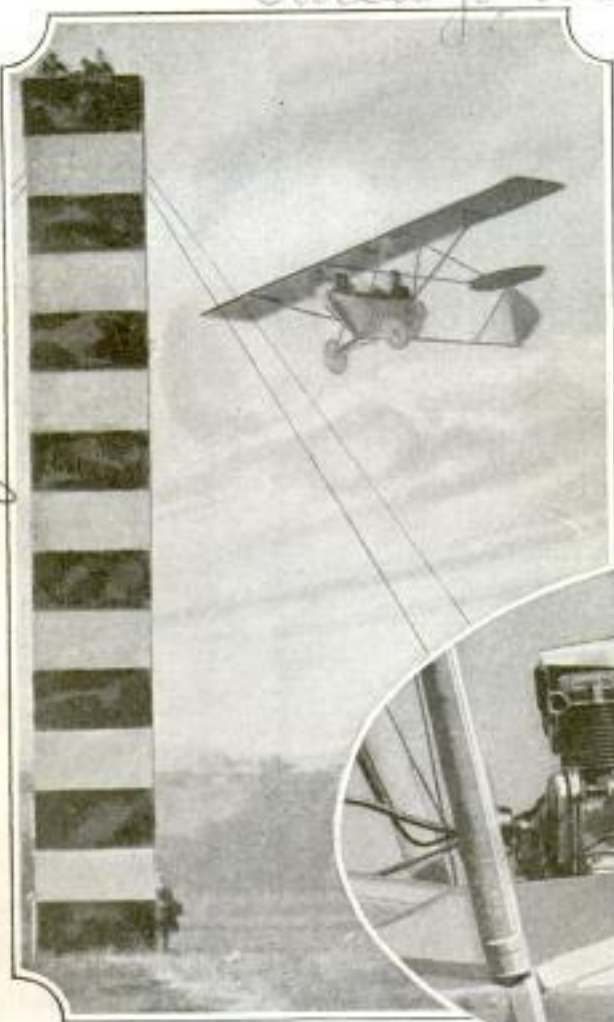

ness. The plane was designed and built by a French mechanic employed at McCook field, the army's airplane testing plant. The engine was turned around, rear foremost, and the flywheel removed. To the end of the crankcase an extension was welded to carry the propeller, with an additional thrust bearing to take up the wear of the load. The propeller itself served as flywheel. An old sidecar body, modified by the addition of strengthening braces to support the motor, formed the fuselage, and a single monoplane wing, with a few braces to steady it, furnished lifting surface. The baby ship consumed

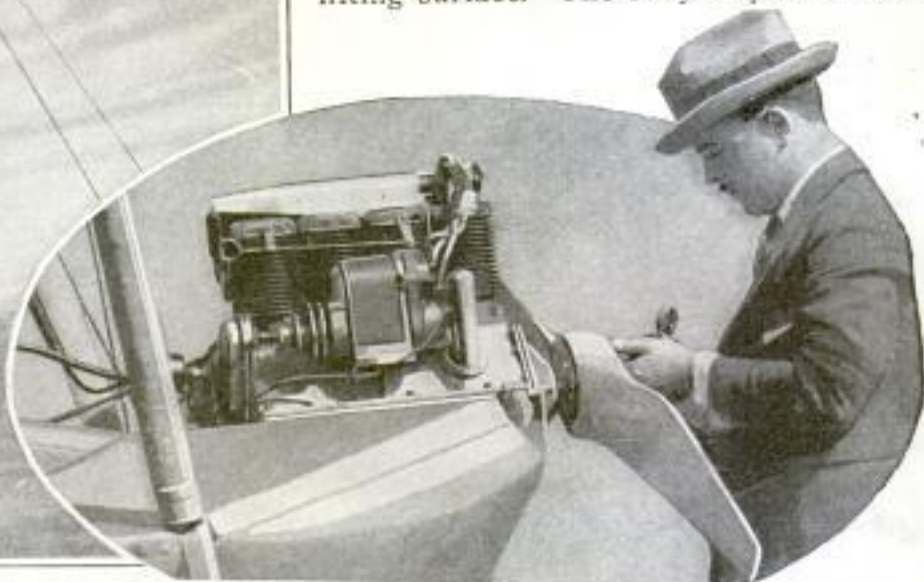

Sidecar and Motorcycle Engine as They Appeared Transformed into Speedy Monoplane That Flew Twenty-Five Miles on Half Gallon of Gasoline, and Start of 150-Mile Flight

Airplane Museum  
"Flying Bathhtub" Built Out of Junk  
Wins Air-Meet Race

A "flying bathhtub," built in a Dayton cellar out of a secondhand motorcycle engine, the body of a sidecar and a few odds and ends of spare junk, flew a twenty-five-mile race at an average speed of fifty miles an hour, and then did a 150-mile cross-country flight just to prove its airworthi-

only one-half gallon of gasoline, while maintaining a fifty-mile-an-hour speed for twenty-five miles. The performance set a new record for "flivver" planes.

By 1926, 20,000,000 motor vehicles will be in service in the United States, according to predictions of Thomas H. MacDonald, chief of the federal bureau of roads.



See also March 1929. 367 Tucson. Ariz.

### Radio Prospector with Loop Aerial Locates Hidden Ores

Locating hidden bodies of ore by radio signals has been accomplished both in the United States and Germany. The German device, called a "radio emanator," is being closely guarded by the Leipzig Mining company, but the American instrument, developed by Daniel G. Chilson, of the bureau of mines, University of Arizona, is being made available for all. The principle used is quite simple. The transmitting set is connected to the earth or, if possible, set up underground in a mining shaft to get it closer to the possible body of ore. The entire ore body then becomes a part of the transmitting antenna.

A receiver, mounted in a tripod, with a swinging loop aerial above, is used to detect the signals. The receiving set is of special design and employs several stages of amplification. In taking readings, the apparatus is set up with the loop in a vertical position, so the latter can be turned in an arc until the signals reach maximum intensity. This gives the "strike" or direction of the ore from the receiver. Without changing the strike, the loop is then "dipped" on its horizontal axis until maximum audibility is reached. This gives the dip angle. After the receiver has been set up in several locations and readings taken, the lines projected from the instrument give not only the location of the ore body, but its depth beneath the surface, which will be where the lines, prolonged, meet.

It is claimed that it is possible to cover thirty or forty square miles without moving the transmitter, while in ground rich in minerals, it is possible to move the receiver about and make as many as eighty or more set-ups and readings in a day. Experiments in the copper fields in Arizona have been highly successful. An operator who knew nothing about mining or geology took several readings in territory outside the mining district, and generally considered barren, getting indications of ore at several points. Some time later Mr. Chilson found traces of sulphides on the ground in four of the indicated places. The instrument now successfully devel-

Radio Prospector Seeking Ore with Tripod and Loop Aerial



oped by Mr. Chilson is the result of studies and experiments continued over a period of about twenty years.

### Electric Coin Sorter Saves Time and Occupies Little Space 2149

To save time and trouble in sorting and counting small coins, an electrically operated apparatus has been designed for economical installation in small space. It consists of a hopper, feed tray and four boxes, one each for pennies, dimes, nickels and quarters. A disk, revolved by a small motor supplied with current from a wall socket, carries the coins from the hopper and passes them to a sorting rail with openings of different sizes over the boxes. Dimes fall through first and the larger coins are carried on until they drop into their proper containers. The sorter is only two feet long.



Coins Passing down Slotted Trough and Falling into Proper Compartments from Hopper and Disk

Radwire Co, Holbrookworth Bldg  
2000 1st Ave. S.E. Wash. D.C.

Jorgensen & Co.  
122 W. Jefferson Ave. Detroit, Mich.  
Copyrighted material



2105

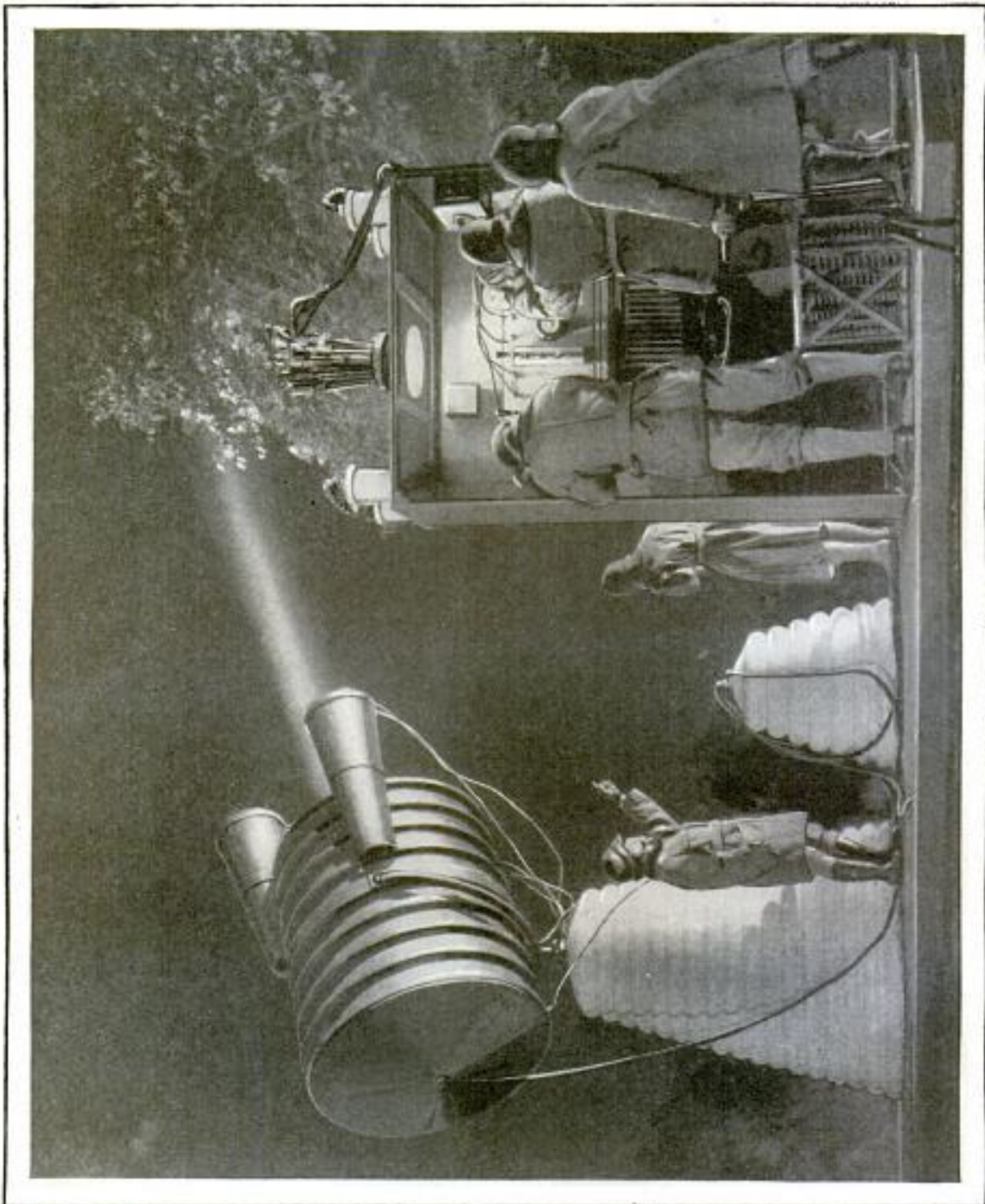

Actual Photograph of Experimental Night Test with So-Called Death Rays, Powerful Electric Beams Which, Their Inventor Believes, Can Be Used to Destroy Airplanes and Other Machinery of War



U. A.

Wm. H. ... Son, Ltd  
207 the ...  
... W. ... and

**Death-Ray Gunners in Rubber Suits**  
**Seek Safety from "Back Fire"**

While scientists are not agreed as to the power of the so-called death ray recently invented, the men who operate the heavily charged mechanism take no chances on being injured by "back fire" from the tremendous current. They wear special rubber suits to insulate themselves from the apparatus. The base of the gun, a beehive-shaped affair which revolves, is composed of porcelain and rubber, while the coils in the three hornlike projections on the barrel are so arranged that the heat given off by them will not injure the rest of the machine. The completed assembly is twenty feet high, and its inventor claims that it will throw its rays 3,000 feet.

**Eighteen-Hundred-Bladed Penknife**  
**Folds in Separate Sections**

To advertise its wares, an English cutlery company has constructed a striking display in the form of an enormous knife



Size of the Unfolded 1,800-Bladed Penknife Illustrated by Comparison with Man

**Pocket Billiards Played in Home**  
**with Pneumatic Cues**

On a small table, weighing little more than twenty pounds, and with pneumatic and spring shooters instead of the regulation cues, the game of pocket billiards can be played in almost any room at home and with approximately the same demand on the skill that is required with the standard apparatus. The equipment is not a toy. The table frame is built of aluminum and contains gullies for the return of the balls as on regulation outfits. The top lifts off so that the table may be placed under a bed or set against the wall. Balls are made of the same material as the ordinary two-and-one-half-inch balls. The shooters eliminate practically all the trouble caused by handling cues in cramped space. The spring device is contained within a small box and is released by pressure on a button. There is a regulating attachment to increase or diminish the force of the stroke. With the pneumatic shooter, the ball is directed by a blow from a small plunger which darts out of the end of the rod when the rubber-bulb handle is pressed. Light strokes, follow and draw shots, and others are possible with these shooters, as well as with the usual cue, it is claimed. The table is cast in one piece so that it cannot warp.

with 1,851 blades. It is arranged in a series of sections that fold into one another. Each of the blades, none of them much larger than those found in an ordinary penknife, will open and shut, is highly polished and has a keen edge. A carved and inlaid back gives the knife a realistic appearance when it is closed. It is firmly fitted in a pedestal for exhibition purposes.



Augie Kieckhefer, Noted Three-Cushion Player, Shows His Family How to Play "Rotation" on Tiny Table with Pneumatic Cue

midget ... Co. 23 or W  
Copyrighted material  
Company.

Marshall ... & Co.



## Electric-Lighted Diving Chamber Permits Work in Deep Water

For use in all sorts of under-water work, such as salvaging, sponge and pearl gathering and repairing ships, a southern engineer has constructed a diving chamber that permits considerable freedom of action and allows the worker to remain at his task longer than is possible with ordinary suits and rigging. The outfit consists principally of a massive electric-lighted extension compartment with openings for the arms, and portholes for illumination and vision. It is made of heavy metal to resist the tremendous pressure and may be lowered to various depths from a floating air chamber that remains on the surface. Connection is maintained by a tubular, hinged link section of special construction. The portholes are so arranged that rays from the lights shed their brilliance over a wide area, enabling the diver, who sticks his arms out of the holes, to use hammer, chisel and other tools with ease and accuracy. The entire equipment is managed from a barge tender which is fitted with air pumps, electric apparatus and various other implements necessary to submarine jobs. Recent tests with the outfit, which is said to be capable of operation at a

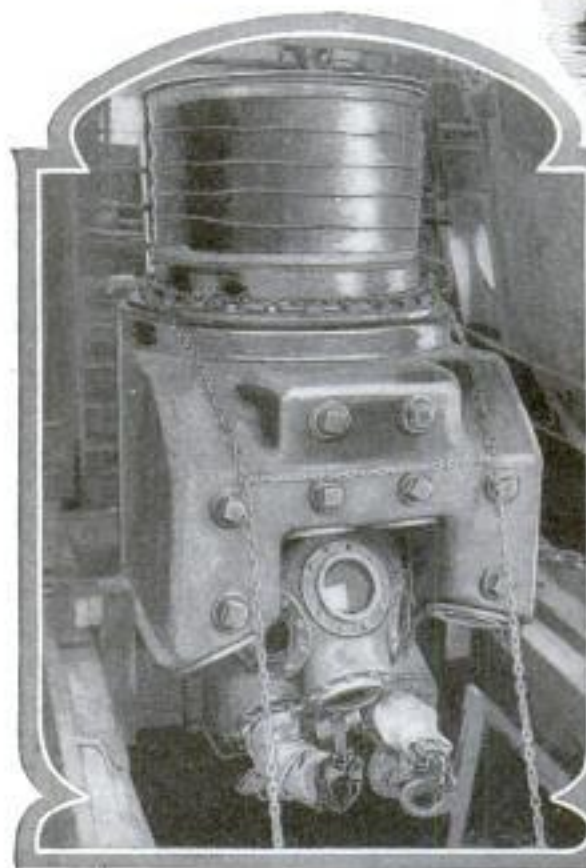

*Static Spark Plug Co.  
1229 W. 9th St  
San Diego, Calif.*

depth of 800 feet as now constructed, are reported to have been entirely successful.

## Spark Plug Grounds Static Current Reducing Crankshaft Vibration

Static electricity caused by the fuel mixture flowing into the cylinders at high speed, is said to be grounded by a newly invented spark plug. It has four points placed in such a way that the ignition current sparks the upper two only but magnetizes the forward ones so that they ground the static. This process is said to flash and increase the ignition flame, and to cause reduction in crankshaft vibration.

Barge Carrying Floating Chamber and Tackle at Stern; Diver inside Work Compartment at Bottom Showing Folding Collar, and Close View of Tank

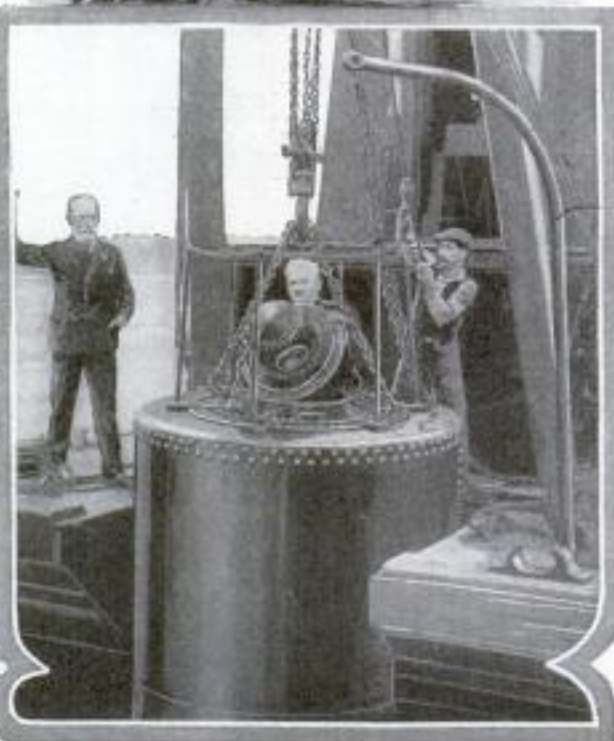



New York Times  
11/16/24

### Ocean Bottom Rises and Falls in Waves, Charts Show 2201

Islands in the seas which have been carried on shipping and marine charts for years are frequently found to disappear suddenly owing to unnoticed sinking of the ocean floors due to earthquakes and volcanic action. Many rise again from the same causes after ages of submersion. The largest isle of a group thrown up in the Pacific ocean by the earthquake which destroyed Tokyo, Japan, rose ninety-five feet above the water and gradually became covered with small vegetation. One morning it was found to have completely disappeared. Investigation showed that it sank back to a depth of twenty-five fathoms beneath the sea. In other volcanic regions many similar islands have appeared and disappeared during subterranean disturbances which pass otherwise unnoticed. Others reported to exist at certain localities centuries ago cannot now be found, though they are marked as "doubtful existence" and "doubtful position" on the maps which guide mariners. Some such isles thrown up in the past have remained to be settled by flourishing colonies, while hundreds of tiny peaks come and go with a regularity that gives great concern to the makers of the charts.

### Stencil Marker Worked like Plane Saves Time and Labor 1860

Closely resembling a carpenter's plane, a time and labor-saving marker for stenciling all kinds of shipping containers has been placed on the market. It is said to work eight times faster than the hand-operated brush-and-stencil method, and while the marks are being put on, a counter at the side tallies the articles, thus saving the need of a separate counting. The stencil, of the ordinary oil-board kind, winds and unwinds over two drums geared to sprocket wheels as the marker is pushed along. It is inked by a revolving brush which has a feed control regulated by the operator according to the kind of material being labeled. The handy tool weighs less than ten pounds, occupies but little space and effects a considerable economy especially in large warehouses.

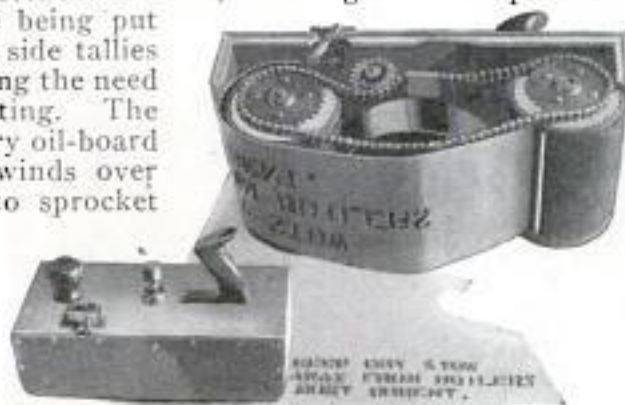

Side View and Working Position of Marker and Sample of Its Lettering

Plane marker

### Portable Fireplace That Burns Oil Adds Comfort to Home 1759

Comforts of an open fire without the bother of ashes and wood are provided in a portable kerosene heater that gives off



Fitted into Fireplace Niche, Portable Oil Burner Furnishes Ruddy and Comfortable Glow

an intense warmth from a clay back similar to that on natural-gas burners. It is so shaped that it fits within the regular fireplace or may be carried about even while burning and set in any desired position in the room. It is constructed as a unit, the fuel being contained in a pressure tank concealed in the base. The kerosene is forced through a small copper tube to the generator, where it is converted into gas and passed into an air-mixing

chamber, and thence to the clay radiants. A gallon of kerosene is said to last from eight to ten hours and to yield sufficient heat to make up to 6,000 cubic feet of space comfortably warm.

By a vacuum-drying process developed in Sweden, lumber is said to be fitted for pattern and cabinet work

within three days after the timber leaves the stump. The cost of the process is estimated at \$1 per thousand board feet.

John W. d'Aglesby, 90 Warwick Machine Co.  
Newport News, Va.

vertical text on the right edge, including "1936" and "October 1924"

From Engineering Co.  
533 Grand St.  
New York, N.Y.

Machinery, 10th Ave  
October, 1924



1941

*200000 lbs of cable*

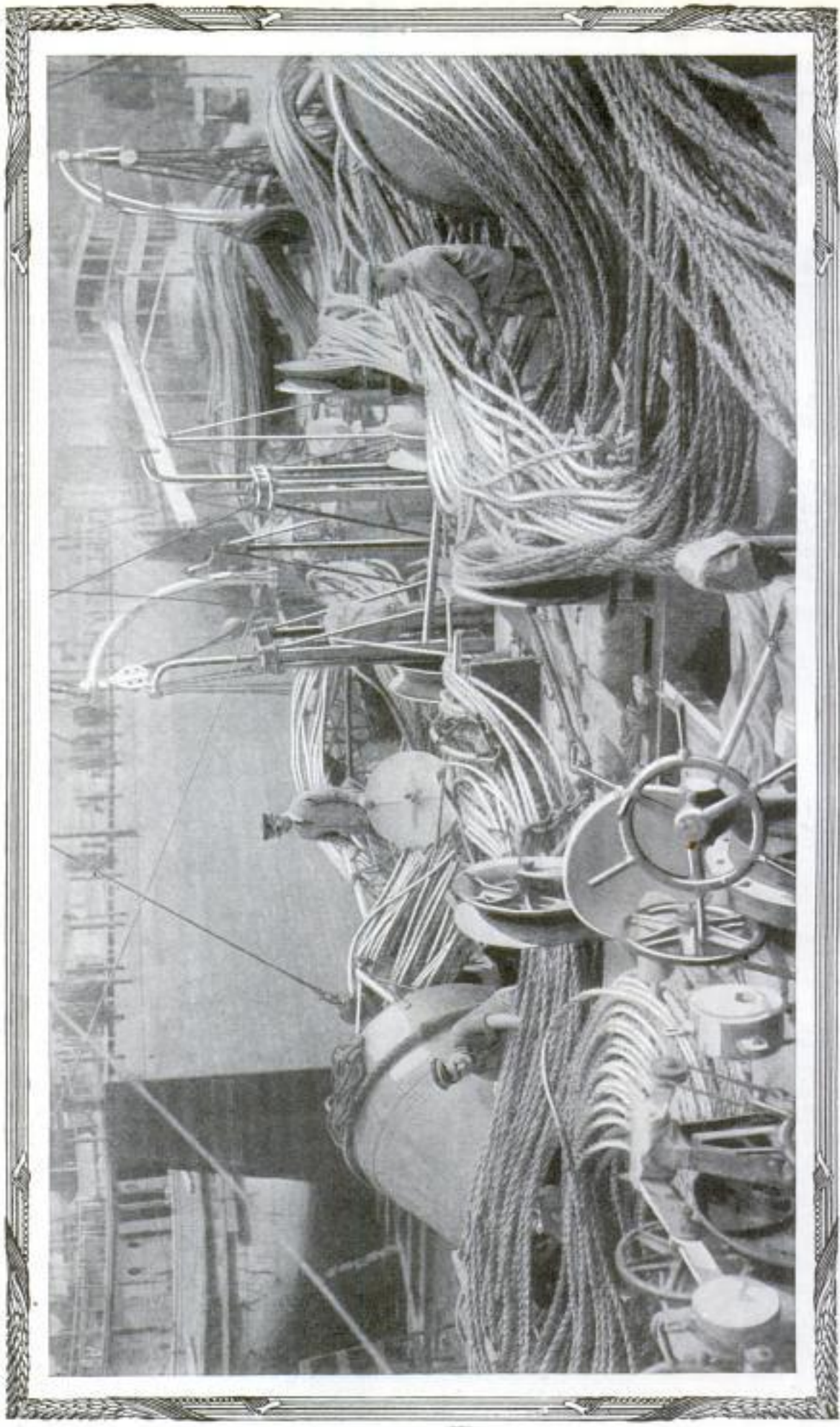

Back from the Task of Repairing a Break in the New York-Cuba Cable, the "All America," a Cable-Repair Ship, Docks at Brooklyn with Her Decks Littered with Miles of Undersea Wires, Gear, Marking Buoys and Other Paraphernalia

*200000 lbs of cable  
 6000 lbs of gear  
 10000 lbs of buoys  
 10000 lbs of other paraphernalia*



Com. H. J. Wilkins, Reg. 31, Hillier Road  
Wandsworth Common, London

## Around the World by Wire

1911  
W. H.  
England

### Constant Cable Communication under the Seas Made Possible by Unceasing Work of More than Fifty Repair Ships

**F**AR out in the North Atlantic the lookout on a great liner's bridge in the lonely watches of the night occasionally sees two red lights, with a white one between hanging vertically from the foremast of a ship dead ahead in the ocean lane. The engine-room telegraph tinkles, and the twenty-knot mistress of the seas swings off her course to give the stranger a wide berth, for her lights are the international signal of a cable-repair ship at work, when she has right of way over all other shipping. The task of maintaining submarine cables, making possible telegraphic communication around the world, keeps more than fifty repair ships busy.

The cables are not much more than an inch and a quarter in thickness in the deeper portions of the seas, and breaks due to submarine earthquakes, chafing against rock or coral or to imperfect insulation are not unusual. When the break comes, delicate galvanometers at either end of the line locate it to within a space of a few hundred yards, and the repair ship is dispatched to the scene. She carries a complete electrical laboratory of sensitive instruments; huge deck tanks of from 150 to 200 miles of extra cable; big one-ton marking buoys, and grapnel hooks so ingeniously constructed that they perform two or three miles down in the ocean as

well as human hands could do. When cables are laid, the ship keeps accurate observations as she crosses the ocean, showing the position of every mile, the depth of the water and the condition of the bottom. Electric recording logs chart the distance traveled, as the ship moves forward, paying out six to eight miles of cable an hour. Bottom "samplers," built like the clamshell buckets of steam shovels, show the nature of the sea floor, and delicate depth gauges record how far below the surface the cable is placed. With these data the repair ship is able to proceed direct to the location of a break. Here a marking buoy is anchored. The vessel then steams off a mile or so to one side, turns back, drops a grapnel over the side, and moves slowly across the course of the

cable, repeating the operation until the cable has been hooked. The grapnels themselves are remarkable devices. Because of the enormous depths at sea — the San Francisco-Shanghai cable is five miles below the surface at one point, while off the Azores an Atlantic cable is three miles down — extreme care must be taken to keep the cable from breaking under the strain. One grapnel is built so that it simultaneously cuts the cable and grips the severed ends. Another type rings a bell when the cable has been hooked or



Steaming Forward along the Cable Line, with Lookout Watching for Faults as Wire Passes over Grapnel



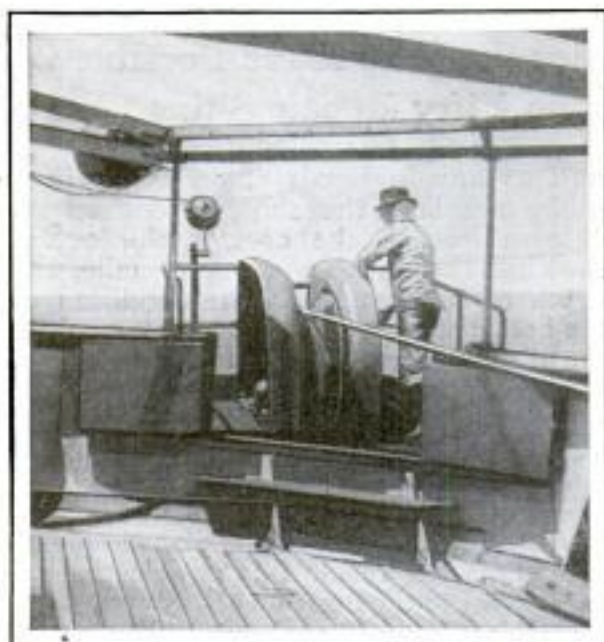

Lifting the Cable, with the Wire Passing through the Bow Sheaves on the Foredeck

when the grapnel enters water so deep that more rope must be payed out.

To take care of the strain of lifting, considerable slack is payed out as the cable is laid. Sometimes, however, the strain on the grapnel rope will become so great as to involve risk of breakage. Then the rope is fastened to a buoy, the ship steams away some distance, another grapnel is lowered that cuts the cable, and the loose

end is hauled aboard, while the other is picked up from the buoy. As soon as the end is aboard, the sheathing of cotton, brass tape and rubber is stripped from the copper core, and the wire connected up to the laboratory apparatus. Tests are started to locate the direction of the break, and the vessel then steams toward it, allowing the cable to run through sheaves while a lookout keeps watch from a boatswain's chair for defects.

Through the cable, but ashore, a constant watch is being kept for the ship's signals. A lamp reflected by the mirror and lens of the sensitive galvanometer records the signals as the beam of light moves back and forth. Once the break is located, it is either repaired or the bad section is cut out and a new piece spliced in from the ship's cable tanks. The vessel then steams back to the buoy marking the other end, if it has been necessary to cut the cable, and the final link is made.

The depth and condition of the bottom are important considerations when a cable is laid, as enough slack must be payed out to pass over the undersea mountains and down the ocean valleys. One of the worst causes of breaks is the frequent seismic disturbances under the sea. In 1923, it was discovered that the bottom of the Atlantic near St. Helena, on the Capetown cable route, had risen two and three quarter miles in twenty-four years.

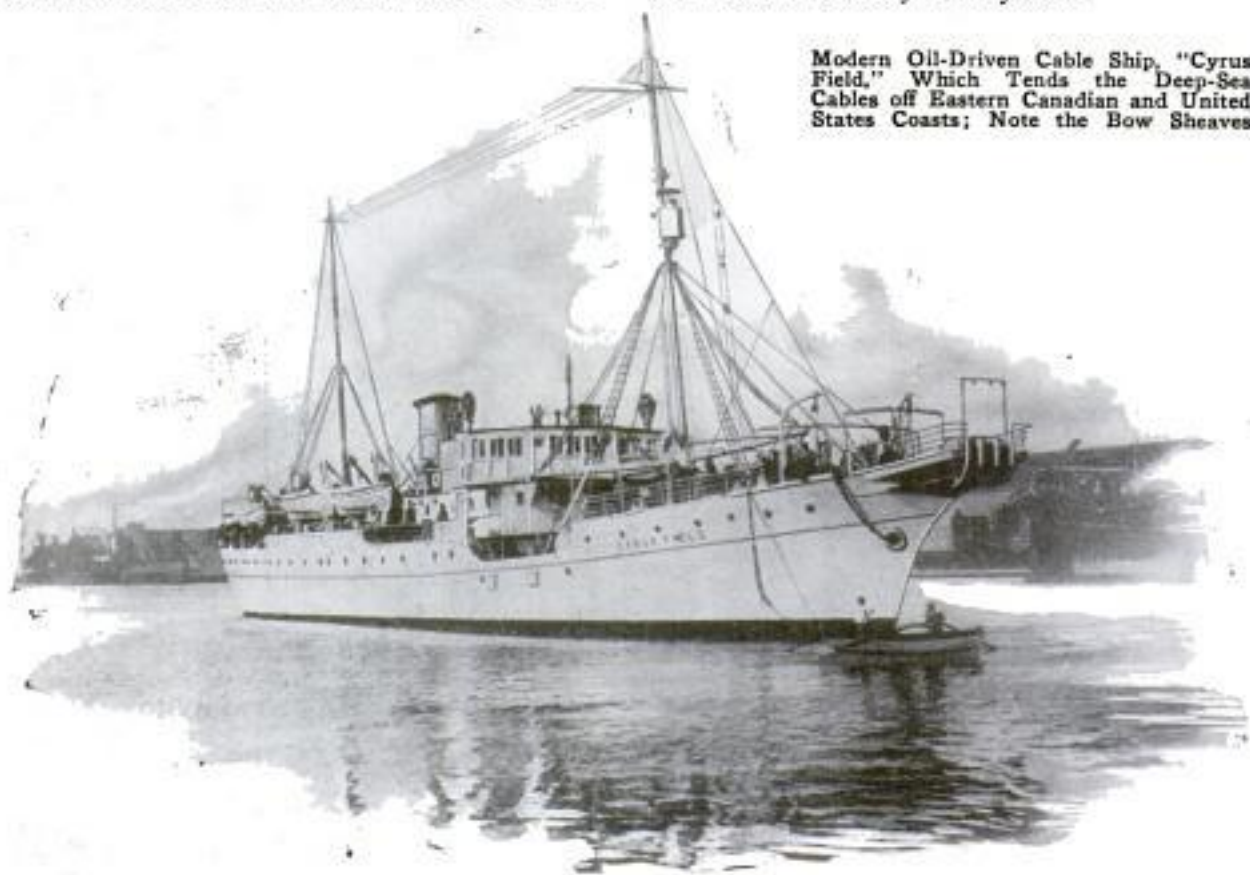

Modern Oil-Driven Cable Ship, "Cyrus Field," Which Tends the Deep-Sea Cables off Eastern Canadian and United States Coasts; Note the Bow Sheaves



1941

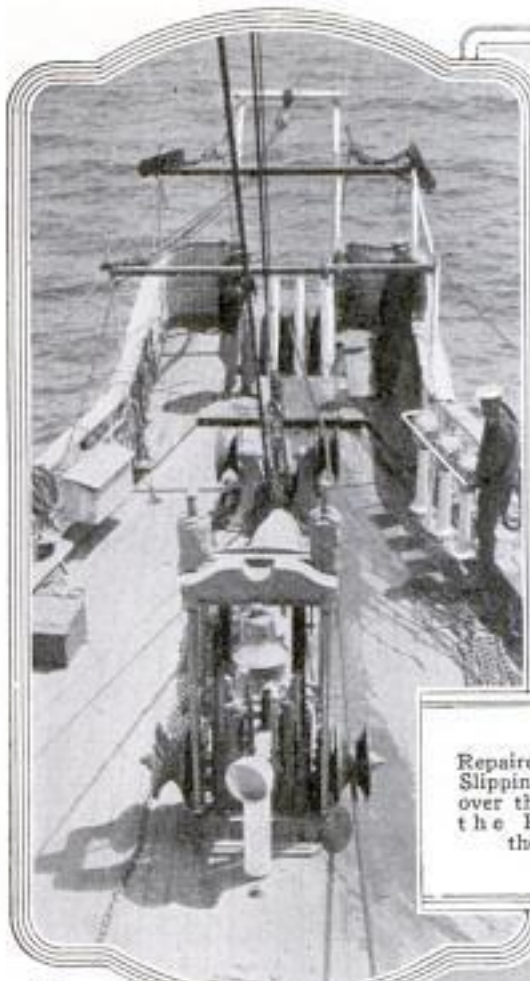

Repaired Cable Slipping Back over the Bow to the Bottom of the Sea

Crew Lowering the Grapple Hook over the Bow to Drag for the Submarine Cable, Which Must Be Lifted and Tested Until the Defective Spot Is Located



Testing New \$4,000,000 High-Speed Cable from New York to Italy, with 1,700 - Letters-a - Minute Capacity



1867

National Lamp Works  
General Electric Co., Lima Park  
Cleveland Ohio.

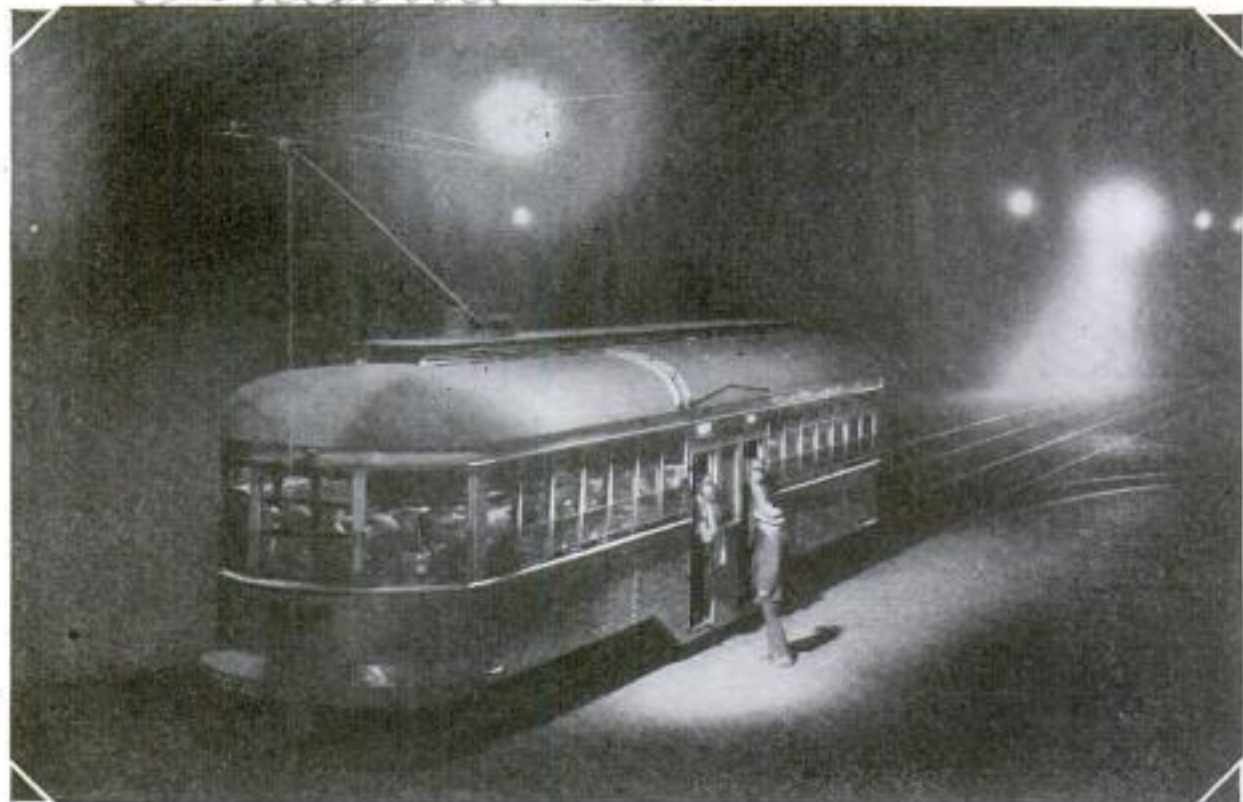

Stepping into Radiant Area of a Powerful and Carefully Focused Floodlight, Shining from Above, Passengers Are Plainly Visible to Motorists Approaching the Safety Zone

### Paint Mixer with Adjustable Paddle Works through Hole in Can

Much of the time and labor required to prepare batches of paint with a stick is said to be saved with a mixer that may be slipped through a hole in the top of the can. It has paddles of metal which normally are in a perpendicular position to allow insertion or withdrawal, but in the can fall into a horizontal plane and are rotated by a crank like that of a carpenter's brace. Paint can be thoroughly mixed in fifteen minutes with this tool, it is said. The contents are kept from dirt and dust and the aperture, easily plugged, may be used for pouring the paint into a smaller container.



### "Light Platforms" for Safety Zones to Reduce Accidents at Night

Studies recently made in thirty-two cities show that seventeen per cent of the fatal traffic accidents that occur at night may be traced directly to insufficient light. To reduce this number and afford better protection for the pedestrian and the street-car and auto driver as well, a plan has been devised for illuminating street safety zones by putting flood lamps high above the street at car stops where the rays will light the area used by passengers getting on and off. The beam covers a zone four feet wide and seventy-five feet long. The lamp is mounted at a height of twenty-three feet and twenty feet back from the zone limit.

### Coal Analysis Catches Thieves

Analysis of the coal that thieves had used to replace a consignment of gloves they stole in Germany from a shipment of merchandise on its way to San Francisco, aided in identifying the criminals after receipt of the crates at their destination. Lumps of the fuel were found carefully wrapped in the packing straw to weight the boxes and avoid discovery of the theft during transport. In an effort to locate the mine from which the mineral was

Copyrighted material  
27 22 Princeton  
New Jersey, Calif.

1946  
Cheney & Co.  
New York



1915  
Erected on Mount Royal, Montreal, Quebec, Canada, by the Ocean Electric Light Co. of that city

taken, the coal was analyzed and checked by experts in the employ of the freight agents. It was learned the source of the material was a well-known working near a small town in the Ruhr district. The information was communicated to the German police who traced the deed to a gang of thieves operating in the mining center, and recovered the stolen gloves with the arrest of the band.

1914  
**Auto-Cleaning Brush Fitted on Hose Saves Work in Washing Cars**

For washing automobiles quickly and thoroughly, a brush that is designed to reach into corners and difficult places has been invented. It is attached to the end of the garden hose and has a three-way valve so arranged that water can be directed from either side, or from the end in a straight, steady stream for rinsing. With the side streams running through the bristles, the exposed parts of the car can be quickly cleansed, while the strong stream that shoots from the end, strikes under the lower parts and into crevices and corners with sufficient force to remove dust, dirt and oil, it is claimed. The brush prevents splashing and wetting the clothing as often occurs when buckets and sponges are used; the bristles are soft and fine so that they will not scratch the finish, and the cleaner is durable, fits any garden hose and does away with much handwork and tiresome stooping over.

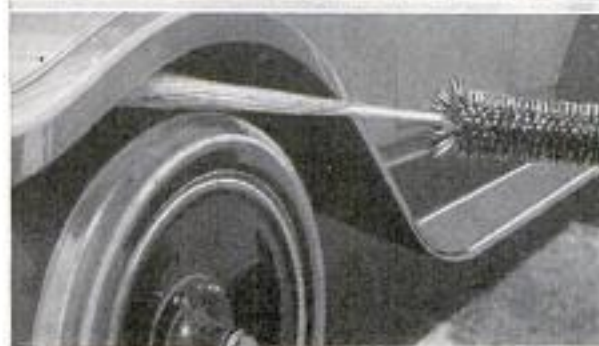

Using Brush to Clean the Hood, and as Hose to Reach Under Parts of Car

Sundt + Co. Inc.  
373 Fourth Ave.  
New York City



Finishing Steel Work on the Skyscraper Cross That Will "Preach" to Thousands Day and Night

**Electric-Lighted Skyscraper Cross to Blaze Message for Miles**

As a silent preacher, a huge cross, fashioned with steel beams after the manner of a skyscraper, has been erected on the heights of historic Mount Royal at Quebec. Electric lights will make the emblem visible at night, and because of its huge size and location on the lofty summit, the cross can be seen from a considerable distance even by day.

2085  
**Wrapping Twine from Pine Trees**

String that is said to be as strong as that made from hemp is being manufactured from the pulp of pine trees by a southern paper company. The long fibers of the wood, three times the length of those of the spruce, are well adapted for making into cordage and the product is reported to be especially fitted for wrapping twine.

2085  
Royal Paper Co. La.



1924

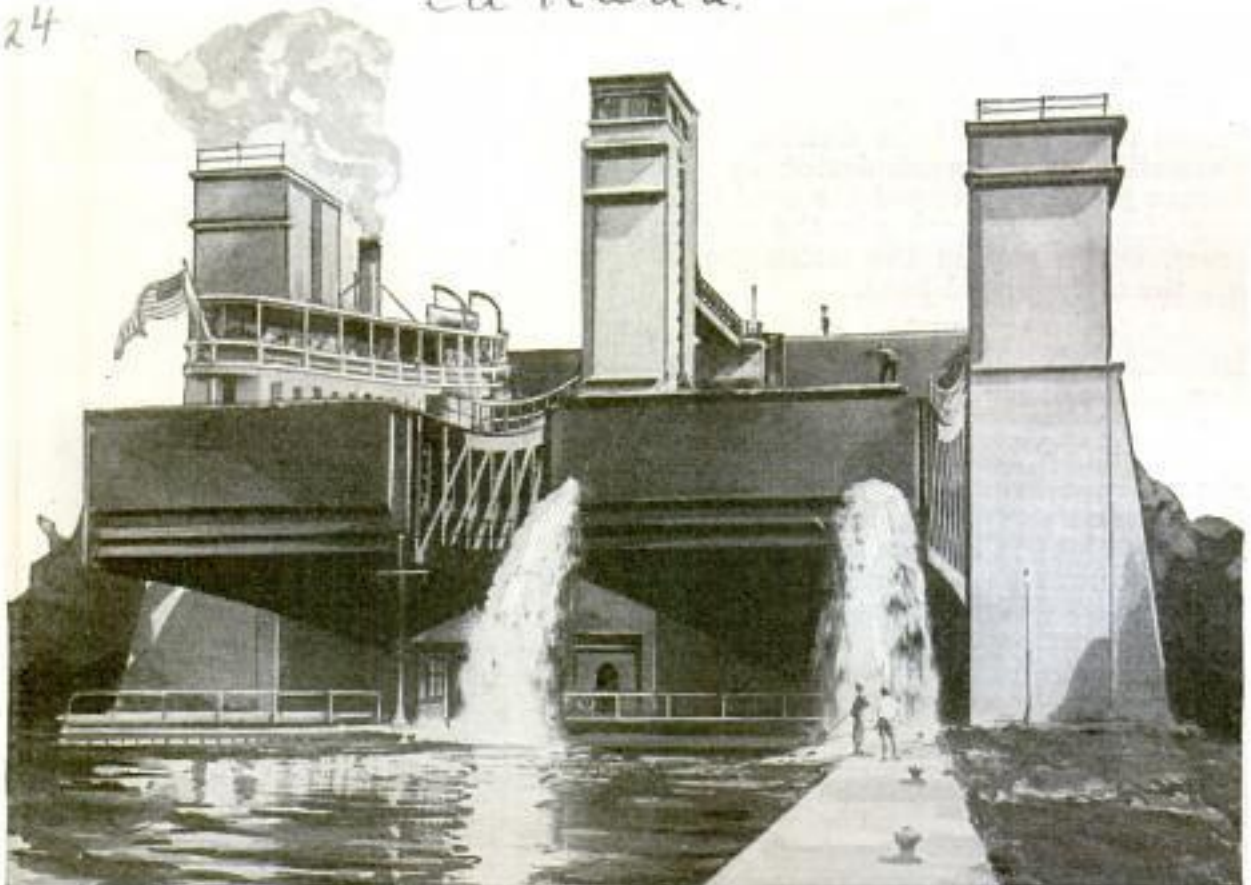

Lowering a Canal Boat in the Hydraulic Elevator Locks, the Ascending Pontoon Being Lightened by Release of Water from the Tank as It Nears the Upper Level

2012  
**Electrified Road Roller Operated with Power from Trolley Wire**

When a steam roller owned by a western company required an extensive overhauling, engineers decided the boiler was past repair, but put the rest of the outfit into service by installing a railway-type electric motor for driving power. Current connection was made with the trolley wire of an interurban line at the side of the road by a cable on an automatic winding reel in front. The roller, thus remodeled, gave satisfactory service, it is said, and



Supplied with Power from Near-By Trolley, Electrified Road Roller as It Appeared Remodeled

as only one man was required for operating, it saved hiring a fireman.

1924  
**Locks That Work like Elevators Lift Canal Boats Sixty-Five Feet**

How application of the principles of mechanics has assisted navigation is well illustrated in the huge hydraulic locks in the Trent Valley canal at Peterborough, Ontario, where boats ride in elevators up and down a sixty-five foot lift, said to be the highest in the world. So nicely is the entire mechanism adjusted, a ship can climb or descend the "hill" and get on its way again in from six and one-half to eight minutes, and only three men are needed for the operation, a lockmaster at his controls in his cabin in a 100-foot central tower and two assistants to manage the gates. In principle, the works are similar to two huge hydraulic elevators of the simple plunger type, the locks being so connected that the descent of one causes the rise of the other. In place of the ordinary elevator platform or car, there is a large tank closed at each end by gates, which are made water-tight by inflating rubber tubes around them with a pressure of ten pounds to the square inch. The lock chambers are 140 feet long, thirty-three feet wide, carry 500 tons of water upward and 600 to 650 tons down.

Milwaukee Electric Railways & Light Co. Milwaukee, Wisc.



*Western*

**Wheat Grows Twelve Rows to Head and Stems of Solid Straw**

Wheat grown under ordinary conditions on the experimental farm of Dr. Seager Wheeler in Saskatchewan, Can., bears heads of grain containing twelve rows of kernels. Other strains of plants are said to ripen within thirty days after the shoots appear above ground, and grades with both hollow and solid stems of yellow and purple have been reared without any special efforts of cultivation. Wheat berries as large as navy beans are also reported to have been developed on the tract, and specimens have been raised on which the heads ripen while the stalks are still green. It is believed that of sixty-five sturdy and fruitful species under cultivation, many will be found to resist plant diseases as well as stand up against heavy storms common to that region.

1811

**Rolling Jacks Worked from Auto Move It Sideways for Parking**

Operated by a lever from the inside of the car, a wheeled hoist attachment for automobiles raises the machine so it can be rolled sideways into a narrow parking space. After the vehicle is lifted from the ground, small wheels of the elevating apparatus allow it to be pushed to either side with little effort. When the car is needed, it may be shoved out into clear



Automobile Raised by Rolling Hoist Attachment Which Allows Car to Be Moved Sideways

space and the jacks released and drawn up close to the running gear to avoid protruding obstacles in the road. Used in congested streets of large cities, it is claimed the device will prove a timesaver and result in the parking of large numbers of automobiles in limited spaces along the curbs.

*Chas. William Williams  
224 Park Ave.  
Baltimore, Md.*

Bricks are used as scrubbing brushes in India in giving elephants baths.

~~*Pacific & Atlantic  
255 Park Ave  
New York*~~

**Model Glider Stays Up Ten Minutes - Flying Mile and a Half**

While real airplanes were demonstrating the latest achievements in aerial navigation at the races at Dayton, Ohio, a

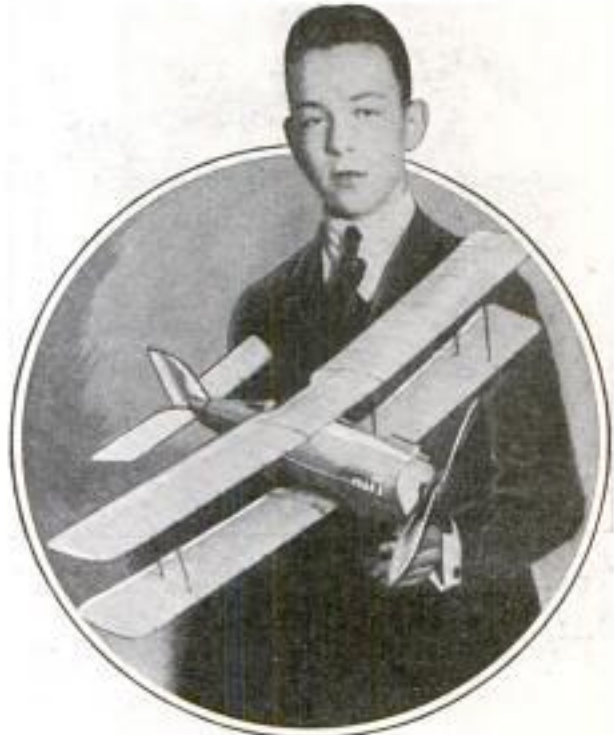

Miniature Biplane Glider That Flew a Mile and a Half, and Its Young Designer

model glider, made by Robert V. Jaros of the University of Chicago, skimmed over the field and shattered all previous records for flights of miniature planes of this type. The tiny ship remained aloft for ten minutes and fourteen seconds and traveled a mile and a half before it finally fluttered to the ground.

*Pacific & Atlantic  
Notes*

**Houses of Metal Built in Day**

Modern four-room dwellings, built of non-burning materials covered with a thin veneer of metal, are being erected completely in twenty-four hours by builders of Budapest, Hungary. Although the homes are inexpensive, it is claimed they have the advantage of being protected against fire and will last over a long period of time without the need of repair. The parts of the structures are all designed and prepared before construction is started, so that the pieces may be quickly slipped into place and fastened without further fitting or cutting. The method is reported to have been copied from that employed in the manufacture of toy houses made from sheet metal.

*see April 1925  
570*

*Chicago Evening Post  
Copyrighted material*



*Financed*  
4-

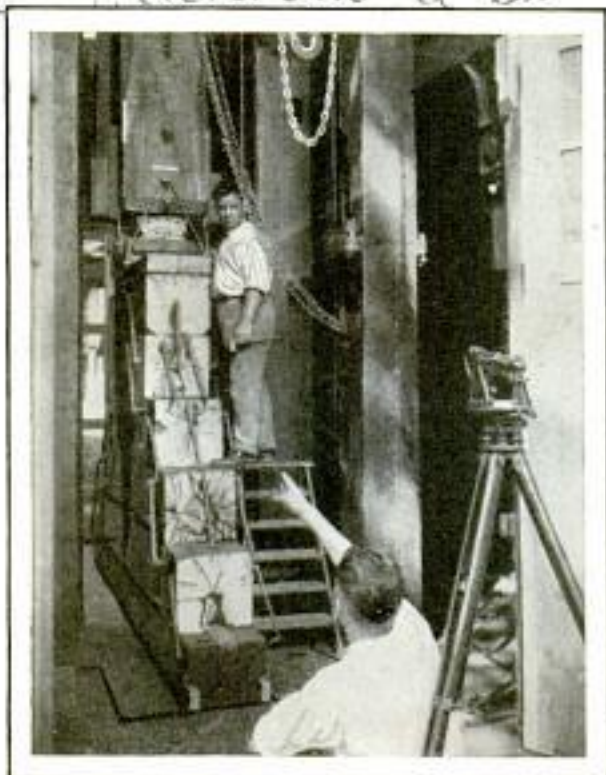

As Big Blocks Were Squeezed in Powerful Press, Cracks Were Measured with Surveyor's Instrument

### Drydock Blocks Tested in Press to Assure Safety for Ships

To determine the exact load that each wooden keel block, the supporting units placed under the vessel in a drydock to protect and hold the hull, will stand, the forest products laboratory recently tested five of them in a gigantic press. The timbers, each fourteen by fourteen inches and of clear white oak, had been submerged for a week in a lake so that they might be tried under the same moisture conditions as would be found in actual service. The load was transmitted to the top of the blocks by a roller bearing in such a way as to allow them to keel over

sideways as they would in failing beneath a ship. As pressure was applied, record was kept of the force exerted, and the pieces were studied for cracks, fissures and other signs of failure.

### Sunken Treasure Liner Is Found by "Sweeping" Ocean Floor

Dragging the floor of the ocean with an iron "sweep" a mile long, two trawlers working near the coast of Virginia found the wreck of the treasure-laden steamer "Merida," sunk in 1911. The vessel, which went down after a collision, was carrying a cargo of gold, silver, copper and precious stones now valued at a sum between \$2,000,000 and \$5,000,000. The search was instituted by a group of wealthy men who financed the undertaking after having the records of the accident carefully checked over with surveys made of the vicinity.

*Chicago Tribune 10/28/24*

### Combination Pupil's Desk and Chair Saves Schoolroom Space

As a solution of the overcrowding problem, now a matter of considerable importance in many schools, a western firm has placed on the market a compact combination pupil's chair and desk. It can be moved about the room and utilizes some of the space usually left for aisles. Its chief feature is that the child has ample room to stand and recite, without stepping to the side of the seat, simply by raising the folding top of the desk. On dark days, pupils may be placed quickly where there is the most light by moving the desks, and groups for special study may be arranged in the same way. Below the seat is a drawer for books and papers. The desk is durably constructed and so shaped as to afford a comfortable and correct position.

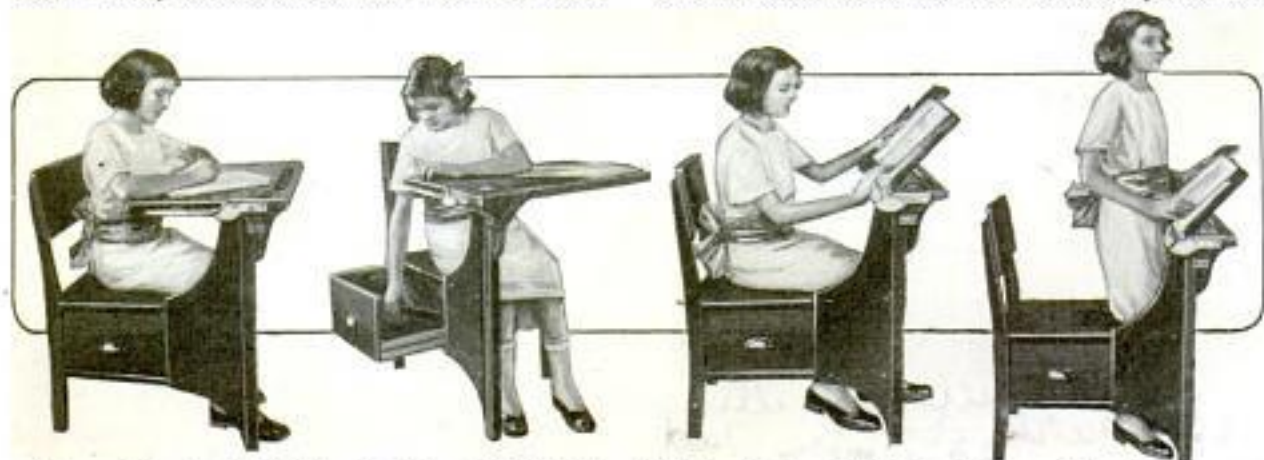

From a Comfortable Sitting Position in Desk-Chair, Child Easily Gets Book from Drawer, Has Convenient Reading Rack and Ample Space to Stand without Stepping into Aisle

*Comrades Inf. Co. St. Louis, Mo.*



### Electric Spark in Vacuum Bottle Tests Removal of Air

In making vacuum bottles, the greatest skill is required to handle the glass parts, which consist principally of two rounded bottles, one within the other, inclosed in an outside metal jacket. The inner bottle is slipped within the larger one which, at first, has no bottom, and the two are fused together by melting them at the neck. Then the larger end of the outside bottle is drawn to a tube-shaped point, and a hole is made in it through which is poured a silver solution that coats the inside of the outer bottle and the outside of the inner one, to prevent radiation when the container is put into service. The air between the bottles is extracted by means of rub-



Pumping Air from Bottles with Suction Tubes in Special Rack



Seeking Flaws in Glass and Taking Temperature Tests

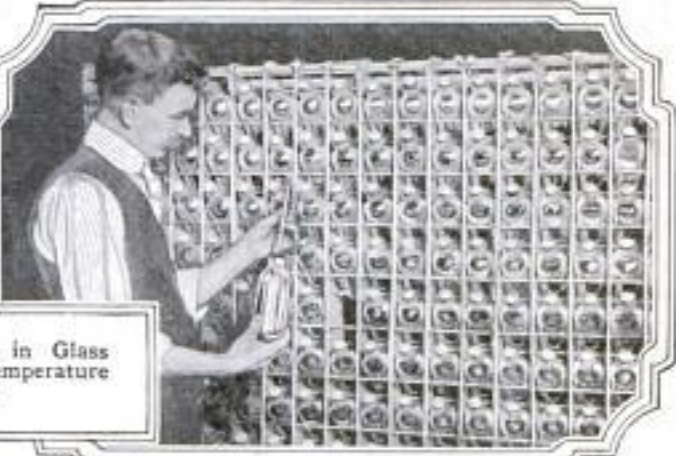

ber tubes connected to a pump. To determine when sufficient air has been withdrawn, tests are made by shooting an electric charge through the space between the walls. This produces a colored glow within the space, which becomes fainter as the evacuation proceeds, and when it is almost invisible, the end of the tube is sealed by the melting process. The bottles are then inspected and tested. Boiling water is poured into them and left for twenty-four hours. If it cools more than ten degrees, the bottle is condemned.

wheels when occasions demand. For instance, every time a train of a dozen cars or so grinds to a halt at a station, it costs the railroad company about \$4. Wear on the brakes, wheels, rails and the locomotive, all must be included. A large elevated-railroad company has estimated it costs about two cents a car to stop and start the trains. Surface lines' engineers say the expense for the same operations on street cars is slightly higher. Under average conditions, it costs a small fraction of a cent to stop an automobile, but a taxicab company, operating about 3,000 cars, estimates that it spends several thousand dollars a year just to make halts for passengers and at traffic stops. The roller coasters at the amusement parks usually require one or more brakemen to slow the cars down from their giddy whirls, and friction brakes must be renewed frequently and kept in constant repair.

1963

### Cost of Stopping Trains and Cars Amounts to Millions Yearly

Everyone knows that it costs huge sums to keep the world's machinery in motion but the layman seldom thinks of the millions of dollars expended just to stop the

machinery & stop it 4



# Mercury-Arc Lamp to Protect Eyes

*1914* Harmless to Vision and Free from Flickers, Soft, Bright Glow Takes Place of Sunlight for Camera

*1914*  
*Chem Laboratory*

EMPLOYING an electric current far stronger than any heretofore used in an equal amount of space, a mercury-arc lamp perfected by mechanics of the chemistry school of the University of Chicago, restrains the escape of rays injurious to the eyes of those engaged under its glare. The lights are designed to furnish illumination for photographic work, delicate laboratory tasks and for all purposes where a substitute or aid for daylight is required. The light, which is said to produce about five times the brilliancy of other lamps of similar type, prevents flicker by means of a siphon arrangement that carries the condensed mercury back to the bottom of the bulb without passing it through the vapor arc. This feature results in a steady, soft glow which can be increased or diminished by adjusting the amount of current permitted to pass through the arc. The tubes are of special heat-resisting glass, which does not pass the ultraviolet rays, so often found to result in painful injury to the eyes, and might replace the glare of "Klieg" lights against which movie workers must often be masked. For this reason it is believed the lamp might materially reduce the ill effects produced on the vision of motion-picture actors and others called upon to

spend a great part of their time under the dazzling glare of the strong lights seen in the majority of photographic studios.

Before the mercury is placed in the glass bulbs, it is subjected to a thorough cleaning in specially constructed apparatus which extracts almost every trace of foreign matter from the mineral. In this way, not only is the quality of light improved but the greatest amount of service is gained, as the process leaves nothing that can impair the steady burning of the arc. The tubes also are carefully cleaned of all particles of dust or other material that might collect on the smooth surfaces, and baked in a vacuum under intense heat. This process is to prevent the entrance of any dirt into the liquid metal during its flow through the tubes.

The mercury tubes can be made in almost any size and shape to meet the needs of the users. On each a condensing chamber is provided into which the vaporized mercury can pass as it rises from the bottom of the arc, returning by way of the siphon tube to the boiling level, thus avoiding contact with the arc and eliminating annoying and undesirable interruptions or breaks in the flame. So readily is the electric circuit formed when starting the lamp to burn, that a slight turn of the tube is



Testing the Return Speed of the Condensed Mercury Passing through the Siphon Tube to the Boiling Level; Insert, Close-Up of a Desk-Type Lamp and Bracket



1914

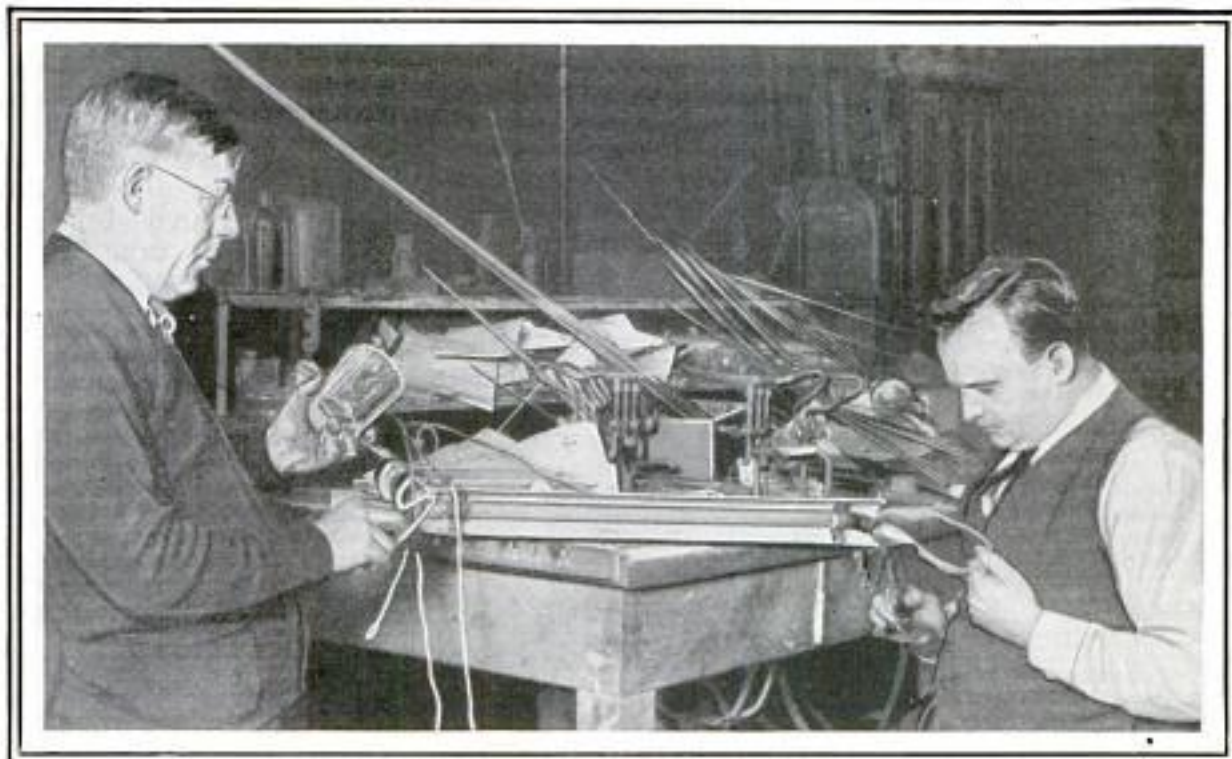

Designers of the Siphon Mercury Arc Lamp, Charles Hanson and George Reppert, Filling the Condenser and Attaching the Electrodes of an Overhead Tube Light in Their Workshop

sufficient to complete the circuit in the bulb, and but slight resistance is required to control the brilliancy of the glow.

In order to insure the highest vacuum obtainable in the bulbs, they are pumped out by specially built mercury condensation pumps to insure a light free from injurious gases that may retard the production of a clear, strong glow. And despite any increase of the size and strength of the lamps, the surface of the glass keeps comparatively cool, making it possible for workers and others to remain within close range of the glare without need of protection against burns or excessive warmth. Since more light can be generated in a small bulb than is ordinarily possible with other lamps, the mercury arc equipped with the siphon may be set up in large batteries or groups, either for overhead suspension or for arrangement along the walls of studios and similar inclosures where great volumes of illumination might be needed. It has also been pointed out that the light may be constructed in a portable case for use by photographers instead of flash powder for night exposures, and sizes to correspond with the familiar incandescent bulb may be made for desk and table use or as part of decorative clusters in signs and show-window displays.

The glass employed as containers for the lights is of such a nature that it can be readily worked into almost any shape. Among the various types of lamps that

can be formed from this material are those fashioned in long spirals, squares, triangles, and circles for special service in the illumination of studios and laboratories, and in straight barlike tubes which can be set upright or suspended horizontally from overhead brackets where only the ordinary lighting effects are desired, such as illumination of shops and workbenches.

2144

### Scientists to Search Sea Jungles in Hunt for Giant Squid

Turning to the sea for one of the most extensive big-game hunts ever organized, a party of scientists from the New York Zoological society seeks to plumb the depths of the Sargasso Sea and other mysterious caverns of the ocean for trace of the giant squid and kindred creatures little known to man. The expedition, headed by Dr. William Beebe, has fitted the 280-foot steamer "Arcturus" with elaborate equipment for scientific research, including hooks, dredges, traps, diving apparatus, complete photographic layouts and a radio-broadcasting set, and contemplates a six months' tour. The ship has a cruising radius of 13,000 miles. Short inland trips in remote sections will also be made and collections of bird and animal life will be gathered on shore as well as from the deeps of the sea.

*see April, 1925 - 593*  
*Kansas City Star*

11/5/24 Copyrighted material



1994



Pushing and Pulling with Feet and Arms, Youngsters Both Turn and Teeter on This Little Merry-Go-Round

### Merry-Go-Round and Teeter in One Give Healthful Exercise

Both for indoor and outdoor play, a combination merry-go-round, teeter and rowing machine has been devised for small children. It is designed with two or four seats that rest in a framework propelled in circles by alternately pushing with the feet and pulling with the hands. With each revolution, the child rises and falls six inches with a smooth, easy motion. The entire device occupies about five square feet, is easily portable and besides furnishing fun, is said to be a splendid exerciser for young arms, backs and legs. There are no chains, gears or belts to get out of order or cause injuries.

### Aerial Traffic Claims Only Six Lives in Five Years' Operation 1913

Despite the wide range of operation and large volume of passenger traffic, only six lives were lost in commercial aviation in England during the past five years, according to reports. In that time more than 50,000 persons were carried and the combined flights totaled about 4,000,000 miles. In 1919, only twenty passengers were transported by the entire English commercial air service. Now regular schedules

are in force between London and Paris and planes make six trips a day over that route. Daily passenger flights are also made to Berlin, Moscow and Cologne and freight capacity of the craft is booked completely several days in advance. New routes are being opened up to include Zurich, Rome and Madrid in the air lines. So great has been the increase in the business of aerial transportation in Britain, that rates of fare have been reduced from ten cents to seven cents a mile.

1436

### Efficiency of Brakes Shown by Tester

Accurate measurements of the efficiency of automobile brakes are taken by an ingenious instrument used by the United States bureau of standards. It tells within how many feet from the point where the brakes were applied any car, regardless of its weight, can be brought to a stop from a speed of twenty miles an hour. The device, outwardly resembling a small bucket with a square-shaped bail and a dial for a lid, is simply placed on the floor of the car. When the brakes go on and speed slackens, a weight suspended on springs inside the instrument is thrown forward, moving the pointer to a figure on the dial corresponding to the number of feet the car will travel before it stops.

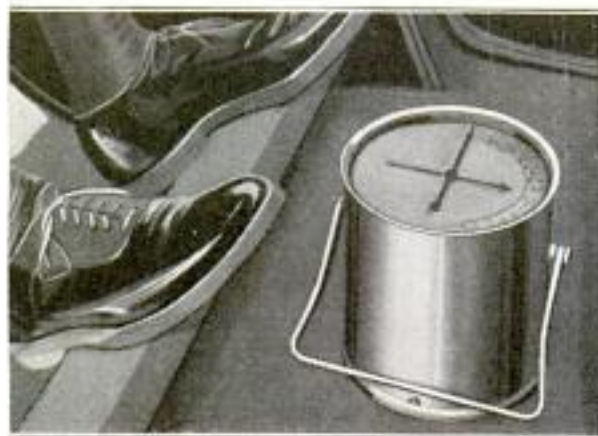

Copyright, Harris & Ewing  
Auto-Brake Tester with Dial Top in Working Position on Floor of Car

4-passenger \$19.75  
2-passenger \$16.00

Chicago Evening Post  
10/27/24





Miners Using the Gas Detector on Roof of Gallery, and Close View of Apparatus Showing the Bulb and Tubes

### Color Change Reveals Poison Gas to Save Lives in Mines

One of the most dangerous of all poison gases, carbon monoxide, is quickly revealed by color changes in a chemical solution now being used in rescue work following mine fires and explosions. The apparatus consists of a tube of charcoal through which the air to be tested is drawn by means of a rubber hand bulb. It is then discharged through another small glass tube containing the chemical. The charcoal removes any gas other than the carbon monoxide, and interfering dust and mist are stopped by cotton-wool filters. If the gas is present, the chemical turns from white to violet-brown and finally black, depending on the amount of poison in the atmosphere. No special skill is required

in the operation of the detector.

Aside from its use in mines, the device is also of value for testing the air around blast furnaces, gas producers, city gas plants and may be employed to promote furnace economy by indicating the percentage of carbon monoxide in the gases escaping from the flues.

### Food for a World Cruise 2047

A large city could be supplied food for many days, with plenty for every person, from the larders of a modern ocean liner prepared for a round-the-world voyage. On a big vessel with a full passenger list more than forty-two tons of beef, twenty-one tons of mutton and four tons of veal of choice grades are consumed in addition to 50,000 oysters, sixty tons of potatoes, and over 51,000 chickens, ducks, turkeys and wild fowl. Requirements of milk, cream, ice cream and preserves run into enormous figures. Crates of canned vegetables are hoisted aboard in stacks as big as a large room, and the supply of bread and pastries is furnished by 500 barrels of flour and 2,600 tins of biscuits. Fresh eggs are used to the number of 180,000, and among smoked meats bacon ranks first with an item of 17,000 pounds.

*Carroll City Series*  
 10/22/54 Copyrighted material



Utility News Service  
Texas Public Information Bureau  
Dallas, Texas

1949

### Fingerprints Are Enlarged to Help in Identifying Criminals

Identification of criminals is said to be made easy by a camera which enlarges the prints of finger tips to reveal the slightest characteristic in the design of whorls and

### Electric Motors in Logging Camps Replace Horses and Steam

2065

Electric motors are replacing horses and steam engines for logging and lumbering



Instructing Police Executives in Fingerprint Identification with Chart Made by Enlarging Camera Below

lines. Although the ordinary photographs made for police files are accurate copies of the telltale marks, reproductions made by the fingerprint machine may be used for rapid comparison, eliminating the need of powerful magnifying glasses. The large charts are also valuable in the instruction of detective forces charged with the tracing of criminals and in the study of identification methods.

in many parts of the country, according to public utility reports. Every year, more current becomes available through the spread of transmission lines, electricity has been found faster than older methods, it is independent of the water supply, and the menace of fire is greatly reduced. Furthermore, the motors can be quickly moved from cutting to cutting. It is estimated that fifteen kilowatt-hours of current will handle 1,000 board feet of lumber from the stump to the loaded car, yanking it down the skidway and lifting it to the trains or waterways that carry it to the mills. There are now nearly 70,000 electric motors in the lumber industry, driving the great ripsaws and other milling machinery that convert the annual cut, valued at about \$900,000,000, into finished products worth approximately \$2,500,000,000. The lumbering industry last year required 800,000,000 kilowatt-hours of electrical energy.



### Guns for Uncle Sam's Navy Made in Kitchens for Cooking Steel

Extracted from the ore by fuel, limestone and air in the blast furnace, the metal for the big naval guns at Uncle Sam's factory, in Washington, D. C., goes to a foundry which is like a big kitchen where the steel melter is the "cook." The raw materials have been analyzed by laboratory experts who send a "menu" to the melter by which he selects the correct amounts of pig iron and scrap steel. These are then subjected to a temperature of more than 3,000 degrees in a huge furnace until the cook thinks that all impurities have been removed and the mass is ready to tap. Before this is done, a long-handled spoon is filled with a sample of the metal, cooled and sent to the laboratory for analysis. A favorable report may be given or the white-hot contents may need seasoning with carbon, nickel or chromium. Afterward, the steel is forged, a step somewhat like the kneading of bread dough to give the metal the required strength by working it under temperatures of from 2,200 to 1,400 degrees. The forged parts are then machined and assembled.

### Hair Remover Worked as Scissors Pulls with Rubber Bands

Superfluous hairs can be removed safely, it is claimed, with an instrument some-

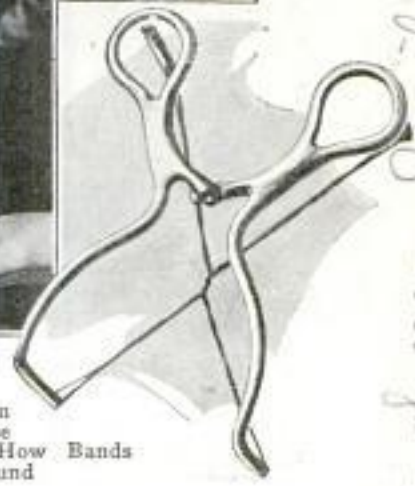

Hair Remover in Use, and Close View Showing How Bands Are Wound

### Dog Mascot Decorated by Pershing Pays Visit to President

"Stubby," mascot of the 102nd Infantry of the Twenty-Sixth division of the A. E. F., is said to possess more medals than any other dog that saw service. He was decorated by General Pershing and added another claim for distinction recently by a visit to President Coolidge. The dog was wounded by shrapnel in 1918. On dress occasions, "Stubby" displays his medals on a comfortable blanket bearing sergeant's stripes and regimental emblems.



Veteran of the World War, Mascot "Stubby" Wears His Medals with Canine Dignity

what like a pair of scissors, with crossed rubber bands instead of the usual blades. As the handles are worked back and forth, the bands, rolling against each other, catch the hairs between them and extract them. If the skin is held tight and the hairs are not too long, little pain attends the process, it is said.

### Lathes That Cut Spiderweb Lines Prevent Banknote Frauds

Practically every government on earth is a customer of a little shop in New Jersey where the geometric lathes for engraving the patterns on banknote and similar plates are manufactured. Finely adjusted gears on the machines produce the closely interwoven curves, spirals and scrolls on the copper surfaces. The tool is so made that combinations of designs can be executed even to the intricate weblike borders. Hardly two lathes are made alike, each one being suited to the individual requirements of each purchaser. The extreme accuracy of these instruments makes it difficult to alter the notes without detection.

*Sold by John W. ...  
Paterson, N. J.  
Made in U. S.  
M. L.*

*Owned by J. W. Conroy*

*Copyrighted material  
15 R. ...*



### Harmonica and Trumpet Combined Easily Played by Chart

With only a few minutes of practice, it is claimed, anyone can learn to play tunes on a combination mouth organ and



With Aid of Instruction Chart, Children Easily Learn to Play Mouth-Organ Trumpet

trumpet. The instrument is about the same size and shape as a cornet. The tones of the harmonica, which is placed inside the horn, are amplified by the trumpet part which is slid back and forth as the breath is expelled or drawn in, according to directions carried on a visible indicator chart in front of the player.

### Tree Rings Aid Weather Forecasts by Showing Rainfall Average

Age of trees and certain characteristics of their growth and development have been told for many years by means of the rings on the stumps, but these records are now believed to be of additional value as a basis for long-range weather forecasts in various sections. According to Dr. A. E. Douglass of the University of Arizona, there is a definite connection between these rings and the rainfall. Noting this relationship on a number of pine trees, he worked out the probable variations of the sun during the last four or five centuries and his deductions are said to have been corroborated by astronomers who have been studying the sun's spots. Knowing something of the changes that have occurred in the past, it is possible to make predictions as to the probable weather changes of the future, with the tree rings as the only known element in the problem.

Study of the rings of the giant Sequoia trees, pronounced the oldest living things, will, it is expected, increase the accuracy of the forecasts and will yield data of weather conditions extending 3,000 years back.

### Flashlight Is Fired by Radio Wave from Across the Ocean

Visitors at the annual wireless exposition in New York witnessed a brilliant illustration of radio magic when a wave, broadcast from the powerful station at Carnarvon, Wales, leaped the Atlantic and set off a flashlight-powder charge, taking a picture of Miss Helen Keller, Gen. J. G. Harbord, and Harold Bolster, director of the show, and other notables. The impulse was made to actuate an electrical circuit through a system of relays to ignite the powder, and at the same time an electrically controlled automatic camera took the photograph.

### Holder for Notebook Aids Writing and Supports Pages for Typing

A folding portable copyholder which can be attached to a stenographer's notebook keeps the pages smooth for writing and supports the leaves upright for typing. Permanently fitted to the tablet, the device affords a solid rest for pen or pencil, and when set up on a desk for typewriting, permits the operator to retain an easy, natural position avoiding eye strain and fatigue.

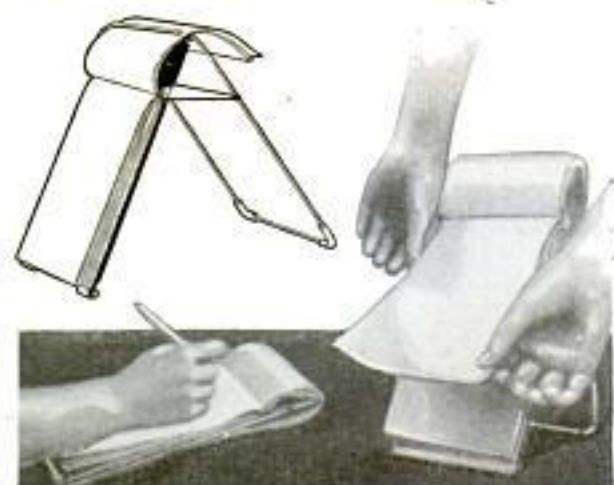

Adjusting Holder to Notebook, Writing with It Flat, and Drawing of Upright Position

Almost any size of office stationery can be placed in the holder, and its ability to protect the sheets against crumpling under constant handling is said to result in a great saving of time and materials.

*Premier Novelty Co., 3516 Charlotte St., Pittsburgh, Pa.*

*Premier Novelty Co., 3516 Charlotte St., Pittsburgh, Pa.*

*Chicago Daily News 11/8/24*

*Office Efficiency, San Francisco, Calif. Distributors, Copy Material, 1234 Clay St., Chicago, Ill.*





Fencing on Horseback, Called the "Balaklava Melee" after the Famous Charge of the Light Brigade, Is One of the Most Exciting Sports Used to Train Mounted Policemen for Rough Work

## The Making of a Detective

### Vigorous Course of Physical Training and Plenty of Schooling in Scientific Methods of Unraveling Crime Required to Qualify

**E**VERY red-blooded boy at some time in his life aspires to be a policeman and ride a horse or motorcycle in the traffic squad, or patrol a beat in search of lawbreakers, picturing such a life as filled with excitement and adventure.

Yet a policeman's work is difficult and exacting and much of it is dull routine. First, there is a strenuous course of physical and mental training to prepare him for the lowest round on the ladder—walking a beat in uniform—and if he aspires to attain the aristocracy of the force and be a detective, in plain clothes, there is an even more vigorous bit of schooling.

The old days when a police officer's most severe work-out consisted in exercising an eighteen-inch locust stick have passed. The modern policeman is a slim, well-trained, clear-eyed fellow who can box, wrestle, ride, shoot straight, and who knows something about scientific crimi-

nology. The first training, which every aspirant for any branch of police work must take, is purely physical. The rookie is taught to stand and walk properly, with head up and shoulders back, and is then put through a course of hardening exercises to develop all the muscles. Most of the rookies during the last few years have been drawn from the ranks of former soldiers, men who didn't care to settle down to office work or routine jobs. Many of them are college graduates. They progress rapidly toward the higher branches, including work on special squads, such as traffic, narcotic, prohibition, bomb and detective-bureau work. Military training and college education tell, and the modern detective bureau includes many of these younger men.

Along with the new type of policeman have come many new methods of development. Nearly every big city now has its



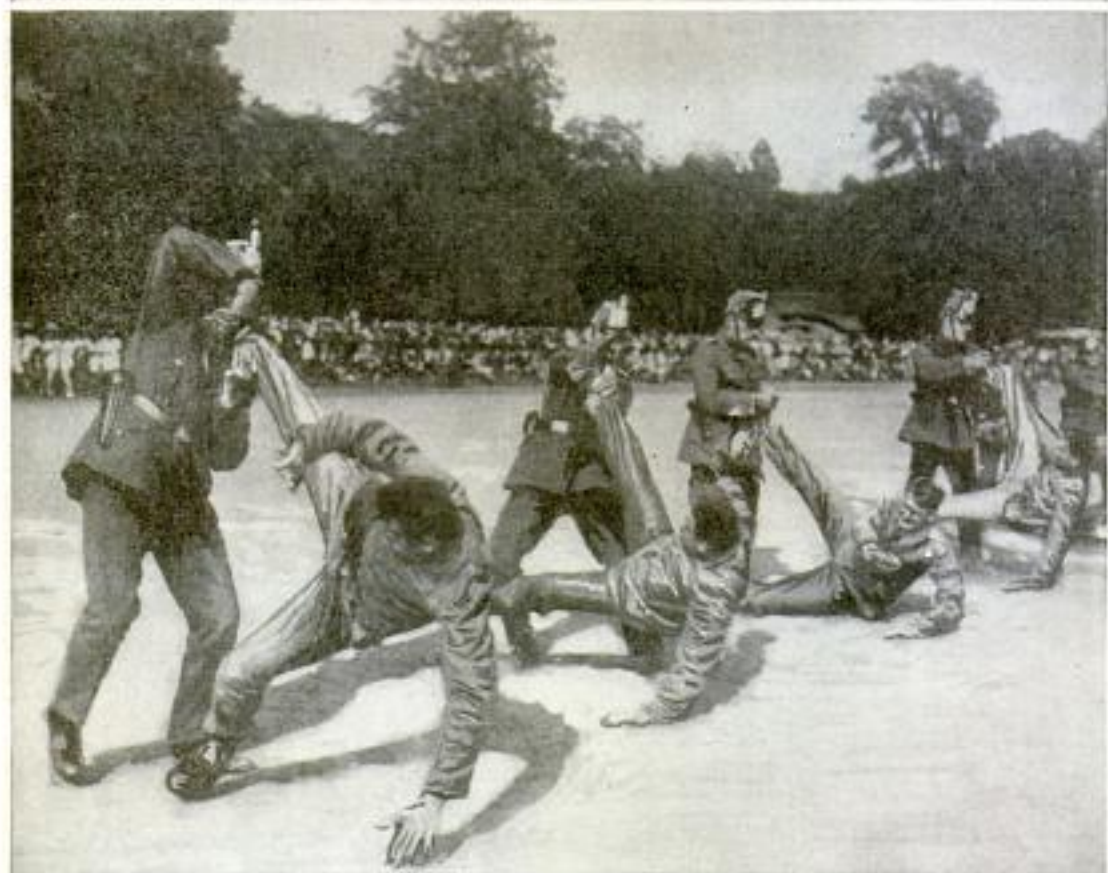

German Police Are Thoroughly Trained in Trick Holds for Rough-and-Tumble Fighting. Above, a Policeman Is Demonstrating an Arm Hold, While Below Is Shown One Similar to the Wrestler's Toehold



annual police games, where the men go through military-formation drills, cavalry stunts, setting-up exercises, trick motorcycle riding, and play polo and mounted pushball. Detective work takes an even harder training, though most of it is mental. Aspirants learn about fingerprints, how to find them and how to classify the telltale marks and locate the owner, if he has a police record, in the department files. They are taught the latest scientific quirks developed by clever thieves, and how to circumvent them. Modern crime detecting is based on a complete library of criminal information, consisting of all the detective reports on crimes committed over periods of many years. Each criminal has his peculiar vagaries which distinguish his work from that of all his fellows. The detective's job is to locate that peculiarity so that whenever it appears again the man responsible will be instantly identified. Besides all this technical knowledge, the candidate for a detective's job must know how to operate a typewriter to write his report, and attend to the clerical work which fills a large part

of his spare time. Criminals are changing their technique constantly. Every new invention which aids humanity is turned to their own peculiar use. The automobile has made a quick get-away possible, and brought into being organized gangs who prey on pay-roll and bank messengers, or "stick up" outlying banks.

To meet these attacks in big cities, squads of detectives constantly cruise about in high-powered cars, armed with riot guns, machine guns and gas bombs. Experiments have even been made in equipping the detective cars with portable wireless outfits so that they may be instantly notified of a crime and kept informed, during the chase, of every report of the criminal's whereabouts. The detectives in those squads must not only be skilled trackers, expert rifle and pistol shots, familiar with the use of tear-gas bombs, but must even know how to operate a radio set, as well as an automobile.

The aim of modern police methods is, not to catch the criminal after the act, but know what he is going to do, and prevent it.

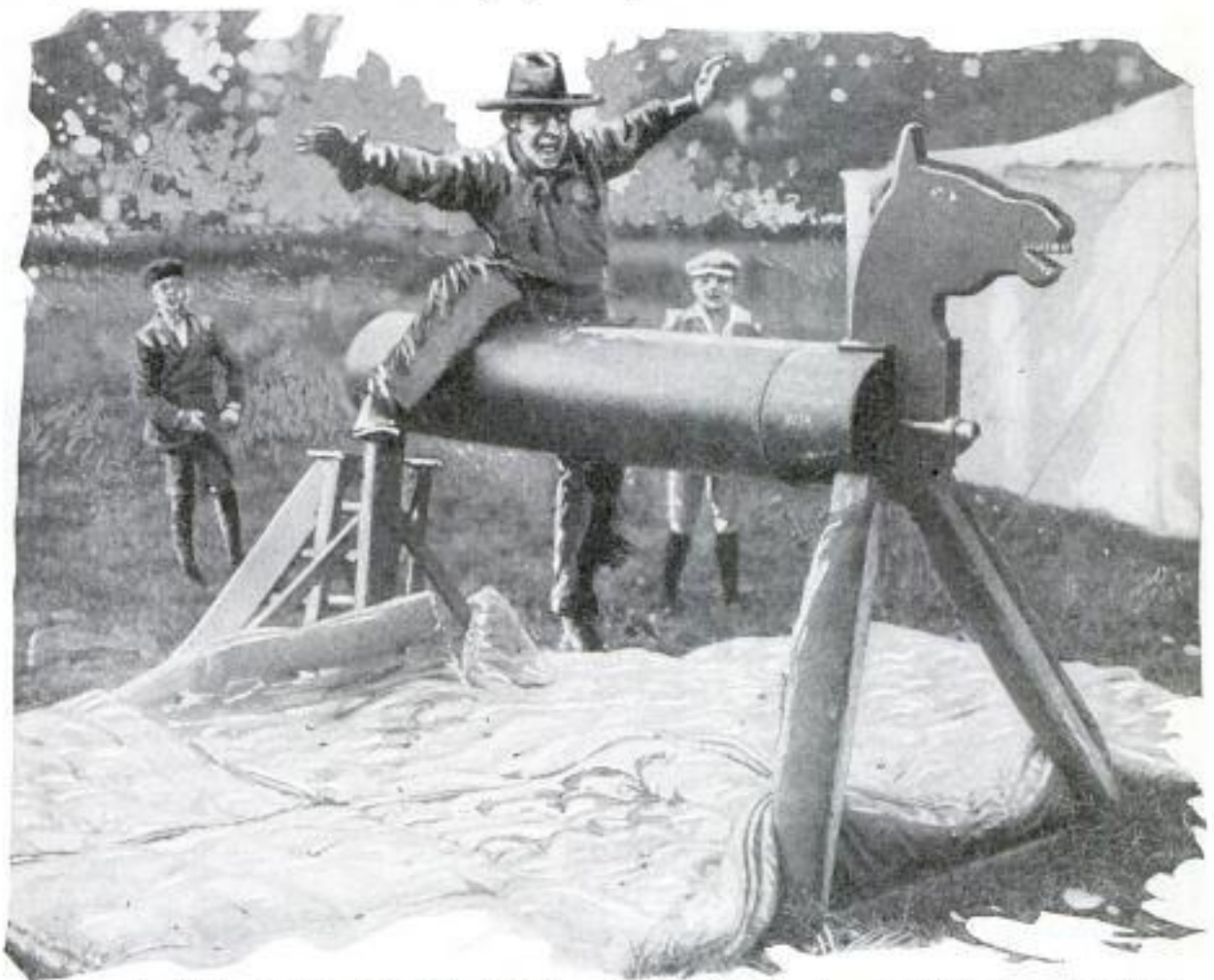

Policemen Are Trained to Ride This Mechanical "Bronc" Whose Body Revolves on an Axle. The Trick Is to Slide from the Tail to the Head without Falling





Detectives Must Master the Intricacies of the Whorls and Loops of Fingerprints and Learn to Distinguish One from Another Before They Are Eligible for Identification Work



The Mounted Squad Is as Well Drilled as Cavalry



Rookie Policemen Doing Their "Daily Dozen" at the Annual Field Games



**Red Is Still Best Danger-Signal Light  
 Government Tests Reveal** 2168

Red, the traditional danger signal, is the best traffic light not only because the color has become symbolic of warning in the minds of almost everyone but because it can be most easily distinguished from other lights, bureau of standards tests reveal. Various colors were given daylight trials at different distances recently in connection with efforts of the bureau and other organizations to standardize traffic signals. Daytime was chosen, as correct identification is especially difficult in natural light. Using lamps of different candlepower and testing at distances up to 1,250 feet, it was found that red is the easiest to distinguish, green second and blue third. Ordinary yellow, though visible, was often mistaken for orange or red. The conclusions were drawn after several thousand tests with different observers had been recorded. It was shown, further, that, on the average, a red light of seventy-five candlepower could be identified at a distance of 600 feet, while green lights had to be 250 candlepower, yellow 750, and blue 1,000 candlepower to be distinguished at that distance. At 1,250 feet, the candlepowers required were 1,500, 2,500, 3,000 and 7,500, respectively.

**Capture of Strange Bear Cub Ends  
 Dispute of Scientists** 2066

The capture of a specimen of a unique species of small white bear on Princess Royal island, off the coast of British Columbia, has ended a twenty years' dispute among scientists. Until the animal was caught, many authorities had doubted that such a bear existed. It is smaller than its black cousin, and the teeth differ greatly from those of the polar family. The eyes are brown, which is declared proof of the fact that it is not an albino. The cub is now in the zoo at Victoria, B. C., and efforts are being made to trace the origin of the species.



Little, but Highly Important to Scientists—the Brown-Eyed White-Bear Cub in Captivity

**Artificial Mouth Built of Rubber  
 to Aid Dumb to Speak** 2030

That dumb persons may be taught to speak with the aid of an artificial resonator



Copyright, Keystone View Co.  
 Artificial Resonator with Rubber "Mouth" Designed to Aid in Teaching Dumb Persons to Speak

invented by Sir Richard A. S. Paget, is the belief of those who tested the ability of the device to magnify the human voice. The instrument is said to reproduce throat sounds by means of a rubber larynx in such a way that they can be formed into words by the "mouth" of the contrivance. It is easily carried and its operation readily learned by the user. During an experiment the resonator transmitted guttural sounds made by a subject and these were turned into words the patient desired to use, by manipulation of the lip piece.

Electric sirens for submarines have been invented by a Swedish engineer to prevent collisions of the boats and to warn other vessels to clear out of the way when the subs are about to return to the surface of the water.

1. Vernonshire Terrace, London, W. 8, England.



### Muff and Hand Bag Are Combined for Convenience of Shoppers

1940

Another use for a muff besides keeping the hands warm has been found in a novelty called a bag-muff. It has an inconspicuous wrist cord at one end and a false bottom at the other, with a decorated tas-

iversity of Wisconsin at Madison. Here, short intensive courses are given on the different properties of various woods, the best methods of handling them in factories and in preparing timber for the mills. Known as the forest products laboratory, this school already has been attended by nearly 800 persons from all over the country, and many firms find it profitable to send representatives to the classes each year. Included in the courses are demonstrations in the kiln-drying of lumber, building and operating the kiln being part of this work; studies in the proper boxing and crating of goods, with actual tests as to the strength of containers of various shapes and kinds of wood, and lessons in gluing. One of the chief objectives of the school, in addition to helping individual firms with their problems, is to teach the economical use of lumber and thus encourage conservation of forests.



Convenient as a Hand Bag with Wrist Cord, as Shown at Left, Accessory Fills All Requirements of a Warm Muff and the Tassel Adds a Decorative Touch

sel appended. When the left hand is removed, the muff falls open as a bag, placing the articles inside within easy reach. Both of an extra carrier dangling from the arm is eliminated with this arrangement, and things are less likely to get lost than if placed loosely inside a muff.

### 1585 Fountain Pen and Pencil in One

Combining a fountain pen and a self-sharpening pencil, a writing implement designed to save pocket space and conveniently provide either device when needed, writes with either end. The barrel is divided in-

to an ink reservoir and a magazine for extra pencil leads. A lever is attached at the side of the stem for use in filling the pen, and the pencil shaft can be withdrawn to renew the point or use an eraser held in the concealed end. A protect-



Sectional View of Combined Fountain Pen and Pencil Showing Ink Sack and Lead Magazine

### Uncle Sam's School for Lumbermen Aids Forest Conservation

2139

Among the many activities in the public service maintained by Uncle Sam, is a school for lumber manufacturers and salesmen run in connection with the Uni-

ing screw cap for the pen can be transferred to the pencil end when ink is being employed. Made in several different models, the device is strongly constructed with few parts to require renewal.

*Eclipse Salgo Co. Dearborn, Mich. 10, Chicago*

*Double Service Sales Co. 14903 Broadway, New York. 3/21/25*



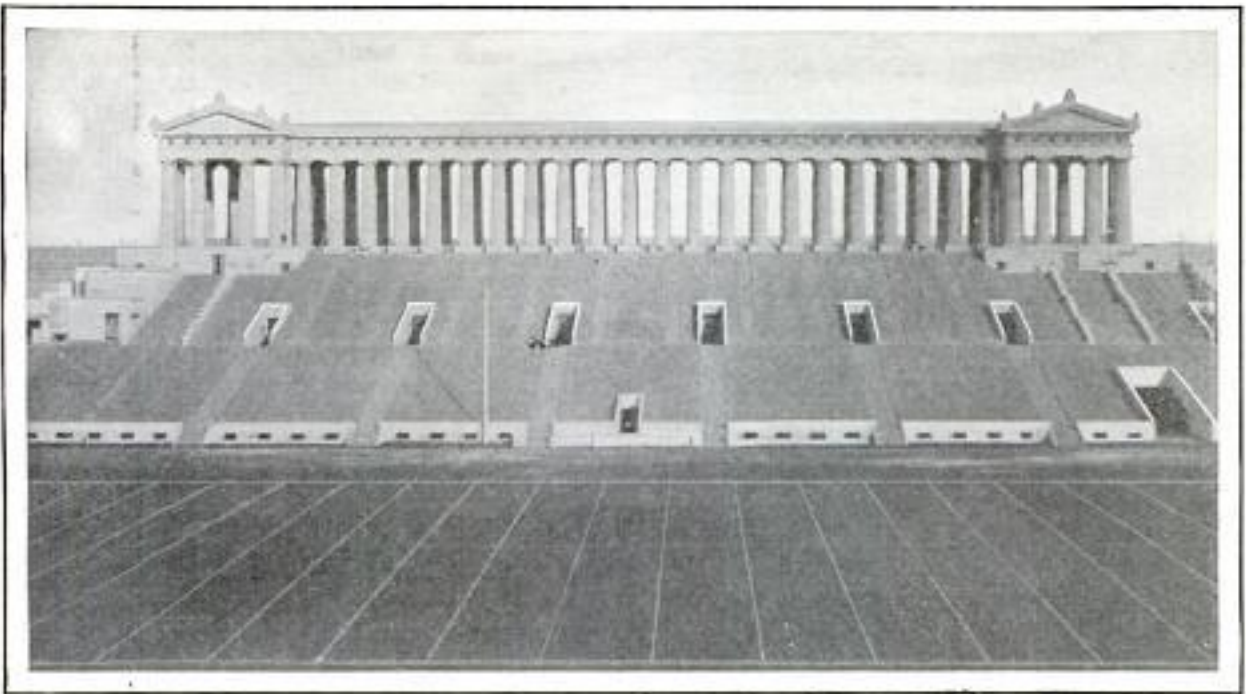

One of Massive Colonnades Crowning Tiers of Seats in Chicago Stadium; Entrances Are Planned so That Capacity Crowds Can Vacate the Inclosure in a Few Minutes

### Huge Stadium Covers Seven Acres and Seats Hundred Thousand

Occupying more than seven acres of land and planned so that all of its 100,000 seats command a clear view of the arena, the new stadium erected in Chicago is one of the largest amphitheatres in the world. With a greater capacity than the Colosseum of ancient Rome, the structure is provided with reception rooms, offices, dressing quarters for athletes and several large meeting halls. Built in the shape of a "U," the massive inclosure is open at one end to permit entrance of parades and pageants in unbroken column when necessary. Under the stand immense halls have been erected to accommodate indoor exhibitions and contests, while the open-air arena is equipped so that it can be flooded with water during the winter for ice skating. A temporary terrace of earth on the curve of the inclosure will be used to support extra seats when occasion demands, and parking space for automobiles will be available. The stadium is located in Grant Park on the shore of Lake Michigan.

and when the material dried a heavy coating of gilt was applied to give the appearance of a polished surface. Devoting his spare time to the task, the artist designed the most difficult scrolls and figures and worked in graceful patterns similar to those usually seen on marble and bronze ornaments. When completed the objects



Artist Modeling Ornamental Urn from Old Newspapers Which Are Softened with Liquid Paste

### Artist Molds Vases of Newspapers Softened with Paste 2024

A sculptor, using old newspapers soaked in liquid paste for his clay, molded a large ornamental urn that rivals the beauty of carved metal and stone. Almost all of the work was done without the aid of tools

present a smooth, hard surface which can be readily painted and gilded in any variety of colors.

*J. Loggans, 1298 - 4-26 at. here for*



Aluminum Drum for Banjo Head  
Amplifies Instrument's Tone

2104

Banjo tones are said to be increased in volume by an aluminum resonator that fits over the head of any instrument from



Burnished brightly, Resonator Adds Sparkle to Banjo as Well as Volume to Tone

ten to eleven and a quarter inches in diameter. The sounds are said to be projected and do not become muffled against the body. The drum is light and easily put on.

U. S. Plant Hunters Travel the World in Search of New Foods

2169

The capital of the United States is the center of one of the most extensive and important research expeditions known to man—the department of agriculture's constant hunt throughout all parts of the world for plants and fruits that can be cultivated profitably here. In the last twenty-five years, these "Columbuses of horticulture" have been the means of introducing more than 58,000 varieties of grains, vegetables, forage crops and ornamental plants to American soil, and these imported finds are said to increase our farming turnover by more than \$100,000,000 a year.

Durum wheat, sent from Russia a few years ago in two small sample packets and now yielding a 40,000,000-bushel crop worth approximately \$50,000,000 yearly; Pima cotton, Sudan grass, and certain kinds of alfalfa and dates, are a few of the profitable crops that are now raised from specimens found by the government plant

explorers in distant lands. Five testing stations are maintained where the new arrivals are cultivated before they are formally adopted. At Chapman field in southern Florida, a former war camp, 1,000 acres are devoted to experiments with various tropical plants; many fruits are given trials at Chico, Calif.; near Savannah, Ga., there is a bamboo-testing station; at Bell garden, sixteen miles from Washington, new plants are grown and examined for trace of disease, and at Bellingham, Wash., is a forty-acre tract devoted to the culture of bulbs.

Automatic Road-Crossing Barrier  
2090 Safely Stops Fast Cars

An automatic highway barrier that drops into place from an overhead position when an approaching train enters an electrical circuit which operates the release mechanism, has been installed near Racine, Wis. It is claimed the safety gate will successfully stop automobiles traveling sixty miles an hour without injury to the cars or occupants. As the train leaves the crossing area the gates are elevated to their original position at the top of the supports. In addition to warning lights and gongs with which the structure is equipped, a preliminary caution is given unwary drivers by a "whiplash" bar that swings out over the roadway four seconds before the barriers fall. This device is placed about 150 feet from the main apparatus and is hung with lengths of



Safety Gate at Highway Railroad Crossing Which Drops as Approaching Train Enters Electric Circuit

rope and light pieces of bamboo, that brush across the top of a vehicle.

C. H. & M. H. Co.  
72 W. Adams  
Chicago

Kansas City Star 4/7/24



St. W. Washington, D.C.



"Heave Ho!" and the "Bull Gang" Gives a Mighty Tug to Swing the Section Ends into Alignment

## The Romance of the Pipe Line

### Seventy Thousand Miles of Underground Conduits Used to Carry Nation's Liquid Fuel to Refineries and to Tidewater

**T**HE average American citizen probably does not realize that one of the nation's mightiest systems of transportation functions day and night, winter and summer, but a few feet underground, with no whirl of wheels to mark its pace and with never a shrill whistle to herald its ceaseless movement.

Yet, while train, trolley car, automobile and aeroplane whiz by on or above the earth's surface to the accompaniment of clang of bell or hum of motor, this prodigious subterranean transport system is carrying silently on at its task of moving, through more than 70,000 miles of metal pipe line, the golden flood of petroleum wherein lies latent the force to set the world's motors purring and the wheels of commerce turning around.

From the bleak Wyoming ranges, the valleys of the Montana Rockies, from the fertile plains of Texas, from the Oklahoma prairies and California's foothills, and from the lesser wells of Ohio, Pennsylvania and Kentucky, the liquid treasure pours from the field storage tanks down the pipes that traverse twenty states, en route to the refineries that dot the Atlantic, Gulf and Pacific coasts and the shores of the Great Lakes.

Born in 1863, four years after the first oil well was brought in, the pipe-line industry started in a modest way with a two-inch line, three miles long, to carry distillate from the Warren refinery to Warren's Landing, on the Allegheny river, where it was loaded on barges to float down to Pittsburgh. From that humble beginning it has grown, in sixty-one years, to 70,452 miles of pipes.

Through that vast network of pipes there flows more than 260,000,000 barrels of oil a year for delivery to distant refineries or the seaboard tanks where ships load for foreign delivery. Practically every barrel of oil produced in the United States—and production in 1922 totaled 557,531,000 barrels—makes part of its journey from well to market through the pipe lines. The beginning of the industry is a part of the romantic fight which convulsed the western Pennsylvania oil field in the sixties and seventies of the last century, when various interests contended for the control of the nation's oil business. The first pipe lines were short affairs built to circumvent the outrageous demands of teamsters who had controlled the business of hauling the oil from the wells to river landings or railroad points. The year 1863





The Steam Cylinder of an Oil-Pipe Pump (Above) Is an Enormous Thing; at the Right, Workmen Alining the Pipe for the Welders



In Some Soils the Pipe Is Covered with Asbestos Paper or Coated with Tar to Resist Corrosion



With the Ends Clamped in Place, the Welder, at the Left, Makes Several Short Welds, or "Tacks," to Hold the Joint; Then Removes the Clamp to Finish the Job



1644

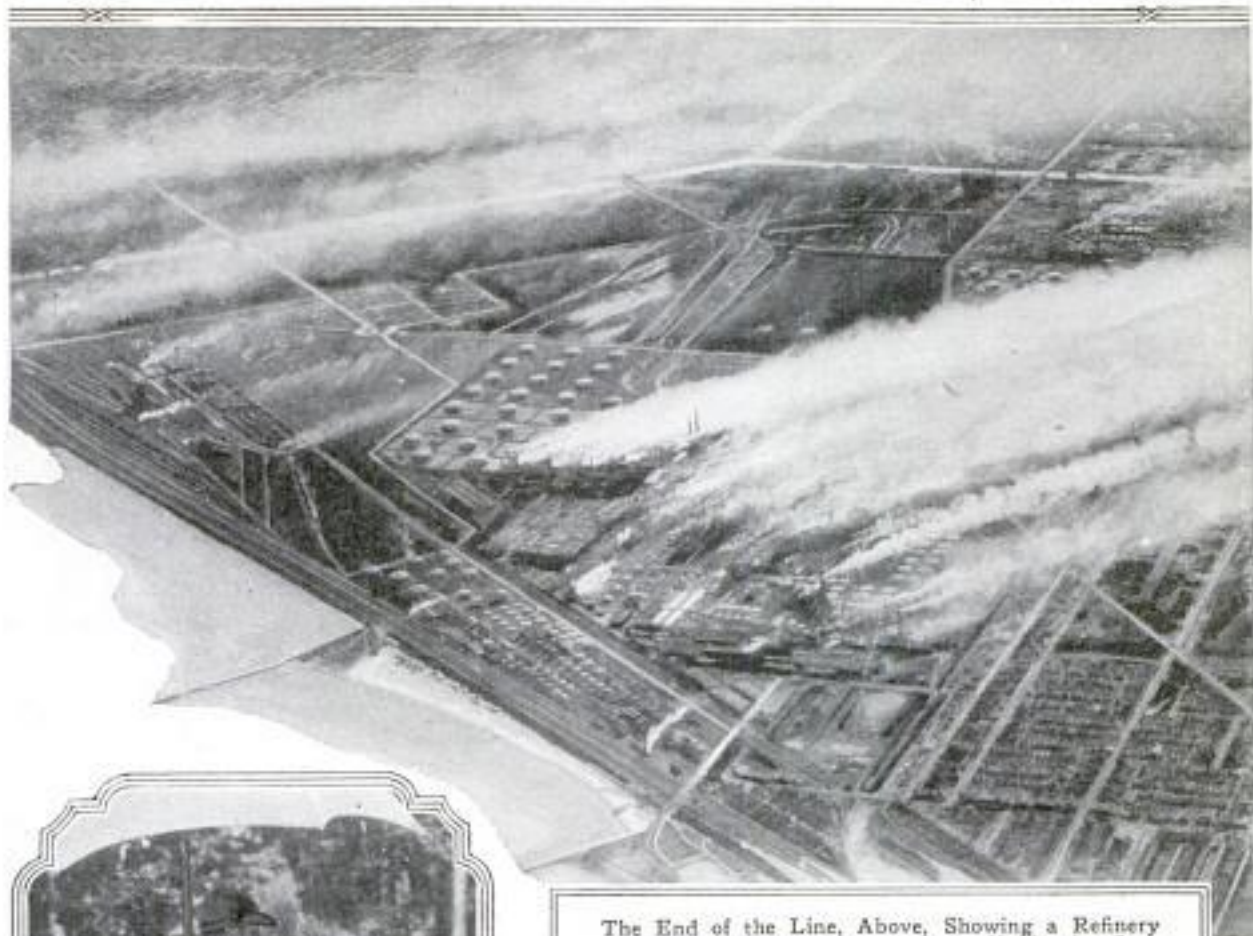

The End of the Line, Above, Showing a Refinery from the Air; the Helper, Left, Holds the Sunshade While the Welder Works on a Pipe Blocked Up to Cross a Gully; Below, Finishing the "Tie-In" of Completed Sections

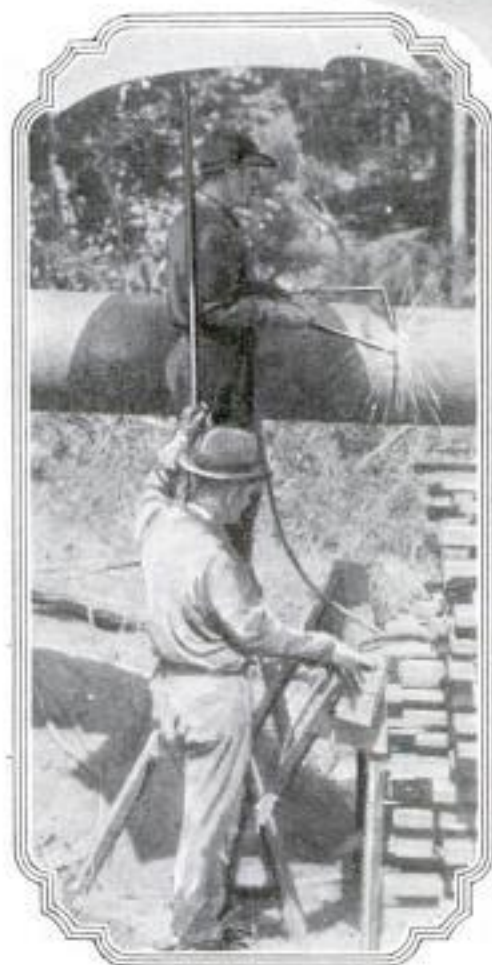

saw the first three-mile line built at Warren, and likewise a two and one-half mile, two-inch line from the Tarr wells to Humboldt refinery at Plumer, Pa. By 1872 pipe lines had displaced the teamsters entirely for gathering the oil from the wells

and carrying it to the shipping points. In that same year, which marked the start of the historic fight for control of the oil industry, the independent producers and refiners began considering a pipe line to the Atlantic coast.



General Herman Haupt, famous Civil War engineer, said it was feasible to pump oil over the Alleghenies and calculated the cost at sixteen and two-thirds cents a barrel, delivered at tidewater. His claims were ridiculed, and it was not until 1878 that a company was organized, obtained a right of way, and started building over the mountains. The first section was 109 miles long, from Coryville, on the edge of the Bradford field, to Williamsport, where the oil was transferred to the railroad pending completion of the line to the sea.

The day finally came for starting the pumps and a huge crowd gathered to see the experiment succeed—or fail. The line was six inches in diameter, crossed mountains 2,600 feet high, and had pumping stations about thirty miles apart. The pumps were started, and actually worked. Seven days later the first oil reached Williamsport. Modern lines are larger, though the majority are eight inches in diameter, yet with better pumps and higher pressures the rate of flow has been increased. Still, with lines stretching from distant Wyoming and Texas to New York the thick, greasy fluid may be four weeks or more on the road.

The early pipes were screwed together and frequently leaked. Then came flanged types, with packing in the flanges, but they too required daily patrol to watch for tell-tale seepage and make repairs.

The most recent development is the welded pipe, by which hundreds of miles

of line are assembled in one piece, with all joints welded by oxyacetylene torches. Besides being cheaper and stronger than the other types, the welded pipe also has the advantage in speed in laying. One 180-mile job was completed recently in 100 working days, despite the handicap of heavy rains over several weeks, which reduced miles of the route to a swamp. Weather conditions were so bad that the acetylene generators, which produced one of the welding gases, had to be taken off their wagon mounts and placed on mud sleds. The pipe was welded together in sections of five, ten or twenty lengths, and the ends of the long pieces then joined as the ditching crew dug the trench and rolled the pipe in. The welded joints are so strong that cold bends are made as needed as the work progresses. In crossing wide rivers the end of a section was plugged and then floated into the stream, more joints being added as a windlass on the other side dragged it across, while the plug kept it afloat.

One of the longest of recent pipe-line jobs was the laying of the 720-mile line from the Salt Creek, Wyo., field to tap the main transcontinental line at Freeman, Mo. Laying the pipe is not the biggest part of a line company's work. Oil lines are common carriers, under interstate commerce regulation. They function like railroads. Producing shippers deliver their oil to the line at the well, and pay the freight for pumping it to the refinery to which it has been sold.



Some of the Valves through Which the Oil Is Routed to Fill the Various Tanks That Dot the Great Storage Fields Surrounding Every Refinery





Seagoing Ship Steaming between Forested Shores at the Highest Point on the Gota Canal Which Carries Water Traffic from Gothenburg, Sweden, to the Baltic Sea

**Ships Climb Hills and Cross Forests on Century-Old Canal** *2035*

Conducting seagoing ships over a system of fifty-eight locks and carrying the craft 300 feet above sea level, the Gota canal in Sweden, built in 1832, affords a deep waterway, 354 miles long, across the peninsula, between Gothenburg and the Baltic. Although some of the natural streams that form the greater part of the route had to be deepened, only fifty-four miles of artificial channels were required to complete the water highway, which consists mainly of large lakes and connecting rivers. At the highest point on the canal, the stream is so narrow that tree branches brush the sides of the boats as they steam past wooded banks. The average time required to make the entire trip along the canal is two and a half days. The longest climb is accomplished between sea level and the 300-foot stage which carries the canal across the high hills to Lake Vener, and is made by means of twenty locks arranged on the order of a huge stairway. The boats are furnished to care for overnight passengers.

**Reserve Valve for Auto Fuel Tank Is Controlled by Button** *1836*

Running out of gas unexpectedly is prevented by a valve for the fuel tank that warns when the supply is low and releases



a reserve that will last from twenty-five to thirty miles farther. It is installed above the sediment bulb and is controlled by a push button on the instrument board. When the tank is being filled, the button is pulled out. This

closes an opening at the bottom in such a way that a reserve supply of gasoline is held below the main outlet. This is made available when needed by simply pressing the push button in again. Used in connection with the speedometer, the valve also furnishes a fairly accurate check as to the number of miles the car will make on a gallon of gasoline.

*The Hillier Carb Co.,*  
*Copyrighted material*

*13.00*



Mr. H. S. Bailey Esq.

224

POPULAR MECHANICS

Weykingham,  
Kent  
England

2038 18, Upper Elmwood Road,



Mr. - Klepper Boat Co. Rothenburg  
Germany



Martin + Maubel, Reading, France

Assembling Ribs and Cover of Portable Boat; Hauling Entire Outfit on Homemade Truck, and the Craft in Use in Shallow Water Where Heavier Boats Would Stick

### Collapsible Three-Passenger Boat Weighs Less than Fifty Pounds

For campers and sportsmen, a collapsible boat that will carry three passengers and their luggage and yet can be folded into a portable package weighing less than fifty pounds has been patented in Germany. Its framework consists of two sections of pliable staves over which a waterproof cover of rubber and canvas is stretched, the top and bottom being in one piece. As this material and the supports are flexible, there is little danger that stones or other obstacles will cause punctures in shallow water, and the boat remains rigid and safe at all times. It is made up to sixteen and one-half feet long, can carry from 385 to 440 pounds, is easily maneuvered and quickly assembled or taken apart. Two bags and a knapsack

are provided for packing it, and the entire equipment can easily be moved on an improvised truck with round chair seats for wheels, arranging the paddles as handles for pushing or pulling the truck.

### Piano with Magnets near Strings Produces Tones of Flute

By installing tiny electric magnets close to the strings of an ordinary piano, two French inventors have succeeded in causing the instrument to produce the tones of an organ, a flute or an oboe, it is reported. The magnets are controlled by tuning forks and the string is kept in vibration as long as the key is depressed. By disconnecting the keyboard from the electric circuit controlling the magnets, the piano can be played in the usual way.

Mr. J. Carrière Esq.  
326 Union Station  
Winnipeg, Canada

Armand & Co. Rothenburg

See also Sept. 1924  
43

U.S. Rajah Mfg. Co.,  
5556 W. Winter St.  
Chicago.



Carl Allen Leibert  
Harrison, N.Y.  
225  
1792

**Water Found Imprisoned in Crystal  
Ten Million Years Old** 2095

Clear and sparkling as though they might have just bubbled from a spring, drops of water more than 10,000,000 years old have been found by O. C. Farrington, head of the geology department of the Field Museum of natural history. They were imprisoned in crystal quartz picked up from rock formations in Brazil. The estimate of the age is based on the character of the rock which belongs to a period that, some scientists declare, flourished over 500,000,000 years ago. *new York*

*James 10/30/24*

**Girl Wins Fame by Carving Figures  
from Blocks of Wood** 1182

Cleverly carved figurines, cut from pieces of wood with the aid of a jig saw and shaped into realistic models of persons, bits of furniture and other articles, have attracted considerable attention in London society and have won fame for their designer, an eighteen-year-old girl. One of her pieces was sent to Queen Mary for the elaborate doll's house exhibited at the Wembley exposition. Coloring the carvings with brilliant hues and tints adds to their attractiveness.



Cutting Patterns of Figurines Which Have Become the Latest Fad in London

*Leticia Apperly  
London, Eng.*



"High Water at Twelve Minutes of Seven" Is Warning of Beach Tide-Time Keeper

**Clock That Tells Time of Tides  
Guards Visitors at Ocean Beach**

Visitors at a bathing beach are provided with an effective warning against the run of the tides in a large clock dial with hands pointing to the hour when high water cuts off a group of rocks from the mainland. The spot is connected to the shore at low tide by a sand bar and is widely visited both by bathers and sight-seers. Plainly visible at a considerable distance, the clock reminds persons on the rocks of the hour they must leave if they wish to avoid being stranded.

**Pearls That Grow in Coconuts  
Valued as Good-Luck Charms** 1981

Among curiosities that recently have been reported from tropic lands are pearls which grow inside of coconuts. They are described as extremely rare, some about the size of a pigeon's heart and others only as large as a pea, and are brilliant white or yellowish. They are formed by the hardening of the embryo plant which solidifies when the shell is "blind," that is, when all three of the small depressions visible beneath the coarse fibers are closed too tightly to permit the maturing growth to push through. Natives of tropic islands value the pearls as charms to protect them against sickness and to give them success in business and war.

*Kansas City Journal  
Post 10/5/24*  
Copyrighted material



2043226

Aerial Photographing Service, Inc.  
222 E. Ontario, Chicago  
POPULAR MECHANICS



# Looking Down On Us

## Aerial Mapping Gives a Bird's-Eye View of the World and Creates a New Industry with Almost Limitless Possibilities

**B**ORN of the necessities of war, the airplane camera has introduced a new and startlingly novel industry—aerial mapping and photography. In its lusty infancy it has already become an accepted, though none the less interesting, part of daily life. Five years ago there was no such thing as civilian aerial photographers. Now there are several important companies and many free-lance workers ready to fly anywhere and photograph anything. The credit for the amazing growth of the new business goes to the American army. When the armistice was signed, the military establishment had on hand large stocks of film; and as every amateur photographer knows, deterioration limits the life of unused film to comparatively few months.

The army decided it was better to "shoot" the film than to let it spoil, so set to work with a prodigal hand to use it all while it was usable. The resulting era of picture taking soon exhausted the supply of military fortifications, and the army flyers and cameramen branched out and "took" cities, farms, mountains and anything else that looked nice from the air.

A complete aerial map of Washington was made. The skyline of New York, the birthplace of the nation at Philadelphia, the historic spots of Boston, Chicago's lake front and the snow-capped peaks of the Rockies all were filmed, and then the army proceeded to give the pictures to anyone who applied and had a legitimate use for them.

Newspapers and magazines used them freely, because of their novelty, and called for more. Chambers of commerce asked the army to come and photograph their towns, real-estate dealers applied for aerial pictures of their subdivisions, and individual owners for photos of their factories.

The government decided it was time to call a halt, but by that day commercial aerial-picture companies had grasped the opportunity.

With an accurate altimeter to show just how high the plane is flying and a table showing the area a camera of given focal length will cover at certain heights, it is possible to make an accurate survey of the ground while flying a mile a minute.

Using a camera of twelve-inch focal length, with films nine and one-half by



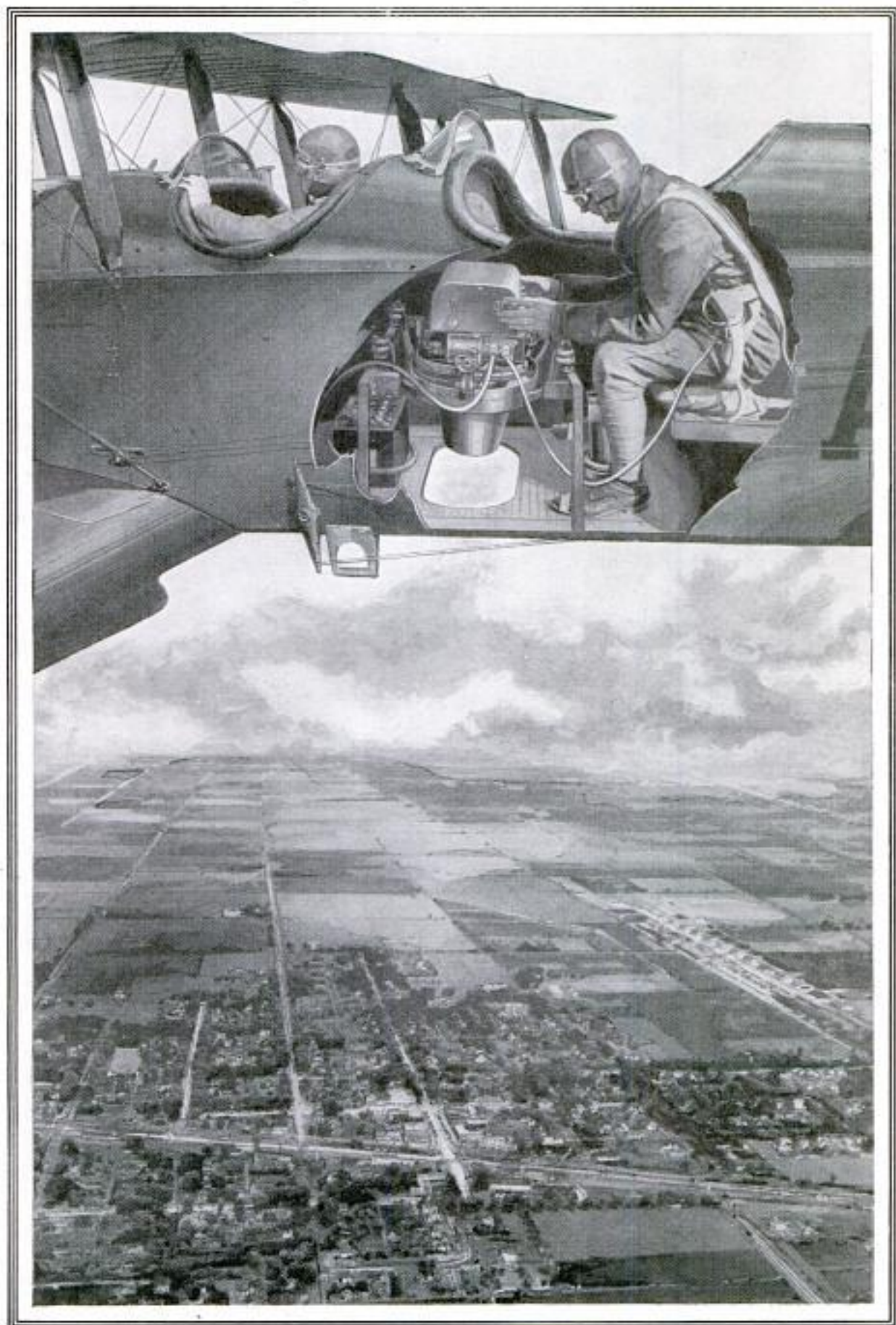

The Aerial Cameraman, 10,000 Feet in the Sky, Focuses His Motor-Driven Camera, Presses the Switch, and It Clicks Off Pictures at the Rate of One Every Thirty Seconds



2093



Films Fifty, Seventy-Five or One Hundred Feet in Length Are Placed in the Aerial Cameras and the End Threaded onto the Motor-Driven Winding Spool; the Motor Which Turns the Film as the Pictures Are Automatically Taken Is Shown at the Left Corner of the Camera

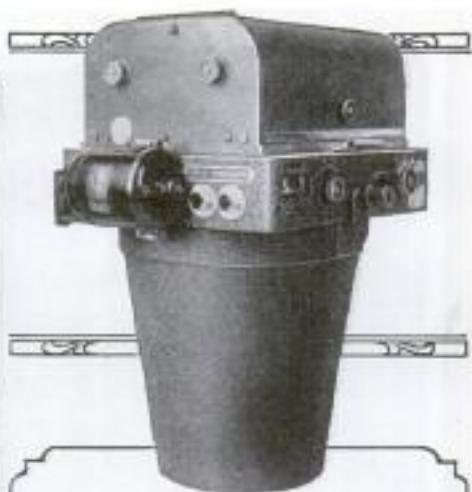

View of Camera with Film Holder in Place; the Battery Wire and Switch Control Are Attached to the Two Plugs beside Motor

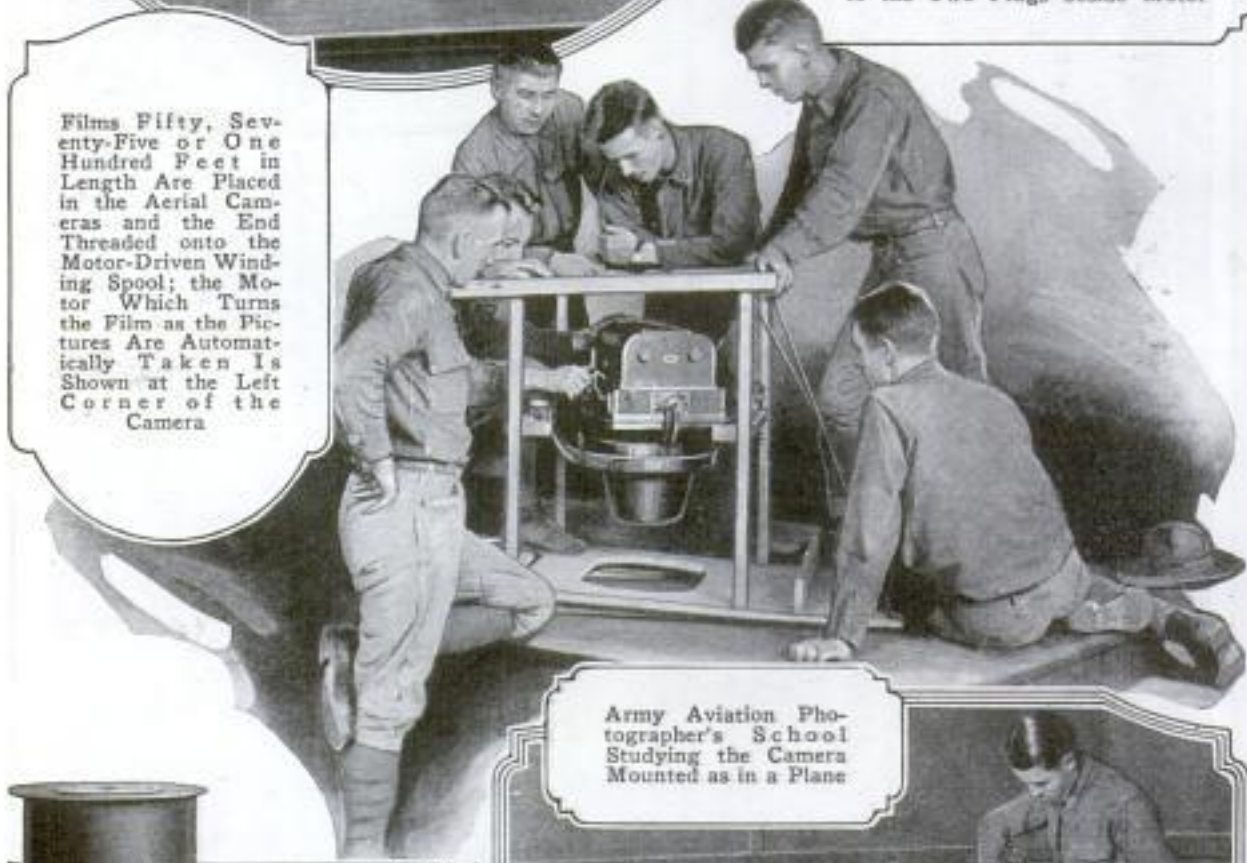

Army Aviation Photographer's School Studying the Camera Mounted as in a Plane

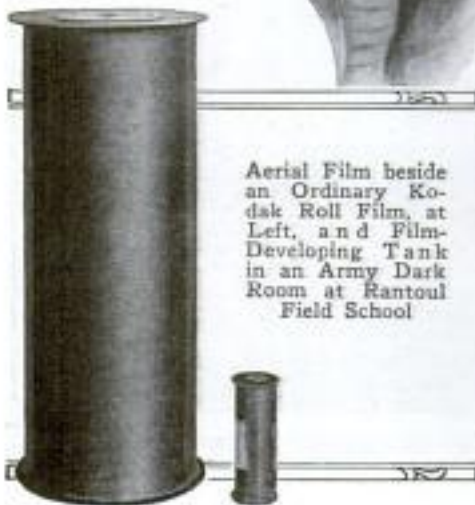

Aerial Film beside an Ordinary Kodak Roll Film, at Left, and Film-Developing Tank in an Army Dark Room at Rantoul Field School



Courtesy of the Army Air Service



2043



At 10,000 Feet the Camera Photographs a Plot 6,250 by 7,916 Feet, Making Small Picture, Which Is Then Pasted into the Assembled Map





The Roll Film Passes through the Printing Machine without Being Cut, the Operator Inserting a Sheet of Photographic Paper as Each Picture Appears

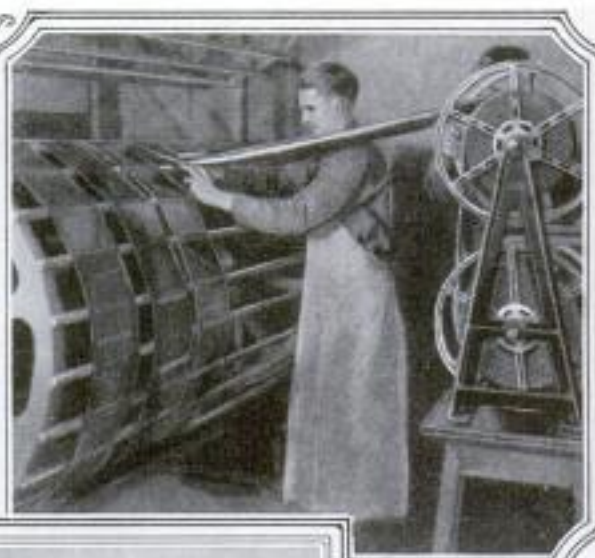

After Leaving the Developing Tanks and the Fixing Bath, the Films Are Unreel'd on to Huge Drying Wheels, Big Enough to Take the 100-Foot Strips



Army Photographers Assembling the Hundreds of Separate Pictures Which Go into One Big Map, Showing Every Detail of Many Square Miles of Country



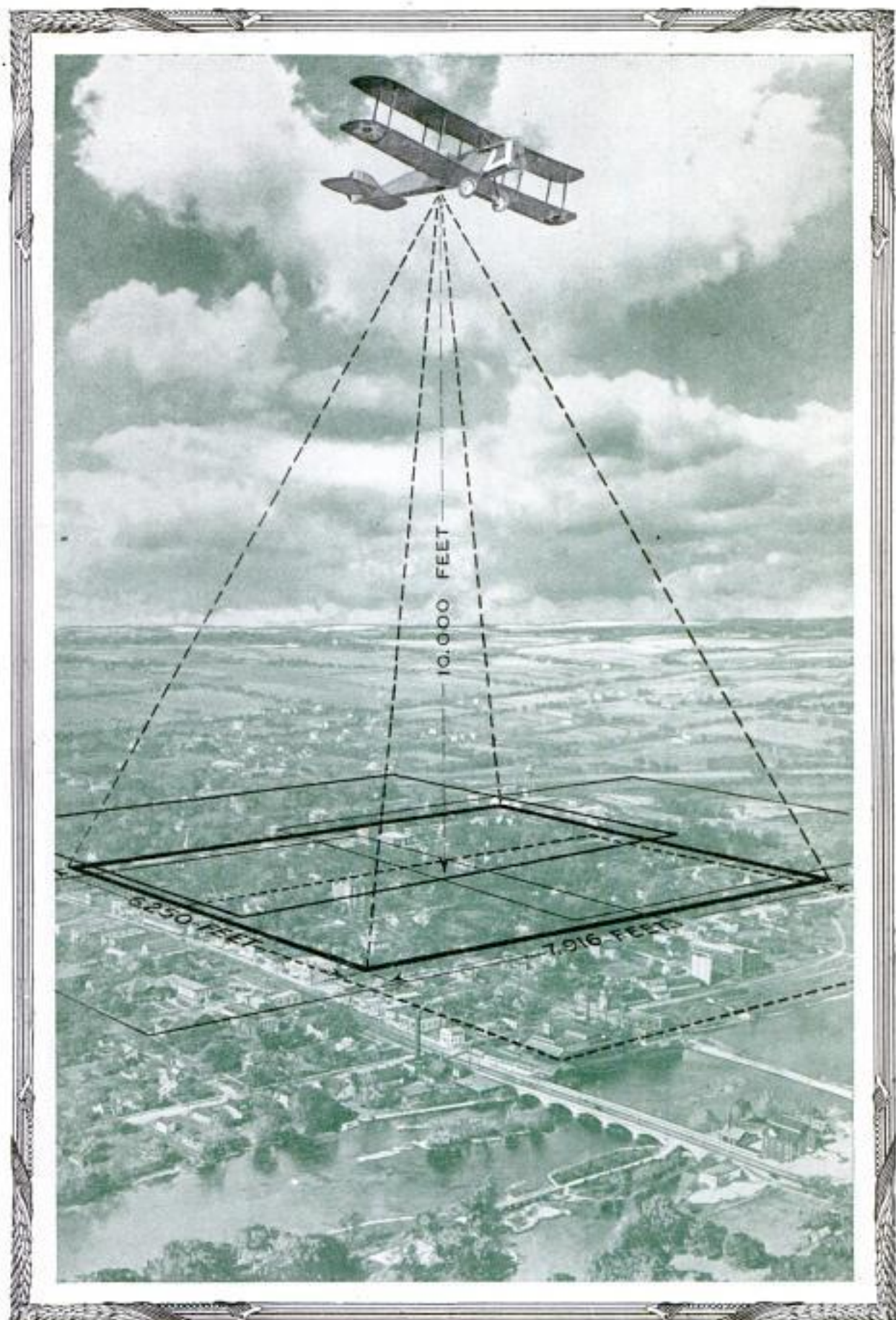

Aerial Cameras Are So Timed That Each Picture Overlaps Its Mates by Sixty Per Cent, Insuring Plenty of Margin for Matching the Edges as the Map Is Assembled



seven and one-half inches, and flying at a height of 10,000 feet, a picture is obtained that covers a ground space 7,916 feet by 6,250 feet. Any desired ratio can be worked out by changing the altitude. One aerial photographer recently mapped a new drainage district several miles long, on a scale of 500 feet on the ground to each inch on the picture. His camera table gave the correct altitude, and in less than five minutes he completed a job that would have taken a surveying party several days. Moreover his aerial map showed details no surveyor on the ground could have indicated. The sky mapper waited until after a rain had soaked the ground, so that every low spot in the fields, where water had collected, showed up darker than the surrounding higher ground, giving an accurate map of how the land lay.

Flying back and forth on parallel courses a little more than a mile apart, an aerial mapper at an altitude of 10,000 feet can easily survey a tract fifty miles long by ten miles wide in a day, covering 500 square miles. The parallel trips are close

enough together so that each picture in one row overlaps its mates on either side. After the prints are developed they are matched up and pasted together, and, if desired, the entire map can then be re-photographed as one unit.

If less detail is desired, the plane can fly at a higher altitude and cover much more territory in a day, as each picture will show more ground area. One army air-service photographer took a picture of the city of Dayton from an altitude of 31,540 feet, the single photograph covering nineteen square miles of ground and showing every street and building clearly. At that great height the airplane was no longer visible from the ground, but the camera's eye functioned perfectly.

Aerial pictures are being used by city-planning experts to show clearly the improvements which can be effected by cutting new streets, straightening or moving streams, or widening traffic arteries, and insurance companies have enlisted the air camera to aid in fire fighting by showing the condition of building roofs and of the streets surrounding the structures.



Streets, Parks, Rivers, Houses and Factories as They Look in an Aerial Picture Taken from a Height of 10,000 Feet—Nearly Two Miles in Air



New York Times  
4/9/24

**Airplane and Radio Forest Patrols**  
**Reduce Yearly Fire Losses 2190**

Organization of airplane and radio patrols into a state and federal system to fight forest fires, which cause an annual loss of approximately \$20,000,000 and devastate 10,000,000 acres, is being urged to save our timber resources. Successful in war operations, aircraft in the hands of flyers of the army air service already have demonstrated their efficiency in combating man's greatest peace-time enemy. In one season, seventeen planes, patrolling the air above national forests in California, spotted 442 fires in time to summon ground crews to the scene before extensive damage was done. In Oregon, two planes on a patrol commanded by Capt. Lowell Smith, leader of the world flight, discovered 128 fires in nine weeks. With portable radio outfits by which crews can be assembled in short time, the service of the aerial observers is greatly increased. Campers and travelers are said to exercise greater caution when they realize that they are being watched from the air by vigilant forest patrolmen and hesitate to leave embers burning or start fires.

**Gas Socket Flush with the Wall**  
**Has a Removable Key 1949**

As an improvement over the projecting gas supply pipe for hose connections, a socket arrangement that is shut off or turned on with a removable key has been devised. Fitting flush with the wall, it is out of the way, attractive in appearance and cannot be opened by accident, thus preventing chance leaks and the danger of children tampering with it.



Cunningham  
Safety T. Buchholz  
Rice St. 249  
Los Angeles, Calif.

**Postage Meter's Electric "Tongue"**  
**Out-Licks Flock of Boys 2052**

Combining a letter sealer with an automatic postage-stamp device, all in one unit, a new office accessory licks, seals and stamps more letters in one day than a whole flock of office boys. Operating on the metered-



Fed into a Hopper, Letters Are "Licked," Sealed and Stamped at Rapid Rate in This Electric Unit

service system, whereby the post office department sets a locked meter to print a given number of stamp permits on the envelopes, the device removes all chance of petty pilfering of stamps. By combining the letter sealer with the stamp machine, one operator can do the work of two, and run the mail through in half the time.

**Parts for Autos "Coined" in Presses**  
**to Speed Production 2166**

Presses, not unlike those used for many years to stamp out coins, are employed in large automobile factories to reduce costs and enable rapid production of small parts. They save a large number of hand and machine operations and turn out work of uniform quality. Some of them are said to have a capacity 900 per cent greater than is possible by ordinary methods.

4911-3 rd Ave. Los Angeles, Calif.  
E. W. Pollock  
Brooklyn, N.Y.

Chicago, Ill. 3 E. Adams St.  
Chicago Postage Meter Co.

Pacific & Atlantic Photo

15 Grove St. New York  
Outstanding Presses

Copyrighted material



### Cranberry Picker Run by Tractor Cuts Loss of Spoiled Fruit

1918

Mounted on six rubber-tired wheels and propelled by a light tractor engine, a mechanical cranberry picker has been in-

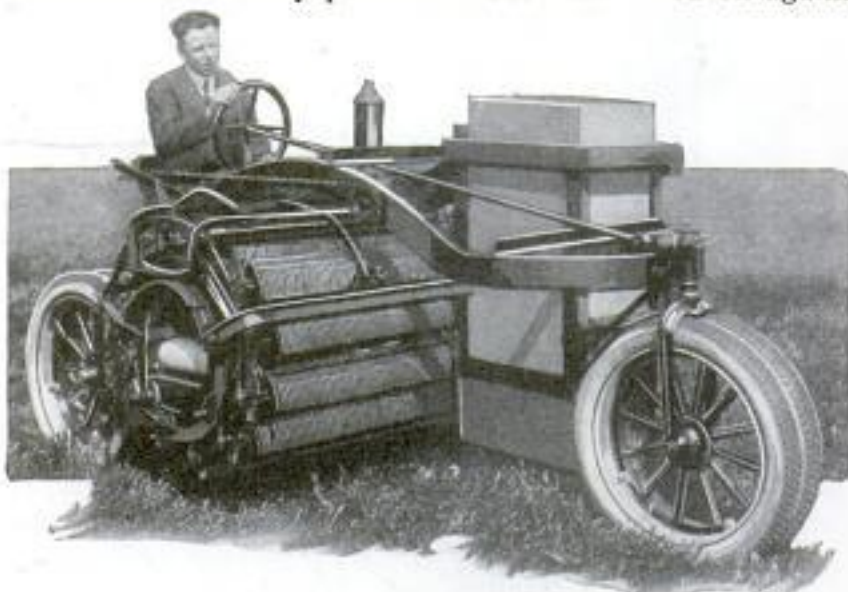

Tractor Cranberry Picker in Operation, Steered by a Single Large Front Wheel, While Revolving Rows of Teeth Remove the Fruit

vented to save time and reduce the cost of harvesting the crops. The machine is built somewhat like a giant tricycle with a single wheel for steering in front. As it passes over the bog, rows of closely placed steel fingers, like the teeth of a comb, sweep through the bushes, picking the berries and depositing them on a canvas belt which carries them to a box. One of these tractors is said to do the work of a large number of hand pickers and only the plump, fully developed berries are removed, the shriveled ones being too small to be caught by the fingers.

### End Fog, Bring Rain by Shooting Clouds with Sand

20%

Using electrified sand thrown by centrifugal force through nozzles on the fuselage of their airplanes, aviators testing a process for dispersing fogs, "shot down" several accumulations of clouds overhanging the field above which the experiments were made. Under the spray of silica, which was devised by Dr. L. Francis Warren of Harvard university, small clouds faded away entirely while larger masses were pierced and crossed by wide swaths cut into them by the blasts of sand. Although forced to climb 13,000 feet to a stratum of mountainous clouds, the flyers could be discerned from the ground by aid of glasses, cutting paths

and gorges through the massive formations. Projecting portions were quickly dissipated as the machines circled the mists or dived into the fringes of the vaporous shapes. Operations were carried on against a section of a large bank of storm clouds with the result that lightning which had been flashing regularly through the dark mass ceased altogether and a fine gentle rain fell for more than four hours, unaccompanied by the thunder and electrical displays usually occurring during such storms. It is thought the process might be employed to clear aviation landing fields of blinding fogs or to cut lanes through the formations so approaching planes can be guided safely to the ground. Similar uses could be made of the sand blasts.

it is said, to permit steamships to enter fog-wrapped harbors. Two large aircraft equipped with sanding apparatus are estimated to be sufficient to quickly relieve London, where a day of fog is said to cause a loss of \$5,000,000.

### Furniture Is Fumigated in Vault to Kill Moths and Pests

1164

Fumigating large pieces of upholstered furniture, pianos, carpets and other bulky articles to kill moths and other pests is



Removing Large Divan from Vault Where It Has Been Fumigated for Twelve Hours

Furniture Fumigation Co.  
916 Cottage Grove Ave.  
Chicago

new 8 for 6 times  
10/30/24



made possible by a roomy air-tight vault. The things to be treated are placed inside, the doors sealed, and for twelve hours the contents are subjected to a bath of fumes calculated to destroy insects of all kinds and their eggs. The process can be used at night, thus saving the time of workers, and the fumes do not spread to other parts of the storage rooms.

2099

### "ZR-3" Engines Stop if Oil Gets Low

The five engines built in Germany for the "ZR-3," last of the Zeppelins and now the "Los Angeles" of the American navy, have several novel features, not the least of which is a device that automatically stops the motor when the oil pressure at the bearings drops below a safe point. The engines were specially designed for commercial aircraft service, and light weight was sacrificed in favor of sturdy construction which would eliminate the necessity of frequent overhauling. The motors are of the twelve-cylinder V-type, with a single camshaft between the two rows of cylinders. Four carburetors are placed between the cylinder blocks, while each six-cylinder bank has a separate muffler. Another unusual feature is the provision for reversing the engine by shifting the single camshaft. Safety devices insure that the engine can be cranked only in the direction for which the camshaft is set, and that the reversing gear can be employed only when the throttle valve is locked in the closed position. Each cylinder is equipped with two spark plugs, while the magnetos operate equally well for either direction of engine rotation, the readjustment of the timing taking place automatically. Another unusual thing about the airship which will interest motorists, is that the water ballast must be doped with an anti-freeze solution because of the cold at high altitudes.

*Automotive industries*  
10/23/24

1890 Feb. 22

### Big Trees That Baffle Inventors Cut by Old-Time "Buckers"

Despite the development of power-operated saws for felling trees, lumberjacks working among big specimens in Oregon

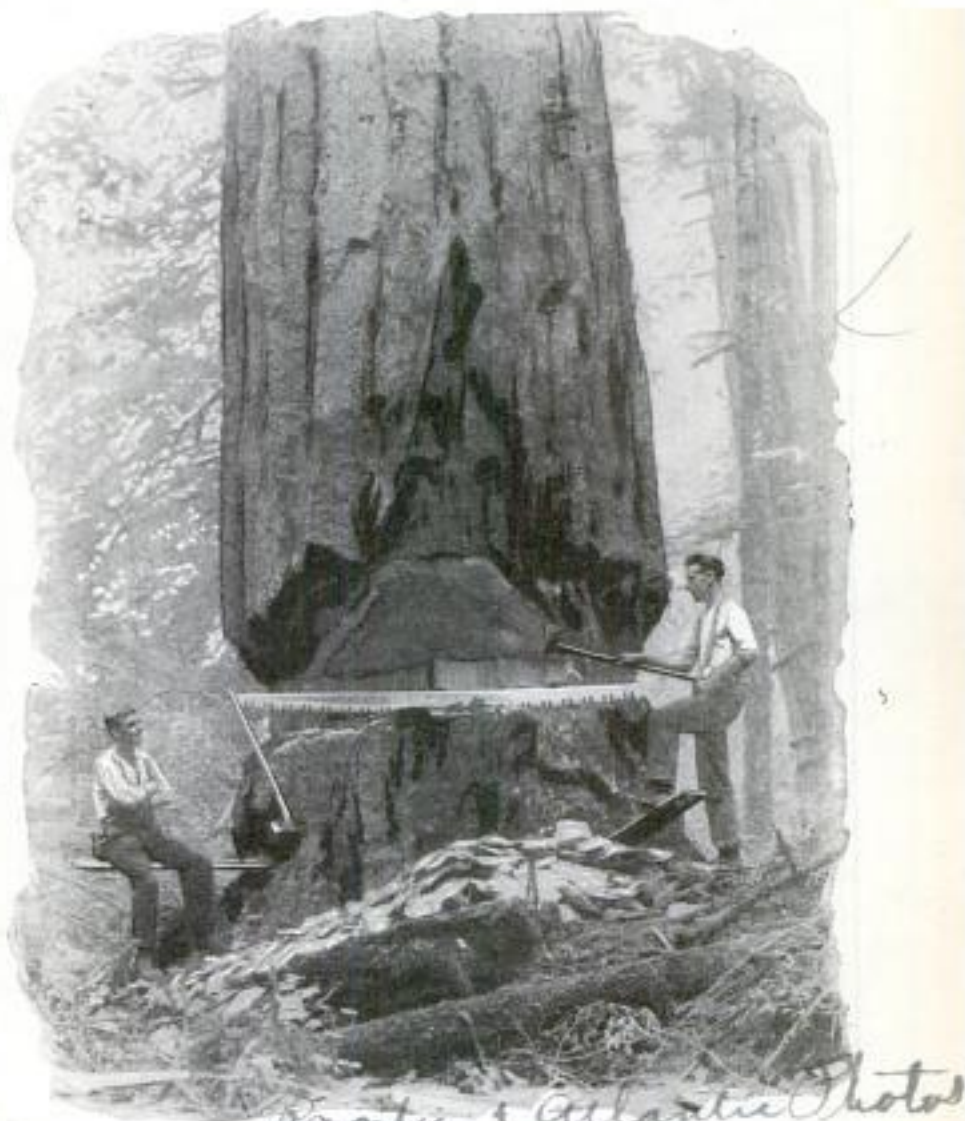

*Pacific & Atlantic Photos*  
Timberland "Buckers" with Saws and Axes Cutting through the Trunk of a Giant Tree Too Large for Power Tools

resort to the old-time saws and axes to bring down the forest giants. Although cutting machines have supplanted the "buckers" with their two-man saws in many timberlands, strong-arm methods seem to be the only means of chopping through the massive trunks of the larger trees. Their bases are so wide that machine saws can not be operated to insure fall in the right direction. Axes are first used to remove the deep thickness of bark before saws can be applied, and much labor is required to "skin" the logs of the tons of rough covering in preparing them for shipment to the mills. Many such trees grow in the forests of the Pacific slopes.



1918



Loading the Gas and Air Chambers of a Light and Whistle Buoy That Operates for Three Months on Single Charges from a Tender Ship Which Carries Generating Plants



1918



Supply Depot of the Lighthouse Service Where Faithful Tender Craft Fit Out for Patrols and Take on Fuel and Provisions for Maintenance of Silent Sentinels of the Seas

## Night Watchmen of the Sea

**Fearless Men on Lonely Lightships and Isolated Towers Keep Beacons Burning to Guide Ships Safely through the Dark**

**R**OLLING and groaning under every breaking sea, with giant anchor chains rasping shrill protest against the tugging weight, forty-seven American lightships keep vigil day and night throughout the year over the dangerous shoals that dot our coasts and the inland seas. They are the far-flung advance line of the 17,000 aids to navigation. Manning the lightships at sea and the lighthouses on islands, rocky reefs and ashore, is the world's greatest organization devoted exclusively to saving life and property on the high seas.

On every lightship a crew of two to three officers and ten to a dozen men keep ceaseless watch to warn shipping away from danger, and rescue those in distress. The hardest life on the seas is theirs, with two months on constant duty and one month ashore with friends and family—always providing that storms abate and permit the relief tender to come alongside on time.

Crowded in the two months aboard ship is more hard work and more danger than the average sailor sees in a year's time. The lightship's one duty is to stay chained to its hidden reef and broadcast its warning, a light by night and a bellowing horn in time of fog. When storms come up, the lightship cannot cut its anchor chains and ride away before the wind. It must stay on the job as long as it will float, and if it sinks the crew stand every chance of going down with their ship. To keep forty-seven vessels on guard the lighthouse service maintains sixty ships, a margin of thirteen to be in port for repairs.

Besides the lightships and lighthouses the service operates 6,000 lesser lights, 600 fog signals, 153 buoys with fog whistles, 397 buoys with signal bells, eight radio-signal stations and thousands of minor floating lights, bells, whistles and plain metal or spar buoys. To keep them all in repair, anchored in place, and with gas



supplies for their lights in order, requires a fleet of more than sixty tenders.

The floating light buoys burn twenty-four hours a day, it being cheaper to furnish gas during the daylight hours than equip them with expensive regulating devices, and also much safer, since there is nothing to get out of order. But three months' constant service exhausts the gas supply of the biggest buoys, and they must then be unmoored, hauled aboard the tender, and a new buoy, with gas tanks charged, moored in place. The tenders perform the work regardless of weather, and many are the men who have been maimed or lost in the dangerous task. America's contribution to the safety of navigation covers 55,900 miles of coast line. The entire Atlantic and Gulf coasts, with their sinuous and irregular shore lines, measure 13,500 miles, but in the far north the much more dangerous shores of Alaska present 21,600 miles to be patrolled. The Pacific coast, fairly regular in contour, is but 4,300 miles long, while the inland rivers are lighted over 7,900 miles of their navigable length, and the Great Lakes around 5,700 miles of shore. The rest of the mileage is divided among the West Indian and Pacific possessions.



Cape Hatteras Light Station. Nearly 200 Feet High and Painted in Barber-Pole Design for Daylight Identification, Stands as a Warning Sentinel to Mariners Far at Sea; at Night and on Dark Days Its Powerful Beacon Guards the Dangerous Shores

Every maritime nation contributes its part toward making the seas safe for the men who go down to them in ships, and in some districts, notably the China and Indian seas and the waters around the West Indies and South Sea islands, the perils of wind and wave are augmented by the dangers from hostile natives. The skipper of a United States shipping-board vessel recently missed the light on the Island of Sokotra, a British possession in a lonely section of the Indian ocean, off the coast of Somaliland. He reported the light dark when he met the captain of a British warship at Aden, and the latter explained that, though a new crew had been placed in the lighthouse only a few weeks before, the cannibal natives probably had surprised and eaten them. In the thirty-one years the English have operated a lighthouse there, the cannibals have repeatedly killed the keepers, but each time a fresh crew is found willing to take the risk.

The lightsips used by the service are all stanch vessels, built of exceptionally heavy planks, and designed to reduce rolling to the minimum. Chained up at anchor in the wildest storms, the vessels are cruelly buffeted, with every wave breaking over them. The men on deck are always lashed in place when a storm breaks.



1918



Tender Tug on Winter Visit to Ice-Locked Buoy on Great Lakes



Fog Signal on Cape Henry, Virginia, Breathing Out Its Warning Roar

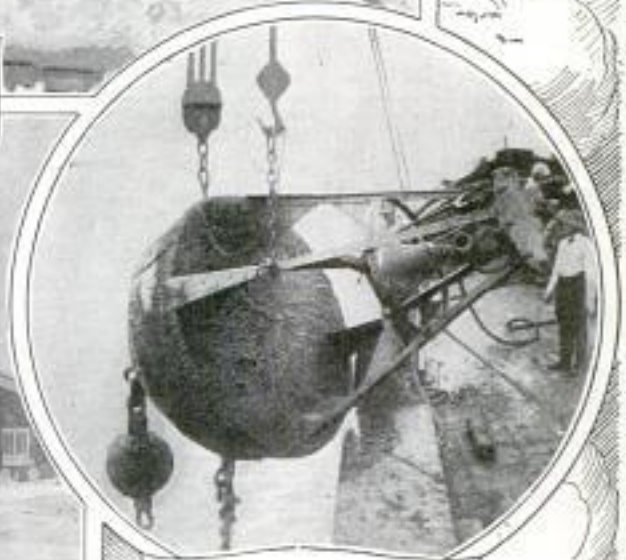

Hauling Barnacle-Covered Buoy aboard Ship for Cleaning



A Tender Leaving for Its Patrol, Ready to Battle Any Weather



Typical Lightship Anchored as Guide Post outside Big Harbor



Most of the light vessels use oil lights at the top of their tall signal masts, though some have been equipped with gas and others with electricity.

Life on board is not one continuous round of duty, the men standing regular sea watches, and as a result the off-watch period for many years was the worst of all, for it was then that the lonely isolation was most keenly felt. Now the radio, and circulating libraries brought out by the tender, relieve the monotony.

Radio and books also have brought relief to the keepers and their families in the lighthouses on lonely islands, reefs and secluded parts of the coast.

Like the ships, the lighthouses are built to withstand the raging seas that break about their bases. The height of the towers varies with the importance of the light and the condition of the shore, but all are strongly built of rock and steel. On the Atlantic coast, where the beach is usually low, are found the tallest towers, while on the headlands of the Pacific, a short, squat tower on some bluff usually suffices. The tallest of American lighthouses is the 193-foot tower at Cape Hatteras, N. C., which is striped like a barber's pole as a distinguishing mark for mariners by day. The world's worst storms, in the opinion of seamen, blow at the dangerous shoals of Hatteras.

So far as brilliance goes, the great 710,000-candlepower beam on the Atlantic highlands at Navesink, N. J., leads them all. Its rated brilliancy is visible twenty-two miles at sea, and even farther in good weather.

The biggest lighthouse lens, however, is at Makapuu Point, Oahu, Hawaii, where the huge glass has a diameter of nearly nine feet, inclosed in a sixteen-foot lantern. The highest light of all is at Cape Mendocino, Calif., 422 feet above water level, but its tower is not important, as the height is due to the cliff on which it stands. Besides the lights, the lighthouse and lightship men now operate radio directional sets and send submarine warnings, as well as radio fog warnings and weather reports. The lighthouses near main steamer channels into important harbors have been equipped with one-kilowatt wireless sets operating on a thousand-meter wave length. With cross bearings from two or more lighthouses, a vessel can find its way unerringly through the thickest fog or the darkest night.

The submarine signals are sent out through an underwater tube from the lightships and picked up by submarine receivers on passing ships, a system of Morse signals serving to identify the lightship, while the direction of the signals indicates its location.



How Gas Buoys Are "Captured" and Moored to a Vessel by the Attending Crew, Who Test the Supply of Fuel with a Gauge They Apply to the Valve of the Lamp's Reservoirs



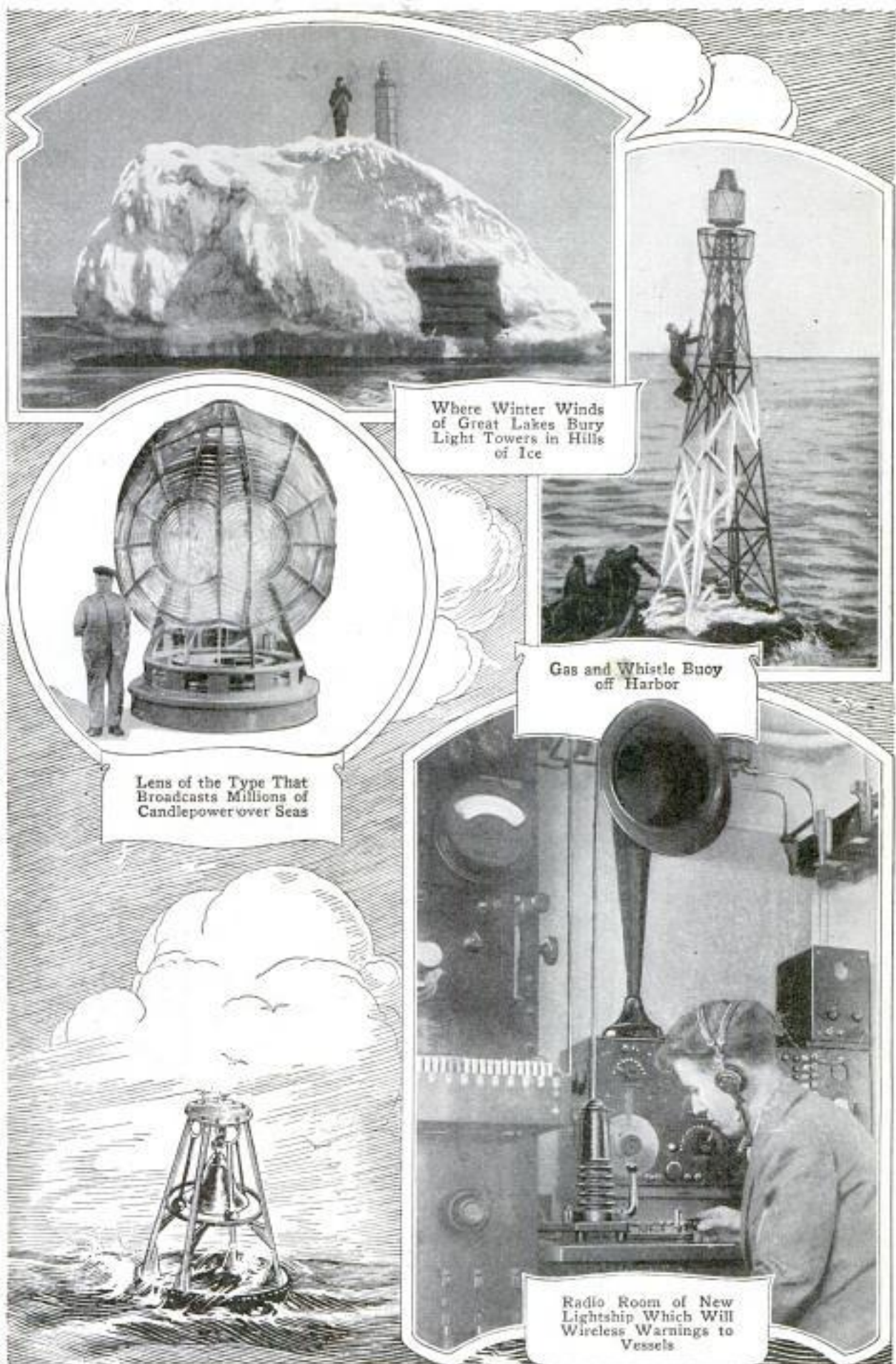

Where Winter Winds of Great Lakes Bury Light Towers in Hills of Ice

Gas and Whistle Buoy off Harbor

Lens of the Type That Broadcasts Millions of Candlepower over Seas

Radio Room of New Lightship Which Will Wireless Warnings to Vessels



Electron News  
10/29/24

George Adams, Esq  
255 16 High Holborn  
London W.C.1

Find Ocean Depth of Over Six Miles without Touching Bottom (2010) Hand Lathe with Direct Gear Drive Is Portable and Quickly Set Up

2086

Fifty miles off the coast of Japan what is said to be the deepest spot yet located in the ocean was recorded from a Japanese man-of-war with a sounding of 32,644 feet,

For a wide variety of wood-turning work, a small hand lathe with a direct gear drive instead of the usual belt transmission has been placed on the market by an English firm. With accessories, it weighs less than thirty pounds, is carried in a small wooden box and can be set up in a few moments almost anywhere, clamped to the end of a bench or table. It is turned with the left hand, the right being used to hold the cutting tool. The work is held by a five-inch face-

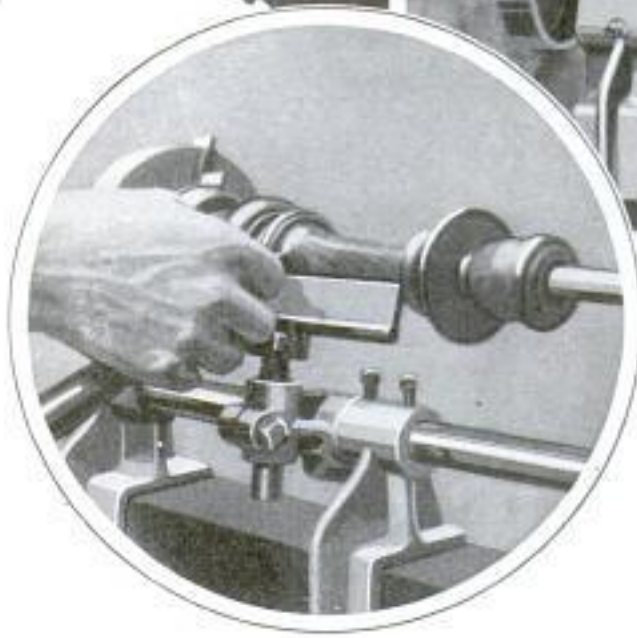
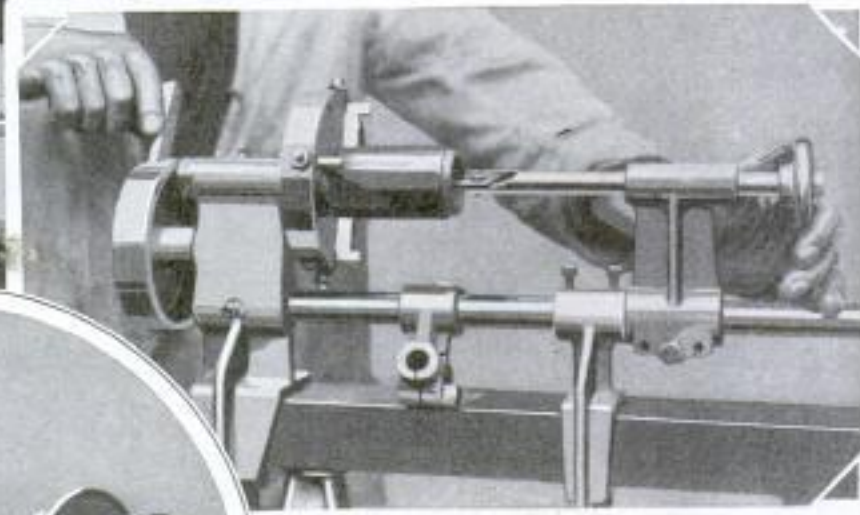
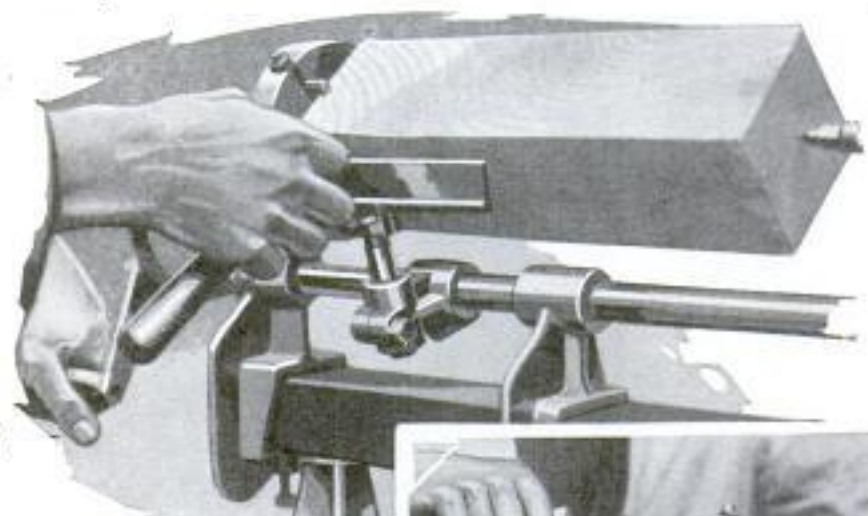

Views of Hand Lathe, Showing Block Adjusted, Boring Operation and Turning a Candlestick

or nearly six and a quarter miles. How much deeper the sea bed lies at this point is not known, for the wire was not long enough to reach farther. The greatest depth previously recorded is off the coast of Mindanao in the Philippine islands, where bottom was reached at 32,113 feet. This is known as the Philippine Deep. The deepest "hole" in the Atlantic, 27,965 feet, is north of Porto Rico.

plate which also acts as the flywheel. The gear is in the ratio of eight to one and as the cutting speed can be adjusted to suit the operator, correct use of the lathe soon becomes a matter of habit and varying speeds are secured at will. Attachments are provided for boring and for working in metal, and an extension bed is furnished which permits handling work fifty-two inches long. A special saw for wood or metal and an eccentric chuck for ornamental designs are also provided with the lathe if desired.

209 Insects Give Off Rays?

The possibility that many insects emit ultraviolet rays just as fireflies give off visible light, was discussed not long ago by eastern scientists. According to Prof. Edmund Newton Harvey, of Princeton

New York Times  
10/30/24 Copyrighted material



American City  
10/19/24  
1952

university, the theory is not improbable, and it is likely that the rays can be seen by other insects with eyes differing from those of human beings. Plates like those used in taking many of the so-called "spirit" pictures, are necessary to record these rays.

2102

**The Handiest Number**

Tricks with numbers are almost unlimited but the figure nine, an important digit in many mathematical stunts, is put to practical use in banks and other institutions in finding errors in balances. If the deficit or surplus in a sum is divisible by nine, the chances are that a transposition of numbers has been made. For instance, suppose 69 is put down instead of 96. The deficit, 27, is exactly divisible by nine. If 816 should be written for 168, the surplus, 648, also divisible by the digit "detective," points to the transposition error as the cause of the trouble.

Int. Mts 10/25/24

**Dirt Pusher Attached to Tractor Saves Shoveling by Hand**

2011

To reduce the expense of handling loose dirt and rubbish on city dumps and in making fills, a leveling attachment that may be fitted to the tractor has been invented. It is a wide, flat, hinged blade fastened between two steel beams on each side of the outfit. It is so suspended that when moving in a reverse direction, the blade slides easily over the top of the surface without dragging the dirt back and in going forward, it is held solidly to the supports by strong braces. The entire attachment may be raised clear of the ground when the tractor is moved from place to place and is long enough to allow scraping dirt to the end of a fill without getting the treads into soft soil. It is said to do in a



Tractor with Dirt-Pushing Attachment in Place, Ready to Batter Down Piles of Rubbish

short time, the work of a number of hand shovelers and is also suited to shoving big pieces of junk, such as boilers.

La Plant-Choate Mfg. Co.  
3015 7th Ave.  
Cedar Rapids, Iowa.

**Tree Is Made of Pipe for Children to Climb Safely on Playground**

Almost all children have an inborn desire to climb but often those in the city cannot find safe and easy natural branches



On This Sturdy Playground Tree of Pipe Lengths, Children May Climb in Safety

for the exercise. As a substitute for the real thing, and to keep boys and girls from venturing on dangerous places, a tree fashioned of lengths of galvanized pipe with protecting guard rails to prevent injury, has been invented for playgrounds. The crosspieces are spaced at convenient heights and the standards are seven feet high. There are no projections to tear the clothing or cause cuts or scratches, and the pipe is meant to withstand rough usage and the weather for a long period.

More than half of the world's annual gold output is produced in British South Africa. In 1921, the yield was valued at nearly \$170,000,000, fifty-six per cent of the total mined throughout the world.

Playground Equipment Co.,  
225 7th Ave. New York City



Chicago Daily News  
4/1/24

1700  
mfr. unknown, cannot locate



Front View of Tractor Post-Hole Digger. Showing Ratchet Feed, Gears and Truck Suspension

Auto Truck That Bores Post Holes Saves Linemen Labor

Digging the deep holes required for telephone or telegraph-line poles is simplified by an auger borer attached to special gearing rigged to a powerful automobile truck. Swung to the side of the road over the spot where the pole is to be set, the digger is quickly put into operation by throwing a clutch. A ratchet feed automatically presses the sharp point of the drill into the soil as the blades revolve. Reversing the gears withdraws the auger, and truck and all can be moved quickly to the next position.

Mystery City Built before Babylon Reveals Origin of Writing

Buried in the dust for more than 6,500 years, records of man's progress in art, literature, commerce and government have finally come to light from excavations

made by members of the Field museum-Oxford university expedition on the site of Kish, nine miles from Babylon on the banks of an old channel of the Euphrates river. Relics found there are said to be the first tangible evidences of the origin of the Semitic dynasties, and prove that, long before the splendor of Babylon and the high civilization of Egypt, the city was the center of a cultured empire ruled by a non-Semitic race, the Sumerians. One of the most important finds is what is said

to be the oldest stylus in the world. Scientists believe that this ancient instrument, a piece of bone about five inches long and as big around as a lead pencil, with the clay tablets also discovered, proves that the Sumerians gave the world the art of writing by originating cuneiform script. The stylus was held in the hand in the same position as a pen of modern days and the characters were inscribed in the soft material by dexterous twists of the implement. A library of tablets, apparently used by the public, was discovered together with large quantities of pottery, copper articles and pearl-inlay

work. The crumbled stones reveal architectural skill, and ruins of roads and canals indicate interest in commerce.

Rubber Marker for Tennis Balls Prevents Loss and Disputes

Doubt and disputes that sometimes arise as to the ownership of tennis balls, are avoided by the use of a compact and simple little outfit, consisting of a rubber stamp, a pad and a supply of indelible ink, to mark the balls. The letters produced are sharp and legible, do not easily blur and can be applied at several places on the ball in a fraction of the time required to print them by hand.



No. H. S. agent  
series

Mess. Richford.  
Chapeau - London  
G. C. Eng.

Copyrighted material



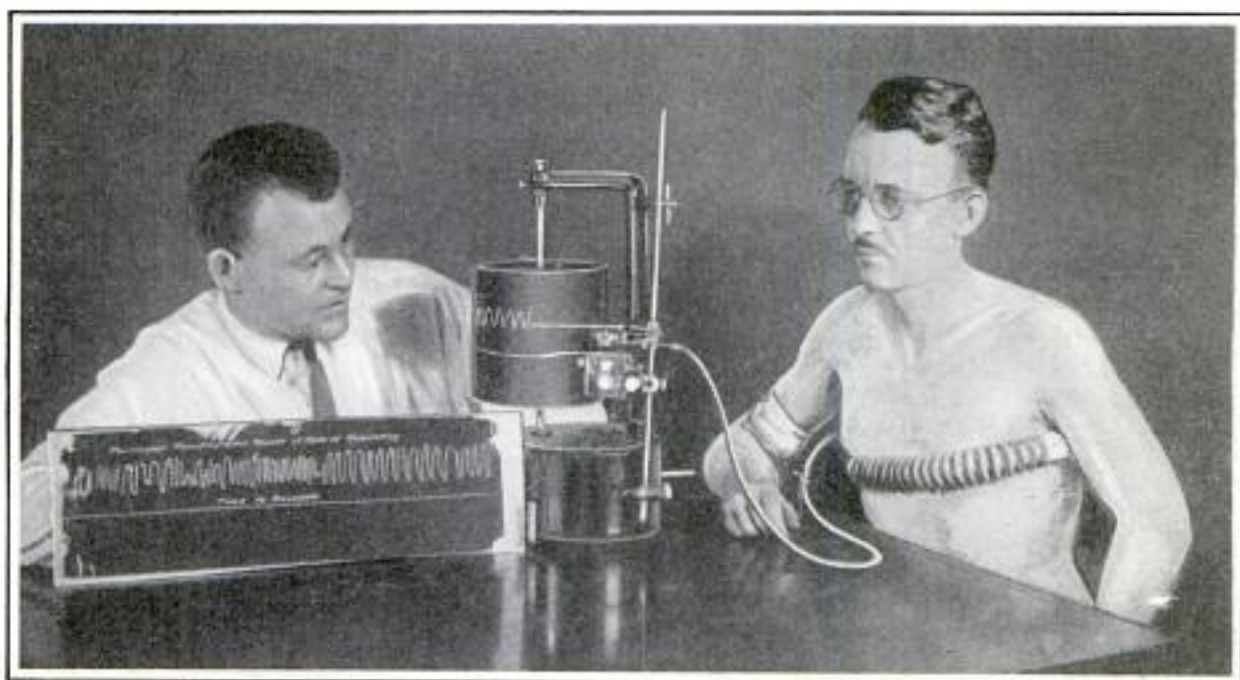

Recording the Rate and Volume of Respiration with a Pneumograph, Which Registers the Movement of the Lungs and the Regularity of Breathing as It Occurs under Changing Temperatures

## How Heat Affects Your Efficiency

*Pittsburgh Courier*

### Bureau of Mines' Experiments on Men Fix Limits of Temperature and Humidity beyond Which Human Beings Cannot Exist

THAT you do better work in the spring and autumn and are more prone to make errors in the hot days of summer and the cold weeks of winter, has been scientifically calculated in experiments completed by the bureau of mines.

The deeper mines go toward the center of the earth, the higher the temperatures rise, while the presence of streams of underground water produces high humidity, so the bureau undertook the study of the combination of heat and damp air on the efficiency of the workers.

While designed primarily for the compilation of industrial-efficiency data, the tests disclosed interesting facts about the effect of temperature and humidity changes on any person exposed to the extremes of weather.

In previous investigations Dr. Ellsworth Huntington, of Yale university, using West Point and Annapolis cadets as subjects, determined that the best mental work could be done at thirty-eight degrees, only six points above freezing, and that manual workers were at their best at fifty-nine degrees.

The bureau of mines' experiments, however, showed the approximate limits at which work was at all possible, and disclosed that it is not so much the body

temperature as the high pulse rate which causes collapse when heat and humidity get too high.

The tests were carried out in two rooms, lined with four-inch cork walls and equipped with apparatus for cooling, heating, washing, drying, measuring and stirring up the air. Control instruments outside the experimental rooms regulated the temperature and humidity, recorded the body temperature and pulse rate of the subjects, and took samples of the air they exhaled. Miners, stripped to the waist to duplicate actual working conditions, could not exist in comfort, the experiments showed, at temperatures above ninety degrees, with 100-per-cent relative humidity, in still air. When a wind tunnel was added and the hot, moist air blown through the experimental rooms at a velocity of 200 feet a minute, the subjects could endure a temperature of 95 degrees indefinitely and by increasing the wind velocity to 400 feet the cooling effect of the air was still more pronounced.

In most of the experiments the subjects remained in the test rooms for three hours, but in tests with high temperatures they usually collapsed and had to be carried out and revived, otherwise the experiment would have proved fatal.



1845

Without exception the men tested all complained of unbearable symptoms when the pulse rate increased, without regard to the temperature. Very uncomfortable sensations were experienced when the pulse passed 135 pulsations per minute, and the condition became unbearable at 160. All of the men tested were weighed before entering the rooms, the scales used being so delicate that they measured quarter ounces, and then weighed again after the tests. It was found that fat men lost more weight than thin men, but that the latter class broke down sooner and could not stand the high temperatures and high humidity through which fat men lived without great discomfort.

After the experiments, the subjects drank large quantities of ice water without any ill effect, dispelling the old belief that ice water would cause cramps if taken when one is overheated.

The effect of the change in temperature on the subjects was watched through glass windows in the sides of the experimental rooms. Frequently men who entered the chambers in happy, joking mood soon became restless and irritable. They experienced headaches, palpitation of the heart, great thirst and inflamed eyes as

heat and humidity increased. Dizziness followed, speaking became difficult and a "dragged out" feeling ensued. Perspiration trickling into the eyes was found to be responsible for the inflammation.

Throughout the tests electric thermometers were applied to the mouth, chest and back of the men, recording the body temperatures in the control cabinet outside. At intervals, unknown to the subjects, the respiration rate was taken by means of an inflated tube strapped around the chest and connected to a recording instrument in the control room. Samples of the expired air from the lungs were collected in an oxygen-breathing apparatus, passing through tubing to a gasometer, while a nose clip prevented nasal breathing.

The scientists in charge of the experiments decided that no human being could possibly exist in a saturated temperature of 135 degrees for any material length of time, while moving air at ninety-eight degrees can be endured in comparative comfort for about three hours. Another interesting discovery was that it was possible for the subjects to hold their breath longer in hot air than in cool. Plans are being considered for duplicating the tests at very low temperatures.

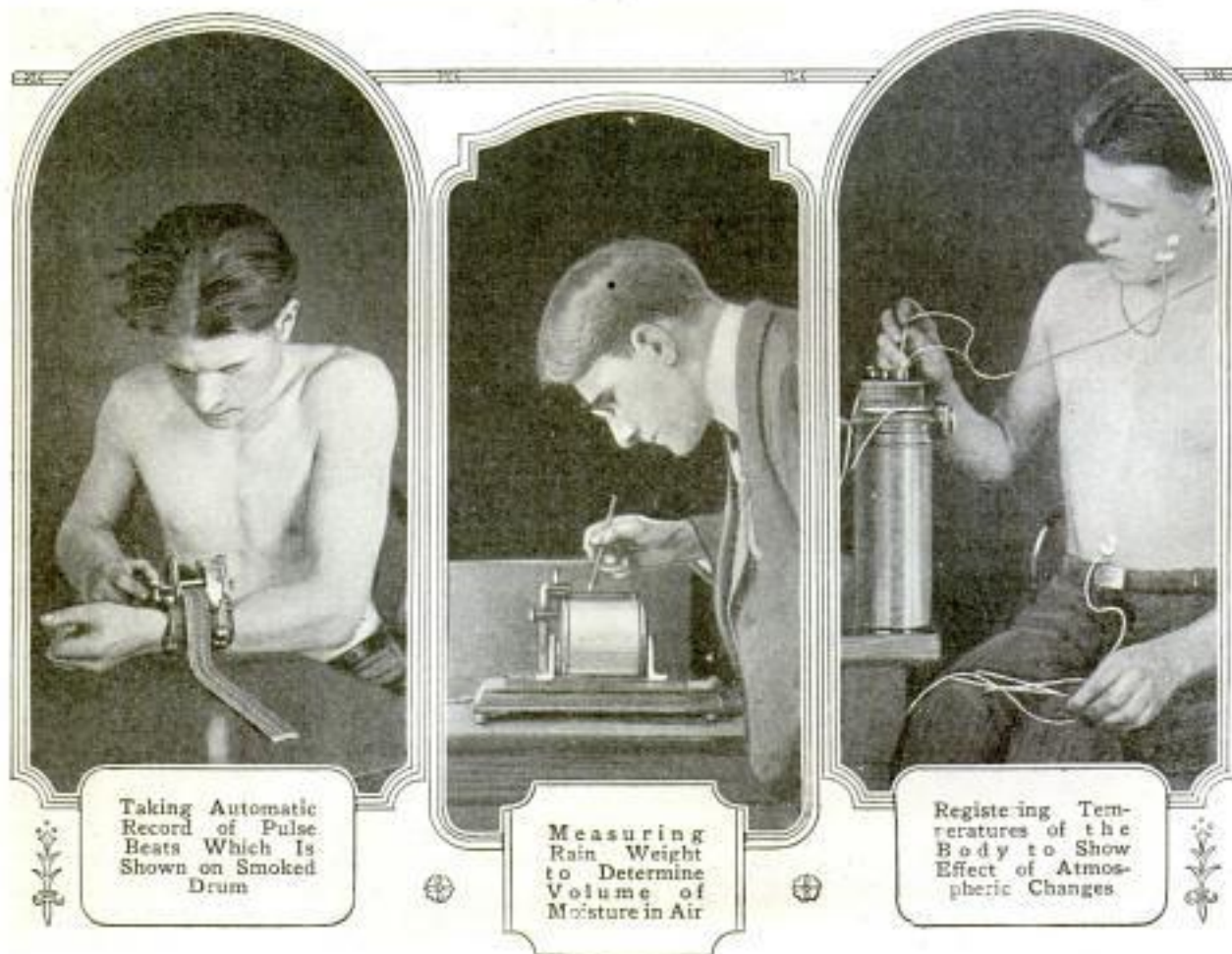

Taking Automatic Record of Pulse Beats Which Is Shown on Smoked Drum

Measuring Rain Weight to Determine Volume of Moisture in Air

Registering Temperatures of the Body to Show Effect of Atmospheric Changes



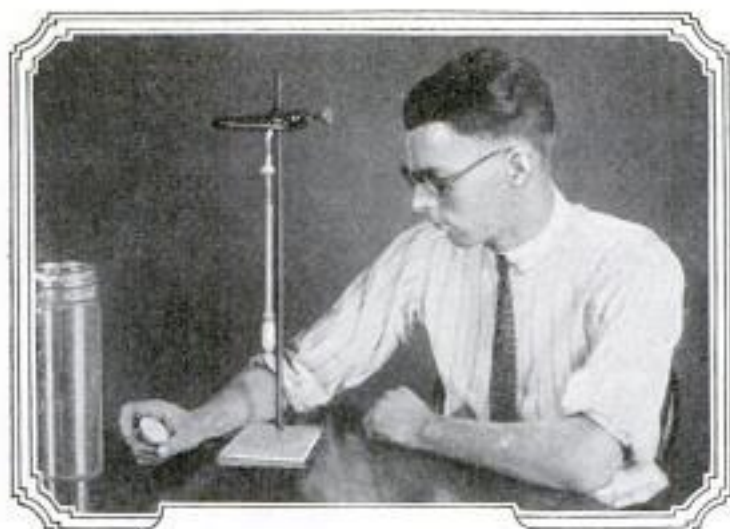

Taking Readings of Blood Temperature to Learn Cooling Power of Air



Apparatus Designed to Trace Blood Pressures

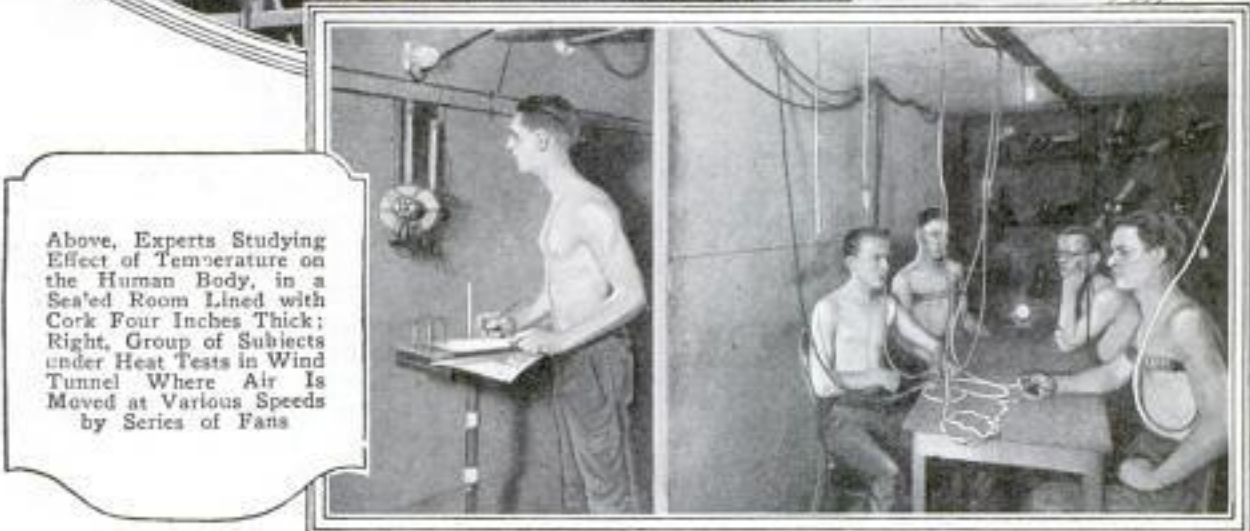
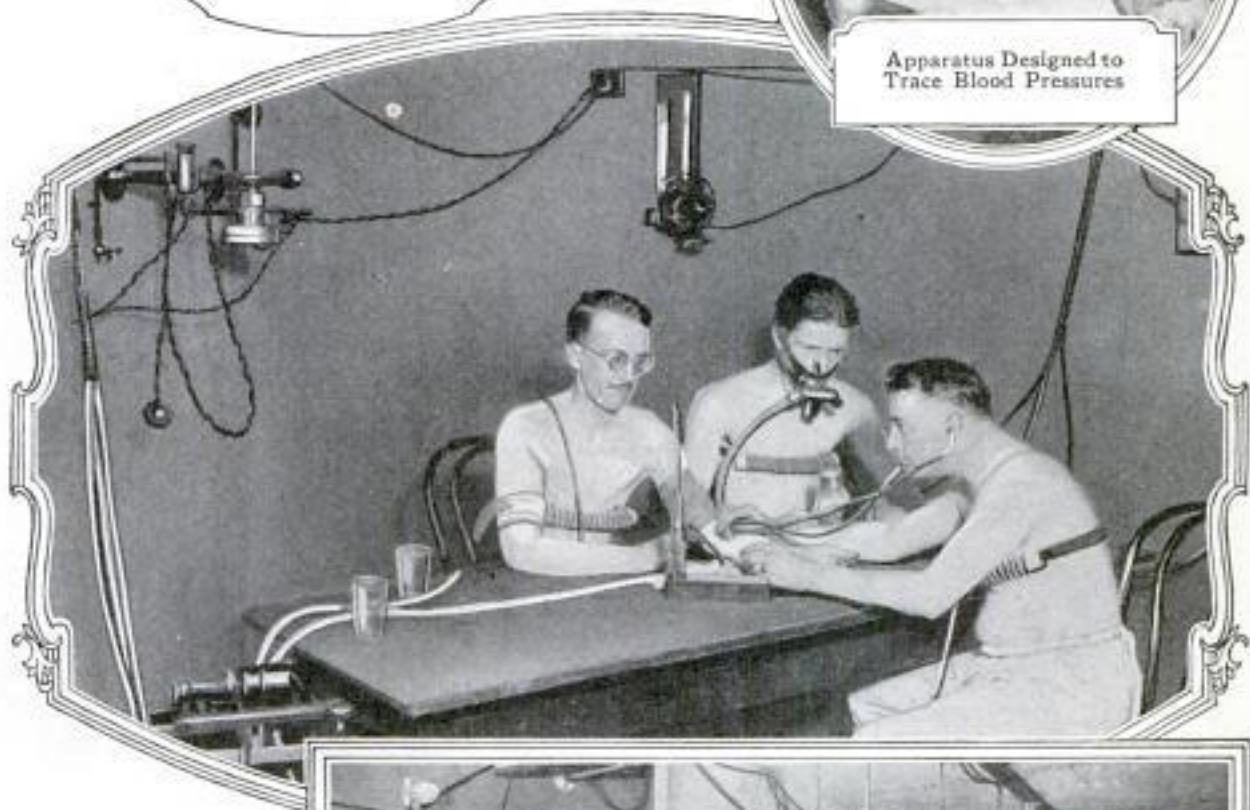

Above, Experts Studying Effect of Temperature on the Human Body, in a Sea'ed Room Lined with Cork Four Inches Thick; Right, Group of Subjects under Heat Tests in Wind Tunnel Where Air Is Moved at Various Speeds by Series of Fans



1950  
**Big Gun on Partly Submerged Sub  
Protected from Bow Wave**

A four-inch gun on the conning tower of the British submarine boat "L-23" can



*Product Atlantic*  
Rifle Turret of Submarine Shaped to Protect Gunners from Wash of the Sea When Craft Is Traveling Partly Submerged

be fired while the craft is partly submerged. The armor-steel turret, shaped like a ship's hull, is designed to cut the bow wave, protecting the gunners from flying spray and the wash of the sea when the boat is traveling at high speed. Signaling devices for the direction of the firing crew are controlled from an inclosed chamber where targets are located and ranges determined. Due to the rifle's long range and its ability to operate when the sub is partly concealed, the craft is claimed to be a formidable weapon for naval warfare.

Products of the forty-five chewing-gum factories in the United States are valued at \$48,524,499 a year, according to figures of the department of commerce.

2115  
**Automatic Elevators Save Time  
for Skyscraper's Traffic**

Elevators that start, stop, and open and close doors without aid from operators have been installed as timesavers in a New York skyscraper. As a car is taking on its passengers, the attendant registers the stops by pressing buttons that correspond to the desired floors. A movement of a small lever starts the lift on its upward journey and at the same time automatically controlled gates are closed. As the elevator reaches a floor previously indicated as a stop, the car halts and the doors are whisked back and closed again by electrical interlocks when the passenger has stepped out. Persons awaiting a lift on one of the upper floors need only push a signal at the shaft to cause either a descending or ascending car to stop at that point. The elevators are equipped with self-adjusting devices which eliminate the necessity for "inching" up or down when leveling the car at a floor. Although the elevators are capable of traveling 1,100 feet a minute, they start and slow down gradually in order not to affect the comfort of the occupants.

With their use it is estimated several minutes are saved on each round trip by the absence of false stops, leveling, and opening and closing doors by hand.

2101  
**Trees as Aerials Relay Messages  
Distance of Three Miles**

Forest rangers in Washington have discovered that with the simple addition of a copper nail, the branches of firs and hemlocks can be made to serve as radio aerials. Tired of carrying wire, they drove a nail at the base of the tree trunk, and connected it to the sender. Messages were received successfully two and three miles away, according to reports.

*Del. Vets*

10/25/24

Copyrighted material



*Richard*

### Derelict's Wanderings Aid Charting of the Ocean's Currents *2119*

Floating unguided on the Atlantic ocean for more than a year, the wreck of the lumber schooner "Governor Parr," abandoned by its crew in October, 1923, during a storm, has been used as an aid in charting the speed and direction of flow of the sea currents. Traveling thousands of miles since it was left to "run wild" on the sea, the ship has been constantly reported from widely separated points along the steamer lanes. By checking up this information, marine authorities are able to correct their charts. Several attempts to salvage or destroy the wreck have failed. Once taken in tow by a coast-guard cutter, the derelict had to be cast loose during a gale. Months later it was sighted off the coast of Portugal, and although set afire in the hope it would sink, the damaged vessel was seen again hundreds of miles from that place.

### Sidecar Rider Risks Life on Curve to Win Motorcycle Race *1713*

While credit for most motorcycle racing records is due to the drivers, sometimes their helpers and mechanics deserve no little praise. This was true in a race in Ireland not long ago. The machines were equipped with sidecars and each carried a passenger. To help preserve the balance in rounding a curve at a high rate of speed, the occupant of one of the cars leaned far

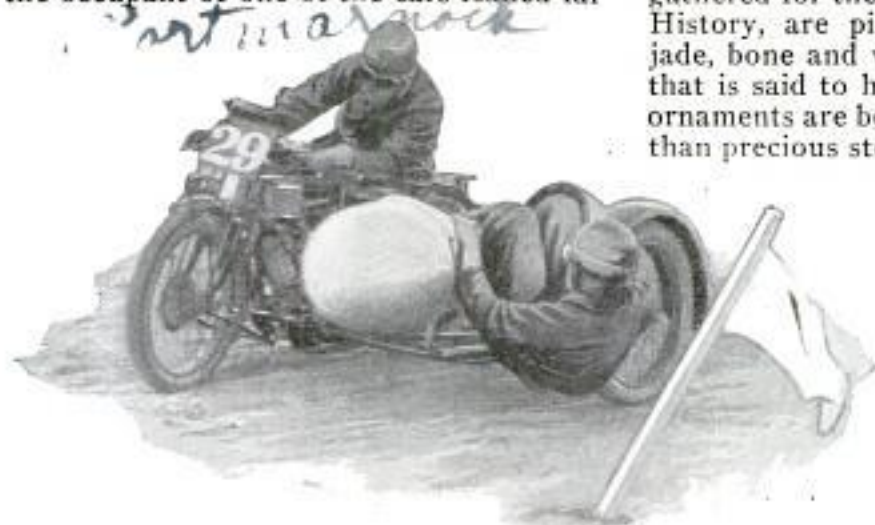

*not in a race*  
**Risking Death to Prevent a Spill, Sidecar Rider Narrowly Misses Flag Post at Sharp Curve of Course**

outward, hanging to the side of the seat and dash. As the racer roared by, the passenger's head barely missed striking a flag post that had been stuck in the ground to mark the course of the track.



*U. S. U.*  
Collection of Ancient Chinese Art Relics That Show Skill of Old Oriental Craftsmen

### Ancient Bride's Chair Is Tribute to Lost Arts of China

In a collection of 2,500 Chinese art relics gathered for the Field Museum of Natural History, are pieces of delicately carved jade, bone and wood, remnants of a craft that is said to have become extinct. The ornaments are believed to be more valuable than precious stones. Among the exhibits

is to be seen a chair in which the oriental bride was carried to the house of her prospective husband. It is built of wood, decorated by beautifully cut figures, and lacquered in red. Some of the articles were made almost fifty centuries ago and are well preserved. Many household utensils and artistically designed pottery, examples of

ancient oriental handicraft, are included in the display.

☞ About 15,000 bakers are needed to supply New Yorkers with their daily bread.



*429*  
**Vessel Is Built of Bargain Goods to Herald Sale in Paris**

To advertise an annual sale of white goods, a Paris store displayed a model of a sailing bark made from articles offered

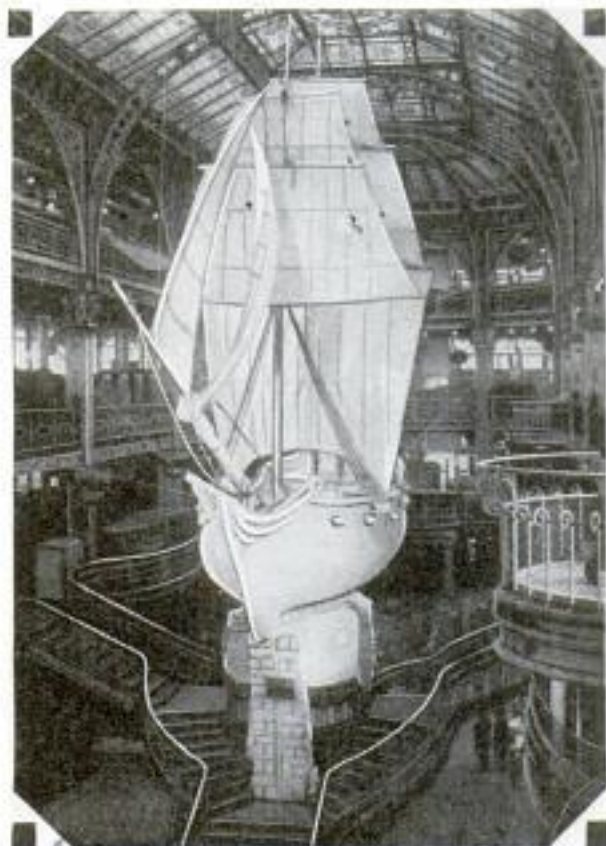

Towel-and-Sheet Sailing Ship Rigged in Store to Advertise White Goods Sale

at the bargain counters. Closely matted piles of towels form the supports for the vessel and the hull is constructed of the same materials. Sails are rigged of muslin sheets, and spars and masts are wrapped in white.

*2140*  
**Treasure Hunters Find Rich Booty on City Garbage Dumps**

The Detroit disposal plant yields for its official prospectors better returns than the average mining claim. The carelessness of people in throwing away their possessions is a constant source of wonder to the inspectors. The largest hauls are in silverware. Recently the manager notified two hotels that he had most of their silverware, and when they sent representatives to the plant he delivered several large gunny sacks filled with monogrammed table silver and a three-foot coffee urn, all recovered from the refuse. Several waiters thereupon lost their jobs. Valuable discoveries are advertised in the

papers, but no owner has been found for an antique solid-gold ring weighing two ounces. A complete golf set, clubs and half a dozen balls, occupies a post of honor in the disposal-plant museum of recoveries. Near by is a hypodermic needle, a complete opium-smoking outfit, a line of silver cigaret cases, cigar cutters and briar pipes, a beautiful gold-incrusted stiletto, a dozen razors, many watches, and heaps of finger and ear rings.

*2129*  
**The Toll of London Fogs**

According to one authority, a single London fog may cost more lives than a pitched battle. The period of the greatest prevalence of the dense mists is in December, with the other winter months not far behind. At this season of the year, the death rate from lung diseases reaches its height. The heavy, moisture-laden air aggravates such maladies, the lack of sunlight reduces physical resistance and illness frequently results from chills caused by the dampness. Mental depression is considered another harmful effect.

*Kansas City James 10/28/24*

*1876*  
**Ventilating Eaves for Closed Cars Clean Air without Drafts**

Formation of steam on the inside of closed car windows in cold weather, or sticking of rain drops and snow to the outer side in the driver's line of vision is prevented, the manufacturers claim, by a newly patented ventilating eave. The suction set up by the device is also said to instantly remove motor gases, smoke and

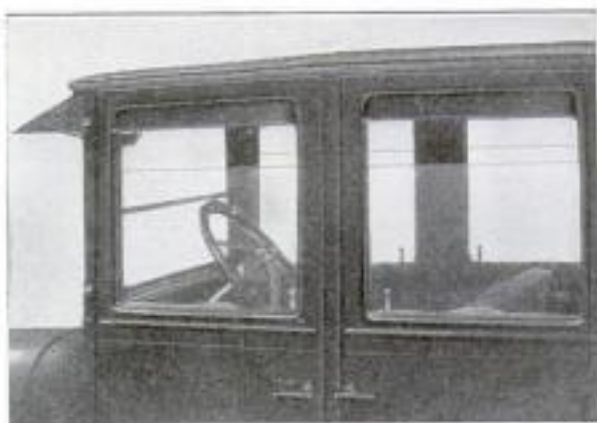

Closed Car Fitted with Ventilating Eaves Extending from Top like a Canopy

foul air from the car, while in cold weather the circulation helps the operation of the car heater without causing disagreeable cross currents. The degree of ventilation can be regulated by raising or lowering the window.

*Hubbard Products Co.  
 Kokomo Ind.  
 Copyrighted material*

*Keystone Nov. 1924*



1997 *Em. Earle W. Isage, Asheville, N.C.*  
 POPULAR MECHANICS 251  
*A. H. Krum, 2722 Prince St  
 Berkeley, Calif.*



Gathering Eggs on a Hen Ranch in California Where the Layers Produce Material with Which the Electric Incubators Work; All Eggs Are Handled Gently to Prevent Injury

## Electric Hens Hatch Billion Chicks

Eggs Produced on Hundreds of Big Poultry Ranches Are Nursed into Flocks of Fluffy Youngsters by Machines

**T**HE sitting hen which for twenty days or thereabout covers a hatch of rarely more than a dozen eggs until ten or eleven of them appear as lively fluffy balls of down may soon have its place entirely taken by the "electric hen" designed to care for 575,000 eggs at a time, hatching 25,000 a day with a total capacity of 3,000,000 chicks a season. One of such hatcheries, and among the largest in the world, is located at Petaluma, Calif., where it takes constantly the egg output of thirty large poultry farms. With 1,260 built-in electric incubators, automatically operated and controlled, and all under one roof, this machine turns out more chickens than all the hatching hens and portable incubators of the neighboring valley combined formerly produced.

The only eggs accepted for the plant are those from hens which run at will in big flocks over large ranches. Eggs intended for food are produced by hens kept in small

coops and pens. These are fed special grains and are stimulated by electric lighting. But it is the eggs of the free-range hen that produce the largest, strongest and longest-lived chickens, which also turn out to be the most productive fowls when they grow up. All eggs gathered from the roving flocks are first weighed and graded according to size and color. They must not weigh over twenty-six ounces nor less than twenty-two ounces to the dozen, and the shell texture, shape and shade must be uniform.

Arriving at the incubating plant, they are candled and tested by electric searchlights which equal X-rays so far as these eggs are concerned. This preliminary treatment insures the quality and uniformity of the chicks by eliminating infertile and otherwise worthless eggs. Then thirty tons of these white ovals are gently placed in trays and slipped into the incubators, where approximately 750,000

*No information on incubators  
 Probably - Petaluma Electric  
 Incubator Co. Petaluma, Calif.*



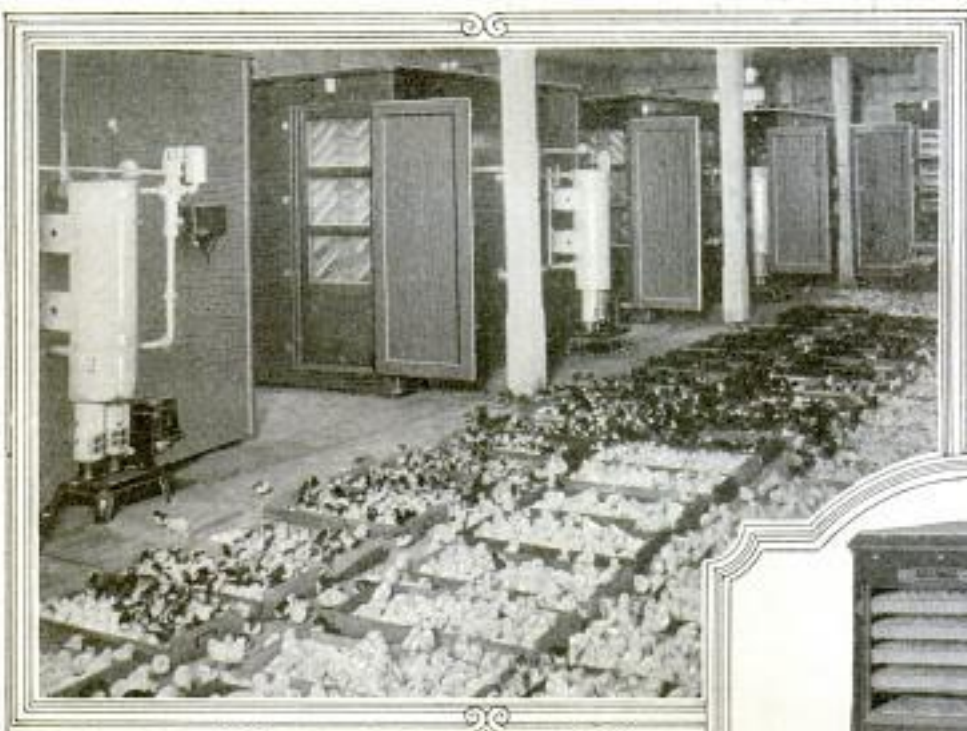

Part of a Brood of 100,000 Chicks Just Out of the Electric Incubator and Strong Enough to Climb from Their Trays and Run About, Due to the Uniformity of Temperature Control Maintained by the Machine



Packing Eggs for Shipment to the Incubator Plant; Care Is Taken That Only Those of Proper Size, Shape, Color and Shell Texture Are Selected; Right, Sectional View of Mammoth Hatching Machine Showing Egg Racks, Chick Trays, and Apparatus for Heating and Ventilating Systems



Transferring the Baby Chickens from an Electric "Hen" That Holds 2,400 Eggs; Youngsters Can Be Removed without Disturbing Other Hatches

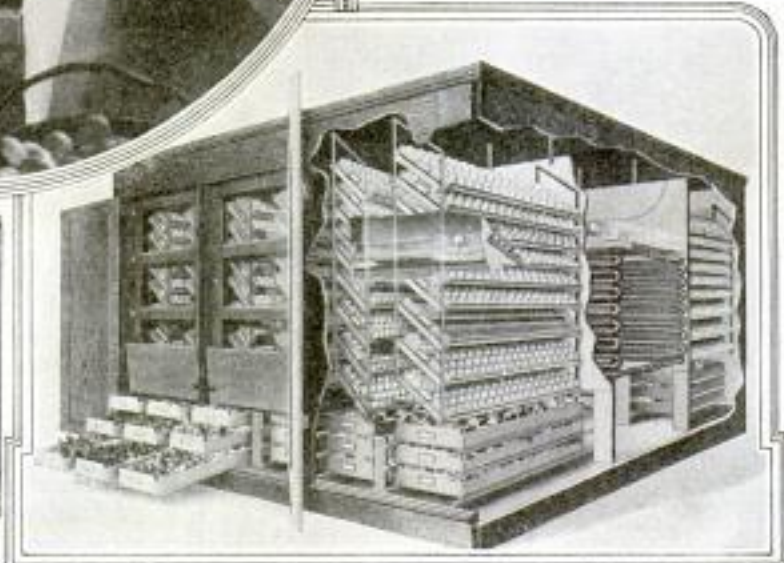



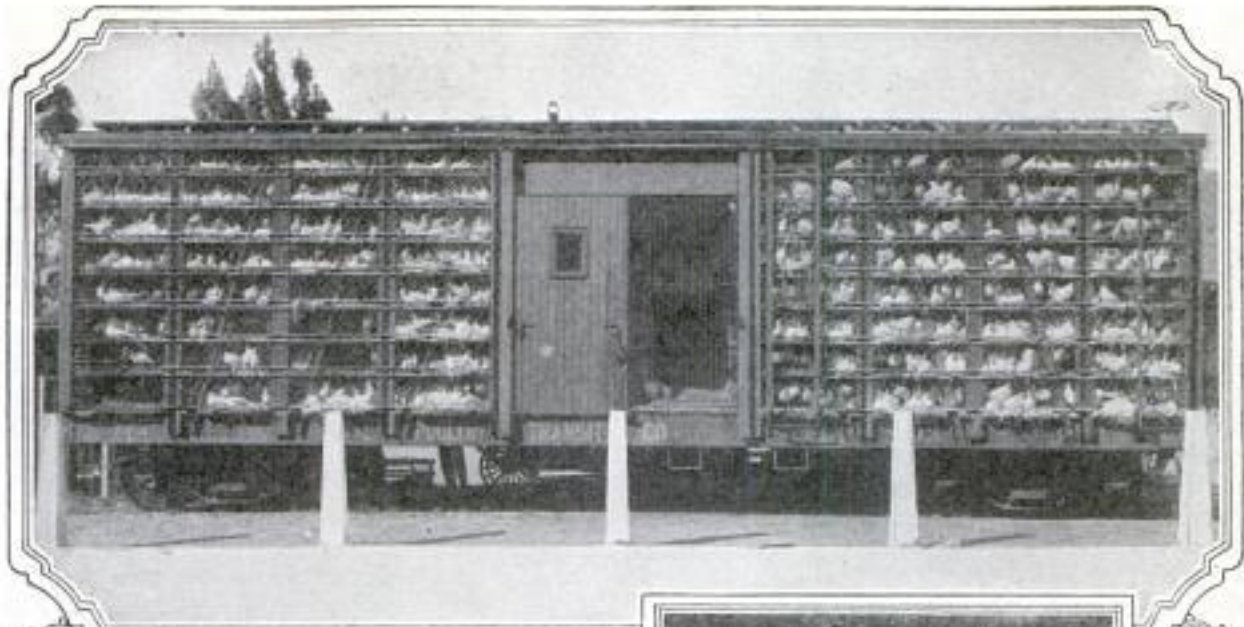

To Guard against Inbreeding and to Insure Vigorous Chicks, Carloads of Breeding Cockerels Are Shipped to the Egg Farms Every Year Where Producing Hens Run Free on the Ranges. Below, a Grader Preparing Baby Stock for Shipment; No Food Is Included as the Little Chickens Have Enough Nourishment for About Two Days When They Issue from the Shells; Insert Shows a Pair of Mother Hens with Their Broods



feet of resistance wiring has been used to form the heating element. Each rack has an automatic turning device which slowly rolls over 100,000 eggs in ten minutes without breakage. All hatches are turned six times in twenty-four hours. On the fifth and thirteenth days after they are set, electric spotlights are employed to test the eggs for fertility and to determine if any show indications of injury.

When the chicks are hatched, they are kept warm by electrical heaters and as soon as they can run about, the "peeps" are packed into corrugated crates for shipment to markets at practically all points west of the Rocky Mountains. Water and food are denied them in transit, for to give them either during the first day or two of their life would prove fatal to the downy youngsters, which retain enough nourishment from the eggs to sustain life and insure development over that period.

Although the science of incubating eggs by artificial methods is as old as poultry keeping, it is only during the past few years that giant machines have been perfected to do the work of thousands of hens. Historical records show that the early Egyptians hatched as many as 100,000 chickens a year by artificial means, but theirs was a crude process not always reliable. It is claimed for the incubating machines that they are directly responsible for the poultry industry now returning

over a billion dollars a year to the wealth of this nation. Under restrictions of the sitting hen, production could not well keep pace with consumption, but now more than 700,000,000 eggs are hatched annually by mechanical methods, while about 300,000,000 are mothered by farm hens. The total value of this "crop" of chicks is estimated at more than \$200,000,000. The machines have almost entirely relieved hens of the hatching in parts of the country where poultry raising is most general. Farmers and poultry raisers have learned that it is far more economical to purchase baby chicks from the big breeding plants than to have them hatched out on the nests. Where hatches were numbered in a few hundred eggs by the old methods, the big incubators turn them out by the hundred thousands in the same space of time. And the machine chick is almost invariably a better fowl.

The most vital element in artificial incubation is temperature control, for even the slightest variation in the state of the surrounding air during the hatching period might result in a decrease of chicks or cause weaklings and crippled fowls. For the purpose of maintaining proper warmth at all times, devices are installed in the machines to regulate the temperature of the water in the heaters and the flow through the pipes on the inside of the incubators.



Hundreds of Thousands of Eggs Awaiting Deposit in the Hatching Chambers of the Big Electric Incubator at Peluma; 750,000 Feet of Wire Was Used in the Heating System



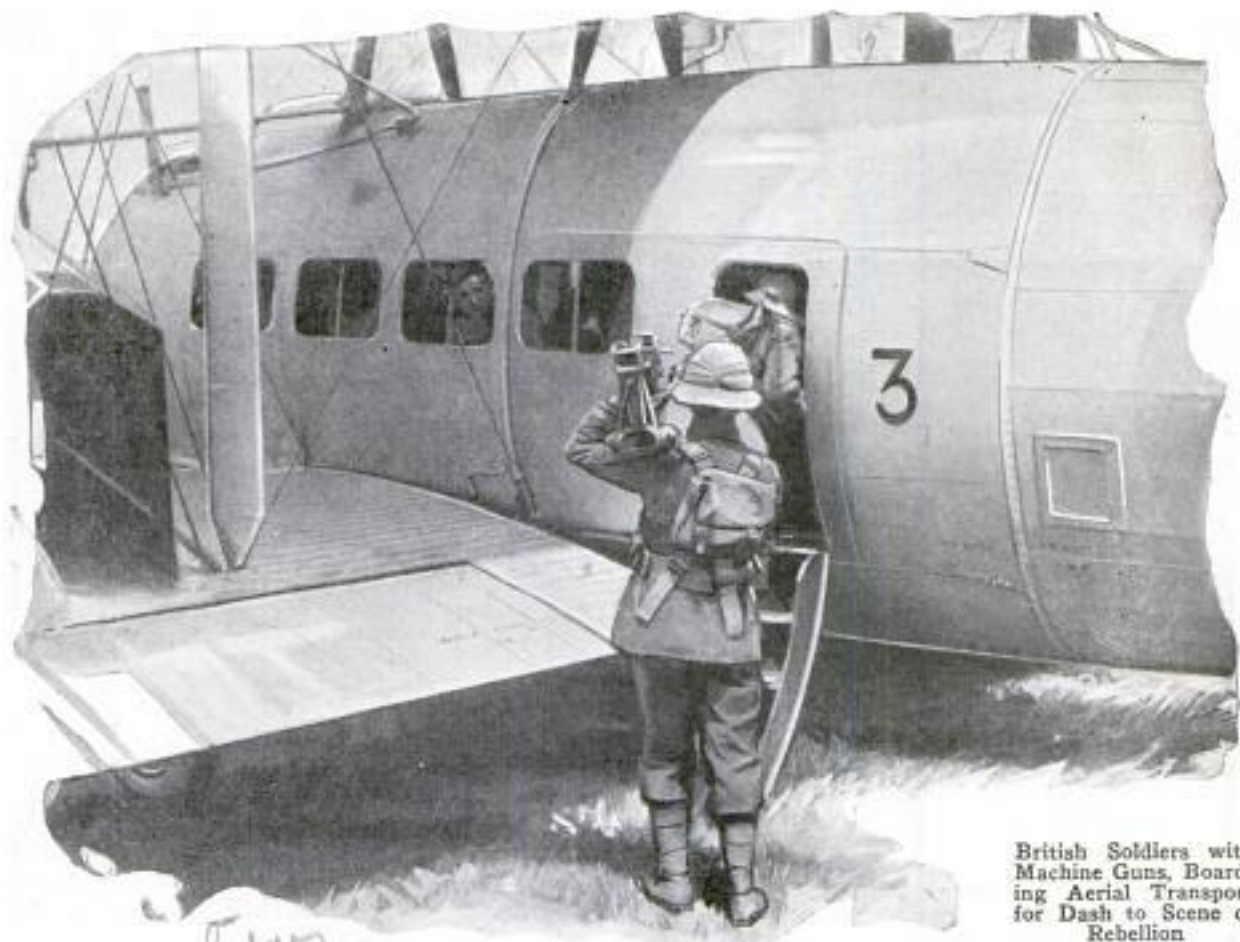

British Soldiers with Machine Guns, Boarding Aerial Transport for Dash to Scene of Rebellion

*Military*

### Airplane Transports Help Soldiers — End Rebellion Quickly 2036

Transporting troops by airplane is an accomplished fact in Great Britain. Huge machines that can carry twenty-two men and two pilots, besides guns and quantities of ammunition, are now part of the army and already have been used for practical purposes. Their effectiveness was illustrated not long ago when a native rebellion occurred in Mesopotamia. A squadron of aerial transports was loaded with troops at a distant post, sped to the scene, and in less than half an hour the uprising had been stopped.

2125

### Whale-Canning Industry Now Links — Distant Points of Empire

British Columbia has become linked to west Africa by an industry which has sprung up recently, the whale-canning trade. In the waters off the northwest coast of North America are large numbers of the finback species of whale, but catching them for their oil proved only moderately profitable and the meat was never saved. Lately, however, the flesh is tinned and shipped to African colonies, where

*Cont. J. Christie  
856 Union Station  
Vancouver, Can.*

the natives are said to consume it greedily. Reports state that they have found it a cheap and palatable addition to their fare, which consists mainly of a puttylike paste done up in leaves and which only native west Africans are said to be able to digest.

*Johns*

### Pipe-Bowl Scraper Removes "Cake" — without Injury to Wood 1999

For quickly removing the "cake" from the pipe bowl, a self-adjusting spring-steel scraper that will not injure the wood has been invented. It is made of a single piece of metal with two spoon-shaped jaws that will slip inside the bowl and are turned by twisting a handle. One of the blades has sawlike teeth for scratching off the carbon, and both are so shaped that they cannot cut the bowl as sometimes occurs when a knife is used for this purpose. The scraper fits large and small pipes and a twist or two suffices to give the bowl a thorough cleaning.



*Inver. Sewlay & Co, Ltd.  
46, Oldshape Gate  
London, E.C.2, Eng.*

Copyrighted material





How Extension Ladder Works on Sloping Roof, and Close View of Attachment

*Acorn*  
**Extension Leg for Ladder Prevents Falls on Sloping Surfaces** 1831

To prevent accidents when ladders are used on sloping roofs or other uneven surfaces, a metal extension that can be applied to either leg of the ladder in a few seconds has been designed. It is firmly held at any desired point by strong set-screws and rests on an angular end that firmly grips the surface without cutting or denting it. It can be adjusted to any length between one and fifteen inches. It does not damage the ladder, as would a temporary extension nailed to the leg, and is considered much safer than blocks.

*2121*  
**Higher Voltages Are Made Possible by Better Insulation**

Recent improvement in insulators has brought currents of 330,000 volts' pressure within the realms of possibility, according to the Engineering Foundation, which has issued reports on the most recent discoveries in handling high-tension electricity. Currents of 220,000 volts are now being used in actual practice, and the same insulators, when dry, will keep 280,000 volts on the line. At one time, about the year 1900, electrical engineers believed 60,000 volts was the absolute limit in cur-

rent which could be handled. Since then new discoveries and gradual modification and improvement of insulators have increased the working limit more than 400 per cent until now transmissions of 330,000 volts' pressure or more are a practical possibility. The problem in long-distance transmission of electricity has been to obtain pole insulators which would protect the high voltages necessary to make economical transmission possible. Electricity has a tendency to jump off the wire and seek an easier path to the ground. The result is a "corona," or faintly visible leakage, or else an "arc" in which the high-pressure current leaps across the insulator as a spark clears a gap.

*Just Ground under. Paymaster*  
*W. H. Hoare, British navy.*  
**Tandem Road Boat Is Propelled**  
 238 *by Pulling on Levers*

Propelled by two hand levers attached to gears on the wheels, a tandem road boat has made its appearance on an English highway. While one occupant furnishes the motive power by pulling on the levers, his companion sitting opposite him, manages the steering wheel. A fair rate of speed is possible with this contrivance, and it is operated easily on smooth roads.



"Rowing" a Road Boat along Automobile Highway; Steering Is Done by Person in Rear Seat

Rubber tires and flexible springs found in regulation motor cars make the boat a comfortable conveyance.

☐ The Popular Mechanics' Bureau of Information offers its free service to all readers of our magazine. Names and addresses of manufacturers and dealers in articles described, and any other details in our possession, will be promptly furnished by addressing the Bureau.

*New York Times*  
*11/3/24*





Exterior of Six-Wheeled Motor Bus and View Looking Down upon Rear Trucks

### Six-Wheel, Double-Deck Motor Bus Gives Greater Comfort

Double-deck busses that run on six pneumatic-tired wheels have made their appearance in a Pacific coast city. They are said to be more comfortable than those with solid tires, safer and more economical. The greater ease possible with pneumatic tires has not been enjoyed in double-deck busses with the ordinary wheel arrangement to any extent, as the load has been considered too great with an attendant danger of punctures and blow-outs. The bus has four driving wheels and all six are equipped with brakes. A six-cylinder motor furnishes the power.

2103

### Fish That Sing Found in Ceylon

Shellfish that produce a low flutelike sound after they have been left for some time on the rocky beach at low tides are reported from Ceylon. As the bivalves have no throat or vocal organs, it is probable that the sound is made by manipulation of the double shell, and increasing dryness is thought to have a part in the phenomenon for the noise is heard only after the fish have been stranded several hours. Scotch fishermen know a species, called the "buttermen," which produces a hooting sound when landed, and the gurnard, a fish found off the shores of England, makes a croaking noise like a crow.

Fish-Butts 10/25/24

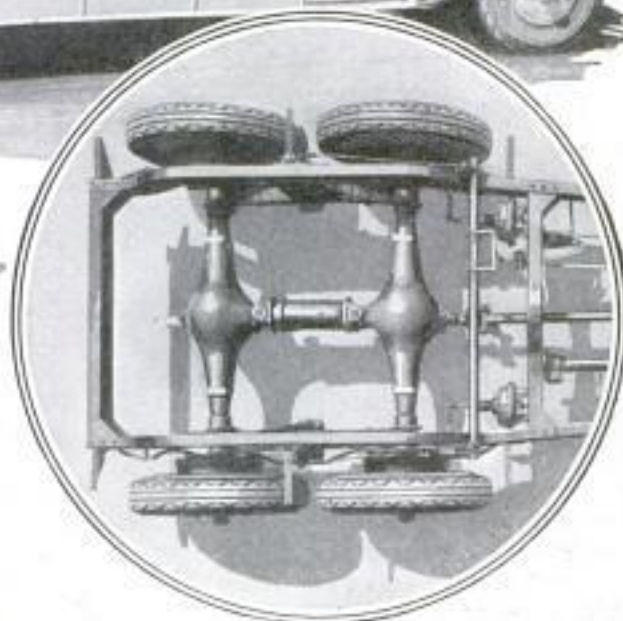

### Power and Mileage Are Increased by Auto Valve Levers 1052

Designed to provide more power and generally improve the performance of Ford motors, an easily installed lever mechanism has been manufactured to increase the lift of the valves. Greater mileage, saving of gasoline and less wear on the engine are claimed for the device and no alterations are required to install



it. With the outfit, a needle-valve control for the carburetor, to give a richer mixture for starting and a gradual decrease of flow as the motor warms up, is provided.

Accessory Valve Action Co.  
 327 Main St. Springfield, Mass.  
 Price - \$15.00



*New 'Strechamper' Trousers  
 Machine, Ltd. 3-A Broad St.  
 258 POPULAR MECHANICS  
 1497*

**One-Piece Trousers Press Removes Baggy Knees and Creases Cuff**

Trousers are quickly creased and pressed and the bag taken out of the knees in a



Smoothing Trousers Before Webbing Strips at Right Are Clamped across to Other Side

stretcher now being manufactured in England. It has no top piece to be unscrewed or adjusted and consists simply of a convex board with two wide strips of webbing attached to a roller at one end. The trousers are laid flat on the board, the webbing is extended and fastened to a clamp at the other end and bound forcibly against the cloth. The curve causes the maximum amount of stretch to occur at the knees. The pressure can be regulated by adjusting the clamp or taking up the slack in the strips.

**2 Aeroplane Oil Made from Locusts**

Science has found a use for the locust, one of the greatest crop destroyers in the insect world, since a way has been discovered to extract an excellent oil for aeroplane engines from them. It is said to have special properties which suit it for that purpose and it retains its liquidity at high altitudes. Locusts are now being exported from Africa to Holland, one recent shipment consisting of eighty-eight bales weighing nearly eighteen tons.

**Single-Wheeled Sulky for Racing 2364 to Prevent Accidents**

To prevent accidents that sometimes occur during light harness races, a well-known driver has designed a one-wheel sulky. It is expected to eliminate the possibility of vehicles becoming locked together on the turns, or the straightaway, and make it impossible for the horse to put a foot through the spokes. The driver sits about ten inches farther back from the horse than he does in the present style, and instead of the high stirrups for his feet, there are strong supports so placed that he sits in an upright position. The wheel is directly under the seat.

*New York Times 10/23/24*

**1852 Washing Big Clock's Hands and Face Requires Skill of Steeplejacks**

Nimble steeplejacks who think nothing of risking their lives on high buildings and in precarious positions, were required recently to clean the soot and dirt from the face of "Big Ben," the famous clock on the tower of the British house of parliament, 300 feet above the ground. Several days were consumed in the task, and the workers were compelled to exercise care not to damage the mechanism of the giant timepiece or the lettering on the dials.

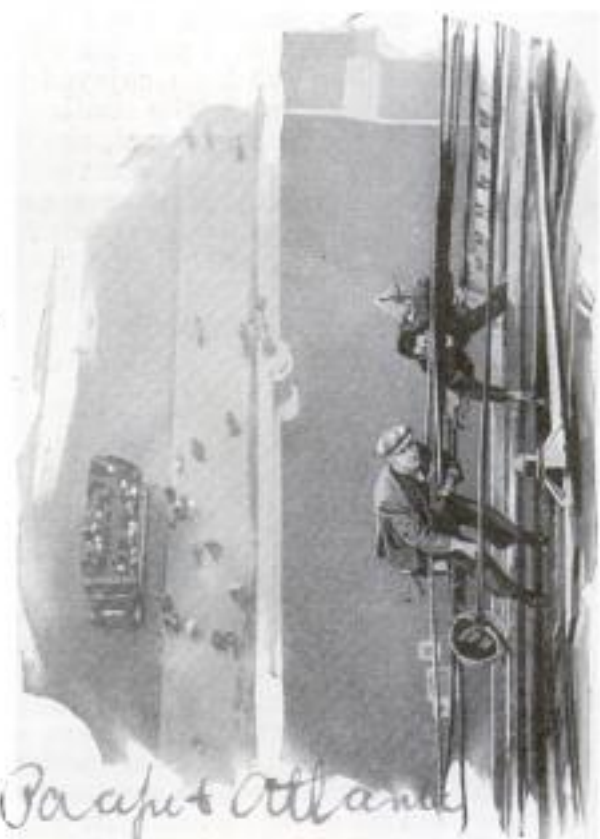

*Paraphrase*

Steeplejacks High above the Bustle of London's Streets Brightening "Big Ben's" Face

*10/25/24*





Worker

Queen

Drone

## Nature's Cleverest Mechanic—the Bee

### Uncle Sam Working to Solve the Perplexing Mysteries of the Modern Beehive for the Benefit of Mankind

**I**F a great international prize were to be awarded to the most efficient factory and workshop in all creation, practically all the other competitors would be distanced by the modern beehive.

In the field of modern invention, in the realm of practical science, in the annals of bustling industry, there is no individual agency eclipsing a bee colony in efficiency. The diminutive bee is the boss architect among insects, the champion contractor, the most resourceful workman, the most industrious laborer.

The scientific facts already gathered and verified by the department of agriculture, qualify the bee as the world's master mechanic. The bees build a fine home. They equip it with heating and ventilating systems. They stock it with food. They perfect an industrial and business organiza-

tion. Provision is made for the removal of all debris. Neither waste motion nor lost energy complicate activities. Distribution of labor is equable.

Uncle Sam's scientists have discovered that the ordinary honey bee is an expert on temperature. You or I can only guess how cold or warm it is. The bee knows exactly when the temperature reaches fifty-seven degrees Fahrenheit. It is the danger temperature for the bustling "buzzers." When the mercury drops to that point they know intuitively that it is time to huddle together and build an imitation bonfire. Without the use of matches, tinder or firewood, they produce heat which keeps them from freezing to death. There is no furnace system in the history of engineering more remarkable than the bee heating plant which runs without fuel. When the temperature of the air immediately surrounding the bees falls to fifty-seven degrees or lower, 15,000 to 20,000 bees will form a cluster. The



These Bees, When They Swarmed, Picked a Fence Post as a Convenient Resting Place

*A. d. Roof Co.  
 Medina Ohio.*



1897

Comb of a Swarm of Wild Bees Revealed Below. When the Bee Tree Was Split Open by the Honey Robber

Section of Honeycomb, at Left, Showing How Six-Sided Cells Are Joined to Produce Strong Structure

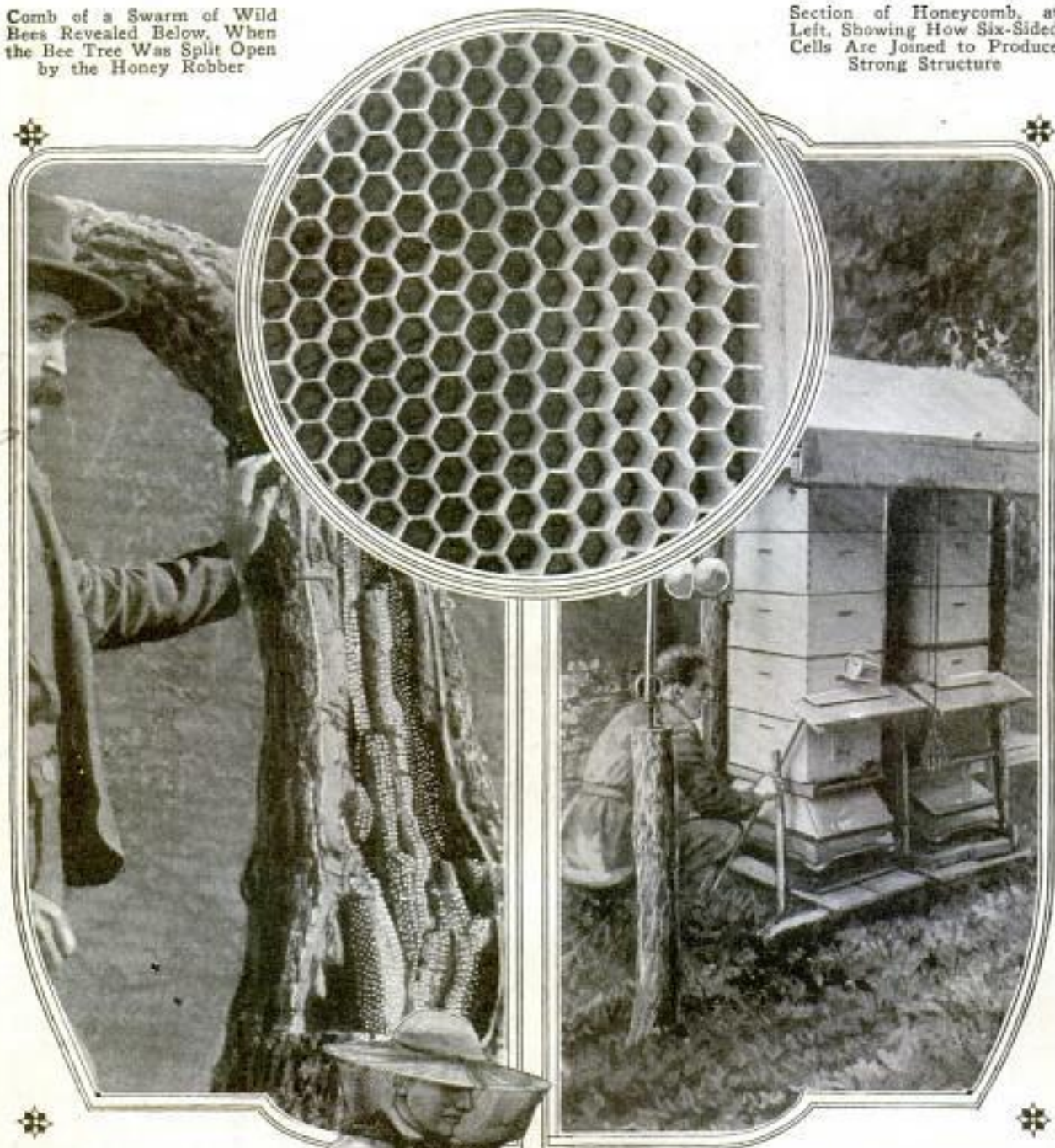

Above, Hive in Which Temperature Readings Are Taken Every Five Minutes; Below, Keeper, with Veil to Protect His Face, Pumps Smoke into the Hive to Quiet Inmates

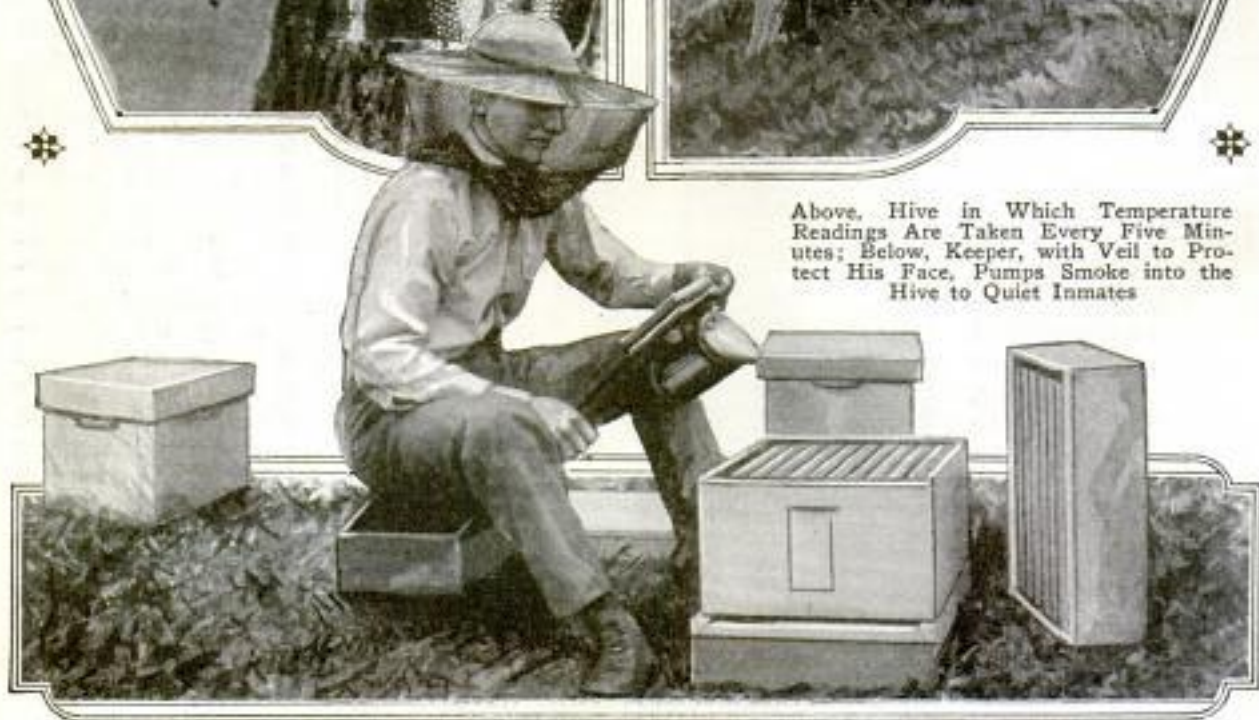



bees in the center of the mass by muscular activity then generate heat. Those on the outer portion of the cluster serve as insulators by crowding close together, usually with their heads toward the cen-

ter. They emerge into life as adult bees with a certain amount of vital energy. When this is exhausted they die. Unlike human beings, these honey-making insects do not have the power to regain lost vi-

If Handled Rightly, Bees  
Make Gentle Playmates  
for Classes of Eager  
Young Girl Students



ter of the cluster. The number of bees that function as stoves depends on the outer temperature. The colder it becomes, the greater the number of these extraordinary furnace men. The entire cluster by contraction becomes smaller as the external temperature falls. By their physical labors, the worker bees produce heat to the extent that the core of the cluster often may attain a temperature of ninety degrees or higher. The insulation of the border of the cluster is so perfect that heat can escape only very slowly.

Although the coal bill for the average bee mansion is nil for the winter season, the beehive has to pay for the heat which its inmates develop when the temperature drops to fifty-seven degrees or lower. Honey is their food. The buzzing bees expend large amounts of energy in their muscular contortions which heat the cluster. This expenditure of energy really shortens their lives and the furnace burns out. Literally, they constitute one class of laborers that work themselves to death. The national scientists have ascertained that honey bees are quite like small dry batteries in so far as their vital energy is

tality. Commercial beekeepers strive to maintain their bee colonies under such winter conditions that the temperature will not fall below the danger point. Thus the bees are able to conserve their energy. They do not have to waste this valuable resource in heat generation.

Queer to tell, the same industrious bees that provide the heat for the unprotected colony during the winter also work as ventilation experts during the summer. Science has determined that the buzz of the beehive is not the echo of industry but the hum of an extraordinary method of ventilation. Squads of worker bees are stationed here and there and everywhere throughout the hive. In regular cadence, these insects flap their wings in order to introduce and circulate pure air throughout the honey workshop. Simultaneously, these bees working as substitute electric fans, force the foul air from the factory. The government bee farm, the largest research establishment of its character in the world, is located in a Washington suburb and consists of sixty-five colonies of Italian bees. The total bee population of this remarkable research



1817 7



Left, Honey Tanks and Extractors, Turned Out in Large Quantities by Factories, Make Bottled Honey Possible; Below, a Steam-Heated Knife, Connected by Tubing to Boiler on the Stove, Slices Beeswax Caps off Honey Frames Before They Go into the Revolving Extractor



Expert Bee Men Scorn to Wear Gloves and Veils When Handling Eighty Thousand Inmates of a Hive, Proving Experience Renders Safety Measures Unnecessary



station during the summer aggregates approximately 4,750,000 workers. A corps of fifteen scientists devote their working hours to the study of bees. There are altogether 800,000 beekeepers in the United States, who maintain about 8,000,000 colonies of honey bees and depend on Uncle Sam's national bee farm for assistance. The experimental project is the testing and proving grounds of the apiary industry in America. During the summer season of rush work, the average bee lives only about six weeks. During the winter, a worker bee often reaches the age of six months if properly cared for. As a consequence of many experimental weighings of worker bees on delicate scales, the national apia-

rists report the average weight of one of these laborers at seventy-five milligrams. The honey bee, although small, is an Ajax of the insect world for it can fly long distances carrying two-thirds of its weight in honey. When the bee sleeps, it rests with open eyes, for this insect has no eyelids. A honey bee can sting but once, for its stinger remains in the wound and the bee dies immediately.

Bees are bought and sold by the pound, like any less volatile commodity. A pound of good Italian bees is now worth about two dollars, and from two to three pounds of them, with a queen, costing anywhere from fifty cents to fifty dollars, are sufficient to start a colony. It takes about 5,000 bees to make a pound. In preparing them for sale, the bees are poured through a funnel onto the scales and bundled around with no more care than a storekeeper would bestow on sugar or coffee.

An average colony may produce as much as 500 pounds of honey in one season. At the height of the flower period,

the hive is robbed as often as every five to eight days, new combs being substituted, or the old uncapped, emptied by the centrifugal extractor, and restored. From 200 to 300-per-cent profit from a hive is not unusual. For example, a man who invested fourteen dollars in a queen, colony,

hive and other equipment, took fifty dollars' worth of honey the first year, while his bees swarmed once, so he had two hives to start the next season. Left to themselves to build a home, the bees will work a curtain by hanging one from the other and begin producing beeswax and molding it into a comb. The honey bees usually make a double comb, the base being a sheet of wax, from either side of which tiny six-sided cells are raised,



Wearing a Hat Full of Bees While Delivering a Lecture on Their Habits, Is One of the Stunts of a Famous Bee Man

to be used as brood cells for the queen bee's eggs, or as storage cells for honey.

Every cell is a mathematically perfect hexagonal prism, which, mathematicians have since demonstrated, gives the maximum space with the least expenditure of wax. In man-made hives and equipment, the natural habits of the bee are assisted by providing beeswax foundation sheets, with the base of each cell impressed in it. The artificial foundation is exactly like that the bees otherwise would make, but by its use they are saved the time and enormous consumption of honey-making nectar otherwise used up to make wax.

The head of the hive is supposed to be the queen, though bee men now doubt whether she rules or is ruled. The rest of the colony consists of worker bees, which are undeveloped females, and drones, or males. There is usually but one queen in a hive, though occasionally a reigning monarch will permit her old mother to remain in some secluded corner, while killing off her sisters.



1897

The worker bee has two stomachs, a "public stomach" to carry the nectar to the hive, and back of that a "private stomach" into which its own food supply passes for digestion. Queen bees and workers are produced from the same eggs, and the hive can produce queens at will by changing the food on which the tiny larvæ are fed.

The drones have no stingers, and are helpless to defend themselves. No worker bee will ever attack a queen, but as soon as the first queen is hatched, she attacks all other queen cells and kills her unborn sisters, and likewise will fight any invading queen, while her subjects stand around in circles to watch.

If it becomes necessary to kill an old queen or a usurper, the worker bees "ball up" around her, forming a living ball of bees, with the victim in the center, to smother or starve to death. In that way the guilt of queen-killing is divided among the entire colony.

One of the unfathomed mysteries of the bee is the practice of swarming to found new colonies. A strong hive, happy and prosperous, with storage cells overflowing with honey and an easy life in prospect, will suddenly divide, and the old queen will lead most of the inhabitants away to found a new colony, where they must struggle in poverty and risk death itself to build up a new city. From a colony of 100,000 bees, as many as 80,000 will suddenly elect to follow the old queen in her flight, leaving not more than 20,000 to

feed and nurse the unborn queens, drones and workers they leave behind. The bees actually "make honey," since the nectar gathered from flowers must be entirely changed, chemically, to become honey. As gathered it is the same as cane sugar, but when modified into true honey it becomes what is known as invert sugar, composed of levulose and dextrose, with small parts of iron, lime, sodium, sulphur, magnesia and phosphoric acid. It is these elements which make honey a desirable food.

The nectar is modified into honey by heat and air. Thousands of bees remain in the hive gently fanning their wings to keep the air circulation going. The fanning is so well organized that a perceptible current is created. A lighted match held at an opening on one side of the hive will have the flame sucked in, and on the other side the fire will be repelled.

The bees have many human traits, and occasionally become thieves. When a bee finds it is easier to steal from a neighbor's hive, getting pure honey, instead of making the long trip to the fields to bring back the much weaker nectar, it immediately returns home and communicates the news to all its friends.

When bees "go wrong" capital punishment is about the only remedy. A "robber trap" placed on the hive lets the thieves in, but keeps them from going out again, and when all have been trapped, justice is inflicted by smoking them to death with brimstone. Trouble arose at an Ohio experimental yard on one occasion when a far-flying robber bee discovered it was easier to loot the candy and watermelon stands at the county fair, a mile away. The entire hive joined in the looting and drove away opposition by stinging the visitors. The robbers were traced to their hive, and a brimstone pot ended their criminal career.



Transferring Bees from an Old Hive, Above, and a Frame Full of Honey Makers, Showing Start of Comb



*Model 2051 Mr. Fletcher Bates,*

*Being investigated by traction, Calif. Authorities at Los Angeles*

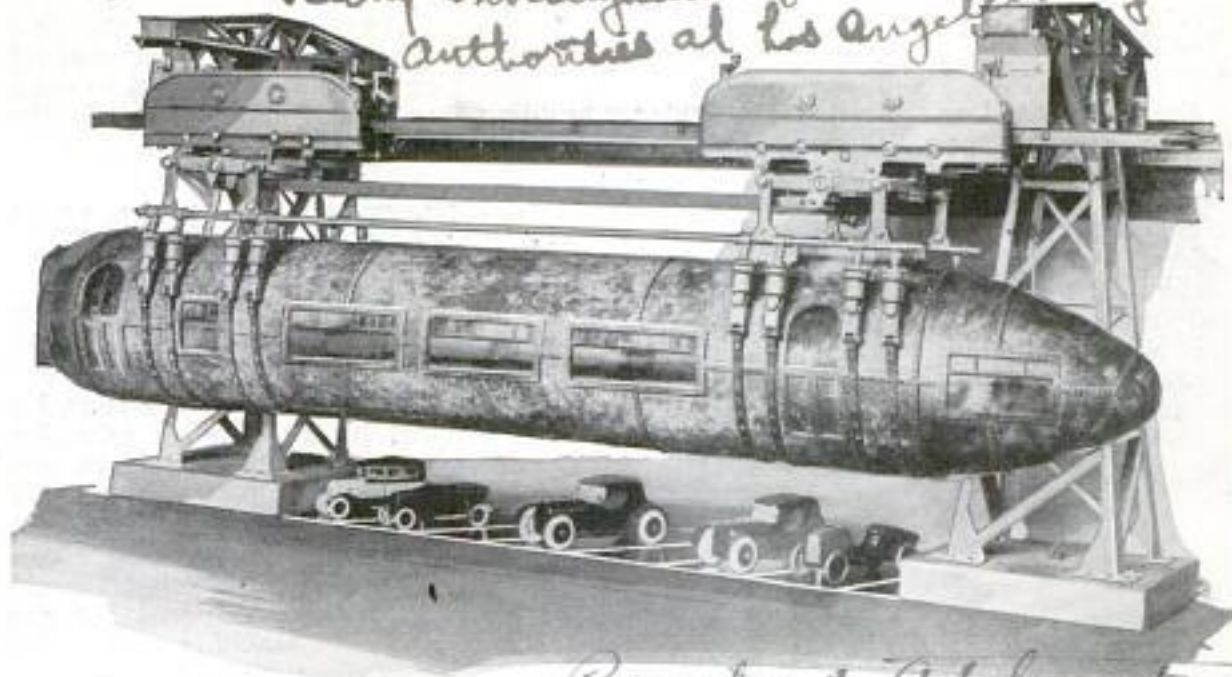

Model of Torpedo Car, a Rapid-Transit Coach Which Is Operated in Twin Arrangement Suspended like a Packsaddle across a Single Elevated Rail over Which It Speeds

*Pacific & Atlantic  
A railroad*

**Torpedo Cars Hung from Single Rail May Speed Future Traffic** *2051*

Cigar-shaped cars suspended in pairs from a single overhead rail and capable of running 100 miles an hour have been designed as a means of relieving traffic of big cities. Built of steel the cylindrical coaches, each of which is to be sixty feet long, are planned to seat 100 people, and can be used over the most crowded thoroughfares without materially interfering with street traffic. The track consists of a single elevated rail supported on a narrow structure, which the twin arrangement of the cars straddles like a packsaddle. Because of their great capacity, speed and small rail requirements, it is claimed the vehicles would reduce travel time and decrease cost of railway installations.

**Force of Train Shocks Is Revealed by Dynamometer Car** *599*

Secrets of modern transportation are revealed by a dynamometer car which records train and locomotive performance. The recording table is provided with indicating gauges and recording pens, and every impact and shock is automatically registered. The apparatus tells the coal and steam consumption of a locomotive, and power pull, speed, time consumed in curves.

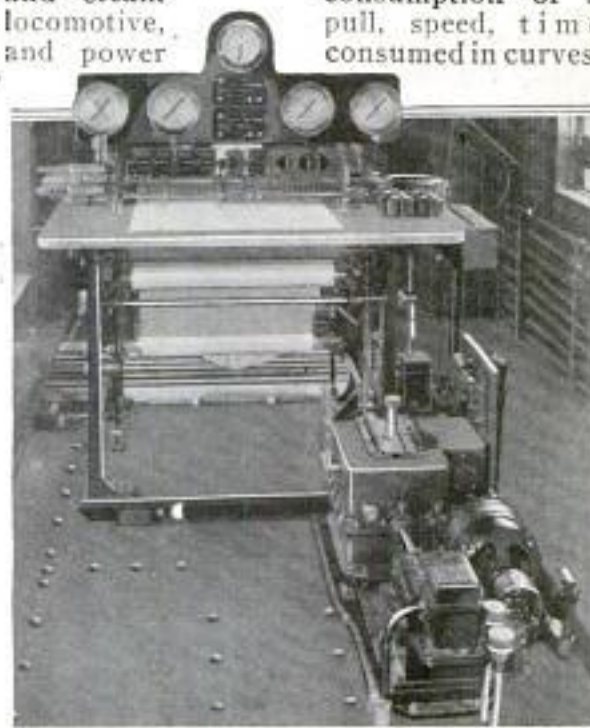

Car Equipped with Automatic Instruments Which Measure Impacts and Record Locomotive Performance

**Rays Are Given Off by All Living Things, Is Claim** *2126*

All living things are radioactive and insects and leaves of plants emit rays sufficiently strong to be photographed on a sensitive plate, according to a French scientist. By means of the pictures so taken, he has estimated that certain kinds of bugs have a greater degree of radioactivity than some chemicals commonly used in making laboratory tests and comparisons of materials. No such rays have been detected from dead organisms and therefore the property is believed to be an accompaniment of life itself.

*Dr. Christie, 356 St. James Station, Winnipeg, Canada*  
*The Burr Co. 360 N. Michigan Chicago*



*General Automobile Corp.*  
 600 W. Jackson Blvd.  
 266

POPULAR MECHANICS

*Messrs. Drummond Bros. Ltd. Engineers*  
 Escondido, Cal.

**Safety Light on Rear Auto Fender Also Serves for Repairs**

1348

Easily mounted on the rear right fender of any automobile, an electric lamp of the headlight type has been designed which,



Inspecting Automobile with Fender Light That Can Be Carried to Any Part of Machine

it is claimed, illuminates the entire outer rim of the road for hundreds of feet ahead. Signs, danger warnings and obstructions near the highway can be readily seen without any manipulation on the part of the driver. The light is supplied with enough wire, concealed on a reel, so that it can be removed and carried anywhere about the machine for inspection or emergency repairs.

**"Inverted Wells" Dug in River Beds to Save Water Supply**

2087

Digging wells in the bed of a river to save the water supply seems like nonsense, but that is what engineers in the Santa Clara valley in California are planning to do for the sake of the 116,000 acres of prune trees. The unusual method is proposed as a means of keeping the natural water supply from running into San Francisco bay. The region normally is provided with abundant artesian water from the mountains. For years it has percolated into the underlying gravel beds where it spread to the entire valley. But lately clay washed down with the freshets has formed a sort of blanket over which the water has passed without sinking into the lower strata. The "inverted wells," as they have been called, will penetrate this accumulation of silt and allow the streams

*San. H. H. ...  
 2722 Bruner St.  
 Berkeley, Calif.*

to soak down to their natural reservoir of gravel and coarse sand. Advocates of this plan point out that it will save the cost of building large dams and other irrigation projects.

**Lathe with Circular Bed Fills Needs 1575 of Home Workshop**

Furnishing almost complete workshop equipment for amateur mechanics and modelmakers, a lathe with a round, hollow bed in which the lead screw runs, has been designed by an English manufacturer. This arrangement is said to protect the covered mechanism from dirt and metal chips. The drive is by means of a comparatively large cone pulley constructed for a flat belt which transmits sufficient power from a pedal for any work done on the machine and makes back-gearing unnecessary. Almost any type of thread can be cut on the tool with a set of change wheels, and plain milling and boring can be readily handled, as the saddle can be partly rotated around the bed and locked at any angle without interfering with the working of the transport gear. The lathe has an over-all length of nearly three feet and can take a piece of work eleven inches long between centers. It weighs slightly over a hundred pounds when the foot-drive mechanism and the supports are detached.



Foot-Power Lathe with Cylindrical Bed in Which Lead Screw Runs and Is Protected





Stunt Riding on a Well-Trained Pinto Cow Pony  
at a Rodeo in the Southwest

© R. R. Doubleday

## Wanted: A Use for the Pig's Squeal

Packers, Long Held Up to View as Models of Industrial Efficiency,  
Also Have a Few Other By-Products for Inventor's Use

THE plants of "Packingtown," where, according to fabled story, everything but the squeal of the porker is utilized, have long been cited as models of industrial efficiency, but, as a matter of fact, the packers still have a few by-products for which no use has been found. When all the meat and all the by-products of an animal are weighed up, there is a shrinkage of from ten to twenty per cent from the weight of the animal when it was purchased, on the hoof. If anybody finds a way to obviate that loss, the price of meat will be reduced. The loss, though, represents unrecoverable elements for which, it is believed, no

use will ever be found. As it is, the packers do remarkably well in converting waste into salable articles, though fluctuating market conditions at times upset all calculations. For example, there was the hairpin industry, once a flourishing business which converted spare bones into imitation tortoise-shell pins. Then someone conceived the idea of bobbed hair, and now the hairpin business prospers no more. A 1,000-pound steer yields only about 550 pounds of dressed meat, and there was a time when the other 450 pounds, with the exception of the hide, represented waste. In those days the meat and



Chemists Preparing Medicines from Animal Glands in  
the Laboratory of a Packing Plant



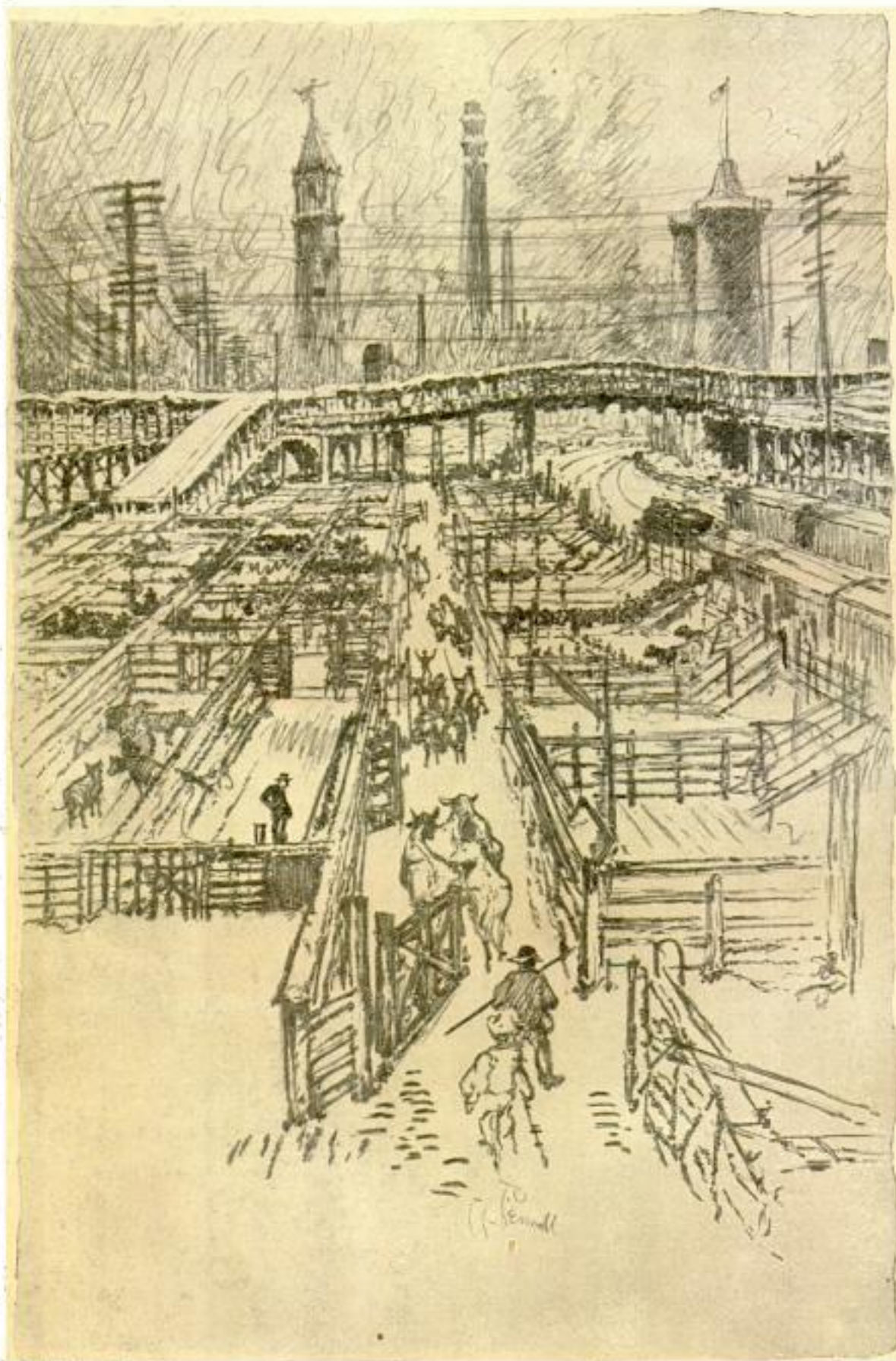

Cattle Pour Out of the Railroad Cars, through the Pens of the Stockyards, and Then up the Inclines and over the Covered Bridges to the Killing Floors of the Packing Plants







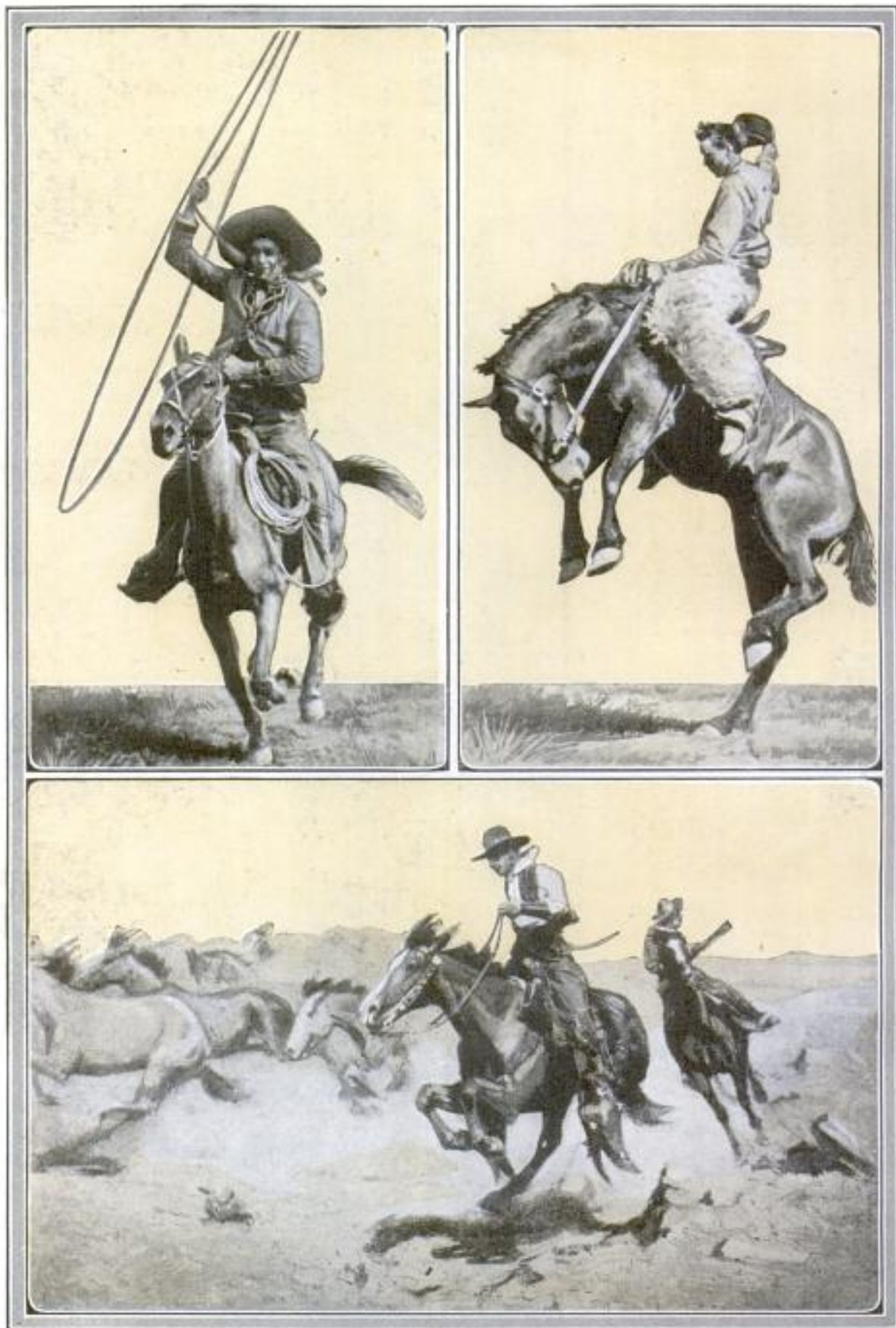

The Cowboys of the Yards, Above, Are Drawn from the Plains of the Southwest and Keep Up Their Skill in Frequent Rodeos; Below, a Wild-Horse Round-Up in the West





Curled Hair for Upholstery Is Made by Twisting Hair into Ropes, Using Cattle Horns for Tools, and Then Un-twisting It



Oleomargarine Is Beaten and Worked Up in Huge Machines, Then Ladled into Trucks



Bottling Drugs in the Laboratory and, Left, Making Wool Soap Flakes in an Automatic Machine

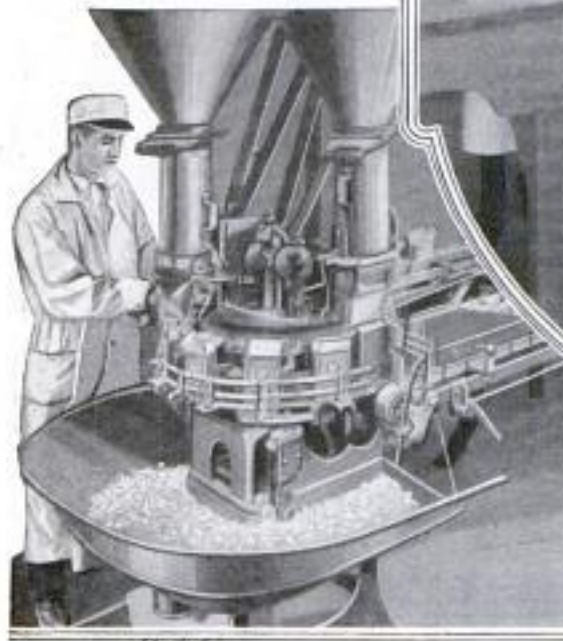



the hide had to bring enough in the market to pay for the half-ton animal. Today, as a result of the work of scientists in developing the by-product business, the meat actually sells for less, at wholesale, than the animal cost on the hoof, yet there is a net profit of from one dollar to a dollar and a quarter on each steer.

The efficiency of the by-product business was made possible by two things—the large-scale operations of the centralized packing house, and the development of mechanical refrigeration, which enabled the preservation of such things as tiny unedible glands until a sufficient supply had been gathered to turn them into pharmaceutical products of great value.

The packing plants divide their by-products into four classes: first, those that come from the exterior, the hide, wool and hair, and the horns; second, the by-products of the meat layer; third, the by-products of the intestines; and lastly those recovered from the bones of the skeleton. The outer covering of the steer produces leather for shoes, harness, saddles, whips, belting, puttees, purses and hundreds of other articles; it yields hair for plastering; glue from the hide; umbrella handles and other articles from the horns; and even "camel's hair" for brushes, made from the stiff hairs plucked

from the inside of the ears. The meat layer by-products range from illuminating oil to sandpaper, garnet paper and emery cloth, all made from glue recovered from the sinews, and likewise include meat meal, lubricating oil, inedible gelatin and tallow, candles, glycerin, soap, blood meal, casehardening bone and stearin.

From the intestines come sausage casings, snuff containers, calf drumheads, ox gall, gall stones and many medicinal preparations, as well as gold beater's skin, whose uses range from protecting hammered gold leaf to lining the gas bags of the "Shenandoah" and other giant airships. The fourth layer of the steer, the skeleton, yields bone for toothbrush handles, pipe stems, chessmen, teething rings, knife handles, knitting needles, buttons, combs, hairpins, as well as glue, bone meal, granulated bone and neat's-foot oil.

When all the by-products have been extracted, there remains the tankage—vast vats filled with the blood from the slaughtering houses and the waste and residue from the lard and tallow plants. A hot-air drier reduces the tankage to a dry substance, ready to be sacked and returned to the farms from which the cattle came and aid in raising more hay and corn to feed more cattle, which eventually will come back to the packing house.



Texas "Cow Town" of Twenty Years Ago, When the First Automobile on the Plains, Proudly Displayed by Its Owner, Heralded the Passing of the Horse for All Purposes but Work on the Range





Canadian Trapper and His Pet Moose Crossing a Lake with the Canoe Hitched to the Swimming Animal's Antlers by Ropes, Which Also Serve as Reins to Guide the Beast

### Moose Pulls Boat While Swimming with Rope Tied to Antlers

A pet moose owned by a trapper near Lake Nipigon, Canada, is trained to swim with a canoe hitched to its antlers. Accustomed to obey the commands of the "driver," the animal is easily directed by the reins, which also serve as traces held in the hands of the hunter. This method of propelling the craft, while much slower than the paddle or an engine, helps to save the trapper's strength for other work while seeking game.

### Power of Sun Stored by Plants May Solve Fuel Problem 2138

Although their progress is slow and unspectacular, scientists are making dogged attempts to discover a way to make artificial fuels which will replace the diminishing supplies of coal and oil. The process they seek to perform in their laboratories is the marvelous one that nature uses every day in storing up energy in leaves and plants by converting waste material into wood, etc., under the action of sunlight. Solution of the riddle is being sought in California by Dr. Herman A. Spoehr and a staff of research workers. A year's consumption of coal at the present time, represents the accumulation of 100 years, he says.

*Christian Science Monitor*

*1/14/24*

### Traffic Marker for Busy Streets Does Work of Many Men 1030

For placing traffic guide lines on streets, a southern inventor has devised an apparatus which he claims will do the work of ten men, easily marking a strip at the rate of 200 feet a minute. It consists of two tanks and a series of brushes carried on a light four-wheeled truck pushed by hand.



Painting Traffic Guide Line with Marker Truck

The paint runs through a nozzle producing lines three to eight inches in width. Revolving spiral bristles in front clean the pavement and as the spray reaches the surface its edges are smoothed by brushes on the sides.

*J. W. H. D. Clark*  
*Copyrighted material*  
*J. W. H.*



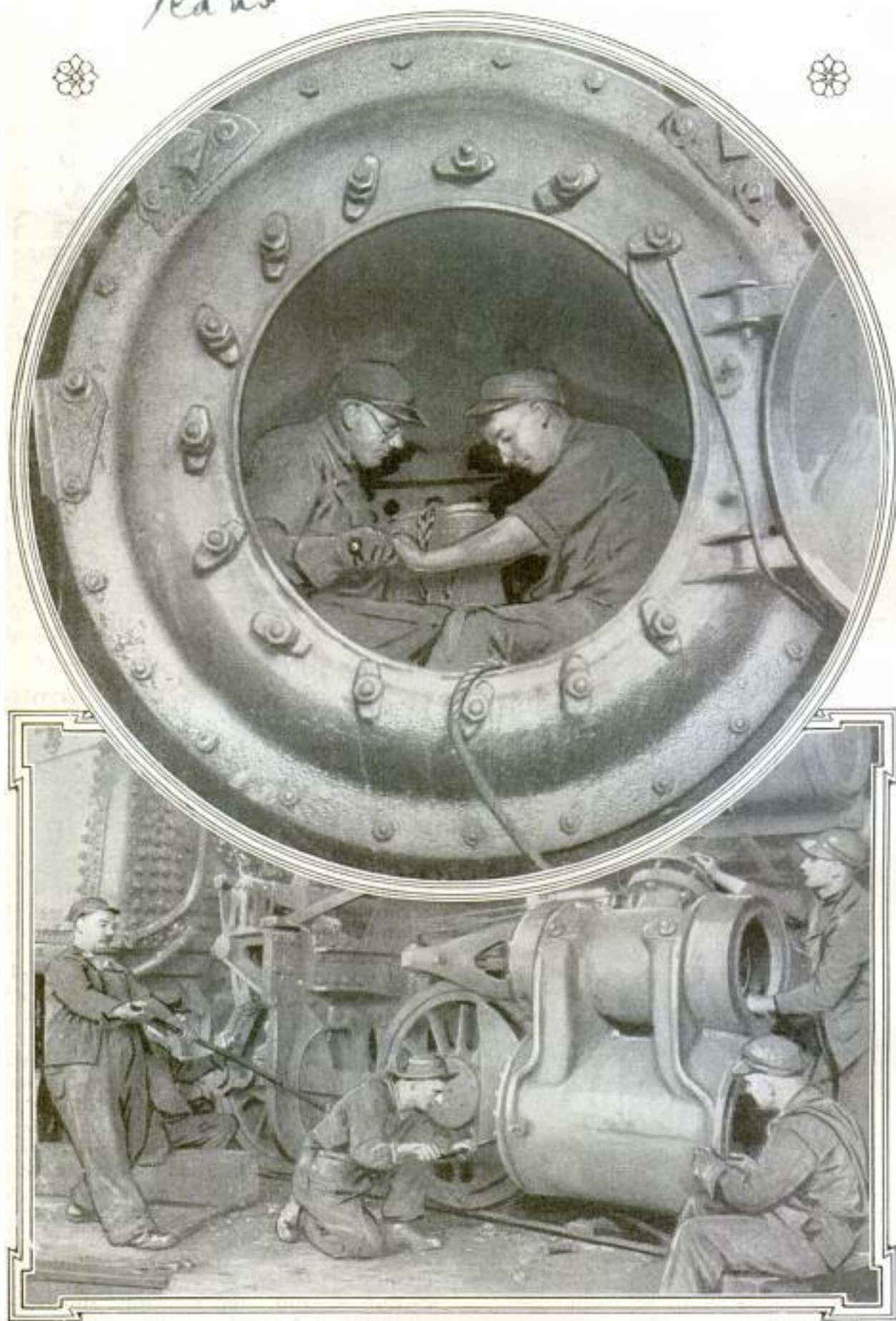

Copyright, Ewing Galloway

When Iron Horses Go to the Hospital—Men Grinding Exhaust Joint in a Locomotive Smokebox; Below, Overhauling the Huge Cylinder of a Twenty-Four-Drive Wheel Engine



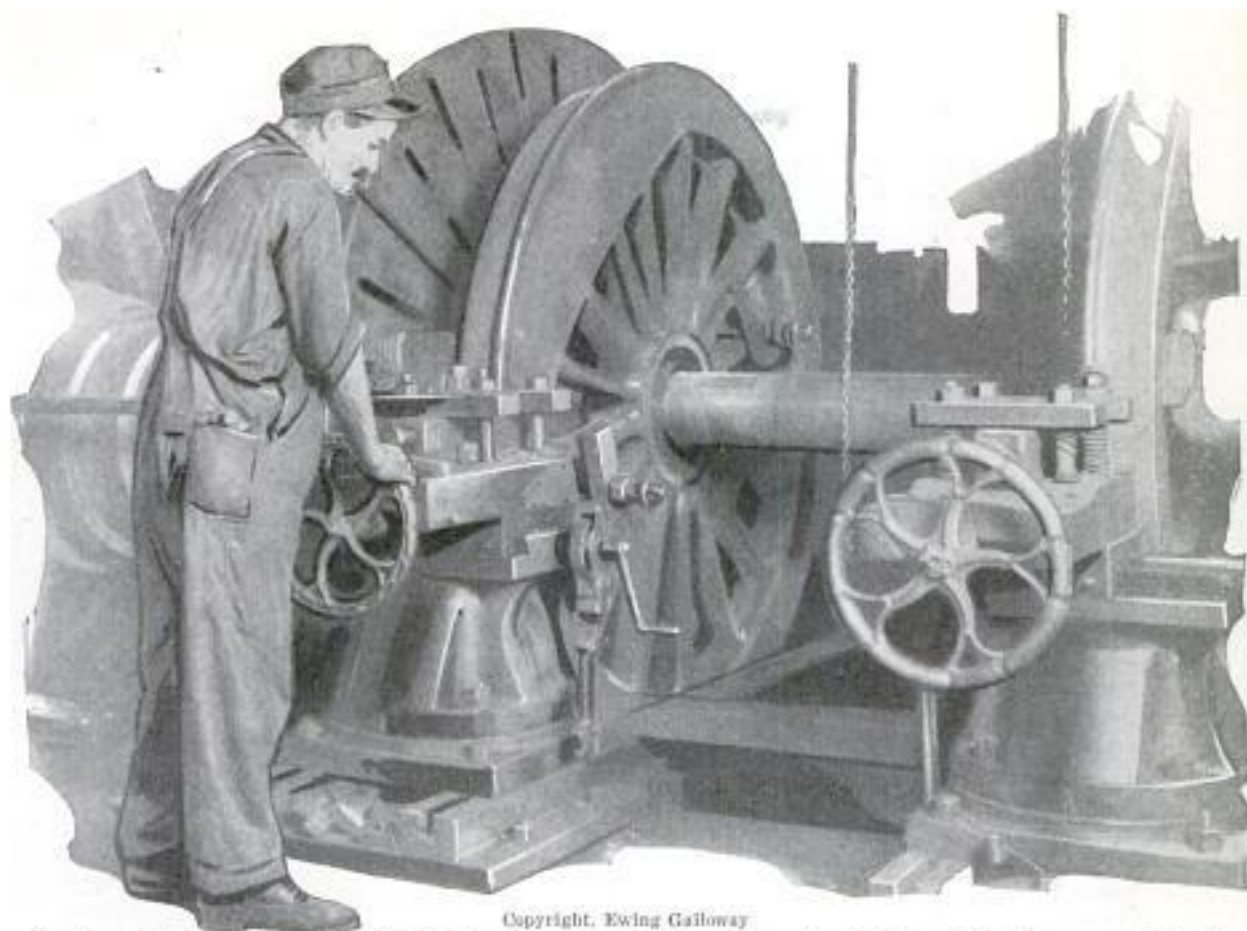

Copyright, Ewing Galloway

Turning the Tire of One of the Big Drivewheels of a 400-Ton Locomotive Is Done with Accuracy and Speed by Skilled Worker on Monster Lathe

## Behind Scenes in a Railway Terminal

How the Roads Protect Lives and Property by Car Inspections and Cleanings in Busy Yards near Big City Depots

**B**EHIND the scenes of every big railroad terminal is a bustling repair and inspection yard where cars are washed and renovated and carefully examined for defects before they are taken to the stations or loading platforms. An army of workers toil here day and night replacing worn-out wheels, brake shoes and other minor parts. Every one of the country's 55,000 passenger cars receives many cleanings and inspections yearly. Similar repairs and examinations are made in other yards on the 2,500,000 freight cars the railroads own, and in the roundhouses, the 65,000 locomotives are constantly being watched for breakage and wear.

The passenger-coach yard, with its necessary buildings, is mainly a series of stub tracks running from one or more leads to the terminal shed and the main line. Among these tracks spreads, underground or overhead, a network of steam, water,

compressed-air, electric and a few surviving gas mains for heating the cars, filling tanks, making air-brake tests, for lighting and for charging batteries. The yard is a service station on a big scale.

Workers are relayed in three shifts of eight hours each, beginning at seven o'clock in the morning. Their duties start as soon as a train reaches the terminal. Almost before passengers have grabbed their baggage, inspectors are running down the sides of the cars, opening the lids to the journal boxes. They feel among the soft woolen waste that had been soaked in oil for forty-eight hours before it was placed there, for signs of a hot box. The lids are left open as the train is taken back to the yards, where a series of inspections follows. Whenever broken parts are discovered they are noted on a bad-order report. This is in duplicate. One copy goes to the foreman



of car repairs and the other to the yardmaster, so that he can order the car set on the proper track and, if necessary, held out from those that are to be used in making up trains.

A modern steel car will last from 200,000 to 250,000 miles, but careful watch has to be kept for worn flanges and "flats." The inspector runs a practiced thumb and forefinger around the flange. If it feels suspiciously thin, he applies a steel gauge, a flat piece of steel with grooves cut in the side that fit over the edge. If this has worn more than fifteen-sixteenths of an inch, the wheel is condemned. Powerful jacks are slipped under the car, the truck is taken off and another put on. Putting wheels on a seventy-five-ton car, to the layman seems like a big job. Three skilled railroad men with modern equipment can do it in forty minutes.

On their rounds, the various inspectors carefully examine every one of the 200 or more parts on passenger cars that are liable to get out of order. These include doors, windows, plumbing—more than 200 feet of it in many cars—radiators, seats, conductor's air signal and fire ex-

tinguishers. The car truck, bulky and sturdy as it is, has from seventy-five to eighty parts, any one of which, if broken, might cause serious trouble. As the inspectors pass along, they check the parts to be repaired on a card which is placed in a conspicuous position on the car. A marker follows, chalking on the side the date and the number of the track to which the car is to be taken for repairs. In the freight service, the position of the card often indicates the degree of overhauling that will be needed.

Many passenger cars today are fitted up as separate electric-power plants with generators and storage batteries. These and all the lamps, fans and wiring must be inspected regularly.

With modern equipment, the brakes of a whole train, or of a single car, while standing still in the yards, can be given trials that practically duplicate the requirements of an actual run on the road.

While the inspectors are going about, the car cleaners, with a clutter of mops, special ladders, rags, sponges and machines, have started work. To remove the grime and dust of several states after a long run, the exteriors of steel cars are washed with oxalic acid and thoroughly rinsed and wiped with a special oil which preserves the paint.

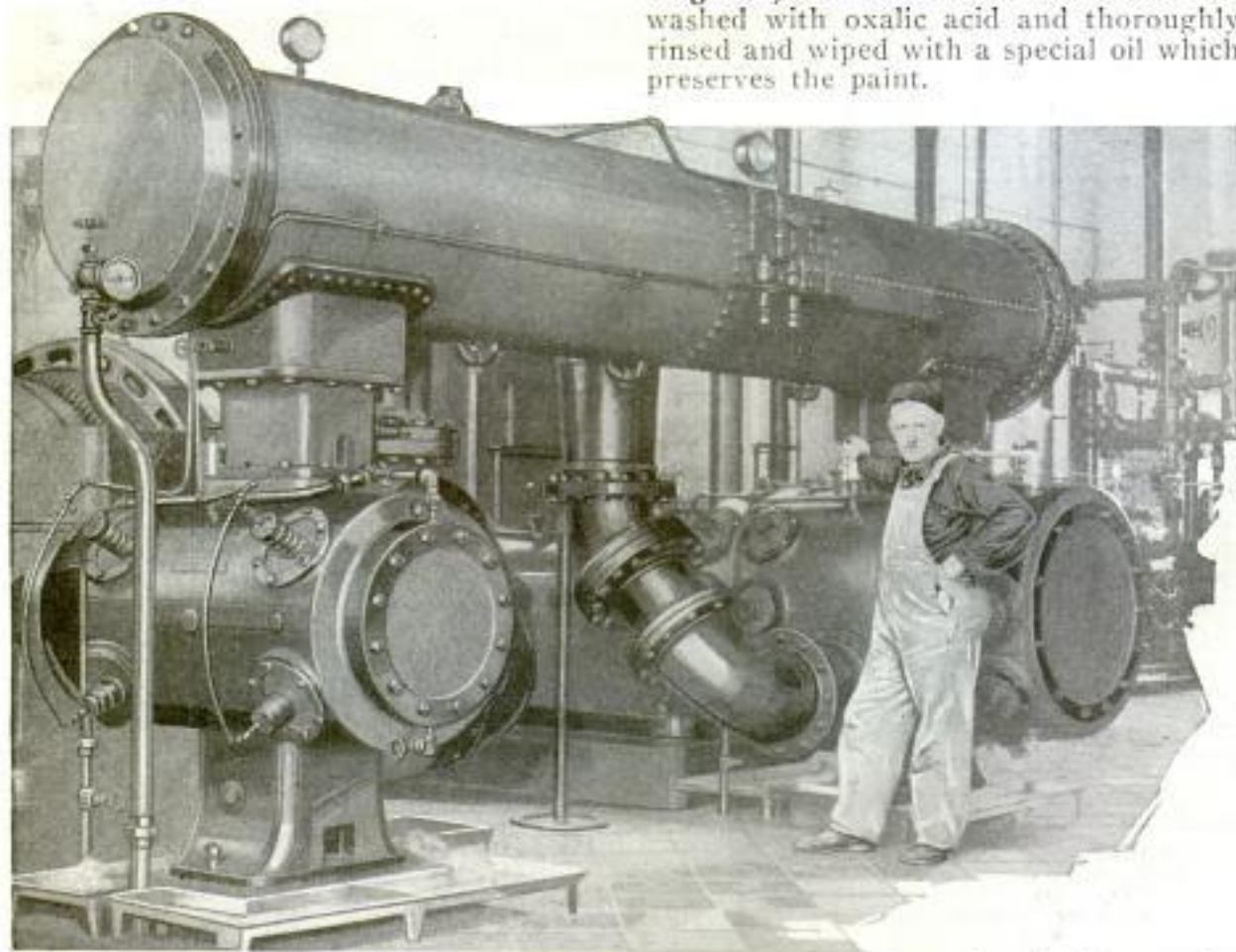

Big Compressor and Storage Tank, the Source of the Air for Making Brake Tests, Operating Cleaners and Various Repair Tools in Coach Yards and Shops



Full page on air brake

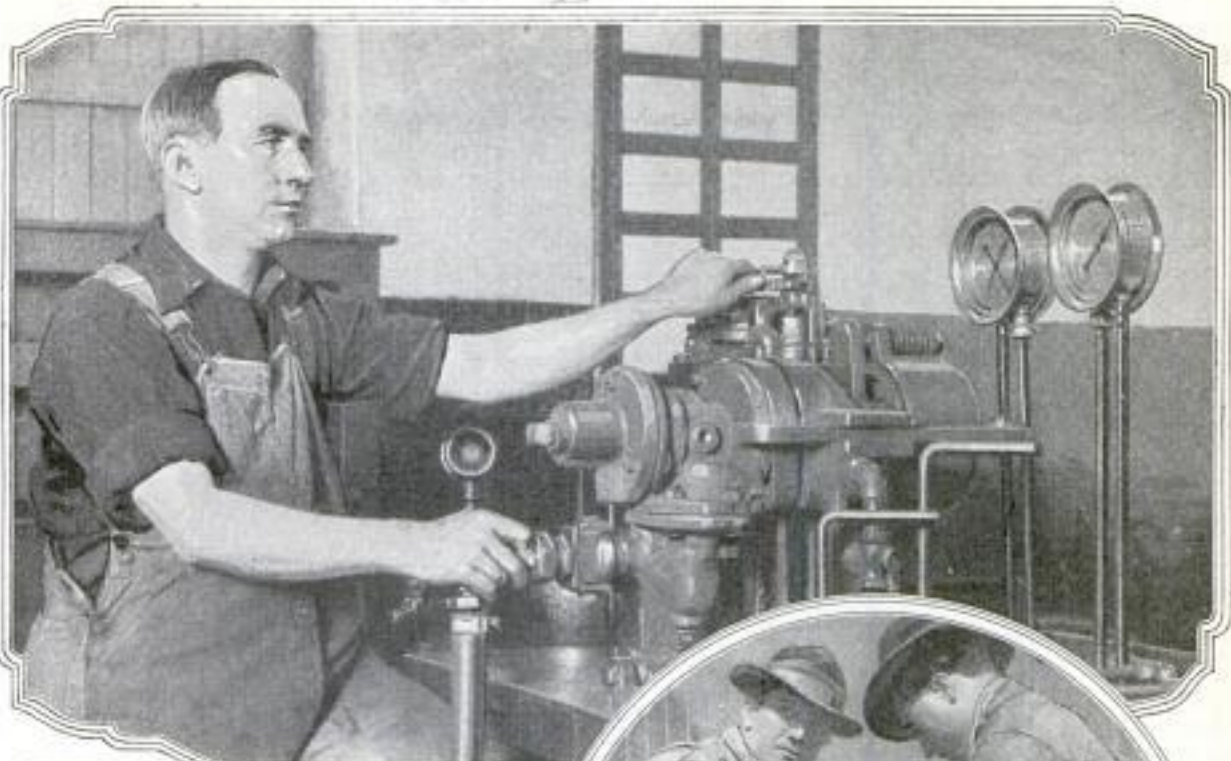

Hunting for Defects in Triple Air-Brake Valve in Testing Rack, and at Right, Cutting Holes in Metal Bar with Air-Motor Drill



In Almost Any Coach Yard, the Car Cleaner with His Vacuum Outfit and Dust-Trap Bag, That Catches the Dirt Removed by Powerful Suction, Is a Familiar Sight

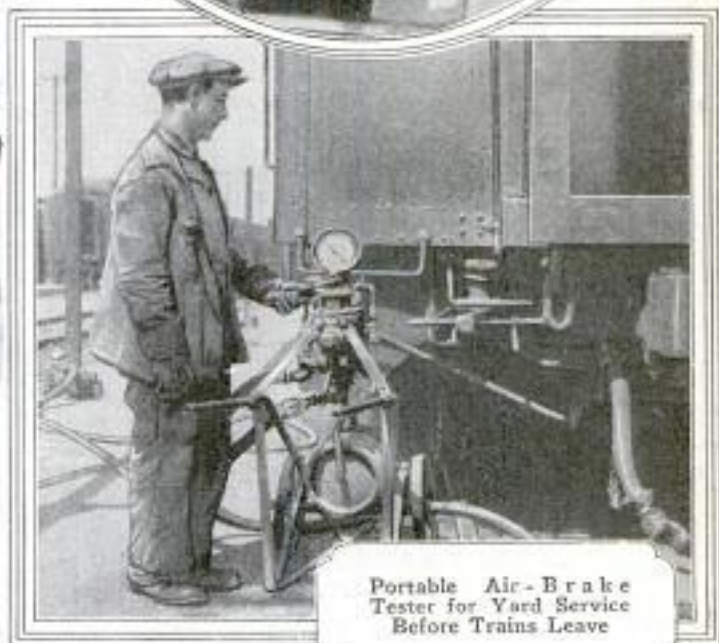

Portable Air-Brake Tester for Yard Service Before Trains Leave



*Reprints, Nov. 1924*  
*The Motor Meter Co.*

**Markers at Scenes of Auto Deaths Warn Drivers against Speeding**

*2109*

"One Was Killed Here." These four words, printed on a blue card hung at spots where automobile fatalities have



*Pacific & Atlantic*

Warning Sign for Motorists by Which It Is Hoped Auto Fatalities Will Be Reduced

occurred in Chicago, grimly remind drivers of the dangers of speeding and silently warn of the importance of caution. Erection of the signs was sponsored by a safety committee and the work was done by a delegation of boy scouts. The cards, though only 180 square inches in size, are visible at a considerable distance.

**Newspaper Pages Flashed by Radio Is Prediction for Near Future**

*215*

Transatlantic transmission of photographs and newspaper pages by radio is a development likely to become a reality in the near future according to Maj. Gen. J. G. Harbord, president of the Radio Corporation of America. Two-way talk by radiophones he also regards as an imminent possibility. A ticker that will actually print words on paper from a central broadcasting point, thus greatly amplifying present news-distributing agencies, is another of the objectives of radio-research engineers, and control of airplanes, submarines and other ships from a remote land station is, he believes, a possibility certain to be realized in view of the astounding progress already made in radio accomplishments.

*New York Times 11/10/24*

**Outside and Inside Temperatures Given by Double Thermometer**

*2141*

A thermometer which records the room temperature, and at the same time gives the outside conditions, both in degrees and as summer heat, warm, cool, cold, freezing or below zero, is now on the market. Beneath the ordinary spirit thermometer, which records the inside temperature, is the dial of a recording instrument, based on the same principle as an automobile radiator indicator, and with an outdoor connection by wire through a groove along the edge of a window. The dial is graduated in degrees at the top, running from forty below zero at the left to 120 above at the right. At the bottom are the equivalent terms, reading in the opposite direction. A single, double-tipped hand extends across the dial and is pivoted at the center, so that as it moves it gives the correct reading on both scales.

*The Motor Meter Co.*

**Hot Electric Cooker Cover Browns Foods on Top 228**

With heating elements in its cover as well as in the bottom, an electric cooker that browns foods on top, and bakes and roasts them, has been placed on the market. Designed like a fireless-cooker cabinet, it has convenient receptacles for the foods and hot plates for frying. It will perform practically every common cooking operation and its insulated construction is such that, after foods are heated to the steaming point, the current can be shut off and cooking completed with heat stored in the sides of the cabinet.

*long & slow cook. easy. very.*



Electric Cooker with Hot Plates for Frying and Baking That Fit Inside

*Shurha... Mfg Co.,*  
*Muncie, Ind.*  
Copyrighted material



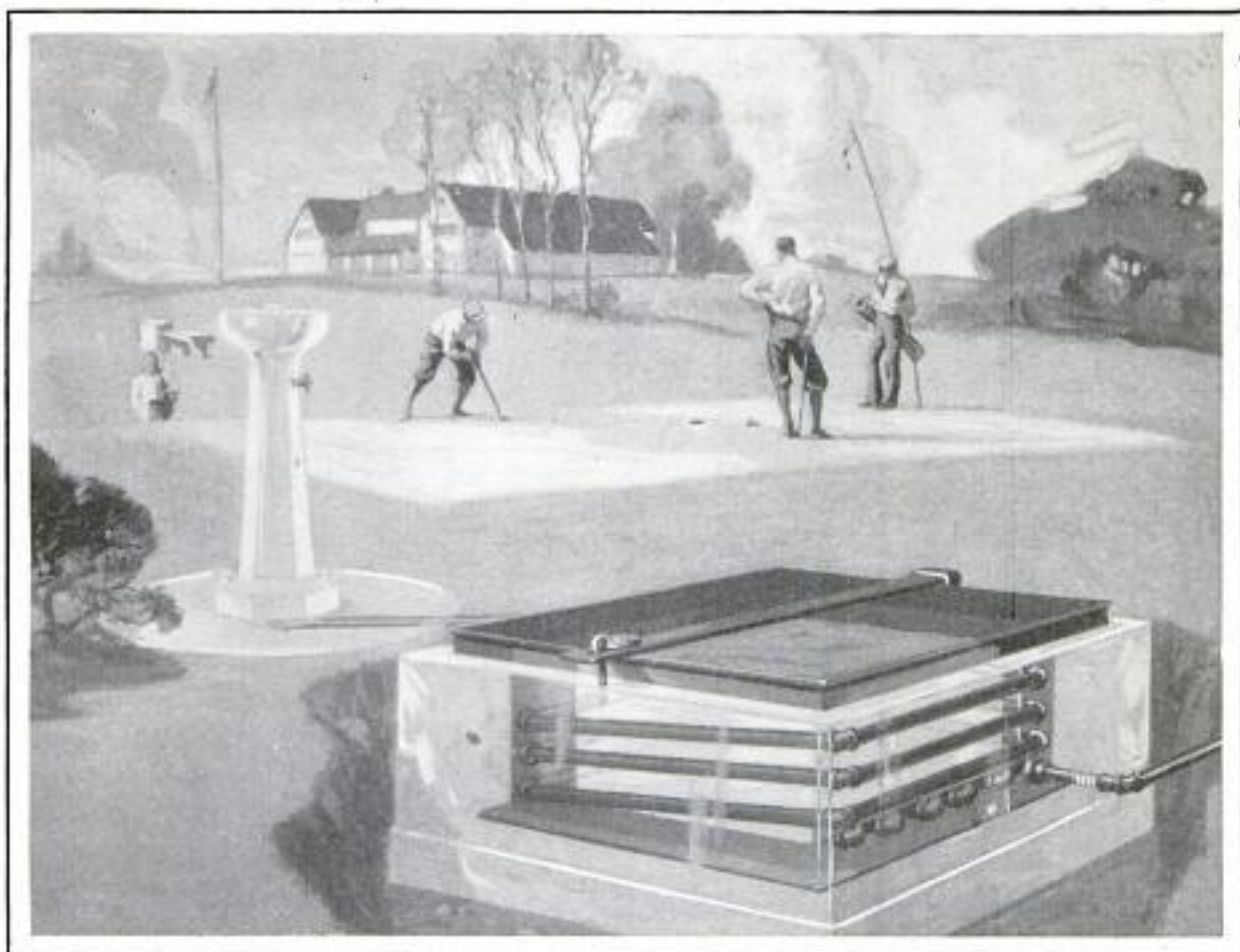

Water Cooler Installed Close to Drinking Fountain on Golf Links; Pipes Fitted in Hollow Square Form Convenient Ice Space, and Thick Concrete Wall Provides Insulation

### Underground Ice Box Cools Water for Outdoor Drinking Fountains

Cold drinking water for outdoor bubbling fountains in parks, golf links and similar places is assured by means of a sunken concrete chamber for a pipe coil and a cake of ice. Tightly covered and secured by a flat lid with a lock, it does not obstruct the field, is inexpensive and requires but little ice. It is especially practical where the feed pipes are so near the surface that water ordinarily gets too warm to be refreshing.

### Invisible Glove for Workers' Hands Makes Them Easy to Clean

Hands soiled with tar, oil, paint, engine grease or similar stains, can be washed clean easily and quickly with cold water, if an invisible glove of a cream preparation is rubbed on before work is started, manufacturers of the article assert. No scrubbing or violent rubbing is required as the substance keeps the dirt from getting into the pores of the skin. The cream is thin, does not interfere with the work-

man's toil, and as it is antiseptic, it aids in preventing infection of accidental wounds or cuts.

### Razor Stropper Roughens Leather to Give Blade Keener Edge

Keener edges for safety-razor blades are said to be possible in less time with a handy stropper that has a knurled fiber roller to lift the nap of the leather every time a stroke is taken, keeping it rough and preventing it from becoming glazed and hard. The roller also helps hold the



Razor Stropper in Use, and Inset Showing the Knurled Fiber Roller That Roughens Leather

blade in contact with the strop at the proper angle, as its small cross grooves firmly grip the surface whether the movement is forward or reverse.

*Patd. U.S. & Foreign  
 U.S. Pat. No. 1,111,111  
 London, E. England.*





Copyright, Underwood & Underwood

Scenes in the Timberland, such as the movement of this giant "mill length" to the busy saws, are becoming scarcer under the tireless harvest of the lumberjacks



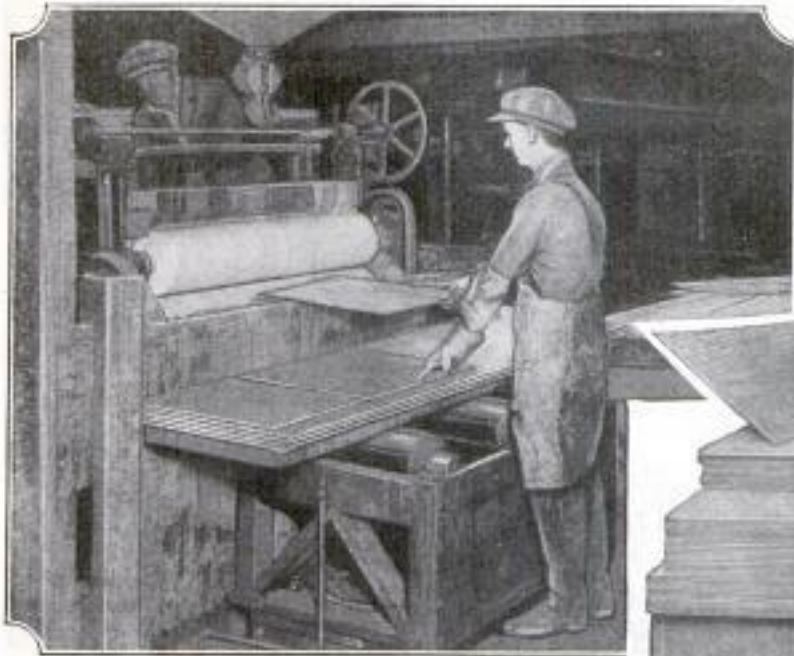

Grading Finished Panels for Beauty of Grain and Desirable Sizes



Glue Spreader into Which Center Cores Are Fed for Coating Before Outer Pieces Are Applied

## Ply Board to Solve Lumber Shortage

**Thin Ribbons of Wood Become Sturdy Slabs of High-Grade Material under Pressure of Powerful Machines**

**T**HE steady decline in production of first-grade lumber, due to shortage of available timber stands, has resulted in the establishment of the ply-board industry, a manufacturing process that utilizes practically every inch of a dressed saw log and produces built-up slabs of wood made from several thin layers glued and pressed to a core or center ply.

In the finished state these panels appear as solid pieces, smoothly surfaced and capable of being worked for almost any purpose with the same ease and adaptability as ordinary boards.

In a modern ply-board factory huge saw logs, in the rough, enter one end of the plant and emerge at the other in literally miles of sturdy panels. Logs of selected Douglas fir are used and are cut into short lengths, usually six to eight feet, which are shunted into steam chambers. While still retaining the bark as they came from the woods, the pieces are steamed under high pressure for forty-eight hours to neutralize the pitch and soften the texture of the timber. They are then conveyed to a lathe where the bark is removed and the inner surface set in con-

tact with a large keen-edged peeling blade. As the log is made to revolve against the knife, the wood rolls away in a steaming ribbon, one-seventh of an inch thick, resting on an endless belt about a hundred feet in length. From this strip sections sixty to seventy feet long are trimmed and passed to a clipper, which cuts them into desired widths and eliminates the waste or knotty pieces before the sheets go to automatic driers where hundreds of hollow steam-heated steel rollers prevent the "slices" from warping. Emerging perfectly dry and flat, the boards are graded. Those having small knots or lacking the grain required for fine panel work are cut into short lengths for cores.

Great care is exercised to keep all imperfect material from being used as surface slabs, for most of the finished lumber is made up for parts of furniture, house decoration, vehicles, trunks and countless other similar uses.

The sheets of cores are fed into a gluing machine which spreads adhesive over both surfaces, expert handling insuring that it is put on uniformly. This material is mixed in the factory, the base be-



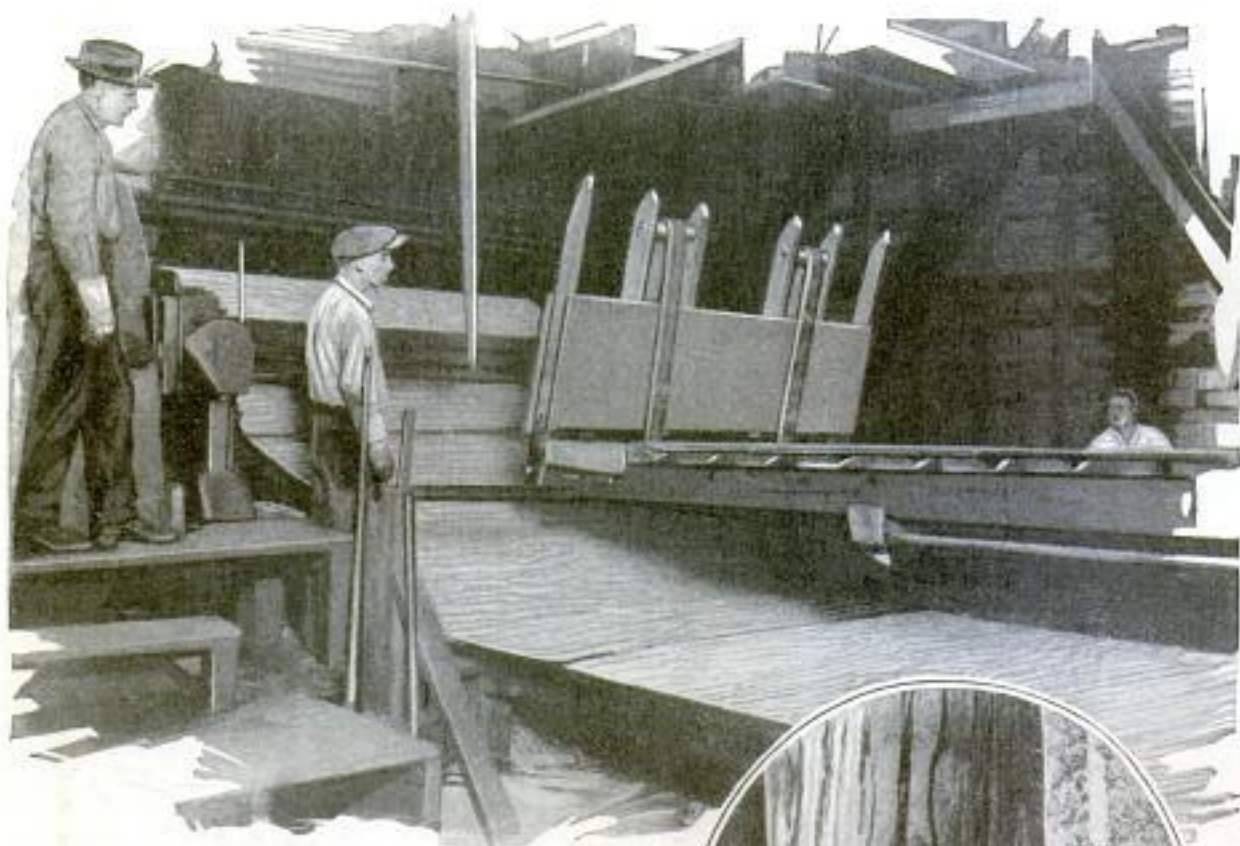

ing composed of casein, obtained from cows' milk. Lavender in color and waterproof, it is applied at a consistency to give the greatest adhesive strength without excessive hardness, a condition that might injure the saws when the wood is worked.

Coming from the gluers, the cores are laid by hand on the surface sheets of the panels and the top board is then placed on the other side of the center ply. Panels are made in three, five, seven or nine plies, depending on the use to which they are to be put. After assembling, they go to hydraulic presses where they are subjected to a pressure of from 2,000 to 4,000 pounds according to thickness. This squeeze is maintained for about twenty-four hours or until the glue has set.

From the press room the panels are taken to saws where all rough edges are trimmed off and the slabs are trued. They are next cut up into standard stock sizes or in accordance with special specifications. Before shipping or storage all the pieces are dressed to a smooth, velvety finish on sanding machines which leave a surface that can be readily painted or treated by any of the familiar methods of decoration. If any small burrs or ragged corners are left, a final inspection results in the return of the panels to the sanders. Usually the slabs are prepared in sizes from twelve to forty-eight inches wide and from forty-eight to ninety-six inches long.



Copyright, Underwood & Underwood  
Sawyers Working through a Massive Tree; Above, Log Unrolling from the Peeling Blade in a Ribbon of Wood



General Electric Co  
Schenectady  
N.Y.

H.C. Harrison Co  
1200 Van Ness Ave.  
San Francisco, Calif.  
283  
1883

POPULAR MECHANICS

**Magnetism Audible by Aid of a Loud Speaker 2106**

Noises caused by the action of a magnet on a piece of iron were made to sound like a roar by the aid of a loud speaker and a device perfected by an electrical concern. While outwardly no change is apparent when the metal is magnetized, scientists hold the theory that magnetism causes a rearrangement of the atoms within the iron forcing all of them to lie in the same direction. The sound producer consists of a piece of soft iron inserted in a coil of 17,000 turns of wire connected to an amplifier, which is attached to either headphones or a loud speaker. When a magnet is brought near the iron, a rustle is heard. If the approach is rapid, the noise is loud and abrupt, but if slow, it is faint and lasts longer. While the magnet is being removed similar sounds result. If the current is reversed while the magnet is close to the metal, a sharp ratchet is heard.



Closed Car Converted into Comfortable Bed; Inset Shows How Folding Springs Extend over Front-Seat Space

Patented spring bed mattress. Your fold coffee & pillow cover!

**Rivets Exploded by Hammer to Aid in Salvage 1694**

Explosive rivets that can be closed from the outside by setting off an inner powder cartridge have been patented by an English inventor. It is expected that they will prove of special advantage in salvage operations where the diver cannot reach the interior of a sunken ship and for attaching steel-plate patches over holes in the ship's sides or lifting straps for a crane. The plates or straps are placed in position and holes are drilled

through just large enough for inserting the rivets. At the center of the rivet is a small opening, running about three quarters of its length and in this a powder cartridge is placed. When the rivet is adjusted, the charge is exploded by a blow of a hammer and the resulting pressure bulges out the free end of the rivet which projects inside the ship, thus forming an effective head.

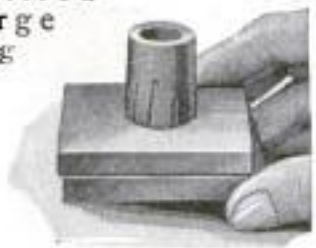

© C. A. Oldroyd

When the rivet is adjusted, the charge is exploded by a blow of a hammer and the resulting pressure bulges out the free end of the rivet which projects inside the ship, thus forming an effective head.

**Bed with Springs Built in Auto Solves Camping Question 13**

A Pullman-type berth built into a closed motor car has been designed for the convenience of tourists. A folding spring rest, which rolls into a compact package to be disposed behind the rear-seat upholstery, forms the base of the bed. The mattress becomes the rear-seat cushion when the bed is not in use. The front seats are made easily removable.

Price - \$34.50

**Buried Indian City Is Found 94**

Almost a hundred years ago, mention was made, in a letter written by a western plainsman, of a buried Indian city in southeastern Nevada. Scientists at last have verified the report with the finding of a stretch of sand-covered ruins of stone and adobe dwellings that apparently formed a pueblo city of some 20,000 population, 3,000 years ago.

4 Park Ave. New York



1734 J.W. Martine Co.,  
 2 Wall St.  
 New York City.

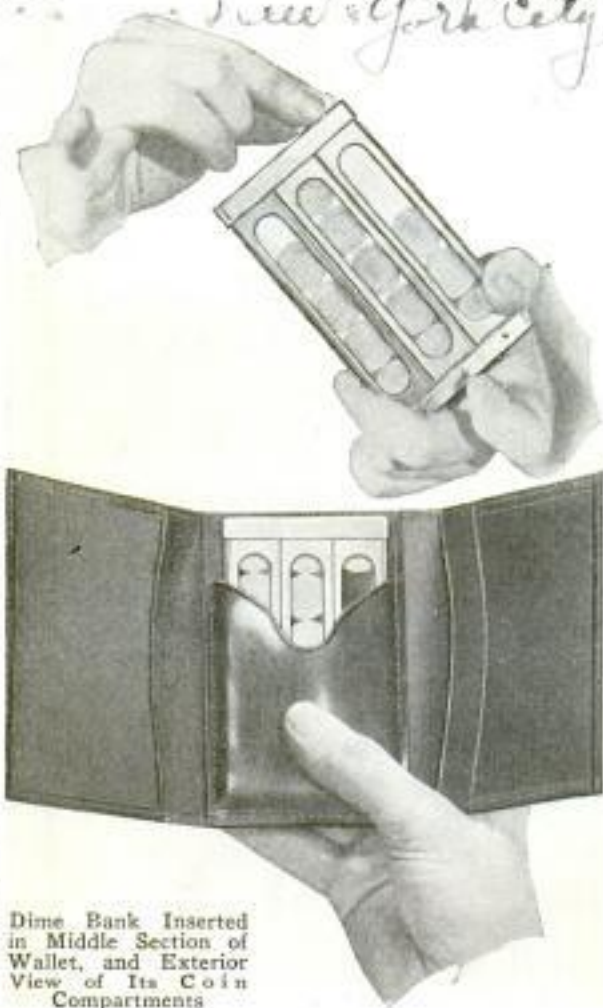

Dime Bank Inserted in Middle Section of Wallet, and Exterior View of Its Coin Compartments

**Visible Dime Bank Carried in Wallet Is Constant Reminder to Save**

As an aid to Christmas savings clubs and similar plans devised by banks and other institutions to cultivate thrift, a dime bank that fits inside the center pocket of a serviceable wallet has been designed. It is a visible and constant reminder of the resolve to save money, prevents the coins from getting lost and enables the owner at a glance to tell just how much has accumulated toward the next deposit. The bank is made of aluminum and brass, weighs only an ounce and has six locks all of which are opened instantaneously by a handy unlocking device. The wallets are made of leather in both men's and women's styles.

\$1.10 to \$2.00 per 100.  
 \$1.09 5/8 \$1.15 per 100

The method involves two principal steps, assembly of the lengths at a central depot, where old track is also broken up and prepared for sale or re-use, and the actual laying of the new line on the roadbed. The first process is accomplished by power machinery and the second is done by a special train and an electrically operated cantilever truck. Loaded with sections, the cars are hauled to the site where the track is to be installed. A length of old rails and ties is lifted bodily from the roadbed and conveyed to the rear of the train. At almost the same time, a new section is interchanged for the used one, slid to the front and, when the ballast has been smoothed, is dropped into the place occupied by the old track. An important advantage claimed for this equipment is that it eliminates the need of handling rails and ties separately.

**Fan Run by Power of Rocking-Chair Provides Cooling Breeze**

Shaped like an ordinary electric fan, a device which operates by energy from a rocking-chair has been invented. It can be easily and quickly attached or detached, and creates a breeze as long as the chair is in motion. The fan is especially designed for use where absence of electric current prevents use of motor-driven blades.



Fan That Operates by Power Provided by Motion of Rocking-Chair

**Electric Track Layer Saves Labor in Building Railways**

With a patented mechanical track layer, old rails and ties can be removed and new ones put down at the rate of more than half a mile in eight hours, according to reports of a recent test of the apparatus.

2117

Emb. J. Moran, 95 Bosterlan, And. Phelps  
 Blackrock Co., Lewis, Prietobong  
 Ireland. East Hartford, Conn.





Shooting Airplane Scenes on Location in the Mojave Desert. Far from the Studio but Reached by Director and Staff in a Short Period of Travel through the Air

## Airplanes in Moving Pictures

*Mechanics*

### Aviation Brings Realism and Thrills to Screen Plays and Lends Speed to Busy Staffs Who Build Pictures

**A**IRPLANES, as yet too unwieldy for most purposes as part of stage plays, have become almost indispensable as aids to the motion-picture industry where, in addition to their value as thrill producers, they are to be found performing as time and labor-saving machines behind the camera. Because of their great speed and spectacular movements no opportunity is lost to include them as the principal properties in "dressing up" the dramatic action of critical scenes in productions which permit their use.

At first, the winged craft were introduced as a novel means of applying realism to plays, or to support performances of aerial stunt flyers often employed to "double" for other actors. But gradually they were called upon to serve such purposes as transporting the exposed film quickly over long distances between locations and the developing laboratories, and to carry busy directors from one point to another during the preparation of outdoor scenes. Now there is seldom a large production filmed without at least one great

situation being "shot" from the air. Where mobs or mass views are desired, the cameraman and his equipment are taken aloft by the plane, which can circle any location at a speed and position to afford an impressive view of the activities on the set below. This method results in a spectacular picture with an effect that can be obtained in no other way.

It has also been found that the airplane's engine is almost limitless in ability to serve in the place of other machinery usually requiring the expenditure of much time and money to transport, even though it is constructed on the most portable lines. With the powerful motor and propeller, ordinary wind effects, hurricanes and rainstorms can be produced without the need of any other apparatus. So strong are the air movements made in this manner that the pressure can tear loose from the ground practically any objects that are not bolted down or deeply rooted in the earth. In one large popular screen play a battery of these agitators was installed around a setting of a country town,



and when put into operation, swept the entire group of structures into a pile of ruins several hundred feet from their original positions. Connected to an ordinary water supply, the engine can transform a fairly heavy flow into a roaring cascade capable of carrying everything in its path in a rush rivaling some of the strongest natural falls.

Often immense lighting circuits supplying the lights illuminating movie sets and buildings, are kept in operation by current made by generators geared to the engines of property airplanes. On many outdoor locations where night shooting is necessary, the ship might act as a means of saving hours and even days of valuable time by furnishing the required power to feed the big lamps that light up the areas, while the busy camera is transferred from one point to another filming the scenes.

In order to select and properly "plot" suitable locations for the filming of certain outdoor situations, it was formerly necessary for a movie director and his staff of assistants to traverse large areas of ground on foot, on horseback or by automobile. These trips required the exploration of remote and almost impassable land, for sometimes the most rugged country was

needed, not only for the reality it might lend to the picture, but because of the surrounding scenery. Days and weeks were spent in this way, and generally several locations would be selected from which the final choice would be made. Now, with the ability of the airplane to cover practically unlimited range, the matter of selection may take only a few hours or a day at the most. And the searchers travel all the distance in comfort. If it be impossible for the ship to fly low, binoculars are brought to bear on the spot in question, and a fairly good idea of its worth as a location gained without need of overland travel. Large producing companies frequently have several groups of players working on as many widely separated locations, each under the direction of a member of the studio staff. All of these troupes must be personally checked up by the chief director, who may now be found racing from one place to the other in the cockpit of an airplane covering great distances in a few minutes, where formerly hours were required in motoring over rough winding roads or on horseback climbing narrow paths to the summit of some mountain where a screen thriller was getting much of its most tense action.

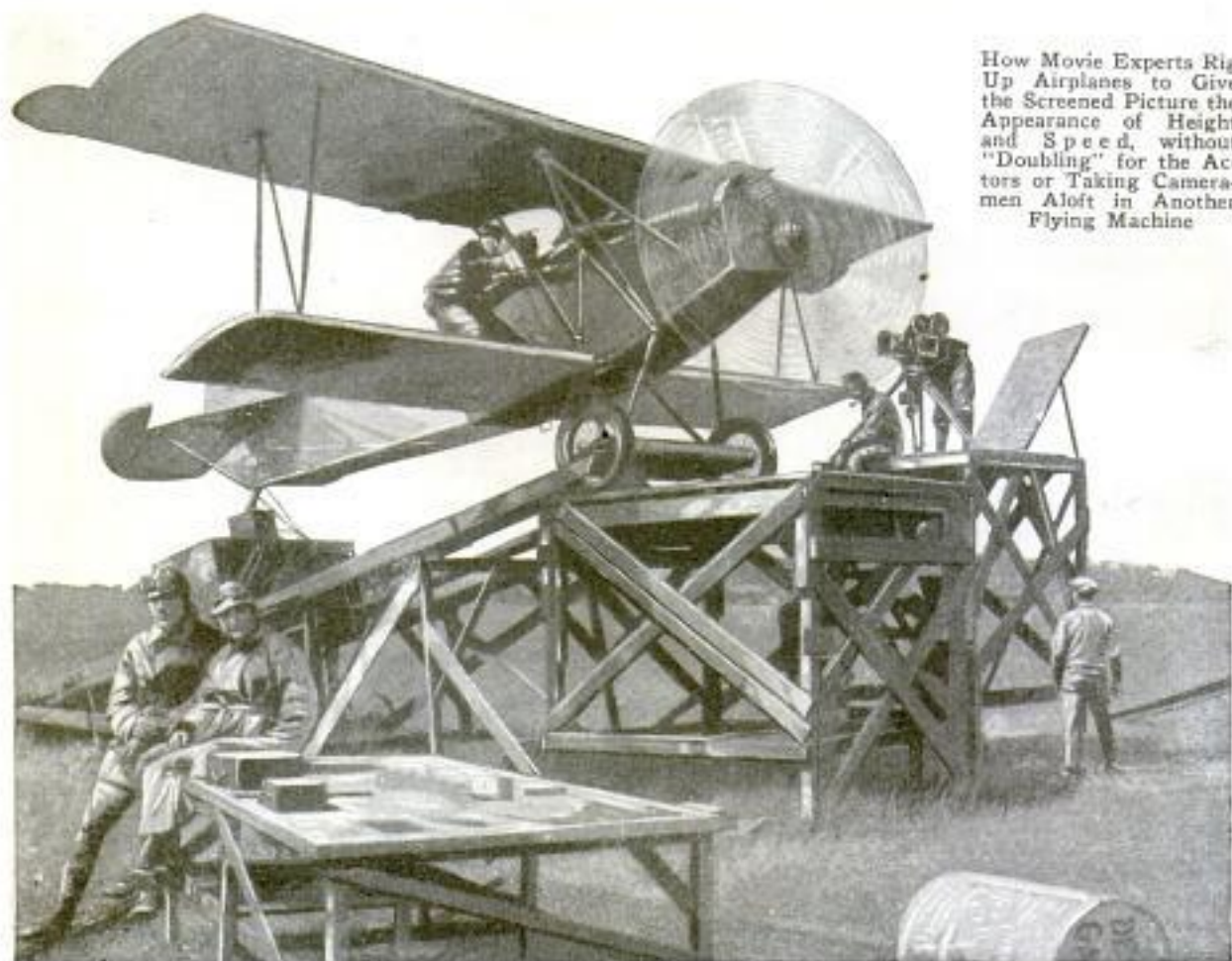

How Movie Experts Rig Up Airplanes to Give the Screened Picture the Appearance of Height and Speed, without "Doubling" for the Actors or Taking Camera-men Aloft in Another Flying Machine



~~Celco Products, Inc.~~

Acetol Products, Inc.

~~29 New York~~

POPULAR MECHANICS

21 Spruce St. New York 287

### Wire-Cloth Substitute for Glass Fills Many Needs 2078

By treating coarse-mesh, galvanized-wire cloth with a transparent, flexible material that fills the spaces between the

*Cel. O. Glass.*



Strip of Wire-Cloth "Glass" Supporting Man, and Close View Showing Texture

strands, a cheap, durable substitute for glass has been made for greenhouses, poultry shelters and coops, hot boxes and similar uses. It is furnished in rolls, three feet wide, up to 100 feet long and is put on like mosquito netting with staples and hammer, no putty or glazing points being needed. According to the manufacturers, it withstands hailstorms, is not affected by intense heat or cold and lets in almost as much light as glass without excluding the beneficial ultraviolet rays. It can be cut and trimmed with shears and bent double and straightened again without injury. Weighing only about one-tenth of a pound to the square foot, heavy and elaborately constructed frames for supporting it are not necessary. In case of accidental punctures, the holes are quickly repaired by application of a mending preparation. Cone-shaped shelters and little "tents" of this material are also furnished for protecting small growing plants, and it is also suited for windows in barns, garages and other outbuildings.

### Gas to Be U. S. Fuel of the Future According to Prediction

Solution of America's fuel problem lies in the economical use of coal for the manufacture of gas, according to Alexander Forward, secretary-manager of the American Gas association. There can be

*Chicago Daily News 11/14/24*

no permanent refuge in oil or water power, he declares, pointing out that the automobiles of the country alone, in

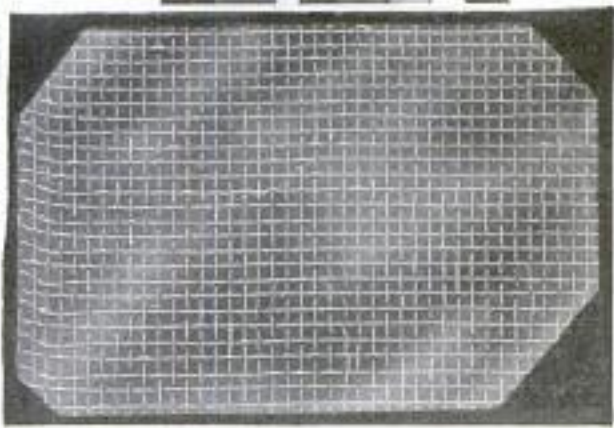

five years will require 250,000,000 barrels of oil annually. Industries, which now use 60,000,000 horsepower, in a few years will require 100,000,000 horsepower, according to this authority, and even with the most rapid development in hydroelectric projects that public policy will permit, the saving in coal cannot compensate for the increasing demand.

### Pipe Cleaner Forces Hot Water Through Clogged Stems

Designed somewhat like a miniature tire pump, a pipe cleaner now on the market forces hot water through the stem to



remove obstructions and deposits. It has a rubber tip which is inserted in the bowl and is pressed down firmly to prevent the entrance of air. By operating a small plunger, hot water is

sucked into the pipe and ejected again repeatedly until the stem is clean.

*No info. on maker. Original product.*

*Copyrighted material  
39, rue de la... Paris*



### Electric Lawn Trimmer Cuts Edges Saving Work with Shears

*1919*

To save time and labor in trimming lawn edges around sidewalks, trees and shrubbery, a Minnesota man has invented



Lawn Clipper in Operation; the Motor, with Cord Attached, Moving Cutting Blades in Front

an electric clipper. It is pushed like an ordinary lawnmower but is operated with a small motor which is supplied with power through a cord that may be attached to any convenient light socket. The wheels are set close together for easy access to difficult places, while the sickle is carried in front where it is free from interference with the rest of the machine and can cut close to any obstruction.

### Marconi Sees New Energy Source Unknown to Scientists

*2097*

If the human eye were sensitive to ultra-red waves used in radio, the voice could be seen transformed into many flashes of brilliant light, according to Signor Marconi, inventor of wireless telegraphy, speaking from a broadcasting station in Italy. The scientist said he was convinced that there exists in nature a means for spreading energy which is still unknown to us. A new wireless apparatus has been devised which may make possible free communication between all parts of the world, the speaker said.

### Plastic Wood Is Worked like Clay; Holds Nails When Dry

*1934*

Wood in plastic form that can be molded by hand and hardens when dry so that nails and screws will hold in it, has been developed in London. The material is of the consistency of moist dough and will stick firmly to wood, metal and similar surfaces. Formed to any shape, the plastic wood hardens on exposure to air into a tough, waterproof mass which can be turned in a lathe or worked with ordinary carpenter's tools. It is said to retain its strength over long periods and equals lumber in its ability to resist wear and tear. Although without grain, the clay-like material can be painted or coated to resemble almost any hardwood.

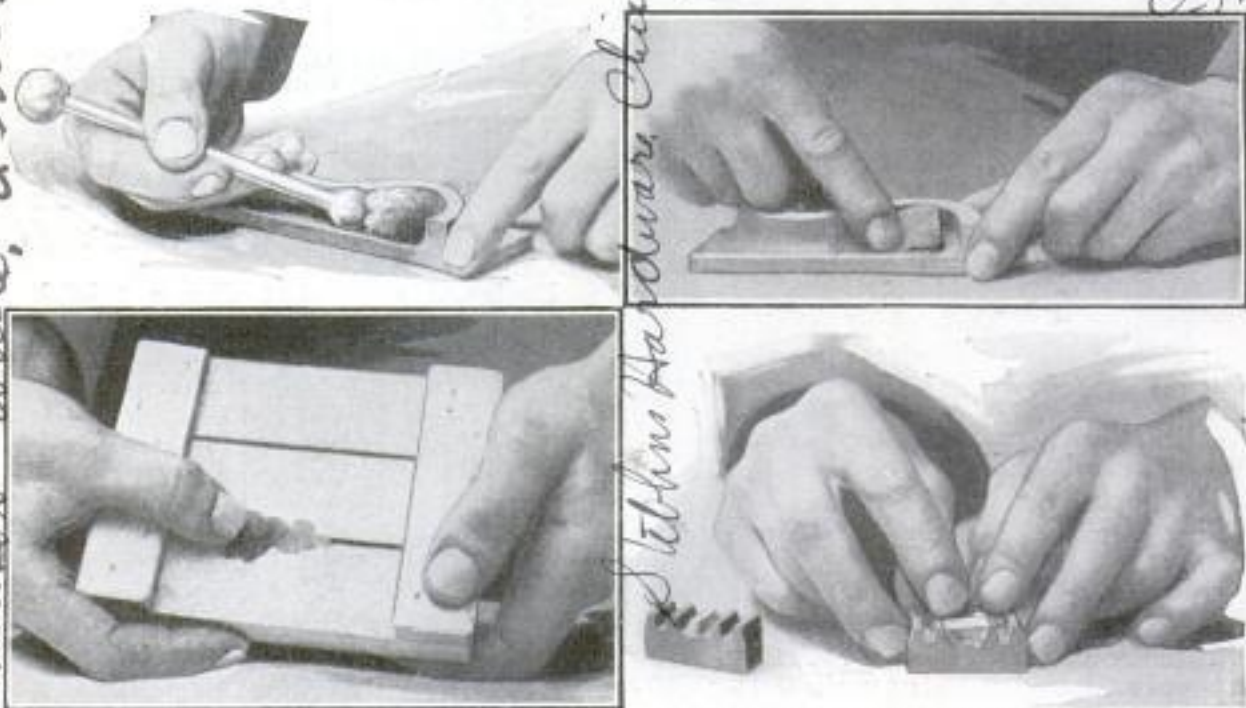

How Plastic Wood May Be Used as Filler for Seams and to Replace the Broken Parts of a Pattern; Above, the Material Being Molded into Ornamental Shapes

*can probably be bought from C. J. Harrison White, Inc., 19 W. 44th St. New York City*

*Buckingham House, London, S. W. 1, Eng.*  
*Nobel Chemical Industries, London, S. W. 1, Eng.*

*Nobel Industries Ltd. Windsor House, Victoria London, S. W. 1, Eng.*



"Limousine" Fire Engine of Paris Ready to Throw Twenty-Four Streams of Water Drawn from River near One of City's Hazard Areas

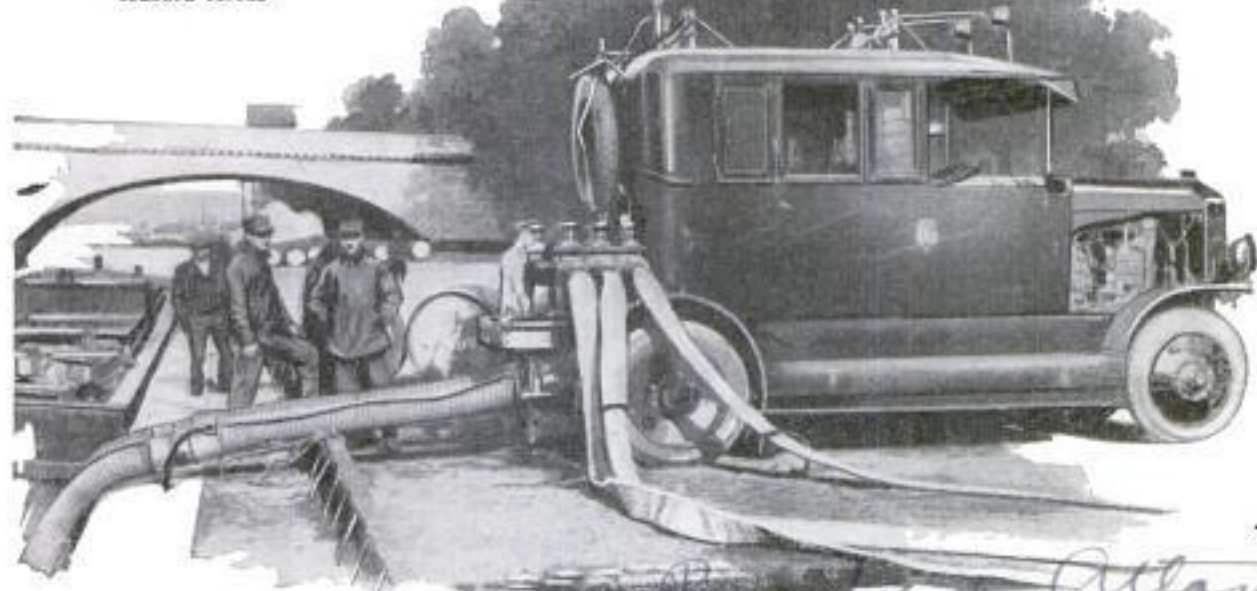

202

### Fire Engine like Limousine Auto Feeds Twenty-Four Nozzles

Resembling a fashionable limousine, an automobile fire engine used by the Paris fire fighters can pump enough water to supply twenty-four nozzles. The closed body accommodates the fire crew and a powerful four-cylinder engine on the rear of the car feeds water to the hose. In cases of emergency, intake lines can be thrown into the river along the water front, near which many of the machines are stationed because of the frail condition of the buildings in that vicinity. It is said the speed of the trucks and their ability to rush through traffic greatly aid in the prevention of big fires.

vehicles. Of 713 deaths due to street accidents in Chicago in 1923, it has been shown, 115 were caused in attempts to pass through moving traffic, while 296 persons lost their lives in efforts to cross busy streets midway in the blocks. It is believed that by spreading the messages of safety by means of silent "missionaries," people can be induced to use more care.

### Death Sign at Street Corner Gives Grim Warning of Danger

As a caution to jay walkers and those who disobey traffic signals, signs bearing a figure symbolizing death and inscribed with words of warning, have been erected at a prominent street intersection in a large eastern city in an effort to decrease the number of accidents resulting from the congested condition of the thoroughfares. Placed on pedestals high above the sidewalks, the signs display different inscriptions in each direction. The boxlike frames are painted with large letters on white background, and the picture of a skeleton is vividly shown pointing into the crowds, or indicating the path of passing



© Keystone  
Death Sign Installed at Street Corner to Warn Jay Walkers and Motorists of Carelessness

cor. 42 road. with the case.  
New York  
Copyrighted material



## Time and Money-Saving Tools



Spring Brace under  
Chair Seat for Rais-  
ing Sunken Bottom



Ventilated Electric Iron Is  
White and Keeps Handle Cool



Electric-Iron Cord  
Carrier Prevents  
Kinks and Twists



Hot Plates and Boil-  
ing Water from  
Same Kettle



Grip for Lifting Fruit Jars  
Saves Burning Fingers  
and Will Not Slip

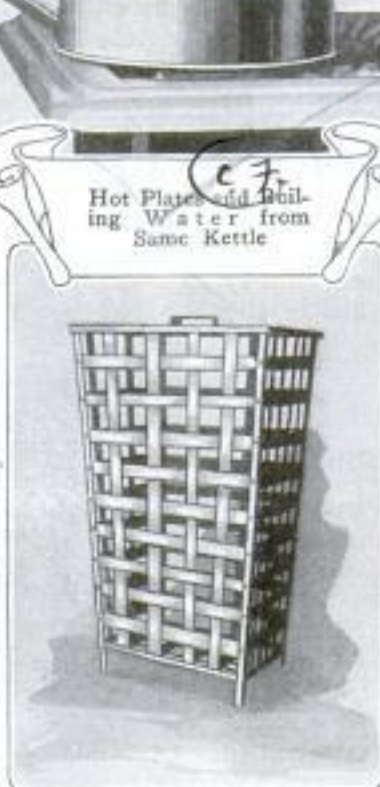

Woven-Steel Refuse Burner  
Can Be Folded Flat When  
Not Used

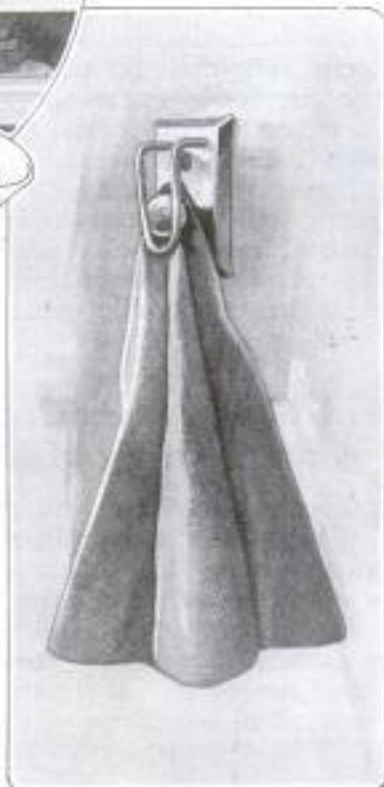

Spring Wall Holder for  
Dish or Dust Rags Pre-  
vents Tearing Cloth

Anyone wishing further information on devices described in the editorial pages can



1922  
for Woman's Workshop in Home



Divided Frying Pan  
Saves Gas and  
Cooks Two Dishes



Condensed-Milk-Can Punch  
Also Seals Holes from Dirt



Safety Window  
Opens Inward and  
Slides Up or Down

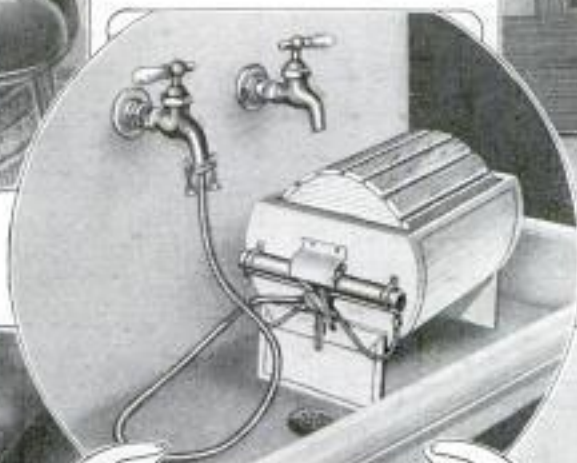

Tiny Water-Power  
Washing Machine  
Works in Sink



Slicer Cuts Beans and  
Other Vegetables into  
Narrow Strips



Bread Is Cut Thin and  
Even Easily in This  
Wire Guard



This Screw-Cap Egg  
Beater Fits Both Pint and  
Quart Jars

obtain it by addressing Bureau of Information, Popular Mechanics Magazine, Chicago.



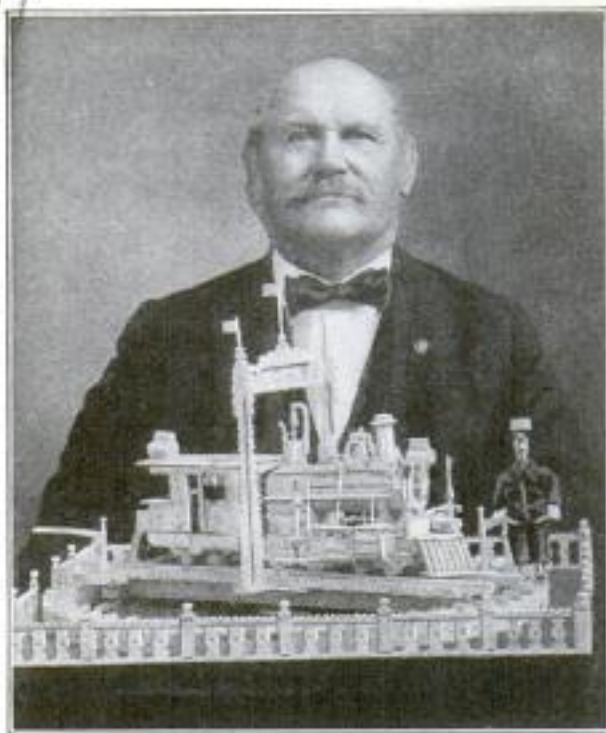

Skilled Carver and a Few of the Articles He Has Shaped from Bone

### Carver Spends Twenty-Four Years Shaping Wonders from Bone

More than 70,000 hours, or the equivalent to twenty-four years of eight-hour working days, it is estimated, have been spent by Conrad Grasshoff of Altamont, Ill., in carving objects from bone. A veteran of the Civil War, he began carving in 1872 and spent years in making a model of a church with the preacher and sixteen worshipers inside. In all he has carved sixty human figures, even the fingers being carefully filed apart, and in nearly every case the individual is holding an article. In making a miniature house, it took three months to carve the pickets in the fence and weeks were needed to make the representations of shrubbery and flowers. A ferris wheel is complete to the most minute detail; the wheel revolves and the cars with the occupants fall into proper place. The mechanical parts of the engine can also be operated.

### Iron Fed Pineapples through Leaves Saves Planters Millions

By feeding a solution of iron sulphate to pineapple plants through the leaves, growers have succeeded in increasing crop values by many millions of dollars. Attempts to better the quality of the growths by applying the material to the roots were found to be almost entirely ineffective and the spraying process was resorted to after

investigations on plantations of Porto Rico. Although the addition of 3,000 pounds of iron sulphate a year to an acre of soil in Hawaii showed no results in the crops, a supply of fifty pounds deposited on the leaves of the pineapple plants during an equal period converted scanty growths to healthy vigorous crops. The iron mixture sprayed on bushes and grasses of pasture lands in New Zealand, where many sheep and cattle died from "bush sickness," eliminated such losses which were caused by the inability of the animals to get a proper supply of the mineral salts.

### Plate Glass Blown in Tubes by Air Blast, Then Rolled into Sheets

Far too large for even the most skilled and powerful glass blower to handle, the gigantic cylinders, from which huge sheets of plate glass are cut, are blown by compressed air from molten masses placed over drum-shaped blowers in modern factories. Clamped in secure position, the tubes are pulled out steadily as they distend to prevent bulbous shapes, the blow-pipe is withdrawn gradually and the amount of air regulated carefully to insure an even "growth" of the tremendous cylin-

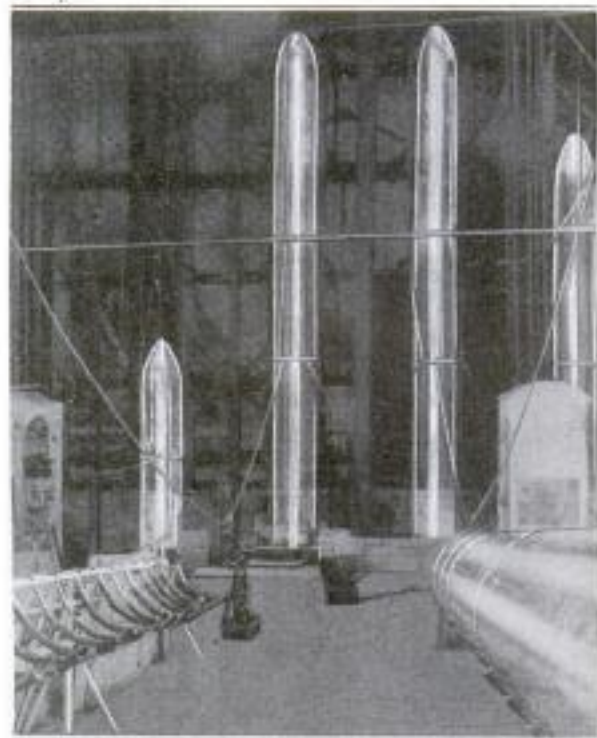

Blowing Cylinders of Glass with Compressed Air; Racks for Finished Tubes in Foreground

der. When they are distended to the desired height and thickness, the tubes are cut, heated and rolled out into flat sheets.

*using a railway.*  
 114 5 28th  
 New York.

*New York Times*  
 10/26/24



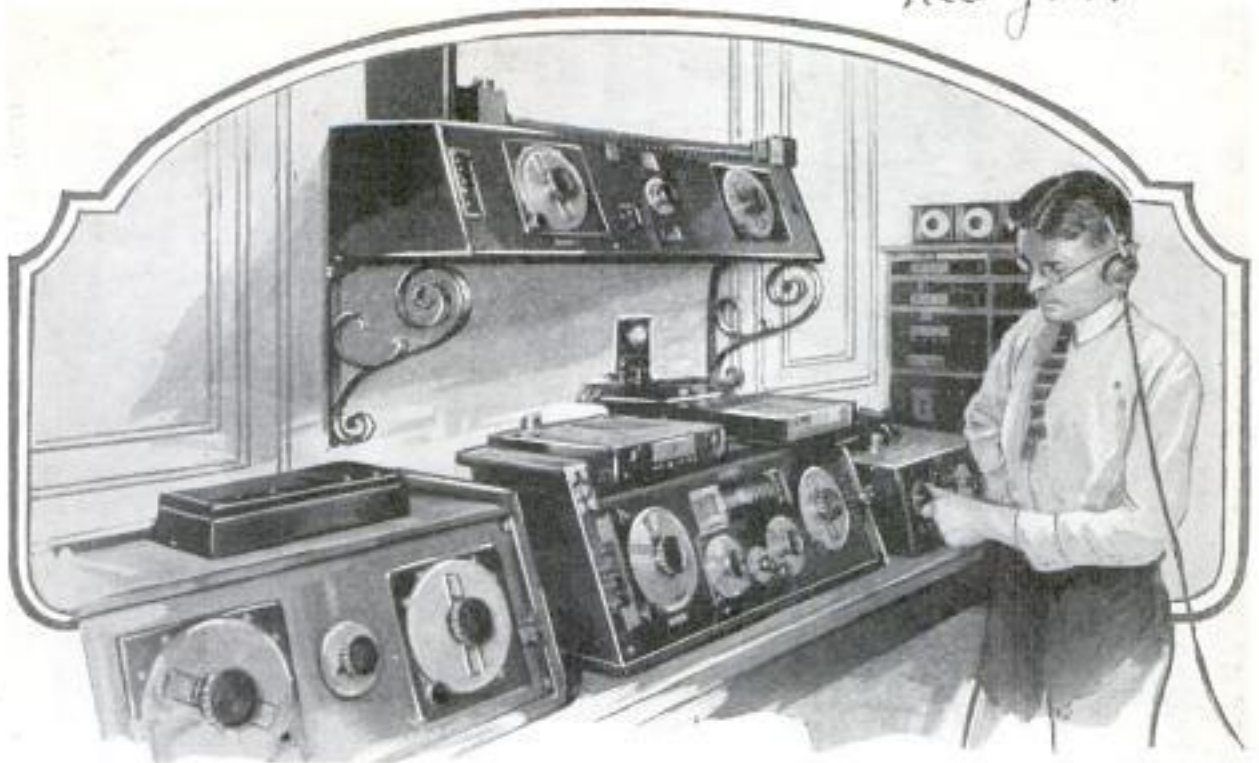

Receiving Apparatus of the Great Radio Station at Nauen, Germany. One of the Most Powerful in the World, Where Germany's Naval and Commercial Wireless Traffic Is Handled

## Girdling the Earth by Radio

### Nations Linked by Giant Stations Which Hurl Messages Back and Forth across the Seas with the Speed of Light

**BOY** scouts assembled recently in the auditorium of a New York public school dispatched a message to Sir Baden-Powell, England's boy-scout master. Twelve minutes later the answer had come back from London and was being read to the boys. The delay was due to the time it took General Baden-Powell to read the message and write his answer. The actual transmission time for the entire radiogram was less than a minute from New York to London and less than a minute to come back. Far up over the wave length of your radio receiving set, the ether is constantly filled with a multitude of busy dots and dashes, tiny streams of electromagnetic waves being sent hither and thither on the world's business. To the average person with a radio outfit designed for receiving short-wave broadcasts, these troops of unseen dots and dashes remain unheard because of the long wave on which they travel, and because they are both unseen and unheard, the romance of their being remains little known.

But go to any telegraph station any place in America and you can dispatch a radio message across the seas to most any

civilized land. By land wires from your town to some spot on the Atlantic or the Pacific coast, your message will go as a telegram, and there, in virtually no more time than it takes to tell of it, the telegram will spring off into space to come down again at its destination, whether that be some place in Europe, in South America, Hawaii, the Philippines, Japan or Asia.

Simple enough in the telling, but the machine that sends the electrons catapulting off into space requires a vast organization, immense areas of ground, enormously tall, slender steel masts, miles upon miles of aerial wires and ground connections, huge power houses and great cooling ponds to chill the water that circulates through the high-speed alternators to insure constant mechanical operation.

Out on Long Island, seventy miles from New York city, is one of the greatest of all commercial broadcasting stations, which is known to the world as Radio Central. Sixteen miles away is its companion receiving station. The one sends out messages to all the world and the other brings back the answers, each working independently and without interference





Sending Operators Punching Messages in Transmitting Tapes at Rate of 100 Words a Minute for Each Machine; Below, Radio Central, Covering Ten Square Miles, as It Will Look When All Twelve Antennas, Each Mile and a Half Long, Have Been Completed

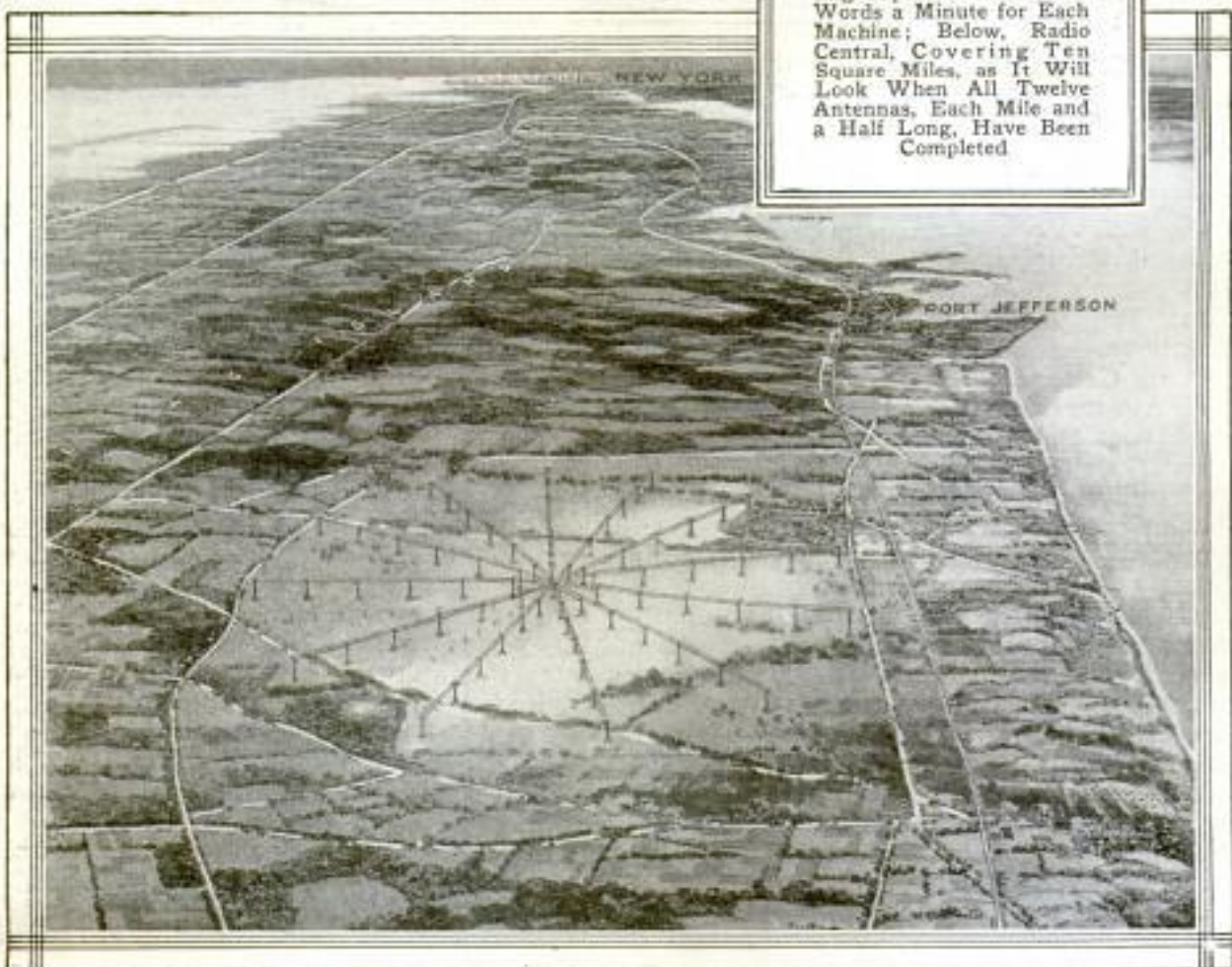



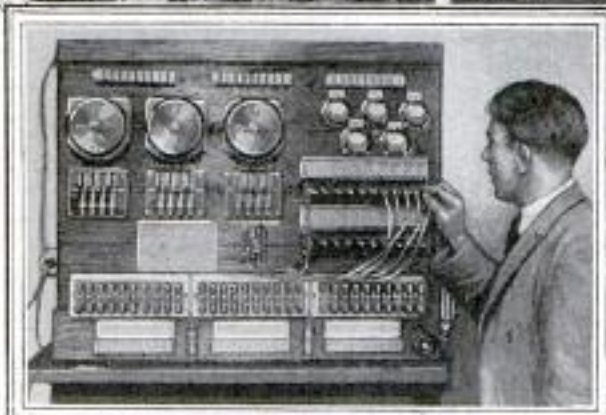
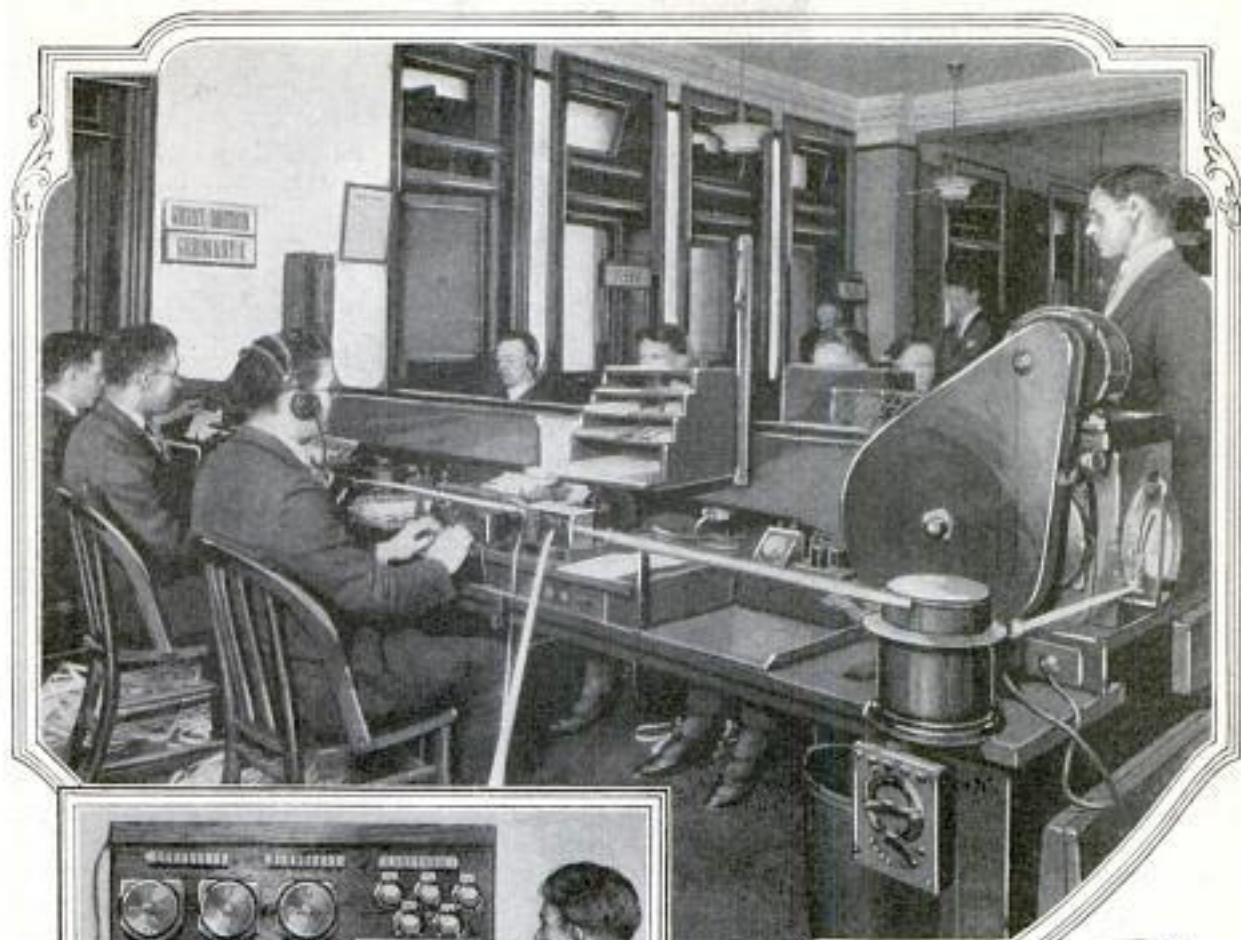

Messages from Overseas Being Copied Direct from Tape Recorder onto Message Blanks in New York, and, Left, One Switchboard in the 300,000-Watt, 20,000-Meter Station at Nauen



Receiving Room in Berlin Where Messages from America Are Copied



from or with the other. Back in New York is the brains of both stations. There, in an office on Broad street, are the operators who send and receive. They are connected with the transmitting and receiving sets by land wires.

The transmitting set at Radio Central will, when completed, include twelve great aerials, each a mile and a half in length, radiating from the power station like the spokes of a wheel. Two of the aerial lines, with a total length from end to end of three miles, are already in operation. Each of the twelve antennas will communicate with a different portion of the globe and each will have a capacity, day and night throughout the year, of 100 words a minute. Three of the aerials are to be set aside for communication with the countries of South America, three for trans-Pacific telegraph and radio telephone to Europe; while of the other six one will serve Poland, the next Denmark, a third Sweden, the fourth Germany, the fifth France and the last England.

Each of the aerials is supported on six lofty towers, 410 feet in height, with a 150-foot crossarm at the top to carry the antenna wires. The towers are spaced 1,250 feet apart. The antenna itself consists of sixteen bronze cables, each three-eighths of an inch in diameter. Fifty miles of the cable were used in the two aerials already completed and 250 miles more will be needed to complete the installation. The ground connections for the two aerials now in use comprise 450 miles of copper wire, buried in starfish and gridiron pat-

tern. The huge plant will, when finished, cover 6,400 acres, or ten square miles. Enormous quantities of steel and cement are going into its construction. The twelve completed towers of the first two aerials used 1,800 tons of steel, with 8,200 tons of concrete for foundations.

The range of the super-station is practically world-wide. Its signals are heard in Europe, Australia, South America and Japan. While no operators are used at the station itself, every message being handled from New York by the remote-control system, an engineer with a staff of fifteen assistants is required to look after the apparatus. A 23,000-volt transmission line from a town seven miles away brings power to the scene, while the ten high-frequency alternators of the completed station will give a power output of 2,000 kilowatts.

The transmitting rate of 100 words a minute is far above the speed of the fastest telegraph operator using an old-fashioned hand key, and is made possible by the use of typewriter sending machines. The operator writes his message on a typewriter keyboard, but instead of being printed on paper it is punched in a moving tape in the form of combinations of holes which constitute the code. As the moving tape passes along, electrical fingers establish contacts through the holes and transmit the signals over the land wires to the sending station, seventy miles away, where they are automatically relayed into the air. The receiving station, with nine individual circuits ready, is no less marvelous.

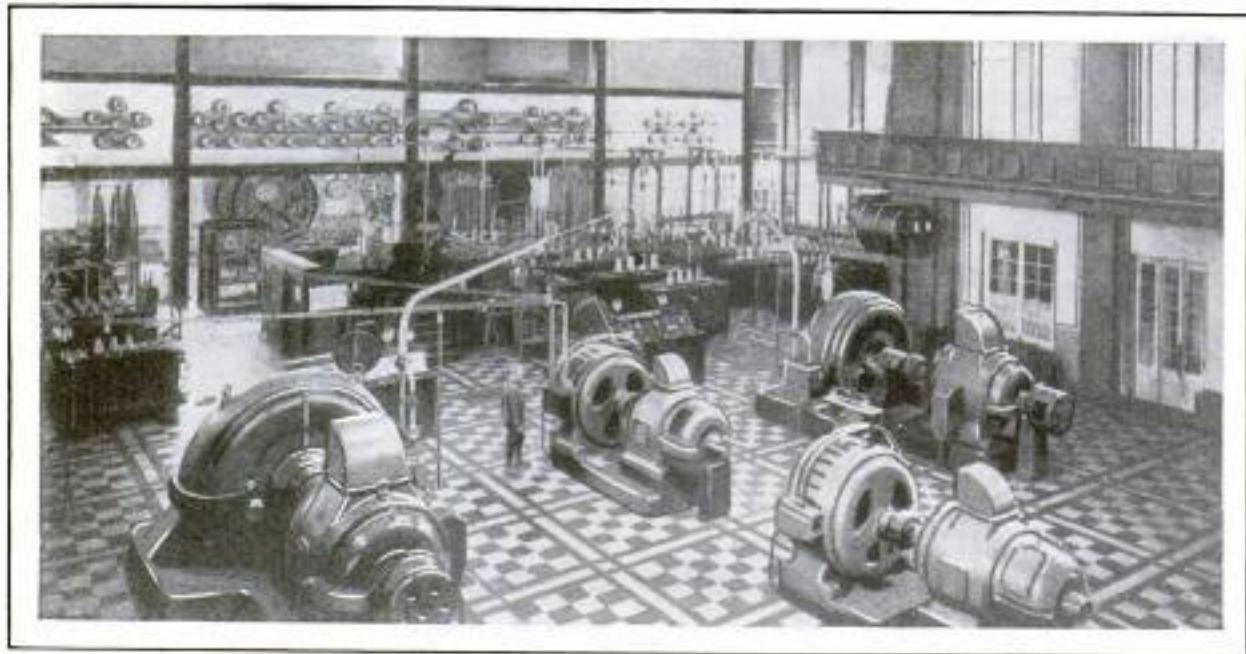

Generating Plant of the Huge Wireless Station at Nauen, Where 1,060 Kilowatts Are Generated as Compared to America's One-Kilowatt, or Less, Broadcasting Stations





## A Skating Whirligig

By G. E. VAN HORN

**T**HE skating whirligig can be used in a number of different ways, and once it is set up in one corner of the lake or river, it will give sport to skaters throughout the season. It can be made from an old hayrake wheel, an iron rod about twice the length of the wheel hub, a long post and a length of rope, and with the help of three

or four industrious friends, any boy can construct it in an hour.

The spot chosen for the device should be quite a distance from the bank, to permit skaters to whirl in a 40 or 50-ft. circle if they desire. Chop a hole in the ice slightly larger than the butt of the post and set the post in the mud on the bottom

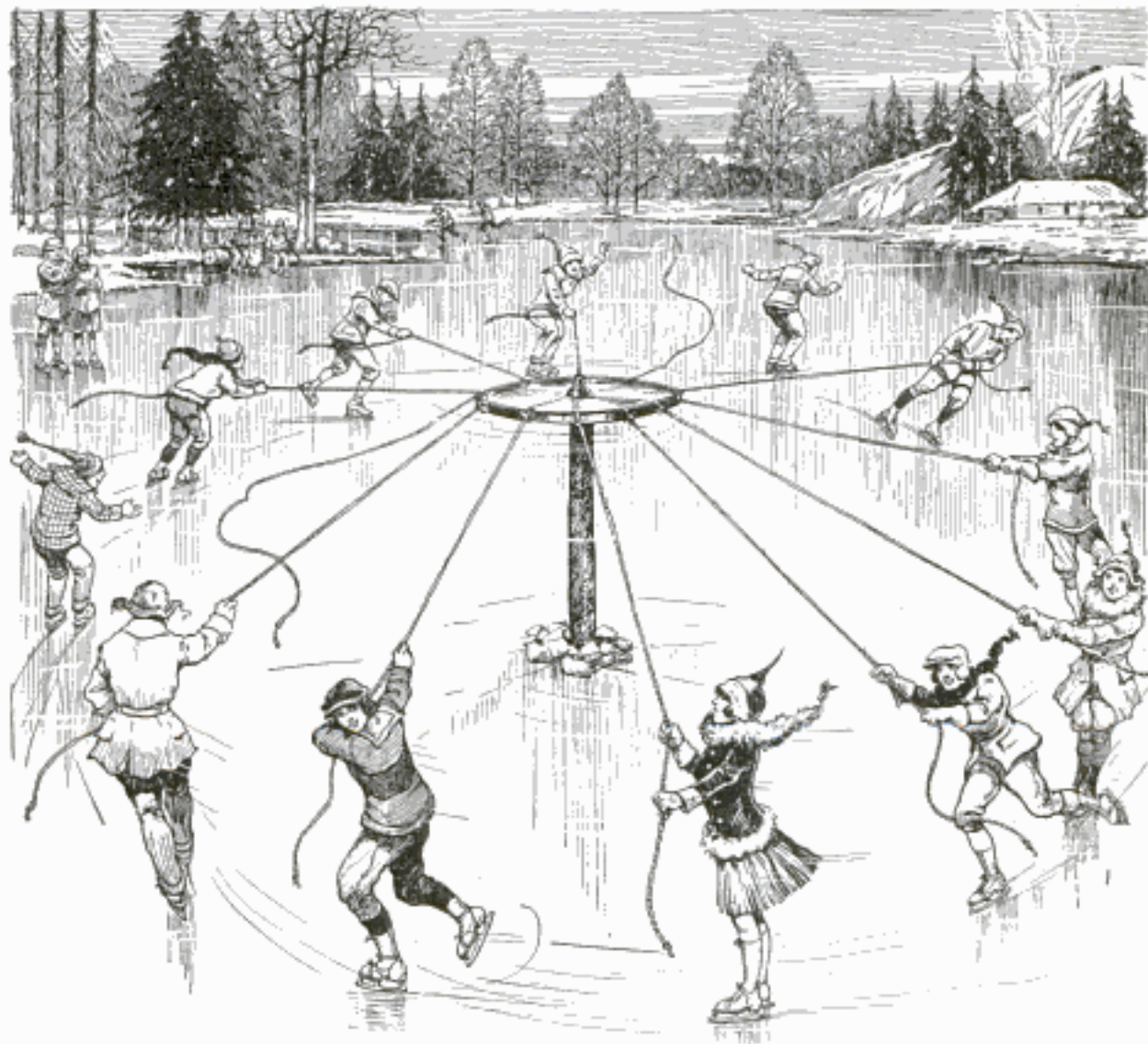

A Long Post, an Iron Rod, an Old Hayrake Wheel and Some Rope Make a Whirligig That Provides Exhilarating Sport for the Skaters on the Pond



so that about 6 ft. of it remains above the ice. Throw the chunks of ice back into the hole around the post and allow it to freeze over again, later carrying away the remainder of the ice chips, which might trip the skaters. With a saw or plane, go around the top edge of the post, making a wide bevel. Now bore a 1-in. hole into the top end of the post for a distance of 12 or 14 in. Drive the 1-in. iron rod into the post, leaving about half the length of the rod exposed to view. Place a washer over the rod and oil it well. Then slip the rake wheel in place. Cut a number of ropes into 8 or 10-ft. lengths and tie them to the spokes of the wheel. Two long ropes may also be attached, each 20 or 30 ft., but they should be on opposite sides of the wheel. When the long ropes are used, they should be coiled up and held by the skater, later being slowly payed out as he skates about the whirligig until he is swinging in a large circle.

### An Outdoor Fireplace

A Wisconsin tinsmith has devised a neat outdoor fireplace for campers and tourists, which allows the full enjoyment of cooking over an open fireplace without annoyance from smoke. The draft caused



Outdoor Fireplace Eliminates Annoyance from Smoke and Provides Grate over the Fire

by this device also aids in building a fire quickly. It consists of a length of 8-in. galvanized-iron pipe with a 24-in. cone at the bottom and a wind-vane elbow at the top. It is supported on a length of 1¼-in. pipe, a bolt through the top of the elbow providing a pivot upon which it may turn with the wind. Two doubled lengths of strap iron are riveted at either end of the pipe on the inside, to strengthen the stack and hold it in a vertical position without interfering with its operation, and these rest on washers pinned to the supporting pipe. The latter is driven into the ground inside of a short length of 3-in. pipe, and the space between the two is packed with soil or ashes. A double loop of strap iron is clamped to the top of the 3-in. pipe to hold cooking utensils.

by this device also aids in building a fire quickly. It consists of a length of 8-in. galvanized-iron pipe with a 24-in. cone at the bottom and a wind-vane elbow at the top. It is supported on a length of 1¼-in. pipe, a bolt through the top of the elbow providing a pivot upon which it may turn with the wind. Two doubled lengths of strap iron are riveted at either end of the pipe on the inside, to strengthen the stack and hold it in a vertical position without interfering with its operation, and these rest on washers pinned to the supporting pipe. The latter is driven into the ground inside of a short length of 3-in. pipe, and the space between the two is packed with soil or ashes. A double loop of strap iron is clamped to the top of the 3-in. pipe to hold cooking utensils.

### Preventing Snow from Sticking to Shovel

It is usually somewhat difficult to use a metal shovel for scooping snow as the snow has a tendency to stick to it. This trouble can easily be prevented by first cleaning the shovel so that it is absolutely free from dirt, heating the metal part, and then covering it well with melted paraffin or wax. When the paraffin is cold, the shovel can be used, and it will be found that the snow will not stick. Of course, this will last only as long as there is a film of wax on the shovel, but it is surprising how long it takes before this film is worn off. Wooden shovels may be treated with grease or rubbed with soap.—Geo. E. Steinberg, Paonia, Colo.



### Novel Dog Wheel Chair

To eliminate the need for propelling his homemade wheel chair by hand, an ingenious cripple of Davenport, Wash., found it practical to use two dogs to push it. The vehicle was made from two ladies' bicycles with a comfortable kitchen chair arranged between and a sturdy frame to hold the parts together. A tongue



Cripple's Novel Wheel Chair, Made from Ladies' Bicycles and Kitchen Chair, Pushed by a Dog Team

with doubletree was arranged at the rear so that the two dogs could be harnessed to the car. While it was provided with a sprocket and chain so that it could be operated by hand, if necessary, the use of dog power proved more satisfactory.

### Air Filter for Carburetor

Analysis of the uncombustible deposit in the cylinders of an auto engine, after the carbon had been burned out, showed it to consist of ordinary sand, clay dust and limestone dust, which had undoubtedly been drawn into the motor through the carburetor. As the sand is highly abrasive, it is obviously responsible for most of the wear on pistons, rings and cylinder walls. The entrance of sand and dust into the carburetor air intake can be prevented by providing a filter of the kind shown in the drawing. This method has been tried out and found highly satisfactory. The space between the dash and instrument board was used as a filtered-air chamber and was connected to the carburetor air intake with a length of flexible metal tubing.

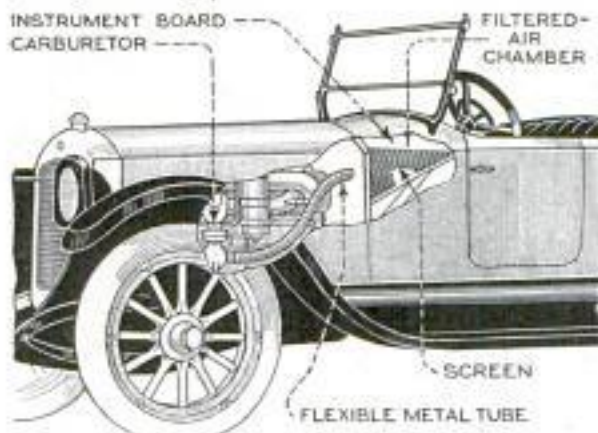

Air Filter on Carburetor Keeps Grit Out of Motor

This space was sealed to prevent air from coming in except through the filter, which was provided in the bottom. It consisted of several layers of closely woven cloth, with a piece of wire screen to make the filter more rigid. After a day's run a painful of dust was brushed from the underside of the filter. Later, when carbon was again burned out, there was no trace of any unburned deposit.—R. P. Cole, Paterson, N. J.

### Hints on Plaster Patching

If a large quantity of plaster of Paris is prepared at once, some of it may become hard before it can be used. To avoid this, mix it in a large shallow bowl, pouring only a little water at a time into the middle of the plaster and stirring it. As soon as this has been used up, repeat the process. If no plaster is at hand and one wishes to patch up holes or cracks, a good substitute can be made by using fine sand, 2 parts; fine ashes, 2 parts, and rye flour, 1 part. Mix with water to a consistency of a thick paste. This will become as hard as stone.





Two-Horse Evener Which Requires About Half as Much Space as the Ordinary Evener

#### Novel Two-Horse Evener

For breaking ground and cultivating in confined places the evener shown here will prove a boon to orchardists and road contractors as the space required for this evener is about half of that usually required, when two singletrees and a double-tree are used. A heavy pulley is attached to the center of a double-tree and a short length of stout rope, with the hooks securely fastened to the ends as shown, is provided on the pulley. The usual chains, with hooks attached, are provided on the ends.—J. T. Garver, Huntingdon, Tenn.

#### Carburetor Choke Adjustment

The carburetor choke on Ford cars is held by means of a spring which necessitates using one hand to keep it closed when starting. During cold weather it is often necessary to have the choke partly closed for some time, and it is then handy to have the pull rod stay in the position put. This can readily be done by filing a number of notches on the underside of the rod, as shown in the sketch, so that they will catch on the edge of the instrument board and keep the choke in any position.—C. W. Furay, Dayton, Ohio.



#### A Razor Kink

To the user of an old-fashioned razor who finds it a nuisance to take it to be honed, or too much trouble to do it himself, my method of keeping the tool in shape may prove of interest. I have kept my razor keen and sharp for a dozen years, by using a trace of flour of emery on one side of the strop. Merely dip one finger into the emery once or twice and rub it on. Start stropping on that side and finish on the other. When the razor gets a little out of condition do it again. No doubt the treatment will have to be varied a little with different razors, but three or four times a year is usually sufficient.—Chas. F. Goldthwait, Waterbury, Conn.

#### Reducing Diameter of Stovepipe

Sometimes it is necessary to reduce the diameter of a section of stovepipe when there is not a tinsmith in the neighborhood. However, this can readily be done by anyone at home with materials and tools available almost everywhere. A piece of tongue-and-grooved board, a little longer than the section of stovepipe, is obtained and stuck through the pipe as shown. By means of a piece of flat iron or steel, such as a discarded plane bit or a wide chisel with the edge dulled, and a hammer, the stovepipe is tapped down into the groove as shown in the drawing. The work must, of course, be done gradually from one end of the pipe to the other and the result will be a neat job. If a board of a width to produce the desired reduction in diameter is not at hand, one may be built up of two pieces and then trimmed down to the right size.—H. E. Gifford, Medford, Mass.

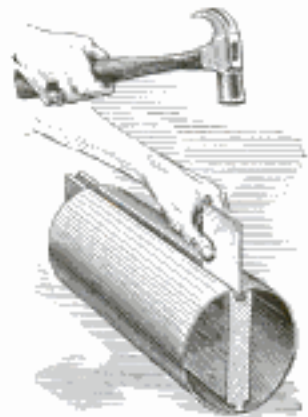

#### Substitute for Gasoline in Cleaning

Due to the inflammable quality of gasoline and benzine, carbon tetrachloride is far superior as a cleaning fluid for home use. It is a water-white fluid obtainable at any drug store and has no equal for removing spots or stains from any kind of fabric. Grease, paint, varnish, paraffin,



shellac, pitch and numerous other stains yield quickly to treatment with this fluid. It leaves no rings as gasoline and benzine do, and although it possesses a rather peculiar odor, no trace of it is noticeable after evaporation. Carbon tetrachloride does not attack the dye of any fabric and may be used for cleaning anything that can be cleaned with gasoline.—G. E. Hendrickson, Argyle, Wis.

### Folding Clothes Drier

A neat, compact and serviceable clothes drier can easily be made from a discarded costumer. Remove the clothes hooks and fasten on either side a collapsible dish-towel rack, which can be bought at any hardware store. Lacking a costumer, the whole drier may be built as follows: Obtain a piece of wood from which can be made an upright  $4\frac{1}{2}$  ft. long, 2 in. square and tapered on two sides to the thickness of  $1\frac{1}{2}$  in. at the top. Dress down two pieces of  $1\frac{1}{8}$ -in. material, about 16 in. long, and 3 in. wide, and notch them to form a base similar to those used for Christmas trees. The upright is braced to the base with four small shelf brackets obtained at a 5 and 10-cent store. Then the two towel racks are screwed on. A little wood stain, enamel and floor wax will dress up the wood and make a neater-appearing job. When opened, this clothes drier will accommodate a surprising number of articles, and when closed, it can be

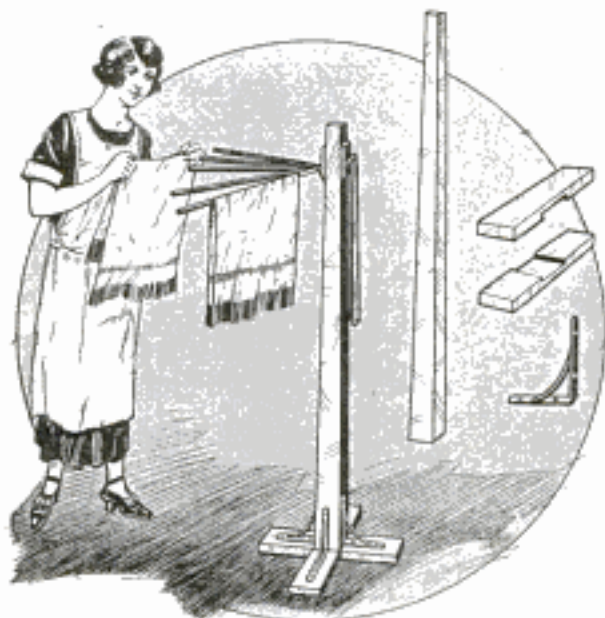

Neat Collapsible Clothes Drier Made from Discarded Costumer

stowed out of the way in any convenient corner or closet.—Bjorn Winger, Indianapolis, Ind.

### Outside Nests for Poultry House

By providing nests on the wall of a poultry house, which enables the hens to reach them conveniently from the inside and permits the eggs to be gathered from the outside, the hens occupying nests

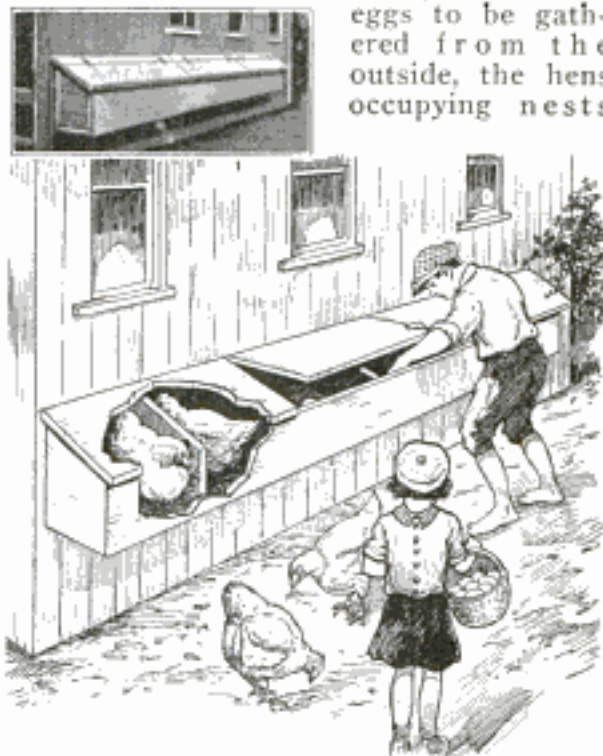

Outside Nests on Poultry House Are Convenient for Gathering Eggs

will not be frightened, with the result that they lay eggs in some unknown place. The box containing the nests should be about 14 in. wide. The nests are separated by partitions, as shown, and fitted with hinged lids covering two nests each, so that the empty ones can be reached without disturbing fowls sitting in the others. The lid should be lifted only high enough to admit the hand.—Dale R. Van Horn, Walton, Nebr.

### Cork Plugs for Drafting Board

Draftsmen, whose work demands the use of paper of uniform size, sometimes experience difficulty in fixing thumbtacks solidly to the board due to the great number of holes already made in the board at that spot. The difficulty can be overcome, however, by using cork plugs, which can be replaced by new ones when worn out. At the four points where the tacks are generally placed, 1-in. holes are drilled through the board. Corks, large enough to make a snug fit, are forced into these holes and the projecting ends trimmed off flush with the surface of the board.



### A Safe Flash-Powder Igniter

Accidents caused by careless firing of flash powder in taking interior photographs are still far from uncommon, al-

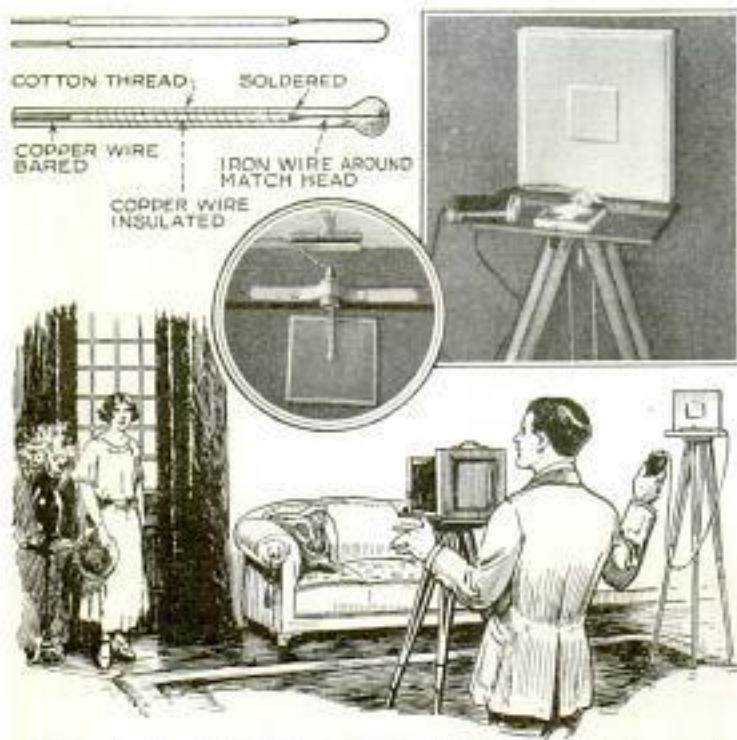

Safe Igniter for Flash Powder When Taking Interior Photographs

though they all belong in the preventable class. A safe igniter, easily made from simple materials, is illustrated in the photos and detail drawing. Its essential parts are an ordinary safety match, a piece of thin iron wire, two pieces of insulated copper wire and a pocket flashlamp. The copper wires are stripped for a short distance at one end and the iron wire soldered to the opposite ends. This combination is doubled over the match so that the iron wire comes across the head, whereupon the copper pieces are pulled tight along the sides of the match and tied to it with a thread. The bared ends are connected, by means of a flexible lamp cord, to the poles of a pocket-flashlight battery. The match may be mounted in a small lamp socket and strapped to a board as shown, and a piece of glass or tile pushed under it to receive the flash powder. This is laid on and around the match head, and the complete assembly may be mounted on a tripod, in which case the board should be fitted with a socket to take the tripod screw. In one of the photos, the igniter is shown so mounted with a square tin-can lid behind it to serve as a reflector. The lamp cord should be sufficiently long to enable the operator to stand out of possible reach of

sparks, and the igniter should, of course, also be placed so that no sparks can hit any other person or the furnishings in the room. For the sake of increased safety, the battery should be taken out of its case before the powder is put on the glass or tile, and not replaced until immediately before the powder is to be ignited. Also, in order to protect the lamp socket in which the match is mounted from the flame of the explosion, it may be provided with a metal cap at the front end. This is drilled to permit the match to pass through, the hole, of course, being large enough to forestall all chances of short-circuiting.—C. A. Oldroyd, Barrow-in-Furness, Eng.

### Banding Chinaware

A serviceable wheel for banding hand-painted chinaware is the turntable of a phonograph. Three old records are placed on the disk to bring the surface of the upper one slightly higher than the center pin. The piece of china to be banded is then set on the exact center of the top record, using the rings on the record as a guide. The brush can be rested on the tone arm of the machine. Care must, of course, be taken not to injure the phonograph.

### A Good Farm-Shop Chimney

To lessen the fire hazard about his shop, a Nebraska farmer used a 6-in. tile

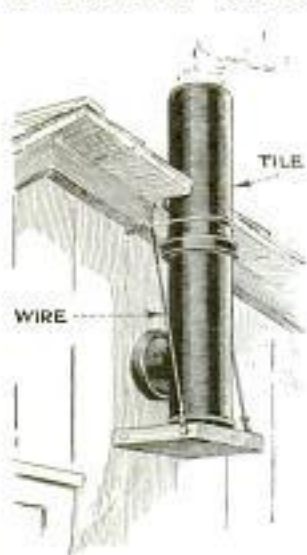

for the outside chimney. The lower section has an opening on the side, in which the pipe fits, and is supported by a wooden block held by wires and nails as shown. The bottom is filled with concrete to a depth of 4 in. The upper section is cemented to the lower tile, wired to the wall, and extends well above the roof. For a building

in which appearance is of secondary importance, this construction is excellent.



# Making Useful Things from Leather Scraps

By EDWARD H. FLAHARTY

WITH some strips of scrap leather and lamb's hide, together with a little patience and ingenuity, a variety of novel and useful articles may be made. A number of these are shown in the accompanying illustrations. The first is a cigaret case. The usual packet of cigarets, when nearly exhausted, allows the remaining "smokes" to become crushed very easily. A pocket case remedies this, while not taking up much more space in the pocket than the original package, which it contains. It is made from a strip of flexible leather,  $2\frac{7}{8}$  in. wide and  $7\frac{1}{2}$  in. long, with four small panels of thin but stiff leather sewn to it at the points indicated, to correspond to the sides of the packet. A snap fastener keeps the case closed.

The pocket shoe shiner shown below this will prove a boon to the man or woman who likes to keep the shoes neat and clean. Carrying a rag for this pur-

pose has sometimes been done, but the rag rapidly becomes so dusty and dirty that other things carried in the pocket become soiled also. This little shiner, on the other hand, is rolled up and snapped shut when in the pocket, and can do no harm. It is also made from a strip of leather, with a strip of lamb's hide sewed to the inside. The hide is sewed to the leather on three sides, leaving one end open, as shown, so that the shiner can be slipped over the fingers like a mitten when in use.

The next article shown is a pocket case for loose papers, letters, etc., and is very easy to make. The portfolio is open along the top, and part way down one side. It is 7 in. long and  $4\frac{1}{2}$  in. wide when finished, sewn across the bottom and 2 in. up one side.

A steering-column matchbox holder is a very handy accessory for the motorist,

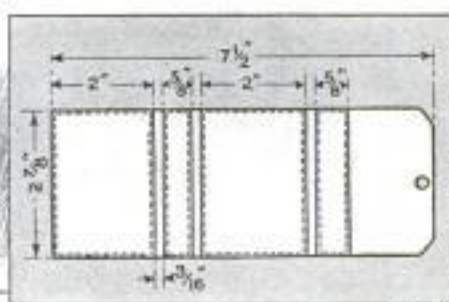

Holder for Preserving Original Shape of Packet of Cigarets and Keeping Them in Good Order. Made from Strip of Leather with Four Small Panels Sewn On; Dimensions at Right

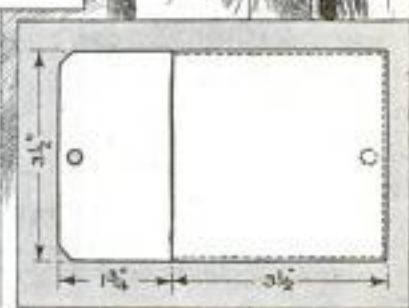

Pocket Shoe Shiner That Aids in Preserving Neat and Tidy Appearance during the Day

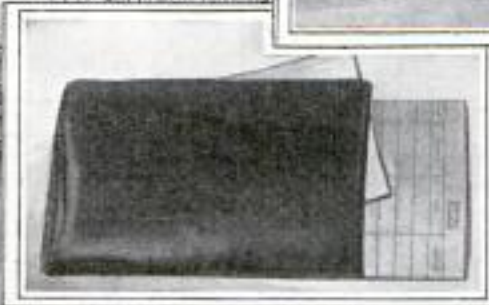

A Pocket Portfolio That Is Very Handy for Loose Papers





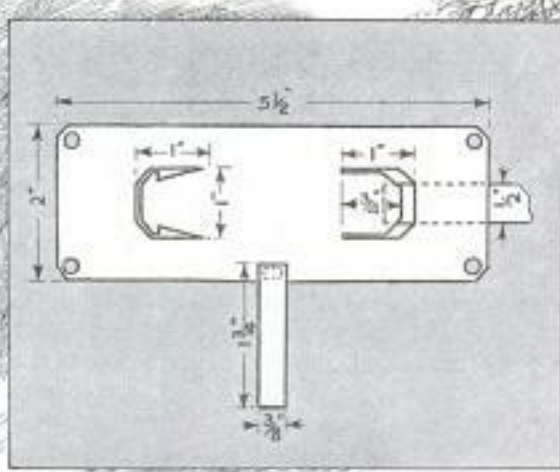
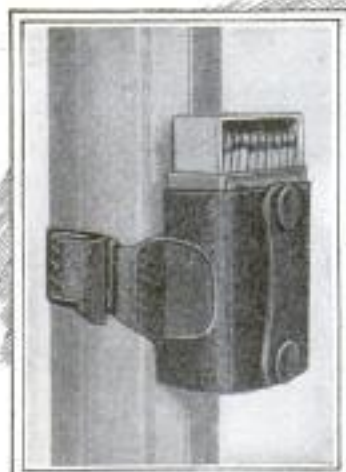

Handy Matchbox Holder for the Autoist; It Is Attached to the Steering Column at a Convenient Height

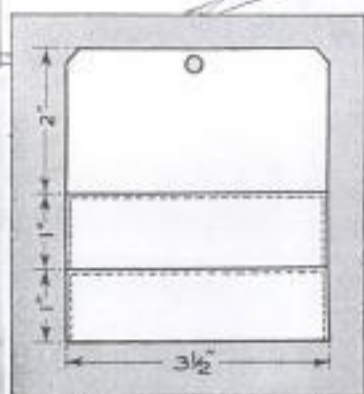

A Finger-Nail Buffer for the Lady's Handbag Is Easily Made and Takes Up Little Room; a Strip of Lamb's Hide Carries Polishing Paste

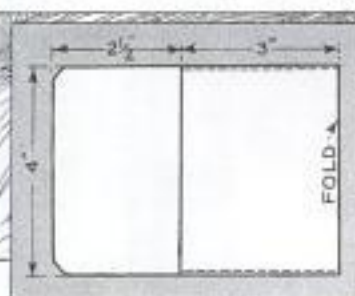

Silver Dollars and Halves Quickly Wear Holes in the Bottom of Pockets; This Little Case Solves the Problem and Keeps Loose Change Together as Well; It Also Holds Bills

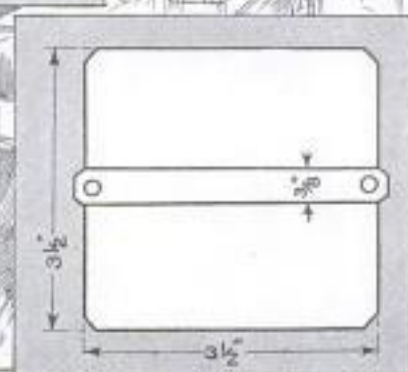

A Compact and Sanitary Powder Puff Made from a Strip of Closely Clipped Lamb's Hide; the Puff Does Not Become Soiled, nor Does the Powder Spill Out



and the one shown in the illustration is an exceptionally neat one. The leather strip is 2 in. wide and  $5\frac{1}{2}$  in. long. Two sections are cut at each end, as shown in the detail drawing, to form ears for fastening the holder to the column. To one of the ears a strip of thin flexible leather,  $\frac{1}{2}$  in. wide, is sewn; this is cut long enough to pass around the steering column, and to the other end is attached a buckle. The other tab is cut so as to form ears that will catch in the buckle. Four snap fasteners, attached so as to hold the match-box neatly, and a small strip of leather, sewed across the bottom of the holder to prevent the box from slipping through, complete the job.

The finger-nail buffer proves popular with the ladies, as it is very compact and takes up little space in the handbag. It is made by sewing a strip of the lamb's hide across the end of an oblong piece of light leather. The leather is 3 in. long, and the hide 2 in. long. The edge of the hide is sewed at a point 2 in. from one end of the leather. This allows 1 in. of the hide to overlap, and the overlapping piece is turned back and sewed on two edges, so as to form a pocket. The pocket is tightly stuffed with cotton wool and the remaining edge sewed. The back of the pocket is used as the buffer, and the pol-

ishing paste or powder is spread on the 1 in. of lamb's wool.

In the west and south, the silver dollar is very popular, but it quickly wears holes in the pockets, and the half-dollar is not far behind in this respect. The little coin case shown in the next illustration will effectively prevent this wear. It consists simply of a strip of fairly stiff leather, 4 in. wide and  $8\frac{1}{2}$  in. long. One end is folded so as to make a pocket 3 in. long and stitched on the sides. No snap fastener is needed with this case, as the folds can be made stiff enough to keep the case closed in the pocket. Bills may also be carried in this case, as it is wide enough to admit a roll of bills folded twice.

The last article shown is also a favorite with the ladies. It is a sanitary powder puff, made from a piece of lamb's hide, the wool of which has been clipped short. Dimensions are given at the right. A small leather strap is sewed to the back to form a support for the snap fastener. This puff rolls up and may be carried in the bag without becoming soiled and without losing any of the powder that is on it.

These are but a few of the many articles that can be made from scraps of leather and lamb's hide, but will serve to suggest a number of other possible uses for this material to the alert reader.

### Secret Switch Prevents Auto Theft

With his snap-on jumper wire an auto thief can readily bridge the ignition wires of a car, when the switch is thrown off, and complete the circuit, which enables him to get away with the car. To prevent this many autoists have a secret ignition switch in addition to the regular one, but the auto thief, after first bridging the regular switch, notices that there is no discharge on the ammeter, which indicates an open circuit, and so he finds the second switch and bridges this one, too. However, the switch and connection shown in the drawing will foil the expert thief, as with this arrangement the correct discharge is shown on the ammeter after the regular switch has been bridged, but the coil is grounded so that the car cannot be operated. This is accomplished by mounting an extra switch behind the dash, of which one side is connected to the frame of the car and the other to the spark coil by carefully concealed wires. Ordinarily, when the car is running, this switch is open, but it is closed to make the ignition system theft-proof.—Richard P. Cole, Paterson, N. J.

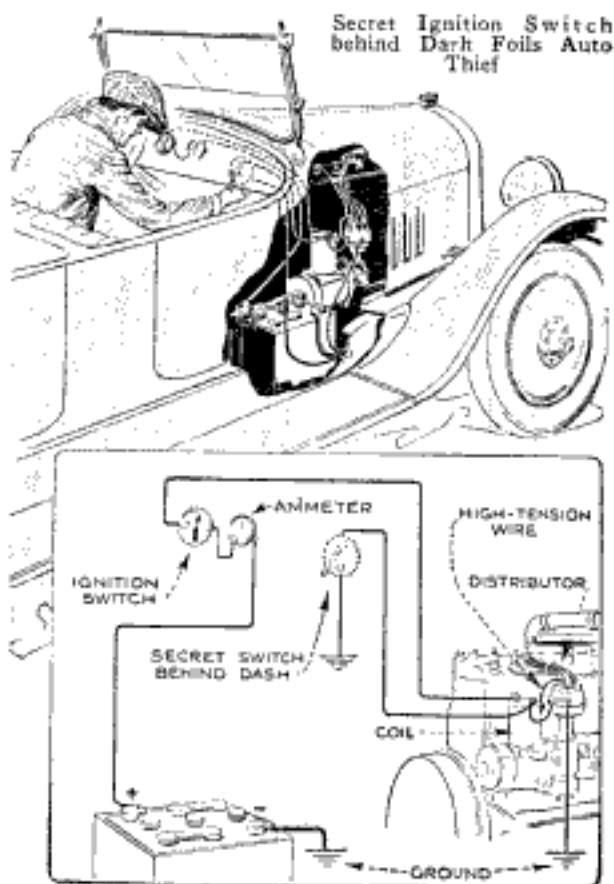



### Mail Box Opens at Both Ends

Constructed along lines entirely different from those of the ordinary mail box, the homemade one shown in the illustra-



Novel Mail Box with Hinged Top and Bottom Permits Easy Insertion and Removal of Mail

tion is of unusual convenience, as the mail is dropped in at the top and removed at the bottom, and it provides sufficient space for fairly large packages, magazines, rolled-up newspapers, and the like. It consists of a sheet-metal shell, about 8 in. wide, 4 in. deep and 16 in. high, open at both ends. The edges of the metal are doubled over to prevent injury. The top and bottom, of 1-in. wood, are hinged to the wall on which the box is mounted and are held tightly against the openings by a heavy rubber band, cut from an old inner tube and attached to the inside of the top and bottom by means of hooks and screweyes, as shown. In use, the postman lifts the top and drops in the mail, while the owner removes it by pressing down the bottom as indicated.

### Silencing Automobile-Door Noises

Squeaking automobile doors can sometimes be silenced by cleaning the rubber bumpers and the parts they touch with gasoline, wiping dry and powdering liberally with talc dust. Oil should never be used as it ruins the rubber. If the door rattles, see if the rubbers are pressing against the door. If not, readjust them with the setscrew, or by forcing small pieces of inner tube under them with a screwdriver. New bumpers may be needed. A few minutes' attention now and then will eliminate the annoyance.—Richard C. Tarr, Gloucester, Mass.

### Repairing Stripped Thread

I was recently engaged in completing the inking-in of an extensive mechanical drawing. The work had entailed many curves, adjustments for the radii of which had caused frequent changes in my little bow-pen compass. When but a few minutes remained to complete the drawing, I found that the adjusting nut on the threaded shank of the compass refused to remain where placed. Seeing that the internal threads were worn, I went to the near-by machine shop, placed the nut in a vise and applied a moderate pressure so as to squeeze it to an oval shape. This changed also the shape of the hole in the nut, and the latter stuck on the shank.—Paul E. Garber, Washington, D. C.

### Simple Cow Collar

Being a lumberman's daughter and interested in the use of wood for every possible purpose, I thought it worth while to pass along an idea I saw the other day—a wooden collar for a cow.

The collar is really as simply made as can well be imagined. It consists of a strip of white oak of suitable width and length cut with the grain and planed down until it is quite flexible and can be bent in a circle. A slot is cut at one end so that the other rounded end can be slipped through it. The wood is bent around the cow's neck and will not come off readily because the twist in it will cause the strip to bind against the sides of the slot, holding the "head" at an angle to the latter.—Miss Reubena Potter, Aquene, N. C.

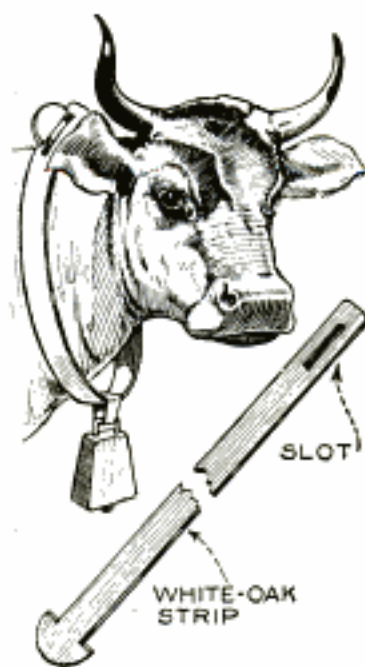

Chimney soot can be removed by throwing a handful of a mixture consisting of equal parts of sulphur and powdered saltpeter into the fire.



### Unusual Newsboy's Vehicle

In a small mid-western town there is a crippled newsboy who found crutches too cumbersome, and therefore had a friend

make the vehicle shown in the drawing and photograph. It is propelled by hand and steered by the feet, and was made from a girl's bicycle. The rear fork was spread about 6 in. to allow for the throw of the rear axle, which was made from a length of  $\frac{3}{4}$ -in. steel rod; the axle was about 30 in. long and had a 4-in. throw. It was run in four bearings made by filling 2-in. sections of 1-in. gas pipe with babbitt, drilled and reamed out to fit the axle snugly. Both rear wheels were rigidly mounted on the axle. An additional fork was made from  $\frac{7}{8}$  by  $\frac{5}{16}$ -in. flat iron to brace the rear end and serve as a support for the seat, which was of special design. The wooden members of the frame and the movable parts were made of 1 by  $1\frac{1}{2}$ -in. oak. The operating lever was about 40 in. long and was pivoted at the points indicated. The handles on this lever were made from two wooden doorstops, drilled and tapped so that they could be threaded on a  $\frac{1}{4}$ -in. iron bolt. The connecting rod was made of  $1\frac{1}{2}$  by 2-in. material. The handlebars of the bi-

cycle were removed and a foot steering apparatus substituted. This consists of two flat-iron bars bent and attached to either side of the front axle, and connected to a pivoted steering board by means of

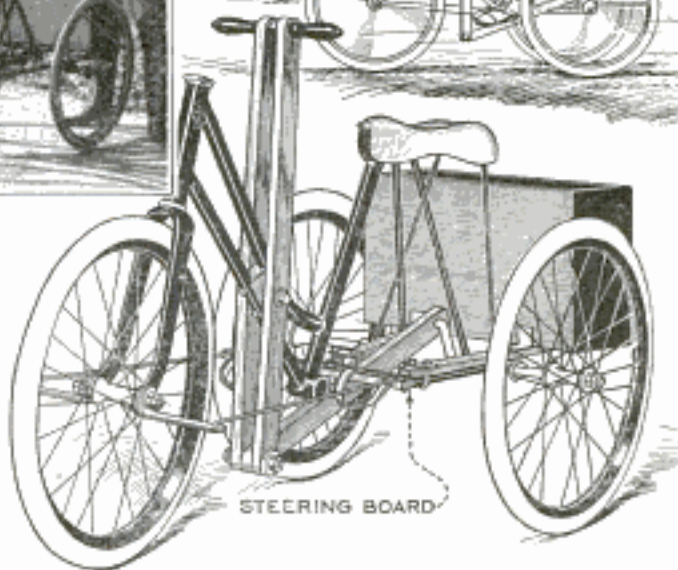

Newsboy's Unusual Three-Wheeled Vehicle Made from Old Bicycle; It Is Driven by Hand and Steered by Foot

$\frac{1}{2}$ -in. iron rods. A box was provided on the rear to hold the newspapers.—R. D. Sundberg, Rochester, Minn.

### Repair Link for Heavy Chains

With his last split repair link in use a farmer found that he had no means for repairing a heavy chain, for which he had immediate need. However, he made an emergency "key-ring" link by clamping a solid link in the vise and splitting it with a hacksaw as shown. This permitted the two parts of the chain to be slipped on the link without much difficulty, using a hammer and chisel to wedge the parts of the split link apart.



After the chain was repaired, the key ring was made solid by brazing.—James F. Hobart, Dunedin, Fla.

### Designing Office Forms

When new forms have to be made for office or factory, much work with ruler and pencil can be avoided, and neater forms prepared for the guidance of the printer, if the first draft is laid out on suitable cross-section paper. If the squares are too prominent, turn the paper over and use the back. Lettering and ruling can then be sketched in quickly and easily. If blank spaces are later to be filled in with a typewriter, their length can be calculated on the basis of the space size of the typewriter, and there will be no troublesome adjustments to make during the writing.



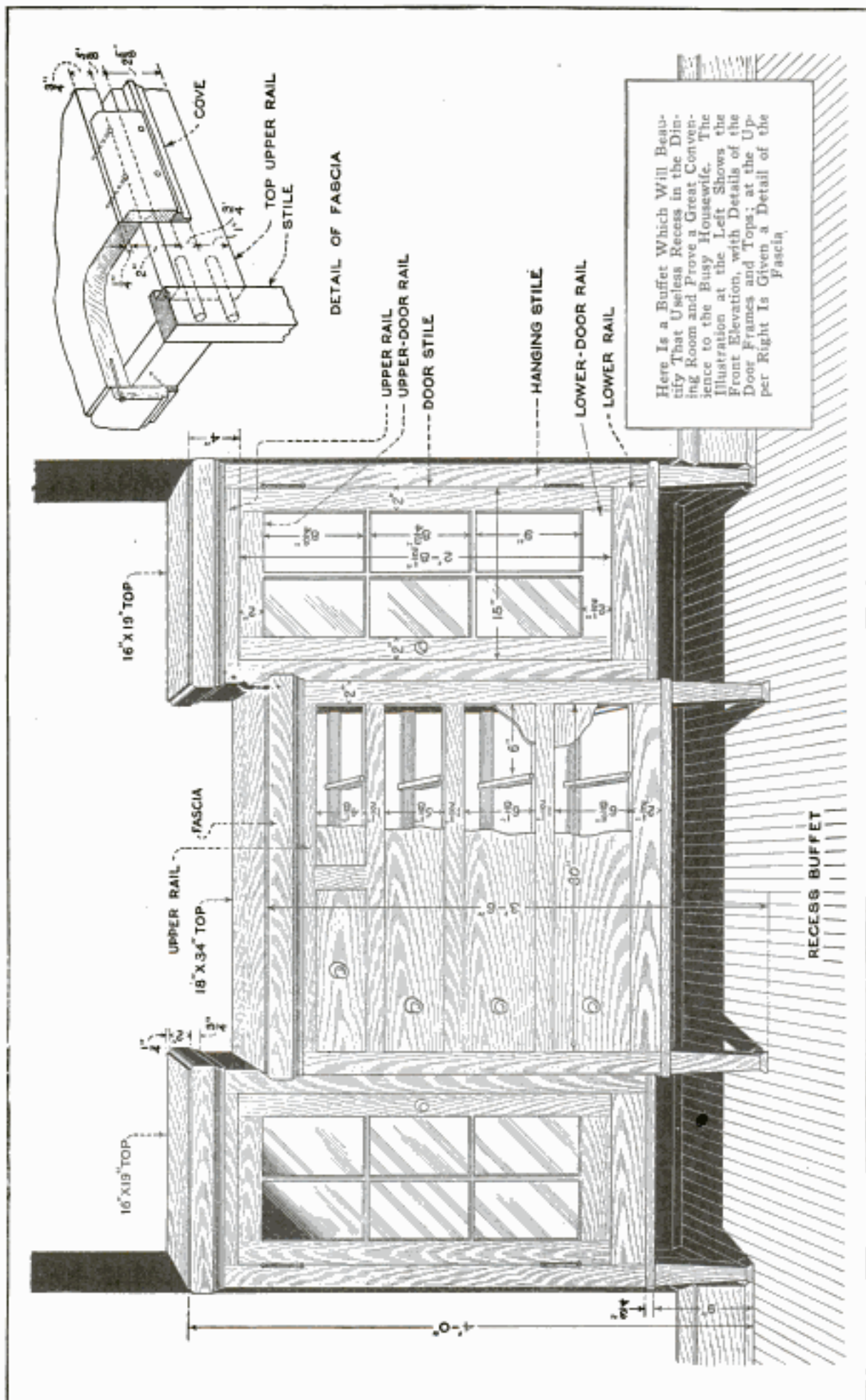



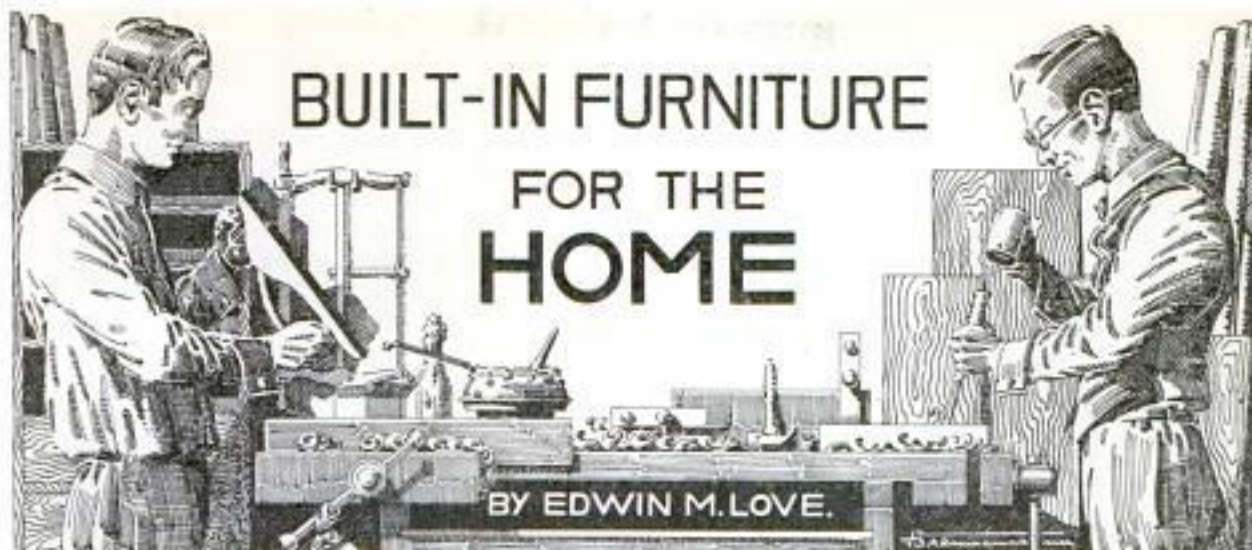

### Part III—A Recess Buffet

**M**ANY dining rooms are disfigured by projecting chimneys, or jogs from clothes closets. The recess buffet illustrated is designed to use and beautify the cubby holes formed by such projections; but the construction is such that, by the addition of end partitions, it can just as easily be built out into the room, using only the back wall for support. Again, a suitable recess might be made by building it into a clothes closet conveniently placed. As with the portable buffet described in Part II, its length may be increased or decreased to fit the space at hand, if care is used in proportioning the width of the drawer chest to the china closets. Using 1 by 10-in. stock, glue up the two partitions, which, when fitted in place, are 1 ft. 5 in. wide and 2 ft. 7½ in. long. Build the front frame for the drawer

chest, using 1½-in. stock, with stiles and upper rail 2 in. net in width, the lower rail being 2½ in. wide, and the drawer rails 1½ in. wide. As the elevation shows, the upper-drawer space is 4⅞ in. wide; the next lower, 5⅞; the next 6⅞, and the lowest 6⅞ in. Joints are united with two ⅜-in. hardwood dowels and glued. If possible, allow the frame to dry thoroughly in the

clamps before removing. Clean off all trickles of glue while wet, and carefully surface the joints flat before placing the frame.

Although the exact heights for the upper edges of the wall cleats are given in the detail, it is well to use the front frame as a template in marking for the drawer cleats, since this takes care of any possible variations. Nail the cleats, of 1 by 2-in. stock, 2 ft. 8½ in. long, to the studding with eight-penny finish nails, guiding by pencil lines leveled across the wall, and keeping the ends plumb. Against these ends, tack the two wide partition boards, and block underneath to hold them steady. Hold a straight-edge horizontally across the front edges to see that they line with the wall; and if they do not, make a suitable allowance in width. Variations in the



View of the Finished Buffet; This Job Is a Comparative'y Simple One for the Amateur Craftsman

plaster at the back make this precaution necessary. Try the front edges for plumbness, and if they lean forward or backward drop a plumb bob down from the top edge and mark suitable lines upon them, then dress or rip accordingly, beveling the edges inward a trifle to insure tight joints outside. Replace the partitions and nail solidly onto the ends of the cleats. Tack



a strip to the top and bottom to hold the front edges parallel, and brace temporarily. This done, nail up the china-case cleats according to dimensions given in the detail. Wedge the back cleats tightly between the side-wall plaster and the partitions. Level guide lines for the shelves on the partitions.

Glue up the shelves from 1 by 8-in. stock, making them 1 ft. 6 $\frac{3}{4}$  in. long. These will dry while other work on the cabinet is being done. Glue and nail the drawer-chest frame to the edges of the partitions. If a particularly good-looking joint is desired, leave the partitions 1 in. wider than called for, and miter the edges to the front frame. This makes a joint that is not quite so strong, but much neater.

Now build the two front frames of the china cases, making the stiles and upper rails of 1 $\frac{1}{8}$  by 2-in. net pine, and the lower rails 1 $\frac{1}{8}$  by 2 $\frac{1}{2}$  in. net. While drying, fit the shelves in their spaces, either by cutting them  $\frac{1}{8}$  in. short and concealing the joints with  $\frac{3}{8}$ -in. quarter-round molding (a rapid method), or by scribing and cutting close to the walls and partitions. Nail to the cleats and into the ends through the partitions. Take great care to keep the fronts plumb.

Fit the china-case frames against the partition and slip them back against the ends of the shelf cleats on the side walls.

The lower shelf projects  $\frac{3}{8}$  in. above the lower rail, forming a stop for the door. The tops of both frames must be alined with each other, and the bottoms must line with the bottoms of the drawer frame and partitions, so that the 1 by 2-in. round-edge bead on the bottom can be mitered neatly. Glue up the tops, using 1 by 10-in. stock.

Build the doors of 1 by 2-in. net material for stiles and upper rails and 1 $\frac{1}{8}$  by 3-in., sized to 2 $\frac{1}{2}$  in. net, for the bottom rails. Cut the stiles 1 in. longer than the finished door and bore for the dowels before rabbeting for the glass molding. The ends of the rails must be carefully notched around in the stiles, as shown, after being bored for dowels. The bars or muntins are cut in between the flanges of the fronts of the doors, the joints at the crossings being half-lapped. This requires careful work, but skillful manipulation will cause the bars to spring inward slightly, so that when the glass is set they will bear tightly against it. Thus one sheet of glass only is necessary. In surfacing the doors, reduce the frame to  $\frac{1}{8}$  in. less in thickness than the hanging stiles, allowing clearance for easy closing.

While the detail of the drawer slides gives exact dimensions, in actual practice it will be found that irregularities in the plaster will necessitate changing their length. They should fit snugly, but care

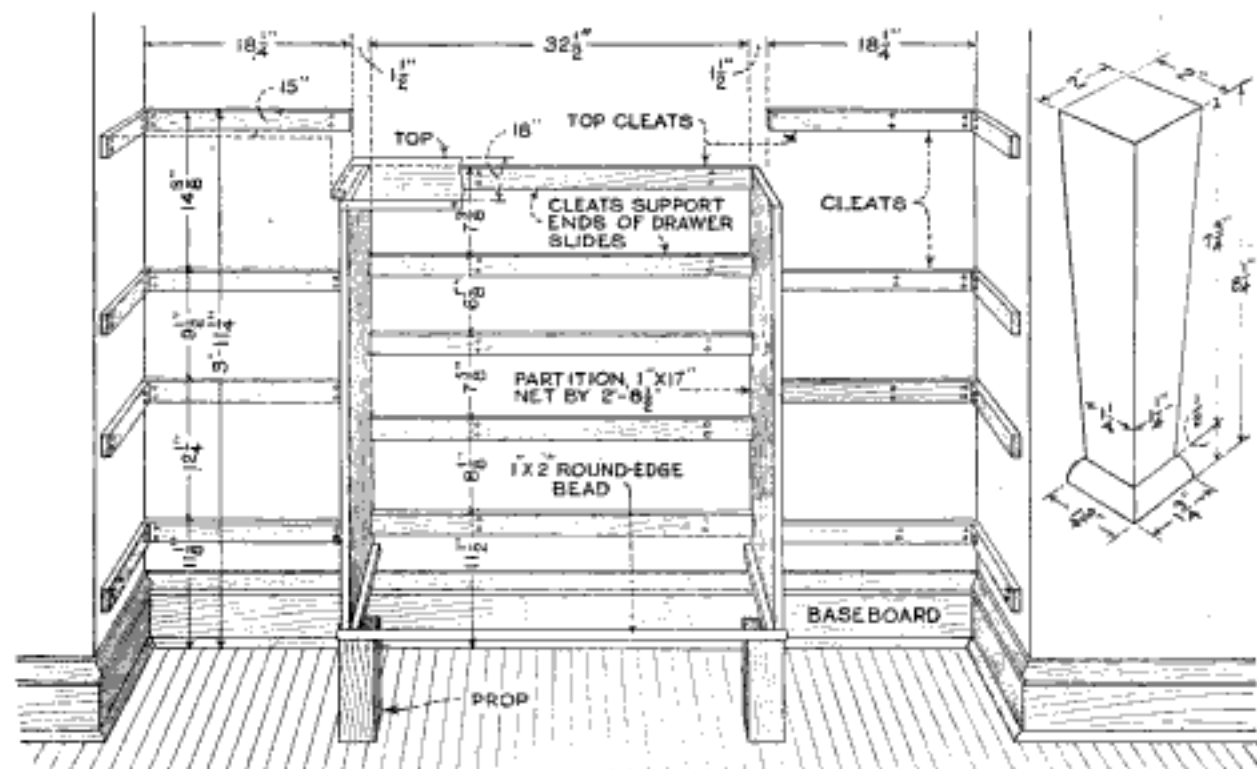

Details of the Shelf and Drawer-Slide Cleats, Nailed to the Wall Studs; Partitions in Place Ready for the Frames, and Detail of Legs



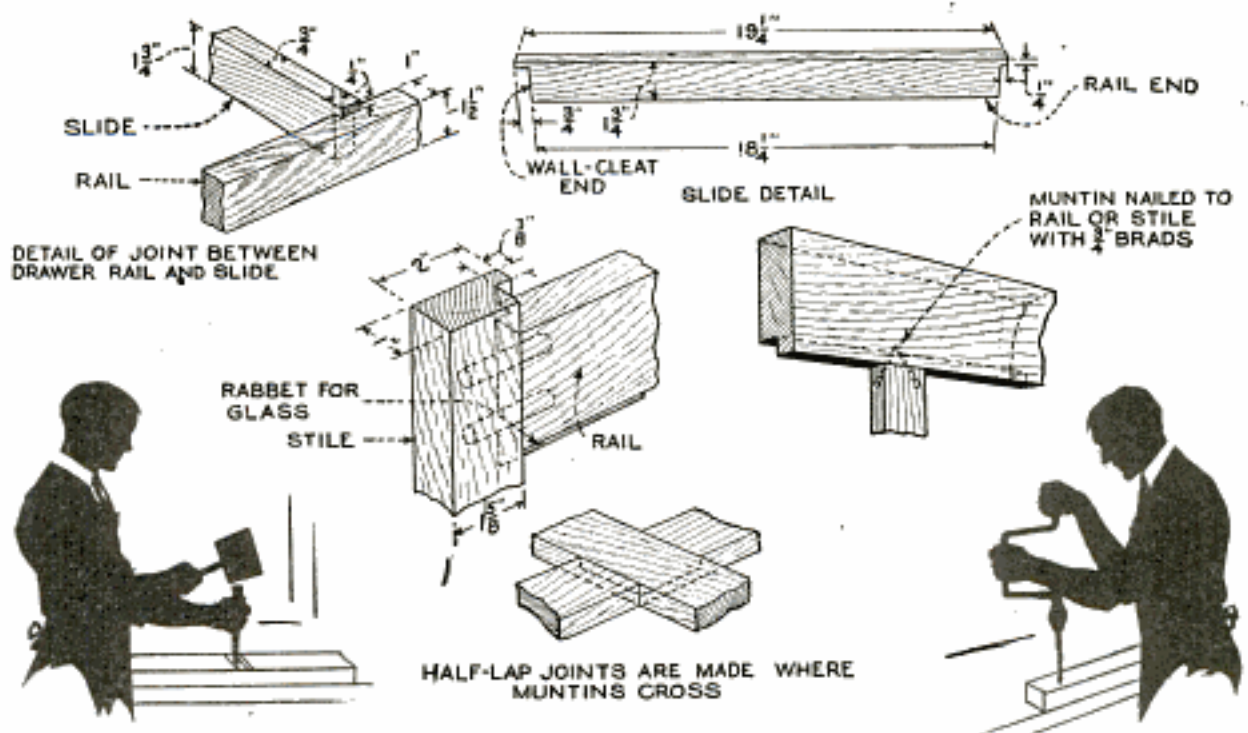

Various Constructional Details; Joints of Drawer Rails and Slides, Door Stile and Rail Joints, Muntin Joints, and Cutting of Drawer Slides

must be taken to prevent them from springing the drawer rails outward. Frequent tests with a straightedge at this stage will eliminate much work in fitting the drawers. Put the guides 6 or 8 in. from the ends of the drawer openings, and those for the two small top drawers in the center of each space, keeping them level and square with the rails. Toenail the front ends from the back.

The front edges of the tops are flush with the front frames. Note that the ends of the drawer-chest top project behind the china-case stiles 1 in., forming a base upon which to support the short sides that project above the chest. If the cabinet is to be painted, these strips may be put in with the grain running horizontally; but

if stained, the grain should be vertical. Miter the fascia, or nosing, around the tops, allowing a margin of  $\frac{1}{8}$  or  $\frac{1}{2}$  in. from the top—a very pleasing line—and fit the cove around underneath. Since the fascia is only  $\frac{5}{8}$  in. thick, and should project beyond the cove, the top of the latter is reduced to  $\frac{3}{8}$  in. in width, both by thinning the back and by removing stock from the front edge.

If it is desired to use three-ply panel veneer for the top, thus eliminating shrinking and warping, use plenty of cleats, carefully lined with each other, as backing, and show not more than a scant  $\frac{1}{8}$  in. margin above the fascia, if any at all, so as to hide the ply joints.

The legs are made of stock, 2 in. square

#### MATERIAL LIST

- |  |   |
|--|---|
| 1 piece, $1\frac{1}{2}$ by 3 in. by 8 ft., pine or fir, S4S, sanded.                           | 1 piece, 2 in. net by 2 in. net by 3 ft., pine (for legs).                                    |
| 3 pieces, $1\frac{1}{2}$ by 2 in. net by 10 ft., pine or fir, S4S, sanded.                     | 1 piece, 1 by 5 in. by 3 ft., drawer front, pine.   |
| 1 piece, $1\frac{1}{2}$ by 2 in. net by 10 ft., pine or fir, S4S, sanded.                      | 1 piece, 1 by 6 in. by 3 ft., drawer front, pine.   |
| 3 pieces, 1 by 2 in. by 8 ft., pine or fir, S4S, sanded.                                       | 1 piece, 1 by 7 in. by 3 ft., drawer front, pine.   |
| 1 piece, 1 by 2 in. by 16 ft., pine or fir, S4S, sanded.                                       | 1 piece, 1 by 8 in. by 3 ft., drawer front, pine.   |
| 1 piece, 1 by 3 in. by 12 ft., pine or fir, S4S, sanded.                                       | Same lengths of $\frac{3}{8}$ -in. stock for drawer backs.                                    |
| 2 pieces, 1 by 8 in. by 10 ft., pine or fir, S4S, sanded.                                      | 1 piece, $\frac{5}{8}$ by 4 in. by 6 ft., drawer sides.                                       |
| 2 pieces, 1 by 10 in. by 14 ft., pine or fir, S4S, sanded.                                     | 1 piece, $\frac{3}{8}$ by 5 in. by 3 ft., drawer sides.                                       |
| 1 piece, $\frac{3}{8}$ by 2 in. net by 10 ft., pine or fir, S4S, sanded.                       | 1 piece, $\frac{5}{8}$ by 6 in. by 3 ft., drawer sides.                                       |
| 1 piece, 1-in. cove, 10 ft. long.  | 1 piece, $\frac{3}{8}$ by 7 in. by 3 ft., drawer sides.                                       |
| 1 piece, 1 by 2-in. round-edge bead, 10 ft. long.  | 10 $1\frac{1}{2}$ -in. glass drawer pulls.  |
| 2 pieces, $\frac{3}{4}$ by 18 in. by 7 ft., three-ply panel veneer (for veneer top).           | 2 pairs $2\frac{1}{2}$ by $2\frac{1}{2}$ -in. loose-pin butts to match other hinges in house. |
| 1 piece, $\frac{3}{8}$ in. net by $\frac{3}{4}$ in. net by 10 ft., pine, sanded (for muntins). | 2 sheets D. S. glass, $11\frac{3}{8}$ in. by 2 ft. $4\frac{3}{8}$ in.                         |
|  | 2 frog catches.   |
|  | 1 lb. eight-penny finish nails.   |
|  | 1 lb. six-penny finish nails.   |
|  | $\frac{1}{2}$ lb. four-penny finish nails.  |
|  | Cost of materials, about \$16.  |
|  | Time to build, about 36 hours.  |



net, tapered on the lower ends to  $1\frac{1}{4}$  in. square, and fitted with hardwood feet, the grain of the latter running crosswise.

In making the drawers, allow  $\frac{1}{8}$  in. clearance for width and  $\frac{1}{16}$  in. in height, using a lip front; that is, the top edge and ends of the fronts are rabbeted to project over the rails and stiles, concealing the joint; this was detailed in Part I. Round off the corners for neatness. Guide strips nailed on the bottom, on each side of the slide, insure smooth drawer action. Tack a length of  $\frac{3}{8}$ -in. quarter-round molding

against the plaster at each end of the buffet to hide the joint between the stiles and the wall, and miter a 1 by 2-in. round-edge bead around the lower edges of the frames. Hang the doors with the hinges projecting in front about  $\frac{1}{2}$  in. Drill the holes for the knob bolts, and bore a  $\frac{3}{8}$ -in. hole for the frog catch in the edge of each stile. Smooth the buffet thoroughly with fine sandpaper before finishing, bearing in mind that the least scratch or bruise will show plainly through the enamel or varnish.

### Repairing Zinc Table Tops

Zinc tops on kitchen tables or cabinets sooner or later crack along the edge of a board that has warped.



At the first sign of such damage, run a strong, sharp knife along the crack and slit the zinc so that the edges turn upward. Dress the edges of the cut down with a flat file and slip a narrow strip of tin under it, working it to the position indicated by the dotted lines, then flatten down the edges. Apply solder with an

iron to sweat the tin and zinc together and to fill up the cut, and finally dress the projecting solder down with a flat file to make the surface smooth. Such a repair is almost unnoticeable and will be even stronger than the rest of the top.—Louis Schneider, Clinton, Mo.

### Chart Record of the Garden

The home gardener often wishes to know what he planted last year and how it came out, but usually the facts are forgotten before the next season. The writer has tried a graphic scheme and found it quite practical. The rows are indicated on a piece of square-ruled paper, each space representing some convenient unit, such as 6 in. The variety of vegetable and date of planting are also recorded, and later in the season the degree of success is indicated.—Chas. F. Goldthwait, Waterbury, Conn.

### How to Clean Jewels

The brilliance of diamonds, sapphires, rubies and emeralds can be restored if they are washed periodically in a little sal volatile and water, the surface being afterward polished with a clean chamois skin or a piece of soft silk. Precious stones in general are usually improved if they are put away in a box containing boxwood sawdust instead of being inclosed in velvet-lined cases. Coral can be successfully cleaned by placing it in boiling water and adding a few pieces of white soap and soda. Boil the coral a few moments, rinse in tepid water and dry on paper.

### Hook for Applying Auto Chains

Auto chains can readily be applied with a hook of the kind shown in the illustration. The hook is made from a length of steel rod, bent as indicated. In use, it is placed over one of the wheel spokes and the second links of the chain are slipped over the bent ends, so that when the car

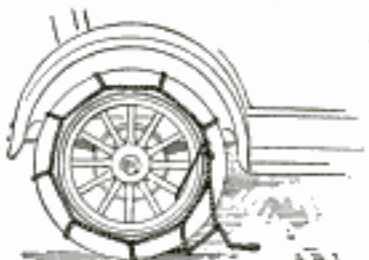
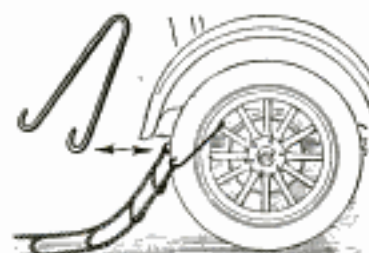

is driven forward, the chain is pulled on the tire. Where the chain comes in contact with the road directly under the tire, the cross links retard the movement, while the hook pulls the chain taut. The first links are then fas-

tened to the opposite ends of the chain, or if this is too loose, the second links are used after the hook has been removed.



# Money-Saving Gas-Stove Hints

## Simple Things That Help to Get the Most Out of the Stove and Heater without Danger to Health

**T**HERE is a right and a wrong way to do everything, even such a simple thing as putting a kettle of water on the stove to boil. Experts say that very few stove users realize the utmost in service and economy that the stove is capable of giving. To get this utmost, the burners should be adjusted so that the flame is high enough to heat the vessel without licking its sides. The food should be ready for cooking before the gas is lighted, and the burner should be turned down immediately the water or food begins to boil. Permitting the contents to boil furiously does not hasten the cooking; it merely wastes gas. Lids should always be used on the pots where possible, as the food then cooks more quickly and gas is saved. Experiments show that cooking in open vessels consumes five times as much gas

as in closed ones. When baking, put as many dishes in the oven at once as possible. Baking each dish separately is a waste in most cases.

The size of utensils has also much to do with the cost, ease and rapidity of cooking. The vessel should always be larger in diameter than the burner, so that most of the heat is concentrated under the pot. Also, there are three-in-one utensils in which three separate dishes can be cooked over one burner so as to save gas. In baking, aluminum, glass, or tin vessels give better results than enameled ware, although the latter is excellent for surface-burner cooking.

The oven must be kept free from rust. The door should be left open about half an hour after each baking, to allow the moisture to evaporate instead of con-

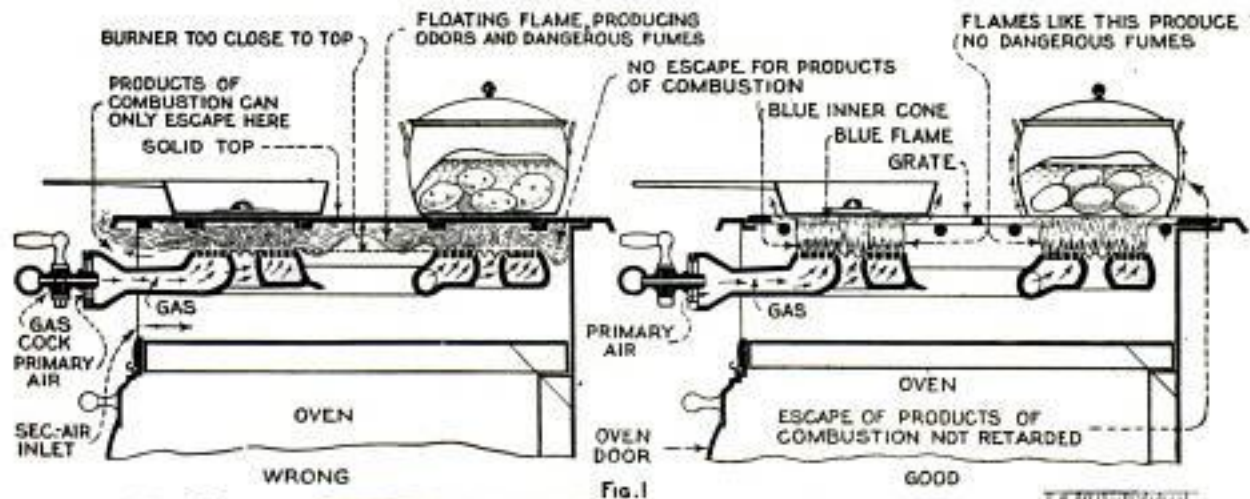

Fig. 1



FIG. 2



There Is Great Danger in Fitting a Solid Top on a Gas Stove Designed for a Grate Top. The Flame Caused by the Change Wastes Heat and Is Bad for Health



densing on the inside. Also, before starting to bake, light the burners, and open the door of the oven for a few minutes. This may seem a waste of gas, but it is not. Any moisture inside the oven will be quickly got rid of, and the practice will lengthen the life and improve the service of the stove.

The burners must be kept clean. This is very easy to do, and a smaller gas bill will soon be the result. Allowing vessels to boil over is one of the commonest causes of clogging the holes in the burner, and should be guarded against. When the burners do get dirty, boil them in a strong solution of lye or washing soda. Then rinse them thoroughly in clean water and set aside to dry. Don't forget to rinse the hands also after using the lye or soda, as these alkalis may hurt tender skins. The cleaning should be done periodically, for the time consumed in the job is more than regained by the saving in gas.

The prudent householder should make no changes in the stove himself, nor permit any self-styled expert to do so in order to "make it more economical." A stove should never be altered unless the local gas company has been first consulted and has approved of the changes, or it may become actually dangerous in more than one way.

A common change made in gas stoves is that shown in Fig. 2. This stove originally had a grate top. The owner, however, was induced to equip it with a solid top, being led to believe that the latter was more efficient, and would not only aid in cooking meals quicker, but retain the heat longer and "concentrate" the heat of the individual burners under the cooking vessels. The result of the change was that the housewife began to suffer from headaches, nausea, fainting spells and similar ills, and this continued until the grate top was replaced, on the advice of the gas company. Fortunately this stove was used in a large kitchen, one door of which was always open, or the result might have been more serious.

The diagrams in Fig. 1 show what happens when a solid top is substituted for a grate top. For the proper combustion of the gas two supplies of air are necessary: the primary air, which enters the burner with the gas, and that which is drawn from the underside and the top of the burner; the latter is called the secondary air. With the solid top, the latter supply is cut down until there is not enough for complete combustion of the gas, and the result is a so-called "floating" flame, which produces an unpleasant odor and dangerous fumes.

There is no escape for the products of combustion except through the front of the stove, under the top, and if a person stands there for any length of time, as is often necessary, the effect is soon felt. If all the burners are in use, the condition is, of course, aggravated, and the room becomes filled with the fumes. With the grate top, on the other hand, the escape of the products of combustion is not hindered; there is a plentiful supply of secondary air, and, provided the primary-air inlet at the cock is adjusted correctly, the flame is smokeless and odorless, and the food will be cooked quickly and without danger to the occupant of the room. The flame should be blue; if it is yellow, heat is being wasted and the gas company should be called upon immediately to adjust the burner.

Gas water heaters are also a potential source of danger, if improperly installed. Fig. 3 shows a bathroom in which a poorly adjusted water heater caused the partial asphyxiation of one person, and, but for the accidental discovery of the victim, might have led to his death. The heater was installed without a vent connection, and the window and door were both kept closed at all times. The water heater should never be in the bathroom, for if the doors and windows are kept closed, no matter how perfect its adjustment, it will consume much of the oxygen in the room, combustion will gradually become imperfect, and the person in the room may succumb to carbon-monoxide poisoning.

In Fig. 4 is shown a gas heater upon which someone had placed a basin of water. Whether this was done with the idea of supplying the necessary moisture to the air, or to heat water for some other purpose, the result was the same. The basin closed the vent holes in the top of the heater, thus restricting the supply of secondary air, and causing a floating flame, with its accompanying dangerous fumes. This led to a near-fatality also, although with the basin removed, the heater was perfectly safe.

A common method of installing a gas plate is shown in Fig. 5, in the condition in which it was found after an intoxicated person had stumbled against it and pulled it from the flimsy shelf on which it was placed. The man was dead when found. The plate was not screwed or clamped to the shelf; the tubing was old, there was no cock to cut off the supply of gas to the tubing and one connection was simply wrapped with a rag. This is an extremely poor installation, but there are thousands like it, each one a death trap.



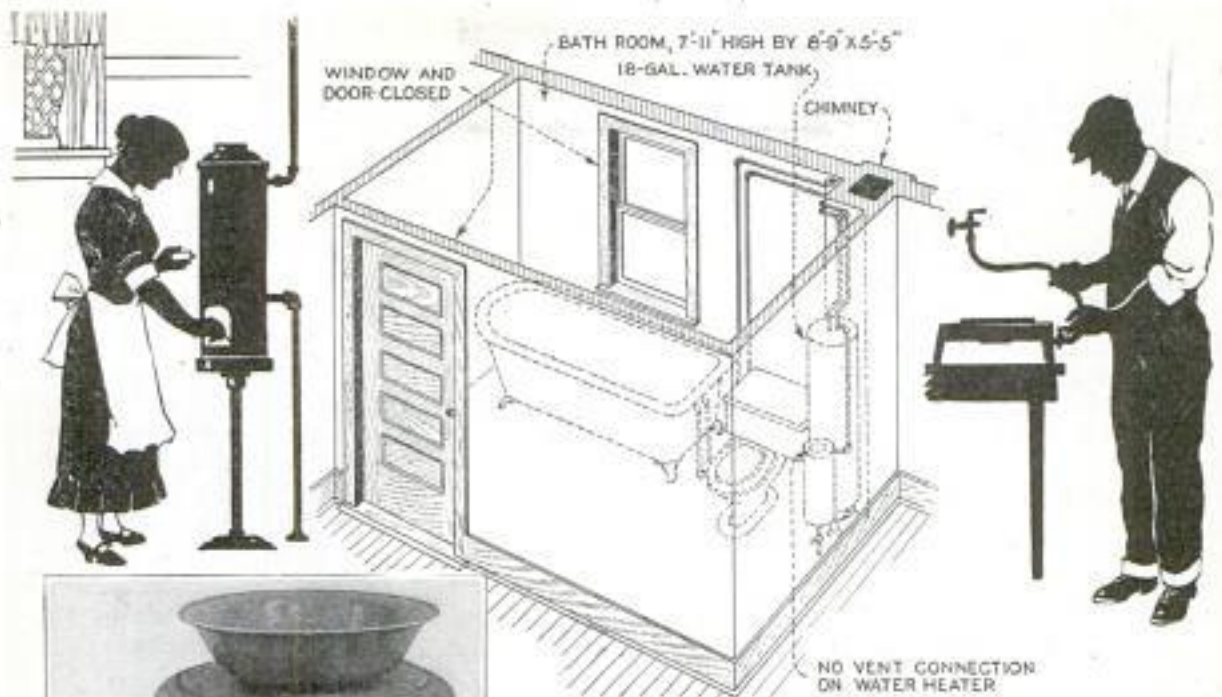

Fig. 4

Fig. 3

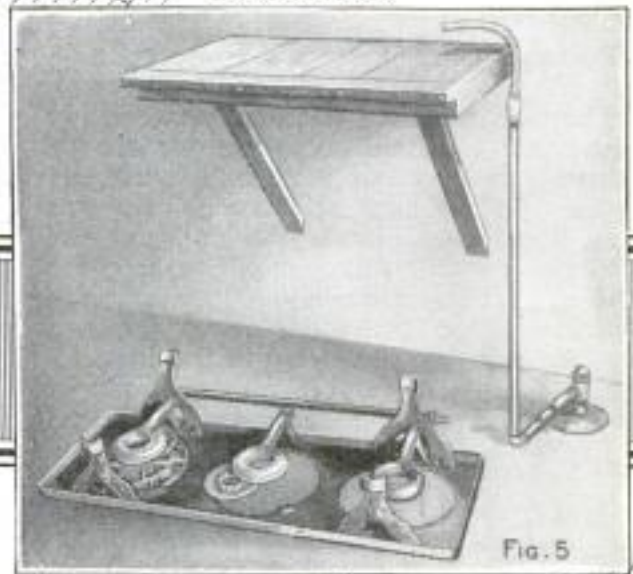

Fig. 5

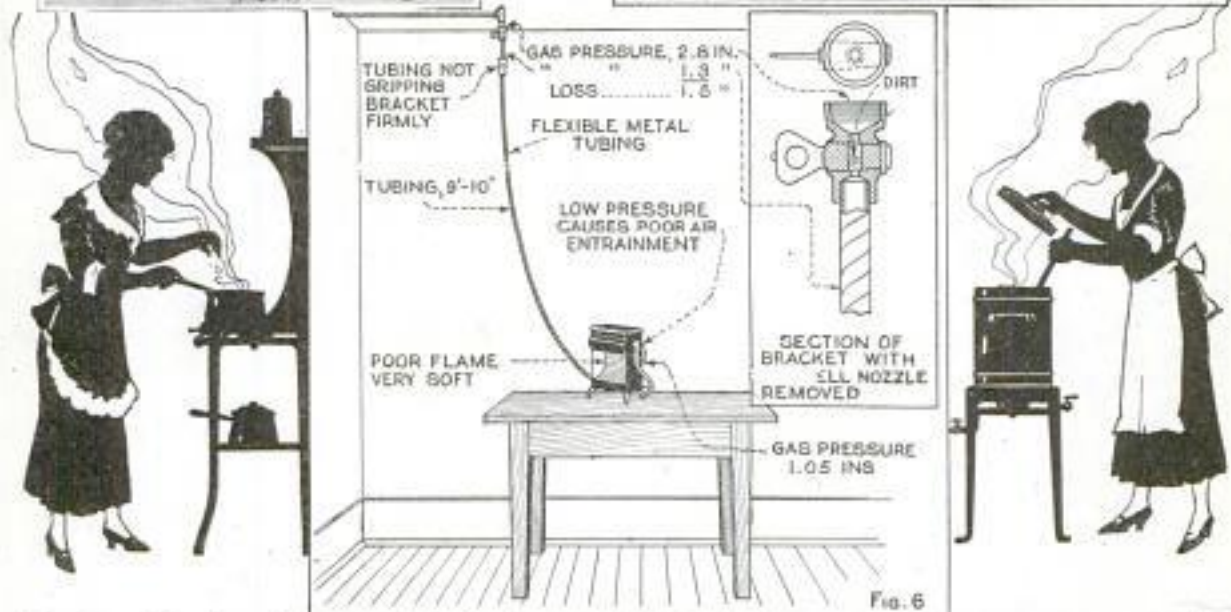

Fig. 6

Here Are a Number of Dangerous Practices in Installing Gas Appliances. Good Installations Are as Easily Made as Poor Ones, and Are Not a Menace to Life and Health as Are Those Shown Here



Gas appliances are often installed by those not familiar with them in the manner shown in Fig. 6. This is not only dangerous, but very wasteful of gas. Gas-lighting fixtures are not designed to supply heating appliances, but in the case shown the long tube is attached to an ordinary gaslight bracket with the ell nozzle removed. The hole in the gaslight cock is too small for the job in the first place, and it takes very little dirt to stop it almost entirely. In this case the gas pressure at the line was 2.8 in.; the loss through the cock was 1.5 in., and the loss through the tubing .25 in., leaving only a pressure of 1.05 in. at the heater. This low pressure caused poor air entrainment, which resulted in a very "soft" yellow flame. Heaters of this type, and all other gas appliances, should be so installed that the amount of tubing required is as small

as possible; in fact, if no tubing at all is used so much the better. Also, the cocks used should be designed for appliance service.

Cheap gas tubing is dear at any price. This is shown by the fact that 240 deaths have occurred in New York city in the past five years from this cause. The difference in cost between safe and dangerous tubing is only about 25 per cent, but the risk is tremendous. The foundation of good gas tubing is a jointless spiral metal tube, over which is a covering of rubber, coated with gelatin to make it impervious to gas. Over this is a wrapping of fiber, and, as a final protection, a braided cotton or silk jacket. The rubber end pieces should be of best quality, firmly attached with glue, and should be clamped on with metal ferrules if they are to withstand being pulled over gas cocks.

### Portable Curb Runways Protect Car

There was plenty of room between my house and the one next door for a wide garage driveway but none had ever been made. As the curb at the sidewalk was 6 in. high it was impossible to drive the car over it without danger of breaking the springs. This difficulty, however, was overcome by providing two inclined wooden runways as shown in the illustration. They were placed on the street at right angles to the curb, and held against

the latter by means of flat-iron hooks. Thus they could readily be picked up so that they would not be a hindrance to traffic on the street.—Robert H. Leitfred, New York City.

### Keeping Plants Moist

When leaving home for a visit, and it is not desired to bother neighbors to care for the flowers, put all the pots together on a piece of tile in a cool and shady place in the house (if it is not freezing weather) and place a saucer under each pot. After giving the soil a good soaking so that some of the water runs into the saucers, cover the top thickly with moss, and the plants will not need water for quite a while.

Another good way is to put one end of a wick, made by braiding together several lengths of thick knitting yarn, in a pail of water and the other on the soil in the pot, near the root of the plant. The wick should reach to the bottom of the pail. The water will pass by capillary attraction from the pail and will supply plenty of moisture to the soil. Plants cared for in this manner will keep moist for several weeks.—Miss Z. I. Dahvice, Grand Rapids, Mich.

### Preventing Vinegar from Darkening

Vinegar usually becomes darker with age. This moderate and gradual change in color, which it shares with all fruit juices, is natural and need cause no alarm. Sometimes, however, it becomes excessively dark, in fact almost black. This is

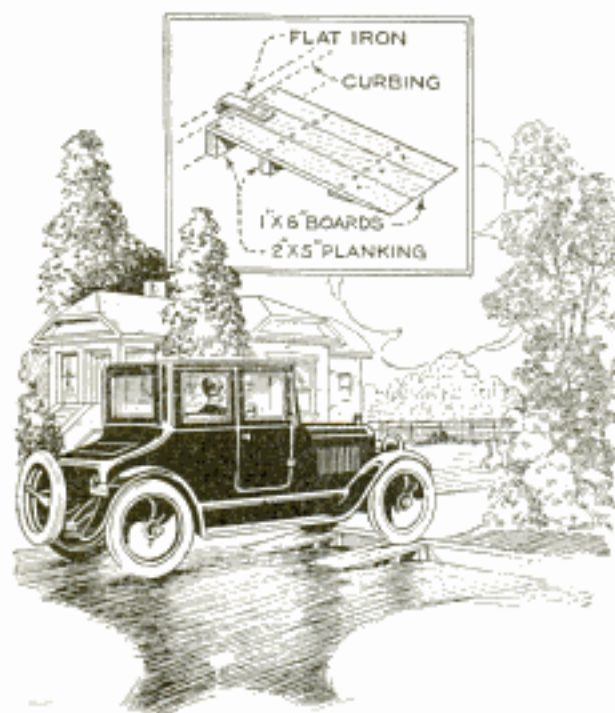

Inclined Wooden Runways Permit Autos to Run over High Curb



caused by the presence of tannin, which is a normal constituent of vinegar, and iron salts which have been introduced during the manufacturing process, and it is the chemical interaction of these two substances that produces the dark color. The discoloring can usually be eliminated by "fining" with gelatin in the following manner: Prepare a solution of  $\frac{1}{2}$  oz. of good edible gelatin by covering it with 1 qt. of water, allowing this to stand for some time, then heating until the gelatin is completely dissolved. This quantity is sufficient to treat a barrel of vinegar, into which it is thoroughly mixed by stirring. After a while the gelatin settles, leaving the vinegar clear. The clear liquid is then siphoned off and the remainder filtered to remove the sediment.

### Winding Wall Clocks



Carrying a ladder to open, wind or set wall clocks in offices, stores or schools is a troublesome task that is made entirely unnecessary by the use of the simple device shown in the drawing. The key of the clock is soldered to a crank made of stout wire which is mounted through a hole drilled in the end of a long pole so that it can turn easily. A piece of flat steel is also fastened to the end of the pole and projects about 2 in. This piece is used to open the door of the clock and to

set the hands: the key may then be inserted and the winding accomplished by the mere raising and lowering of the pole.

When making floating lids for developing tanks give them one or two coats of the varnish that is sold by sporting-goods stores for varnishing fishing rods. It is waterproof and is more convenient to use than paraffin.

### Holder for Water Bottles

In many cities drinking water is bought in 5-gal. glass bottles and unless specially



Holder for Large Bottles of Drinking Water Facilitates Pouring

constructed stands are used to hold them, it is rather difficult to obtain water from them without spilling, as they are clumsy and quite heavy to handle, especially for women. A homemade holder, which eliminates this trouble, is shown in the drawing. One U-shaped piece of heavy flat iron and two rings of 1-in. band iron, are riveted together to form a snug-fitting receptacle for the bottle. This is in turn pivoted on a U-shaped support, of the same material as the other "U" and securely screwed to a wooden base. This arrangement permits the bottle to be swung over to pour the water out. The pivots should be located just above the center of the bottle's height, so that a child can readily tilt it.—V. S. Martin, Drumright, Oklahoma.

### Measuring without a Rule

It is often necessary to measure some object or distance without a rule or tape. In cases where an error of  $\frac{1}{8}$  in. per foot is permissible, the following method can be resorted to: Take a silver dollar, and mark off eight diameters on a stick or piece of paper. As the diameter of a silver dollar is  $1\frac{1}{2}$  in., this distance will be very close to 12 in.—Frank W. Bentley, Jr., Missouri Valley, Iowa.



### Re-Hairing a Violin Bow

Few violin students, or full-fledged players for that matter, know that the re-hairing of a bow of which the hair has become worn out is a job that they can do themselves, and well too. The writer has re-haired as many as seven bows in less than half a day, and has never had any trouble with any of them. New hair can

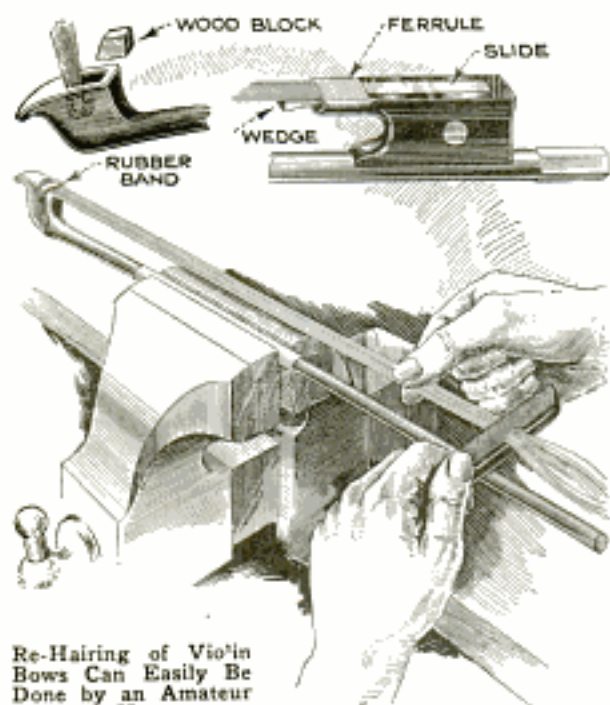

Re-Hairing of Violin Bows Can Easily Be Done by an Amateur at Home

be purchased at any music-supply house and, in smaller cities, usually at a drug store. It comes in rolls, each containing enough for one bow, and costs from 25 to 50 cents per roll.

The old hair is first cut off near each end and the small wooden block and hair from the hole in the tip, or nut, of the bow are removed with a pocketknife. The glue in the hole is then cleaned out with the point of the knife. The small wedge holding the hair and ferrule at the opposite, or frog, end of the bow is also carefully taken out, the ferrule pried off, and the pearl slide pulled out, taking care not to break it. It is then an easy matter to get the hair and glue out at this end. The bow is next placed in a small bench vise, as shown in the lower part of the drawing, a piece of paper or cloth being wrapped around the bow, to protect it from being marred by the vise jaws. The new hair is now unrolled, the knotted end held close to a lighted candle or match to melt the wax at this end, scorching the hair but not destroying the wrapping of thread. Cover the thread wrapping with glue and warm it by holding the candle or match close to

it. Put about two drops of glue in the hole at the nut and place the hair in the hole. Spread the hair a little near the end by pinching it with the finger and thumb and force the wooden block down into the hole over the end of the hair, pushing it down flush with the tip so that the hair can be drawn over it smoothly. A rubber band is used to hold the hair in this position. The hair is now combed out straight with a fine-tooth comb, starting at the nut and working toward the frog from the underside. In doing this, follow the comb with the finger and thumb as indicated, holding the hair evenly and tightly. The frog is then loosened, by turning the hexagon nut at the end of the bow, and pushed as far forward as possible. Hold it in this position and pull the hair tight; then wind the hair with thread at the point directly over the hole in the frog and clip off the loose ends with a pair of scissors. Treat this end of the hair the same way as the hair at the nut, with glue and candle or matches, scorching the ends to form a knot. Put two or three drops of glue in the hole, slip the ferrule over the hair, place the end of the latter in the hole, and press the wooden block down so that the pearl slide can be pushed in over it. Then replace the ferrule on the end of the frog. Using the comb, straighten the hair and spread it evenly, and hold it securely in this spread position with the fingers while forcing the small wedge under it into the end of the ferrule. The hexagon at the end is then screwed up enough to take the slack out of the hair. There will be a few loose hairs, but these can be picked up with a pin and clipped off at each end of the bow. Loose hairs should never be pulled out of the bow as this may loosen some others. The bow is then hung up to dry overnight, after which the resin is applied and it is ready for use.—F. J. Hiscock, Cody, Wyo.

### Relining Ford Transmission Bands

When relining Ford transmission bands it has been found advantageous to cut a piece out at the bottom as shown in the drawing. This permits the oil to work through the transmission, enabling the car to start more easily when cold and causing the grip band to work more freely. The lining is attached in the usual way and the piece cut out afterward.—A. Bronson, Argyle, Wis.





# RADIO

The word 'RADIO' is written in large, bold, serif letters. On either side of the letters are silhouettes of people. On the left, a man stands with a woman, both looking towards a radio on a table. On the right, a man sits at a table with a radio, while a woman and child stand nearby.

## Building a Charging Panel 434-R

**I**N certain parts of the larger cities, and in many other localities, the lighting current is direct. If this is the case, the tuncar or the vibrating type of charger cannot be used for recharging radio batteries. It is a simple matter, however, to build a small charging panel that will meet the requirements. The reader who has a d. c. supply is fortunate, in a way, because a charging panel can be built for much less than he would have to pay for a charger of the rectifying type. The panel is so designed that the battery can be placed on charge by merely throwing two switches. This eliminates any changing of wires or danger of wrong connections.

Of the parts needed for building this instrument many will be found among the odds and ends around the home or workshop and the remainder can be bought at any electrical-supply dealer's. The requirements are: a bakelite or formica panel,  $\frac{3}{16}$  by 10 by 12 in.; two small angle irons; a baseboard  $\frac{1}{2}$  by 6 by 12 in.; one 25-volt, 15-amp. single-pole, single-throw knife switch; one 125-volt, 30-amp. double-pole, double-throw knife switch (these switches are of the common porcelain-base type); one cheap auto ammeter, reading charge and discharge; one 125-volt, 5-amp. snap switch; four porcelain cleat receptacles; three 32-cp. car-



Left, Front View of the Panel, Nearing Completion; Right, Close-Up of the Panel and Lamp Bank, Showing How the Leads Are Brought Down from the Panel to the Bank and Neatly Clamped to the Shelf



bon lamps; a 10-amp. fuse; two battery clamps; one  $\frac{1}{2}$  by 6-in. bakelite strip for the terminals, and six binding posts; sufficient lamp cord or fixture wire to install the instrument; seven 6-32 brass or nickel-plated machine screws,  $\frac{1}{2}$  in. long; four 6-32 brass machine screws, 1 in. long, and sixteen wood screws. The reader will note that the instrument panel is mounted on a table, and the lamp bank on a shelf under it. This arrangement is recommended to avoid heating and warping of the panel, but any similar arrangement that would be handier for the builder can be used.

Referring to the circuit diagram, the single-pole switch at the left is for the purpose of cutting the A-battery line from the receiver, and can be omitted if desired, as most receivers have off points on the rheostats or a filament switch for this purpose. The ammeter is mounted flush with the front of the panel by means of three machine screws. This ammeter shows the rate of charge and discharge; one side of the ammeter is connected to one side of the lever of the double-pole switch at the right, and the other side to one battery post on the terminal strip. The other lever post of the double-pole switch goes to the other battery terminal on the strip. The upper left-hand post of this switch is connected to one side of the bank of carbon lamps, and the other to one line post on the terminal strip. The lower-left post on the switch is connected to one side of the single-pole switch and the other lower post on the switch is connected to the second battery post on the strip. The snap switch is mounted below the ammeter, in the center of the panel; one side of this switch is connected to the fuse receptacle, and the other side to the bank of carbon lamps. The lamp bank and the fuse socket are mounted on a board, the terminal strip being screwed at

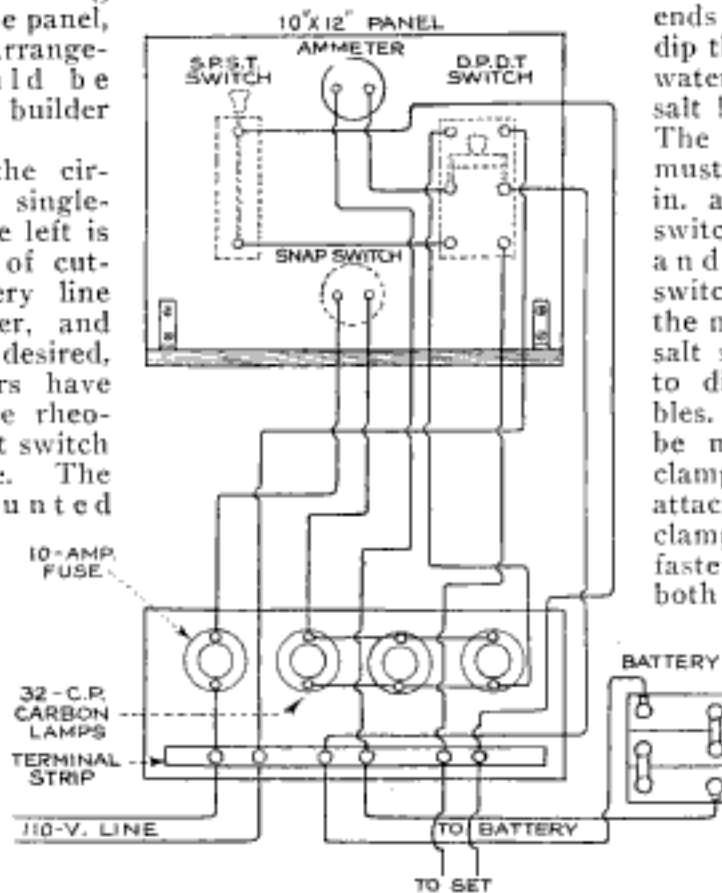

WIRING DIAGRAM FOR PANEL AND LAMP BANK

the rear of the lamp bank, the fuse at the left and the lamps in a line at the right. The circuit diagram clearly shows the method of connecting the lamps and fuse plug. The three 32-cp. carbon lamps will pass 3 amp.; this will answer for all practical purposes. If a greater current is desired, use more of the lamps; each lamp of this type will pass 1 ampere.

Before connecting the leads to the storage battery it is necessary to determine their polarity. Bare the ends of the wires, and dip them into a glass of water in which a little salt has been dissolved. The ends of the wires must be kept at least  $\frac{1}{2}$  in. apart. The snap switch being turned on and the double-pole switch lever thrown up, the negative wire in the salt solution will begin to discharge gas bubbles. This wire should be marked and the clamp marked negative attached to it. The other clamp should then be fastened to its wire and both clamps attached to the battery.

positive clamp to positive terminal and negative to negative. Now, upon throwing the switches as before, the ammeter should read "charge." If it reads "dis-

charge," reverse the ammeter connections. The single-pole switch should always be open, for safety's sake, when the battery is charging, and the snap switch turned off when the current is going to the set. The double-pole switch is thrown down and the single-pole switch thrown in when it is desired to use the set. To check the polarity of the wires leading to the set, use the salt solution as before, and mark the wires, or the terminal strip to which they are led, positive and negative.

Ⓐ Washington inventor has developed apparatus that will photograph a message, transmit it by radio and reproduce it at the receiving end. The invention is expected to be especially useful in China, due to the number of characters in the language.



### Soundproof Building Materials Tested by Radio

353- (R)

To determine the relative soundproof qualities of materials used in apartment-house construction, the bureau of standards has developed novel radio instruments that produce and accurately record sound of a measured tone, pitch and volume, the factors that affect its penetrating quality. The tests are carried out in a specially constructed room, divided into two sections by a soundproof partition. A large square section of the partition is removable, and may be

replaced by a closely fitting section of the material to be tested. The sound-producing apparatus is located on one side of the partition; this consists of a three-tube set with a circuit so arranged that the first tube can be made to "howl" at any desired frequency. The remaining tubes amplify the output of the first tube so that it can operate an ordinary loud speaker. The latter is mounted on a revolving arm, driven by an electric motor, so as to break up the sound "pattern" produced. The sound is picked up by a receiver on the other side of the par-

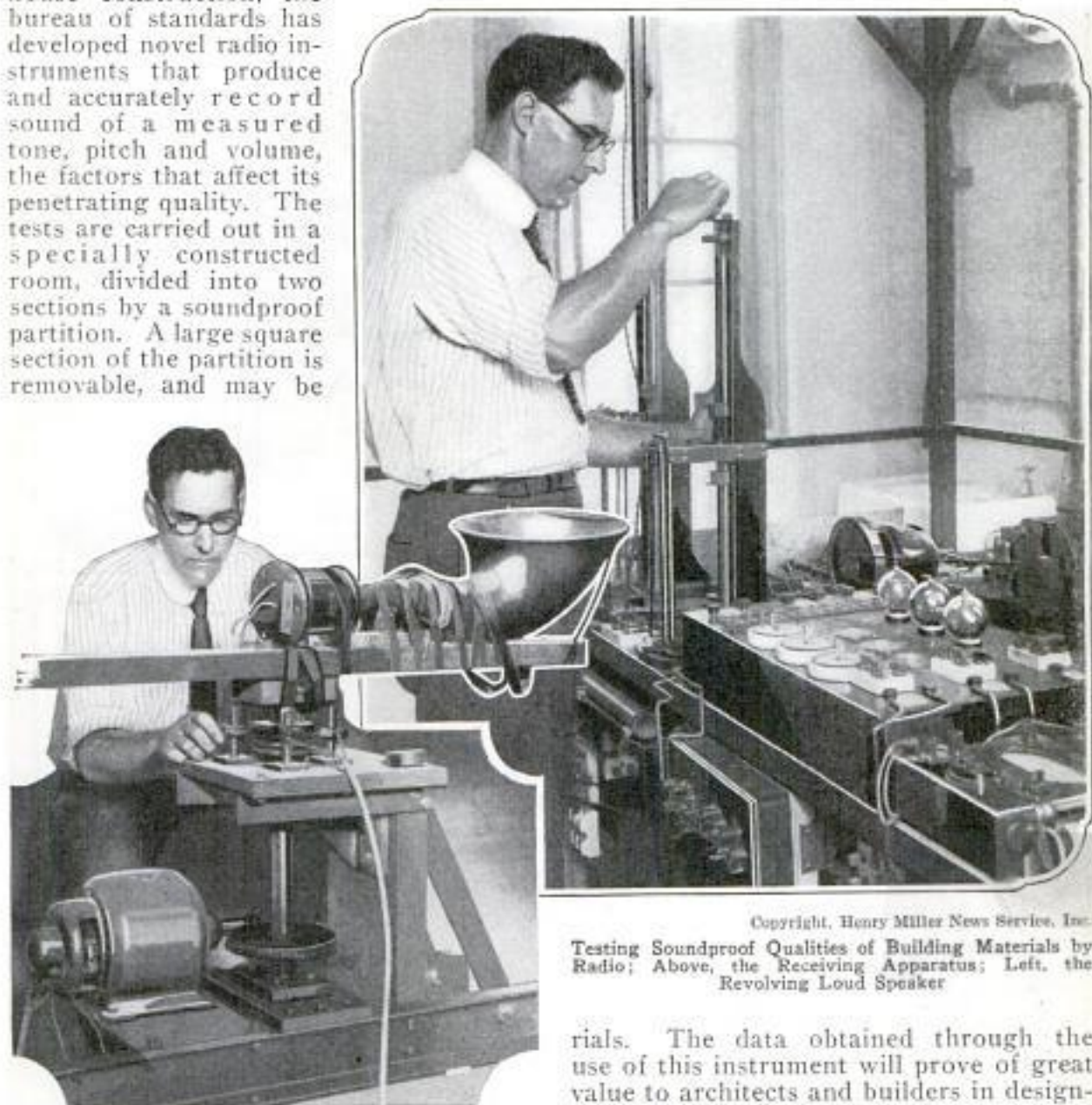

Copyright, Henry Miller News Service, Inc.  
Testing Soundproof Qualities of Building Materials by Radio; Above, the Receiving Apparatus; Left, the Revolving Loud Speaker

replaced by a closely fitting section of the material to be tested.

The sound-producing apparatus is located on one side of the partition; this consists of a three-tube set with a circuit so arranged that the first tube can be made to "howl" at any desired frequency. The remaining tubes amplify the output of the first tube so that it can operate an ordinary loud speaker. The latter is mounted on a revolving arm, driven by an electric motor, so as to break up the sound "pattern" produced. The sound is picked up by a receiver on the other side of the par-

tion, and the intensity of the signals received by the detector amplified so that they will deflect a sensitive galvanometer, thus affording a means of comparing the soundproof qualities of the various materials. The data obtained through the use of this instrument will prove of great value to architects and builders in designing homes and apartments, offices in factory buildings, or any other type of structure where the exclusion of noise is a matter of importance. 29. R

Ⓢ The silverlike deposit on the inside of vacuum tubes occurs in the manufacturing process, when metallic magnesium is flashed inside the tube toward the end of the evacuating process. This is supposed to take up the last remaining gas inside the tube. Some tubes are of a reddish-brown color, and this is caused by a similar treatment, in which phosphorus is used in addition to the magnesium.







423-62



# How to Build the Popular Mechanics' Superheterodyne Eight

By F. L. Brittin

**R**EPRESENTING the closest approach to perfection yet attained, the superheterodyne circuit well deserves its widespread popularity. It is the general opinion of radio experts that any further advancement will not come until some discovery is made that will upset all our present methods of radio communication.

The superheterodyne receiver described in this article embodies all the most advanced ideas pertaining to this circuit. Nothing has been overlooked that would add to the efficiency of the instrument. Every piece of apparatus used in its construction has been carefully selected and thoroughly tested by the author; the completed instrument seemingly leaves little to be desired in selectivity, range and clearness of tone. All body-capacity effects have been eliminated by simple shielding, and the instrument is easily tuned, even by a novice, after a few minutes of instruction. The

receiver can be built at a fraction of the cost of similar manufactured instruments, and has many refinements not yet included in the superheterodyne receivers on the market.

Any radio fan can build this instrument as only a few simple tools are required. If the reader follows the directions closely he will encounter very few difficulties. All

parts are standard, and easily obtained from any dealer in radio supplies. There are many good instrument kits on the market for the construction of superheterodyne receivers, but the instruments in such kits are intended for operation in a circuit especially designed by the manufacturer. Such kits should not be purchased with a view to using the instruments in the circuit described here, as any departure from those specified herein will result in loss of the perfect balance that is absolutely necessary in this type of receiver. The

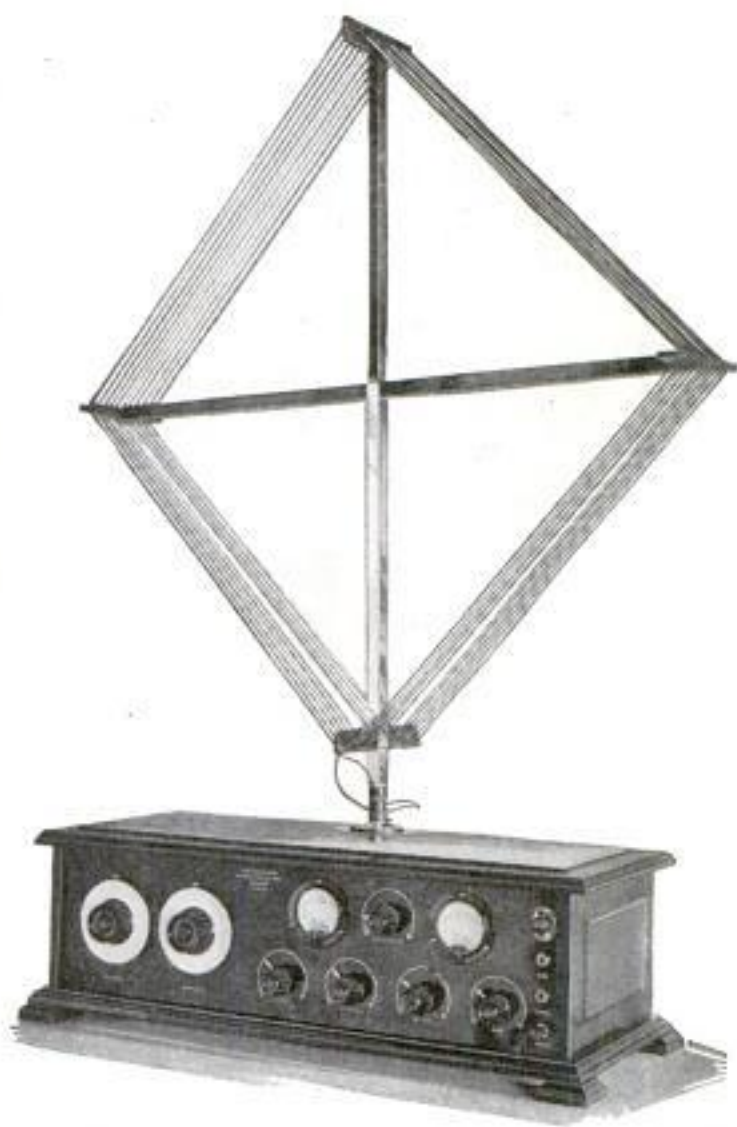

View of the Completed Superheterodyne Receiver, with Collapsible Loop Extended and Plugged into the Jack in the Cabinet Lid



superheterodyne circuit employs a force that is extremely sensitive, and at the same time powerful, and cannot be compared to any other type of circuit.

Before attempting to build the instrument, read this article carefully, to become familiar with all the details. Obtain all the parts, even to the smallest items, such as screws, wire, lugs, etc., before starting actual construction. By doing this, you will find every step described much easier to follow. Equip yourself with a good small electric soldering iron, a small tin of non-acid soldering paste, and a coil of solid-wire solder. It is essential that all connections be soldered, using lugs under all binding posts, and also under all terminal posts of sockets, rheostats, voltmeters, and transformers. Screw these lugs down tightly and solder the connecting wires of the circuit to them; use very little soldering paste, and wipe it off carefully before applying the solder; the paste is used more to clean the surface than to act as a flux, and a very thin film is sufficient. The paste has a tendency to run under the terminal posts and make poor connections unless this precaution is taken. This advice is given in advance of all other construction details because poorly soldered connections will cause failure, even if every other detail is followed exactly.

Some of the tools necessary are as follows: A pair of long-nosed pliers; blunt-nosed pliers; small side-cutting pliers; a small screwdriver; a heavy screwdriver; a small hacksaw; a hand drill; a center punch and a scribe. An ice-pick makes a good and easily ob-

tained tool for this purpose. Do not make marks on the panel with a lead pencil.

Refer now to the drawing of the front-panel template. Obtain some heavy cardboard, such as bristol board, to make this. It is always best to make a template of the front panel so that the holes for mounting the various instruments can be properly located. The panel is of radion, 7 by 26 by  $\frac{3}{16}$  in. in dimensions; these panels can be obtained already cut to this size from your local dealer and may be had in either mahogany or black finish; the material machines well. Lay the panel on the bristol board and carefully outline it; then cut the bristol board to the exact size of the panel. On the template thus made locate the position of the holes for mounting the various instruments. Lay out this template exactly as shown in the drawing. In the template drawing the oscillator condenser is shown at the left of the panel, and the wave-length condenser to its right; in the diagram of connections this

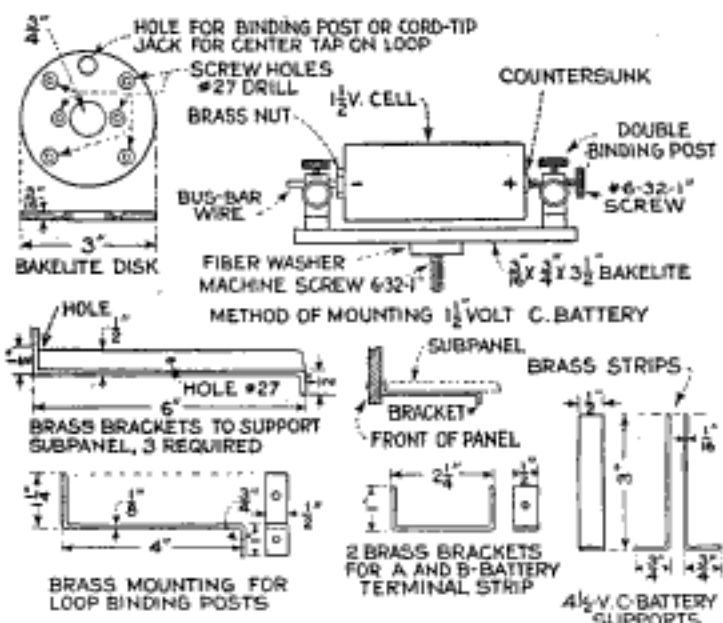

ALL HOLES MARKED  $\odot$  ARE COUNTERSUNK

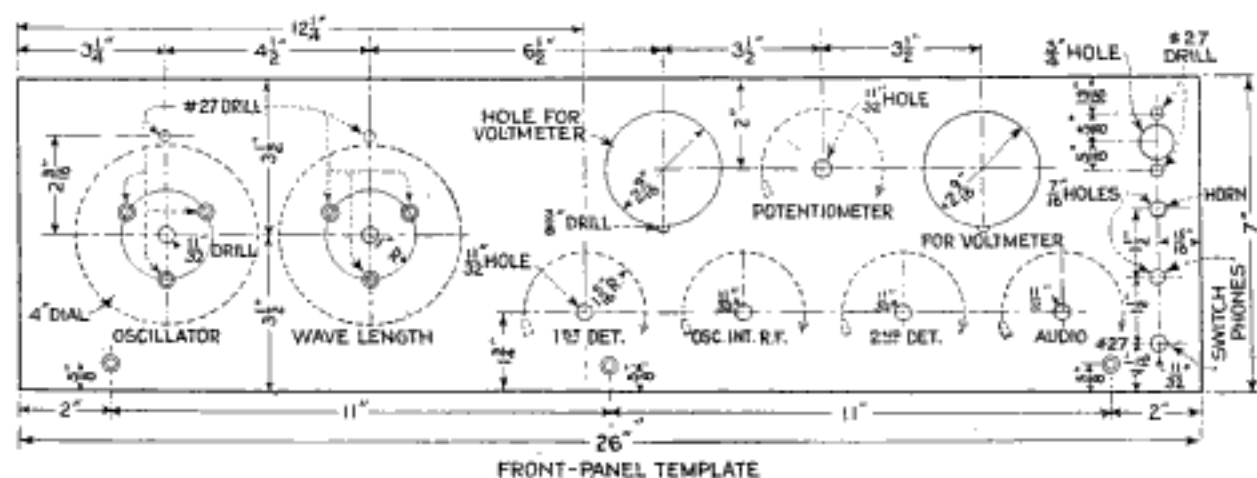

FRONT-PANEL TEMPLATE

Above, Various Constructional Details; Method of Mounting Flashlight Cells. Disk for Loop Mounting. Binding-Post, C-Battery and Subpanel Brackets; Below, Layout of Template for Drilling Front Panel



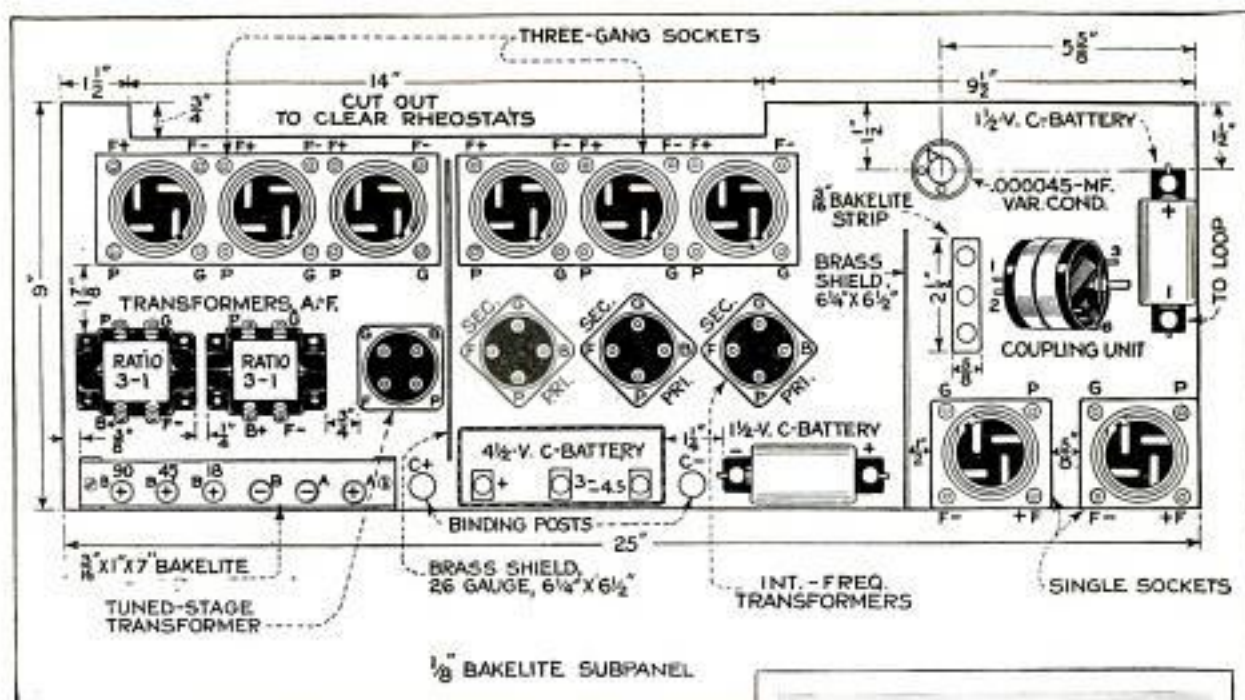

Above, Layout of Subpanel, Showing Location of the Various Instruments; Below, View of Rear of Completed Instrument

arrangement is reversed. The panel template is correct, and the reverse arrangement was used in the diagram merely to simplify the tracing of connections.

After the template is completed, lay it on the panel and clamp it at the edges with small C-clamps, so that the template cannot shift on the panel while locating the holes for the instruments. Now, with the center punch or icepick, carefully mark the center of each hole through the template into the panel; make each mark in the panel deep enough so that no errors will be made when drilling. Then remove the template from the panel. Always drill the panel from front.

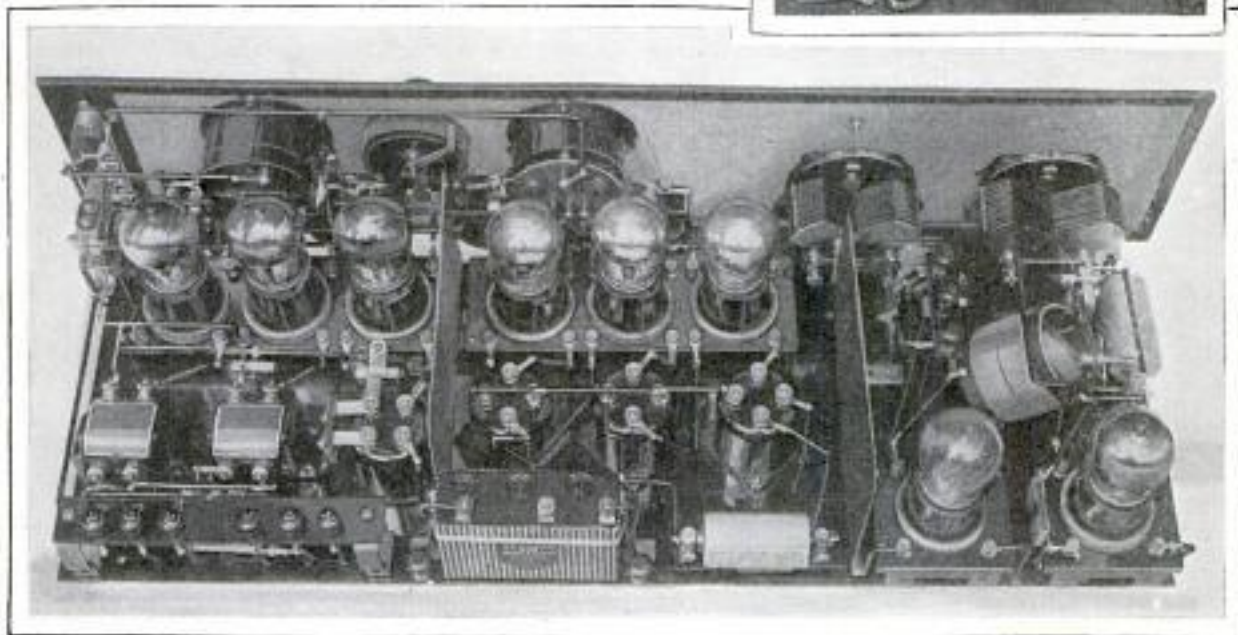



to back, never from back to front. It will be noted that the oscillator and the wavelength condenser holes, shown with the double circle, are to be countersunk for machine screws. A No. 27 drill is used for all screw holes, and an  $1\frac{1}{2}$ -in. drill for the shafts of the condensers and rheostats. The rheostats are of the new single-hole mounting type, and have a little projecting point at the outer edge, on the side that goes next to the panel. This point is for the purpose of preventing the rheostat from turning out of position; drill a small hole part way into the rear of the panel to fit it, being careful not to drill the hole any deeper into the panel than is necessary to take the point and permit the rheostat to lie flat against the panel. The rheostats are mounted with the terminals up, to facilitate the wiring of the circuit. The potentiometer is mounted in the same manner as the rheostats, except that the terminals are turned down. After the rheostats are fitted to the panel, remove them. Now drill the holes for the voltmeters; this will not be easy unless one is equipped with an expanding or wing bit. It will be best to have these holes drilled in the local machine shop. It is necessary first to make the  $\frac{3}{16}$ -in. cut-out at the lower edge of the hole for the voltmeter; this is done with a  $\frac{3}{8}$ -in. drill, right on the line of the larger hole, and the latter,  $2\frac{9}{16}$  in. in diameter, is then drilled. The  $\frac{3}{16}$ -in. cut-outs are to take the shafts of the little pointers and switches on the voltmeters. Place the voltmeters in the holes and mark off the mounting-screw holes. The exact location of these holes will be found when the voltmeters are fitted into place on the panel; care should be taken in marking and drilling them so that the voltmeters will be lined up correctly when the screws are placed in position. Use a No. 27 drill for the holes and nickelplated screws for mounting the voltmeters. They provide a check on the condition of the A and B-batteries at all times and prevent using excessive filament voltage.

In the upper right-hand corner of the panel will be found the  $\frac{3}{4}$ -in. hole for mounting the red pilot light; the socket for this is of a standard nickelplated auto dash-light type and mounted on the front of the panel. The lamp is a 2-cp. 6-volt double-contact bulb, and can be had in colors (red is used by the author); this lamp is lighted whenever the instrument is in operation and reminds the operator

not to leave the instrument without first cutting off the A-battery from the tubes; this feature will be appreciated by anyone who has inadvertently left his tubes lighted, and returned later to find his A-battery run down. The screw holes above and below the  $\frac{3}{4}$ -in. hole are for the nickelplated machine screws used to mount the pilot-lamp socket.

Directly below the pilot lamp are the holes for mounting the horn jack, and lower down the hole for the phone jack; these holes are  $\frac{7}{16}$  in. in diameter. The horn jack is of the filament-control type, and the second audio-frequency amplifying tube remains unlighted until the plug from the horn or loud speaker is pushed into this jack. The author has found it unnecessary to use the loud speaker in the horn jack on many stations, even some 500 or more miles away, because the volume obtained when the loud speaker is plugged into the phone jack is more than sufficient; there is really more amplification than one knows what to do with, unless the instrument is detuned. For extremely distant stations, however, the second step of audio-frequency amplification can be used to good advantage. The phone jack is of the open-circuit type. The hole for mounting the push-pull filament switch is located directly below the phone jack; this hole is drilled with the  $1\frac{1}{2}$ -in. drill. Use the No. 27 drill for the holes at the lower edge of the panel, to mount the brass brackets that support the bakelite subpanel. The drilling of the front panel is now finished. If there are any instruments mounted on this panel, remove them, and the panel is ready for engraving; this can be dispensed with, if desired, and transfers or other markers used; however, engraving adds much to the appearance of the completed instrument, and good work can be obtained in most any city for from 3 to 5 cents a letter; for the arrows around the rheostat knobs the cost is from 12 to 15 cents each.

The next step after the panel has been engraved, and the builder has made sure that all holes have been drilled, and that those so marked have been countersunk, is to fit the sheet of tinfoil on the back of the panel. This tinfoil sheet is 6 by 24 in. in size; coat one side of the foil with a good grade of orange shellac and stick it on the back of the panel. The foil should be placed on the panel  $\frac{1}{4}$  in. from the end where the oscillator and wave-

What are your radio problems? Perhaps the same trouble that perplexes you has also been encountered by another reader. Turn to page 352 and you may find the solution among the questions and answers there. If not, write to us, and the services of our radio experts will be placed at your disposal. This service is free, so do not hesitate to ask us to help you.



length condensers are to be mounted, and  $\frac{1}{2}$  in. from the top and bottom of the panel; it will now reach across the panel to a point about  $1\frac{3}{4}$  in. from the other end; this is clearly seen in the photo of the rear-panel assembly. The foil will stick tightly to the panel and effectually shield the instrument from any hand capacity when tuning. Before the shellac has had time to dry hard, cut away the foil from around the instrument-mounting holes (a safety-razor blade is handy for this purpose); be sure that the foil does not touch any of the instruments when they are mounted on the panel. The writer used a 3-in. square of mica between each of the rheostats and the panel, and also between the potentiometer and the panel. Thin mica sheet was used, and a hole sufficiently large for the shafts of the instruments cut with the points of a pair of dividers. This is an extra precaution, but insures that no metal on the rheostats or potentiometer will come in

shield; these brackets are made from  $\frac{1}{8}$ -in. brass strip,  $\frac{1}{2}$  in. wide and 7 in. long. A  $\frac{1}{2}$ -in. bend is made at each end in the manner shown in the detail drawing. There are three of these brackets, and holes for the machine screws used to mount the panel on the brackets are drilled through the upturned end of each, using a No. 27 drill. A hole is also drilled through the center of each bracket for the short  $\frac{1}{2}$ -in. machine screws used to mount the subpanel on the brackets. The turned-down ends of the brackets then form supports for the subpanel and rest on the bottom of the cabinet; the brackets hold the subpanel  $\frac{1}{2}$  in. above the bottom of the cabinet and permit wiring under the subpanel. Remember that the subpanel is not yet mounted on the brackets; the latter are supporting the front panel by means of machine screws through the upturned ends; the screws used have flat black-japanned heads, and are countersunk flush with the front of the panel.

## LIST OF MATERIALS

1 3-16 by 7 by 26 in. radion panel mahoganyized (or black).....	\$ 4.00	1 No. 601 Dubilier micadon condenser .0005-mf., with grid-leak clips.....	\$ .45
1 $\frac{1}{4}$ by 9 by 25 in. formica or bakelite subpanel.....	3.38	1 No. 601 Dubilier micadon condenser .00025-mf., plain.....	.35
3 No. 600 Remler intermediate-frequency transformers.....	18.00	1 Dubilier by-pass condenser .5-mf.....	.90
1 No. 610 Remler tuned-stage transformer.....	6.00	1 " by-pass condenser 1-mf.....	1.25
2 No. 631 Remler .0005-mf. capacity units (variable condensers), complete with dials.....	10.00	1 Daven grid leak, 2 meg.....	.50
1 No. 620 Remler coupling unit.....	3.00	2 1 $\frac{1}{2}$ -volt flashlight cells.....	.40
2 No. 619 Frost shock-absorber sockets, 3-gang type, standard base.....	6.50	1 bakelite disk 3-16 by 3 in. in diameter.....	.15
2 No. 618 Frost shock-absorber sockets, single, standard base.....	2.50	1 auto dash-light socket, nickel, flush-mounting type.....	.35
1 No. 651 Frost vernier rheostat, 6-ohm, single-hole mounting type.....	1.25	1 auto lamp, 2 cp., 6-volt (red if possible).....	.30
2 No. 650 Frost rheostats, 6-ohm, single-hole mounting type.....	2.20	1 strip of bakelite, 3-16 by 1 by 7 in.....	.14
1 No. 657 Frost rheostat, 25-ohm, single-hole mounting type.....	1.25	2 strips of bakelite 3-16 by $\frac{3}{4}$ by $3\frac{1}{2}$ in.....	.16
1 No. 654 Frost potentiometer, 400-ohm, single-hole mounting type.....	1.25	6 binding posts, Eby type, with engraved tops for A and B-bats.....	1.20
1 No. 233 Frost jack, open-circuit type.....	.70	5 binding posts, plain.....	.50
1 No. 235 " jack, filament-control type.....	.95	20 2-foot lengths of tinned-copper bus-bar wire.....	.75
1 No. 608 " push-pull filament switch.....	.30	15 3-foot lengths of good-grade black spaghetti tubing.....	1.80
1 No. 250 " loop jack and plug complete.....	1.50	7 doz. tinned-copper lugs, long type, round hole.....	.70
1 No. 850 Chelton midget variable condenser .000045-mf., table-mounting type.....	1.50	1 strip of bakelite, 3-16 by $\frac{3}{4}$ by $2\frac{1}{2}$ in.....	.06
2 R-12 All-American audio-frequency transformers, ratio 3 to 1.....	9.00	4 double binding posts.....	.40
1 No. 55 Jewell voltmeter 0-8 volts, d.c., three-reading type.....	10.00	1 sheet tinfoil, 6 by 24 in.....	.10
1 No. 55 Jewell voltmeter, combination A and B, 0-10 and 0-100.....	10.00	2 brass sheets .016 in. thick, 6 $\frac{1}{4}$ by 6 $\frac{1}{2}$ in.....	.40
1 Mathieson collapsible loop, three-terminal type.....	12.50	3 brass brackets $\frac{3}{8}$ by $\frac{1}{2}$ by 7 in.....	.45
1 No. 601 Dubilier micadon condenser .006-mf.....	.75	1 brass bracket $\frac{3}{8}$ by $\frac{3}{8}$ by 6 in.....	.10
3 No. 601 Dubilier micadon condensers .0025-mf.....	1.20	2 brass brackets 1-16 by $\frac{1}{2}$ by $4\frac{1}{2}$ in.....	.15
		1 4 $\frac{1}{2}$ -volt Burgess C-battery.....	.40
		8 6-32 brass machine screws, 1 $\frac{1}{2}$ in. long, with nuts.....	.10
		2 6-32 brass machine screws, 1-in. long, with nuts.....	.05
		15 6-32 brass machine screws, $\frac{3}{4}$ in. long, with nuts.....	.15
		26 6-32 brass machine screws, $\frac{1}{2}$ in. long, with nuts.....	.30
		6 wood screws, nickelplated, oval head, 1 in. long.....	.10

contact with the foil. Use a little alcohol for removing any traces of shellac remaining on the panel.

The brass brackets for supporting the subpanel are then screwed to the lower part of the panel and make contact at this point with the foil, for grounding the

The brackets act as a support for the front panel and all the instruments of the latter can now be mounted in their proper positions, after soldering lugs have been placed under all the instrument terminals. The front panel is then completed.

(Continued Next Month)



392-R Kadet & Herbert

POPULAR MECHANICS

Radio  
Review  
C. W. P.

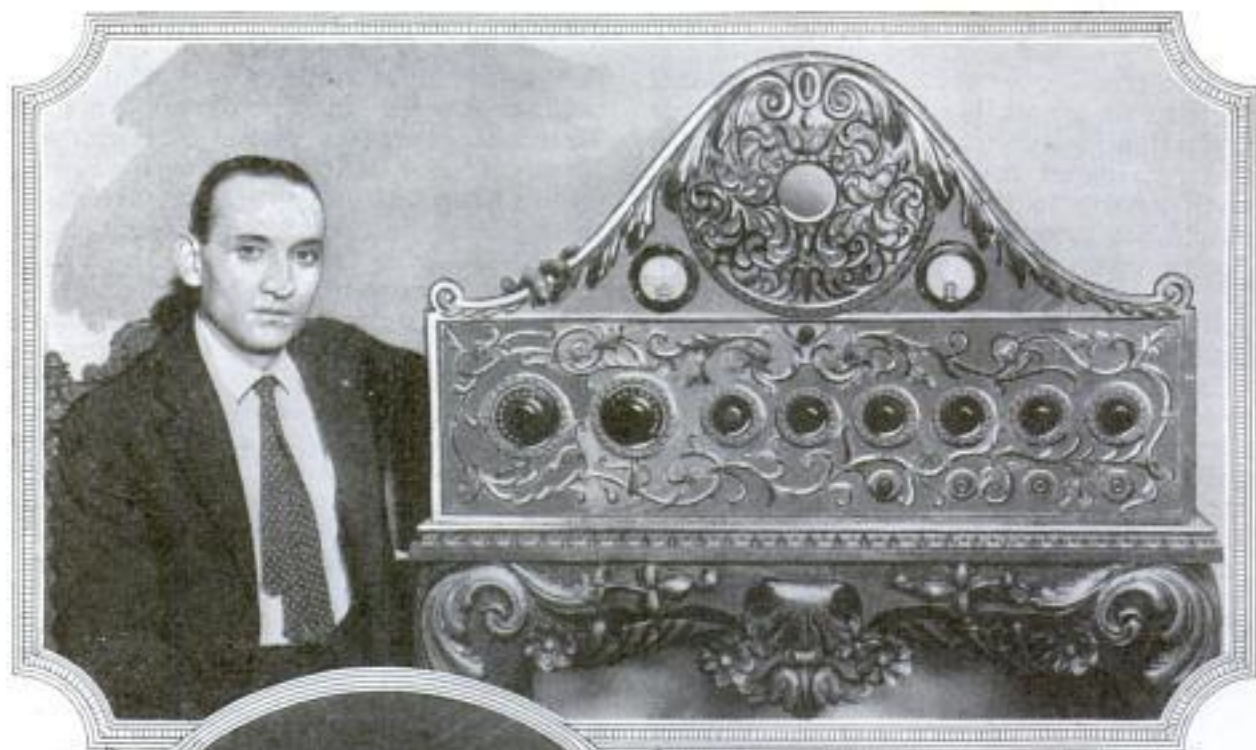

398-R

406 R

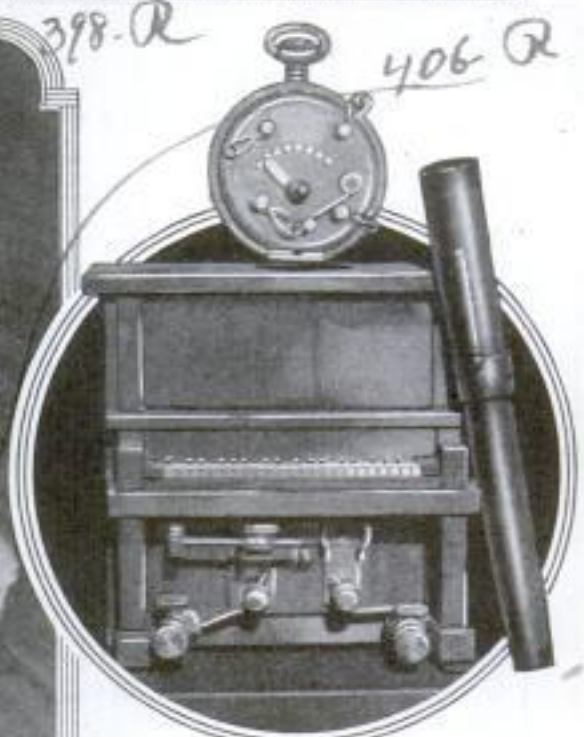

406-R  
Photo Tappan, 229 W. 52nd St.  
New York City

Here Are a Few of the Freak Sets Shown at the Radio World's Fair. At the Top Is Shown Alfred Savastano's Superheterodyne, with Its Panel of Beaten, Chased Copper, and Its Built-In Loud Speaker. At the Left Is the "Lollypop" Crystal Set, Which Miss Mary Junk Says She Likes Better Than Any of the Multi-Tube Sets She Has Seen; Above, a Real Receiver Built in a Watch Case, and a Crystal Set Built as a Miniature Piano; the Pen Merely Shows the Relative Size, and Is Not a Radio Receiver

Kadet & Herbert



403 *Photo Topics*

*Radio Weekly photo*

POPULAR MECHANICS

399 *R.*

329

*Kadel + Herbert*



The Tiny Crystal Receiving Set Mounted on a Wrist Strap, Shown Above, Proved Very Popular with the Ladies at the Show, as Did the Set Built into a Vanity Case Shown at the Right; Considerable Ingenuity Is Displayed by the Builders of Sets like These, and the Best of It Is That, Despite Their Unconventional Design, They Work, and Work Well

*389-R*

*404-G*

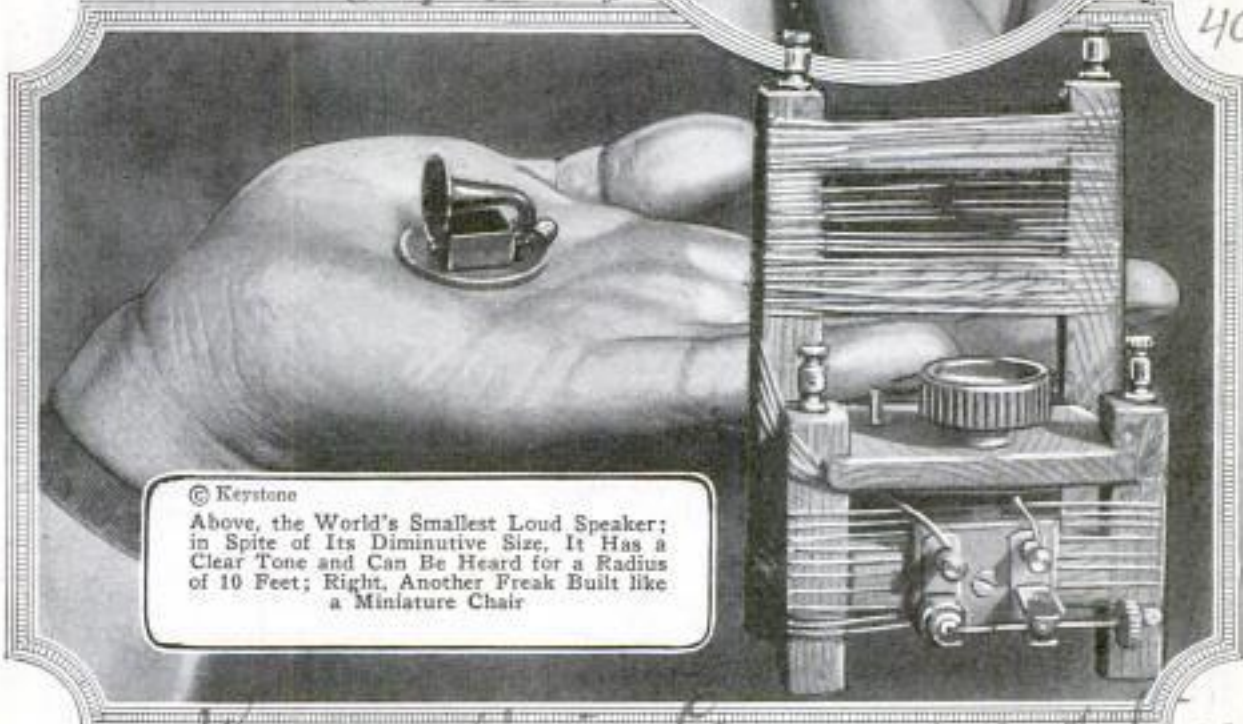

© Keystone

Above, the World's Smallest Loud Speaker; in Spite of Its Diminutive Size, It Has a Clear Tone and Can Be Heard for a Radius of 10 Feet; Right, Another Freak Built like a Miniature Chair

*Keystone Union Co.*

*Photo Topics*



**"Baby" Transmitter Made for Home Use**

Dr. Lee DeForest's latest invention, a compact portable radio-telephone transmitter, is designed for use in the home, in the office, on large ranches, etc. This

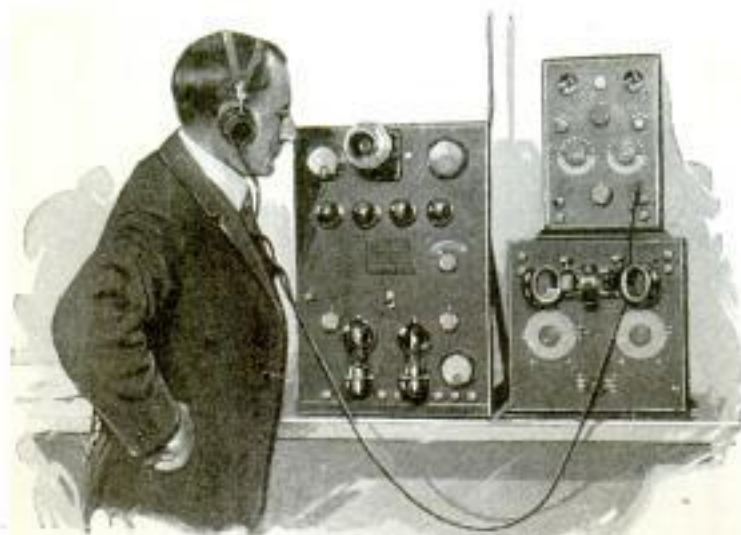

Copyright, Western Newspaper Union  
Designed for Use on 110-Volt Current, This "Baby" Transmitter  
Has an Operating Range of 30 Miles

wonderful little instrument has an operating range of close to 30 miles, and sound-wave filters prevent interference or unauthorized listening in, as the receivers used with the set can be adjusted to pick up the waves from the transmitter while other sets cannot. The whole outfit is designed so that it can be operated by an amateur. It is anticipated that it can be sold for around \$200, and if this can be attained, such "baby" sets will find a wide field of usefulness.

414  
**Resin-Core Solder Aids  
in Wiring Sets**

In conquering the problem of radio frequency, radio engineers and manufacturers learned of the importance of using only a pure resin flux for all soldered joints. Tests show that where acids, pastes and compounds are used, they either spatter, fume or run over surrounding delicate parts. This causes leakage and reduces resistance in a manner comparable to a grid leak. Therefore these fluxes should never be used on radio work.

To assist in developing better soldering, a special radio solder has been put on the market in a most convenient form. It is a hollow ribbon of genuine tin and lead, having inside a pure resin flux. This flux is in proportion to the surrounding solder and feeds out as the solder is used.

**Economy Tips for Battery Users**

Do not use too small a B-battery in the set. The smaller sizes will not give good service in multiple-tube sets, as they will depreciate rapidly, necessitating frequent renewals. The number and type of the tubes, as well as the range desired, should determine the size of battery required.

Make certain that the B-battery is not connected to the A-battery terminals, or the filaments of the tubes will be burned out. Burn the tubes at the lowest possible point that will give good reception. Turning them higher will not give better results and will drain the battery more rapidly. Do not touch the rheostat after it has been adjusted properly. Don't use any more tubes than necessary to bring in the desired station. Many users burn all the tubes in a multiple-tube set on local stations, for example, and then detune to lessen the volume of sound. This is very wasteful.

For local stations it is seldom necessary to use more than the first stage of audio-frequency amplification.

Current is flowing as long as the filament is lighted. Common sense demands, therefore, that the tubes be turned out as soon as the user has finished listening.

**Preventing Headphone Cords  
from Twisting** 401-DR

Headphones often have a tendency to turn around in the frames that hold them and this causes the cord to kink, making



it unhandy to put the set over the ears. An easy way to overcome this difficulty is to remove each phone and slip a short heavy rubber band over the sliding adjustment rod, as shown in the illustration; unscrew the rubber

cap of the phone; pass a piece of string through the rubber band, and wind the string in the last two threads on the phone body. Then, by screwing the cap tight, the string will be securely held on the shell, and the phones cannot turn.—L. B. Robbins, Harwich, Mass.





All Shop Notes published in 1924, in book form—Fifty Cents—from our Book Department

## A Simple Trap Nest for Poultry

COMMERCIAL poultrymen, who keep and breed hens for egg production and for exhibition, regard the use of trap nests as highly essential for obtaining accurate egg-laying records. Upon the basis of these records the unprofitable hens are culled out of the flock, and eggs from the most productive hens are selected for incubation. A trap nest is so arranged that the entrance of a hen automatically closes the door and confines her in the nest until released by an attendant, who notes the number on her leg band and sees that she is properly credited in the record book, if she has laid an egg. The attendant should visit the nest at least four times daily, although more frequent visits are preferable, especially during the laying season. There should be approximately one-fourth as many nests as there are hens, and the nests should preferably be attached to the underside of the dropping boards or arranged on the walls so that they will not occupy any floor space, and will permit the hens to pass under them freely.

A trap nest that has been found entirely satisfactory and can readily be made by anyone handy with tools is shown in

the illustrations. It is a three-compartment nest, which has cleats on the ends so that it can be held in slides attached to the dropping boards, to permit its easy removal whenever it is necessary to clean and disinfect it. The nest is made of  $\frac{3}{8}$ -in. and  $\frac{1}{2}$ -in. lumber, the  $\frac{3}{8}$ -in. material being used for the ends and partitions, which measure 12 by  $18\frac{1}{2}$  in., and the  $\frac{1}{2}$ -in. material for the bottom, back, strips along the top and front, and for the crosspieces in each nest, which serve to keep the nesting material away from the door. The doors are cut from  $\frac{7}{8}$ -in. wood, and the ledge along the front is a length of 1 by 2-in. wood, mounted on cleats fastened to the

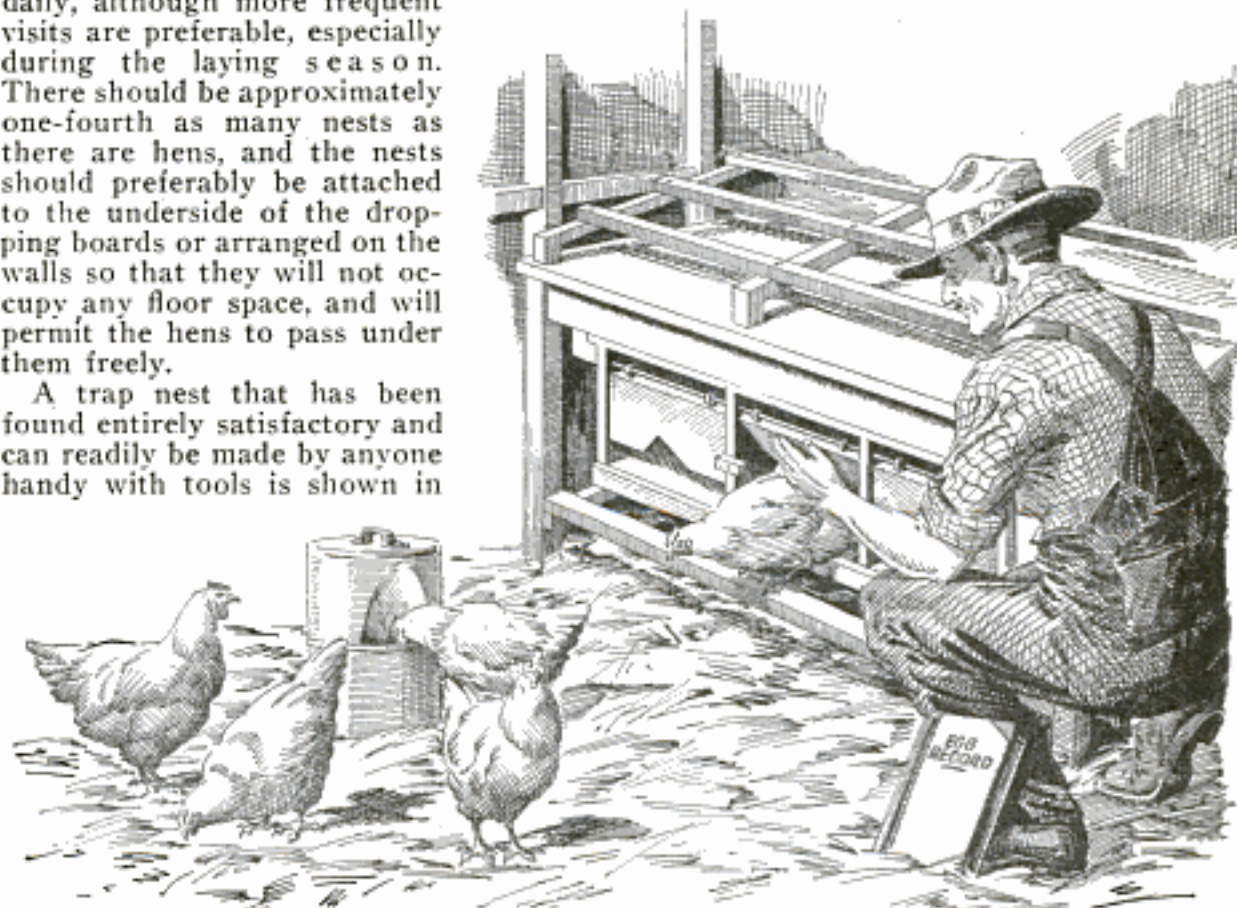

Simple Homemade Trap Nest That Enables Poultryman to Obtain Accurate Egg-Laying Records, on Basis of Which He Eliminates Unprofitable Hens and Selects High-Grade Eggs for Incubation



bottom of the nest. Wire mesh with a 1-in. opening is used for the top; it should be stapled to a frame made of 1 by 2-in. material, and hinged on as indicated, to make the interior readily accessible for cleaning. It is not necessary to make three separate doors on top as shown in the illustration: one covering the entire top is sufficient. A wire-mesh top is preferable to a wooden top as it permits better ventilation. Most of the dimensions are given and the others can readily be approximated. Two screweyes are driven into the top edge of each door so that it can be hung on a length of  $\frac{3}{16}$ -in. iron rod, which is pushed through the ends and partitions, holes being drilled for this purpose. The doors are opened by swinging them inward and are kept in this position by means of a wooden latch. When the hen enters the nest she raises the door and this releases the latch, which is pivoted eccentrically so that it readily

falls to a horizontal position, permitting the door to close against a stop. The doors should be planed down on the edges to fit loosely between the partitions in order to avoid binding. A triangular notch is cut in the bottom of each door, as shown, to permit the hen to pass into the

nest more easily; the size of the notch must, of course, be varied according to the size of the hens using the nest. The latch is made of  $\frac{1}{2}$ -in. material and is  $1\frac{1}{2}$  in. wide at the upper end and  $\frac{3}{4}$  in. wide at the lower end. A nail or screw is driven through the narrow end at such an angle that it will serve as a stop, permitting the latch to be raised just far enough under

the edge of the door to hold it. To prevent the latch from sticking, it is advisable to drill a hole through it and pivot it loosely on a wood screw of smaller diameter, a washer being provided on each side. It is best to use hardwood for the latch as the pivot hole will not wear so readily.

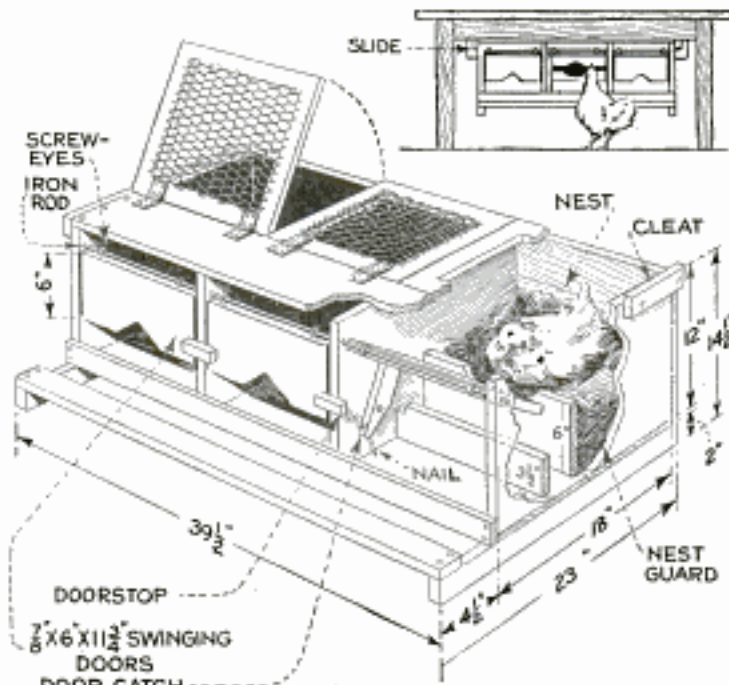

Method of Constructing the Trap Nest; the Door of the Right Compartment Is Open to Show the Latch; It Normally Closes When the Hen Enters

### A Toolpost Grinding Fixture

A toolpost grinding fixture for the lathe that will answer equally well for internal and external work as for surface grinding and is within reach of even the smallest shop, is shown herewith. A piece of flat stock,  $\frac{1}{2}$  by 2 by 6 in., is cut to the shape shown, the narrow part forming a shank fitting into the toolpost slot. A  $1\frac{1}{16}$ -in. hole is drilled through the wide end. An 8-in. length of extra-heavy  $\frac{3}{4}$ -in. pipe is threaded for a distance of  $1\frac{1}{2}$  in. from one end and brass or babbitt plugs are tightly driven into each end. The plugged pipe is then chucked in the lathe and the plugs drilled and reamed to fit the  $\frac{3}{8}$ -in. grinding-wheel spindle; the ends of the pipe are faced to become thrust bearings for the collars on the shaft. An oil hole is drilled somewhere near the

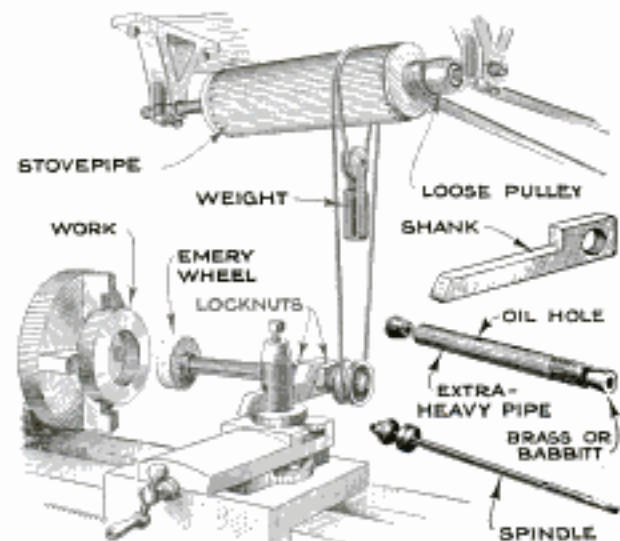

An Easily Constructed Toolpost Grinding Fixture for the Lathe That Is Adaptable to Internal, External and Surface Grinding Operations



center of the pipe, which becomes an oil reservoir when the shaft is in place. The pipe bearing is secured to the shank by means of locknuts, such as those obtainable from any electrical contractor who uses them in conduit work. The spindle is turned from a 10-in. length of 1-in. stock and a small grooved pulley, drilled to fit the spindle, is held to it with a setscrew, so that end play can be taken up.

The drum pulley is simply a length of 8-in. furnace pipe that is fitted with wooden heads, the driving pulley being integral with one of them. The heads are turned with a slight taper so that they can be easily driven into the pipe and fastened with small nails. The belt take-up consists of nothing more than a grooved pulley with a weight attached; this permits of moving the cross slide in any direction. A  $\frac{3}{8}$ -in. round belt is used between the drum and grinder.—Edwin J. Bachman, Fullerton, Pa.

#### Automatic Inner-Tube Deflator

Deflating inner tubes after they have been tested is a tedious and time-consuming task in the vulcanizing shop; but this work can be done automatically by means of the simple device shown in the drawing. It consists of two wooden rollers, spaced about  $\frac{1}{2}$  in. apart and mounted on the wall at a convenient height. A length of sash cord, to which a weight and a wire hook are tied, is run over two pulleys attached to the wall or ceiling. The inner tube is hung on the hook and forced between the rollers, and the weight will then pull it upward until all the air is squeezed out. The valve must, of course, be open.

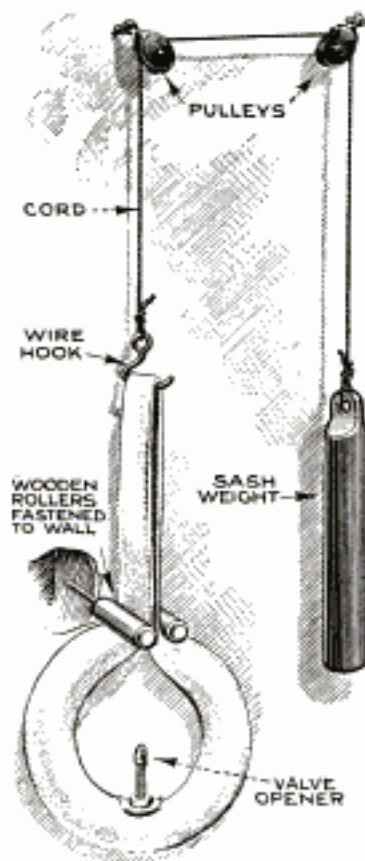

#### Protecting Young Trees

Young trees can be protected against cold by means of old inner tubes and cas-



Old Casings and Inner Tubes to Protect Young Trees during Winter

ings slipped around the trunks as shown in the drawing. In the case of very small trees the tubes can be slipped right over the branches, the latter being squeezed together with one hand. The tube is then tied with twine as shown. For larger trees casings may be used, as shown at the right. In the spring the coverings are taken off. After their removal a rubbery odor will be left on the bark, which insects and other vermin dislike.—W. Mehanna, Bussey, Ia.

#### Cleaning Conduit

I recently had some experience in cleaning conduit and other pipe into which some concrete had run and set. Some of the pipes were in places almost inaccessible, which made it very difficult to remove the concrete. However, the following method proved quite effective. Obtaining a 6-ft. length of six-strand cable, made of No. 10 wire, I spread the strands on one end so that the diameter of the flared end was about twice the diameter of the pipe. The ends of the strands were then bent to form hooks, which turned outward radially. After driving an iron bar through the center of the pipe, I was able to shove the cable through the hole thus made, and in pulling the cable out again, the hooks caught in the concrete and brought it out whole or in pieces, the process being repeated until the pipe was clean.—Morris K. Jessup, Monroe, Mich.



### Truck Seat for the Extra Hand

Long-haul trucks carrying building material, furniture, etc., usually have a crew of sufficient size to enable the loading and

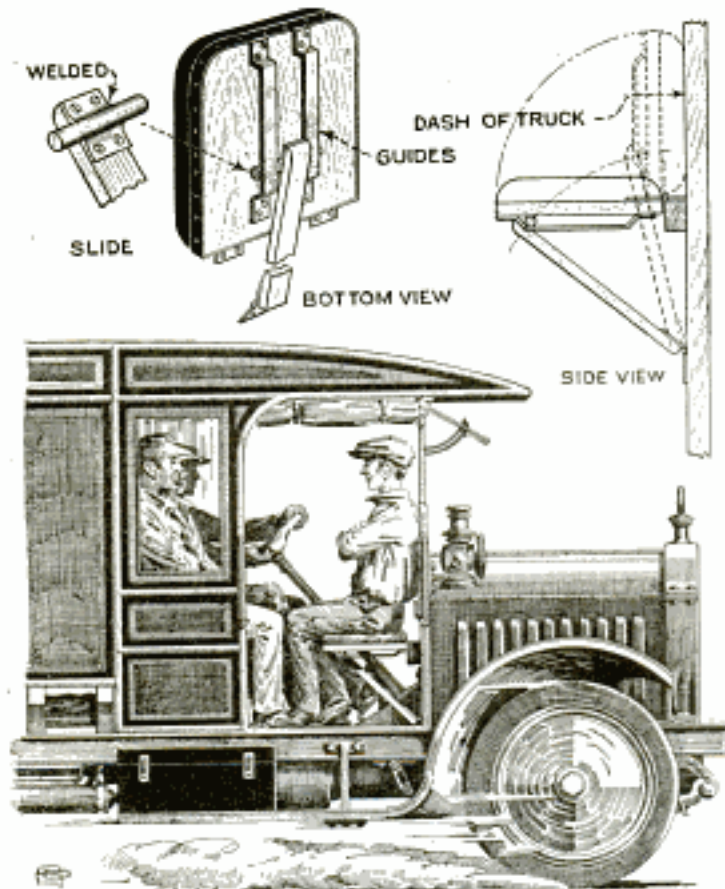

The Extra Helper Is Accommodated on a Long Haul by a Simple Folding Seat in the Cab

unloading to be done with ease and dispatch. Long journeys require some facilities for seating the crew, and where the extra hand cannot be accommodated on the load, or in wet weather, the simple folding seat shown in the drawing will be appreciated, as the regular truck seat usually will not take more than two without inconveniencing the driver.

The seat proper is hinged to a piece of wood bolted to the inside of the dash, and has two slides made of flat steel screwed to the underside. The bracket that supports the seat is also hinged to the dash, and, at the top, has a piece of round steel that will slide under the flat-steel slides fastened to it. The simplest method of attaching the rod is to weld it to a flat-steel bracket, which is drilled for heavy screws. The top of the seat may be padded, as shown, and, when not required, folds flat against the dash as indicated by the dotted lines in the side view. With this arrangement the extra hand is fully protected from rain and snow.

### Making Temporary Bushings

Replacement of worn parts on machines and automobiles, which usually involves considerable expense, is unnecessary if temporary repairs can be made to give additional service. This is the case especially with bearings, bushings, sleeves, shafts and spindles. In Fig. 1 is shown a lining put inside of an enlarged sleeve. It takes away considerable play, reducing noise to a minimum and putting the working parts back into correct alignment. The sleeve is removed and the amount of play accurately measured all around. A piece of sheet brass or tin of one-half this thickness is carefully cut so that when turned to cylindrical shape and inserted inside of the sleeve it will fit exactly. The sleeve, with the lining in it extending a trifle, is put on the end of the shaft, and the edge of the lining is tapped over and soldered to the edge of the sleeve so that it will be held in place securely. If the shaft fits too tightly, a piece of emery cloth is wound on a round stick and the surface of the lining brought down a trifle until it slips over the shaft easily. In soldering tin to steel a flux consisting of muriatic acid cut with zinc has been found effective. Fig. 2 shows a repair made on a worn shaft where it has been scored by a bearing or sleeve. The shaft is recessed about  $\frac{1}{4}$  or  $\frac{1}{2}$  in. by turning the scored part down in the lathe as shown in detail A. A piece of sheet brass corresponding in thickness

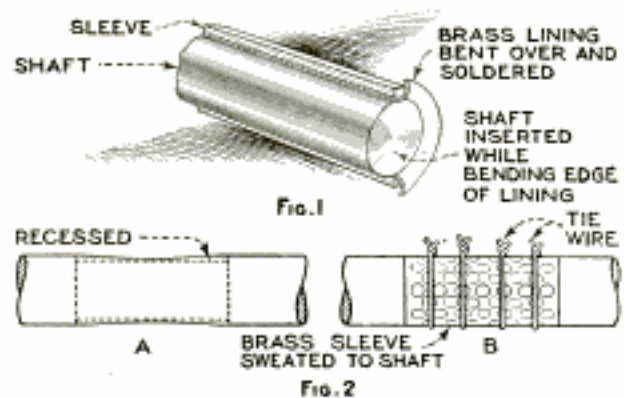

Making Temporary Bushings for Bearings and Building Up Wearing Surfaces of Journals

to the depth of the recess is cut to the same width and long enough to fit around the shaft so that the ends fit together



snugly. Holes are punched in it and it is wired to the shaft as shown in detail B. The sleeve thus formed is sweated on the shaft, the holes being filled with solder and the wires then removed. The excess thickness is turned down on the lathe to the thickness of the shaft and the repair is complete. The shaft is then just as useful as it was before and the cost of repairing it is negligible compared to the cost of a new shaft.—J. E. Decker, Chicago, Ill.

### Holding Small-Diameter Rod

Attempts to hold short lengths of the smaller sizes of drill rod or cold-rolled stock in the ordinary tongs for flattening the ends or bending them over to form boring tools, are likely to result disastrously, as very frequently the work jumps out of the tongs at the first blow of the hammer. In such cases there is always the possibility of the flying bit of metal striking the operator or someone else. Few

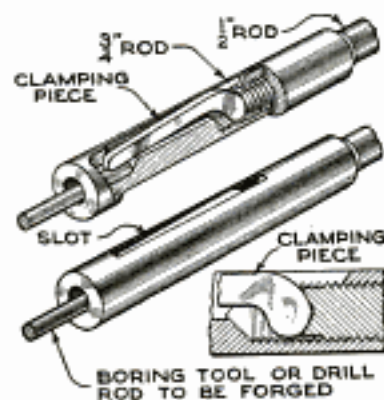

shops have tongs that are in good enough condition to hold these small pieces securely and for such the holder shown in the drawing will be found not only convenient but safe. It is made from two pieces of cold-rolled stock, one  $\frac{3}{4}$  in. in diameter, the other  $\frac{1}{2}$  in., and a flat clamping piece. The larger rod is drilled with a  $\frac{1}{4}$ -in. hole at the front end and drilled and tapped at the opposite end to take the smaller piece, which is threaded, and may be as long as desired to serve as a handle. The large rod is slotted to take the clamp, the front end of the slot being tapered. The clamp is made from flat stock, about  $\frac{3}{16}$  in. thick, and shaped as in the drawing. A slight vee is filed on the underside of the clamping piece where it bears against the pieces held.

When a rod is slipped into the hole in the front end of the holder the  $\frac{1}{2}$ -in. threaded rod is screwed up, forcing the clamping piece forward and downward, and tightening it on the work. The work is released from the holder by unscrewing the threaded piece, when the work will drop out, provided it does not fit tightly.

### Convenient Sawhorse

In order to save the trouble of carrying a pair of sawhorses about from job to job, a carpenter has added crosspieces



Crosspieces Make Single Sawhorse Give Service of Two

to an ordinary sawhorse. He can then lay his boards to be sawed over the crosspieces and saw with as much convenience and ease as if he used two horses. This horse is also more steady.

### Combination Paintbrush and Scraper

It frequently happens that a painter wants to use a putty knife to scrape off some foreign matter from the surface he is painting

and that the knife is not within convenient reach, or he has to lay his brush down while reaching into a pocket for the knife. To eliminate



this waste of time, a painter made the combination tool shown in the drawing. The end of the handle was split and a piece of steel inserted in the split, where it is held by two rivets.

☐ Smoke from soft coal will cause varnished furniture to look cloudy.



Parts from Samuel Harris,  
114 N. Clinton, Chicago  
can make up saw to order

## MAKING AN 8-INCH BENCH SAW

By J.V. Romig



**A** MOST necessary tool for the small shop is the bench saw, with which it is possible to cut both metal and wood, and which is fitted with guides for ripping and cut-off work. With such a machine, at a cost of a few cents an hour for power, many times the amount of work can be done that is possible with hand methods, and with less physical fatigue.

Such a saw can easily be built from steel flats and structural shapes, together with machined parts taken from other machinery. It may be designed in an excellent manner, and built at low cost. To obtain rigid bearings, with long life, is the main thing to consider in the design, and it is with this in mind that a Ford front-wheel hub has been selected for the bearing unit in the saw described in this article.

These hubs can be bought from any service station at a cost of a little over \$1 a piece. They come with the two ball races and bearings assembled. By the use of the hub a strong, rigid bearing is secured, that can be taken up when any wear takes place and is easily lubricated, by filling the cap with grease in the regular manner and giving it an occasional turn. The bearings may also be made dust-tight by using the regular Ford dust washer, which is made of steel and lined with felt.

The most important part of the tool the builder himself must make is the spindle. This is turned from a good grade of steel

and threaded as shown in the drawing. The seat for the large cone bearing, at the right, must be made exactly 1.19 in. in diameter, as it must be a light driving fit on the seat. The small cone, or race, screws onto the other end of the spindle, which is threaded 16 to the inch, the cone being an easy turning fit. A washer and locknut are used to hold the small cone in place, after it is adjusted. The two cones should also be bought from a service station, as this is very much cheaper and more satisfactory than trying to make and harden them correctly. The shoulder behind the larger cone is turned to a diameter of 2 in.,

and the end, which is  $\frac{7}{8}$  in. in diameter, is also threaded 16 to the inch, but left-hand. This shoulder is slightly undercut, as shown in the drawing, so that the saw will come up close against the seat. A bearing and mandrel unit is thus obtained, capable of

standing up under the stress of sawing metal and of being kept without side play, which is necessary to insure a good clean cut that will need little hand planing or filing. To insure proper tightening of the saw, it is well to cut a spanner-wrench slot in the shoulder of the spindle and drill a pin-hole in the driving pulley; the latter acts as a nut for the saw, and has a left-hand thread to fit the spindle.

The saw frame is made of channel iron, with the top flange cut off as shown. The

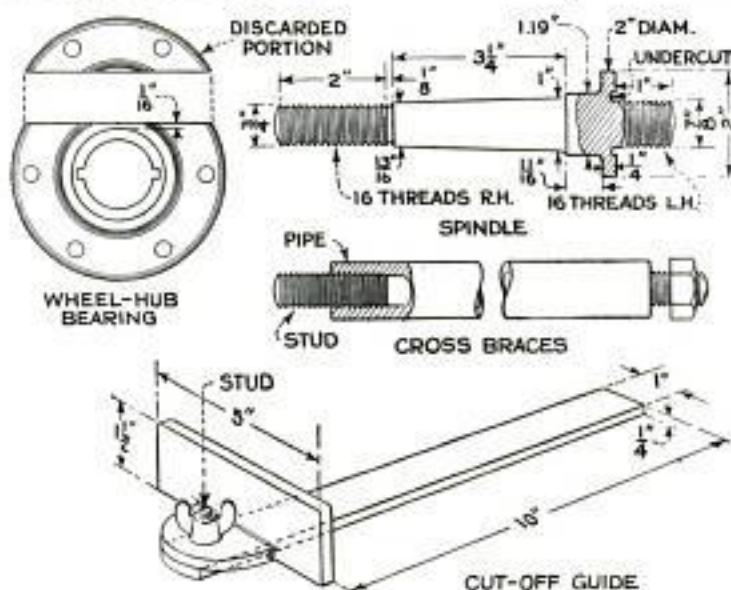



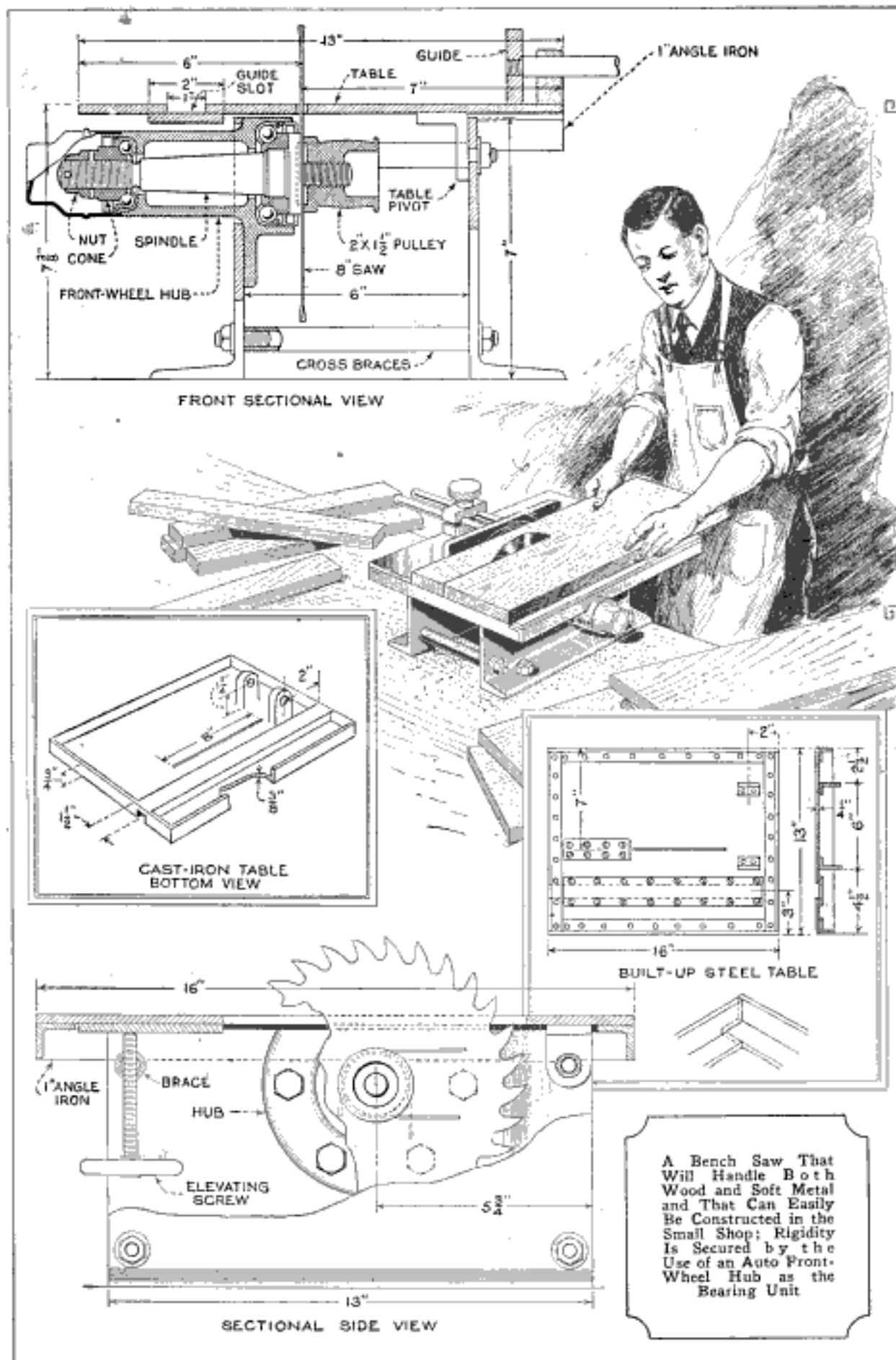

A Bench Saw That Will Handle Both Wood and Soft Metal and That Can Easily Be Constructed in the Small Shop; Rigidity Is Secured by the Use of an Auto Front-Wheel Hub as the Bearing Unit



lower flanges serve as the base of the machine, and lagscrews are used to fasten the tool to the bench; bolts, of course, may be used if desired. These pieces are easily cut to length, and require only drilling. They are coupled together with cross braces made from lengths of pipe, the ends of which are squared and fitted with studs, screwed in as shown in the detail. All braces are of  $\frac{1}{2}$ -in. pipe.

The table may be made of cast iron or built up, as desired. If a cast table is wanted, a pattern must be made. White pine or spruce, dressed down to a thickness of  $\frac{5}{8}$  in., should be used for this. A tapered flange is run around the underside as shown, to strengthen the table and keep it from warping. The two pivot lugs are then cut, shaped, and glued and tacked in place, and the inner corners of the flange filleted. This is a simple pattern to make, even if a patternmaker is not employed. When the casting is planed, the ends and sides should be surfaced as well as the top. If this is done, the table can be used as a laying-out plate

for pattern or metal work. The saw slot is cut through the table with a  $\frac{1}{4}$ -in. slitting saw.

If a built-up table is preferred, sheets of good straight steel plate are cut and filed to width and fastened to an angle-iron frame with small flat-head screws. A short piece of narrow plate is fastened to the front of the table in line with the slot; the end of the elevating screw bears against this. The pivot lugs are made of  $1\frac{1}{2}$ -in. angle iron, and fastened to the underside of the table with capscrews; the upper ends of the capscrews are cut off and riveted into countersinks in the table top, then filed or ground flat. The lugs are drilled a neat fit for the rear upper cross brace, and pivot directly

on it. The guide, or fence, is made from a piece of flat stock, fitted with two parallel round bars. It is held in any desired position by means of a split double-slide bearing, which is fastened to the table by two flat-head machine screws driven into the lower half of the clamp from the underside of the table, as shown in the detail drawing. A knurled-head screw is used to clamp the two parts together. In assembling the machine care must be taken that the saw and guide are parallel.

The crosscut guide moves in a slot planed the length of the table, if the latter is made of cast iron, or cut through, if built up. In the latter case the slot is strengthened and a bottom formed for the groove by a length of plate or wide flat stock screwed to the underside. The guide is made from a flat piece of steel, 1 in. wide. To one end is fastened a swinging head, made from an angle iron, which may be clamped at any angle by means of a stud and wingnut. With the aid of this guide, angles and miters can be cut, as well as square cross-cuts. The guide is also used

when cutting soft metals, such as brass or aluminum.

The elevating screw may be one taken from an old valve, or it can easily be made in the shop. It passes through a hole, drilled and tapped through the front upper cross brace.

The saw is driven by a  $1\frac{3}{8}$ -in. belt, which may be run either in a slanting rearward direction to the motor or shaft, or vertically through slots cut in the bench. A  $\frac{1}{2}$ -hp. motor is the most desirable form of power, although the drive may be taken from a countershaft, if necessary.

The 8-in. saws used can be purchased for both sawing metal and ripping and cutting off wood. The metal-cutting and crosscutting saws have fine teeth, while

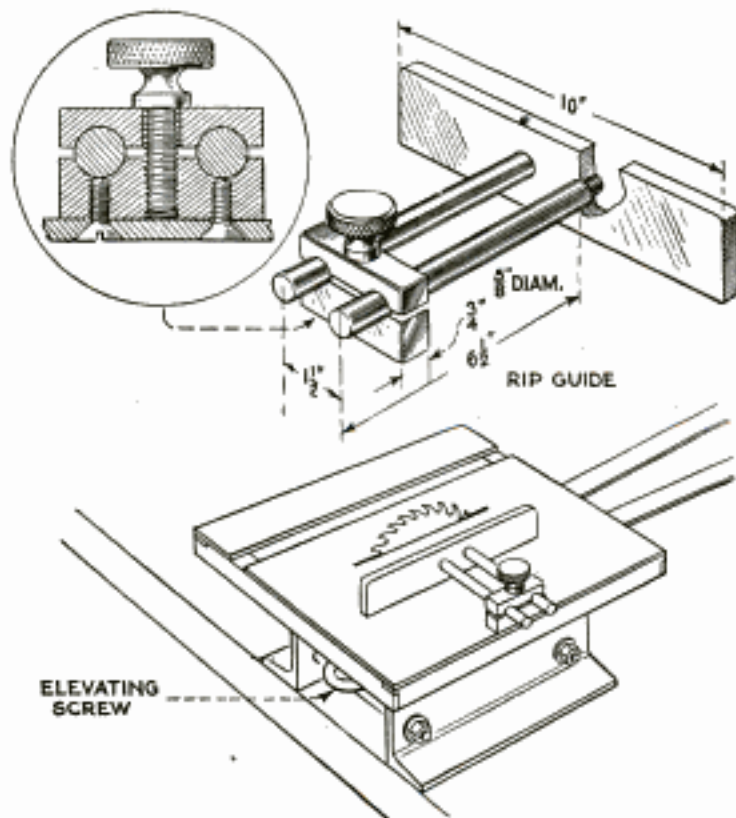



ripping saws have coarse teeth. This size of saw usually has a  $\frac{3}{8}$ -in. hole and is 18 gauge in thickness, but thinner saws can be obtained if necessary. Saws 6 in. in diameter should be used for thin work.

The saws should be kept well filed and sharp, as a sharp saw makes good work and consumes less power than a dull one. A piece of work should never be pushed through the machine if the saw smokes, but the saw should be changed at once.

### Making Perspective Drawings

While making a perspective drawing my straightedge slipped and the drawing, nearly finished, was ruined. To prevent such an accident from recurring, I made an attachment for the rule, by which it could be pivoted to the drawing board at either vanishing point. I cut a piece of tin from an empty tobacco box and bent it as shown in the detail to form a holder. This was fitted to the end of the straight-edge and holes were punched in the tabs for pins. In use, a pin is driven into the board and the straightedge hooked over it allowing the ruler to be swung around without danger of getting it out of place at the pivot.

By arranging the drawing sheet at an angle, a smaller drawing board can be used and perspective work can be done

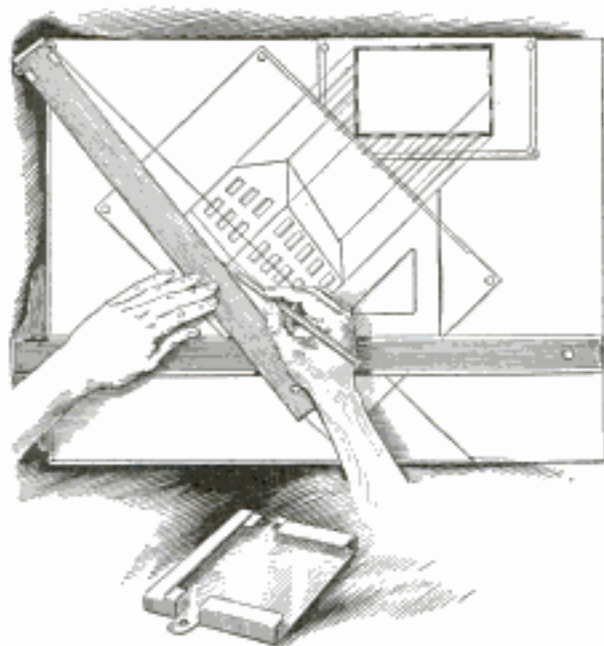

Straightedge, Pivoted at Vanishing Point, Eliminates Danger of Drawing Wrong Perspective Lines

much more easily than ordinarily, as it can be laid out from a plan as indicated, a triangle being used to draw the vertical lines of the building.—G. M. Beerbower, Tarrytown, N. Y.

### Center-Punch Holder

Prick punching boiler plate or any sheet metal, is facilitated considerably by the fixture shown in the illustration, as this

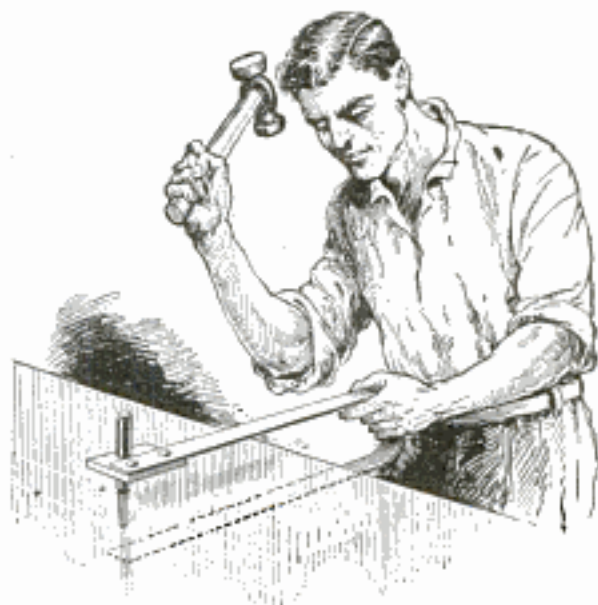

Simple Center-Punch Holder Prevents Misplaced Punch Marks and Avoids Injury

holds the punch securely on the work so that it cannot slip off the mark, and also eliminates the disagreeable experience of hitting one's fingers with a misdirected hammer blow. The holder consists of a length of flat spring steel bent over to a U-shape. A small piece of iron with a hole drilled through it for the center punch to fit in snugly, is riveted on the end of the holder. In use, the end of the holder is slipped under the work and the punch is brought down on it, the left hand being used to move the holder.—James E. Noble, Toronto, Can.

### Sediment Bulb in Oil Burners

Kerosene burners for stoves and furnaces are becoming quite common, but, whether gravity or air-pressure fuel feed is employed, a sediment bulb, or similar receptacle, in the pipe line will prove a worth-while addition to the equipment. Sand, grit and water are present in much of the barreled kerosene sold, and as these impurities are heavier than the oil, they readily flow from the bottom of a tank through the feed pipe, and sooner or later will reach the burner and cause trouble. If a sediment bulb is placed between the tank and the burner, however, this foreign matter will accumulate there and may be drained off at intervals.—G. E. Hendrickson, Argyle, Wis.



### Portable Folding Dolly

As an accessory for delivery trucks and wagons that handle bulky but fairly light boxes and bags, the folding dolly shown in the drawing will be found very useful. It was designed and first used by mail collec-

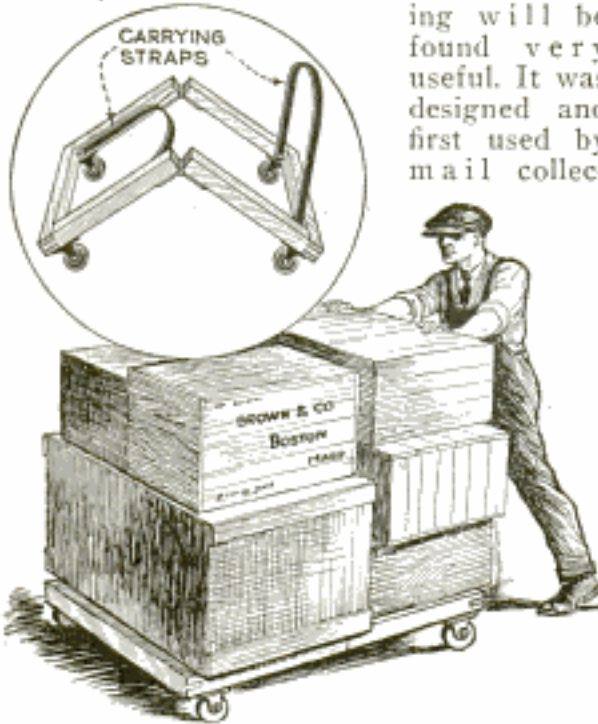

Collapsible Dolly Is Light in Weight and Can Easily Be Carried

tors and carriers of a large city in moving bulky bags in office buildings. It consists of a wooden frame, of 2 by 4-in. material, which is cut in half, as shown, and the two parts hinged together. Casters are provided at the corners and flat-iron handles are attached for carrying when folded. In this state it takes little room for storage,

### Homemade Bench Centers

A set of bench centers is a convenience around any small shop or garage, for holding centered work not requiring to be driven, such as small motor or generator armatures, for soldering or rewinding; crankshafts for fitting bearings or testing for alinement or bars or pins while filing keyways. The drawing shows a bed with a pair of adjustable centers, one of them being a screw center, built up entirely from square, rectangular and round soft or cold-rolled steel, though, of course, any shop equipped for making patterns would prefer to use castings. For the amateur the arrangement shown will prove very satisfactory and may be built mostly by hand with the use of a small drill press, and a set of taps and dies.

The length of the bed depends upon the length of the bars used as well as the char-

acter of the work to be done between centers; the longer the bed and the more strain put upon the centers, the more liability there is of the bed springing sideways. The two bars should be smooth cold-rolled steel carefully tested for straightness. They are clamped between two uprights of square stock, by means of capscrews and nuts, taking care that the top edges are in line. Two flat strips are screwed to the bottoms of the uprights and drilled for holding-down bolts.

Each center is built up of two square uprights, a base plate, a horizontal spacer bolt and sleeve, a guide block drilled for alining screws and a clamp bolt. The drawing shows the construction clearly so that little description is necessary. The base plates and guide blocks should be drilled a close fit for the bolts, to prevent shifting; dowel pins may be fitted if necessary. The alining screws are of such length that the center will move rather stiffly along the bed with no play whatever. The spacer sleeve is made from a length of iron pipe. One center is free to slide, as shown, and one end is pointed like a lathe center at  $60^\circ$  and the other cupped at the same angle. An extra center may be made and threaded to take a lathe chuck for holding uncentered work. The other center is threaded and screwed in and out somewhat like a tailstock in order to clamp the work tightly between centers. Both centers are provided with bolts ex-

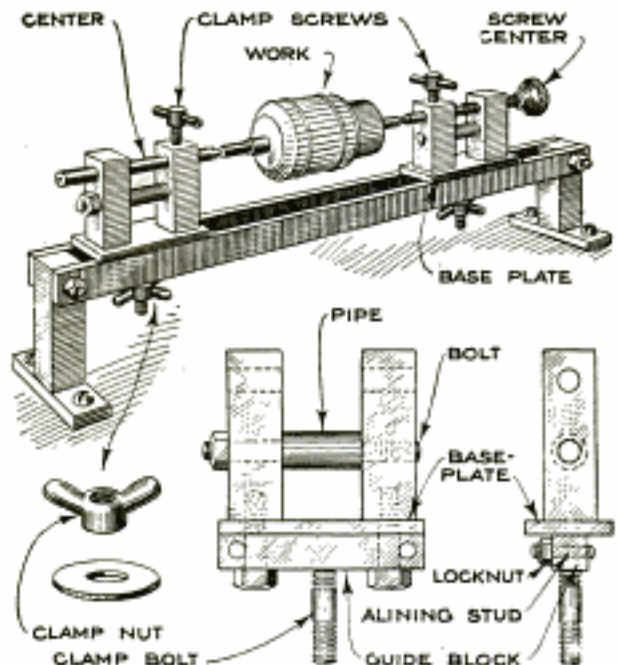

A Homemade Bench Centering Device for the Garage and Small Shop

tending through the bed, with plates and clamping nuts underneath.



### Locknut for Small Pipe Connections

The small nut, which screws down on the bridge washer of a tire valve, fits a  $\frac{1}{8}$ -in. pipe thread if screwed on well. This makes it possible to mount petcocks and small tubing connections on sheet metal. Such nuts are not so good as regular pipe locknuts, but are easier to obtain in small sizes. Often the nuts fit rather loosely on the threads and it is best to solder them on.—E. T. Gunderson, Humboldt, Iowa.

### Drying Rack for Lacquered Work

The photo shows a convenient drying rack used by a jobbing brass shop for holding lacquered work. The special feature of this rack is that the hooks are adjustable sideways, which permits them to be moved around to accommodate any shape of work without the risk of the pieces rubbing against each other. The rack consists of a length of rod

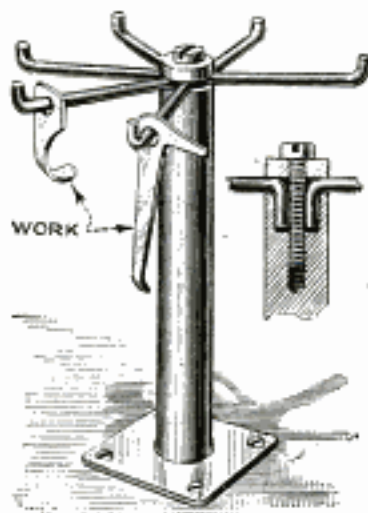

which is held vertically on a plate screwed to the bench. The top end of the rod is drilled and tapped for a screw, and a recess is drilled as shown to receive the ends of six hooks, which are made of lighter steel rod and bent to the shape shown. The hooks are held on the top of the rod by a washer and a flat-head screw, which is tightened sufficiently to hold the hooks securely without preventing them from being pushed sideways.—Harry Moore, Rosemount, Montreal, Can.

### Drilling Holes in Doors

In interior-finishing jobs, where it is necessary to drill numerous holes in doors for locks or latches and corresponding holes in the door jambs, it has been found convenient to use a brace support of the kind shown in the drawing. It consists of a length of wood equal to the distance that the holes are to be drilled above the floor, so it can be set up against the door and the center of the hole marked, and



Support for Brace Aids in Drilling Holes in Doors

can then be used to steady the brace while drilling, a round notch being cut at the top to receive the brace. It holds the brace perfectly horizontal, thus permitting a hole to be drilled straight. The lower end of the stick is about 3 in. wide and cut to the radius of the length of the stick, so that the height of the drill does not change greatly as it is fed forward.—G. M. Beerbower, Tarrytown, N. Y.

### Raising a Fallen Pump Rod

While overhauling a deep-well pump, a farmer lost hold of the suction rod and it was drawn down so far that only the end could be grasped. The suction was too great to allow the rod to be lifted by hand power; so the following method was resorted to. A pipe wrench was clamped over the projecting end of the rod and a small jack placed on the spout, as shown, a wedge or two of wood being used to give

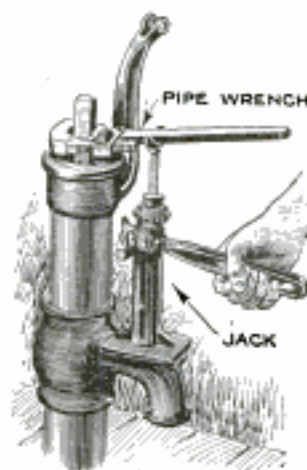

the jack a firm support. The jack was raised against the wrench and the rod was then readily brought up.—L. B. Robbins, Harwich, Mass.



### Dusting Conduit with Soapstone

An electrician who formerly used a cumbersome air-pressure tank-and-hose outfit to force soapstone into conduit, found that the simple contrivance shown



Simple Method of Dusting Soapstone in Conduit to Prevent Wires from Sticking

herewith did the work equally well and with less trouble. Four rubber washers, cut to fit snugly inside of the conduit, were mounted on a  $\frac{1}{4}$ -in. eyebolt in the manner shown. After placing a quantity of soapstone in the open end of the conduit, with a knife blade or spatula, the drag tape and insulated wire were attached to the ends of the eyebolt as shown. The tape was pulled from the opposite end, the rubber washers being drawn through the pipe, and in this way the soapstone was forced along. As the soapstone gradually sifted past the washers, the conduit was sufficiently dusted to prevent the wire from sticking.

### Cleaning Rusty Tools

Take the lid of an ordinary round baking-powder can and partly fill it with a thick mixture of fine emery dust and light machine oil. Touch the emery mixture with an ordinary cork, kept handy for the purpose, and rub it over the surface of any slightly rusted tool or other article of steel. This will instantly remove the rust and leave a thin protecting film of oil.—James E. Noble, Toronto, Can.

### Renewing Worn Files

Old files, which have become badly worn, can be renewed by immersing them in a solution consisting of six parts of water and one part of nitric acid for about five minutes. The file is then rubbed a few times over the edge of a block or table padded with about two or three thicknesses of cloth. This wipes the acid from the surface of the teeth but does not remove it from the spaces between them. The file is laid down for half an hour, which allows the acid to eat the grooves deeper; it is then thoroughly washed.

### Ring and Piston-Fitting Tool

As a means of compressing piston rings when inserting the piston in the cylinder, or holding them expanded so that they can easily be slipped into the piston grooves, the simple fixture shown in the illustration will appeal to any automobile mechanic who has considerable work in overhauling engines. It can be made in a few moments from a rectangular piece of sheet iron. The two edges are turned outward and the piece then bent to conform to the curvature of the piston. A small tapered strip of the same material is cut and the edges bent inward to draw the ends of the sleeve together when it is pushed down over them. In use, the piston rings are first slipped over it as shown in the right-hand detail and can then easily be pushed over the edge into their respective grooves. After this has been done, the sleeve is clamped around the piston to compress the rings in the

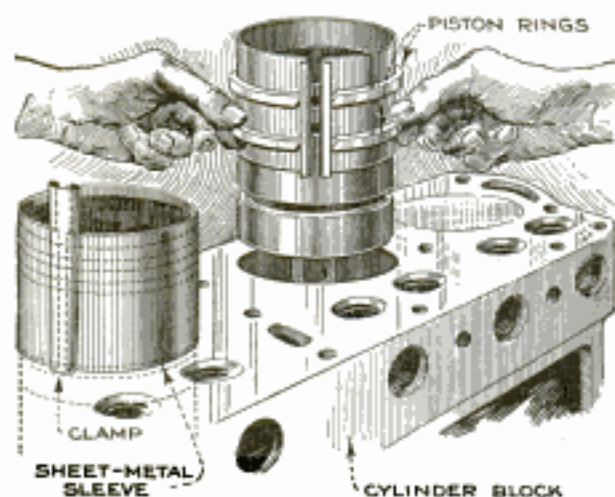

Sheet-Metal Sleeve Proves Useful in Assembling Piston Rings

grooves and hold them in this position while the piston is pushed into the cylinder.—G. A. Luers, Washington, D. C.



# A Floating Hydroelectric Plant

By F. D. BURKE

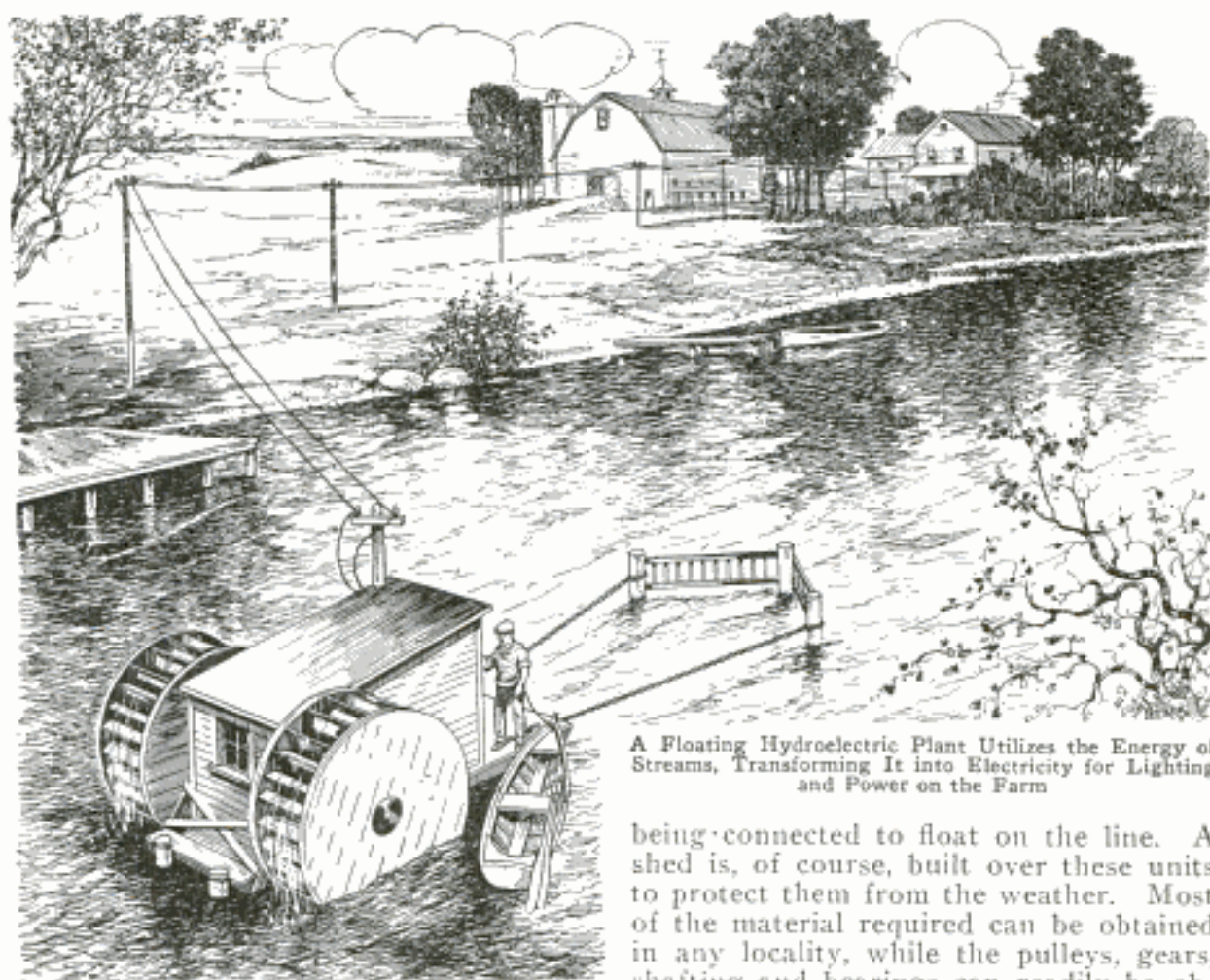

A Floating Hydroelectric Plant Utilizes the Energy of Streams, Transforming It into Electricity for Lighting and Power on the Farm

**R**URAL comforts can be greatly increased and much labor eliminated by transforming the energy available in thousands of small streams into electricity by means of a floating hydroelectric plant, which any enterprising farmer can easily build. The advantages of such a plant are quite obvious; it is the only logical installation where the slope of the land does not permit the construction of a dam, and by eliminating a dam with its associated features, such as a flume, turbine, power-house foundations and other concrete work, the cost of the installation is kept down considerably. Furthermore, a floating power plant is quite independent of shifting water levels.

The plant consists of two water wheels, mounted on a heavy shaft and supported on a scow, which is held at anchor in the stream. The generator, which is the heart of the outfit, is run from a countershaft connected to the main shaft by gears and pulleys. The electricity is stored in six automobile storage batteries, or it may be supplied directly to the lines, the batteries

being connected to float on the line. A shed is, of course, built over these units to protect them from the weather. Most of the material required can be obtained in any locality, while the pulleys, gears, shafting and bearings can readily be obtained from mail-order houses.

Yellow pine or cypress is used for the scow, the water wheels and their supports. The scow is 16 ft. long, 5 ft. wide and has a 12-in. draft. The builder should begin with the side and center planks, which are cut to the shape and size shown in the drawing from 1½-in. stock, straight-grained and reasonably free from knots. Notches are cut in the under edge of the center plank at the points indicated so that any water that may get into the hull will circulate freely and prevent unbalance. After the side and center planks are cut, they are laid, with their upper edges down and properly spaced, on a level surface, and are held in this position by means of a piece of 1½-in. stock, 12 in. wide, nailed across the stern, and a piece 4 in. wide across the bow. The bottom planking is then applied. It consists of 1½ by 10-in. lumber and 16-penny galvanized nails are used to fasten it down. The edge of each plank should be given a ¼-in. bevel so that a narrow V-shaped groove will be formed between adjacent planks. The planks are nailed on so that these grooves



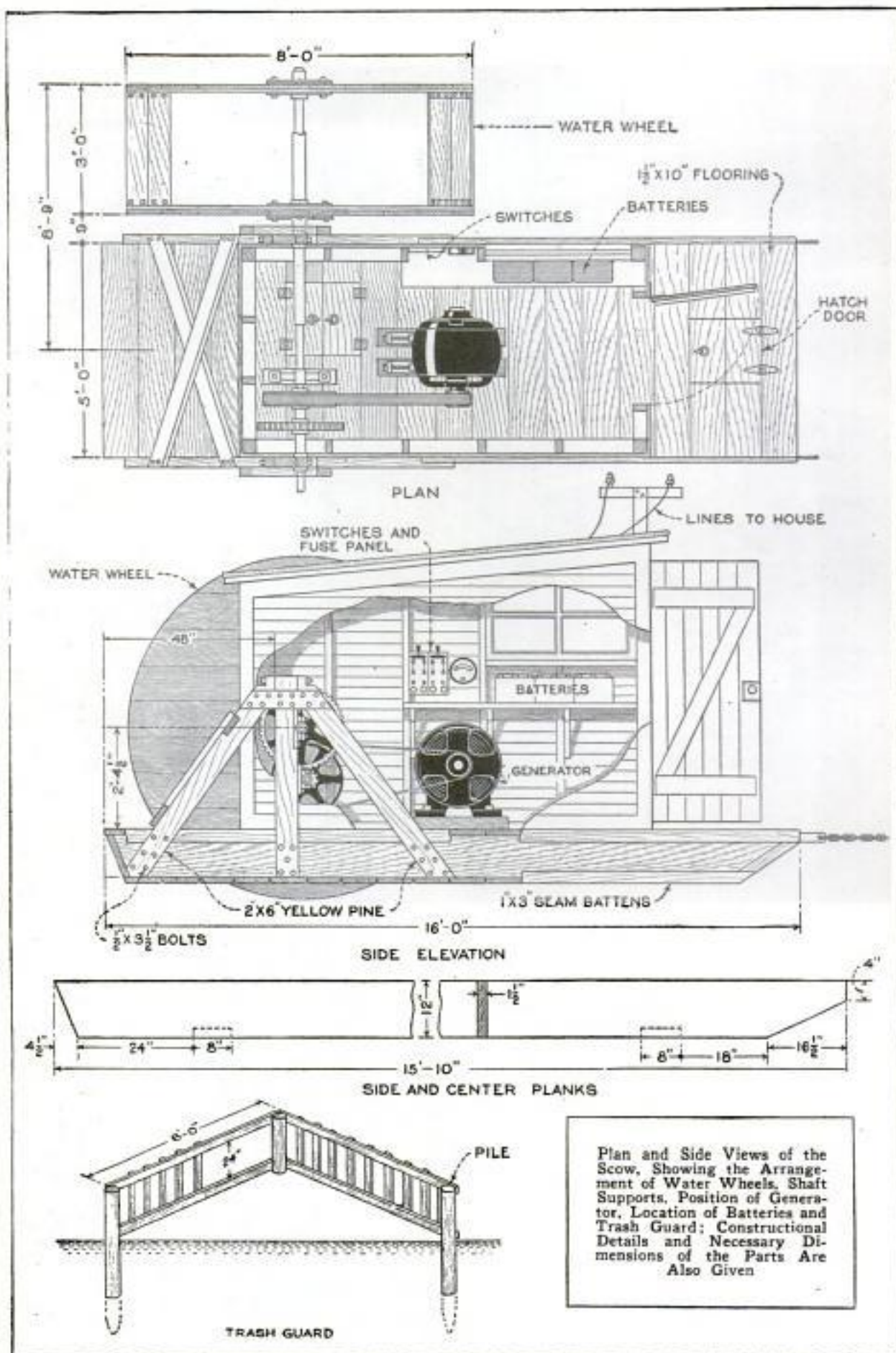

Plan and Side Views of the Scow, Showing the Arrangement of Water Wheels, Shaft Supports, Position of Generator, Location of Batteries and Trash Guard; Constructional Details and Necessary Dimensions of the Parts Are Also Given



come on the outside, permitting them to be calked with cotton wicking. This is forced into the grooves tightly with a putty knife or a thin hardwood wedge, and one or two coats of well thinned white or red lead are then smeared in.

After the bottom has been completed, the hull is turned over and 2-in. reinforcing strips, beveled with a plane and coated with white lead, are nailed over the joints at the lower edges of the end and bottom planks. This greatly increases the strength and helps to make the joints water-tight. Diagonal braces are then nailed inside of the hull at the center, bow and stern; the center ones are shown in the detail of the hull and shaft mounting. The inside of the hull should be given several coats of water-resisting paint. The supports for the water wheels are bolted to the sides of the scow on the outside, which must, of course, be done before the deck boards are nailed down. Each of these supports consists of an upright and two diagonal braces

of 2 by 6-in. material. The transverse braces fastened to the rear diagonals, shown in the deck plan, need not be put on until the deck has been planked. Two flat-iron chain brackets are bolted to the side planks, at the bow, on the inside, after which the deck planking may be applied. The edges of the deck planks need not be water-tight, although this is preferable. They should, however, be nailed together tightly. The underside and the edges of the deck planks should be given a coat of paint before they are nailed down. Two small hatch doors should be provided, one at each end of the scow; these are necessary to permit inspection of the interior of the hull and occasionally for bailing out water that may have seeped in. By

leaving them open there will be sufficient ventilation in the hull to dry it out thoroughly. Seam battens should be nailed along the top and bottom edges of the scow, over the ends of the planking. It is a good idea to give the inner surface of these battens a heavy coating of white lead and nail them down while wet.

The two water wheels are 8 ft. in diameter, 3 ft. wide and are provided with 25 blades each, uniformly spaced. They may be straight or trough-shaped, as shown in the detail of the wheel construction. The former are simpler to make but

the latter are more efficient. The sides of the wheels are made up of two layers of 1-in. stock toenailed to each other at right angles. Sheet-iron disks are used to reinforce the centers on the outside. Before assembling the wheels, the exact location of each blade must be carefully marked on the sides; wooden cleats are bolted or screwed on at these points, and the blades are then bolted to the cleats. A hub is provided on each

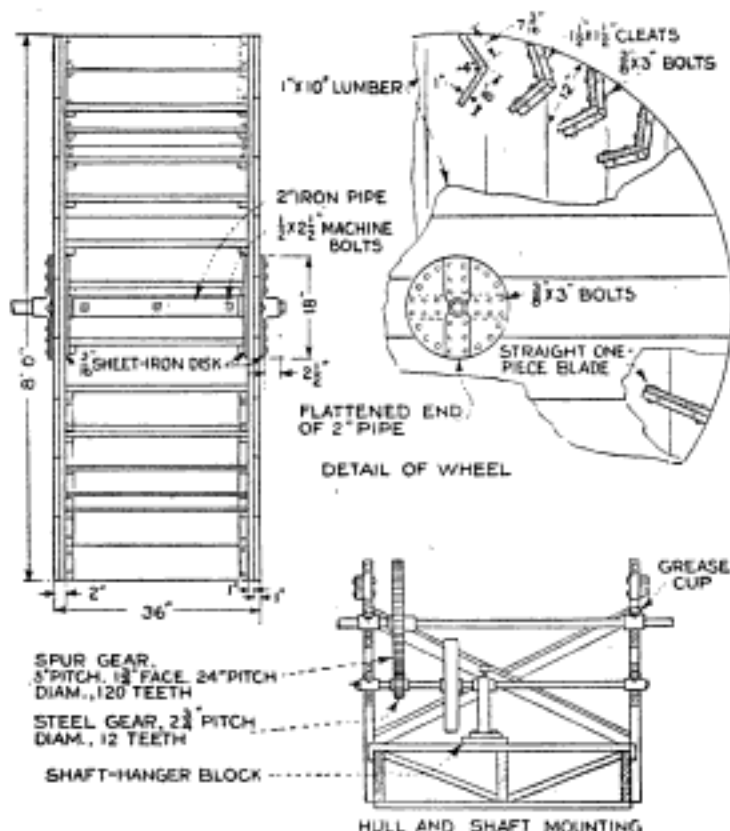

Details of Water Wheels, Showing Method of Attaching Blades and Hubs; Lower Detail Shows Arrangement of Shaft, Gears, Pulley and Cross Section of Hull

wheel; this is made of three lengths of 2-in. iron pipe, one length fitting inside and two short lengths on the outside; the ends of these lengths are split open for about 18 in., flattened and then bent over at right angles to permit fastening them to the sides, holes being drilled through the flattened ends to receive bolts with which they are attached. If large floor flanges are obtainable, it is better to use a single length of pipe instead of three short lengths for the hub, and then thread the ends to permit the flanges to be screwed on, four flanges being used on each wheel. One is screwed tightly against each side of the wheel and they are then bolted together. The completed wheels are mounted on a 2-in. steel shaft, held in



suitable bearings, which are securely bolted to the upright members of the supports, previously described. The shaft runs clear through the hubs of the water wheels and these are bolted to it. A 24-in. pitch-diameter steel spur gear with a 1 $\frac{3}{4}$ -in. face is keyed to the shaft as indicated in the detail. This must be done before the water wheels are bolted on. A countershaft is mounted in bearings similarly bolted to the end supports, and a small steel gear of 2 $\frac{3}{4}$ -in. pitch diameter is keyed to the countershaft to mesh with the gear on the main shaft. The diameter of the countershaft will be limited by the small gear, and may be 1 $\frac{1}{2}$  in. or less. The ratio of the gears should be about 10 to 1. To prevent the countershaft from whipping, an additional bearing, held in an ordinary overhead shaft hanger, is provided at the center, the hanger being securely screwed down to the deck. Large self-feeding grease cups must be provided on all the bearings, as the equipment is to be used for long periods at a time with little attention. A 22-in. cast-iron pulley with a 3-in. face is mounted on the countershaft near the center and is belted to a 3-in. pulley on the generator, which is bolted to the floor.

The generator should be of the 32-volt type, having an output of 2 kilowatts, which is approximately the amount of power developed by the plant floating in a stream having a velocity of four miles per hour. The generator should produce this amount of energy at a speed of 700 to 1,000 r.p.m. No other kind of generator will give satisfactory results for this purpose, and therefore care must be taken to give the correct specifications when ordering it. The generator should be mounted in such a manner that it can be slid toward and away from the shaft, to permit tightening of the belt or its removal from the pulley, which is done when the generator is not used. Other methods of keeping the plant at rest are to fasten the water wheels to the deck with large iron hooks, or to provide means for shifting the gears out of engagement.

Six 6-volt automobile storage batteries, or 16 cells of a farm-lighting battery, are mounted on a rigid bench made of 2-in. material. The batteries are connected in series, the open leads being connected to a single-throw knife switch, provided with 15-amp. screw fuses. The generator leads are connected to the other side of the switch. The house wires are also connected to the same terminals, but are run through a similar switch to permit disconnecting them when desired. An am-

meter may be connected in the line to the batteries and the switches and ammeter can be conveniently mounted on a wooden panel. Six 6-volt batteries will give a potential of 36 volts, which is a trifle too much for 32-volt lamps, but this will be taken care of by the resistance of the lines to the house, which will cause sufficient drop in voltage.

The entire plant is housed in a small cabin or shed built on the deck. The scow should be securely anchored with the bow facing upstream. If the blades are not submerged sufficiently the scow should be ballasted as much as necessary. It is advisable to provide a trash guard in front to protect the wheels from floating debris. The guard consists of three piles driven down into the stream bed and extending about 2 ft. above the surface of the water. A strong fence can readily be nailed to them. The guard should be considerably wider than the width of the scow and water wheels, and the lower edge of the fence should be at least 2 ft. below the surface of the water. The piles form an excellent mooring place to which the scow can be tied with heavy chains, hooks being provided on the piles for this purpose. The scow should be moored as close to the piles as practicable.

### Steady Rest for a Small Lathe

The drawing shows an easily built open-type steady rest that was originally designed for a bench speed lathe but which will fit almost any small lathe. There is but one pattern required, and this is of the one-piece type, with no cores or loose pieces. If more than one casting is to be

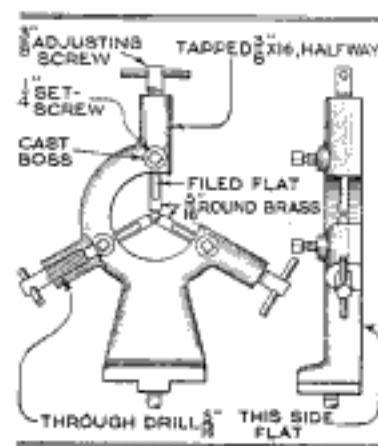

made from it, the pattern should be built up of two  $\frac{3}{8}$ -in. pieces of lumber, with the grain crossing at right angles to prevent the pattern from splitting while being rapped in the mold. The pieces are glued together and re-

inforced by three small screws through the setscrew bosses, thus holding everything firmly together. After the casting is obtained, the lower part of the base may be finished by hand filing or it can be ma-



chined in a planer or shaper. Then, three  $\frac{5}{16}$ -in. holes are to be drilled through the arms. As this drilling should be accurately done, it would be best to turn up a hardwood or metal collar to fit the circular opening of the body casting, this collar being centrally drilled for a bolt to secure the work to an angle plate. Then, without moving the angle plate, the casting may be rotated until each arm is drilled. Next, all three holes are tapped halfway through with a  $\frac{3}{8}$ -in. 16-thread tap for the adjusting screws.

Three arms are sawed from a  $\frac{5}{16}$ -in. brass or bronze rod and a flat is filed on one side of each, this flat being engaged by the point of a  $\frac{1}{4}$ -in. setscrew tapped through the side boss so that the brass arm may be clamped in position as well as prevented from turning. The adjusting screws may be ordinary  $\frac{3}{8}$ -in. machine bolts, long capscrews or made up from cold-rolled stock, fitted with cross handles.

#### Extension Box Holds Finished Work

Work that comes in short, straight lengths, such as tubes, angles, strips, etc., can be conveniently held in an extension box of the kind shown in the illustration. It consists of two movable endpieces which slide in the space between a double bottom, permitting adjustment for work of different lengths. The two bottoms are held together with three screws and nuts. To extend or reduce the length of the box the screws are loosened, the endpieces slid out or in as far as necessary, and the screws

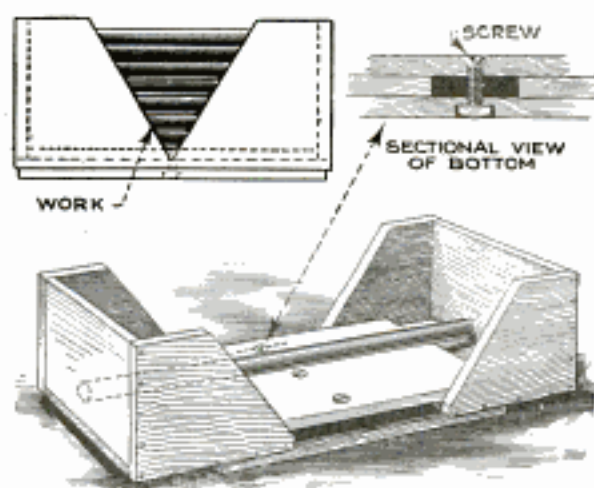

Adjustable Extension Box Holds Many Sizes of Polished Work

tightened, causing the bottom to hold the endpieces securely. These boxes are especially useful in plating plants and other shops where finely finished work of this type is produced.

#### Small Homemade Pile Driver

The small pile driver shown in the illustration was successfully used by a Michigan bridge contractor to drive sheet piling. The hammer is an ordinary

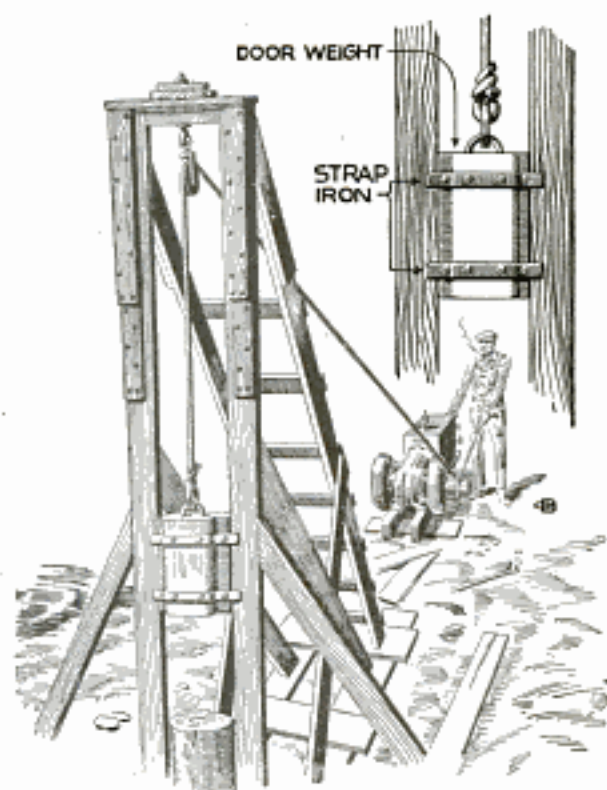

Small Homemade Pile Driver Used by Bridge Contractor Saves Considerable Expense

garage-door weight, hung between two 2 by 10-in. planks about 16 ft. long. Pieces of flat iron are bolted to the weight and allowed to project on each side as guides to keep the hammer between the planks. A 1-in. rope is strung over the pulley of a gasoline engine. In use, the operator grasps the free end of the rope and by drawing it tight, as the engine is started, raises the hammer. Then he releases his grip on the rope, allowing it to slip around the pulley, and the hammer falls with considerable force upon the pile. This outfit was assembled at small cost. An average of 40 piles per eight-hour day were driven by two men with it, and this meant quite a saving in expense, considering the cost of installing and operating a regular pile driver.—Paul L. Fetherston, Jackson, Michigan.

☞ To blacken aluminum clean it thoroughly and apply a mixture of the following chemicals: sulphate of iron, 1 oz.; white arsenic (poison), 1 oz.; hydrochloric acid, 10 oz., and water, 12 ounces.



### Concrete Mixer Made from Mower and Water Tank

When building a concrete silo two farmers improvised the novel concrete mixer shown in the photo. The pole, seat, levers



Novel Concrete Mixer Made from Mower and Circular Water Tank

and one wheel of a mowing machine were removed, and the remaining part of the mechanism was mounted on a wooden frame so that the wheel was held in a tilting position. A galvanized-iron water tank was then clamped to a wooden cross made of heavy material, and this was in turn attached to the mower wheel as indicated. A pulley was provided on the driving shaft of the mower so that it could be run by a belt connected to a small gasoline engine. In this way an efficient concrete mixer was provided.—B. S. Williams, Chicago, Ill. 2116 & 69th Street

### Paring and Burning Soils

Paring and burning soils is a method of improvement accomplished by turning up a thin layer of the surface, which consists mainly of stubble, roots, and humus, allowing this layer to dry thoroughly and then burning it.

This treatment is particularly beneficial for soils that contain a large amount of organic matter, as it makes them crumbly. Another benefit is that it greatly increases their fertility; the organic matter is reduced to ashes, which, upon being dissolved by acids and water in the soil, become available to the plants as food. However, as the nitrogen in the organic matter is lost by burning, soils poor in nitrogen should never be so treated. Peat soils have so large a quantity of nitrogen that much of it may be lost without destroying their fertility.

Burning also will clear marshes of matter that must either be left to decay or must be cleared away before the marsh can be cultivated. Where a deep growth of sphagnum moss occurs, which makes plowing impossible, the most practical method of removing this is by burning. This can best be done during the dry summer months, as July and August, but in so doing great care must be taken to prevent the fire from spreading and from burning into the soil too deeply, a danger that exists in marshes where the water level is low. Stiff clay soils can also be improved considerably by burning, but as these soils usually do not contain enough organic matter to supply fuel for burning, the fuel in form of brush, peat, or whatever material is available, is distributed over the surface and burned. The benefit of burning clay soils is that it destroys their cohesive character to a great extent, making them more

similar to sandy soils, with the result that air and water can circulate through them much more freely, and this makes tillage operations easier.

### Keeping Wood-Turning Chisels Sharp

Wood-turning tools, especially those used on softer woods, require frequent sharpening. Not only can time be saved, but a keener edge also kept if the slightly dull chisel is held for a moment at the proper angle against the inside of the driving belt of the lathe, as shown.



Both faces of a chisel are applied alternately to the moving belt. In the case of a gouge, the inside is first placed against the edge of the belt and then the outside touched up in the same way as the chisel. The troublesome burr left on tools after grinding or

stoning can be instantly removed by this method.—D. Allis, Asbury Grove, Mass.



# A Printing-Press Silencer

By FORD A. CARPENTER

**N**OWADAYS many offices and large establishments have their own small job presses. It is economical and efficient to print forms, reports and bulletins on the premises. One of the great objections to a printing press, however, is the heretofore unavoidable noise. Motors may be made to run without objectionable vibration; the presses may

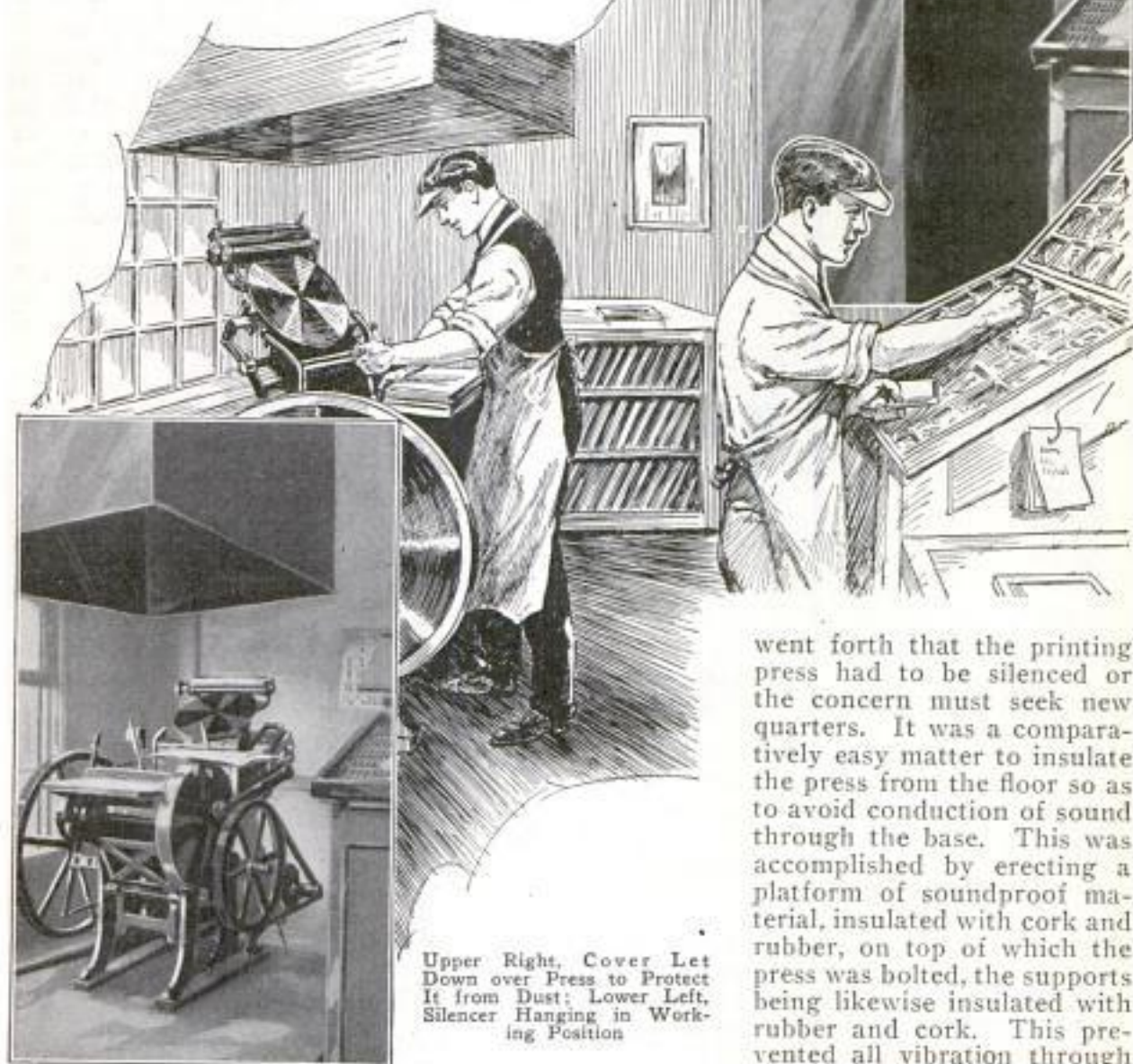

Upper Right, Cover Let Down over Press to Protect It from Dust; Lower Left, Silencer Hanging in Working Position

be insulated from the floor, but the clank of the inking roller over the plate and the banging of the cams make a racket that prohibits the use of a press in a first-class office building.

Several years ago the writer was confronted with this problem. It was absolutely necessary to do the printing next to the main office of the business concern, which was located on one of the floors of an office building tenanted by professional people. It was the only printing press in the twelve-story building and the edict

went forth that the printing press had to be silenced or the concern must seek new quarters. It was a comparatively easy matter to insulate the press from the floor so as to avoid conduction of sound through the base. This was accomplished by erecting a platform of soundproof material, insulated with cork and rubber, on top of which the press was bolted, the supports being likewise insulated with rubber and cork. This prevented all vibration through the floor. The rhythmic clatter of the press still persisting, experiments looking toward absorption of the sound were made. After months of trial, it was found that a boxlike structure of heavy canvas, stretched over an iron-rod frame and hung from the ceiling just above the head of the pressman, absorbed practically all of the sound caused by the operation of the printing press. With the press running full speed, the sound was so deadened by this simple silencer that it was unnecessary to keep the doors to the adjoining rooms closed. People passing



along the halls had no knowledge of a running press except from the shadows cast by the revolving wheels.

The silencer has another virtue in that, when let down from its position above the press, it forms a dust-proof cover for the press. This apparatus has been in use for more than ten years and has proved to be of great utility. The same principle may be successfully applied to the quieting of other noise-making machines.

### Self-Tightening Paint-Pot Hanger

When painting on a ladder, it is customary to use a wire hook on one of the



Handy Paint-Pot Hanger Is Self-Tightening on Ladder

rungs to hold the paint pot, but it is much handier to have the paint pot on the right side of the ladder, held by a self-tightening hanger of the kind shown in the drawing. It can readily be swung open and loosened so that it can be shifted up or down as desired. Pushing or pulling the arm down only causes the hanger to grip the ladder more firmly. The arm is notched to receive the bail of the paint pot, and the weight of the pot keeps the hanger securely clamped to the ladder—C. Home-wood, Ontario, Calif.

### Paraffin Waterproofs Stone

The superiority of paraffin treatments for waterproofing stone has been demonstrated by a weathering test of colorless waterproofing compounds conducted at the bureau of standards during the past three years. Samples of Indiana lime-

stone and of sandstone have been used in the tests, one-half of each specimen being coated with the waterproofing compound while the other half was left untreated.

Very little deterioration was noticed in the case of the paraffin-treated specimens during the period of the test. Coatings using aluminum stearate, and mixtures of paraffin and Chinese wood oil were also found to have good waterproofing values when properly applied. Coatings consisting of solutions of glue, magnesium fluosilicate, cellulose nitrate, resins, etc., are not sufficiently durable to justify their use.

Most of the materials tried discolored the stone to a considerable extent at first, depending on the porosity of the stone. Very dense types were not appreciably discolored, while very porous ones appeared greasy for several months after treatment. After a year or more of weathering, the discoloration disappeared and the treated surface appeared lighter and cleaner than the untreated.

A new series of tests is being started with these materials on dense limestones and marbles. A new compound has recently come into use in England which consists of a silicon ester. This material is also to be included in the tests.

### Clamps for Battery-Repair Work

In a battery-repair shop, where it is necessary to hold the battery cases firmly on the bench while working on them, a clamp of the kind shown in the illustration has proved useful. It consists of a short length of iron rod, one end threaded to take a nut and the other end bent over to form a hook to engage with a screw-eye, which is driven in the bench top. A

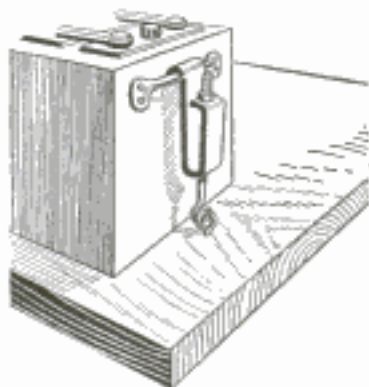

short length of flat iron is bent to the shape indicated and two holes are drilled through it to receive the straight part of the hook. The curved end is slipped over the handle or edge of the battery and the nut is turned down until the clamp is sufficiently tight to hold the battery securely.



# Prize Offers and Announcements

## \$500—Bait for Rat Poison

We have perfected and patented a new chemical composition based on cyanide, the smallest particle of which in a rat's stomach will cause the animal's instant death. By the use of this poison rats die within a foot or two of where they eat it. We desire to market this poison already prepared, so that the user has simply to spread the poisoned bait in infested areas. The bait should be a neutral one, that is, neither acid nor alkaline, and of such a nature that it can be manufactured in small particles about the size of a grain of wheat, so that the rat will be tempted to eat them where he finds them instead of carrying them away. What is required is a bait, filler, or carrier which will have either an odor or food appeal sufficient to impel rats to eat it, even in the presence of other food. It should be a bait or food which rats will prefer to any other that would ordinarily be available. For a satisfactory formula, or bait combination for the poison that passes our test, this concern will pay the sum of \$500 in cash. This offer is good for one year from November 1, 1924. Address American Chemical Works, 720 Washington Avenue, Minneapolis, Minnesota.

## \$300—Hand-Printing Press

The sum of \$300 in cash and royalties will be paid for a satisfactory design and drawings of a simple self-inking hand-operated printing press by this donor. The press should be six by nine inches in size and one which can be manufactured from cast iron at a cost not exceeding \$25. All designs submitted must of course meet the requirements of the donor before being considered for adoption. Address all matter to C. L. Whitfield, 429 East Bute Street, Norfolk, Virginia. May 1, 1925, is the closing date for this offer.

## \$25—New Uses for Cel-o-Glass

The sum of \$25 will be paid by Cello Products Incorporated for each suggested new use for its product, Cel-o-Glass, provided said use is of such character as to open up an entirely new and definitely accessible market for the sale of this adaptable material. Entries will be judged by the company alone. In case of duplication of suggestions, preference will be given to the one first received. List of present uses and other information can be had from the donor. Address all replies to Cello Products Incorporated, Box 28, 89 Fulton Street, New York, N. Y.

## PREVIOUSLY ANNOUNCED

ALL OFFERS CLOSE MAY 1, 1925

FOR THE BEST SUGGESTED IMPROVEMENT on a gasoline-heated blowtorch and soldering and branding iron combined an award of \$500 will be paid by the Everhot Manufacturing Company. *J. J. Wood*

AWARDS OF \$500 EACH WILL BE PAID for a waterproofing process for a library paste and a method that will produce increased sales of this product. *John J. Harris and Company. 4035 W. Kensington, Chicago*

\$2,000 WILL BE PAID BY THE NORTH Shore Food Products Company for a method of processing or preserving cottage cheese to keep it fresh for at least two weeks. *112 W. Morgan, Chicago*

THE CARR FASTENER COMPANY WILL pay \$500 for a reservoir grease cup which can be filled with a grease gun and feed out the grease at a slow rate. *Cambridge Mass.*

FOR NEW WAYS OF USING BUTTON molds \$500 will be paid by donor in Problem HA-1, and the same concern will pay \$500 for new uses for button-mold machines as stated in Problem HA-2. *P. W. Reed, Pleasant, New York*

THE SUM OF \$50 IS OFFERED BY THE Parsons Manufacturing Company for the best plan they receive for uses of ground slate. *Pan Argyll, Pa.*

Full Details Regarding the Previous Offers Listed Above, May Be Obtained by Addressing the Bureau of Information, Popular Mechanics Magazine

TO THE PERSON SUBMITTING TO THEM an article which they can make in their machine and electrical shop, the Guyan Machine Shops will pay \$250 over and above its royalties or sales price. *Box 757, Lorain, N. Y.*

GRANITE STATE MOWING MACHINE COMPANY offers \$500 in cash and royalties for satisfactory working drawings for gasoline-motor lawn mower they accept for manufacture and marketing. *Hinsdale, N. Y.*

NATIONAL BRASS COMPANY WILL PAY \$300 for design of key guide that can be made of sheet metal and which will properly fit acetabulum plate of similar material. *Grand Rapids, Mich.*

TO ANYONE WHO WILL PRODUCE FOR them a saxophone reed to satisfactorily replace the present reed, the Buescher Band Instrument Company will pay the sum of \$1,000. *Rosebush, Pa.*

THE PHENIX RADIO CORPORATION WILL pay the sum of \$1,000 for the design of a new form of condenser for radio reception. *New York, N. Y.*

FOR A SATISFACTORY HAMMER-BLOW arrangement for a portable hammer drill, the Wodack Electric Tool Corporation will pay the sum of \$500. *138 Jefferson, Chicago*

\$2,000 WILL BE PAID IN SEVERAL AWARDS for processes and machines for salvaging waste lumber. National Lumber Manufacturers' Association. *Wash. D. C.*

FOR SKYROCKET STICK HARMLESS IN descent, \$1,000; bombshell with illuminated flag, \$250; chemical combinations to produce smokeless fireworks colors, \$250. *Thearle-Duffield Fireworks Company. 624 S. Michigan, Chicago*

MOTOR-OPERATED HANDSAW FOR MANUFACTURE and sales; award, \$10,000 in royalties. *R. L. Barker and Company. 642 W. Wash. Chicago*

ELECTRIC HEATING ELEMENT WHICH will operate and interchange with base and cover of Imperial self-heating gasoline iron, \$500. Imperial Brass Company. *1200 W. Harrison, Chicago*

DISCOVERY OF NEW USES FOR CARBON-dioxide gas or improvements to present uses. Award \$1,000. *James Carbonic Co. 3100 S. Redzie, Chicago*

FOR A SIMPLE DESIGN OF A 2-KW. MOTOR generator set, or rotary converter and one which this concern will accept, the William H. Mitchell Company will pay \$500. *Troy, Ohio*

THE GEMCO MANUFACTURING COMPANY will pay \$250 for suitable article they can make in their general metal-working plant. *Milwaukee, Wis.*

DONOR IN PROBLEM PD-1 DESIRES A DESIGN for a starting switch for an alternating current motor and will pay \$100 for the one accepted. *Burlington, Vt.*

THE BENJAMIN ELECTRIC MFG. COMPANY will pay \$250 for fitting stand lamp clusters to old vases; \$150 for most practical method of using electric shop materials for lamp stand and \$100 for business boosting scheme. *547 W. Jackson, Chicago*

FOR ACCEPTED IDEAS FOR NEW USES OF fans, blowers, shutters, and unit heaters Ilg Electric Ventilating Company offers \$5,000 in various awards. *1800 N. Crawford, Chicago*

\$500 FOR SALES PROMOTION PLAN FOR absorbent, non-heat-conducting powder that can be used with other materials. The Feasby and Mattison Company. *Amblin, Pa.*

NATIONAL SLATE ASSOCIATION WILL pay \$200 for best suggested new use for slate; other accepted suggestions paid for in proportion to value. *761 Bristol Bldg. Phila., Pa.*

WILLIAM H. MITCHELL COMPANY WILL pay \$500 for three new uses suggested for low-voltage generators which they adopt as part of sales plan. *Troy, O.*



## Radio Questions and Answers

**Question.** Will an indoor antenna, 75 ft. long, in a frame building give as good results as an outdoor antenna? **Answer.** No indoor antenna is as good as an outdoor one, but with a tube set, if the antenna is well insulated from walls and does not run parallel with electric-light wires, it will often give good results.

**Q.** Does rain pipe make a good ground and is it safe? Is B-battery current running through the set when A-battery rheostat is turned off and B-battery terminals are not disconnected? **A.** Rain pipe is a poor ground. B-battery current is not consumed unless the tube is lit.

**Q.** When tuning outside stations with my set, if I hold my hand at a certain distance from the condenser or over it, the signals become louder, and when I remove my hand, they fade. The same thing happens on the variable grid leak, the taps and coil. Is there something wrong with the hook-up or don't I tune right? **A.** Your trouble is caused by body capacity, and to eliminate it, a shield should be placed between the 23-plate condenser and the panel. This should be connected to the ground, but insulated from the mounting shaft and the screws of the variable condenser.

**Q.** My B-batteries, which are the ordinary block type, are run down, and, as it is 15 miles to town, I would like to know of some way of renewing them. Can you tell me if this can be done? **A.** We do not know of any practical way of renewing worn-out B-batteries, and, even if they could be given a little extra life, the result would probably not justify the trouble.

**Q.** Must the paint be scraped off a water pipe before the ground wire is clamped or soldered to it? One of my friends has a wire simply wrapped around the pipe and he gets very good results. **A.** Some paints are fairly good conductors, and it happens that your friend has a pipe that is coated with such a paint. However, no ground that is formed merely by wrapping a wire around a pipe, painted or unpainted, is really a good one. A good ground is a very important item of the radio installation, and to make a satisfactory job it is essential that the wire be fastened to the clean metal of the pipe, either by soldering or by means of a copper ground clamp.

**Q.** Can an inside aerial be used with a crystal set for local stations? **A.** Some crystal sets work all right with an inside antenna and others do not. You will find that two or more turns of bell wire run around the picture molding of the room will do, if an inside aerial will work at all.

**Q.** Can I empty my storage battery, wash it out and leave it for five months or so without injury to it? **A.** Yes. A good method is to give the battery a charge before removing the acid, which should be kept tightly corked in a glass bottle. All that is necessary to put the battery in service again is to replace the acid and recharge.

**Q.** I have a three-tube radio receiver with storage batteries. Is it necessary to connect a lightning arrester to the batteries? **A.** In any properly installed set, a lightning arrester must be used in the aerial circuit between the aerial and the outside ground connection; it has nothing to do with the batteries.

**Q.** Can I use a UV-201A tube in an amplifier when the detector tube is a UV-199? **A.** This would not be practical, as the UV-201A is a 5-volt tube and the UV-199 a 3-volt tube. This would necessitate two A-batteries. It is always well to use the same type of tube throughout the set.

**Q.** With a three-tube receiver I have just constructed, I get good results on the detector tube but a constant singing noise with the first and second stages of the amplifier. Where is the trouble? **A.** Perhaps the tubes and amplifiers are mounted too close together. If space is limited, it is best to mount the amplifying transformers at right angles to each other. Possibly you are not using enough plate voltage on the amplifier tubes. You should try using a B-battery of 90 volts with these tubes.

**Q.** Is a long aerial good for distance? Mine is 75 ft. with a lead-in of about 30 ft. **A.** A long aerial is best for long-distance reception, but it may make your set tune broadly, if you are near high-powered stations. Long aeriels also give louder signals, while the shorter ones are best for selective tuning and are preferred in congested radio districts.

**Q.** I want to use plate glass for the panel of my receiver. Can you advise me how to drill the holes? **A.** A good way is to use a pointed piece of carborundum as a grinding tool with frequent applications of turpentine to facilitate quick drilling.

**Q.** How can I test the polarity of the wires leading from my charger to the battery? The charger is a homemade one, and the person who built it did not mark the leads. **A.** The simplest way is to dissolve a little salt in a glass of water, turn on the current, and dip the ends of the wires into the solution, being careful to keep them at least  $\frac{1}{2}$  in. apart. The negative wire will "gas" freely, that is, a constant stream of bubbles will be discharged from it. The wires can then be marked. If the line current is taken through a screw plug, it will not be necessary to mark this, provided it is not separable, but if the plug is a two-pole unit or is a separable one, it will be necessary to mark the position of the two halves. If the plug is not marked the charging current may become reversed.

**Q.** How does one know if a radio storage battery is fully charged or in what condition it may happen to be? **A.** The condition of charge of a storage battery is tested by means of a hydrometer. This instrument may be obtained at any radio shop, together with instructions for its use.

**Q.** My outside aerial has two parallel wires, each 45 ft. long, and a lead-in of 15 ft. If I added another 45-ft. wire, how long an effective aerial would I have? **A.** Your effective aerial length would still be 45 ft. The best aerial for general use is a single wire in a straight line, 100 ft. long and from 25 to 50 ft. above the ground.

**Q.** I am using two aeriels on my one-tube set, one as the aerial proper and the other connected to the ground binding post. Will this extra aerial rebroadcast what I receive? **A.** The effect is to make a counterpoise, and will be no worse as far as reradiation is concerned than the common arrangement if a regenerative set is used.

**Q.** Can I use alternating current with a C-300 detector tube by stepping down 110-volt alternating current through a suitable transformer? **A.** It is impractical to use alternating current for lighting the filament of detector tubes in radio sets in this way, unless proper filters and chokes are used, with some means of rectifying the current.

**Q.** Can I use a loud speaker on a crystal set? **A.** Not on the crystal receiver alone; it will be necessary to add two steps of audio-frequency amplification for good results.

The Radio Department is willing and anxious to serve you. If you contemplate buying or building a set, we will be glad to advise you in selecting the proper instrument to suit your purpose, furnish you a circuit, or tell you where to get the best parts. When you run into trouble in building or operating your set, tell us about it, and we will endeavor to clear it up for you.

Address all inquiries to the Radio Editor, Popular Mechanics Magazine, 200 E. Ontario St., Chicago.



# To the Million Young Men who will buy their first saws this year



Whatever work you have to do, there is a Disston Saw to do it



Disston Back Saw, No. 4—For accurate cutting of mitres, fine joints, or stock of small dimensions.



Disston Coping Saw, No. 10—For cutting scroll work, ornamental wood work, toys, etc. Tension of blade adjustable to each job.



Disston Nest of Saws, No. 3—Ten-inch key-hole saw, 14-inch compass saw, and 16-inch utility or pruning saw, with adjustable handle.

**Y**OUR first saw! When you choose it, you are setting a standard for the work you have to do in all the years to come.

You need not be an expert when you go to buy your saw, for the carpenter has chosen for you.

The Disston Saw, everywhere, is "The Saw Most Carpenters Use."

The Disston Hand Saw cuts true to the line. It is true itself — smithed and tensioned on the anvil by a master of the craft.

It cuts fast without binding because it is ground right for clearance. Only a Disston craftsman can taper a saw blade to work like that.

It seems "alive" when

you use it, so easy is its balance. Only a Disston expert can give a saw such balance.

And your Disston Saw will hold its edge: Disston makes the steel and gives it the Disston temper!

You will find the Disston Hand Saw at the nearest hardware store.

Take it in your hand. Try its spring, its easy thrust and balance. Then make that saw your own!

### Ask Disston!

Tell us what kind of work you are doing, in wood, metal, stone, ivory, rubber, leather, cloth, fibre or other material, and we will tell you what types of saws to use. Disston issues many books to aid the users of saws and tools.

Henry Disston & Sons, Inc.  
Philadelphia

Hardware dealers the world around sell Disston Saws, Tools, and Files

# DISSTON



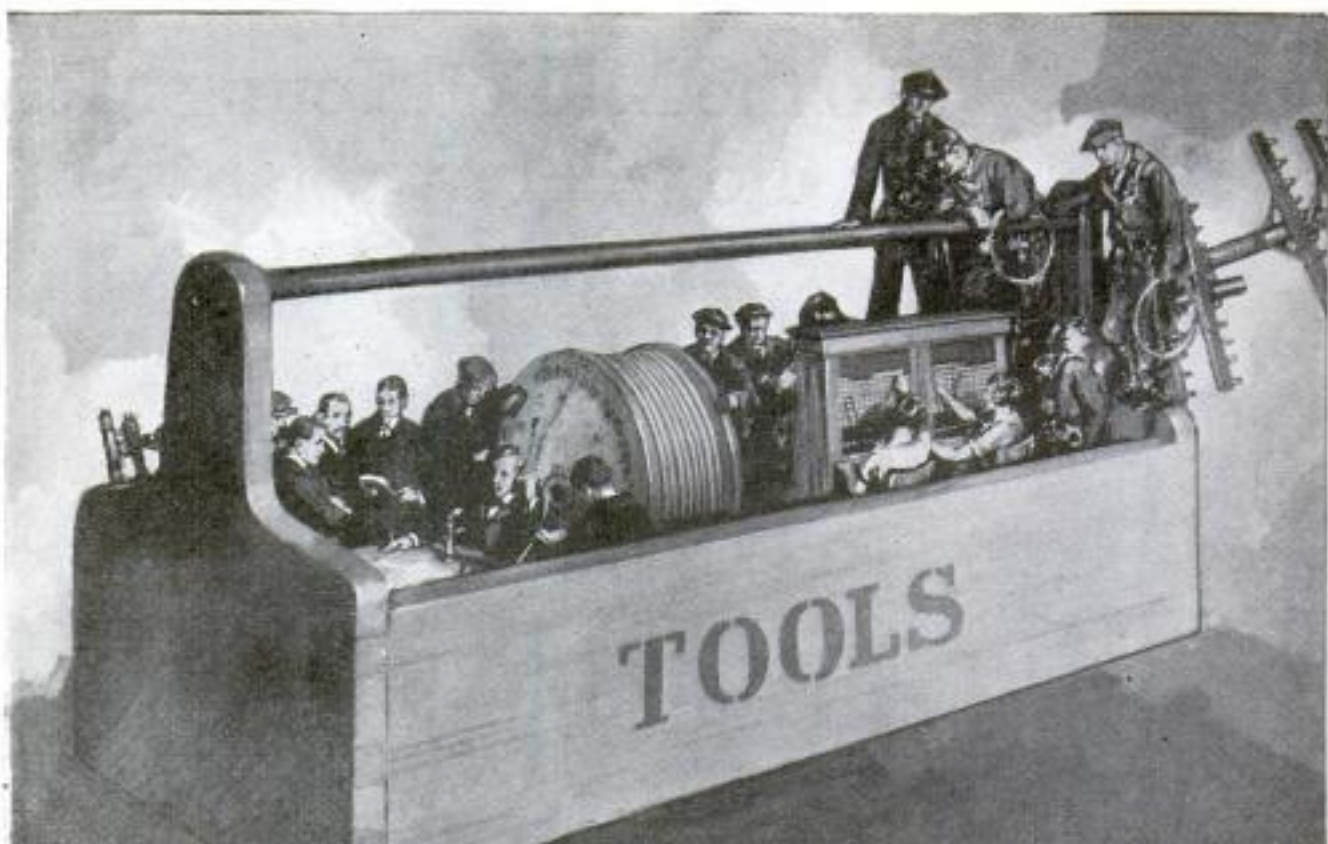

## The Tools of National Service

The American people lead the world in the efficiency of industry. Who can say what part of their success is due to the superior implements they use. This much we know. They have the world's best telephone system as an instrument of communication, and they use it without parallel among the races of the earth. To this end our telephone service must be equipped with proper tools.

The tools of management. Bell System executives, rising from the ranks of those who know telephony, must share our responsibility to the public, most of whom are telephone users, shareholders or workers.

The tools of service. The national, two-billion-dollar Bell System, han-

dling fifty-eight million telephone calls a day, must be enlarged and extended while in use.

The tools of forecast. We must continue to know the rapid and complex growth of communities and make provision in advance, so that the telephone will be ready when needed.

The tools of supply. The Western Electric Company, our manufacturing and purchasing department, its factories manned by 40,000 workers, assures us that extension of facilities need never be interrupted.

We must have the best tools of finance, of invention, of everything else, in order to continue serving the American people.

**AMERICAN TELEPHONE AND TELEGRAPH COMPANY  
AND ASSOCIATED COMPANIES**

**BELL SYSTEM**

*One Policy, One System, Universal Service*





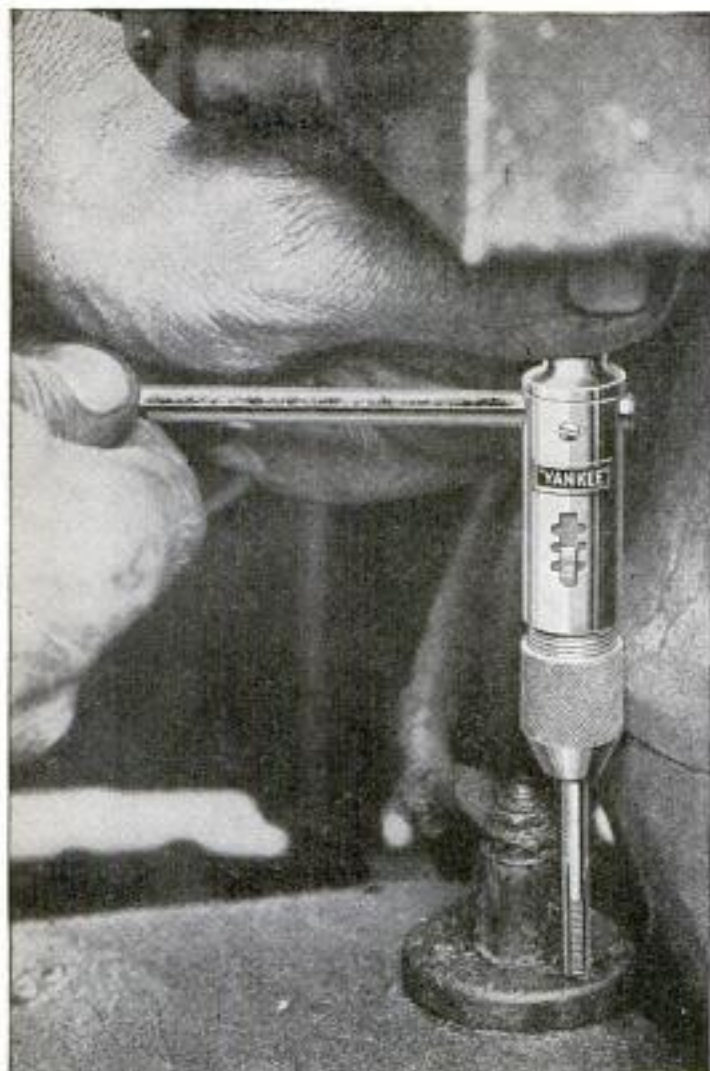

An awkward job  
made easy  
by the  
**“YANKEE”**  
Ratchet Tap Wrench

He had to tap a thread in the transmission case for a magneto plug screw.

He couldn't get his hand under the coil box to turn the wrench.

If he had been working with only an ordinary tap wrench, he would have been compelled to remove the coil box, and lose valuable time.

Fortunately he was using a “Yankee” Ratchet Tap Wrench. So he just pulled the sliding cross bar out to the end position, where he could move his hand freely. Then he set the Ratchet Shifter and tapped the hole quickly and easily.

No need to tear down construction if you have a “Yankee” Ratchet Tap Wrench. No matter where the hole is you can tap it with this ingenious tool.

Three adjustments. Right-hand Ratchet, Left-hand Ratchet and Rigid. Knurled finger turn at top quickly starts or backs out taps.

**No. 250**—Length 3¼ in. Chuck diam., ¾ in. Holds up to 3/16 in. taps.

**No. 251**—Length 5 in. Chuck diam., 7/8 in. Holds up to 5/16 in. taps.

**No. 1251**—Length 13 in. For jobs needing long reach. Otherwise same as No. 251.



If you like tools,  
you'll want  
this book—  
Mailed you FREE

Shows every “Yankee”  
Tool, and tells you all  
about them. Write for  
your copy today.

Some other  
**“Yankee” Tools**

Spiral Screw-drivers

Quick-Return Spiral  
Screw-drivers

Plain Screw-drivers  
1½ to 30 in. blades

Ratchet Breast Drills

Ratchet Hand Drills

*Dealers everywhere  
sell*

**“YANKEE” Tools**

NORTH BROS. MFG. CO., Philadelphia

**“YANKEE” TOOLS**  
*Make Better mechanics*





*Why are  
Starrett Tools  
Standard  
in every Shop*



## Fine Precision Tools—2200 from One

In something over forty years the Starrett Line has increased from a single tool, the famous Combination Square, to include over 2200 different Precision Tools, Hacksaws and Steel Tapes. Those years have seen the growth of a business that now requires the largest plant in the world devoted exclusively to the manufacture of fine mechanical tools.

From the first mechanics to whom Mr. L. S. Starrett sold his Improved Squares and Rules, the roll call of Starrett Users has grown year by year until today every country in the world which uses machinery and precision tools knows Starrett as the standard of accuracy.

What is the cause of this world-wide preference for the Precision Tools that are made in Athol, Massachusetts? If you use Starrett Tools you know.

Shown in the group at the right are the following popular Starrett Tools: Micrometer Depth Gage No. 440, Improved Firm-Joint Callipers, No. 26, Foy Spring Dividers, No. 77, Quick Reading Steel Tape, No. 510 (with Leather Case and Patented Push Button Handle Opener), Micrometer No. 224 A (with interchangeable Anvils giving range of 2" to 6"), Combination Square No. 11, and Thickness Gage No. 72. Write for Catalog No. 23 "AP" for description of the complete Starrett Line.

### THE L. S. STARRETT CO.

*World's Greatest Toolmakers  
Manufacturers of Hacksaws Unexcelled  
ATHOL, MASS.*

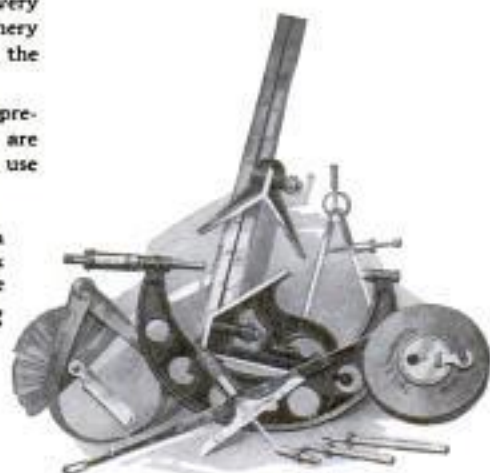



# Electrical Energy

## Columbia EVEREADY Dry Batteries

*—they last longer*



for—

gas engine ignition  
tractor ignition  
fring blasts  
motor boat  
ignition  
telephone and  
telegraph  
doorbells  
buzzers  
heat regulators  
starting Fords  
ringing burglar  
alarms  
protecting bank  
vaults  
electric clocks  
calling Pullman  
porters  
lighting tents and  
outbuildings  
running toys  
radio "A"

Don't just ask for "a dry cell."  
Ask for Columbia Eveready Dry  
Batteries by name and get 100%  
battery efficiency. Columbia  
Eveready Dry Batteries are sold  
by electrical, hardware and auto  
accessory shops, marine supply  
dealers, radio and implement deal-  
ers, garages and general stores.  
Columbia Eveready Ignitors can  
be purchased equipped with  
Fahnestock spring clip binding  
posts at no extra cost to you.

COLUMBIA Evereadys furnish power and pep for a thousand and one tasks. Everything from workaday tasks like ringing the doorbell and starting the Ford, to running toys for the children and providing current for inventors and experimenters.

For more than thirty years Columbia Evereadys have been known for their abundance of electrical energy. They are better than ever—they last longer.

*Manufactured and guaranteed by*

**NATIONAL CARBON COMPANY, INC.**  
New York San Francisco

Canadian National Carbon Co., Limited, Toronto, Ontario



No. **111****Spiral-Ratchet  
Screw Driver**

Price \$2.80

The improved positive lock-nut permits automatic driving or drawing; will instantly convert it into a ratchet screw driver, or will lock it rigidly for use as a plain screw driver. Beveled edges prevent finger-pinching.

Steel spiral nuts and steel spiral, machined at a 20° angle.

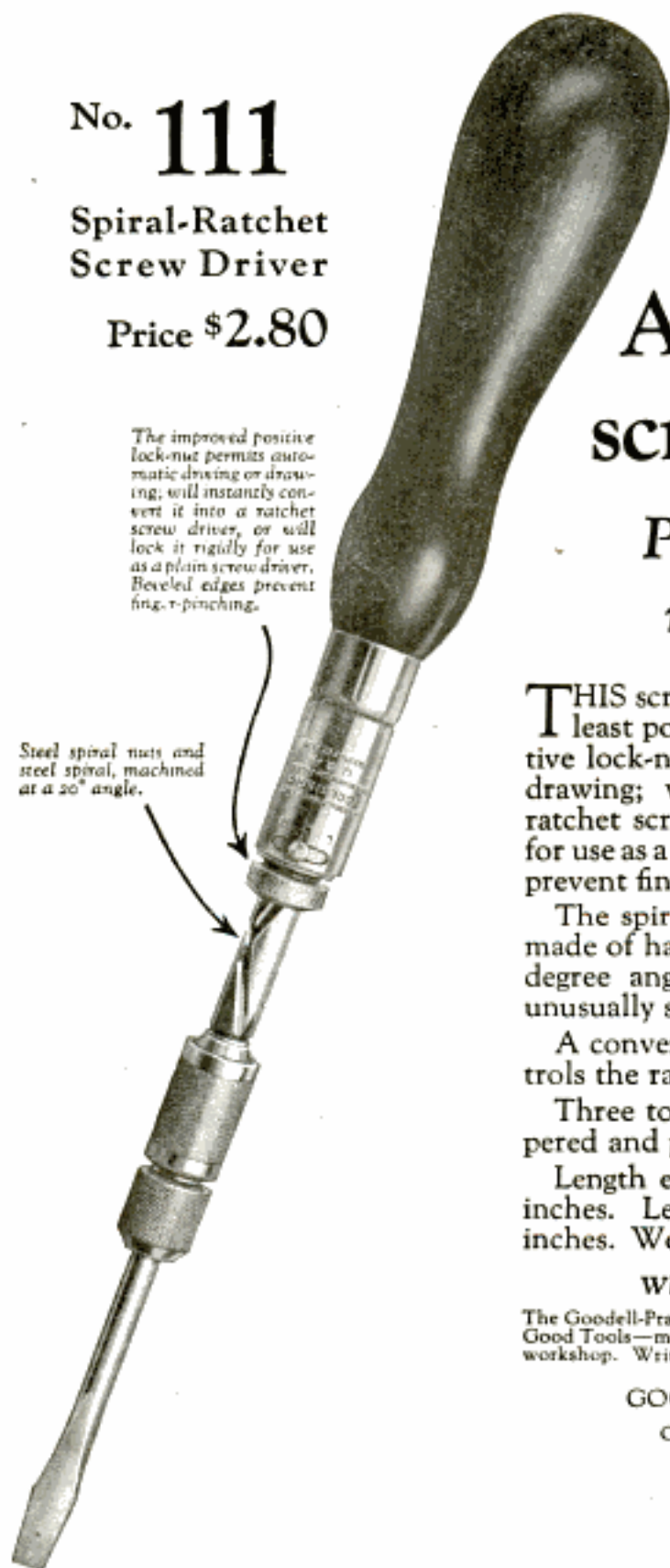

## Automatic screw driver

*Perfected with  
new features*

**T**HIS screw driver sinks a screw with the least possible effort. The improved positive lock-nut permits automatic driving or drawing; will instantly convert it into a ratchet screw driver, or will lock it rigidly for use as a plain screw driver. Beveled edges prevent finger-pinching.

The spiral nuts and the steel spiral are made of hardened steel, milled at a twenty-degree angle. Thus this tool withstands unusually severe strains.

A conveniently located shifter knob controls the ratchet mechanism.

Three tool-steel blades—hardened, tempered and polished—are provided.

Length extended, with blade in place, 18 inches. Length closed, without blade, 10 inches. Weight, 14 ounces.

### *What other tools do you need?*

The Goodell-Pratt Catalog No. 15 shows the entire line of 1500 Good Tools—many of them particularly adaptable for the home workshop. Write for a copy.

GOODELL-PRATT COMPANY

GREENFIELD, MASS., U. S. A.

*Toolsmiths*

Makers of Mr. Punch

# GOODELL-PRATT

## 1500 GOOD TOOLS



# 3 Tubes DO THE WORK OF 6



Crosley Trirdyn Special, \$60.00  
With tubes and Crosley Phones \$75.75

## In the CROSLEY Trirdyn

SINCE the inception of radio, the results obtained with Armstrong Regenerative Receivers have been the goal of comparison for all others. Trick circuits have been designed to get around the Armstrong Patent hoping to obtain results "just as good." This has resulted in the use of more tubes, necessary without, but unnecessary with regeneration. This is one reason why Crosley Radios, licensed under Armstrong U. S. Patent No. 1,113,149 have performed everywhere so remarkably on so few tubes.

The Crosley Trirdyn, employing Armstrong Regeneration combined with tuned non-oscillating radio frequency amplification and reflexed audio frequency amplification and using only three tubes, consistently gives greater selectivity, more volume and wider range than can be obtained where five or six tubes are employed without regeneration. With no regeneration, two stages of radio frequency amplification, requiring at least two additional tubes, must be employed in front of the detector tube to get the same results as furnished by one tube where regeneration is used.

Every additional tube means additional expense; an added dial to tune, greater difficulty in operation, more distortion and more tube noises. The three tube Crosley Trirdyn has only two dials. These operate but two circuits, making tuning and logging very easy.

You can't beat the results obtained from an Armstrong Regenerative Crosley Radio. A trial will convince you.

**BEFORE YOU BUY—COMPARE  
YOUR CHOICE WILL BE A CROSLEY  
For Sale by Good Dealers Everywhere**

*Crosley Regenerative Receivers are licensed under Armstrong U. S. Patent 1,113,149. Prices West of Rockies—Add 10%*

*Write for Complete Catalog*

**THE CROSLEY RADIO CORPORATION**  
Powel Crosley, Jr., President  
215 Sassafras St. Cincinnati, Ohio  
*Crosley Owns and Operates Broadcasting Station WLW*



Crosley One Tube  
Model 50, \$14.50  
With tube and Crosley Phones \$22.25

**CROSLEY**  
Better—Costs Less  
Radio



Crosley Two Tube  
Model 51, \$18.50  
With tubes and Crosley Phones \$30.25

Crosley  
Head Phones  
Better—Cost Less  
\$3.75



Crosley Three Tube  
Model 52, \$30.00  
With tubes and Crosley Phones \$45.75



Crosley Trirdyn Regular, \$50.00  
With tubes and Crosley Phones \$65.75



Crosley Trirdyn Newport, \$85.00  
With tubes and Crosley Phones \$100.75

Mail  
This  
Coupon  
At Once

The Crosley  
Radio Corp's.  
215 Sassafras St.  
Cincinnati, O.

Mail me, free of  
charge, your catalog  
of Crosley receivers  
and parts.

Name \_\_\_\_\_

Address \_\_\_\_\_



# SARGENT

## PLANES



*Sargent Steel  
Block Plane*

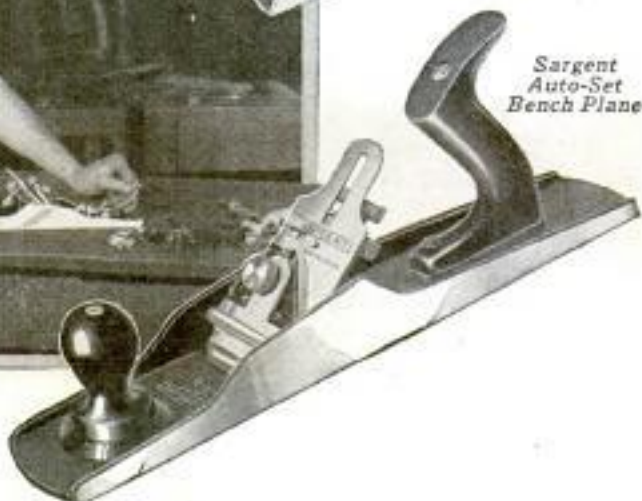

*Sargent  
Auto-Set  
Bench Plane*

## Built for master carpenters .. best for home workshops

SARGENT Planes have been used for years on construction work from one end of the country to the other. They are fashioned from finest metals, perfectly finished and easily adjusted. They are designed to make short work of the hardest jobs, to stand up under the strain of constant usage. Yet they are so moderate in cost that they should be on every home or school work-bench.

You need the two types shown above. The larger is the Sargent Auto-Set Bench Plane. The auto-set feature permits the chromium steel cutter to be removed for whetting and replaced without changing original adjustment. The Sargent Steel Block Plane is great for smaller jobs and cross-grain or knotty surfaces. See both at your hardware dealer's and write for booklet.

**SARGENT & COMPANY, *Manufacturers***  
49 Water Street, New Haven, Conn.



# Combines distance, selectivity, power, deep full tone, beauty and simplicity!

Looks like—and performs like—a \$200 radio set

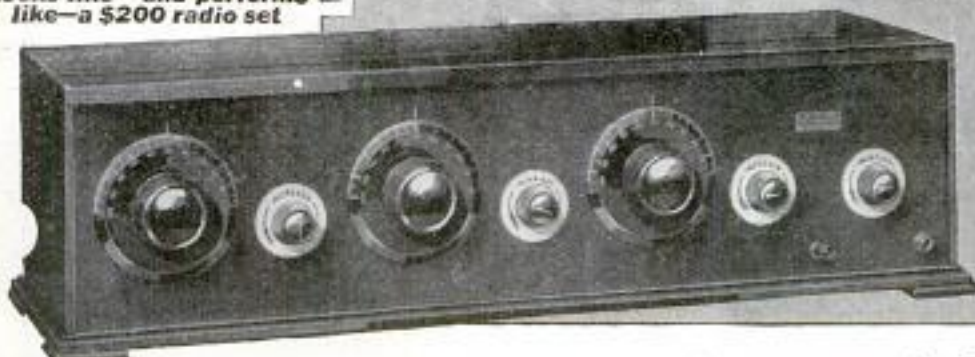

BUILT TO GIVE LOUD SPEAKER ENTERTAINMENT FROM STATIONS THOUSANDS OF MILES DISTANT WHILE LOCAL STATIONS ARE BROADCASTING

## MIRACO RADIO GETS 'EM COAST TO COAST

### Iowa Hears Cuba

Miraco is working fine. Have had Havana, Cuba, and all of the stations along the coast in the United States.—J. F. Abraham, Talleysrand, Iowa.

**Oklahoma Hears Europe**  
Nov. 27th, was able to get two of the foreign stations on my Miraco, also Porto Rico and Guatemala, Mexico.—W. J. Lowe, Verdun, Okla.

**Michigan Hears Germany**  
My Miraco is working fine. Nov. 28th I got 5 NO, Newcastle, England and LP, Berlin, Germany. Can you beat that record?—Thomas Walker, Howell, Mich.

**Pennsylvania Hears Paris**  
Believe Miraco the best distance-getter on the market for the price. Nov. 24th I picked up Paris, also Havana, Cuba and San Juan, Porto Rico. Nov. 25th I picked up 5 NO, Newcastle, England. Nov. 27th got 5 NO and 2 BD, Aberdeen, Scotland. Now have 98 other stations on my log to date including KGO, Oakland, Cal.—Earl C. Way, Coleman, Pa.

**Indiana Hears Europe Nightly**  
During the European test I had some foreign station every night on my Miraco. Nov. 22nd I also heard New York, Los Angeles, Canada, Texas, and 31 others.—C. J. D. Rudolph, Evansville, Ind.

**Kansas Hears Coast to Coast**  
Am using a Miraco and will let the following list of stations tell what I think of your sets. These are not all the stations I have tuned in as I do not "log" a station unless I hear it at least twice. The unrecorded stations include several in Canada, two in Mexico and one in Cuba. Expect to do better still: KHJ, KFI, Los Angeles; KGO, Oakland, Cal.; KPO, KVO, San Francisco; WBZ, Springfield, Mass.; WGY, Schenectady, N. Y.; WOO, Philadelphia; WEB, Atlanta, Ga.; KFDX, Shreveport, La.; WOAI and WCAI, San Antonio, Tex.; WFAA, Dallas, Tex.; WGR, Buffalo, WBAH, Minneapolis; WCAM, Villanova, Pa.; KSD, St. Louis; WOAW, Omaha; KOKA, Pittsburgh; WEBB, KYW, WGN and WMAQ, Chicago; WTAS, Elgin, Ill., and twenty others in Missouri, Kansas, Iowa, Illinois, Minnesota, Nebraska and Oklahoma.—J. A. West, Augusta, Kan.

# The Marvelous MIRACO Ultra 5

- costs only \$75

Send for free bulletins and

**SPECIAL OFFER today!**

[FIVE TUBE OUTFIT IN BEAUTIFUL SOLID MAHOGANY CASE]

Completely built, thoroughly tested and factory guaranteed by one of America's oldest and most reliable manufacturers of quality sets! Years of experience and quantity production explain its almost incredible price. Users say that friends who see and hear it are amazed that it sells for less than \$150 or \$200. Radio experts, who know good construction and quality parts, are equally astonished. You, too, will be delighted, thrilled, amazed with your big five-tube Miraco Ultra 5 in its beautiful hand-rubbed solid mahogany cabinet!

Imagine getting all this for \$75—a beautiful sweet toned "coast to coast

loud speaker" set, composed of finest parts, equipped with the latest improvements, refinements and features found on costliest sets. An instrument approved by radio's highest authorities! A set anyone can connect and operate. Even beginners learn quickly to cut through the "locals," get distant stations loud and clear, log stations and return to them at will. (Full directions with each set.) It is non-radiating, non-distorting, non-howling. Has cut-out switch—and a first stage phone jack for tuning—on Bakelite panel. All wiring concealed under Bakelite sub-base. Works on storage battery or dry cells. Literature describes other newest features.

## Other Miraco Long Distance Sets \$14<sup>35</sup> up



operate and log. Covers all wave lengths 150 to 625 meters. Like all Miraco sets, it operates on a storage battery or dry cells. Never such value before at only \$14.35. Send coupon today!

Miraco Model R justly deserves its title, "Radio's finest low priced quality receiver." One tube acts as a tuned radio frequency amplifier and detector combined. A great distance getter. Easy to

This wonderful new Miraco Model R-3 is the three-tube, long distance, loud speaker set that has created such a sensation.

Easy to tune and log. Covers wave lengths 150 to 625 meters. Detector acts also as a tuned radio frequency amplifier. 2 stages audio frequency amplification. Has no equal for simplicity, volume, range or clearness at anywhere near its price of \$29.50. Use coupon

**All the Proof you want is waiting for You!**

Reports from the many users in every state prove Miraco Tuned Radio Frequency Receivers—at rock bottom prices—have efficiency of sets costing up to three times as much. Remember that Miraco Sets are the product of a long established, reputable manufacturer—pioneer builders of sets. Send for further evidence that they are Radio's finest moderately priced receivers. All Miraco sets bear the endorsement of radio's highest authorities. Mail coupon now for latest bulletins, SPECIAL OFFER and plenty of additional testimony from users leaving no doubt that "Miraco Radio Gets 'em Coast to Coast."

**Dealers! Jobbers!**

Write for the new Miraco proposition.

**Agents!**

The wonderful tone, volume and distance-getting ability of Miraco Sets makes them easy to sell. Send coupon for proposition good territories open.

Send coupon for free bulletins

[or order direct from this ad]

**MIDWEST RADIO CORPORATION**  
Pioneer Builders of Sets, 407 - 7 E. Eighth St., Cincinnati, O.  
Send free literature, SPECIAL OFFER and all particulars regarding Miraco Sets. ( ) Jobber ( ) Dealer ( ) Agent ( ) User

NAME.....  
ADDRESS.....



# Mechanics Know They Measure Closer with a BROWN & SHARPE Accurate Graduations

Examine a Brown & Sharpe Micrometer. Notice how accurately the graduations on the thimble line up with those on the barrel. Turn the thimble. See how easily and accurately the clean cut graduations can be read. Or study a Brown & Sharpe Vernier or Protractor—the excellence of its graduations is instantly apparent—visible evidence of the superior workmanship which goes into all Brown & Sharpe Tools.

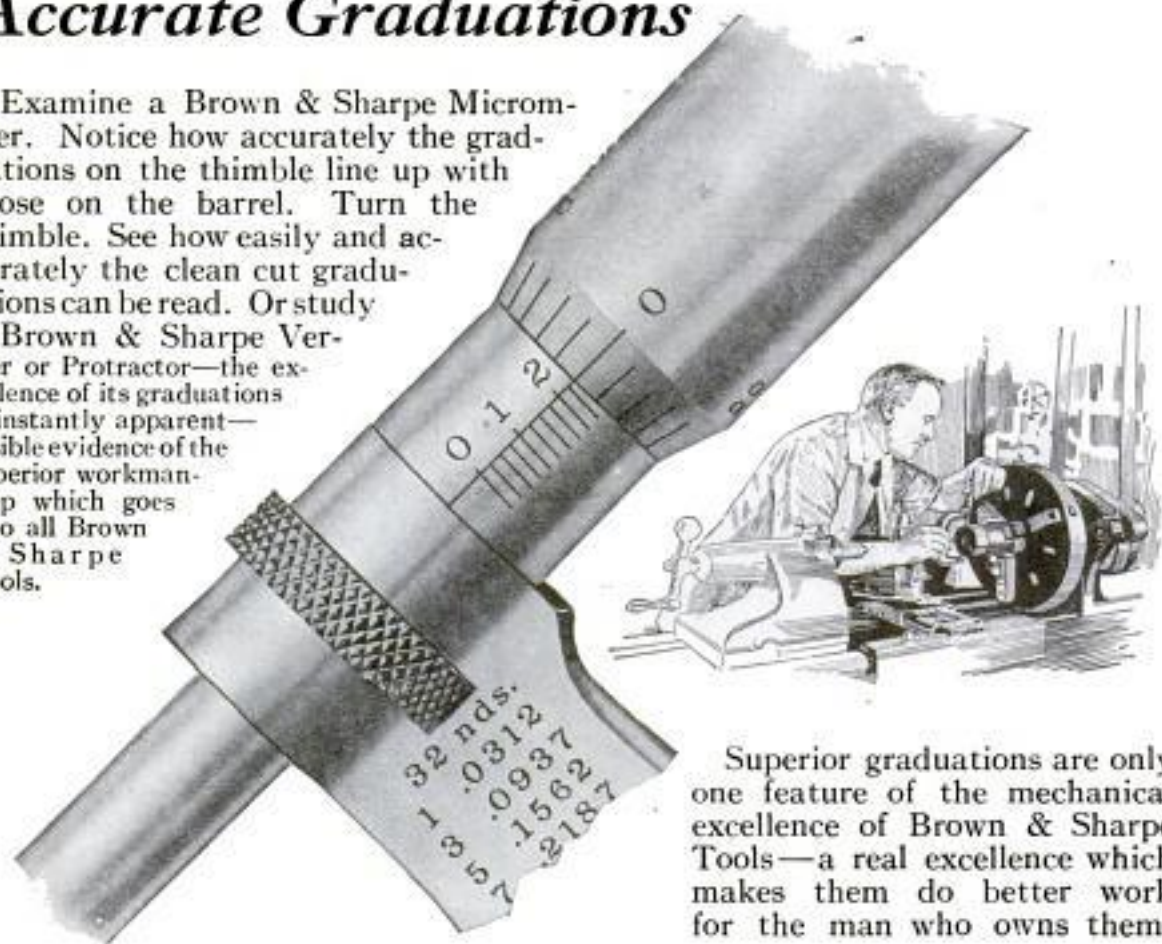

Superior graduations are only one feature of the mechanical excellence of Brown & Sharpe Tools—a real excellence which makes them do better work for the man who owns them.

*You ought to have Brown & Sharpe Small Tool Catalog No. 29, which lists over 2,000 of the best tools you can buy. It is sent free to any address.*

**BROWN & SHARPE MFG. CO.**

Providence, R. I., U. S. A.

## **BROWN & SHARPE TOOLS**

*“Standard of the Mechanical World”*



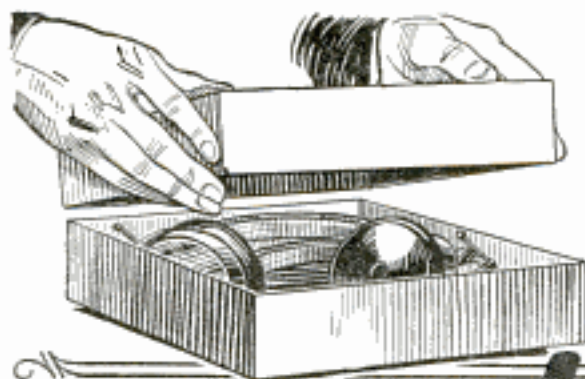

# Put Away Your Headphones

# Now!

*You Can Tune Across the Country  
with Loud Speaker Volume.*

*1 on Just **ONE** Dial*



**Y**EARS ahead in perfected, simplified tuning and in loud speaker volume, the sensational new Mohawk is the first and only true ONE Dial Control for a 5-tube coast to coast radio set.

The new Mohawk is fundamentally and essentially conceived and constructed to be a loud speaker receiver. Without headphones the Mohawk's ONE Dial will tune in stations all across the country direct on the loud speaker for everybody to hear. Even more delightful, the selectivity of this ONE Dial tuning goes far above the average. It will cut through the nearby stations with unflinching precision and bring in the distant ones loud and clear. Children can do it—elderly people—any member of your family and friends.



## The Mohawk 5 Tube Receiver

Never before has there been this freedom from the difficult task of carefully adjusting several complex controls. And in your home Mohawk beauty of appearance will again increase the pleasure of its wonderful performance with just ONE Dial. Table model, console and consolette are each built in distinctive period type Adam Brown walnut cabinets. The console and consolette have built-in loud speaker, also battery compartments. Every model is broadly, fully guaranteed.

*Write for descriptive circular giving complete information and prices on the three Mohawk models*

**Mohawk Electric Corporation**  
2242 Diversey Blvd., Chicago, Ill.



Write today for your **FREE** copy of—

# Ward's New Radio Catalogue

**T**HIS advertisement is published to tell you three things that everyone interested in Radio *should know*.

That we believe Ward's is today the greatest Radio store in the world—that it is the real Headquarters for Radio.

Second, that at Ward's you can buy everything in Radio without paying the usual "Radio Profits."

Third, that this big 68-page book—a genuine reference book on Radio—is yours free for the asking.

### *Our Radio Experts*

This Catalogue is a book gotten up by experts. It shows all the best hook-ups, everything in parts and

complete sets—so simple that you yourself can easily install them.

And it shows only tested and approved Radio equipment—selected and tested thoroughly by our Experts who are up-to-the-minute in Radio.

Write for Ward's free 68-page Radio Catalogue and see the low prices.

### *Our 53 Year Old Policy*

Every Radio set we sell is guaranteed to give complete satisfaction. In buying Radio from Ward's you are buying from a house whose reliability is above question. For 53 years we have sold quality goods only. Address our house nearest you. Dept. No. 6-R

## Headquarters for Radio

*Satisfaction Guaranteed  
or Your Money Back*

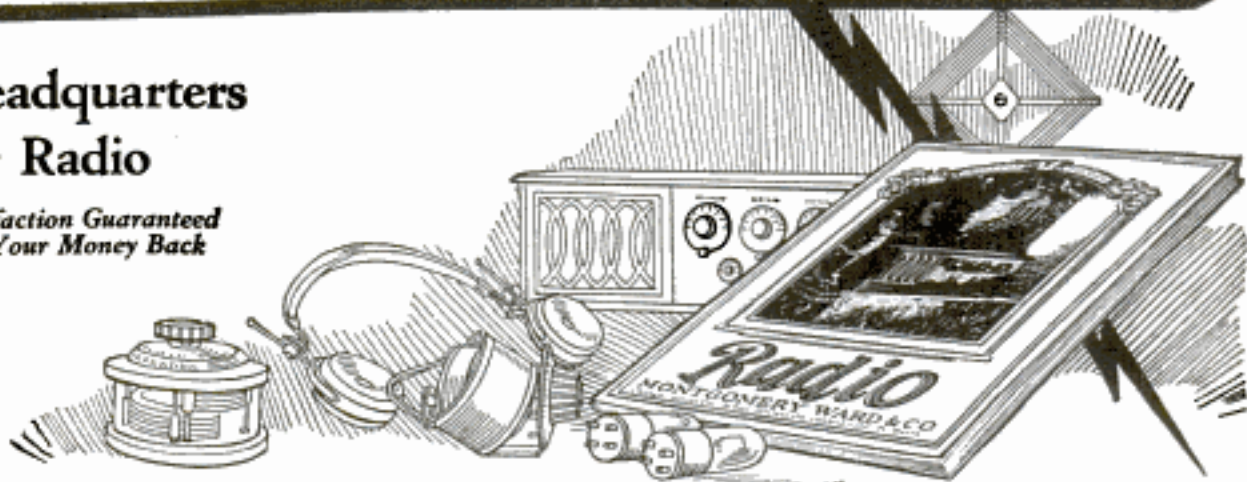

ESTABLISHED 1872  
**Montgomery Ward & Co.**

*The Oldest Mail Order House is Today the Most Progressive*

Chicago Kansas City St. Paul Portland, Ore. Oakland, Calif. Fort Worth



# Western Canada is Calling You



Come where rich land is low priced—where virgin soil produces big crops—where you can double or triple your acreage with the same investment, with 35 years to pay.

## Free Use of Land for One Year Stop Paying the Penalty of Farming High-Priced Land

Canada needs farmers. In return, she offers independence, prosperity and wealth. Canada wants you for a partner—to bring your skill as a farmer to her rich, low-priced soil.

Fertile land sells for an average of twenty dollars an acre. It is near the railroad, stores, towns, churches and schools.

### 35 Years to Pay—First Year, Free Use of Land

Under our liberal plan, you pay down only 7% of the total purchase price—then use the land a year without even an interest charge, after which the balance of the principal and interest will be amortized on an easy payment plan of 34 equal payments. The second payment does not fall due until two years after purchase. On 160 acres costing \$3,000, you pay down but \$210. Your annual payments will be but \$195.30.

### Interest Receipts Are Worthless

Try to buy a mower with your interest receipts. They are worthless! Put your profits back in your pocket—we don't want them. We want farmers—business men farmers—to build the country and fortunes for themselves.

### No Taxes on Improvements

Taxes are low. No tax on livestock, buildings, improvements, implements or personal effects. Good markets nearby. Modern schools, churches, roads and amusements make farm life worth while in Western Canada.

*This is your chance. Don't turn this page until you clip and mail the coupon. Act now.*

**Send coupon Today  
for FREE booklet**

**M. E. THORNTON**

Supt. of Colonization

Dept. 502, Canadian Pacific Ry. Depot  
Winnipeg, Manitoba, Canada



### Irrigated Farm Lands Also

In sunny Southern Alberta—a district especially adapted to mixed farming—the Company has constructed a vast irrigation system with an unfailing water supply. This insures a crop every year—makes you independent of weather conditions—produces great quantities of coarse grains, pasture, alfalfa, etc. Here the stockman prospers in an industry ultimately more profitable than wheat farming. These lands are for sale on the same easy terms.

### We Won't Sell Until You Investigate

You must investigate before you buy. Special inspection trips at reduced fares. We arrange details. Write for information.

How about your boys? Where will they find farms if present prices increase further?

**M. E. THORNTON, Supt. of Colonization  
Dept. 502, Canadian Pacific Ry. Depot  
Winnipeg, Manitoba, Canada**

I am interested in learning more about:

- Prairie Provinces of Canada.  
 Irrigation Farming in Sunny Alberta.  
 Business and Industrial Opportunities in Western Canada.

My Name.....

Address.....

Town..... State.....



## For Circuit Supremacy— CIR-KIT and Supereflex



Erla Supereflex—new epoch in circuits. Not just a “wave” of popularity, but the permanence of *basically* superior principles, just as advanced today as when Erla introduced the circuits still rated more powerful, tube for tube.

Expressing the best of Erla science, Supereflex circuits also are so easy to own! Not only because of extreme economy in first cost and operation, but also because Erla *CIR-KIT* enables any experimenter to produce these greater circuits flawlessly. *CIR-KIT* provides every needed item of Erla Precision Radio Apparatus—exclusively responsible for matchless Erla range, volume, clarity, sensitiveness and remarkable ease of control.

*CIR-KIT* also provides full-size blueprints; stenciled base-board; and drilled, lettered panel, so that every step must be correct. Assuring lasting supremacy in circuits; the pride of a truly professional hook-up; and incomparable entertainment, *CIR-KIT* is outstanding in radio today.

**Electrical Research Laboratories**  
Dept. J, 2500 Cottage Grove Ave., CHICAGO

# ERLA



Erla  
Floor  
Console

*Erla complete radio instruments lift  
radio to the realm of art, with the  
same superiorities CIR-KIT brings.*

Erla Table Cabinet



Erla  
Table  
Console





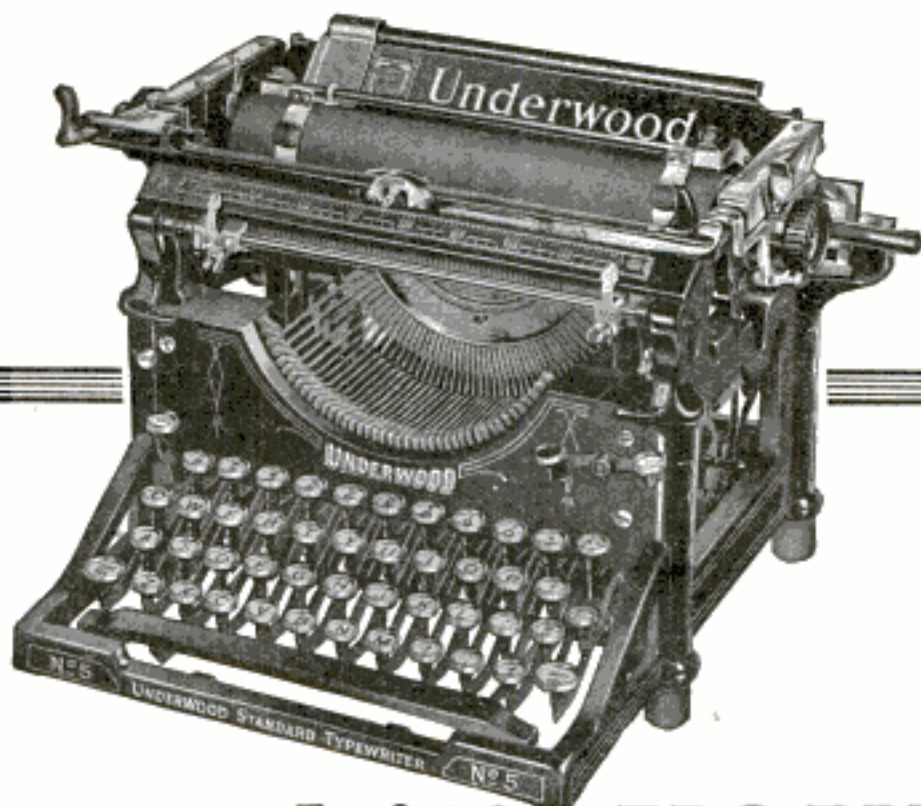

**\$3**  
**DOWN**

## and it's YOURS

**The Greatest Typewriter Bargain Ever Offered**

Right now we are making you the greatest typewriter offer you ever dreamed of—an eye opener. This wonderful standard Shipman-Ward Rebuilt Underwood only \$3.00 down. Ten days' free trial and the easiest monthly payments, shipped direct to you from our big factory.

### 10 Days' Free Trial From Factory to You

Yes, only \$3.00 down puts this genuine late model Shipman-Ward Rebuilt Underwood in your home. You can try it, test it, and then decide. See for yourself how new it is, how it writes. You must be satisfied. Your \$3.00 unconditionally returned if at the end of ten days you are not satisfied. The entire transaction will not cost you one cent.

### EASY Monthly Payments

Little more than rental. Balance of payments so small you will hardly notice them, while you enjoy the use of this wonderful machine. You don't have to scrimp and save to pay cash. All at a big saving to you.

### 5 Year Guarantee

With every typewriter we give a written guarantee. These machines are rebuilt like new by the famous SHIPMAN-WARD PROCESS. Equipped with late improvements. You can't tell them from a new machine. The world's standard typewriter, the same models as sold by the Underwood Typewriter Company today, at a big saving to you. Act now! Get this splendid offer and save money.

These machines are shipped direct from our factory—the largest typewriter rebuilding plant in the world. They are rebuilt by the famous SHIPMAN-WARD PROCESS. Developed through 30 years in the typewriter business. Through our money saving methods of rebuilding and elimination of a large expensive sales force we are able to make this wonderful money saving offer to you. ACT TODAY, take advantage of it and you will SAVE MONEY. ACT NOW! Mail this coupon today.

### Free Book of Facts

Write for this free book of facts explaining Shipman-Ward's wonderful system of rebuilding typewriters. We show you exactly how it's done. How you are able to buy them. Complete and valuable information about the typewriter industry, both instructive and educational.

### FREE with Every Typewriter

A complete course in touch typewriting. You don't have to know how to operate a typewriter. You can learn to operate this machine in one day. We also give free a waterproof cover and all tools that come with a typewriter.



*All Shipments made direct to you from our modern factory—the largest typewriter rebuilding plant in the world.*

### FREE BOOK COUPON

**SHIPMAN-WARD MFG. CO.**  
2122 Shipman Bldg.  
Montrose and Ravenswood Aves.  
CHICAGO

Send by return mail your wonderful offer of Shipman-Ward Standard Rebuilt Underwood, also your book of facts. (This is not an order and does not obligate me in any way.)

NAME.....

STREET.....

POST OFFICE.....STATE.....

**SHIPMAN-WARD MFG. CO.**

2122 Shipman Bldg., Montrose and Ravenswood Aves., Chicago





The model shown is the "C" Melody Buescher Saxophone

# What a difference just a few months make!



## Free!

This beautiful book shows how easy it is to learn to play a Buescher. In it you will find the first lesson chart.

Only a few months ago this boy was what you fellows call a "false alarm". He missed most of the fun because he had "nothing to offer". Girls avoided him. Fellows gave him the "Ritz". But now. What a difference! A few weeks with his Buescher put him "across". He's the center of attraction; the life of the party; welcome - everywhere.

### Free Lessons Start You

Anyone who can whistle a tune can learn to play the Buescher Saxo-

phone. The first 3 lessons sent free with the instrument give you a quick, easy start. You can pick it up yourself and later get a teacher if you wish to join a band or orchestra or make the Saxophone your profession. It's great fun practicing because you learn so rapidly.

We want you to try a Buescher 6 days in your own home Free. Clip and mail the coupon for particulars. We'll send free book and easy payment plan. Do this today.

### BUESCHER BAND INSTRUMENT CO.

Everything in Band and Orchestra Instruments  
700 Buescher Block Elkhart, Ind.

181

**Easy to Play - Easy to Pay**

## Mail

Buescher Band Instrument Co., 700 Buescher Block, Elkhart, Indiana

Gentlemen: Without any obligation to me

send me your beautiful book "The Story of

the Saxophone" described above. Check here

Write plainly, Name, Address, Town and State in margin below.

If you prefer literature describing any other

band or orchestra instruments, check below

Cornet  Trumpet  Trombone  Tuba

Mention Any Other.....



# 500 PUNCTURES Yet Leaks No Air



# We Want Agents

A new Puncture Proof inner tube has been invented by Mr. A. Y. Milburn of the Milburn Puncture Proof Tube Company, Chicago. In actual test it was punctured with 500 nail holes without the LOSS OF AIR. This amazing new inner-tube increases mileage from 10,000 to 12,000 miles; eliminates changing tires and makes riding a real pleasure. Many users have run over 20,000 miles without removing a tire from the wheel.

These wonderful, no-trouble, puncture proof inner tubes cost no more than ordinary tubes and Mr. Milburn wants agents everywhere to help him introduce them.

## CAR OWNERS WANTED

To sell and demonstrate this wonder tube. Interests everyone immediately. Automobile owners buy on sight. It makes no difference what car they drive or what tires they use. Our salesmen are coining money on our "DIRECT FROM FACTORY" scheme of selling. Absolutely no competition. We control all basic patents. No capital required to start. Previous selling experience not necessary.

## EARN \$5,000 to \$10,000 A YEAR

### Read What These Men Say

**J. D. Cooper**—"I have made 30,000 miles with my Milburn Puncture Proof Tubes and have not as yet removed a rim or casing and my casings are still in excellent condition."

**J. C. Jerves**—"I sold 50 Milburn Tubes in the first three days."

**Chas. Cayton**—"I sold twelve tubes yesterday in ten minutes."

**L. S. Knapp**—"My first few hours out I sold eight tubes, no trouble at all to sell them. The most wonderful tube on the market today, I think. I am hoping you will give me the agency for a big territory."

**D. Edelero**—"I have driven seventy-five miles in one of the 30x3 tubes and twenty were spike nails. It has gone above the test that you recommended to me it would do."

Earn \$5,000 to \$10,000 yearly or more. Get into business for yourself. Sell Milburn Puncture Proof Inner Tubes. Every car owner is a prospect. Your field is unlimited. Get in while it is good. Be independent. Find out all about it now and get started at once. Then you will be ready to make big money when the heavy spring selling season starts.

## FREE TUBE SPECIAL FREE TUBE OFFER

Send coupon or write today for special free tube offer and further details. References, Industrial State Bank of Chicago, National Bank of the Republic, Chicago, Baker State Bank of Chicago. Don't hesitate. Fill out the coupon and send it in or write and send name and we will send you all details. This is your opportunity so don't delay. Address

**A. Y. MILBURN, Pres.**  
**Milburn Puncture  
Proof Tube Co.**  
331 West 47th Street  
CHICAGO, ILLINOIS

**MILBURN PUNCTURE PROOF TUBE COMPANY**  
331 West 47th Street, CHICAGO, ILLINOIS

A. Y. MILBURN, Pres. If the money-making opportunity is as big as you claim, I am interested in getting the facts on this. Without obligation send me information about commission and FREE TUBE OFFER TO AGENTS.

Name   
Address   
City   
State



# Only \$10 Down

Buy This  
Fully Guaranteed  
Burroughs Adding Machine

Balance in  
easy  
Payments



This is a standard Burroughs Machine used in banks, offices and stores everywhere. It has been completely overhauled and worn parts replaced. It is guaranteed for the same period as a new machine.

Take advantage of this remarkable offer today—pay only \$10 down and let the machine pay its way in your business. Total cash price only \$100.

**Mail This Today** Other styles and sizes in leading makes of figuring machines.

General Adding Machine Exchange  
6808 Second Blvd., Detroit, Michigan

Please send me information about this special guaranteed Burroughs Adding Machine.

Name \_\_\_\_\_

Business \_\_\_\_\_

Address \_\_\_\_\_

## GET THIS FIRE GUN FREE!



## AND EARN

# \$100 A WEEK

I will teach you how to make it—give you a free course in selling and a Free Selling Outfit. L. J. Clement made \$62.70 in one day. McPhail made \$1,140 in 4 months. The Weldon Fire Gun is an amazing new invention that sells on sight because it requires no pumping—requiring only the turn of a valve to shoot a continuous fire-smothering chemical more than 25 feet. One demonstration often means 10 sales. Your profit \$40 or more. Write quick for details of this wonderful opportunity to make big money in full or spare time.

WELDON MANUFACTURING CO., Dept. 72, Grand Rapids, Mich.



## WADE BENCH LATHE

AMATEUR MECHANICS, MODELMAKERS, INVENTORS, STUDENTS  
A real machine tool for the home work bench—capacity 4" dia. x 12" length. For Metal—Wood—Composition Materials—Turning—Facing—Boring—Drilling—Winding—Thread Cutting. Accurate—Strong—Quiet—Compact. Slide-rest has travel entire length of bed. Leadscrew inside bed. Send for literature—Price \$28.00. THE GEROLD CO., Dept. P-7, 120 Liberty St., New York

# DIAMONDS

FOR A FEW CENTS A DAY

Don't spend a single penny. Ten days Free Trial. When the ring comes, examine it—if you are not convinced it is the Greatest Bargain in America, send it back at our expense. Only if pleased, pay 20% as first payment—then send \$1.50 weekly—at the rate of a few cents a day. This Bargain Cluster Ring with 7 Blue-White Perfect Cut Diamonds can be yours. No red tape. No risk.

**Your Spare Pennies will pay for this Diamond Ring**

**MONEY BACK GUARANTEE**

Million Dollar Bargain Book FREE. Send for it today. It pictures thousands of Bargains. Address Dept. 1712

**J.M. LYON & CO.**  
2-4 Maiden Lane N.Y.

Million Dollar Bargain Book FREE

## I Want 700 Agents At \$90.00 a week



Men and Women! Write me today and by this time next week I can place you in a position to make \$2.00 to \$5.00 an hour in your spare time, up to \$15.00 a day full time. Thousands of our representatives are making that and more with our New Plans. Simply introduce and take orders for famous World's Star Hosiery and Underwear sold direct from mill to home—a complete line for whole family. Permanent customers and repeat orders make you steady, big income. No delivering or collecting. No capital required.

**Write Quick** It's a chance to make thousands of dollars. Your profits begin at once. Exclusive territory. No experience needed. Write today and I'll send all facts and tell how to start Free. (Established 29 years.)

World's Star Knitting Co.  
272 Lake Street Bay City, Mich.



## THE TOOL OF A THOUSAND USES \$1.00

More Than a Wrench. Better than Pliers.

Does the work of both. Instant adjustment. Unbreakable Drop-forged steel. Saves time and trouble for mechanics, plumbers, electricians, farmers, automobilists, housewives. Grips, holds or twists anything round, square, or hexagon up to one inch. Order your Plier-Wrench now.



ABOUND AUTO

LOOSENING TAP

STOPPING LEAKS

SENDING WIRE

MONEY-BACK GUARANTEE

If a dealer cannot supply you, order direct.  
Noble & Westbrook Mfg. Co., Hartford, Ct.

FOR HARD-TO-REACH PLACES

Sales Agents Write for Special Discount

## \$20 A DAY EASY

That's the average of our men selling elegant, individual, distinctive, tailored shirts. Exclusive patterns. "BUY ON HONOR TO HONOR THEIR MAKERS!" Direct from our large, airy mills to wearer. Out of ordinary value. Tremendous demand. Big repeat business. We deliver for you. Not sold in stores. No capital or experience required. Write J. W. NEITJAN, Gen. Mgr., CHICAGO SHIRT COMPANY 114 Chicago Shirt Bldg., Chicago, Ill.



# Be a McSweeney Trained AUTO EXPERT



Why not leave the rut and get into a business that pays real money—dignified work—Be a McSweeney Trained Auto Expert! It's easy and it will only take you eight weeks. Are you willing to take eight weeks out of your life and spend them working in overalls with dirty hands, if you were sure you were going to benefit your position in life? Of course you are. Read every word of this and my other announcements on pages 50 and 51, also on the inside front cover of this magazine—Fill in the coupon and start on your way to being a McSweeney Trained Auto Expert.

## Why McSweeney Trained Means BIG PAY AUTO JOBS

Because employers all over the country recognize the fact that McSweeney men are the best mechanics they can get—because their training is so thorough that they can be given a job and told to go ahead. McSweeney Trained Men need no supervision.

### I Use Up-to-Date Equipment Only

My three big training shops are filled with the most modern and up-to-date equipment and machinery—and you work on every bit of it—nothing in any of my shops is for show.



### I use the highest paid Instructors

Only the best instructors in the country can work for me—they must know their stuff—and not only that, they must be able to teach it to you, so that you will know as much about it as they. My strict method of supervision keeps them on their toes. They are all giving you the best they have all the time—and their best is the best money can buy.

### I OPERATE THREE BIG SCHOOLS

For your convenience, I carefully selected the locations of my Schools, Cincinnati, and Cleveland, Ohio, and Chicago, Ill., because they are nearest to the most automobiles on the roads—the ones which need repairing—the ones which you will work on. All of my Schools are operated on the same high scale.



### Get This Big FREE BOOK

Don't fail to get my big 64-page catalog. I'll send it free with full details of my special offer, if you'll send the coupon.

### SPECIAL HOME STUDY COURSE

To those who cannot come to one of my schools right away, I am offering my Home Study Course—the result of three years' experience operating three automotive schools. I want to see you get started on the road to success—this will make it easy for you.

### FREE RAILROAD FARE FREE BOARD

For a limited time, I am going to pay your Railroad Fare to my nearest School and give you your board free for eight weeks. Send the coupon now—today—this minute, for my full particulars.

# McSWEENEY Auto, Tractor and Electrical SCHOOLS

Dept. 1417

CINCINNATI, O. CHICAGO, ILL. CLEVELAND, O.

9th & Walnut Sts. 517-21 South Laffin St. 1815 East 24th St.

See my announcements on Pages 50-51, and on the inside front cover



This  
Great  
Auto  
Book  
FREE!

### USE THIS COUPON FOR MY SPECIAL OFFER

J. H. McSweeney, Pres. Dept. 1417  
McSweeney Auto, Tractor & Electrical Schools,  
9th and Walnut Sts., CINCINNATI, OHIO  
517-21 South Laffin St., CHICAGO, ILL.  
1815 East 24th St., CLEVELAND, OHIO  
Address School nearest you.

Dear Mac: Send me your 64-page catalog and full particulars of your special offer.

Name .....

Address .....

City ..... State .....

I am interested in the  Resident Course  
 Home Study Course  
(Check the one you are interested in.)



**Red Devil Tools**  **Better Made**

## "Red Devil" Pliers

—Your First Choice



No. 1226

There are many different styles of pliers, and many different makes. You want to be sure you get the styles best adapted to your purpose; that you get properly made pliers that will do exactly what you want them to do, and will last for years.

Look at the workmanship—see that the handles fit the hand snugly, and do not pinch—try the wire cutters, and see if they are properly set. The "Red Devil" trade mark is your assurance that every one of these points has been properly looked after in the design and manufacture.

## "Red Devil" Adjustable Wrench



No. 90

The most convenient tool for all-around usefulness. Gives better leverage than the old style monkey wrench.

Sturdy forged steel jaws will not spread. No. 90—size 4, 6, 8, 10 and 12 inches. 8-in. size, 80c each.

"Red Devil" Tools are on sale at all hardware dealers—if not in stock, send dealer's name and order from us.

*Mechanic's tool booklet free.*

**SMITH & HEMENWAY CO., Inc.**  
Manufacturers of "Red Devil" Tools  
260 Coit Street Irvington, N. J.

**no freezing**  **no boiling!**

**A**N absolutely genuine article, prevents freezing or boiling from 57° elbow up, running or standing. The system weighs less than one pound, has no moving parts, requires no attention, outlasts your Ford. As practical as water, easily installed. Thousands making good. **Price, \$6.50.**

**Ford Owners:** Send \$1.00 for demonstration outfit, balance \$5.50 C. O. D.

**Ford Dealers:** Stock no more winter fronts, or summer pumps. Equip with AIR-LOCK now.

**Ford Agents:** Park at the curb, demonstrate, and coin money.

**AIRLOCK PRODUCTS**  
Box 703-A, Willow St. Long Beach, Calif.

## Fords Get Double Mileage With New Invention

Simple Device Works Wonders

The most amazing and remarkable invention that has come to light in recent years has just been produced by Robert Martin of Chamberlain, S. D. Fords that were formerly making only 12 to 14 miles on a gallon of gas are now getting from 28 to 43 miles, by using this new attachment. This marvelous invention is a simple affair of aluminum and glass and can be installed by anyone in just a few minutes. In addition to increasing mileage, it filters every drop of gasoline fed to the cylinders and removes every particle of carbon at the same time. Mr. Martin guarantees it to increase mileage on any car and is willing to give one free to any person who will help him introduce it. Write Robert Martin, 800-19 Somers Bldg., Chamberlain, S. D., and ask for his free sample offer. *Adv.*

## AGENTS NEW SPARK PLUG

### Visible Flash

**Just Out—Amazing Invention—Beacon Lite Spark Plugs.** You see the flash of each explosion in the cylinders. Tells which are firing right. Greatest improvement in spark plugs since gas engines were invented. Wonderful gas savers. Agents coin money.

**\$90 A WEEK**  
Easy to make with new sure-fire plans. Sells on sight to every auto owner. Phillips, Ont., writes "Sold 2 dozen today, 3 dozen yesterday. Rush 10 dozen." Write for special **Free** Demonstrator Offer and **FREE** deal to introduce these wonder spark plugs in your territory. Write quick—today.

**CENTRAL PETROLEUM COMPANY**  
503 Century Building Cleveland, Ohio



LOOK FOR THE  
**Red Handle**  
 WITH THE  
**Black Head**  
 (Color Combination  
 Registered as Trade  
 Mark, U. S. Pat. Off.)  
 EXCLUSIVELY  
**PLUMB**



Plumb Hammer cut away to show Plumb Take-up Wedge, which retightens the handle with a turn of the screw.

**“Just right  
 in shape and balance”**

**YOU** will say what the carpenter says when you try a Plumb Nail Hammer—the hammer that mechanics helped to design for you.

Just what you want in your hammer:

- a larger face that works with you to hit the nail on the head;
- a shorter neck that lets the weight come close to the head of the hammer;
- claws bent more sharply, to make your nail pulling easier;
- the Plumb Take-up Wedge, to keep your handle always tight.

Forged from Plumb Special Steel, armor-plate heat-treated, tempered hard for service, tough for wear. Your hardware merchant has this hammer for you. Price, \$1.30 (except in Far West and Canada).

FAYETTE R. PLUMB, Inc., Philadelphia, U. S. A.

**And you will  
 say the same!**

“The Plumb is the best proportioned hammer I ever had my hands on, in my 25 years at the carpenter’s trade,” says J. R. Piercey, Conway, Ark.

“It fits the hand as if it were made to order,” says J. A. Crist, Arcadia, Fla.

“Whenever I lend my Plumb to any other carpenter, he tells me it is the nicest balanced hammer he ever used,” says M. R. Warner, La Junta, Colo.









# Send For This Sensational Radio Bargain Book-FREE

Order Direct from This Page! Save About One-Half!

Compare our prices with others. Only highest grade nationally known GUARANTEED parts. OUR GUARANTEE PROTECTS YOU. Money cheerfully refunded if you are not satisfied. Be sure to write your order and state prices plainly. Send post office or express money order or bank draft for total amount to insure prompt shipment. ALL PRICES ON THIS PAGE INCLUDE SHIPPING CHARGES RIGHT TO YOUR DOOR. Refer to any bank or commercial agency regarding our reliability. If your favorite circuit is shown here, order direct from this ad. No skill required to build your own radio with Randolph parts. Panels are all drilled. Instructions are simple and complete. Everything comes ready to assemble. Order direct! All shipping charges prepaid.

is shown here, order direct from this ad. No skill required to build your own radio with Randolph parts. Panels are all drilled. Instructions are simple and complete. Everything comes ready to assemble. Order direct! All shipping charges prepaid.



Big Radio Book

Send For it At Once

COMPLETE PARTS FOR  
ACME 1-Tube REFLEX... \$17.45  
ACME 4-Tube REFLEX... 39.85

with Genuine Acme parts as specified, drilled bakelite panel and full wiring diagram.

COMPLETE PARTS FOR  
**Reinartz**  
1-Tube Reinartz Set... \$10.45  
3-Tube Reinartz Set... 17.55

**Our Guarantee**  
Every article exactly as represented. Every article is tested before shipping. Complete satisfaction guaranteed or money will be cheerfully refunded.

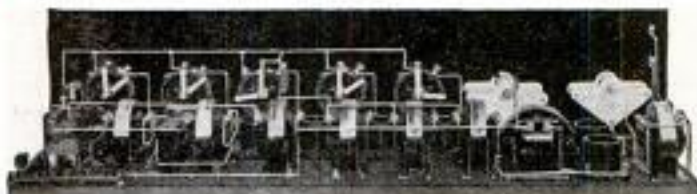

COMPLETE PARTS FOR 8-TUBE

## SUPER-HETERODYNE

- |  |   |
|--|---|
| 2 23-Plate Bremer-Tully or Duplex Low Loss Condensers    | 1 .0005 Mica Condenser and 2 megohm Grid Leak |
| 3 Remler or Columbia Intermediate Frequency Transformers | 3 .0025 Mica Condensers                       |
| 1 Remler or Columbia Tuned Circuit Transformer           | 10 Binding Posts                              |
| 1 Special Oscillator Coupler                             | 1 .00025 Mica Condenser                       |
| 1 Midget Condenser                                       | 1 Bakelite Terminal Strip for Binding Posts   |
| 8 Bakelite Sockets                                       | 1 Multicolor cable for connecting batteries   |
| 2 Thordarson or Columbia A. F. Transformers              | 1 7x30x $\frac{1}{4}$ Drilled Bakelite Panel  |
| 1 Connecticut Filament Switch                            | 1 Baseboard                                   |
| 2 Bakelite 6 ohm Rheostats                               | 35 ft. Hook-up Wire                           |
| 2 Bakelite 30-ohm  | 2 4 in. Bakelite Dials                        |
| 1 Bakelite Potentiometer, 400 ohms                       | 2 4 $\frac{1}{2}$ volt C Batteries            |
| 1 Currier Double Circuit Jack                            |   |
| 1 Dubilier 1 mfd. Condenser                              |   |
| 1 .005 Mica Condenser                                    |   |
- Complete wiring diagrams, base board layout, blue-prints and instructions. **\$59<sup>75</sup>**

COMPLETE PARTS FOR  
**2-Tube Harkness Set**  
including Licensed Harkness Coils, Drilled Panel and wiring diagram. Easy to build. Wonderful results. **\$17.95**

COMPLETE PARTS FOR  
**Two Stage Amplifier**  
with Thordarson or Columbia Transformers; with drilled panel & wiring diagram **\$10.90**

**Randolph Special Headphones**  
2200 Ohm..... \$2.45  
3000 Ohm..... 2.95



COMPLETE PARTS FOR 3 AND 5-TUBE  
**NEUTRODYNE RECEIVING SET**  
Genuine Hazelitine Licensed Neutrodyne Parts Furnished.  
PARTS FOR 5-TUBE SET

1 7x24x $\frac{1}{4}$ Drilled Panel	1 Grid Leak and Condenser
2 Thordarson or Columbia Audio Transformers	5 Bakelite Sockets
3 4" Bakelite Dials	1 .001 Condenser
2 Precision Jacks	1 .008 Mica Condenser
1 Bakelite Rheostat, 30 ohm	35 feet Hook-up Wire
1 Bakelite Rheostat, 6 ohm	1 Kit consisting of 3 Hazelitine Licensed Neutrodyne and 2 Neutrodons
1 Bakelite Binding Post Strip	1 Baseboard
Complete blue-prints and working diagrams.	3 Bezels
7 Marked Binding Posts	

**\$33<sup>75</sup>**

Easy to build your own radio set. All complete parts for sets consist of standard advertised guaranteed parts and include drilled bakelite panels and wiring diagrams for easy set construction. Everything guaranteed on money-back basis. All transportation charges paid.

**FREE — BIG MONEY SAVING RADIO CATALOG** containing a thousand bargains of everything on radio—parts, supplies, complete parts for sets, complete sets, etc., also a mine of very latest information on all different circuits, complete list of broadcasting stations, and other valuable, up-to-the-minute radio data. Send your name and address on a card or letter. We will send catalog free.

**FREE Service Department**  
Our radio engineers will help you solve all your radio problems, and furnish up-to-date information on set construction, operation and improvement. This service is free to our customers.

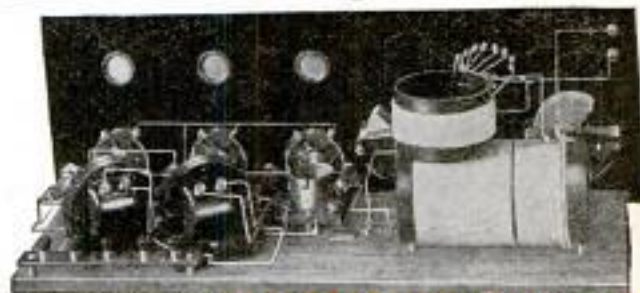

COMPLETE PARTS FOR 3-TUBE  
**COCKADAY RECEIVING SET**

1 Cockaday Coil	7 Switch Points, 2 stops.
2 23-Plate Hy-Grade Cond.	1 Bakelite Binding Post Strip
1 Bakelite Rheostat, 6 ohm.	7 Binding Posts
2 Bakelite Rheostat, 30 ohm.	1 7x21x $\frac{1}{4}$ in. Drilled Bakelite Panel
3 Bakelite Sockets	3 Bezels
1 high ratio Columbia or Thordarson Transformer	1 Baseboard
1 Single Circuit Jack	1 switch lever
1 low ratio Columbia or Thordarson Transformer	24 ft. Hook-up Wire
2 Double Circuit Jacks	Complete blue-prints and wiring diagrams.
2 3 in. Bakelite Dials	1-Tube Set..... <b>\$10.45</b>
1 Grid Leak and Mica Cond.	

Complete 5-Tube Improved Cockaday Receiving Set  
Parts for  
With Resistance Coupled Amplification  
As designed by L. M. Cockaday. Including drilled panel and wiring diagram complete, ready to wire. **\$39<sup>65</sup>**

## RANDOLPH RADIO CORPORATION

159 N. Union Ave. Dept. 345 Chicago, Illinois



# Florida is Calling You

Do you want to get away  
From the *grind* of every day—  
From the drudgery of things you have to do?  
Do you want to settle down  
Near a lively, busy town,  
Where the joy of living will appeal to you?

Do you want to scent the breeze  
Coming through the orange trees?  
Do you want to hear the birds call—loud and clear?  
Are you seeking perfect health  
That's combined with certain wealth  
And an income from an orange grove each year?

Do you want a piece of land  
That will grow to beat the band  
All the different garden crops that you enjoy?  
Do you want to make a "Nest,"  
And a permanent bequest  
For the future welfare of each girl and boy?

Do you want a sunny clime  
Where there's fishing all the time?  
Where there's ducks and deer and quail and other  
game?

Where the summer climate's cool,  
And within each lake and pool,  
You can swim in January—just the same?

Do you want to buy this land  
On an easy-payment plan,  
With about your monthly outlay for cigars?  
Do you want to read a book  
That will make you want to look  
On the finest land that lays beneath the stars?

Send a letter right away;  
Put it in the mail today,  
We will send this Booklet absolutely FREE.  
After you have read it through,  
If a *thought* occurs to you—  
Just address another letter here to me.

We will answer, straight and true,  
Questions that occur to you.  
We have nothing to evade or to conceal.  
On an Orange County Farm  
Life will take on added charm,  
And you'll never lack a dollar—nor a meal.

Send for our Big, FREE Illustrated Book—  
"TWENTY ACRES AND PLENTY." It tells of  
almost unbelievable profits made from trucking and  
fruit-growing in our part of FLORIDA. Also about  
sick-and-out-of-work Clauses, and other protective  
features of our contract. Address Sylvester E.  
Wilson, Dept. U-1, Orlando, Florida.

## REPAIR THAT CRACKED BOILER SECTION YOURSELF!

—do it with a few cents' worth of Smooth-On No. 1 and you'll get a perfect permanent repair without putting anything harmful inside the boiler and without having a big plumber's bill.



### Smooth-On No. 1

affords the simple, quick, sure means for stopping leaks in boilers, radiators, furnaces, water pipes and tanks, stove pipes, kitchen pails, etc., and can be used for hundreds of other house and automobile repairs.

The book we send free tells you how to use it, and you can get your supply in 6-oz., 1-lb., 5-lb. or 10-lb. tins from any live dealer.

**SMOOTH-ON MFG. CO.**  
574 Communipaw Ave., Dept. 37  
JERSEY CITY, N. J.

144 pages  
This Book  
FREE

**SMOOTH-ON  
REPAIR  
BOOK**

## AMERICAN BOY SCROLL SAW It's Easy to Build Things When You Use This Saw

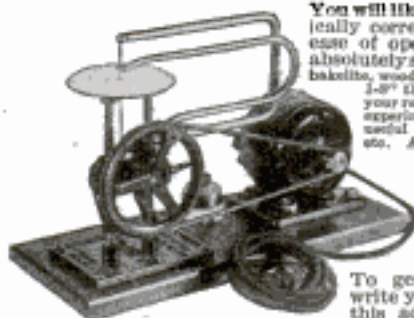

You will like its sturdy, mechanically correct construction; the ease of operation; the smooth, absolutely square cut. Cuts fibre, bakelite, wood up to 1" and metal up to 1/8" thick. A real tool to make your radio sets, scooters, cabinets, experimental work and lots of useful things around the house, etc. An Ideal Xmas gift.

**It's a Regular Tool  
And the Price Is Right**

To get complete details write your name plainly on this ad, clip and mail to

Delta Specialty Co., 858-K Third Street, Milwaukee, Wis.

## MOVIES In Your Home



Our marvelous, practical Movie Machines sell as low as \$3.75 postpaid, and use same size film as big theatres. We also have wonderful films at lowest prices—with a new film exchange service. Don't Miss This!

Write NOW for Free Catalogue

**PARAMOUNT MFG. COMPANY** Dept. M7  
Boston, Mass.

## Before You Buy an Engine



Write for the facts about the wonderful Edwards Farm Engine. This marvelous engine gives from 1 1/2 to 6 H. P. Gasoline or kerosene. Light, easy to move, free from vibration. Requires no anchorage. Easy starting—no cranking. Pumps, saws, grinds, and does all chores. Plenty of power for every purpose.

**LOW FACTORY PRICE—FREE TRIAL OFFER**

Tremendous value. Thousands of satisfied users. Write now for details and FREE trial offer on this amazing engine.

Edwards Motor Company,

318 Main St., Springfield, Ohio





# 10 Months to Pay!

## Cash Prices, Easy Terms!

Our liberal terms make it easy for you to get your Saxophone, Trumpet, Cornet, Banjo right away! Small first payment, balance in amounts you won't miss. Learn to play, enjoy real fun! We help you organize band or orchestra.



"C"  
So-  
prano  
SAX

The wonderful Sax with the human voice singing tone. Learn to play in a few lessons at home! It's a "Standard"—our own famous make—World's finest quality, brand new, only

## Write for Bargain Book Quick!

Illustrations, complete information about all musical instruments. Nothing but BARGAINS from cover to cover. Supplies, repairs, instruction books shown at cut prices. Beginners, musicians, teachers, professionals, write today for your free copy!

**Cut price on this Clarinet!**

\$87<sup>50</sup>

**Genuine BACON TENOR BANJO**

Choice of all famous Banjo Soloists. Most beautiful, sweetest toned. Brand new. \$5.00 brings it. Small first payment. Balance 10 months.

(No terms on rebuilt instruments.)

**STANDARD MUSIC CO.**

Dept. 2422 214 S. Wabash Ave., CHICAGO

Slightly used, rebuilt like new, price less than one half. Our catalog shows all musical instruments, brand new standard makes, and bargains in rebuilt instruments. Cash Price. \$16<sup>00</sup>



## I Make the Best CHOCOLATE BARS

Mints and Chewing Gum. Be my agent. Everybody will buy from you. Write today. Free Samples. MILTON GORDON, 186 Jackson St., Cincinnati, Ohio

## PILLIOD

### Tool Cases Excel

Machinists, Tool Makers and Carpenters find them most satisfactory in construction, appearance, service and price. Immediate shipment.

Booklet describing 20 styles on request. THE PILLIOD LUMBER CO. Dept. 1 Swanton, Ohio



### Carrying Case FREE with 3 ft. Telescope

See people and objects miles away just like they were close; see Moon and Stars as never before. Opens over 3 ft. long, 6 sections, brass bound, powerful lens. Useful and entertaining.

Order today.

Send No Money pay Postman only \$1.25 plus a few pennies postage. Satisfaction Guaranteed.

FERRY & CO., 3224 N. Halsted Street, Dept. 9772, CHICAGO, ILLINOIS



"Could tell color of aeroplane 4 to 10, 5 away." "Watch my boy arrive at school 2 miles away."—Mrs. Horn. "Read numbers on freight cars mile away, see mountains on moon."—A. C. Palmer. "If I could not get another would not take \$10.00 for it."—A. B. Walker. "I saw a Light House 18 miles away."—Clyde Scribner. Thousands pleased. Write today; on arrival of Big 3 ft. Wonder Telescope with FREE Carrying Case and Strap. Satisfaction Guaranteed.

## ADDING MACHINES

Your choice of Burroughs, Dalton, Wales and all standard makes often at less than one-third regular price! All sizes and styles. Every machine guaranteed A-1 condition. Rebuilt by experts.

**SOLD ON INSTALLMENTS**

You can buy a regular \$300 machine for as low as \$5 down. Why pay big prices? Hundreds of well-known firms our customers. Write for FREE list of models and bargain prices that save you money. Do it NOW.

RELIABLE ADDING MACHINE CORP. Dept. 105 168 W. Washington Street CHICAGO, ILL.



# THE 21 JEWEL Santa Fe Special

## No Money Down

WE will send this famous watch, express prepaid, for you to examine, to inspect, to admire, to approve, without one penny advance payment. Examine the watch and be convinced it's the best watch buy you ever saw, just a small payment down, the balance in easy MONTHLY payments. You use the watch while paying for it.

Save 1-3 to 1-2 of Your Money By purchasing this Famous Santa Fe Special Watch. Not only are you saving money from the present day prices of watches but you can still secure the "Santa Fe Special" Watch at the same low prices and terms that have made our watches famous.

Ladies' Wrist Watches This Artistic dependable Ladies' Wrist Watch, fitted with genuine Illinois Springfield movements. A perfect timepiece. Beautiful 14-Karat white or green solid gold cases. Ask for New Watch Book showing Cases in all the new shapes and designs. Watch sent on approval and sold on payments.

Send for Free Watch Book Clip the coupon, fill out and receive the FREE WATCH BOOK. All the newest watch case designs in white or green gold, fancy shapes and thin models are shown. Read our easy payment offer. Wear the watch 30 days FREE. Watch sent for your examination and approval without a penny down. Nothing to risk. See the watch before you buy. Write for FREE book Today and Select Your Watch—Mail Coupon.

SANTA FE WATCH COMPANY 26 Thomas Building TOPEKA, KAN. The Home of the Great Santa Fe Railway

Santa Fe Watch Co., 26 Thomas Bldg., TOPEKA, KAN. Please send prepaid and without obligation your Watch Book Free, explaining your "No Money Down" Offer on the Santa Fe Special Watch.

Name.....  
Address.....  
State.....



## 5-Room \$498 ALADDIN

WE PAY THE FREIGHT

You can buy all the materials for a complete home direct from the manufacturer and save four profits on the lumber, millwork, hardware and labor.



## 6-Room \$648 ALADDIN

Living room, dining room, 2 bedrooms, kitchen, bath. Four other plans, some with pantries and dining alcoves. Get Free Aladdin Catalog.

## 7-Room \$799 ALADDIN

Living room, dining room, kitchen, three bedrooms, with bath room opening into hall. Casement arch between living room and dining room. Three plans.

## 7-Room \$825 ALADDIN

Story and a half semi-bungalow, with second floor available for two bedrooms. Two excellent floor plan arrangements are shown in Free Catalog.

## 7-Room \$999 ALADDIN

Large living room, dining room, kitchen, pantry, three bedrooms, clothes closets, bath. Semi-open staircase and rear porch. Four-bedroom plan at same price.

## 7-Room \$1,199 ALADDIN

Dutch Colonial with full ceilings first and second floors. 14'x22' living room, large dining room, large kitchen, three bedrooms, bath, linen and clothes closets.

## 12-Room \$1,775 ALADDIN

Dutch Colonial for wide inside lots or narrow corner lots. Full ceiling heights entire second floor, sewing room, columned, inset front entrance.

**Price includes** all lumber cut to fit; highest grade interior woodwork, siding, flooring, windows, doors, glass, paint, hardware, nails, lath, roofing, with complete instructions and drawings. **Freight paid** to your station. **Permanent Homes—NOT PORTABLE.** Many styles to choose from. **Write nearest mill today for FREE Money-Saving Catalog No. 913.**

**The ALADDIN Co.** BAY CITY MICHIGAN  
Wilmington, North Carolina; Portland, Ore.; Toronto, Ont.

## THE CROWN FUEL SAVER AND SMOKE CONSUMER

Not an oil burner  
but a scientific  
method of  
burning coal  
and coke



## 20% COAL-SAVING GUARANTEED

This inexpensive coal-saver and heat producer is a positively safe investment paying extraordinary dividends in money and comfort. Why pay out any more than you have to for coal? By simply attaching the CROWN Fuel Saver to your heating plant you can burn lower quality coal, get more heat and a *guaranteed* fuel saving of at least 20% or your money back on demand.

*The CROWN offers MORE heat, quicker heat, steadier heat, less firing, less ashes, less expense*

The CROWN fits the feed door of any heating plant—steam, hot water, or warm air. Furnishes by natural draft pre-heated air to burn smoke and gases usually wasted. (See illustration.) Works automatically. Nothing to get out of order. Lasts a lifetime. Install it yourself. In successful use 10 years in homes, apartments, stores and greenhouses. Write for full information.

CROWN Fuel Saver Co., 42 N. 10th St., Richmond, Ind.

Distributors—Write for our profitable  
Wanted Business building plan.



## "Lighting Fixtures"

READY TO HANG

(Direct from Manufacturer)

Completely wired, including glassware. Send for Catalogue No. 26. Just Off the Press.

Special proposition to DEALERS.

ERIE FIXTURE SUPPLY CO.  
STA. A ERIE, PA.

## REMINGTON PORTABLE TYPEWRITER Dealers and Branches Everywhere

## RAISE BELGIAN HARES

NEW ZEALAND REDS—Chinchillas—Flemish Giants  
**MAKE BIG MONEY**—We supply stock and pay you following prices for all you raise: Belgian Hares \$2 each—New Zealand \$3 each—Chinchillas \$4 each—Flemish Giants \$5 each. 32-page illustrated book, catalog and contract, also copy of *Far Farming* magazine, tells how to raise skunk, mink, fox, etc., for big profits, all for 10c. Address

OUTDOOR ENTERPRISE CO., Box 25, Holmes Park, Mo.

## Build and Fly Model Aeroplanes



Build your own Model Aeroplane; make trial flights and learn the principles of Aeroplanes. With IDEAL Scale Drawings and Building and Flying Instructions you can easily build exact 1/4-lb. duplicates of Real Planes. Send now for Plans for the one you want to build.

"EVERY-BOY'S" Airplane  
slips together without nails, wire or screws. Ready to fly in 2 hours.  
The newest idea. Read for catalogue and find out all about it.  
IDEAL AEROPLANE & SUPPLY CO., 409 West Broadway, cor. Spring St., NEW YORK

PLANS AND INSTRUCTIONS 25c



## No Winter Troubles!



**WHIZ** to and from your favorite sport-places on a 1925 Harley-Davidson "Stream-Line" Motorcycle. No radiator or starting troubles. A Harley-Davidson speeds you over roads often impassable to automobiles — and at a fourth the expense.

"Stream-Line" models—with 27 real improvements — are the finest motorcycles ever built. Yet prices are reduced! Ask your dealer for free demonstration ride and Pay-as-You-Ride plan.

Write us for new illustrated literature. No obligation.

HARLEY-DAVIDSON MOTOR CO.  
Dept. P Milwaukee, Wisconsin

## Harley-Davidson The Motorcycle

### 21 Jewels

Nothing less than 21 Ruby and Sapphire Jewels is good enough for the Burlington masterpiece.

#### Quality and Style

Adjusted to the second—temperature—synchronism—positions, 25 year Gold Strata Case, in 100 exquisite designs. Only \$1 down. Balance in small monthly payments. Send for free book.

**Burlington Watch Company**  
19th Street and Marshall Boulevard  
Dept. 13-52 Chicago, Illinois



## POWER-AUTOMOTIVE PATENTS

Specialized service—your protection.

M. P. LAUGHLIN, 47 West 42nd St., N. Y.



**Ford Owner** Stop that rattle chatter on your car. **MAKE THIS TEST**—take out your floor boards, pull your emergency brake back and forth. If you notice play at the ball joint, you need Bredar's Ball Shim. Price \$0.50. Ask your Dealer or send money order. We will ship prepaid.  
Nic Bredar's Son Mfg. Co., Rock Island, Ill.

## FORD Owner's Look Here!

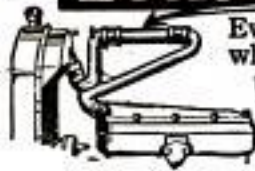

Every Ford owner looks when you show him, with this convincing Visible Demonstrator, how a

### NEW-RODE

### WATER PUMP FOR FORDS

forces a big stream of water so fast it ends over-heating, prevents freezing, makes engine work better, saves oil, reduces repairs. Our men are making

**BIG MONEY** equipping Ford cars with these fast selling Pumps at \$5. Put on in a few minutes.

Get agency, equip your car, lift hood, draw crowds, make quick sales for cash. Keep big share for your work. Exclusive territory. Good men wanted everywhere. Write now.

JENKINS VULCAN SPRING CO. 514 North 8th Street  
RICHMOND, INDIANA

Applying the new tread—the inventor, Emil Nestler, rubber expert and engineer, demonstrates one of the seven simple steps in this amazing process.



## Be President of your Own Company

The discovery of the first known method of joining new rubber to old by actual fusing or welding is your opportunity to own a highly profitable business in your own name. Millions of pneumatic tires—car, truck, balloons—now junked merely because part of the rubber has worn off the treads, can now be kept in service. Car owners can cut tire costs in half.

Think of what this service would mean right in your community! Not an experiment. Process has been carefully perfected during past seven years. Thousands of tires already Nestlerized (retreaded by Nestler Process) have demonstrated soundness of method in actual road service.

No experience necessary to become an expert in this line. Process is amazingly simple. We teach you free when you buy your equipment. Profit possibilities are unlimited. Small capital required. Right NOW we can make you a SPECIAL Proposition that assures EARNINGS FROM THE FIRST WEEK—just like entering a going business.

This is the opportunity book. It gives the full story of our Special Proposition. Write for it today!



Get the facts. No obligation. Fullest investigation invited. Just write for the booklet. Ask for the Special Proposition. Limited and exclusive territories now being assigned. To get the territory of your choice, write NOW! This is an opportunity of a lifetime and you should not miss it.

**Nestler Rubber Fusing Co., Inc.**

Dept. 7

245 West 55th Street  
NEW YORK CITY



# This BLOTORCH meets today's requirements— 400 degrees more heat Gasoline or Kerosene Embodies these exclusive features

**TURNER BLOTORCH**  
*Safe as a Candle*

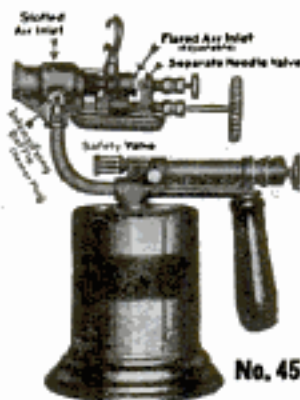

CAPACITY—1 Quart

**\$8.25**

One opening in tank prevents leaks from soldered connections. Automatic safety valve and air release obviates the danger of excess or bursting pressure. Baffle in the burner tube and heating plug gasifies gasoline or kerosene without clogging.

Adjusting needle separate from shut-off—impossible to enlarge the orifice so common an occurrence on ordinary blotorches. Pistol-grip handle allows for any size hand.

Every blotorch thoroughly tested and **FEARLESSLY GUARANTEED**

*Your dealer will supply you—or write direct*

**THE TURNER BRASS WORKS**  
Industry Ave., Sycamore, Ill.

*The World's Largest Exclusive Manufacturers of Blow Torches, Fire Pots and Brazers*

**N&K**  
*Imported*  
**LOUDSPEAKER**  
TYPE W

New in principle, new in shape, new in quality of reproduction, price \$27.50.

Made by the makers of the famous N & K Head Set, Model D, 4000 ohms, price \$8.50.

TH. GOLDSCHMIDT CORP.  
Dept. M-2, 15 William Street, New York

**THE NEW PARAGON RADIO RECEIVERS**



Introducing the new non-radiating Paradyne Circuit, new simplified tuning, and new low prices. Write for Folder

**ADAMS-MORGAN CO., Inc.**  
5 ALVIN AVE., UPPER MONTCLAIR, N. J.

## How to Build ULTRADYNE

MODEL L-2

32-page illustrated book with detailed instructions on drilling, wiring, assembling and operating Model L-2 Ultradyne Receiver. Latest authentic edition by R. E. Lacault, E.E., A.M.I.R.E., inventor of the Ultradyne, the most selective receiver known.

Write for Descriptive Circular.

PHENIX RADIO CORP.  
3 Beckman St., N. Y.



Our BUREAU OF INFORMATION will answer all questions regarding articles appearing in this magazine.

Licensed by  
Independent Radio Manufacturers, Inc.  
**NEUTRODYNE**  
Reg. U.S. Pat. Off.  
Pat. March 27, 1923 and April 1, 1924  
Naxtime Pat. Nos. 1,450,000 and 1,489,228  
Other Patents Pending

**H**OWARD 5 Tube Neutrodyne in Chicago successfully brought in European Stations on recent Trans-Atlantic tests. If your dealer cannot demonstrate them to you, write for information, giving dealer's name.

**GUARANTEED**  
**Howard**  
Mfg. Co. Inc. PRODUCTS Chicago, U.S.A.

469 East Ohio Street



## The Kellogg Trans-B-former Replaces Your "B" Batteries



No. 502

**THE KELLOGG** Trans-B-former furnishes the necessary plate voltages for your radio set from your 110 A. C., 60 cycle electric light socket without any interference.

This unvarying current is furnished at less than one-fifth cent per hour. Throw away

your "B" batteries and install a Trans-B-former and your set will operate at maximum efficiency constantly. **The Kellogg Trans-B-former will—**

Improve reception  
Reduce operating cost to a minimum  
Add to the appearance of your set

Developed, perfected and guaranteed by the Kellogg Switchboard & Supply Company. At your dealer's. Each

# \$50

**KELLOGG SWITCHBOARD  
& SUPPLY COMPANY**

1066 West Adams Street  
CHICAGO, ILL.



DeForest  
License



## HONEYCOMB COILS

The Universal all-wave inductance. Back and front panel mountings. Send 25c for Super Het., R. F. and Honeycomb Coil Circuits and Complete Catalog.

**Chas. A. Branston, Inc.**  
853 Main St. Buffalo, N. Y.  
Chas. A. Branston, Ltd., Toronto

## Cut Prices on Radio

Save 25 to 50 per cent. Standard Sets, all types, \$5.00 to \$79.00. Everything in accessories Wiring diagrams and estimates free. 150,000 customers. Money-back guarantee. Immediate delivery. Illustrated catalog on request. Special proposition to community agents.

Radio Dept. 108

IMPERIAL LABORATORIES, Coca Cola Bldg., KANSAS CITY, MO.

## FARAWAY RADIO



# \$29.50

Gets stations  
Far and near  
Loud and Clear

**FARAWAY** Radio Sets are amazing values at bargain prices. Users get stations from New York to Frisco—loud and clear. Operate with either dry cells or storage batteries. Beautiful cabinet finished in mahogany with new platinum-finished panel. **SATISFACTION GUARANTEED.** Don't pay \$100 to \$125. Write for our money-saving plan and literature.

2-Tube Set - \$29.50  
4-Tube Set - 59.50

**Dealers - Agents:** Biggest possibilities you ever heard of. Write for plan and territory quickly.

THE FARAWAY RADIO CO., 645 W. THIRD ST., CINCINNATI, O.



Surface leakage exceptionally low  
with this panel  
*built to order for radio*

**RADION** is a special material, developed to order by our engineers to meet the needs of radio. For radio-frequency insulation its characteristics are highest as proved conclusively by authoritative laboratory tests. Surface leakage and dielectric absorption are shown to be exceptionally low.

*You can see the difference  
by the finish*

You can see that Radion is different if you look at the finish. That high-polished, satin-like surface is not only good-looking, but useful as well. Moisture and dirt cannot gather to form leakage paths and cause leakage noise.

Radion is mechanically right, too. It resists warping. No special tools are needed to make a clean-cut workmanlike job. Everybody knows that it is the easiest material to cut, saw or drill. Comes in eighteen stock sizes, two kinds, Black and Mahoganite.

Send for Booklet  
"Building Your Own Set"  
(Use the coupon below)

**AMERICAN HARD RUBBER COMPANY**  
Dept. PM2, 11 Mercer St., New York City  
Chicago Office: Conway Building  
Pacific Coast Agent: Goodyear Rubber Co.,  
San Francisco—Portland

# RADION

*The Supreme Insulation*  
**PANELS**

*Dials, Sockets, Binding Post Panels, etc.*

**AMERICAN HARD RUBBER COMPANY,**  
Dept. PM2, 11 Mercer St., NEW YORK CITY  
Please send me your new booklet, "Building Your Own Set," for which I enclose 10 cents (stamps or coin).

Name .....

Address .....

City.....State.....



# ALL-AMERICAN



## Reliable!

ALL-AMERICAN Standard Audio Frequency Transformers in any radio receiving set mean but one thing—assured efficiency in amplification. Since 1919 ALL-AMERICAN Audios have answered the demand for an instrument that could be relied upon for maximum amplification and faithful tone reproduction. Set builders who know radio do not experiment—they specify ALL-AMERICANS, with full assurance that they will consistently perform with highest efficiency.

### Precision-Made

ALL-AMERICAN reliability is a natural result of ALL-AMERICAN precision manufacture. Each part is scientifically designed and accurately built to exact standards. Special machinery and testing equipment assist in achieving perfection. 3 to 1 Ratio, \$4.50. 5 to 1 Ratio, \$4.75. 10 to 1 Ratio, \$4.75.

### ALL-AMERICAN Reflex Receivers

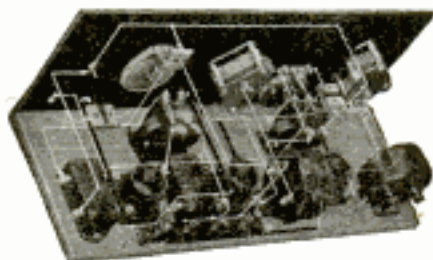

Complete receiving sets with range, volume and selectivity unequalled in receivers of this type. All instruments are mounted on panel and base-board ready to be wired. Clear photographs, blue-prints and a 48-page instruction book make wiring the easy work of only one delightful evening.

All-Amax Junior (one-tube, semi-finished) \$22.00  
All-Amax Senior (three-tube, semi-finished) \$42.00

The Radio Key Book is the most valuable book of radio facts ever published. Sent for 10 cents, coin or stamps.

#### RAULAND MFG. CO.

Pioneers in the Industry

2656 Coyne Street Chicago

There's an ALL-AMERICAN Transformer for every circuit

*The Largest Selling Transformers in the World*

Please Mention Popular Mechanics

## FREE Greatest Catalog of Radio Bargains

### Send for It Today

It contains a thousand bargains of everything in radio: parts, supplies, complete parts for sets, complete sets, etc., also a mine of very latest information on all different circuits, complete list of broadcasting stations and other valuable data. Send your name and address and we'll send FREE catalog.

### BUILD YOUR OWN RADIO SET

All complete parts for the following sets consist of standard advertised guaranteed parts and include drilled bakelite panels and wiring diagrams for easy set construction.

Ultra Audion Circuit . . . . .	\$ 8.95
Five Tube Licensed Neutrodyne . . . . .	33.75
One Tube Cockaday . . . . .	10.45
Three Tube Cockaday . . . . .	19.95
Eight Tube Superheterodyne . . . . .	59.75
One Tube Reflex . . . . .	15.85
Two Tube Reflex . . . . .	20.55
Three Tube Reflex . . . . .	27.85
Four Tube Acme Reflex . . . . .	39.85
Five Tube Improved Cockaday . . . . .	39.65
One Tube Reinhartz . . . . .	10.45
Three Tube Reinhartz . . . . .	17.55
Two Stage Amplifier . . . . .	10.90

Order from this ad and send for catalog. We pay all transportation charges. Everything guaranteed. Money back if you are not fully satisfied.

#### FREE SERVICE DEPARTMENT

Our radio engineers will help you solve all your radio problems, and furnish up-to-date information on set construction, operation and improvement. This service is free to our customers.



HEADPHONES  
"Randolph Special"  
2200 Ohm Moulded  
Headset.

**RANDOLPH RADIO CORP.**  
159 N. UNION AV. Dept. 344 CHICAGO, ILL.



### FASTEST SELLING HEADSET in the WORLD

There's a mighty good reason—  
Over two million users.

If your dealer cannot supply you,  
order direct by post card, and we  
will ship immediately Parcel Post,

THE TOWER MFG. CORP.  
70 BROOKLINE AVE., DEPT. B, BOSTON, MASS.



Scientific



## Have You Heard THE RADIO SHACK New Shacton Low Loss 3 Circuit Receiver?



Send for our Catalog

A SLIGHT turn of the Visidial, then—music, lectures and entertainment of all sorts from all parts of the country. These long, cold winter evenings hold many a surprise for the owners of the new "SHACTON."

For design, construction, performance and ease of operation the SHACTON is the most remarkable achievement in present day radio. The most important feature and without a doubt the cause of SHACTON'S success lies in the fact that Low Loss instruments of the highest grade are used throughout the entire circuit. Equipped with VISIDIALS—dials behind the panel, enabling fine, sharp tuning without vernier. The Visidial adds to the appearance and improves the performance to a surprising extent. Something new, something better.

### STANDARD PARTS with VISIDIALS

- 1 7x18 Drilled Radion Mahogany Panel, Engraved in Gold.
- 1 Brunswick Low Loss 3-Circuit Tuning Coil.
- 1 Genuine Brunswick Low Loss Condenser.
- 1 Brunswick Triploid Mounting Socket and Binding Post Strip.
- 2 Brunswick Cast Foundation Brackets.
- 2 Brunswick Jacks with Gold-Plated Fronts; 1 for phones, 1 for Loud Speaker.
- 1 Freshman Mica Grid Condenser.
- 1 Standard Glass-Enclosed Grid Leak.
- 2 30-Ohm Shacton Bakelite Rheostats with Gold-Plated Indicators.
- 2 Molded Mahogany Dials grained to match panel.
- 5 Lengths Professional Bus-Bar.
- 1 Special Blue Print for this circuit. Not an ordinary hook-up but a clear picture form that a child can understand and make.
- 2 Premier Hegehog Transformers.

ALL ASSEMBLED READY TO WIRE  
**THE RADIO SHACK**  
55 Vesey Street, New York City

The  
Supreme Achievement  
with  
**VISIDIALS**

**PRICE**  
**\$29<sup>39</sup>**

### ACCESSORIES

Everything needed to operate after building is listed here—

- 5 Type 201A Tested Tubes . . . . . \$10.35
- 1 60-Ampere Hour Storage Battery 11.25
- 2 45-Volt Extra Large Enco "B" Batteries . . . . . 6.50
- 1 Pr. 3000-Ohm Head Phones and Cord 3.75
- 1 Antenna Equipment . . . . . 1.50
- 1 Phone Plug, Double . . . . . .70

COMPLETE OUTFIT . . . . . \$34.05

Parts also sold separately

### CABINET FREE

Order Set and Accessory Outfit both together, and we will send Fine Mahogany Finish Cabinet FREE!

### MAIL COUPON TODAY

THE RADIO SHACK, Dept. B-28  
55 Vesey St., New York, N. Y.

Please send me the "Shacton" outfit I have marked. When it arrives I will pay the postman the amount. If I am not satisfied I will return it in 5 days, and you agree to refund my money instantly. Mark choice in square.

- (A) Complete Building Kit . . . . . \$29.39
- (B) Operating Outfit . . . . . \$34.05

Name . . . . .

Address . . . . .

City . . . . . State . . . . .

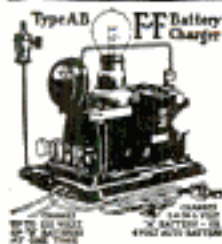

### The Triple Duty Charger

Charges radio 2, 4 or 6 volt "A" battery, radio "B" battery up to 120 volts and auto batteries from lamp socket. Average cost per charge about a nickel. Solidly built—will not get out of order. Fool-proof and simple. The first successful charger—introduced over ten years ago. Type A. B., price \$30; West of Rockies, \$23. Type G for 5 volt "A" or "B" batteries, price \$16; West of Rockies, \$10.50. \$2.50 battery charging attachment, \$2.50 extra. Write for literature and name of dealer who will supply you with the genuine FF charger.

**FRANCE MFG. CO.**

10424 Berea Road CLEVELAND, OHIO

## LATEST WHOLESALE RADIO CATALOG

**FREE** Simply send name  
TODAY for big  
48-page catalog  
of latest radio goods at Wholesale.  
Live dealers and agents wanted.

STANDARD RADIO CO., 102 East 13th, Kansas City, Mo.

## FREE RADIO CATALOG

Sent You Every Month

ALL the latest improved apparatus is listed in our monthly bulletin: "The American Radio Transmitter." If it's new we have it.

Lowest Prices in U.S.

Our prices to deal in are the lowest in the United States.

All nationally advertised

goods at discounts that make you real money. Dealers,

get your name on our mailing list. Simply send name

today for latest, big monthly bulletin, showing 75 nationally advertised factory lines and 4,800 items.

AMERICAN RADIO MFG. CO., 6 W. 14th St., Dept. O, Kansas City, Mo.





# 5 TUBE RADIO SET \$38.50

COMPLETELY ASSEMBLED

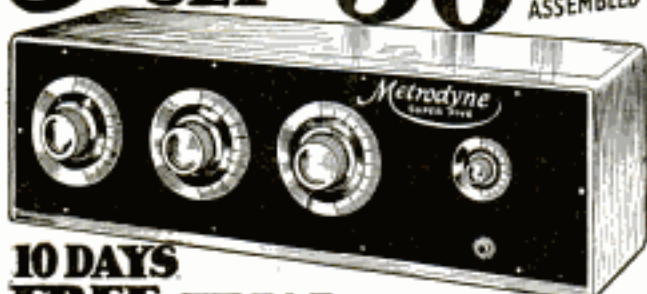

## 10 DAYS FREE TRIAL

Direct from factory to you at less than Dealer's Cost. Marvelous 5 tube radio set. Latest and most efficient TUNED RADIO FREQUENCY circuit. Approved by America's Leading Radio Engineers. Easy to operate. Dials can be logged. Tune in your favorite stations instantly, on the same dial numbers every time. No guessing. Mr. Howard of Chicago said, "While 5 Chicago Broadcasting Stations were on the air, I tuned in 17 out-of-town stations from 40 to 1,000 miles away, on my loud speaker, very loud and clear as though they were all in Chicago."

**Description:** 5 tube set. Comes completely assembled in beautiful mahogany cabinet, size 25 x 7 1/2 x 7 1/2. Has 2 stages Tuned Radio Frequency, Detector and 2 stages Audio Frequency. Equipped with the highest quality, approved standard low-loss parts. Genuine Bakelite Panel, Bakelite dials. Use any standard tubes and batteries.

## 10 DAYS FREE TRIAL

Don't miss this chance to buy this high grade 5 tube set direct from factory. Regular value \$100.00. Our factory price only \$38.50. Send no money. Sign and mail coupon. Pay only \$38.50 when delivered (plus small transportation charges). Try it 10 days. If you are not delighted with results—if you do not consider it equal or better than any \$100.00 set, send it back and we will cheerfully refund your money.

### COUPON

Metro Electric Co.  
400 N. Michigan Ave., Dept. 11, Chicago, Ill.

Gentlemen: Ship me on approval your 5 tube long distance radio set. I will pay \$38.50 on arrival (plus transportation charges) with the understanding that if I am not fully satisfied after ten days' free trial, I may return it and you will refund my money.

Name.....

Address.....

City.....State.....

## EASY TO BUILD YOUR SET WITH NATIONAL CABINETS



Get our descriptive matter and prices on the Latest Styles.

NATIONAL CABINET CO.  
2 Cinti. St., DAYTON, OHIO

## RADIO TEXT BOOK & CATALOG FREE



Contains—  
75 Radio "Hook-Ups"  
300 Illustrations  
556 Articles  
84 Pages

"Build Your Own with RASCO Parts"

RADIO SPECIALTY CO.

98-E Park Place, NEW YORK, N. Y.



\$3.50  
each

## RADIO Storage "B" Battery

Lasts Indefinitely—Pays for Itself

For a limited time only, and to introduce this new and superior Storage "B" Battery to the public, we are selling it direct to the consumer for \$3.50. Regular retail price is \$5.00. You save \$1.50 by ordering NOW. Equipped with Solid Shocker Case, an insurance against acid and leakage. Extra heavy glass jars. Heavy, rugged plates. Takes place of dry "B" batteries and will last indefinitely. Re-charged at a negligible cost. Eliminates many noises so often blamed on "static". Order yours today!

SEND NO MONEY Just state number of batteries wanted and we will ship day order is received. EXTRA OFFER: 4 batteries in series (60 volts), \$13.00. Pay \$5.00 upon after examining batteries. 5 per cent discount for cash with order. Save \$2.00 by ordering NOW!

WORLD BATTERY COMPANY  
1219 So. Wabash Ave., Dept. 6, Chicago, Ill.  
Makers of the Famous World Radio "A" Storage Battery.  
Prices: 6 volt, 100 Amp., \$12.50; 150 Amp., \$15.50; 140 Amp., \$16.00.  
Guaranteed in writing for two years.

## World FOR RADIO STORAGE BATTERIES

WAB - WEA - WGB - WJS - WLU - WSO - WTA - WUY - WZK

## DX "mushy"?

**FREE** "TUBE CONTROL" BOOKLET

On "Tube Control" tells how to bring in distant stations clear and loud. Just drop a post card to

UNITY MFG. CO.  
228 North Halsted Street,  
CHICAGO, U. S. A.

## ABSOLUTELY FREE

Thousands of RADIO BARGAINS

You Can't Equal This Anywhere  
BRACO lead sets—2000 Glens—lead  
batteries and cord complete. Ex-  
traordinarily sensitive.  
Write Dept. 3 for  
wonderful catalog. **\$2.69**

STANDARD RADIO CORP.  
227 WEST MADISON ST. CHICAGO

## YOUR CRYSTAL SET

will work 400 to 1000 miles if made by my plans. No tubes or batteries. Copyrighted plans \$1.00; or furnished FREE with complete parts for building set, including special coil and panel correctly drilled, for only \$5.00. Satisfaction guaranteed or money refunded. Satisfied customers everywhere. Particulars free. LEON LAMBERT, 539 Kaufman Building, Wichita, Kansas

## RADIO ENCYCLOPEDIA

FREE! Thousands of radio bargains, standard sets, standard parts for sets, vacuum tubes, etc. at one-third less than regular prices. New latest information on all events, complete list of broadcasting stations and other valuable data. Send name and address, we'll send you the book FREE! FREE SERVICE DEPARTMENT, Mr. Decker of N. Y. Co. World will help you solve your radio problems, and furnish you the latest information on all construction, operation, improvement. This service FREE to our customers. Write today!

NORWALK RADIO CORP.  
Dept. 58A 66 READE ST., NEW YORK



# LOFTIS

BROS. & CO. 1828

## DIAMONDS WATCHES

### CASH or CREDIT

### Send for Catalog

Over 2,000 Illustrations of Diamond-set Jewelry, Watches, Wrist Watches, Pearls, Mesh Bags, Silverware, etc. Sent prepaid for your Free Examination. Catalog explains everything. **Satisfaction Guaranteed or Money Refunded.**

**RAILROAD WATCHES—Guaranteed to Pass Inspection**  
**HAMILTON No. 992, 21 Jewels, Adjusted to 5 positions. \$55**  
 Gold filled 25-Year Case  
**ELGIN'S LATEST RAYMOND, 21 Jewels, 3 Adjustments, Runs 40 hours one winding. Gold filled 25-Year Case. \$55**

**LOFTIS BROS. & CO. National Jewelers**  
 Dept. K-894 108 N. State Street, Chicago, Ill.  
 Stores in Leading Cities



No. 20 Blue White Diamond, Solid 18-k White Gold. \$100. Delivered on first payment of \$10, then **\$2.50 A WEEK**



No. 27 Blue White Diamond, Solid 18-k White Gold. \$75. Delivered on first payment of \$7.50, then **\$1.75 A WEEK**



No. 31 Blue White Diamond, Solid 18-k White Gold. \$150. Delivered on first payment of \$15, then **\$3.75 A WEEK**



No. 32 Blue White Diamond, Solid 18-k White Gold. \$25. Delivered on first payment of \$2.50, then **\$1.25 A WEEK**



No. 15 Green Gold filled, assorted patterns. Guaranteed 25 years, 12 size, 4 1/2" dial. \$30. Delivered on first payment of \$3.00, then **\$1.00 A WEEK** thereafter until paid.



No. 17 Jewel Eight Watch



### DIVINE RED DEVIL Water Motors

Simple—strong—durable. Wonderful little workers for all sorts of household and shop uses. Thousands in use. For all light power purposes. Attaches to faucet.

Two sizes: 4"—\$4.25  
6"—\$6.75

The higher the water pressure the more work they do.  
 Send today for catalogue.  
 Divine Water Motor Company  
 Utica, N. Y.

## Free Mailing Lists

Will help you increase sales. Send for FREE catalog giving costs and prices on thousands of classified names of your best prospective customers—National, State and Local—Individuals, Professions, Business Journeymen.

**99% Guaranteed** by refund of 5¢ each

**ROSS-Gould Co.** 381 N. 7th St., St. Louis

## AGENTS 500% PROFIT

### GENUINE GOLD LEAF LETTERS

**S** guaranteed to never tarnish. Anyone can put them on stores and office windows. Enormous demand, large profits. Paul Clark says: Smallest day \$28.70. R. L. Reel made \$920 in two months. Write today for free sample and liberal offer to general agents.

**METALLIC LETTER CO., 433-B N. Clark St., CHICAGO**

## BUILD YOUR OWN PHONOGRAPH

**WITH OUR HELP—SAVE HALF**

Choraleon Aristocrats are unexcelled. Play any record. Finest motor, tone arm, case materials, blueprint, full instructions at LOW COST. Write for catalog and FREE Blueprint offer.

**Choraleon Phonograph & Radio Co.**  
225-1st St., Elkhart, Ind.

## RAISE THE NAP ON SHINY CLOTHES

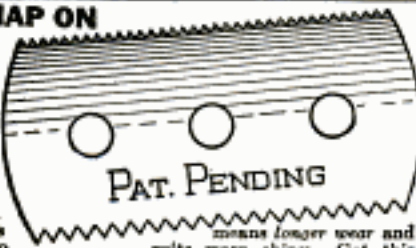

Pat. Pending

Slip this Nap Blade into your Gillette safety razor holder—gives the necessary guard so blade can be run over the cloth and raise a new nap. This restored appearance to blade now—for a few cents you get many months more wear from every suit. Ask for No. 3 Nap Blade with instructions, only 35 cents prepaid.

**LINCOLN MFG. CO.**  
P. O. Box, Station 1-46 Cincinnati, Ohio

## Make Your Dreams Come True



### Join the P. H. Davis force of profit-making Tailoring Salesmen

You men who want to realize your ambitions—consider the P. H. Davis tailoring line. Hundreds of salesmen making fine incomes—steadily—taking orders for Davis \$29.50 made-to-measure suits and overcoats. Davis clothes have nation-wide reputation for quality. First sales and repeat orders come easy.

### SUCCEED with Davis \$29.50 Quality Clothes

You can offer finest woolsens, combined with high grade tailoring. Selling direct from factory to wearer, you save customers \$10 and more on suit or overcoat. Satisfaction guaranteed or money returned. You make big commissions. Also liberal profit-sharing bonus on sales. To men who quality, we furnish \$40 selling outfit without charge. A chance to go into business for yourself.

Write today for free book of facts. Address  
**THE P. H. DAVIS TAILORING CO.**  
 Dept. T-2 Cincinnati, Ohio

**What One Man Did**  
 "Earned \$300 first six days. Moved into my own home bought with Davis profits."  
 E. A. Stafford, Ohio.

## PLAY INSTANTLY WITHOUT PRACTICE



### PRICE CUT TO ONLY \$5.95

### JAZZ-BO SAX

Not a toy but a full throated, full sized quality built reed wind instrument. One that you can be proud to own and play. Substantially made with heavy highly polished throat and bell. Can be used for Solo work, accompanying, and in bands and dance orchestras. You play the Jazz-Bo Sax at once—the minute it arrives. No knowledge of music required, no tedious lessons or long months of practice, for with each Jazz-Bo Sax even at the new low price of \$5.95 you get our wonderful Method enabling you to actually play popular Jazz the first time you take this handsome Sax in your hands. Entertain others and be the envious center of attraction wherever you go.

**FREE** Send today and you will receive FREE our wonderful new Easy Method, 30 pieces of music, and a fine Carrying Bag enabling you to take your sax with you wherever you go.

**SEND NO MONEY** Pay postman only \$5.95 plus a few pennies postage on delivery. If you are not satisfied just send it back and your money will be immediately refunded under the terms of our legal money back guarantee. No fairer offer can be made. Send at once.

**C. F. JOHNSON & CO. Dept.**  
19 W. Jackson Blvd. CHICAGO





Everybody likes good music. Nearly everybody would like to play a musical instrument. And very soon everybody will be playing one, for anybody can play a Hohner Harmonica.

Twelve million music lovers, young and old, have learned to call the Hohner Harmonica "That Musical Pal of Mine." They know that there's nothing like good music for happiness, and nothing like a Hohner for good music.

Don't hum—play it on a Hohner. Get one today—50¢ up—and ask for the Free Instruction Book. If your dealer is out of copies, write M. Hohner, Inc., Dept. 181, New York City.

If you want a musical treat ask to hear Victor Record 19421, by Borrah Minevitch.



**Agents \$12.00 a day**  
**NEW Self-Heating IRON**  
 New invention now makes ironing easy in every home. Ends hot stove drudgery. Cuts ironing time in half. Saves steps. Costs one cent for 3 hours use. No attachments. No cords. No tubes. Gives quick regulated heat. Guaranteed. Sells fast. Mrs. Wagner, Ohio, sold 24 in few hours spare time. Meyer, Pennsylvania, made \$164 in one week. You can do as well. Work all or spare time. No experience needed. No capital. New plan. Simply take orders. We deliver and collect. Commissions paid same day you take orders. Send for exclusive territory and FREE OUTFIT OFFER. Write today. **THE AKRON LAMP CO., 32 Iron St., AKRON, OHIO**



"If I hadn't been all through it myself, I wouldn't have the assurance to say to you 'cheer up.'"

ERICKSON.

Those who wear them say:  
**ERICKSON LEGS** are Wonderful  
 because they do not chafe, overheat or draw end of stump.

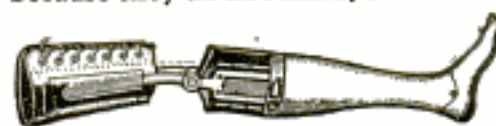

If you have had a recent amputation send for new booklet on TEST LEGS for beginners.  
**E. H. ERICKSON CO.**  
 38-A Washington Av. N.  
 MINNEAPOLIS - MINN.

# Spencerian Personal Steel Pens

No. 42—Gold  
 and dome  
 pointed, smooth  
 action.



One of  
 50 styles

SPENCERIAN Personal Steel Pens differ from ordinary kinds just as tailored clothes differ from "ready-mades." They are hand-built from the finest Spencerian steel. They are perfect in finish, with just the proper flexibility and smoothest possible points. One of the fifty different styles and sizes was built especially for your handwriting! It will prove a revelation in writing-ease. It is worth any two ordinary pens. It costs no more.

Send 10c for 10 sample pens and free booklet, "What your handwriting reveals."

SPENCERIAN PEN CO.  
 349 Broadway New York

Self-Filler DE LUXE Style Pen  
**"INDEPENDENT"**  
 All the best features of a Fountain. Lasts longer. Writes smoother. Improves handwriting. Eliminates ink-blot. GUARANTEED.  
**\$2.00**  
 By Mail  
 14 Kt. White Gold Point, Chased Rubber Holder, Lever Filler, Pocket Clip.  
 Your Name in Gold Inlay, 25c.  
 Write for Pen Catalog. Agents Wanted.  
**J. C. Ulrich & Co., 161 Washington St., New York**  
 Known the World Over for 40 Years.

**CAMERAS**  
 Over a Hundred Styles and Sizes  
 Send for new illustrated catalog showing latest reduced prices. It's Free.  
**10 days' trial given**  
**SENECA CAMERA MFG. COMPANY**  
 300 Central Avenue Rochester, N. Y.

**CLASS 25¢ PINS**  
 BUY DIRECT FROM THE MAKER  
 CATALOG FREE  
 Either pin shown made with any 3 letters and 2 figures. 1 or 2 colors enamel. Silver plate 25¢ ea. \$2.50 doz. Sterling silver. 40¢ ea. \$4.00 doz.  
**BASTIAN BROS. CO.**  
 650 590 Bastian Bldg., Rochester, N. Y. 3214



**WEAR ONE 7 DAYS FREE**

A \$352  
B \$384  
C \$393  
D \$284  
E \$348  
F \$418

**If You Can Tell It From A Genuine DIAMOND SEND IT BACK** These Amazingly Beautiful CORODITE GEMS match the scintillating beauty of GENUINE DIAMONDS in every way. They have the same gorgeous blazing flash and dazzling play of living rainbow fire. Standing the terrific Acid Test of direct comparison. Lifetime experts need all their experience to see any difference. Prove this yourself. **MAKE THIS TEST** Wear a Genuine CORODITE and a Diamond side by side on the same finger. For SEVEN days. If you and your friends can tell the difference send it back, you won't be out a single penny. That's fair enough. If you keep the ring the price printed here is all you pay. No installments. Remember CORODITES alone have the same facet cutting as Genuine Stones.

A. Ladies Hand Carved Basket Ring, Platinum effect \$3.52  
B. Ladies Pierced Filigree 4 Post Ring, Platinum effect \$3.84  
C. Ladies Filigree Ring, Fine Sapphire Set Sides \$3.93  
D. Ladies Bridal Blossom Round Chased Solitaire \$2.84  
E. Mens Heavy Belcher 14K Gold Filled Ring \$3.48  
F. Mens Massiva Carved Hexagon Gyzer, Sapphire Sides \$4.18

**Carat Size Gems Beautiful Hand Carved and Engraved Rings** reproducing in exact and faithful detail the most modern high priced and fashionable Platinum Diamond Jewels at home.

**SEND NO MONEY** Keep your money right at home. Just send name and address stating which ring you want and size as shown by slip of paper filling out to and around finger joint and your ring will come by return mail. Deposit amount shown above with postman. **Yes do not risk a penny as our binding legal guarantee to refund your money in full is attached to every ring we sell. SEND TODAY.**

**E. RICHWINE CO., Dept. 296** 12 West Jackson Blvd. CHICAGO, ILLINOIS  
Original and Sole Importers of Genuine CORODITE GEMS

# Stop Snuffling



**Get rid of nasty Catarrh.** Stop sneezing, hawking, spitting, and coughing. You weren't born with that disgusting disease. You acquired it because your Lungs, Liver, Bowels, Kidneys and all other organs designed to eliminate waste matter, are not functioning properly. Now your vitality is falling, your tongue is coated, your breath is foul and your Nose, Throat, Lungs and every part of your body, are loaded with Catarrh poisons. Don't waste your time and money on dope and drugs, sprays and washes, pills and powders. These can never remove the cause of your trouble. The only way to gain relief is to drive out the waste matter and build up your body—all of it—through Nature's Laws.

**STRONGFORTISM—The New Science of Health Promotion, will aid Nature in forever banishing Catarrh and all other ailments. I guarantee it.**

Mark the subjects on the free consultation coupon on which you want special confidential information (write additional ailments on extra line) and send with 10c (one dime) for postage, etc. on my "Practical Talk on Catarrh" and my free book, "Promotion and Conservation of Health, Strength and Mental Energy." Send for them Right Now TODAY.

## LIONEL STRONGFORT

**Strongfort** Physical and Health Specialist over 35 years  
The Perfect Man Dept. 1710 Newark, New Jersey, U. S. A.

\*\*\*\*\* Cut out and Mail this Coupon \*\*\*\*\*  
**FREE CONSULTATION COUPON**

Mr. LIONEL STRONGFORT, Dept. 1710, Newark, N. J.—Please send me your book, "PROMOTION AND CONSERVATION OF HEALTH, STRENGTH AND MENTAL ENERGY," for postage on which I enclose a 10c piece (one dime). I have marked (X) before the subjects in which I am interested. Also on those I may write on extra line below.

- |                         |                         |                         |
|-------------------------|-------------------------|-------------------------|
| .. Colds                | .. Pimples              | .. Rheumatism           |
| .. Catarrh              | .. Diabetes             | .. Falling Hair         |
| .. Asthma               | .. Blackheads           | .. Neurasthenia         |
| .. Hay Fever            | .. Insomnia             | .. Weak Eyes            |
| .. Obesity              | .. Short Wind           | .. Fear                 |
| .. Headache             | .. Flat Feet            | .. Gastritis            |
| .. Thinness             | .. Stomach              | .. Heart Weakness       |
| .. Rupture              | .. Disorders            | .. Poor Circulation     |
| .. Lumbago              | .. Constipation         | .. Skin Disorders       |
| .. Neuritis             | .. Billousness          | .. Dependency           |
| .. Neuralgia            | .. Torpid Liver         | .. Round Shoulders      |
| .. Debility             | .. Indigestion          | .. Lung Troubles        |
| .. Flat Chest           | .. Nervousness          | .. Stoop Shoulders      |
| .. Deformity (Describe) | .. Weaknesses (Specify) | .. Muscular Development |
| .. Increased Height     | .. Poor Memory          | .. Great Strength       |

Mention other ailments here .....

Name.....

Age..... Occupation.....

Street.....

City..... State.....

**SWEATERS** Any Style or Design for Men, Women, Boys, Schools, Clubs, Teams Order direct from mill. Save 20% to 30%. Any style, color or size, from stock or to order. Finest virgin wool. Send now for free catalog of big bargains. Special offers to schools, clubs, teams. **AMERICAN KNITTING MILLS, 1538 Clyburn Ave., Dept. 42, CHICAGO**

**NEW VEST POCKET ADDING MACHINE**

Adds as rapidly and accurately as a \$300 machine, yet fits the vest pocket. Mechanically perfect. Easy to operate. Everyone who uses figures should own one.

**COUNTS UP TO 999,999,999**

**\$2.95**

Total visible at all times. A pull of the finger clears it. Don't carry a pocket full of pencil stubs and scrap paper to do your figuring. Carry a Ve-Po-Ad.

**10 DAYS TRIAL, SEND NO MONEY.** Just name and address and we will send machine postpaid. Pay postman on delivery \$2.95. Use it for 10 days to prove it does all we claim. If not perfectly satisfied we will refund your money. Limited supply. Order today.

**RELIABLE ADDING MACHINE CORP., Dept. 67** 170 West Washington Street, CHICAGO, ILL.

Here's a money maker for you. Everybody wants one. Splendid profit. Write for special offer. **DO IT NOW.**

**AGENTS**

**MAKE MONEY SELL MADISON SHIRTS**

Direct from our factory to wearer. Easily sold. Over one million satisfied wearers. No capital or experience required. Large steady income. Many earn \$100. to \$150. weekly. Territory now being allotted. Write For Free Samples. Madison Shirt Mill, 511 B'way, New York

**PLANS for HOMES**

"THE NEW COLONIALS" 50 Houses—6 to 10 Rooms—\$1

"WEST COAST BUNGALOW BOOKS" 5 to 7 B'ns, \$1; 3 to 5 B'ns, \$1

"ALL-AMERICAN HOMES" 50 Houses—7 to 10 Rooms—\$1

"SOUTH-WEST STUCCO HOMES" 75 Duplexes and Bungalows—\$1

E. W. STILLWELL & CO., Architects  
284 California Building LOS ANGELES

**AGENTS EARN A GOOD INCOME**

You can sell Premier Knife Sharpeners to housewives, restaurants, stores, etc. 9 out of 10 will buy. Sells for 50c. Write today for attractive offer. **PREMIER MFG. CO.** Dept. 29 Detroit, Mich.

**LARGE PROFIT for you**

**Made To Measure Suit \$12.50**

**FREE COMPLETE SELLING OUTFIT!** Earn \$150 a week, regular line, or \$75 a week, side line. Commission in advance. No delivery.

**Outfit Worth \$10 sent FREE**

Most remarkable innovation in clothing industry. Quality union tailoring. Popular patterns. Outwear three ordinary suits. No competition. Sells on sight. Experience unnecessary.

**ECONOMY CLOTHING MFG. CO., Dept. G-52, 2025-49 Charleston St., Chicago**

**Also Free Sales Outfit on Famous Iron Kloth Boys Line**



# \$4000.00 IN TWO MONTHS

## Jacob Gordon's Profit

Making and selling Crispettes. Bram bought first outfit April 5, and seven more outfits by August 28. Iwata, Cal., bought one outfit, then 10 more within a year. Mrs. Lane of Pittsburgh says, "Sold 8000 packages Crispettes in one day". J. R. Bert, Ala. wrote, "Only thing I ever bought that equaled advertisement". J. M. Patillo, Ocala, writes, "Enclosed find draft to pay all my notes. Getting along fine. Crispettes all you claim and then some." John W. Culp, So. Car., writes, "Everything going lovely. Crispette wrappers lying over. It's a good old world after all."

Kellog \$700 ahead end of second week. Mosser, of Baltimore, \$250 in one day. Baker sold 3000 packages in one day. Ferrin, \$380 in 1 day.



## WE'LL START YOU IN BUSINESS

Furnish secret formulas, raw material, and equipment. Very little capital required; no experience needed.

## Build Paying Business of Your Own

No limit to the sale of Crispettes. Everybody likes them. It's a delicious food confection made with or without sugar. Write me for facts about a business that will make you independent. Start now, in your own town.

## Profits \$1,000 a Month Easily Possible

Send postal for illustrated book of facts. In contains enthusiastic letters from others—shows their places of business, tells how and when to start, and all information needed. Free. Write now!

### LONG-EAKINS COMPANY

228 High Street

Springfield, Ohio

## Beautiful HOUSES \$900 and BUNGALOWS

CAN BE BUILT FOR AND UP

This and many others in my new book, Building Plans for Modern Homes, will save you hundreds of dollars. One of the most complete and comprehensive books of plans ever published by any architect. New edition just off the press. Nearly 500 floor plans and photographs of bungalows, Colonial houses, etc., costing from \$200 up; gives sizes and cost to build. Sent prepaid for \$2.00.



FREDERICK H. GOWING  
ARCHITECT  
101 Tremont St., BOSTON, MASS.

## SEND NO MONEY 2 Genuine Diamonds 4/100 Each Cut Stones, No Chips

### SOLID GOLD \$25

Terms if desired (6 mos. to Pay)  
14 kt. White gold top.  
Gold Emblem (any Lodge)  
or any Initial (Old English)  
Inlaid in Genuine

### HOPE RUBY

Also, in Black Onyx

Send size of finger and ring. This Reg. Trade Mark will be sent for inspection, guarantees you genuine diamonds.

Send for Free Catalog B H C M S M Any Letter

BUFFALO JEWELRY MFG. CO., "THE MAIL ORDER HOUSE"  
Dept. P, Brisbane Bldg., Buffalo, N. Y.



No. 6132

## \$85 a Week like play

### Man or Woman

Big Money for you quick showing my line of charming ladies' silk lingerie and hose, receive profits in advance. No experience required. Miss Grace James averaged \$36 a day spare time. R. G. Thompson earned \$32 in 1 day. The secret of success in offering exclusive articles women love at sight.

## SELL PRINCESS RADIUM Lingerie and Hose

These dainty garments, exclusive in design, not carried by any store, our low mfr's direct prices unbeatable. Splendid opportunity, big cash quick, write for exclusive territory, build a steady income. District managers wanted, territorial rights going fast, don't delay, write now.

ROBERTS - FRANK & CO.  
1733 Irving Park Blvd. Dept. P-12 Chicago

Profits in Advance

Free

Handsome photos from actual models and actual samples of genuine "PRINCESS RADIUM" silk, free.



## BIG PROFITS for YOU sells for 50¢

Your profit 35¢. Make \$10 daily. Sells to 7 out of every 10 housekeepers and stores. The "Handy Multiple Disc" Sharpener. Guaranteed Best on the market. Sample 25¢. Dozen \$2.00. Gross \$20.00. Free Delivery. Order now.

Address DEPARTMENT D

MORGAN MFG Co.  
443 So. Dearborn St. Chicago, Ill.



## ALUMINUM SOLDER

SOLDERS ALUMINUM of any description. NO ACIDS OR FLUX NECESSARY. For home, shop and garage use. Your tool kit is not complete without HAMILTON LEAD CO. ALUMINUM SOLDER. (Name on every bar.) Send 25c for 2 six inch bars, postpaid.

HAMILTON LEAD CO., HAMILTON, OHIO

## Delivered to You Free

for 30 days trial on approval. You can have your choice of 44 Styles, colors and sizes of the famous RANGER Bicycles. Express prepaid. Factory-to-Rider Prices save you \$10 to \$25 on your bicycle.

\$5 a Month if desired. Many boys and girls easily save the small monthly payments. Parents often advance first payment.

Best quality, at factory prices, express prepaid. Tires, lamps, wheels and equipment, low prices. Send No Money, do business direct with makers.

MEAD CYCLE COMPANY  
DEPT. B - CHICAGO

Write today for free Ranger Catalog, factory prices and marvelous easy payment terms



## DEAFNESS IS MISERY

I know because I was Deaf and had Head Noises for over 30 years. My invisible Antiseptic Ear Drums restored my hearing and stopped Head Noises, and will do it for you. They are Tiny Megaphones. Cannot be seen when worn. Effective when Deafness is caused by Catarrh or by Perforated, Partially or Wholly Destroyed Natural Drums. Easy to put in, easy to take out. Are "Unseen comforts." Inexpensive. Write for Booklet and my sworn statement of how I recovered my hearing.

A. O. LEONARD, Suite 226, 70 5th Avenue, New York City

## CLASS RINGS & PINS

Largest Catalog Issued—FREE

CATALOG FREE

Samples loaned class officers. Prices \$1.20 to \$8.00 each. No order for class, society, club emblems too large or too small. Special designs made on request.



METAL ARTS CO., Inc.

7705 South Ave., Rochester, N. Y.

## WHITE FLAME

BURNERS make your old kerosene lamps and lanterns give a brilliant white light better than electricity or gas. Doubles your light. Saves oil. NO WAX TO BREAK. Guaranteed Safe and Reliable. Delights every user. Send now for complete sample postpaid, 50 cents, stamps or coin. \$ for \$1.25. Money Back if Not Satisfactory. Live Representatives Wanted. Exclusive Territory. WHITE FLAME LIGHT CO., 68 Clark Bldg., Grand Rapids, Mich.





## A Different OIL-GAS BURNER for Cooking and Heating Stoves

Turn low-cost kerosene or furnace oil (not fuel oil) into gas giving steadier heat. No carbon—no noise.

Bronze generator and a special flame control valve with a German silver needle insures results beyond your expectations. Simple in construction, low in cost.

Write today for free folder and price list with our 10-day Guarantee of satisfaction or money back.



**E. R. Caldwell & Son Brass Co.**  
Dept. 190 Syracuse, N. Y.

AGENTS—Write for sales proposition.

**Home Economy Oil-Gas Burner**



## Make Your Ford a Closed Car!

Limo weather-proof sections will change your 1923-1924 Ford Touring or Roadster, into classy limousine-style closed car. Doors open from outside. Sliding front panels for ventilation. Three ply, double covered veneer frames. Color matches your top. Easily, quickly installed. Guaranteed. Low priced. Fine for bad weather. Write for prices.

**BUOB & SCHEU, Dept. A-8, 216 Webster St., Cincinnati, O.**

Cal.  
30

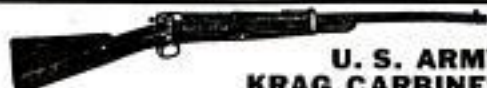

**U. S. ARMY  
KRAG CARBINES**

All Carbines have the new model 1898 stocks. The barrels, actions and parts are either new or have been refinished by the Government and equal to new. **\$15**

Krag Rifles.....\$12.50 Krag Sporting Rifles...\$14.00  
Sprgd. 45 Shot Guns...4.50 Sprgd. 45 Carbines...3.50

SEND FOR CATALOG

**W. STOKES KIRK, 1627-PM, North 10th St., Phila., Pa.**

Taxidermy  
Book  
FREE



## Mount Birds

We teach you by mail to stuff and mount all kinds of Birds, Animals, Game Heads. Also to tan skins and make rugs. Be your own taxidermist. Decorate your home with your beautiful trophies or increase your income selling specimens and mounting for others. Easily, quickly learned in spare time by men and women. Highest endorsements by thousands of students. Write today for our great free book "How to Mount Birds and Animals" Free—write today, N. W. School of Taxidermy, 1772 Elwood Bldg., Omaha, Neb.

## District Salesman with Ford Cars

An unusual money-making opportunity is offered by the "Fit-Gage." See Classified Section.

**A. J. KIRSTIN CO., 201 Kirstin Bldg., Escanaba, Michigan**

## Going to Build Remodel or Repair?

DON'T think of planning a new home or repairing an old one without copies of our two free books.

Our Building Material Catalog shows latest ideas and most advanced styles for everything in building. We ship everywhere everything in the way of high grade lumber roofing, doors,



**Material Complete for Houses from \$500.00 Up**

windows, porchwork, screens, builder's hardware, paints, wallboard, interior woodwork, plumbing, heating and water supply outfits—all at money saving prices direct to you. Plan Book shows skillfully planned homes of all kinds, bungalows, city homes, suburban residences, country homes, barns. Tells you how to get building plans FREE. Write today. No obligation.

Let us develop plans from your rough sketches. Send your material bills for free estimates.

Catalog of 8000 Price Bargains

Beautifully Illustrated PLAN BOOK

CHICAGO MILLWORK SUPPLY CO., 1144 W. 57th St., Chicago, Ill.

PLEASE SEND ME YOUR FREE BOOKS.

Name \_\_\_\_\_ St. No. \_\_\_\_\_  
Town \_\_\_\_\_  
State \_\_\_\_\_  
Occupation \_\_\_\_\_

Books Are Free

## "I Would Not Part With It for \$10,000"

So writes an enthusiastic, grateful customer. In like manner testify over 100,000 people who have worn it. Conserve your body and life first.

## The Natural Body Brace

Overcomes WEAKNESS and ORGANIC AILMENTS of WOMEN and MEN. Develops an erect and graceful figure. Brings restful relief, comfort, energy and pep, ability to do things, health and strength. Does away with the strain and pain of standing and walking; replaces and supports misplaced internal organs; reduces enlarged abdomen; straightens and strengthens the back; corrects stooping shoulders; develops lungs, chest and bust; relieves backache, curvatures, nervousness, ruptures, constipation, after effects of Flu. Comfortable and easy to wear.



For Children Also

### Costs You Nothing to Try It

Write today for illustrated book, free, with full information and measurement blank. Address

**HOWARD C. RASH, Pres. Natural Body Brace Co., 222 Rash Building, SALINA, KANSAS**

## MAKE YOUR FORD INTO THIS SPORT CAR—SAVE \$50 to \$150 WITH Red-i-Kut Life-Size Patterns \$6.40

Famous Red-i-Kut life-size patterns and picture-fit instructions show you how you can easily convert your Ford into this Fast, Snappy Sport Car as thousands have done, with easily obtained materials. No need to lay up the car. LOOK AT WILFRED ENO'S PAL—Eno says, "I feel material cut with steel and paid for my Pal only \$14.51. It took me just 3 Sundays to build it and I sure am proud to hear them say, 'He built that snappy sport car. I never cut any steel or did any woodwork before but we can't go wrong with your patterns.'" Overland Club St. Louis, Mo. The "Pal" with pressed metal streamline rear.

Life-size patterns for each part of the body so you can't go wrong, picture instructions and CONICAL DISK WHEEL PATTERNS Only \$6.40 delivered. Order now while we can make good delivery, and really enjoy these wonderful days in your "Pal." Keep Glassy, Up-to-the-minute. You can build it. Over 11,000 in use. Don't hesitate. "Swing Lo." Underlying iron, no frame cutting kind, only \$6.99. Send 5¢ coin for new manual of other distinctive sport body patterns from \$1.50 up —"REG" Steel "Spring-Lo" Irons, "Jiffy" Tops and "Gascon" Windshields. Order Right Now. Kumpel Co., 57 Kumpel Bldg., Guttenberg, Iowa



30-inch, Easy-riding seat

CLASS SNAP



# Roofing Book FREE



## World's Best Roofing at Factory Price

Don't buy Roofing of any kind until you get our big Free Roofing Book, describing full line of Edwards Famous "Tightcote" Galvanized Roofings, Sidings and Ceilings, and our lowest factory prices. Then see for yourself how much we save you by selling direct and saving you all in-between dealers' profits.

### EDWARDS Metal Shingles "REO"

Absolutely rust proof. By our patented "Tightcote" process, edges as well as sides of metal sheets are heavily coated with zinc—not a space the size of a pin point exposed to weather. Fire and lightning proof. Outlasts three ordinary roofs. Forever wind and weather proof. Need no repairs—end all roofing expense. Patent INTERLOCKING DEVICE makes water tight seams—all nail heads covered—no chance for rust or leaks.

#### EDWARDS Galvanizing Test

Edwards "Tightcote" Galvanized Roofing can be bent, twisted or struck by lightning, and the galvanizing will not crack or flake. Bend it or hammer it—you can't loosen or scale the galvanizing. No other galvanized roofing can withstand this test.

#### Low Priced Garages

Wide variety of styles, all sizes of Portable Fireproof Metal Garages. Lowest prices ever made. Postal brings Big Garage Catalog free.

Write Today for free samples and proof that we can save you a lot of money on any kind of roofing, siding or ceiling you may need. Ask for Roofing Book No. 154.

**THE EDWARDS MFG. CO.,**  
200-250 Pike St., Cincinnati, O.

**FREE**  
Samples &  
Roofing Book



Dealers write for terms

INGERSOLL COMPANY  
200-208 E. Illinois St., Chicago, Ill.

## New Glands for Your Ford INGERSOLL ELECTRIC VAPORIZER

Fuel Heater and Economizer

Starting troubles eliminated. Winter is here—Get yours—Step on the gas and you're off. Easily installed without alterations to car by anyone in a few minutes between Carburetor and Manifold.

New Principle  
PRICE \$1.50  
M. O.  
or Draft **1-**

**GUARANTEED**  
Money back if not satisfied.



## TURN WASTED TIME INTO MONEY!

Every Purchaser Finds Numerous Uses for the **Terit Acetylene Torch No. 13**

Uses Acetylene only. No oxygen or air pressure is required. Tips suck in air. Simply connect to Presto auto tank, light gas, and the outfit is put to work. Beats anything you ever

tried for soldering, heating or light bracing. Outfit consists of 4 tips for different kinds of work, soldering copper, 5 feet tubing, tank connection, and full instructions.

**ST. PAUL WELDING & MFG. CO., 177 W. 3rd St., St. Paul, Minn.**



\$7.50

## Tire AGENTS WANTED

Use and Introduce **MELLINGER GORD TIRES**  
**12,000 MILES GUARANTEED**

Lowest Wholesale Prices in America. Shipped prepaid on approval. Make big money all or part time. No capital or experience. Sample sections furnished.

**YOUR TIRES FREE!** Simply send name today for valuable **FREE BOOK**, tells how thousands have gone into big business. **SPECIAL AGENTS' OFFER** Wholesale Prices and **FREE SAMPLE KIT**.

**MELLINGER TIRE & RUBBER CO.**  
1769 Grand, Kansas City, Mo. \$600,000 Capital



**\$3.85**  
AND UP  
Custom Made

## RECOVER IT YOURSELF

Make your car look like new and save a big labor bill. We have been making top roofings, side curtains and seat covers for 15 years. We have patterns for all makes, no model too odd for us. Easy to apply, simple instructions given. Write for our big money saving catalogue with samples.

**THE LIBERTY TOP & TIRE COMPANY, Dept. E-7 Cincinnati, Ohio**

## RADIO SETS—AUTO BODIES



### SEND FOR THE INTERNATIONAL CATALOG

Our net price list. Full line of Radio Sets, and auto bodies for Parts at Wholesale Prices. Save big money by buying direct from factory.

**INTERNATIONAL BODY WORKS, 914 W. Ohio Street, Dept. 7, CHICAGO, ILL.**



## Catch Fish, Lobsters, Eels, Mink, Muskrats and many fur-bearing animals, in large numbers, with my Latest Improved

Folding, Galvanized **STEEL WIRE TRAPS**. They catch them like a fly-trap catches flies. Strongly built. In all sizes. Write today for **Descriptive Price List**, and my Special **Free Trap and Bait offer**. Best bait known for attracting all kinds of fish. In fresh or salt waters. **J. F. GREGORY, Dept. 26, Lebanon, Mo.**

## MOTORCYCLES



### RELIABLE STANDARD MAKES

that you can **DEPEND** on. Enjoy the delicious experience of going wherever you like—wherever you like. The price is within your means—55% to 80% less than others. These machines are widely used. Thoroughly overhauled or rebuilt. See-8 form 10-10-20.

**MYEROW BROS.,**  
15 Berkeley St. Boston, Mass.

## SHAW MOTOR ATTACHMENT MAKES YOUR BIKE A MOTORCYCLE!

A high grade 2 1/2 H. P. motor attachment quickly clamped on any bike frame. Speed 4 to 40 miles an hour. 90 to 125 miles per gallon of gas.

**Special Low Price Now!** Write today for Complete Description and Special Low Prices on SHAW Motor Attachments and the SHAW Complete Motorbicycle. **SHAW MANUFACTURING COMPANY**  
Dept. 37 Galesburg, Kansas



WRITE FOR FREE BOOKLETS describing and illustrating complete line of **IVER JOHNSON Bicycles, Velocipedes, Revolvers and Shot Guns.**

**IVER JOHNSON'S ARMS & CYCLE WORKS**  
4 River Street FITCHBURG, MASS.

## MOTORCYCLE BARGAINS

Save 25% to 65%

on Slightly used and Rebuilt Motorcycles, Side Cars, Johnson Motor Wheels, Evans Power Cycle, Bicycles. Send for Free Bargain Bulletin and Money Saving Message, listing hundreds of Bargains in used, rebuilt and new machines, supplies, accessories, etc.

**AMERICAN MOTOR CYCLE CO.**  
Dept. 227, 2047 W. Chicago Avenue, CHICAGO





# You see them everywhere

because the dealers who handle them know that nothing else will satisfy the man who knows the "feel" of Crescent Tools in his hand. The strength of these tough, drop forged tools gives a feeling of confidence in Crescent workmanship and material. Try a Crescent next time you need a wrench, plier or screw-driver and then you'll know why so many dealers display them in their stores.

CRESCENT TOOL COMPANY  
210 Harrison St., JAMESTOWN, N. Y.

## CRESCENT TOOLS

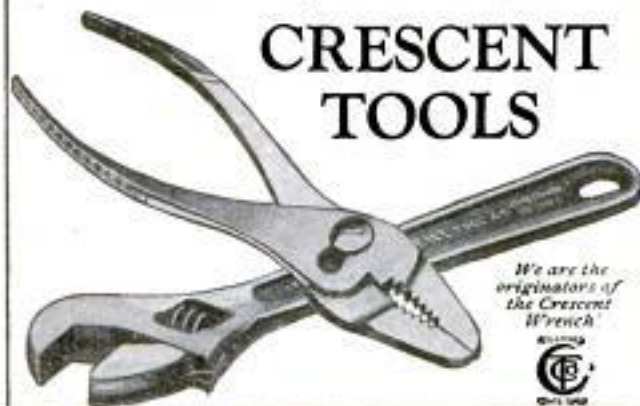

We are the originators of the Crescent French



## Saw Books FREE

"Saws in the Shop," "Saw Sense," "Saws on the Farm;" just send your name and address, and say which of these helpful books you want—and we will send it FREE.

E. C. ATKINS & CO., Dept. P, Indianapolis, Ind.

## Interlox

MASTER SLIDE RULE

The quick acting and durable rule. Slides out; no folding. Any length 2 to 8 feet, 20¢ per lineal foot. If not at dealers, sent postpaid. Dealers and Agents: request attractive proposition. Master Rule Mfg. Co., 813 East 136th St., New York

Takes inside as well as outside measurements accurately



## CITY SALESMEN

WE have a few openings for high grade salesmen to sell Corona Typewriters and typewriter supplies. No traveling—steady work, remarkable chance for advancement. We can probably place you in your own town. The new Corona Four, just out, is the greatest typewriter value ever offered. A wonderful chance for the right man. Experience unnecessary. Write today.

Corona Typewriter Co., Inc.  
Dept. S. S. Groton, N. Y.



## AGENTS

Saleswomen—Salesmen!

Make big money taking orders for our beautiful Dress Goods, Silks, Wash Fabrics and General Yard Goods. Large Book of Fabric Samples furnished to Agents. Write today.

National Imp. & Mfg. Co.  
573 Broadway, Dept. G, N. Y. City

## Amazing Tool FREE Booklet

Get this valuable booklet, describing amazing demonstrations of Cornwell Tools. You can make tests with chisels, wrenches, punches, bearing scrapers, etc. no other tools in the world can stand.

## FINEST IN THE WORLD CORNWELL Tools Made by Hand

Made of finest Swedish Charcoal Process Molybdenum Steel, from our famous Cornwell secret formula. Forged, heat treated and hardened and tempered in oil. Made by hand. NOT drop forged and case hardened.

## Money-Back Guarantee

—Any tool harmed by astounding tests described in booklet, replaced or money returned. Send trial order at our risk. Strong money-back guarantee.

## Mail Coupon—Now!

Mail the coupon now—get prices and booklet with illustrations. If you ever saw tools like these, return your order and get your money back. Hundred thousand mechanics use Cornwell Tools.



CORNWELL QUALITY TOOLS CO.  
Dept. F, Cuyahoga Falls, Ohio  
Send me illustrated booklet with prices on Cornwell Secret Formula Hand Made Tools.

..... Occupation  
Name.....  
Address.....  
City..... State.....

## BURN YOUR NAME ON TOOLS

## WITH THE ARKOGRAF

### PROTECT YOUR TOOLS FROM THEFT

Write with electricity any name or design on the hardest and finest tools and instruments, or any metal, like writing on paper with pen or pencil. Complete Outfit \$3.50—Prepaid Anywhere. Interesting illustrated circular free. Write today. Agents wanted. ARKOGRAF PEN CO., 1171 E. Stark St., Portland, Oregon



## Toolmakers and Machinists FIND GERSTNER Tool Cases

valuable because of the time they save. No time wasted—every tool has its place. Use one and you will wonder how you got along without it. Catalog free.

The Gerstner & Sons

414 Columbia St., Dayton, Ohio



**5 SIZE AUTOMOBILE TAP AND DIE SET, ONLY \$3.00**  
DIRECT FROM THE FACTORY TO YOU! Our No. 12 Automobile Set furnished in our highly finished chestnut box contains 5 each taps and dies (1-4, 5-16, 2-8, 7-16 and 1-2"), in the S.A.E. thread, 1 die stock, and one tap and reamer wrench. Our No. 11 Set is the same as No. 12 except that the thread is U.S.S. instead of S. A. E. You are purchasing a splendid set at a very low figure. Send us your order at once and be one of our many satisfied customers. Let us also send you one of our circulars illustrating our full line of Handy Tools. WORCESTER STEEL PRODUCTS CO., DEPT. 41, 25 UNION ST., WORCESTER, MASS., U.S.A.



## Diamonds

### Here at 60% of Market Price

Never in three quarters of a century have we offered such amazing bargains. Hundred of money-saving opportunities in latest Diamond Bargain List, equalling those shown here.

Here's why we can offer such remarkable values: This 75 year old firm—rated at over \$1,000,000.00 capital—the largest and oldest diamond banking institution of its kind in the world has made loans on Diamonds, Watches, and other jewels in excess of \$25,000,000.00.

### Why Pay Full Prices Costs Nothing to See

Thousands of unpaid loans. Most sell now. Diamonds, Jewels, Watches and other Gems of unusual qualities—at an entirely different price basis—viz: loan values not market values. At our risk we send you any bargain you wish for absolutely free examination. No red tape. No obligation. Don't buy unless satisfied you can not match the bargain at 60 per cent more. Diamonds of desirable quality at \$225 per carat. Yes, some even lower priced—also, finest gems obtainable at lower per carat—but proportionately low bargain prices. Our bargains have guaranteed loan values also, unlimited exchange privilege at full prices.

### Latest List Diamond Loans

Send at once for latest list. Thousands of unpaid loans and other special advantage bargains. Many from big cash deals direct with European diamond cutters. Every gem described in full detail with exact weight, color, quality, etc. Get details of Free Examination offer. No obligation. List is free.

### MAIL COUPON NOW

Only Opposite Post Office

Without obligation, send me free, your latest Bargain List of Diamonds, Watches and other jewelry.

Name.....

Address.....

City.....State.....

## Diamonds

### Here at 60% of Market Price

Never in three quarters of a century have we offered such amazing bargains. Hundred of money-saving opportunities in latest Diamond Bargain List, equalling those shown here.

Here's why we can offer such remarkable values: This 75 year old firm—rated at over \$1,000,000.00 capital—the largest and oldest diamond banking institution of its kind in the world has made loans on Diamonds, Watches, and other jewels in excess of \$25,000,000.00.

### Why Pay Full Prices Costs Nothing to See

Thousands of unpaid loans. Most sell now. Diamonds, Jewels, Watches and other Gems of unusual qualities—at an entirely different price basis—viz: loan values not market values. At our risk we send you any bargain you wish for absolutely free examination. No red tape. No obligation. Don't buy unless satisfied you can not match the bargain at 60 per cent more. Diamonds of desirable quality at \$225 per carat. Yes, some even lower priced—also, finest gems obtainable at lower per carat—but proportionately low bargain prices. Our bargains have guaranteed loan values also, unlimited exchange privilege at full prices.

### Latest List Diamond Loans

Send at once for latest list. Thousands of unpaid loans and other special advantage bargains. Many from big cash deals direct with European diamond cutters. Every gem described in full detail with exact weight, color, quality, etc. Get details of Free Examination offer. No obligation. List is free.

### MAIL COUPON NOW

Only Opposite Post Office

Without obligation, send me free, your latest Bargain List of Diamonds, Watches and other jewelry.

Name.....

Address.....

City.....State.....

## KEDS—A complete line of canvas rubber-soled shoes

United States Rubber Company

## SQUAB BOOK FREE!



Squabs are selling at highest prices ever known. Greatest market for 20 years. Make money breeding them. No mixing feed, no night labor, no young to attend. Start small, grow big. Start now. Read how our customers sell squabs for \$12 a dozen. We have been established for 24 years. Better look into this. Let us send now, at no cost to you, our big, illustrated free book telling how to make money breeding squabs. Address

Plymouth Rock Squab Co., 534 H. St., Melrose Highlands, Mass.

## NOW! New Low Engine Prices Only \$5<sup>69</sup>

month for a few months—easy to own the famous standard WITTE Engine. Uses Kerosene, Gasoline, Distillate or Gas. Equipped with celebrated Troubleproof WICO Magneto. Simplest and cheapest to operate. New device makes starting easy. 50% surplus power. Sizes 2 to 25 H-P—all styles. Sold direct from factory to you on NINETY DAYS' FREE TRIAL. Write today for my new illustrated engine book—sent absolutely Free. No obligation to you.

**WITTE ENGINE WORKS**  
1742 Witte Building, - - - KANSAS CITY, MO.  
1742 Empire Building, - - - PITTSBURGH, PA.

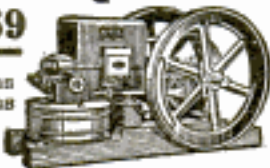

# \$14<sup>95</sup> Suit

## Made to Order Now

### SEND NO MONEY

To introduce unbeatable values, classy style, perfect fit of PROGRESS tailoring we offer, for \$14.95 tailored to measure any style suit of your choice, delivered post-paid. We Guarantee Satisfaction or Money Back. Other wonderful values up to \$39.50.

### AGENTS WANTED

Earn \$9 to \$18 Daily spare time showing our samples to friends and neighbors, we explain how, no experience needed. Big Outfit, agent's wholesale prices, real wool pieces, fashion styles, tape measure, etc. Complete outfit and simple directions FREE, write at once. SAMPLES

### FREE

The PROGRESS TAILORING CO., Dept. L.B.-218 CHICAGO

## Mr. Brush Salesman

Unusual opportunity is offered for aggressive, ambitious, hustling men to represent an old established manufacturer of high grade, guaranteed, fastest selling line of Sanitary Twisted in Wire Brushes, sold direct to the Home. We have openings for experienced brush men as managers in all territories. We want live wire, energetic Go-Getters. We pay larger commissions than any other Brush House in the Country. If you want to earn some real money, it will pay you to write us immediately for our proposition.

WIRE GRIP SANITARY BRUSH CORP., 15 MERCER STREET, NEW YORK CITY

## WALLS FULL OF PICTURES

Your boy won't injure wall paper, plaster or woodwork when he uses

### MOORE PUSH-PINS

Glass Heads—Steel Points

#### Moore Push-less Hangers

"The Hanger with the Twist"

For all heavy pictures.

10c pkts. Sold Everywhere

MOORE PUSH-PIN CO., Philadelphia, Pa.

## THIS WONDERFUL INVENTION



converts any ordinary cook stove into a gas stove. OXO-GAS is made from kerosene and air. Cheaper, cleaner and more efficient than coal. Responsible distributors wanted.

**GLORIA LIGHT CO.**

111-2 N. May St. Chicago, Ill.

## SELL SHIRTS!

Our salesmen make \$5 to \$20 a day, actual figures. 40 latest patterns, fine quality, all guaranteed. Money refunded if not satisfactory. Liberal commission. Your own territory and a square deal. Write today.

**SUPERIOR SPECIALTY COMPANY**  
Dept. -H 410 Andrews Bldg., Cincinnati, Ohio

## Save Time and Money Get a SHAW GARDEN TRACTOR

Now you can get a better power Garden Tractor at less cost. Amazingly Low Price on the SHAW. Just the thing for Truck Gardeners, Small Farms, Estates, etc.; Low Cost; Simple to operate.

**SPECIAL OFFER**  
Write at once for Special Offer.  
Address Dept. P. M.  
**SHAW MFG. CO.**  
GALESBURG, KANSAS



2½ H-P  
FULL PARTICULARS FREE  
Write Today



# \$1662<sup>00</sup> Earned IN ONE SEASON

## A NEW BUSINESS—BIG BUSINESS

### A Business to Enthuse Over—The "Ideal" Lawn Mower Sharpener

W. F. Kendt,  
1476 Main St., Buffalo  
writes:

I sharpened 564 lawnmowers  
last season, and the receipts  
were \$1662.00 which is not  
bad for a  
side line."



A wonderful invention that sharpens lawn mowers scientific-  
ally—quickly—perfectly; does the work as nothing else can.

**Fred C. Milkert of Melrose Park, Ill., writes:**

"The Ideal Lawnmower Grinder put me in business, starting  
in the basement of my home and forcing me now for the  
third time to move into bigger quarters. Today the dream of  
my life—a shop of my own—is realized. With a machine like  
yours and a little hustle any man can have a business of his  
own and be independent."

**You Start Now** No town too small. Lawn mowers are dull—  
owner doesn't know where to get them sharp-  
ened. Mowing the lawn dreaded because of dull or improperly sharpened  
mower. Lawn mowing healthful, invigorating and pleasant when Mower is  
"Ideally" sharpened. You do the work scientifically—you are in big demand.

### Lawn Mowers Sharpened to Razor Edge—

People glad—owners delight in mowing  
lawn with mower sharpened on an "Ideal."  
Mower runs light—click-click-click and  
the grass is cut. Build permanent busi-  
ness for yourself. Start now!

**Write Today** Get our pro-  
position  
**Free**—We have detailed illus-  
trated book to send you. Write  
today for our proposition.

**The Fate-Root-Heath Company**  
Dept. 39, 801 Bell St., Plymouth, Ohio

**USE THIS—Mail it Today**

**The Fate-Root-Heath Company**  
801 Bell Street, Dept. 39, Plymouth, Ohio  
Please mail at once details of your com-  
plete proposition.

Name.....

Address.....

### TOPS FOR ALL CARS

SAVE \$10 OR MORE. BUY VANCO TOPS  
DIRECT FROM FACTORY. WINTER TOPS  
PRICES REDUCED! Ford tour. top and back curtains, 32 sq., \$4.75;  
36, \$6.25. Ford side tour. curtains, \$4.95; door opening type, \$6.95; back  
curtain, \$1.50. Dodge, Overland, & Chevrolet, etc., top and back cur-  
tain, 36 sq. yds., \$12.25. Ford Radiator and Engine Cover, \$2.95.  
VANDERPOOL TOP FACTORY Dept. P-2 SPRINGFIELD, OHIO

**"NO MORE BROKEN BOLTS"** Don't snap the bolts in  
replacing your engine  
head. A few turns with the **BOLT HOLE CLEANER** removes all car-  
bon and dirt from bolt holes, and you'll never have to drill out  
another broken bolt. Gives better compression. Used by Ford service stations.  
Write for one today. Pay postman on delivery. Obtain from your dealer.  
**BOLT HOLE CLEANER CO., Room 2, Sanford Hotel Bldg., Omaha, Nebr.**

**AGENTS SELL TAILORED PANTS**  
At Lower Prices Than Ready Made Pants  
Big Money Making all year round  
proposition. Every man is your  
prospect.

**FREE SALESMAN OUTFIT**  
250 Different Patterns of the highest grade wools.  
No selling experience required. Commissions paid in ad-  
vance. Write for our free today. No deposit required.  
**WASHINGTON SQUARE TAILORING CO., Inc.**  
Dept. 50 832 Broadway NEW YORK CITY

### Magnified 225 Diameters

This is what the tip of a fly's leg is like when seen through the  
**ULTRALENS MICROSCOPE**



Any amateur can immediately start using  
his Ultralens to examine the edge of a  
razor, the mesh of a cotton shirt, the  
bacteria in dirty water. No technical  
training required, yet hundreds of sci-  
entists and teachers are using this in-  
strument. Gives enormous magnifi-  
cation and perfect definition. Send  
\$7.50 for complete  
outfit.

Send for descriptive  
literature.

\$7.50 for  
Complete Outfit  
Prepaid

**SCIENTIFIC APPARATUS CORP.**  
Dept. 209 MILTON, PA.

## PRICES REDUCED

Only  
**\$3**  
Down



A  
Year  
to  
Pay

Yes, lowest  
prices on  
**UNDERWOOD,**  
**ROYAL,** and all standard makes on easiest terms ever  
offered. Re-manufactured like new by the famous  
"Young Process" to give a lifetime of service.

**10 Days Trial** Our liberal "direct from factory plan"  
saves half. You actually use the type-  
writer 10 days without obligation to  
buy. Let us prove we have the greatest typewriter bargains  
ever offered. You actually save from \$40 to \$20.

**Big Illustrated Catalog FREE**  
This interesting valuable book explains fully how "Young  
Process of Re-Manufacturing" guarantees you highest qual-  
ity, perfect service and satisfaction. Rush coupon today to

**YOUNG TYPEWRITER CO., (Est. 1911)**

SEND COUPON NOW  
Young Typewriter Co., Dept. 1102, 654 W. Randolph St., Chicago

Send me Free book and Special Reduced Prices. This  
does not obligate me in any way.

Name.....

Address.....

City..... State.....



# PATENT TRADE MARKS

**Any new article, machine, design or improvement thereof, or any combination of parts or improvements in any known article which increases its efficiency or usefulness, may be patented, if it involves invention.**

## IF YOU HAVE ANY NEW IDEAS

which you feel are useful, practical and novel, **take prompt action to protect your rights.** If you have invented any new machine, or new combination of parts or improvement, or any new design or process, **SEND DRAWING, MODEL OR DESCRIPTION** of it for information as to procedure to **secure protection.**



DRAFTING, and SPECIFICATION ROOM of CLARENCE A. O'BRIEN, Registered Patent Lawyer, Washington, D. C.

**All Communications** are held in strict confidence. My personal, careful and thorough attention is given to each case. I offer you efficient, reliable and prompt service—based upon practical experience. **Highest references.**

**NO CHARGE FOR ABOVE INFORMATION**

# Clarence A. O'Brien

REGISTERED PATENT LAWYER

Member of } Court of Appeals, District of Columbia, United States Court of Claims;  
Bar of } Supreme Court of United States, Supreme Court, District of Columbia

**Practice Confined to Patents, Trade Marks and Copyrights**



# NTS

## -COPYRIGHTS

### PROTECT YOUR IDEAS

Write Today for **FREE BOOKS,**

**"How to Obtain a Patent"**

and

**"Invention and Industry"**

and **BLANK FORM,**

**"RECORD OF INVENTION"**

These books will give you valuable information, and they may save you much time and effort. **Send for them, NOW.** My practice is devoted **exclusively** to United States and Foreign Patents and Trade Marks. Write me freely, frankly and with full confidence; it is very probable that I can help you.

#### Use the Coupon Attached

and immediately upon its receipt I shall send you the form, Record of Invention, to be returned to me with drawing, description or model of your idea; promptly upon receiving your idea I shall write you as to procedure and costs.

## FREE COUPON

**CLARENCE A. O'BRIEN, Registered Patent Lawyer**

709-B Security Savings & Commercial Bank Bldg., Washington, D.C.  
Directly Across Street from Patent Office

Please send me your free books, "HOW TO OBTAIN A PATENT" and "INVENTION AND INDUSTRY," and blank form "RECORD OF INVENTION," without any obligation on my part.

Name.....

Address.....

**IMPORTANT—WRITE OR PRINT NAME CLEARLY.**

## FREE



**These Books Free**





Our New York Office  
Suits 1007 Woolworth Bldg.



Our Philadelphia Office  
Suits 714-15 Liberty Bldg.



Our Washington Office  
Victor Building

# PATENTS TRADE-MARKS AND COPYRIGHTS

## Have You An Idea?

### Our Offer: FOR THE PROTECTION OF YOUR INVENTION YOUR FIRST STEP

Before disclosing an invention the inventor should write for our blank form

#### "RECORD OF INVENTION"

This should be signed and witnessed and returned to us together with model or sketch and description of the invention for instructions. No Charge for the Above Information.

#### Our Four Books Mailed Free to Inventors

*Our Illustrated Guide BOOK*

#### How to Obtain a Patent

Contains full instructions regarding U. S. Patents. Our Methods, Terms, and 100 Mechanical Movements illustrated and described.

#### Our Trade Mark Book

Shows value and necessity of Trade Mark Protection. Information regarding *Trade Marks and unfair competition in trade.*

#### Our Foreign Book

We have Direct Agencies in Foreign Countries, and secure Foreign Patents in shortest time and lowest cost.

#### Progress of Invention

Description of World's Most Pressing Problems by Leading Scientists and Inventors.

*We Regard a Satisfied Client* as our best advertisement, and furnish anyone, upon request, lists of clients in any state for whom we have secured patents.

**Highest References—Prompt Attention  
—Reasonable Terms**

## VICTOR J. EVANS & CO.

### PATENT ATTORNEYS

Main Offices: 956 9th St., N. W., Washington, D. C.

*Opposite U. S. Patent Office*



# PATENTS TRADE-MARKS AND COPYRIGHTS

## IMPORTANT

Do not submit your invention to anyone before you furnish proof that the invention is patentable or application has been filed. **IN ORDER TO HAVE YOUR CASE MADE SPECIAL TO AVOID DELAY YOU SHOULD TAKE THE PRECAUTION OF HAVING YOUR CASE MADE SPECIAL IN OUR OFFICE** to secure protection, save correspondence and secure early filing date in Patent Office. To secure special preparation of your case send \$25.00 on account with model, sketch and description.



MAIN OFFICE, VICTOR J. EVANS & CO.—VICTOR BUILDING, WASHINGTON, D. C.

All Communications and  
Data Strictly Confidential.  
Interference and Infringe-  
ment Suits Prosecuted

OUR ORGANIZATION OFFERS  
PERSONAL SERVICE  
By Experienced Patent  
Solicitors and Draftsmen

**FREE  
COUPON**

**VICTOR J. EVANS & CO.  
PATENT ATTORNEYS**

NEW YORK OFFICES  
1007 Woolworth Bldg.

CHICAGO OFFICES  
1114 Tacoma Bldg.

PHILADELPHIA OFFICES  
714-715 Liberty Bldg.

PITTSBURGH OFFICES  
514 Empire Bldg.

SAN FRANCISCO OFFICES  
Hobart Bldg.

MAIN OFFICES: 956 9th Street, N. W., WASHINGTON, D. C.

Gentlemen: Please send me *Free of Charge* your books as described on preceding page.

Name .....

Address .....



Our Chicago Office  
Suite 1114 Tacoma Building



Our Pittsburgh Office  
Suite 514 Empire Building



Our San Francisco Office  
Suite 1010 Hobart Building



## PATENTS— and Patents

It is not unusual to find an inventor who believes that the degree of protection afforded by a patent depends upon the merit of the invention.

Such is not the fact.

The strength of a patent lies in the breadth of the claims that have been allowed by the Patent Office. These in turn depend upon the care and skill with which they have been prepared and prosecuted by the patent attorney.

Trademarks are even more valuable than patents in many cases. It is essential that their registry be placed in expert hands.

The standing of Munn & Co., identified with the publication of the "Scientific American," has been earned in a continuous practice of nearly eighty years before the Patent Office. The facilities and resources they have accumulated in that time are at the disposal of individuals and business houses at fees that are as moderate as conscientious service will allow.

Write for Munn & Co.'s book on Patents. A succinct and accurate booklet of information on Patents, Designs, Trademarks, Foreign Patents, Copyrights, Labels and Patent Office Practice. It also describes the methods and the terms of Munn & Co.

**MUNN & CO.**  
PATENT ATTORNEYS  
EST. 1846

672 Woolworth Bldg., New York City  
523 Scientific American Bldg.,  
Washington, D. C.  
412 Tower Bldg., Chicago, Ill.  
365 Hobart Bldg., San Francisco, Cal.  
220 Van Nuys Bldg., Los Angeles, Cal.

## U.S. PATENTS



SEND FOR THIS FORM

### DON'T LOSE YOUR RIGHTS TO PATENT PROTECTION

Before disclosing your invention to anyone send for blank form "EVIDENCE OF CONCEPTION" to be signed and witnessed. A sample form together with printed instructions will show you just how to work up your evidence and establish the same before filing application for patent. As registered patent attorneys we represent hundreds of inventors all over the United States and Canada in the advancement of inventions. Our schedule of fees will be found reasonable. The form "Evidence of Conception," sample, instructions relating to obtaining of patents and schedule of fees sent upon request. Ask for them—a post card will do.

PATENTS AND TRADE MARKS



Registered Patent Attorneys In U. S. and Canada,  
480 Ouray Bldg., WASHINGTON, D. C.  
Originators of forms "Evidence of Conception."

## Have You An Invention?

If so the WORLD PROGRESS will show you how to  
**PROTECT AND PROFIT FROM YOUR IDEAS**  
Sample copy free. One year's subscription \$1.00.  
Send for free book,

### "WHAT TO INVENT"

containing SUGGESTIONS TO INVENTORS as to Inventions Needed. We invite manufacturers to address us regarding inventions they want.

**WORLD PROGRESS PUB. CO., Inc.**  
Room 203 Victor Bldg. WASHINGTON, D. C.

## PATENTS

REGISTERED PATENT ATTORNEY SINCE 1905  
**CHARLES W. LOVETT** SECURITY BLDG. LYNN MASS.  
SEND FOR FREE BOOKLET

## INVENTORS

who derive largest profits know and heed certain simple but vital facts before applying for Patents. Our book Patent-Sense gives those facts; sent free. Write **LACEY & LACEY**, 646 F St., Washington, D. C. Established 1869.

## PATENTS

### Trade-Marks, Copyrights and Patent Litigation

Write for advice and instructions how to proceed, costs, etc. Hand Book with illustrations of 100 Mechanical Movements sent free on request.

### ALBERT E. DIETERICH

Patent Lawyer and Solicitor  
Successor to Fred G. Dieterich & Co. 621A Ouray Bldg., Washington, D. C.



# INVENT!

## Your Ideas May Bring A Fortune



**Big FREE BOOK**  
tells how 15  
great inventors  
teach you

**O**NE single idea can make you independently wealthy in a short time. It doesn't have to be anything big. Inventors have made hundreds of thousands of dollars from such common things as the crimped hair-pin, the paper safety match, the ordinary wire clip. Surely you have often thought of ideas just like these—common, everyday things, that properly developed, might have brought you all the wealth you ever dreamed of. The man who invented the Kiddie Kar is said to have made over \$5,000,000. B. T. Babbitt is worth millions because of his soaps. Gillette is said to have made as much as TWO AND ONE-HALF MILLION DOLLARS a year!

### Anyone Can Become An Inventor

Of course you realize the wonderful opportunities in Invention. But you may doubt your own ability to invent. Listen to what the greatest inventor of all has to say. Read this wonderful, helpful message by Thomas A. Edison: "Invention is a science and should be taught as a profession!"

What does that mean? Only this, YOU CAN LEARN HOW TO INVENT! After all, nobody ever was born an inventor. Think of what all the great inventors were *before* they invented anything. Lake was a schoolboy, Gillette was a salesman. So was Waterman. Edison was a telegrapher. Others of our leading inventors were office clerks, mechanics, farmers, peddlers, housewives. The truth is plain—no matter what you are today you have it in you to make your fortune through invention!

After all, Invention is only the science of thinking inventively. Prove it for yourself. Suppose, when you went home tonight, you found a window rattling. Through your mind would flash, almost instinctively, one regular order of thought. First, you would recognize a problem to be solved—the rattling of the window. Then you would think of several principles of science or mechanics which would solve your problem. You might think of the scientific fact that if you poured water on the frame the wood would swell and tighten the window. You might think of using a nail. But what you most probably would do would be to use the oldest mechanical principle known to man, the wedge.

That is exactly the way every invention has been made—combining two ideas; a problem which must be solved and some fact which solves the problem. So, although you may never have thought of it in just that way, every time you solve a problem you use the fundamental, scientific principles of Invention!

### Fifteen Great Inventors Teach You Secrets of Successful Invention

However, you will agree that you need more than this bare fact to become a successful inventor. You must develop your inventive instinct. You must train your brain so it will quickly seize upon the only practical solution.

That is exactly what 15 great inventors teach you in a wonderful new course. For the first time, you are taught how to use the wonderful facts of invention to ACTUALLY PRODUCE INVENTIONS! They tell you how to originate ideas, how to develop them, how to get patents, how to protect your patents, how to prove your idea is original, how to get the greatest possible value from your inventions—everything you will ever want to know.

In fact, these inventors tell you the secrets which every successful inventor knows and uses, secrets for which they suffered poverty, hunger, desperation and disappointment to learn. And now you can acquire these secrets easily, simply, quickly through absorbing reading in your spare time at home.

### FREE BOOK Explains All

The Bureau of Inventive Science has prepared a wonderful booklet explaining in detail this first course in practical invention ever devised. Ambitious men and women are urged to send for a copy of this book at once—it is FREE. Simply mail the coupon. The Bureau is not connected with patent attorneys, promoters, or manufacturers. Its only purpose is to help men and women to learn the secrets of practical, profitable, money-making invention. The free book tells all about it. Write for it NOW.

**BUREAU OF INVENTIVE SCIENCE**  
WISNER BUILDING DEPT. 32 ROCHESTER, N. Y.

Bureau of Inventive Science, Dept. 32,  
Wisner Building, Rochester, N. Y.

Please send me, without cost or obligation, your free book, "The Science of Invention," explaining how 15 famous inventors teach me, at home, the secrets of practical invention.

Name.....Age.....

Address.....

City.....State.....



RAYMOND F. YATES,  
who with 14 other  
famous inventors now  
teach you the secrets of  
practical invention.



# PATENTS

**Booklet Free**

**Highest References**

**Promptness Assured**

**Best Results**

Send drawing or model for preliminary examination

## ALL BUSINESS GIVEN PROMPT AND PROPER ATTENTION

Listed Patent Lawyer in the latest editions of the Rand-McNally Directory of Bankers and Attorneys, published by Rand-McNally & Co., Chicago, Ill.; The Baggott & Ryall Directory of Attorneys, published by the Ryall Legal Directory Company, New York City; the United Lawyers' List of Attorneys, published by the United Lawyers Association, Chicago, Ill.; The Lawyers and Bankers Quarterly, published by the Legal Directory Publishing Co. of St. Louis, Mo.; the American Lawyers Annual, published in Cleveland, Ohio; and Snow-Church Directory Co. Lawyers List, published in New York City.

**WATSON E. COLEMAN,** 644 G Street, N. W., Opp. U. S. Pat. Office  
**REGISTERED PATENT LAWYER** **WASHINGTON, D. C.**

## Mason, Fenwick & Lawrence

*Trade Mark and Patent Lawyers*  
 Washington, D. C. New York Chicago

*Established over 60 years* *Write us*

References, National Confectioners' Association, Chicago; National Cannery Association, Washington, D. C.; Life Savers Inc., Port Chester, N. Y.; Bon Ami Co. and U. S. Cigar Co., New York City; Hershey Chocolate Co., Hershey, Pa.; Stephen F. Whitman & Son, Philadelphia, Pa., and many others.

**Inventions Protected** **Trade Marks Registered**

## PATENTS

**C. L. PARKER**  
 Formerly Member Examining  
 Corps, U. S. Patent Office  
**PATENT LAWYER**  
 MCGILL BLDG.  
 WASHINGTON, D. C.

Patents, Trade Marks, Copyrights, Patent Litigation  
 Handbook for Inventors, "Protecting, Exploiting  
 and Selling Inventions," sent free upon request.



## PATENTS

Send us sketch or model for free patentability opinion and exact cost of patent. Our book "How to Obtain a Patent" sent free on request. It tells how to apply for Patents, Trade Marks, Foreign Patents, Copyrights, etc.; gives information on Patent Procedure; tells what every inventor should know. Thousands of inventors, who are our clients, are our references.

**CHANDLEE & CHANDLEE, 25 Years' Experience**  
 473 7th St. **Washington, D. C.**

# INVENTORS PROTECT YOUR IDEAS

Send for our Guide Book, **HOW TO GET A PATENT**, and Evidence of Invention Blank, sent Free on request. Tells our terms, methods, etc. Send model or sketch and description of your invention for Instructions. No charge for the above information.

**RANDOLPH & CO.**  
 300 Victor Bldg., WASHINGTON, D. C.

NAME.....

STREET.....

CITY..... STATE.....



# PATENTS

## To the Man with an Idea

I offer a comprehensive, experienced, efficient service for his prompt, legal protection and the development of his proposition.

Send sketch, or model and description, for advice as to cost, search through prior United States patents, etc. Preliminary advice gladly furnished without charge.

My experience and familiarity with various arts frequently enable me to accurately advise clients as to probable patentability before they go to any expense.

*Booklet of valuable information and form for properly disclosing your idea free on request. Write today.*

**Richard B. Owen, Patent Lawyer**  
9-303 Owen Building, Washington, D. C.  
2276-E Woolworth Bldg., New York City

## BLUE BOOK ON PATENTS

gives instructive information and candid advice.  
**MONROE E. MILLER, PATENT LAWYER**  
411-2 O'urray Building WASHINGTON, D. C.  
ELECTRICAL AND MECHANICAL EXPERT



## Do Your PRINTING

Cards, stationery, circulars, labels, paper. Complete Outfits \$8.85 up, Rotary Jobber, \$150. Card Cutters \$3 Save Money. Print for others, big profit. Easy with rules sent. Write for catalog presses, type, paper, cards link, etc. **THE PRESS CO., L-37, MERIDEN, CONN.**

**SELL OUR  
DOUBLE PANTS  
SUITS**  
\$28.50 and UP

## Tailoring Salesmen and Merchants

everywhere, earn \$75.00 to \$150.00 a week selling our guaranteed all wool suits and extra pants at \$28.50 and up—\$5.00 to \$12.00 profit on each order. We furnish the most complete and attractive swatch line, showing 250 large size samples, together with a durable carrying case. Write for exclusive Agency, today, and secure our Spring and Summer samples.

**JAY ROSE & COMPANY**

411 S. Wells Street, Dept. 450, Chicago, Ill.

**Clear-Tone**  
FOR  
**PIMPLES**  
Your skin can be quickly cleared of Pimples, Blackheads, Acne Eruptions on the face or body, Enlarged Pores, Oily or Shiny Skin. **\$1,000.00** Cold Cash says I can clear your skin of the above blemishes. **WRITE TODAY** for my FREE Booklet—"A Clear-Tone Skin"—telling how I cured myself after being afflicted for fifteen years.

**FREE**  
**E.S. GIVENS, 129 Chemical Bldg., Kansas City, Mo.**



**"Been on a vacation, Bill?"**

**"No, Jim — I've stopped smoking."**

Gained six pounds in a week. You know how I used to smoke—a package of cigarettes and a cigar or two a day—it sure had some hold on me. But I'm cured—took a scientific home tobacco treatment—fixed me up in two weeks.

"Wasn't hard on me at all—noticed improvement the first day—I feel like a new man. It didn't interfere with my work—didn't leave any druggish after-effects—the money I saved in the last two weeks has paid for the treatment alone.

"Why don't you take it? It has cured men like you and me for over forty years—it is a doctor's individual prescription that sure fixes you up. Just send the coupon for full information NOW. No obligation. All correspondence is strictly confidential."



**A Doctor's Prescription**

## The Keeley Institute, Dwight, Ill.

Please send me, without any obligation on my part, your free booklet which will tell me how to rid myself of the tobacco habit.

Name .....

Town .....

Street.....State.....PM-2



# \$30 A DAY

to Introduce New Wonder  
Gloss-Shines All Shoes



Make that much and more selling this amazing new CEROLA SHOE GLOSS and other Harley specialties among your friends and neighbors. It's a cream-white paste quickly and easily applied which imparts a most brilliant lustre to smooth surfaced shoes of ANY COLOR—black, tan, brown or patent leather. CEROLA softens and preserves the leather and is non-injurious. Clean to use—will not stain hands or clothing. Get in on this today.

## Easy Work—Big Profits

### A Permanent Business of Your Own

Make big money like other Harley men—J. R. Moore, Penna., made \$1124 in one month—Lewis Bodine, New York, \$616 in one month—W. J. Glasstetter, Penna., \$125 in one day—L. S. Arthur, Ohio, \$109 first 4½ days. Every home in the Nation a prospect for the famous Harley specialties. You can do as well as these men. No experience needed—I train you free and stand behind you and help you make big money.

## AUTOMOBILE FURNISHED

I am now giving Automobiles to agents who show determination—no contests, no prizes, no guesswork. Don't wait until someone in your community gets ahead of you. Write immediately for full information as to the new Harley Plan, my Free Sample Case offer and my Free Automobile offer. It costs you nothing to start—you don't risk a single penny—I furnish everything. Address me personally, E. C. Harley, President.  
The E. C. HARLEY CO., B-391 Harley Bldg., Dayton, O.

# \$7.65 IN 4 HOURS

## SPARE TIME

Hampton made \$7.65 in four hours spare time just wearing this Beautiful Hand-Tailored Cap, made to his Individual Measure, and you can do the same—you can easily earn \$50—\$75 a week in your spare time.



## Get This Cap FREE

I want to give you this cap FREE—I know your friends will be delighted with its Class, Style and Fit and you will make a generous profit taking their orders. Choice of 5 styles and 25 fine fabrics. Send your name right away and I'll tell you how to make \$50 a week in your spare time. Write me at once, J. W. Taylor, Pres., Taylor Cap Mfrs., Dept. 8-B, Cincinnati, Ohio.

Watch for announcement of Ives wonderful electric reversing locomotive.

Ives Manufacturing Corp.,  
Holland Ave., Bridgeport, Conn.

Hand Forged  
Razor Steel  
Blades, No. 57



A GENUINE \$2 KNIFE  
FOR  
\$1.18 POSTPAID

## Direct at Factory Prices

This \$2 KNIFE \$1.18 Postpaid  
Hand Forged Razor Steel Blades  
Handy shaped Blade makes this knife best for mechanics, sportsmen and farmers; light but strong; re-sharpened easily. Stag handle. German silver finish; blades file tested, hand forged from razor steel and warranted.

Sample \$1.18 3 for \$3.00 Postpaid.

Send for our 100-page List and "HOW TO USE A RAZOR" FREE

MAHER & GROSH CO., 106 A St., Toledo, Ohio

# I Can Train You For A \$3500 Hotel Job in 20 weeks



The Hotel Business offers wonderful opportunities to the trained man or woman! Now fourth largest industry in America. Hundreds of high-salaried executive positions now standing open—waiting for the trained worker. You can easily qualify for one of these big-paying jobs—in your spare time at home. No previous experience necessary.

## I Guarantee to Teach You

in my 50-lesson home-study course on hotel work, all that the leading hotel experts know about the business—men making from \$5,000 to \$50,000 a year! My students are eagerly sought by the biggest and best hotels in the country. You won't have to start at the bottom. You won't have to look for a job. Big pay, fine living, free meals and apartment, fascinating work—these are only a few of the many advantages of hotel work.

## Send for FREE Book

20 Years' Experience in 20 Weeks is what this wonderfully complete course gives you. Course prepared by Clifford Lewis, a hotel expert of national reputation. Endorsed by managers of such hotels as Biltmore, Waldorf-Astoria, Copley-Plaza, Commodore, etc. Interesting free book "Your Big Opportunity" explains all. Send for it today.

## Lewis Hotel Training Schools

CLIFFORD LEWIS, President

Room M-330

Founded 1916

Washington, D.C.

## CROSS WORD PUZZLES QUICKEN THE MIND

But a snappy Ford-speed adds zest to your entire being

9 model bodies Under-slung Fix. \$6.95 3-g Gears \$5.50



DISCS

90% WITH ORDER, BALANCE C.O.D. Come in today and inspect our wonderful display of complete cars, sport and speed bodies and racing specialties.

M. P. FORDSPEED BODY MFRS., 250 W. 54th Street, NEW YORK

## You-and This New Machine Can Earn \$500 a Month



### Operate a Tire Repair Shop

70,000,000 Tires in use. America's greatest opportunity for men with small capital. We furnish everything—\$100 and up. Easy payments. We train you FREE right at home. Start making money at once. Write today for Free Book of Opportunity.

Haywood Tire Equipment Co., 1344 S. Oakley, Chicago



HOW THE  
ARTEX DIAMOND  
LOOKS IN A  
BEAUTIFUL  
MOUNTING



Send  
Only

# 10<sup>c</sup>

To Help Cover Cost of Handling and We  
Will Send You a Full Cut One Carat

**"ARTEX DIAMOND"**  
**Nothing more to pay**

*Nothing to Sell—Nothing to Buy  
No Red Tape Attached to This Offer*

We want Thousands of new owners and boosters of ARTEX DIAMONDS and we will distribute these gems FREE to the readers of Popular Mechanics Magazine.

ARTEX DIAMONDS are full 24 facet cut and are of such radiant beauty that even experts are astonished at their likeness to the genuine.

WE ARE MAKING this unusual offer only to get ARTEX DIAMONDS into the hands of appreciative friends.

SLIP your name and address with 10c in stamps or coin (to help cover cost of handling) in an envelope and get it right off to us. Your ARTEX DIAMOND will reach you by return mail fully prepaid.

L. D. ARTEX CO., 1133 Broadway, N. Y. C.



**"BOW LEGS and KNOCK-KNEES" UNSIGHTLY**

SEND FOR BOOKLET SHOWING PHOTOS OF MEN WITH AND WITHOUT THE PERFECT LEG FORMS

PERFECT SALES CO.

140 N. Mayfield Ave., Dept. 5, Chicago, Ill.



## No Joke To Be Deaf



**—Every Deaf Person Knows That**

I make myself hear, after being deaf for 25 years, with my Artificial Ear Drums. I wear them day and night. They are perfectly comfortable. No one sees them. They stop head-noises. Write me and I will tell you a true story, how I became deaf and how I make you hear. Address

**GEO. P. WAY, Artificial Ear Drum Co. (Inc.)**  
89 Hoffman Bldg., 2529 Woodward Ave., Detroit, Mich.



## Must Men Fear 40?

**M**EDICAL authorities agree that 65%, or nearly two-thirds, of all men past middle age, are afflicted with a disorder of the prostate gland. Here is the known cause for many of the ailments commonly ascribed to declining years—including aches in back, feet and legs, frequent nightly risings, sciatic pains, nervousness and lack of vitality. But now, science knows that thousands suffer needlessly.

For a member of the American Association for the Advancement of Science has discovered a remarkable new drugless hygiene that usually restores the prostate gland to its normal functioning. Already it has been used by more than 15,000 men—Doctors, Statesmen, Teachers, Bankers, Lawyers, men in every walk of life—with amazing results.

"I know too plainly the effects of prostate gland disorder when it is allowed to continue unabated," says the scientist mentioned above. "I know of the operations and the common saying among many that the average life after this operation is only two or three years. That is why I am doing everything possible to let people know of this important discovery."

### FREE BOOK

If you have prostate trouble, if you suffer with any of the ailments mentioned above, you should not lose a day in finding out about this wonderful new method.

If you will mail the coupon below you will get, in plain wrapper, a free copy of an interesting book describing this new method. It contains facts every man should know. But send immediately, for the edition of this book is limited; address



THE ELECTRO THERMAL COMPANY

2142 Main Street, Steubenville, Ohio

Please send me Free, and without obligation, a copy of your booklet, "Why Many Men Are Old at 40." Mail in plain wrapper.]

Name.....

Address.....

City.....State.....

Western Office—Dept. 21G, 711 Van Nuys Bldg.  
Los Angeles, Cal.





# FREE Musical Instruments

**WITH FULL AND DETAILED INSTRUCTIONS** How to Play the Instrument of Your Choice

THIS IS A BONA-FIDE OFFER. You get both an instrument, valued at \$18.00, and complete instructions

**ABSOLUTELY FREE**

for selling fine candy. Do not confuse this offer with musical correspondence schools. We are **NOT** selling courses or methods of any kind. No strings or red tape. 100,000 instruments and complete instructions to be given **ABSOLUTELY FREE**. Never before has a similar offer been made. If you want to become popular—to be the "life of the party," write today for our fascinating novel **MUSICAL PLAN**. It's **FREE**.

**HOME SUPPLY COMPANY**  
131 DUANE STREET, DEPT. 947, NEW YORK



**Your Choice!**  
**Given Away**

**Instruments and Lessons FREE**



**BANJO UKULELE**



**TENOR BANJO**



**HAWAIIAN GUITAR**

**43.8 Miles on Gal. of Gas** Obtained in Official Test (Affidavits on File)

Blancke Thermostatic Carburetor Control is guaranteed to increase mileage on your Ford car or truck 50% to 100% or purchase price refunded. Makes Fords start easier winter or summer—almost entirely eliminates carbon formation—greatly reduces repair bills. Motor runs smoother—prevents dilution crank case oil. Faster acceleration. Lower speeds possible in high gear. Easily and quickly installed. Costs only \$5 and you will find it quickly pays for itself many times.

**BLANCKE THERMOSTATIC CARBURETOR CONTROL**  
An Automatic Carburetor Control for Ford Cars and Trucks

**Guaranteed Trial Offer**  
We will send sample control at our risk to one Ford Owner in each district in U. S. Just send name and address and get our Guaranteed Trial Offer NOW!

**A. C. BLANCKE & CO.**  
Dept. 364, 602 W. Lake St., Chicago  
AGENTS - DEALERS - Write for usually liberal proposition.



*Cadillac now uses as standard equipment Thermostatic Carburetor Control under Blancke license.*

**One Man Saws 15 Cords a Day!**

—Easy with the OTTAWA Log Saw! Wood selling for \$3 a cord brings owner \$45 a day. Use 4 H. P. Engine for other work. Wheel mounted—easy to move. Saws faster than 10 men. Shipped from factory or nearest of 10 Branch houses. Write for **FREE Book**—"Wood Encyclopedia"—today.

**OTTAWA MANUFACTURING CO.**  
1741-T Wood Street, Ottawa, Kansas  
Room 1741-T Magee Bldg., Pittsburgh, Pa.

**Saws Logs—Falls Trees—**  
**Buzzes Branches—**  
**Does Belt Work**

**10-Year Guarantee—Cash or Easy Terms.**

**TRY 30 DAYS**



**Driver Agents Wanted**

**RACING BODIES for FORDS at \$34.50** Up

Send today for free particulars. Our book "How to Build a Ford Racer" sent anywhere on receipt of 25 cents—cash or stamp.

**CENTRAL AUTO SUPPLY CO., Dept. 120A, LOUISVILLE, KY.**

To Avert Repair Bills, "Build for Keeps" with

# "TIDE WATER" CYPRESS

"THE WOOD ETERNAL"

**\$2 Brings This Genuine DIAMOND RING**

**SIMPLY** send \$2.00 for the most sensational, price-amazing diamond ring offer ever made. A perfectly cut, guaranteed, blue white, fiery diamond is set in an 18 Karat white gold cup; 1/4 Karat size. Latest design, hand engraved mounting.

**10 DAYS' FREE TRIAL**  
We take all chances—if you are not satisfied at the end of ten days for any reason whatsoever, return the diamond ring to us and your deposit will be refunded to you. Send only \$2.00, and receive this genuine steel blue white diamond ring exactly as illustrated; in a handsome gift box charges paid. A legal guarantee bond as to quality and value accompanies each ring. After ten days' trial pay balance \$6.46 a month for twelve months. **Price only \$79.50.**



**3/4 Karat Solitaire Setting**

**NO RED TAPE—NO DELAY**  
**Order Now!** This offer is limited. It may never appear again. Don't delay. Just send \$2.00 as a deposit. If you wish to return the diamond ring after trial, your deposit will be refunded.

**FREE BOOK OF GEMS**  
Most complete Jewelry Catalog ever issued of Diamonds, Watches and Jewelry—newest designs at lowest prices.

**A full year to pay on everything you order from our TWO MILLION DOLLAR STOCK.**

Address Dept. 1259. Est. 1895

**ROYAL DIAMOND & WATCH CO.**  
**35 Maiden Lane - New York**



# Easy! To Own

## A LATHE of Your Own

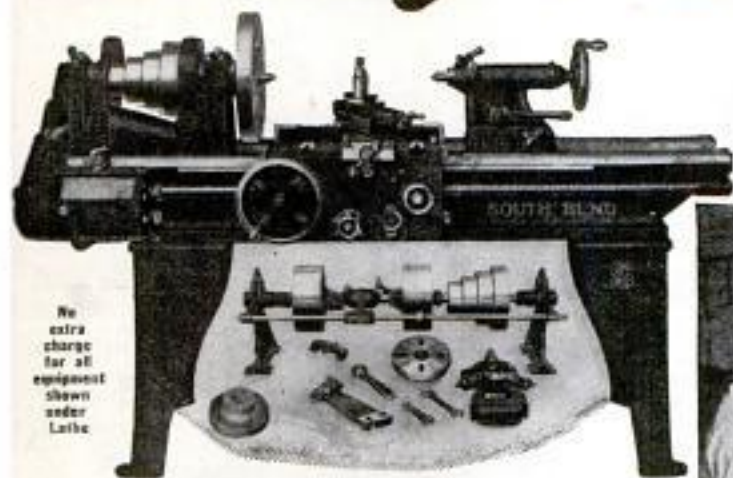

No extra charge for all equipment shown under Lathe

Get Our **Easy-Payment Plan** on This **16" x 6' Quick Change Gear South Bend**

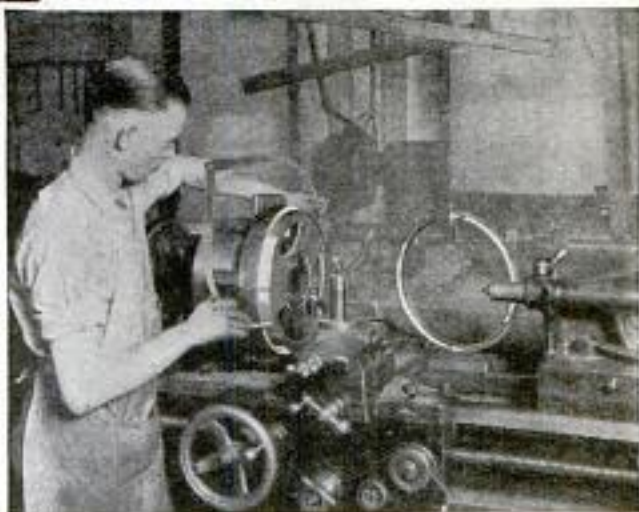

## SCREW CUTTING LATHE

Our easy-payment plan enables you to use your South Bend Lathe while you are paying for it. You make a payment down, and the Lathe is shipped at once on 30 days' trial. Convenient monthly payments may be arranged for the balance. In this way the Lathe helps earn its own cost, and you secure the same high quality product used in America's leading shops. For example:

South Bend Lathes are used in plants of 2 largest Steel Companies, in 8 largest Auto Factories, in 5 largest Railroad Shops, in world's largest Sewing Machine Factory, in 2 largest Fire Arms Factories, by largest Oil Company, by the U. S. Government, and in 64 Foreign Countries.

### 32 Major Improvements —Increased Accuracy and Efficiency

The New South Bend Lathes embody 32 major improvements made in the last 2 years—all insuring extreme accuracy, efficiency, economy and convenience. More than 31,000 South Bend Lathes are in use.

## CATALOG FREE!

**Showing 96 Styles—All Sizes**

Let us send you a copy of this Free Book. Then you can select just the Lathe you need. Compare our money-saving prices and liberal terms with what others offer. Write or send coupon today.

**South Bend Lathe Works** 316 East Madison Street  
South Bend, Ind., U.S.A.

Only  
**\$466**  
Complete

Other Lathes  
as Low as  
\$197  
on Terms



Threading  
Pipe Union



Milling attachment  
cutting  
keyway



Threading an  
automobile  
axle

SOUTH BEND LATHE WORKS,  
316 East Madison St., South Bend, Ind.

Gentlemen: I would like your factory price and terms on a ..... Lathe. Please send Free Catalog.

Name.....

Address.....



*Holtzer-Cabot*  
**LOUD SPEAKER**



**A New Standard of Quality ONLY \$12.00**

If you want a Loud Speaker which brings in volume so that you don't have to strain your ears to hear it—which in spite of its power does not distort, but makes Radio reception a musical and artistic pleasure—which is sensitive to every tone so that a piano sounds like a piano and not like a tin pan—which is so beautiful that it harmonizes with any surroundings, this new Holtzer-Cabot National Loud Speaker for you. Furthermore, its price—\$12.00—has established an entirely new standard of value in Radio.

Dept. P. M.

**THE HOLTZER-CABOT ELECTRIC CO.**  
125 Amory Street BOSTON  
447-65 South State St. CHICAGO

*Holtzer-Cabot*

  
General Electric Company, Schenectady, New York

**Como Duplex Transformers**  
(Push Pull Power Type)



**Price \$12.50 Per Pair**

The Como Duplex system of audio frequency amplification (push-pull) gives the maximum volume without distortion and tube noise. There is a combined filtering action which assures perfect results when ordinary amplification transformers fail. Can be used as a single-stage, two-stage, or a three-stage amplifier.

**The World's Standard Push Pull Transformer**  
Send for copy of "How to Build a Power Amplifier."

**COMO APPARATUS CO.**  
446 Tremont Street - BOSTON, MASS.

## Make BIG MONEY! IN RADIO

**We Need Men—Can You Qualify?**

Ozarka representatives make real money because they give real values and deliver a real service. For instance, there is a 4-tube Ozarka instrument for loud speaker operation, giving wide range of reception, at \$39.50. Our men demonstrate Ozarka instruments and install.

The instrument makes the sale easy by its performance. We train you to know radio and our methods, make you worthy to wear the Ozarka button as our accredited representative. Previous experience is not necessary. In fact, we prefer to do our own educating. If you have a clean record, are industrious, and have saved up a little cash, here's a real opportunity, if you can qualify for an exclusive territory. We already have 2247 representatives. Territory going fast.



**FREE, LARGE Illustrated BOOK**

WRITE Today for illustrated book No. 100 that gives the entire Ozarka Plan. Don't fail to give the name of your county.

**OZARKA, Inc.**  
851 Washington Blvd., CHICAGO

**4-Tube Sets as Low as \$39.50**



## The Traffic Cop of the Air

**FERBEND Wave Trap**



Add a Ferbend Wave Trap to your Radio Set and "Police" your reception. Regulate traffic. Guaranteed to tune out any interfering station. Widely imitated but never equalled. The original and only successful WAVE TRAP. Now in its third year. Sent Postpaid upon receipt of \$3.50 or C. O. D. plus postage. Send for Free Booklet

**FERBEND ELECTRIC CO.**  
15 E. So. Water St. Chicago



Our BUREAU OF INFORMATION will answer all questions regarding articles in this magazine. Address Popular Mechanics Magazine, Chicago.

## RADIO Buyers' GUIDE

FOR CONSUMERS

Get it now—before you buy any set or parts to build one. Bargains in all kinds of complete Sets, Parts and Accessories.

**FREE**

100 PAGES

Just send your name. (Will you be so kind as to add the name of one or more friends you believe will enjoy this?) Thank you!

LIBERTY M. O. HOUSE, Dept. B-171, 106 Liberty St., N. Y.



## Pays For Itself ~ Earns Big Profits

No experience is needed to start making big monthly profits with HB One Day Battery Charging. Only \$35 sets an HB outfit in your shop complete with bench, bus-bars, connectors, cable, etc. Your big monthly profits easily carry the small monthly payments. 30 days' free trial on money-back guarantee. HB Voltage Regulator insures best results for day and night charging.

Write today for free bulletin 247

**Hobart Bros. Co. Box M25 Troy, Ohio**

**\$300 PROFIT Monthly from HB & Mr. Battery Charging**

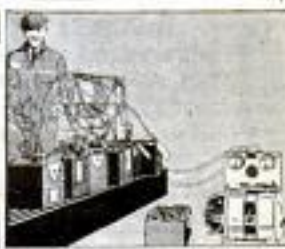



## "Old Town Canoes"



*Where the highway  
is the water way*

SURELY you have felt the call of the open—the urge to hie away somewhere beyond the haunts of men. Answer that call in an "Old Town Canoe."

"Old Town Canoes" are light in weight, but remarkably strong and rigid in construction. They are fashioned after true Indian models. Sleek and fast, "Old Towns" are the one canoe for every water highway. "Old Town Canoes" are low in price too. \$64 up. From dealer or factory.

The 1925 catalog shows all models in full colors. It is free. Write for your copy today. OLD TOWN CANOE Co., 1562 Middle Street, Old Town, Maine, U. S. A.

**THIS \$4.95 and Postage**  
**TOP**

Fits 1915-1922 Ford Tourings, with rear curtain, tacks, braid and instructions. Chevrolet 490 Touring 16-24, \$8.95. Tops for all cars, whatever make or year of your car. Write for free samples and estimate. Every order with money-back guarantee.

Comfort Auto Top Co., Dept. P, 1621 Germantown Ave., Philadelphia, Pa.

**LYON BODIES** Send For Our 1924  
**FREE BOOK OF BARGAINS**

Containing a full line of bodies and accessories at exceptionally low prices. Buy direct from the factory.

**AUTO TIRE SALES CO.**  
Body Division Dept. P-28  
1346 S. Michigan Ave., Chicago

**\$27.50 AND UP**

**For Your Boat**

**Elto** Old Evinrude's New Quick Detachable ROWBOAT MOTOR

Easily carried. Quickly attached to any boat (without tools). Drives boat any speed, 2 to 10 miles per hour. No rowing, no work, no bother.

**Fast—Light—Powerful  
Easy to Carry**

Has 12 exclusive features, all described in our new Free Catalog. Write for it today.

**Elto Outboard Motor Co.**  
Manufacturer's Home Bldg.  
Dept. AA  
Milwaukee, Wis.

**Elto—The Motor that Starts with a Touch**

10 Shaves Free  
Send Coupon



## We've Won Millions

*to this unique shaving cream;  
please try it—5 new joys await you*

GENTLEMEN:

Palmolive Shaving Cream is a national sensation. Men have flocked to it by the millions.

Only outstanding and superlative advantages could have won them over.

For 60 years we have been improving soap.

We asked 1000 men what they most desired in shaving lather. We spent 18 months in modern laboratory work. 130 formulas were discarded before we found the right one. Then we offered men a test. And that test changed the shaving cream situation; made a new leader in the field.

Palmolive Shaving Cream may or may not meet your ideals.

So in fairness both to you and us, won't you give Palmolive Shaving Cream a trial? Simply mail the coupon.

### Five remarkable results

- 5**  
*delights*
- 1 Multiplies itself in lather 250 times.
  - 2 Softens the beard in one minute.
  - 3 Maintains its creamy fullness 10 minutes on the face.
  - 4 Strong bubbles hold the hairs erect for cutting.
  - 5 Fine after-effects, due to the palm and olive oil content.

To add the final touch to shaving luxury, Palmolive After Shaving Talc—especially for men. Doesn't show. Leaves skin smooth and fresh, gives that well groomed look. Try the sample we are sending free.

THE PALMOLIVE COMPANY (Del. Corp.), Chicago, Ill.

## PALMOLIVE SHAVING CREAM

**10 SHAVES FREE**  
and a can of Palmolive After Shaving Talc

Simply insert your name and address and mail to Dept. P-244. Address for residents of Wisconsin, The Palmolive Company (Wis. Corp.), Milwaukee, Wis. Address for residents of other than Wisconsin, The Palmolive Company (Del. Corp.), 3702 Iron St., Chicago, Ill.

2679



The Old Way  
1864



# INTRODUCING The New SPREDTOP REG. RING U.S. PAT. OFF.

The New  
SPREDTOP  
Way  
1925

## It Makes the Diamond Look Larger

The new SPREDTOP Ring, sold exclusively by us) is scientifically constructed to give the AAA quality blue-white Diamond greater brilliancy and a larger appearance. 18K White Gold hand-engraved mounting. Regular \$65 value—our Special Introductory Price only \$45.

**Send No Money**—we will send the SPREDTOP Ring for FREE EXAMINATION. If satisfied pay only \$5.00 upon acceptance, and then only \$4.00 a month until balance is paid. Transactions Strictly Confidential—ORDER TODAY.

**FREE**—complete book of Diamonds, Watches and Jewelry all on TEN MONTHS' Credit Terms. Also our pamphlet of other SPREDTOP Rings.

### Our Challenge

If you can duplicate any Diamond purchased from us for less money in any cash jewelry store, we will gladly refund any amount deposited if returned within fifteen days.



\$1<sup>00</sup> a  
-Week  
PAY BY THE MONTH  
10 MONTHS  
TO PAY



**L.W. SWEET INC. DEPT. 65-G 1650 BROADWAY NEW YORK CITY**

## CRAIGULATOR

More Heat  
Less Work  
No Worry

**CRAIGULATOR**

SAVES COAL

Patent Pending

1. 20% saving in coal or wood
2. Less ashes and less smoke
3. Eliminates gas odors
4. Snappy responsive fire
5. Holds heat at even temperature with less attention
6. Makes heater more efficient
7. Burns cheaper grades of coal

A Scientific Regulator  
for the heater that

## CUTS COAL BILLS

\$2200 complete with quadrant controlled damper for the flue pipe. Easy to install. Sent, with full instructions, parcel post, prepaid or Express C. O. D. Thousands in use. Send width and height of fire box door and diameter or circumference of flue pipe.

### OPPORTUNITY

Our present sales system is being extended by further division of territory. This may create an opportunity for you as our local distributor and installer.

**KEYSTONE SALES CORP.**  
233 Main St. SPRINGFIELD, MASS.



It is the well known quality of CRESCENT machines that justifies you in selecting one of them each time you have need for good working machinery. The CRESCENT line is better than ever and will always give you satisfaction in every particular. Ask today for catalog of hand saws, saw tables, jointers, shapers, planers, borers, trimmers and matchers, coping saws, disk grinder, cut off table, hollow chisel mortiser, variety wood worker. Universal wood workers.

THE CRESCENT MACHINE CO., 83 Columbia Street, Leontia, Ohio

**You Can Cut Your Own Hair**  
Any style—feather edge if you wish—as easily and quickly as you comb your hair. Saves you time and money. Gives a quick, clean-cut hair out. You need it.

Over 80,000 in use. Write for Free Trial Offer

**"I use it!" COWAN HAIR CUTTER** Dept. 74  
Indianapolis, Ind.

### ANYONE USING FIGURES NEEDS IT

to check mental calculations. For General Office or Personal Desk. Over 200,000 in use—mostly sold thru recommendation. Guaranteed—money refunded if not satisfactory after 10 days' trial. Buy from your stationer or order direct. Agents Wanted.

**P. GANCHER, A. A. M. Co.**  
119 W. Broadway, NEW YORK



\$15 Golden Gem  
Adding Machine

Multiples - Subtracts

## We Want Agents at \$50 to \$90 a Week

**New Invention—Just Out.** Needed in every home every day. Patented. Nothing else like it. Low priced—**Sells on sight.** Sharpens any kitchen knife, paring knife, carving knife, bread knife, or shears in **ten seconds.** Mechanical masterpiece. A child can use it. Just put knife in slot—turn crank—sharpens both sides at once automatically. **We want representatives at once—men and women hustlers.** Get this position where **profits start first day.**

### No Experience Necessary—200% Profit

Make as much money next week as these men are making now. J. C. Lewis, of Kansas, says: "I have sold one hundred sharpeners in four days." Hobart Keer, of Md., writes: "The women can hardly wait till they get them." Herbert Cain, of Ky., sold nine after supper. At the end of the first day, J. W. Gordon, of Pa., writes: "I sold two dozen and I sold to everyone I saw." Wm. G. Hall, of N. J., says: "I think it is great. I sold six in about one-half hour. The machine is a mighty fine proposition. I am a mechanic and I know what I am talking about." You can make this money. **WRITE TODAY, TERRITORY FREE. Get busy at once.**

**QUICKEDGE SHARPENER CO. 102 Sharpener Building JACKSON, MICH.**

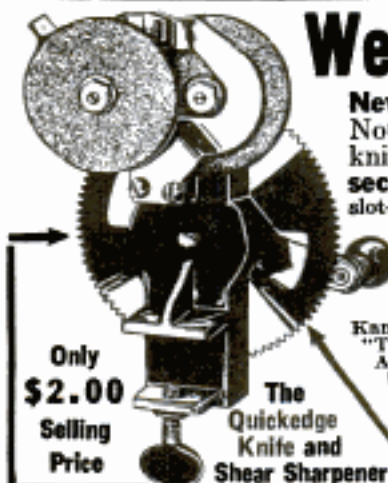

Only  
\$2.00  
Selling  
Price

The  
Quickedge  
Knife and  
Shear Sharpener



# Club Feet

Straightened 5 Years Ago

Claire Reynolds, born with Club Feet, had them straightened in a few months at McLain Sanitarium when he was 14. Read of permanent result in brother's letter written 5 years later:

We will gladly call on prospective patients near here, to show them what marvelous and permanent work you do. I know what a wonderful thing it has been, to have my brother's feet made straight and useful. Will answer any inquiries.

GUY L. REYNOLDS,  
Olean, New York.



## For Crippled Children

McLain Sanitarium is a thoroughly equipped private institution devoted exclusively to the treatment of Club Feet, Infantile Paralysis, Spinal Diseases and Deformities, Diseases of the Hip, Knee, and other Joints, Wry Neck, etc., especially in children and young adults. Write for these FREE books: "Deformities and Paralysis" and "Book of References."

McLAIN ORTHOPEDIC SANITARIUM  
902 Aubert Ave. St. Louis, Mo.



## Improve Your Nose Quickly and Easily



Model No. 25 Junior  
for children

Trados Model No. 25, latest improved nose shaper, U.S. and Foreign Patents, corrects now ill-shaped noses quickly, painlessly and comfortably at home (excepting cases caused by an improper bone structure). It is a superior, safe, and guaranteed device that will actually give you a better looking nose. 87,000 satisfied users. For years recommended by physicians. 18 years' experience in manufacturing nose shapers is at your service.

Write for Free Booklet

M. TRILETY, Specialist  
Dept. 2194, Binghamton, N. Y.

## FORD RUNS 57 MILES ON A GALLON OF GASOLINE

A New Automatic Vaporizer and Decarbonizer which in actual test has increased the power and mileage of automobiles from 25 to 50 per cent, and at the same time removes carbon from the cylinders, is the proud achievement of John A. Stransky, 148 Fourth St., Pukwana, South Dakota. A remarkable feature of this simple and inexpensive device is that its action is governed entirely by the motor. It can be installed by anyone in five minutes. With it attached, automobiles have made from 30 to 57 miles on a gallon of gasoline. Mr. Stransky wants distributors for his marvelous invention and is willing to send a sample at his own risk. Write him today.—Adv.

# Why? Pay More



## Big Saving!

Take advantage of the great saving we offer on the genuine, world-famous ball-bearing, long-wearing L. C. Smith Typewriter. Late model machines, standard size, up-to-date in every way, at remarkably low prices.

## Free 10 Days' Trial

Just ask us to send you a machine. Then test it thoroughly for 10 days in your own home or office. If you are not more than satisfied that it is the finest typewriter and the greatest bargain you ever saw, just return it with absolutely no obligation to you. All our machines are sent for 10 days' free trial—they must sell themselves.

## Send No Money

Do not send us a cent—just mail the coupon below. There are no strings tied to this unusual offer. Thousands of people have taken advantage of it and all are highly pleased.

## A Year to Pay

Our special price is extraordinarily low and yet you have a full year to pay on easy installments. There is no "red tape." We employ no solicitors—no collectors—no chattel mortgage.

## PERFECT MACHINES AT LOWEST PRICES

we have ever offered.

## Guaranteed 5 Years

We do the most perfect and highest class job of rebuilding known to the typewriter industry. Our machines do perfect work and last for years and years. Just like new. The L. C. Smith is the easiest machine to operate and you can easily type your own letters. Complete lessons on typewriting, also our 5 Year Guarantee with every machine.

**FREE**—Send today for Free Booklet of Valuable Typewriter Information, Big Catalog and our Special Offer.

**SMITH TYPEWRITER SALES CO.**  
300-340 East Grand Avenue CHICAGO

MAIL COUPON AT ONCE.

**SMITH TYPEWRITER SALES CO.,**  
300-340 East Grand Ave., Chicago, Ill.

Please send me your Free Booklet of Valuable Typewriter Information, Catalog, Special Offer and Free Trial Application.

Name \_\_\_\_\_

Address \_\_\_\_\_



# Floor Surfacing Pays Big Profits



**THIS MACHINE EARNS YOU**

Young men, middle aged men, and older men whom we started in the Floor Surfacing business with American Universal Floor Surfacing Machines make from \$25.00 to \$40.00 and more per day and get all the business they can handle.

They are men from factory, store and office jobs who saw only endless drudgery ahead for them as wage earners. They wanted a chance to "get somewhere," to make real money, to be their own bosses and to build a future for themselves and their families. They saw that chance in the Floor Surfacing game and grabbed it. Most of them were "greenhorns" at this business, but they had ambition, energy and good sound "horse-sense," and that is all any man needs to succeed as an American Universal Floor Surfacing contractor.

## Every New Floor Must Be Surfaced Every Old Floor Needs Resurfacing

There is surfacing work to be done in every new and old business or residence building in your town. Think man, what that means! Have you energy and "get-up" enough to go out and get the business that is waiting for you on every hand?

Would you don a pair of overalls and guide an electrically driven American Universal Floor Surfacing Machine over a floor for \$25.00 to \$40.00 a day, until you can build up enough business to hire others to do the work for you? If you can and will do so we can help you get into a business that is not overcrowded, that is easy to manage and operate, easy to build and enlarge; a business that

requires very little capital, almost no operating expense and one that can be made to pay big, handsome profits from the very first day you start. *No town or community is too small.* We can show you successful floor surfacing contractors in villages of 100 people.

## No Experience Necessary

Any intelligent man can learn to operate the electrically driven American Universal Floor Surfacing Machine in half an hour, and with a few days' practice, can actually do the work of six men scraping by hand. And with the American Universal you can do better, smoother and more uniform and beautiful work than any man living could ever do by hand.

**Write Now for Particulars.** Send your name and address to us today with just a note saying, "Tell me how I can get into the floor surfacing business." We'll send you full information about the wonderful opportunity open to you. We'll tell you all about the American Universal Machine, what it does, how it works, what it costs, and give you letters, facts and figures that will cause you to do some tall thinking. Do it right now before you lay this book aside.

**The American Floor Surfacing Machine Co.** 523 So. St. Clair St., TOLEDO, OHIO

**\$25<sup>00</sup>**  
**Per Day**

# Make Your Roofs Last a Lifetime!

Positively that! The wonderful Seal-Tite method renews, preserves, and makes your old, wornout roofs watertight. One application lasts 10 years. Write today for this great money-saving roofing offer.



**Not a Paint**

## NO Money Asked

We send you everything you need to stop all roof leaks without asking you to send a single penny. No C. O. D. No notes. Pay four months later if our material proves to be exactly as represented.

**Write!** Don't put off another day finding out all about this wonderful way of solving all your roof problems. We'll make you an offer so liberal, so clear, so suprisingly unprecedented that you simply MUST take advantage of it at once. Don't wait for rain to remind you that your roof leaks. Write TODAY!

**Monarch Paint Co.** Established 1903 Dept. 13-12 Cleveland, O.

# Salesmen Are Astounded!



At the **BIG MONEY** They Can Make Selling the Wonderful

**OLIVER OIL-GAS BURNERS**

You'll be, too! Make \$25 to \$75 a week! Wonderful invention. Women are amazed! Want it the minute they see it demonstrated. **Makes any coal or wood cooking range a real gas range!** Ends coal nuisance, expense, dirt, work and mess. Gives better heat, intense, clean controlled heat. Just turn a valve. Models for Heaters too, and Furnaces. Burns OIL, mixed with air. Over 200,000 sold. Here's your big chance to make real money. Get details at once. Liberal offer. Big National Advertising. The OLIVER sells like wildfire! **Free Sample Case Offer!** Write:

**\$25 to \$75 a Week!**

**OLIVER OIL BURNER CORPORATION**  
225 Oliver Bldg. ST. LOUIS, MO.  
Oldest and Largest Manufacturers of Oil-Gas Burners in the World.

## THE DE LUXE

*The Machine That Cheats The Printer*



Pays for itself over and over each year. Prints the merchants' "ad" automatically on wrapping paper in one or more colors. Simple in construction, an ornament to any counter, guaranteed for five years. Thousands already sold. Average sales 2 to 6 a day, big profits. We want EXCLUSIVE distributors who are financially responsible and are looking for a real live proposition. Woodworkers Hardware Mfg. Co., 105 N. Clark St., Chicago



## Different from all others—the NEW BENJAMIN



### AIR RIFLE

Made on a different principle from all other Air-Rifles.

The Benjamin is really a strong air-pump used to compress the air in the air chamber to any degree of power desired. From one to six strokes of the pump give all the force necessary. Each additional stroke gives increased power. The Benjamin works on the same principle as all air-drills and air-hammers—with this difference:

*You control the shooting force as you desire. Look at this block of hardwood, it shows how Benjamin power is regulated as you wish.*

You can't have accidents with a Benjamin. It's safe, always, because you control the power. The Benjamin never loses shooting force, and has no springs to get out of order or shake your aim. Write us for an interesting folder about this wonderful air-gun.

If your dealer does not handle same, send direct to factory.

**(PRICE \$5) POSTPAID**

**BENJAMIN AIR-RIFLE & MFG. CO., 415 N. Broadway, St. Louis, Mo.**

Ask your dealer for demonstration.

Pacific Coast Representatives  
**THAYER & BOWEN**  
Los Angeles, Calif., and San Francisco, Calif.



## NO MORE PUMPING UP TIRES

An air-tight valve cap which prevents all loss of air in tires has been put on the market by F. C. Hughes. With this valve cap one inflation lasts the life of the tire and doubles tire mileage. Tested and approved by leading automobile manufacturers. We furnish proof of tests. Retail price \$1.25 for set of five. Great demand. Wonderful opportunity for agents. Write at once to F. C. Hughes, Dept. 518, 2512 W. Monroe St., Chicago, Ill.

## Big Fence Sale

164 styles—Hog, Poultry, General Farm and Ornamental Fence and Gates at Wire Mill Prices.

Honest Weight **OTTAWA** Quality Fence

Fresh from the Loom  
Every foot guaranteed, **FREE**  
**BOOK** of Bargains—write today!

**OTTAWA MFG. CO.**  
Chicago, Kansas  
Box 817-D Chicago Heights, Ill.



## HANDS UP!

Protect yourself against hold-up, rowdies, etc. with this clever cigarette case of light weight metal. Looks exactly like the real thing! Pull the trigger, back flies the lid showing your cigarettes. Lots

of fun scaring your friends, and a great protector. Sold exclusively by us. **PAY POSTMAN \$1.75** on delivery plus postage. **Money back if not satisfied.**

**PAT. PENDING**  
**PATHFINDER CO., Dep. HK10B, 524 Sixth Ave., N. Y.**



## 16 NEW YORK Hits

**(BROADWAY'S LATEST SONGS AND DANCES)**

### Fox Trots

*Tessie Stop teasing Me*  
*Southern Rose*  
*Little Old Clock on the Mantle*  
*Doo Wacka Doo*  
*Toodles—Eliza*  
*Choo Choo—Words*



### Vocals

*Morning Blue-Eyed Sally*  
*I Made a Hit With Kit Kit Kitty*  
*If I Stay Away Too Long From Carolin*

### Waltzes

*Dreamer of Dreams All Alone*  
*Honest and Truly Melody Rose*

Here they are! The 16 song and dance successes of the hour! All New York is humming, whistling and dancing to these pieces. We offer you—all 16 of them—for only \$2.98 on eight 10-inch, double-faced guaranteed records. Play them on any phonograph. Each record beautifully rendered by famous orchestras.

**Send No Money!** Just send coupon or post card. Play these records for 10 days in your own home. See how wonderful they are. Note clearness, beauty and volume of tone. Only give postman \$2.98 plus a few cents delivery charges. If not entirely pleased, return records and we'll refund money and pay postage BOTH WAYS without question. Low price is possible by manufacturing in sets and selling direct to thousands of users. Don't wait. Mail coupon below or postal.

**Co-operative Record Co., Dept. 310**  
**PORT WASHINGTON, WIS.**

Send me on 10 days trial, your 16 Fox Trots, Songs and Waltzes on 8 double-face, 10-inch records, guaranteed equal or better than any records made. I will pay postman only \$2.98, plus delivery charges on arrival. However, this is not a purchase. If records don't entirely please me, I will return them within 10 days and you will refund my money without question.

Name \_\_\_\_\_  
Address \_\_\_\_\_  
City \_\_\_\_\_ State \_\_\_\_\_ (655)





# Perfect by the Micrometer

EVERY Conn instrument is mechanically and scientifically correct, by micrometer and every known test.

The famous hydraulic expansion process, originated and patented by Conn, assures ease of blowing, perfect pitch, that sweet yet brilliant tone which sets Conns apart from all others as supreme in quality.

World's foremost artists use Conns—the Conn you buy is exactly the same quality as theirs.

Free Trial, Easy Payments. Conn is the only maker of every instrument for band. Send coupon for "Success in Music and How to Win It," and details of trial offer; mention instrument.

Dealers and Agents Everywhere



Isham Jones, famous saxophone star, uses and endorses Conn instruments.

**CONN**  
BAND  
INSTRUMENTS  
WORLD'S LARGEST MANUFACTURERS

C. G. CONN, Ltd.  
131 Conn Bldg., Elkhart, Ind.

Gentlemen: Please send Free Book and details of trial offer on.....

Name ..... (Instrument) .....

St. or R. F. D. ....

City, State .....

County .....

Use Pencil Please



## Only 113 Motors

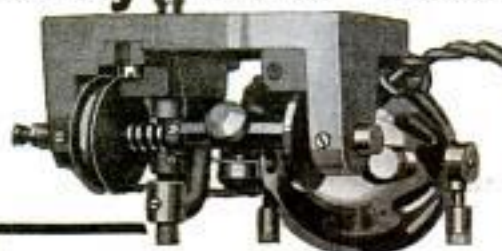

Left at  
**\$10**

Each

Ideal for home-made phonographs, experimental purposes and combination **phonograph-radio** sets.

We have 113 small motors which are greatly under-priced for quick clearance. You will never again equal this low price, when this lot is sold.

They are **universal motors**, 110 volts, 60 cycle single phase, complete with turntable, cord and socket for immediate use. 1400 R. P. M. Motor has 1" pulley with flange for  $\frac{3}{4}$ " flat belt. Housed in highly polished, nickel-plated shell.

Don't lose out on this remarkable offer. Order your motor today. Tomorrow may be too late. **DO IT NOW!** Price, **\$10.00** f. o. b. Steger, Illinois.

Industrial Division

**Steger & Sons Piano Manufacturing Company**  
Dept. 50, Steger Building CHICAGO, ILLINOIS

## DON'T WEAR A TRUSS

BE COMFORTABLE—

Wear the Brooks Appliance, the modern scientific invention which gives rupture sufferers immediate relief. It has no obnoxious springs or pads. Automatic Air Cushions bind and draw together the broken parts. No salves or plasters. Durable. Cheap. Sent on trial to prove its worth. Beware of imitations. Look for trade-mark bearing portrait and signature of C. E. Brooks which appears on every Appliance. None other genuine. Full information and booklet sent free in plain, sealed envelope.



MR. C. E. BROOKS

**BROOKS APPLIANCE CO., 215-A State St., Marshall, Mich.**

## No Joke to be Bald



Grow  
New  
Hair  
Quick

### Let Me PROVE It To You FREE

What I accomplished on my own head, pictured above, I believe I can do for you, provided you are under 45 years of age and loss of hair was not caused by burns or scars. Anyhow, *I must succeed or you pay nothing.* No apparatus—my home treatment is simple, quick and inexpensive. **SEND NO MONEY**, just your name and address and I will mail you full information with PHOTOGRAPHS, NAMES and ADDRESSES of men and women who have successfully used my treatment for dandruff, falling hair and particularly for baldness. *Write Now.* A postal will do. **VREELANDS, 1869-P. E. 40th St., Cleveland, O.**



## IT'S A WONDER!

Does Everything in Woodworking

ONLY  
**\$225**  
complete  
with motor



8 inch circular rip saw  
8 inch circular cross cut saw  
11 inch band saw  
4 inch jointer  
shaper  
10 inch sander  
lathe—14 inch swing

### Parks Cabinet Shop Special

is the last word in portable, small shop equipment.

It is a band saw, shaper, lathe,—all in one. You can do sawing, rabbetting, planing, moulding, matching, panel raising. Just the thing for your home shop! You can order it complete or with just the attachments you want.

Write for circular

The Parks Ball Bearing Machine Co.  
1500-1540 Knowlton St. Cincinnati, Ohio  
Canadian Factory: 200 Notre Dame East, Montreal, Can.

# PARKS

WOODWORKING MACHINES



## How did your Garters look this morning?

Nothing is so hard to forgive as your own forgetfulness. But in the matter of fresh, clean Bostons we at least are glad to lend a hand by reminding you—do you not need a fresh, clean, new pair today, sir?

George Frost Company, Makers,

Boston

## \$945 in ONE MONTH!



That's the earnings of R. A. Prentiss, taking orders for Corner All-Weather Topcoats and Raincoats. We need representatives in every community. No capital, experience or training required! No collecting or delivering! Immediate profit in cash and a chance to get a Dodge Touring Car FREE! Write for details quick.

The Comer Mfg. Co.  
Dept. W-5104 Dayton, Ohio

## An Easy Way to Make \$30 to \$50 a Week EXTRA



Take orders direct for men's *Imperial Underwear!* Every man a prospect. Quick sales everywhere. Manufacturer with enormous plant and excellent reputation now wants men and women in your territory for Imperial agencies. Big assortment of samples and styles. Famous drop seat feature. Free initials. Written money back guarantee of satisfaction. Amazingly low, money-saving prices. Big profits for you in advance. Known to Thousands.

In your own territory are hundreds of men who want Imperial Underwear. National advertising campaign created enormous demand. You can take orders by merely showing samples. Earnings unlimited. \$50 a week possible in spare time.

**FREE** Selling Outfit

Write quick, giving complete experience. We will send you selling outfit absolutely FREE. No charge whatever. Write The Imperial Underwear Corp. Dept L-2 Piquet, Ohio



No. 1988 Working Plans  
Only \$20.00



## Save \$1000 When You Build

LITTLE mistakes often run into a \$1,000 or more. Keith's remarkable new book and Keith's Magazine show how to avoid these costly errors—also many short cuts that save money. This amazing book, "Beautiful Homes," contains two hundred actually tested plans. Shows all types of houses—Stucco, Brick, Tile or Frame. Gives fashionable new ideas on Interior Decoration. With this De Luxe Plan Book you receive a year's subscription to Keith's Magazine, the recognized authority on home building for twenty-five years. Just send your name and address and pay postman only \$3 plus a few cents postage upon arrival. Write at once.

**KEITH CORPORATION**

100 N. 7th Street Minneapolis, Minn.

Keith Corporation, 100 N. 7th St., Dept. 9-B, Minneapolis, Minn. Send us "Beautiful Homes" De Luxe Edition and a year's subscription to Keith's Magazine. I will pay the postman only \$3 plus a few cents postage.

Name.....

Address.....

City..... State.....

(If you send \$3 with order, book will be sent postage paid.)



## Food that Brings the Old Vigor BACK!

Vigor Chocolate is the food for quick and lasting strength, wide-awake brain—and for the requisite vitality to convert your ambitions into complete success. Add it to your daily diet either as a toothsome sweet chocolate or as a delicious beverage.

Mental workers, campers and hikers, athletes, nursing mothers, growing children, invalids, convalescents and aged people everywhere find a ration consisting solely of whole wheat crackers and Vigor Chocolate, wonderfully strengthening and sustaining, and exceedingly digestible.

Vigor Chocolate contains the rich nutriment of high grade chocolate (without its usual indigestibility) blended with the food and tonic equivalent of cod liver oil, food iron, phosphates and beef extract.

Vigor Chocolate adds tremendously to health, vigor and energy without taxing the most delicate digestion. It costs somewhat more than ordinary chocolate, because it has many times the latter's strengthening, nourishing value in much more digestible form. Completely descriptive book, "Condensed Vitality," FREE on request.

**HAUSWALDTS**  
GENUINE  
**Vigor**  
CHOCOLATE

Factory Established 1788

ORDER COUPON

VIGOR CHOCOLATE CO., Dept. 142,  
41 Union Square, New York City

I enclose \$1.50, for which send me your full pound package of four 4-ounce cakes of Vigor Chocolate. Or I will pay Postman on delivery.

Name.....

Street.....

City.....

**Buchstein's Fibre Limb**  
is soothing to your stump—strong, cool, neat, light. Easy payments. Braces for all deformities.  
**D. BUCHSTEIN CO.**  
610 3rd Ave., So., MINNEAPOLIS, MINN.

Send for Catalog Today

## ADDING MACHINE VEST POCKET SIZE



ADDS  
SUBTRACTS  
MULTIPLIES  
DIVIDES

\$2.50

**NEW** Does Work of \$100 Machine. Total Visible at all Times.

**FREE TRIAL—Send No Money**

Anyone Can Operate It. Guaranteed for Life

Just write "Send me a Baby Calculator" and give your name and address. We will ship it immediately, all charges prepaid. On delivery pay postman \$2.50. You can return it after 10-day trial for full refund if the Baby Calculator is not the greatest time and labor saver you ever used. This is the lowest priced practical calculating machine made. Order today.

**BABY CALCULATOR SALES CO.**

P. O. Box 1118, Chicago, Illinois

### AGENTS

Every business firm, man or woman, will buy the Baby Calculator on sight. 50% COMMISSION.

## The Very Latest Radio Book

Free

This Book Full of Radio Bargains

Shows Big Savings on parts, sets and accessories.

Our prices are lowest on highest quality standard goods.

All Orders Shipped Same Day Received

Send for your copy today

*The Barawick Co.*

Dept. C-31, No. Wells Street, CHICAGO, ILL.

## SAW FILING PAYS



Buy a Foley Automatic Saw Filer and Setter and establish an independent, profitable business.

H. Ungles, Lodi, California, writes: "The Foley Saw Filer and Saw Set are perfect in all respects and will beat any master hand saw filer at any time, not only in better and more accurate work, but also in the number of saws turned out in the same time."

Prices and catalog on request. Territory open to interested parties.

**FOLEY SAW TOOL CO.**  
914 E. Lake St. Minneapolis, Minn.

**Sell Earn \$10,000 a Year**  
Hustlers earn \$3,000 to \$10,000 a year, depending on territory and industry. Our suits are all pure wool, union made, with hand tailoring. Topcoats have genuine satin lining. Money back guarantee. Protected territory and liberal commission in advance. Experience helpful. Prefer men over 35. This is a rare opportunity for a honest, energetic man to get into a big paying business with large, well established house. Apply 3-8 Harvey, Box 66, Chicago

**\$23.50 ALL WOOL Suits**

## 20 Acres in Florida

Farming and fruit land in the heart of North West Florida, close to a city of 35,000, railroads, highways, schools, churches; not a wilderness, but an already developed section. Co-operative marketing, cannery and dairy. Choice 20-acre tracts for \$495 each. McCaskill Estate (owners, not agents) Dept. 1, 7 South Dearborn Street, Chicago, Ill. Also DeFuniak Springs, Fla., and Pensacola, Fla., Dept. 1.

WRITE for Illustrated Booklet

## Buy Now Pay Later Let Boice Help You Build It!

No matter what you want to build, Boice can help you. He'll send you the

### Boice-Crane Junior Saw

or any other Boice-Crane machine on monthly payments. He gives you lowest prices and biggest values with a positive money-back guarantee. Machine shown will saw, sand, grind, mill, rabbet, trim, etc. Sturdy, accurate, economical. Saws 1 1/2" stock. Sold with or without motor.

Write today for Descriptive Catalog of Brook Saws, Drills, Jointers and Band Saws and the Boice Pay-Plan.

**W. B. & J. E. BOICE**

Dept. P. M. 2-A, TOLEDO, OHIO

"World's Largest Makers of Small Bench Machines"





# 60 MILES ON A GALLON OF GASOLINE

## TESTS SHOW FORD CAN RUN 60 MILES ON A GALLON

The amazing fact that a Ford can run 60 miles on 1 gallon of gasoline was recently brought to light through tests conducted by America's foremost engineers, where it was shown that a gallon of gasoline contains sufficient heat units which if properly atomized and mixed with air would give this additional mileage. Great strides have already been made in this direction by the recent invention of a simple attachment which can be installed in a few minutes without any alterations to the motor. It is common for Ford Owners to make from 40 to 44 miles per gallon after this marvelous device is attached.

## MOST WONDERFUL INVENTION TODAY BRINGS JOY TO FORD OWNERS

### Starts Ford Instantly

Starting a Ford Car in cold or zero weather is something every Ford Owner dreads—everybody realizes that difficult starting is an abuse on the starter and battery. Thousands of Ford Cars are "laid up" during the Winter just for these reasons. This great difficulty has been overcome. The SUPER positively starts a Ford Car instantly in the coldest weather.

### Marvelous Device

The SUPER is no trick affair—requires no mechanical adjustments and contains all the scientific principles of carburetors costing \$20 to \$35 and in its natural action uses up every particle of unused gasoline and breaks it up into a perfect vapor. The hitherto impossible is now realized by the SUPER.

### Everybody Satisfied

**Saves 3 to 7 Dollars Per Month**  
The best investment I ever made. The SUPER is saving me from three to seven dollars each month, besides putting new life into my motor. A. H. WORRA, Iowa.

### Makes 44 Miles Per Gallon

I have tried the SUPER and the results of the experiment are satisfactory. One quart of gasoline run my Ford 11 miles over improved roads which is just about again as far as I could run with the plain Ford Carburetor. G. E. YODER, Penn.

### Finds That Our Claims Are Correct

I find that your claims for increased mileage are correct and that a big saving is made by your SUPER. In fact, the best device I have met with in that line.

M. J. VAN LEEUWEN, Mass.



The Heart of the Motor

### Eliminates Oil Pumping in Front Cylinder

What a wonderful relief to Mr. Ford Owner when he realizes that he can run his car without the motor pumping oil in the front cylinder. Sounds like an awful lot to expect of any device, but that is what the SUPER does and this is only one of its many advantages because it puts real efficiency into any Ford Car.

### Complete Combustion

The SUPER is so designed that it takes advantage of the present Ford Carburetor and properly atomizes the light as well as the heavy elements of the fuel, converting every atom of gasoline and kerosene into power preventing liquid fuel from passing into the cylinders, thus avoiding carbon formation and oil dilution.

### Easy to Sell

#### Sells Like Hot Cakes

This is a recent letter from one of our distributors: "Enclosed find draft for 200 more SUPERS, rush as I need them badly. I sold and banked \$104.00 in one day. Hope to sell 1000 SUPERS next month."

A. W. LEONARD, Penn.

#### Making Big Profits Every Noon

I have been working the SUPER at noon only. Yesterday noon I made more money with the SUPER than I did at my 11 hours' hard work in the factory all day. J. L. LEHNER, Wis.

#### Had No Previous Selling Experience

This letter shows what ambition does: "I sold six SUPERS in less than 2 hours tonight. I think it's a pretty good start—for it's the first thing I ever sold."

E. MANGOLD, Ind.

## \$60.00 TO \$150.00 PER WEEK EASY

You just can't help making Big Money selling the SUPER because a trial sells itself and soon everyone in the neighborhood get talking about this marvelous device. Men like Leonard, Shaw, Manner, Kinsley, Peters, Sands, Beck and Hall are not exceptional salesmen but just the type of men that saw an opportunity and were quick to grasp it when within reach. No previous selling experience is necessary, just a little ambition on your part to make money is all we ask and we will extend the same opportunity to you. Spare time will pay you well. If you can devote your entire time so much the better, because the SUPER is a whirl-wind seller and takes hold in a locality like wildfire.

### Men Wanted Everywhere To Introduce

We want distributors in all parts of the country to take orders and deliver the SUPER and to look after the repeat business that is bound to follow and to such distributors we are willing to assign territory. You do not have to own a Ford to take up this proposition but if you have a Ford it is easier to explain its many advantages. However a Trial of the SUPER convinces the most doubtful person and tells a wonderful story.

### A REAL FUTURE HERE

**WEEKS SUPER CARBURETOR CO.**

1304-753 Fond Du Lac Ave., Milwaukee, Wis.

**MAIL TODAY**  
WEEKS SUPER CARBURETOR CO.  
1304-753 Fond Du Lac Ave., Milwaukee, Wis.  
GENTLEMEN: Please mail me full free particulars about your wonderful invention.

Name .....

St. or R.F.D. ....

Town .....

County .....

State .....



# Deafness



Perfect hearing is now being restored in every condition of deafness or defective hearing from causes such as Catarrhal Deafness, Relaxed or Sunken Drums, Thickened Drums, Roaring and Hissing Sounds, Perforated, Wholly or Partially Destroyed Drums, Discharge from Ears, etc.

## Wilson Common-Sense Ear Drums

require no medicine but effectively replace what is lacking or defective in the natural ear drums. They are simple devices, which the wearer easily fits into the ears where they are invisible. Soft, safe and comfortable.

## Free Book on Deafness

Write today for 168 page book on deafness giving full particulars and testimonials from hundreds of grateful users whose hearing has been re-

stored by use of these "little wireless phones for the ears."

**WILSON EAR DRUM CO., Incorporated**  
634 Inter-Southern Bldg. LOUISVILLE, KY.

## Kerlin's Leghorn Chicks

**\$5.73 Profit each in 1 year made by W. L. Mowen.** World Famous White Leghorn 265-331 egg record stock. Greatest winter layers known. Highest quality **BABY CHICKS**, stock, supplies, shipped safely. **FREE Feed** with chick order. **Big Discount** if ordered now. Valuable catalog free. Member Internat'l Baby Chick Assn. **PAY BIGGEST PROFITS**  
Kerlin's Grand View Poultry Farm, Box 57, Center Hall, Pa.

## FREE! ART PICTURES



of Ideal Chickens in Beautiful Natural Colors, 5 x 11 in., suitable for framing. Given only with Poultry Tribune—every issue. World's Great Poultry Paper. Check full of money-making ideas, articles, news by foremost poultry authorities. Pub. monthly, 60 to 120 pages. **SPECIAL OFFER!**

**5 Big Trial Issues 25c**  
1 Year 50c; 3 Years \$1.00  
Send stamps or coin today.

Poultry Tribune, Dept. 41, Mount Morris, Ill.

**WEBER'S BEST** laying, **BEST** paying chickens, ducks, geese & turkeys. Fine pure-bred quality, hardy northern raised. Fowls, Eggs, Chicks, High-grade incubators at lowest prices. **43 years** Experience with my 100 page Catalog and Breeders' Guide Free.  
**W. A. Weber, Box 82, Mankato, Minn.**

**GREIDER'S FINE CATALOG** of fine bred poultry and incubators and brooders for 1925; choicest breeds illustrated and described; how to make hens lay, grow chicks—all facts. Low price on breeding stock and hatching eggs. 32 years in business. This book only 10c.  
**B. H. Greider, Box 19, Rheams, Pa.**

**64 BREEDS** Most Profitable chickens, ducks, turkeys and geese. Choice, pure-bred northern raised. Fowls, eggs and incubators at low prices. **America's great poultry farm.** At it 32 yrs. Valuable 100-page book and catalog free.  
**R. F. Neubert Co., Box 908, Mankato, Minn.**

## PLANS & Poultry Houses

All styles, 150 illustrations; secret of getting winter eggs, and copy of "The Full Egg Basket." Send 25 cents.  
**INLAND POULTRY JOURNAL, Dept. 74 Indianapolis, Ind.**

# TOBACCO OR SNUFF HABIT

Any form quickly conquered. No long waiting for results. Costs \$1 if it cures. Nothing if it fails. Perfectly **HARMLESS**. Full treatment on approval.  
**DR. C. M. SIMPSON, 168 W. 44th St., Cleveland, O.**

## KING

### Band Instruments

**WHETHER** you are just learning to play or are a finished musician you will find "King" Saxophones, Trumpets, Trombones and Horns, easier to play than any other make.

Every "King" Instrument has the latest improvements—is built by experts and is laboratory-tested before being shipped. Every "King" is fully guaranteed.

It is easy to own a "King" Instrument. They are sent on trial and sold on easy payments.

"King" Band Instruments and Saxophones are fully described in beautifully illustrated catalogs. Send for free copy.

Write for list of bargains in rebuilt instruments.

**THE H. N. WHITE CO.**  
5211-60 Superior Avenue, Cleveland, Ohio  
Please send me free, your latest catalog on

..... Instrument.

Name .....

Address .....

City .....

State .....

**American Poultry Journal**  
**OLDEST, LARGEST and BEST**  
**4 MONTHS' TRIAL 25 cents**  
**1 Yr. 75c 2 YEARS \$1 5 Yrs. \$2**  
Averages over 100 pages per issue—tells how to feed, house and breed; how to secure high egg production; how to hatch and rear poultry successfully. Established 1874. Only 25 cents for 4 months. Stamps accepted.  
**American Poultry Journal, 14-523 Plymouth Ct., Chicago**

## Per Chick Hatched "SUCCESSFUL" Is Cheapest to Buy



Mail a postal—Get our offer. Poultry lessons free to every buyer. Eastern customers will be served quickly from our Eastern Warehouse. Catalog FREE. Make green, egg-making feed in "SUCCESSFUL" Grain Sprouters.

**DES MOINES INCUBATOR CO.**  
689 Second St., Des Moines, Iowa

## NO MORE BALD HEADS



**WHEN** our VACUUM CAP is used a few minutes daily. We accept no pay until you have tried the Cap 60 days and are satisfied. The Vacuum Cap is an appliance that draws the blood to the Hair Roots and starts a new healthy crop of hair. It stops Dandruff, stops the hair from falling out.

Bought by Doctors and men who know that it is the only reasonable HAIR GROWER known to science. No Drugs Used. Write for application blank, testimonials and booklet on "HAIR," sent sealed in plain envelope, FREE.

**THE MODERN VACUUM CAP CO.**

E-559 BARCLAY, DENVER, COLO.



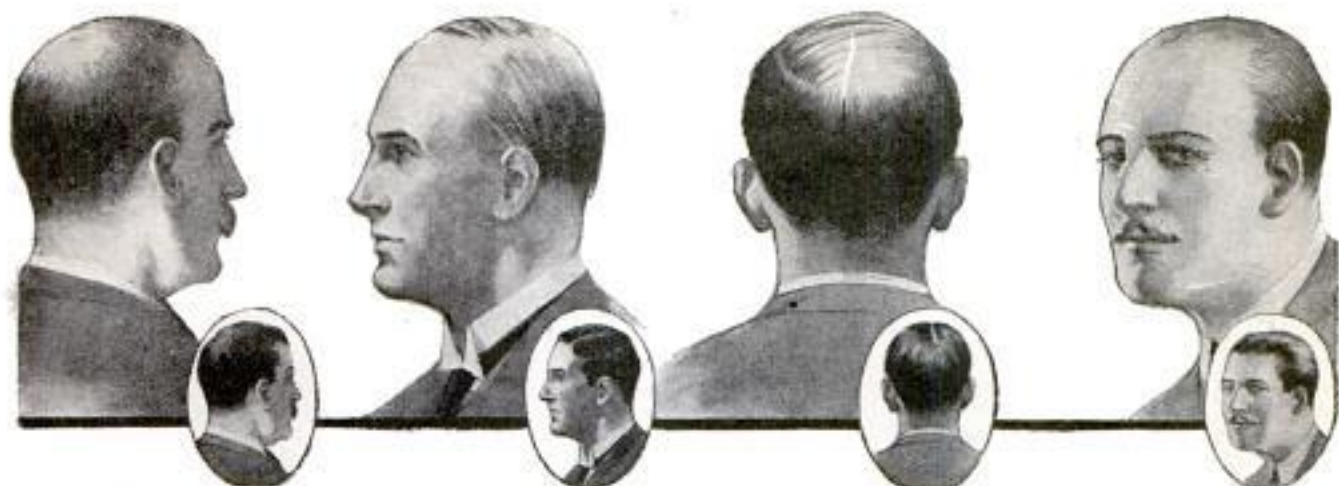

# Falling Hair Stopped - New Hair Grown In 30 Days - Or No Cost!

By **ALOIS MERKE**

Founder of Famous Merke Institute, Fifth Avenue, New York

**S**AVE yourself from baldness! No matter how fast your hair is falling out—no matter how little of it is now left—no matter how many treatments you have tried without results—I have perfected a new scientific system that I absolutely guarantee will give you a new head of hair in 30 days—or the trial costs you nothing!

I have found during many years research and from experience gained in treating thousands of cases of baldness at the Merke Institute, Fifth Avenue, N. Y., that in most cases of loss of hair the roots are not dead—but merely *dormant*.

It is useless and a waste of time and money to try and get down to these undernourished roots with tonics, massages, crude oil, etc., etc., for such measures only treat the surface of the skin.

But my scientific system involves the application of entirely new principles in stimulating hair growth. It penetrates below the surface of the scalp and gets right to the cause of most hair troubles—the starving dormant roots, and provides not only an efficient way of reviving and invigorating these inactive roots, but of giving them the nourishment they need to grow hair again. And the fine thing about my system is the fact that it is simple and can be used in any home where there is electricity without the slightest *discomfort or inconvenience*.

## Positive Guarantee

Of course there are a few cases of baldness that nothing in the world can cure. Yet so many hundreds of men and women whose hair was coming out almost by "handfuls" have seen their hair grow in again as the shrunken roots acquired new life and vitality that I am willing to let you try my treatment at my risk for 30 days. Then if you are not more than delighted with the new growth of hair produced, write to me immediately. Tell me my system

has not done what I said it would. And the 30-day trial won't cost you a cent!

## Free Booklet Tells All

The very fact that you have read this announcement shows that you are anxious about the condition of your hair. So why not investigate? Find out for yourself. That's the only common-sense thing to do. If you will merely fill in and mail the coupon below I will gladly send you without cost or obligation a wonderfully interesting booklet which describes in detail my successful system which is growing new hair for thousands all over the country. Clip and mail the coupon today. Allied Merke Institutes, Inc., Dept. 162, 512 Fifth Avenue, New York City.

ALLIED MERKE INSTITUTES, Inc., Dept. 162  
512 Fifth Ave., New York City

Please send me—without cost or obligation—a copy of your book, "The New Way to Grow Hair," describing the Merke System.

Name.....  
(State whether Mr., Mrs. or Miss)

Address.....

City..... State.....

## PROOF!

### Results Gratifying

"Ten years ago my hair started falling. I used hair tonics constantly but four years ago I displayed a perfect full moon. I tried everything—but without results. Today, however, thanks to your treatment I have quite a new crop of hair one inch long."  
—F. H. B., New York.

### Hair About Gone

"My hair had been falling for the last two years and I had hardly any more hair on the front of my head. But since I started using your treatment I am raising a new crop of hair. Your treatment is best I ever saw."  
—O. J., Northbridge, Mass.

### Falling Hair Checked

"My hair was coming out at an alarming rate but after four or five treatments I noticed this was checked. My hair is coming in thicker and looks and feels full of life and vigor."  
—W. C., Great Neck, L. I.

### New Hair Growing

"Results are wonderful. My hair has stopped falling out and I can see lots of new hair coming in."  
—F. D. R., Washington, D. C.



# 10 Days FREE TRIAL

Only  
\$8.50

UNCONDITIONALLY  
GUARANTEED 1 YEAR

Send  
No  
Money

## The New Majestic Speaker

The Last word in Radio Re-Creation

Embodies all proved principles of reproduction. Delicate shading, inflection and modulation of voice—this and the musical instrument re-created with remarkable volume and clarity of tone, with astounding purity and faithfulness, even when sending is weak. Floods room with best that's in your set. Horn acoustically perfect. No battery needed—simply plug in like headphones. Handsome crystalline finish fibre horn approx. 22" high; heavy base prevents tipping. Polar indicating connecting cord included.

### You Save Middlemen's Profits

Send direct—today—for your Majestic Speaker. Try it for ten days. Hear distant stations plainly. Test its clarity of tone and volume—no distortion, no harshness, no rattle, no buzz or screech. Compare it with loud speakers selling for \$15 to \$25 and more.

**Send No Money** Simply pay postman on delivery, after free examination, then if you're not satisfied, simply return it at our expense and back goes your money. You—and you alone, are the judge. Your loud speaker should speak for itself. So mail your order today.

JAMES M. DAVIS CO.  
30-B Euclid Arcade, Cleveland, Ohio  
Send a Majestic Speaker on your free examination offer.

Name.....  
Address.....  
City..... State.....

OUR BUREAU OF INFORMATION will answer all questions regarding articles appearing in this magazine. Address Bureau of Information, Popular Mechanics Magazine, Chicago.



Direct from Factory at Half  
Price, only  
**\$1.00**

## CUT YOUR OWN HAIR— EASIER THAN SHAVING

You do not need any experience or practice to use the **DUPLEX AUTOMATIC HAIR CUTTER**. It comes to you ready for instant use, and five minutes after you receive it you can have your hair cut better than it was ever cut before.

The **DUPLEX** will cut as close or trim as long as you wish it to. No clippers or scissors are needed with the **DUPLEX**; it finishes the work completely. It cuts the front hair long and the back hair short. Trims around the ears, etc.

Inside of a very short time you will have to pay \$2 for the **DUPLEX**. The price today is \$2, but while our present stock lasts we will accept this advertisement the same as \$1 Cash. Cut it out and send it with **ONLY \$1**, and we will send you the **Duplex Automatic Hair Cutter** ready for instant use, postage paid, to any address. **SEND TODAY.** Agents Wanted. **DUPLEX MFG. CO., Inc., Dept. No. 105, Detroit, Michigan**

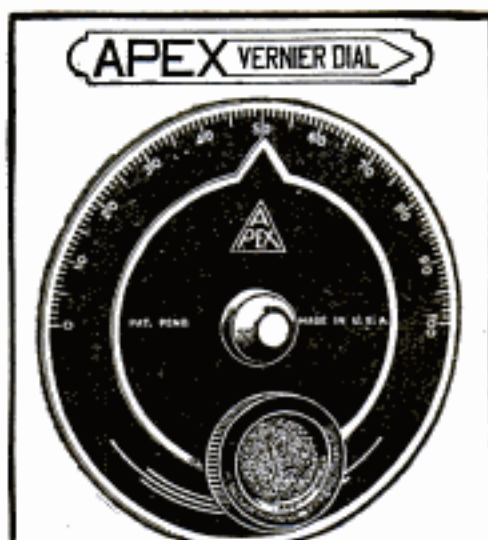

## It Brings 'Em In!

Get more stations—greater range—bigger volume—finer selectivity—less interference. Lasts forever. The one big advance yet made in tuning. Ratio 12 to 1. Quickly applied to any shaft. For sale by all good Radio Dealers. If unable to obtain from dealer, enclose \$2.50 for nickel-silver finish, or \$3.50 for De Luxe satin finished gold.



## 7-Tube Super-Heterodyne for \$97.50

Receive the parts complete to assemble your own set. Cost to construct on an 18-1/2" Loop. Assemble this 7-tube Microdyne Super-heterodyne on a 7x18 in. panel in three hours. Parts complete, including drilled and engraved panels, condensers, sockets, transformers, dial connecting plugs, cables, etc., with drawings, diagrams and instructions. Price of cabinet—to fit on application. If your radio dealer cannot supply parts for complete Microdyne Radio Set, send check or money order for \$7.50 and name of your dealer.

**APEX ELECTRIC MFG. CO., Dept. 201**  
1470 W. 59th Street, CHICAGO

# STOPS FALLING HAIR

ASK YOUR BARBER OR DRUGGIST

Millions of men, women and children have found the secret of hair-health in "**Lucky Tiger**"—the world's greatest remedy for falling hair, dandruff and all scalp disorders. A single application stops that miserable itching. Always sold under a positive Money-Back Guarantee.



## LUCKY TIGER



## "DARN-IT-ALL"

The Magic Mender

Darns stockings, mends clothes, patches all fabrics, rubber and leather. Does away with drudgery of darning and mending. Does the work cheaper, easier, quicker. Stands repeated washings. Send 50c for full size tube. Money back if not satisfied.

**Agents** Get our generous offer.  
Dept. P. M.

**DARN-IT-ALL COMPANY**  
1524-34th St., Des Moines, Iowa





### \$25,000 to 1,000 Men, Big Profits to Live Radio Fans

Here is the latest type of the Blue Seal Cineodyne. Not just a "Receiving Set," but a real go-getter that picks up all distant signals and builds them up to pleasing audibility.

A five-tube tuned radio frequency set so accurately designed and constructed that each set is equipped with a station-finding chart on the front panel, so that all you have to do, knowing the wave-length of the station you want, is to set your dials according to the chart and in they come.

Our selling plan is Co-operative, and enables our representatives to make a handsome profit. To this end, we send these sets to our representatives fully assembled in a handsome walnut cabinet as shown in illustration, but not wired; though all wire, spaghetti, and an instruction book that will enable anyone with the slightest mechanical ability to complete the set.

We will train 1,000 Radio Fans in the wiring and adjustment of our sets to fit them to act as our agents and representatives, and handle the volume of business that comes to all in a position to demonstrate these sets in competition with any other radio set on the market.

The public buys a Winner; therefore, when they have seen the operation of a Blue Seal Cineodyne, that is the set they buy, and our representatives are making handsome profits thereby.

The retail price of the Blue Seal Cineodyne as above illustrated assembled complete ready for wiring, is \$90.00. To those able to devote all or part of their time to the sale of these sets, we offer a liberal agents' discount from the price of unwired sets, and a still greater income may be derived from the wiring for delivery to your customers.

We want real HUSTLERS, and while the income to be derived from the sale and wiring of these sets is very attractive, in order to encourage extra activity and enable us to select the best of our agents as exclusive representatives, we are offering

### \$25,000.00 IN PREMIUMS AND BONUSES

Based On Volume Of Sales  
 WRITE TODAY for illustrated circular and full details which may be the means of putting you in a permanent and profitable business.  
 If you are not in a position to become our representative, but want the best radio set in your community, we will supply you direct until such time as a local agent is appointed.

**BLUE SEAL MANUFACTURING CO.**

Dept. 3, 1406-08 South Michigan Ave., CHICAGO, ILLINOIS

## Build Your Own Radio

Anyone can build NEW 1000 Mile Lowloss Radio with our simplified instructions and fitted parts. 1-Tube Parts \$7.25, 3-Tube Parts \$14.50. Write for information "HOW TO EARN A RADIO."

**KAPLAN RADIO CO., 416 So. Dearborn St., CHICAGO**

### RADIO SALESMEN AND SET BUILDERS—

We need you and you need us. If you are reliable and well known in your community, we will appoint you our representative and furnish you with standard well-advertised sets and parts at prices that will enable you to sell at a handsome profit.

Write us now for catalogue and sales plan.  
**WAVELAND RADIO CO., DIV. 51, 3027 NO. STATE ST., CHICAGO, ILLINOIS**

**FREE!** DIAMOND, WATCH AND JEWELRY CATALOG, showing latest designs and highest quality jewelry at lowest prices and EASY CREDIT TERMS. Ten months to pay. Prices from \$10 to \$1000. Legal guarantee bond with every article. Don't buy until you send for this Free Catalog. **Baer Bros. Co., Dept. 226, 6 Maiden Lane, N. Y.**

**SHOTGUN or RIFLE** There's remarkable gun value in a Stevens. Write for the interesting catalog describing our line.

**J. STEVENS ARMS COMPANY**  
 Dept. 575, Chicopee Falls, Mass.  
 Owned and Operated by the Savage Arms Corporation

the best four tube set that you can build?  
**Do You Know The Browning-Drake Receiver**

Using the National Regenator, Dials, and Condensers, designed by Harvard experts. Simple, easy to build—wonderful results. Bul. 105 P. M. describes it.  
**NATIONAL COMPANY, INC., CAMBRIDGE, MASS.**

**SOLDERALL**  
 METAL IN PASTE FORM

The only convenient metal solder  
 Every Electrical Connection needs Solderall for perfect reception  
**25¢**  
**The SOLDERALL CO., NEWARK, N.J.**

## Can We Count You Among the Progressives?

A million men a year are coming to Barbasol. Escaping the torture of old-fashioned shaving. Saving their time and getting a better shave. No brush. No rub-in. Try Barbasol just three times, according to directions, 35c and 65c tubes.

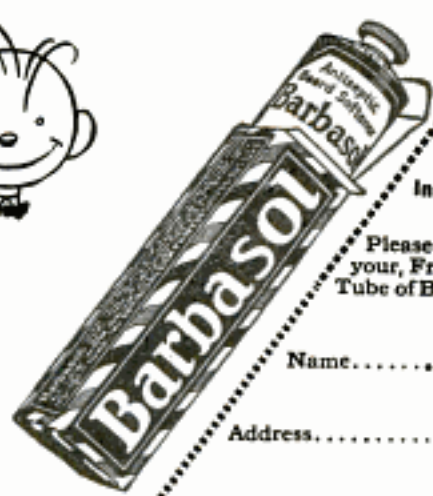

The Barbasol Co.  
 Indianapolis Ind.

Please mail me your, Free Trial Tube of Barbasol.

Name.....

Address.....

P.M. 2-25

## For Modern Shaving



Save \$2.25 ON COST OF NEW TUBES BY HAVING YOUR OLD TUBES REBUILT AT \$1.75 Each

Guaranteed equal to new. Send us your tubes by parcel post. We return parcel post, C. O. D. and try to maintain 24 hour service.

**Harvard Radio Laboratories**  
 204 Old Colony Ave., So. Boston, Mass.



## FROST-RADIO Catalog and Instruction Book

THIS new booklet on the care and operation of FROST-FONES and FROST-RADIO is now ready. Contains 36 pages of valuable information on radio apparatus. Your copy mailed free on request.

Address Dept. 14F431  
**Herbert H. Frost, Inc.**  
 154 West Lake Street  
 CHICAGO, ILLINOIS



A post card from you will bring this 40-page catalog.



# AGENTS! QUICK!

Get  
This While  
Gettin's Good  
Grab Your Territory  
**NOW**



Here's the chance to make a big, quick clean-up—and to keep right on cleaning up for years to come.

It's one of these rare opportunities to grab off an article that needs no selling—no argument.

## GRIP-N-STIK

actually does talk for itself, sells itself. Your only job is to **SHOW** it. Let any mechanic see it, and **YOUR** job is done—your **MONEY** is made.

**GRIP-N-STIK** is a newly patented he-man's tool—a new kind of tool; the handiest, most practical, efficient and useful tool that any mechanic ever held in his hand.

**Grip-N-Stik** is neither a plier nor a wrench, but wrench and plier combined. It grips a pinhead or a 1½ in. square or hexagon nut with equal firmness and hangs on in a way that makes a bulldog ashamed of himself. It changes from one adjustment to another instantly, and **IT CAN'T** slip. **Grip-N-Stik** opens up and takes a new grip as naturally as a plier—but it **out-grips** a plier and **out-sticks** a wrench—every time. **Grip-N-Stik** does not require a strong hand—the power is in the cleverly applied principle of internal leverage. Works with ease in difficult places, too. **Grip-N-Stik** is the strongest and most powerful tool of its size that you ever saw.

### \$20 a Day, Easy

**Grip-N-Stik** is needed in every machine shop, garage, factory repair shop, plumbing shop and home. Automobile owners and handy men at home are quick buyers, too. The market is tremendous. **Grip-N-Stik** is needed by every man who uses wrenches or pliers in his work. You can easily sell from two to ten in small shops, more in large ones, on every call. Ashelman, of South Carolina, sold 150 on one order, in 3 hours. Richardson, of Ohio, made \$36.50 in one day, while trying out our proposition—and held down a regular job, too. McDougal, like thousands of other **Grip-N-Stik** users, said, "I wouldn't sell my **Grip-N-Stik** for \$5.00 if I couldn't get another." Warther says, "It's the first thing I put in my pocket in the morning and the last tool I lay down at night." Remember **Grip-N-Stik** is a **NEW** tool, a better and more practical tool than these men had ever seen before. Its merit and advantage are recognized at a glance, instantly.



### Good Territory Open Everywhere

but going fast—Write quick for detailed description, prices, agent's discounts, and our plan by which any good man can make \$20.00 or more daily.

**Mechanics:** Write for descriptive folder and details of how to get a **Grip-N-Stik** and a handsome check on the side by showing it to your friends.

**Dealers or Agents:** Write for attractive proposition. We are establishing either live dealers, or live agents—but not both in the same community.

### THE GRIP-N-STIK CO., Dover, Ohio

Print or write your name and address plainly.

THE GRIP-N-STIK CO., Dover, O.

Gentlemen: Please send full particulars about **Grip-N-Stik**.  
( ) Mechanics ( ) Agent ( ) Dealer

Name.....

Address.....

City..... State.....

# KERMATH

## BOAT ENGINES

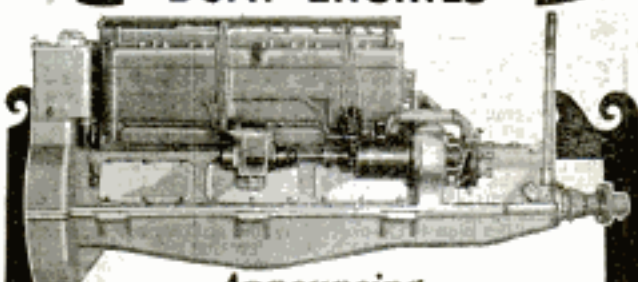

Announcing

### A New Six Cylinder Kermath

Made in two types, both 4¾ inch bore and 5¾ inch stroke. High speed model develops from 75 to 100 H.P. at from 1500 to 1850 R.P.M. Low speed model develops 40 to 60 H.P. at from 600 to 1000 R.P.M.

Like all Kermaths, these wonderful motors sell at sensationally low prices. Only \$1350 for the low speed, and only \$1450 for the high speed motor!

Many interesting and most advanced technical details. See this motor at the New York Motor Boat Show. And by all means write for more detailed specifications—they are interesting.

3 to 100 H. P. \$135 to \$1450

**KERMATH MANUFACTURING CO.**  
5886 Commonwealth Ave., Detroit, Michigan  
11 E. Wellington St. Toronto, Ontario

*A Kermath Always Runs*

# 1000 NEEDED INVENTIONS!

Here is the most remarkable book ever offered to inventors. One Thousand needed inventions listed and described. Arranged as follows: General Problems; Automotive; Mechanical; Electrical; Chemical; Radio; Marine; Separate chapter on the Ten Most Needed Inventions. This book may give you one idea that will win you a fortune. Nothing else like it has ever been published. Compiled at enormous expense. Edited by Raymond Francis Yates, formerly Managing Editor of a leading scientific magazine. Over 100 pages, durably bound. Send no money. Pay postman only \$1.00 plus postage on arrival. Money back after 10 days examination if desired. Limited edition. Write NOW.

### BUREAU OF INVENTIVE SCIENCE

Dept. 32 ROCHESTER, NEW YORK

# AGENTS \$200

Looks Like \$5.00 Worth Gives You \$1.10 Profit!



This is What Gets the Coin

investment—no delays. You bank immediate profits, also a winning plan, a premium to each sale. Write today for illustrated circulars explaining our unique plan. Act Now.

E. M. DAVIS CO.

Dept. 5626

CHICAGO

You should see our Nifty Nine Packets. Our Representatives introduce our products with a first sale of beautiful combination sets of Toilet Articles, Soaps, etc., at half store prices. No fancy talk—they sell on sight. Make twenty to thirty sales a day, with \$1.10 profit on each.

**EASY TO AVERAGE \$100.00 A WEEK**

Could you ask more while introducing line establishing a permanent business for yourself? Another plan calls for no deliveries—no



# \$5000<sup>00</sup> a Year to Agents



How  
\$53,000,000  
Was Lost  
Last Year  
and How the  
**SECURITY**  
FOUNTAIN PEN  
Stops the Loss

\$16,000,000 was lost on "raised" checks—made out "away from the office." \$37,000,000 was lost on stolen or lost checks cashed through changing payee's name to "bearer" or "cash." Both kinds of loss prevented by the "Security." It is carried in pocket—always at hand. The revolving steel, cutting wheel, concealed in cap, scores amount, name, date, number, etc., and fills the ridges with acid proof red ink. Absolutely defies crooks. Gives more complete protection than \$100 machine. This protection is free. For the Security—although 17 years of experience have given it superior writing qualities—costs no more than other good Fountain Pens. Prices \$3.50 to \$7. Write quick if you want big money in your territory. Ask for agent proposition and figures.

**SECURITY PEN CORPORATION**  
Dept. P.M. 25, 910 W. Jackson Blvd., CHICAGO, ILL.

This Check Protecting Fountain Pen Has Already Proved the Greatest Money Maker Ever Sold by Agents.

A dozen of these pens often sold in one office in a half hour. A hundred customers often found in a single office building. Nine men out of ten buy it. No competition. Not sold in stores. You have a monopoly. Side line men make \$20 to \$35 a week. Full time men make \$75 a week and more. District managers make \$10,000 to \$25,000 a year. Write quick.

Prices  
\$3.50  
to \$7

## FREE! NEW MONEY SAVING BOOK

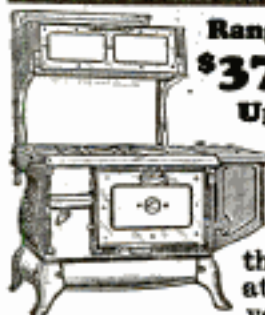

**Ranges** Buy direct from factory! Save \$37<sup>75</sup>  $\frac{1}{4}$  to  $\frac{1}{2}$  on your stove, range or furnace. Take advantage of the biggest SALE in our 25 years. Kalamazoo quality is the highest; prices are at bedrock. This is the year to

buy. Send for our big, new catalog—it's full of new ideas, new features, new models. 200 bargains in heating stoves, gas ranges, combination ranges, coal ranges, furnaces, both pipe and pipeless, and household goods. Cash or easy payments. 30 days' trial. Money-back guarantee. Quick, safe delivery. 530,000 pleased customers.

**Furnaces**  
\$59<sup>95</sup>  
Up



Write today for Your FREE Book Now Ready  
**KALAMAZOO STOVE CO., Mfrs.**  
391 Rochester Avenue.  
Kalamazoo, Michigan

**A Kalamazoo**  
Direct to You



# ANew Ford \$285

FOR YOUR OLD ONE SEND NO MONEY



This is not an "Arabian Nights" story, nor is it a fairy tale. If you would like your Ford to get away just as quick and sure as you can feed it gas, you will find "Spad" to be the answer. If you want to get the vim, pep and vigor of a big car—if you want to climb hills as easy as you go down—if you want to save time, money and end ignition trouble forever, get a "Spad." No matter how badly your Ford now bucks, jerks, misfires, sputters—no matter if it is hard to crank or if you can't keep it running with its full power and speed, you can change it into a smooth running, fast, powerful, trouble-free car in less than five minutes—"Spad" will fix it for life. "Spad" is made of genuine bakelite. There can be no short circuit, nor oiling needed.

**AGENTS WANTED**

## Guarantee

We hereby unconditionally guarantee, that if inside of 30 days the SPAD Timer fails to save you between 15% and 20% of your gas bill, start your motor quicker, give it more pep and power, keep the plugs clean and dry and in fact entirely delight you in every way, we will return your money in full on receipt of timer.

## Starts Any Ford Easily— In Coldest Weather

Don't break your back cranking a "Non-startable" motor or drain your batteries and grind your starter to pieces. Don't worry about cold, leaks, winter mornings, when it usually takes you half an hour and a lot of hard, disagreeable work to get L. e Ford going. SPAD starts any Ford regardless of age, weather or anything else, generally with one pull of crank handle.

# SPAD

## What Users Write

McClern's Garage, Gadsden, Va.—  
"I received the timer and she is a beautician. It beats everything I ever saw on a Ford. I put it on a 1915 model which could hardly start with a Hot Shot battery. It starts now every morning, hot or cold, on the magnets with one pull up."

Charlotte Sweet, Worcester, Mass.—  
"I have a 1917 Ford car which was always slow with the roller type timer. As soon as I put on a Spad, it would travel with any of them. The best I could do with a roller timer was 23 miles. Have been 47 miles an hour with the Spad without coming it up to the limit."

We have on file thousands of letters like these.

## 30 Days Free Trial

Never before has such an ironclad guarantee been placed behind a Ford accessory. Just think—you are to use the SPAD for one month to judge yourself whether it is worth your money. Remember, if at the end of 30 days you are not more than delighted with how the SPAD saves you gas—how it increases your power and the general running of your Ford—send it back and without asking a question, we instantly and gladly refund every penny of your money.

## Send No Money

You don't need to send a single penny in advance. Every day your Ford is running with a gear timer, it's costing you good money and we can prove it. Mail the order and your SPAD will be sent at once. Simply pay the postman on arrival.



## Rush Bargain Coupon

**SPAD MANUFACTURING CO.**  
244-246 West 40th St., NEW YORK

Please send me a "Spad" by return mail. I will deposit with the postman \$2.85 plus a few cents postage on arrival. It is understood that if I am not satisfied after 30 days' trial, I can return my "Spad" and get my money back.

Name.....

Address.....

City..... State.....



# 30 Days FREE TRIAL

## NO MONEY DOWN

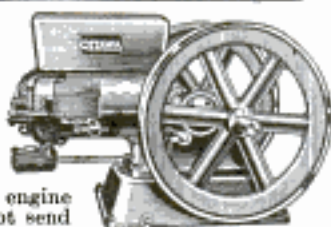

Your request to try this engine is all we ask. You do not send a penny down—you try your engine first. After you have tried your OTTAWA Engine right at your own work for THIRTY DAYS, send us the small payment of \$4.95 a month. SOLD DIRECT FROM FACTORY TO YOU.

# \$4.95 MONTHLY

## OTTAWA ENGINES

Smallest monthly payment ever made on a 1½ H-P. engine—other

sizes 2½ to 22 H-P. at proportionally low monthly payments—a whole year to pay if you want. No interest; no C. O. D.; no tiresome red tape. Use kerosene or gasoline without changing. New patented Venturi makes starting easier. Throttling governor. WICO Magneto ignition.

**FREE BOOK** Send your name and address on a post card for new OTTAWA Catalog. Get this book before you test any engine. Find out about this trial offer now. WRITE TODAY.

H. C. OVERMAN, President

**OTTAWA MFG. COMPANY**  
530-E King St., OTTAWA, KANSAS  
Desk 530-E Magee Bldg., Pittsburgh, Pa.

**How to  
KNOW  
BETTER  
ENGINES**

The LARGEST RADIO STORES in AMERICA



# Hook-ups!

All the latest and best kits in our new

## RADIO CATALOG

# FREE

NO other Radio Catalog includes such a complete assortment of the best and latest Knock-Down Kits, Parts and Accessories. You need this book — Write for your FREE copy today!

**We Save You Money!**

Our business is to buy up manufacturers' and government surplus stocks, jobber and dealer bankrupt stocks—but only brand-new, fully guaranteed, nationally advertised apparatus. Our enormous buying power permits us to pay spot cash and get rock-bottom prices—even way below manufacturer's costs. That's why our catalog is crammed with thousands of wonderful Radio Bargains.

**CHICAGO SALVAGE STOCK STORES**

509 So. State St., CHICAGO, ILL., Dept. PM6

Please Mention Popular Mechanics

# KLEIN PLIERS

That lamp has always needed a new shade and now it's going to get it! Easy enough with Klein Pliers. A pair of Klein's is a real worker and a real playmate. You'll enjoy them for making and fixing things all over the house—for your radio and auto, too. They're thoroughbreds, are Klein Pliers—the result of sixty-seven years of manufacture of pliers. Electrical and telephone companies all specify them. Pick up a pair when at your hardware dealer's.



Mathias **KLEIN** & Sons  
Established 1848 Chicago, Ill.

## CALCULATIONS



in Office and Shop can be instantly made with the Midget Slide Rule. It gives the answer to any problem involving fractions, mixed numbers, decimals, whole numbers, roots, powers, Logs, and Trigonometric Functions. Thousands of these rules are used by Accountants, Engineers, Clerks, Students, etc. It is the most versatile calculator ever invented. If you have any figuring to do, order a Midget Slide Rule on trial. Made of aluminum with figures on white celluloid. Size 4". Price with Instruction Book, \$1.50. Leather Case, 50c extra. Catalogue Free. Sent C. O. D. if desired.

Your money back if you are not satisfied.  
**GILSON SLIDE RULE CO., Niles, Mich.**

**Eveready**  
COUNTER SALESMAN

**MAKES \$5,000 A YEAR**



and an initial investment of only \$19 starts you. Marvellous "Eveready" wanted by confectionery, drug, grocery, cigar stores, waiting rooms, newsstands, pool rooms, barber shops, restaurants, soft drink parlors, everywhere.

### WE GUARANTEE AGENTS

100% to 150% profit on every deal. Scores of men make \$5000 a year and more selling or leasing "EVEREADYS," then keeping merchants supplied with quality salted peanuts, candies, nut meats, etc.—Repeat orders weekly. Our contract with large manufacturer furnishes you all supplies at wholesale. Be a Specialty Jobber,

### Whole or Part Time

You can build amazing business in short while. Absolutely nothing like "Eveready"—works automatically—refills easily—no hooks, clips, or sticks. When bag is removed, alarm automatically rings! ACT NOW!—write for territory.

(Patent applied for)  
**THE INTERSTATE CO., 2383 E. 9th Pl., CLEVELAND, O.**

(References: Mutual Bank, Cleveland)  
**Dealers:** If no "Eveready" distributor has called—remit \$2.25 (\$2.95 nickel-plated) 15 days must prove claims or return device—money back.



The best and most complete saw equipment on the market—Complete Outfit as shown, including cord, plug, belt and pulley.

**\$45**



## For Handy Man and Mechanic

With this saw you can make your own repairs in shop, home, farm or garage. Makes a clean edge on the toughest wood—no planing necessary. Rips, crosscuts, bevels, miters, mortises, tenons, or grooves.

## MECHANICS' BENCH SAWS

Attach to any lamp socket. Weight only 61 lbs. Will cut up to  $1\frac{1}{4}$ ". All metal. Saw-size 6 in. Table 10x13, base 7x11, height 7 in. Table tilts for beveling 5 degrees left, 10 degrees right. Hinged top for cutting grooves, tenons, rabbets. Bearings solid bronze with grease cup lubrication. Guides removable and adjustable rip and cut-off. Sunlight  $\frac{1}{4}$  h. p. motor; 110 volts; 60 cycle; 4.5 amps; 1750 R. P. M. Current A. C. Centrifugal switch with auxiliary finger. High grade steel shaft with ground bearing surface. Water and moisture proof insulating material used throughout. Exterior connections to allow change of direction of rotation. Large grease cups with wick lubrication. Bearings of Bunting phosphor bronze metal.

**SAW TABLE** can be purchased with 6" saw for \$29.50; We Pay Delivery Charges Anywhere in U. S. \$29.50

**\$45. Complete Outfit**

**\$70 VALUE**

East of the Mississippi. We Pay Delivery Charges.

West of the Mississippi. We Pay Delivery Charges.

including cord, plug, pulley and belt, everything complete, ready to attach. Duxton 6" Novelty Combination Cross Cut and Rip Saw, guaranteed to run without set. Extra heavy duty motor guaranteed to handle 50% overload.

## BUILDERS' HARDWARE and TOOLS AT $\frac{1}{2}$ PRICE!

SEND FOR OUR NET PRICE BUILDERS' HARDWARE CATALOG

### Starrett 12-inch Carpenter Square



We Pay Delivery Charges Anywhere in the U. S. **\$1.25**

### Starrett Leveling Instrument No. 101



No. 101-A—With plain sight tube, long legs and plain level vial. **\$13.00**  
No. 101-C—With telescope, long legs and ground level vial. **\$21.00**  
Targets for the above. **\$1.75**  
We pay delivery charges anywhere in U. S.

### Starrett Transit



No. 99-F—With telescope, long legs, and ground level vial. **\$33.00**  
Iron Target to go on pole, extra. **\$2.00**  
We pay delivery charges anywhere in U. S.



$\frac{1}{4}$  H. P.

**Sunlight MOTOR \$15.90**

**GUARANTEED 50% OVERLOAD**  
Complete with Cord, Plug and flat or grooved Pulley  
110 volts; 60 cycle; 4.5 amps; 1750 R. P. M. Current  
A. C. Guaranteed to handle 20% overload.....  
We Pay Delivery Charges Anywhere in U. S.

**Regular Value \$30**

SEND FOR OUR CATALOG

**PAUL J. DEVITT, 1101-1107 So. 2nd St., Phila., Pa.**

HARDWARE HEADQUARTERS OF PHILADELPHIA



# Great *New* Invention

for seekers of

## Health Power Beauty



Elco Health Generators at last are ready for you! If you want more health—greater power to enjoy the pleasures and delights about you, or if more beauty is your desire—write! Ask for the book on these inventions which has just been prepared. It will be sent to you without cost. It tells you how Elco Health Generators aid you in leaving the lethargy and hopelessness of bad health and weakness behind forever. Re-vitalize yourself. Bring back energy. Be wholly alive. Write today!

10 Days Free Trial—Write for FREE BOOK



These great new inventions generate *High Frequency Violet Ray, Mechanical Vibration, Medical Electricity and Ozone.* Combined or separate.

They operate on the electric light in your home or on their own motive power at less than 50 cents per year. Elco Health Generators are positively the only instruments which can give you in one outfit Electricity, Violet Ray—Vibration and Ozone—the four greatest curative agents. Send coupon below. Get the Free Book NOW!



### For All These:

Rheumatism	Asthma
Gout	Hay Fever
Lumbago	Sore Throat
Neuralgia	Catarrh
Sciatica	Deafness
Headache	Insomnia
Neuritis	Pain
Nervousness	Development
Circulation	Skin Disease
Weakness	Pimples
Paralysis	Scalp Disorders
Eye Trouble	Obesity

## MAIL the COUPON for FREE Book!

Do not put this paper down without sending the coupon. Don't go on as you are with pains and with almost no life and energy. You owe it to yourself to be a better man or woman. You were put here to enjoy life—not just to drag through it. So do not rest another day until you have put your name on the coupon here. That will bring the whole story of these great new inventions. Do it today—now.

Health Power Beauty

**Lindstrom & Company**

30 W. Lake St. Dept. 13-52 Chicago, Ill.

Please send me your free book, "Health—Power—Beauty" and full information on your 10-Day Free Trial Offer.

Name .....

Address .....

For sale in Canada by C. FRASER MACTAVISH  
247 Hillside Ave. E., Toronto



## Just 17c

a Day Pays for This Beautiful Chair

Tapestry or Velour

Over 1000 other bargains, Furniture, Rugs, Lamps, Silver,

China, Blankets, Stoves, etc. Save Big Money at our Factory-to-Family prices. Pay as little as \$3 down; up to a year and a half to pay balance. Get all your Furnishings at once—pay as you use. Thousands buying this new way.



## Big Catalog FREE

New Spring "Larkin Book of Better Homes." Shows everything for parlor, porch, dining-room, bedroom, kitchen. Bargain Prices on famous Symphonola Phonographs; also Symphonola Pianos, Player-Pianos in genuine Mahogany, Walnut, Fumed Oak. Free trial. Up to four years to pay. Satisfaction or money back. Check below article interested in.

- Home Furnishings
- Pianos or Players
- Phonographs

Cut out this Ad.—Write TODAY for FREE Book.



Larkin Co. Inc.

Dept. 239 BUFFALO, N. Y.  
Peoria, Ill. Chicago, Ill.

**FREE** Book of Newest Styles just out. Women's, men's, children's clothing on credit and at bargain prices, less than cash prices everywhere. Very latest fashions; best materials. Open a charge account with us. Buy on credit and save money! Dress in newest styles. Send for Style Book absolutely FREE today! Elmer Richards Co., Dept. 1772, W. 35th Street, Chicago



2409 BUNGALOW \$1606

WE PAY THE FREIGHT

538  
5 ROOMS

LET us ship you direct from our mill all the materials complete for a Sterling cut-to-fit home, (not portable) and save you four big profits on lumber, hardware, mill-work and labor, besides a proved 20% saving in waste. Substantially built and lasting. Satisfaction Guaranteed or Your Money Back!

Buying Direct Saves 1/3

ABOVE prices include everything complete—all lumber cut-to-fit (highest grade only), windows, doors, flooring, shingles, lath, glass, paints, varnish, putty, hardware, nails, molding, cupboards—everything plainly marked and easily assembled according to drawings and directions we furnish.

\$1606 Home includes double walls and floors. \$538 five-room house includes single walls and floors; for double add \$50.

International Mill & Timber Co.  
2221 South Wenona Ave.  
Bay City, Mich.



FREE CATALOG

with many other beautiful homes at \$538 to \$4,797—all at big savings. Garages \$73 and up.





# Radio Without the Horn!



Goodbye to the Old-Fashioned Horn Speaker!

A Vastly Better Reproduction With This New Radio Console!

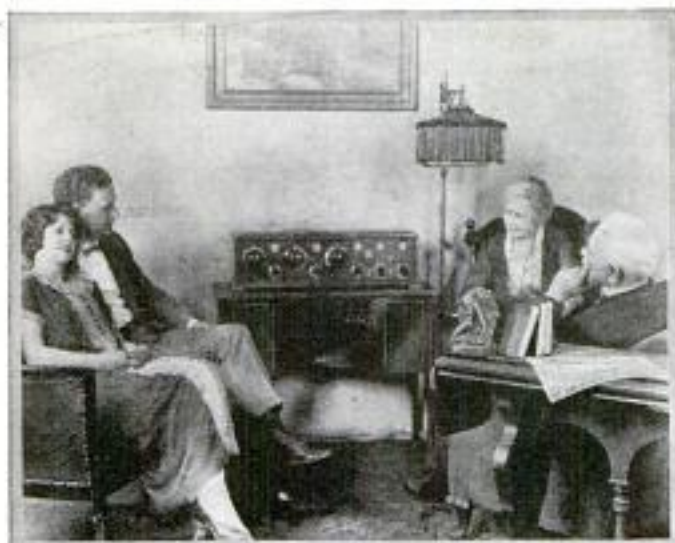

"Our old horn speaker never gave tones like this! An artistic addition to the living room—everything in its place—it's a joy!"

New Console Has Its Own Perfect Loudspeaker!

Ample Space for All the Rest of Your Outfit!



HERE is something that enables you to enjoy radio in the home without the clutter of unsightly apparatus that plays havoc in the decorative scheme of your living room! The horn speaker is out of date and out of place in radio for the home. This console with its in-built loudspeaker is scientific and sightly.

## A Truly Wonderful Tone

It does a good job of reproducing, for it has a good unit and its sound-box is of resonant wood instead of metal, fibre, or composition.

The appearance of a Windsor loudspeaker console is a delight. Its convenience is a joy. A piece of real living room furniture of pleasing lines and finish—and it accommodates all the miscellany of equipment which hitherto had no place except on table tops, shelves or floor. Ample space on top for any set, with plenty of elbow room in front. Nothing in sight but the console and receiving set. Everything else goes inside—from behind—in spaces cleverly designed to hold the largest batteries and outfit for home use—besides the self-contained loudspeaker—all unseen and protected from dust or disturbance.

## You Need This Console, Whatever Your Present Outfit Is

It makes no difference what kind of radio outfit you have—this console was designed for your use. The graceful exterior of this console gives no hint of its inner utility, for it is a simple and effective piece of furniture in every line. But a glance at the interior reveals a most ingenious arrangement of the in-built loudspeaker with space either side and in back. These spaces are ample for the largest A

battery, and the largest wet B batteries and the largest charging outfit for home use. It is 38 in. long, 18 in. deep, and 29 in. high. Notice the artistic grill that conceals soundbox, and the provision for "knee room" beneath. Made in mahogany or walnut finish, and the price is only \$40! (West of the Rockies, \$42.50.)

## Dealers!

The sale of these consoles has already reached extraordinary figures. They are selling in surprising quantities in even smallest stores where there is one in the window or on the floor. It is a convenience and a value not to be duplicated.

Write us for discounts and particulars of big newspaper advertising campaign.

## INVESTIGATE!

Dealers everywhere are now showing the Windsor loudspeaker console, and have them for immediate delivery to your home. If you haven't already seen this

remarkable contribution to radio enjoyment and convenience, write us now for the name of a nearby store where you may view it. We will also send you complete information. Remember, this console gives you not alone a reproducing unit and sound box, but an altogether new beauty and utility in the provision for your entire radio outfit. Mail coupon or postal.

If you wish to use your own favorite unit, a deduction will be made for omission of unit.

WINDSOR FURNITURE COMPANY (12)  
1422 Carroll Ave., Chicago

Please furnish pictures and full details, also name of nearest dealer who has the new Windsor loudspeaker console.

Name.....

Address.....



Pat. Nov. 13, 1924

**\$40**

Loudspeaker included  
West of the Rockies, \$42.50

*Windsor Loudspeaker Console*



## LUMINOUS PAINT

**Make Your Watches, Clocks, Etc., Visible by Night**

The very latest discovery in the scientific world, Hitherto, practically unobtainable LUMINOUS PAINT, which, applied to the surface of any article, emits rays of white light, rendering it perfectly visible in the dark. **THE DARKER THE NIGHT, THE MORE BRILLIANT IT SHINES.** Quite simple to use. Anyone—you can do it. A little applied to the dial of your watch or clock will enable you to tell the time by night. You can coat the push buttons or switch plates of your electric lights, match boxes, and innumerable other articles; make your own Luminous Cufflinks, Luminous Flowers, etc. Small bottle, price 25c. Larger sizes, 50c and \$1 postpaid. **JOHNSON SMITH & CO., Dept. 290, RACINE, WIS.**

## Serpent's Eggs Exploding Cigarettes

Box contains 12 eggs. When lit with a match, each one gradually hatches itself into a snake several feet long, which curls and twists about in a most life-like manner. Price per box, 10c postpaid, 3 for 25c.



**JUST LIKE ORDINARY CIGARETTES, BUT SUCH REAL STARTLERS!** The box contains ten genuine cigarettes of excellent quality. They appear so real, but when each cigarette is about one-third smoked, the victim gets a very great surprise as it goes off with a loud BANG! A great mirth provoker yet entirely harmless. Price 25c per box.

## CIGARETTE MAKER



Roll your own and save money. Makes them better and quicker besides saving more than half! Use your favorite brand of tobacco. Neat, useful and handy. Pocket size, weighs 7 1/2 lbs. Made entirely of metal, nickel-plated. Price 25c postpaid.

## MIDGET BIBLE

**GREAT CURIOSITY** Smallest Bible in the World. Size of a postage stamp. 200 Pages. Said to bring good luck to the owner. A genuine work of art. Must be seen to be appreciated. Make good money selling them to friends, church acquaintances, etc. PRICE 15c each, 3 for 40c, 12 for \$1.35, 100 for \$7.90. Also obtainable in Leather Binding, with gold edges. Price 50c each, 3 for \$1.25, \$4.50 per doz. Magnifying Glass for use with Midget Bible, 15c.



## STAGE MONEY

With a bunch of these bills, it is easy for each person of limited means to appear prosperous by flashing a roll of these bills at the proper time and peeling off a genuine bill or two from the outside of the roll, the effect created will be found to be all that can be desired. Prices, postpaid: 25 Bills 15c, 50 Bills 25c, 125 for 50c, or \$3.50 thousand.



## Wonderful X-Ray Tube

A wonderful little instrument producing optical illusions both surprising and startling. With it you can see what is apparently the bones of your fingers, the lead in a lead pencil, the interior opening in a pipe stem, and many other similar illusions. A mystery that no one has been able to satisfactorily explain. Price 10c, 3 for 25c, 1 doz. 75c. **JOHNSON SMITH & CO.**



## Good Luck Ring

A VERY striking and uncommon ring. Silver finish, skull and crossbones design, with two brilliant, flaking gems sparkling out of the eyes. Said by many to bring Good Luck to the wearer, hence its name, **Good Luck Ring.** Very unique ring that you will take a pride in wearing. **ONLY 25 CENTS.**



**Quaint and Novel Design**

Address orders for all goods on this and opposite pages to

**JOHNSON SMITH & CO. Dept. 290 RACINE, WIS.**

A DeLuxe Edition of our new 1925 CATALOG mailed on receipt of 25c. Handsome cloth binding. Only book of its kind. 420 pages of all the latest tricks in magic, the newest novelties, puzzles, games, sporting goods, interesting books, curiosities in seeds and plants, etc., unobtainable elsewhere. Only a limited number available.

## BLANK CARTRIDGE PISTOL

Protection against Burglars, Tramps & Dogs

Prices **50c** **\$1.00** Post-paid



Well made and effective; modelled on latest type of Revolver; appearance alone is enough to scare a burglar. When loaded it may be as effective as a real revolver without danger to life. It takes standard .22 Cal. Blank Cartridges obtainable everywhere. Price 50c, superior quality, \$1.00 post-paid. Blank Cartridges, by express, 50c per 10. Holster (Dowboy type) for Blank Cartridge Pistol, 50c. **JOHNSON SMITH & CO., Dept. 290, Racine, Wis.**

## DANCING BEAUTIES BEST EVER

Get a Kinetograph and see the picture move. Franco's latest sensation. A great surprise. Is worth twice what they cost. Are made of solid brass, highly nickled and very durable. Satisfactory or your money back. Price..... 50c. **JOHNSON SMITH & CO., Dept. 290, Racine, Wis.**



## BOYS! BOYS! BOYS! THROW YOUR VOICE

Into a trunk, under the bed or anywhere. Lots of fun fooling the teacher, policeman or friends. **THE VENTRILO** a little instrument, fits in the mouth out of sight, used with above for Bird Calls, etc. Anyone can use it. Never Fails. A 32 page book on ventriloquism, the Ventrillo, ALL FOR 10 CENTS



## 1000 Silk Remnants

For patching Crazy Quilts, Sofa Cushions, Head Rests, Pin Pads etc. Large pieces, all colors and shades. Sure to delight you. **For 10 Cents** stamps, we send a large package and Book of quilt designs. 3 packages, 25c. 1 pound makes a lovely large quilt. Price 15c postpaid. Our silk is the best. **JOHNSON SMITH & CO., Dept. 290, RACINE, WIS.**



## LOOK 35 Look

Wonderful instrument. Greatest thing yet. Nine separate articles in one. Everybody is delighted with it. Odd, curious and interesting. Lots of pleasure as well as very useful. It is a double Microscope for examining the wonders of nature. It is also an Opera Glass, a Sereoscope, a Burning Lens, a Reading Glass, a Telescope, a Compass, a Pocket Mirror, and a Laryngoscope—for examining eye, ear, nose and throat. It is worth all the cost to locate even one painful cinder in the eye. Folds flat and fits the pocket. Something great—you need one. Don't miss it. Sent by mail, postpaid. **Only 35c or 3 for \$1.00**



## Resurrection Plant

One of the most wonderful plants known. Possesses the strange power of turning in a few minutes from an apparently lifeless, dry herb to a BEAUTIFUL LIVING FERNLIKE PLANT of a dark green color. Simply place the plant in saucer of water, it will open up and start to grow in 20 minutes. When taken out it will dry up and go to sleep until placed in water again. Fine house plant—summer or winter. **10 cents each or 3 for 25c. AGENTS WANTED** post paid. **JOHNSON SMITH & CO., Dept. 290, RACINE, WIS.**



## Popular Watch Charms

**ONLY 15c**  
3 for 40c; \$1.25 doz

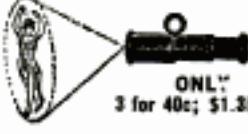

Very pretty little curiosities and decidedly novel. Fitted with Magnifying Lenses that enlarge the pictures to a very surprising degree; in fact, it seems almost incredible that a clear picture could be possible in such a small compass, and here sharp and distinct they show up when you look through. Come in assorted views—Actresses, views of Panama Canal, Lord's Prayer in type, etc.

## Mystic Skeleton

A jointed figure of a skeleton 14 in. in height, will dance to music and perform various gyrations and movements while the operator may be some distance from it. **10c & pd.**



## NEW BOOK ON ROPE SPLICING

Useful Knots, Hitches, Splices, etc. A most practical handbook giving complete and simple directions for making all the most useful knots, hitches, rigging, splices, etc. Over 100 illustrations. All about wire rope attachments, lashing, blocks, tackle, etc. 37 Heraldic Knots Illustrated. Of great value to mechanics, riggers, carpenters, boatmen. Price 20c ppd.



## MAGIC FLUTE

Wonderfully Sweet Toned and Musical The Magic Flute, or Hummer-aloon, is a unique and novel musical instrument that is played with your hand and mouth combined. There is just a little knack in playing it which, when once acquired after a little practice will enable you to produce very sweet music that somewhat resembles a flute. There is no fingering, and once you have mastered it you can play all kinds of music with facility and ease. When played as an accompaniment to a piano or any other musical instrument, the effect is as charming as it is surprising.



Post Paid 25c



## JAPANESE ROSE BUSHES

### The Wonder of the World

Japanese Rose Bushes bloom all the year round. Just think of it. Six weeks after planting the seed, the plants will be in full bloom. It may not seem possible, but we positively guarantee it to be so. They will bloom every ten weeks, Summer or Winter, and when three years old the bush will be a mass of roses, bearing from five hundred to a thousand roses on each bush. The flowers are in three shades—white, pink, and crimson. The plants will do well both in and out doors. We guarantee at least three bushes to grow from each packet of seed. Price, 10c packet, 3 pkts. for 25c postpaid.

10 Cts.

### Chinese Fragrant Tree Fern

Just introduced; noted for its rapid growth. An exceptionally pretty ornamental plant. Foliage rich dark green. Forms good pyramidal bushes about 4 feet high. Branches very desirable for decorative purposes, wreaths, etc. Seeds 15c pkt., 3 for 40c.

### Shoo Fly Plant

A very remarkable Botanical curiosity you should have. Though quite colorless it is said flies will remain in a room where it is grown. Bears very pretty blossoms summer and winter. Grows rapidly from seed. SEEDS 15c pkt., 3 for 40c, postpaid.

### Gigantic New Butter Beans

The New Edible Vegetable Wonder—Grows to an astonishing size, the Beans measuring from 3 to 6 feet long, and weighing anything from 10 to 18 lbs. and even more. One Bean is sufficient for a family for several meals. Very palatable and rich in nutritious materials. The delicate Buttery flavor is much appreciated. The Vines are easy grown, very prolific, and a most welcome and valuable adjunct to your garden. Try them; you will find them the most delicious vegetable you have ever tasted. Imported direct. Unobtainable elsewhere. Sample package of Seeds with full directions for cultivating and cooking. 25c, postpaid.

### Perfume Plant

Blooms only at night, giving forth the most delightful scented fragrance for quite a distance. Causes some or garden. Also valuable because of rare perfume made from it. SEEDS, 10c pkt., 3 for 25c.

### Weather Plant

NATURE'S WEATHER PROPHECY—By mysterious changes that take place, this remarkable plant accurately forecasts the weather many hours in advance. Will grow anywhere all the year around. An interesting house plant. Bears large, fragrant, pink, butterfly shaped flowers. Seeds, 15c packet, 3 for 40c, postpaid.

## GROUND ALMONDS

Amazingly Prolific—Easily Grown From Seed The Ground Almond has a flavor that is MOST EXCELLENT, resembling the coconut. The meat is snow white, covered with a shell or skin of brown color. It grows close to the surface and anything from 200 to 300 Almonds may be expected from a single nut. There is no trouble whatever in growing anywhere and in any kind of soil. May be planted any time, and in eight or ten weeks from time of planting you will have an ENORMOUS CROP of the MOST DELICIOUS ALMONDS YOU EVER TASTED. Seeds 15c Pkt.



### The Great Wonderberry

A luscious berry that may be grown and ripened from seed in any soil or climate in 8 months. The flavor is fine and unsurpassed for eating raw, cooked, canned or preserved in any form. The fruit is blue-black in color, and tastes like a luscious, rich blueberry. One bush will produce an enormous amount of fruit, yielding great masses of rich fruit all Summer and Fall. Packet, 10c, 3 pkts. for 25c, postpaid.

### Bush Musk Melon

A vineless Musk Melon, grows in bushes, and thus can be cultivated in the smallest garden. The fruit is of the popular "Jenny Lind" type, but larger, averaging 5 inches in diameter. The flesh is very deep, edible almost to the rind and is colored light green, flushed with salmon toward the center. The quality is superb, but closely sweet and nice. Packet of seeds, with full directions for culture, 15 cents, 3 packets for 40 cents, p.p.d.

### TREE OF HEAVEN

This splendid ornamental tree is a native of China, and is called the Tree of Heaven, on account of its great beauty. Very hardy, thrives in any soil, no matter how poor, and grows from 6 to 10 feet high from seed the first summer. The leaves are from 5 to 6 feet in any length, giving it a grand appearance. Nothing outside the tropics can rival it for lawn decorations. Large panicles of bloom, followed in season by great clusters of colored seed pods, make this tree a continual thing of beauty. Price, 15c, 3 packets for 40c.

### THE REMARKABLE

### FIREFLY PLANT

A Vine that Blooms at Night Fills the Atmosphere with Fragrant Aroma

One of the most rapid growing vines known. Under favorable conditions this vine has been known to grow OVER 200 FEET IN A SINGLE WEEK. In a very short space of time indeed the Vine has climbed to a great height, and is covered with IMMENSE FLOWERS, from 5 to 7 inches in diameter. It is, indeed, a great novelty for, unlike other plants, the flowers OPEN IN THE EVENING, and remain open until about noon the following day. In dull weather they will remain open all day. It is a most INTERESTING SIGHT to watch the opening and closing of the flowers as the clouds appear and disappear. As the flowers open they give forth the most DELICIOUS, AROMA and the whole atmosphere around is full of sweet fragrance. It is always the object of favorable comment, and much curiosity is aroused by people passing at night time so to the cause of the charming aroma, frequently stopping to enquire to satisfy their curiosity. PRICE, 15 CENTS packet, two packets for 35 CENTS, POSTPAID.

SEEDS, 10c packet, 3 for 25c, postpaid.

Send remittance (Postage Stamps accepted) for all articles listed on above and previous page to

## THE EXPO WATCH CAMERA



The most wonderful and ingenious Camera made. It is but little larger than a watch, which it closely resembles. You can carry the Expo about in your pocket and take pictures without any one being the wiser.

Less Than 2 Cents a Picture

The Expo loads in daylight with 10 or 20 Exposure Films, costing 25c and 35c respectively, and thus the picture taking part of a whole day's outing may be had for a very nominal sum—Little more than one cent a picture.

Easy to Manipulate

It is simplicity itself to operate. Takes pictures through the stem, where the Rapid Fire Lens is located. The plates (5-8x-8) may be enlarged to any size.

Operated as Quick as a Flash Time and instantaneous shutters; weights but 3 ounces; nickel plated. Endorsed by amateurs and professionals the world over. Thoroughly practical—printing and developing of films just the same as ordinary cameras—in daily use by the police, newspaper reporters, detectives, and the general public. Improved models have been secured with the Watch Camera by enterprising reporters. Produces clear, sharp negatives indoors or outdoors equal to any camera on the market, size or price notwithstanding.

Expo Watch Camera \$3.60 FILMS, 10 Exposures 25c, 20 Exposures 35c. Price Post Paid Leather Pouch Carrying Case, 35c

JOHNSON SMITH & CO., Dept. 290, Racine, Wis.



Runs for hours without mechanism of any kind. Speed Record 9 miles an hour. Kicks up water and sends like real motor boat. Entirely new and patented principle never before applied to toys. Just place a small lump of Coated Hot Wax such as Sterno, obtainable anywhere, in boat and light. Costs only One Tenth of a Cent for One Charge. Runs wherever there is water—in a bath-tub, disposes—anywhere at all. Any child can operate it. Made entirely of metal, attractively enameled in colors, hull dark green and deck bright red. Indestructible, fool-proof and safe, 9 inches long. Price \$1.00 Postpaid.

### U. S. BABY TANK

It goes with its own Yankee Pep—by its real power



Most remarkable Toy ever invented. By drawing the Tank backward, either with the hand or over the floor or table and then releasing it down, it will crawl along, overcoming all obstacles, in the same life-like manner as the larger Tank that proved so sturdy in the great war. What makes it go is consistent of a mystery, for there is no mechanism to wind up as is usually understood with mechanical toys.

It will pull, displace of the most wonderful extent; it will go backward or forward at will. 2 1/2 in. in length. Price only 25 cents prepaid.



Everything about the Ku Klux Klan told in a clear, fearless manner. Book tells all—How it started and was suppressed in 1871—The New Ku Klux Klan—How organized—How members are enrolled—Oath of the Klan—Questions for Candidates—Creed—Objects of the Order—Obedience—Fidelity—Pledge of Loyalty—Ku Klux Klan and the Masons—The Jews—The Masons—Real K. of C. Oath—The Negro Ku Klux Klan, etc., etc. Latest and most complete book on the Klan published. Price, 35c, Postpaid.

### Female SEX Indicator 25c Male SEX INDICATOR



Hold the MAGIC INDICATOR over a man's hand—Instantly it moves in a straight line, backward and forward. Hold it over a woman's hand and it describes a complete and continuous circle. The same action can be obtained over a letter written by a man or woman, etc.

It is fascinating, baffling. We have never been able to figure out how it's done—but we've never seen it fail. Many novel and entertaining tests may be performed with the Sex Indicator. For example, similar results can be obtained with animals, cats, dogs, rabbits, even birds, chickens, canaries, etc. Also used to predetermine the sex of children and birds, etc. In fact it is sold as a patented sex tester in Europe. Price 25c, or 3 for 65c, postpaid.

### All the Latest Surprising and Joke Novelties

- |                                    |     |                                    |        |
|------------------------------------|-----|------------------------------------|--------|
| Miniature Water Pistol             | 10c | Lion's License                     | 10c    |
| Croquet's Snake (very lifelike)    | 15c | Famous Simplex Typewriter          | \$2.50 |
| False Mustache                     | 10c | Surprise Matches, per box          | 10c    |
| Pocket Detective (see behind yard) | 15c | Everlasting Writing Pad            | 15c    |
| Great Mind Reading Mystery         | 10c | Billions of Dollars                | 15c    |
| Thorston's Mysterious Trick Cards  | 10c | Fortune Telling Cards, per deck    | 25c    |
| Fighting Roosters, pair            | 10c | 3-Roll Moving Picture Machine      | \$2.00 |
| Spirit Ring                        | 20c | Excellent Solar 4-Drawer Telescope | 1.85   |
| Monstrous Penny                    | 20c | Keyless Combination Padlock        | 25c    |
| Magic Plate Lifter                 | 25c | Rubber Dugger (very surprising)    | 25c    |
| Resisting Gold Teeth               | 10c | Boys' Book "How to Make Toys"      | 10c    |
| Barking Dog (imitates dog bark)    | 20c | Irresistible Ink, per bottle       | 15c    |
| Great First-coming Trick           | 20c | Magic Nose Blower                  | 10c    |
| Magic Ball and Vase Trick          | 20c | Dying Pic Balloon                  | 25c    |
| Naked Truth Joke (Magic Card)      | 15c | Imitation Bird Eggs                | 25c    |
| Chicken Inspector Badge            | 10c | Kissing Permit Badge               | 10c    |

JOHNSON SMITH & CO. Dept. 290, Racine, Wis.





## Tobacco Is Hurting You

Look at the facts square in the face, Mr. Tobacco User. You may think tobacco is not hurting you.

That is because you haven't as yet, perhaps, felt the effects of the nicotine poison in YOUR system. For you know that nicotine, as absorbed into the system through smoking and chewing tobacco, is a slow working poison. Slow, yes—but sure.

Tobacco is lowering your efficiency. It slows a man down. Makes it harder for you to concentrate your mind on your work. You haven't near the amount of "pep" and energy you would have if you stopped using it. There's many a man twice as old as you in years who's twice as young in energy, simply because he lets tobacco alone.

Some day you will realize to what an alarming extent tobacco has undermined your system.

When your hands begin to tremble—  
and your appetite begins to fail—  
and your heart seems to "skip a beat" now and then—  
and slight exertion makes you short of breath—  
then you have a right to suspect that  
**TOBACCO** is getting the upper hand.

Any well-informed doctor will tell you that these are only a few of many symptoms of tobacco poisoning.

And YOU know that the use of tobacco in any form is an expensive, utterly useless habit. You know you ought to quit.

## Tobacco Habit Banished Let Us Help You

It doesn't make a particle of difference whether you've been a user of tobacco for a single month or 50 years, or how much you use, or in what form you use it—whether you smoke cigars, cigarettes, pipe, chew plug or fine cut or use snuff—**Tobacco Redeemer** will positively remove all craving for tobacco in any form in a very few days. Not the slightest shock to the nervous system. Your tobacco craving will usually begin to decrease after the very first dose—there's no long waiting for results.

**Tobacco Redeemer** contains no habit-forming drugs of any kind and is marvelously quick, scientific and thoroughly reliable.

It is in no sense a substitute for tobacco. After finishing the treatment you have absolutely no desire to use tobacco again or to continue the use of the remedy. It helps to quiet the nerves and make you feel better in every way.

### Results Guaranteed

A single trial will convince you. Our legal-binding, money-back guarantee goes with each full treatment. We will refund every cent you pay for the treatment if after taking it according to the easy-to-follow directions, it should fail to banish the tobacco habit completely.

### SEND Coupon for Free Proof

Let us send you our free booklet on the deadly effects of tobacco, together with testimonial letters from men all over the country telling how they have been absolutely freed from the tobacco habit by this simple home treatment. You could not ask for stronger proof that **Tobacco Redeemer** will free you from the habit than the evidence we will gladly send on request. Just mail the coupon—or a postal will do.

**NEWELL PHARMACAL CO.**  
Dept. 300 St. Louis, Mo.



## Free Book Coupon

**NEWELL PHARMACAL CO.**

Dept. 300

St. Louis, Mo.

Please send, without obligating me in any way, your free booklet regarding the tobacco habit and proof that **Tobacco Redeemer** will positively free me from the tobacco habit or my money will be refunded.

Name .....

Street and No. ....

Town..... State.....



# We Guarantee You From \$1 to \$5 an Hour Profit

Our Agents Are the Aristocrats of the Specialty Selling Field

## The Bamboo Self-Filling Fountain Pen

Makes Money Flow Into Your Pocket

A Combined Fountain Pen and Everlasting Ink Pencil All In  
One Perfect Writing Instrument—At One-Third the Cost  
of An Ordinary Fountain Pen

**SAMPLE 65c** *Money Back  
If Not  
Pleased*

*Actual  
Size*

**New and  
Original  
Selling Plans**

The way people in every walk of life buy our Bamboo Self-Filling Style Point Fountain Pens is little less than startling. It has been demonstrated without a question that it is the most profitable specialty for agents to handle. Here are but a few of its remarkable selling advantages:

**A Steady Feed**—The highest priced old style pen, selling for many times the price of the Bamboo Pen does not equal its feed. The Bamboo Pen has **No Metal** to corrode. The point being a solid piece, just as your pencil is solid the ink flows down the grooves on all sides of the point.

**It's the Point—  
Makes Perfect  
Carbon  
Copies**

With every order of pens we send our agents a complete set of **Selling Plans**, any one of which will enable you to make at least \$30 a day from the very start.

**Read What Our Agents Say  
About Profit**

Gentlemen: Enclosed find check for \$70 as part payment on five gross Bamboo Fountain pens. Total amount \$324. \$70 with order, balance C. O. D. Please rush. O. A. LUNDBERG, Willmar, Minn.

A look and a trial! That's all that was necessary to convince me of the great selling value of the Bamboo Pen. Send me at once three dozen pens and a dozen points, as a starter. Enclosed find my check for \$22.10.  
ALEX SONNENSCHNEIN, Columbia, Mo.

**Amazing Profits** Selling Price \$1.25—Agent's  
Sample Only 65c. Sample  
Free With First Dozen. We Take Back What You Don't Sell

We guarantee that if you can not make from \$1.00 to \$5.00 an hour from the start if you follow our selling Plans to take back the pens and refund your money, including postage both ways. Did you ever hear of a fairer offer!

**Get Started at Once—TODAY You Take No Risk and Have Everything to Gain**

sample order on attached coupon. Our agency is a valuable asset and worth trying for. We limit the number of agents appointed but do not coop an agent up in one small territory. In this way all have an equal chance and the agent may work wherever he feels that he can get business with least effort, and he can also appoint as many sub-agents to work under him as he likes, or can sell by mail and by any of the numerous dandy selling plans we supply.

**A Smooth Writing Style Point**—The Bamboo Pen has a Special Constructed POINT which maintains a smooth, even flow of ink. It is a treat for your pen-cramped fingers. No Scratching. No Blotting. No soiled records or instruments. You can purchase extra points, some of these write fine, others medium or heavy at only 15c each or two for 25c where pens are sold.

**Ruling Pen**—The Bamboo Pen is superior to any Special Made Ruling Pen. No ink on your ruler. No blotches, a fine even line. Neat records.

**Duplicate and Triplicate Copies**—Copying is a Pleasure with the **Style Point**. Make as many copies as you like with the same fine lines. Original instrument. No other pen can duplicate this service.

**Cleanliness—Self-Filling**—The Bamboo Pen has an unusually large ink reservoir. Everwear Pencil-like Point. No bend. No leaks. Clean fingers. Clean records. Always ready.

**Durability**—This pen is especially constructed for service and to best meet every requirement of the business and professional world. Bamboo construction gives this pen the light weight of an ordinary pencil, and you know how durable are the strong fibers of bamboo.

**Our Guarantee**—The Bamboo Pen is fully guaranteed for a period of one year against any defect in workmanship. If, for any reason, it ceases to function satisfactorily we will, upon its return, repair or replace without charge regardless of how it breaks.

## Ford Car FREE

To every hustler. Write for our FREE Ford Offer. Send for our FREE wholesale specialty and novelty catalogue. Anyone can establish a large mail order business. Get our mail order proposition.

**FRANK SPORS & CO.**

340-344 Main Street

Lesueur Center Minnesota

-----CUT OUT AND MAIL TODAY-----

**FRANK SPORS & CO.,**  
Dept. P. M., Lesueur Center, Minn.

Gentlemen: Kindly send me your Bamboo Self-Filling Fountain Pen as marked below. I will pay postman agent's special price indicated (plus postage) on arrival, with the understanding, that my money will be returned on return of pen if I can not earn from \$1.00 to \$5.00 per hour.

- One Bamboo Self-Filling Pen at agent's price, 65c.  
 One Dozen Self-Filling Pens at agent's price, \$7.80.  
(Mark cross in box opposite proposition wanted.)

Name.....

Address.....

City..... State.....



## A Home and Income For You in Sunny Florida



### Be Independent—Own a Grapefruit and Orange Grove—A Truck or Poultry Farm. Increase Your Income

#### You Can Start a Grove Today Under Our New Plan

Develop a profit-earning fruit farm without leaving your present position—provide for your future. A small payment now and a few dollars invested each month.

A profit-producing fruit grove is a permanent investment and provides protection against old age.

#### THE RIGHT LAND IN THE RIGHT LOCATION AT THE RIGHT PRICE

#### We Have It—Any Size Farm

These splendid lands are suburban to Tampa, the metropolis of South Florida. Here you find the most healthful, the most delightful climate in North America. For ten years we have been right here helping develop Hillsboro—the banner agricultural County of Florida, and we are still here to serve you and to help you obtain the farm you want, on very easy payments extending over 2 or 3 years' time to suit.

#### Groves Developed for Non-Residents

If you want to remain in your present position for a few years we can develop a grapefruit and orange grove for you. When you are ready we will clear your land, furnish fruit trees, plant and care for your grove until you are ready to look after it.

#### We Raise Our Own Guaranteed Citrus Trees in Our Own Nurseries

This insures every purchaser the best fruit trees that can be grown. This also insures a successful grove. We can save you money on planting and caring for your grove.

#### \$300.00 to \$500.00 Per Acre Profit

This is not an unusual return for truck farmers in the Famous Tampa district. All kinds of vegetables can be grown. Big prices are paid for early potatoes, Winter cabbage, Bermuda onions, tomatoes, celery and dozens of other vegetables during the Winter and early Spring, when the north is covered with ice and snow. Strawberries, Melons and other small fruits, also yield large profits.

#### Write for Facts About Sunny Florida

IT COSTS YOU NOTHING TO LET US PROVE TO YOU that we have the land you want—in the location you want—at a price you can afford to pay and on the easiest terms you can imagine. Let us show you.

Fill out and mail us the coupon today and receive our large descriptive book FREE!

## NORTH TAMPA LAND CO.

404 Zack Street

TAMPA, FLA.

*Coupon for FREE Book on Florida*

NORTH TAMPA LAND CO.

404 Zack St., TAMPA, FLA.

Please send me your large illustrated Book, "The Call of the Southland," on choice Citrus Fruit and Truck Farms suburban to Tampa, Florida, and information on how I can have a grove developed on the monthly payment plan. P. M. 2-25

Name.....

St. No.....

City.....

State.....

## SANDS LEVELS

### The Sign of Master Workmen

Novices and apprentices may start out with various other levels—but sooner or later they come to Sand's. Experienced craftsmen know. That's why no matter where you go, the majority of levels on the job carry the name "Sands."



If you like good tools, the factory built-in accuracy and many other advantages of Sand's Levels will appeal to you.

Ask your dealer.

Sand's  
Wood and  
Aluminum Levels  
For Every Purpose at  
Good Hardware Stores  
Everywhere

24" 6 Glass  
Aluminum  
**\$5.50**

**SANDS LEVEL & TOOL CO.**  
5883 Fischer Ave., DETROIT, MICH.

**Home Mechanics** 329 ideas for repairing, improving and making devices needed about the home. Simple directions and illuminating illustrations. Only 50 cents. Write POPULAR MECHANICS PRESS, Popular Mechanics Bldg., Rm. 711, Chicago, Ill.



## Don't Risk a Truss!

Now you can throw away forever steel bands, chafing leg straps and other heavy makeshift devices. For a well known American Scientist has found a new easy way to support rupture assisted by means of a wonderful little invention weighing less than 1-25 of an ounce. Not only do you do away with the objectional pressure and tight strapping, but you eliminate the "coming down" of rupture—when running, straining, exercising, sneezing, etc.—which too frequently leads to strangulation. So great has been the success of this wonderful device that it is being offered to ruptured people on an absolute guarantee of instant satisfaction or no cost. Simply drop a postcard or letter requesting free literature to **NEW SCIENCE INSTITUTE, 2109 Clay Street, Steubenville, Ohio.**



# AGENTS ~ \$100 to \$200 a Week ~ and a Ford Besides!



## Hutchison Discovers New Fuel for Automobiles

Inventor of Klaxon Horn and former chief of Edison Laboratories perfects inexpensive gasoline vitalizer that ends carbon formation—increases mileage 20%—cuts down deadly carbon monoxide gas—makes motor start easily in cold weather—adds power and pick-up to motor—reduces repair bills and makes motoring a greater pleasure than ever before! Amazing opportunity for agents and city distributors.

ONLY two ounces of this amazing new super-fuel added to five gallons of gasoline produces remarkable results! The carbon-knock stops—the hard, brittle carbon in cylinders begins to soften up and disappear—starting becomes easy even in zero weather—and the motor actually uses about 20% less gasoline! Motorists go wild over it. Salesmen are cleaning up!

### By Inventor of Klaxon Horn

Hutch-Olene is the only product of its kind with a real scientific foundation. Perfected by Dr. Miller Reese Hutchison, inventor of the famous Klaxon Horn, the Acousticon and the Dictograph. For 20 years Dr. Hutchison was chief of the Edison Laboratories and helped to perfect the wonderful Edison Storage Battery!

### 15 Million Prospects

Auto owners everywhere are now using inferior and often harmful gasoline tonics. Even the most ordinary of these tonics are in big demand because the public knows that gasoline itself is inadequate. Millions

of dollars have already been spent "educating" motorists to use gasoline tonics. And Hutch-Olene comes right at the peak of the big demand.

### Big Money Being Made

You can start in on very little capital. The profits on the first order put you on the road to big money. You need not give up your present job—you need not drop your other lines in order to handle Hutch-Olene. Try it out—test it in your own car and prove to yourself that it is the greatest money-making proposition you ever heard of! Hundreds of agents and salesmen now selling Hutch-Olene in spare time are making \$10 to \$25 a day. Scores of live-wire salesmen who devote their full time to Hutch-Olene are making \$100 to \$200 a week!

### FREE OFFER— Send No Money

If you want to make a lot of money quickly—mail the coupon now for our Special Offer that enables you to try a can of Hutch-Olene without cost. Act Quick. This is your one BIG chance to earn a great deal of money on little capital. Mail this coupon now!

Salesmen  
Distributors  
Spare Time  
Workers—



### We Furnish an Auto

To help you sell more Hutch-Olene—to help you get the most out of your full time or spare time, we offer to provide you with a Ford car—without a penny of expense to you. Send coupon below for offer that enables you to own an auto and to earn \$100 to \$200 a week besides. Do it now!

HUTCH-OLENE COMPANY, Dept. 42  
334 Fifth Avenue, New York City.

Gentlemen:  
Send me full particulars about your special free offer and show me how to earn \$100 to \$200 a week selling Hutch-Olene. This does not obligate me in any way.

Name.....  
Address.....  
City..... State.....

# Hutcholene





## Harris Homes Beautiful

Bungalows — Semi-Bungalows — Cottages — Residences! If you want a real home combining an impressive exterior and comfortable, well planned, homey room arrangement, you must see the latest De Luxe Addition of our latest book of Homes and Building Materials. More than a hundred modern, attractive, livable houses, featuring all that is best in construction—each one an architectural triumph carefully planned and designed by expert architects.

All Harris Homes Beautiful have been built many times with big economy and life-long satisfaction to their owners. They present a perfect combination of approved construction, finest materials, "planned the Harris way" to save from \$500.00 to \$1,500.00 of your money. Ask for your copy of this free 400-page Building Material Book, No. CB-7, today.

### Thousands of Bargains Like These



Combination Screen and Storm Door. Size 2/8x7/1. quickly changed, each

\$6.77



2 light 24"x20" glazed, checkrail windows, 1-3/8" thick, outside measure 2/4-1/8 x 3/10, each

\$2.50



The bathroom outfit shown includes bathtub five feet long, white porcelain enameled on the inside, low pattern white tank closet outfit and white porcelain enameled lavatory complete with all fittings above floor line, special at.....

\$65.00



Clear White Pine Storm Sash with frames, 1-1/8" thick. Best clear glass, each light 8x10. Outside measure 1/8x11 3/8, each.....

\$1.53



Economy Special panelled doors, size 2/6x6/6, 1-3/8" thick, each.....

\$3.20

## HARRIS BROTHERS CO.

Dept. CB-7

35th and Iron Streets

CHICAGO, ILL.

### Make Your Tool Kit Complete

10 WRENCHES IN ONE

## Polly

No tool kit is complete without an assortment of wrenches. The "Polly" affords complete equipment with fewer wrenches at less cost. Entirely new principle, instant adjustment. Jaws cannot change adjustment while using. Light weight; more convenient handle; strongest wrench made. 6 in. 85c; 9 in. \$1.25; 12 in. \$1.75 or complete set, \$3.85. From your dealer, or sent prepaid on receipt of price.

GELLMAN MFG. CO.  
Dept. 15 Rock Island, Ill.



Pat. Appl. 17, 1921



### WHY APPEAR BOWLEGGED OR KNOCK-KNEED?

Put on a pair of Straight Leg Sock Supporters and be convinced

\$3.00 Per Pair

Send for Free Booklet

SUPPORTER SALES CO.

DEPT. F

ROME CITY, INDIANA



## Try This on Your Hair 15 Days



Then let your mirror prove results. Write for FREE Trial Offer.

Your hair need not thin out, nor need you become bald, for there is a way to destroy the microbe that destroys the hair. This different method will stop thinning out of the hair, lifeless hair, remove dandruff, itching, darken gray hair and threatened or increasing baldness, by strengthening and prolonging life of the hair for men and women. Send your name now before it is too late for the 15 days' free trial offer.

AYMES CO. 3932 N. ROBEY ST., M-390, CHICAGO, ILL.



TRADE MARK REG.

# WURLITZER

SUPREMACY IN MUSICAL INSTRUMENTS



## Learn to Play

You are always popular and sure of a good time if you can play some musical instrument. By yourself, with your friends around the piano, in orchestras or bands—there is no end to the pleasure music will give you. And there is no easier way to earn money in your spare time. Choose your instrument now and let Wurlitzer help you buy it and learn to play it.

## New Offer!

**Free** We now furnish free with every Wurlitzer instrument a Special Scholarship in a nationally famous school of music. This school has taught thousands to play by a special home study method. Many of its graduates are successful professional musicians. Whether you wish to play for pleasure or for profit, choose your favorite instrument and send for this New Offer now! Use the coupon below.

### Free Trial—Easy Payments

You may have any Wurlitzer instrument for a week's free trial in your own home. No obligation to buy. See for yourself the superior quality of these famous instruments, the result of 200 years' experience in musical instrument building. Masters in every sphere of music praise Wurlitzer instruments for artistic quality, rich tone values and fine workmanship. Payments are arranged in convenient small monthly sums—a few cents a day will pay for your instrument.

### Send for **Free Book!**

Every known musical instrument described and illustrated—many shown in full colors. More than 3,000 articles. All genuine Wurlitzer instruments—buying direct from Wurlitzer saves you money. Special offers on complete outfits; also full details of our Free Trial—Easy Payment plan and New Free Scholarship Offer. Book is free—no obligation. Send for it TODAY.

**The Rudolph Wurlitzer Co., Dept. 1772**  
 117 E. 4th St., Cincinnati    329 S. Wabash Ave., Chicago  
 120 W. 42nd St., New York    250 Stockton St. San Francisco

Send me your Free Book on Musical Instruments with details of Free Trial—Easy Payment plan and New Free Scholarship Offer. No obligation.

Name.....

Address.....

City..... State.....

Instrument.....  
(State instrument in which you are interested.)



# DELTA



## No. 37 BICYCLE SPOTLIGHT

*A Strong Beam of Light Where the Rider Wants It When He Wants It*

### A Bike Light That Equals a Good Auto Spotlight

The only truly Bicycle Spotlight on the market. Strictly high powered. Not a common Bicycle light or marker, but a spotlight equal to a good auto spotlight. Throws powerful beam of light in any direction at will of rider. Head 4 1/4 inches in diameter. Improved bracket, fits any handlebar. Operates on two dry cells. At your dealer or sent prepaid for \$3.75 complete (less batteries). Packed in Christmas wrappers—makes very appropriate gift.

#### DELTA ELECTRIC COMPANY

100 Delta Block MARION, IND.

Standard Makers of Auto Spotlights, Motorcycle Spotlights, Bicycle Lamps, Electric Lanterns, Radio Head-Phones, Flashlights and Flashlight Batteries.

New York  
Export Dept.  
10 Water St.

Chattanooga  
Faucette-Huston Co.

San Francisco  
Sanford Bros.  
311 Minna St.

## "The Only Thing of Its Kind in the World!"

That is what many have said of The Boy Mechanic Library. And it is true, because there is no other library that contains so many practical ideas so simply explained. The ideas are of interest to men, women and children everywhere.

### Four Books—4,311 Articles, 3,917 Pictures

Can you imagine such a world of interesting things? Where did they all come from? Every one is the experience of someone who actually made the device described. Dad can learn how to make fishing tackle, furniture, hunting equipment, electric light fixtures, and so on. Mother will learn how to make hot-dish holders, broom holders, clothes dryer, work basket, decorative leather work, and so on. Sister will learn how to make a hanging vase, reed furniture, film developing machine, paper lamp shades, and so on. And the boys will learn how to make a boy's motor car, a coasting toboggan, an ice yacht, a model monoplane, a merry-go-round, a submarine camera, and so on.

**SEND NO MONEY**—These books sell for \$2 per book, but you should have the entire library of four books. A special price of only \$7 is made on the complete library. Simply write a postal asking that the books be sent C.O.D. When the postman delivers the books to you, hand him \$7 plus the few cents postage.

#### POPULAR MECHANICS PRESS

Popular Mechanics Building  
Room 711, Chicago, Ill.

S  
E  
N  
D  
N  
O  
M  
O  
N  
E  
Y



# 1925 SHOP NOTES Ready

Filled to overflowing with ideas for all kinds of shop work, the 1925 edition of Popular Mechanics Shop Notes is the biggest bargain in this type of information. Hundreds of simple mechanical devices are described so simply that even a boy can make most of them with ordinary tools.

## 519 Articles—596 Pictures

The fact that there are more pictures than articles shows you that this is an easy book to use. In many cases, the pictures alone show you how to make a clever device that will save time or labor on some important job.

## Make up a Complete Library

There are now 15 volumes of the Shop Notes Books available at 50c each. You should have the complete library. If you have a few volumes and want to complete your set, write and tell us what numbers you have. We will then send those you do not have C.O.D. and you may pay the postman when they arrive. The complete library of 15 volumes for \$7.

**Send No Money.** Simply tell whether you want the complete library or certain numbers. When the postman delivers them to your home, pay him the price plus the few cents postage.

**50c** POPULAR MECHANICS PRESS Room 701 Popular Mechanics Bldg., Chicago **50c**

**FREE** Illustrated 16-page magazine, "Personal Advancement." Tells how to plan a career, to prepare yourself for a bigger salary; how to improve your knowledge and ability on many important subjects. Issued about eight times a year. Free if you ask for it.

**POPULAR MECHANICS PRESS**  
Popular Mechanics Building, Room 711, Chicago, Ill.

## Handbook for Farmers

861 discoveries by practical farmers, telling how to make, repair or improve the various devices and machines used about a farm or garden. 683 illustrations. "The Most Remarkable Book Ever Published for Farmers," says one authority. **Send No Money.** When the postman delivers the book to you, hand him \$1 plus the few cents postage.

**POPULAR MECHANICS PRESS**  
Popular Mechanics Building, Room 711, Chicago, Ill.

## BUILD A BOAT

Simple and complete directions for building 21 kinds of boats and canoes are to be found in Popular Mechanics Boat Book. Tells how to make most every kind of boat, from a log canoe to a high-powered motor racing boat. Also tells **50c** how to make anchors, landings, and other boat accessories. For boys or men.

**POPULAR MECHANICS PRESS**  
Popular Mechanics Building, Room 711, CHICAGO, ILL.

**FREE MAGAZINE**  
A free subscription to Personal Advancement with each order. Mail postal to-day direct to the publishers.





*"Buy a Studebaker Direct from the Maker"*

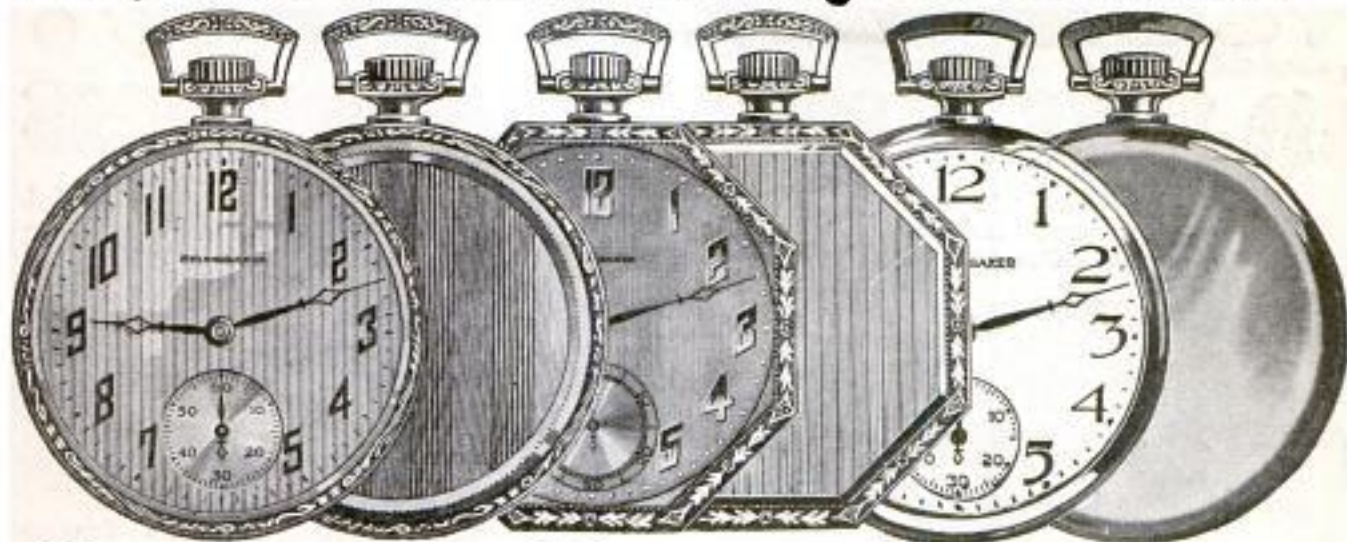

**Only \$1 Down!**

Just \$1.00! The balance in easy monthly payments. You get the famous Studebaker, 21 Jewel Watch—Insured for a lifetime—direct from the maker at lowest prices ever named on equal quality. Send at once for FREE Book of advance Watch Styles.

## 21 Jewel STUDEBAKER -the Insured Watch

Choice of 54 latest, thin model, Art Beauty Cases in yellow gold, green gold or white gold effects; 8 adjustments, including heat, cold, isochronism and 5 positions. Direct to you from the factory—the greatest watch value in America today!

**Write for Style Book!** Send at once and get a copy of this book—FREE! See the newest, beautiful, advance styles in Studebaker Art Beauty Cases and Dials. Read how you can buy a 21 Jewel Studebaker Insured Watch direct from the maker—save big money—and pay for it while you are using it. Write for our Free Book. It will post you on watch styles and watch values. Send coupon at once. Get Free Chain offer today while it lasts.

**STUDEBAKER WATCH CO.**  
Dept. H-22 South Bend, Indiana  
Canadian Address: Windsor, Ontario

### Mail Coupon for Free Book

**STUDEBAKER WATCH CO.**  
Dept. H-22 South Bend, Indiana  
Please send me your Free Book of Advance Watch Styles and particulars of your \$1.00 down offer.  
If you live in Canada send your inquiry to our Canadian office: Windsor, Ontario.

Name.....

Address.....

City..... State.....

- Check here for Ladies' Watch Folder.  
 Check here for Jewelry Folder.

#### FREE! WATCH CHAIN

For a limited time we are offering a beautiful Watch Chain FREE. Write now while offer lasts.



Write for special folder showing Ladies' Bracelet Watches in newest designs and shapes.

Latest  
Style,  
Thin Models



# \$1000<sup>00</sup> Monthly! in this fascinating business



You have wished a thousand times for a thriving, money-making business—**here it is!** You have often read of men and women who started out in a small way and quickly accumulated a fortune, and have wondered why you never had a similar opportunity—**here it is!**

This automatic machine does the work. It makes TATER-FLAKES, an improved potato chip that is relished by everybody. With this newly invented machine—a good location—and a medium-sized storeroom—you can make more money than you ever dreamed of making. You not only retail across the counter, but you sell thousands of packages wholesale.

Grocers, restaurants, druggists, pool rooms, cigar stands, and so on buy TATER-FLAKES in large lots. Sullivan, Ind., makes

**\$150 weekly.** Hoffman and McLeish, Ky., running around **\$60 daily.** Tice, Ill., **\$125 weekly.**

**\$2.50 Worth of Potatoes Make \$25 Worth of Tater-Flakes**

Figure the profit. Is it any wonder over 200 Tater-Flakes stores now in operation are averaging from \$100 to \$250 weekly? Women as well as men are successful. TATER-FLAKES are such a vast improvement over ordinary potato chips that sales increase rapidly from the start.

*Tater-flakes*  
"They're Smackin' Good"  
**10¢**

## This Machine

is entirely automatic. Anybody may operate it without previous experience. It slices, drops, cooks, crisps, browns and delivers. Place in a display window, if possible. Its action attracts widespread attention. Appetizing odor whets the appetite and sales are readily made.

## Write Now for Information

Get into this fascinating business. Be the TATER-FLAKES man or woman in your vicinity. We give every reasonable assistance possible to machine owners—furnish supplies, display material, advertising matter and sales helps. You become a member of the TATER-FLAKES organization of manufacturers which is fast becoming national in scope, and will be of untold advantage to you. Get complete and full information. Write today

### TATER-FLAKES COMPANY, Inc.

20 E. Jackson Blvd. Suite 214 Chicago, Ill.



## Dynamos, Motors, Battery Chargers

Farm Plants  
Motor-Generators, Etc.  
**1/2 K.W. \$39.50 Up to 10 K.W.**

Any voltage 6 volts to 500 volts.  
Fine new machines. Standard type.  
Factory Prices. Guaranteed. Tell us what you need. We have it.

STAR DYNAMO WORKS

JEFFERSON CITY, MO.



## HB 8 HOUR Battery Charging Pays Big Monthly Profits

Just \$35 cash puts HB One Day Battery Charging in your shop—complete with bench, bus bars, resistance leads, connectors, cables, etc.—all ready to set up and operate. Easy terms let your monthly profits quickly pay balance. This HB is the lowest-priced complete outfit on the market. 30 days' trial on money-back guarantee. More HB's in use than any other make. Write for free bulletin 268.

HOBART BROS. CO.

Box M 2

TROY, OHIO

Profits Easily Carry Small Monthly Payments





# Makes Autos Go 49 Miles On One Gallon of Gas

I have perfected an amazing new Gas-Saver and Carbon Remover for practically all makes of cars that is enabling auto owners all over the country to more than double their mileage from gasoline used. At the same time it removes every particle of carbon from their motors. Many cars with this device attached have made over 49 miles on a gallon. It also greatly increases motor power and pep and eliminates all spark plug difficulties. And the best part of it is this inexpensive little device is entirely automatic and self-regulating and can be easily attached or detached by anyone in five minutes.

## I Want You For My Agent To Sell My Marvelous New Device

I want this startling new invention introduced everywhere. I need energetic men who desire to earn big money to act as State and County Distributors—men who appreciate a REAL opportunity.

My Wesco Gas-Saver and Carbon Remover practically sells itself. Wherever it has been shown, the demand has become so great that my representatives are practically besieged with orders. If you do not have an automobile don't let this hold you back, for one of my best state distributors had no car when he started. My plan will start you practically without capital in a business of your own that should make you big profits. I will give you particulars about my famous sales plan, and help you with free advertising matter, inquiries from prospects, etc. It means big money in your pocket. Send coupon now for my SPECIAL FREE WESCO DEVICE OFFER and further details.

### Gets 50 Miles on One Gallon of Gasoline

"Customers like Wesco fine. Have one myself on my old Overland and ran 50 miles on a gallon."

H. J. KRAMER, Minnesota.

### Gets 44 Miles on a Gallon

"Received the Wesco and am well pleased. I gave it a test and made 44 miles on a gallon of gas."

DEWEY S. KAGG, Ohio.

### Wesco Proves 20% Better Than a More Expensive Gas Saving Device

"Took a \$10.00 gas saving device off a car and put on a Wesco—result was a 20% further reduction in gas used, more power, better getaway and a satisfied customer."

GLEN E. MORRIS, Iowa.

### Made 35 Miles on 3 Gallons of Gas

"I made 11 miles on a quart of gas on one test and 35 miles with three quarts of gas."

CHAS. LUTZERN, Wisconsin.

### Drove 20 Miles on 1/2 Gallon of Gas

"I tried the Wesco Gas-Saver. Drove 20 miles and only used 1/2 gallon of gas, and my car has more pep, runs like new and spark plugs do not dirty so fast."

FRANK A. CHEVAL, Nebraska.

### Made 41 Miles on Gallon of Gas

"I made 41 miles on a gallon of gas and know I can make 45 on a trip."

ARTHUR N. SOLLEE, Florida.

### Gets 42 Miles on One Gallon Wouldn't Take \$50.00 For His "Wesco"

"I am getting about 42 miles on a gallon regularly with Wesco. Wouldn't take \$50.00 for it."

A. KIMBALL, Ohio.

### 100% As Advertised

"I WAS a skeptic of all gas-savers but after I have given your Wesco the acid test I find it to be 100 per cent as you advertised."

JAMES E. KARRS, Indiana.

### Gives Buick New Life

"I received the Wesco. It gives my Buick new life."

SPENCER MILLER, Idaho.

### Works Fine on Studebaker and Chevrolet

"Put a Wesco on my Studebaker and it works fine. Put one on a Chevrolet and owner said he wouldn't take ten dollars for it."

ROY ARMSTRONG, Illinois.

### Satisfies Oldsmobile Owner

"I am well satisfied with my Wesco."

WM. THOMPSON, Quebec, Canada.

### Satisfies Briscoe and Chevrolet Owners

"I have put one Wesco on a Briscoe and one on a Chevrolet and they work fine."

J. J. PROSSER.

### Put on Star and Maxwell Satisfactorily

"Have tried the Wesco on a Star and Maxwell and found them satisfactory."

GEORGE HANAN, Illinois.

## Car Owners Wanted To Sell and Demonstrate this Amazing New Device

—part or full time. Interests every auto owner immediately and each one sold sells others. It makes no difference what car they drive. I have a Wesco to fit all makes in general use.

## Get Your WESCO GAS SAVER FREE and Carbon Remover FREE

Equip your own car without a penny of cost and you will find it easy to take orders everywhere with my free trial and money back offer. I am willing to send a sample at my own risk to one car owner in each locality who can show it to neighbors and handle the big volume of business which will be built up wherever it is shown. Don't wait, be the first from your territory to distribute this quick seller. Clip out the coupon below and mail it now.

## Make \$10,000 A Year

Read the letters in this ad telling how my men are earning BIG MONEY. You have often said to yourself, "How easy it would be to sell a device which increased gasoline mileage and removes carbon. I could sell thousands of them." Well, here it is—for you. The field of prospects runs into millions. It is easy to install and sells like hot cakes. Auto owners want it because it saves them money—cuts down gasoline consumption from 1/2 to 1/3, banishes carbon and gives an amazing increase in power and pep.

You can sell a whole delivery truck fleet just as quick as you can sell one car. You can sell WESCOS to merchants or farmers for every car, truck or tractor they may have—all with the one sale. That means hundreds of sales—SURE QUICK PROFITS—BIG MONEY FOR YOU—A BUSINESS OF YOUR OWN. Don't wait. Get a Wesco on your car and show it to a prospect. He will want one at once. Thousands being sold—millions can be and will be sold. Some of that money might just as well be yours if you become my agent. Grasp this big money-making opportunity. Send in this coupon and get started quick, selling this whirlwind money maker. Don't delay—Mail coupon today to

JAMES A. MAY, President  
**Western Specialty Co.**  
101 Lacotah Bldg., Sioux Falls, S. Dak.

### Sells 50 in Half-Day, Profit \$112.50

"Received lot of 100 Wescos this morning. Before noon had personally sold 50. There's a wonderful field for your article, and when we get organized will be able to sell 500 to 1,000 per week." A. O. GALLOWAY, Ohio.

### Sold 3 in 3 Minutes

"I received my Wesco O. K.—was well pleased. Sold 3 in 3 minutes."

JESSIE H. PETTYJOHN, Georgia.

### Wesco Sells Itself—Will Make Me Independent

"You were right when you said the Wesco sells itself. I have placed every one I ordered. Your article will make me independent."

F. M. VON KARLOWITZ, Texas.

### Hupmobile Owner Wouldn't Be Without It

"Put the Wesco on my 1919 Hupmobile. Got perfect satisfaction in gas consumption and carbon removing. Wouldn't be without it."

MAX HANSCHMANN, New York.

### Sells Wescos Faster Than He Can Order Them

"Am getting along fine—sell them faster than I can order them."

GLEN SPOONEMORE, Iowa.

### Sold 2 in 5 Minutes

"I have tried my Wesco Gas-Saver and am satisfied it is all right. Sold 2 in 5 minutes."

A. E. JOHNSON, Wisconsin.

### Sold 8 in One Day

"I have sold eight today."

J. C. MURPHY, Georgia.

### Sold 61 in 2 Days

"I am sure your Wesco will prove O.K., have 91 orders in two days."

M. L. HOCKETT, Calif.

### Sold 10 One Morning

"I have given the Wesco a good tryout and am well pleased with it. Sold ten this morning."

THOS. E. HAN-

SINGTON, Louisiana.

### Mail This Coupon To-day

Western Specialty Co., 101 Lacotah Bldg., Sioux Falls, S. Dak.

Attention: J. A. May, President. I am interested in your Wesco and would like to try it on my car. Please send me a Wesco and the literature. I will pay for the shipping and handling charges. Also send me how I can secure a WESCO FREE.

Name \_\_\_\_\_

Rt. or R. F. D. \_\_\_\_\_

Post Office \_\_\_\_\_

State \_\_\_\_\_





What a whale of a difference  
just a few cents make



# Marshall Radio Frequency Receivers

*Embodying a Marvelous New, Non-Oscillating Principle*

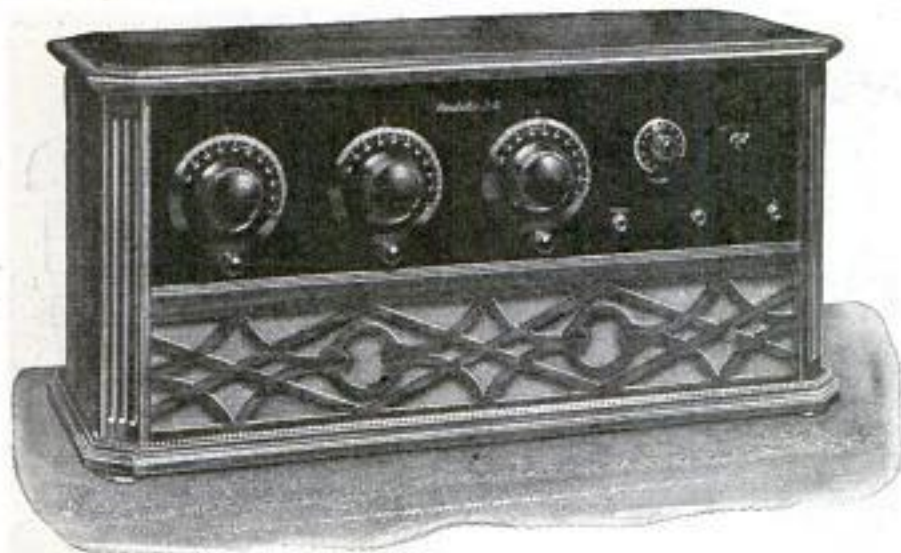

*Receiver and Loud Speaker in Combination Cabinet of Solid mahogany*

**Sold Direct to You  
on FREE TRIAL  
and TERMS as low as** **\$5<sup>00</sup>  
DOWN**

**WRITE TODAY** for full particulars of this most exceptional offer. Marshall Sets embody the very latest improvements known to radio. The wonderful new principal involved is proving the sensation of the 1924-25 radio season. Zero Coupling—the problem which radio engineers have been working on for years—has at last been solved. As a result, the Marshall has no need of neutralizing condensers or other make-shift methods of avoiding internal oscillations which invariably reduce efficiency. The Marshall Tuned Radio Frequency Receiver brings to radio a new degree of musical quality. Its selectivity will delight the experienced radio operator. Yet it is so easy to tune that the novice will handle it like an expert.

## Small Monthly Payments—2 Weeks Free Trial

That is the remarkable offer we are prepared to make you. Two weeks to prove that the outfit you select is everything we have said for it. If it doesn't make good our claims, back it comes, and your deposit will be cheerfully refunded. But if it fulfills all your expectations, you may pay for it in easy monthly installments. You don't risk a cent when ordering from us. You *must* be satisfied, or we don't do business. Is it any wonder that radio buyers, the country over, are rushing to take advantage of such an offer? If YOU are interested, figure on getting your order in early, while prompt shipment can be made. Everyone predicts a serious shortage of radio supplies this season. Send for full particulars today.

### Beautiful Solid Mahogany Combination

Compare the beautiful Combination Cabinet, pictured above, with the usual radio box and horn. Here the Receiver and Loud Speaker are contained in a single handsome cabinet. Or, if you prefer, we also have the Receiver in a separate cabinet of the same design. These cabinets are the work of a master designer—fashioned of solid mahogany. They will harmonize with the furnishings of the finer homes. In spite of the extra value, these Marshall sets are surprisingly low in price. Compare them with others which sell for cash. Then remember you can order a Marshall outfit on two weeks' free trial and pay for it on very easy terms.

### Complete Outfits If Desired

In buying from Marshall, you have the choice of a set complete with all accessories, or the set alone. You have choice of dry cell or storage battery outfits. Unless you already own the accessories, you can buy them from us at less-than-market prices, with your set, on easy terms. Your outfit will come all ready to set up and operate within a few minutes—saving time and trouble—and saving money, too.

**MARSHALL RADIO PRODUCTS, INC.**  
Marshall Blvd. and 19th St., Dept. 13-52 Chicago, Ill.

### Send Coupon for Special Offer!

If you have any idea of buying a radio set this year, don't let this chance slip by. Our terms and liberal guarantees have set a new pace in the radio business. The low prices we will make you on a 3, 4, or 5 tube Marshall set will surprise you. A letter, postcard, or just the coupon will do. But send it today. We also have a most favorable offer for radio dealers. Write.

Marshall Radio Products, Inc.  
Marshall Blvd. and 19th St., Dept. 13-52 Chicago  
Please send me your special offer price, terms and full description of Marshall Radio Outfits. Though I may change my mind on receiving your proposition, my preference now is for a:

.....3 Tube .....4 Tube .....5 Tube (Please check)

Name .....

Address .....



# How You Can Make Soft Woods Beautiful as Hardwood



Send for the Johnson Book on Wood Finishing. It is authoritative and profusely illustrated—includes color charts. Use coupon below.

## Johnson's Wood Dye

(PENETRATING)

With Johnson's Wood Dye, inexpensive soft woods may be finished so they are as beautiful and artistic as hardwood. Johnson's Wood Dye is very easy to apply. It dries in four hours and will not rub off or smudge. It penetrates deeply bringing out the beauty of the grain without raising it.

Johnson's Wood Dye is made in 17 beautiful shades—all of which may be easily lightened,

darkened or intermixed. Full directions on every label.

Among the most popular shades of Johnson's Wood Dye are:

123—Dark Oak	131—Walnut
129—Dark Mahogany	128—Light Oak
127—Brown Mahogany	124—Golden Oak

Select the shade of Dye you want and order it from your dealer by name and number.

**—FREE—25c BOOK ON WOOD FINISHING—**



Ask for a FREE copy of the Johnson Book at stores displaying the sign shown at right. These stores carry Johnson's Artistic Wood Finishes and will be glad to show you wood panels—and answer questions on how to properly finish wood. If no store in your locality can supply the Johnson Book—mail this coupon for a copy Free and Postpaid.

YOUR DEALER'S NAME .....

Your Name .....

Your Address .....

City and State .....

Mail to:

S. C. JOHNSON & SON, Dept. PA2, RACINE, WIS.  
"The Wood Finishing Authorities" (Canadian Factory: Brantford)







The large staff of Greer Automotive Instructors. Each man is an expert trainer, hand-picked for his specialized knowledge in the automotive trades.



ERWIN GREER

"Since 1903 I have welcomed thousands of men to my school, and sent them out equipped to work better, earn more and LIVE better. Mail the coupon below.

# 16 Things I Will Do To Make YOU

## A HIGHLY PAID MAN

### In The Automobile or Garage Business

1. Get you a job after training you.
2. Make your Scholarship unlimited—for life.
3. Allow railway fare from any point in the U. S.
4. Free taxi ticket from railroad depot to our big building.
5. Give you \$20 Kit of 23 Automobile Tools—Free.
6. Allow you free use of Shop Equipment.
7. Allow you free use of our Employment Department while training, and for life thereafter.
8. Free assistance of our welfare department.
9. Free advice to graduates on all automotive or business problems.
10. Free membership in the Greer Alumni to all graduates.
11. Free assistance in buying materials and equipment after you graduate.
12. Grant you degree of C.A.E. (Certified Automotive Engineer)
13. Free engraved diploma certifying your degree.
14. Conduct you on special inspection tours through prominent industrial plants such as the Ford Motor Co., Union Stock Yards, etc.
15. Allow you privilege of attending either day or night classes.
16. Obtain for you Social Membership in the Y. M. C. A.—Free.

### Only 8 Weeks to Complete the Training

You owe it to yourself to get into a business where you can push ahead fast. This is the business. Men leave our shops after 8 weeks of training ready to earn up to \$125 per week. We get you a job—or show you how to start in for yourself on small capital. From there on it's up to you how much you'll earn.

### Here is Where the Big Money Is Made

One man trained here earned enough in 8 years to retire in comfort—at 40. Another Greer graduate started in business for himself 18 months ago with a capital of \$400. His business is now worth \$30,000. Another averages \$400 to \$500 per month and has only been established 8 months. You have the same opportunity, but you need Greer shop training. Over 47,000 men have been trained in the big Greer Shops—over 30,000 of these men are now in business for themselves. The others are in good jobs, earning far more than they ever earned before taking Greer training. Your opportunity is HERE, too.

### Railroad Fare Allowed to Chicago

*The City of Automotive Opportunity*  
There is room for thousands more trained men in the auto, garage, or accessory business. Right here in Chicago there are over 5,000 garages and repair shops. Within 10 blocks of the big Greer Shop Building there are over 40 Auto sales Agencies. Hundreds more throughout the city. Over 16,000,000 automobiles in the U. S. Plenty of work for trained men. Come to Chicago, men. I allow railroad fare to Chicago. Get my FREE BOOK. Learn all about it. Mail the coupon.

### We Get You a Job—Which Job Do You Want?

Which job do you want? We train you for success in Automobile, Truck and Tractor repairing—Shop Management—Selling—Machine Shop—Automotive Electricity—Storage Batteries—Tire Repairing—Vulcanizing—Welding—Driving—every auto, shop and accessory job in the business. Take your choice of subjects. We get you the job after we train you. And if you need assistance we'll get you an earn-while-you-learn job while training. Mail the coupon and get my Special Offer in detail.

### Mail Coupon for Book and Offer

Take my word for it, men, this book will open your eyes to the possibilities I have only touched on here. Many pages of pictures and automobile facts. It's FREE. Get it, and look it over. Address me personally, ERWIN GREER, President

GET THIS  
FREE  
BOOK



ERWIN  
GREER

President  
Dept. 201  
2024 S. Wabash  
Avenue

CHICAGO, ILL.

Please send me FREE BOOK "How to Succeed in the Automobile and Tractor Business," and special training offer. This request does not obligate me in any way.



This mammoth new building, containing over 3 acres of floor space, is filled with modern shop equipment entirely devoted to training Greer Students.

# GREER

COLLEGE

# Automotive Engineering

Dept. 201, 2024 S. Wabash Ave.  
CHICAGO, ILL.

Name.....

Address.....





This superb 110-piece set, with initial in 2 places on every piece, decorated in blue and gold, with gold covered handles, consists of:

- 12 Dinner Plates, 7 1/2 in.
- 12 Breakfast Plates, 7 inches
- 12 Soup Plates, 7 1/4 in.
- 12 Cereal Dishes, 6 1/2 in.
- 12 Fruit Dishes, 5 1/4 inches
- 12 Cups
- 12 Saucers
- 12 Individual Bread and Butter Plates, 6 1/4 inches
- 1 Platter, 18 1/2 in.
- 1 Platter, 11 1/4 in.
- 1 Celery Dish, 8 1/2 in.
- 1 Butter Plate, 6 in.

Your Own  
Initial  
in Gold

In Two  
Places on  
Every Piece

1 Sauce Boat Tray, 7 1/4 inches  
1 Vegetable Dish, 10 1/2 inches, with lid (2 pieces)

1 Deep Bowl, 8 1/4 in.  
1 Oval Baker, 9 in.  
1 Small Deep Bowl, 5 inches

1 Sauce Boat, 7 1/4 in.  
1 Creamer  
1 Sugar Bowl with cover (2 pieces)

# NO MONEY DOWN!

No C. O. D.—Nothing to Pay for Dishes on Arrival

Mail the coupon and Hartman will send you this 110-piece Dinner Set, and with it, FREE, the 7-piece Fish and Game Set. Use both sets 30 days on *Free Trial*, and if not satisfied pay nothing—send them back. If you keep them, pay only for the Dinner Set—a little every month. Nothing for the Fish and Game Set. Every article in the Dinner Set has a white, lustrous body with rich gold band edge, a mazarine blue follow hand and 2 pure gold initials in Old English design, with

**IMPORTANT!** Hartman guarantees every piece in this set is absolutely first quality—no "seconds." This is a standard or "open" pattern. Replacement pieces may be had of us for 5 years. Each piece wrapped in tissue paper. Excellent packing to prevent breakage. Shipped at once.

graceful gold wreaths. All handles covered with gold. Every piece guaranteed perfect.



## FREE Full Size, 7-Piece Porcelain Set for Fish or Game

This beautiful 7-piece set of handsome, durable porcelain comes to you absolutely FREE, when you order the 110-piece Dinner Set. Includes one 11 1/2-inch platter and six 7-inch plates—all with assorted tinted borders and attractive colored designs in center. This complete set costs you nothing either now or later.

### FREE BARGAIN CATALOG

Over 200 pages (of which 85 pages are in actual colors) of the world's greatest bargains in Furniture, rugs, carpets, draperies, aluminumware, sewing machines, silverware, watches, etc. 30 days' free trial. Easy monthly terms on everything you buy. Opening an account with us is like opening a charge account at your local store, but you have nearly a year to pay Hartman's. Send post card only for Catalog No. E 6998



Send Post Card Today For Your FREE Copy "Let Hartman's Feather YOUR Nest"

### FREE GIFTS

Look also explains Hartman's wonderful gift plan which brings you, absolutely FREE with purchases, many splendid articles such as glassware, dishes, silverware, toilet sets, jewelry, table linens, etc.

### 110-Piece Colonial Initialed Blue and Gold Decorated DINNER SET

See these beautiful dishes on your table—then make your decision. If not satisfied, send them back and we will pay transportation charges both ways. If you keep them, pay only for the Dinner Set—a little every month. Pay nothing for the 7-piece Fish and Game Set. It is FREE. Send coupon now.

Order No. 320FFMA25. 110-Piece Dinner Set. Our Bargain Price, \$33.85. No Money Down, \$4 Monthly. 7-Piece Fish and Game Set is free

Use Coupon Only When Ordering Dishes—Mail Today!

### HARTMAN FURNITURE & CARPET CO. Dept. 6998 Chicago, Ill.

Send the 110-Piece Dinner Set No. 320FFMA25, Price \$33.85, and with it the 7-piece Porcelain Set absolutely FREE. I am to pay nothing for goods on arrival—only the small freight charges. I am to have 30 days' free trial. If satisfied, I will send you \$4.00 monthly until full price of Dinner Set, \$33.85, is paid. Will pay nothing at any time for the 7-piece Porcelain Set. Full retail price with you until paid in full. If not satisfied after 30 days' free trial, I will ship all goods back and you will pay transportation charges both ways.

Name.....  
R. F. D., Box No.....  
or Street and No.....  
Town..... State.....

**HARTMAN FURNITURE & CARPET CO.** Dept. 6998 CHICAGO  
Largest Home Furnishing Concern in the World