

# POPULAR MECHANICS

## MAGAZINE

WRITTEN SO YOU CAN UNDERSTAND IT

REGD. TRADE MARK GREAT BRITAIN No. 410428

REG. U.S. PAT. OFF.

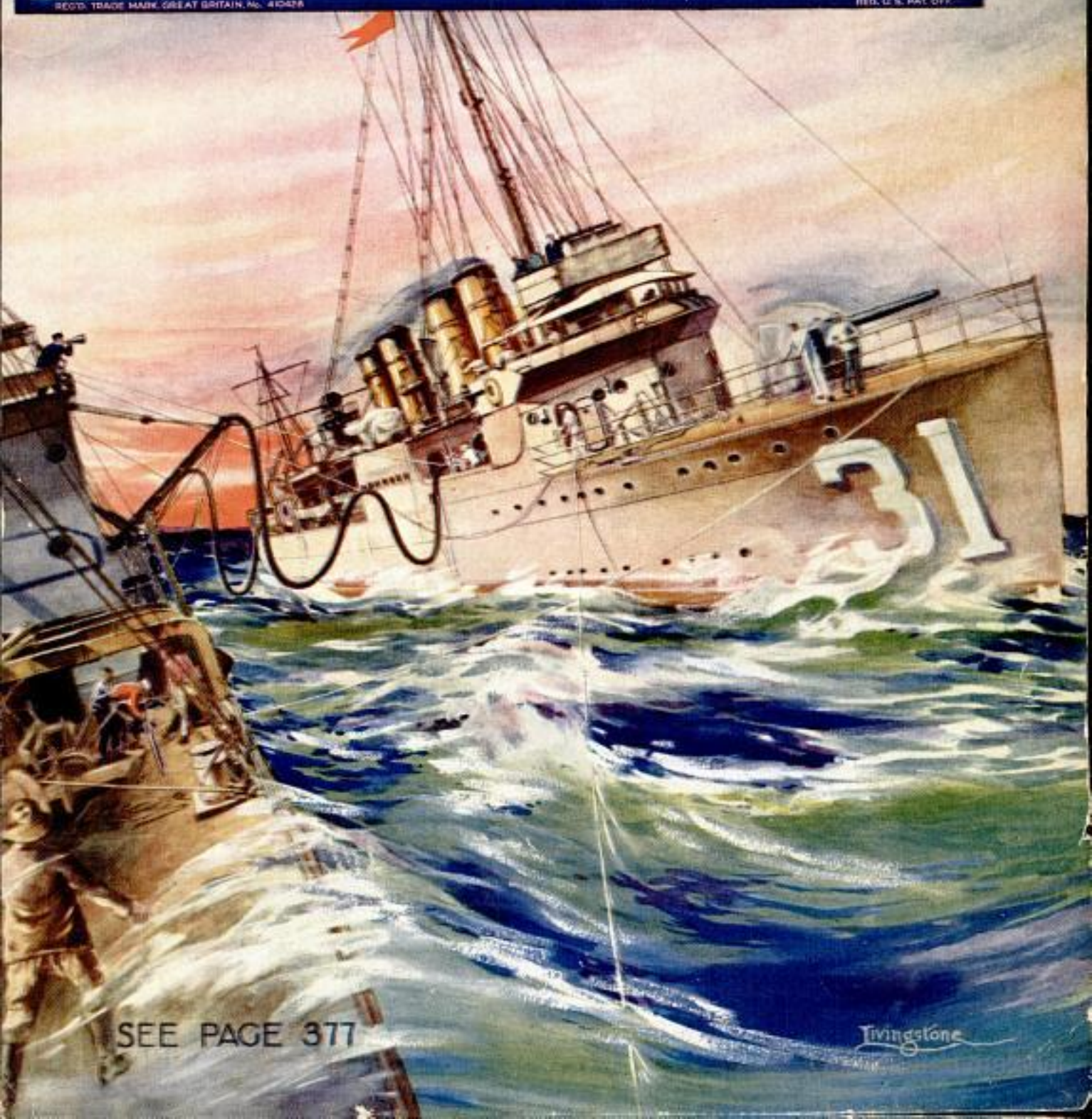

SEE PAGE 377

Livingstone





Electrical Expert

# Big Demand for Auto & Electrical EXPERTS



Tractor Expert

## \$800 Month

DEAR MAC:

Before going to your school I was working on a farm for fifty dollars a month and did not have steady work nor a bright future. Now, as a result of your training, I have my own garage and sales agency and average \$800 per month. I owe it all to your training.

(signed) GEORGE SMITH,  
West Alexandria, Ohio.

And Fred Pendley, Blowing Rock, N. C., writes: "McSweeney training made me Chief Mechanic of a big plant in three months." These two are typical of many we could quote to prove that McSweeney training paves the way to better jobs and bigger pay.

Auto Salesman or Demonstrator



Automotive and electrical fields growing by leaps and bounds. A hundred thousand more expert mechanics needed now. I can fit you in fifty days to fill a big job. McSweeney trained men earn from \$50 to \$250 per week. Read on for proof of this—

## Guarantee

To whom it may concern:

I, J. B. Dudley, will state under oath that I am now attending the McSweeney School and find everything as represented. In fact, better than expected. The course of instruction is practical and the McSweeney method of learning by actually working with real tools on real jobs under experienced instructors enables a fellow to learn a powerful lot in a few days.

(signed) J. B. DUDLEY,  
McSweeney School Student.

What more could you ask than this guarantee of satisfaction — sworn testimony of a student!

Garage Owner or Manager



**NOW**  
Two Big Schools  
to train You  
for a Big Job!

I now control the former R a h e School of Cincinnati, Ohio, and the former Cleveland Auto School of Cleveland, Ohio. Chances are you can reach one of them by a day's trip. Two fine schools advantageously located—nearest the masses of population, the most autos and most jobs.

## Railroad Fare Paid Board 8 Weeks FREE

Lack of space prevents full details.

Write for complete information about my special tuition offer with railroad fare paid and board for eight weeks free.

McSweeney Auto, Tractor & Electrical Schools

Dept. 148 (Address School Nearest You)

Send me your Big Free Book on auto and tractor business, and send me information on special reduced tuition offer with railroad fare and board paid, now in effect for short time.

Name.....

Street or R. R.....

City or Town..... State.....

NO FACILITIES FOR COLORED STUDENTS

# McSWEENEY

## Auto, Tractor & Electrical Schools

9th & Walnut Ohio 1815 E. 24th Cleveland Ohio

Successors to Rahe School of Cincinnati and the Cleveland Automobile School





# Radiotrons WD-11 and WD-12 *Made History!*

It isn't a genuine WD-11 unless it's a Radiotron.  
It isn't a genuine WD-12 unless it's a Radiotron.  
It isn't a genuine UV-199 unless it's a Radiotron.  
It isn't a genuine UV-200 unless it's a Radiotron.  
It isn't a genuine UV-201-a unless it's a Radiotron.

#### You Can Change Your Set to Dry Battery Operation.

If your radio set is equipped with navy type tube sockets, you can change to dry battery operation by inserting WD-12 Radiotrons. Ask your dealer for information as to how this can be done.

These are dry cell tubes—the tubes that made possible the swift progress of radio in the home everywhere. They meant clear tone—undistorted detection—radio and audio amplification—and volume reproduction—all with dry batteries. They meant radio in the city—on the farm—off in camp—everywhere!

And to-day, there are millions of these popular Radiotrons in use. Everybody

knows them familiarly as "WD-11's" and "WD-12's." But they are not genuine unless they are **RADIO-TRONS.**

Always be sure to look for that mark on the base, and for the RCA mark on the glass. It's important, whether you are buying a new set with the Radiotrons in it, or buying new Radiotrons to replace old ones. Then you have the genuine—sure to live longest—serve best.

Radio Corporation of America

233 Broadway  
New York

Sales Offices: Dept. 519  
10 So. LaSalle Street  
Chicago, Ill.

433 California Street  
San Francisco, Cal.



This symbol of quality is your protection

# Radiotron

REG. U. S. PAT. OFF.



CBX8-726-5SHE



"BUILD OF CYPRESS  
the 'Wood Eternal'  
AND YOU BUILD  
BUT ONCE".

Tide Water  
**Cypress**  
"The Wood Eternal"



## "If Your SILLS Rot What Have You Got?"

Why not build your Garage, sills and all, of Cypress, "the Wood Eternal,"—the lumber that *don't* rot? But of course you must make sure that you build of genuine "TIDEWATER" Cypress. How to be sure? Insist on seeing the arrow trade mark, shown below, on every board or bundle.

While you are about it, why not write right away for Volume 28 of the world-famous Cypress Pocket Library? (That "guide, counselor and impartial friend of every home-lover.") It will come promptly on request, with our compliments. It contains not only full size working drawings and complete specifications for the garage (which you can amplify to suit your needs as to space), but also many plans for pergolas and other home beautifiers. We leave it to you to positively insist on "Tidewater" Cypress, "the Wood Eternal," when you order your lumber. You will do so for your own sake. (And it must be admitted that is a sufficient motive.)

SOUTHERN CYPRESS MANUFACTURERS' ASSOCIATION



1219 Poydras Building, New Orleans, Louisiana  
or 1219 Graham Building, Jacksonville, Florida



Insist on **TRADE-MARKED "TIDEWATER" CYPRESS** at your local lumber dealer's. If he hasn't it please advise us and we will see that you are supplied.



Lemon powder 472

# Popular Mechanics Magazine

200 E. Ontario Street, Chicago, U. S. A.

H. H. WINDSOR, Founder

H. H. WINDSOR, Jr., Editor and Publisher

London: Hachette & Co.,  
16-17 King William Street, Charing Cross, W. C. 2

Paris: Hachette & Co.,  
111 Rue Reaumur

Melbourne, Australia  
The Australasian News Co.

## ISSUED MONTHLY

## SUBSCRIPTION:

## SINGLE COPY, 25 CENTS

In United States and its possessions, also Canada, Cuba, and Mexico, per year, postpaid - \$2.50

To all other countries in the Postal Union - 3.00

All subscriptions are discontinued at expiration. Please examine the date printed on your wrapper.

Entered as Second Class Matter Sept. 18, 1903, at the Post Office at Chicago, Illinois, under Act of March 3rd, 1879.

Entered as Second Class Matter at the Post Office Department, Canada.

Published monthly by POPULAR MECHANICS CO.

Copyright, 1924, by Popular Mechanics Co.

Copyright in Australia. Copyright in France

Vol. 42

Contents for September, 1924

No. 3

Advertising—illuminated ads on trucks at night	394	Electric Power—electricity for city carried through subway	400
Aeronautics—motor-made gale used for testing airplane	415	Electrons—electric mysteries, vacuum tube explores	411
Agriculture—increase predicted in farming	356	Elephants—African, dangerous	471
Agriculture—United States—farmers, juvenile, nation's crops improved by	420	Elevators—machine for testing	394
Airships—ZR-3, modern luxuries on	358	Embroidery—embroidering machine for the home	418
Aluminum—given strength of steel for airship construction	367	Essences—lemon and orange in powder form	472
Ants—raised to aid fruit growers	355	Fire Department—passing of fire horse	442
Art—of native Americans, world contest in design inspired by	419	Fire Protection—fire nozzles on top of skyscraper protect building	463
Asphalt—pure, oil well produces	472	Flowers—cut, sugar in water adds to life of	459
Automobiles		Forest and Forestry—logging taught by miniatures to forestry students	434
on railway wheels for fast emergency service	423	Fountain—electric humidifier	433
U. S. owns four-fifths of	418	Garages—doors that roll overhead	389
Automobiles—Equipment and Supplies		Gases—hospitals use chlorine and mustard gases	353
disappearing top converts roadster into coupe	440	Gasoline—stations, automat filling	424
lavatory under running board	374	Ghosts—scientists rout "ghosts" from machine to study nature of light	368
Aviation—man-power machines near	362	Glass	
Banana—fiber substitute for graphite	362	heat resisting, light rays bent by	401
Barrels—rubber lined, proof against acids	394	industry, automobiles use half of output	432
Beads—stringer	463	made to stop bullets, will not break	424
Beet—digger and topper attached to tractor	462	Golf—practice net	466
Blindness—blind taught to weave rugs	423	Harpichord—ancient parent has strings plucked by quills	400
Boar—wild, encased in ice	397	Heart—throbs, radio carries to physicians	493
Boats and Boating—boat, folding, hunting or fishing	441	Heat	
Bookcases—end table combined	355	billion dollars' worth wasted every year	466
Books—bookshop, New York's smallest, radio aids	494	instrument for measuring	463
Boots and Shoes—buckle of shoe, picture worn in	400	man's endurance of, set at ninety degrees	431
Bricks—work of twenty done by electric bricklayer	369	Helicopter—designer wins prize by flight	356
Bridges		Household Devices	460
built on wheels and transported to site	441	Ice	
suspension, across Hudson river	431	leaves used to make	374
Butterflies—auto traffic hampered by	367	machine for tourists	459
Cable—phone, yearly output of	417	Ice Cream—vender on motorcycle	395
Canals—asphalt lining stops loss of water in irrigation	369	Inkstand—president's, made from horseshoes	376
Canoe—collapsible, for automobile tourist	433	Inventions—chance leads to useful discoveries	470
Casters—of fabric, noiseless	376	Lamp Shades—in forms of birds and animals	391
Chimes—in tower of war memorial at Washington to have two hundred tones	431	Laundry—washdays of world	398
Chimneys—lone chimney sweep, wears tall hat	396	Lifeboats—lightweight, for seaplanes	376
Cigars—automatic lighter handy as paper weight	439	Lighthouses—Port Said, twenty-four mile range	472
Clothing—the men of the nation	433	Lighting—building, floodlights on	395
Color—butterfly colorings rivaled by brush	434	Lost and Found Articles—gold lost at beaches, diving for	439
Comets—three, due in 1924	394	Medicine—Practice—patients treated with oxygen in sealed glass room	356
Concrete		Merry-Go-Round—adds to seashore sport	355
"gas concrete," made for sawing, planing and nailing	459	Metals—prospecting, electrical, tested in search for metals	433
tree trunk office of realty firm	411	Milk—poured through hole in door to prevent theft	462
Conveyor—scoop, sand loaded with	374	Mines and Mining	
Cookery		ice serves as concrete in sinking shaft	368
barbecue, roadside, for motorists	417	miners move village twenty miles	374
cooking guide cabinet, metal	464	Models	
Copper—alloy, glitter of gold found in	389	electric village, toy	425
Corn—Uncle Sam tests	391	locomotive—model as dinner decoration	424
Costumes—fashions, thousand years of, shown by dolls	392	Moving Pictures—pulsated light gives depth to	468
Date Palms—date pickers walk up tree to harvest fruit	361	Music—the soul behind the movies	412
Diamond—craftsmen of Amsterdam polish	370	National Academy of Science, Washington, D. C., science wonders shown in	427
Dogs—poodle, wins prize	362	Naval Warfare—guns of U. S. fleet, how trained on targets	419
Earthquake—cracks in earth caused by	409		
Eggs—hens, light rays increase lay of	415		
Egyptology—Egyptian feats rival modern works of engineers	403		
Electric Locomotive—switch engine cuts cost and smoke	395		

Landslide Train Wreck  
Lights 376

movie of genius in Pocket Case 475

[Continued on Page 4]

Kelley - Has letter of sold  
Light Safety Like Candle 389  
470



Paper covers for records 439  
 Perfume Plant in  
 Florida 390

Permalloy to  
 speed up telegraph  
 cables 363

Orange powder 477  
 Attygen, Patents  
 made with 356

Noise—loudest, deafens persons ten miles away	464
Nuts—nut cracker, black walnut, produces uncrushed halves	428
Ocean—current sought with sea thermometer	375
Ovens—camping oven, double walled	425
Overalls—transparent, save drosses	439
Paints—for radio cardboard panels and coils	494
Palestine—excavations reveal new light on	466
Paper Money—counterfeiting checked by vivid hues of	391
Park—acres taken from Lake Michigan to make	402
Peanut—harvester, horse drawn	433
Photography—photographic power of wood	440
Piano Players (Mechanical)—push button, eight rolls played by	390
Polo—"aerial," played with balloons	375
Printing million words engraved in inch	397
on round objects, machine for	434
Prize Offers	451
Rabbit—ranch in apartment house	429
Radio Apparatus—loud speakers, method of selling	504
Radio Broadcasting—talking through your own loud speaker	495
Radio—industry growing	504
Radio Receivers—making a push pull amplifier	502
Radium—under concrete walk, electroscope locates	357
Railroads carries ship over land	357
railway junked in eight years	391
Railroads—Rolling Stock—car, box, eight men build in six and one-half hours	389
Rats—war gas used to kill rats	410
Recreation—fourteen million spent in U. S. and Canada for	468
Refrigeration artificial, hundreds of industries use	396
drinks cooled quickly with chemicals in glass tubes	462
Rope—machine, worked by hand	410
Rubber—many uses for old	428
Safety Devices and Measures actors' eyes protected by helmets	400
landslide, lights warn trains of	376
"lighthouses," land, warn motorists	395
light, safety, resembles candle	470
swimming vest, puncture proof	418
Sandstone—flexible, easily bent	402
Saws and Sawing Rigs filing machine operated by crank	440
saws, band, several boards cut from one log with	467
Searchlight—giant, to aid war on crime	363
Shipwrecks—ship, "Frangestan," afire at sea	409
Spectacles—eyeglass cleaner, fits pocket	425
Sprayers—metal, molten, sprayed like paint from gun	432
Stage Mechanism—footlights for amateur stage vanish under floor	466
Stereopticon—fireproof, glass slides replaced by films	434
Stereoscope—movie machine, pocket	415
Storage Batteries for dry cell tubes	493
rubber mat for storage battery	504
Stoves—camp fire cooker, with revolving bracket grid	389
Street Lighting—lights on towers, London's light bill to be cut by	411
Surf-Riding pneumatic, inflated surf board	362
surf board, cowboy rides bucking broncho on	429
Telegraphy—permalloy, to speed up cables	363
Telescope—huge, Mars to be photographed with	397
Tin—"catches cold"	418
Toys air from balloon drives boat	369
balloons, toy, help in aiming big guns	467
blockhead, giant, dispenses gum in amusement park	470
wood horse has rubber tired wheels	351
Travel—swiftest way to girdle earth by land and water	440
Trees—growth, instrument for measuring	402
Tunnel—oldest electric, extended with boring shield	360
United States Navy—maneuvers of, in peace times	377
Vocabulary—radio increases	495
Voice—instrument for taking picture of	467
Wedding—first radio	495
Weights and Measures—short, tested by U. S. inspectors	364
Women—queer jobs undertaken by	464
Wood Carving—bird models, wood carver makes	368
Wood—wood made from wood for insulating buildings	416

Conveyor—turning corner on	474
Dynamite—fuses, carrying case for	477
Excavating Machinery—excavation, cellar, novelty in	491
Gland—broken, substitute for	480
Handle—comfortable machine handle	492
Harvesting Machinery—binder hitch for small tractor, adjusting	476
Inlays—wood inlays, replacing	490
Loading and Unloading—using hand truck for	479
Lumber—using blue stained	486
Mechanical Powers—part VII—The Screw	481
Milk—delivery cart, novel	476
Photography—photographing tracings	478
Polishing—stand for polishing tubular parts	492
Popcorn—keeping the pop in	474
Reamer—odd fluted, measuring	478
Roads—sand drifts prevented on	475
Roofs coping, double purpose	486
novel, lumber economized on	492
Safety Devices and Measures—road culverts, markers for	479
Sanders—floor sanding machine	473
Saws and Sawing Rigs—saws, circular, homemade	487
Sleds—for transporting cordwood	480
Spraying—fruit trees, emulsion for spraying	491
Swine—hog wallow, concrete	475
Tile—plunger aids in laying	477
Tools—case for small tools	478

AMATEUR MECHANICS

Automobiles—Safety Devices—limiting speed of	516
Babbitting—repairing worn bearings	520
Boats and Boating—portable canvas, building	511
Bookcases—supporting sagging shelves	509
Boxes—battery box, waterproof	518
Canoes—increasing buoyancy of	521
Can Openers—can opening made easy by handy block	527
Compass—easily constructed beam compass	526
Corn—new use for cobs	525
Doors anti-rattling doorstop	527
barn doors, locking	525
push plates, decoration for	508
Drills—watchmaker's lathe, drill press made from	524
Drinking Fountain—sanitary fountain for windmill pump	507
Electric Lighting—water-tight fixture protects light	525
Electric Switch—automatic switch for garage	506
First Aid—tape, adhesive, making it stick	526
Fishing fisherman, back and foot rest for	514
landing net, novel	513
Fountain—table, how to make	505
Garages novel floor	508
storage space, increasing	522
Hay—hayloader timesaver	519
Hayrack—ladders, folding	508
Household Devices breakfast nook, spacious	526
radiator, hot water, hiding	516
Hunting—night, spotlight for	523
Ladders—holding on tile floors	516
Loading and Unloading furniture, heavy, moving up stairways	522
pulling motorboat on beach	507
Milk—card box and indicator	513
Motorboat Engines—outboard motor, gasoline tank for	515
Photography—Developing washing tank for roll film	509
preventing ferrotype prints from sticking	521
Polishing—automobile headlamps, cleaning	518
Poultry—convenient window for poultry house	513
Pumps—hand, made from auto oil pump	521
Refrigerator—iceless, for camp	520
Roofs—shingle holder, nailed to wall or roof	521
Safety Devices and Measures—thieves, petty, fending	515
Screens—covering frames with wire	527
Smoker's Stands, etc.—ash trays made from automobile pistons	519
Solder and Soldering—battery corrosion as flux	522
Spokeshaves—made of steel pipe	525
Stepladder—pantry step, handy	519
Swine—hogs, feeding trough for	514
Thermostat—renewing a wafer	516
Tire—emergency patch	509
Toothpaste—preserving	514
Toys optical illusion, toy provides	520
plane, bombing and battleship	517
Trailers—light automobile trailer	513
Woodfinishing—floors, yellow pine, finishing	512

SHOP NOTES

Automobiles—Ignition—spark plug cleaner	479
Automobiles—Repairing—accelerator rod bushing	475
Barns—stanchionless dairy	491
Boats and Boating—boat hoist, concrete	477



# DRAKE'S PRACTICAL MECHANICAL BOOKS

## THEY WILL RAISE YOUR PAY—

### ORDER ON 5-DAY TRIAL

The books listed below will perfect you in your chosen trade—pave the way to the big positions. Written in non-technical language—easy to read and understand. **Every book covers its subject completely. An entire course of instruction condensed into one volume.** Your choice sent postpaid—you benefit 5 days—money refunded in full if not entirely satisfactory. Order direct from this page.



### Automobile Books

Automobile Starting, Lighting and Ignition, by Manly. [Pub. Jan. 1924.] 700 pp. . . . .	Leatherette	\$3.00
Brookes' Automobile Handbook, 1924 Edition. . . . .	Leatherette	\$2.00
Ford Motor Car, Truck and Tractor, by Manly. . . . .	Cloth	\$1.50
Starting and Lighting Troubles, Remedies and Repairs, by Manly. . . . .	Leatherette	\$3.00
Automobile Battery, Care and Repair, by Manly. . . . .	Leatherette	\$2.00
Automobile Catechism and Repair Manual. . . . .	Leatherette	\$1.50
Tires and Vulcanizing, by Telford. . . . .	Cloth	\$2.00
Gas and Oil Engine Handbook. . . . .	Cloth	\$1.50
Automobile Upkeep and Care, by Manly. . . . .	Cloth	\$1.50
Motocycle Handbook, by Manly. . . . .	Cloth	\$1.50

### Shop Practice Books

Sheet Metal Workers' Manual. . . . .	Leatherette	\$2.00
Oxy-Acetylene Welding and Cutting. . . . .	Cloth	\$1.25
Slide Rule and Logarithmic Tables. . . . .	Leatherette	\$2.00
Handbook for Millwrights. . . . .	Cloth	\$2.00
Modern Blacksmithing. . . . .	Cloth	\$1.25
Machine Shop Practice. . . . .	Cloth	\$2.00

Mechanical Drawing and Machine Design. . . . .	Cloth	\$2.00
Pattern Making. . . . .	Cloth	\$1.50

### Carpentry Books

Cloth Binding

Modern Carpentry, 2 vols. . . . .	\$3.00
The Steel Square, 2 vols. . . . .	\$3.00
Wooden Boat and Shipbuilding. . . . .	\$1.50
Modern Estimator. . . . .	\$1.50
Timber Framing. . . . .	\$2.00
Builder's Architectural Drawing. . . . .	\$2.00
Concrete. . . . .	\$1.50
Practical Bungalows. . . . .	\$1.00
Low Cost Homes. . . . .	\$1.00
Roof Framing, by Van Gasbeek. . . . .	\$1.50
Stair Building and Hand Railing. . . . .	\$1.50

### Electrical Books

Telephony, Including Automatic Switching, by Smith. [Pub. Jan. 1924.] 500 pp. . . . .	Leatherette	\$2.50
Practical Applied Electricity. . . . .	\$2.00	
Alternating Current. . . . .	\$1.50	
Electric Motor Control Systems. . . . .	\$1.50	
Wiring Diagrams and Descriptions. . . . .	\$1.50	
Electrical Tables and Data. . . . .	\$1.50	
Armature and Magnet Winding. . . . .	\$1.50	
Modern Electrical Construction. . . . .	\$1.50	
Modern Electric Illumination. . . . .	\$1.50	
Electricians' Operating and Testing. . . . .	\$1.50	
Motion Picture Operation. . . . .	\$1.50	
Drake's Electrical Dictionary. . . . .	\$1.50	
Electric Motors, D. & A. . . . .	\$1.50	
Electrical Measurements and Meter Testing. . . . .	\$1.50	
Drake's Telephone Handbook. . . . .	\$1.50	
Easy Experiments. . . . .	\$1.25	
Wireless Telegraph and Telephone Handbook. . . . .	Cloth	\$1.25
Telegraphy Self-Taught. . . . .	Cloth	\$1.25

### Steam Engineering

Swingle's Handbook for Steam Engineers and Electricians. Leatherette Examination Questions and Answers for Marine and Stationary Engineers. . . . .	Leatherette	\$4.00
Steam Boilers. . . . .	Leatherette	\$2.00
Swingle's Catechism of Steam, Gas and Electrical Engineering. . . . .	Leatherette	\$1.50

### Painting Books

The Mixing of Colors and Paints, By Vanderwalker. . . . .	Cloth	\$2.00
Scene Painting and Bulletin Art. . . . .	Cloth	\$4.00
A Show at Show Cards. . . . .	Cloth	\$4.00
Sign Painting. . . . .	Cloth	\$4.00
Strong's Book of Designs. . . . .	Leatherette	\$4.00
Strong's Art of Show Card Writing. . . . .	Cloth	\$4.00
Signal's Alphabets. . . . .	Cloth	\$1.50
Modern Painter's Cyclopedia. . . . .	Cloth	\$2.00
Automobile Painting. . . . .	Cloth	\$1.50
Estimates, Costs and Profits, Painting and Decorating. . . . .	Cloth	\$1.50
New Hardwood Finishing. . . . .	Cloth	\$1.50
The Amateur Artist. . . . .	Cloth	\$1.25
New Stencils. . . . .	Cloth	\$1.25
Chalk Talk and Crayon Presentation. . . . .	Cloth	\$1.25

### Farm Books

Farm Mechanics. . . . .	Cloth	\$1.25
Farm Buildings. . . . .	Cloth	\$1.25
Farm Engines. . . . .	Cloth	\$1.25
Traction Farming. . . . .	Cloth	\$1.50

### Business and Reference Books

Better Business Letters. . . . .	Cloth	\$1.00
Better Business English. . . . .	Cloth	\$1.00
Better Advertising. . . . .	Cloth	\$1.00
Finger Prints Simplified. . . . .	Cloth	\$1.25
Practical Bricklaying. . . . .	Cloth	\$1.25
Practical Instruction for Detectives. . . . .	Cloth	\$1.00
Practical Plumbing. . . . .	Cloth	\$1.50
Hot Water Heating. . . . .	Cloth	\$1.50
Elementary Chemistry. . . . .	Cloth	\$1.50
Courses in Civil Service. . . . .	Cloth	\$1.50
Cyclopedia of Recipes. . . . .	Cloth	\$1.50
American Star Speaker. . . . .	Cloth	\$1.50

### Modern Languages

By Prof. P. S. Allen, U. of Chicago		
French without a Teacher. . . . .	Cloth	\$1.25
Spanish without a Teacher. . . . .	Cloth	\$1.25
German without a Teacher. . . . .	Cloth	\$1.25
Everyday French. . . . .	Cloth	\$1.25
Everyday Spanish. . . . .	Cloth	\$1.25

## ORDER DIRECT FROM THIS PAGE—ON OUR MONEY-BACK PLAN

The books listed above are only a few of the many in our catalogue, which you will receive promptly after filling out and mailing us the attached coupon. For quick action order direct from this page—cross name of each book wanted and send in with price quoted. We prepay postage and send the books on our money-back plan.

### FREDERICK J. DRAKE & CO.

PUBLISHERS

1008 Michigan Ave., Chicago

Drake Books Are For Sale at All Book Stores

**FREDERICK J. DRAKE & CO.**  
1008 Michigan Avenue  
Chicago, Ill.

GENTLEMEN:—Please send me free, postage paid, your illustrated catalogue which lists and describes over 100 Practical Mechanical Books for Home Study.

My name is .....

and my address .....

Mail Coupon For Free Catalogue  
Your Guide to Home Study





## Making Successful Men by Home-Study Training

How can I make more money? How can I advance more rapidly in business? Literally millions of untrained men—yourself, perhaps, among them—are continually disturbed by those two questions.

“Be industrious; keep everlastingly at it”—that’s the way the writers of *copy-book maxims* would tell you to go about it. But honestly—are you fooled by that sort of talk?

Argue it any way you like, it takes something beside mere *work* to push men ahead—it takes *specialized work*.

And to suggest, for a second, that an untrained man—no matter how hard he works—is going to be promoted to a highly specialized position without first *equipping* himself for that position, is as absurd as to intimate that the boatman in the park who has been on the job for twenty years is likely to be chosen captain of a trans-Atlantic liner!

\* \* \*

Recognizing these facts—what is the wise thing to do to change one’s situation for the better?

Many will tell you that promotion will take care of itself—if you keep your eyes open.

It will. *But, oh, how slowly!*

While one man is advancing by this tedious route from \$25-a-week to \$30-a-week to \$35-a-week, another chap, not a bit smarter than he, is climbing from \$15-a-week to \$30-a-week to \$50-a-week to \$100-a-week.

No—there’s more to advancement than merely “catching onto things.” *TIME* is the all-important factor—and that is the big reason why thousands of earnest men have refused to wait, but have turned instead to LaSalle Extension University and have shortened by many years their journey to success.

That they—in so doing—have acted to their own advantage is borne out by the fact that during only three months’ time as many as 1193 members reported definite advancement which they were frank to attribute to home-study training under the LaSalle Problem Method. The total salary-increases so reported amounted to \$1,248,526, an *average increase per man of eighty-nine per cent.*



Your future is, of course, your own problem—and no one can solve it but yourself. If you are content to drift, you will find plenty of company tho little profit.

If, on the other hand, you are really in earnest when you say that you want to get ahead in business, you will find both companionship and gain in home-study training under the LaSalle Problem Method.

Below this text there’s a coupon—very similar to the one which has set many, many thousands on the path to success.

A good way to gauge your strength of purpose is—by what you do with that coupon—NOW.

### LaSalle Extension University

The Largest Business Training Institution  
in the World

Dept. 964-R Chicago, Illinois

Please send me catalog and full information regarding the course and service I have marked with an X below. Also a copy of your book, “Ten Years’ Promotion in One,” all without obligation to me.

- Business Management
- Modern Salesmanship
- Higher Accountancy
- Law — Degree of LL. B.
- Traffic Management
- Railway Station Management
- Commercial Law
- Industrial Management
- Efficiency
- Banking and Finance

- Modern Business Correspondence and Practice
- Modern Foremanship and Production Methods
- Personnel and Employment Management
- Expert Bookkeeping
- Business English
- Commercial Spanish
- Effective Speaking
- C. P. A. Coaching

Name.....

Present Position.....

Address.....



# CARPENTERS

## GUIDES THAT SOLVE PROBLEMS

A Complete Course in Practical Carpentry and Building Work

POCKET SIZE—  
FLEXIBLE  
COVERS—  
3100 ILLUSTRATIONS—  
1600  
PAGES

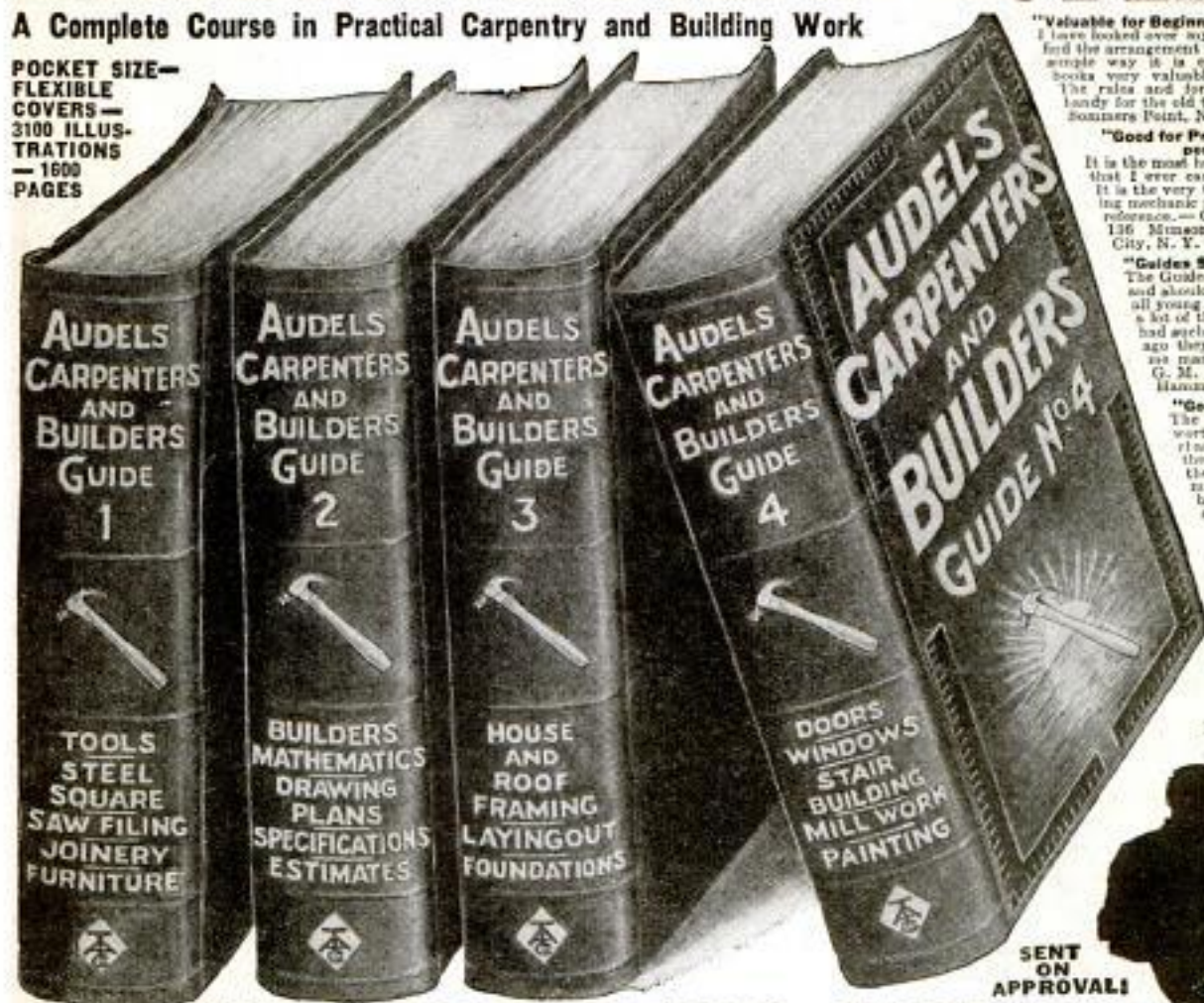

"Valuable for Beginners or Old Timers"  
I have looked over my Audel Guides and find the arrangement of subjects and the simple way it is explained makes the books very valuable for the beginner. The rules and formulas are mighty handy for the old timers.—Ross Smith, Sommers Point, N. J.

"Good for Professional Carpenters"

It is the most handy reference work that I ever came in contact with. It is the very thing that the building mechanic needs every day for reference.—George H. Watson, 136 Miamon St., Long Island City, N. Y.

"Guides Save Hard Knocks"  
The Guides are truly wonderful and should be in the hands of all young carpenters as well as a lot of the older fellows. If I had such information 20 years ago they would have saved me many a hard knock.—G. M. McJohnston, R. R. 1, Hammond, Ind.

"Good for Amateurs"

The books are surely worth more than the price paid, especially as they serve as a guide to the nonprofessional like myself who is trying to build himself a home at the least expense.—Otto Schrader, P. O. Box 182, Westmont, Ill.

\$1

PER MONTH



SENT ON APPROVAL!

### NEW IDEAS—MODERN METHODS—SHORT CUTS

This course, "Audel's Guides for Carpenters and Builders," consists of 4 handy volumes of over 1600 pages with thoroughly illustrated charts, diagrams, graphs, pictures with calculations for every job from making the excavation to constructing the entire building. You will find these new Guides most complete and comprehensive in addition to being both timely and practical. There are 3700 actual examples of efficient construction work with new methods, ideas, solutions, plans, systems, short

cuts, time and labor saving suggestions, new ways that cover the entire theory and practice of the subject illustrated by sketches and forms all specific and practical. Audel's Guides give you the short cut, professional information you want. No need to guess or take chances. Every day you have before you in this set the exact, practical, useful information that will help you with every job that comes up in your daily work.

### HOW To Handle the Job That Puzzles YOU

There are thousands of examples of modern construction and building work—new methods, new ideas, proved efficiency plans, short cuts, time saving suggestions, new ways that cover the entire theory and practice of modern carpentry. Every point is easy to read and understand and clearly illustrated with sketches and forms. Inside Trade Informa-

tion for Carpenters, Builders, Joiners, Building Mechanics and all Woodworkers on—Care and Use of Tools—How to Use the Steel Square—File Saws—Make All Kinds of Joints—Draw and Read Plans—Write Specifications—Make Estimates—How to Frame Roofs and Houses—Lay Out Work—Put in Foundations—Full Instruction on In and Outside Building Work—Stair Building—Saw Mill Work—Practical Painting—Thousands of Short-Cuts that save time and money—Information usually obtained only by hard experience.

### NO MONEY!

MERELY SEND COUPON AND LOOK THE SET OVER AT AUDEL'S RISK

THEO. AUDEL & CO., 72 5th Avenue, NEW YORK CITY  
Send me for free examination Audel's Carpenters and Builders Guides  
I will send you \$1 within 5 days and mail \$1  
monthly until \$6 is paid.

Name.....

Address.....

Occupation.....

Employed by.....

Reference.....

9 T 30

# FREE EXAMINATION

Not a cent to pay until you see the books. No obligation to buy unless you are satisfied. Fill in coupon in pencil. Send now—today—get this great help library for carpenters and builders.



# Be a **B.W. Cooke-Trained** Auto **EXPERT!**

**\$3,500. TO \$10,000. A YEAR.**

The world's biggest, most fascinating business needs you! Why slave away at small pay when there are unlimited opportunities as a *Cooke-trained* Auto Expert waiting for you? Mail coupon and I will tell you how I train you **at home** in your spare time for **AUTO EXPERTS** big-pay position.

### Earn \$75 to \$200 a Week!

When you read that there are now 15 MILLION autos, trucks and tractors—that car owners are paying out SIX THOUSAND MILLION DOLLARS A YEAR for upkeep you will realize here is the business to get into! Enormous demand for *Cooke-trained* Auto Experts. My training includes Garage management, automobile salesmanship and advertising—many other special features—how to go into business for yourself and make a success of it.

**FREE**

**2**

TWO BIG REPAIR and TESTING

**OUTFITS!**

*Costly testing and repair outfits free to every student for a limited time. Coupon brings special offer.*

### No Other Training Like Mine!

As Directing Engineer of the great Chicago Auto Shops I know what training you need to make big money, and I GIVE YOU THAT TRAINING! Right in your own home, I make you MASTER of every branch of Auto, truck and tractor work. I train you with JOBS—not books. I give you complete and practical instruction in every detail of Mechanical and Electrical work, Battery, Ignition, Farm Power Plants, Welding, Brazing, Vulcanizing, etc., and my Employment Department helps you to Position.

### Go Into Business!

W. J. Morriston, without previous experience—now in business for himself—and only half-way through Cooke JOB-WAY training, writes: "I would not take \$500 for what I've already learned. Am already in business and clearing over \$50 a week, with wonderful prospects." Hundreds others have done it. Mighty little capital needed. I'll train you, too, to do it.



W. J. MORRISTON  
Parkersburg, W. Va.

## FREE! AUTO BOOK

**B. W. COOKE, Directing Engineer**  
CHICAGO AUTO SHOPS, Dept. 616  
1916 Sunnyside Avenue, CHICAGO, ILL.

Send me FREE Auto Book and proof that I can become an Auto Expert at home in spare time. Also send your special offers of 2 FREE outfits.

..... Name

..... Address

..... City..... State

..... Occupation..... Age

**Earn While You Learn!** Get my big Auto Book—it's FREE—see what others have done after only a few months of my JOB-WAY training. In this book I prove to you under a written Money Back Guarantee that you will find your success as a *Cooke-trained* Auto Expert. Almost at the start I train you to do actual jobs and make extra money doing it. 82 out of 100 of my students report that they are doing practical work, many of them are already making more money than the entire cost of "JOB-WAY" training!

**Big Auto Book FREE!** I don't care how old or young you are, how much or little education you have, this training will make you a successful Auto Expert. Special inducements and many EXTRA features right now. Easy terms and low cost. Coupon brings free book and complete information. Mail it today!

**B. W. COOKE, Directing Engineer**  
CHICAGO AUTO SHOPS, Dept. 616  
1916 Sunnyside Avenue Chicago, Illinois





# BUILDING TRADES NEED TRAINED MEN

*Thousands of good positions  
at good salaries*



**T**HE building trades are still booming. Trained men are in demand at good salaries. Government experts estimate that billions of dollars will be spent for construction this year. *And that is only a start!*

"It will take us 12 years, working 25 per cent above normal," said John Ihlder, Manager of the Civic Development Department of the United States Chamber of Commerce, "to provide as adequately for our population as before the war."

To-day the most vital need of this great building program is men—*trained men*—men who can step right in and do the skilled work that building construction requires.

There is a simple, easy, practical way by which you can prepare for a better position, at a bigger salary. You can do it right at home, in spare time, no matter where you live, through the International Correspondence Schools.

There is no question—no doubt—about this. For 32 years the I. C. S. has been training men for advancement in the building trades and in many other business and technical subjects.

A recent investigation of 13,298 students enrolled in I. C. S. Building Trades Courses showed that 1291 had become Architects, 246 had become Designers, 494 had become Chief Draftsmen, 2827 had become Draftsmen, 1845 had become

Contractors, 211 had become Assistant Foremen, 4030 had become Foremen, 2354 had become Superintendents.

You, too, can have the position you want in the work you like best, an income that will give you and your family the home, the comforts, the luxuries you would like them to have.

All we ask is the chance to prove it. That's fair, isn't it? Then mark and mail this coupon.



----- **TEAR OUT HERE** -----  
**INTERNATIONAL CORRESPONDENCE SCHOOLS**  
Box 5629-D, Scranton, Penna.

Without cost or obligation, please tell me how I can qualify for the position or in the subject before which I have marked an X in the list below:

#### TECHNICAL AND INDUSTRIAL COURSES

- |  |   |
|--|---|
| <input type="checkbox"/> Architect                       | <input type="checkbox"/> Surveying and Mapping    |
| <input type="checkbox"/> Architectural Draftsman         | <input type="checkbox"/> Gas Engine Operating     |
| <input type="checkbox"/> Reading Architects' Blue Prints | <input type="checkbox"/> Automobile Work          |
| <input type="checkbox"/> Building Foreman                | <input type="checkbox"/> Airplane Engines         |
| <input type="checkbox"/> Concrete Builder                | <input type="checkbox"/> Plumber and Steam Fitter |
| <input type="checkbox"/> Contractor and Builder          | <input type="checkbox"/> Plumbing Inspector       |
| <input type="checkbox"/> Structural Draftsman            | <input type="checkbox"/> Foreman Plumber          |
| <input type="checkbox"/> Structural Engineer             | <input type="checkbox"/> Heating and Ventilation  |
| <input type="checkbox"/> Electrician                     | <input type="checkbox"/> Sheet Metal Worker       |
| <input type="checkbox"/> Electrical Engineer             | <input type="checkbox"/> Steam Engineer           |
| <input type="checkbox"/> Electrical Contractor           | <input type="checkbox"/> Railroad Positions       |
| <input type="checkbox"/> Electric Wiring                 | <input type="checkbox"/> Chemistry                |
| <input type="checkbox"/> Mechanical Engineer             | <input type="checkbox"/> Pharmacy                 |
| <input type="checkbox"/> Mechanical Draftsman            | <input type="checkbox"/> Metallurgy               |
| <input type="checkbox"/> Machine Shop Practice           | <input type="checkbox"/> Mining Engineer          |
| <input type="checkbox"/> Toolmaker                       | <input type="checkbox"/> Navigation               |
| <input type="checkbox"/> Civil Engineering               | <input type="checkbox"/> Mathematics              |
|  | <input type="checkbox"/> Radio                    |

#### BUSINESS TRAINING COURSES

- |  |   |
|--|---|
| <input type="checkbox"/> Business Management       | <input type="checkbox"/> Salesmanship           |
| <input type="checkbox"/> Industrial Management     | <input type="checkbox"/> Advertising            |
| <input type="checkbox"/> Personnel Organization    | <input type="checkbox"/> Better Letters         |
| <input type="checkbox"/> Traffic Management        | <input type="checkbox"/> Foreign Trade          |
| <input type="checkbox"/> Business Law              | <input type="checkbox"/> Show Card Lettering    |
| <input type="checkbox"/> Banking and Banking Law   | <input type="checkbox"/> Stenography and Typing |
| <input type="checkbox"/> Accountancy               | <input type="checkbox"/> Teacher                |
| (Including C. P. A.)                               | <input type="checkbox"/> Civil Service          |
| <input type="checkbox"/> Nicholson Cost Accounting | <input type="checkbox"/> Railway Mail Clerk     |
| <input type="checkbox"/> Bookkeeping               | <input type="checkbox"/> Common School Subjects |
| <input type="checkbox"/> Business English          | <input type="checkbox"/> High School Subjects   |
| <input type="checkbox"/> Private Secretary         | <input type="checkbox"/> Illustrating           |
| <input type="checkbox"/> Business Spanish          | <input type="checkbox"/> Cartooning             |
|  | <input type="checkbox"/> French                 |

Name .....

Street  
Address .....

City .....

State .....

Occupation .....

Persons residing in Canada should send this coupon to the International Correspondence Schools Canadian, Limited, Montreal, Canada.





# \$200

## Drafting Course

There is such an urgent demand for practical trained Draftsmen that I am making this special offer to deserving, ambitious men. You get your course FREE for getting two additional students. I will teach you to become a Draftsman and Designer until you are drawing a salary of \$250.00 a month. You need not pay me for my personal instruction or for the complete set of instruments. But you must take advantage of this special offer at once.

# FREE

## \$300 a Month Salary — \$450 on the Side at Home!

That's the kind of money my drafting students make. Read what this one says:

*"As a beginner I am doing fine. Am earning a salary of \$300 per month, besides I made over \$450 at home the last two months, drawing plans for private parties. The practical drafting training you gave me by mail put me where I am in less than six months' study. Thank you for all your personal interest and help you gave me so far."*

(Signed) J. B.

(Name and address upon request)

## I Guarantee

**To Train You Until You Are Placed in a Position Paying up to \$250 and \$300 a Month**  
Write and I'll tell you how I make you a first-class, big-money-earning draftsman in a very few months! I do this by a method no other man nor institution can imitate. I give you personal training at home by mail until you are actually placed in a position paying up to \$250 and \$300 a month. Six thousand draftsmen are wanted every month.

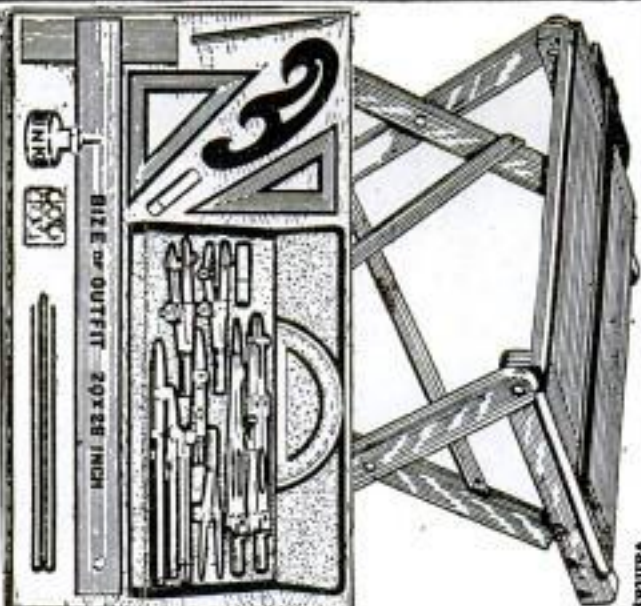

## Drawing Table FREE

Complete drawing outfit. Positively everything you need. Wonderful instruments, splendid table. They are yours the minute you become my student.

## Free Book!

### Send Coupon Today

No matter what plans you have for the future. Get this great book—"Successful Draftmanship." Find out about the simply marvelous opportunities ahead now. How the world needs draftsmen, engineers, architects and builders. What great salaries and possibilities there are! Send coupon for free book today.

Chief Draftsman, Engineers Equipment Co.,  
1951 Lawrence Ave. Div. 13-56 Chicago, Ill.

Chief Draftsman, Engineers Equipment Co.

1951 Lawrence Ave. Div. 13-56 Chicago, Ill.

Without any obligation whatsoever, please mail your book, "Successful Draftmanship," and full particulars of your liberal "Personal Instruction" order to few students.



Name.....

Address.....

City.....

Post Office.....

State.....



# Be a BIG PAY Expert!

**Learn  
Electricity  
in  
12 Weeks**

**In the Great Shops of**

# C O Y N E

**Earn  
\$200  
to  
\$600  
per  
Month**



**STUDENT WINDING STATOR**

Make this the most profitable and enjoyable summer of your life. Come to Chicago, the greatest summer resort city in the country, on beautiful Lake Michigan, and the greatest electrical center in the world. I pay your railroad fare from any place in the United States. See the country at my expense. Become a skilled electrical expert in the great shops of Coyne.

## Complete Electrical Training in 12 Weeks

Not a correspondence course—no books or useless theory—everything is practical. You are trained on thousands of dollars' worth of electrical equipment. Everything from door bells to power plants. You work on motors, generators, house wiring, autos, batteries, radio, switchboards, power plants—everything to make you an expert ready to step right into a position paying

from \$50 to \$200 a week. A Coyne trained man is trained completely. He can take his place anywhere in the electrical world.

**You Don't Need Education or Experience**  
I give you the training and education you need to fit you to be a big PAY Electrical Expert.

### Great Summer Resort City

Chicago, on beautiful Lake Michigan, is the Nation's summer playground. Free bathing beaches, beautiful parks, excursion boats and the great Municipal Pier, zoo, ball parks. Coyne is near the Lake and bathing beaches.



## FREE Railroad Fare to Chicago

H. C. LEWIS, President

## Coyne Electrical School

1300-10 West Harrison Street, Dept. 135-6 Chicago, Ill.

### Radio and Auto Course FREE

Besides paying your railroad fare, I include FREE a course in Radio—the marvel of the age. Also a complete course in auto, and truck and tractor electricity and storage batteries.

### Earn While You Learn

My employment department helps you get a job to earn a good part of your living expenses.

### Send Coupon NOW!

This is the greatest offer ever made by a school and it is for a limited time. Don't delay a single minute. Send the coupon in right away for my big, free catalogue and full particulars of this wonderful offer. Act now! I pay your railroad fare.

Coyne Electrical School, Dept. 135-6  
1300-10 W. Harrison St., Chicago, Ill.

MR. H. C. LEWIS, Pres.

Dear Sir:—Please send me free your big catalog and full particulars of your special offer of free railroad fare and two extra courses.

Name .....

Address .....





## The only man who could talk to the Superintendent

"SOON after I began studying," a student wrote to us the other day, "we had a change in management at our plant. I certainly was glad then that I had decided to study in my spare time. For, thanks to my I. C. S. course, I was the only man in the organization who could talk to the Superintendent in his own language. As a result, I was promoted over men who had been here from ten to twenty years. My salary has been increased 90% in the last ten months."

THAT'S a true story of what just one I. C. S. student has done. There are thousands of others. Every mail brings letters from men and women telling of promotions and increases in salary due directly to spare-time study.

One hour a day, spent with the I. C. S. in the quiet of your own home, will prepare you for success in the work you like best. *Yes, it will!* Put it up to us to prove it. Mail this coupon to-day.

### INTERNATIONAL CORRESPONDENCE SCHOOLS Box 5634-D, Scranton, Penna.

Without cost or obligation, please tell me how I can qualify for the position or in the subject before which I have marked an X:

#### BUSINESS TRAINING COURSES

- |  |   |
|--|---|
| <input type="checkbox"/> Business Management                     | <input type="checkbox"/> Salesmanship                                     |
| <input type="checkbox"/> Industrial Management                   | <input type="checkbox"/> Advertising                                      |
| <input type="checkbox"/> Personnel Organization                  | <input type="checkbox"/> Better Letters                                   |
| <input type="checkbox"/> Traffic Management                      | <input type="checkbox"/> Show Card Lettering                              |
| <input type="checkbox"/> Business Law                            | <input type="checkbox"/> Stenography and Typing                           |
| <input type="checkbox"/> Banking and Banking Law                 | <input type="checkbox"/> Business English                                 |
| <input type="checkbox"/> Accountancy (including C.P.A.)          | <input type="checkbox"/> Civil Service                                    |
| <input type="checkbox"/> Nicholson Cost Accounting               | <input type="checkbox"/> Railway Mail Clerk                               |
| <input type="checkbox"/> Bookkeeping                             | <input type="checkbox"/> Common School Subjects                           |
| <input type="checkbox"/> Private Secretary                       | <input type="checkbox"/> High School Subjects                             |
| <input type="checkbox"/> Spanish <input type="checkbox"/> French | <input type="checkbox"/> Illustrating <input type="checkbox"/> Cartooning |

#### TECHNICAL AND INDUSTRIAL COURSES

- |   |  |
|---|--|
| <input type="checkbox"/> Electrical Engineering | <input type="checkbox"/> Architect                                   |
| <input type="checkbox"/> Electric Lighting      | <input type="checkbox"/> Architects' Blue Prints                     |
| <input type="checkbox"/> Mechanical Engineer    | <input type="checkbox"/> Contractor and Builder                      |
| <input type="checkbox"/> Mechanical Draftsman   | <input type="checkbox"/> Architectural Draftsman                     |
| <input type="checkbox"/> Machine Shop Practice  | <input type="checkbox"/> Concrete Builder                            |
| <input type="checkbox"/> Railroad Positions     | <input type="checkbox"/> Structural Engineer                         |
| <input type="checkbox"/> Gas Engine Operating   | <input type="checkbox"/> Chemistry <input type="checkbox"/> Pharmacy |
| <input type="checkbox"/> Civil Engineer         | <input type="checkbox"/> Automobile Work                             |
| <input type="checkbox"/> Surveying and Mapping  | <input type="checkbox"/> Airplane Engines                            |
| <input type="checkbox"/> Metallurgy             | <input type="checkbox"/> Navigation                                  |
| <input type="checkbox"/> Steam Engineering      | <input type="checkbox"/> Agriculture and Poultry                     |
| <input type="checkbox"/> Radio                  | <input type="checkbox"/> Mathematics                                 |

Name.....  
Street.....  
Address..... 3-6-24

City..... State.....

Occupation.....

Persons residing in Canada should send this coupon to the International Correspondence Schools Canadian, Limited, Montreal, Canada.

## CHICAGO TECHNICAL COLLEGE \*

**Drafting  
Engineering**  
— MECHANICAL,  
CIVIL, STRUCTURAL  
AND ELECTRICAL.  
**Architecture**

{ 21<sup>ST</sup> YEAR }

\* Technical training insures your future. It puts you immediately in a high-salaried position. So great is the demand for trained men in Chicago that many of our students are placed in responsible part-time positions before graduation.

#### Short, Intensive Training

Two-year Diploma Courses. Degree of B. S. conferred in three years. Special short courses for special students. In all cases, the course is adapted to meet the special needs of the individual. Instruction is largely personal and instructors are experts, actively engaged in their professions.

#### 52-Page Blue Book, FREE

This illustrated book states inspiring facts about the great demand for trained men. It explains how students support themselves while studying. It tells what others have accomplished. Write for it now—without obligation.

CHICAGO TECHNICAL COLLEGE  
18 Chicago Tech. Building, CHICAGO

**LEARN VIOLIN** 3¢ A DAY

New Easy Way. Violin Furnished. Marvellous new Master Method teaches you by mail in 1 1/2 time and at 1/50th cost. No numbers or trick music. Costs only 8¢ a day. Play a real piece by note in fifth lesson. Easy as A B C. All music free. Diploma awarded. Beginners or advanced players. Money back guarantee. Send today for free booklet. Will be sent in plain wrapper. Please write plainly. MASTER VIOLIN SCHOOL 51 E. 42 St., Conv. 704, New York, N. Y.

**A Great Career! - BOOK FREE**

## LEARN WATCH REPAIRING

Be a watchmaker—you can learn this profitable trade by correspondence in a few weeks in your own home by the DeSelms Chart System. After you complete the course you will know a watch from A to Z. You will know just what the matter is and how to repair one. When you graduate you will be a practical watchmaker and repairer and competent in all any position. Positions for our graduates. Ask for our Free Book. It explains our system and terms.

THE DeSELMS WATCH SCHOOL  
23 Perry Street ATTICA, INDIANA



## for big money learn PHOTO FINISHING



#### A MODERN BUSINESS

Thousands of Films To Be Developed and Printed EVERYWHERE

INCOME FROM \$40 TO \$200 WEEKLY AND MORE

TEACH EVERYTHING BY Mail

Supply Forms, give sound advice. You can begin at once to make money as I did. Spare Time at first if desired, practically no capital required. Send for eye-opening information about this uncrowded business.

CHIPMAN (Ten years a photo-finisher)

Suite 104 Mitchell Bldg. Syracuse, N.Y.



# Be an Auto Expert

# You Can EARN \$75 to \$200 A Week

## I'll get You

# A Big Pay Auto Job!

**H**OW MUCH MONEY do you draw today? Would you like to get more? I'll tell you how! Get into the Automotive Industry—where there are plenty of big pay jobs. How would you like to be an Automotive Engineer, a Garage Owner, a Service Station Manager, an Automobile Salesman, or an Expert in some other branch of this wonderful business? I can teach you—right at home—while you keep your present job. In less than a year's time you can be an Auto Expert—earning big money—anywhere from \$3500 to \$10,000 a year.

### I'll Fit You For a Big Pay Job

My Course in Automotive Training is the oldest and best home study course. It is intensely practical. It is simple, easy to understand, easy to apply. Let me be your partner and I'll give you the best training in America—teach you the business from top to bottom—make you a practical expert able to boss a big-pay job.

### I've Been Through the Mill Myself

I know what you should learn, and all the short cuts to the right training. I started as an apprentice with the Daimler Co., then spent several years in the famous Rolls Royce factory. I worked with the Packard and other companies until I became experimental engineer with one of the biggest firms. Every step was practical—24 years of learning, until I knew that I could teach others every step on the road to success. Then came my big opportunity. The American School—a million dollar institution, with 27 years successful experience in Home Study, enabled me to get the help of 16 great automotive specialists in preparing and giving the very best automotive course that I could plan. I know this course will teach you how to go to the very top of the automotive business without going through the weary grind I had to take.

**I Guarantee You Success!** If I cannot give you a successful and satisfactory training, my guarantee protects you. You get your money back without a quibble. Could anything be fairer and squarer than that?

### Earn While You Learn—Earn Big Money Anywhere

You won't have to wait a full year before cashing in on my instruction. Almost from the start you can begin to do odd repair jobs and earn good money—just in your spare time. Then when you are ready for the BIG PAY AUTO FIELD, you can go to work anywhere—the trained auto expert is never out of a job.

**Enter This Big Money Field—Act Today** The greatest decisions are made on impulse. Delays are dangerous. Grasp your opportunity now—sign the coupon attached—get my big FREE book "The Way to Bigger Pay" which will tell you in a wonderfully interesting way all about this glorious field of opportunity and the best way to fit yourself for it. Start today! You'll never regret it!

**Tom Plumridge, Chief Engineer**

Automotive Division, American School  
Drexel Ave. & 58th St., Dept. A674, Chicago, Ill.

# Let Me Show YOU How

Tom Plumridge,  
Chief Engineer  
Automotive Div.,  
American School  
Dept. A-674  
Drexel Ave. & 58th St.  
Dept. A674, Chicago

Send me your free book and other information on how I can best get into the Big Pay Field. This request is to put me under no obligation.

Name.....

Address.....

City..... State.....

### FREE

Auto Library  
—Free Tools

When you decide to take my Course I send you an expensive set of Free Auto Tools and Precision Instruments for immediate, practical work. I also give you a handsome, big 5-volume Auto Reference Library, beautifully bound—the best in the world—without extra cost.



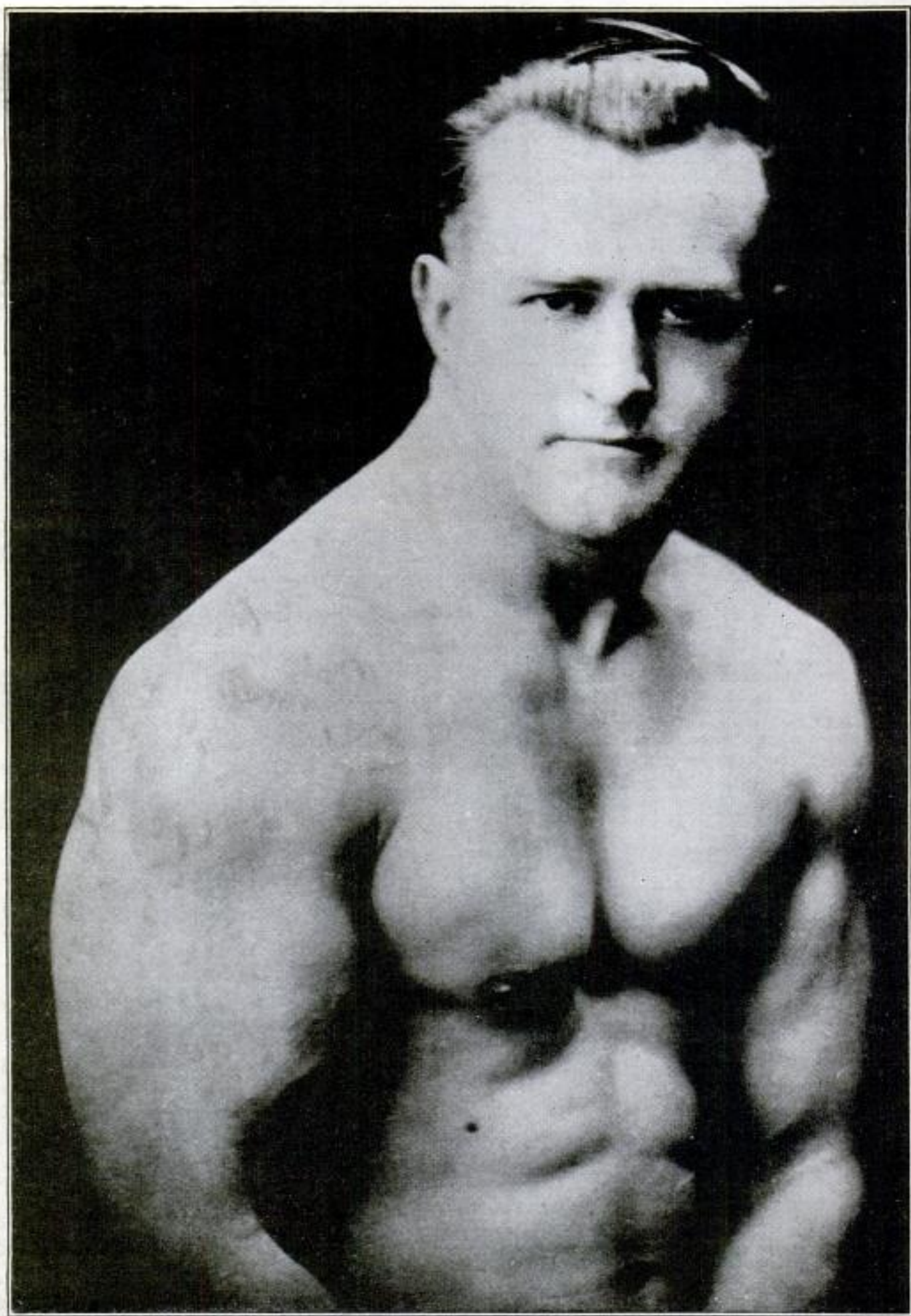

EARLE E. LIEDERMAN, *The Muscle Builder*

Copyrighted material



# IF YOU HAD A FACE LIKE A MONKEY

you would try to change it. But just because you wear a pair of pants and a coat to cover the rest of your body you don't seem to care a rap what you look like from your neck down. Come on out of it, fellows. Get wise. Don't you know you can't keep this up? It's only a few years and, *ZOWIE!*—it's too late. Your body is clogging up with all kinds of poisons. The only way to get rid of these poisons is to drive them out. Exercise wears off the worthless tissue, the blood carries it to the surface and then you sweat it out through your pores. That's simple enough. But if you don't—your blood will absorb all this poison and soon you're nothing but a human wreck.

## I MAKE STRONG MEN

No one likes to look at a narrow-shouldered, flat-chested dyspeptic. Such a man is no good to himself or anyone else. It's the strong, robust, energetic man who gets ahead. He is admired and sought after in both the business and social world. No matter where you find such a man, he is the whole works.

Come on then—snap into it. Right now—this minute. This is your day. This message was meant for you or you wouldn't be reading it. I'm all set and waiting for you, and, oh boy! what I do to you will sure open your eyes. I'm going to push out that chest of yours, broaden your shoulders and put a pair of arms on you that will carry the kick of a mule. I'm going to build up your whole body with good, solid muscle. I'm going to strengthen every vital organ and shoot a quiver up your old spine that will make you feel like a jack rabbit.

## I CAN DO IT

Just because a man is built like an ox doesn't mean he can show you how to be the same way. There are plenty of strong men today who couldn't tell you how they ever did it. I made my reputation teaching and building others. And my biggest achievements have been made during the past year—not ten years ago. My instructions are modern and up-to-date. When you come to me your success is assured. I don't promise strength—I guarantee it. Are you ready? Let's go.

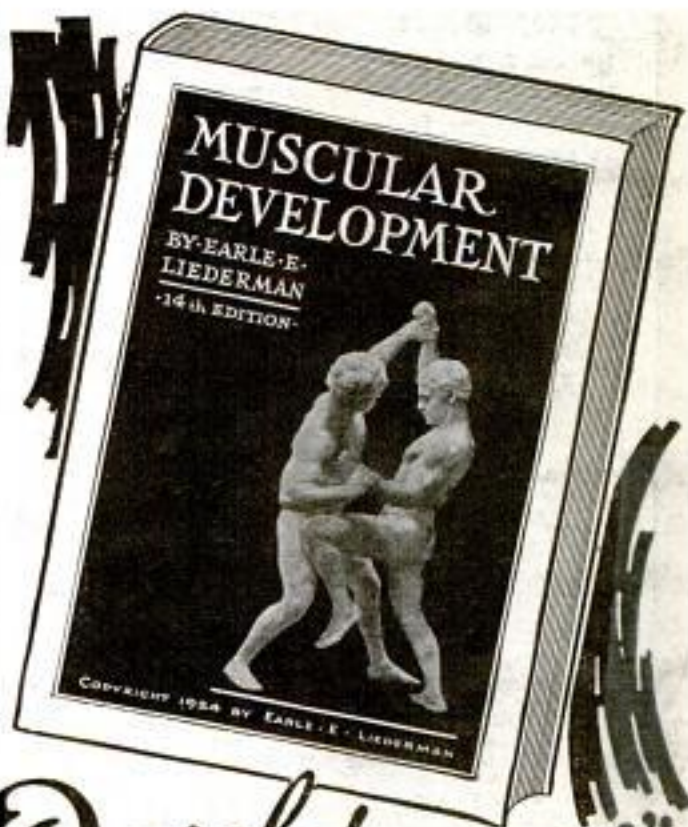

Send For My New  
64 Page Book

*"Muscular Development"*

IT IS FREE

It will show you what I have done for others and what I guarantee to do for you. It contains forty-three full page photographs of myself and some of the many prize-winning pupils I have trained. Some of these came to me as pitiful weaklings, imploring me to help them. Just look at them now and you will marvel at their splendid physiques. This book will prove an impetus and real inspiration to you. It will thrill you through and through. All I ask is 10 cents to cover the cost of wrapping and mailing and it is yours to keep. This will not obligate you at all, but for the sake of your future happiness and health do not put it off. Send today—right now before you turn this page.

**EARLE E. LIEDERMAN**  
Dept. 2009, 305 Broadway, New York City

**EARLE E. LIEDERMAN**

Dept. 2009, 305 Broadway, New York City

Dear Sir: I enclose herewith 10c. for which you are to send me, without obligation on my part whatever, a copy of your latest book, "Muscular Development."

Name.....

Street.....

City..... State.....

(PLEASE WRITE OR PRINT PLAINLY)



# for Dental Laboratory EXPERTS

## I'll Train You in 4 Months!

With my training any good mechanic now earning less than \$50 a week can in 4 months become a Dental Laboratory Expert and make from \$3 per hour up to \$10,000 per year! Every McCarrie-trained Dental Laboratory Expert will tell you there are more big-pay jobs than experts to fill them. So I invite every ambitious man regardless of age or education to write for my sensational training offer—mail coupon for complete information on how you can prepare for a salary of \$100 a week or more in double-quick time and at trifling cost.

### Fascinating Mechanical Profession!

Biggest-paying, fastest growing profession and not overcrowded. 70,000 Dentists in U. S. but only 1,000 laboratories to do their work. More Laboratories needed everywhere, more all-around Experts trained as I will train you,

to master every branch of Dental Laboratory work—to make vulcanite plates, crowns, fixed and removable bridge-work, metal base dentures parallel removable bridges, etc. Only dental laboratory school on earth with ethical practicing Dentist supplying clinical and actual cases. Work is delightfully pleasant and easy.



### Look How I Help You!

**I GUARANTEE My Personal Individual Training to Every Student**

I will make it worth your while to start now to get ready for the big opportunities in high-salaried positions and to go into business for yourself in a good location THIS FALL.

## FREE

R. R. Fare to Chicago or Detroit FREE. Big \$50 Outfit of Tools, Instruments and Supplies FREE. Free consulting Service. Post

Graduate Course FREE. Free Employment Bureau. We help you find work to pay expenses while here (if desired) and help you secure a position when you graduate.

### Work Your Way Through

McCarrie Schools are open days and evenings for the convenience of students who wish to work their way through. Plenty of work in both Chicago and Detroit. We will help you find work to your liking to help pay your tuition and expenses. So don't hesitate on account of lack of ready cash. We even pay your Railroad fare to Chicago or Detroit.

### Mail Coupon for Big New Book FREE

Tells you all about the surprising opportunities waiting for you when you are a McCarrie-trained Dental Laboratory Expert. Explains my rapid, practical method of training you for big-pay positions or to open your own laboratory. Contains my free offers of FREE railroad fare and \$50 Outfit. Write me personally right away!

Address, H. A. McCARRIE, Director

## McCarrie Schools of Mechanical Dentistry

Dept. 1201-1, 1338-40 So. Michigan Blvd., Chicago

\$3.00 an Hour  
 \$20.00 a Day  
 \$125.00 a Week  
 \$500.00 a Month  
 \$6000 to \$10,000 a Year



### Not Correspondence Instruction—You Learn by Doing Actual Dental Laboratory Jobs

This picture shows how I train my students. No classes—no text books. You learn by working on ACTUAL laboratory jobs with standard tools, instruments and materials under my personal instruction. By this plan you can complete the entire course in 4 months.

Because of this thorough, practical training, my graduates are qualified to step right into responsible, big-pay positions and do the highest grade work. In fact, I guarantee you success. So come to Chicago or Detroit where I have built up and equipped the largest Dental Laboratory Schools in the world. Then you'll understand why McCarrie graduates, men and women, are preferred by employers—why they are so well fitted to open laboratories of their own, and build up a business of from \$6,000 to \$10,000 a year.



McCarrie Schools of Mechanical Dentistry  
Dept. 1201-1, 1338-40 So. Michigan Ave., Chicago

Without obligation please send me your FREE R. R. Fare Offer and free catalog with complete information about how I may become a Dental Laboratory EXPERT.

Name .....

St. No. or R. F. D. ....

City ..... State .....





# Blame Yourself

**If This Message Doesn't Bring You A Big Salary Increase**

**L**ET'S be specific. What do you want in life? You want more money than you're getting. You want your own home, car, membership in a good club, you want to wear good clothes, educate your children and put away enough money to make you independent. If you are like other men, you want to be your own boss. You want to travel and meet the wide-awake people who are doing things.

All right. I'll tell you a quick, easy way to accomplish all this. If you don't take it you are the only loser.

You are the only one who will have to face the accusing finger of the man you might have been. If you do take it you'll thank me the rest of your life for putting this information in your hands. For now it is possible for you to quickly enjoy bigger earnings, and have all the joys in life that your bigger self demands. If this was a guess I couldn't print it. I know it to be a certainty. It is proved by the cases of thousands of other men who have done exactly the same thing. Listen.

## What It Brought These Men

For instance, Ellis Sumner Cook, 58 Superior St., Oak Park, Ill., left a \$25 a week job and last year made \$9,000! H. D. Miller, a Chicago boy, was making \$100 a month as a stenographer in July, 1922. In September, 3 months later, he was making \$100 a week as a salesman. W. P. Clenny of Kansas City, Mo., stepped from a \$150 a month clerkship into a selling job at \$500 a month. He is making \$850 a month now. M. V. Stephens of Albany, Ky., was making \$25 a week. He took up this training and now makes 5 times that much. J. H. Cash of Atlanta, Ga., exchanged his \$75 a month job for one which pays him \$500 a month. O. H. Malfroot of Boston, Mass., stepped into a \$10,000 position as a SALES MANAGER—so thorough is this training. All these successes are due to this easy, fascinating and rapid way to master certain invincible secrets of selling. But why continue here when I can send you hundreds of similar stories of success?

## The Secret Is Yours

What you want to know is how it's done. I'll tell you. Although none of these men had ever sold a thing in their lives, we took them without experience or training of any kind, and in a short period of time made Master Salesmen of them. Then our Employment Department helped them to select the right position and they were off with a boom to the success they had dreamed of.

The National Salesmen's Training Association can do exactly this for you. If this big organization of Master Salesmen and

Take any ten average men who are in blind alley jobs at low pay. Analyze each case without prejudice. You'll find that every one of them is solely and entirely to blame for his poor earning power. Every one of them has had a golden opportunity. They either have failed to recognize it, or, recognizing it, lacked the courage to follow it up. But now comes your chance. If this page doesn't bring you a big increase in salary—quick—you have no one to blame but yourself. **By J. E. Greenslade**

Sales Managers had raised the salaries of only a few men, then you might call it luck. But we've been doing it for sixteen years, day in and day out. Today we're so accustomed to the amazing increases in salary our members receive that we take them as a matter of course.

There is only one thing I ask of you in return for this offer. Don't let the idea of a big salary, the thought of traveling all around the country and meeting worth-while people, make you think that the job is beyond you. Keep an open, unprejudiced mind on this subject—at least until you have read the remarkable book that I want to send you without charge.

## Read This Free Book

This book, "Modern Salesmanship," explains why thousands have quickly succeeded in the selling field—how it is easy to make big money once you are in possession of the Secrets of Selling and how you can quickly get these fundamental secrets. It will also explain the National Demonstration Method which shows you how to overcome nearly every sales problem you will meet in a lifetime in the selling field. This is the book I will send you, absolutely free. Read it—then decide for yourself.

**National Salesmen's Training Association**  
Dept. 12-M 53 W. Jackson Blvd. Chicago, Ill.

### National Salesmen's Training Association

Dept. 12-M, 53 W. Jackson Blvd., Chicago, Ill.

I am willing to investigate the opportunity you offer without cost to myself. Please mail me Free Proof that I can become a Master Salesman and qualify for a good sales position. Also send your illustrated book, "Modern Salesmanship," and particulars of membership in your Association and its Free Employment service.

Name.....

Address.....

City..... State.....

Age..... Occupation.....



# MECHANICS' HANDBOOK



**330 PAGES**

**More than 300,000 sold**

**H**ANDIEST book of its kind ever written. Prepared by experts under the direction of the International Correspondence Schools. Written in language that you can understand. Note this partial list of subjects:

Weights and Measures; Easily Understood Mathematics; Formulae; Mensuration; Belting; Hydro-mechanics; Strength of Materials; Boiler Design; Care and Inspection of Boilers; Horsepower of Boilers; Chimneys; Exhaust Heating; Machine Design; Horsepower of Engines; Boilers and Pumps; The Slide Valve; Belt Pulleys; Rope Belting; Cylinders and Steam Chests; Electricity; Currents; Wiring; Dynamos and Meters; Batteries; Cable Testing; Compass Surveying; Curves; Leveling; Etc.

Just mail this advertisement with a dollar bill and your name and address, and this 330-page I. C. S. Mechanics' Handbook or any of the other I. C. S. Handbooks that you want will come to you by return mail.

Only  
\$1

INTERNATIONAL CORRESPONDENCE SCHOOLS  
Box 5635-D, Scranton, Penna.

I enclose \$..... for which send me, post-paid, the Handbooks marked X, at \$1.00 each. It is understood that if I am not entirely satisfied I may return any or all of them within five days and get my money back.

- MECHANICS' HANDBOOK
- |   |  |
|---|--|
| <input type="checkbox"/> Automobile Handbook      | <input type="checkbox"/> Radio Handbook        |
| <input type="checkbox"/> Electrical Handbook      | <input type="checkbox"/> Salesman's Handbook   |
| <input type="checkbox"/> Chemistry Handbook       | <input type="checkbox"/> Advertising Handbook  |
| <input type="checkbox"/> Building Trades Handbook | <input type="checkbox"/> Bookkeeper's Handbook |

Name.....

Address.....

**PLAY TEN-TEN-TENNESSEE!**

**ON HA HA**

**THE TENOR BANJO JAZZ**

No Previous Musical Knowledge Necessary--Quick--Easy--Positive  
Prof. Barker's method is so simple and easy that you quickly play any and all of the popular dance hits just as you have heard them played in dance or orchestra, on the stage--everywhere.

**JAZZ NEW ORCHESTRA STYLE  
NEW EASY WAY--FUN GALORE**

Just Mail a Post Card for Details of our remarkable **FREE Tenor Banjo Offer**--simply write: "I am interested"--**BUT DO IT TODAY.**

**First Hawaiian Conservatory of Music, Inc.**  
Desk 60  
233 Broadway  
(Woolworth Bldg.)  
New York City

Special courses under famous teachers: Hawaiian Guitars, Violin--Ukulele, Instrument Free

**FREE A Beautiful Tenor Banjo**

**ELECTRICAL ENGINEERING**

Course for men of ambition and limited time. Over 4000 men trained. Condensed course in Theoretical and Practical Electrical Engineering including the closely related subjects of Mathematics and Mechanical Drawing taught by experts. Students construct motors, install wiring, test electrical machinery. Course complete.

**IN ONE YEAR**

Established in 1893. Prepare for your profession in the most interesting city in the world. Free catalog.

**BLISS ELECTRICAL SCHOOL**  
104 Takoma Ave. WASHINGTON, D. C.

**ARTIST'S OUTFIT FREE**

Write quick for our remarkable offer. Learn **NOW** at home, in spare time, by our new instruction method. Commercial Art, Cartooning, Illustrating, Designing. Delightful, fascinating work in big demand. **\$50.00** paid for one drawing. Hand-some book free explains everything. **SEND FOR IT TODAY.**

**WASHINGTON SCHOOL OF ART, Inc.**  
Rm. 309, 1115-18th St. N.W., Washington, D.C.

**LEARN TO PITCH**

Lessons by "MATTY" WALSH, WHITE, JOHNSON, RUCKER, WOOD -- **PITCH THE FADE-A-WAY, SPITTER, KNUCKLER, SMOKE BALL, etc.**, clearly described and illustrated by 56 Pictures. Entire COURSE OF LESSONS sent p.p. for **25c.**

J.C. DORN, 7215 Dearborn St., Dept. 65, Chicago, Ill.

**Wrestling Book FREE**

Learn to be an expert wrestler. Know scientific wrestling, self-defense, and jiu-jitsu. Develop a splendid physique, and have perfect health. Join this popular school and learn by mail. The famous world's champions--the marvelous **Frank Gotch and Farmer Burns** offer you a wonderful opportunity. Wrestling is easily and quickly learned at home by mail. Men and boys write now for splendid free book. Learn all the science and tricks. Be able to handle big men with ease. Accept this wonderful offer **NOW.** Send for free book today, stating your age.

**Farmer Burns School of Wrestling, 1776 Ramps Bldg., Omaha, Neb.**



# \$3500 to \$5000 a Yr.

## 3 Months' Training

Will Qualify You for Success in the Most Rapidly Growing Professional Trade—

# MECHANICAL DENTISTRY

The very best opportunity for men who like to use tools. There is need right now for 2500 more Dental Mechanics and the demand is rapidly growing. There are now approximately 56,000 practicing Dentists in the U. S. and only about 4000 full-fledged Dental Mechanics! At the present time the shortage of Mechanical Dentists runs into the thousands with no immediate prospects of this demand being filled. Unequaled opportunity—pleasant, dignified work—steady income—rapid advancement—no "slack seasons" as in most other trades.

## You Learn by Doing

We train each student individually—no classes whatever. Instruction is practical from the very beginning. From the start you use the tools and instruments of the trade and work on practical dental work. But we do not make the serious mistake of depending on practical work alone as some schools do. You are given a definite theoretical training as well, so that you become familiar with both the theory and the practical working methods of Mechanical Dentistry used throughout the Dental Profession.

## Unequaled Curriculum

All phases of Vulcanite Denture construction, with clasp technique, bars, and patented attachments. Occlusion of teeth and anatomical articulation. Crowns of all types—Seamless, Two-piece, Darby, Richmond, Telescope, Carmichael, etc. Fixed Bridges—with and without interchangeable teeth; Sanitary Bridges; Dummy Bridges. Removable Bridges—Nesbit and Bonwell styles; Peso, Brown-Maier and Gollobin attachments using the Parallelometer. Metal Plates—Bodee Span Swedged Plate with attachments, partial rim and full upper swedged Plates, Partial rim Plates with tagged tooth and metal dummy, etc. Casting—every phase of this branch including crowns, bridges, saddles, clasps, plates, etc. Both direct and indirect methods used. Also the technique of carved teeth.

## Why Bodee-Trained Men Lead the Field

The Dental Profession recognizes the Bodee course as the highest standard of efficiency. This institution has maintained its leadership for over 30 years and is the oldest and largest school of Mechanical Dentistry in the world. It is and always has been the chief source of supply for competent dental mechanics. Compare the cost of our course with the charges of other schools offering to teach Mechanical Dentistry. Ask your own dentist to examine the course we give and tell you just how thorough and valuable it is.

## FREE PARTIAL SCHOLARSHIPS

In order to meet the urgent demand for the men we train, we are offering for a limited time Free Partial Scholarships. Be sure to ask immediately for this exceptional offer. It will very much reduce the cost of your training. Remember, this offer will be discontinued soon—so act NOW while it is still in effect.

## SEND FOR CATALOG AND SCHOLARSHIP OFFER

Catalog No. 2 fully describes the field and why the demand. Shows how students "Learn by Doing" actual work through practical, individual instruction, day or evening sessions. Shows how you can "Earn while Learning." This catalog is your First Step to Success in Mechanical Dentistry. IT IS FREE. SEND THE COUPON TODAY.

## BODEE DENTAL INSTITUTE

136 West 52d Street, NEW YORK

1335 No. Broad St., PHILADELPHIA

1226 Main Street, BUFFALO

85 Court Street, BROOKLYN

The Shortest  
Way to  
Professional  
Earnings

WE  
DO  
NOT

1—Offer "Free" Railroad Fare—

It is plain that any such expense would have to be added to charges for tuition.

2—Offer "Free" Sets of Tools—Our regular tuition covers the cost of a Complete Set of Standard Tools of the trade. (See catalog page 25.)

## HERE'S WHAT WE DO

We give the Most Thorough Course in the Most Practical way. Ask your Dentist about the High Standing of the School and the Quality of the instruction given.



## SEND THIS COUPON

BODEE DENTAL INSTITUTE:  
Without obligation to me send me a Free Copy of your catalog and complete details of the Free Partial Scholarship Plan No. 2.

Name.....

Address.....





## High School Course in Two Years!

### You Want to Earn Big Money!

And you will not be satisfied unless you earn steady promotion. But are you prepared for the job ahead of you? Do you measure up to the standard that insures success? For a more responsible position a fairly good education is necessary. To write a sensible business letter, to prepare estimates, to figure cost and to compute interest, you must have a certain amount of preparation. All this you must be able to do before you will earn promotion. Many business houses hire no men whose general knowledge is not equal to a high school course. Why? Because big business refuses to burden itself with men who are barred from promotion by the lack of elementary education.

### Can You Qualify for a Better Position

We have a plan whereby you can. We can give you a complete but simplified high school course in two years, giving you all the essentials that form the foundation of practical business. It will prepare you to hold your own where competition is keen and exacting. Do not doubt your ability, but make up your mind to it and you will soon have the requirements that will bring you success and big money. YOU CAN DO IT.

Let us show you how to get on the road to success. It will not cost you a single working hour. Write today. It costs you nothing but a stamp.

### American School

Dept. H674 Drexel Ave. and 58th St., Chicago

### American School

Dept. H674 Drexel Ave. and 58th St., Chicago  
Send me full information on the subject checked and how you will help me win success.

- |                             |                           |
|-----------------------------|---------------------------|
| ....Architect               | ....Lawyer                |
| ....Building Contractor     | ....Machine Shop Practice |
| ....Automobile Engineer     | ....Photoplay Writer      |
| ....Automobile Repairman    | ....Mechanical Engineer   |
| ....Civil Engineer          | ....Shop Superintendent   |
| ....Structural Engineer     | ....Employment Manager    |
| ....Business Manager        | ....Steam Engineer        |
| ....Cert. Public Accountant | ....Foremanship           |
| ....Accountant and Auditor  | ....Sanitary Engineer     |
| ....Bookkeeper              | ....Surveyor (& Mapping)  |
| ....Draftsman and Designer  | ....Telephone Engineer    |
| ....Electrical Engineer     | ....Telegraph Engineer    |
| ....Electric Light & Power  | ....High School Graduate  |
| ....General Education       | ....Fire Insurance Expert |
| ....Vocational Guidance     | ....Wireless Radio        |
| ....Business Law            | ....Undecided             |

Name .....

Address .....

## We Teach COMMERCIAL ART

Meyer Both Company, the largest Commercial Art Organization in the World offers you a practical training based upon twenty-five years of success. This nationally known organization each year produces and sells to advertisers over 15,000 commercial drawings.

This well paid profession equally open to men and women. Home study instruction.

### Get Facts Before You Enroll in Any School

Ask the Advertising Manager of the leading newspapers in your city about Meyer Both Company—let them tell you about us. Send four cents in stamps for illustrated book telling of the success of our students.

### MEYER BOTH COMPANY Department of Art Instruction

CHICAGO, ILLS.

Michigan Ave. at 20th St. Dept. 16

Note—To Art and Engraving Firms: Secure artists among our graduates. Write us.

### Delivered to You Free

for 30 days trial on approval. You can have your choice of 44 Styles, colors and sizes of the famous RANGER Bicycles. Express prepaid. Factory-to-Rider Prices save you \$10 to \$20 on your bicycle.

\$5 a Month if desired. Many boys and girls easily save the small monthly payments. Parents often advance first payment.

Best quality, at factory prices, express prepaid. Lamps, wheels and equipment, low prices. Send

Tires No Money, do business direct with makers.

**Mead CYCLE COMPANY**  
DEPT. W-108 CHICAGO

Write today for free Range Catalog, factory prices and marvelous easy payment terms.



## STAMMER

If you stammer attend no Institute till you get my large FREE book entitled "STAMMERING, Its Origin and The Advanced Natural Method of Treatment." Ask for special tuition rate and a FREE copy of "The Natural Speech Magazine," published monthly in the interest of those afflicted with stammering, stuttering and other speech impediments. Largest, best equipped and most successful school in the world for the cure of stammering. Established 20 years. No sing-song or time-beat. Write today. Millard Institute of Normal Speech, 2317 Millard Bldg., Milwaukee, Wis.

NOTICE—All men, women, boys, girls, 17 to 65, willing to accept Government Positions, \$117-\$300 monthly, traveling or stationary write Mr Orment, 111, St. Louis, Mo AT ONCE

**FREE**  
\$20  
Fine Tone  
Musical  
Instruments



We have a wonderful new copyrighted system of teaching note music by mail! To first pupils in each locality we will give free a \$20 superb Violin, Tenor Banjo, Ukulele, Hawaiian-Guitar, Banjo, Mandolin, Banjo-Ukulele, Banjo-Mandolin, Cornet or Banjo-Guitar absolutely free. Also teach Piano and Organ. Very small charge for lessons only. Four lessons will teach you several pieces. Over 100,000 successful players. We guarantee success or no charge. Complete outfit free. Write today, Dept. 167. No obligation. SLINGERLAND SCHOOL OF MUSIC, 1815 Orchard Street, CHICAGO, ILLINOIS





# BRICK

## CONCRETE—TILE—PLASTER

Audels new set for Masons and Builders is a practical, up-to-the-minute trade assistant for **Bricklayers, Plasterers** and all **Cement Workers**. A complete course and trade-teacher for the apprentice; a working companion for the Journeyman; a ready reference for the boss builder; a practical instructor for the home builder. These Guides for Bricklayers, Stone masons, Cement workers, Plasterers and Tile setters are based on modern practice. They explain in practical, concise language and clear illustrations, diagrams, graphs and pictures, the methods, principles, advances and short cuts—including instructions on How to Figure and Calculate various jobs.



## AUDELS MASONS & BUILDERS GUIDES

EASY TERMS

ONE DOLLAR PER MONTH

Complete set, 4 vols., price \$6.

Pocket size, flexible covers

Gilt edge, clearly printed

1080 Pages—all easy to read

2067 Trade Illustrations

Shipped for free trial, test and examination

\$  
**1**

**Audels Guides Tell You All About:—**

**BRICK** (GUIDE No. 1) Brick laying, classifications, strength tests, different kinds of mortar; classification of tools, scaffolding, Brick Designs, Bonding, walls, veneering, corners, openings, setting frames, Foundation walls, piers, chimneys, underpinning, repairing old work, arches.

**TILE** (GUIDE No. 2) Tile Setting, hollow tile, porous terra cotta partitions, shell wall tiles, clay roofing tiles, sizes, sorting and grading, concrete setting beds, reinforcement, mortar beds, troweling, beating in, straight edge test, ceramic mosaic; ESTIMATING—How to figure brick work, examples, tables, labor estimating.

**CONCRETE** (GUIDE No. 3) Materials, aggregates, cement, mixing, placing forms. Reinforced Concrete, metal systems, bonding, anchoring, how to figure concrete work, costs of materials and carpenter work; Stucco, application on new and old buildings, concrete block and tile walls, foundations.

**PLASTER** (GUIDE No. 4) On wood and metal, wall boards, plasterers' materials and tools, plastering on stone, brick or concrete, Stone Masonry, selection and strength of stone, cutting, finishes, classification of masonry, derricks and rigging, Steel Construction, Outline of structural shapes, beams with girders, riveting rules; Building Suggestions, garage, pavement, ice house, etc.

**FREE TRIAL OFFER**

If you want to know the advances in building progress—save mistakes — save work — save materials—solve your problems, it will pay you to send in this coupon NOW. Examine and test out the Guides for yourself. No obligation to buy unless satisfied. No money now. Nothing to pay post man. Fill in in pencil and send TODAY!

THEO. AUDEL & CO., 72 Fifth Ave., New York City

Send me postpaid, for free examination, AUDELS MASONS AND BUILDERS GUIDES, 4 numbers. If satisfactory I will mail you \$1 within 5 days and \$1 monthly until \$6 is paid.

NAME.....  
ADDRESS.....  
OCCUPATION.....  
EMPLOYED BY.....  
REFERENCE.....

9730



# LEARN CARTOONING

Successful cartoonists earn big salaries. Many of the most popular cartoonists of today learned to draw in their spare time, at home, through the Landon Course of Cartooning and now earn \$75 to \$200 a week.



The Landon Picture Chart Method of teaching ORIGINAL drawing makes cartooning easy to learn. Hundreds of sketches like the above explain every step in creating ORIGINAL heads, figures, animals, etc.

Write today for Sample Landon Picture Chart, long list of successful Landon students and full information showing possibilities for you. Please state your age.

The LONDON SCHOOL, 738 National Building, CLEVELAND, OHIO

## Four Successful Landon Students From One Village

Here is the record of four boys—all from Nappanee, Ind. (2200 population)—who, after taking the Landon Course, won national reputations:

Merrill Blosser is now nationally famous as creator of "Freckles and His Friends."

Henry Maust's work appears in Saturday Evening Post, Cosmopolitan, etc.

Francis Parks, following their advice, is now a cartoonist for the Omaha News.

Fred Neher is comic artist with the Universal Feature Co.

## If I Send You a Suit



made to your measure, in the latest style, would you keep and wear it, show it to your friends, let them see our beautiful samples and splendid new styles? Could you use \$3.00 an hour for a little spare time? **Every tailoring agent, send for our wonderful new proposition.** Just write a letter or postal or fill out and mail coupon below. I will send you our big new book of samples and styles to pick from and my new, special offer, **all free.** Even if you don't care to be agent, send anyway, and learn how to get all your own clothes **FREE.**

Send Name and Address on This Coupon

To **L. E. ASHER, President**  
**BANNER TAILORING CO.**  
Dept. 289, CHICAGO, ILL.

Dear Sirs: Send me your special offer, all **FREE.**

Name.....

R. F. D. .... Box ..... St. and No. ....

P. O. .... State.....



Wonderful, new device, guides your hand; corrects your writing in few days. Big improvement in three hours. No failures. **Complete outline FREE.** Write C. J. Ozment, D-34, St. Louis, Mo.



## WANTED!

### U.S. RAILWAY MAIL CLERKS

**Steady Work—No Layoffs—Paid Vacations**  
**Travel—See Your Country**

Common Education Sufficient—Mail Coupon Today—**SURE**

## "STAMMERING Its Cause and Cure"

You can be quickly cured if you stammer. Send 10 cents, coin or stamps, for 288 page cloth bound book on Stammering and Stuttering. It tells how I cured myself after Stammering and Stuttering for 20 years. **BENJAMIN N. BOGUE**  
6913 Bogue Building, 1147 N. Ill. St. Indianapolis

## FREE BOOK



## Learn Piano!

### This Interesting Free Book

shows how you can become a skilled player of piano or organ at **quarter** the usual cost. It shows why one lesson with an **expert** is worth a **dozen** other lessons. Dr. Quinn's famous **Written Method** includes all of the many important modern improvements in teaching music. **Bring right to your home** the great advantage of conservatory study. For the beginner or experienced player. Highly endorsed. Successful graduates everywhere. Scientific yet easy to understand. Fully illustrated. **All music free.** Diploma granted. Write today for freebook. **Quinn Conservatory, Studio P.M.89, 598 Columbia Road, Boston, 25, Mass.**

**CHIROPODY**—a well paying, dignified profession for men and women. Opportunities for big practice all cities. Faculty of physicians, surgeons and chiropodists. Largest foot institution in the world. Eleventh year. Degree Doctor of Surgical Chiropody. Write for catalog, Dept., 68, Illinois College of Chiropody, 1327 N. Clark St., Chicago

## EARN BIG PROFITS Selling Electrical Appliances

WE START YOU OUT

The electrical industry is yet merely in its infancy. Get in on the ground floor of a **dignified, interesting and profitable** business. Steady income, pleasant, easy, demonstrating Violet Rays and electrical appliances which sell on sight. Experience not required. **MEN and WOMEN** earn big money, spare or all time. Salary to producers. Commissions liberal, in advance. We deliver and collect. Write for exclusive territory. **VI-REX CO., Dept. A-80, 211 S. Peoria St., Chicago**

## \$1600 to \$2300 Year

**MEN—BOYS 18 UP SHOULD**  
**MAIL COUPON IMMEDIATELY**

Franklin Institute, Dept. N177, Rochester, N. Y.

Sirs: Send me, without charge, (1) sample Railway Mail Clerk Examination questions; (2) tell me how to get a U. S. Government job; (3) send list of places at which examinations will be held; (4) send copy of illustrated book, "How to Get Government Jobs."

Name.....

Address.....





# FREE TRIAL LESSON

Send the coupon and get this lesson in Drafting. It will show you how well qualified you are to take up this great profession. Also shows the Chicago Tech. method of instruction by mail. Find out about all this before you enroll or pay a penny. Mail the coupon now.

# DRAFTING

## Train in Spare Time—Double Your Income

Put yourself in the big pay class. Get expert training in Drafting under the Chicago Tech. experts. Be master of a profession in which there are not enough highly skilled men to fill the paying jobs that are open. The Chicago Tech. method of training men by mail gives you a finished, practical education in Drafting—in your own home in spare time. Just a few hours a week and you get a thorough training under the personal direction of experts.

## Get Your Instruction Under Practical Men

Enrolled at Chicago Tech. you are instructed by practical engineers—not by mere theorists. These men have been "through the mill." They know just what problems you will have to solve in actual practice and show you how to master them. No time wasted on unnecessary studies. You get this training at a low cost and on easy terms, and you graduate early.

## The Big Job Will Be Ready When You Are

Everywhere there is a call for capable Draftsmen—men who can take hold of important work and see it through. Men of this kind are always in demand at high salaries by railroads, manufacturers, architects, contractors, electrical works and other big industries. Chicago Tech. training which you can get by mail or in day or evening classes at the College in Chicago will make you the man wanted for the big positions that are open to highly trained men.

## Chicago Tech. Men Succeed

Every year Chicago Tech. graduates step into the ranks of successful men. You find them everywhere employed at high salaries or in business for themselves—independent and prosperous because they have the practical knowledge that enables them to handle the kind of jobs which command big pay.

Chicago Tech. training increased my salary 300%.  
F. L. Cary.

Successful in own business as a result of Chicago Tech. training.  
O. L. Rosin.

Have had my pay raised \$73.70 a week since I took Chicago Tech. course.  
S. Schrier.

**To Employers:**  
Chicago Tech. men a practical. Write to us when you need Draftsmen.

## FREE Drawing Outfit

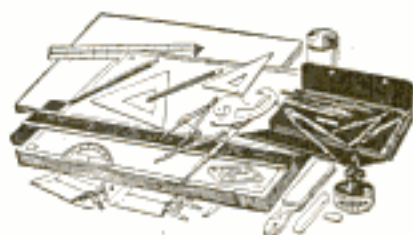

Enrolled in the Chicago Tech. Home Study Drafting Course you get this complete Drawing Outfit (Retail price \$25.00) without extra cost (or you are given a credit on fees if you have an outfit).

## Send the Coupon

Mail the coupon and get the Free Trial Lesson—also catalogs and full information about the Chicago Tech. Method of teaching Drafting by mail. Find out about the opportunities that Drafting offers to ambitious men. No cost to you—no obligation. Send the Coupon.

**Chicago Technical College**  
Dept. 930, Chicago Tech. Bldg.  
118 East 26th St., Chicago, Ill.

Without cost or obligation on me please send instructive matter about opportunities in line I have marked with "X."

**Drafting.** (The Big Salary Course.) No experience necessary. Free Lesson sent now.

**Building Trade Course.** For men in the building lines.

Write or Print Name Plainly

Name.....

Address.....

City.....

State.....

**Chicago Technical College** Dept. 930, Chicago Tech. Bldg.  
118 E. 26th St., CHICAGO, ILL.





## An Easy Way to Learn PHARMACY AT HOME

Graduate pharmacists are always in demand. The work is interesting and pleasant and salaries are good. Many young men open drug stores of their own and become independent.

There's an easy way to learn pharmacy right in your own home in spare time, without losing a day or a dollar from your present work.

The International Correspondence Schools course in Pharmacy supplies the knowledge which it will be necessary for you to have in order that you may pass your State Board Examination.

Just mark and mail the coupon printed below to the International Correspondence Schools, Box 5631-D, Scranton, Pa., and full particulars about the Pharmacy Course or any other work of your choice will come speeding to you by return mail.

### INTERNATIONAL CORRESPONDENCE SCHOOLS Box 5631-D, Scranton, Penna.

Without cost or obligation, please send me full information about the subject before which I have marked an X in the list below:

#### TECHNICAL AND INDUSTRIAL COURSES

- |  |   |
|--|---|
| <input type="checkbox"/> PHARMACY                | <input type="checkbox"/> Civil Engineer                                     |
| <input type="checkbox"/> Chemistry               | <input type="checkbox"/> Surveying and Mapping                              |
| <input type="checkbox"/> Automobile Work         | <input type="checkbox"/> Mine Foreman or Engineer                           |
| <input type="checkbox"/> Navigation              | <input type="checkbox"/> Steam Engineer                                     |
| <input type="checkbox"/> Agriculture and Poultry | <input type="checkbox"/> Gas Engine Operating                               |
| <input type="checkbox"/> Mathematics             | <input type="checkbox"/> Wireless <input type="checkbox"/> Airplane Engines |
| <input type="checkbox"/> Electrical Engineering  | <input type="checkbox"/> Architect  |
| <input type="checkbox"/> Electrician             | <input type="checkbox"/> Contractor and Builder                             |
| <input type="checkbox"/> Mechanical Engineer     | <input type="checkbox"/> Architectural Draftsman                            |
| <input type="checkbox"/> Mechanical Draftsman    | <input type="checkbox"/> Concrete Builder                                   |
| <input type="checkbox"/> Machine Shop Practice   | <input type="checkbox"/> Structural Engineer                                |
| <input type="checkbox"/> Railroad Positions      | <input type="checkbox"/> Plumbing and Heating                               |

#### BUSINESS TRAINING COURSES

- |   |   |
|---|---|
| <input type="checkbox"/> Business Management                              | <input type="checkbox"/> Salesmanship                                     |
| <input type="checkbox"/> Industrial Management                            | <input type="checkbox"/> Advertising                                      |
| <input type="checkbox"/> Personnel Organization                           | <input type="checkbox"/> Better Letters                                   |
| <input type="checkbox"/> Traffic Management                               | <input type="checkbox"/> Foreign Trade                                    |
| <input type="checkbox"/> Business Law                                     | <input type="checkbox"/> Stenography and Typing                           |
| <input type="checkbox"/> Banking and Banking Law                          | <input type="checkbox"/> Business English                                 |
| <input type="checkbox"/> Accountancy (including U.P.A.)                   | <input type="checkbox"/> Civil Service                                    |
| <input type="checkbox"/> Nicholson Cost Accounting                        | <input type="checkbox"/> Railway Mail Clerk                               |
| <input type="checkbox"/> Bookkeeping                                      | <input type="checkbox"/> Common School Subjects                           |
| <input type="checkbox"/> Private Secretary                                | <input type="checkbox"/> High School Subjects                             |
| <input type="checkbox"/> Business Spanish <input type="checkbox"/> French | <input type="checkbox"/> Illustrating <input type="checkbox"/> Cartooning |

Name .....

Street .....

Address .....

City .....

State .....

Occupation .....

Persons residing in Canada should send this coupon to the International Correspondence Schools Canadian, Limited, Montreal, Canada



## LEARN BY DOING

Every phase of all branches of

## ELECTRICITY

taught by

### Actual Practice

In America's foremost  
and oldest institution  
for trade training

### No Books Used

Individual Instruction  
Start Any Day

Write for FREE 64-page catalog

## THE NEW YORK ELECTRICAL SCHOOL

44 West 17th St., New York City  
Open All Summer

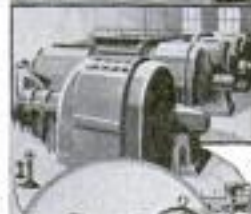

## PIANO JAZZ

By Note or Ear With or without music. Short Course. Adult beginners taught by mail. No teacher required. Self-instruction Course for Advanced Pianists. Learn 67 styles of Bass, 180 Syncopated Effects, Blue Harmony, Oriental, China, Movie and Cafe Jazz, Trick Endings, Clever Breaks, Space Fillers, Sax Sturs, Triple Bass, Wicked Harmony, Blue Obligato, and 247 other Subjects, including Ear Playing and Musical Invention. 110 pages of REAL Jazz, 25,000 words. A Postal brings our FREE Special Offer.

Waterman Piano School, 259 Septha Theatre Bldg., Los Angeles, Cal.

## BE AN ARTIST

WE CAN TEACH  
YOU DRAWING in  
your own home during your  
spare time. Twenty-five years of  
successful teaching proves our ability.  
Artists receive large salaries.

Write Today for Art Year Book

SCHOOL OF APPLIED ART  
ROOM NO. 2 BATTLE CREEK MICH.



Can you afford to

## STAMMER?

or STUTTER?

It ruins many chances for promotion.  
Send postage for large free book "The Correction of  
Stammering and Stuttering." Methods successful for  
over a quarter-century. THE LEWIS INSTITUTE,  
33 Lewis Bldg., 77 Adelaide St., Detroit, Mich., U.S.A.

## RAISE POULTRY FOR PROFIT

We teach you how. Easily learned at home. Our guaranteed methods make success certain—indorsed by leading Agricultural Colleges. Send TODAY for FREE BOOK—"How To Raise Poultry For Profit."

National Poultry Institute  
Dept. 312 Washington, D. C.





# GREER will help you climb the Salary Heights

Increase Your Earning Power In The Auto Business

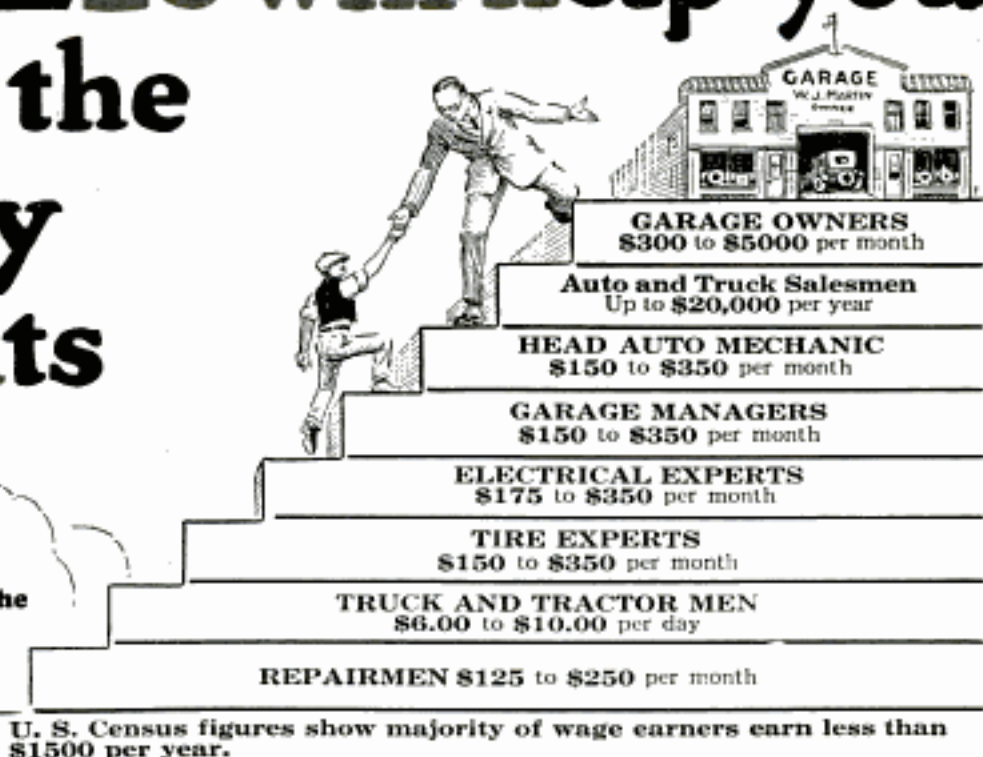

## SPECIAL TRAINING OFFER

Income statistics show that by far the largest class of wage earners earn less than \$90 per month. Don't waste YOUR life away in the low salary class! In from 8 to 12 weeks I can prepare you to earn \$35 to \$100 per week, and more as you progress. I pay railroad fare to Chicago and find you a home. If you need assistance while training I get you an earn-while-you-learn job. I GUARANTEE to get you an automobile job at good pay after you learn. Or you can go in business for yourself.

Special training group now forming. Be one of them. Rates reduced. Time Payments. Special kit of tools—21 pieces—FREE. Every Auto, Truck and Tractor subject covered in actual shop work. Free RADIO COURSE. Day and evening instruction. Choose your own time.

### I Have Trained 47,781 Men

Of these men, trained by my staff of experts under my personal direction, 30,245 are now in business for themselves. Here is the answer to YOUR FUTURE!

### Mail Coupon for FREE AUTO BOOK

This book brings you my entire proposition and pages of valuable automobile information. It is FREE. Get it NOW, while above offers are held open. Send this coupon to me today.

How To Succeed  
in the  
Automobile & Tractor  
Business

ERWIN  
GREER

President  
2024 S. Wabash  
Avenue  
Dept. 901  
CHICAGO, ILL.

Please send me FREE Book, "How to Succeed in the Automobile and Tractor Business" and special training offer. This request does not obligate me in any way.



### The First Step Upward

This magnificent new seven story building is filled with repair shops and modern shop equipment entirely devoted to training Greer students.

**GREER**  
COLLEGE  
**Automotive  
Engineering**

2024 S. Wabash Ave.  
Dept. 901  
CHICAGO, ILLINOIS

Name .....

Address .....





## HOW MUCH do ARTISTS EARN?

WOULD you like to earn \$100 a week as a commercial artist? If you like to draw, you should develop your talent, for well-trained artists earn \$75, \$100, \$150 a week, and oftentimes much more. Beginners who can do practical work soon command \$50 a week.

The Federal home-study course develops your talent on a sure foundation by the **quickest possible method**, and makes the work truly a pleasure. It is the **original, practical course in commercial art**, created by men with more than 25 years' experience in the field, and after 8 years of unequalled success today stands supreme as America's Foremost Course in Commercial Designing. It contains **exclusive lessons** from leading American artists, gives you individual personal criticisms on all lessons and teaches you the methods that make your drawings worth real money.

### Send Today for "YOUR FUTURE"

If you are in earnest about your future, send 6c in stamps today for this book. It is beautifully illustrated, tells every detail about the Federal Course, gives you convincing proofs of its merits and shows work done by Federal Students. Fill out and mail the coupon NOW, kindly stating your age and occupation.



Federal School  
of Commercial Designing  
699 Federal Schools Bldg., Minneapolis, Minn.  
Gentlemen: Please send me "YOUR FUTURE" for which I enclose 6c in stamps.

Name .....

Age..... Occupation.....

Write your address  
plainly in margin.

# Learn to Write



## I Teach by Mail

I can make a good penman of you at your home during spare time, no matter where you live or how poorly you now write. My simplified system has shown thousands the way to good penmanship during the past twenty-five years — it CAN and WILL do the same for YOU.

My beautifully illustrated 32-page Book

### "How to Become a Good Penman" FREE!!

It contains many beautiful specimens of penmanship showing what others have accomplished by the Tamblin System, with testimonials and general information about our courses. (Your name elegantly written on a card if you enclose stamp for postage.) Ladies taught as successfully as men. Write Today, Address

**F. W. TAMBLIN**  
418 Ridge Bldg. Kansas City, Mo., U. S. A.

# Tamblin

## MUSIC LESSONS FREE



IN YOUR  
OWN  
HOME

You can read Music like this quickly

Piano, Organ, Violin, Mandolin, Guitar, Banjo, etc. Beginners or advanced players. One lesson weekly. Illustrations make everything plain. Only expense about 2c per day to cover cost of postage and music used. Write for FREE booklet which explains everything in full.

AMERICAN SCHOOL OF MUSIC, 51 Lakeside Building, CHICAGO

## LEARN WATCH REPAIRING



You can learn by our modern and original system of instruction every part of the **Watch Repairing Trade** at home as good or better than at a shop. You can earn money while learning and secure a well paying position or start in business after completing our course of instruction. Good watch repairers are always in demand and earn from \$40 to \$70 per week. For particulars apply to the

**Wisconsin School of Watch Repairing**  
166 Mason St., MILWAUKEE, WIS.

## STAMMER NO MORE

Kill the fear of stammering. Re-education the key. The widely famed Hatfield Method fully outlined in an accurate, dependable, worthwhile book—"HOW TO STOP STAMMERING." It has inspired thousands. Free copy today

THE HATFIELD INSTITUTE, 109 N. Dearborn, Chicago, Ill.

## PIMPLY SKIN made WELL

When a few applications of this wonder-working lotion has cleared faces of **pimples, blackheads, acne eruptions** on the face or body, **barbers itch, eczema, enlarged pores, oily or shiny skin**, you can realize why **CLEAR-TONE** has been tested and approved in over **100,000 Test Cases**. The simplicity of the treatment, and **The Story of How I Cured Myself** are all explained in my free booklet, "**A Clear-Tone Skin**." Write for your copy today and learn of the results gotten by thousands of men and women.

FREE BOOK

Clear-Tone



E. S. GIVENS, 128 Chemical Bldg., Kansas City, Mo.



# YOU CAN PLAY THIS

Professional Style

# HAWAIIAN GUITAR

JUST LIKE THE HAWAIIANS!

## BECAUSE OUR NATIVE HAWAIIAN INSTRUCTORS WILL SHOW YOU HOW!

Be the Most Popular Member of your Set. Play "What'll I Do", "So This Is Love", "Memory Lane", "Minding My Business", "Fair Lady", "Lazy", "Linger Awhile". All the late song and dance hits. You can play First Selection in Half an Hour and Harmonious Chords at ONCE. Entertain your friends. Play for money. Don't be a wallflower. Be the Life of the Party.

## FAMOUS HAWAIIANS TEACH YOU TO MASTER QUICKLY THEIR SECRETS OF THIS FASCINATING MUSIC

The instructions you receive from such world famous experts as Lawrence Kalaluki, Walter Kolomoku, Frank Perera, Carl Seville and others are invaluable. NO OTHER Conservatory can even begin to give you the expert teaching and knowledge you gain through us. And remember, while it is conceded that the Hawaiian Guitar produces the sweetest music, yet its mastery by you will be simple and quick. We guarantee it.

**ONLY 4 EASY MOTIONS**—to learn to be able to play any music, popular, dance, classical, native Hawaiian Airs or old time melodies and hymns. Just think of it! You need never have read a musical note in your life. For that matter, even though you haven't the slightest knowledge of any musical instrument, we guarantee to teach you to play just like the native Hawaiians.



## NEW INVENTION MAKES IT EASY

Here is your chance to learn to play the most fascinating of all instruments, the Hawaiian Guitar. JUST AS THE HAWAIIANS DO, and in an amazingly short time. Our method is so simple, plain and easy that you begin a piece your first lesson. In half an hour you can play it! Thousands of successful students prove this to be true. No matter how little your knowledge of music may be, you can positively learn to play by our plain, easy picture method.

## COMPLETE CONSERVATORY COURSE

You get 52 complete lessons. An entire conservatory course. Nothing is omitted. Success is assured. It is the best course of Hawaiian guitar lessons in the entire world. Real Hawaiians instruct you. This is the only Conservatory teaching Hawaiian Guitar exactly as played by the Hawaiians. It is your good fortune as well as ours, that these Native Masters of Hawaiian Guitar come to this Conservatory to teach. That is why we are the largest and the best known Conservatory of the kind. Your success is assured when you enroll.

## ANYONE CAN PLAY

We guarantee it. 40,000 pupils prove it. You don't have to know music. Our picture method makes it easy. Don't be afraid to try it.

## WE FURNISH YOU WITH EVERYTHING

When you enroll as a student in this conservatory, you receive FREE a handsome, sweet toned, Genuine Hawaiian Guitar—valued at \$15.00—52 especially arranged lessons, as well as all the necessary Picks, Steel Playing Bar, etc. There is NOTHING extra to buy; everything is furnished.



**EXTRA!** As a special offer to readers of this magazine, we supply 52 pieces of music as a part of the course of lessons. Study the pictures of the good times you can have at parties, etc. Get in on the fun. Don't pass up this chance. Send the coupon at once for information and proof.

FIRST HAWAIIAN CONSERVATORY OF MUSIC  
Dept. 48, 233 Broadway (Woolworth Bldg.) New York, N.Y.

**SPECIAL COURSES UNDER FAMOUS TEACHERS, TENOR BANJO, VIOLIN, BANJO-UKULELE AND UKULELE**



**THIS COUPON MAKES IT EASY**

# FREE!

THIS \$15.00  
GENUINE  
HAWAIIAN  
GUITAR



## WORTH \$15.00

Yes, that is the price charged in the music stores for these beautiful Hawaiian Guitars. We can afford to give them away free of charge to every pupil because we manufacture them in huge quantities in our own factory, which is the largest stringed instrument factory in the world.

## SWEET TONED

You will get the same haunting, soothing, plaintive fascinating tunes that the real native Hawaiians get on these same instruments.

Plays any kind of music. 40,000 satisfied pupils prove all our claims are true.

**Yours Free!** We mean it. There are no strings tied to this generous offer. You get it absolutely free as soon as you enroll for our course of 52 easy lessons, taught by real Hawaiians. You can't possibly lose, so mail the coupon at once for full information.

**Be Popular** You'll never be lonesome after you learn to play on this beautiful Hawaiian Guitar. You can be the life of the party. Don't be a wallflower. Use the coupon for complete information. Mail it right away.



**TEAR OUT AND MAIL**

FIRST HAWAIIAN CONSERVATORY OF MUSIC, Inc., Dept. 48, 233 B'way, Woolworth Bldg., New York, N. Y. Gentlemen: Of course I want to get this handsome \$15.00 Hawaiian Guitar free of charge, because I am interested in learning to play it. Please mail full information about your 52 easy lessons under real Hawaiians, and proof that I can play a piece after the first lesson. I am not obliged to enroll unless I want to.

Name.....  
Local Address.....  
City & State.....





## Hotels Start You With Salaries up to \$3,500 a Year — with your living

**H**OTELS, restaurants, clubs, apartments, everywhere need trained men and women—salaries to start up to \$3500 a year with your living. Over 70,000 high-class positions paying up to \$10,000 a year are open every year in the hotels of the United States. Today this is the 1st INDUSTRY IN AMERICA—with over 8992,394,968 in new hotels being built in 1924—exceeding by \$200,000,000 the next largest industry. These new hotels, restaurants, etc., will need over 60,000 trained men and women.

You can have one of these high-class big-pay positions, with luxurious meals and apartment and fascinating work. No previous experience necessary. The Lewis Schools guarantee to give you the valuable knowledge that it has taken some of the most successful hotel men years to obtain—men who are now making \$5,000 to \$50,000 a year. We train you by mail in your spare time at home with the Lewis Simplified Study Plan, and we put you in touch with big opportunities. Our students employed, our methods endorsed by leading hotel men everywhere. Send today for Free Book, "YOUR BIG OPPORTUNITY," showing how we can train you for one of these splendid positions in 20 weeks or less, and explaining our Money-Back Guarantee.

**LEWIS HOTEL TRAINING SCHOOLS**  
Room D-388 Washington, D. C.

\*\*\*\*\* FREE BOOK COUPON \*\*\*\*\*  
LEWIS HOTEL TRAINING SCHOOLS, Room D-388, WASHINGTON, D. C.,  
Send me without obligation the Free Book, "YOUR BIG OPPORTUNITY."

Name .....

Address .....

City .....

State .....

## TELEGRAPHY

(Morse and Wireless) and RAILWAY ACCOUNTING taught thoroughly. Big salaries; great opportunities. Oldest, largest school. Endorsed by Telegraph, Railway, Radio, and Government officials. Expenses low—opportunities to earn large portion. Catalog free. **DODGE'S INSTITUTE, Jones St., Valparaiso, Ind.**



## Dhassi Will Tell You FREE

Do You Know? Are You Lucky?  
Under which Zodiac sign you were born?  
What significance it has in shaping your life?

IN LOVE  
MARRIAGE  
FRIENDS  
INHERITANCE  
SUCCESS

Send Birth Date  
I have made Astrology my life's work and offer the most interesting astrological interpretations of the Zodiac sign under which you were born. Send exact name, address and exact date of birth in own handwriting and receive your astrological interpretation in plain sealed envelope, post paid. A great surprise awaits you. Enclose 12c to cover cost of this notice and mailing. Address me personally—DHASSI.

**TARA STUDIO, 1133 Broadway, Desk 44, NEW YORK**

"THERE'S MONEY IN IT"

## AT HOME LEARN TELEGRAPHY AT HOME MORSE AND WIRELESS

TEACH YOURSELF

in half usual time, at trifling cost, with the wonderful Automatic Transmitter, **THE OMNIGRAPH**. Sends unlimited Morse or Continental messages, at any speed, just as an expert operator would. Adopted by U. S. Government, and leading Universities, Colleges and Telegraph Schools. 3 Styles. Catalog free. **OMNIGRAPH MFG. CO., 16-22 Hudson St., NEW YORK**

If you own a Radio Phone Set—and don't know the code—you are missing most of the fun.

Whatever Your Question;—be it the pronunciation of Fascista, the spelling of a puzzling word, the location of Esthonia the meaning of soviet, realtor, vitamin, etc., this Supreme Authority—

## WEBSTER'S NEW INTERNATIONAL DICTIONARY

contains an accurate, final answer. 407,000 Words 2700 Pages. 6000 Illustrations.  
Regular and India-Paper Editions. G. & C. MERRIAM CO., Springfield, Mass.

Write for specimen pages, prices, etc. and FREE Pocket Maps per POPULAR MECHANICS



## Why Miss Half the Fun in Life?

**BE POPULAR**—Learn to dance well! Arthur Murray, America's greatest dancing teacher, has invented a remarkable new easy method which enables anyone to learn all the newest dances at home—in a few hours—at very little cost! No music or partner needed. *Success positively guaranteed!* "90,000 learned dancing by mail."

**FREE 5 DANCING LESSONS**—To prove you can learn easily and quickly, Arthur Murray will send you Five FREE lessons, including Fox Trot, Secret of Leading, and How to Gain Confidence. To pay cost of mailing, printing, etc., enclose 10c. Act NOW and be a good dancer soon.

**Arthur Murray, Studio 255**  
290 Broadway New York

## AVIATION Information FREE

Send us your name and address for full information regarding the Aviation and Airplane business. Find out about the many great opportunities now open and how we prepare you at home, during spare time, to qualify. Our new book "Opportunities in the Airplane Industry" also sent free if you answer at once.

**AMERICAN SCHOOL OF AVIATION**  
Dept. 13-56 3601 Michigan Ave. CHICAGO

## Bé a Bricklayer!

Attend a School Operated by Building Contractors. Three Months' Day Course \$75.00.

**ASSOCIATED BUILDING EMPLOYERS**  
1120 A. B. E. Building Grand Rapids, Mich.

## LEARN WATCHMAKING

and become independent. Good-paying positions secured. Easy to learn. Send for FREE CATALOG.

**ST. LOUIS WATCHMAKING SCHOOL, Dept. 5, ST. LOUIS, MO.**



# THIS? — OR THIS?



## Work Over a **CLEAN** Job Not Under a **DIRTY** One!

### BE A "WHITE-COLLAR" MAN— Earn \$60-\$150 a Week—CLEAN Money!

What's the use of doing dirty, greasy, *hard* work, when you can *NOW* make *TWICE* as much money in a manly profession that is **CLEAN**, profitable and full of opportunities?

#### Easy to Learn— Quick to Earn!

That's **BARBERING** for YOU! And the best part of it all is this—scientific barbering, as taught the modern **MOLER** way, makes YOU a Master Barber in a *short* course of *intensive* training, at *small* expense! You soon step out as your own Boss, if you wish, in your own Shop, which we will gladly help you equip.

#### See the World, Too!

Or, if you prefer, we will help you step into a *real* job, with *good* pay the *first* day, after you graduate. Ocean Liners, crack trans-continental passenger trains, big luxurious hotels and skyscrapers all over the world, as well as *thousands* of Barber Shops *everywhere*, demand **MOLER** trained men.

#### **MOLER** Graduates Are Always Busy!

**MOLER** trained Men are always given the preference, for they alone possess the valuable, thor-

ough **MOLER** training in the application of all the *latest scientific Barbering methods* including the Electric hair cutter, the mechanical massage, and the latest vogues in ladies' hair bobbing. **MOLER** also gives special training in ladies' marcelling and an easy practical course in the treatment of skin diseases.

#### Earn While Learning!

"Where there's a Will there's a Way" to earn **BIG** pay! Write to the nearest **MOLER** College, *there is one near you*, and learn how you can *earn* while you learn the barber trade. Ask for the new **FREE** **MOLER** Barbering Booklet B. Find out **HOW** **MOLER** helps you help yourself **AFTER** you graduate, as well as **BEFORE**! Find out why **MOLER** Men are making **DOUBLE** the money others made last year, before Ladies' Shingle Bobbing became so popular. You're **NEXT** in line for big pay—the **MOLER** way. Send Coupon **TODAY**!

### **MOLER SYSTEM OF COLLEGES**

30 Branches in United States and Canada

New York, N. Y.  
Chicago, Ill.  
St. Louis, Mo.  
Kansas City, Mo.  
Cincinnati, Ohio.  
Cleveland, Ohio.  
Detroit, Mich.

Denver, Colo.  
Omaha, Nebr.  
Milwaukee, Wis.  
New Orleans, La.  
Atlanta, Ga.  
Memphis, Tenn.

Dallas, Tex.  
Houston, Tex.  
San Antonio, Tex.  
Seattle, Wash.  
Tacoma, Wash.  
Spokane, Wash.



"The XXth Century," "Oriental Limited" and other crack trans-continental trains carry barbers.

## and THIS!



The Majestic, Leviathan and U. S. Shipping Lines all carry barbers.

## NEXT! For BIG Pay

### Mail THIS

**MOLER SYSTEM OF COLLEGES**

← Address Nearest Branch  
(Street Address NOT Needed)

\*Please send me without obligation on my part your Booklet B.

Name.....  
Address.....  
City..... State.....



# FIVE GOOD BOOKS



for readers of  
"Popular  
Mechanics"  
Only \$1  
Each

## I. C. S. Building Trades' Handbook

A convenient pocket manual for everyone in the building trades. Tells you everything you want to know about arithmetic, weights and measures, formulae, mensuration, geometrical drawing, structural design, masonry, carpentry and joinery, roofing, plastering, plumbing, heating, ventilation, gas-fitting, estimating, elements of architectural design, etc. 372 pages. 189 illustrations. A wonderful bargain at \$1.

## I. C. S. Plumbers' and Fitters' Handbook

The only book of its kind ever published. Filled with sound, practical knowledge and information that you need every day. A condensed encyclopedia of the art and practice of plumbing, heating, ventilating, gas-fitting, etc. Contains much new material. More than 50,000 copies sold. 375 pages. 148 illustrations. Only \$1.

## I. C. S. Concrete Engineers' Handbook

A handy reference book worth many times its small cost of \$1. Contents—Useful tables, mathematics, loads in structures, mechanics, homogeneous beams, columns, sands and cements, plain concrete, steel reinforcement, foundations, building details, form work, building laws and specifications, etc. 368 pages. 230 illustrations. Only \$1.

## I. C. S. Business Man's Handbook

175,000 sold. A handy business book that no builder should be without. Tells all about business forms, card systems, bookkeeping, correspondence, postal information, definition of financial terms, money and the money market, corporations, business law, contracts, partnerships, commercial paper, law of landlord and tenant, etc. 315 pages. 57 illustrations. Only \$1.

## I. C. S. Automobile Handbook

Tells all about gasoline engines, transmission and control systems, carburetors, self-starters, bearings, electric ignition, tires, automobile management and maintenance, horsepower calculations, how to make quick repairs, how to anticipate trouble, digest of automobile laws, and other useful information that will save you time and money. 301 pages. 156 illustrations. Only \$1.

These five books, containing 1731 pages and 780 illustrations, represent the greatest book value ever offered for the money. They will be sent anywhere—postage prepaid. Mail the coupon to-day with \$1 for each book you want. You run no risk. Money back if not satisfied.

### INTERNATIONAL CORRESPONDENCE SCHOOLS

Box 5626-D, Scranton, Penna.

I enclose \$..... for which send me, post-paid, the Handbooks marked X, at \$1.00 each. It is understood that if I am not entirely satisfied I may return any or all of them within five days and get my money back.

- BUILDING TRADES' HANDBOOK  
 PLUMBERS' AND FITTERS' HANDBOOK  
 CONCRETE ENGINEERS' HANDBOOK  
 BUSINESS MAN'S HANDBOOK  
 AUTOMOBILE HANDBOOK

Name.....  
 Address.....

## HOTELS OFFER YOU \$150 TO \$500 per Month

### Trained Men and Women in BIG DEMAND



If your present position is not paying enough; if advancement is too slow, investigate what hotels offer you. 80,000 trained employees must be secured this year; no previous hotel experience necessary.

Wonderfully interesting work in luxurious surroundings; many opportunities for advancement to executive positions. Positions paying \$150 to \$500 per month are numerous, meals and often room furnished.

We train you at home in spare time at moderate cost. Course endorsed by many leading hotel men. Hundreds of successful graduates.

Write today for Free Booklet H-165.

Standard Business Training Inst.  
BUFFALO, N. Y.

## LEARN ENGINEERING

Great Demand for Practical-Technical Engineers. Big Salaries. Wonderful Opportunities. Thousands of our graduates holding responsible high-salaried positions. Practical-Technical Courses from 3 Months to 2 Years in Electrical and Mechanical Engineering. Simple and Condensed Method. Faculty of Trained Experts. New Building. Extensively Equipped Laboratories and Shops. Department of Architecture. Structural and Mechanical Drafting. Degrees Awarded. Positions Secured. Day and Night Sessions. 22nd Year Begins September 17. Write for Catalog D.

FINLAY ENGINEERING COLLEGE, Kansas City, Mo.

## LAW STUDY AT HOME

Become a lawyer. Legally trained men win high positions and big success in business and public life. Greater opportunities now than ever before. Lawyers earn \$3,000 to \$10,000 Annually. We guide you step by step. You can train at home during spare time. Let us send you records and letters from LaSalle students admitted to the bar in various states. Degree of LL.B. conferred. Thousands of successful students enrolled. Low cost, easy terms. We furnish all text material, including fourteen-volume Law Library. Get our valuable 120-page "Law Guide" and "Evidence" books FREE. Send for them NOW.

LaSalle Extension University, Dept. 964-L Chicago, Ill.

## Music Lessons At Home

With Celebrated TEACHERS

Lessons specially prepared for home study. Endorsed by Paderewski. Not a new method. Long established school now celebrating its 30th Anniversary.

Any Instrument Write naming course you are interested in—Piano, Harmony, Voice, Public School Music, Violin, Cornet, Mandolin, Guitar, Banjo or Reed Organ—and we will send FREE CATALOG. SEND for it NOW!

UNIVERSITY EXTENSION CONSERVATORY  
990 Siegel-Myers Building Chicago, Illinois

## Tri-State College of Engineering

Makes you a Civil, Mechanical, Electrical or Chemical Engineer in two years. 48 weeks each. No entrance examinations. High school Diploma not required. Compact courses made up of essentials only. Expenses low. For catalog address, Box M-9, Angola, Ind.

## "BECOME A LIGHTNING TRICK CARTOONIST"

MAKE MONEY QUICK TALKING. SEND \$1.00 FOR SNAPPY, PROBABLY OF TRICK DRAWINGS WITH INSTRUCTIONS BY A PROFESSIONAL CARTOONIST. SATISFACTION GUARANTEED. CIRCULAR FREE. BALDA ART SERVICE, 61, 05HKOSH, WIS.

## RAILWAY MAIL CLERKS

## WANTED!

\$1600 TO \$2300 A YEAR

TRAVEL—See Your Country  
MEN—BOYS  
18 UP

MAIL COUPON IMMEDIATELY

Franklin Institute  
Dept. N180, Rochester, N. Y.

Write: Send me, without charge, (1) Specimen Railway Mail Clerk Examination questions; (2) schedule showing places of U. S. Government examinations; (3) Send list of Government jobs now obtainable.

Name.....  
 Address.....



# No Free Railroad Fare after Sept. 10<sup>th</sup> 1924

By the Chicago Painting School

## Get Your Application in at Once

or You're Out of Luck because I can't keep this offer open any longer than September 10th, 1924. I mean business—I tell facts—I don't believe in handing bunk—When I tell you something, I know what I am talking about—When I make a promise, I stick to it—When I say September 10th, that's

### JUST WHAT I MEAN

**I Know** that I can increase your earning power. I want to prove it to you—that's why I offered to pay your Fare to Chicago—But—I can't wait forever—I can make an expert of you

### In a Few Weeks

In Sign Painting—Pictorial  
Painting—Auto Painting—  
Interior Decorating—  
Paper Hanging—  
Graining and Mar-  
bling—Show Card  
Writing

Every course is taught by actual practical work under regular shop conditions by expert instructors. Every instructor that I employ must SHOW ME that he can deliver the goods or he never becomes a teacher at this school.

**\$3,500 to \$8,000  
PER YEAR**

**\$10 per Day and Up**

You can have this income by spending a few weeks at

**THE CHICAGO  
PAINTING SCHOOL**

149 W. Austin Ave., CHICAGO

"The school that makes you 100% proficient"

*The World's Largest Painting School*

Established 23 Years

If you haven't my catalog—

**SEND FOR IT TODAY**

**FREE** For a limited time I will send 2 Color Plates **FREE**  
of work done at this school.

**FREE COLORPLATE COUPON**

CHICAGO PAINTING SCHOOL, 149 W. Austin Ave., Chicago  
Please send without obligation on my part your catalog and FREE  
Color Cards to

Mr. ....

Address.....

City..... State.....





**Make \$3500 to  
\$10000 a Year in**

# ELECTRICITY

## I Will Show You How

Electricity is the ONE big field of opportunity today. In all other trades and professions competition is already so keen from over-crowding that only the exceptional man can get to the top. But it's different in electricity. Here you have the fastest growing industry in the world, an industry that's growing so fast that even right now there are more good positions open than there are good men to fill them. And these are real jobs, jobs that carry with them plenty of money—good, round, spendable dollars—the kind that buy you what you want when you want it; jobs that pay \$12 to \$30 a day, \$75 to \$200 a week, \$3,500 to \$10,000 a year.

### I Will Train You at Home for One of These "Big-Pay" Jobs

Regardless of how little schooling you have had, regardless of what kind of work you have done I can teach you Electricity and do it in a few short months. You can read; you can write; and that's enough. As chief engineer of the Chicago Engineering Works, I know exactly the kind of training you need to get the big money in this profession—and I will give you that training. Not the theoretical kind you get in books, but good, practical, hard-fisted training, dug by me out of the grease and grime as my own 20 years of engineering experience. And I will train you at home—in your spare time.

### With Training Comes the Job—I Will Help You Get It

Not only will I train you for a "Big-Pay" job in electricity, but I will, also, help you in every way to land the kind of a job you want, when you want it. And I will do this absolutely without cost to you. In my position as Chief Engineer, I am constantly in touch with all of the largest employers of Electrical help in the United States and Canada, and am thus able to place practically every one of my "boys" who asks me for assistance.

### Your Money Back If I Don't Make Good

That's my guarantee. And back of me in this guarantee stands the Chicago Engineering Works, a Million Dollar Institution.

### INVESTIGATE! It May Mean THOUSANDS OF DOLLARS TO YOU!

It costs nothing to investigate, and, as stated above, it may mean thousands of dollars to you. Tear out, sign, and return the coupon below, and receive my big free booklet—The "Vital Facts," containing full information of what Electricity has to offer. **But do it NOW—TODAY—THIS VERY MINUTE—Send me the Coupon!**

L. L. COOKE, Chief Engineer

### Chicago Engineering Works

Dept. 16, 2150 Lawrence Avenue, Chicago

### THESE MEN, Through My Training, have Al- ready Made Good in Electricity

J. R. Morgan, of Columbus, Ohio, is making \$10,955 a year.

William Covert, of Carletoi, Pa., is making \$5,000 a year.

Jos. Cunningham, of Athens, Ohio, is making \$8,500 a year.

John Jirinec, of Astoria, N.Y., is making \$10,000 a year.

### SO CAN YOU!

L. L. COOKE,  
Chief Engineer,  
Chicago Engineering  
Works, Dept. 16,  
2150 Lawrence Avenue  
Chicago, Illinois

Dear Sir: Send me at once full particulars of your Free Outfit Offer; also your Free book, The "Vital Facts" of Electricity. No obligation on my part.

Name.....

Address.....

Occupation.....

**The "Cooke" Trained Man is the "Big Pay" Man**



# Classified Advertisements

## WORLD'S BEST WANT AD MEDIUM

Advertisements in this section, 25 cents per word, each insertion, minimum 10 words, payable in advance.  
To be inserted under proper classification in October issue, copy should be in our office August 18th.

### ADVERTISING AGENCIES

TO secure agents or salesmen or for selling farms and reaching investors, use classified (want) ads in largest newspapers and magazines. Price list No. 30 sent free. Ankrum Advertising Agency, 20 W. Jackson Blvd., Chicago, Ill. The largest classified advertising agency in the U. S.

25 WORDS—355 Rural Weeklies \$14.20. Ad-Meyer Agency, 4112-M Hartford, St. Louis.

28 WORDS—80 Rural Newspapers \$3.40. Shaw, 221 A St., Northeast, Washington, D. C.

ADVERTISING in all magazines and newspapers at publisher's lowest rates. Rate book free. Taylor's Advertising Service, Dept. F, Freeport, Ill.

### FOR ADVERTISERS

25 WORDS fifty magazines \$1.00; three \$2.00. Smith's Service, 1194, Waukegan, Wash.

LET me write your sales letters, booklets, folders. Wide experience, fair prices, quick service. L. Taylor, Box 44M, Freeport, Ill.

ADVERTISE in 24 Big Sunday Newspapers, 24 words \$15.00. Catalog listing 1,000 leading Dailies, Weeklies, Magazines, 4c stamps. Union Advertising, Baltimore Bldg., Chicago.

ADVERTISE, hundred magazines, three issues, 10c word. Pennell-Company, Covington, Ky.

### SALES PROMOTION

\$50 TO \$50,000 Daily Sales developed during twenty-six years for clients by my direct-mail plans, copy, campaigns. Ten years Sales Promotion Manager Larkin Co. Submit sales problems, free diagnosis. James C. Johnson, 118A Woodbridge Ave., Buffalo, N. Y.

\$10,000-A-YEAR Sales Promotion Executive writes powerful, virulent sales letters \$5; Broadside, catalog, advertisement copy special quotation. Consultation all sales problems any business. Sales Promotion Guild, 250 West 54th Street, New York.

### AUTOMOBILE SUPPLIES

BARGAINS—Champion X Plugs 35c, A-C Titans 41c. Pyraes 37c. Ignition Coils \$3.47 each. Ford Coil units, each 85c. Terms Cash. Kelly Lamp Works, Oak Park, Illinois.

AUTOMOBILE Parts—Used parts for most any car at half factory list prices. Allen, Briscoe, Buick, Cadillac, Chalmers, Chevrolet, Dodge, Deet, Grant, Hudson, Hupmobile, Oakland, Overland, Oldsmobile, Reo, Studebaker and many others. Send list of parts wanted. Century Auto Parts Co., 4106 Olive St., St. Louis, Mo.

HOTSPARK Transformers. Increase spark. Save gas. 85c set. Guaranteed. Agents wanted. George Anderson, Hawarden, Iowa.

AUTO and Truck Parts. Save 25-30%. New and used motor, gears, axles, bearings, springs, generators, \$10 up. New Zenith, Johnson, Rayfield, Stromberg carburetors, \$7.50 up; new waterproof Simms and Berling magnets, \$15; Ford retooling, \$4-\$6; other cars, \$12 up. Brightman Auto Exchange, 321 Windsor Ave., Hartford, Conn.

AUTO Parts at cut prices! All kinds of new and used, for all cars. Engines, Clutches, Transmissions, Axles, Radiators, Magnets, Generators, Batteries, Shafts, Gears, Bearings, Springs, etc., etc. If you have never known the house of Warshawsky, you had better write us and get acquainted. Think of buying the Shaler lens for 85c a pair, and rims for any car at \$2.00 each. Windshields from \$8.00 to \$10.00. Spotlights \$1.75. Welding outfits at a low price. Specify make and model of car when writing. "Ask for Bargain List." Warshawsky & Co., 1935 S. State St., Chicago, Ill.

FORD Touring Top and Back Curtain \$5.25. Back Curtain \$2.00. Chevrolet, Dodge, Overland 4, \$9.75. Double Texture \$12.25. Delivered 1,900 Miles. Vanderpool's, Springfield, Ohio.

BARGAINS—Radiators—Sport Bodies built to order—send sketch. All standard makes radiators furnished at bargain prices. State make and model. We guarantee satisfaction. Independent Radiator Co., 1119 Wabash Ave., Chicago.

### AUTOMOBILES

\$350 TO \$500 added profits monthly from one-day battery service. Costs only \$16.50 per month. Start a big money-making business in your shop today. Write for complete particulars. No obligation. Hobarts, Troy, Ohio.

PATENTS Procured. Send sketch or model today for examination, prompt report and advice. No charge for preliminary advice. Write for free Booklets "How to Obtain a Patent" and "Invention and Industry" and blank form on which to disclose your idea. Highest references. Promptness assured. Clarence A. O'Brien, Registered Patent Lawyer, 586 Security Bank Building, Directly across the street from Patent Office, Washington, D. C. See pages 146 and 147.

AUTO Tourist's Handbook—An indispensable help for those who wish to make a motor trip. Tells how to prepare your car for the long grind to avoid trouble, how to make and use camp equipment, how to cook on the road and how to make comfortable sleeping quarters. Will reduce your touring bill many dollars if you follow the ideas presented. Only 50 cents. Popular Mechanics Press, Room 897, Popular Mechanics Building, Chicago, Ill.

PATENTS—Write for our Guide Books and "Record of Invention Blank" before disclosing inventions. Send model, or sketch and description of your invention for our free Examination and Instructions. Highest references. Reasonable terms. See advertisement on pages 148 and 149. Victor J. Evans & Co., 185 Ninth, Washington, D. C.

RACING Bodies for Fords and Chevrolets 400. Send for free particulars. Our book "How to Build a Ford Racer" sent on receipt of 25c. Central Auto Supply Company, Dept. 120-C, Louisville, Ky.

DYKE'S Automobile Encyclopedia. 13th edition, new, greater than ever, entirely rewritten and rearranged. Contains greatest array of automobile facts ever published in one volume. Separate books containing same information cost \$21. Over 1200 pages and 4100 illus. Cloth \$6. Plex Amer. Morocco \$7.50 postpaid. Popular Mechanics Book Dept., 205 E. Ontario St., Chicago.

### FOR FORD OWNERS

FORD Repair Book Free! A very complete and well illustrated book explaining how to make repairs on most every part of your Ford. We offer this book free with a nine months' subscription to Ford Owner and Dealer Magazine at only \$1.00. Everyone interested in the Ford car should read this big magazine of about 200 pages monthly. It clearly explains the things you want to know about cutting down the cost of operation, the engine, ignition, transmission, carburetor, etc. Send today and get the valuable Repair Book Free. Ford Owner and Dealer Magazine, 545 Montgomery Bldg., Milwaukee, Wis.

FORD Owners who want Power-Speed-Economy, which come from increased valve lift should buy our Auxiliary Valve Action, price \$15, complete. Write for literature. Auxiliary Valve Action Company, Fitzburg, Mass.

TWO-DOOR Ford Sedan beds \$6.50. Particulars. Milligan & Chrey, Bremerton, Wash.

SAVE Half on Ford Parts! 50% off list prices guaranteed, salvaged, genuine Ford parts; example: No. 3930 crankshaft, list \$8.00, our price \$4.00; No. 2509 complete rear axle assembly, list \$55.00, our price \$27.50; complete stock. Satisfaction guaranteed or money refunded. Terms 25% deposit, balance delivery. Order today! B. E. Fordspeed Parts Mrs., 250 W. 54th, New York.

UNDERSLING with "RKO" Swing Lo Irons. See "Red-I-Kut" ad page 129.

BEST Prices—Radiators—Sport Bodies any make. State year and model; send sketch of body desired. Guarantee Radiator Co., 1246 Wabash Ave., Chicago.

OILOMATIK—What every Ford needs. Real necessity. Saves repair bills, cuts oil consumption 25% to 50%. Harvest for Agents, Salesmen, Distributors. For full details see our ad page 161. Oilomatik, 343 E. Ohio, Chicago.

FORDSPEED Sport Ford Bodies—Specialties. See Sensational announcement Page 154.

### MOTORCYCLES, BICYCLES AND SUPPLIES

SEND for our Bargain Bulletin and Money Saving Message. It will save you money on Motorcycles, Side Cars, Motor Wheels, Repair Parts and Accessories. Some used parts at less than half. Cleveland and Ace Motorcycles our specialty. See our ad on page 158. American Motor Cycle Co., 2043-5-7 W. Chicago Ave., Chicago.

USED Motorcycle Bargains; Lists free. Secher-Hoffheims, Buffalo, N. Y.

USED parts for all motorcycles, cheap. State wants. Schuck Cycle Co., 1922 Westlake, Seattle, Wash.

1922 HARLEY-DAVIDSONS, \$135; 1921, \$115; 1920, \$85; 1919, \$65; 1917, \$50; 1916, \$45; 1915, \$40; 1914, \$35. Guaranteed. Money refunded if not satisfied. Circular free. Wisconsin Cycle Sales Co., 726 National Ave., Milwaukee, Wis.

DON'T buy a Bicycle Motor Attachment until you get our new catalogue and prices. Also runs washers, pumps, and shop machinery. Shaw Mfg. Co., Dept. 27, Galesburg, Kans.

SEND for big list of slightly used motorcycles on the easy payment plan. Howard Cycle Co., Trenton, N. J.

NEW and used parts for Motorcycles and Bicycles. Get our prices on parts needed. Kingshighway Motor Co., 1166 N. Kingshighway, St. Louis, Mo.

### AVIATION

COMPLETE Scale Plans, with Building-Flying Instructions for following 3 ft. Model Aeroplanes, 2c each postpaid; JN1D-2; DeHavilland; N.C.-4; Curtiss Tractor; Bleriot; Nieuport or Taube Monoplanes; Cecil Paul Racer. Complete 48 pp. catalogue 5c. Ideal Aeroplane Co., 165½ Spring St., New York.

"MOTORCYCLE Engine Monoplane." Body \$90. Wings \$75. Plans \$1. Sport-ford Biplane. Plans \$2.50. Propellers \$8. Curtiss motor \$75. Flying Instruction \$109. Circular Free. Aviation Engineering Co., Lawrence, Kans.

AIRPLANES, Flying Boats, Motors, Aircraft Supplies. New 80 H. P. LeRhone Rotary Motor \$77.50; Ballon Baskets \$50; OX5 Motor \$400; Zenith Carburetor \$12.50; Compass \$15; Unshatterable Goggles—Jumbo \$2.50; wide-dial \$3; Leather Helmet \$4.50; Spark Plugs 40c; 26x1 Wire Wheel \$6.50; Cord Tires, Slightly Used, \$3; Moderately Used \$2; New Tubes \$2; Airplane Fabric, 65c Yd. Floyd Logan, 719 W. Superior, Cleveland, O.

SEND 10c for our latest aeronautical catalog listing a complete line of airplane goods at reduced prices; Propeller circular (c.). Ford Airplane, or Motorcycle Airplane circulars, 4c each. Resistal goggles \$2.90. Heath Airplane Co., Chicago, Ill.

AIRPLANE Engineering, under the Western Airplane Corporation method of practical home training, offers you a chance to be Successful and become a Leader in this newest industry. Written for the Airplane Industry by Airplane men, this Up-to-date Course is offered to you for the First time after training hundreds of successful Mechanics and Engineers. Write for catalog. Western Airplane Corporation, Monardnock Block, Chicago.

BOYS get a three-foot model aeroplane free. Nothing to sell. Write to Aero Shop, 3059 Hurst Ave., Detroit, Mich.



TEN lessons in the air of twenty minutes each, will make you a pilot, by our advanced method of training. This, together with our five-week shop course at \$100.00, makes America's oldest aircraft factory the most popular flying school. Work after class hours guaranteed. Heath Airplane Co., Chicago, Ill.

ONE Dollar Bill Buys Both "Aerodrive" Boat, "Aerodrive" 75mph guaranteed Bled Blueprints, Aircraft Supplies, Ostergaard Aircraft, 4209 North Narragansett, Chicago.

MOTORCYCLE Motored biplane for sale. Photos 15c. Eugene S. Shank, Morgan, Minn.

PATENTS Procured. Send sketch or model today for examination, prompt report and advice. No charge for preliminary advice. Write for free Booklets "How to Obtain a Patent" and "Invention and Industry" and blank form on which to disclose your idea. Highest references. Promptness assured. Clarence A. O'Brien, Registered Patent Lawyer, 586 Security Bank Building, Directly across the street from Patent Office, Washington, D. C. See pages 146 and 147.

THE American School of Aviation announces a new correspondence course in Mechanics of Aviation. A thorough training in Practical Aeronautics. American School of Aviation, Dept. 1805, 3601 Michigan Ave., Chicago, Ill.

#### WELDING AND SOLDERING

SOLDERING—Safe easy method for keeping irons tinned. Many weeks' supply and instructions, \$50. Money back guarantee. Crawford Laboratory, P. O. Box 47, City Hall Station, New York City.

WELDING Encyclopedia—New Third Edition. Complete training course for operators in all welding processes; oxyacetylene, electric arc, electric resistance and thermit. Welding of all weldable metals fully discussed. 437 pp., 600 Ills. The accumulated experience of the welding brains of America is yours for \$5. Money back if not satisfied. Popular Mechanics Book Dept., 205 E. Ontario St., Chicago.

#### BOOKS AND PERIODICALS

HYPNOTISM astounds, controls others. Wants gratified. 25 easy lessons \$1.00. "Mindreading" (any distance). Wonderful. 50c. Popular Institute, 81014 Belmont, Chicago.

HOW To Run a Lathe, a new 160-page book containing 250 illustrations. Price 15 cents, postpaid. See our Advertisement on page 158 for Easy Payment Plan on Lathes. South Bend Lathe Works, South Bend, Ind.

ARTS-CRAFTS Library—How to make lamps, decorative handles, metal etched articles, and many other useful art objects. Three cloth-bound pocket-size books. Only \$1.50. Popular Mechanics Press, Room 807, Popular Mechanics Building, Chicago, Ill.

"NATURE'S Finer Forces"; Vibrations; Lights; Color tones; Electromagnets; Occurrences; Radio; Coldlights; Inventions; Wonderful Opportunities; Fifty Lessons; Marvelous Cures; Illustrated. Satisfaction Guaranteed. 270 pages, \$2.00. DeLuxe \$3.00. M. Stevens, 242 Powell, San Francisco, Calif.

LAUGH, Be Happy, and Prosperous. Auctioneer Joker (393) \$1. Missouri Auction School, Largest in World, Kansas City, Mo.

CURIOUS Books, Unique Novelties, Stunning Pictures. Samples, 10 cents Prepaid. Linds, 214 W. 34th Street, New York

MECHANICAL Drawing—A Practical Course in Mechanical Drawing has helped thousands. It is simple enough for a boy, yet advanced enough for a trained mechanic. Cloth bound, pocket size, illustrated. Only 50 cents. Popular Mechanics Press, Room 807, Popular Mechanics Building, Chicago.

WRITERS: Study at home; 30 text books; criticism and advice regarding markets for manuscripts. Catalogue free. Correspondence invited. James Knapp Reeve (former editor The Editor), 50 Alexander Bldg., Franklin, Ohio.

INDUSTRIAL Alcohol. Wright's book. Full directions for making drawings. \$2.50. Spen & Chamberlain, 120 P. M. Liberty Street, New York, N. Y.

FREE—Send for my Newthought, Self-culture, Occult, Mystic and Scientific book literature. Martens Publisher, Burlington, Iowa.

176 PRACTICAL Subjects, how to master any of them. A new booklet giving reliable advice on how to study 176 subjects at home is free. Write your name and address on a postal and say, Send me "An Easy Way to Master 176 Practical Subjects" and mail to Popular Mechanics Press, Room 807, Popular Mechanics Building, Chicago, Ill.

#### PICTURES AND POSTCARDS

IMPORTED Art Study Cards, 100 assortment \$2.00; 50 \$1.25; 25 75c; 15 50c. John Ruse, Importer, 347 East 73rd Street, New York.

ATTENTION! 15 Classy Post Cards. Big Interesting Mail. Agents Propositions, 25c. Woods, Box 586, Omaha, Nebr.

JOIN Live Postcard Club; Membership Lists including Catalog, 10c. Harvey Teeple, Decatur, Ind.

SEE Johnstown, Penna., in Pictures thirty-five years after the Memorable Flood. Ten interesting Views for 25c (silver) or Fifty Views, including "Unknown Plot" in Grandview Cemetery, for one Dollar, all prepaid. W. A. Auchincrope, 1019 Linton St., Johnstown, Penna.

#### GAMES, ENTERTAINMENTS AND PLAYS

VENTRILQUISM taught almost anyone at home. Small cost. Send 2c stamp today for particulars and proof. George W. Smith, Room M-894, 125 N. Jefferson Ave., Peoria, Ill.

POPULAR MECHANICS new illustrated Book Catalog lists books of entertainments and games. A copy is free. Address Popular Mechanics Press, Room 807, Popular Mechanics Building, Chicago, Ill.

#### MAGIC TRICKS, BOOKS AND JOKER NOVELTIES

BOOK of magic tricks, 10c. Book of card tricks, 10c. Book of coin tricks, 10c. Princess of Yogi. Wonderful card trick, creates a sensation, 10c. Geo. Fenner, Louisville, Ky.

SEVEN Magic Effects, Four Catalogs—15c. Gilmaglio, Morgan Park, Ill.

10 MAGIC Tricks free with low price catalog. Sylvian's Magic Shop, 6 North Main, Providence, R. I.

250 MAGIC Tricks 10c. Lowe, Box 387, Spokane, Wash.

MAGIC—Tricks, Books and Supplies. For Amateurs as well as the great professionals. Anyone can learn through our instructions. Feature Acts in Mind Reading, Spiritualism, Rope Ties, etc. Large Illustrated Professional Catalog, 20c. Chicago Magic Co., 140 S. Dearborn St., Dept. B, Chicago, Ill.

TRICKS, puzzles, jokes, magical apparatus, plays, stage supplies, mind-reading, sensational escapes, large illustrated professional catalog, 10c. Oaks Magical Co., Dept. 548, Oshkosh, Wis.

DIMINISHING Billiard Ball, 50c. Secrets, Pocket Tricks, Small Magic. Lowest Prices. Catalogue free. C. Pentz, Minneapolis.

LATEST and Best in Magic Books—Personal Advancement, Popular Mechanics new magazine keeps you posted on the best books of magic. Helpful suggestions for making money with magic performances. Free for one year. No strings to this offer. Send your name and address to Popular Mechanics Press, Room 807, Popular Mechanics Building, Chicago, Ill.

#### STAMP COLLECTING

BOYS! Have you ever owned a nice, shiny, new pair of steel stamp tongs? Lakeside offers: Famous "Confiscated" set of Bulgaria (the stamps that nearly started a war); set of new Germany with (prewar) face value over forty million dollars; perforation gauge; small album; nice packet 100 different from Argentine, British Guiana, Newfoundland, Africa, Dutch Indies, etc., etc.—and last but not least, a dandy pair of stamp tongs! The entire big outfit only 15c to approval applicants! Lakeside Stamp Co., 338 Columbia St., Toledo, Ohio.

BOYS! Bet you haven't got a single stamp from the Irish Republic! We offer this month only to approval applicants; Packet of 100 different from Cape of Good Hope, San Marino, Plume (triangle), Travancore, Malay (tiger), Guatemala, Congo (Savage), etc., etc.; also a fine set of 5 dif. Ireland. Perforation gauge and mime. scale, and 250 peelable hinges—all for eight cents! Supply limited, order at once. Paul Revere Stamp Co., Watertown, Mass.

ANCHER'S \$\$\$ Outfit—only 12c! Fine (triangle) stamp; set German stamps with (pre-war) value forty million dollars (interesting!); perforation gauge, mime. scale; small album; 2 approval sheets; airmail set; scarce stamp from smallest republic on earth; newspaper set; packet good stamps from Travancore, Johore, Dutch Indies, etc. Entire outfit for 12c to approval applicants! (Nice pocket stock book, value 25c, with every order!) Ancher Stamp Co., 148½ Clerk St., Jersey City, N. J.

\$7.50 WORTH for 25c! 500 excellent stamps, (world-wide collection), packet French Colonials, superb mixture, packet Estonia, Schlessig, etc.; 10 dif. Australian, packet rare British Colonies, package hinges. All for 25c. Stamp Exchange, Box 63, Savannah, Ga.

BOYS! Here it is—Victoria's Unused Hundred! Contains 100 different stamps, All Unused, from Georgia, Venezuela, Poland, New Germany (prewar value millions of dollars), Turkey (pictorial), San Marino, etc. If purchased from sheets would cost over \$1.00 net. This beautiful packet, 250 hinges and list for only 85 Cents to approval applicants. Write at once, Victoria Stamp Co., London, Canada.

FAMOUS Fenway Outfit—2 triangle stamps, small album, 5 blank approval sheets, 250 hinges, perforation gauge, 5 large French Colonials, 2 special deliveries, animal set, red cross set, packet 55 different, including Abyssinia, Azores, Cape of Good Hope, Bosnia, Crete, Congo, etc., 16-page price list, all for 12c to new approval applicants. Fenway Stamp Co., Fenway Station, Boston, Mass.

NYASSA Giraffes and packet of 52 different scarce stamps, Plume Triangle, large \$1.00 U. S. Rev., millimetre scale, perforation gauge and ruler for only 9c. To introduce our Sudden Service approvals, Fennell Stamp Company, Dept. P, Fullerton Bldg., St. Louis, Mo.

SNAPS—200 different stamps, 10c; 60 different United States Stamps, 12c. With each order we give free our price list of sets, packets, albums, etc., and our pamphlet which tells "how to make a collection properly." Queen City Stamp Company, Room 25, 604 Race, Cincinnati, Ohio.

A DOVER Bargain Stamp Outfit! 250 Peelable Hinges, 50 all dif. stamps, Plume (triangle), Nyassa, French Cols. (Pictorials), Malay (Tiger), etc.; 20 Wars. War and New Europe, 5 Blank Approval sheets, 26-page list and Bargain list, all for only 10c to those asking to see my choice 50% approvals. L. B. Dover (Dept. C), Clayton, Mo.

500 DIFFERENT foreign stamps, 35c; 100 different British Colonies, 25c; 100 different French Colonies, 30c; 100 different Portuguese Colonies, 35c. Prices for larger packets on request. Send for my famous Net Approval Books. G. H. Wildman, 543 Coggeshall St., New Bedford, Mass.

MYSTIC'S "Mysterious" Packet! Contains stamps from the lands of cannibals, heathens, sun worshippers, and wild savages. Included are Travancore, Malay, Dutch Indies, Liberia, Siam, Africa, Abyssinia, North Borneo, Nyassa, Congo, etc. This wonderful packet containing 110 all different (mostly unused) for only 8 cents to approval applicants. Mystic Stamp Co., Dept. 8, Camden, New York.

\$3.00 FOR 12c! 100 different Newroupe, Catalogued \$2.00 Red Cross set, Airplane set, Perforation gauge, Millimetre scale, Fine wallet, 5 approval sheets, 250 hinges, scarce packet from Nyassa, Abyssinia, etc., price list and approvals—all for 12c to approval applicants. Atlanta Stamp Co., Box 522, Atlanta, Ga.

PACKET of 23 stamps, no two countries alike. Packet hinges. Set of \$1 and \$2 U. S. Rev., all for 5c. P. M. Miami Stamp Co., Toledo, Ohio.

NEWFOUNDLAND Stamps Sent on Approval. Rev. Butler, St. Georges, Newfoundland.

FOUR unused sets, including "Prisoners of War," 55 different, hinges, premium, 15c. Deering, Newton St., Marlborough, Mass.

FINEST one-cent approvals. Boehm, 401 W. 149th St., New York.

DANZIG Free—Nice Set Danzig Stamps with Biggest Lists issued, 2c. postage. Midland Stamp Co., Station E2, Toronto, Canada.

FRENCH Colonies, 150 different, \$1.60. Nice Morocco set free. Biggest values on ½ cent approvals. Postage 2c. Something new. Georges Stamps, 4153 Second, Detroit, Mich.

FREE! While they last! 10 German Mourning Stamps to approval applicants. Last Chance, Penna Stamp Co., Manor, Pa.

PARK City Special—Set 9 mint Cuba, including No. 238 cat., 50c; No. 245 cat. 35c, etc. All for 12c to approval applicants. Park City Stamp Co., Dept 25, Housatonic Ave., Bridgeport, Conn.

50 DIFFERENT South American stamps 25c; 90, 50c; 200, \$2. Fred Onken, 630 70th Street, Brooklyn, N. Y.

TWENTY-FIVE different Czecho-Slovakia free to approval applicants. King Stamp Co., 4559 N. St. Louis Ave., Chicago, Ill.



**FREE:** Sets Bosnia, Jamaica Pictorials by asking 50% approvals. Reference, Elliot B. Southward, 260 Pleasant St., Willimantic, Conn.

100 RARE Stamps, all different; bargain lists, Stamp Paper, everything 7c. Stanton, Niantic, Conn.

100 DIFFERENT Stamps, 12c. Harold Robinson, 41 First St., Fulton, N. Y.

100 STAMPS and four old coins 25c. Durso, 25 Mulberry, N. Y. City.

UNIVERSAL Packet, 100 varieties, all over the world, 10 cents. Cover Stamp, 39 State, Rochester, N. Y.

BRITISH Colonies on approval; premium, reference, Maschal, 341 Hastings St., Pittsburgh, Penna.

SIXTY different used stamps, 7c; Nine Belgium, German Occupation, 10c, to approval applicants. Davies Stamp Co., Box 198, Toledo, O.

APPROVALS. Liberal discount new applicants; 10 foreign stamps free. References required. Tower Stamp Co., 42 Westville St., Dorchester, Mass.

FREE! World's smallest stamp. Postage 2c. Approvals. Cannon Co., Davenport, S. Iowa.

STAMPS on approval 1/4 cent up. Free Premium. Herbert Kelgwin, Middletown, N. Y.

250 MIXED stamps and souvenir photo, 10c. Phil Lunsted, Cape Cottage, Maine.

STAMPS sent on approval at 70% discount. Reference required. Emory Renoll, Hanover, Pa.

105 CHINA, etc., stamp dictionary, list, 2c. Album (500 illustrations), 3c. Bullard, Sta. A, Boston.

BIG Variety Packet Foreign Stamps Free for 2c postage. Gray Stamp Company, Station K19, Toronto, Canada.

FRENCH Colonies Free.—Pretty Picture Set, Native Chiefs, Tigers, 2c Postage. Empire Stamp Company, 342 Lippincott, Toronto, Canada.

BIG \$4.00 outfit and premium to approval applicants 10c. Buckley, 712 Bowen, Dayton, Ohio.

POSTAGE Stamps, 200 Mixed Foreign 10c; 50 U. S. Each different, 10c. Marie Stamp Exchange, Villa Park, Ill.

20 UNUSED stamps free. All different. Postage, 2c. P. M. Fisk Stamp Co., Toledo, Ohio.

FOREIGN Stamp Collection Sent Free. Cornish Co., Schenectady, N. Y.

FREE! Loose Leaf Postage Stamp Album at rate of 8 pages each month given with subscription to monthly Journal. Send 2c stamp for prospectus. United Stamp Co., Marquette Bldg., Chicago, Ill.

FREE—50 varieties to approval applicants sending 2c. Richard P. Lamprecht, Valparaiso, Ind.

STAMPS, 50 varieties, Africa, Brazil, Peru, Cuba, Mexico, etc., 10c, 50 different U. S., 25c; 1,000 mixed, 40c; 1,000 hinges, 10c. List free. C. Stegman, 5948 Cote Brillante, St. Louis, Mo.

ZAMBESIA, Zanzibar, Abyssinia, Herzevotina, Alensstein stamps, menagerie collection, album, 10c. Liberty, 3974 Arsenal, St. Louis, Mo.

FREE—25 different U. S. Stamps with 60% approvals to reliable parties. 75 different U. S. Stamps 25c. C. Seidenberg, Merton, Wis.

FREE—Two sets Nyassa, 20 Diff. British Colonies Barbados and Jamaica pictorials and a packet of hinges—all for a request for my 1, 2 and 3c net approvals, none better. Chas. T. Egner, 4821 Frankford Ave., Frankford, Phila., Pa.

30 DIFFERENT Newpore, German Air Mail Set. Free to applicants for my 1, 2, and 3c net approvals; also my high-priced stamps at 50% discount. Chas. W. Schmidt, 3227 Benner St., Wissinoming, Philadelphia, Pa.

24 VARIETIES Cuban stamps, 10 cents. List of 6,000 low-priced stamps free. Address Chambers Stamp Co., 111P, Nassau St., New York City, N. Y.

STAMPS, 100 all different. Postage 2c. Lists free. P. M. Quaker Stamp Co., Toledo, O.

158 GENUINE Foreign Stamps, Mexico War Issues, Venezuela, Salvador and India Service, Guatemala, China, etc., only 5c. Finest approval sheets 50 to 80%. Agents Wanted. Big 72-p. Lists Free. We Buy Stamps. Estab. 29 years. Hussman Stamp Co., Dept. 54, St. Louis, Mo.

#### RARE COINS

**OLD Money Wanted.** Do you know that Coin Collectors pay up to \$100.00 for certain U. S. Coins? And high premiums for all rare coins? We buy all kinds. Send 4c for large Coin Circular. May mean much profit to you. Numismatic Bank, Dept. H, Fort Worth, Texas.

3c. NICKEL, and 2c; 15c. California Gold 1/4, 27c; 1/2, 53c. 100,000 German Marks, 10c. Price Lists and Wild Cat Bill, 6c. 10 Foreign Copper Coins, all Different, and German Bill, 25c. Al. E. Bonsall, Richmond, Ind.

CALIFORNIA gold quarter 27c, half 52c; 1822 cent 20c; \$100.00 Confederate 20c; 1776 Colonial bill 50c. A. Wylie, Wheaton, Ill.

50,000 COINS, medals, bills. Catalogue free. Nagz, 33P, South 18th, Philadelphia.

RARE Coins, Medals, Paper Money, United States, Foreign and Ancient Mexican Bill and New Catalogue, 10c. Alexis Mengelle, Box 387, Colorado Springs, Colo.

OLD Coins. Large Spring sealing catalogue of coins for sale, free. Catalogue quoting prices paid for coins, 10c. William Hesslein, 101 A Tremont St., Boston, Mass.

CALIFORNIA gold, 1/4 size, 27c; 1/2 size, 53c; three-cent-piece and catalogue, 10c. Norman Schultz, Colorado Springs, Colo.

GET Profit and Pleasure in collecting Old Coins. Send 10c for Sample Old Coin, together with my Large Illustrated Coin Catalogue. You'll be delighted with it. Send for it right now. B. Max Mehl, Professional Numismatist, Mehl Bldg., Dept. P, Fort Worth, Texas. Largest Rare Coin Firm in U. S.

#### FOR BOYS

**BASEBALL:** Learn to Pitch Real Curves, Illustrated Pocket Size Book, Satisfaction Guaranteed, 25c. B. and N. Publishing Co., 240 Orpheum Bldg., Wichita, Kans.

**MOUTH-ORGAN** Instructor (136 big pages), 25c. Play in one hour. Eighteen good selections of music, including "Mocking Bird," with complete instructions for playing immediately. Thousands sold. Order today—become popular. Boxing Instructor, 25c. 150 Song Parodies, 10c. 250 Magic Tricks, 10c. Ford Joke Book, 10c. "Ventriquoism," 10c. Boy Electrician, 10c. Toy-maker Book, 10c. All for \$1.00. G. Elser, Burlington, Green, Ohio.

**BOYS:** Sell our needle books. Sample ten cents. Universal Sales Company, Dept. D, Box 152, Springfield, Ill.

**FREE Magazine**—For boys who want to learn how to make things and who want to see the best books of travel and entertainment. Personal Advancement is sent free for one year to those who send their name and address to Popular Mechanics Press, Room 807, Popular Mechanics Building, Chicago, Ill.

#### CAMERAS AND PHOTO SUPPLIES

**YOUR** Pictures, drawings, designs copied, enlarged or reduced in any medium, pencil, ink, wash, water color, etc. Satisfaction guaranteed or no money. Send your picture with instruction or ask for particulars. N. T. Zam, 1720 16th St., Washington, D. C.

**MAIL** us \$2.98 with your Photo or Kodak Picture. We will make you a 11 by 14" Hand Oil Painted Picture from it. State color of hair, eyes, clothes. Satisfaction guaranteed. Huezer Art Studio, Okahosa, Iowa.

**POCKET** Kodaks \$5, 3 1/2 by 5 1/2 Pocket Kodak, anastigmat lens, \$15. Graflex P. 4.5 lens, \$10. Ray, 324 3th Ave., New York.

**NEED** a camera, lens, binocular, telescopes, microscope, write at once, shotguns, revolvers taken in trade. National Camera Exchange, 7th Marquette, Minneapolis, Minn.

**MODERN** Photography in all its branches now taught by mail. New Successful Method. Students earning \$200.00 while learning. Big opportunity. Write for particulars and unusual offer open for short time. Dept. 15-56, International Studios, Inc., 3601 Michigan Ave., Chicago.

**CINE** Cameras only \$35.00, make Motion Pictures. Film Cost Small. Write W. C. Bliven, 403 Lafayette Ave., Brooklyn, N. Y.

**FILMS** Developed, Prints made. Write for Price List and sample print today. Z. Koscielniak, Box 1381, Detroit, Mich.

**PHOTOGRAPHIC** equipments and accessories of every description are listed and illustrated in our 178-page catalogue. It will pay you to secure a copy which is issued free, as our prices are low. We also deal in used goods which are sold under the same guarantee as new goods. Ask for our Bargain Book. Central Camera Co., Dept. E-85, 124 S. Wabash Ave., Chicago, Ill.

**SPECIAL Trial Offer.** Films Developed correctly 10c. Prints 3c. each. F. R. B. Photographers, 1503 Lincoln Avenue, Cincinnati, Ohio.

**HAVE** You a Camera? Write for Free sample of our big magazine, showing how to make better pictures and earn money. American Photography, 116 Camera House, Boston, 17, Mass.

**FILMS** Developed. Special Trial Offer. Any Size Kodak film developed 5c, prints 3c each. Trial 6x10 Enlargement in handsome folder 40c. Overnight Service. Roanoke Photo Finishing Co., 209 Bell Ave., Roanoke, Va.

**FILMS** Developed 5c—Prints 3c each. The new Duro finish. Davis Photo Shop, Dept. A, Cincinnati, Ohio.

**HAND** colored slides from your negatives, 50c. Art Slide Studio, 52 Niagara St., Buffalo, N. Y.

**FILMS**, 5c each; Prints, 3c each. Any size. One hand-tinted Free with each order. Azylyken, Bristol, Vt.

**SUPERIOR** quality finishing and enlarging. Trial offer: Any size 6 exposure roll developed and printed, 25 cents. 8x10 enlargement unmounted, 30 cents. Carhuff Photo Finishing Co., 2129 W. Van Buren St., Chicago, Ill.

**FILMS** Developed Free—Write for proposition. Lens cleaner free. Macks Photo Shop, Waterloo, Iowa, Box 26.

**BIG** Money Saved on Photographic Lenses and Apparatus—goods exchanged; repairing done. Ralph J. Golsen, 1128 Arroyo St., Chicago, Dept. P.

**AMAZING** Trial Offer! Your Kodak Films developed; 6 fine glossy prints; only 15c. Associated Photo, Box 1463-W, Cincinnati, Ohio.

**IF** you are interested in pictures you are interested in Camera Craft (15c a copy), 702 Market Street, San Francisco, Calif.

**KODAK** Films—Special trial offer: your next kodak film developed, 5c—prints, 2c each. Moser & Son, 1917 St. James Ave., Cincinnati.

#### MOTION PICTURES

**O BOY!** The Bass "Bargaingram" for this month will astonish you. Think of a complete Professional Motion Picture Camera, Tripod, Film, ready to start in a news weekly studio or commercial motion-picture film for only \$74.50. Dozens of other items just as good. Write for your copy at once. Hundreds of Bass' customers have become financially independent making motion pictures. The 375-page "Cinema Handbook" for only \$3.00 postpaid. The 52-page "Bass Catalogue" is free! Write or wire at once! Bass Camera Company, 105 North Dearborn St., Chicago, Ill.

**AMERICA'S** Greatest Fortunes made in the Motion Picture business. We furnish complete theatre equipment on easy payments. Openings everywhere. Catalog free. Monarch Theatre Supply Co., Dept. A, 724 So. Wabash Ave., Chicago, Ill.

\$150 SEPT Movie Camera, \$75. Movie Camera, F. 3.5 lens, \$35. Tripod, with panorama and tilt, \$25. 1,000-foot Home Movie Projector, \$25. Road Show Projector, \$50. \$150 New Motor-Driven suitcase Projector, \$75. Ray, 324 5th Ave., New York.

**MACHINES**, films, stereopticons, supplies. Bargain lists free. National Equipment Co., Duluth, Minn.

**MOVING** Picture Machines and Films for sale. Send Stamp for List. National Film Brokers, 3907 Summit, Kansas City, Mo.

**MOVIE** Films for Home, School, Church, and Theatres. Comedies, Drama, Cartoon, Cowboy, Indian, Jungle, Religious, Historical, Fairy, Travel, Vodevil and Educational subjects. \$7.00 per reel up. Complete List. Monarch Theatre Supply Co., Dept. G, Memphis, Tenn.

\$35.00 **PROFIT** nightly. Small capital starts you. No experience needed. Our machines are used and endorsed by government institutions. Catalog free. Atlas Moving Picture Company, 482 Morton Bldg., Chicago.

**\$\$\$ FOR** Ideas. Photoplay plots accepted any form; revised, criticized, copyrighted, marketed. Advice free. Universal Scenario Corporation, 206 Security Bldg., Santa Monica and Western, Hollywood, Calif.

**MAKE** money writing photoplays; details free to beginners. No correspondence course. Producers League, 230 Wainwright, St. Louis.

**ELECTRICITY**—Make it yourself with our auto generator. Write for particulars. Monarch Theatre Supply Co., Dept. 7, 724 So. Wabash Ave., Chicago.



**BIG Money Nightly**—Good assortment. Complete Outfits, installment plan. Splendid Home Outfit, \$25.00. Ralph J. Golden, Dept. M, 1128 Argyle St., Chicago.

**WONDERFUL Opportunities for Making Fortunes in this Business.** No Experience needed. Complete Theatre Outfits sold on Easy Terms. Free Catalog. Monarch Theatre Supply Co., Dept. P, Memphis, Tenn.

#### SCENERY TO RENT

**SETTINGS** for Opera, Plays, Minstrels, Plush drops. Address Amelia Grain, Philadelphia.

#### EDUCATIONAL AND INSTRUCTION

**WORLD-ROMIC System.** Masterkey to All Languages. Primers, \$1.94 each language: Bohemian, Chinese, Danish, Dutch, English, French, German, Italian, Japanese, Latin, Polish, Portuguese, Rumanian, Russian, Szechuan, Singhalese, Spanish, Swedish, Tamil. Pronunciation-Tables, 30¢ each language. Dictionaries, grammars, 4,000 languages, of 1,700,000,000 people; Afro-Asiatic, Amerindic, Eurindic, Indopacific, Siberic, Sinindic. Languages Publishing Company, 8 West 40th Street, New York.

**CIVIL Engineer** teaches Arithmetic, Algebra, Geometry, Trigonometry. Mondell, 50 E. 42nd, New York.

**HOW To Run a Lathe,** newly revised 140-page book, 250 illustrations, over 1,000,000 copies now in use. Price 15 cents postpaid. See advertisement page 155 for Easy Payment Plan for South Bend Lathes. South Bend Lathe Works, South Bend, Ind.

**PERSONAL Advancement** tells how to decide upon a vocation, how to plan a course of home study, how to avoid duplication in the books you buy, how to secure the best books on any subject. And it's free for a year. Send your name and address on a postal today to Popular Mechanics Press, Room 807, Popular Mechanics Building, Chicago, Ill.

**LEARN Penmanship;** instructions 25¢ (Silver). Prince, 130 W. 104, New York.

**SHOWCARD Writing Made Easy.** Instruction Book and Complete Outfit \$1.00. D. A. Gale, Box 313, White Plains, N. Y.

**USED educational matter** bought, sold, exchanged. Bulletin free. Instruction Correspondence Exchange, 1968 Broadway, New York.

**LEARN Patent Drafting.** Complete instructions 50¢. Patent Drafting Syndicate, Box 858, Schenectady, N. Y.

**MEN, Get Better Jobs.** Learn Blue Print Reading and become a foreman. Write, tell us your trade. I will show you how to earn more money. Carroll Rumser, Dept. 164, Drexel Bldg., Philadelphia, Pa.

**HASHFULNESS,** fear and timidity quickly banished through mirth, merriment and subconscious reconstruction or your remittance, \$2.00, for the wonderful "Personal Liberty Course," promptly refunded in 10 days. H. L. Juhnke, Dept. A, Box 854, Sacramento, Calif.

**"SIGN Painting Simplified"** teaches you this big paying trade. Beautifully illustrated book and working outfit \$1. Sign-Book Shop, 910 N. 18th St., St. Louis, Mo.

**ARTHOL Shorthand** learned in four evenings. Full course seven dollars. Used everywhere. Sent on free trial. Particulars, Hellefreund's Arthol Institute, Stratford, Ontario.

**USED books and educational matter** bought, sold, exchanged. List 1,000 items free. Students' Exchange, 47-A West Forty-second Street, New York, N. Y.

**CARTOONISTS**—Improve your style by following the work of the greatest cartoonists found in the bound volumes of *Cartoons Magazine*. Three volumes, each covering six months, Jan.-June 1919 to Jan.-June 1920, inclusive, 1200 cartoons, 900 pages to a volume, 7 by 9½ in., 3 in. thick. New books, durable and attractive binding. Sold separately at \$2 per vol. postpaid. Supply limited. Send at once. Popular Mechanics Book Dept., 206 E. Ontario St., Chicago.

**DOUBLE Entry Bookkeeping** mastered in 60 hours with 8 keys; guaranteed; diplomas. International Bookkeeping Institute, Dept. 8, Springfield, Mo.

**BOOKKEEPING in a Week,** \$2 complete. Dukes, 1857 Walton Av., New York.

**ARTIFICIAL Marble, sanitary flooring instructions, ornamental casting, concrete plaster, papier-mache decorations, garden furniture, statuary, Rubber-moulds, Electro-metallurgy, particulars and 200 illustrations free.** Chris Mahler, Box 122, Huntington, N. Y.

**WRITE articles, stories, news,** in spare time for newspapers and magazines. Big pay. Copyright book free. Press Syndicate, 581, St. Louis, Mo.

**YOU can have a business profession of your own and earn big income in service fees.** A new system of foot correction; readily learned by anyone at home in a few weeks. Easy terms for training; openings everywhere with all the trade you can attend to. No capital required or goods to buy, no agency or soliciting. Address Stephenson Laboratory, 1 Back Bay, Boston, Mass.

**"WHAT to Invent for Profit"** free. Patent News-N, Washington, D. C.

**USED educational matter, books, etc.,** sold, rented and exchanged. Big list free. Lee Mountain, Pisgah, Ala.

**ROPP'S Calculator and Short-Cut Arithmetic** shows the answer as quickly as a watch shows the time to all problems likely to occur in office, store, shop, bank, farm or factory. Price, pocket size, paper 35 cents; cloth 50 cents; leatherette \$1. Desk size, cloth \$1.50 postpaid. Popular Mechanics Book Dept., 206 E. Ontario St., Chicago.

#### RADIO OUTFITS AND SUPPLIES

**CRYSTAL Set,** 75¢ prepaid; D12, U200, U201A; Guaranteed Tubes \$2.50 prepaid; 45 volts B-Battery, Large Size \$4.00 prepaid. Radio Sales Co., 1166 N. Kingshighway, St. Louis, Mo.

**48 STATIONS on Crystal** without tubes or batteries. You fellows who haven't tried my hook-up don't know what you are missing. Write, Leon Lambert, 539 Volusia, Wichita, Kans.

**MAKE Good Money** selling standard radio parts and sets to yourself and friends. Write for Catalog 5-M, Western Radio Corporation, Cedar Rapids, Ia.

**CRYSTAL Radio Receiving Set.** Guaranteed to work. 50¢ postpaid. True-Blu Supply Company, 23 Tacoma, Rochester, N. Y.

**RADIO Map of the U. S.**—Government Radio Stations, Broadcasting Stations, Commercial Stations, Call Letters, Wave Lengths, etc., 35¢ postpaid. Popular Mechanics Book Dept., 206 E. Ontario St., Chicago.

**RADIO Sets—\$30 to \$300.** Super Heterodynes Neutrodyne and other types. All makes, at 50% off list. Why pay more? Send for Bulletin 214. Radio Exchange, 925 Broadway, New York.

**RADIO Generators—500V, 100 watt \$28.50.** Battery Charging Generators \$8.50. High Speed Motors—Motor Generator Sets, all sizes. Motor Specialties Co., Crafton, Penna.

**2,650 MILES** Distance with one tube. Any Notice understands our Simplified Instructions, including Panel Layout and Photo 25¢. Vesco Radio Co., Box PM-117, Oakland, Calif.

**LOUD Speaking Crystal Set.** Broadcastings heard throughout house. Easily constructed. Instructions complete 25¢. Catalog free. Steinmetz Wireless Mfg. Co., Eastend, Pittsburg, Pa.

**DICTIONARY of Radio words and terms,** electrical symbols, wiring diagrams, radio diagrams and complete electrical dictionary, new, up-to-the-minute, just published, 188 pages, cloth cover, vest-pocket size, 35¢ postpaid. Popular Mechanics Book Dept., 206 E. Ontario St., Chicago.

#### TELEGRAPHY

**TELEGRAPHY**—Both Morse and Wireless—taught thoroughly and quickly. Tremendous demand. Big salaries. Wonderful opportunities. Expenses low; chance to earn part. School established fifty years. Catalog free. Dodge's Institute, H St., Valmar, Ind.

#### TRADE AND TECHNICAL SCHOOLS

**The Greatest Painting School** offers you practical courses in Sign-Pictorial-Auto Painting-Decorating-Graffing-Marbling-Paperhanging. Short terms, Low Cost. Chicago Painting School, 147 W. Austin Av., Chicago.

**CHICAGO Technical College** offers short, intensely practical courses in Drafting and Engineering—civil, mechanical, electrical, structural—Architecture, Building Construction, Plan Reading, etc. Courses fitted to your needs. No time wasted. Instructors are experts. Graduates in demand at big salaries. Opportunities for part-time work while studying. Day and evening classes, 21st year. Enter any time. No special preliminary training required. Low tuition—easy terms. Write for 32-page illustrated Blue Book, describing opportunities open to our graduates. Chicago Technical College, 25 Chicago Tech. Building, Chicago.

**BE a Bricklayer.** Attend a School operated by Building Contractors, Three Months' Day Course \$75.00. Associated Building Employers, 112 A. B. E. Building, Grand Rapids, Mich.

**No matter what trade you are interested in,** you can get help from *Personal Advancement* magazine, published by Popular Mechanics and sent free to all who request it. Will help you decide upon a vocation. Send your name and address on a postal to Popular Mechanics Press, Room 807, Popular Mechanics Building, Chicago, Ill.

#### BUSINESS OPPORTUNITIES

**\$5 TO \$15 daily**—year around position, monthly bonus besides. Groby made \$499.50 in 30 days, Oregon \$443.03, Whiteside \$435.00, Robey \$352.00, Bickel \$339.91. No experience or capital required. Exclusive patented necessity. Millions of prospects, homes, stores, schools, factories, auto and truck owners. Spare time satisfactory; we deliver and collect, also carry accounts. Cash in on our advertising and approval by National Board and big users. Our original new plans produce results. Write quick for full details. The Fry-Fryer Co., 340 Fry-Fryer Bldg., Dayton, Ohio.

**BE ready for your golden opportunity** by preparing yourself. *Personal Advancement*, a new magazine, tells how to do this. Will be sent one year free. No strings to this offer. Popular Mechanics Press, Popular Mechanics Building, Room 807, Chicago, Ill.

**UNPATENTED Ideas Can Be Sold.** I tell you how and help you make the sale. Free particulars (Copyrighted). Write W. T. Greene, 810 Jenifer Building, Washington, D. C.

**120 MONEY-MAKING Plans Free!** Wolverine Bureau, G-5, Muskegon, Mich.

**TNT SILVER Radio Crystal and Desert Cactus Cat-Whisker.** Latest Startling Radio Discovery. Supersedes All Other Crystals. Ten Million Want TNT. Fortune for Distributors. Write Quick, Sample 50¢. TNT Products Co., 935 Phelan Bldg., San Francisco, Calif.

**SILVER Foxes,** Highest quality. Before buying, write, Augustus's Whitehall, Wis.

**REAL Estate Business in all branches.** Complete course taught by mail. Easy terms. Bulletin free. Penn Realty School, Ellsworth & 19th Sts., Phila., Pa.

**PATENTS Procured.** Send sketch or model today for examination, prompt report and advice. No charge for preliminary advice. Write for free Booklets "How to Obtain a Patent" and "Invention and Industry" and blank form on which to disclose your idea. Highest references. Promptness assured. Clarence A. O'Brien, Registered Patent Lawyer, 586 Security Bank Building. Directly across the street from Patent Office, Washington, D. C. See pages 146 and 147.

**OLOMATIK—What every Ford needs.** Real necessity. Saves repair bills, cuts oil consumption 25% to 50%. Harvest for Agents, Salesmen, Distributors. For full details see our ad page 161. Olomatik, 543 E. Ohio, Chicago.

**MEN, Women and Children** make the Arco, and big money. Commercial possibilities unlimited. We teach you. Send \$1.00 for complete instructions. Arco Mfg. Co., 284 Seymour Ave., Newark, N. J.

**CLASSIFIED Advertising** gets big results at little cost. Sell your patent, your business, get agents, etc. Rate book of leading magazines and newspapers free. Taylor's Advertising Service, Dept. G, Freeport, Ill.

**EVERYBODY** knows of the remarkable success of the 10¢ stores. Now comes the 25¢ and 50¢ Mail Order Business. Write for free circular. Taber Bros., 311 Fifth Avenue, New York.

**TWELVE Percent** on savings deposited in your own bank. How, one dollar cash. William Goldsmith, Box 152, Trinity Station, New York.

**START Mail-Order Business** During Spare Time, 10,000 Money-Making articles. Information and Genuine Diamond Cuff Links \$1.00. Cowan's, Dept. 44, 25 Raines Park, Rochester, N. Y.

**ATTENTION!!** Go into business for yourself. Establish and operate New System real estate; business brokerage and Insurance Agency in your community. Office at home; earn \$5,000 year. Representatives wanted everywhere; send stamp for booklet. Hayes Realty Association, Cincinnati, Ohio.

**PATENTS—Write for our Guide Books** and "Record of Invention Blank" before disclosing inventions. Send model or sketch and description of invention for examination and instructions. No charge for the above information. See advertisement on pages 148 and 149. Victor J. Evans & Co., 192 Ninth, Washington, D. C.

**SIGNS, Banners, Showcards,** Easily Painted with the aid of Letter Patterns. Sample for Stamp. John F. Rahn, A2423 Greenview Ave., Chicago.



EARN money spare time or evenings. No peddling. Permanent. Work in your own home. Write Downs Co., 2323 Myrtle, St. Paul, Minn.

PUBLISH a Monthly Magazine. We will tell you how. Very interesting, profitable. Information free. P. M. Lutz Printing Co., York, Pa.

WHY work for someone? Start a business; \$100 sufficient. Information Dept. N. Paul Kaye, 149 Broadway, New York.

PATENT applications filed guarding priority \$20; drawing; deferred \$15; caveat advantages; basic protection. Inventors' Service, 11 Broadway, New York.

MONEY! Silvering Autolights, Radiators, Mirrors, tableware, stoves. "Outfit" Methods Free. Sprinkle, Plater, Dept. 28, Marion, Ind.

"STEPPING Stones to Wealth"—New book of 1000 Plans, Formulas and Trade Secrets. Biggest and best mail order book ever published. \$1.00 postpaid. Large descriptive circular free. Thompson Publishing Co., Cincinnati, Ohio.

YOUR Wife Can Help You Run a Mail Order Business. Keep your present job too. Write, Leon Lambert, 559-D Volusia, Wichita, Kans.

POPCORN Machine—Concession Model, self-seasoning, very speedy. Money maker. \$60. Northides Co., 1306 Fifth, Des Moines, Iowa.

I MADE \$100,000 as Real Estate Specialist. Free information tells how. American Business Builders, Dept. A-439, 1133 Broadway, New York.

PATENTS Procured; Trade Marks Registered—A comprehensive, experienced, prompt service for the protection and development of your ideas. Preliminary advice gladly furnished without charge. Booklet of information and form for disclosing idea free on request. Richard B. Owen, 30 Owen Bldg., Washington, D. C., or 2276-B Woolworth Bldg., New York.

SUCCEED With Your Own Products—Formulas, Processes, Trade-Secrets. Different, dependable, profitable. Catalog free. B. Thaxly Co., Washington, D. C.

FOR \$10 we'll write three catchy order-pulling classified advertisements that simply must bring you business. Rates of profitable magazines included. Martinek Companies, Corona, N. Y.

MONEY in your back-yard. Something new. Spare time, little capital. Complete detailed instructions 25c. R. Henderson, Hartsville, Pa.

FREE Book—Start little Mail Order business anywhere; home employment evenings; beginner's working outfit furnished; 500 circulars; samples; novelties to sell; you deal with manufacturers; no stock to carry; also tell how to secure agents to sell your novelties. Instructive booklet free. Pier, 787 Cortland Street, New York.

MAKE money with your camera. (Lancaster), Box 436, Los Angeles, Calif.

MIX many articles to sell by mail or locally. Descriptions; winning plans; valuable information, 10c. John Brackland, 1455 So. Ninth, Philadelphia, Pa.

NEW Book explaining the wonderful Mail Order Business and where to buy thousands of articles wholesale 25c. Circulars free. Harvey Teagle, Decatur, Ind.

PRINTING Presses, Type, Materials. Make easy money Printing for Self and Others. Interesting Circulars, Stamp, Watson, 160 William St., New York.

BE your own Boss—Book containing 100 different things to make, and Digest 3 months, 25c. Digest, Grand Rapids, Mich.

MAIL Order Information, worth hundreds of dollars, for dime. Whitney, Box 55A, Station C, Cincinnati, Ohio.

3,384 MONEYMAKING Plans, Formulas, Trade-Secrets. "Encyclopedia Business Opportunities," 3 Volumes 98c. "Ideal," 5501-V9, North Robey, Chicago.

EARN \$15.00 Daily. Learn—Interior Decorating of Homes. Refinish and Retrim automobiles, make automobile specialties; Unlimited Demand—Modern approved methods. Start your own Business while you learn at Home. Fred DeWilde, Sheboygan Wis.

\$120 STARTS profitable mail order agency business; no soliciting; can make \$40 weekly part time; everything supplied. Free book. Marvell Co., 6002 Market, Philadelphia, Pa.

LEARN the collection business. Good income, quick results. Interesting booklet, "Skillful Collecting" free. National Collectors Assn., Long St., Newark, O.

PATENTBOOK, 139 mechanical movements and illustrations, sent free. Labinere, 3 Parkrow, New York.

A TEA Room or Cafeteria will make you a fortune—you can operate one of your own or manage one for others. We teach you in a few weeks and put you in touch with positions and money-making opportunities—earn \$5,000 a year—be independent. Write today for book "Pouring Tea for Profit." Lewis Tea Institute, Bureau D-31, Washington, D. C.

GOLD Window Sign Letters. Manufacture them at home. Unlimited profits and business opportunities. Complete instructions and patterns. No experience required. Particulars, Witterding, 1114 Pleasant Street, Oak Park, Ill.

SIGN work made easy with "Perfect" Letter Patterns. Beautiful and exact gold-leaf lettering on glass now easy. We teach you. Samples and information free. Ross System, 2152 Alice Place, Chicago.

BIG money Writing photoplays, stories, poems, songs. Send for free copy America's greatest magazine for writers. Tells you how to write and sell. Writer's Digest, 603 Butler Bldg., Cincinnati, Ohio.

ENTER a new business. Earn \$3,000 to \$5,000 yearly in professional fees making and fitting a foot specialty, openings everywhere, with all the trade you can attend to; easily learned by anyone at home in a few weeks, at small expense; no further capital required, no goods to buy, job hunting, soliciting or agency. Address: Stephenson Laboratory, (1) Bark Bay, Boston, Mass.

INVENTORS—Write for our Guide Book, "How to Get Your Patent" and Evidence of Invention Blank. Send model or sketch of your invention for our free Examination and instructions. Randolph & Co., Dept. 435, Washington, D. C.

"GET into the Specialty Manufacturing Business" or "Why Work for Others?" may sound good to you, but you won't succeed in that business unless you possess Formulas that are absolutely reliable, the same required by leading manufacturers supplying the Best. Don't be Bunked into buying a Collection of cheap "Formulas" and expect to succeed. Send today for my valuable literature and Formula Lists and Real Money-Makers in the Specialty Manufacturing Business. 26 years supplying the Best. Miller, Chemist, 895 De Leon St., Tampa, Fla.

EXCEPTIONAL Opportunity for Sales Manager capable of handling state distribution. Marvelous new Adding Machine. Retail \$15. Work equals \$350 machine. Tremendous possibilities. Unlimited Profits. Write quick for details. Lightning Calculator Co., Dept. B, Grand Rapids, Mich.

MAIL Order Business is your opportunity. Brenner's Famous Handbooks teach how to start small, grow big. Sell merchandise, service, ideas; enormous profits. Spare time to begin. Get complete set, 11 books, \$3.00, and be posted. Brenner, 335 Walnut, Philadelphia. Descriptive Catalog and big batch interesting mail order information, 25c. None free.

\$3,000 TO \$6,000 Yearly. Want it? Others are making it. Send check or money order today for our invaluable books "How to Sell Real Estate" \$3.00—and "How to Conduct Real Estate and Insurance Business," \$1.50. Absolute satisfaction guaranteed. Free catalogs. Realty Book Co., Dept. 52, Cleveland, Ohio.

"HOW to Sell Patents" free. Patent News-H, Washington, D. C.

START and Operate Your Own Business. Our System proprietary specialty manufacturing offers wonderful opportunity to make \$109 to \$500 weekly. Openings everywhere. Either men or women. We furnish everything and show you how. Big explanatory book, "The Open Door to Fortune" free. Write for it now. National Scientific Laboratories, 208 Monroe, Richmond, Va.

EARN \$10 daily silvering mirrors, plating and refinishing metalware, autos, chandeliers, bedsteads, headlights. Outfits furnished. E. Decie Laboratories, 1133 Broadway, New York.

MARBLE mixing instructions, covering wood or cement flooring 1/2 in. thick, fire-proof, waterproof, low cost, sanitary, all colors. Particulars, 200 illustrations free. Chris Mahler, Box 122, Huntington, N. Y.

"SCHEMER Magazine," Alliance, Ohio, prints big profit schemes; one subscriber making \$25,000 from three; another \$10,000 from one. Try your luck. Year, only \$1.00; three months, 25c.

START a Real Estate Office of your own. Earn from \$3,500 upwards. Our course of 21 lessons tells you how. Booklet M on application. Frederick Jenkins, Corlaer Heights, Schenectady, N. Y.

DOLLARS Yearly in your Backyard. No mushroom dope. Particulars free. Metz, 311 East 89th, New York.

CEMENT Masons, Plasterers, Contractors. Build successful business, succeeding old and new buildings with Everlastone Indestructible Stucco; also installing Corkstone Floors over worn-out flooring. Write immediately for agency proposition. Everlastone Corporation, 828 W. Pratt St., Baltimore, Md.

100,000,000,000 GERMAN Mark free with 100,000 Polish Mark for 60c. 10,000 Austrian Kronen 25c, and 10,000 Hungarian Kronen 50c. Don't send us any Money, but write for Dealer's Terms. Arrow Sales, 1748 North Park Ave., Chicago.

MAKE toys and novelties at home. Big profits. Instructions and 200 Illustrations, 25c. Astrofile Company, Sharsburg, Pa.

WE Start You in Business, furnishing everything; men and women, \$30.00 to \$100.00 weekly operating our "New System Specialty Candy Factories" anywhere. Opportunity lifetime; booklet free. W. Hillyer Bagdala, Drawer 4, East Orange, N. J.

BIG Money made at home. Information free. 429 Hildreth Bld., Lowell, Mass.

I MADE \$30 a Week Home. French Breadmaking. 15 years' experience; Free Booklet tells. Ashbrook 67, Marengo, O.

CHEMICAL Expert will furnish Formulas and Trade Secrets. All lines. Lists Free. W. L. Cummings, Ph. D., 228 Gordon Ave., Syracuse, N. Y.

RAISE guinea pigs. Pay better than poultry or rabbits; easy to raise; little space required. We guarantee market. Particulars and booklet how to raise free. Cavies Distributing Co., 3102 Grand Ave., Kansas City, Mo.

"WHAT to Invent for Profit" free. Patent News-C, Washington, D. C.

COST \$5.00. Your profits \$104.75, transferring monograms on autos, trunks, bags, etc. No skill required. Samples and information free. World Monogram Co., Dept. 16, Newark, N. J.

INCH Display Advertisement 166 Magazines Thrice \$15. Year \$50. Page \$100. Wood's Popular Services, Atlantic City, N. J.

#### WANTED—BUSINESSES FOR SALE

IF You Want to Sell Your Business for Cash quickly and privately, we take the prospective buyer directly to you at our expense, no matter where located. We specialize in selling out-of-town businesses. If your business is worth \$5,000 or more, write us The Mutual Security System, 68 W. Washington St., Chicago.

#### CHEMISTRY

YOUR chemical problem solved and working process furnished Five Dollars. Write me, W. Stedman Richards, Consulting Chemist, address, Box 2102, Boston, Mass.

CONSULTING Chemist, Manufacturing Processes, Analysis, Information. Robert Henderson, Madison, Maine.

PRODUCTS formulated, duplicated, improved, cheapened. Booklet, Harding, L-B 1029P, Chicago.

#### FORMULAS AND TRADE SECRETS

NOTICE—Withdrawn after Oct. 15th Your Chance to Cash In on a Real Money-Maker. I Am Getting Rich on It—Complete Formula and Details One Dollar Bill. Chess Electric Co., Terre Haute, Ind.

HOW to manufacture hundreds of articles in daily use. Full directions in trade edition book of formulas. Price 50 cts. postpaid. Penland Service, 2 Thames Ave., Norwalk, Conn.

500 VALUABLE formulas 25c. Literature free. Harvey Teagle, Decatur, Ind.

THREE Cents a pound Coffee Substitute. Wall Paper Cleaner, Polishing Cloths, Furniture Polishes, Liniments, Salves, Cements, Tobacco Cure, Water Paint, Silvering Mirrors, and 150 Selected Formulas, etc., and Digest three months, 25c. Digest, Grand Rapids, Mich.

LIQUID Free Powder and Permanent Wave Solution. Formulas, Both, \$5. Guaranteed. M. Haghey, 1517 Glenarm, Denver, Colo.

1,000,000 FORMULAS, 1,016 pages, \$1.98. 500 Formulas Free if you order quick. Ideal Book Shop, 5501-M9, North Robey, Chicago.

FIFTEEN Ink Formulas, 10c. R. Brong, Broadheadville, Pa.

ARE You Old at Forty? See our advertisement on page 143 of this issue. The Electro Thermal Company, 2137 Main Street, Steubenville, Ohio.



**500 FORMULAS**, including Luminous Paint—Renewing Dry Batteries—Mechanics' Soap—Gas Tonic—25c. Catalog Free. Ideal Book Shop, 5501-P9, North Robey, Chicago.

**5,000 FORMULAS** and receipts \$2.00; 500 formulas 25c; 200 formulas for making medicine from herbs 10c; All three \$2.25. Rodgers Book Co., 839 Oak, Cincinnati, O.

**20TH Century Business Encyclopedia** Contains hundreds formulas, money making plans, sources of supply. \$1.00 postpaid. Smith's Service, 1194, Wrentham, Wash.

**\$5.00 WILL** furnish you with working formula for manufacture of any article. Work guaranteed. Chemical analysis of any nature. Chemical Technical Laboratories, Allston, Mass.

**BIG**, interesting formula catalog free. National Scientific Laboratories, 208 Monroe Street, Richmond, Va.

**FORMULAS**—Best that Chemical Science can devise. Not "Better Sort" Formulas, but Guaranteed Reliable processes in all lines. Stamp brings Valuable Literature and Latest Summer Sellers from an Analytical Chemist, Miller, Chemist, 807 De Leon, Tampa, Fla.

**10,000 SELECTED** chemical, technological and practical recipes and processes, including hundreds of so-called trade secrets for every business, alphabetically arranged in one large volume of 800 pages. Price \$4 postpaid. Popular Mechanics Book Dept., 208 E. Ontario St., Chicago.

#### AGENTS WANTED

**BEATS** Owing a Store. "This new way of selling beats owing a store. Any earnest worker can easily make \$4,000 to \$5,000 a year net without investment or financial risk," says Wm. Garden, former merchant who started with us two years ago. Other former merchants now happy and prosperous with us are De Longe, Pack, Carter, Hogen, Lee, and Peck. They earn as much or more than ever; have no investment or financial worries and are building a constantly growing business. We are now making the best suit that we ever produced retailing at \$31.50. Our values are remarkable. Our fit and style so good that you can sell the best trade. Every fabric is virgin wool. Every garment tailored to order. We have openings for men who are looking for a chance to build a steady, profitable business. Such men will find a wonderful opportunity with us. Write for new sales plan, full information. Dept. 953, J. B. Simpson, Inc., 843 Adams St., Chicago.

**\$8.50 TO \$20.00** daily easy—Writing orders for New Insured Hosiery—for men, women, children—57 styles—37 colors—Must wear or replaced free—Sales easy—repeat orders sure—Nylond made \$393 one month—Edward made \$460.60—Mrs. Bone, \$445.25. You should do as well—Hundreds of other men and women have been wonderfully successful—Be your own boss—Work as many hours as you please and have a big steady income—Even spare time work should pay you \$2 to \$3 per hour—Your Pay Daily In Advance—We deliver and collect, leaving you free to devote all your time to writing orders—No experience or capital needed—We furnish elegant outfit free—All grades—colors, including silks—No matter what you are now selling—it will pay you to get our proposition. Macroeche Textile Company, Room 3589, Cincinnati, Ohio.

**GENUINE** Gold Leaf Letters anyone can put on Store windows. Guaranteed to never tarnish. Large Profits. Enormous Demand. Free Samples. Write today. Metallic Letter Co., 438-A North Clark, Chicago.

**WHY** Work for others? Start and operate your own business. Our system proprietary specialty business offers wonderful opportunities to make \$100 to \$500 weekly. Openings everywhere. We furnish everything and show you how. Booklet free. National Scientific Laboratories, 208 Monroe, Richmond, Va.

**CALIFORNIA** Rosebuds selling like hot cakes. Agents coining money; new stuff. Big profits. Catalog free. Mission Factory PM, 519 No. Halsted, Chicago, Ill.

**DUSTLESS** Sponge Cloth. New Invention. (1) Rub—Dusts, Cleans and Polishes Automobiles, Furniture, Pianos, Retail (50c)—Costs (16c). "Sample Free." NuLife (E) Sponge, Hartford, Conn.

**AGENTS**—Quick sales, big profits, outfit free. Cash or credit. Sales in every home for our high class line of Pure Food Products, Soaps, Perfumes, Toilet Articles, etc. Write today for money-making plans. American Products Co., 1799 American Bldg., Cincinnati, Ohio.

**EVERYBODY** Needs and Buys the "Business Guide." Wells cleared \$1,150 in 35 days. Send for sample. It's Free. Nichols Co., Dept. 4B, Naperville, Ill.

**MAKE \$75** to \$125 a week selling our strictly All-Wool made-to-measure suits at one amazing low price. We pay big cash profits in advance, liberal bonus besides and supply finest selling outfit in America showing almost 150 Virgin Wool Fabrics of highest quality—fine long-yarn Worsted and Serges—our famous Broadcloth Silk Stripes, our own exclusive design—the new Powder Blues, Sand Tans, and all the other new shades. Also a big assortment of fine heavy-weight overcoatings in through-and-through weaves and fancy plaid backs, and a big assortment of raincoats at the lowest prices in America. If you have ever sold tailoring, raincoats or other specialty goods, or are ambitious to sell such goods and are looking for the quickest-selling, best-paying line of its kind in the field, get in touch with us at once. Address Dept. 292, Goodwear Chicago, Inc., 844 West Adams Street, Chicago.

**AGENTS**, Salesmen, Demonstrators, you will have the devil's own time trying to find a better seller than "Zippe." If there was such a thing we'd have it. Splendid profit on 50c "Go Getter" repeat article that sells on ten second demonstration. Works While You Watch It. Demonstrates value, while others waste time making claims. New Discovery! Greatest Scientific Triumph of the age. It's the berries. Haven't room to tell our story here. Write immediately. Karan-Smith Co., 609 Bosan St., Ft. Wayne, Ind.

**AGENTS**—\$15 a day—Easy, quick sales—Free Auto—Big Weekly Bonus—\$1.50 premium Free to every customer. Simply show our Beautiful 7-piece Solid Aluminum Handle Cutlery Set. Appeals Instantly. We deliver and collect. Pay daily. New Era Mfg. Co., 803 Madison St., Dept. 21-BD, Chicago.

**AGENTS** Make Big Money selling new auto invention. Hoffenberg's sold 906 in 2 months. Profit \$2,700. For full particulars write Stransky Co., Dept. A-12, Pukwana, S. Dak.

**AGENTS** to demonstrate and sell to car owners, Nationally advertised Auto Polish that removes that dull gray film, restores the factory lustre, and leaves a glass-hard, dust-proof surface. A scientifically correct cleanser that is saving thousands of car owners the expense of repainting, yet it costs only \$1.00. Agents everywhere proving that quick sales result from demonstrations; and a steady growth of profits from repeat business. For free testing sample and details, address, C. S. Mfg. Co., 502 N. Whittier St., St. Louis, Mo.

**AGENTS**, Salesmen—Sell New Thermostatic Automatic Carburetor Control Attachment for Fords. Big Profits, full or part time. Burns 95% air. Doubles Mileage. Attached in 2 minutes. No drilling. Does automatically exactly what Ford manual says by hand. Cadillac now using Thermostatic Carburetor Control under Blanche license. Write today. A. C. Blanche & Co., Dept. 450-C, 602 Lake St., Chicago.

**SELL** the Hanna Memorandum and Billing Register. Near 100% Commission. Two Models, entirely new and practical, both selling sensations. The quickest selling, biggest money maker ever offered specially salesmen. For office executives, clerks, stenographers, private secretaries, professional men and stores. Large drug stores, wholesale houses and offices buy three to ten registers each. Printed sales tickets showing customer's name. Sells at \$5.00 and \$6.50. Additional commission on printing. Join hands with success by writing for complete information. Hanna Register Co., Wulshner-Stewart Bldg., Indianapolis, Ind.

**AGENTS**—Write for Free Samples. Sell Madison "Better-Made" Shirts for large Manufacturer direct to wearer. No capital or experience required. Many earn \$100 weekly and bonus. Madison Mills, 544 Broadway, New York.

**PORTRAITS**, photo pillow tops, frames, sheet pictures, medallions, merchant's signs, water-proof and tea aprons, guaranteed hose, toilet requisites, luminous crucifixes. Catalog 50 specialties free. 30 days' credit. Jas. C. Bailey Co., Desk A-9, Chicago.

**GOODYEAR** Mfg. Co., 1747 Goodyear Bldg., Kansas City, Mo., is making an offer to send a handsome raincoat free to one person in each locality who will recommend it to friends. Write today.

**GET** exclusive state rights sell new auto product. Costs 50c, including literature; sells \$3.75. Samples to try sales possibilities which retail for \$11.25 free to agents. Mickman Co., St. Paul, Minn.

**AGENTS**: Brand New Hosiery Proposition for men, women, children. Must wear 12 months or replaced free. All styles, colors and finest silk hose. Sell at less than store prices. Write for samples. Thomas Mfg. Co., Class 662, Dayton, Ohio.

**AGENTS**—\$10 to \$25 daily. No investment. Free outfit. Best values. Largest commissions. World Raincoat Co., 658-B Morris Park Ave., New York.

**\$15 DAILY** Easily Made: Great Opportunity Men and Women—Experience unnecessary. 95c Profit every Dollar. A Whirlwind Seller. Write Quick! Particulars Free! Smith Specialties Company, 71 Plank Road, Waterbury, Conn.

**AGENTS**—Biggest money taking orders for newest style written guaranteed hosiery. Complete line, men, women, children's, including silks. No competition. Not sold in stores. Written guarantee with each pair. You display samples and write order. We deliver and collect. Pay you daily in advance. No experience necessary. Spare time satisfactory. Write for samples. Jennings Mfg. Co., Dept. N-12, Dayton, Ohio.

**BIG Profits**, New \$3.50 Automatic Adding Machine. Quick Sales. No competition. Ten daily easy. Absolutely accurate. Fully guaranteed. Pocket size. Business people everywhere positive customers. Exclusive territory to workers. Act quick. Bassett Company, 1458-L Hollywood Ave., Chicago.

**MAKE \$75.00** a week and up selling our fine made-to-measure, all-wool suits at \$31.50 retail, direct to wearer. Biggest values—positively sell on sight. Biggest commissions, paid in advance. We attend to delivery and collections. 629 swatch samples furnished Free. W. Z. Gibson, Inc., Dept. J-8, 161 W. Harrison St., Chicago.

**300% PROFIT**: Whirlwind Seller. Tremendous repeater. "Kleanrite." Marvelous Discovery. Washes clothes without rubbing. Premiums for customers. Sells 25c. You make 18c. Free samples make easy sales. Write quick. Bestever Products Co., 1941-K9, Irving Park, Chicago.

**TWO Knock Outs**; Over Million sold each day. Are necessary; both full size with agents proposition, 25c. American Co., 1551 Donaldson, Cincinnati, O.

**SELL** Shirts and Overalls direct to wearer. Big profits. Work full or spare time. No experience required. Big variety dress shirts with splendid line Union-made work and flannel shirts, Overalls and Coveralls. Write today for free samples. The Nimrod Shirt Co., Dept. 8, 4712 N. Kedzie Ave., Chicago, Ill.

**AGENTS**, Men and Women: Sell Photo-Pillow-Tops, the old reliable money maker for live agents. \$1.50 for sample roll starts you in business for yourself. Sales waiting for you everywhere. Write today. Canvasograph Company, 6215 Wentworth Ave., Chicago.

**AGENTS**—Some new advertising. No novelties. Opportunity in town of 10,000 or more. W. Hartshorn, 1112 Lake, Ft. Worth, Tex.

**REPRESENTATIVES** wanted to take orders for Evergreens and Shrubs. Send for proposition. Ridgewood Nursery, Ridgewood, N. Y.

**AGENTS**—\$75.00 Weekly Selling Nustle Guaranteed Hosiery direct to wearer. Your pay daily in advance, we deliver and collect. All styles and colors. No experience necessary. Special extra monthly bonus. Sample outfit furnished. Write for particulars. Nustle Hosiery Mills, Dept. 175, Philadelphia, Penna.

**AGENTS**: Make \$5.00-\$25.00 daily—all or spare time—selling new sensational novelty wanted every home. Wonderful gift. Pay advanced. We deliver and collect. Art Craft Home Products Co., 357A West 63rd, Chicago.

**NEWEST** Invention! Improved Calculating Machine. ("2 machines in 1"). \$15.00. Without competition. Demands instant attention. Does work of expensive machine. Schultheis, 1065-J Bergen Street, Brooklyn, N. Y.

**DOES** Anyone Owe You Money? 6 Collection letters gets the dough; makes friends; 30c (coin). Terry Sales Agency, Box 700, Minneapolis, Minn.

**CAN** you sell to colored people? Write, Strane Co., Dept. 101, 2500 Second Ave., Birmingham, Ala.

**EARN** \$5-\$10 weekly, at home. Co-operative plan 12c. Palace Mfg. Co., Toledo, Ohio.

**MARVELOUS** Radio Gas Lighter—lights instantly, sells instantly—easily demonstrated, good for 10,000 lights, retails 25c, cost \$10.00 gross, \$26 profit. Send \$1.00 for sample dozen with self-selling plans. W. Masterliffe Co., 110 East 23rd, New York.

**NEEDLES**—Self threading; sell easy; 100% profit. Sample free. Other fast sellers. P. Miller, Box 3, Tremont Station, New York.



**SELLS** at sight. Prints the merchants Ad. on Wrapping paper, Sacks, Blotters, Boxes, etc. Nothing exactly like it. Good Commission collected with order. Automatic Ad-Stamping Company, Joplin, Mo.

**AMERICAN Woolen Mills Co.**, Dept. 3099, Chicago, are making a free suit for one agent in each community to introduce their fine tailored to order suits at \$18 and up. Write them today for their offer.

**CLEAN** your car for 5c. Dri-Klean-It removes mud, dirt, dust. No soap or water. Agents wanted. Write Amer. Accessories Co., Dryclean 278, Cincinnati, Ohio.

**ARE** you old at forty? See our advertisement on page 143 of this issue. The Electro Thermal Company, 2137 Main St., Steubenville, Ohio.

**PATENTS** Procured. Send sketch or model today for examination, prompt report and advice. No charge for preliminary advice. Write for free Booklets "How to Obtain a Patent" and "Invention and Industry" and blank form on which to disclose your idea. Highest references. Promptness assured. Clarence A. O'Brien, Registered Patent Lawyer, 586 Security Bank Building, Directly across the street from Patent Office, Washington, D. C. See pages 146 and 147.

**OILOMATIK**—What every Ford needs. Real necessity. Saves repair bills, cuts oil consumption 25% to 50%. Harvest for Agents, Salesmen, Distributors. For full details see our ad page 161. Oilomatik, 243 E. Ohio, Chicago.

**NEW** Invention Lighting Worm. Fast diesel seller. Master Works, 710 Wyandotte, Kansas City, Mo.

**WANTED:** Agents to sell manifold heater quick cold weather starting. Good seller. Write for exclusive territory and circular. The Higgins Mfg. Co., Bellvue, Ohio.

**AGENTS.** One in Every Town to Sell washing crystals, starch tablets, laundry tablets, carpet renewer. Quick sales, large profit. Write Clean-It, 1608 E. 66 St., Cleveland, Ohio.

**AGENTS** Selling Our Popular New Style Felt Rugs and Combes, coin money fast. Big demand everywhere. Get details quick. Newark Felt Rug Co., 27-C 16th Ave., Newark, N. J.

**BIG** sellers, big profits. Our popular line of liniments, hair tonics, coconut oil shampoo, bay rum, etc., sell like wild fire. Net you 100%. Write for details. Felborn Pharmaceutical Co., 17p Fulton St., Brooklyn, N. Y.

**CLARKE** made \$18 an hour selling pocket windshield cleaner, needed by every autoist, motorman, engineer; one rub keeps glass clear 24 hours. \$9,000 sold; amazing proposition free. Security Mfg. Co., Dept. 501, Toledo, Ohio.

**AGENTS** and Side Line Salesmen wanted to sell the Easy Fill Gasoline Tank Cap and Gauge for Fords. A big proposition for live men. Write today. Easy Fill Cap Co., 929 Lawrence Ave., Chicago.

**DISTRICT** Managers, Sales Agency, Independent Salesmen; complete line of hosiery, special number ladies' silk full-fashioned, 3 pairs for \$5; \$1 commission; also silk and wool; also famous Penna. silk knit neckties; liberal commissions; state full details as to experience and territory desired. Penna. Hosiery Mills, Dept. F, 24 S. 17th St., Philadelphia.

**I'VE** got it boys. A silver Plating Solution that's a marvel. Just Completed. Original—New—Different. Surprising results. Wonderful seller. Repeater. Great money-maker. Big profits. Hurry. Write B. N. Hallgren, 6017 South Racine, Chicago.

**START** You in Business—No Capital Required. Monogramming Automobiles, Luggage, Windows, Wagons. Six Initials Bring \$1.50—Costs You Only (6c). No license. No Experience. "Samples Free." Nullife (E) Monogram, Hartford, Conn.

**FOLD-UP-CHAIR** Converts any chair into highchair for baby. Our first call for agents on this new useful article for every home. Write for territory immediately. Sample \$1.00. Ganger Company, 3125 Essex Road, Cleveland.

**NEW** discovery enabling motorists to enamel their autos any color in 15 to 20 minutes. Applied with brush or cheese-cloth. Profit 150% to 400%. Write for sales offer. Pruden Corp., Wilmette, Ill.

**BIG** Profits. Rubber Specialties. Fifty fast sellers. Everybody needs and buys, \$50 weekly easily made. B. & G. Rubber Co., Dept. 628, Pittsburgh, Pa.

**BIG** Seller—Every autoist needs Handy Auto Gasoline Dipper. Sample Dozen \$1.50. A. H. Waage, 8 Beade St., New York City.

**HOW'S** this offer? We will send prepaid, no money down, 12 bottles Renaud's world's finest rare Perfume made in France. One of these odors made exclusively for Czarina of Russia. Others have sold as high as \$100 an ounce. Today you sell these 12 bottles assorted odors 50c each and remit to us after selling only \$2.50. Your profit \$3.50. Our \$100,000 coming National Advertising will help you. In writing for representation give 3 references. Glee Products Company, Importers, Leicester, Mass.

**SUIT** Free To Agents. Tailoring agents, raincoat men, and salesmen of other lines—get in touch with us at once. We have most powerful selling proposition in field. Our line offers finest quality suits made to order all at one amazing low price including big profits for agent. We supply finest swatch line outfit showing big cloth samples in handsome carrying case and give every active agent his own suit absolutely free. Lines are going fast. Write for yours at once. Address Dept. 539, Knickerbocker Tailoring Company, 131 S. Peoria St., Chicago.

**NEW** Invention. Cleans whole house from cellar to attic, inside and out. All complete only \$2.85. Over 100% profit. Write O. P. Morgan, Mgr., 226 Grimes St., Fairfield, Iowa.

**AGENTS:** \$11.80 daily in advance (send for sworn proof) Introducing New Insured Hosiery—47 styles—35 colors—guaranteed seven months—Fall line now ready—No capital or experience required—You simply take orders—We deliver and collect for you can deliver, suit yourself. Credit given—Pay You Daily—Monthly bonus besides—We furnish samples—spare time will do. Macorhee Textile Company, Room 3869, Cincinnati, Ohio.

**EVERYBODY** Buys new, instant stain and rust remover. For clothing, table linen, etc. Fine premium with every sale. Big. Quick Profits. Free Outfit. Write today. Christy, 51 Union, Newark, New York.

**\$6** To \$15 daily—year around position, monthly bonus besides. Grossly made \$499.50 in 30 days. Cregan \$443.83, Whiteside \$435.00, Robey \$332.09, Bickel \$329.91. No experience or capital required. Exclusive patented necessity. Millions of prospects, homes, stores, schools, factories, auto and truck owners. Spare time satisfactory; we deliver and collect, also carry accounts. Cash in on our advertising and approval by National Board and big users. Our original new plans produce results. Write quick for full details. The Fyr-Fyter Co., 339 Fyr-Fyter Bldg., Dayton, Ohio.

**SAMPLES** Free and a Sale in Every Home. Everybody uses Food Flavors. There are already thousands of satisfied purchasers of Pitkin's Guaranteed Tube Flavors who will have no other. We are the originators of the process that saves every purchaser \$2.70. The sales are quick—the profits big. Ask about the Free outfit. J. M. Pitkin & Co., 521 Com'l Bldg., Newark, N. Y.

**EARN** \$40 to \$45 extra every week taking orders for our high-class tailoring—made-to-measure suits from \$14.95 to \$39.50. Your own clothes at low wholesale prices. No experience necessary. Write for our Big Free Sample Outfit. Progress Tailoring Company, Dept. J-142, Chicago, Ill.

**WHY** Work for others? Start and operate your own business. Our system proprietary specialty business offers wonderful opportunities to make \$100 to \$500 weekly. Openings everywhere. We furnish everything and show you how. Booklet free. National Scientific Laboratories, 208 Monroe, Richmond, Va.

**MOST** Wonderful Seller, 90c profit every dollar. No stock to carry. License unnecessary. Sample free. Mission Factory PM, 519 No. Halsted, Chicago, Ill.

**\$50-\$200** A WEEK. Genuine Gold Letters for store windows. Easily applied. Free samples. Liberal offer to general agents. Metallic Letter Co., 428-D North Clark, Chicago.

**A BUSINESS** of Your Own. Make Sparkling Glass Name and Number Plates, Medallions, Checkerboards, Signs. Big illustrated Book Free. E. Palmer, 512, Wooster, O.

**YOU** Can Make Good Durable Paint and Varnish 40c per gallon. Write Dept. 2, Emmelmann Bros. Mfg. Co., Indianapolis, Ind.

**AGENTS**—Make a dollar an hour. Sell Mendets, a patent patch for instantly mending leaks in all utensils. Sample package free. Collette Mfg. Co., Dept. 404, Amsterdam, N. Y.

**AGENTS** Wanted—To sell and install Automatic water regulator for residence steam boilers. Yankee Burner Co., 4324 Armitage, Chicago.

**THESE** Advertisements of mine have appeared in Popular Mechanics for sixteen years. Hundreds of Successful Manufacturers today owe their success to my formulas and valuable information. Majority started with practically nothing. You can do the same—write today for my valuable literature relative to my Guaranteed Manufacturer's Formulas for making Non-Thermic Ice-Saving Cloths, Delicious Beverages for Home, Bottlers and Fountain sale. Pure Food Products, Non-Alcoholic Flavors, Launderite Washing Marvel, Zebest, greatest stain remover, Sta-Comb, Marcel Hair Curler, and latest Toilet specialties, Mexican Yucca Soap, Laundry Soaps, Flynox, Sensol, and all latest disinfectants, Amazon Tire Repair, Toy Rubber Balloons and all latest selling goods in all lines. Don't compare these with "junk" commonly offered. Analytical work carefully done. Highest references. Miller, Chemist, Tampa, Fla.

**MEN:** \$50 to \$100 a week guaranteed good hostlers selling world's greatest all wool \$31.50 suits and overcoats. We start you without a nickel and train you. Fall line greatest ever. Write for new sales plan. J. B. Simpson, Dept. 951, 843 Adams, Chicago.

**EVERY** Ford Owner in the World Wants This! The Hamer Visible Vaporizer guarantees increased mileage (3 to 8 miles per gallon), more power (20% and better), quicker pickup, no carbon, smooth running motor, less heat, longer life, more driving comfort. Sells \$4.50; your commission, \$3. Exclusive territory. Details and proofs, Visible Vaporizer, Dept. 19, Chamberlain, S. D.

**TAILORING** Agents—Sell Bradley's fine made-to-measure suits and overcoats direct from maker to wearer. Steady permanent income of \$50.00 a week and more. You make liberal commissions in advance. Your customers save middlemen's profits. Over 140 Virgin Wool, water-shrunk fabrics, all one price—\$32.50. Finest tailoring. Perfect fits. Union label. Satisfaction guaranteed or money refunded. Complete outfit furnished free to producers. Also actual cost form. Write today for details. Robert E. Bradley, Inc., "The Old Reliable," Dept. PMU-9, Indianapolis, Ind.

**AGENTS**—Make \$25.00-\$100.00 weekly selling Comet Sprayers and Autowashers to farmers and Autoists. All brass. Throws continuous stream. Established 30 years. Particulars free. Rusler Co., Johnstown, Ohio, Box C-46.

**MONEY!** Silvering Autolights, Radiators, Mirrors, tableware, stoves, Outfits, Methods Free. Sprinkle, Plater, Dept. 28, Marion, Ind.

**AGENTS** Coining Money. \$1.40 profit on every \$1.50 sale. Monogramming Automobiles. Free Samples. Worcester Monogram Co., Worcester, Mass.

**BIG** money in serving Waffles made on Waage Electric Waffle Iron. Start Waffle stand and be independent. Waage Electric Co., 8 Beade St., New York City.

**10,000,000** FORDS need "Teacher" fan belts. 50% profit selling dealers; 25% selling owners. Write quick. Teacher Belting Co., St. Louis.

**THE** National Fibre Broom Co., St. Louis, Mo., wants a representative in this County to sell the National Patent Fibre House Broom. Write today for selling plans and Free Sample Offer.

**EVERPLAY** eliminates needles for photographs. Preserves records. Abolishes scratching. \$15 daily easy. Carry day's supply in pocket. Free sample to workers. Everplay, Desk 7K, McClurg Bldg., Chicago.

**EARNINGS** unlimited. Every woman, girl likes jewelry, especially imported, such as selected, most modern, latest styles of necklaces, bracelets, etc. In attractive case. Halo Sales Co., 1018 E. Wabash, Chicago.

**START** in a permanent business of your own selling guaranteed Hosiery and Underwear direct from mills. No capital or experience needed; many representatives make \$3,000 to \$5,000 per year. Become our district manager—get orders working for you. Write for details to Malloch Knitting Mills, 549 Grant St., Grand Rapids, Mich.

**AGENTS**—Mosco Corn and Callous Remover will build you a steady repeat business. Send today for a pocket size trial outfit. The Moss Company, 209 Searle Bldg., Rochester, N. Y.

**AGENTS** Wanted: To sell wonderful new invention that beats the finest fountain pen or automatic pencil made. Every man, woman and child a prospect. Quick easy sales, 100% profits paid daily. Beautiful \$2.50 model to interested agents for \$1.25. Write for full information and special offer to agents. Address Mr. Ecker, Dept. D, 219 S. Dearborn St., Chicago, Ill.



**AGENTS**—Three neckties, boxed singly \$1.00. Retail \$2.00, cash with order. Maxwell, 401 Searle Bldg., Rochester, N. Y.

**AGENTS**—Big money selling tricks. Let me start you. Particulars and a mind-reading card trick 10c silver. Ed. Fisher, Box 717-P, Seattle, Wash.

**WANTED:** Agents to sell high grade, practical auto accessory direct to car owners. Has been on the market for four years and is going good. Live wires can make some real profits. Write for information. Dept. A, The J. R. Watkins Company, Winona, Minn.

**DISTRICT Sales Agent.** Let druggists display; it sells itself—collected in five days and got real orders, increasing steadily. Sells so fast many retailers place \$500 orders. No competition. As necessary as tooth paste. 100% profit to both druggist and agent. Add salesman and \$10,000 a year income quickly possible. Responsibility essential. Waddell & Co., 912 Oakdale Ave., Chicago.

**YOU** can sell every merchant in town our changeable signs. Large profits; easy sales. Write for territory now. Changeable Sign Co., 581 East 192nd, Cleveland.

**\$100 WEEKLY** easy selling Oriental Perfumes and Cosmetics. Highest profit. Sample Case and illustrated catalogue absolutely free. Romola Parfumerie Inc., Woodlawn, Chicago.

**AGENTS** and District Managers, 35 Hosiery and Neckwear Styles, as high as 120%. 10% Bonus. Write for Free Samples. The S. Q. S. Company, Dept. 1381, Lexington, Ky.

**GOLD-LEAF Sign Letters;** make and sell; 1,000% profits. Particulars, Johnson Co., Quincy, Ill.

**ADD \$75-\$150 weekly** to your Bank account, Selling Reliable Brushes. F-1814 No. Ashland, Chicago.

**MAN** wanted in each town to wear and introduce C. T. A. suits in spare time. We furnish samples and free suit to hustlers. Write for our great offer. Chicago Tailors Assoc., Dept. 644, Sta. C, Chicago.

**\$8 TO \$16 daily easy**—New Patented Cutlery and Carving Set—You take orders—We deliver and collect—Your Pay Daily—No experience necessary. Not for sale in stores—Full or spare time. Macroeche Company, Stand 1109, Cincinnati, Ohio.

**FREE Sample.** "Rain Shield Wiper." Retail \$1.00—Costs (25c). Sold, Clear and Rainy Days. No Cloth—No Paste—No Attachment. (1) Hub keeps Windshield Clear (48) Hours. Experience unnecessary. Nulife Corporation, Hartford, Conn.

**WHY** Work for others? Start and operate your own business. Our system proprietary specialty business offers wonderful opportunities to make \$100 to \$500 weekly. Openings everywhere. We furnish everything and show you how. Booklet free. National Scientific Laboratories, 208 Monroe, Richmond, Va.

**AUTO-OWNER.** Agents. Make Polish. Removes. Prevents Checking. Guaranteed. 200% Profit. Price \$2.00. Polaxa Laboratories, Box 288, Ypsilanti, Michigan.

**EASY** Money applying monograms on automobiles, gold initials simply transferred from paper, no experience needed. Takes 5 minutes, make \$1.50, cost 5c. Sample Free. "Bakeo," 323 Harrison Av., Boston, Mass.

**OVERCOATS,** 814 Lined \$18.50 Wholesale, Made to Measure—Union Tailors. Collect and keep your profits. We ship Customer COD. Greatest Money Making opportunity. Large Swatch Line ready—Leeds Tailors—Chicago.

**SUCCEED** With Your Own Products—Formulas, Processes, Trade-Secrets. Different, dependable, profitable. Catalog free. B. Thaxly Co., Washington, D. C.

**TAILORING Agents!** \$90 week and steady job taking orders for Longworth All-wool suits and overcoats \$23.75, boy's suits \$11.75. Special offer \$45 cash and free Suit for 3 days' spare-time work. Postal brings big outfit free—no waiting, no deposit. John G. Longworth & Sons, Dept. 50TT, Address: 1301-11 West Congress St., Chicago.

**SHYNT** silverplated metals quick and lasting. Sample bottle 50c. Agents Wanted. Leonard, 2875 California St., San Francisco, Calif.

**AGENTS**—Best seller; Jem Rubber Repair for tires and tubes; supercedes vulcanization at a saving of over 80% per cent; put it on cold, it vulcanizes itself in two minutes, and is guaranteed to last the life of the tire or tube; sells to every auto owner and accessory dealer. For particulars how to make big money and free sample, address Amazon Rubber Co., Philadelphia, Pa., Dept. 565.

**CASH** in on this quick seller. Wings cleared \$1,000 with Never Fail Razor Sharpener in six weeks; Parady, \$40.50 first day. Applewhite, also inexperienced, six orders in thirty minutes. No end to ready buyers. Exclusive territory for quick workers. Be first. Address Never Fail Company, 166 Allen Bldg., Toledo, Ohio.

**BIG** profits selling our practical patented specialties. Write for particulars. Welch Brothers Co., North Chicago, Ill.

**PORTRAIT** and Medallion Agents—Our Goods Will Make You Big Profits; delivery guaranteed; prompt shipments; low prices; send for latest catalog. Adam J. Kroll & Co., 59 East 18th St., Chicago.

**AGENTS**—Sell Combination Salt and Pepper Shakers, Sanitary, Moistureproof. Orrenso Co., 542 W. Jackson, Chicago.

**BIG** Money selling new Household cleaner. Washes and dries windows. Sweeps, scrubs, mops. Complete outfit less than brooms. Over 100% profit. Harper Brush Works, 132 2nd St., Fairfield, Iowa.

**A RARE** Opportunity to make large profits. Can make \$15-\$30 daily. Particulars free. Address Empire Novelty Co., Amsterdam, N. Y.

**MEN'S** Shirts. Easy to sell. Big demand everywhere. Make \$15.00 daily. Undersell stores. Complete line. Exclusive patterns. Free Samples. Chicago Shirt Manufacturers, 220 W. VanBuren, Factory 211, Chicago.

**BIG** Profits with Exclusive Territories—\$50 to \$100 weekly easy. More has often been made in one day's work. A hot or cold running water bath equipment for any home at only \$7.50. No plumbing or water works required. Investigate. Send no money. Write today. Sanitary Supply Co., 721 Allen Building, Toledo, Ohio.

**AGENTS** Wanted—for Red Dog Tube Patch. Repairs largest blow-outs or punctures without heat or cement. Startling demonstration sells it. 300% profit. If you can't stand "big money" don't answer. Exclusive territory. Free Samples. Auto Products Co., Marion, Ind.

**AGENTS**—Control your territory on fast-selling specialties. Earn \$40.00 to \$80.00 Weekly. Huber Rubber Mfg. Co., Dept. B, 708 Penn Ave., Pittsburgh, Pa.

**SALESMEN** — Sell "Amenz" Radiator Shirts, guaranteed to wear a year. Very liberal commissions. Get our proposition first. Menzin Shirt Co., 481M East Tremont Avenue, New York.

**AGENTS**—Good salary and commission selling "Ratskyl," new rat and mouse exterminator; ready for use; no bait required; non-poisonous; rodents die outside premises; no odor. Empire Specialties Co., 1549 N. Wells, Dept. 301, Chicago, Ill.

**AGENTS**—Big Money and Fast Sales. Wide-awake men and women are making \$50 weekly, and up, representing us. Our Polish—for windows, mirrors, aluminum, brass, nickel, silverware, etc.—sells fast, at 50c, to housewives, auto owners and others, and repeats. A two-minute demonstration gets the money. Exclusive territory and free sales helps to hustlers. Write at once for full particulars and free sample. The Mallard Chemical Company, Dept. E., St. Louis, Mo.

**EASY,** pleasant work for Mechanics. Shop Men, Clerks, during spare hours; will add many dollars to their salaries. Also want persons who can give full time. Big wages assured. Novelty Cutlery Co., 67 Bar St., Canton, Ohio.

**POLMET**—The Wonderful Polishing Cloth that cleans all metals without liquid, paste or powder. Approved by "Good Housekeeping" and "Modern Priscilla"—sells fast at 25c. Sample free. Gale & Co., Inc., 15 Edinboro St., Boston.

**SELL** Komik Display Cards, Price tickets, card holders, display stands, etc. Big Demand. Komik Advertising Co., Cambridge, Ohio.

**AGENTS**—Men's Moccasin Work Shoes. Your commission \$1.00 pair. We carry stock. Direct to wearer. Exclusive territory open in various counties. Big repeat business. Write now. Charles Kellert Co., 116 Bedford St., (Dept. 501), Boston, Mass.

**ASTOUNDING** invention. Fords use kerosene, start instantly. Mileage doubled. Big profit. Super, 1306 Fondulac, Milwaukee, Wis.

**DIAMOND** Sensation at Last! Amazing discovery of Rajah Gem startles Jewelry World. \$100 weekly introducing these magnificent gems. Sample case free. Write quick! Rajah Company, Dept. F7, Salisbury, N. C.

**AGENTS:** Big returns, fast office sellers; particulars and samples free. One Dip Pen Co., 2 Daily Record, Baltimore, Md.

**AUTO** owner tire agent wanted each locally to use and take orders for handmade Mellinger fabric and cord tires; guarantee bond 8,000 and 12,000 miles (no seconds); shipped prepaid on approval; get your tires free; no capital or experience required; make \$190 to \$300 weekly. Write for wholesale prices and sample kit. Address, Mellinger Tire Co., Dept. 206, Kansas City, Mo.

**AGENTS**—Clever Invention! Inkspoon makes every pen a fountain pen. Fast office seller; big profit, demand increasing everywhere. Exclusive territory offered. Sample free. H. Marul Company, Tribune Bldg., New York, N. Y.

**AT** Last—World's Greatest Adding Machine. Almost human. Retail \$15; work equals \$300 machine. \$500 monthly easily made, demonstrating to stores, offices, garages, factories. Simple, easy; adds, subtracts, multiplies, divides automatically. Speedy, accurate, durable, handsome. Five year guarantee. Tremendous demand, amazing profits. Liberal trial offer. Protected territory. Write quick. Lightning Calculator Corp., Dept. F, Grand Rapids, Mich.

**GET** Our Free Sample Case—Toilet articles, perfumes and specialties. Wonderfully profitable. La Derma Co., Dept. A, St. Louis, Mo.

**AGENTS**—Stamping names on Pocket Key Protectors; sample Check with your name and address, 25c. Stamping Outfits, Emblem Checks, Check Fobs, Name Plates, Hart Mfg. Co., Desk 2, 303 Degraw St., Brooklyn, N. Y.

**AGENTS**—Steady income. Exceptionally useful household article. Handrap Co., Newark, N. J.

**125% CLEAR** profit selling neckties; 2 samples \$1.00; satisfactory or money refunded. Raymond Mfg. Co., 132nd St. and Madison Avenue, New York.

**AGENTS.** Household necessity. Sells rapidly. Large Profit. Square deal. Premier Mfg. Co., Dept. 813, Detroit, Mich.

**MAKE** \$17 daily—Finest Extracts, Food Products, Toilet Preparations, Household Necessities. Credit: Sample Case Free. Write for amazing offer. Perkins Products, B-6, Hastings, Neb.

**AGENTS:** Big Money Monogramming by Transfer Method. Catalog Showing Over 50 Styles and Particulars Free. Motorists' Accessories Co., Mansfield, Ohio.

**"HOW** to Sell Patents" free. Patent News-O, Washington, D. C.

**TAILORING** Agents—50 good men wanted, who can earn \$50 weekly and up. Our line contains 220 big-value all-wool fabrics to retail at \$25 to \$47.50 for suits and overcoats. Your profit \$5 to \$8.50 in advance. Big 6x9 swatch outfit free. Ref. req. R. B. Ferrin, Mgr., P. O. Box 1097, Chicago.

**AGENTS:** Big Profits, Best and cheapest window letters made. Easily applied. Dime brings five samples. Particulars free. Stairbrite Co., 1115 Second Ave., New York.

**WANT** Distributing Agents everywhere for Hanslick, the new original powdered hand soap. Removes grease, grime, ink, paint, and most anything from the hands without injury to the skin. Every mechanic and auto-owner, everybody who gets his hands dirty will be a customer. A great opportunity for a hustler to get in business for himself. Full information free. Send 10 cents, coin or stamps, for liberal sample can. Solar Products Company, 122 West Lake Street, Chicago.

**YOU** can make \$75.00 to \$100.00 a week selling our big line of 150 articles, used constantly in every home. Write us, we will send you our handsome \$15.00 Sample Case Outfit on trust. Federal Pure Food Co., Dept. PP, Chicago.

**BEST** proposition in the Specialty field. Perry Lykoll Paintings, Photo Medallions, and Novelties have no equal. Every interview means a sale. 600% profit. Write for details. Perry Photo Novelty Corporation, Sect. PMT, 360 Bowery, New York.

**MAKE** \$25 to \$50 Week, representing Clow's Famous Philadelphia Hosiery, direct from mill—for men, women, children. Every pair guaranteed. Prices that win. Free book "How to Start" tells the story. George Clow Company, Desk 31, Philadelphia, Pa.

**MAKE** Big Money Easy in your spare time. Double profits. New Self-Wrapping Mop. Eastway Company, 405 St. Paul, Baltimore, Md.

**SELF - THREADING** Needles, Needle Books, Machine needles, find sales in every home. Fine side lines, easily carried, big profits, sample and catalogues free. Prentice Lee, 145 East 23rd St., New York.



**\$12 DAILY Easy**—Introducing Latest Style Sweaters—Silk, wool and artificial silk—23 colors—10 snappy styles for girls—women—men—Prospects in every house—Going like wildfire—You simply show samples we furnish—take orders—We deliver and collect—Your Pay Daily—Get your own sweater free. Macchoe Company, Form 1109, Cincinnati, Ohio.

YOU can be your own boss with our Key-Check outfit. Good for \$5 a day stamping names on pocket key checks, fobs, etc. Sample check with your name and address, 20 cents. Pease Die Works, Dept. M, Winchester, N. H.

**INSTANT Weld.** Repairs largest punctures without cement or heat. Lenn's profit one day, \$56. Write quick. Free sample; territory going fast. Tourists' Pride Mfg. Co., Desk T, Minneapolis, Minn.

**EARN \$10 daily** silvering mirrors, plating and refinishing metalware, autos, chandeliers, bedsteads, headlights. Outfits furnished. E. Dele Laboratories, 1133 Broadway, New York.

**AGENTS sell Wolverine Laundry Soap.** Wonderful repeater and good profit maker. Free Auto to hustlers. Wolverine Soap Co., Dept. B37, Grand Rapids, Mich.

**EVERYBODY uses extracts.** Sell Duo Double Strength Extracts. Complete line household necessities. Big repeaters. Write today. Duo Co., Dept. Et, Attica, N. Y.

**PATENTED Cigar Lighters with Glass Advertising Front.** Also Electric Cigar Moisteners. Wonderful Sellers. No Competition. Big Steady Profits. Proof, Cuts, Sales Plan Free. Drake Mfg. Co., Dept. M, Milwaukee, Wis.

**\$8.00 TO \$20.00 per day.** A wonderful seller. Any man, woman, boy or girl can make big wages Selling Crimp Grip Clothes Line Fasteners. It is a perfect rope holder and can be used for many purposes. Crimp Grips are a simple, time-saving device. They last a life time and will not rust; it holds the line tight, and saves time on wash days. Every buyer is a booster. Send 50c for Mounted Sample and one pair of Crimp Grip Clothes Line Fasteners. Write for particulars. Crimp Grip Company, Belvidere, Ill.

**AGENTS:** You can coin money selling our new Fabric Table Covers, require no laundering. Size 56 x 56, prepaid \$1.50. 13-piece Luncheon set included Free. Write for sample and special offer. P. Condon, 77 Bedford St., Boston, Mass.

**AGENTS clear \$50.00 weekly** selling Opaline Portraits. Expense money advanced. Credit given. Big line now ready. Samples and Catalog free. Consolidated Portrait Co., Desk 2, Chicago.

**MAIL-ORDER houses and distributors;** we pack big profit beauty creams, face powders, perfumes, toilet preparations with your label. Chemist, 944A No. Clark, Chicago.

**WE Start You Without a Dollar.** Soaps, Extracts, Perfumes, Toilet Goods. Experience unnecessary. Carnation Co., Dept. 201, St. Louis.

**IF you want good live agents—fellows who can get the business—ask me how others are doing it. I'll gladly render the necessary assistance.** Geo. F. Baker, Mgr. Classified Advertising, Popular Mechanics Magazine, Chicago.

**BUILD permanent business.** Men's, Women's, Children's guaranteed shoes direct to wearer. A. P. Condon, Sales Manager Allen Shoe Co., 110 Sumner, Boston.

**PORTRAIT Agents!** Get busy on the biggest profit proposition you've ever seen! The new sensation in the portrait field—Artistic Portrait Paintings—exactly like oil paintings. Easy, big seller, great for "repeats." A "clean-up" in combination with famous P. & G. Medicines. Write now. Puddin' & Goldstein, Dept. "A," 259 Bowery, New York.

**MAKE money silvering mirrors,** all kinds plating, knives, spoons, auto headlights. Outfits furnished. Free booklet. International Laboratories, Dept. 25, 311 Fifth Ave., New York.

**AGENTS—Send for free sample "Fretnot"—washday wonder.** You can clear at least \$20 to \$100 weekly, according to spare or whole time. You don't have to talk; if she doesn't buy at sight, leave sample; she will be looking for you long before you are able to make the rounds again. Samples furnished free. Premiums for your customers. Exclusive territory. Credit given. Empire Specialties Co., 1549 N. Wells, Dept. 101, Chicago.

**BIG Money and Fast Sales—Everybody—Everywhere—Everyday finds hundreds of uses for Darn E-Z Universal Fabric Cement—Good exclusive territory still open.** Darn E-Z Laboratories, Dayton, Ohio, Dept. P. S.

**AGENTS—50 to 100% profit** selling our complete line of rugs, axminsters, velvets, Smyrna, tapestry and felt rugs. Etc. Sells on sight. Constant demand. Quick sales. Excellent opportunity to build big business. Eastern Mills, Everett, Mass.

**TO secure agents or salesmen or for selling farms and reaching investors,** use classified (want) ads in largest newspapers and magazines. Price list No. 30 sent free. Ankrum Advertising Agency, 20 W. Jackson Blvd., Chicago, Ill. The largest classified advertising agency in the U. S.

**AGENTS:** A sale in every home for our beautiful dress goods, silks and general yard goods. Quick sales! Big profits. Large book of nearly 1,000 handsome fabric samples furnished to agents. Write today. National Importing & Mfg. Co., Dept. 6X, 573 Broadway, New York, N. Y.

**NEW 1924 Specialty, 200% Profit** when sold at 50c. Real \$1.00 value. Sells in every home. No Competition. \$1.00 to \$3.00 an hour, full or spare time. Thirty other big sellers. Free sample case offer. Send post card today for particulars. General Products Company, Dept. 7, Newark, N. J.

**AGENTS—Men and Women.** Establish permanent business. 84c money order brings can of Gravy Crystals, a wonderful Gravy and Stew Improver. Try it and convince yourself. Every Store and Home a prospect. New product with big future. Exclusive territory to live representatives. Smith & Gray, Manufacturers, Guinda, California.

**WONDERFUL! Startling! Amazing!** Our Ex-Cel Luminous Crucifix and Magical (Luminous) Necklace shine brilliantly in the dark. Sell on first demonstration. Big profits to you. Write for further particulars, or better still, send for sample and territory protection immediately. Crucifix \$1.50, Necklace \$1.00, postpaid. W. G. Hannan Co., Dept. B, 57 E. 18th St., Chicago.

**LIVE Agents make \$10 day** selling Eureka Strainer and Splash Preventer for every water faucet. Takes on sight. Widely advertised and known. Get details today. A. B. Seed Filter Company, 73 Franklin, New York.

**\$10 DAILY easy.** Experience unnecessary. Complete line fancy aprons and house dresses. Something new. Nothing like them. American Braiding Co., Dept. P, 329 Monroe, Chicago.

**YOU Can Easily Make \$60 Weekly** selling new, popular Perfex Fibre Broom. Outlasts four ordinary brooms. 100% profit. Get agent's Special Introductory Offer. Brooklyn Perfex Corp., 145-C New Jersey Ave., Brooklyn, N. Y.

**BIG Money and Fast Sales.** Every owner buys Gold Initials for his auto. You charge \$1.50; make \$1.35. Ten orders a day easy. Write for particulars and free samples. American Monogram Co., Dept. 40, East Orange, N. J.

**MAN in each town to plate auto parts, reflectors, bathroom fixtures, refinish beds, mirrors, chandeliers;** by new method. No capital or experience required. Simple plan of manufacturing at home starts you in big money-making business. Outfit furnished. Free particulars and proofs. Gun Metal Co., Ave. H, Deatur, Ill.

**EXCLUSIVE agents \$225 weekly.** Genuine gold letters for store windows. Free samples; selling instructions. Chicago Window Sign System, 6226-A Kimbark Avenue, Chicago.

**EARN big money fast** applying gold initials to autos. Every owner buys—\$1.35 profit on \$1.50 sale—particulars and samples free. Write quick. Lithogram Co., Dept. 17, East Orange, N. J.

**WHY Work for others? Start and operate your own business.** Our system proprietary specialty business offers wonderful opportunities to make \$100 to \$500 weekly. Openings everywhere. We furnish everything and show you how. Booklet free. National Scientific Laboratories, 208 Monroe, Richmond, Va.

**BIG money and fast sales—every owner buys gold initials for his auto.** You charge \$1.50, make \$1.44. 10 orders daily easy. Samples and information free. World Monogram Co., Dept. 73, Newark, N. J.

**AGENTS—Big Profits Genuine Gold Leaf window letters and scripts;** anyone can put up. Consolidated Sign Letter Co., 632 S. Dearborn, Chicago.

**SELL the Livest, Quickest Selling Specialties Ever Known—Famous "Hahway" self-lighting pocket Cigar Lighters and Gas Lighters.** Low Prices. Easily Demonstrated. Sell to Dealers. Employ Sub Agents. Exclusive Territory. Make over 100% Profit. P. Bernhardt, 148 Chambers Street, New York.

**NEW JERSEY manufacturer wants salesmen and agents, and distributors for Trim Spark Plug Combination Tool.** For particulars—E. U. Engineering Co., Orange, N. J.

#### HIGH GRADE SALESMEN WANTED

**GET into the tailoring game—**one of the most profitable of all lines in the selling field. Experience isn't necessary, and spare time will do. We teach you how to sell our line and supply you with everything necessary to go out and make from \$10 to \$20 a day from the very first day. Our selling outfit is the finest ever gotten together and shows almost 150 large samples of finest quality Virgin Wool Suitings. Many of them our own exclusive patterns. Also a big showing of high-class heavyweight overcoatings. You do no delivering with our line. You just write your orders. We do the rest. Your profits run big and you get them cash with order. If you want to get into this most profitable business, write us quick. Address Goodwear Chicago, Inc., Dept. 203, Chicago.

**MORE Dollars for You.** Wonderful side line or for your whole time. Wherever you go, you can make splendid profits selling the marvelous Security Check Protecting Fountain Pen. Writes and positively protects checks quickly and easily. Even without this check protecting feature, it would be a fast seller, because it writes so smoothly, the ink flowing easily and evenly and it is so durably made. But when added to these merits, you can so quickly demonstrate its check protecting feature, the sale is clinched right then and there even though the prospect may be using some other make of pen. He will surely discard it in favor of the Security. The Security makes friends for you. Every business man is a potential and logical prospect and every pen sold will help to sell others for you and thus rapidly increase your income. The amount you can make will depend strictly on how many demonstrations you can make. \$5,000.00 yearly and up is being made easily by Security salesmen. A five-year written guarantee with each pen. Fully protected by basic patents. Write for our interesting proposition today. Security Pen Corporation, Dept. L-9, 90 W. Jackson Blvd., Chicago.

**THE Best Evidence that our men are the best paid salesmen in the whole world is the records they have made.** Reads like Romance but is true as the gospel. If you want to get out of the field of competition and into an advertising line covering over 50 different classes of real prospects—business men—not door-bell pulling—here is your opportunity to make your last and a permanent change. Astounding Earnings are usual, not the extraordinary, with our men. It's a one-call seller and nets you over \$50 per sale—and no investment. Good men can pick it up in two weeks and are on Easy Street in a month or less. Our whole story is worth while for the man who has never had his chance to make enough money. Write for it today. Alexander Film Co., 3389 S. Broadway, Denver, Colo.

**WANTED—Tailoring Salesmen.** Make \$60.00 to \$125.00 per week—Set your own profit on each sale. We show largest assortment, guaranteed all wool suitings and overcoatings, retailing for \$25.00 to \$45.00. Our made-to-order clothes are highest quality and lowest in price. Absolute satisfaction guaranteed or no sale. This is your opportunity—you can make big money—a hustler can make over \$50.00 a day. Write for big sample equipment to be shipped prepaid and please give all information about yourself. Address G. M. Harris, Sales Manager, Box 483, Chicago, Ill.

**\$6 TO \$15 daily—year around position,** monthly bonus besides. Groby made \$499.50 in 30 days. Cregan \$443.93, Whiteside \$425.00, Robey \$352.00, Bickel \$320.91. No experience or capital required. Exclusive patented necessity. Millions of prospects, homes, stores, schools, factories, auto and truck owners. Spare time satisfactory; we deliver and collect, also carry accounts. Cash in on our advertising and approval by National Board and big users. Our original new plans produce results. Write quick for full details. The Fyr-Fyter Co., 341 Fyr-Fyter Bldg., Dayton, Ohio.

**SELL men's high grade shoes direct to wearer.** The most permanent, profitable, and satisfactory proposition in the direct selling field. Every working man a prospect. Not sold house to house, 85% of orders repeated. We have one hundred men making from \$75.00 to \$150.00 per week. If you are ambitious, want to make money, and are willing to work you can do the same. A postal written this minute will bring you full details. Caroon Shoe Co., 22-24 Line's St., Boston, Mass.



**GREAT Free Suit Offer**—The Knickerbocker Tailoring Company of Chicago is making a wonderful offer to salesmen this season. They are supplying an elegant and elaborate swatch line outfit showing a tremendous assortment of finest quality fabrics in large size samples and besides are giving every active agent a suit himself absolutely free. They have already given away more than 1,000 of these suits. We advise every tailoring agent and other salesmen to write to them at once and address Dept. 340, Knickerbocker Tailoring Company, 131 So. Peoria Street, Chicago.

**SALESMEN** with real sales ability to sell dealers and garages a leading advertised line of aluminum Accessories, Accelerator Pedals, Signal Lamps, Illuminated Kick Plates, Step Plates, Roof and Cowl Ventilators, etc., for all cars. Attractive dealer discounts. New selling plan reduces unfruitful calls to the minimum. Year 'round demand. Liberal commission. Earnings warrant the attention of big caliber men. Write for the plan today. National Aluminum Co., Box No. 5, Racine, Wis.

**WANTED**—Tailoring Salesmen, make \$60 to \$125 per week. Biggest merchants in many towns have started with our line. We are the largest made-to-measure tailoring house in the country, furnishing elaborate sample equipments, including 500 all-wool fabrics. You make your own profits from \$8.90 to \$15.00 on each order. Guaranteed absolute satisfaction, perfect fit, best workmanship, or no sale. Write for line and all accessories to be sent free. Tell us all about yourself. Address N. O. Perry, Sales Manager, Box 483, Chicago, Ill.

**MAKE \$100 Weekly in Spare Time.** Sell what the public wants—long distance radio receiving sets. Two sales weekly pays \$100 profit. No big investment, no canvassing. Sharpe of Colorado made \$955 in one month. Representatives wanted at once. This plan is sweeping the country—write today before your county is gone. Ozarka, 802 Washington Blvd., Chicago.

**EVERYONE Buys Every Day** some part of our line. You can take orders for complete line of groceries, paints, roofing, motor oils, tires and radio sets, from institutions, boarding houses and private families. We deliver and collect. Our goods are nationally known and guaranteed quality; just show samples and secure large orders. No capital or selling experience necessary. Heavy orders make a steady profitable business. Address Hitchcock-Hill Company, Dept. 226, Chicago. Reference: any bank or express company.

**SEND 25c** for quart best ink made. Indelible on paper. Washes from clothing. Acidproof Ink Co., 3240 North 13th, Philadelphia.

**DISTRIBUTORS, Envelope Sealer.** Seals 3,500 envelopes hour. Amazing invention!! No competition. Retail \$4.00 only. \$20,000 yearly. Red-E Co., Dept. AE, 190 Buxton, Boston, Mass.

**WORLD'S Fastest Selling Auto Accessory!** County distributors wanted; write today. G. L. W. Spring Oiler Co., San Diego, Calif.

**OILOMATIK**—What every Ford needs. Real necessity. Saves repair bills, cuts oil consumption 25% to 50%. Har-est for Agents, Salesmen, Distributors. For full details see our ad page 161. Oilomatik, 345 E. Ohio, Chicago.

**SALESMEN:** Earn \$50.00 weekly selling custom-made shirts at ready-made shirt prices. 100 latest patterns; price \$2.95 up. Shirts Individually cut. Unconditional guarantee. Custom Bilt Shirt Company, 538 Broadway, New York.

**SELL** advertising pencils. Big profits. Peerless Novelty Works, 740 Hodapp, Dayton, Ohio.

**SALESMEN or Salesladies**—Sell Ladies' Sanitary Necessities, belts, aprons, step-ins, baby pants, syringes, etc. Moneymaking, repeat-order line. Harr Mfg. Co., Nora Springs, Iowa.

**ARE You Old at Forty?** See our advertisement on page 143 of this issue. The Electro Thermal Company, 2137 Main Street, Steubenville, Ohio.

**SALESMEN**—Here's a legitimate profitable business opening as distributor for household article that is proved success. Thousands in use. Nationally advertised. No investment proposition, no "back door" job, but permanent business with steady profits. Write for proposition giving details of your past business experience. CFSCO, 15 N. 10th St., Richmond, Ind.

**STATE Distributor.** Wonderful newly invented Pricing System retails \$4.99. Tremendous demand!! Big repeat business, \$20,000.00 yearly. Miller Mfg. Co., Dept. AS, Colonial Bldg., Boston, Mass.

**SALESMEN**—We pay larger commissions than any other Brush House in the country to men selling our line of sanitary twisted-in wire Brushes. Sanitary Wire Grip Brush Co., 15 Mercer St., New York.

**\$60-\$200 A WEEK.** Genuine Gold Letters for store windows. Easily applied. Free samples. Liberal offer to general agents. Metallic Letter Co., 438-B North Clark, Chicago.

**\$75.00 WEEK** selling made-to-measure clothes at \$29.50, \$50.00 values; every man buys. Satisfaction Guaranteed or Money Back. Big commissions paid in advance. \$25.00 Selling Outfit Free. Broadway Tailoring Company, Dept. M, Cincinnati, Ohio.

**SALESMEN**—Sell Four-Square Work and Business suits \$12.50; guaranteed two years, four different patterns. Profits in advance; \$3.00 to \$5.50 each sale. Complete line. Coat, vest, pants, riding pants, overcoat, cap. District territories open. Stone-Field Corporation, X 2536 Wabash, Chicago.

**SALESMEN'S** greatest moneymaking opportunity. \$25.00 daily taking orders for Walton-Duplex Shirts. New creation gives double wear, factory to wearer. Pay advanced. We deliver. Walton-Duplex Co., 808 Brooks Bldg., Chicago.

**BRUSH Salesmen, Dist. Mgrs.** \$30-\$75 weekly. High quality line. Get our 50-50 proposition. We train the inexperienced. Neway Brush Co., Hartford, Conn.

**FOUR \$7.50 sales** to merchants net you \$29.00 daily. Savers Systems, 2803 Sheffield Ave., Chicago, Ill.

**DOES** your trade use salesboards? The largest and most complete salesboard catalogue now off the press. Big commissions. Lincoln Sales Co., Dept. F, 212 N. Sheldon St., Chicago.

**AGENTS**—Best seller; Jem Rubber Repair for tires and tubes; superseded vulcanization at a saving of over 800 per cent; put it on cold, it vulcanizes itself in two minutes, and is guaranteed to last the life of the tire or tube; sells to every auto owner and accessory dealer. For particulars how to make big money and free sample, address Amazon Rubber Co., Philadelphia, Pa., Dept. 510.

**TAILORING Salesmen**—profits in advance, bigger commissions and bonus. America's fastest selling line, union made to measure All Wool suits, overcoats \$32.50. W. D. Smith & Co., Established 1895, Chicago.

**\$19.50 DAILY** from three \$10.00 sales. General Protection service universally demanded. Federal Detective Association, New Orleans, La.

**SALESMEN:** Make big money selling our attractive radio agency-advertising proposition. Sells as well in summer as in winter. All dealers. No knowledge radio needed to sell. E. Main Co., Cedar Rapids, Iowa.

**SALESMEN**—Become Independent. Own your business; experience unnecessary; selling our \$7,500 Accidental Death, \$50 Accident, \$25 Sick Weekly Benefits; \$12.50 yearly; other amounts proportionate. Guaranteed steady income from renewals. \$250,000 deposited Insurance Department. Registration Dept. A, Newark, N. J.

**TRAVELING Salesmen** calling on retail stores wanted by large manufacturer to sell unique line of business-boosting articles. Year round, fast selling, main or side line. If not earning \$150 weekly, address Elsasor Works, 222 Charles St., Boonville, N. Y.

**SALESMEN** sell sales and order books, auto, reg. rolls and bill ladings. Large demand. Liberal commission. Wirth Sales Book Co., Dept. PM, Chicago.

**SALESMEN**—Sideline pays five to ten dollars a day taking orders for Specialty printed gummed advertising and Match Box Stickers. Write for proposition, samples, etc., today. Beardsley's Printery, Rock Island, Ill.

**WHY** Work for others? Start and operate your own business. Our system proprietary specialty business offers wonderful opportunities to make \$100 to \$500 weekly. Openings everywhere. We furnish everything and show you how. Booklet free. National Scientific Laboratories, 298 Monroe, Richmond, Va.

**\$1.00 PROFIT** on Every \$3.00 sale. "Free Sample"—New Specialty. (Money Getter.) Every Storekeeper, Doctor buys quickly. Experience unnecessary. Territories open. Box 595, Hartford, Conn.

**SALESMEN** Can make \$5.00 a day selling our Calendars, Pencils, Signs, Advertising Novelties, Yardsticks, Whistles, etc. Liberal terms. Sells entire year. Fine side time. Local and traveling agents. Model Calendar Co., Dept. 226, South Bend, Ind.

**CALIFORNIA** Rosebuds selling like hot cakes. Agents coinng money. Absolutely new. Big profits. Catalog free. Mission Factory 8P, 519 No. Halsted, Chicago, Ill.

**A WONDERFUL Seller!** Any man, woman, boy or girl can make big wages. Some agents make from \$8.00 to \$20.00 per day. Crimp Grip Clothes Line Fasteners are a simple, time-saving device for holding a rope—also used for many other purposes. It pays for itself quickly in time saved on wash days. No knots—it fastens and releases quickly. Every home a prospect. Every housewife who uses Crimp Grips—and there are thousands of them—is a booster. There is but one Crimp Grip. Write for particulars, or send 50c for one pair and a mounted sample, with full particulars to agents. Crimp Grip Company, Belvidere, Ill.

#### HELP WANTED

**BOOKKEEPERS** wanted to prepare as Income Tax Auditors under Civil Service appointment. Lowest starting salary \$50 weekly, up to \$1,000 yearly. Get ready for next examination. A few weeks of our special coaching prepares you. Free information. Write Dept. H-17, Federal Auditors Institute, Washington, D. C.

**MEN**—Boys, 18 Up. Travel—See your country. Become U. S. Government Railway Postal Clerks. Steady employment. Commence \$133 month. Raise to \$195. Paid vacation. Experience or influence unnecessary. Common education sufficient with our coaching. Full information and sample examination questions free. Write immediately, today. Franklin Institute, Dept. N-3, Rochester, N. Y.

**\$60-\$200 A WEEK.** Genuine Gold Letters for store windows. Easily applied. Free samples. Liberal offer to general agents. Metallic Letter Co., 438-C North Clark, Chicago.

**\$5 TO \$15 daily easy**—Your Pay in Advance—Introducing New Style Guaranteed Hosiery—Must wear or replaced free—No capital or experience required—Just show samples—write orders—We deliver and collect—Outfit furnished—All colors—grades including silks, Maoches Textile Company, Room 2409, Cincinnati, Ohio.

**LOCOMOTIVE** Firemen for railroads nearest their homes—everywhere; beginners \$150-\$250 monthly. Railway Association, Desk M 1, Brooklyn, N. Y.

**FOREST** rangers for National Forests. Steady work. Write for free particulars of exams. Mukane, Dept. A-12, Denver, Colo.

**MEN 18 Up.** \$117-\$192 month. Become Railway Postal Clerks or Mail Carriers. Steady. Specimen examination questions—free. Write immediately. Franklin Institute, Dept. N-19, Rochester, N. Y.

**FINGER Print Experts**—Excellent paying positions; particulars free. Finger Print Headquarters, 188 East 79th, New York.

**\$100 TO \$300 weekly.** Men with slight knowledge of motors who can reach car owners can earn \$300 weekly without making a single sale. If they can also make sales, profits may reach \$25,000 yearly. Only proposition of its kind ever offered. S. A. Phillips, 235 West 27th, New York.

**WANTED**—Railway Mail Clerks, Post-office Clerks and Carriers, Customs, Internal Revenue, and many other classes of Government help. \$1,400 to \$2,600 yearly. Our 36-page Booklet shows how to obtain these desirable life positions. Write Chicago Civil Service College, A-41 Kesner Building, Chicago.

**\$35.00 WEEK.** Men, 15 up. Become Automobile Experts. Learn while earning. Write Franklin Institute, Dept. N-400, Rochester, N. Y.

**MONEY!** Silvering Mirrors, Autolights, Radiators, tableware, stores, Outfits, Methods Free. Sprinkle, Plater, Dept. 28, Marion, Ind.

**GET** a United States Government Position. Good Pay, Short Hours, Vacation, Sick Leave, Pension, etc. Prepare for Railway Mail, Post Office, Custom House, Internal Revenue, Rural Carrier or other branches. Examination all the time. Common education sufficient. Let our expert (Former U. S. Civil Service Secretary-Examiner) train you. Guaranteed Preparation. Write today for Free Booklet. Patterson Civil Service School, Dept. 8, Rochester, N. Y.

**RAILWAY** Postal Clerks: Start \$133 month. Railroad pass; expenses paid; questions free. Columbus Institute, E-2, Columbus, Ohio.

**EARN \$10 daily** silvering mirrors, plating and refinishing metalware, autos, chandeliers, bedsteads, headlights. Outfits furnished. E. Decie Laboratories, 1133 Broadway, New York.



**MEN—Women 18 Up.** Get Government Jobs. \$95-\$250 month. List positions—free. Write immediately. Franklin Institute, Dept. N-19, Rochester, N. Y.

**MEN** wanting forest ranger, postal clerk and other govt. positions; particulars free. Write Mokane, Dept. A12, Denver, Colo.

**WHY** work for others? Start and operate your own business. Our system proprietary specialty business offers wonderful opportunities to make \$100 to \$500 weekly. Openings everywhere. We furnish everything and show you how. Booklet free. National Scientific Laboratories, 208 Monroe, Richmond, Va.

**SILVERING** Mirrors, French plate. Easily learned; immense profits. Plans free. Address, Wear Mirror Works, Excelsior Springs, Mo.

**OUR** genuine gold window sign letters are an excellent money-making proposition for handy men. Slann Sign System, Bethune Ave. E., Detroit, Mich.

**MAKE** money writing Photo-plays; details free to beginners. No correspondence course. Producers' League, 230 Wainwright, St. Louis.

**STEADY.** \$135-\$192 month. Railway Postal Clerks. Specimen examination questions—free. Write immediately. Franklin Institute, Dept. N-19, Rochester, N. Y.

**INVENTORS** desiring to secure patents should write for our book "How to Get Your Patent," tells our terms and methods. Send sketch for our examination and instructions without charge. Randolph & Co., Dept. 418, Washington, D. C.

**WRITE** articles, stories, news, in spare time for newspapers and magazines. Big pay. Copyrighted book free. Press Syndicate, 982, St. Louis, Mo.

**ALL** men, women, boys, girls, 17 to 65, willing to accept Government Positions, \$117-\$250 traveling or stationary. Write Mr. Dugent, 101 St. Louis, Mo., immediately.

**EARN** \$1.20 an hour cutting blanks at home; spare time. Men only. Send addressed reply envelope. Goodyear Sa., 147 W. 23d St., New York.

**STORIES,** poems, plays, etc., are wanted for publication. Good ideas bring big money. Submit manuscripts or write Literary Bureau, 522, Hannibal, Mo.

**MEN—Age 18-40,** wanting Railway Station-Office positions, \$115-\$250 month, free transportation, experience unnecessary. Write Baker, Supt., 74 Wainwright, St. Louis.

**RAILWAY** Postal Clerks, \$133-\$192 month. Specimen examination questions—free. Franklin Institute, Dept. N-19, Rochester, N. Y.

#### INFORMATION

**INFORMATION** and advice, any business or advertising problem, \$1.00. W. L. Taylor, Business Counsellor, Box 44, Freeport, Ill.

**LEGAL** questions answered, guaranteed correct \$1.00. Edgar Keller, Augusta, Montana.

**COMPLETE,** accurate, information on any subject. \$1. National Information Bureau, 1429X Milton St., Grand Rapids, Mich.

**COMPLETE** information on any book published. Or will supply lists of books that are the best on any subject. Information is free. Room 897, Popular Mechanics Building, Chicago, Ill.

#### BUSINESS SERVICE

**TRANSLATIONS—English-German** and German-English. Business letters, manuscripts, accurately constructed, translated and typewritten. Prices reasonable. Write for details. B. Kraft, Box 896, San Francisco, Calif.

**DELAWARE** Incorporator. Charters; Fees Small; forms. Chas. G. Guyer, 901 Orange St., Wilmington, Del.

#### TYPEWRITERS AND SUPPLIES

**UNDERWOOD** Typewriters — only \$3.00 down. Easy monthly payments. Low prices at less than manufacturers. 10 days' free trial. Rebuilt, all worn parts replaced. Just like a new machine. 5-year guarantee. Write for big free catalogue C-151. Shipman-Ward Mfg. Co., 1516 Shipman Bldg., Chicago, Ill.

**TYPEWRITERS** All Makes. Save one-half. Thoroughly rebuilt in our factory by the famous "Young Process." Fully guaranteed. Free Trial. We handle all standard makes. Cash or sold on easy terms. Write for Catalog. Young Typewriter Co., Dept. 5629, Chicago, Ill.

**TYPEWRITERS,** all makes; real bargains; guaranteed. Dee Typewriter Rebuilding Co., Ada, Okla.

**TYPEWRITERS,** All makes, \$15 up. Guaranteed. Write for our bargain price list and Free Trial offer. Department 16. Manufacturers Typewriter Clearing House, 193 N. Dearborn Street, Chicago.

**TYPEWRITER** Papers—Second Sheets. Samples free. R. Elliott, 305 S. Third, St. Louis.

**TYPEWRITERS,** all standard makes, \$10 up. Fully guaranteed. Free trial. Write for complete illustrated lists. Northwestern Typewriter Exchange, 121 N. Francisco Ave., Chicago.

#### TYPEWRITING

**TYPING** Solicited—50c per 1,000. Perkins, 741 Brady, Davenport, Iowa.

#### PRINTING, ENGRAVING AND MULTIGRAPHING

500 **MULTIGRAPH** letters \$4.25. Postcards, Envelopes, Letterheads — Bargains. Price List Free. Carlson's, 8743 Essex Ave., Chicago.

**PERSONAL** Stationery, 200 sheets, 100 envelopes, name, address, printed in Blue Ink, \$1.00 postpaid. Beyond 3rd zone, \$1.15, 100 calling Cards, 75c. The National Print Shop, Box 1483, Dept. P. M., Washington, D. C.

**NEED** Printing? Send for Samples and Prices. It will pay you. Community Printing Co., 2645-P Lafayette Ave., St. Louis, Mo.

250 **HAMMERMILL** letterheads or envelopes \$1.50, postpaid. News, Blanchard, Okla.

**"NEARGRAVURE"** — different — 1000 Letterheads printed, \$3.50 postpaid. Soliday's, Knox, Ind.

**CARDPRESS,** (Automatic) \$90. 200 pounds mixed type \$50. Julius Greenburg, Montclair, N. J.

**QUALITY** Printing! Reasonable Prices! Send for Free Standardized samples and prices. Folders, Circulars, Catalogs our specialty. Ernest Fantus, 525 South Dearborn, Chicago.

**YES—We** will print 100 each, Letterheads and envelope, 20 lb. Hammerrill bond, postpaid for \$1.00. Woodward Printing Co., Dryden, N. Y.

1,000 **HAMMERMILL** Letterheads or Envelopes, \$4.00. Full Line Samples Free. Quality Printshop, Marietta, Ohio.

**ADVERTISING** Stickers! Parcel Post Labels! Interesting Samples Free! Edward Harrison, "Attractive Printing," Baltimore.

5,000 **LETTERHEADS** or Envelopes printed \$13.50. Foster, 4342 N. Robey, Chicago.

**"NEARGRAVURE"**—1,000 each Letterheads, Envelopes, \$7.00 postpaid. Soliday's, Knox, Ind.

**ILLUSTRATIONS,** letterhead designs, trade-marks. Give details for free estimate. Taylor's Advertising Service, Dept. H, Freeport, Ill.

1,000 **LETTERHEADS** \$2.50 — 5,000 \$10.00—10,000 \$17.50. Samples Free. John P. Sprinkle Company, Martinsburg, W. Va.

26-LB. **Hammerrill** Bond Letterheads—1,000 \$3.60—5,000 \$13.75; envelopes—1,000 \$3.30—5,000 \$9.60. Jefferson Pig. Co., 305 S. Vernon, Dallas, Texas.

3,000 **ENVELOPES,** printed, \$8.00; 1,000 \$3.25; 500 \$2.50, prepaid. National Envelope Co., 160 North Wells, Chicago.

5,000 **ELEGANT** Envelope Slips, \$4.75; 5,000 5 1/2 x 8 1/2 Circulars, \$9.00; Post Cards, \$9.00. All Printing Low Prices, Samples. Good's Printery, Harrisburg, Va.

250 **BOND** Letterheads, 250 Envelopes, both for \$3.00; 500, \$4.50; 500 cards \$2.00. Samples. Midland Press, 543 West Hickory Street, Kankakee, Ill.

**BUSINESS** Stationery printed to please. 500 letterheads \$1.50. Place, Harding, Mass.

100 **EACH,** Letterheads and Envelopes, \$1.00. Culpepper Press, Faith, Ark.

250 **LETTERHEADS,** 250 white envelopes, printed and mailed, \$3.00. Samples printing free. Sunco, Mohawk, N. Y.

**PRE-USED** Printing Presses, Type and supplies. List for stamp. Popular Bargains, Richland, Pa.

**PRINTING** Outfits—Presses, type supplies, type novelties. Send stamp for catalogue. Model Press, York, Penna.

**WE** print Stationery, Booklets, Catalogs, Circulars, Campaign printing. Samples. Commercial Press, Batavia, Ohio.

1,000 **LETTERHEADS** or Envelopes, \$3.00. Sent Prepaid, Samples Free. Monitor Press, Morrisville, Pa.

150 **EACH** Letterheads; Envelopes, C. O. D. \$2. Jacobus Service, Irvington, N. J.

225 **BOND** letterheads, envelopes, bill-headers, cards, \$1.25 each. Combination, \$4.00. Economic Press, Leonia, N. J.

#### ADDING MACHINES

**NEW** \$3.50 Automatic Adding Machine. Adds, Subtracts, Multiplies. Absolutely accurate. Capacity \$999,999.99. Fully guaranteed. 75,000 pleased users. Makes adding easy, positive, quick. Eliminates Mistakes. Saves Time. Postpaid \$3.50. Bassett Co., 1458-N Hollywood Ave., Chicago.

**FREE** Trial. Marvelous new Adding Machine. Adds, Subtracts, Multiplies, Divides, automatically. Work equals \$350.00 machine. Price only \$15.00. Speedy, durable, handsome. Five-year guarantee. Used by largest corporations. Write today for catalog and free trial offer. Lightning Calculator Co., Dept. E, Grand Rapids, Mich.

#### DUPLICATORS AND DEVICES

**STENCIL** Duplicating Outfit—Typewriting, Handwriting. Letter \$4.00, Note \$3.00, Card \$2.00. Returnable. Primos Specialty Co., 3-M, Primos, Pa.

**YOU** can make 50 to 100 copies of a letter, notice, etc., at a cost of three cents on a Hoyer Quality Duplicator. Write for free trial offer. The Hoyer Duplicator Co., 14 S. Wells St., Chicago, Ill.

#### MAILING LISTS

**MORE** Sales By Mail! Circularize! Use guaranteed accurate lists. Classifications Free. Martineck Company, Corona, N. Y.

#### FOR SMOKERS

**HOMESFUN** Tobacco, chewing, 5 lbs., \$1.25; 10 lbs., \$2.50; 20 lbs., \$4.50; smoking, 5 lbs., \$1.25; 10 lbs., \$2.00; 20 lbs., \$3.50. Farmers Union, Mayfield, Kentucky.

#### BOATS AND LAUNCHES

**BOATS** that always go are propelled by Ford Engines. Ford Engine Booklet free to boat owners. Harry Rider, 206B Commercial Bldg., Norwalk, Conn.

**NEW** Boat Book telling how to make 21 kinds of boats. Also many other helpful ideas for those who like boats. Profusely illustrated. 50 cents. Popular Mechanics Press, Room 897, Popular Mechanics Building, Chicago, Ill.

**"HOW** to make your boat leakproof." Send for booklet. L. W. Ferdinand & Co., 132 Kneeland St., Boston, Mass.

#### RAZORS AND BLADES

**BLADES** for Gillette Razor 35c per dozen. Brand New. Postage prepaid. Agents wanted. Razoblade Co., 2743 Broadway, New York.

**\$3** RAZOR, blade, clippers, sharpeners, \$1. Windshield "Keepclear" free. Honory, Roseto, Pa.

#### FOR THE HOME

**CALIFORNIA** Bungalow Home Plans drawn to suit your individual desires. Reasonable fees. E. M. Howard, P. O. Box 1077, Visalia, Calif.

**SAVE** 1/2 to 3/4 the money you spent for coal last year, and get more heat by attaching the Crown Fuel Saver to the feed door of your furnace. This inexpensive device is an amazing heat-producer and coal-saver. Works automatically—never gets out of order. Guaranteed to save 20% of coal or money refunded. Write CFSO, 15 N. 10th St., Richmond, Ind.

**GRANDFATHER** Clock Works, \$5.00. Build your own case; Instructions free; make good profits selling your friends. Clock works with chimes for old or new cases. Write for full particulars. Clock Co., Ruffner St., Philadelphia.

**LOOMS—Only** \$9.90—Big money in weaving rugs, carpets, portieres, etc., at home, from rags and waste material. Weavers are rushed with orders. Send for free loom book. It tells all about the weaving business and our wonderful \$9.90 and other looms. Union Loom Works, 480 Factory St., Boonville, N. Y.

**HOMEMADE** Furniture—Popular Mechanics Mission Furniture Library tells how to make all kinds of furniture in the easiest way. It is not only cheaper to make your own furniture, but you have a lot of fun making it. The library consists of three cloth-bound volumes and the entire library is only \$1.50. Popular Mechanics Press, Room 897, Popular Mechanics Building, Chicago, Ill.

**ANTIQUES, WAR RELICS AND INDIAN GOODS**

**FOR** Dens—Relics Collected from Europe's Battlefields. Illustrated catalogue and sample War Photographs 25c. Weapons, decorations, etc. Lieut. Welsh, 2117 Regent Pl., Brooklyn, N. Y.



SEND 5c for fine, new list Indian relics, antique firearms. F. E. Ellis, Webster Groves, Mo.

HUNTING BOWS, relics, minerals, geology, stamps, butterflies. Thousand Indian articles. Catalogue 10c. Indiancraft—P—Co., 466 Connecticut, Buffalo, N. Y.

#### PHONOGRAPHS AND RECORDS

BUILD your own Phonograph. We furnish everything. Write for Phonograph and Radio Parts Catalog. American Phonograph Co., 3734 Belmont, Chicago.

BUILD Your Phonograph. Quality phonographs. Quality Serenado motor and motors of other types. Electric Motors, tonearms, reproducers, amplifiers, case materials, accessories. Free blueprints and building instructions. Big saving. Wonderful results. Prompt delivery. Catalog mailed for ten cents. Hoosier Manufacturing & Supply Co., 313 Baldwin Block, Indianapolis, Ind.

BUILD your own phonographs. We can supply you with motors, tone arms and all accessories at wholesale prices. Write for catalogue AX. Pleasing Sound Phonograph Co., 204 East 112th St., New York, N. Y.

#### MUSIC AND MUSICAL INSTRUMENTS

BANJO-UKULELES. All the rage! Special Sale. Only \$1.00 prepaid. Tea-Blue Supply Company, 23 Tacoma, Rochester, N. Y.

WRITE Songs. Big money and reputation. Write for information. J. Gordon Pub. Co., 201 N. Hayne Ave., Chicago.

A \$500 CASH Prize is offered for the best second verse to "I'll Be Waiting." Those wishing to compete may receive a free copy of this song and rules of contest by addressing Equitable Music Corp., 1638 Broadway, New York.

VIOLINS. Deep, Mellow, Soulful—on credit. Easy terms for wonderful instrument. Get details today. Gustav F. Henning, 2424 Gaylord St., Denver, Colo.

"MUSIC Composed" to words. Bauer Bros., (formerly of Sousa's Band), Oshkosh, Wis.

CORNETISTS—Trambonists—Saxophonists—Charinetists. Get "Free Pointers." Name instrument. Virtuosi School, Concord, Mass.

#### PATENT ATTORNEYS

PATENT Procured. Prompt Service. Personal, careful and efficient service. Highest references. Moderate fees. Send sketch or model for actual search and advice. George P. Kimmel, Master of Patent Law, 54-I Loan and Trust Bldg., Washington, D. C.

PATENTS Procured; Trade Marks Registered—A comprehensive, experienced, prompt service for the protection and development of your ideas. Preliminary advice gladly furnished without charge. Booklet of information and form for disclosing idea free on request. Richard B. Owen, 30 Owen Bldg., Washington, D. C., or 2276-B Woodworth Bldg., New York.

PATENTS—Let me assist you in obtaining your Valid Patent Rights. Personal Service. Promptness assured. George Van Den Berg, Barrister Bldg., Washington, D. C.

H. F. LOWENSTEIN, Registered Patent Attorney, Technical expert. McLachlen Building, Washington, D. C.

MILLIONS spent annually for ideas! Hundreds now wanted! Patent yours and profit! Write today for free books—tell how to protect yourself, how to invent, ideas wanted, how we help you sell, etc. American Industries, Inc., 500 Kresge Bldg., Washington, D. C.

PATENTS, Trade-Marks, Designs. This firm has 27 years' experience and gives expert personal service at reasonable rates. We properly protect your invention. Write for free information and exact cost of procuring patent before proceeding. John B. Thomas & Co., 902 F St., N. W., Washington, D. C.

PATENTS, patent litigation, trademarks, copyrights. Handbook of instructions "How to protect inventions" free on request. R. H. Fratel, Patent Attorney, formerly of the U. S. Patent Office Examining Corps. Room 503 McLachlen Bldg., Washington, D. C.

ESTABLISHED 1864. Milo B. Sterens & Company, Registered Attorneys (No. 830). Patents—Trade Marks—Copyrights. Full information upon request. Moderate fees. Office: Barrister Building, Washington; Leader Building, Cleveland; Monadnock Block, Chicago.

CASHING In—If you have a sound patent or pending patent to sell, write us promptly. American Patents Corporation, 635 F Street, Washington, D. C.

PATENTS, Trade-Marks, Copyrights, and Patent Litigation. Write for advice and instructions how to proceed, costs, etc. Hand Book with illustrations of 100 Mechanical Movements sent free on request. Albert E. Dieterich, Patent Lawyer and Solicitor, 621-B Ouray Bldg., Washington, D. C.

THE PATENTOME. Impartial advice to Inventors and Manufacturers. Mailed on request. Anderson & Son, Patent and Trade Mark Lawyers, Established 1865, 635 F St., Washington, D. C.

PATENTS and Trade-marks obtained. Prompt service. Write for our new book on patents. Established in 1889. D. Swift & Co., 369 7th St., Washington, D. C.

INVENTORS—Send for form "Evidence of Conception" to be signed and witnessed. Form, fee schedule, information free. Lancaster and Albino, Registered Patent Attorneys in United States and Canada, 221 Ouray Bldg., Washington, D. C.

MONROE MILLER, Ouray Bldg., Washington, D. C., Patent Attorney; Mechanical, Electrical Expert. Free Blue Book gives candid advice.

INVENTORS: Send sketch or model for free opinion concerning patentable nature and exact cost of patent. Book "How to Obtain a Patent," sent free. Tells what every inventor should know. Established twenty-eight years. Highest references. Prompt service. Reasonable charges. Chandler & Chandler, 474 Seventh, Washington, D. C.

TRADEMARKS \$35; Design patents \$25; Copyrights \$5; Booklet Free; 20 years' experience. Sanders, Registered Patent Attorney, 7 Rand-McNally Building, Chicago.

PATENTS—Write for our Guide Books and "Record of Invention Blank" before disclosing inventions. Send model or sketch of your invention for Examination and Instructions. No charge for the above information. See advertisement on pages 148 and 149. Victor J. Evans & Co., 934 Ninth, Washington, D. C.

PATENT SENSE—"The book the inventor keeps." Free. See Lacey ad, page 151.

PATENTS Procured. Send sketch or model today for examination, prompt report and advice. No charge for preliminary advice. Write for free Booklets "How to Obtain a Patent" and "Invention and Industry" and blank form on which to disclose your idea. Highest references. Promptness assured. Clarence A. O'Brien, Registered Patent Lawyer, 586 Security Bank Building, Directly across the street from Patent Office, Washington, D. C. See pages 146 and 147.

PATENTS—Send for Booklet. Contains valuable information for inventors. Our charge for search of Patent Office records \$5.00. Prompt service, twenty years' experience. Talbert & Talbert, 508 McGill Building, Washington, D. C.

UNPATENTED Ideas Can Be Sold. I tell you how and help you make the sale. Free particulars (Copyrighted). Write W. T. Greene, 807 Jenifer Building, Washington, D. C.

INVENTORS—Write for our Guide Book, "How to Get Your Patent" and Evidence of Invention Blank. Send model or sketch of your invention for our prompt examination and instructions free. Randolph & Co., Dept. 420, Washington, D. C.

"INVENTOR'S Advisor," the valuable Patent book with 139 mechanical movements and illustrations, sent free upon request. M. M. Labiner, Patent Attorney, 3 Parkrow, New York.

PATENTS, Booklet free, Highest references. Best results. Promptness assured. Send model or drawing for preliminary examination. Watson E. Coleman, Patent Lawyer, 644 G Street, Washington, D. C.

PATENTS, Trade marks, copyrights. Prompt, personal, reliable service. Over 36 years' active practice. Write for terms. Book free. Address E. G. Siggers, N. U. Bldg., 918 F St., Washington, D. C.

HERBERT JENNER, patent attorney and mechanical expert, 600 F Street, Washington, D. C. I report if patent obtainable and exact cost. Send for circular.

"INVENTORS' Guide" sent free on request; this book contains illustrations of patented inventions and gives valuable information and advice for all who have original ideas or improvements. Frank Ledermann, Registered Attorney and Engineer, 15-P Park Row, New York.

PERCY S. WEBSTER, Savings and Loan Building, Stockton, California. Long established organization. Send for free book on Patents.

PATENTS. My fees in installments. Advice book free. Frank Fuller, Washington, D. C.

#### FOR INVENTORS

PATENTS. If you have an invention which you wish to patent you can write fully and freely to Munn & Co., for advice in regard to the best way of obtaining protection. Please send sketches, or a model of your invention and a description of the device, explaining its operation. All communications are strictly confidential. Our vast practice, extending over a period of seventy-eight years, enables us in many cases to advise in regard to patentability without expense to the client. Our Hand-Book on Patents is sent free on request. This explains our methods, terms, etc., in regard to Patents, Trade Marks, Foreign Patents, etc. "Scientific American" contains Patent Office Notes, Decisions of interest to inventors and particulars of recently patented inventions. Munn & Company, Solicitors of Patents, 623 Woolworth Building, New York; Scientific American Bldg., Washington, D. C.; Tower Bldg., Chicago, Ill.; Hobart Bldg., 582 Market St., San Francisco, Calif.; Van Nuys Building, Los Angeles, Calif.

WHY Waste Money on Patents? Your invention may have great theoretical merit and at the same time have no practical usefulness. It may not have selling possibilities or it may cost too much to manufacture or it may have economic disadvantages. Why waste money on a patent when you can expect no material benefits? My years of experience in these matters may save you time, money and worry. I am not a patent attorney and do not give advice on patent law, but it will pay you well to consult me before filing your application for a patent. Your invention will be treated with the utmost confidence. Frank W. Watts, Invention Analyst, 408 5th Street N. W., Washington, D. C.

INVENTORS—Write for our Guide Books and "Record of Invention Blank" before disclosing inventions. Send model or sketch of your invention for our free examination and instructions. See advertisement on pages 148 and 149. Victor J. Evans & Co., 157 Ninth, Washington, D. C.

LACEY Patent Sense. See page 151.

WHY not have a lathe of your own? See description of our Easy Payment Plan on page 158 of this issue. South Bend Lathe Works, South Bend, Ind.

PATENTS Procured. Send sketch or model today for examination, prompt report and advice. No charge for preliminary advice. Write for free Booklets "How to Obtain a Patent" and "Invention and Industry" and blank form on which to disclose your idea. Highest references. Promptness assured. Clarence A. O'Brien, Registered Patent Lawyer, 586 Security Bank Building, Directly across the street from Patent Office, Washington, D. C. See pages 146 and 147.

HOW To Sell Your Invention Without Being Swindled. Free Instructions. Write Today. Scholtz & Co., Wyandotte, Mich.

PATENTS Procured; Trade Marks Registered—A comprehensive, experienced, prompt service for the protection and development of your ideas. Preliminary advice gladly furnished without charge. Booklet of information and form for disclosing idea free on request. Richard B. Owen, 30 Owen Bldg., Washington, D. C., or 2276-B Woodworth Bldg., New York.

MONROE MILLER, Ouray Bldg., Washington, D. C., Patent Attorney; Mechanical, Electrical Expert. Before proceeding, read free Blue Book.

INVENTORS' Educator: 900 Mechanical Movements, 50 Perpetual Motions. How to procure and sell patents. Mechanical Movements greatly assist inventors, suggest new ideas. Explains how to select an attorney and avoid Patent Sharks. Price \$1.50. Postage Free. Albert E. Dieterich, 621 Ouray Building, Washington, D. C.

INVENTORS, before applying for Patent, send for our free circular "Advance Confidential Service for Inventors," designed to save you money and increase your opportunities for success. Caston Guay Engineers, 20 Sixteenth Street, Southeast, Washington, D. C.

INVENTORS: Expert assistance rendered in preparing and prosecuting your own patent applications; Inventions designed; Low fees. C. Williams, Engineer Counselor, 320 Pacific Bldg., San Francisco.



**CASHING In**—If you have a practical, useful invention to sell (patented or pending), write us promptly. American Patents Corporation, Barrister Building, Washington, D. C.

**DETAILED** mechanical drawings from your sketches or descriptions. Write Joseph H. Salisbury, Sandusky, Ohio.

**FREE** information on Technical Books—Personal Advancement is a new magazine published by Popular Mechanics to help those who want information on books. Will supply you with lists of books on various subjects, and information as to price and where they may be secured. Free. Popular Mechanics Press, Popular Mechanics Building, Room 807, Chicago, Ill.

**HAVE** you a patent that you want to get into some reliable manufacturer's hands, either for cash or on a royalty basis? Introducing the inventor to the leading manufacturers in America is our business. It will cost you nothing to investigate. National Patent Sales Service, P-1 Investment Building, Washington, D. C. Cable address P.A.T.

**CANADIAN** and foreign patents secured. Fine references. Reasonable rates. Prompt, personal service. The Ramsay Co., 273 Bank St., Ottawa, Canada.

**CLASSIFIED** Advertising will sell your patent. Write for rates leading newspapers and magazines. Taylor's Advertising Service, Dept. K, Freeport, Ill.

**UNPATENTED** Ideas Can Be Sold. I tell you how and help you make the sale. Free particulars (Copyrighted). Write W. T. Greene, 806 Jennifer Building, Washington, D. C.

**TO** sell your Patent. Write me; experienced handling, immediate action. Address Arthur S. Billings, Suite 101 Dekum Bldg., Portland, Ore.

**PATENT** Application Blanks free to inventors. Patent News-D, Washington, D. C.

**SPECIALIZED** service for inventors. You furnish the idea, we'll work it out. Expert machine designing. Drafting. Opinions given on practicability of ideas. Confidential dealings. Your ideas fully protected. Write for full particulars. Oils Engineering Co., Desk C D, Omaha, Neb.

**WE** Develop your ideas into commercial shape for presentation to purchasers, making working models, drawings, experiments or tests. Courtesy, efficiency, secrecy and ample equipment; 30 years' experience. Ducommun-Rieh Engineering Co., 501 Pacific Mutual Bldg., Los Angeles, Calif.

**GET** your own patents. Application blanks, complete instructions \$1. Cutting Sons, Campbell, Cal.

**PATENTS**—Send for Booklet. Contains valuable information for inventors. Our charge for search of Patent Office records \$5.00. Prompt service, twenty years' experience. Talbert & Talbert, 500 McGill Building, Washington, D. C.

**I** SELL Patents. Established in 1900. My Service is employed by inventors who are also Bankers, Lawyers, Patent Attorneys, Mechanics. Men in all walks of life—and Corporations with patents to sell. Why not you? Charles A. Scott, 775PM Garson Avenue, Rochester, N. Y.

**HAVE** you an invention? If so, write for our free book, "How to Get Your Patent," tells our terms and methods. Send model or sketch for our free examination and instructions. Randolph & Co., Dept. 144, Washington, D. C.

#### PATENTS FOR SALE

**SCIENTIFIC** shorthand machine, demonstrated utility and market, 5,000 per annum. Weighs 5 lbs., has 300 parts, punch-press, screw machine. Factory cost \$10.00; retail through commercial schools to stenographic students, \$75.00. Cash and royalty. Earl Pendell, 1458 Victoria, Cleveland, Ohio.

**FOR** Sale—Electric Washing Machine Patents No. 1,418,586, and 1,418,587. Adjustable Compression. Positive Vacuum. The world's greatest invention in washing machines, proven by a two years' service test. A high class mechanical engineering product worthy of your consideration. C. F. Lockhart, 9616 Hilgert Drive, Cleveland, Ohio.

**FOR** Sale, Outright or Royalty, United States and Canada Patents, Wheel Retainer, Automobile Safety Device, Inexpensive to Manufacture. Address, "McNeill," Box B, Hamlet, N. C.

**PATENT** pending. Calculating pencil and equipment. See description July Popular Mechanics. Computing Pencil Co., Greensboro, Ala. Sample 25c.

**INVENTORS**—Sell your own inventions. Send for our list; includes Patent buyers, Manufacturers, Distributors and Promoters, from all parts of the country. Price \$2.50. La Page Sales Co., 30 Euclid Arcade, Cleveland, Ohio.

**FOR** Sale, Oil Burner Patents 1,322,771, 1,368,908, for Ranges and Heating Stoves. Ernest E. Eisenbach, 1111 Marlborough St., Philadelphia, Pa.

**FLYING** Motorcycle. For Sale Outright or on Royalty. Has passed through U. S. Pat. Office. Benj. Johnson, 429 Campbell St., Lexington, Ky.

**FOR** Sale; Patent 681,006; Improved ratchet screw driver; the simple and strong practical tool. Address Eli Hendrickson, 105 Yester Way, Seattle, Wash.

**BEST** offer takes Patent on simple device of exceptional merit. Swedenborg, 70 Cook St., Akron, Ohio.

**FOR** Sale Improved headlight for cars; throws light directly on road. This invention I will sell outright or royalty. Address G. L. Morgan, 1708 8th Ave., N. Belle Plaine, Iowa.

**SALE** or Royalty, tire valve that is perfect seal. U. S., Canada, England. No replacement expense. G. W. Sheeley, Smithsburg, Md.

**OUTRIGHT** or royalty: "Auto Turn Signal." Patent pending. John H. Williams, Box 54, Dalton, Ohio.

**ATTENTION:** Outright or royalty. Safety device for gas jets; for gas stoves and ranges. If interested address Florence Leiser, and F. P. Stewart, 309 Atwood Ave., Madison, Wis.

**OUTRIGHT** or Royalty: "Comic Dial," a cardboard toy. Patent Pending. Especially interesting to children. Amos K. Pearce, Route 2, Box 49, Gustine, Calif.

**NEW** shoe cleaner, saves house cleaning; outright or royalty, H. Moore, Floodwood, Minn.

**PATENT** for sale on device for easily lifting jars from boiling water. Every housewife buys. Easily and cheaply manufactured. Write, Alison May, 441 Tenino Ave., Portland, Ore.

**PATENT** pending on Combination Cigar and Cigarette Holder. United States and Canada. Cash or Royalty. For particulars address Geo. C. Leibfried, P. O. Box 205, Yakima, Wash.

**FOR** Sale, United States and Canada Patents, Outright or Royalty, Steering Rod Protector, Automobile Safety Device, Inexpensive to Manufacture. Address, "McNeill," Box B, Hamlet, N. C.

**PATENTS** For Sale: To sell, buy or obtain patents, write Patent News-P, Washington, D. C.

**PATENTS** for Sale on Dust Receptacle and also on safety-razor sharpener. Large profits to manufacturer. Write for particulars, J. P. Binder, 206 Kenton St., Ludlow, Ky.

**PATENT** for Sale on Improved method for skinning cattle. More sanitary and efficient than any other system. Write for particulars, Wm. S. Callery, Dixon, Calif.

**YOU** have a worth-while patent, haven't you? Why don't you tell our two million readers about it? Most of them are specially interested in patents and new inventions. Ask me to tell you how other inventors successfully sold their patents. Geo. F. Baker, Manager Classified Advertising, Popular Mechanics Magazine, Chicago, Ill.

#### SURVEYING INSTRUMENTS

**LARGEST** stock of new and used surveying instruments in the country direct from factory. Satisfaction guaranteed or money refunded. Wissler, 619 N. Broadway, St. Louis.

#### MODELS AND MODEL SUPPLIES

**STEEL**, Brass, Iron in Tubing, in Bars and Sheets. Models, Tools, Gears. Send sketch for estimate. Arthur Schmidt, 400 Canal Street, New York.

**SEND** Sketch and get lowest prices on Model and Experimental work. Ideal Company, 165½ Spring St., New York.

**WE** Build Models, design, develop and manufacture articles in large or small quantities. Homeyer Mfg. Co., 1385 E. 17th St., Cleveland, Ohio.

**HULIT & CO.**, Model Makers and Experimental Machinists. Tools and Dies, 625 West Jackson, Chicago, Ill. We specialize in high-grade model work on inventions of merit. New parts and repairing. Your patronage solicited.

**MODELS**, Dies, Metal Stampings, Light Manufacturing. Modern Shop. Reasonable Prices. Osborne Register Company, 123 West Pearl, Cincinnati.

**INVENTORS**—Write for our Guide Books and "Record of Invention Blank." Send model or sketch of invention for our free examination and instructions. See advertisement on pages 148 and 149. Victor J. Evans & Co., 165 Ninth, Washington, D. C.

**PATENTS** Procured. Send sketch or model today for examination, prompt report and advice. No charge for preliminary advice. Write for free Booklets "How to Obtain a Patent" and "Invention and Industry" and blank form on which to disclose assured. Clarence A. O'Brien, Registered Patent Lawyer, 586 Security Bank Building, Directly across the street from Patent Office, Washington, D. C. See pages 146 and 147.

**WE** make working models for inventors and do experimental work and carry a complete stock of brass gears and model supplies. Send for catalogue. The Pierce Model Works, Tinley Park, Ill.

**DIES**, Tools and General Manufacturing. Models and Manufacturing of new inventions our specialty. Logan Machine Co., 126 S. Clinton St., Chicago, Ill.

**MODEL** steam engine ½" x ¾" \$8.50. Finished parts for same, \$7.25. Other engines, boilers, blowlamps. Catalog for 10c stamp. Model Machine Shop Co., 417 East 71 St., New York City.

**SPECIAL** machine builders, tool and die makers, inventors' models, production work of all kinds. Dept. L, Quality Hardware & Machine Co., E. Ravenswood and Thorndale Avenues, Chicago, Ill.

**THE** Modelmaker. For those interested in making working models. Send 10 cents. Address P. M. 120 Liberty Street, New York.

#### MANUFACTURING

**METAL-CRAFT**—Eventually—Metal-Craft. Competent Engineers, Designers and Producing Organization await your commands on dies, stampings, die-casting, deep pressing, screw-machine and wire products. Plating, Enameling, Burnishing, Assembling, Wrapping and Packing to your specifications. Large completely equipped plant. It is not the quality of raw materials alone, nor the precision in manufacture, and not just the service rendered that has given Metal-Craft the good reputation they bear—but all of these, as a constant certainty, in combination. Estimates promptly furnished. Metal-Craft Mfg. Company, Box 259-W, Chicago.

**WE** design and build special machinery, tools, dies, jigs, and fixtures. Experimental work. Reliable Machine Co., 400 W. 23rd Street, New York City.

**WELL** equipped metal manufacturing plant wants several good selling articles to manufacture. We specialize in high-grade dies, tools, metal stamping. Reasonable prices. Sheldon Tool Co., Rosedale Station, Kansas City, Kans.

**WOOD** Finishing in stain, varnish or enamel. George Conway, 43 North Front St., Columbus, Ohio.

**EXPERIMENTS** developed, dies, models and manufacturing machine designing. Estimates and information promptly given. Address Schroer Bros. Machine Works, 512 East 25th St., Kansas City, Mo.

**LET** us manufacture it for you. Can quote low prices and can furnish a product you would be proud of. Ideas worked out and simplified. Models made. Metal parts made to drawings or sample. Simplex Tool Co., Woonsocket, R. I.

**WIRE** goods made to order. Cooley Mfg. Co., 524 N. Western Ave., Chicago.

**SCREWS**, nuts, screw machine products, all metals. Autoscrew Works, 255 West Broadway, New York City.

**LONG** established manufacturer of auto accessories which are daily sold by practically all wholesale and retail accessory houses will consider manufacturing and distributing new automobile products, capable of equally wide sale through same channels. Patented articles preferred. Address Auto Accessory Manufacturer, Room 2104, 310 S. Michigan Ave., Chicago, Ill.

**IRON**, Brass, Aluminum Castings, Models, Patterns, Light Manufacturing. Welch Brothers Co., North Chicago, Ill.

**OUR** factory will make your models, manufacture your articles as well as build your tools, dies and fixtures. Standard Die & Specialty Co., 817 W. Washington Blvd., Chicago, Ill.



**PATTERNS**, wood and metal. Models, tools and dies. Brass, bronze, aluminum and iron castings. Screw machine work, production work of all kinds. Write Modern Machine & Pattern Co., Terre Haute, Ind.

#### MACHINERY, TOOLS AND SUPPLIES

**CONCRETE** Building Block Machines and Molds. Catalogue free. Concrete Machine Co., 303 South Third St., St. Louis, Mo.

**SPECIAL** labor saving machinery designed and built. Punches and Dies and other special tools furnished for manufacturing work. Simplex Tool Company, Woonsocket, R. I.

1-15" x 8 MONARCH Engine lathe complete \$190.00. 1 20" Metal Shaper complete \$225.00. 1 No. 60 Hand Auto Cylinder grinder, complete, \$65.00. Complete line of machinery and supplies. Cincinnati Machinery Supply Co., 218 E. Pearl St., Cincinnati, Ohio.

YOU can install a lathe in your shop now under our Easy Payment Plan. See page 158 for details. South Bend Lathe Works, South Bend, Ind.

#### ENGINES, MOTORS AND DYNAMOS

**GENERATOR** 32 Volt, 300 Watt \$16.00, 500 Watt \$22.50. 1,000 Watt \$35.00. 1/2 Horse Alternating Motor connected to 25 Volt 5 ampere Generator \$30.00. Also bargains in other Motors, Generators and Motor Generators. Queen City Electric Company, 1736 West Grand Avenue, Chicago, Ill.

**PRACTICAL** Steam Engines, 1 H. P. \$18.00; 1/2, \$12.00. James Chambliss, Bessemer, Ala.

**MOTORS**—Manufacturers' Surplus Sale; 1/4 hp. \$8.50. 1/2 hp. \$32.50. 1 hp. \$51.50. 8-volt Charging Generators \$8.50. Complete Lighting Plants, Generators, Light Machinery. Write for Catalog. Motor Specialties Co., Crafton, Penna.

**BLUR** Generators, brand new, 6 volts, maximum output 22 amperes at 2,000 r. p. m. Government paid \$45.00 each, our price \$10.00. General Sales Company, 1919 S. Michigan Avenue, Chicago, Ill.

#### FOR MECHANICS

**PATENTS**—Write for our Guide Books and "Record of Invention Blank" before disclosing inventions. Send model or sketch of your invention for examination and instructions. No charge for the above information. See advertisement on pages 148 and 149. Victor J. Evans & Co., 184 Ninth, Washington, D. C.

**AUTOMOBILE** Repairman's Handbook—334 ideas for those who repair automobiles, gleaned from the experience of those who repair all makes and models of cars. 337 illustrations. Not only ideas and methods for making repairs, but specific instructions for making fixtures and devices that will lighten labor and improve the quality of work. Only 50 cents. Popular Mechanics Press, Room 807, Popular Mechanics Building, Chicago, Ill.

#### BLACKSMITHS

**SENSATION** of the season; the new Hossfeld Wrenchless Universal Bender; bends eye bolts, U's, Angles, etc. Bends 1 1/2 in. standard Pipe cold. Also rolls perfect Automobile Spring Eyes. Machine can be instantly set for any kind or size of work without the use of a wrench. Simple, Powerful, Inexpensive. Send for circular. Universal Iron Bender Co., Inc., Winona, Minn.

**BLACKSMITHS**, Listen! Make more money doing hard jobs easy with Toy's Modern Methods of Master Machine Blacksmithing. Forging and Solid Welding, Tool Dressing and Tempering to a standard with colored tempering charts. All for One Dollar. Samples Free. W. M. Toy, Sidney, Ohio.

#### FOR SALE—MISCELLANEOUS

**KARSTADT'S** Mammoth Pecans. Pound \$1.40; Five Pounds \$6.25. W. Karstaedt, Dayton, Ohio.

**SLIGHTLY** used Long-Eakins Crispette outfits, complete with formula and full directions. Fully guaranteed. Less than half price. Write for particulars. Boyer, Box 1268, Omaha, Nebr.

**FAMOUS** Salt Water Taffy, 60c per pound; mailed anywhere in America. Richard Lavery, Asbury Park, N. J.

**NEW**, Better "Ever-In" Kepurse. Smallest Made. Keys stay in. Saves Pockets. Excellent gift. Leather six and twelve key sizes 50c. 75c. Pigskin \$1.50. Henry Schooley, 4045 University Way, Seattle.

**FOR Sale** at a Bargain, a Complete Set of Watchmaker's Tools. R. Jaegermann, 5815 Easton Ave., St. Louis, Mo.

**ADDRESSOGRAPH**s. Letter Folders, Multigraphs, Envelope Sealers, Duplicators, less than half price. Guaranteed. Pruitt Co., 170 N. Wells, Chicago.

**BUY—Exchange—Sell!** Many of our readers have for sale or exchange the article you are looking for—and lots of them are looking for the very items you want to turn into cash. Get together! Let our two million readers know your wishes—they'll help you! Send your ad today to Geo. P. Baker, Manager Classified Advertising, Popular Mechanics Magazine, Chicago.

#### WANTED—MISCELLANEOUS

**WANTED:** Light Machinery—Lathes—Drill Presses—Model High-Speed Gasoline and Steam Motors. Best Cash Prices Paid. Motor Specialties Co., Crafton, Penna.

**WANTED:** Selling agency of a good article for Texas. W. S. Brown, Harrison, Ohio.

#### REAL ESTATE, FARM AND ORCHARD LANDS

**FLORIDA** Orange Grove for \$1,650. An association of orange growers and nurserymen, not land men, but residents wishing to rapidly develop this beautiful section, will sell you ten acres of fine, young orange or grapefruit grove for only \$1,650, or \$165 per acre, about one-fourth cost elsewhere. Terms, \$750 cash and \$10 a month. Fine trees and fine land in Florida's great highland lake region. No swamps, palmetto or malaria. Save all agent's or middlemen's profits; buy from owners. No time for curiosity seekers or tourists, but if you want a grove, write for free book of actual facts and photos. Lake County Land Owners' Association, 93 Nursery Avenue, Fruitland Park, Fla.

**FOR Sale**—Three full sections in McKenzie County and two sections in Billings County, North Dakota. Each section contains land suitable for crops, balance for cattle. Each section has valuable deposits of lignite which some day will alone be worth many times the present value of the land. This part of the state is developing very rapidly with good schools within easy access. As owner cannot use this land himself, will sell one or more sections at a price which almost anyone can afford to pay. Address W. care Popular Mechanics, 200 East Ontario St., Chicago.

**20 ACRES** or more of our best land in Michigan; \$20 to \$30 per acre; near town 3,000 pop. \$10 down, balance long time. 52 page book Free. Swigart Land Company, P-1259 First National Bank Building, Chicago.

**FINE** Modern Home and 17 Acres. Full Equipment; Only \$1150. Convenient city, loamy tillage, variety fruit; good 10-room house, bath, hardwood floors, built-in features; barn, poultry house. Only \$1150, part cash, horse, cow, poultry, season's crops. Details page 7 illus. Catalog. Copy Free. Strout Farm Agency, 1507 Nassau St., New York City.

**PECAN-ORANGE** Groves "On the Gulf" \$10 monthly. Guaranteed care. Soon produce \$500.00 yearly. Suburban Orchards, Dept. M, Biloxi, Mississippi.

**WILL** Trade 160 acre Minnesota farm for industrial stocks or bonds. What have you to offer? Address X4J, care Popular Mechanics.

**ATTENTION!** "Get Acquainted." Cash for your property. Farm, Hotel or Retail Store, no matter where located; confidential service. Hayes' Business Agency, Cincinnati, Ohio.

**SELL** your property quickly for cash, no matter where located. Don't pay big commission. Particulars free. Real Estate Salesmen Co., Desk B, Lincoln, Nebr.

**\$5.00 DOWN**, \$5.00 monthly; 10 acres unimproved poultry, fruit, stock, woodland; \$100; Ozarks. Fishing, hunting, trapping. Alfred Zimmerman, 1800 N. Fifth, Kansas City, Kans.

**WANTED**—I want farms for cash buyers. Give description, price. R. McNow, 312 W. Kinison Bldg., Omaha, Neb.

#### DOGS AND PETS

**GERMAN** P-ice pups, pedigree, males \$50.00, female \$40.00. Rat Terrier, Fox Terrier pups, males \$10.00, females \$5.00. Rabbits, canaries. Berg's Pet Farm, Hendrum, Minn.

**PRIZE** Winning English Bulldogs and Puppies Monte Kennels, Huntington, Ind. **EDGETOWNE** Farm, Pella, Iowa, Offers Purebred German Police Puppies. Write for information and prices.

**FOX** Terriers, males, \$12.00; Females, \$7.50. C. L. Buckingham, Ridgeway, Wis.

**SILVERBLACK** Foxes \$350.00. Time Payments. Muskrats. Arthur Schumacher, Lockland, Ohio.

**FOR Sale**, A. K. C. pedigree Airedale pups. Ulysses February, Ridgeway, Ill.

**POLICE** Puppies, good quality, shipped on approval. Fiem T. Gillespie, Crosbyton, Texas.

**FOR Sale**—White Collie Pups. Registerable A. K. C. Satisfaction guaranteed. Henry Morrison, Route 7, Shelbyville, Ind.

**BEAUTIFUL** registered bull pups cheap. Bulldogs, 501 Rockwood, Dallas, Texas.

#### POULTRY

**CHICKS**; 6 1/2 up. Leading kinds. Catalogue free. Colonial Farms, Windsor, Mo.

#### PERSONAL

**SEND** 25c and your date of birth for forecast of your vibrations for 1925. Aryel Synclair, Numerologist, Astoria, Ore.

**YOUR Future?** Know Thyself! Wonderful three-page horoscope by world-renowned Astrologer. Learn your talents, character, love, friends, enemies, future possibilities. Send birth date, year, your handwriting and 10c. Gargills, Box 271-DD, Boston, Mass.

**SECRET** formula; positively cures Tobacco Habit. \$1.00 Complete. Dr. Awad, D-12, Shemanshah, Penna.

**YOUR success** depends on your future. Send birthdate for astrological reading of your life; postage 10c. Ducese, 3918 Thirtieth Avenue, Brooklyn, N. Y.

**TOBACCO** or Snuff Habit cured or no pay. \$1.00 if cured. Remedy sent on trial. Superba Co., TP, Baltimore, Md.

**UNUSUAL** Horoscope—Six pages, 2,500 words, consisting of extensive four-page Special Horoscope, Astro-Analysis, and two-page valuable guide giving daily and monthly advice covering entire year. Send 50c and birthdate. Money returned if dissatisfied. Prof. Bolles, Box 125, Cranford, N. J.

**TOBACCO** Kills manly Vigor. Quit easily. Cigarettes, chewing, smoking, snuff conquered or no charge. Small sum if satisfactory. Stops craving; harmless. Full treatment on trial. Perkins Co., 31-A, Hastings, Neb.

**FREE**—Information of a scientific nature that has brought happiness through perfect health to thousands. No charge, no obligation. Enclose stamp for reply. Fair Sales Co., Dept 246-O, Colorado Springs, Colo.

**FREE**—Stop using tobacco. We will give free information how to conquer habit easily and permanently. Results guaranteed. Anti-Tobacco League, Box K, Omaha, Neb.

#### MISCELLANEOUS

**FORMS** to cast Tin Soldiers, Indians, Marines, Trappers, Animals. Send 5c for Catalogue. Henry Schlenke, 1034 72nd St., Brooklyn, N. Y.

**BEAUTIFUL** Child's China Cabinet Patterns instructions 25c. Circular Free. Bogren Kiddie Cabinet, 2651 8th Ave., New York.

**PEARLS** and Slugs. Pearl hunters should send their pearls and slugs by registered mail or express to Herbert H. Verrees, Pearl buyer, Pittsfield, Ill.

**MONEY!** Silvering Mirrors, Autolights, Radiators, tableware, gloves. Outfits, Methods Free. Sprinkle, Plater, Dept. 28, Marion, Ind.

**SIMPLIFIED** Photo-Engraving Process. Line and Half-tone cuts easily made. Particulars 2 cents. Horton and Fisher, Princeton, Ill.

**TRAP** Catching Fur Animals alive, without hurting. Instructions \$1.00. Make your own Trap. N. Weller, Canton, Ill.

**LOCKSMITHING**, complete 500 tricks of the trade, new edition, many added features. \$1.50, money back if dissatisfied. H. Routsen, 3406 Andover St., Oakland, Calif.

**ROCKS** and Minerals for sale—hundreds of varieties—Price List Free. Peter Zoda, 157 Wells St., Peekskill, N. Y.

**ARTIFICIAL** Eyes, \$3. Booklet free. Denver Optic, 559 Barclay, Denver, Colo.

**CUTS** anybody can make. Simple, cheap process. \$1. Specimens, particulars, 2c stamp. M. Day, Windfall, Ind.

**HOMEOPATHIC** and Biochemic preparations sent postpaid to all parts of the world. Manual and booklets free. Halsey Bros. Co., 111 N. Wabash Ave., Chicago, Ill. Established 1855.



# 500 PUNCTURES Yet Leaks No Air



# We Want Agents

A new Puncture Proof inner tube has been invented by Mr. Milburn of the Milburn Puncture Proof Tube Company, Chicago. In actual test it was punctured with 500 nail holes without the LOSS OF AIR. This amazing new inner tube increases mileage from 10,000 to 12,000 miles; eliminates changing tires and makes riding a real pleasure. Many users have run over 20,000 miles without removing a tire from the wheel.

These wonderful, no-trouble, puncture proof inner tubes cost no more than ordinary tubes and Mr. Milburn wants agents everywhere to help him introduce them.

## CAR OWNERS WANTED

To sell and demonstrate this wonder tube. Interests everyone immediately. Automobile owners buy on sight. It makes no difference what car they drive or what tires they use. Our salesmen are coining money on our "DIRECT FROM FACTORY" scheme of selling. Absolutely no competition. We control all basic patents. No capital required to start. Previous selling experience not necessary.

## EARN \$5,000 to \$10,000 A YEAR

### Read What These Men Say

**J. D. Cooper**—"I have made 30,000 miles with my Milburn Puncture Proof Tubes and have not as yet removed a rim or casing and my casings are still in excellent condition."

**J. C. Jerves**—"I sold 50 Milburn Tubes in the first three days."

**Chas. Cayton**—"I sold twelve tubes yesterday in ten minutes."

**L. S. Knapp**—"My first few hours out I sold eight tubes, no trouble at all to sell them. The most wonderful tube on the market today, I think. I am hoping you will give me the agency for a big territory."

**D. Edelere**—"I have driven seventy-five nails in one of the 30x3 tubes and twenty were spike nails. It has gone above the test that you recommended to me it would do."

Earn \$5,000 to \$10,000 yearly or more. Get into business for yourself. Sell Milburn Puncture Proof Inner Tubes. Every car owner is a prospect. Your field is unlimited. Get in while it is good. Be independent. Find out all about it now and get started at once.

## FREE TUBE SPECIAL FREE TUBE OFFER

Send coupon or write today for special free tube offer and further details. References, Industrial State Bank of Chicago, National Bank of the Republic, Chicago, Baker State Bank of Chicago. Don't hesitate. Fill out the coupon and send it in or write and send name and we will send you all details. This is your opportunity, so don't delay. Address

H. S. HANSEN, Sales Mgr.

**MILBURN PUNCTURE  
PROOF TUBE CO.**

**331 West 47th Street  
CHICAGO, ILLINOIS**

**MR. H. S. HANSEN, SALES MANAGER, CHICAGO, ILLINOIS**  
331 West 47th Street, Chicago, Illinois

Dear Sir: If the money-making opportunity is as big as you claim I am interested in getting the facts, so that I can see & share of the profits with Mr. Milburn in the Puncture Proof Tube business. Without obligation send me information about commission and Free Tube Offer to Agents.

Name.....  
Address.....  
City.....  
State.....





# Follow this Man

*Secret Service Operator 38 is on the job*

**F**OLLOW him through all the excitement of his chase of the counterfeit gang. See how a crafty operator works. Telltale finger prints on the lamp stand in the murdered girl's room! The operator's cigarette case is handled by the unsuspecting gangster, and a great mystery is solved. Better than fiction. It's true, every word of it. No obligation. Just send the coupon and get—

# FREE!

## The Confidential Reports No. 38 Made to His Chief

And the best part of it all is this. It may open your eyes to the great future for YOU as a highly paid Finger Print Expert. More men are needed right now. This school has taken men just like you and trained them for high official positions. This is the kind of work you would like. Days full of excitement. Big salaries. Rewards.

## Can you meet this test?

Can you read and write? Are you ambitious? Would you give 30 minutes a day of your spare time preparing yourself for this profession? Would you like a life of excitement, thrilling adventures and high pay? Answer "yes" and I'll show you how to attain all this.

Send the coupon and I'll send the Free Reports—also a wonderful illustrated book telling of the future awaiting you as a Finger Print Expert.

T. G. COOKE, Pres.

**UNIVERSITY OF APPLIED SCIENCE**  
1920 Sunnyside Ave., Dept. 13-56, Chicago, Ill.

**University of Applied Science**  
1920 Sunnyside Ave., Dept. 13-56, Chicago, Ill.

Gentlemen:—Without any obligation whatever, send me the Reports of Operator No. 38, also your illustrated Free Book on Finger Prints and your offer of a FREE course in Secret Service Intelligence and the Free Professional Finger Print Outfit.

Name .....

Address .....

Age .....

# \$50 to \$100<sup>A</sup> WEEK

## While Learning Commercial Photography

Yes, you can make big money and get started in a business of your own even in your spare time. There is a tremendous money making opportunity waiting for you in Modern Photography. The picture above was made for a lingerie catalog. Thousands of manufacturers now use photographs to sell their merchandise. Here is your chance to get in on this big business. There is now a real shortage of trained photographers.

### LEARN at HOME by Wonderful New Method

No matter where you live, I can teach you how to do the kind of work turned out by the biggest and most exclusive Chicago and New York studios, right at home. Get your share of this profitable business. Within thirty days you will begin to earn big money. Joe Canaris cleared \$500 in his spare time while studying. I am so sure that you will be satisfied that I guarantee, under bond, to return every cent of your tuition if you are not satisfied.

**FREE** Write at once for my remarkable offer. I give you this Professional View Camera FREE. Just the kind of camera you need to give you a fine start in your work. This offer is open for a limited time only—don't delay. Write for further information.



**INTERNATIONAL STUDIOS, Inc.**  
3601 Michigan Avenue, Dept. 93-56, Chicago, Ill.

## Learn Expert Auto Painting



There is Big Money in auto painting and refinishing. Our Home Study Course in Practical Auto Painting will enable you to do the finest work and earn big money, or come here for training under our experts. Wonderful opportunity.

**FREE** circular tells all about this big new business. Be first. Write quick.  
**CHICAGO COLLEGE OF AUTO PAINTING**  
Dept. 94, 140 S. Dearborn St., CHICAGO, U.S.A.

**Taxidermy Book FREE.**



**Stuff Beautiful Birds.** Learn by mail to stuff and mount

all kinds of birds, animals, fish and game heads, make rugs, tax skins. Mount your own specimens and make money preserving for others. Men, women and boys learn easily and quickly. Success guaranteed or no tuition. Write today for our wonderful FREE book "How to Learn to Mount Birds and Animals. N.W. School of Taxidermy, 1776 Elwood Bldg., Omaha, Neb.

Write Today.



## BECOME A RAILWAY MAIL CLERK

Examinations coming. \$1600 to \$2300 a year. Steady life-time job. Common education sufficient. No "pull" necessary. Mail coupon for Catalog.

**Patterson Civil Service School**  
Dept. 89 ROCHESTER, N. Y.

Send me without charge your Catalog, describing this and other U. S. Government positions.

**Patterson Civil Service School**  
Dept. 89

**Rochester, N. Y.**

Name .....

Address .....



# Know Your Job and Earn Big Money!

**Y**OU can never expect to *earn* as much as the boss *earns* until you *know* as much as the boss *knows*. That is a fact which applies in every line of business, but it is particularly true in the automotive field. There is probably no other industry today where such unusual opportunities are available to *trained* men, yet there is an oversupply of "laborers" and not enough "experts" to fill the big pay jobs that are waiting. Why plug along day after day—doing the kind of low-pay work that anyone can do—when you can quickly prepare yourself *at home* for the opportunities and pay of a specialist? Why not *know* your job and earn big money?



## Big Demand for Auto Experts

There are plenty of big-pay jobs open in the automobile field to men who have *studied* the principles of automobile engineering, who have acquired a practical knowledge of every important phase of the work and who can supervise and instruct those who "never found time to study." You can quickly qualify for one of these positions and earn from \$75 to \$200 a week. It makes no difference what you are now doing—it doesn't matter whether you've had a high school or college education—you can train for a big pay job in your spare time at home; and you can *start today!*

stand, highly authoritative and thoroughly up-to-date. 2600 pages, 2000 pictures, printed on fine paper, handsomely bound, stamped in gold and indexed for ready reference. Just look at the titles below and you will understand how these books can help you to a better job and bigger pay.

### Free Consulting Membership

Back of these six big books on "Automobile Engineering" stand 20 Experts who are ready to help you until you are expert yourself. This expert advisory service is offered in the form of a *Free Consulting Membership* in the American Technical Society. A letter or wire to the Society will bring back the information you want to help you in your work. You can use this free service daily if you like. The coupon makes it available at once.

### These 6 Big Books Will Help You

Everything you want to know, ought to know, and will have to know in order to make a future for yourself in the automotive field is now available in these six big volumes of "Automobile Engineering." These six splendid books will help you to quickly acquire a knowledge of every important phase of automotive work. They are pleasant to study, easy to under-

### Send No Money—Mail the Coupon

Don't send a cent in advance—merely the coupon. When the six big volumes of "Automobile Engineering" arrive, deposit only \$3 with the postman and examine them for five days. If you decide to keep them send us \$3 monthly for six months; otherwise you may return them and get your money. Don't miss this splendid chance to *Learn* more and *Earn* more. Mail the coupon today! American Technical Society, Dept. A-92, Chicago, U. S. A.



### SPECIAL FIVE DAY EXAMINATION COUPON

AMERICAN TECHNICAL SOCIETY  
Dept. A-92, Chicago, U. S. A.

I want to *Learn* more and *Earn* more. Please send me, postpaid, the six volumes of "Automobile Engineering." I will deposit \$3 with the postman on arrival. If I decide to keep the books, I will send you \$3 monthly for six months; otherwise I may return them in 5 days and get my money. It is understood this entitles me to a Free Consulting Membership in the Society which I may use daily if I like.

Name \_\_\_\_\_  
Street \_\_\_\_\_  
City \_\_\_\_\_ State \_\_\_\_\_  
Employed by \_\_\_\_\_

## 20 Experts Stand Back of These Books — Waiting to Help You!





## This Man is Sure of His Job

He saw the handwriting on the wall. Men in his department were being dropped right and left.

He might have been the next to go but for a familiar coupon which he saw in a magazine. He tore it out, marked it, and mailed it to Scranton.

Then one day his employer called him in.

"Young man," he said, "I have just received a letter from the International Correspondence Schools telling me you have enrolled and have received a mark of 93 for your first lesson.

"I don't mind saying that this letter has saved your job. I had you on the list of men to be dropped. But I'm going to keep you now. And there are bigger things ahead of you. The man who thinks enough of his future to study his job is the kind of a man we want."

**H**OW about you? Are you sitting on the anxious bench wondering if you will be the next to go? Or are you training yourself so that you will not only be sure of your present job but will be ready for the job ahead? Your future depends on your answer.

This is all we ask: Without cost, without obligating yourself in any way, put it up to us to prove how we can help you. Just mark and mail this coupon.

### INTERNATIONAL CORRESPONDENCE SCHOOLS Box 5630-D, Scranton, Penna.

Without cost or obligation, please tell me how I can qualify for the position or in the subject before which I have marked an X:

#### BUSINESS TRAINING COURSES

- |  |   |
|--|---|
| <input type="checkbox"/> Business Management                     | <input type="checkbox"/> Salesmanship                                     |
| <input type="checkbox"/> Industrial Management                   | <input type="checkbox"/> Advertising                                      |
| <input type="checkbox"/> Personnel Organization                  | <input type="checkbox"/> Better Letters                                   |
| <input type="checkbox"/> Traffic Management                      | <input type="checkbox"/> Show Card Lettering                              |
| <input type="checkbox"/> Business Law                            | <input type="checkbox"/> Stenography and Typing                           |
| <input type="checkbox"/> Banking and Banking Law                 | <input type="checkbox"/> Business English                                 |
| <input type="checkbox"/> Accountancy (including C.P.A.)          | <input type="checkbox"/> Civil Service                                    |
| <input type="checkbox"/> Nicholson Cost Accounting               | <input type="checkbox"/> Railway Mail Clerk                               |
| <input type="checkbox"/> Bookkeeping                             | <input type="checkbox"/> Common School Subjects                           |
| <input type="checkbox"/> Private Secretary                       | <input type="checkbox"/> High School Subjects                             |
| <input type="checkbox"/> Spanish <input type="checkbox"/> French | <input type="checkbox"/> Illustrating <input type="checkbox"/> Cartooning |

#### TECHNICAL AND INDUSTRIAL COURSES

- |   |  |
|---|--|
| <input type="checkbox"/> Electrical Engineering | <input type="checkbox"/> Architect                                   |
| <input type="checkbox"/> Electric Lighting      | <input type="checkbox"/> Architects' Blue Prints                     |
| <input type="checkbox"/> Mechanical Engineer    | <input type="checkbox"/> Contractor and Builder                      |
| <input type="checkbox"/> Mechanical Draftsman   | <input type="checkbox"/> Architectural Draftsman                     |
| <input type="checkbox"/> Machine Shop Practice  | <input type="checkbox"/> Concrete Builder                            |
| <input type="checkbox"/> Railroad Positions     | <input type="checkbox"/> Structural Engineer                         |
| <input type="checkbox"/> Gas Engine Operating   | <input type="checkbox"/> Chemistry <input type="checkbox"/> Pharmacy |
| <input type="checkbox"/> Civil Engineer         | <input type="checkbox"/> Automobile Work                             |
| <input type="checkbox"/> Surveying and Mapping  | <input type="checkbox"/> Airplane Engines                            |
| <input type="checkbox"/> Metallurgy             | <input type="checkbox"/> Navigation                                  |
| <input type="checkbox"/> Steam Engineering      | <input type="checkbox"/> Agriculture and Poultry                     |
| <input type="checkbox"/> Radio                  | <input type="checkbox"/> Mathematics                                 |

Name.....

Street.....

3-6-24

Address.....

City..... State.....

Occupation.....

Persons residing in Canada should send this coupon to the International Correspondence Schools Canadian, Limited, Montreal, Canada.

## Learn Watchmaking Engraving Jewelry Repairing

I am showing these men; let me show YOU the way to independence.



### Swezey Training

In Watchmaking, Engraving, Jewelry Repairing, offers you the opportunity to get into this cleanest of trades.

brings you into contact with the best of people and

**You Can Be Your Own Boss**

J. Eric Smith, Tiffin, Ohio, one of the most successful jewelers in that part of the state, writes, "Strictly square dealings and the excellent training I received at your hands have made this possible."

Harry Townsend, another former student, writes from the U. S. Veterans Vocational School, "Two months after I came here as assistant in Watchmaking and Engraving I was put in charge. Now have two very good assistants and will require two more."

Floyd Bagdale, Waterloo, Iowa, after less than five months from the time he started, writes "My work is giving complete satisfaction, for which I give you thanks," and a month later, "I have no trouble at all with my work. Have been turning out from \$75.00 to \$100.00 repairs work per week."

Lois C. Hachon, Oelwein, Iowa, "Swezey Trained," started in a very small way, now doing over \$30,000 a year.

"SWEZEY METHODS" ARE "PROVEN METHODS"

Write today to me personally for interesting book. It's FREE.

CHICAGO SCHOOL OF WATCHMAKING

Thomas Swezey, Prin., 4845 Lincoln Ave., Chicago

## What Shall I Be?

You cannot attain real success and happiness unless you enjoy your work. We show you what occupation you are best fitted for, and guide you step by step until you succeed—eliminating all guess work. Write for free information.

BUREAU OF VOCATIONAL RESEARCH, 206 Broadway, Dept. 102, New York City

## FREE Electrical Training Book

Mail postcard for amazing FREE book on electricity. Shows you how to earn \$150 to \$600 a month in this immense field. Famous S & H shop-type training fits you quick at home for big jobs. Exclusive system. Lack of experience or education no bar. Write, S & H Engineering Co., 1422 W. Monroe St., Dept. L-1, Chicago, Ill.

## Ranger \$5 a Month

Finest bicycles built—44 Styles, colors and sizes. Factory-to-buyer prices. FREE delivery, express prepaid on 30 Days Free Trial. Cash or easy payments. Bicycles, \$21.50 and up.

Tires, lamps, wheels and equipment at half usual prices. Send no money. Write today for big catalog, special factory prices, free trial plan and marvelous offers.

**Mead CYCLE COMPANY**  
DEPT. 100 CHICAGO

Write today for free Ranger Catalog, factory prices and marvelous easy payment terms



CHARLES ATLAS

Twice pronounced the World's MOST PERFECT Man, receiving two \$1000.00 FIRST PRIZES. No other living man can claim this title.

## EXERCISE!

But do it Scientifically and have a Development you are proud of. Through my course of instructions you can take off or put on weight wherever you desire. Muscles that are powerful—yet beautiful and symmetrical—will make you the admired instead of the pitied.

**FREE** Send NOW for my amazing 64-page book full of extraordinary pictures that will thrill you and make you want to be the man or woman you should be.

Enclose a dime to cover wrapping and mailing. Grasp this opportunity of learning the rare secrets of becoming physically perfect and do it now. Address

**CHARLES ATLAS**  
96 Fifth Avenue Suite 462 NEW YORK CITY



# Look Here!



**I WILL MAKE  
YOU A  
DRAFTING  
EXPERT**



If you're earning less than \$65.00 a week GO INTO DRAFTING. I guarantee to train you AT HOME, the JOB-WAY, with actual Drafting Room jobs. Send for my free book, find out about the wonderful opportunities to earn *big money* in this easy, fascinating business. Drafting Experts are close to the Boss, are first in line for promotion to executive positions.

**\$250 to \$400 a MONTH!**

Common schooling all you need. I train you by my copyrighted "JOB-WAY" instruction. I train you thoroughly in Drafting by giving you actual Jobs to do. Most complete training, only instruction giving my original "Job-Way" training. No books or useless theory to waste your time. My graduates are SUCCESSFUL—employers ask for Coyne-trained Draftsmen. So I guarantee to satisfy you or to refund every penny of your money.

**Learn at Home!**

Thousands of big-salaried jobs, all over the country, looking for DRAFTING EXPERTS! Railroads, factories, builders, architects, ship-yards, auto-plants, Cities, Countries, States, the U. S. Government—all hungry for Drafting Experts. Man alive, wake up to your biggest opportunity!

**Experts' Outfit FREE!** "JOB-WAY" training makes you a DRAFTING EXPERT quick be-

cause you learn to do actual jobs with the same professional instruments you will use when employed at a big salary. To encourage you to START RIGHT NOW, I will give you with my course this costly outfit without one penny of cost! Coupon brings complete information.

**DRAFTING BOOK FREE!**

**Mail Coupon Today!**

Address **CHIEF DRAFTSMAN  
COYNE SCHOOL OF DRAFTING  
1920 Sunnyside Ave., Dept. 619  
CHICAGO, ILL.**



**FREE!**

**MAIL COUPON TO-DAY!**

**Chief Draftsman  
COYNE SCHOOL OF DRAFTING  
1920 Sunnyside Ave., Dept. 619, CHICAGO, ILL.**

Without obligating me in any way, please send me your book, "Drafting, the Foundation of Industry" absolutely free. Also complete information of your rapid "Job-Way" home-study Drafting course, free instruments and special offer.

Name.....

St. No.....

City..... State.....



# BE A RAILWAY TRAFFIC INSPECTOR

EARN UP TO **\$250**  
Expenses Paid **Per Month**



Many  
Chances  
for  
Advance-  
ment  
In This  
Uncrowded  
Profession

Joseph W. Mensinger writes: "It is about time to be expressing my appreciation for the position, training and courtesy that your school has given me and the **wonderful opportunities** a student has after receiving a diploma from your school, which means a well-trained inspector and **sure success**."

## Good-Paying, Pleasant Work



"I like the work fine, for it is a good-paying, healthy and pleasant position and one where business and pleasure go together. My work must be satisfactory as my wages have been increased."

"I have done considerable traveling from coast to coast, from old Mexico to Canada and on all classes of gravity, steam and electric railways. There are great opportunities for first-class inspectors and my advice to anyone wishing such a position,—anyone who likes to travel, see the sights, meet new acquaintances, etc., which is in itself a fine education to gain—is that they will make no mistake in securing a training in your school."

## POSITION GUARANTEED

Upon Graduation

**Hundreds of Openings.** We train you at home in spare time. Any average man can qualify in three months. We **guarantee** you a position upon graduation, paying at least \$110 per month and expenses, or refund what you have paid.

**Unlimited Opportunities.** A. A. Quintano writes: "I have been working in my present position for over a year and the manager is well satisfied with my work and I have already had good advancement in salary." Ralph E. Becker states: "Finished my course five months ago and **ten days after receiving my diploma** I was given position with a large railway company in the east."



This interesting work places you in contact with high railway officials. Many opportunities to travel — or remain near home. **Railroads need more trained traffic inspectors—we must supply them.**

You take no risk! Send for full details of this unusual opportunity. Mail coupon today.

Standard Business Training Institute  
BUFFALO, N. Y.

### MAIL COUPON

Standard Business Training Institute  
Buffalo, N. Y.

Send me, entirely free, Booklet No. D-63, giving full particulars about course in Railway Traffic Inspection.

Name.....  
Street.....  
City.....

# MEN WANTED

to become  
**Professional  
Photographers**



Great new opportunity to enter one of the most interesting and best paying professions on earth. No previous experience needed. Thousands of big money positions in all branches of photography: Motion Picture, Commercial, Studio Portraiture, News.



**\$100 to \$250 a Week**

There's practically no limit to the salaries paid in this fascinating field. Expert photographers receive as high as \$500 a week! Or go into business for yourself. Opportunities everywhere to start Commercial or Portrait Studio.

**LEARN AT HOME** New plan qualifies you quickly in spare time at home without interfering with present work. Start earning money at once on the side and in just a few short weeks you are ready for your career in Professional Photography.

## Motion Picture or View CAMERA FREE



Your choice of Motion Picture or View Camera absolutely FREE if you act quickly. Motion Picture Camera takes real motion pictures on standard professional film used in all theatres. View Camera is 5 x 7, anastigmatic lens for real professional work.

**Write for New Book** Send today for free, illustrated book explaining great opportunities in all branches of Photography. Also particulars of free Camera and special offer to those starting at once. This may be the big opportunity you have been looking for.

Send postcard or letter for free book NOW. Address:  
New York Institute of Photography, Dept. 499, 143 W. 36th St., N. Y. City



## U. S. Government Needs Men!

Wonderful opportunities in Civil Service. Thousands of men and women appointed every year as Income Tax Auditors, Bookkeepers, Railway Mail Clerks, Postmen, Deputy Collectors, etc. Generous salaries, short hours, liberal vacations. Positions open in Washington and in every other city of this country as well as in Porto Rico, Alaska, Hawaii and the Philippines. Write for 48-page FREE BOOKLET on CIVIL SERVICE.

Mail the Coupon To-day

INTERNATIONAL CORRESPONDENCE SCHOOLS  
Box 5638-D, Scranton, Penna.

Without cost or obligation, please send me a copy of your 48-page CIVIL SERVICE BOOKLET, which tells how I can secure a good-paying position with the U. S. Government.

Name.....  
Address.....





## Do Your Friends Marvel

at your physique as it stands today? Do they talk about you as the strongest man in the neighborhood? Most likely they do not, but if you had only enrolled with me three months ago, you would now be the talk of your friends and relatives.

This popularity would be brought about by the fact that you would now be reaping of better health and overflow of pep and endurance; strength that would make you a leader, even among real men; a physique that would make your friends wistful; you and your enemies respect your joints and muscles that would be so supple your body would possess the greatest possible suppleness. And beside these you would have learned in these three short months more about your body and its needs; more about exercise and physical culture in general than you ever have in any time in the future.

put six months or will in the same length of

## HOW WOULD A 15-INCH UPPER ARM LOOK

in place of that frail one you now possess? How would it look as good solid muscle instead of flabby fat? You can imagine how it would look, with other measurements in proportion, because you surely know that a 15-inch upper arm is a man's arm. Yes, you can imagine how it would look, but you can never get it on there with imagination. So finally, yourself that you must "make a break," "take the step"—anything for a start. That is it—get started. But just as important as starting—is the matter of starting right.

## YOU START RIGHT When You Send for My FREE Booklet

and you end right when you finish my course. The title of my Booklet is "The Royal Road to Health and Strength." It has sixty-four pages which are given to many pieces of myself and my pupils. It also gives a thorough explanation of my methods

as well as of my muscle control tests, toning, hand balancing and other valuable information. You receive all this FREE and never in the history of physical culture was there put out a booklet worth more to the eye, mind, and body. You need this Booklet.

**IMPORTANT**  
My New Leaflet, "Your Muscles, Where They Are and What They Do," will be sent with my Booklet and it is also free. Every person contemplating physical culture should get this Leaflet first. Then you will really know what you are doing. Get both of them by return mail.

**CHARLES MacMAHON**

2109 Orianna St., Philadelphia, Pa.  
STUDIO D-4

## EARN \$35 TO \$100 A WEEK

AS A MECHANICAL DRAFTSMAN. Write today for Free Book telling how we train you in spare time, at home, and help you secure a position. Fine set of professional Drafting Instruments furnished Free. Write today.

**COLUMBIA SCHOOL OF DRAFTING**  
Dept. 1-14, 14th & T Sts., N. W., Washington, D. C.

## Perfect Health Absolutely FREE through a Natural Law

Address ALOIS P. SWOBODA  
1262 Berkeley Bldg. NEW YORK

## Wanted Men and Women to Learn Photography!

Photographers and Photo-Engravers earn \$200 to \$500 a month. The field is under-wed. Learn these profitable and fascinating professions. Taught by largest and best college of its kind in the world. Established over 30 years. Demand for our graduates far exceeds supply. Good positions secured. Tuition and living expenses low.

Get this FREE Book! Write today for free book describing wonderful opportunities in this field.

Illinois College of Photography, Box 494, Effingham, Ill.

## The Automobile Storage Battery Its Care and Repair

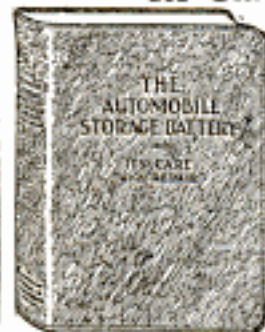

A new authoritative work upon the construction, repair and care of the storage battery used on the gasoline motor car.

### Chapter Headings

Introductory — Batteries in General — Chemical Actions which Produce Electricity — How Chemical Actions Produce Electricity — Loss of Charge in an Idle Battery — The Discharge Phenomena — The Charge Phenomena — Capacity of Storage Batteries — Internal Resistance — Battery Diseases — Conditions of Operation — How to Take Care of the Battery on the Car — Manufacture of Storage Batteries — The Workshop — Analysis of the Condition of the Battery — Work on the Battery.

289 Pages—186 Illustrations. Bound in Flexible Leather. Price, \$5.00 postpaid.

POPULAR MECHANICS BOOK DEPT., 200 E. Ontario St., CHICAGO

## The Household Painter

Intended for the use of the Household, with Full Directions for Painting, Decorating, Papering, Calcimining, Whitewashing, Stenciling, Wood Finishing, Wood Staining, Varnishing, etc. Cloth binding, Illustrated.

Price \$1.25 Postpaid

POPULAR MECHANICS BOOK DEPARTMENT  
200 E. Ontario Street, Chicago

# Blame yourself

If you are not making \$200 to \$450

a month **50 DAYS FROM NOW**

If Ellerd, Ludlow, Duffy, Rockingham, and hundreds of other men are earning \$200 to \$1200 a month as automotive electrical experts WHY NOT YOU?

These men had only 50 days' training at AMBU ENGINEERING INSTITUTE—not a day more. Now they are money-makers. My free books tell all about how these men did it. No special education—no experience needed. Just the courage to enroll now. Special Home Study Course for those who can't come to Chicago. AMBU can refer you to numerous successful graduates. Only 50 days' training—practical training in big Ambu shops—only 20 men to each class. Send for free book today for all details.

**FREE** A complete course on Radio, prepared by the Radio Board of Engineers of the American Bureau of Engineering—to the student who enrolls for the above course. Worth at least \$50—offer limited for short time—Free Book tells all. Send for it today!  
**AMBU ENGINEERING INSTITUTE**  
2632 Prairie Ave. Dept. 19 CHICAGO, ILL.

Send for this  
**FREE BOOK**  
To-Day!



**MAKE \$100 a DAY** **BE AN AUCTIONEER**  
TERM OPENS SOON: TUITION, \$100  
18 years one of the largest Auction Schools in the world. Thousands of graduates. Reference?—the first auctioneer you meet.  
CATALOG FREE  
W. B. CARPENTER, President  
Missouri Auction and Banking School  
818 Walnut Street Kansas City, Missouri

**THE COMMERCIAL ART SCHOOL** "The Oldest Professional Art School in America"  
Individual Progress — Student Sales Bureau  
Dept. 755 116 So. Michigan Blvd. CHICAGO, ILL.



**THE BART CHALK-TALK**  
If you can draw a little, you can do the Bart Chalk-Talk. Send 4c in stamps for Chalk-Talk folder and complete catalog of art and Chalk-Talk Supplies. Bart Supplies, 409 Eustis Bldg., Minneapolis, Minn.

## Joy-STOMACH for SUFFERERS

I positively guarantee Macerated Wheat to relieve the worst cases of stomach trouble and banish constipation or it costs you nothing. Soothing to a weak stomach as a poultice to inflammation. Stays down and nourishes. Testimonials without number. My reputation of 25 years backs my guarantee. Write for proof.

BYRON TYLER 172 Gibraltar Bldg. KANSAS CITY, MO.



# DETROIT

## Is the Logical Place to Learn the Automobile Business

You want to earn more money. You want to fit yourself for a better job or a business of your own. Then the automobile business is your opportunity. Literally **thousands** of trained men are needed **right now**. Come to Detroit now and learn this business right. Then go out, a trained man. Start your successful business career.

Come to Detroit now. Three-quarters of all the cars are made right here. Study autos where they are made. Learn at the "Old Reliable" **Michigan State**—endorsed by the auto makers. They approve our courses of training because they are complete, because we use up-to-date equipment, because our instructors are experts. We know how to **train you right**, and that is what you want.

### Get Into the Auto Business Now!

Learn to fill the great demand for skilled repair service. There are 15,000,000 cars in the U. S. A. alone. What a chance for the trained man! Car owners search for reliable repair shops. Garage owners advertise for competent mechanics. They don't want **green men**. But the skilled auto man always has a job.

More good garages, battery shops, tire shops, welding shops, and electric service stations are needed. Open a shop any place, right at home where your friends are; or in some other town or at country cross-roads. They are all money makers. **You are needed** to become a trained man, to do this profitable work.

### DETROIT TRAINED MEN EARN MORE MONEY

Detroit trained men get preference every time and get jobs quickly. It means a whole lot when you graduate from the "Michigan State" to go back home and tell people you trained in Detroit, the Auto Center.

Customers will go miles out of their way to take their jobs to Detroit trained men. It brings you business, jobs, success. Detroit trained men get the best jobs and the highest pay. Your "Michigan State" diploma is a valuable money-making asset.

### LEARN IN A FEW WEEKS—START NOW!

Without any previous experience—just a liking for mechanics—you can learn the automobile business in a few short weeks at the "Michigan State" in the auto center, by factory endorsed methods.

A thorough training in Detroit, at the "Michigan State" is the thing that fattens the pay envelope or puts profit in a business of your own. You can take a full Automotive Course, or specialize in any one of its money-making branches; you can be an Auto Electrician; a Tire Expert; a Battery Service Man; a Repair Man; a Welder; a Machinist; or specialize in motorized farming, with truck, tractor, and farm electric-lighting and farm engine training. Course includes training in Garage Management, Business Methods and Selling. Classes are always open. You need make no special arrangements—you can start at once—now—and that's the thing to do. The cost is so low and terms so easy that any man, anywhere, can afford it.

### EARN WHILE YOU LEARN

If necessary we can assist students to secure part time work to earn a small amount each week. Or students who wish to take our evening course will be assisted to full time day jobs. Ask for details, and when writing please explain your circumstances fully.

## MICHIGAN STATE

309 Auto Building

Detroit, Michigan





# The AUTOMOBILE CENTER

## Learn at the School Endorsed by <sup>the</sup> Manufacturers

The auto makers are the best judges of an auto school. They know how training should be given. They know the "Michigan State" training is right. That is why they endorse this school. The auto makers helped outline our courses, they furnish us equipment, they employ our graduates. When they say you will make no mistake in coming to the "Michigan State," their advice is worth a lot to you. Read some of their letters here, and many more in our big catalog.

### Up-To-Date, New Equipment

Here you learn on best equipment. All types of cars, engines, axles, transmissions, electrical systems. Some of the new cars and engines that you will find in our equipment are the new Packard Straight Eight with four wheel brakes, Packard Twin Six, new Buick with four wheel brakes, Oakland (four wheel brakes), Cadillac Eight, Hupmobile, Reo, Oldsmobile, G. M. C. truck, Hudson, Overland, and many others.

### Repairs Cost More Than New Cars

I wonder if you realize what an enormous business the repairing of cars really is. Last year the selling price of all the new automobiles sold was \$2,500,000,000, on which the dealers made a net profit of 3%, or \$75,000,000. But look at this: the selling price of parts used on repair jobs was \$2,900,000,000 or \$400,000,000 more than the price of the new cars, and the repair shops made a profit on these parts of 15%, or \$435,000,000. Nearly six times as much profit on service as on new cars!

But this is only on the parts used in repair jobs; it doesn't include the charges for the work, which run as high or higher than the parts and materials. When you add that, you see that the money spent for repairs is many times greater than the money spent for new cars. The repair business is the business to get into. And now is the time to get into it.

### Michigan State Graduates Succeed

G. C. Rice, Knoxville, Tenn., writes back to tell us, "When I commenced your course I could not drive a car; now I am assistant foreman of Reo Service with good salary. I give you the credit."

R. T. Hoppe, Elizabeth, Ill.: "I am head mechanic in this town. All the trade coming my way. The training in your school put me where I am."

L. O. Cyr, Madawaska, Me.: "Today I earn \$9.00 to \$10.00 per day and before I went to school I was a common laborer like everybody else."

Read hundreds of other graduates' testimonials in our big catalog.

### MAIL THIS COUPON NOW

Get all the interesting facts from our big catalog. It's a book of information concerning your future that you must not fail to get. It's illustrated with photos of school equipment and graduates. It tells you how you can get a good paying job—how you can go into business for yourself with little capital. Let us send it to you FREE without obligation. Mail the coupon or send us a postcard today. Write now. (We do not enroll colored students, except for our Home Study Course.)

## AUTOMOBILE SCHOOL

3729 Woodward Avenue Detroit, Michigan

### Read What Factories Say:

#### PACKARD MOTOR CAR CO., DETROIT

"I do not believe you would make any mistake in attending this school if you wish to become thoroughly experienced in the automobile business."



#### BUICK MOTOR COMPANY

"We believe the MICHIGAN STATE AUTO SCHOOL, Detroit, would best meet your requirements, as its course in technical training is most thorough and complete in every detail."

#### THE STUDEBAKER CORPORATION

"We do not know of a better automobile school than the MICHIGAN STATE."

#### HUDSON MOTOR CAR COMPANY

DETROIT, MICH., U.S.A.

"This school is thought very highly of by the automobile men of Detroit, and is considered one of the best equipped and most efficient schools in the country. You will make no mistake in attending the M. S. A. S."

#### DODGE BROTHERS

DETROIT, U.S.A.

"We believe the Michigan State Automobile School of this city to be an exceptionally high class school, and no doubt a diploma from this school would assist materially in obtaining employment with high class automobile dealers."



### Mail Coupon To Day

Michigan State Automobile School 309 Auto Building  
DETROIT, MICHIGAN

Send me FREE and without obligation your illustrated catalog, giving complete information about Detroit-training to make the most money.

Name.....

Street or R. F. D.....

City..... State.....

I am interested in  Resident Course at your School  
 Home Study Course.





## Make That Dream Come True!

"Another \$50 raise! Why, that's the third increase I've had in a year."

**WOULDN'T** you like to be able to say that? *You can!* Not by just wishing for promotion or dreaming of it, but by getting the special training that employers everywhere are looking for and are glad to pay for.

One hour a day, spent with the International Correspondence Schools in the quiet of your own home, will prepare you for the position you want in the work you like best.

Yes, it will! Put it up to us to prove it. Without cost, without obligation, just mark and mail this coupon.

### INTERNATIONAL CORRESPONDENCE SCHOOLS Box 3633-D, Scranton, Penna.

Without cost or obligation, please tell me how I can qualify for the position or in the subject before which I have marked an X:

#### BUSINESS TRAINING COURSES

- |  |   |
|--|---|
| <input type="checkbox"/> Business Management                     | <input type="checkbox"/> Salesmanship                                     |
| <input type="checkbox"/> Industrial Management                   | <input type="checkbox"/> Advertising                                      |
| <input type="checkbox"/> Personnel Organization                  | <input type="checkbox"/> Better Letters                                   |
| <input type="checkbox"/> Traffic Management                      | <input type="checkbox"/> Show Card Lettering                              |
| <input type="checkbox"/> Business Law                            | <input type="checkbox"/> Stenography and Typing                           |
| <input type="checkbox"/> Banking and Banking Law                 | <input type="checkbox"/> Business English                                 |
| <input type="checkbox"/> Accountancy (Including C.P.A.)          | <input type="checkbox"/> Civil Service                                    |
| <input type="checkbox"/> Nicholson Cost Accounting               | <input type="checkbox"/> Railway Mail Clerk                               |
| <input type="checkbox"/> Bookkeeping                             | <input type="checkbox"/> Common School Subjects                           |
| <input type="checkbox"/> Private Secretary                       | <input type="checkbox"/> High School Subjects                             |
| <input type="checkbox"/> Spanish <input type="checkbox"/> French | <input type="checkbox"/> Illustrating <input type="checkbox"/> Cartooning |

#### TECHNICAL AND INDUSTRIAL COURSES

- |   |  |
|---|--|
| <input type="checkbox"/> Electrical Engineering | <input type="checkbox"/> Architect                                   |
| <input type="checkbox"/> Electric Lighting      | <input type="checkbox"/> Architects' Blue Prints                     |
| <input type="checkbox"/> Mechanical Engineer    | <input type="checkbox"/> Contractor and Builder                      |
| <input type="checkbox"/> Mechanical Draftsman   | <input type="checkbox"/> Architectural Draftsman                     |
| <input type="checkbox"/> Machine Shop Practice  | <input type="checkbox"/> Concrete Builder                            |
| <input type="checkbox"/> Railroad Positions     | <input type="checkbox"/> Structural Engineer                         |
| <input type="checkbox"/> Gas Engine Operating   | <input type="checkbox"/> Chemistry <input type="checkbox"/> Pharmacy |
| <input type="checkbox"/> Civil Engineer         | <input type="checkbox"/> Automobile Work                             |
| <input type="checkbox"/> Surveying and Mapping  | <input type="checkbox"/> Airplane Engines                            |
| <input type="checkbox"/> Metallurgy             | <input type="checkbox"/> Navigation                                  |
| <input type="checkbox"/> Steam Engineering      | <input type="checkbox"/> Agriculture and Poultry                     |
| <input type="checkbox"/> Radio                  | <input type="checkbox"/> Mathematics                                 |

Name.....  
Street..... 3-6-24  
Address.....

City..... State.....

Occupation.....

Persons residing in Canada should send this coupon to the International Correspondence Schools Canadian, Limited, Montreal, Canada.

## Read Jimmy De Forest's Book



The world-famous trainer and conditioner of Jack Dempsey, Louisbrot, Firpo, Rocca, Albert Hubard and many others has written "Physical Fitness and the Pay Envelope," a book for ambitious men.

De Forest bases his book on the accepted fact that the physically fit man commands the big income. It's full of news. Ten cents to cover postage and mailing brings you a copy.

**Jimmy De Forest Physical Training System**  
347 Madison Ave., Dept. 33, New York City

**SEND  
FOR  
IT!**

## LEARN MUSIC

**AT HOME!** Special Short Time Offer—Easy Lessons Free—Piano, Organ, Violin, Banjo, Mandolin, Guitar, Cornet, Harp, Cello, Singing, etc. You pay only for music and postage—which is small. No extras. Beginners or advanced pupils. Plain, simple, systematic. Twenty-five years' success. Start at once. Send for special short-time offer and free booklet and illustrated folder by return mail. Address **U. S. SCHOOL OF MUSIC, 79 Brunswick Building, NEW YORK CITY**

## Choose as Your Profession ELECTRICAL ENGINEERING

Electricity offers a brilliant future to the young man who is about to choose his career. Never before has there been such wonderful opportunity in this great field. Big paying positions in electrical work the world over are open to trained men.

### B. S. Degree in 3 Years

Come to School of Engineering of Milwaukee. Here you are trained in both theory and practice by a faculty of experts. You learn in large, finely equipped laboratories. If you have 14 high school credits or equivalent, you can become an Electrical Engineer with a Bachelor of Science degree in 3 years. If you lack these credits they can be made up in our institute of Electrotechnics in a short, intensive course.



### A Complete, Practical, Electrical Education

Learn by the thorough approved scientific methods which our seventeen years of specializing enable us to give you. In addition to Electrical Engineering, the following complete courses are given: **A. C. and D. C. Armature Winding—Wiring and Testing—Practical Electricity—Drafting—Electrotechnics—Commercial Engineering—Automotive Electrical Engineering and Automotive Electricity.**

### EARN WHILE YOU LEARN

You can earn money to help defray your expenses while learning. Our wonderful co-operative plan brings an Electrical Career within the reach of every ambitious man. Our Free Employment Department secures positions for those students who wish to earn part or all of their expenses. In addition, the Department will help you get a good position in the Electrical industry when your training is completed. The new Students' Loan Fund offers financial aid to worthy men. Daily Broadcasting WIAO.

**Fall  
Term  
Opens  
Sept. 2nd**

**Big Book FREE** Mail the coupon today for our big new illustrated catalog. Mention the course that interests you most and we will send you special information. Read about the school that trains men for practical and quick success. See how easy it is for you to get the training that will enable you to step to a splendid position and a handsome income. Mail the coupon right NOW. No cost or obligation.

## SCHOOL OF ENGINEERING OF MILWAUKEE

Dept. P M 924, 415 Marshall Street, Milwaukee, Wis.

School of Engineering of Milwaukee  
Dept. P M 924, 415 Marshall St., Milwaukee, Wis.

Please send me your free illustrated catalog; also details of your "Earn While You Learn" plan.

Name.....

Address.....

Town..... State.....

Age..... Education.....

Course Wanted.....



# There's a Big Future for You in Electricity



## Pick the Job You Want and Train for it at Home

With These 8 Big Books and the Free Help  
of 20 Experts You Can Start Today!

ARE you doing the kind of work you like to do and getting the salary you would like to have? What sort of a future do you see in your present work and how long will you have to wait for a chance at a big job with real pay? Just look at the facts for a moment. Then ask yourself one more question and you'll have the answer to your problem:—Are you getting paid for what you *know* or merely for what you *do*?

### Big Demand For Trained Men

There are two types of men in the electrical field as in every other line of business—those who *give* orders and those who *take* them. The first are the *trained* men—men who have studied the principles of electricity, acquired a knowledge of its practical application and who are able to tackle the *big pay* jobs and supervise every phase of the work. The others are the *laboring* men—men who "never found time to study," who work only with their hands, and who are dependent on the man with the trained mind for supervision and guidance.

### Get In Line For More Pay

There are thousands of "hand workers" in the electrical field and not enough "brain workers." Yet the only difference between the two is knowledge; and knowledge is quickly acquired through study. There's a big demand for *trained* men and plenty of big pay jobs waiting. Why not get in line for a real job and a real salary? Thousands of men of all ages, in all walks of life, have trained themselves for such big paying jobs

as Electrical Contractor, Power House Foreman, Radio Expert, Electrical Salesman, Telephone Wire Chief and numerous other positions of responsibility and profit. You can do the same. *And you can start today!*

### These 8 Books Will Help You

These eight big volumes of "Applied Electricity" will help you to quickly acquire a knowledge of electricity in all its branches. They are pleasant to study, easy to understand, highly authoritative and thoroughly up-to-date. You will find them a handy guide in your work, a ready solution to your problems and a dependable help to a better job and bigger pay.

### Free Consulting Membership

Back of these eight electrical books, stand 20 Experts who are ready to help you qualify for the job you want. This expert advisory service is offered FREE by the American Technical Society to every man who sends for a set of "Applied Electricity" on the easy monthly terms. By ordering this splendid set of home study books today you receive a *Free Consulting Membership* in the society. A letter or wire to the Advisory Staff will bring you the information and help you need. You can use this expert service daily until you are expert yourself. The coupon will make it available immediately.

### Send No Money

Don't send a cent in advance—merely the coupon. The eight volumes of "Applied Electricity" will be shipped at once, parcel post prepaid. When the books arrive deposit only \$3 with the postman and, if you decide to keep them, send us \$3 monthly for nine months. Otherwise you may return them in 5 days and get your money. Don't miss this offer. Here is your chance to *Learn* more and *Earn* more. Mail the coupon today and prove it.

AMERICAN TECHNICAL SOCIETY  
Dept. E-92, Chicago, U. S. A.

### Here They Are—Look at Them

Eight Big Volumes—3,800 Pages—3,000  
Pictures—Printed on Fine Paper—  
Attractively Bound—Stamped in  
Gold and Indexed for Ready  
Reference.



### SPECIAL 5 DAY EXAMINATION COUPON

American Technical Society  
Dept. E-92, Chicago, U. S. A.

I want to *Learn* more and *Earn* more. Please send me, post paid, the eight volumes of "Applied Electricity." I will deposit \$3 with the postman on arrival and, if I decide to keep the books, will send you \$3 monthly for nine months. Otherwise I may return them in 5 days and get my money. It is understood this entitles me to a Free Consulting Membership in the Society, which I can use daily if I like.

Name \_\_\_\_\_

Street \_\_\_\_\_

City \_\_\_\_\_

State \_\_\_\_\_

Employed by \_\_\_\_\_



## YOU Too Can Make \$125<sup>00</sup> A WEEK



"I had no experience in selling before going with GOODWEAR. Now I make \$125 a week regularly. I believe that any man who'll work can do the same, and would advise every man who wants a fine paying job to write to GOODWEAR."

Peter Birdakis

To earnest men everywhere we offer a wonderful opportunity taking orders for our fine, pure wool suits and overcoats, regular \$55 values, all at the one low price of \$31.75. Our values are so remarkable they sell on sight. You get your commissions in advance; simply take the orders, and we deliver and collect. Our salesmen are making \$50 to \$125 a week and even more.

No experience is needed and spare time will do. We teach and train you, supply the finest selling outfit in America, big 6x9 cloth samples and everything else you need, all packed in a beautiful carrying case. If you want to get into a high-class business, make big money, and be independent, write for full information today. Address Dept. 201.

### GOODWEAR Chicago, Inc.

West Adams Street at Peoria CHICAGO

Please send me complete information about your Line and the opportunity you offer: 201

Name.....

Address.....

Town..... State.....



### FOR YOU—MR. SIGN PAINTER

It's the very newest and latest help for Sign Painters and Showcard Writers. Letter Patterns. Helps the inexperienced and aids the finished expert. Make Sign Painting and Showcard Writing an easy to A. B. C. Sample for stamp. John F. Rahn, A 2433 Greenview Ave., Chicago



## RAILWAY MAIL CLERKS NEEDED

Thousands of appointments yearly. Permanent positions. Good salaries. Pleasant work. Generous vacations. And you can study at home in your spare time! World's largest correspondence school. Individual instruction. Thousands of successful students. Write to-day for full details.

INTERNATIONAL CORRESPONDENCE SCHOOLS, Box 5637-D, Scranton, Penna.



## Make Money Drawing Cartoons

It's Easy To Learn When Shown In The Right Way

Some of the cleverest cartoonists and comic artists in America today learned to draw during their spare time by following CARTOONIST EVANS' SIMPLE AND EASY METHOD. This school is recommended by foremost cartoonists because they know the students are handled right. If you like to draw, send a sample of your work, either an original or a copy, and we will send you a portfolio of cartoons and full details. The course is NOT EXPENSIVE.

The W. L. Evans School of Cartooning 821 Leader Building CLEVELAND, OHIO

## WANTED

RAILWAY MAIL CLERKS

\$1600 to \$2300 Year

MEN—BOYS 18 UP.

MAIL COUPON IMMEDIATELY

Steady work. No layoffs. Paid Vacations

Common education sufficient:

TRAVEL—SEE YOUR COUNTRY

## BE A PAINTER Earn \$10 to \$20 a Day

We will teach you in a short time to be an expert, all-round painter capable of doing any kind of a job—sign and pictorial painting, house painting, calcimining and paper hanging, show card writing, graining and marbling.

### STEADY WORK—BIG PAY

Painters and decorators always in demand the year round. Pay up to \$20 a day—\$125 a week—\$500 a month. Pleasant outdoor and indoor work. You learn by doing actual painting and decorating jobs under guidance of skilled experts. Learn quick and step at once into a big job. Work under boss painter at big wages or go into business for yourself as contract painter and decorator! Earn your way—Day and Evening Classes.

WRITE NOW for full particulars. FREE!

SUPERIOR SIGN SCHOOL, 2139 S. Wabash Ave., Dept. 101, Chicago, Ill.

## Your Salary

Is it adequate compensation for your ability?  
Write for our interesting free circular.

**PREFERRED POSITIONS, Inc.**  
6 North Michigan Ave. Chicago, Ill.

## \$500<sup>00</sup> a Week and More

Prepare yourself for a big pay job in the Automobile business after a few weeks training in New York. Learn with tools, not books. Personal instruction. Founded 1909. Thousands of successful graduates. Our Employment Dept. helps you to earn while you learn and can place you in a good position after you graduate.

**Free Book** Write today for new illustrated catalogue describing in detail the Stewart School and the opportunities in the Automotive industry.

STEWART AUTOMOBILE SCHOOL  
225 W. 57th St. Dept. 1756 New York

## Learn Watchwork, Jewelrywork and Engraving.

A fine trade commanding a good salary, and your services are always in demand. Address Horological, Dept. P, Bradley Institute, PEX. 41A, ILL., for our latest catalog.



FRANKLIN INSTITUTE, Dept. N178, Rochester, N. Y.  
Sirs: Send me without charge, (1) Sample Railway Mail Clerk Examination questions, (2) Send List of U. S. government jobs now obtainable, (3) Send free illustrated book, "How to Get Government Jobs."

Name.....

Address.....



# Drawing Table Free!

Yes, this is exactly what I am doing. I am giving this drafting table free to you when you enroll as my student. I do this because I want you to have the right kind of Draftsman's Working Outfit — because I want to help ambitious men and boys get ahead. This is the kind you will use when you have completed my course and have become a regular draftsman.

## Complete Drawing Outfit FREE

Besides the drafting table I also furnish free the set of regular working instruments shown here. You get both table and instruments free if you enroll at once. I will do everything possible to help you get ahead.



Mail Free  
Coupon Below

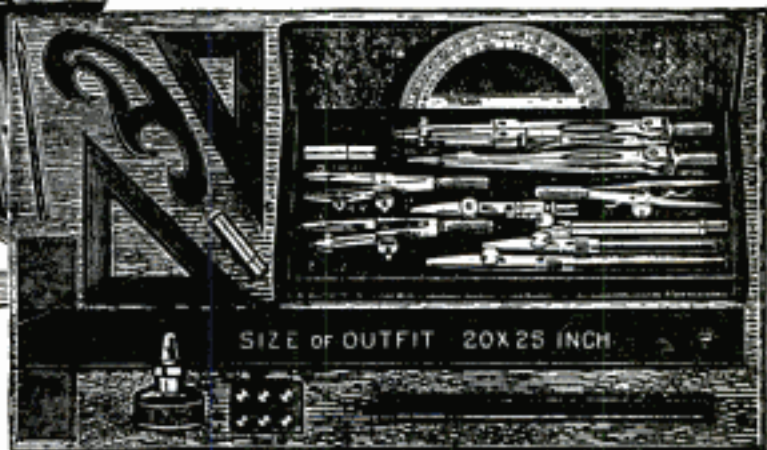

## Also FREE \$90 Drafting Course

To my students enrolling now I give an opportunity of getting a \$90 drafting course absolutely without cost to them. This means you need not pay me for my personal instructions or for the complete working outfit.

### Salaries up to \$250 and \$300 a Month

Positions paying up to \$250 and \$300 a month which ought to be filled by skilled draftsmen are vacant everywhere. There are in every part of the country ambitious men, who with practical training and personal assistance will be qualified to fill the positions. I can now take and train a limited number of students, guarantee to train them by mail UNTIL placed in a permanent position at a salary up to \$250 and \$300 a month.

### The Well-Trained Man Always Has a Job

No time like the present to get training in draftsmanship. Even when jobs are hard to find, the trained man is seldom out of work. His income goes on in good times and bad. Be a skilled draftsman. Don't lose a single week.

## Mail Coupon For Free Book

Mail coupon at once for full information about how you can get the table and working instruments Free, also how you can get the \$90 drafting course Free. I'll mail you my free book just as soon as I receive the coupon.

Chief Draftsman, Engineers' Equipment Co.  
1951 Lawrence Ave., Div. 93-56 Chicago, Ill.

## I Guarantee

to instruct you until competent and in a permanent paying position at a regular draftsman's salary of at least \$250 per month and guarantee to furnish you free, complete draftsman's working outfit, free, "Chief's Own" drawing table and all the instruments you need just as soon as you become my student.



Chief Draftsman Dobe

Chief Draftsman, Engineers' Equipment Co.  
1951 Lawrence Ave., Div. 93-56 Chicago, Ill.

Without any obligation to me please mail your book "Successful Draftsmanship" and full particulars of your liberal "Personal Direction" offer to a few students. Also full information as to how I can get a \$90 Drafting Course Free.



Name .....

Address .....

Age .....





## "Keep Your Eye on Jim!"

"It's not alone what a man does during working hours, but outside of working hours—that determines his future. There are plenty of men who do a good job while they're at it, but who work with one eye on the clock and one ear cocked for the whistle. They long for that loaf at noon and for that evening hour in the bowling alley. They are good workers and they'll always be just that—ten years from now they are likely to be right where they are to-day.

"But when you see a man putting in his noon hour learning more about his work, you see a man who won't stay down. His job to-day is just a stepping-stone to something better. He'll never be satisfied until he hits the top. And he'll get there, because he's the kind of man we want in this firm's responsible positions. You can always depend on a man like Jim.

"Every important man in this plant won out in the same way. Our treasurer used to be a bookkeeper. The sales manager started in a branch office up state. The factory superintendent was at a lathe a few years ago. The chief designer rose from the bottom in the drafting room. The traffic manager was a clerk.

"All these men won their advancements through spare-time study with the International Correspondence Schools. To-day they are earning four or five times—yes, some of them ten times as much money as when they came with us.

"That's why I say that Jim there is one of our future executives. Keep your eye on him. Give him every chance—he'll make good!"

Employers everywhere are looking for men who really want to get ahead. If you want to make more money, show your employer that you're trying to be worth more money. If you want more responsibility, show him you're willing to prepare yourself for it.

For 32 years the International Correspondence Schools have been training men and women right in their own homes after supper, or whenever they had a little time to spare. More than two million have stepped up in just this way. More than 180,000 are studying now. Ten thousand are starting every month. Can you afford to let another priceless hour pass without making your start toward something better? Here is all we ask—without cost, without obligation, mark and mail this coupon. It's a little thing that takes but a moment, but it's the most important thing you can do to-day. Do it now!

### INTERNATIONAL CORRESPONDENCE SCHOOLS

Box 5632-D, Scranton, Penna.

Without cost or obligation, please tell me how I can qualify for the position or in the subject before which I have marked an X:

#### BUSINESS TRAINING COURSES

- |  |   |
|--|---|
| <input type="checkbox"/> Business Management                     | <input type="checkbox"/> Salesmanship                                     |
| <input type="checkbox"/> Industrial Management                   | <input type="checkbox"/> Advertising                                      |
| <input type="checkbox"/> Personnel Organization                  | <input type="checkbox"/> Better Letters                                   |
| <input type="checkbox"/> Traffic Management                      | <input type="checkbox"/> Show Card Lettering                              |
| <input type="checkbox"/> Business Law                            | <input type="checkbox"/> Stenography and Typing                           |
| <input type="checkbox"/> Banking and Banking Law                 | <input type="checkbox"/> Business English                                 |
| <input type="checkbox"/> Accountancy (including C.P.A.)          | <input type="checkbox"/> Civil Service                                    |
| <input type="checkbox"/> Nicholson Cost Accounting               | <input type="checkbox"/> Railway Mail Clerk                               |
| <input type="checkbox"/> Bookkeeping                             | <input type="checkbox"/> Common School Subjects                           |
| <input type="checkbox"/> Private Secretary                       | <input type="checkbox"/> High School Subjects                             |
| <input type="checkbox"/> Spanish <input type="checkbox"/> French | <input type="checkbox"/> Illustrating <input type="checkbox"/> Cartooning |

#### TECHNICAL AND INDUSTRIAL COURSES

- |   |  |
|---|--|
| <input type="checkbox"/> Electrical Engineering | <input type="checkbox"/> Architect                                   |
| <input type="checkbox"/> Electric Lighting      | <input type="checkbox"/> Architects' Blue Prints                     |
| <input type="checkbox"/> Mechanical Engineer    | <input type="checkbox"/> Contractor and Builder                      |
| <input type="checkbox"/> Mechanical Draftsman   | <input type="checkbox"/> Architectural Draftsman                     |
| <input type="checkbox"/> Machine Shop Practice  | <input type="checkbox"/> Concrete Builder                            |
| <input type="checkbox"/> Railroad Positions     | <input type="checkbox"/> Structural Engineer                         |
| <input type="checkbox"/> Gas Engine Operating   | <input type="checkbox"/> Chemistry <input type="checkbox"/> Pharmacy |
| <input type="checkbox"/> Civil Engineer         | <input type="checkbox"/> Automobile Work                             |
| <input type="checkbox"/> Surveying and Mapping  | <input type="checkbox"/> Airplane Engines                            |
| <input type="checkbox"/> Metallurgy             | <input type="checkbox"/> Navigation                                  |
| <input type="checkbox"/> Steam Engineering      | <input type="checkbox"/> Agriculture and Poultry                     |
| <input type="checkbox"/> Radio                  | <input type="checkbox"/> Mathematics                                 |

Name.....

Street.....

Address..... 3-6-24

City..... State.....

Occupation.....

Persons residing in Canada should send this coupon to the International Correspondence Schools Canadian, Limited, Montreal, Canada.

# WEALTH, HONOR, RICHES

Do not depend upon opportunity or intellectual brilliancy of any kind, because it is well known that uneducated people often acquire great wealth, while cultured and talented people remain in poverty.

Again, they do not depend upon capital, because many men with capital lose what they have, while others with no capital acquire phenomenal wealth.

Whatever finds a place in human experience is the result of the operation of natural laws, and the determining factors are therefore within your own control.

This may seem "too good to be true," but if you will consider that by the touch of a button or the turn of a lever science has placed almost infinite resources at the disposal of man, it becomes evident that there may be still other laws not generally known which contain even greater possibilities.

We have published a Remarkable little book, giving the conclusions of science concerning these laws, which we will send upon request. If you want to underwrite success on a magnificent scale, send for it.

### MASTER-KEY INSTITUTE

214 Howard Bldg.,

ST. LOUIS, MO.

# EXPERTS

Teach you to become an expert in the Auto or Building Trades at the STANDARD TRADE SCHOOL

Learn  
One  
of  
These  
Big  
Pay  
Trades

Learn a trade in the auto or building business. Become an expert and earn \$10 to \$18 per day. STANDARD TRADE SCHOOL TRAINING guarantees to make you a big pay expert in a few short weeks of intensive training. Standard courses are short but THOROUGH. You learn by actually doing by "on-the-job" methods, without books or rules, but with your head, hand and tools. You are trained under the personal supervision of STANDARD EXPERT INSTRUCTORS. To have a trade is to have capital—it is the sure foundation of success. Capitalize this opportunity to secure the training you need before the big Fall rush starts. Don't let lack of ready money stop you — if you have the will, we'll supply the way. Our "Free Employment Bureau" has hundreds of requests for men every day. Possibly one of these "pay as you earn" jobs are just what you need. Hundreds of our graduates are in business for themselves and others are earning big pay—so can you—by qualifying as an EXPERT.

Write TODAY for our big, brand new catalog just off the press. Clip the coupon NOW

Standard Trade School

416 Woodward Avenue, Detroit

Auto Repairing <input type="checkbox"/>	Auto Metal Finishing <input type="checkbox"/>
Auto Painting <input type="checkbox"/>	Auto Battery Building <input type="checkbox"/>
Auto Trimming <input type="checkbox"/>	Auto Electrician <input type="checkbox"/>
Bricklaying <input type="checkbox"/>	Plastering <input type="checkbox"/>
Plumbing <input type="checkbox"/>	Construction Electrician <input type="checkbox"/>

Name.....

Street..... City.....



# Sand in Your Bearings?

You love inventions and machinery—you wouldn't be reading Popular Mechanics if the subject didn't fascinate you.

No machine ever constructed can compare in marvelous, all-around efficiency with the one in your own body; get wise to your own machine.

The human machine will stand a lot of abuse—ininitely more than any man-made mechanism—but like the latter, some parts wear out and BREAK DOWN if they do not get the attention they ought to have. You know when your physical machinery is running wrong, just as you do your car or watch. **Don't ignore the signs of inward trouble.**

## DON'T WAIT for THE MACHINERY TO BREAK DOWN

Chronic ailments, dyspepsia, biliousness, rheumatism, pimples, bad breath, constant lassitude or headaches, are red-light warnings that there is "sand in the bearings"—a screw loose somewhere—danger that the machine will rack itself to pieces if it isn't overhauled and put in order.

Busy men often "don't bother" about what they consider minor ailments. They put off from day to day "doing something" about them; or dope themselves with patent medicines, pills and potions, hoping to get relief that way. They don't realize how they HANDICAP themselves.

## ARE YOU MAKING THAT MISTAKE?

Are you underestimating some chronic ailment—not realizing that it may be poisoning your blood, weakening your vital organs, cutting off your chances of success in life, and gradually making you a thing despised by red-blooded men and tolerated with pity by the women you admire?

Many men today are doing so. Thousands of men and women—some of them when they came to me on the very brink of a breakdown—have found in STRONGFORTISM a PERMANENT RELIEF, and with it new Health and Strength and ability to Enjoy Life.

# STRONGFORTISM

**The New Science of Health Promotion and Muscle-building** will rejuvenate your brain, heart, lungs, liver; muscular, nervous, digestive and assimilative systems; all working together in harmony, like the parts of a perfectly constructed, well-oiled machine—that means Health, Strength, Virility—FITNESS to do a man's work, vigor in all parts, to enjoy life to the full and make a success of it—and that is exactly what STRONGFORTISM is bringing to thousands of my pupils scattered throughout the world.



**LIONEL STRONGFORT**

DR. SARGENT, of Harvard, declared that "Strongfort is unquestionably the finest specimen of physical development ever seen."

That is what it will bring to you, whatever your present condition and whether or not the fault is your own, if you follow its principles for a short time. I GUARANTEE IT.

Learn what a simple, safe, sure, scientific method of personal re-invigoration and re-vitalization STRONGFORTISM is. Then you won't wonder it has been so enormously successful in every quarter of the globe.

I have written a new book "DO IT WITH MUSCLE," full of Bare-Faced facts about your Body.

It will tell you all about Strongfortism and tell you the facts about your Body which you would be glad to pay for in good money.

Get out your pen or pencil right now; fill in the coupon, enclose a dime to help pay mail charges, and it will bring you free my new book, besides a special, confidential letter from me in a plain sealed envelope. **Mail it to me TODAY**, using coupon.

# Lionel Strongfort

Physical and Health Specialist for Over 25 Years  
Dept. 1600, Newark, N.J., U.S.A.

## CONSULTATION COUPON

**Absolutely Confidential**

LIONEL STRONGFORT, Department 1600, Newark, N. J.

Send me free my private copy of "DO IT WITH MUSCLE," for which I enclose one dime (10c) towards mailing expense. It may teach me something startling about ME. Send me special information on subjects marked (X) below, without obligation. If you have taken my "Regular" or "Advanced" courses, kindly indicate same by making a cross in box for this purpose in coupon.

..... Colds	..... Skin Disorders
..... Catarrh	..... Debility
..... Too Fat	..... Torpid Liver
..... Too Thin	..... Vitality Restored
..... Stomach Trouble	..... Muscular Development
..... Flat Chest	..... Great Strength
..... Bad Blood	..... Rupture
..... Nervousness	..... Lumbago
..... Constipation	..... Neuralgia

Name.....

Age..... Occupation.....

Address.....

I have taken your  "Regular" course      I have taken your  "Advanced" course

I have also received your book "Promotion and Conservation of Health, Strength and Mental Energy". Date.....





## How I Make \$400<sup>00</sup> a Month in RADIO

"A few months ago I was plodding away on a dull, small-pay job. Now, I am in business for myself. I am my own boss. I make over \$400 a month—and the amazing thing about it all is that until a few months ago when I started with you I didn't know the first thing about Radio."

Every week letters like this arrive at the office of the director of National Radio Institute—letters which indicate the amazing successes made by graduates of this school.

Radio offers golden opportunities today. Thousands of trained men are wanted as Radio Executives, Radio Salesmen, Radio Engineers, Radio Operators, etc.

You can easily qualify at home for any one of these big pay positions during your spare time. The National Radio Institute—the biggest and best—will guarantee to make you a Radio expert in a few months. All necessary instruments are furnished you free. You can take the easy, quick road to wealth that thousands of others have taken.

### Send for BIG BOOK

Radio will pay you ten times more money than any other field just now. Let us show you what wonderful salaries our graduates are making—read about the splendid positions now open to you in Radio. Send today for free 32-page book, "Rich Rewards in Radio," and see how easy it is to become a Certified Radio Expert in your spare time, and how you can qualify for a splendid radio position, paying from \$50 to \$250 a week! Mail coupon now for this "big-pay" book. National Radio Institute, Dept. 15JA, Washington, D. C.

**NATIONAL RADIO INSTITUTE**  
Dept. 15JA, Washington, D. C.

Send me the book, "Rich Rewards in Radio," which tells all about the opportunities in Radio, how spare time study at home will qualify me quickly as a Certified Radiotrician so I can get one of these splendid positions, and how your Free Employment Service helps me to secure a good position.

Name..... Age.....

Address..... Occupation.....

City..... State.....



## play *for profit or -just for fun*

THE new Gibson Mastertone banjo fills your leisure hours with the pleasure of music you like—as you play it yourself. So easy to learn, you master it quickly, because of exclusive Gibson features. Play professionally, if you choose, whole or part time, and increase your income. Banjo players are in great demand.

Write for details of Free Trial; Easy Payments on any Gibson banjo, mandolin, mandola, mando-cello or guitar.

GIBSON, INC.

911 Parsons St., Kalamazoo, Mich.



Wm. Crookes, Hartford, Conn. banjoist uses and endorses the Gibson. Let us tell you of the opportunities opened by the new epoch in music which crosses stringed instruments.

# Gibson

STRINGED INSTRUMENTS

World's Leading Manufacturers

## HOME STUDY

### Become More Efficient

through courses in Chemistry, History, Mathematics, English, Psychology, Education, Business and 35 other subjects which the University gives by mail. They command credit toward a Bachelor degree and may be begun at any time.

The University of Chicago 15 Ellis Hall Chicago, Ill.

The University of Chicago 15 Ellis Hall Chicago, Ill.

### YOU CAN BE A

## \$5000 AUTO EXPERT

Here's the quickest way to big pay work. Taken only an hour a day of your spare time for a few months. Robinson jumped from \$20 to \$100 a week in six months. You, too, can boss Auto Job. I'll show you how. Learn at home. Learn by "Job-Way" Plan. Send for big illustrated book, explaining "Job-Way" course. Tells about money back guarantee, free tools offer. Low price and easy terms. Book is free. No obligation. A postal will do. Write NOW.

J. R. BAYSTON, Pres., CHICAGO AUTOMOTIVE INSTITUTE  
Dept. 1776 536 South Clark Street, Chicago, Illinois

## LEARN TO GET DOLLARS OUT OF WATCHES.

WATCH-REPAIRING, ENGRAVING, JEWELRY REPAIRING.



WRITE NOW,

ENICAR TRADE SCHOOL  
530 W MONUMENT SQUARE, RACINE, WIS.

## MEN; WOMEN; WANTED

U. S. Government Jobs. Easy, pleasant work. \$1140 to \$3000 year. Paid vacation. Short hours. Experience unnecessary. Write IMMEDIATELY for free list positions open. FRANKLIN INSTITUTE, Dept. N183, Rochester, N. Y.

## BE AN ARTIST

Comics, Cartoons, Commercial, Newspaper and Magazine Illustrating, Panel Croquet Portraits and Pastimes. Our simple method quickly develops your talent in spare time. By Mail or Local Classes. Write for terms and list of successful Students. ASSOCIATED ART STUDIOS Dept. K-100 W. 23rd St., NEW YORK.



# Unrivalled Accountancy Training



LaSalle Extension University has so long dominated the field of Higher Accountancy training that its standing in this field is generally recognized as supreme.

## Points of Superiority:

**1 COMPREHENSIVENESS:** The LaSalle course is the most comprehensive because it embraces the entire range of accounting—with electives covering all the principal types of business, industry, and organization.

**2 INSTRUCTION STAFF:** No other institution approaches LaSalle in the size and standing of its Accountancy Instruction Staff, which is composed of over seventy-five instructors—thirty-one Certified Public Accountants, including men of the highest standing in the profession. The staff is headed by Wm. B. Castenholz, C.P.A., M.A.I.A., author of Cost Accounting Procedure, and Auditing Procedure.

**3 EXPERIENCE:** Having for many years held first rank in the Accountancy field, LaSalle has trained far more Accountants and has made many more C.P.A.'s than any other institution. Its graduates are holding high salaried positions with business firms in every American and Canadian city.

**4 PRACTICAL METHOD:** LaSalle training can be had without interruption to a man's present work. The *LaSalle Problem Method* of home-study hurls the student right against the actual problems of the factory, office, store, bank, etc., and he solves these problems by actually doing them under the direction of experts. The big propositions of business are open to the men who can solve the problems of business.

**5 STANDING WITH BIG BUSINESS:** On account of the widely recognized standing of LaSalle in the Accountancy field, and the wide range of its students, it is the first source of supply turned to by Public Accountants and

business executives when in need of all kinds of Accountants, from cost clerks and auditors at moderate salaries up to treasurers and controllers at very handsome salaries.

**6 PLACEMENT SERVICE:** LaSalle maintains a Placement Department to give employment service free to both students and employers.

**7 SAVING IN TIME:** It has been abundantly demonstrated that nowhere else can you develop such practical and quick application of your abilities to insure your greater business success as thru the LaSalle Problem Method of training and service. Training for junior and senior positions in Accountancy consumes less than two-thirds the time required by any other practical and thoro advanced Accountancy training.

Write for Catalog and complete information sent free upon request.

### —FREE BOOK COUPON—

LaSalle Extension University  
Dept. 964-HR Chicago, Ill.

Please send me your book, "Accountancy, the Profession That Pays" and full information regarding the course and service. Also a copy of your book, "Ten Years' Promotion in One," all without obligation to me.

Name.....

Present Position.....

Address .....





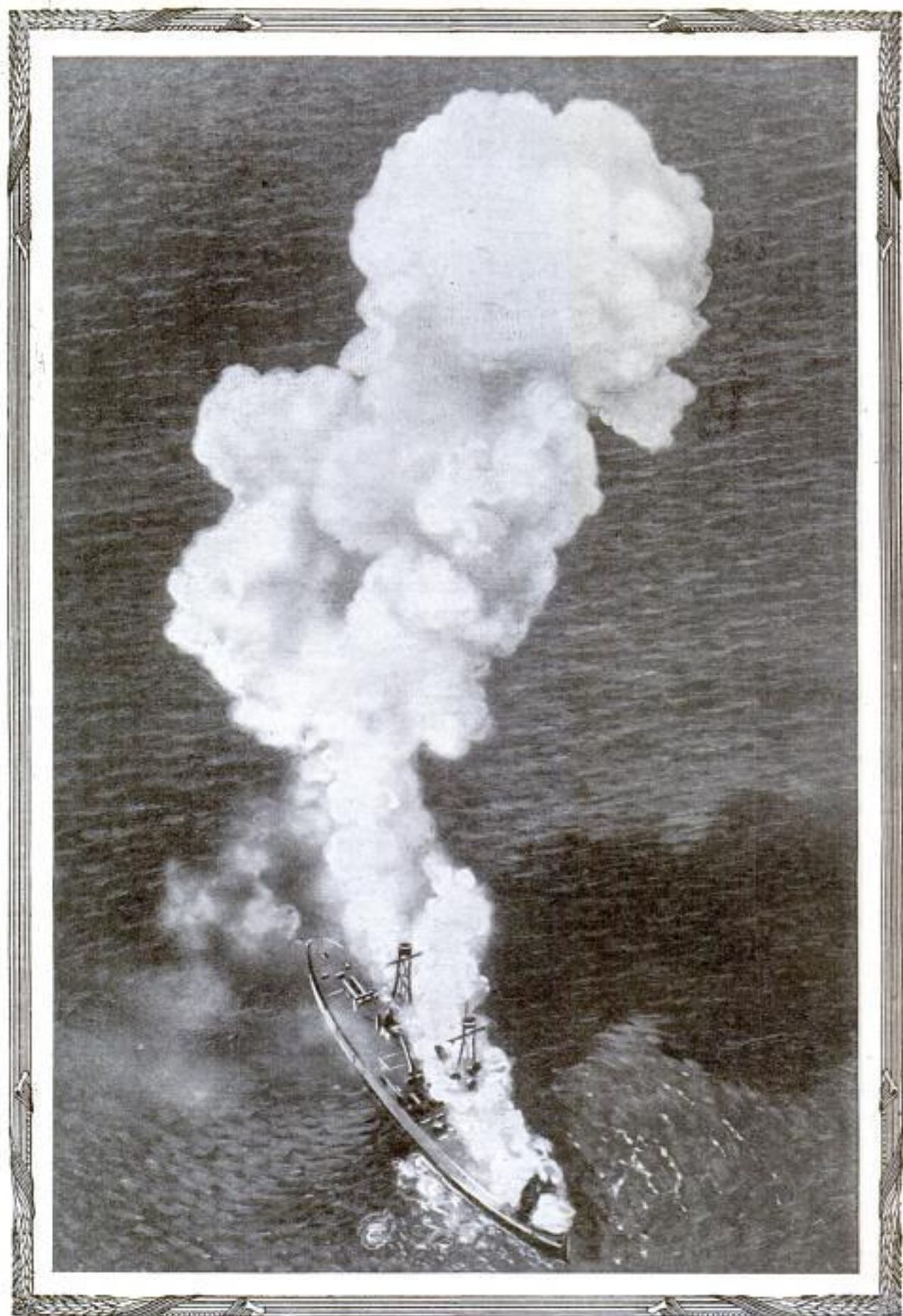

Dropping Destruction from the Skies; a Direct Hit on the Scrapped Battleship "Alabama" Illustrates How Airplanes Could Defend Our Coasts from Hostile Fleets—See Page 377



Williams Service, 32 Union Square  
East, New York City

# Popular Mechanics Magazine

REGISTERED IN U. S. PATENT OFFICE

WRITTEN SO YOU CAN UNDERSTAND IT

Vol. 42

SEPTEMBER, 1924

No. 3

1363



Portable Gas Cabinet Being Used in Treatments with Chlorine Which Is Permitted to Pass to the Patient in Small Quantities That Can Be Inhaled without Risk of Injury

## Poison Gases of War to Cure Human Ills

Volumes of Chlorine and Mustard Adopted as Treatment by Hospitals Where They Are Administered from Special Cabinets

POISONOUS gases that wrought so much havoc during the great war may now prove beneficial to mankind because of properties which might be found to cure several of the most malignant ill of the human race. Continued tests are said to be indicating that chlorine will relieve many of the bronchial afflictions which are common in certain seasons and climates. In the early days of the gas treatment for such affections, members of congress and high officials of the government, including President Coolidge, were administered chlorine, with helpful results. The greatly feared mustard gas of the war is being experimented with in the hope that it will prove a remedy for some diseases universally held to be almost incurable.

Although leading medical men have

taken up the development of these gases as an aid to the practice of medicine, the chemical warfare service and the medical corps of the army are responsible for the discovery that the gases are valuable for other purposes than those of war. Thus, these same deadly chemicals that were not so long ago weapons of the battlefield have been successfully turned into effective agents for the relief of human ailments.

Hospitals and clinics throughout the United States and Canada have adopted this method of treatment for respiratory troubles and for use in prevention of many more serious diseases. Preparations are even being made to spray the air of churches, theaters, public meeting places and schools with a weakened solution of chlorine, so germs, always thick in such spots, may be quickly killed and the carry-

Machines made by Wallace, Torrington, Conn.

See also May, 1924 Edgewood, Ind. 353  
659

Copyrighted material



1063  
ing of diseases of the throat and lungs from one person to another there may be prevented. The suggestion has also been advanced that the purifying of air over large cities by these poison vapors may in time be as necessary and usual as the sanitary processes used to clean drinking water.

Already gassing chambers have been declared impracticable and means are being sought whereby any doctor may treat his patient with the gases in an ordinary room. Some of the apparatus employed are very simple, one implement consisting of a few bottles which can be easily uncorked to permit the fumes to escape slowly. Such appliances as this may soon become part of every physician's equipment to be carried about with his other supplies while he makes his rounds among patients.

The success achieved with chlorine and mustard gas in the relief of severe minor ills has caused scientists and medical men to experiment with other dread war gases to find whether they, too, in small quantities, might not prove as effective against contagious germs as they were against armies when poured out in full strength from tanks on the battlefields. It is hoped by experts of the chemical warfare service that the detested fumes of mustard gas may be found to enable victims of painful, paralyzing diseases of the spinal system, listed among the incurable afflictions of mankind, to gain control over their

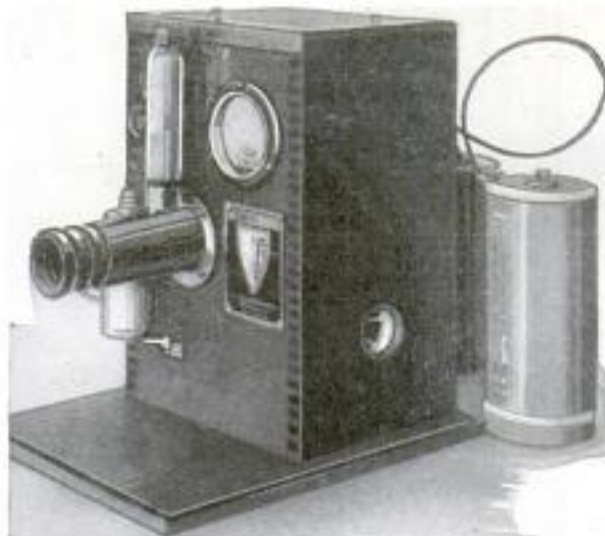

Mixing Device by Which Chlorine Gas and Air Are Formed into Medicinal Vapor

muscles after they have felt the influences of the ailments, and chemists and physicians are expecting the announcement of the discovery of a combination of chemicals that may end the spread of the "white plague."

Research is steadily going ahead with these purposes in view. But the fact that chlorine gas acts as a curative agent in certain diseases of the breathing organs

has been known for some time. Almost ten years ago a German scientist reported that inhaling of slight doses of chlorine was used successfully to clear up meningitis and diphtheria carriers. It is said that when the influenza epidemic struck the Edgewood arsenal of the government during the great war, the hospitals were crowded with sufferers. However, no cases were recorded from among the operating force of the chlorine plant, although every other branch of service had its full percentage of victims. Even on the battlefronts it was noticed that when the "flu" broke out, thousands of men in the military camps were prostrated by it, but those troops who had been exposed to gas attacks suffered the least.



Beginning of a Gas Attack on a Battlefield during the Great War When Clouds of Deadly Fumes Rolled over the Armies with Disastrous Results to Those Not Masked



H. P. Henry,  
North Worth,  
Texas.

no information in  
AR MECHANICS *maker* 355  
*water 21. 10*

**Ants Raised to Aid Fruit Growers  
in Combating Insect Pests, 1335**

To help California fruit growers exterminate the insects that damage their trees, a Texas man has devised a method of hatching tiny black or red ants, which are known to thrive on the eggs of the pests, in a sponge "incubator." To entice the ants into the sponge, it is saturated with melted sugar and swung from the limb of a tree on the "farm." A week or two later, when the weather is favorable and the myriads of ants have left their porous nest in search of food, it is slipped from the branch and incased in a special container for shipment to California. There it is hung onto an orange or other fruit tree in the grove and soon its burden of eggs is hatched and thousands of tiny ants launch their drive on the pests.

**Beach Merry-Go-Round Adds to Fun  
of Seashore Sports, 1308**

To add to the attractions of the seashore, beach merry-go-rounds have been built at some resorts on which young and



Copyright, Underwood & Underwood  
Seashore "Fans" Enjoying Whirl Aboard Beach Merry-Go-Round Which Rocks and Sways as It Revolves about a Standard Planted in the Sand

**Bookcase and Table  
Combined, 1263**

Of novel design, a library or hall table, which solves the problem of disposing of books in a hall or living room in a convenient manner, has recently been brought out in England. The table top is circular, but the lower part square. On the four sides shelves of various heights are fitted, which allow books and periodicals of widely different sizes to be stored. In this way reading material is available at a moment's notice, and yet everything can be cleared away instantly without having to carry the books to a shelf in a far corner of the room. To hold the books at a convenient level and to protect them from damage, a false bottom is fitted which elevates the lowest shelf several inches from the ground.



old find amusement when not in the water. The apparatus consists of an upright pole sunk in the sand and topped with a large inverted metal cup from which rods are suspended that hold boards forming a continuous seat in the shape of a large wheel. Circular braces keep the rods spread out toward the bottom. When rapidly turned, the wheel sways in addition to going around, the double motion increasing the enjoyment of the sport.

Thirty-five pigeons were defeated by an airplane in a race from Miller field, Staten Island, to Washington, recently, the plane leading the fastest bird by one hour and eleven minutes. The pilot and three of the pigeons carried invitations to government officials to attend a benefit garden party in New York.

*see Sept. 1921 - 34<sup>th</sup> Sea swimming made by Maurice Amusement Co., 48 National Bldg. Cleveland, Ohio*

*Neal & Son, Ltd.  
Tottenham Court Road  
London, W.1, Eng.*

*Chicago Tribune  
5/3/24  
Copyrighted material*



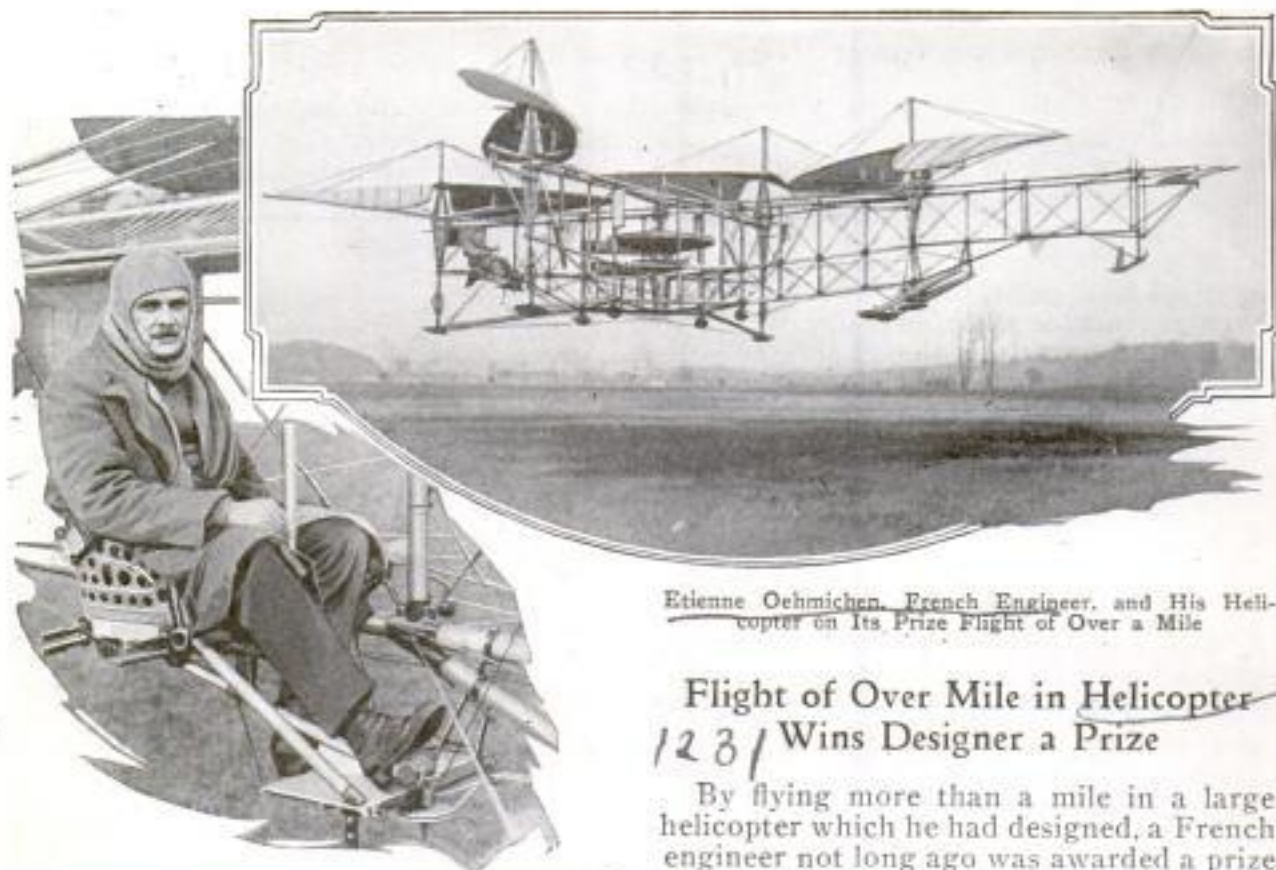

Etienne Oehmichen, French Engineer, and His Helicopter on Its Prize Flight of Over a Mile

### Flight of Over Mile in Helicopter 1231 Wins Designer a Prize

By flying more than a mile in a large helicopter which he had designed, a French engineer not long ago was awarded a prize of over \$5,000 and encouraged to still further efforts to perfect a heavier-than-air machine that will make perpendicular ascents and descents. In the test, it described a circular course and kept at an even altitude as it glided over the field, controlled by its designer at the "stick." It was supported mainly by a series of large, deeply curved propellers, while forward motion was supplied by smaller ones. Engineers for several years have been striving to produce a practical machine of this type to solve some of the problems now encountered in landing and taking off with the ordinary airplane.

1285

### Great Increase in Farming Lands Is Seen in Next Fifty Years

To feed the 150,000,000 population which it is estimated the United States will contain by 1950, approximately 38,000,000 acres must be added to the present crop-producing lands in this country, government statisticians declare. The extra acreage, it is figured, would suffice for domestic consumption and still leave a surplus for export. An increased yield per acre was taken into consideration in arriving at these figures. There are said to be between 400,000,000 and 600,000,000 acres of potential crop land, of which some 220,000,000 acres lie in the forested regions of the eastern part of the country.

Chicago Tribune  
May 26, 1924

### Patients Sealed in Glass Rooms Are Fed Oxygen by Pump

560 For treating patients with oxygen, a sickroom of sealed glass has been installed by a London hospital in which double the amount of the gas usually found in the air is supplied the occupant. Special apparatus also is furnished to keep the atmosphere pure and there are no openings that might permit entrance of any impurities. Oxygen is pumped into the case through a



Copyright, Underwood & Underwood  
"Show-Case" Sickroom of Hospital Where Oxygen and Pure Air Are Pumped to Patient

tube. It is believed the ward will serve to stimulate persons while under treatment for wasting and weakening ailments.



Carl R. S. Shackwell,  
319 Monroe Bldg.  
Chicago

POPULAR MECHANICS

Pacific & Atlantic  
Photos, etc.  
25 Park Place,  
New York City

357

**Sun Valve Gives Automatic Control of Electric Traffic Lights** 1264

Designed to automatically control electric street-traffic signals by turning on the current at approaching darkness and shutting it off at daylight, an electric sun valve was described in a report read to the National Electric Light Association convention. The valve operates by the use of selenium and turns the electric current off and on as the visibility becomes high or low. The report dealt with the use of the device in connection with various types of traffic signals, ranging from the control towers used in large cities, down to the automatic crossing beacons.

*Made in Europe*

**Electroscope Locates Radium under Concrete Walk** 129

With the aid of a gold-leaf electroscope, an instrument for measuring the value of radium, a woman expert in the bureau of standards recently found a thousand dollars' worth of the substance among some ashes in a can under a concrete walk after it had been lost for weeks. So eager was she to retrieve the precious metal that she emptied the can on a floor and handled the radium barehanded, escaping without injury. This is said to be the first time in the history of the bureau that an employe



Radium Expert in Bureau of Standards Measuring Value of Metal with Gold-Leaf Electroscope

has worked with it unprotected from its rays. Since the discovery of radium the young woman has measured \$4,000,000 worth with the electroscope.

*Miss Mary Brouer,  
Radium Expert,  
U. S. Bureau of Standards*

**Railroad Carries Ships Overland with Passengers and Cargoes** 1046

So that vessels may carry their passengers and cargo overland between separated bodies of water, a railway ship canal, con-

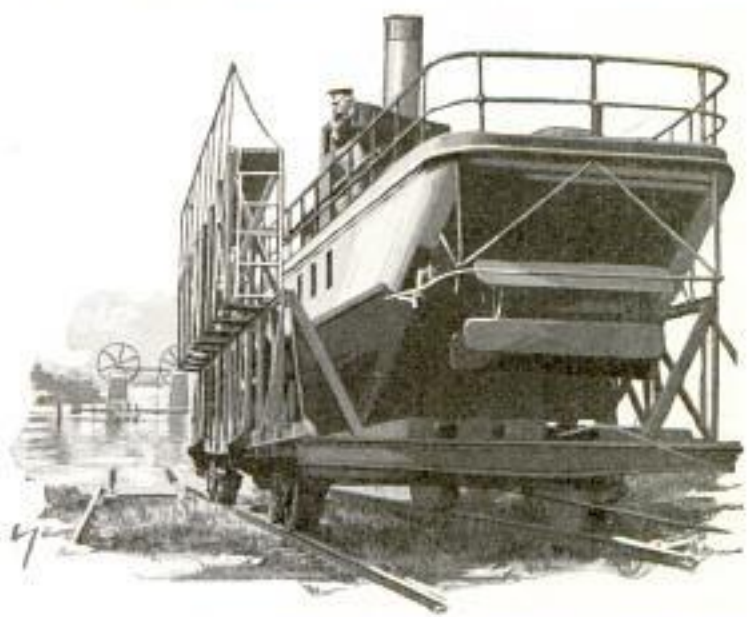

Flat Car Carrying Ship down Incline to Launch It in Deep Water after Transporting the Craft over Land

sisting of sluices, inclined planes and large, specially designed railroad flat cars, has been built in Germany. When a steamer reaches its terminal, the flat car is rolled on rails down an incline into the water and slipped underneath the boat. It is then drawn back up the slope and, with the ship on top, is transported to the next body of water into which it runs far enough to permit the vessel to float. This line was built to provide communication between East Prussia and the different bodies of water from which it has been cut off by the new divisions of territory resulting from the war.

**Beginning of the Sheep Industry**

Sheep are said to have been unknown in the domesticated state in America until after the Spanish conquest, with the beginning of the industry in the new world dating back to the time of Cortez and his rule of Mexico in the early part of the sixteenth century. Nearly all Mexican sheep can be traced to early Castile breeds which, it is said, were also the source of supply of the first flocks in the western part of the United States. It is believed that the English colonists first brought them to Virginia in 1609. Originally all sheep probably came from Asia, but the American breeds sprang from stock imported from Europe.

1340

*Home News 4, 1924*



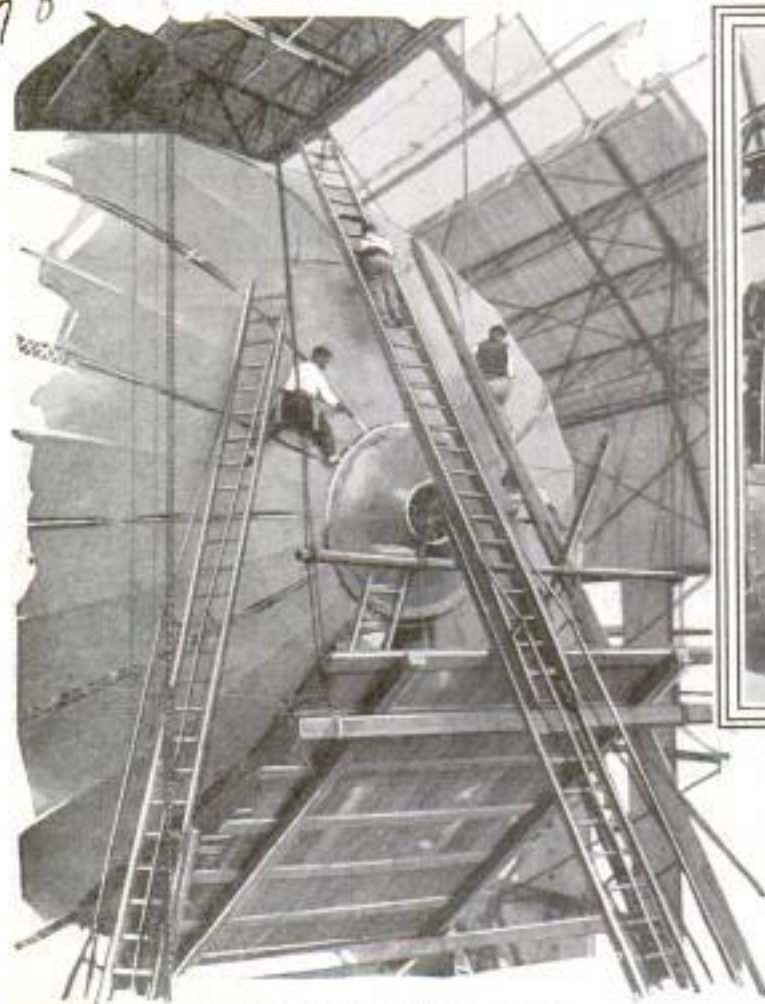

Copyright, U. S. A., Wide World Photos

### Giant Liner of the Air to Provide All the Modern Luxuries

Surpassing the mighty "Shenandoah" in size and in the luxury and completeness of its equipment, the "ZR-3," the latest addition to Uncle Sam's navy from the works of the Zeppelin company at Friedrichshafen, Germany, is considered the pinnacle of modern heavier-than-air construction. Planned exclusively for passenger and light freight service, the ship, now the property of the United States under the terms of the reparations agreement, has been fitted with conveniences that rival any found in hotels or Pullman cars. Sleeping and seating accommodations are provided in a special cabin on the underside of the hull and about ninety feet from the extreme point of the bow, and have been planned with a view to privacy and comfort. Completely equipped toilet rooms, a radio chamber, buffet and kitchen in which all food is cooked by electricity, and the navigating room containing the steering wheel, compass and charts are included in the pas-



Applying Outer Covering to Ship's Nose; Front End of One of Five Engine Gondolas Showing Sliding Radiator Door, and One of the Big Gasoline Tanks, So Light That Small Boy Can Carry It Easily

senger cabin. Accommodations for the officers and crew are furnished within the hull of the ship along the sides of a central corridor and here are also twenty compartments for baggage, mails and cargo.

Mechanically, the "ZR-3" is the most powerful airship ever built, having five twelve-cylinder Maybach engines giving a total of 2,000 horsepower. The motors are reversible, are all connected directly to the propellers and each is housed in a separate car. The ship's storage tanks have a capacity of seventeen tons of fuel and the dirigible will have a cruising radius of from 3,480 to 5,121 miles depending upon the number of engines used. A full-power speed of seventy-five and eight-tenths miles per hour and a normal rate of sixty-seven miles are planned.



Luxurious Compartments in Passenger Cabin of "ZR-3" Are Finished in Soft, Rich Upholstery of Skillfully Blended Tones to Add to Comfort of Journeys by Airline

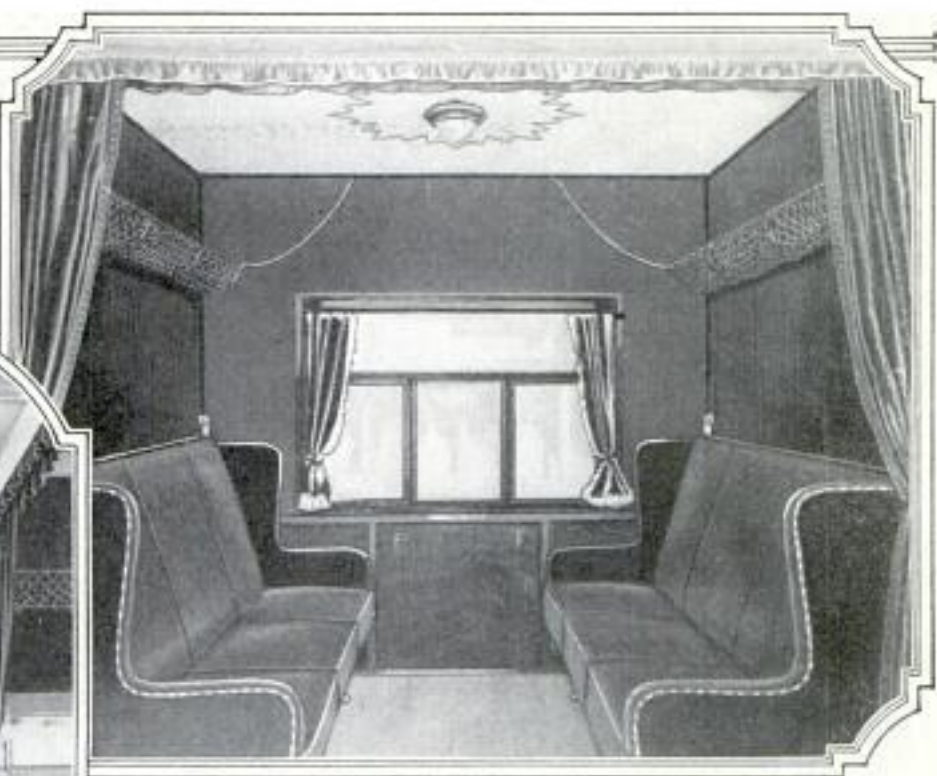

Curtained Corridor Like Aisle of Pullman Sleeper Extends Full Length of Sunny Cabin Aired and Lighted through Broad Windows; At Right, Dr. Eckner, President, and Dr. Durr, Managing Director, of the Zeppelin Company, Who Had Charge of Building the Mighty Ship

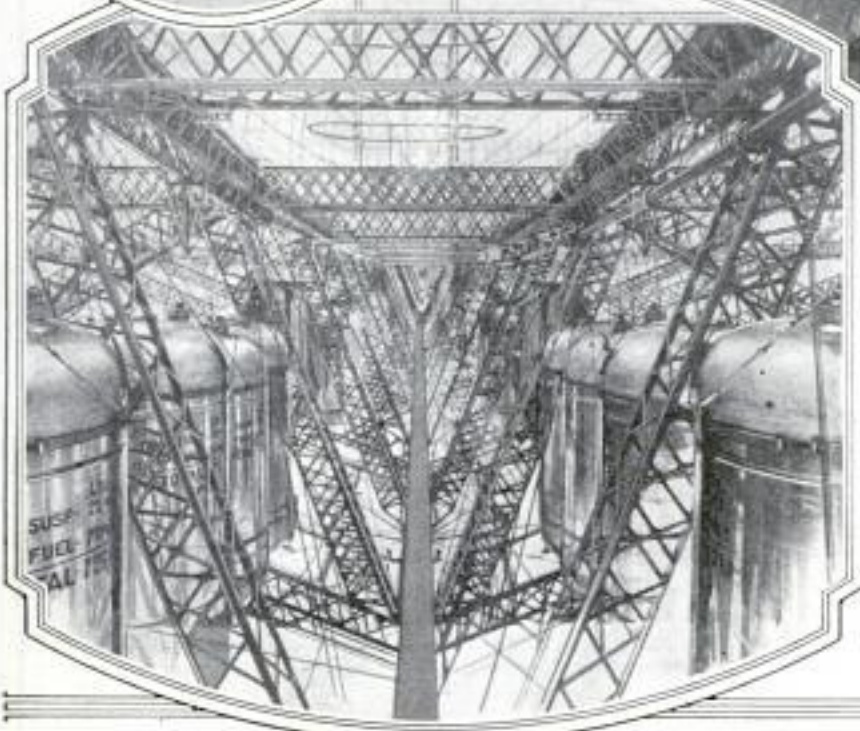

Looking down Interior of Hull along Central Passageway; Suspended on Each Side among the Network of Aluminum-Alloy Girders Are Some of the Tanks That Feed the Ship's Five Powerful Engines; Thirty Additional Tanks besides the Regular Seventeen Tons' Fuel Capacity Were Provided for the Atlantic Flight



1211

Cont. H. J. Watkins, Esq., 31 Hillier Road, Wandsworth Common London, S.W.11, England.

### Oldest Electric Tunnel Is Extended by Use of Boring Shield

Deep down under the streets of a great city there is a roaring of air and a clanging of steel doors, and the lurid glare of electric lamps lights up the white faces and grimy overalls of men who are crawling under the rings of a tunnel to the shaft head of new workings. They enter the brilliantly illuminated interior of a large cylinder forming part of a remarkable device, called the "Greathead shield" after its inventor, an English engineer. This shield

has superseded the more costly system of timber supports, which characterizes mining operations in loose ground. Hydraulic jacks are placed close to this cylinder, or "skin" as it is styled, and parallel to the axis of the tunnel. A grinding noise comes from the front of the shield, where the resistless edges are cutting through the earth. Men are here at work under an air pressure much higher than that of the atmosphere above, for an inrush of water has to be held at bay and kept from flooding the tunnel. Tunneling in compressed air in the bowels of the earth is attended by the same dangers for the workers as diving in the depths of the sea to raise a sunken liner. In each case, nitrogen bubbles tend to form in the body tissues. No man working in compressed air is allowed to go into the open air until he has spent some time in chambers containing air at successively reduced pressures. The

boring shield was invented to aid in modernizing the oldest underground electric or "tube" railway in the world — the "City and South London" — dating from 1890, and linking it up to more up-to-date subway systems. Junctions had to be made with two other underground lines, and none of these could be crossed on the level because of the density of the traf-

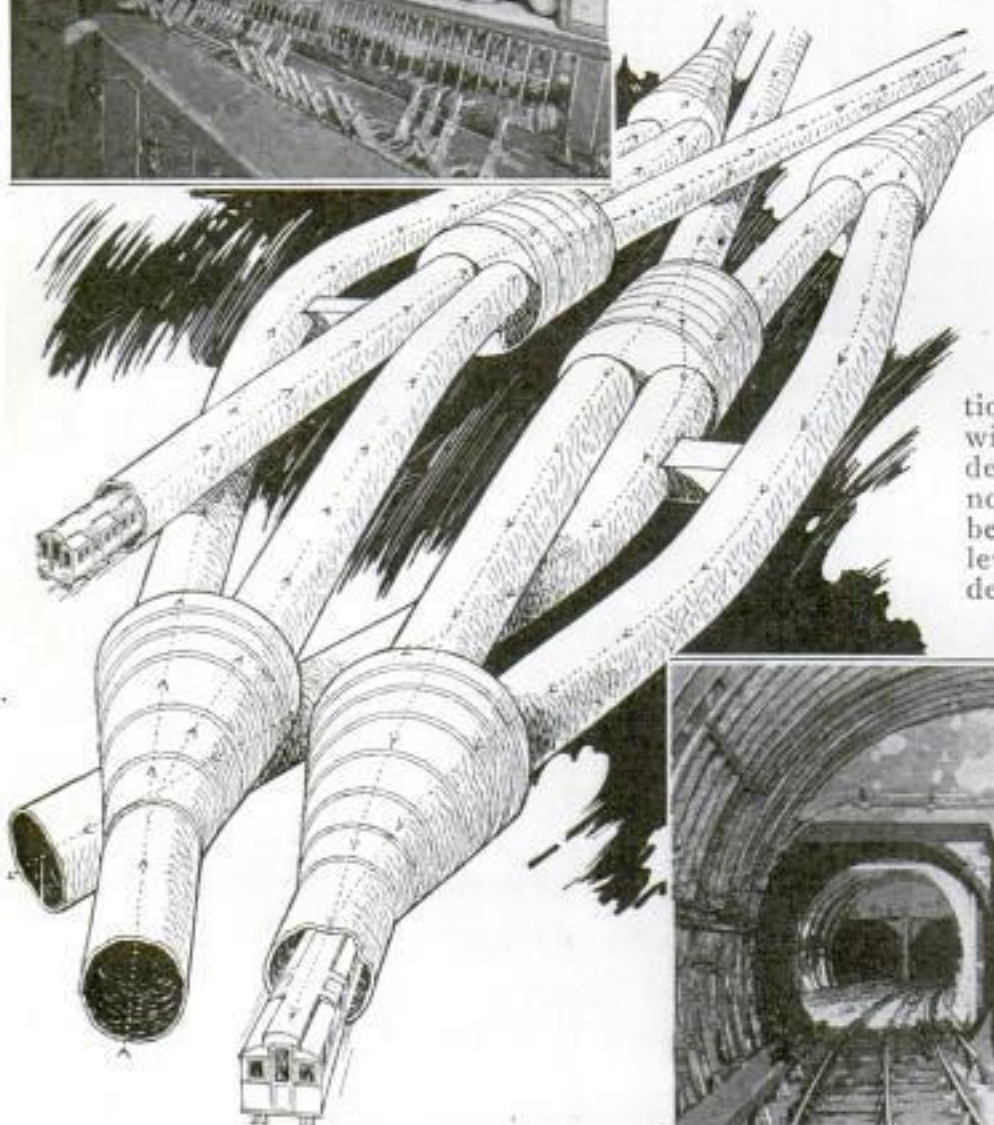
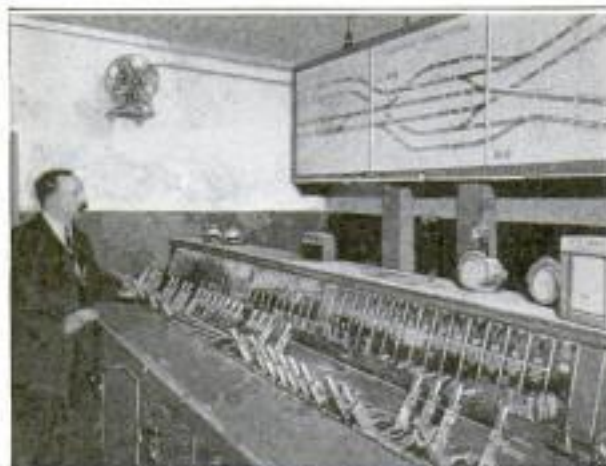

Diagram of Intersecting Underground Railway Tubes; at Top, Control Set Which Governs Automatic Switch and Signal System, and, Below, Inside the Tunnels at Junction of Tracks



fic. Moreover, the mechanical operations necessary were restricted to four to five hours after midnight. The diagram reproduced shows how this was done by the device of "burrowing" or flying junctions which took seventeen months to make. In the operation of trains, a device known as the "dead man's handle" is used to protect passengers. This brings the coaches to a full stop the instant the engineer's hand is removed from the control lever. The brain of the underground is its signal box or cabin from which both switches and signals are controlled. Movable disks on an illuminated diagram show the signalman the state of the lines in his neighborhood, and the destination of each train. He can thus give it the required path, and he is in telephonic communication with the junctions, should an accident occur or emergency require it.

1251

### Wooden Horse Gallops on Rubber Wheels

Solidly constructed, a wooden horse that gives a galloping sensation when moved, has been invented as a child's toy. Mounted on three steel disk wheels, the one in front is off center to produce the up-and-down motion, and all are rubber-tired so they cannot mar the floors. Made of hardwood



Galloping Hobbyhorse Toy on Wheels, Rubber-Tired to Prevent Marring Polished Floors

with no glued joints, the toy will stand rough handling and is claimed to be so balanced that it will not tip over.

*The E. S. Clemens Co.  
New Orleans, La.*



Copyright, Ewing Galloway  
Harvesters in Spain Climbing Tall Trunks of Date Trees to Gather Yields of Fruit from among Palms

### Date Pickers "Walk" up Palm Tree to Harvest the Fruit 11 4 7

In date-growing countries where almost primitive methods are still practiced in harvesting the fruit, natives climb to the top of the palm, sometimes 100 feet high, aided only by a short rope. Looped around the tree and the body of the climber, the belt is lifted repeatedly as the man "walks" up the trunk. Reaching the top, he leans back in the loop while pushing against the tree with his feet and is supported much in the manner that a lineman is when working on a telephone pole. In this way he is free to use both hands to gather the dates. These are lowered to the ground in baskets.

*1329 Alicante, Spain*  
Bass have proved themselves to be good fathers, according to a report made by a state conservation commission. The black variety will guard its young after hatching and will defend its shoal against big odds, having been known to attack the pickerel and pike when they swim too close to its swarm.

*new York Times  
June 1, 1924*



21. S. Aubrey Co, mfgs  
 362 58th St. POPULAR MECHANICS  
 11th Ave. New York City  
 Pneumatic Boards for Surf Riders  
 1302 Are Safe and Easily Carried

Prof. Hans Watterick

Sold by Abercrombie  
 + Fitch, Madison Ave  
 + 45th St. New York  
 Chesterfield  
 England

For those who enjoy the sport of surf riding, a pneumatic board that is inflated with a hand pump has been placed on the market. It is constructed of a durable, rubberized fabric and has ribs which hold it flat for riding on the surface. It will support



Cay-Colored Pneumatic Surf Board Inflated; Note Rib-like Structure and Size

port the weight of a heavy person. When deflated, it folds up into a small bundle weighing about six pounds, and is four feet eight inches long and twenty inches wide when blown up. It is said to be safer for the rider and other bathers than those of wood and cork. Bright-colored designs give the new boards a festive touch.

**Banana Fiber Cuts Cost of Pencils as Substitute for Graphite**

Owing to the increasing cost of graphite, European experts are busy with several substitutes calculated to cheapen pencil production. One of these consists of banana fiber. After the waste is burned in retorts, it is crushed and then mixed with what is technically known as "binding" to give it a gluey consistency and to improve its marking qualities. The whole is then worked up into pulp by machinery, and when partly dry, is crushed again and forced through molds under considerable pressure. The rolls are then baked, cut

into lengths and packed with great care in cast-iron crucibles and kept at red heat for two hours. After cooling gently, the "leads" are ready for the wood.

**Man-Power Flying Near Is Belief as Result of Gliding Tests**

Flight by human muscular power will become a reality before long, in the opinion of a German scientist. The discovery that airplanes could be driven by gasoline temporarily halted experiments in flying man-propelled machines, but the results achieved by gliders, he declares, give new encouragement to the idea. The planes will have to be built extremely light, although at the same time strong enough to stand the strain, and the legs will have to be the driving force as the hands will be necessary for guiding. The scientist pictures the machine as a bi-plane, in the center of which the flier sits, on a structure looking much like a bicycle, and drives a propeller in the rear.

**Poodle's Long Curls and Quick Wits 1277 Win Prize at Dog Show**

Prize winner at an English kennel-club show, "Captain Swift," a poodle, attracted the attention of judges and spectators because of its intelligence and long, carefully curled coat. This breed is said to be the cleverest of all domesticated dogs and has long been a favorite as a pet and circus performer, although fanciers declare that in recent years, they have been supplanted somewhat by varieties with shorter hair as the latter are more easily groomed.



Prize-Winning Long-Haired Poodle Proudly Wearing Ribbon Awarded at Kennel-Club Show

d.w. Allen and Macmillan  
 Holden, Highfield View,  
 328 S. Apton View Road,  
 Chesterfield, England

Ladies Kennel Club Show, Olympia, Eng.



1317 Ave. Dr. H. St. Arnold  
 and E. W. Elmer, Research  
 Engineers for New York City

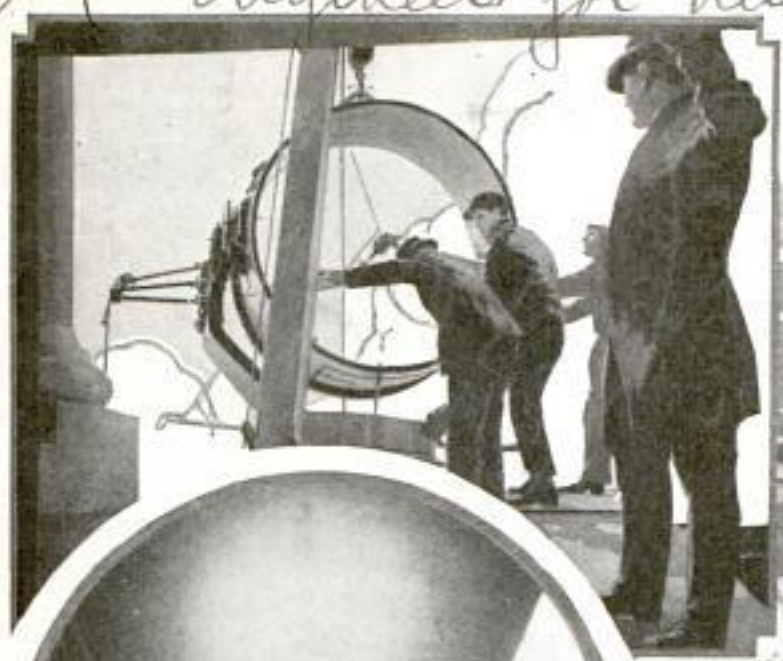

Law's "Eye of the Night" Signaling to Police Patrols, and Raising the Searchlight to Its Place



**Giant Searchlight in War on Crime**  
 1928 to Aid Hunt for Bandits

To aid the Philadelphia police in catching criminals, a huge searchlight of 300,000 candlepower has been installed in the tower of the city hall, 400 feet above the street. Specially designed for the purpose, it throws a beam of light that can be seen fifty miles. The city has been divided into four sections and each section subdivided. The moment news of a crime reaches a police station, it is flashed to headquarters in the city hall with the number of the section and the location of the subdivision. The rays of the searchlight are then directed upon that district, followed by flashes of light, signaling to all patrolmen that a crime has been committed and indicating the district. At the same time squads of police close in on the section from other parts of the city so as to hem in the criminals. Different colors can be flashed by pressing a button, and it is expected that this feature will be utilized in directing traffic in the most congested streets during the day.

¶ Giant bees of India build honeycombs that are eighteen feet high.

**New Alloy to Speed Up Cables**

Discovery of a new alloy, called permalloy, possessed of such remarkable magnetic properties that it will accomplish results heretofore believed impossible and, used in the manufacture of submarine cables, will permit messages to be transmitted at a speed many times that now obtainable, was recently announced by research engineers. The new substance is described as being one of the many results of modern methodically planned research and has proved practical after repeated tests, giving "new wind" to the cable, with advantages of control and privacy, in its race with wireless as a message bearer. It is an alloy of nickel and iron.

463 West St.  
 New York City

Announced by Engineering  
 Foundation 29 W. 39th St.  
 New York City.



364  
3895  
Cmt. Mrs Edna M. Colman  
5604-14th St. N.W.  
POPULAR MECHANICS  
Washington, D.C.



Weights and Measures "Sleuth" Checking Up on Honesty of Pushcart Vender's Scales While the Owner and "Gallery" of Curious Bystanders Await Outcome of Test

## Guarding Your Dollar against Short Weights

Full Measure in Purchases Insured Buying Public by Watchful "Sleuths" Who Detect Incorrect Scales and Yardsticks

**D**EFENDING the pocketbook of a buying public against faulty measuring instruments and unscrupulous dealers who "fix" their scales or shorten tape lines to gain a few cents of illegitimate profit on each sale they make, inspectors enforcing the weights and measures law of Washington, D. C., have tested more than 65,000 devices in that district in a single year.

Appliances of every description, used in the buying and selling of commodities, are included in these tests, and offenders ranging from immense corporations to obscure pushcart venders have received reprimands and penalties for failure to comply with the regulations. The inspections take in weighing machines of butchers, grocers, druggists, coal yards, dairies, coin-in-the-slot vending apparatus, and measuring tapes and yardsticks of dry-goods stores. If the appliances are correct, they are stamped and sealed with a

label bearing the date of examination. But where they do not conform to the rules of the law, they are tagged "condemned," and are confiscated by the authorities who destroy the machines and penalize the owners.

Store-to-store inspections are laid out and men and women agents of the bureau of weights and measures, acting as "buyers," make purchases of bulk articles in the sale of which dishonest traders generally resort to short weights. Ice wagons are checked up as their attendants are weighing out pieces for delivery along streets, and at any moment a milk cart may be stopped by a stranger who demands to see one of the bottles used as containers. If the block of ice or jar of milk is found to consist of a smaller quantity than is paid for by the buyer, the driver of the wagon is arrested and his employers summoned into court to answer to the charge of cheating.





Examining Milk Jars for Short-Measure Evidence; Omissions of Two or Three Thimblefuls from Each Quart Would Result in an Amazing Total for a Day's Deliveries



Inspecting an Automatic Pump at a Gasoline Filling Station to Insure Automobile Owners Full Gallons in Their Fuel Purchases

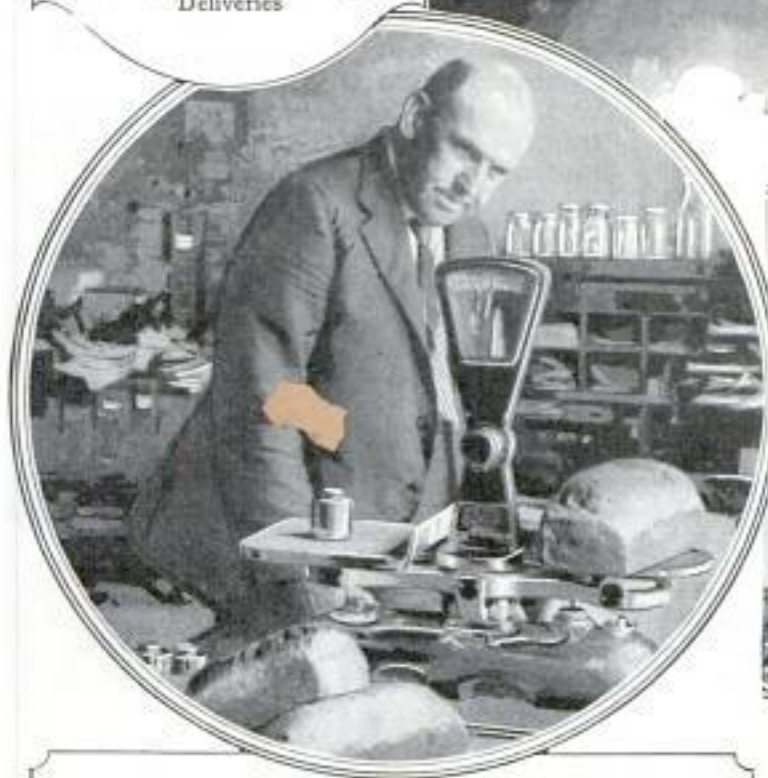

Bread Scales in Laboratory of Bureau of Weights and Measures in Washington Where Records Are Kept of Both Big and Little Bakeries

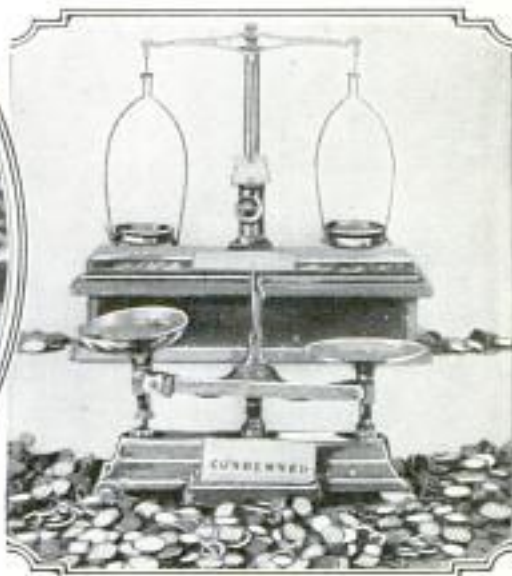

Inaccurate Scales Used in Filling Prescriptions by Druggists, Who Were Haled into Court after Their Appliances Were Seized and Destroyed



Quite a number of errors exist in measuring implements unknown to the dealer, and in such cases, when discovered, he is reprimanded and instructed in the methods of testing his own machines. Where corrections can be made in the device without demolishing it, it is adjusted by the inspectors and the cost of the work collected from the owner. Recently two large shipments of new milk bottles were smashed by inspectors and thrown into the river because they were two drams short of the amount marked in the glass. The shortage for each bottle represented only about enough cream for a cup of coffee, but the authorities decreed that customers were entitled to the full amount for which they paid.

A large amount of short weighing, it was found, was done among dealers in fruits and vegetables, but now such commodities must be sold in standard containers, or by weight or count. The packages are regular shipping containers and the law requires that they be compactly filled. Formerly the practice was widespread among some dealers to remove a portion of the contents before sale and make seven or eight "light" bushels where six full ones had existed. Fruit hampers had raised bottoms and berry baskets were pinched in at the sides or had middle hoops to displace a quantity of the article. The buyer would not learn of this until the package was emptied, and then it was generally too late to have a correction made. Now all barrels and boxes for this class of produce must be made according to sizes specified in the regulations.

"Shucked oysters" must be sold by liquid measure or by count, and if the seller allows more than ten per cent of fluid to be present in the quantities, he is open to charges of cheating. One vender of oysters, delivering an order to a customer, was amazed to see his patron unwrap a glass graduate measure he had concealed and pour the liquid from the holder into the vessel. The test showed thirty per cent liquid in the purchase, and the dealer was ordered to appear in court.

Various commodities are constantly being purchased by "shoppers" for the inspection bureau. These buy food articles, ribbons, dress goods, household linens and almost everything that can be sold by weight or measure. Innocent-looking automobiles are driven about the gasoline filling stations by watchful detectors of dishonesty, who order a quantity of "gas" put into the car. Instead of running into the fuel tank, the liquid passes into a hidden container and is later measured at the laboratory, where proof of the dealer's guilt or innocence is quickly shown by accurate measures. After this campaign complaints to the bureau from car owners dropped.

In one year of inspections, tests were made of 19,238 scales, 22,098 weights, 2,262 yardsticks, 9,802 measures, 1,766 automatic gasoline pumps and 6,996 drug and jewelry weights. Of these, 2,365 pieces were condemned, of which 665 were beyond repair or correction and had to be destroyed. Throughout the campaign to eliminate unfair methods almost every scheme known for falsifying weights was found.

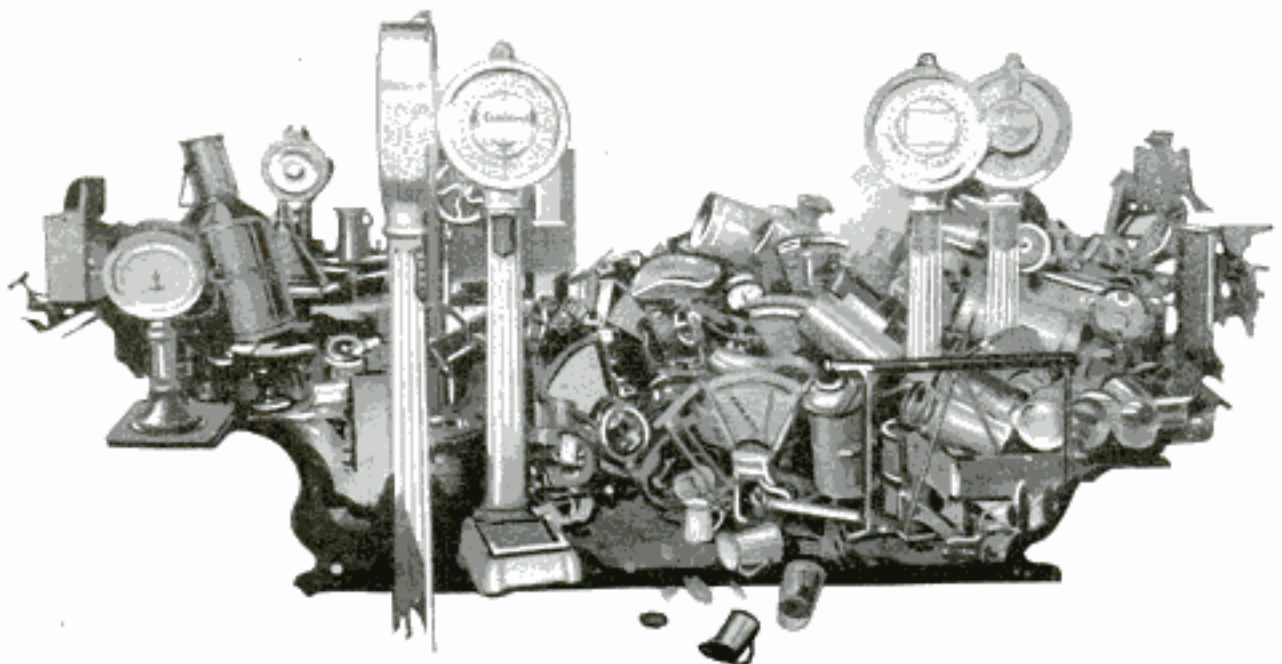

"Junk Heap," Collection of Falsified or Incorrect Weighing Appliances and Liquid Measures Confiscated by Authorities in Campaign to Eliminate Unscrupulous and Careless Dealings among Shopkeepers



1256 Aeromarine Plane & Motor

POPULAR MECHANICS

Keyport N.J.

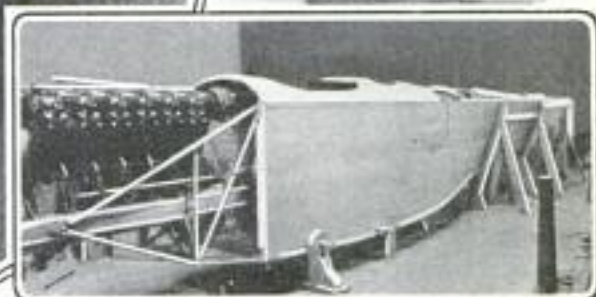
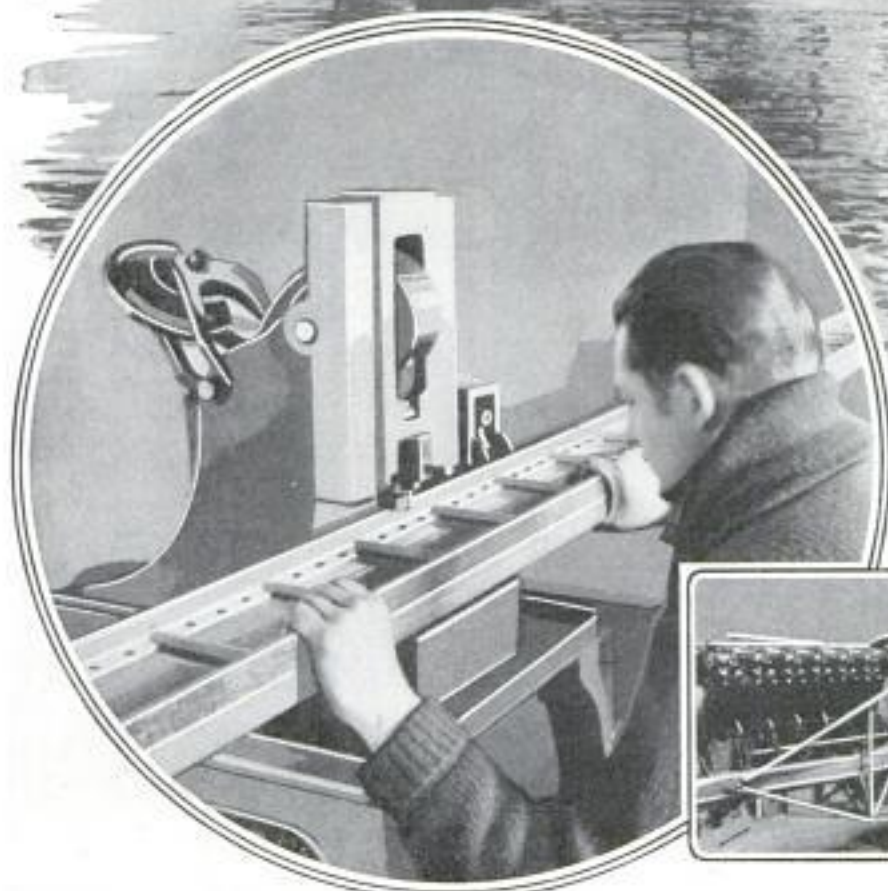

Flying Boat with Fuselage and Hull Built of Aluminum Alloy; Left, Working on One of the Light Metal Girders, and Right, Airplane Body in Course of Construction

### Aluminum Given Strength of Steel for Building Metal Aircraft, 256

Aluminum alloy, treated to give it resistance to corrosion, is being manufactured by an eastern company for the construction of airplane and flying-boat bodies. It is said to have about the same properties as low-carbon steel although it weighs only one-third as much. It withstands a "pull" of 55,000 pounds and costs about the same as brass. It is hardened by heating to between 920 and 960° Fahrenheit and is then immersed in cold or warm water and allowed to "age" for about an hour before it is riveted. For flying boats, the alloy has been found especially practical as it resists the action of salt water.

Aluminum Company of America, Pittsburgh Pa.

### Butterflies Hamper Auto Traffic by Plugging Up Radiators 1013

Swarms of beautiful red butterflies are reported to have seriously hampered automobile traffic along southern California highways by filling crevices in the radiators, thus causing overheating of the engines. In some cases, motors were badly damaged when drivers pushed on without sweeping the insects off or investigating the cause of the trouble, and many vehicles were stopped while the butterflies were removed. Scientists attributed the swarms to lack of food supply in the mountain regions, where a dry winter had caused many plants to wither and die. The insects therefore migrated to the valleys.

Club Hoag & Ford, Bldg 416, Union League, Los Angeles, Calif.

Attention J. A. Cherrin

Copyrighted material



### Carves Lifelike Models of Birds from Patterns Traced in Wood

Birds of all sizes are shaped from wood by a carver at Cape Cod, Mass., who has achieved fame among nature lovers because of his skill. Filed in long drawers in his shop are skins and paper patterns of

a problem that challenged the skill and resourcefulness of engineers. Menaced and obstructed by the sand and wet marl, workmen found it next to impossible to



Wood Carver Who Imitates Birdlife, with Model of Wild Duck; Study of a Fowl in Flight and Group of Small Specimens

practically every bird found along the Atlantic coast. Outlines are traced from the patterns on cedar that has been seasoned for ten years. The shape is then cut out, first by a small saw and then with a common jackknife. Long bills, extended wings, tails and legs are carved separately and glued on later. The model is sandpapered to a smooth finish and the feather marks and eyes of beads or glass added. With the preserved skin as a model, the wooden bird is painted in the exact colorings and markings of the original.

until it connected with the adjoining ones. When the "wall" was completed the unfrozen earth inside was removed without difficulty. Freezing is transmitted differently to different strata, and to water which may be standing or gushing or of varying degrees of saltiness.

### "Ghosts" Millionth of Inch in Size Are Routed by Scientists

"Ghosts" that have baffled scientists using a Rowland's ruling machine, a device employed in studying the nature of light, have been routed with the discovery that they were caused by errors of a millionth of an inch in the rulings of the point of the sensitive apparatus. These, it was found, were caused by the heat of the human body in the same room.

Johns Hopkins University  
Copyrighted material

40 L. O. Robbins, Harwich, Mass.

1266

1366

### Ice Serves as Concrete in Sinking Shaft to Coal under Swamp

To sink a shaft through 6,000 feet of swamp in order to reach the deposits of coal in the northern part of Belgium was

side  
fect  
thro  
tippe  
bee  
slab  
tha  
an b  
Wher  
angl  
, an  
wall  
olding  
ition  
simec  
vrick  
rking



Sir Wm. Arroll & Co.  
 Ltd., 85 Preston St.  
 Bridgeton, Glasgow, Scotland

Standard Oil Bulletin  
 May, 1924 369

POPULAR MECHANICS

**Electric Bricklayer Does the Work  
 of Nearly Twenty Masons**

**Asphalt Lining in Irrigation Canals  
 Stops the Loss of Water**

Electrically operated, a bricklaying machine that lays 1,200 bricks an hour, against 500 a day for the average mason, has been invented. Upon rails placed around the outside walls of the building, a traveling boom is set, and upon this are the mortar tank and laying mechanism, driven by an electric motor. A wheel rotates, taking two bricks from the carrier, while another wheel spreads mortar as the carrier moves along the boom. At the end of the wall the machine changes direction and proceeds as before, until it has laid one row entirely around the structure. The boom is then raised and another trip begins. Three men are required to supply the device, which is said to do the work of nearly twenty masons.

Lining irrigation canals with asphalt to increase their capacity, prevent seepage and reduce maintenance costs has proved a



Applying Asphalt Coating to Bed of Irrigation Canal, Using a Heated Roller to Distribute and Compress the Material Evenly over the Surface

**Air from Balloon  
 Drives Toy Boat**

Moved by the air exhausted from a rubber balloon, a toy boat travels several feet before the elastic bubble collapses. The air is allowed to escape at the stern end and causes a string of bubbles which make a sound similar to that of a motorboat when they burst on the surface. After each performance the balloon may be blown up again to give "power" to the toy.

success in the west, where the material is applied like paving, sand and rock dust being the principal substances added. After the mixture is heated, it is spread to the desired thickness and then compressed with rollers, tampers and irons to give it a smooth waterproof surface. No curing is needed. Asphalt also is said to be an excellent material for repairing and relining canals with cement interiors, as its elastic qualities adapt it to extremes of temperature and prevent breaking and cracking. In the construction of canals for power purposes, such a lining permits steeper slopes and the full benefit of the current is obtained. Breakages seldom occur in asphalt-lined ditches and losses due to water-logging of adjacent valuable lands are avoided.



Toy Boat Propelled by Escape of Air from Balloon

Experiments have proved that moles may be controlled by placing teaspoonful quantities of concentrated lye in their runways at twenty-five to fifty-foot intervals.

Reeves Mfg. Co.  
 Milford, Conn.  
 10¢ each





Kafirs, Natives of South Africa, Some of the 4,000 Toilers Who Glean the Precious Rough Diamonds from Their Places in the Rocky Depths of the De Beers Mines

## Fires of Diamond Revealed by Dust and Steel

Raw Gems Given Glitter of Beauty at Hands of Skilled Craftsmen in Mills of Old Amsterdam

**B**EFORE the war the busy city of Amsterdam, Netherlands, had rivals for its place as leading export center for the world's diamonds, but for the past few years has been the chief point of distribution for the gems, besides being the main polishing and cutting source from which finished stones are obtained.

Within the city are between seventy-five and a hundred factories operating almost 10,000 dressing mills, and as many skilled workmen in charge of them. Wages are said to be good and employment for the diamond experts steady the year around. In all, more than 50,000 people derive their livelihood from this industry, toiling in the many departments of the city's cutting and polishing establishments.

Coming from the mines of South Africa or diggings situated at several other far-off points of the earth, the rough stones are subjected to harsh treatment in order to prepare them for the processes which reveal the scintillating beauty and brilliance

that make these gems the most popular of jewels. After splitting, a hand operation performed with a steel tool inserted at a faulty spot, all weak portions are trimmed off by means of bronze saws and diamond dust, if the stone is of the hard variety, otherwise the same splitting implement is used.

The task of polishing requires more skill and time than any other operation designed to give the stone its necessary shape and quality. This consists in giving the rounded product the "sides" which account for the brilliant rays that mark the better-quality gems. Shapes of diamonds are divided into five classes, brilliants, eight-cuts, squares, fancies and roses. The brilliant, with fifty-four tiny facets, reflects the most sparkle and is scientifically planned to give all the freedom possible to the rays thrown out from the heart of the stone. The largest facet is known as the table and is to be seen at the top of the finished diamond. The smallest, called the



1206



Inserting Gem in Matrix Which Forms Case While Polishing

Putting Horizontal Wheel in Place for Trimming and Grinding Rough Diamonds; These Wheels Are Made of Special Materials and Are Manufactured Only in Holland

Preparing Surface of the Stone for Splitting; Below, Cooling Solder Mount after Heating to Harden Cement

Centuries of Devotion to the Carving of Millions of Carats of Finest Diamonds Cause Work of Dutch Craftsmen to Be Regarded as a Standard of Skill in Preparing Stones for Market



1206  
372

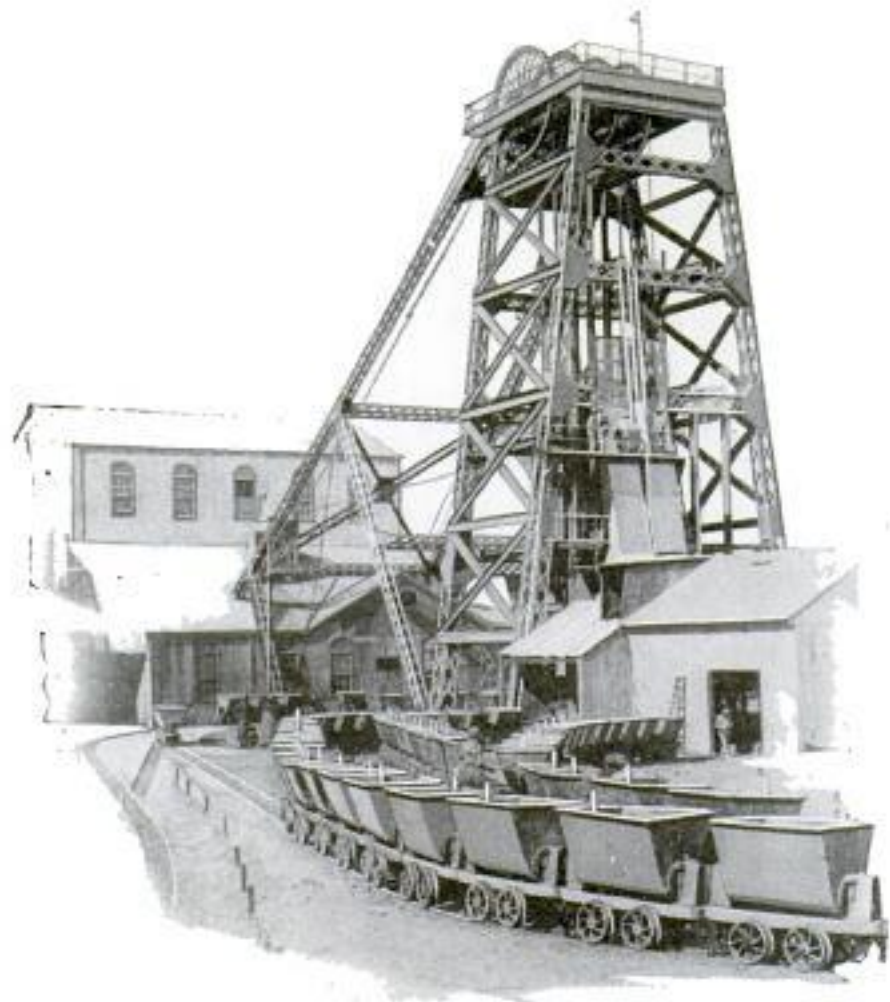

Copyright, Underwood & Underwood  
Entrance to a Diamond Mine in South Africa, Showing the Shaft Head and Cars Awaiting Loads of Gem-Bearing Soil to Be Scattered in Plots for Air-Curing

culet, is almost unperceivable at the tip of the cone on the bottom. The eight-cut has only eighteen of these minute planes and is generally used on diamonds smaller than a thirtieth of a carat, where the cost of labor would increase the price beyond a reasonable figure. The square, which is said to have added much to art in jewel creations, is at present popular for bracelets, bapins and wedding rings. Fancies comprise marquises, pear-shapes, emerald-cuts, kites and other special forms which are often used in famous gems of great size and quality. Roses are only seen in cheaper grades of the stones, but were formerly the designs of a few of the notable jewels. They are the least brilliant, having the facets on one raised side while the opposite section is flat.

When a diamond is ready for polishing it is soldered into a conical frame of an alloy. The mass is then dipped into a preparation of oil and diamond dust before being fastened with several others on a strong structure that brings it in contact with a horizontal iron wheel. This disk is

revolved at great speed and the friction of the stone with its surface, aided by the gritty action of the oil and dust, forms the flat surfaces which slowly appear as the smooth planes of the diamond. One side of the stone is polished at a time, and when finished, the entire series of raw gems must be removed from their places and are resoldered in position for the next facet.

Of the famous historic gems, the Victoria diamond, the Cullinan and the Kohinoor were all cut and polished by workmen in the finishing mills of Amsterdam. The United States receives a greater volume of the city's gem products than any other nation, the total importation of cut and uncut diamonds to this country for one year amounting to 406,553 carats valued at \$35,686,606. About one-eighth of these were uncut stones. South

Africa produces about \$870,000,000 worth of rough gems a year, most of which go to Amsterdam for polishing.



Copyright, Underwood & Underwood  
Trolley Cage and Its Operator Bound for the Bottom of a Big Working



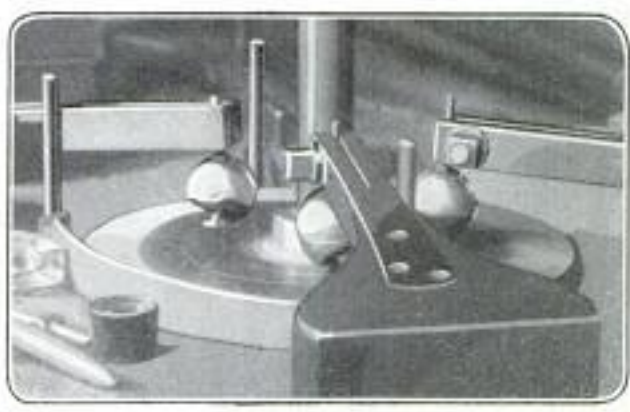
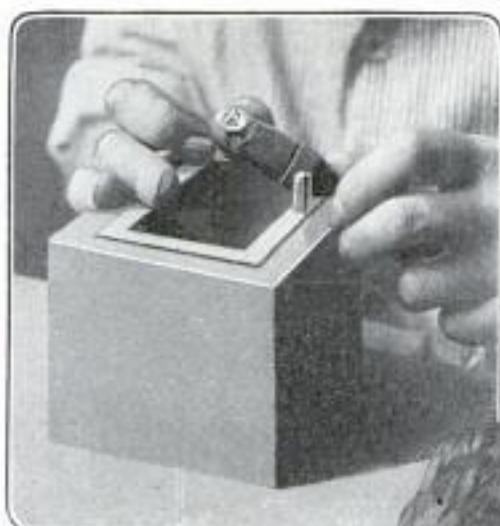

Polishing Frame in Which Series of Several Stones Is Held during Single Operation

Diamond After All of the Soft and Faulty Parts Have Been Removed by the Splitter

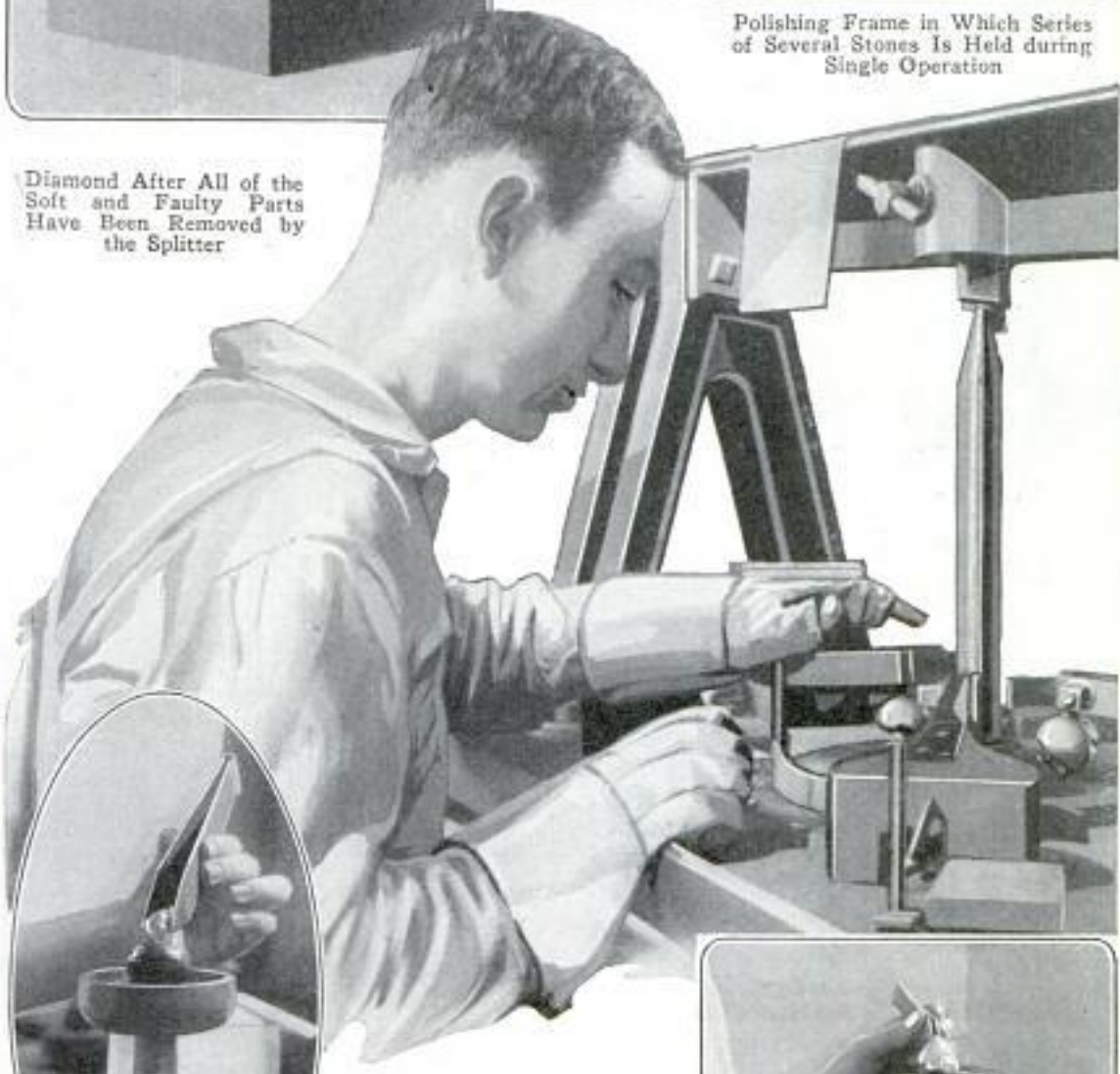

Setting the Mounts Containing Raw Gems in Holding Frame of Polishing Machine; Left and Right, Shaping the Soft Mold for the Diamond, and Placing the Stone in the Tip of the Cone



Delicate Instruments and Operations to Be Seen in the Diamond-Cutting Plants Which Have Made the City of Amsterdam the World's Chief Source of the Finished Gems



### Scoop Conveyor with Endless Belt Saves Time in Loading Sand

1146

For loading sand easily, quickly and without waste into trucks or wagons, a conveyor that carries the material into the

Portable Machine Co.,  
Passaic, N.J.



Copyright, Ewing Galloway

Loading Sand into Truck by Scooping It onto Endless Belt of Portable Conveyor

vehicle on an endless belt is being used. Light in weight, the apparatus can be readily backed into the pile and one end of the belt tipped down so that the sand can be scooped upon it. It is claimed that by using the conveyor, two men can fill a vehicle in less time and with less effort than several men working with shovels.

### 915 Leaves Used to Make Ice

Although temperatures about Durango, Mexico, are not low enough to freeze water in open streams or uncovered utensils, it is said that when left standing in the cuplike leaves of the century plant, the liquid turns to ice in a few hours. After the flower has bloomed and the sap has been withdrawn, the leaves are laid out in a large straw-covered field during cold weather and filled with water. The ice is gathered in the early morning and stored in adobe buildings where the pieces pack closely and melt together. Cut up into large lumps, it is used for purposes not requir-

ing the artificial product. It is believed that because the leaves are shallow and expose a broad surface to excessive evaporation, freezing is made possible in a climate appearing to be too warm for the ordinary process.

### Miners Move Village Twenty Miles When Coal Vein Disappears

1284

Sawing their houses into sections, the miners of an Illinois community moved their town approximately twenty miles. The place was once a prosperous mining center with a population of about 500. In recent years the coal played out, and it was decided to transport the town to another site where a new mine had been opened. The houses were cut into sections in order to transport them across a narrow bridge.

Chicago Evening Post  
May 24, 1924

### Lavatory on Auto Running Board Carries Water and Soap

875

Added comfort is afforded the motorist by a patented lavatory fitted under the running board of the car to supply water and liquid soap. The outfit consists of a supply tank, bolted to the frame, and faucets and filler nozzles, which are placed under the hood. The tank has a large



Easy to Wash on Auto Trip with Water and Soap Nozzles on Car

compartment for water and a smaller one for soap. The faucets fold out of sight when not in use.

St. Joseph News-Press  
3/26/24

Emmons Mfg. Co.  
Franklin, Ohio





English Girls in Spirited Game of Balloon Polo; Player Has Just Intercepted the Sphere and Sent It Bounding High into the Air with Blow of Cane

### "Aerial Polo" Played with Balloons Adds Novel Thrill to Sport

English girls have given the ancient game of polo a new "twist" by substituting balloons for balls and short canes for sticks. Charging down the field on their ponies, the players endeavor to score by bursting the elusive sphere with a sharp blow of their canes. Considered less hazardous than the regulation style of playing, the sport still provides opportunities for clever riding and skill in keeping the balloon from an opponent's reach, while the caprices of the wind often add to the surprises of the match both for players and spectators.

### "Lost" Ocean Current Sought by Test with Deep-Sea Thermometer

Puzzled by a rise of seven degrees in the temperature of a large section of the north Atlantic ocean and by the unusually small number of icebergs reported by steamers, the United States coast guard last spring dispatched experts in oceanography to determine if the Arctic current had disappeared or changed its course.

Equipped with a deep-sea thermometer and other apparatus, scientists explored the normal path of the stream, making repeated tests of the temperature of the waters. The theory was advanced that some



Copyright, Underwood & Underwood  
Lieut. Edward H. Smith (in Uniform) and Assistant Taking Temperature with Sea Thermometer

upheaval in the ocean's floor might have caused a change in the current's course.



Pacific + Atlantic Photos, Inc.  
25 Park Place

376 *New York City* POPULAR MECHANICS

### Lightweight Lifeboats for Seaplanes to Save Wrecked Fliers

To aid in saving lives of aviators who might be wrecked while flying over large areas of water, lifeboats so light they can be easily carried on seaplanes have been designed. Strongly built and equipped with oars and rope,

*Shown at Marine and Small Craft Exhibition, Royal Agricultural Hall, London, England*



Lightweight Lifeboat Designed for Seaplanes That Face Risks of Flights over Ocean Areas

the boat is said to add but little to the burden of aircraft. In case forced landings in the sea are necessary, when planes become damaged, it can be easily unshipped from its moorings and navigated by one man. Constructed with a wide beam, the lifeboat can safely negotiate ordinary rough seas.

### Lights Warn Trains of Landslide and Show Exact Location

Electrically operated, a device that gives warning by flashing red lights when a landslide has occurred along a railroad right of way, has been invented in New Zealand. Two boards, kept apart by spiral springs and connected to a battery, are placed between the rails at points where slides are likely to happen. Wires from the device run along the track in both directions to red electric lamps. A pressure of ten pounds is sufficient to bring contact points on the plates together, completing a circuit with the result that the red warning lights will be illuminated on either side of the obstruction, while a white light will show the exact location of

*Shown at British Empire Exposition*

*1185*  
Cont. L. Jackson, High St.,  
Waimate, Canterbury,  
New Zealand.

the slip. The device can also be made to throw a switch to warn the engineer. Connected with the nearest station, the signal can be received there before the arrival of a train, giving additional time to clear the road.

*734*  
*Uterine Caster Co.*  
*Utica, N.Y.*  
Casters of Fabric Prevent Noise

As a substitute for rubber-tired casters used on various kinds of carts, a fabric-faced wheel is now being made for which an exceptionally long life is claimed. These "tires" are constructed of many pieces of waterproofed and specially woven material, tightly pressed and stitched together. When completed, the covering is said to be almost as hard as rock but noiseless. It is placed upon the wheel by clamping it between steel parts that are riveted to the casting in which the bearing is to be bored.

### President's Ink Is Held in Stand Made from Two Horseshoes

Fashioned from two steel horseshoes, a penholder and inkstand recently presented to President Coolidge, is the product of a Boise, Idaho, blacksmith's skill. A small anvil rests between the points of a large symbol of good luck and the inkwell fits into a rack that supports the ornaments. Places for pens and pencils are formed by the heads of six nails that appear to pro-

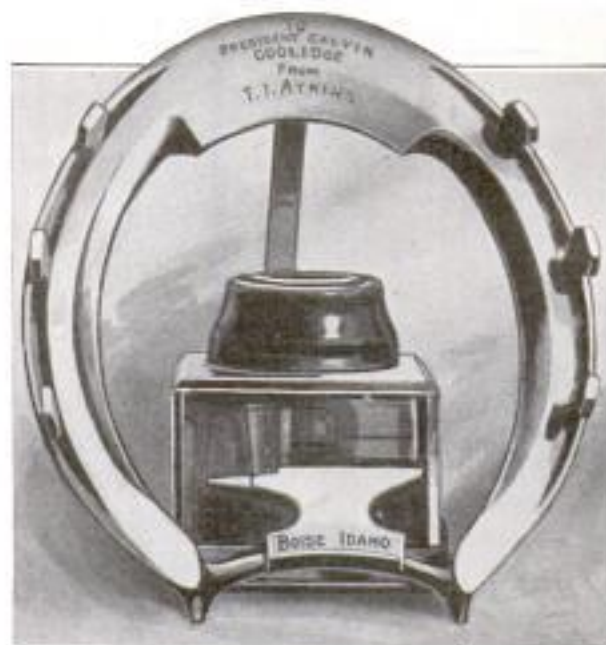

Inkstand Fashioned from Two Horseshoes by Idaho Blacksmith and Presented to President Coolidge

trude from their holes in the shoe. A neatly engraved inscription bears the names of the executive and the giver.

*made by T. J. Atkins*  
*Boise, Idaho*

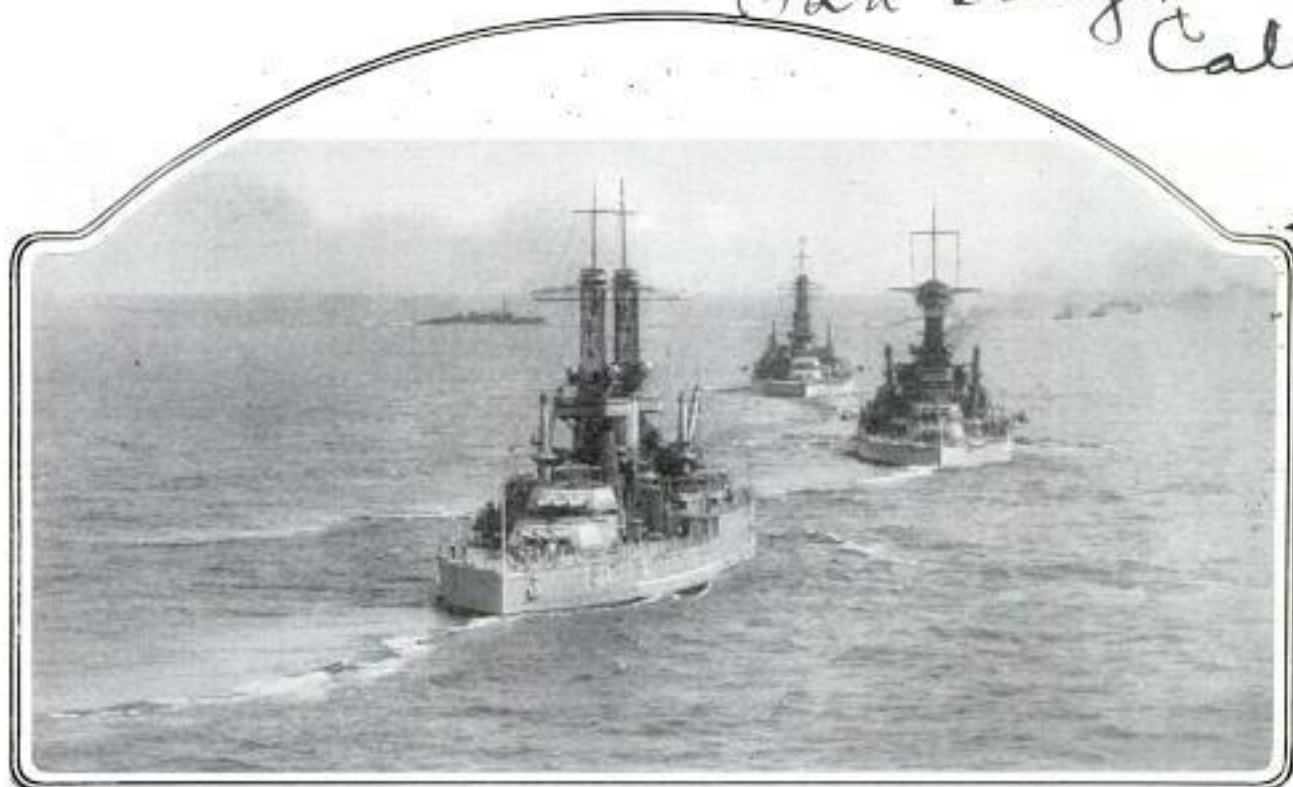

San Diego,  
Calif.

One of Uncle Sam's Fighting Fleets in Peace-Time Maneuvers off the Coast of Panama; the Ships "New Mexico," "Tennessee" and "Idaho," Moving into Line for Battle Formation

## With the Navy in Peace Times

### Battle Practice and Maneuvers Keep Fighting Ships at Highest Degree of Efficiency

OVER a dark sea canopied by a night sky sprinkled with stars, two lines of swift warships, portlights gleaming, lifting and falling, drive through the swell toward the Vieques area of the Caribbean sea for battle practice. On their arrival the sober work of war begins. All day long the ships steam past targets which are towed behind tugs. Decks are cleared for action and all forces are engaged, including the aircraft and the carrier ships.

In the lower handling rooms, narrow steel-locked coffins below the turrets,

sweating men haul out the great shells and the powder charges and speed them upward on the hoists to feed the guns above. In the turrets, men shoot the shells home. In "plot," a secret room in the bowels of the ship, officers, not seeing the "battle," but in

constant touch by telephone with every fall of shot, chart the ranges. From the foretop, a breezy room at the top of the forward skeleton mast, observers shout information into a telephone for the men working plot. The "enemy" are on the horizon. Your ship is steaming at full speed,



Submersible's Periscope Is Withdrawn by Unseen Observer Below after Sighting Target in Distance



1107

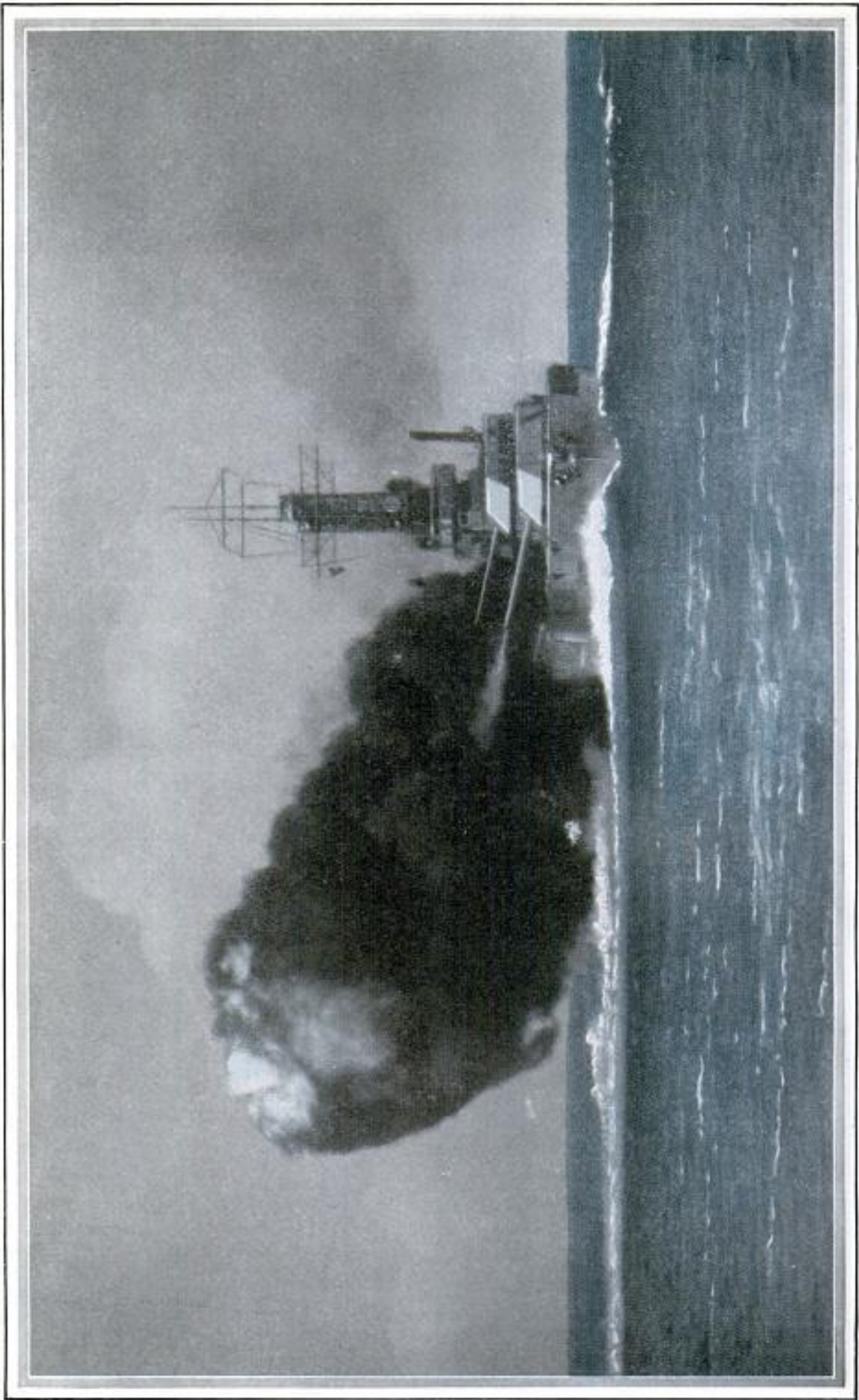

"Rocking the Ocean" with a Broadside during One of the Batt'e-Practice Drills Held by the U. S. Navy; the Roar of the Bombardment Was Heard a Hundred Miles Away as the Floating Fortresses Boomed at a Fleet of Target Rafts Which Were Splintered by the Gun Fire



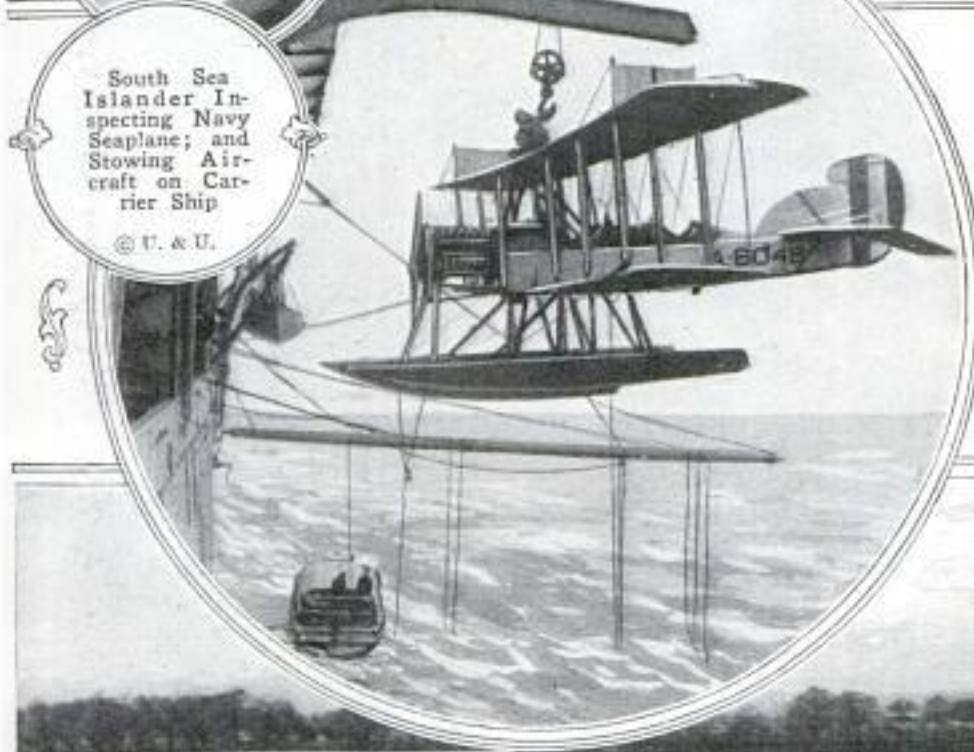
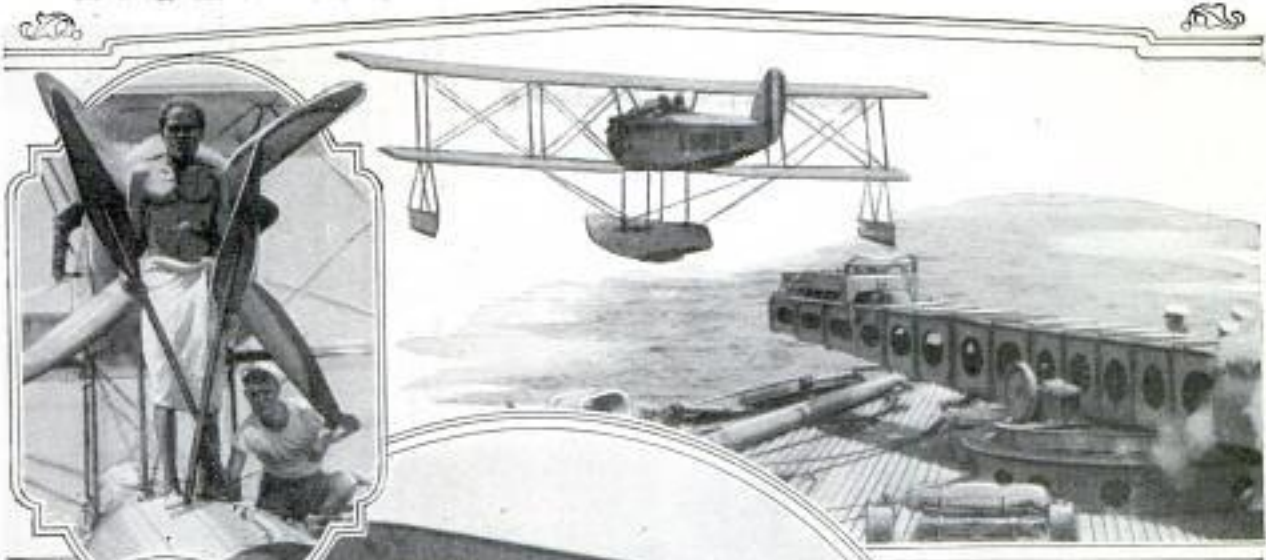

Lofting a Seaplane from Deck of Battleship by "Shooting" the Machine from a Catapult; the Device Launches the Plane with the Same Speed as a Torpedo Tube Throws Out its Missile; Below, One of the Navy's New Long-Distance Scout Planes Which Can Make a 2,400-Mile Non-Stop Flight

South Sea Islander Inspecting Navy Seaplane; and Stowing Aircraft on Carrier Ship

© U. & U.





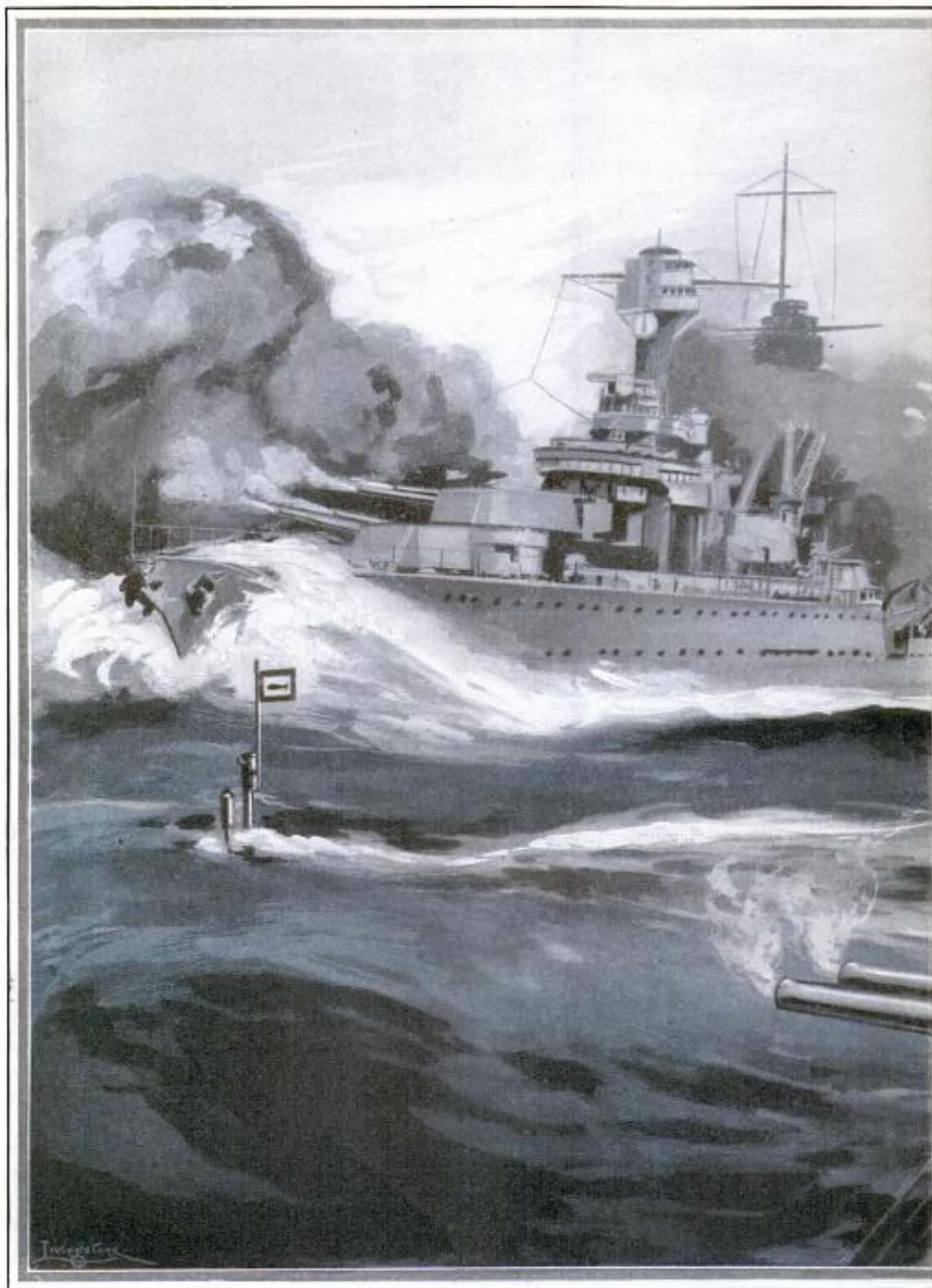

At the Height of Action during War Practice by Battle Fleets of the U. S. Navy; the Enemy Is Imitated by Barges Bearing Huge Targets Towed across the Line of Fire





All Services of the Sea-Fighting Arms Are Represented in Big Naval-Combat Drills, and Aircraft and Submarines Join Forces with the Thundering Armadas of Warships



1107



Sailors Inspecting New High - Powered Seaplane with Which Their Ship Is Equipped



U. S. S. "Langley," One of the Navy's Floating Aviation Fields That Carries Aircraft Fleet

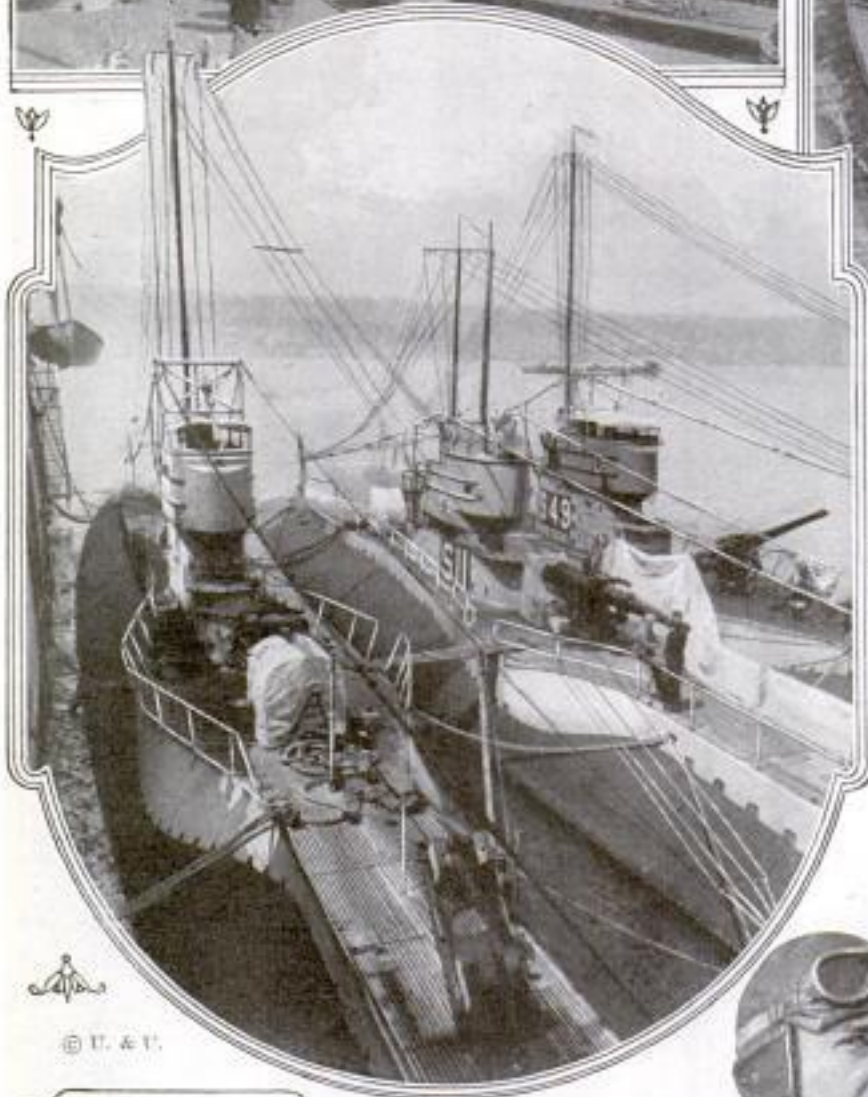

© U. & V.

Submarines of Latest S-Boat Type Tied Up after Long Trip: Right, Lieut.-Comm. Davis, Senior Flight Surgeon of Naval Air Force





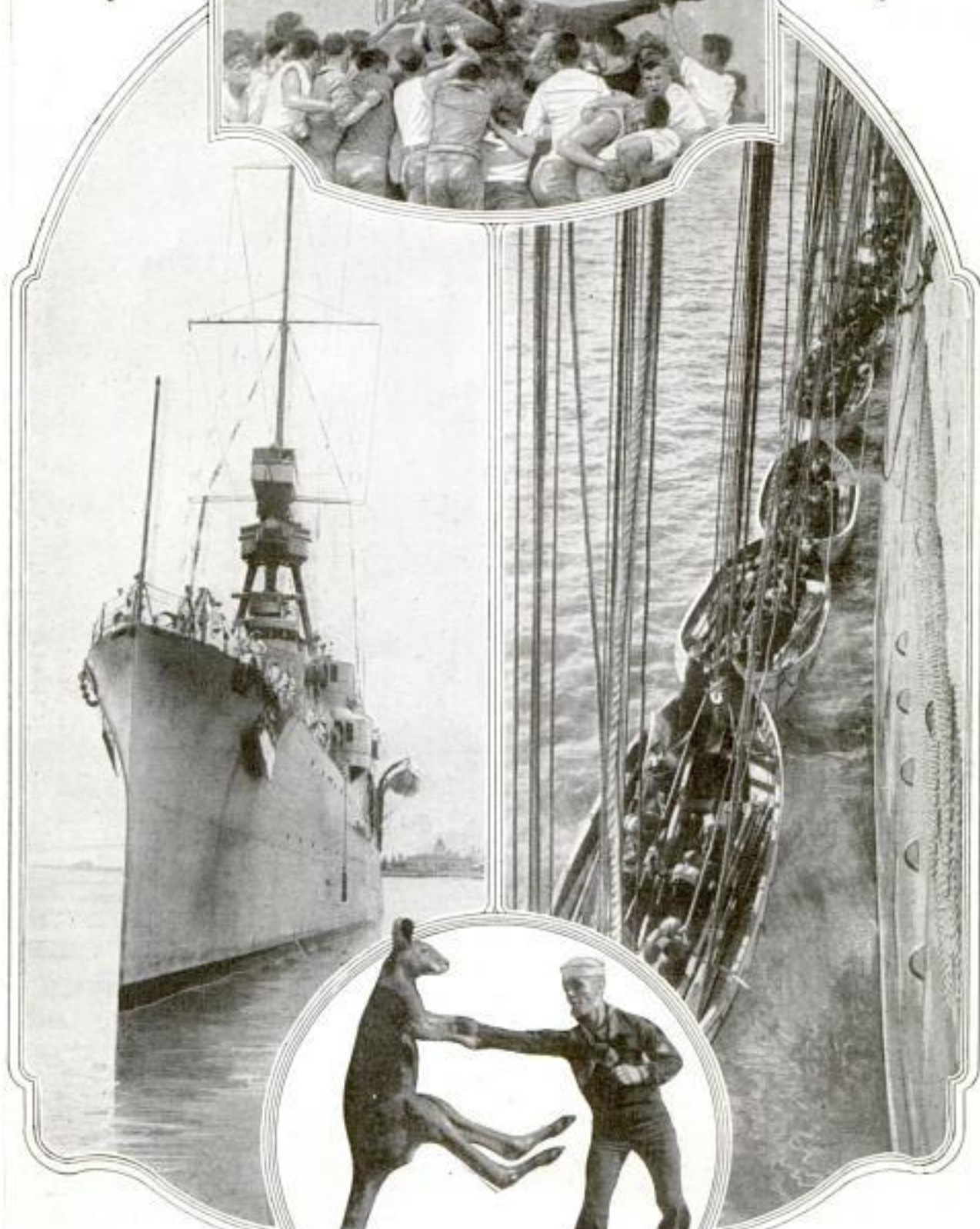

At Top, Push-Ball Scrimmage during Recruits' Game at Naval Training Station; Below, Speedy Scout Cruiser "Omaha," Entering Harbor at Honolulu

Lifeboats Taking to Water in "Abandon Ship" Drill aboard Ocean Liner "Aquitania"; Below, Kangaroo Getting Boxing Pointers from Bluejacket



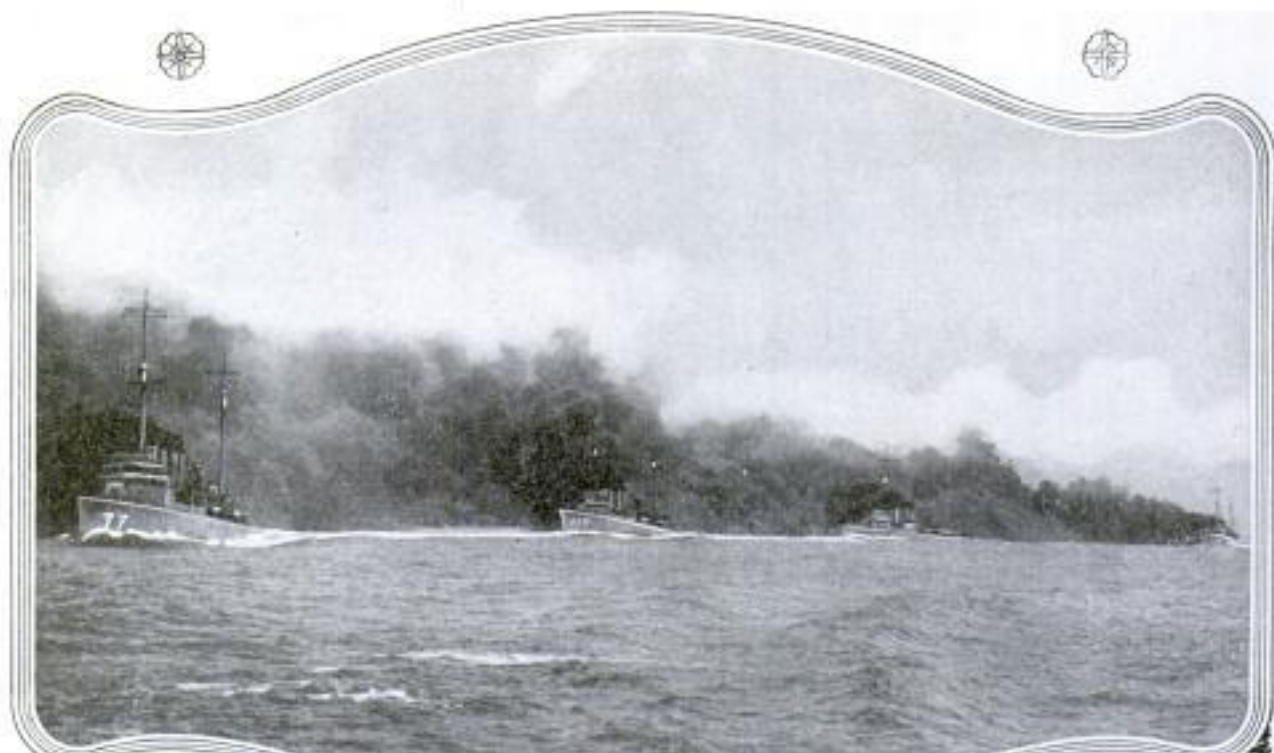

Destroyer Squadron at Full Speed  
Laying Down a Smoke Screen, and  
Below, Seaplane Flying along the Con-  
cealed Path Entirely Hidden from the  
"Enemy"

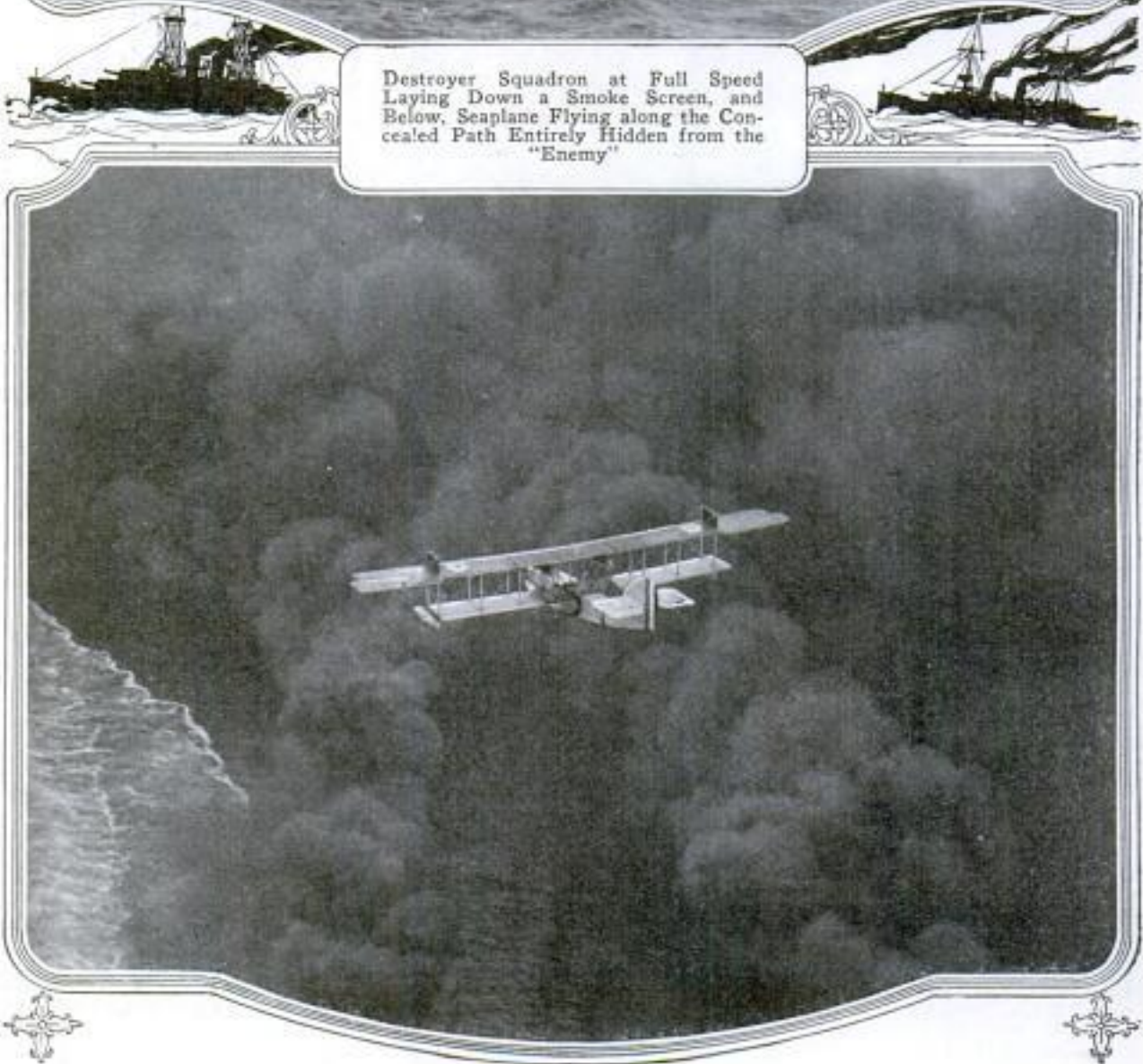



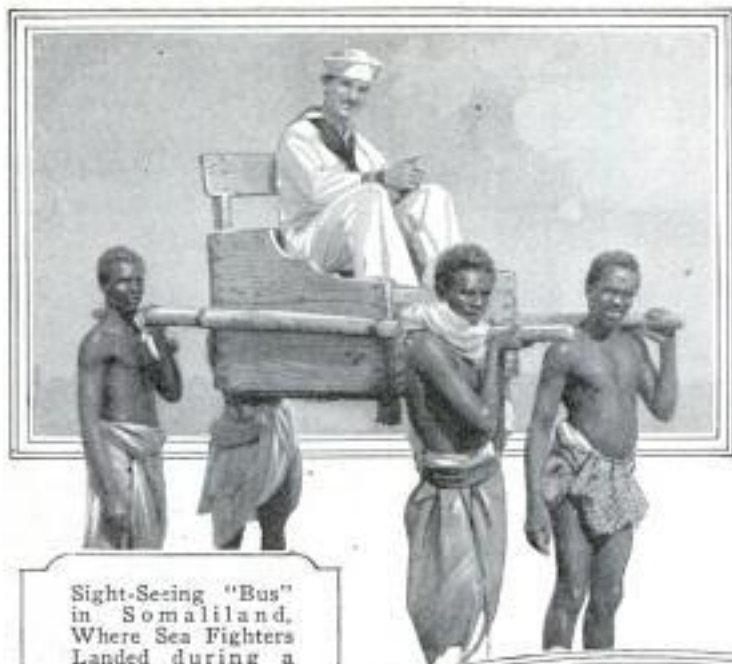

Sight-Seeing "Bus" in Somaliland, Where Sea Fighters Landed during a Cruise

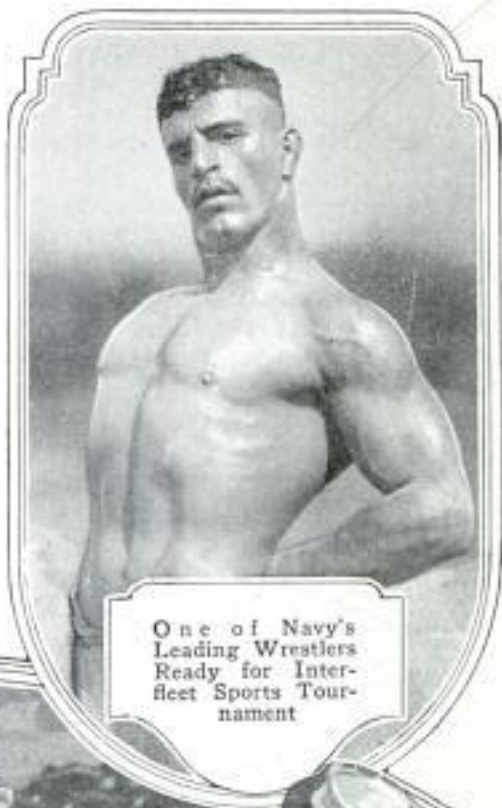

One of Navy's Leading Wrestlers Ready for Inter-fleet Sports Tournament

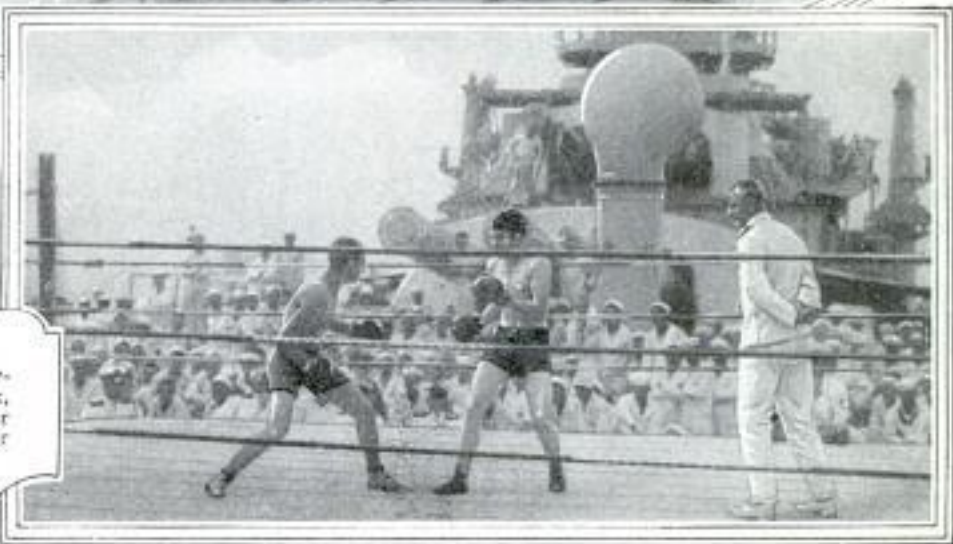

"Gobs" off Duty, Playing Maj Jangg on Deck, and Boxing Bout for Championship of War Vessel



dodging hypothetical submarines. There is not a soul moving on the maplike decks below, but the thin noses of the guns move slowly to and fro, keeping "on" the target. Then comes the swift order. There is a flare of fire. Simultaneously the mighty ship is slammed back, shuddering from the recoil, quivering as if it had hit a mountain side. Gray-black smoke and a thundering roar follow the flare. A broadside is exciting.

There, three-quarters of the way across the span of water are two great, black birds, apparently, flying low and almost slowly, side by side. They are the shells, so large and heavy that their relatively slow flight is visible. You watch them, fascinated, as they rip through the target and plunge into the sea beyond. A great white shaft of spray lifts into the air from the turbulent water. It is like the blow of a mammoth whale. It falls and the ocean is silent. Another hit has been scored. That is battle practice, but it is only a small part of the work of the American navy in peace times. In the Yangtze river, naval gunboats protect American interests from river pirates. In Central America, special-service cruisers watch over our extensive fruit interests. In Turkish waters, destroyers insure the movement of American oils. Other naval craft are disposed throughout the world, in Asia, in the South China patrol, the destroyer squadron at Manila, the submarine divisions also at Manila, the destroyer detachment in European waters, the special-service squadron operating in the Caribbean and South America, and a fleet of fifteen large liners constantly employed in naval transportation. This entire force,

comprising hundreds of vessels, is organized under a single battle command, and is so moved by the office of naval operations that at least once a year it operates as a unit for three or four months, and is at all times ready for immediate junction. No fleet movement is made which could conceivably prevent a quick and efficient rendezvous in the event of an emergency arising. But, in addition to being a first-class insurance, the navy has been called the nation's greatest university, because of the numbers of men it trains, and the largest scientific laboratory, as a result of the encouragement it gives to manufacturers. Andrew Carnegie once declared that the steel industry was built on naval specifications; that its demands for perfection enabled the industry to evolve the higher grade steels now in general use today. Strange as it may seem, the electric light also might have been impossible had not naval scientists, in support of Thomas A. Edison, demanded that the navy purchase the early lamps and assist in their development. Recently, a marvelous advance has been announced in the tool industry—a metal known as "monel" has been discovered, which is sweeping the mechanical trades. This industry, too, was first subsidized by naval authorities who recog-

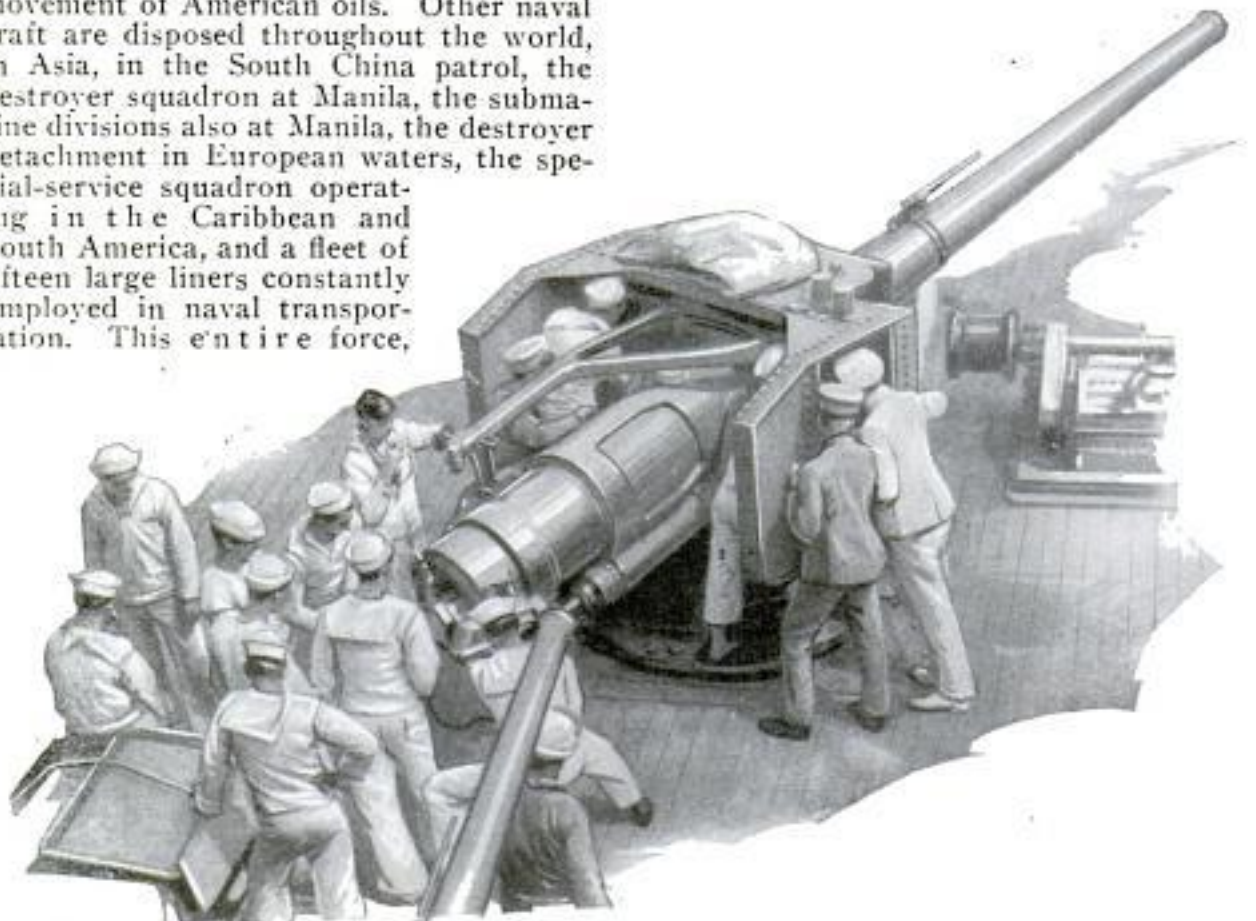

Fighting Crew of Warship at Gun Drill with a Five-Inch Naval Rifle; Almost a Daily Duty of the Vigorous "Tars" Charged with Handling the Piece during a Battle





Thirty Tons of Anchors That Grip the Ocean Floor to Hold a Giant Battleship in Leash, and a Closeup of a Propeller Just Before It Is Scraped Clean in Drydock by a Crew of Sailors

flies, are maintained. Not only does the navy maintain a first-class advanced radio school, but the pathway to commissions for enlisted men is an ever-beckoning light, in addition to the post-graduate courses in radio engineering which graduates of the naval academy may secure.

To date, more than 500 naval aviators have given their lives in planes and airships in the cause of aviation. The naval air service comprises a military body of men who are at all times available for the testing of new advances in aircraft. Oftentimes they sacrifice their lives, but they believe their country en-



nized its value, and the monel-metal industry, now so important in American tool manufacture, was placed on its feet.

With the advent of radiotelegraphy and telephony, the naval technicians rapidly began to set the standards in these arts, and today navy radio and its rules and regulations dominate the wireless of the country. The naval radio-communication service now includes more than 1,000 land and ship stations in every part of the world. Regular overseas schedules between San Francisco, San Diego and Honolulu and the Canal Zone, between Washington and European stations and South American stations, between Manila and Honolulu and our legation at Pekin, between Alaska and Hawaii and the United States mainland, wherever the flag

gages them for the risks they assume—and so the danger is accepted as a routine matter. For instance, there was the recent death of Lieut. Lambert Hewitt, test pilot for the aircraft squadrons of the battle fleet, who lost his life last autumn while testing a new camber wing, invented by an enlisted man. The camber wing has since been demonstrated to be worthy of adoption; but that particular day it was not complete in its safety element—and Hewitt, engaged in flying the test, crashed to earth and was killed.

The naval observatory at Washington, D. C., is the country's standard time-setting center, and the naval hydrographic office is the standard mariners' bureau of the United States, and charts are sold by it to all ships afloat. Two destroyers, the "Hull" and the "Corry," are now in



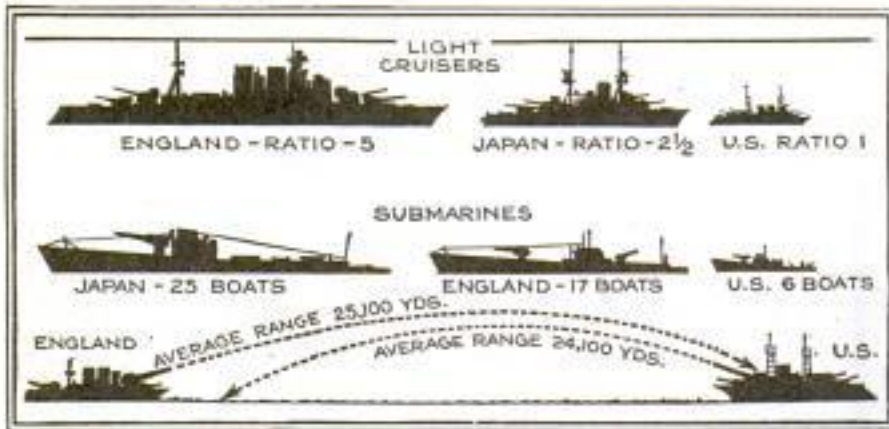

Chart Showing Present Standing of Navies of "Big Three" Sea Powers, According to Naval Experts; Compared with Other Two Nations, the United States' Equipment Falls Far Below the Allowances Permitted under Various International Treaties, in Several Important Features of Armament, Which Include Gun Range, a Leading Point in Both Offensive and Defensive Combat



Cleaning the Barnacle and Rust-Covered Bottom of a Destroyer in Dock in Preparation for Protective Coats of Paint; Left, a Champion Rope Maker Framed in a Coil of Ten-Inch Rope That Weighs a Ton and a Half and Can Hold a Load of 75,000 Pounds

Alaskan waters sounding every inch of the coast, and perfecting charts which will benefit all ships which navigate those waters. But perhaps the most vital of all the naval functions is the annual pouring into American industry and science, of several thousand trained young men who are skilled in every conceivable branch of industry, from excellent opticians, pharmacists and radiomen, to coppersmiths, blacksmiths and sheet-metal workers. An estimate made recently, based on actual examination of records, shows that eleven per cent of all pharmacists in the United States are ex-naval personnel. Also three-fourths of all commercial radio operators and superintendents are men with naval experience. Recently, the photograph of the apprentice class aboard a United States naval ship in 1895 was checked, and it was found that out of the twenty-two men shown, two are mayors of cities, four

are prosperous lawyers, one owns a flourishing department store, seven are engaged in successful mercantile enterprises, one is a farmer of means and one is a leading American magazine artist. Of the remaining six—less than one-third of the class—no trace could be found.

Graduates of the naval academy equipped with special technical knowledge have passed into civil life and made national names for themselves. Among these may be mentioned Homer L. Ferguson, president of the Newport News Shipbuilding company; the present secretary of the navy, who was chief justice of the state of California; Joseph Powell, recently head of the Bethlehem shipbuilding plants; W. L. R. Emmett, consulting engineer, General Electric company, and designer of electric ship propulsion, and Professor Michelson, of Chicago University, one of the greatest living scientists.



New York Times  
8/15/24  
1402

Edw. L. C. Lear  
508 S. Mont. St.  
Butte, Mont. 389

### Eight Men Rebuild Railroad Box Car in Six and One-Half Hours

Rebuilding a double-sheathed freight car of 60,000 pounds' capacity in six and one-half hours was the accomplishment of a picked crew of eight men in a three-team contest conducted by officials of the Delaware and Hudson railroad. The feat is said to establish a record in car construction. The task involved completion of the entire superstructure, installing the gears and couplers and assembling the car on the track. To speed the work, parts were piled in convenient positions and in the order that they would be needed. Pins, bolts and nuts were sorted by sizes. The purpose of the competition was not to establish a speed record but to demonstrate efficiency and timesaving methods.

### Garage Doors That Roll Overhead Save Space and Repair Bills 894

Garage, factory and warehouse doors that roll up overhead are being manufactured to replace the ordinary hinged or sliding door. They are constructed in panels, somewhat like the roll top of an office desk, and slide on flanged rollers and steel tracks. When the door is opened, it is inside where it cannot be damaged by the weather and cannot blow shut. It is counterbalanced by strong steel springs, locks automatically when closed, fits flush with the floor and is not hard to install. As it

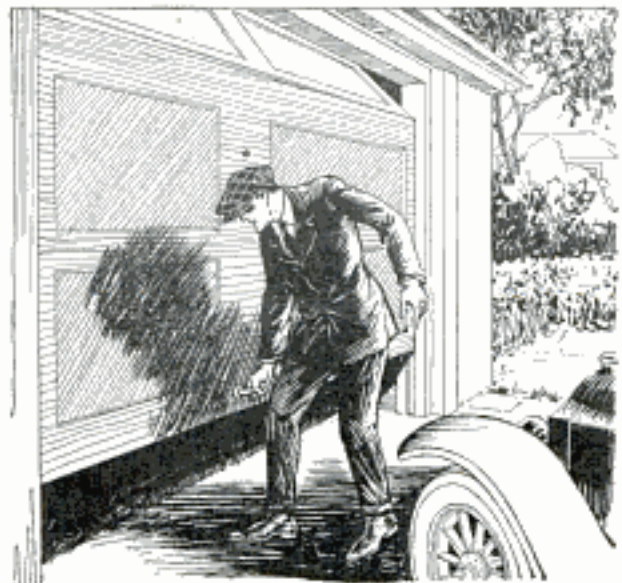

Sliding Garage Door Overhead, Where It Cannot Slam Shut or Protrude on Sides

does not project beyond the building, it is convenient where the garage or other structure is erected in limited space.

Overhead Door Corp.  
7301 Cottage Grove Ave  
Chicago

### Camp-Fire Meals Are Cooked Easily on Revolving Bracket Grid 1230

Much of the unpleasantness of cooking over the camp fire may be eliminated by the use of a revolving bracket grid recently



Sketch of Camp-Fire Cooker; Pots Are within Easy Reach on Grid Frame That Revolves

invented. It consists of a short, pointed base which is driven into the ground and about which the fire is built, an extension tube, a revolving top piece and four interchangeable grids. Several things may be cooked at once, and a light touch is sufficient to swing the arrangement around for stirring the contents of a pot or for placing anything over the hottest part of the fire without stepping into the smoke. The entire outfit is quickly assembled or taken apart, occupies but little space and is durable. The surfaces of the cooking grids are angular-shaped, making them easy to clean and well suited to broiling steak or toasting bread.

1349

### Glitter of Gold Is Found in Alloy

Resembling real gold in appearance and said to possess some of its chemical and physical properties, a composition of copper and aluminum mixed by a patented process has been invented by Swedish scientists and is now being manufactured in this country. It is not affected by the common acids and alkalis, does not turn black or corrode and is reported to be nearly as hard and durable as steel.

The Ungold Corp.  
728 Metropolitan Bank Bldg  
Minneapolis, Minn.



1285 **Push-Button Piano Cabinet Plays Program of Eight Rolls**

For playing a number of piano records one after another without the bother of changing them by hand, a cabinet attachment that can be fitted to any make of player has been designed. It is electrically



Push-Button Record Selector in Use and Interior View of Playing Side of Cabinet, Showing Cable Connections and Rolls on Battery of Reels

operated and may be placed at any distance from the playing instrument. Connection is made by an electric-pneumatic cable. The records, eight in number, are wound on separate reels within the cabinet and may be played in any order desired simply by pressing corresponding buttons in a small control box which may be placed in any convenient position and is connected to the cabinet by wires. Opposite the buttons, the names of the selections are written on a card. Any roll may be stopped at will or replayed simply by pressing the control. One side of the cabinet contains space for the library of selections. To change the program it is merely necessary to put new rolls on the reels. If desired, more than one control box may be used, so that the player may be started from various parts of the house.

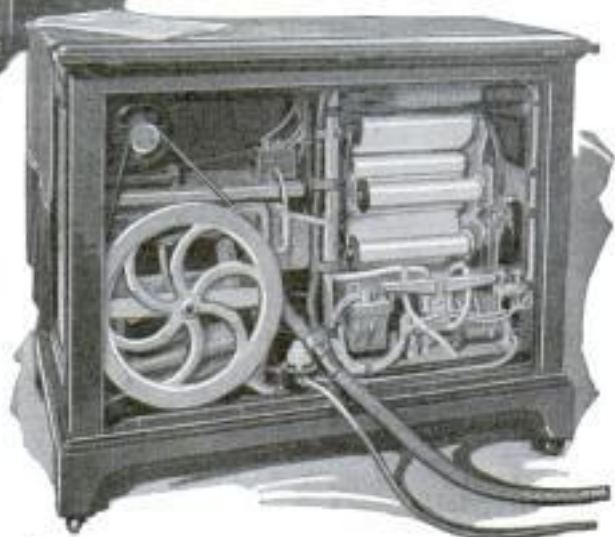

country. One hundred and seventy acres of flowers are now under cultivation and an additional tract of 500 acres is being prepared. Five buildings, comprising over 27,000 square feet of floor space, have been erected for the manufacture of perfumes, toilet waters and all sorts of cosmetics. Labor-saving machinery, which is said to enable one man to duplicate the labor of seventy-two workers using the obsolete methods in vogue in the Orient, is being used; the absence of frost results in a saving of fuel and production costs are further decreased by the fact that there are vast quantities of a white clay, used

1295 **Perfume Plant in Florida May Cut Cost of Essential Oils**

Within the past year, American capital has fostered the establishment of an es-

Essential Co. of America  
 Groveland, Florida



in extracting the perfume, on the tract owned by the company.

Besides the many kinds of flowers cultivated in the gardens, acres of citrus trees provide orange, lemon and other kinds of blossoms for perfume manufacture. The petals are gathered in sheets spread under the trees and are placed in air-tight glass cabinets, where they are exposed to the absorbent clay for twenty-four hours. The perfume is later extracted by treating the clay with alcohol.

### Vivid Hues Brighten Paper Money to Check Counterfeiting // 57

So that it will be harder to counterfeit United States paper currency and spurious notes may be more readily detected, legal tender is being brought out in distinctive colors. The denominational figure, serial number and treasury seal will be printed blue on silver certificates, red on United States notes, green on federal-reserve notes, brown on national-bank notes and yellow on gold certificates.

*Chicago Herald Examiner*  
5/6/24

### Lamp Shades Designed in Forms of Birds and Animals // 115

Designed in the shape of birds and animals, shades for electric lights have been introduced in England, where it is said their odd appearance has resulted in a great demand for them. Painted in the natural hues of the subject, with the incandescent lamp inside, the shade presents a novel effect while softening the glare of the light. Of various models, they are used on floor lamps, ceiling and wall lights.



Painting Electric-Lamp Shade That Is Designed in the Shape of a Duck

*maker unknown*

### Corn That Grows in Seventy Days Is Tested by Uncle Sam

Revolutionary experiments in corn are in progress at the department of agriculture following the discovery of a number



Some of the Species of Corn Tested in Effort to Obtain More Hardy Varieties

of new varieties in the Andean highlands of South America. One kind, with stalks so short that the ears appear to grow directly out of the ground and which matures in seventy days, is being tested. It is planned to breed this with several other foreign species in an effort to obtain a cereal that will thrive in much colder areas than the present corn belt in the United States. The South American product grows in a climate twenty degrees colder.

### Junk Thirty-Five Hundred Miles of Railway in Eight Years // 58

Within the last eight years, 3,500 miles of railways have been abandoned in the United States, according to statistics. Reports to the interstate commerce commission show that between 1916 and 1921 there were increases in mileage in only sixteen states and reductions in thirty-one. The states in which more than 100 miles of track were abandoned include Louisiana, 483 miles; Colorado, 423; Michigan, 275; Indiana, 270; Georgia, 242; Arkansas, 235; Washington, 201; Missouri, 195; Wisconsin, 192; Pennsylvania, 187; Mississippi, 165; Nevada, 157; Ohio, 150; North Carolina, 149; Alabama, 145; Minnesota, 143; California, 134; Virginia, 131; New York, 109, and Iowa, 103.

*Chicago*

*Daily News*

Copyrighted material

5/5/24

*Fred W. Pitchey, Bureau of Cereal Investigation*





Lifelike Group of Manikins Gowned in Fashions Conforming with Those in Vogue during Various Periods of Nineteenth Century; at Left, the Modeler Who Designed and Arranged the Display

## Thousand Years of Fashions Shown by Dolls

Styles in Women's Dress for Past Ten Centuries Depicted in Group of Clay Manikins for Exposition

**W**OMEN'S fashions for the past ten centuries, worn by a hundred tiny clay models, each formed to represent some prominent woman of the times represented by its dress, have been arranged in an interesting exhibit designed for display at the Philadelphia exposition in 1926. Each of the dolls is an exact counterpart of the human figure and about eighteen inches in height. The garments with which they are dressed are not only faithful copies of the styles of former periods but are also made of the same materials as were then in use among popular seamstresses.

Five years were consumed by the molder of the figures in searching old books and manuscripts for proper descriptions of the costumes of the various periods. Nothing was overlooked in the hunt for information, as styles covering bonnets, hair-dresses, shoes, stockings and even parasols had to be copied faithfully to perfect every detail of the work. The dressing and making of the models, after all research work was completed, required a little more than a year. A colored plate drawn to size was made for each figure, and tissue-paper patterns were cut for each dress and gown, so that similar tiny garments may be made in the future for other manikins of the same size, should the artist desire them.

The heads of the dolls are crowned with daintily made wigs formed from human hair and dressed to meet the style corresponding to the costumes. Besides the

gowns that drape the manikins, each is robed with undergarments and other accessories of dress in vogue during the period it indicates. Ornaments for trimming the clothing and tiny bits of "jewelry" shaped from colored glass serve to enrich the effect of the individual displays.

The faces of the figures are carefully painted and each subject is made to look like some notable woman of the time and country represented by the garment.

All of the research work, designing, painting and arrangement of the group for exhibition was done by Mrs. Agnes Ericson of Berkeley, Calif., for her own entertainment and pastime. The styles of the clothing and other articles of dress as well as the portraits from which the faces of the figures were copied, were obtained by the artist in the library of a university. Another set of similar models is now being planned by the maker, who expects to include fashions as far back as the ninth century. In this collection the styles of both men and women of the various periods will be portrayed. The new group will consist of more than a hundred small characters modeled after those seen in familiar historical illustrations of the past. It is believed that at least five years will be necessary to perform all the work required to produce a perfect exhibit, as all of the tiny boots, shoes, hats, swords and scabbards will have to be made by hand, in addition to minute copies of gems and other ornaments with which the figures are to be decked.





Exhibit of Carefully Clothed Clay Models of Notable Women of History Robed in Costumes of Their Times to Illustrate the Progress of Feminine Styles during Past Thousand Years



Pacific + Atlantic Photos  
29 Park Place

*113* Elevator Passengers Are Protected  
by the Testing of Cable

To protect the lives of elevator passengers, engineers in the bureau of standards have designed a machine to study the effect of internal and external wear on

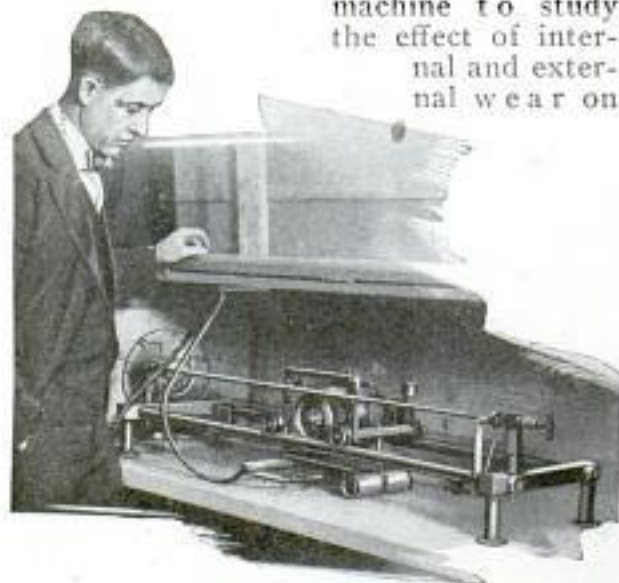

How Elevator Cable Is Being Tested by Uncle Sam, to Protect Passengers

the strands of the steel cable before it is put into service. For the latter test, an individual wire is placed between two supports with just enough tension to keep it straight. It is then subjected to friction from a revolving wheel which touches it on one side and travels on a small motor carriage from one end of the wire to the other. At each round trip of the wheel, the wire is turned a small fraction of its circumference so that the wear will be uniform.

*13* 24 Illuminated Ads on Motor Trucks  
Attract Attention at Night

Automobile trucks carrying illuminated advertising signs have made their appearance in London. The sides of the trucks



Automobile Truck with Illuminated Advertising Signs That Change Automatically as Machine Is Driven

are divided into frames, behind each of which a set of rollers is mounted containing forty different posters. The lighting apparatus is fitted inside the cars, and as it does not take much space, the trucks can carry merchandise, thus making the enterprise self-supporting. The current is generated by a dynamo driven by the motor. The ads are changed automatically as the machine is driven.

1221

Three Comets Shooting at World

Three comets are due to approach near the earth in 1924, astronomers at the naval observatory have announced. They are the Encke and Temple, which will appear in November, and the Tuttle, coming in December. Special preparations are to be made to study them, it is said, as scientists have no means of determining what may have happened to them since they passed out of sight.

*Chicago Herald-Examiner*  
5/16/24

1241 Rubber-Lined Barrel for Chemicals  
Is Proof against Acids

Lined with rubber, an oak barrel designed for shipping liquids, chemicals and acids which cannot be satisfactorily sent in metal drums, carboys or the ordinary unlined wood containers, has recently been developed. Of high-grade oak, the barrel is equipped with either six or eight hoops, depending upon the weight of the material to be carried. Into it, at the time it is made, is fitted a corrugated paper lining next to the wood, to prevent splinters from puncturing the sheet rubber. The rubber lining is equipped with a molded neck which protrudes through a bunghole. The bung itself is also of rubber and is wedged tightly against the rubber neck by a steel plate. Three corks that go through the wood permit air to escape while the barrel is being filled. To empty the contents, the corks are pulled out, the bung plate taken off and the rubber stopper removed. The barrel may be filled completely, as, it is claimed, its construction allows for considerable expansion of the contents.



Developed by American  
Chemical Co., Copyrighted Material  
Phila.

*Ent. C. A. Aldroyd,  
1241 Abbey Road,  
Barrow-in-Furness,  
Lancs Eng*

*Developed by American Chemical Co., Philadelphia*



### Land Lighthouses Warn Motorists of Dangers and Bad Roads

Experiments in building lighthouses on land to warn motorists and other land travelers of dangerous places such as curves, cross roads and rough thoroughfares, are said to have been so successful that in Australia their construction has been made part of the highway-system program. In a small way the oscillating lights used at busy paved street intersections in American cities have been classified as lighthouses of that type.

140 Y

### Ice-Cream Vender on Motorcycle Moves His "Store" Easily

So that he could transport his wares cheaply and quickly to fairs, celebrations and other places where crowds gather, a



Copyright, Underwood & Underwood  
French Vender Selling Ice Cream from "Store" Mounted on Motorcycle Sidecar Chassis

French ice-cream vender built his "store" on the frame of a motorcycle sidecar. Space for three large freezers is provided in the body, while the cones and utensils are stored in an inside cabinet. Covered with a canopy and gaudily decorated, the novel "shop on wheels" enables the owner to go to his customers instead of waiting for them to come to him.

### Colored Flood Lights on Building Add to Its Beauty at Night

Bathed in a flood of colors, a Chicago building is nightly illuminated by a battery of projectors hidden from view on the structure. From a balcony on the second floor, a deep blue creeps upward along the entire 540-foot length of the building, fading slowly through violet, purple, magenta and orange into red at the cornice. A strip of amber light that produces a golden glow along the top, and a clear white light reflected against reliefs, add beauty to the scene. By connecting the projectors to a flasher, a fascinating effect has been produced, one color predominating for a few moments before blending into the next. The building is believed to be the first to be permanently illuminated in this manner.

1265



Building Front Illuminated by Floods of Various Colored Lights Hidden under Powerful Reflectors; Shades Change Regularly Every Few Minutes, Bathing the Walls in Different Hues

Madjunkin Bldg, Wilson Ave.  
+ Broadway, Chicago



1384 Lone Chimney Sweep Still Plies Trade in Tall Hat

While modern methods and new types of buildings in America have caused the once familiar chimney sweeps to seek



Chimney Sweeper in Unique Outfit with Which He Goes About His Sooty Job

other occupations, there is one in New York who still goes about in the high hat and with the ladder that once marked his calling. Small chimneys he cleans by lowering his brush, but the large ones he lowers himself into and cleans by hand. Attached at one end to a rope and to a heavy ball at the other, the brush is pulled up and down, the heavy bristles rubbing against the sides of the stack and knocking the soot to the bottom.

1390 Magic of Artificial Cold Touches More Than Hundred Industries

Almost everything eaten and worn is now affected by artificial refrigeration. Besides the foods kept fresh by this means, medicines, motion-picture films, furs, watch springs, seeds for the garden and silk are commonly subjected to cold to keep them in good condition. It is estimated that there are more than one hundred industries that now depend more or less upon cold storage in their business. Its application to ventilation of hotels, theaters and other buildings is rapidly increasing. Millions of cubic feet in huge warehouses throughout the country are devoted to cold-storage purposes and thousands of workers are employed.

1197 Electric Switch Engine Cuts Cost and Does Away with Smoke

Driven by four fifty-horsepower motors with electricity generated by an oil-burning engine, the first Diesel-electric locomotive built in America was recently given a practical test in New York freight yards. The engine consumes from twenty to twenty-six cents' worth of oil an hour in switching service, which is said to be approximately one-third the cost of coal burned by an ordinary steam locomotive in similar work. A muffler reduces the noise of the exhaust, and the absence of smoke makes it particularly suitable for use in cities. An economical feature claimed for the locomotive is that, like an automobile, it is necessary to feed oil and operate the engine only when it is being run. It is said enough fuel can be carried to keep the locomotive in switching service continuously forty-eight hours.

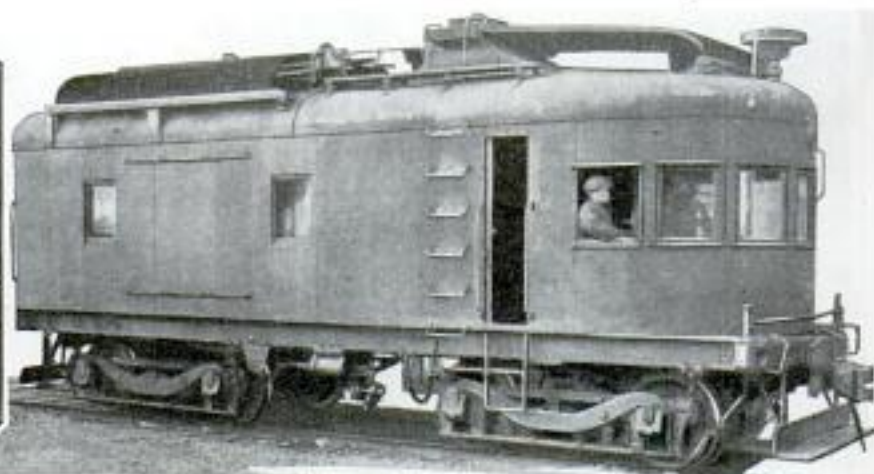
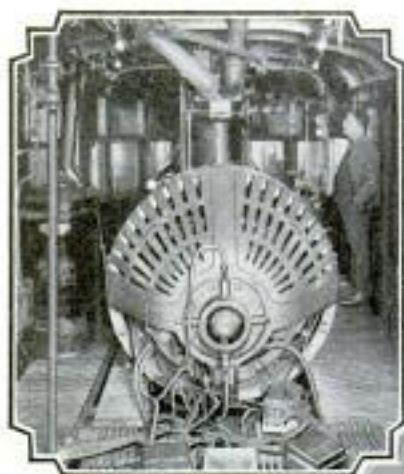

Electric Switch Engine Which Can Be Operated at One-Third Fuel Costs of Coal-Burning Locomotives; Left, View of Interior Showing One of Fifty-Horsepower Motors

General Electric Co., Schenectady, N.Y.  
Ingersoll-Rand Co., 11 Broadway, New York



Kansas City Star  
May 29, 1924

Dominion  
Astrophysical Observatory  
Victoria, B.C. Canada. 397

POPULAR MECHANICS

**Million Words Engraved in Inch  
Are Invisible to Eye** 1353

For years it has been a favorite feat of engravers to write the Lord's Prayer on the head of a pin. Getting sixty-five words into that small space would seem an amazing achievement, but such an engraving is as large as a three-sheet poster compared with that done by a special reducing apparatus called a micropantograph. With this machine letters have been engraved so small that in the space of one square inch, it is said, eighty complete copies of the Bible could be written. These figures have been confirmed by tests made by the bureau of standards. It is pointed out that engravings of this kind would prove of value in war time, as messengers could carry written communications of great length on the surface of a button which it would be practically impossible for the keenest enemy officer to find a trace of unless he were an expert micrographist. The device operates like the ordinary pantograph used by artists, but is, of course, more intricate in construction. The arm which does the actual engraving contains at its end a tiny chip of diamond, selected with the greatest care. After the writing is completed, the surface is cleaned and then rubbed with a piece of soft paper containing finely powdered graphite, or, if the metal surface is dark, some other contrasting color, which fills in the lines and brings them up sharp and clear under the microscope.

**Huge Telescope to Photograph Mars  
Has Lens Weighing Two Tons** 1252

With Mars and the earth closer together in August than they have been for many years, special arrangements have been made by universities and at astronomical observatories to study the planet. It has

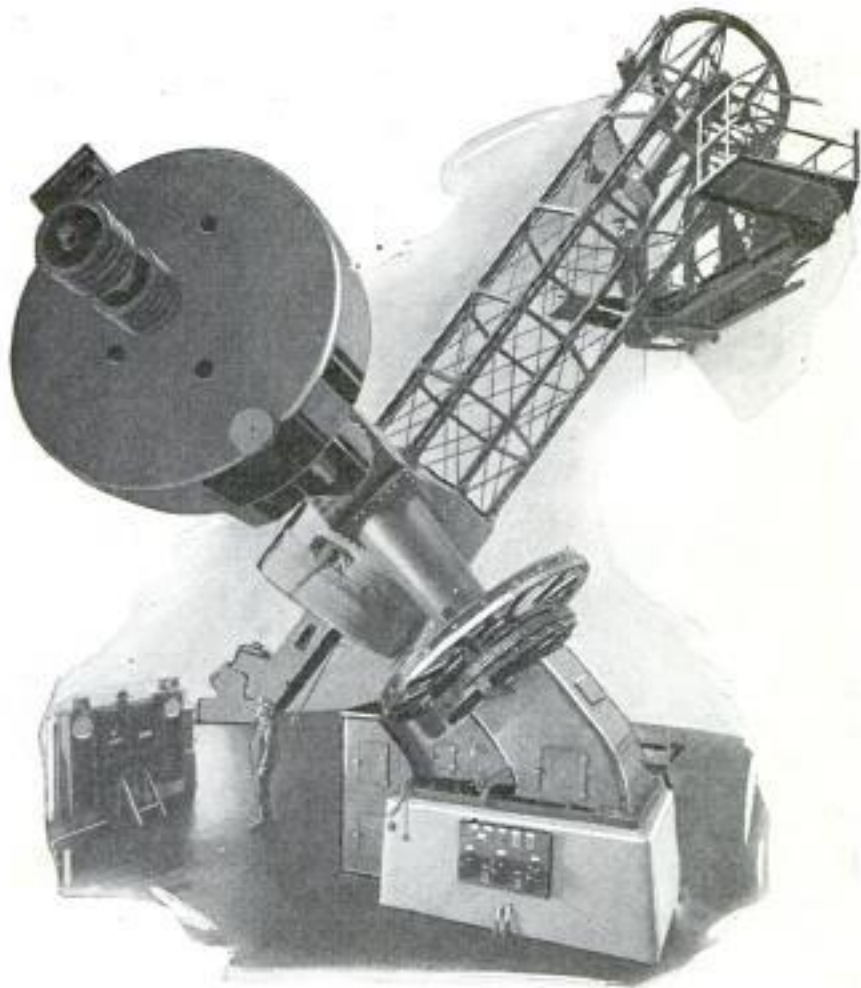

Forty-Ton Telescope by Which Efforts Will Be Made to Get Close-Up Photograph of Planet Mars and Any Possible Evidence of Life

also been planned to send out radio waves in an effort to communicate with the inhabitants if there are any. In many of the observatories throughout the world, telescopes have been improved and other instruments invented since the last time the two planets were as close, which was fifteen years ago.

**Wild Boar Incased in Ice** 1409

Sweeping across a road near Rochetaille, France, an avalanche recently dropped off a huge block of ice which was found to contain the body of a wild boar. It is believed that the animal had been swept up as the mass of snow, ice and rocks started on its wild career and was frozen within it.

At the Dominion astrophysical observatory at Victoria, B. C., a giant photographing telescope, weighing forty tons, has been installed in the hope that it will be powerful enough to take pictures from which it can be determined whether or not Mars is inhabited. The lens is seventy-two inches in diameter and twelve inches thick and alone weighs 4,000 pounds. The axle on which the great tube is mounted weighs nine tons.

The Home News  
6/15/24

Done by Alfred McEwen  
London banker  
W. Peter



## Washdays the World Round Show Progress



In Brittany, France, the Women Find a Convenient Laundering Place in an Old Moat, the Banks Providing Space for Drying. Above, Left, Formosa Women Struggling with the Family Washing in a Public Basin with Crude Stones; Right, Concrete Tubs Built for Public Laundering by Provident Officials of a Mexican City



# of Civilization from Days of Hand Labor



Scrubbing by Hand at Public Steps, Women in Como, Italy, Seen at Left, "Do" the Week's Washing and Dry It on Near-By Lines; Above Is a Glimpse of River Laundry in India Where Men Assist by Beating Clothing on Boards; Inset Shows a Corner of a Well-Ventilated American Laundry Where Machinery Lightens Labors



Combs, Esardner Wilson  
No. 1453 Railway  
400 Exchange Bldg.  
Chicago

New York Times  
5/2/24

**Ancient Parent of Modern Piano  
Has Strings Plucked by Quills**

801

Extremely popular in the 16th and 17th centuries, the harpsichord, the forerunner of the modern piano, has a double key-



Keyboard of the Ancient Harpsichord, the Forerunner of the Modern Piano

board but instead of the strings being struck by felt hammers, they are plucked by a piece of quill. This produces a brilliant tone and several combinations are gained with the aid of stops and the two or more strings for each note. Little expression is possible, however, because the quills do not register differences in the player's touch.

**Picture Worn in Buckle of Shoe  
Is Latest Fad of Fashion**

Keystone Vario Co., 1201  
91-7th Ave.  
New York



Buckles on women's slippers that have a space for a photograph, are among the latest fads to be introduced in Parisian shops. The frame is so made that the picture can be removed and replaced by

another. Studded with jewels, the odd clasps are said to have created a sensation in the French capital.

**POPULAR MECHANICS**

**Electricity for City of a Million  
Is Carried through Subway**

Electricity sufficient for a city of a million population is being carried through cables the size of a thumb in Cleveland. The importance of the development is said to lie in increasing the practicability of forming a nation-wide superpower system. Necessity for the construction of the cable arose from the need to supply current to interior territory of Ohio, Pennsylvania and West Virginia where water power is not available. As overhead wires were out of the question because of the danger in the thickly populated sections, a subway was dug across the city, with manholes at 300-foot intervals, to house the cables at least four and a half feet below the pavement. One cable alone carries 66,000 volts. In overhead construction, a voltage of 220,000 has been transmitted on the Pacific coast. With the success of the underground installation, it is believed that it will be possible to develop electricity at distant points, carry it hundreds of miles overhead and run it through subways for distribution in large cities.

**Movie Actors' Eyes Are Protected  
from Lights by Helmets**

To assist motion-picture actors and others employed under the strong glare of the Klieg lights used in studios, a mask that conceals the head and drapes over the body has been invented in England. While the players are not in action or are await-



Movie Worker Wearing Mask as Protection against Harmful Rays of Strong Studio Lamps

ing their scenes, the shield may be put on, thus decreasing the length of time they would otherwise be exposed to the rays.

International Copyrighted material



HEAT-RESISTING GLASS BENDS LIGHT RAYS



Inspecting Pieces of Fused Quartz, a Clear Crystalline, Heat and Cold-Resisting Material That Can Be Molded into Any Form



Heating a Ribbon of Fused Quartz in Oxy-hydrogen Flame

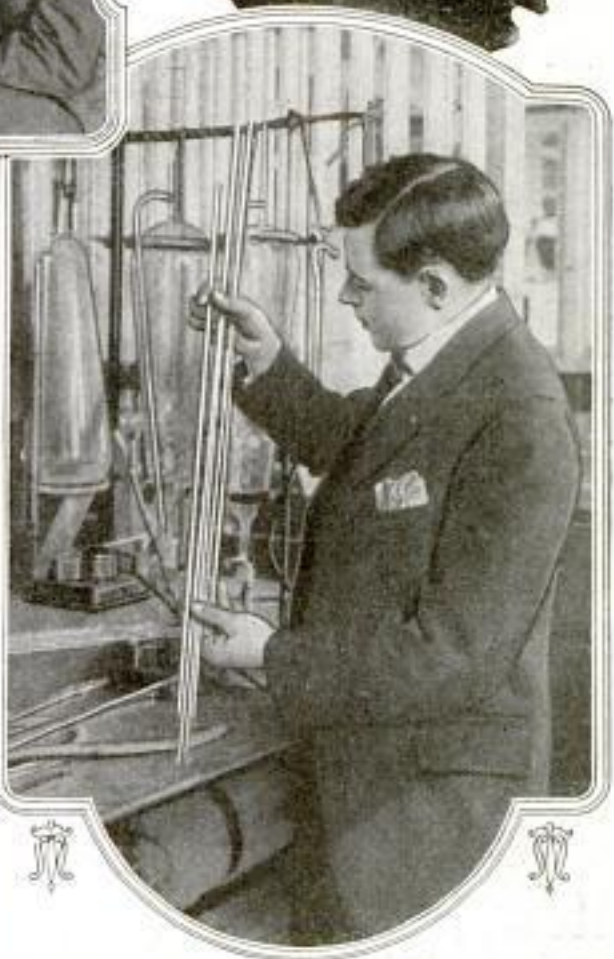
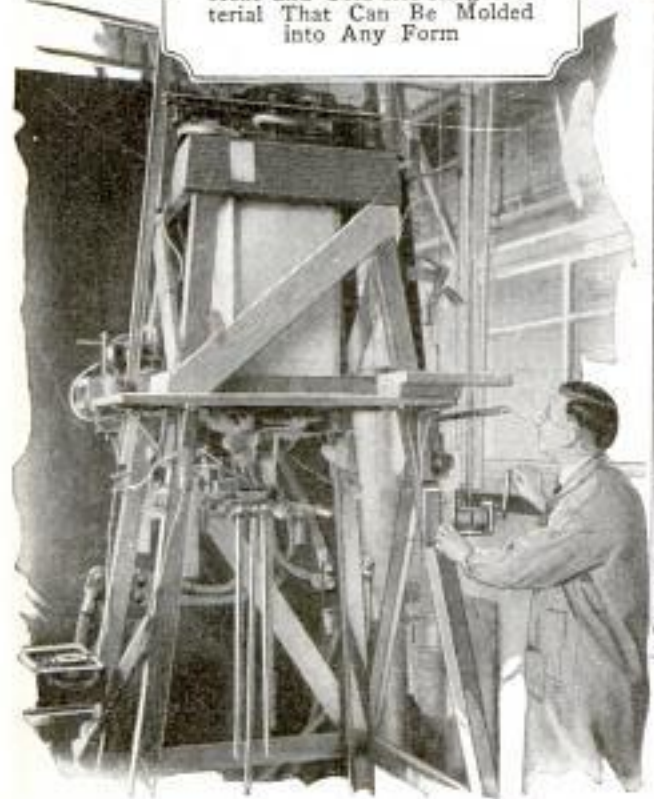

Making Rods of Fused Quartz Which Is Forced by a Heavy Weight through Shapers as It Flows Hot from Furnace, and Tubes of the Crystal Used for Experimenting with Light

By fusing quartz crystals into a clear, transparent solid, scientists at the laboratory of the General Electric company have produced a material which is expected to make possible great advances in many fields of research. It is practically unaffected by temperature and its reflectional qualities are such that light will travel down a curved rod of it and appear around

the corner at the other end or even describe complete circles without the slightest radiation from the sides of the rod. Already, it has been suggested as excellent material for making astronomers' lenses which now have to be kept artificially at the temperature predicted for the night of observation and are often useless because of expansion or contraction if the pre-



dictions were wrong. Measuring instruments of far greater precision than those now in use, chemists' glass containers that will not break under extreme heat or cold are also made possible by this process, as are better lenses for motion-picture cameras since they will not crack under the great heat of the electric arc. It is also believed to be suited for tuning forks, pendulums of clocks and for the transmission of various rays now used in the treatment of diseases. The substance is prepared in an electric furnace. The crude quartz crystals are fused into clear slugs, said to be the most perfectly transparent

material now known to man, under terrific pressure and forced out through molds by heavy weights. To test its qualities, a tube of it was heated to incandescence on the inside by an oxyhydrogen flame. The outside was so little affected by the heat that the experimenter easily held it in his bare fingers throughout the test. It requires an even greater heating point than platinum before it will melt, 4,000° F. being produced in the carbon crucible of the furnace in which it was manufactured. A plant is being equipped for the commercial production of this material, in the preparation of which nine years have been spent.

1163 **Rate of Tree Growth Is Measured by Instrument on Trunk**

For measuring the rate of tree growth, an instrument has been invented that records the increase in the diameter of the



Instrument Attached to Pine Tree in California to Measure Its Rate of Growth

trunk. The device is placed against the tree some distance above the ground and supported by wooden blocks. It is then adjusted so that a contact point is held firmly against the bark on the opposite side. As the girth increases, pressure reveals it by the movement of a lever.

When you want anything and do not know where to get it, write Bureau of Information, Popular Mechanics, Chicago.

937 **Acres Taken from Lake Are Turned into Great Park Area**

Huge quantities of the bottom of Lake Michigan are being carried thousands of feet and turned into dry land to form 11,000 acres of parks and boulevards in Chicago. Most of the transposing is being done by hydraulic dredges. A fan arrangement converts the soft bottom into a watery mixture far out in the lake. This is then pumped through thirty-six-inch pipes to the shore. From one-half to one mile has been added to the shore line for six miles. Before the summer is over, it is estimated that about 6,000,000 cubic yards of soil will have been moved.

*Chicago Evening Post 10/5/24*  
**Flexible Sandstone Is Easily Bent 105° or Twisted Out of Shape**

Rock, similar to sandstone, which can be bent or twisted when formed into thin shafts, has been found at several widely separated places. A fragment of the material, sixteen inches long and about two inches square, will vibrate like a piece of rubber when held by one end and shaken, and in some instances will sag under its own weight. The sand grains of the rock, which is supposed to exist only in the neighborhood of gold or diamond deposits, are said to be loosely locked together by their irregular shapes. Exposure to weather is claimed to cause the stone to become porous, which permits room for movement of the granules in the tiny pockets.



*Sgt. Carl W. Titman  
Smithsonian Institution  
Washington, D.C.*

*cl no. Prof. W. J. MacDougal  
no address*



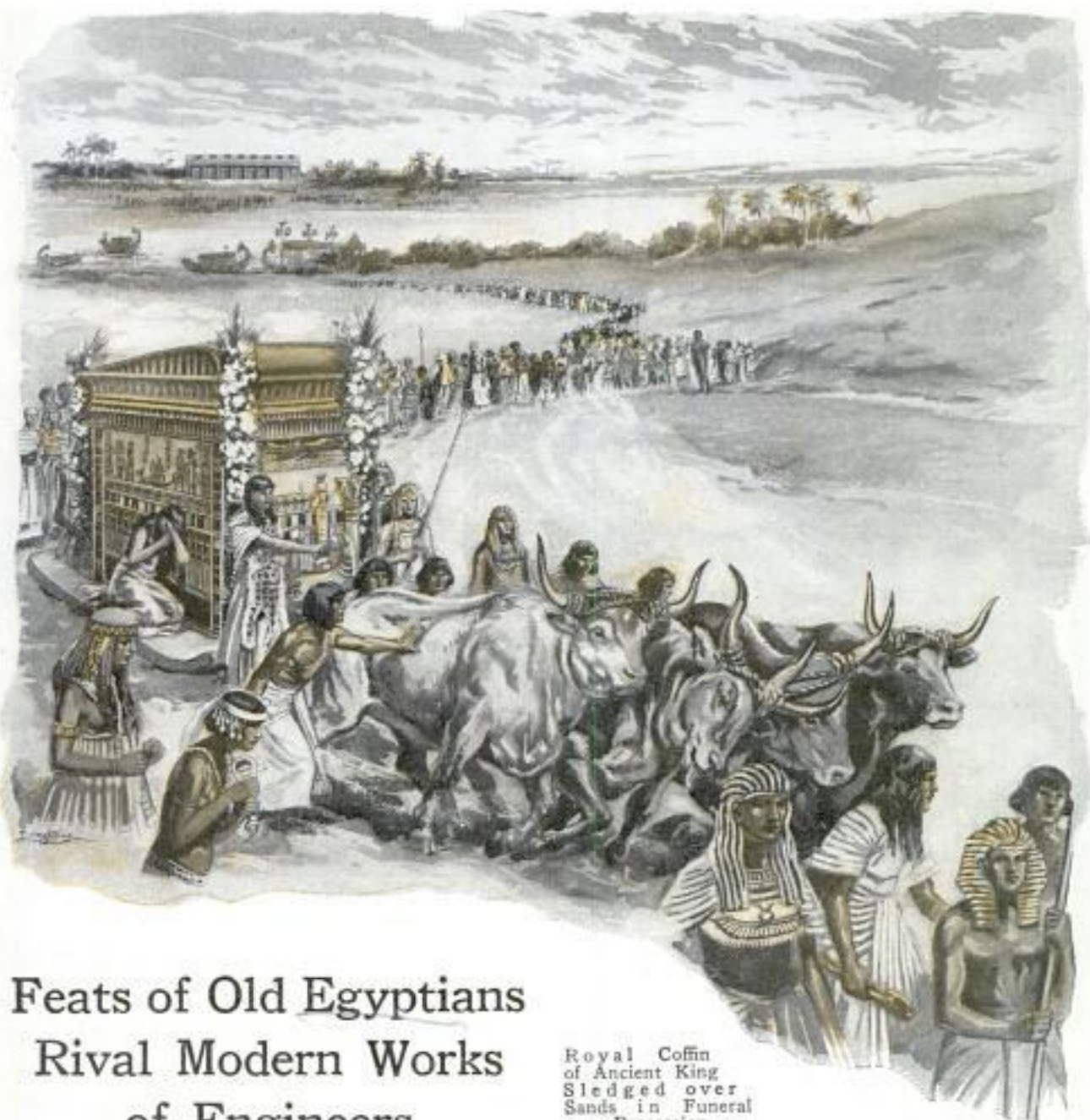

Royal Coffin  
of Ancient King  
Sledged over  
Sands in Funeral  
Procession

## Feats of Old Egyptians Rival Modern Works of Engineers

By JAMES HENRY BREASTED

(The University of Chicago)

*The Oriental Institute Chicago*  
**W**E in America are quite well aware how largely the development of our country has depended upon the progress of mechanical invention and our ability to apply mechanical forces to the subjugation of a continent. Perhaps we are not so conscious of the fact that in all ages the progress of mankind has been largely conditioned by his growing ability to produce devices for the application of mechanical power to the practical problems of material life. To no small extent human history is the story of just such development, if we take into consideration also the consequences, commercial and economic, so-

cial and spiritual, which have resulted from the great mechanical conquests of past ages.

With the rise of domesticated animals and grains and the development of cattle breeding and agriculture, it was not only possible but necessary that men should live together in communities. A social instinct arose as men felt the necessity for common enterprises in which the whole community must share, like extensive defences, irrigation works, or great public monuments, buildings and memorials. Responding to requirements like this the mechanical ingenuity of early men developed far more rapidly and effectively than was ever possible in the hunting stage. The earliest communities possessed of



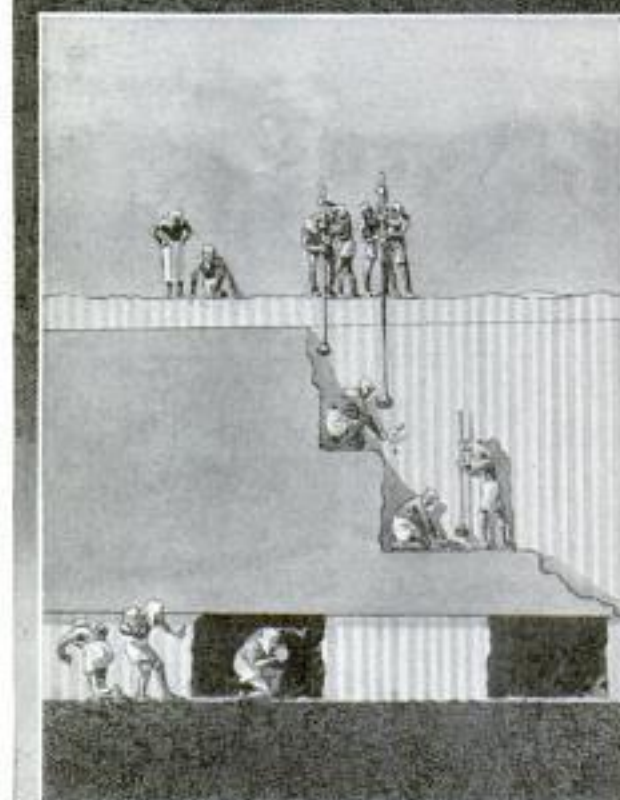
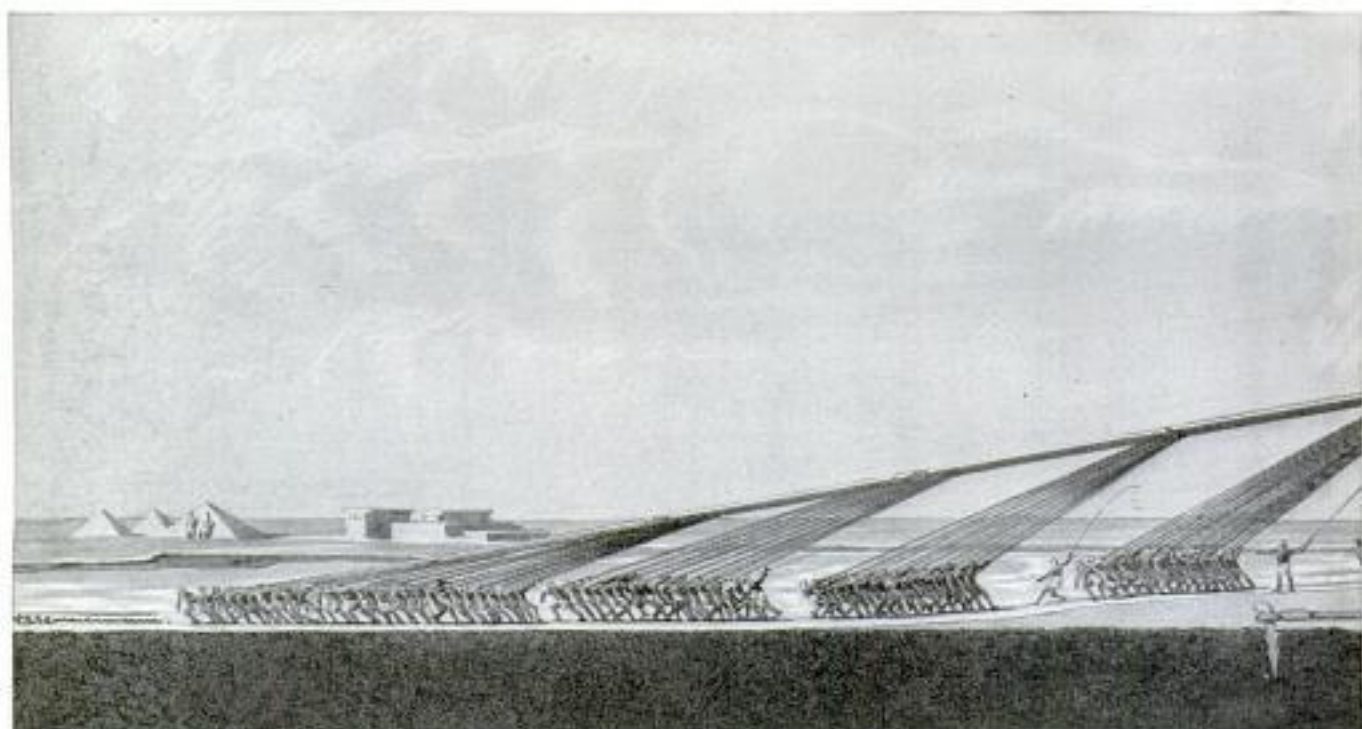

How Egyptian Engineers Rolled Great Granite Shafts from Quarries Where They Were Carved; Below, Crumbling Surrounding Rock for Removal

metal, writing, cattle breeding and agriculture that we know anything about, arose on the Nile, and there civilization first developed. In the surviving monuments and records of Egypt we can trace the development of the earliest known and simplest devices to which the name machine may properly be applied. The crankshaft of the modern automobile is lineally descended from the earliest con-

trivance possessing a shaft and crank ever devised by ancient men—a drill invented by Egyptian craftsmen in the centuries just before 3000 B. C., for hollowing out the interior of their superb stone vases, some of which they did not hesitate to fashion in the hardest materials like granite or diorite. This drill consisted of a vertical wooden shaft with a short crank at the top and a cutting edge of stone at the base, while two stone weights fastened just under the crank served to furnish pressure on the drill point as well as momentum, like a flywheel. This contrivance, devised over five thousand years ago, displays the earliest surviving crank and shaft, and is therefore the earliest known machine. In work requiring less weight and power and at the same time more speed, as in carpentry and joinery, or the exceedingly fine work of the lapidary in semiprecious stones, the Egyptian craftsman had already devised the bow drill. It is interesting to observe that this labor-saving device passed from Egypt to Babylonia, probably as early as 2500 B. C., and once possessed of this increased facility in cutting his hard stone cylinder seals, the Babylonian lapidary quickly lost skill and his work steadily degenerated.

The shaft, as first developed by the Egyptian in his drill, was vertical. This was true at first of all types of drill, including the hollow or tubular drill, which he invented about 3000 B. C. It was likewise true of another new machine which appeared on the Nile in the latter half of the fourth millennium B. C., that is, the



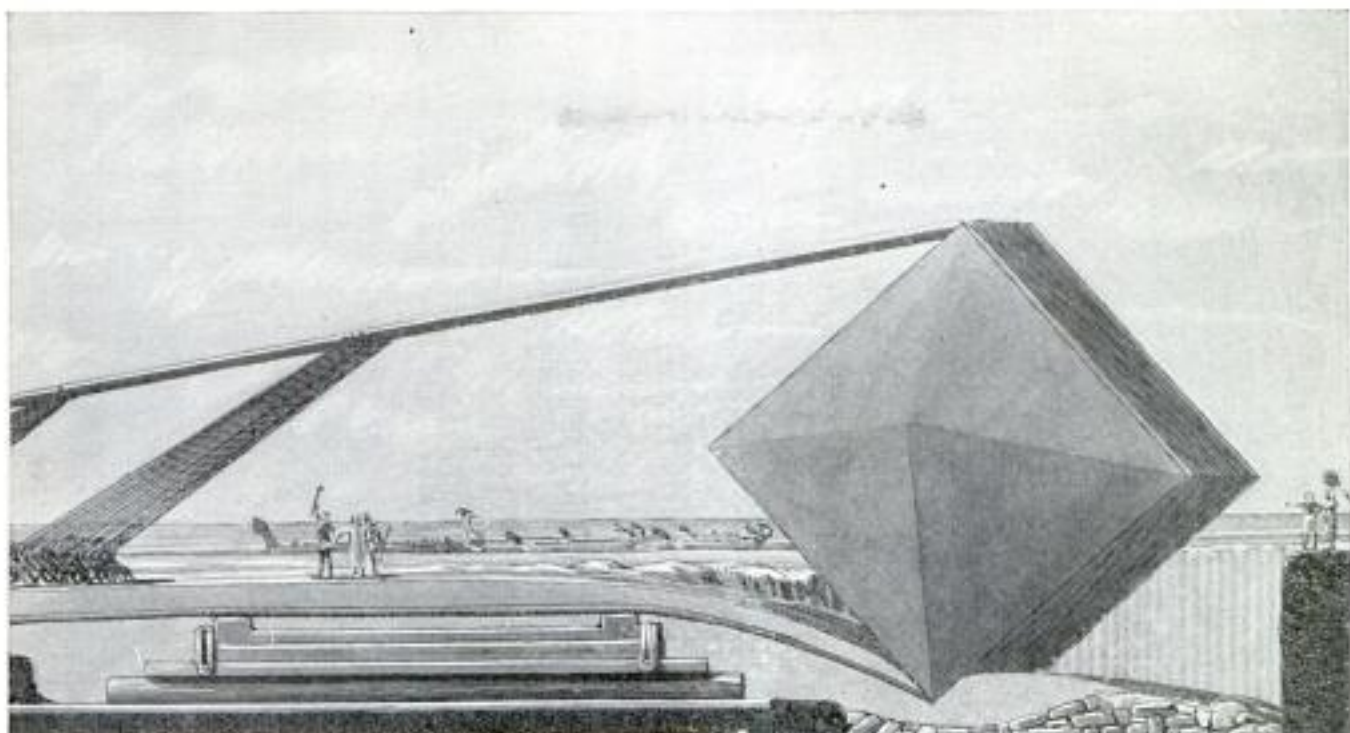

centuries just preceding 3000 B. C.—the potter's wheel. Apparently in the effort to turn more conveniently the soft clay vessel he was manipulating, the potter inserted a pivot under the board or base on which his vessel was mounted. The result of this innovation was a wheel of which the axis was again vertical as in the case of the drill. From its home in the near east, the potter's wheel spread throughout Europe in prehistoric times.

In all these Egyptian devices it will be seen that these early men first gained acquaintance with the vertical shaft. The wheel with a horizontal axis as a burden-bearing device for reducing friction, was at first unknown to the Egyptian mechanics, and the existent evidence would indicate that this type of wheel originated in Asia, presumably from round tree trunks used as rollers. Sumerian chariots were known in Babylonia well toward 3000 B. C. Thence the chariot passed across western Asia to the Mediterranean and reached Egypt with the Hyksos in the eighteenth century before Christ; but it was not common on the Nile until 1600 B. C., at the rise of the Egyptian empire. When the craftsmen at the court of Tutenkhamon in the middle of the fourteenth century B. C. built the magnificent chariots which were found in his tomb, such vehicles had therefore been in common use in Egypt only some 250 years—a matter of seven generations. There are evidences, however, that the pulley wheel, which originally was another example of the burden-bearing

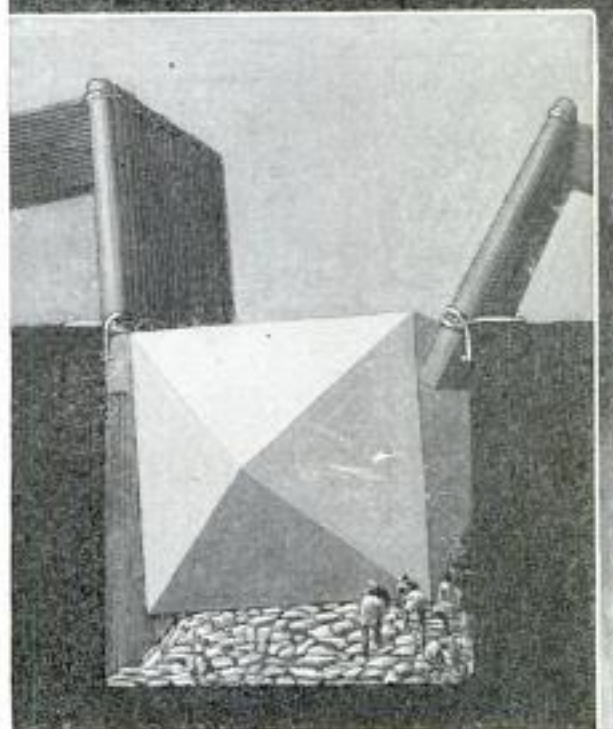

Levers to Alternately Tip Pillar to Admit Packing of Stones for Elevation from Trench

wheel with horizontal axis, was known to the Egyptians at an early date. A pulley



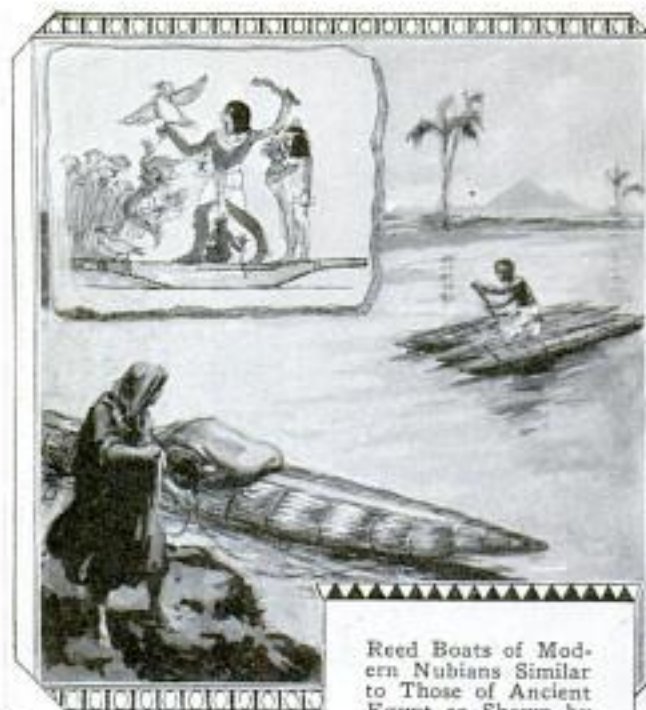

Reed Boats of Modern Nubians Similar to Those of Ancient Egypt as Shown by Hunting Scene on Old Tomb Wall

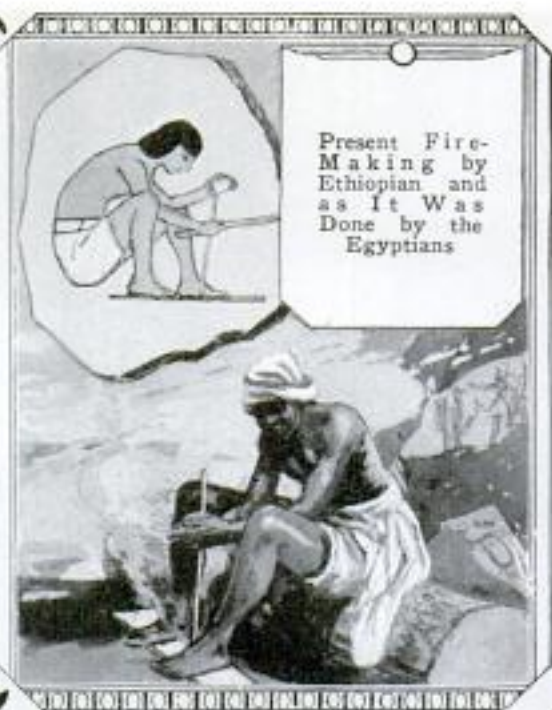

Present Fire-Making by Ethiopian and as It Was Done by the Egyptians



Egypt's Farming Tools Have Changed Little in 3,000 Years; Plow of Pharaoh's Day and as It Is Now Seen along the Nile



Small Warriors Whose Dress and Weapons Resemble Those in Ancient Pictures of Egyptian Soldiers



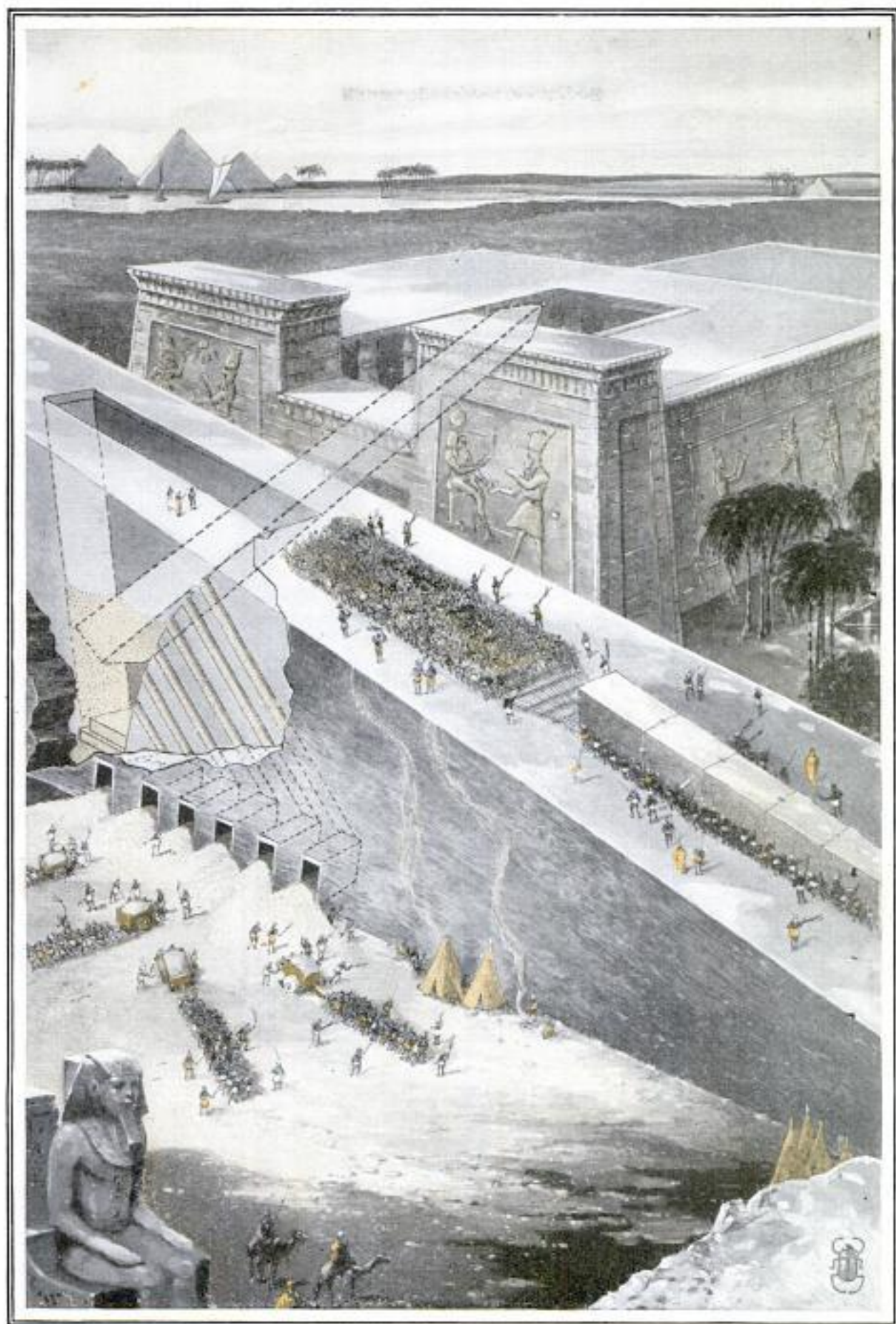

Suggested Solution to Riddle of How Egyptians Raised Massive Obelisks in Position; Dragging Shafts Up Temporary Sloping Planes They Were Lowered to Bases by Draining Sand from Pits



block still containing the rope is preserved in the Egyptian museum at Leyden; and the present writer purchased from an Egyptian native at Luxor a year ago several small pulleys probably employed in an ancient Egyptian loom. Around the bases of the Great Sphinx at Gizeh which once bore the Pharaohs' massive statues, some of which are now in the museum at Cairo, are holes cut in the stone floor and so grouped that it is evident they were used as sockets for timbers which converged at a point over the statue and served as support for the suspension of tackle employed in lifting the statues into place.

While the pulleys used here may have been a great convenience in changing the direction of the applied force without too great loss by friction, there is no evidence that they at the same time multiplied that force. With the exception of the lever no device for multiplying power was known to the ancient oriental world. The multiple chain hoist used by all modern motorboat enthusiasts, and the screw as employed in powerful lifting jacks, involve devices and principles which were unknown throughout the ancient career of man until the Hellenistic age after the death of Alexander the Great, when leadership in power and civilization had long since passed from the Orient to the Mediterranean peoples. Extraordinary as it may seem, therefore, multiplication of applied power as we know it today, played no part in the great engineering achievements of the ancient Egyptians.

Petrie has calculated that the Great Pyramid of Gizeh contains about 2,300,000 blocks of stone weighing on an average two and a half tons each. The building

rose 481 feet above its base and the colossal burial chamber, roofed with granite beams weighing fifty to sixty tons each, is situated halfway to the top. To these high levels the blocks of stone were dragged up a succession of inclined planes or ascending ramps, constructed of sun-dried bricks. These ascents were purely temporary and were taken down like scaffolding when the building was completed. In dragging the blocks up the slope not even rollers were employed, for Egypt possessed no forests which could furnish such timber. Nevertheless, about 2900 B. C., the builders of the Great Pyramid, whose great-great-grandfathers had put up the first buildings of stone masonry ever erected, did not hesitate to plan and carry to completion the greatest building ever attempted by ancient man.

After the beginning of the Egyptian empire (1580 to 1150 B. C.), the great conquerors erected monuments involving astonishing feats of engineering and mechanics. The magnificent obelisks of Queen Hatshepsut, the first great woman in history, were wrought each of a single block ninety-seven and one-half feet long and weighing about 350 tons. The quarry work was done in seven months. Both shafts, laid butt to butt, were brought 150 miles down the Nile from the granite quarries at the First Cataract to the temple of Karnak at Thebes, in a single huge barge some 300 feet long, towed by thirty "tugs" of thirty-two oars each. Even these huge blocks were dragged on sledges without rollers. Our own obelisk, now in Central Park in New York City, was first erected by the great soldier Thutmose (Thotmes) III.



Painted Limestone Statuette of Ancient Egyptian Potter, Made almost 5,000 Years Ago, Showing Worker Turning Wheel with One Hand While He Molds Jar with the Other





Courtesy Illustrated London News

5/17/24 O. 883  
 War-Time Measures for a Peaceful Cause; the Burning Steamer "Frangestan," Pierced by Shells from a Submarine, Slowly Sinking to the Bottom Where Its Hull Cannot Menace Shipping

### Adventure on Liner Afire at Sea Rivals Tales of Fiction

Almost duplicating a scene from a novel of the sea by Joseph Conrad, the British steamer "Frangestan" took fire during passage through the Red Sea with 1,200 persons aboard. The occupants were taken off by other vessels summoned to the aid of the burning ship. Unable to check the flames or save the million-dollar cargo of cotton the craft carried, the commander of a large submarine arriving on the scene, ordered the submersible's gunners to sink the doomed hulk with shell fire, thus ridding the sea of a menace that might imperil other steamers if the hull were left to float unguarded. Enveloped in fire and smoke, it went down a few minutes after the projectiles had pierced its sides.

### Cracks in Earth Caused by Quake Peril Travelers in Hawaii

7274  
 Huge fissures in the crust of the earth, caused by quakes during the recent eruptions of Kilauea volcano, were found in many parts of the Hawaiian islands after the disturbances. Some of the cracks were so large that a full-sized man could walk in them without difficulty. Occurring in roads, they made traveling at night perilous. The violent explosions of the vol-

cano were accompanied by eruptions of sand and ashes and the heavier detonations were followed by showers of rocks of immense size, some of the missiles being hurled three quarters of a mile. Predictions of several scientists that a tidal wave would follow the disturbances caused na-



Man in One of the Large Fissures Caused by Hawaiian Volcano and Earthquake

tives to flee from their homes. Japanese fishermen along the coast took to the sea in their boats.

One of the world's largest mints, which is to have a coining capacity of fourteen tons of silver a day, is being built in China under the direction of an American expert.

Pacific Photo Club  
 25 Park Place, New York.



410

Stokes  
E 33rd Ave  
POPULAR MECHANICS

Denver  
Colo

1253



Soldiers Protected by Masks Placing Gas Cylinders in Underbrush near Their Barracks to Kill Rats and Other Vermin; Above, Preparing Tanks for Use; Right, Releasing Poisonous Fumes

### Rope Machine Is Worked by Hand Twisting Strings into Cords

Several feet of rope can be made in a few minutes by a device recently invented that is so small it can be held in the hands during the operation. Strands of string are placed on the four clasps of the machine while the other ends are anchored to one hook. Turning the crank on the



Twisting Cords into Rope Quickly with Aid of Small Hand-Operated Device

handle twists the strings into cords. By repeating the process with a different gear and the strings replaced by the cords, the latter are twisted into a rope.

One-third of the farm land in Sweden is said to be worked by electric power.

### War Gas Now Used to Kill Rats 1291 by Army in Porto Rico

Poisonous gases are now being used to check the depredations of rats which annually cause a loss estimated at millions of dollars in food products consumed and wasted. One of the most notable applications of this war weapon to peace-time purposes was undertaken at a United States army post in Porto Rico. The buildings in which the rodents had concentrated were made practically air-tight by pasting papers around the outside of the walls. Gas was then released from movable cylinders into the rooms, and after the latter had remained closed for half of an hour, all of the vermin were found to have been exterminated. Lizards, rats, crabs, cockroaches and other pests succumbed to the deadly fumes immediately. The department of agriculture recently advocated the use of poisonous fumes from the exhaust of the engine of an automobile in cases where rats had gathered in holes in great numbers. Gas from cylinders applied through a hose, however, has been found to serve the same purpose.

1291  
S. A. Winters  
Electric Hall Building  
Washington, D.C.

Mr. Joe M. Cotton 2161 Arapahoe St. Denver, Colo. Oil of Peas



Carl Stafford Ransome  
6, Priory Road,  
New, Surrey England.

### Glow of "Moons" on Towers May Cut London's Light Bill

Plans for illuminating the west and west-central districts of London, an area of thirty-six square miles, with enormous floodlights placed on nine towers, 500 feet high and a mile and a half apart, have been presented to the British institute of public-lighting engineers. These brilliant lamps are intended to replace existing installations and are expected to provide a moonlight glow, free from glare and devoid of deep shadows. Promoters of the scheme maintain that it would effect a considerable saving over the present cost of about \$2,000,000 a year to light the inner area of the city along its 2,223 miles of streets.

### Concrete Tree Trunk Makes Unique Office for Realty Firm

Constructed of concrete, a replica of a giant tree stump serves as a real-estate office in Los Angeles. A large gash on one side, giving the impression that wood choppers had started to cut down the tree at that point, and "roots" seeming to enter the ground add realism to the idea that a huge trunk has been hollowed out. On the flat top a miniature house has been



Concrete Tree Stump Used as Real-Estate Office with Miniature House on Top

built. The unique structure also helps to advertise the surrounding land to prospective purchasers.

Carl L. O. Lunn,  
2322 Victoria Ave.,  
Los Angeles, Calif.

### Electric Mysteries Are Explored by Special Vacuum Tube

By shooting a stream of electrons against the coated end of a glass tube in somewhat the same way that water might



Tube Devised So That the Alternations of High-Frequency Currents May Be Followed

be shot from a hose against a board fence, engineers have been able to reveal with a luminous spot such secrets as the changes in an alternating current up to millions of cycles per second, measure the modulations of radio-transmitting stations and explore other electrical mysteries. This is done in a tube designed by Dr. J. B. Johnson of the Western Electric company. Produced by a heated filament, the electrons, speeding at the rate of 6,000 miles a second, pass between two sets of plates. Deflected according to the momentary field set up by the potential difference between them, the stream, as a "weightless pointer," traces, by means of a luminous spot it makes as it strikes the end of the tube, the resultant of the deflecting forces. Neutralizing the oscillations by means of a current of known frequency passed through one set of the plates, determines the changes in the unknown current. The invention is being used to test the performance of vacuum and X-ray tubes, for measuring nerve reactions and for studying other phenomena.

☐ To span the harbor at Sydney, Australia, what will be the world's longest single-arch bridge is in process of construction. The span will be 1,650 feet long and 170 feet above the water.



11 7 7 412  
Cmt. Harry Van De mark,  
Box 1484,  
POPULAR MECHANICS  
Houston  
Texas



## Music—The Soul Behind the “Movies”

Dramatic Action of Pictures Performed to Soft Melodies for Emotional Scenes and “Jazzy” Harmonies for Comedies

SO essential to the success of motion-picture drama has music become, that every studio now has its orchestral staff made up of players who know by memory great numbers of classic selections, popular pieces and “jazz.” These musicians are at hand during the filming of both dramatic and comedy plays. Where deep emotions are to be interpreted by the actors, appropriate selections are played to help the character toward the various moods ranging from tragic grief to intense joy.

Although the appearance of a pianist and violinist on a set or in a studio during former days of the motion-picture industry quite often provoked laughter from the company, hardly a member of any of the producing organizations of today would question the value of music for the scenes. Without it, tearful scenes could not be so vividly portrayed by the heroines, nor gladness by the child actors necessary to many of the pictures.

Even the director is swayed by the rhythmic notes of the ever-present musi-

cians who play behind the camera. To him they are almost indispensable aids. Even the principals of the action have their favorite pieces to fit the various parts they are called upon to perform, and the musicians themselves are in numerous cases able to anticipate the progress of the situations and to change their music to suit the drama. Quite often, if the music is not right, the play itself suffers by being poorly acted in “spots.”

During the action of the large spectacles orchestras are increased in size. Military scenes are accompanied by stirring strains of martial airs rendered by brass bands, while the pomp and ceremony that attend the acts of royal personages are carried out to classical numbers taken from the long list of music masterpieces. Wedding scenes laid amid the more quiet splendor of big churches or ancient halls are always enacted to appropriate peals of large organs or fitting melodies from orchestras at the rear of the clicking cameras.

When an actor is “keyed up” to a big scene and is being carried along by emo-



1177



How the Motion-Picture Actors Are Worked into Moods by the Power of Music behind the Camera

Rehearsing a Part for a Screen Comedy with the Help of a Violin and a Portable Organ





tion, a discordant note from one of the instruments may be the means of interrupting the even progress of the situation. The "movie" musician is aware of the value of his performance to the players and carefully guards against the introduction of any notes or pieces that might disturb the moods of the actors. At the same time the orchestra director must know what to play in order to produce the desired effect on the individual actors, in whatever kind of scene they may be taking part. Comedies must have the quick, swinging rhythm found in most popular dance numbers, mixed with crashes and swells to emphasize mirth-provoking moments. Tragedy calls for the opposite class of music with soft, weird parts that serve to work the actor toward tense, dramatic moods.

Sobbing heroines are generally to be seen speaking their lines to music such as Gounod's "Ave Maria," or the intermezzo from "Cavalleria Rusticana." For tragedy and drama a variety similar to the "Prelude" of Chopin and Massenet's "Elegie" has proved to be effective in assisting movie directors to influence the actors to proper interpretations of "heavy" parts. Most comedies are played to catchy tunes selected from popular musical reviews of the day or current popular songs.

Special kinds of music are used for cer-

tain types of pictures. If the play itself is laid in France, the orchestral program will probably be made up of selections from the music of that country. Wherever possible, folklore music and native melodies are introduced into the studios to aid the principals to assume corresponding roles dealing with life in countries represented by such airs.

Frequently, where the companies have to travel great distances to locations for the filming of open-air scenes, the musicians are taken along, and a common sight in and around the country about motion-picture colonies is a group of actors and actresses going through their parts along the roadside or beach to the accompaniment of sharp suggestions from the director mixed with the sobbing of a violin or more weighty throbbing of a portable organ. Sometimes entire orchestras, often selected from near-by theaters or "gardens," are employed to furnish the music for locations or ballroom scenes where the cast consists of hundreds of people taking parts as guests, dancers, attendants, soldiers or fleeing mobs.

One prominent movie star who is frequently called upon to assume difficult roles, always resorts to the music treatment when she fails to acquire necessary moods. On her favorite list of instrumental pieces are several for each purpose.

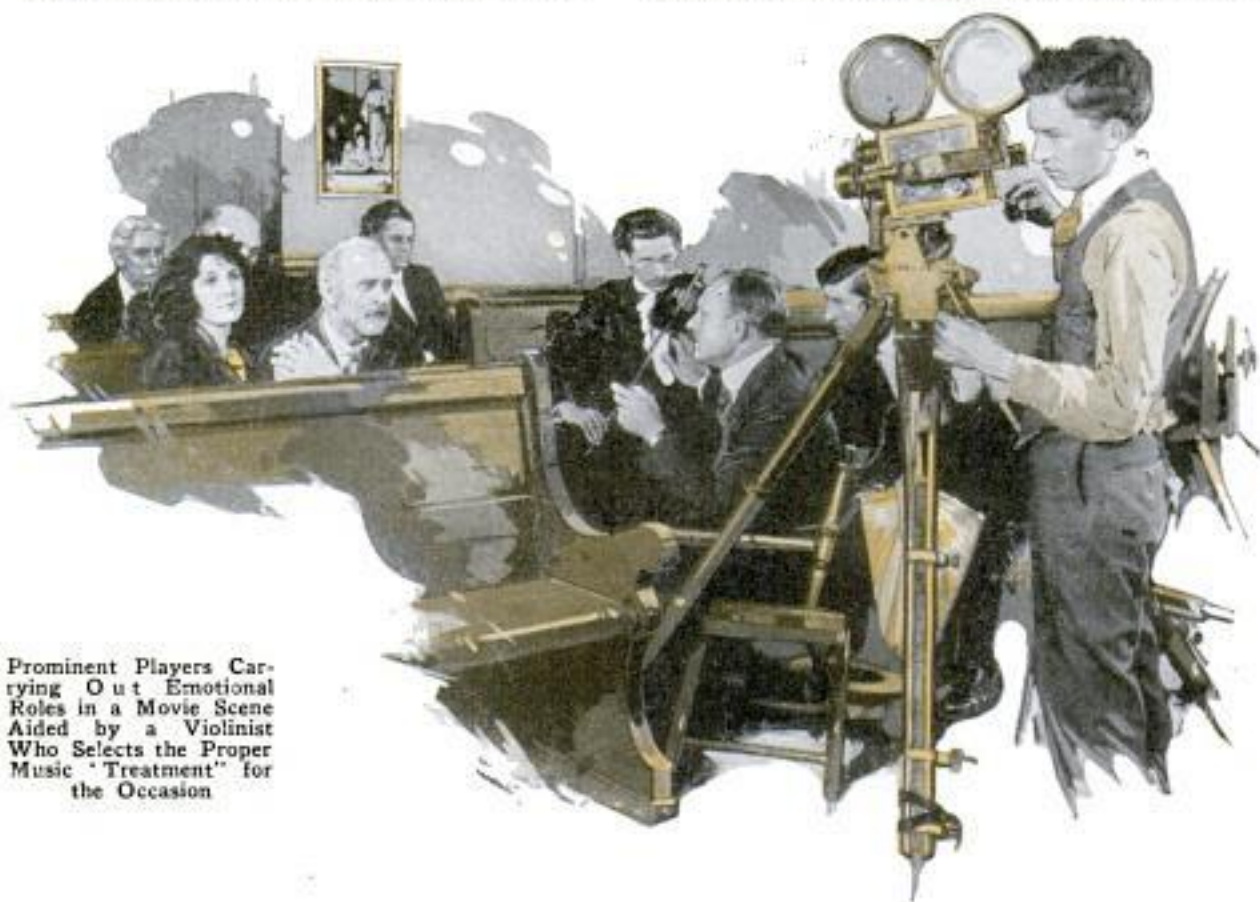

Prominent Players Carrying Out Emotional Roles in a Movie Scene Aided by a Violinist Who Selects the Proper Music "Treatment" for the Occasion



Com. Andrew R. Boone,  
Box 10, Stanford University  
Calif

*1214*  
**Airplane "Flies" in Motor-Made Gale to Test Propeller's Pull**

To obtain data for new designs, a model plane body has been subjected to tests in a special laboratory at Leland Stanford university. Connected to four wires hung

the blood of the fowls. The chickens thrived and laid even in dark coops provided they were exposed to the ultra-violet rays or were dosed with cod liver oil, Dr.

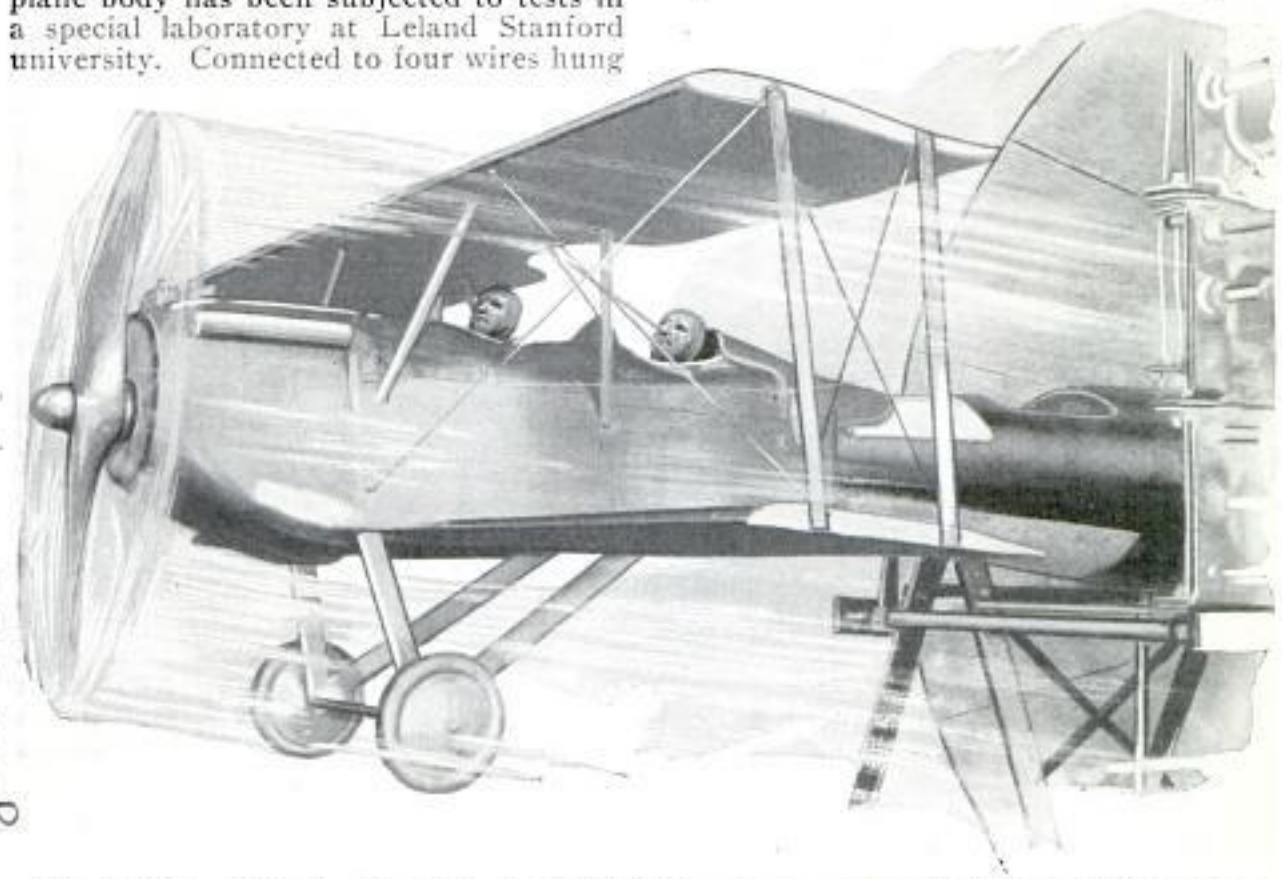

Model Airplane Flying in Motor-Made Gale While Undergoing Experiments for Design of Propeller and Wing Curves in Special Laboratory of Leland Stanford University

from the ceiling, the model, about three-eighths the size of an ordinary plane, is fitted on a shaft which passes through the body and carries on the front end a 36-inch propeller. From a tunnel in the rear, a forty-mile wind is blown directly upon the "ship" by means of a rapidly revolving eight-blade, sixteen-foot propeller. The front propeller is started and run at a speed of 1,500 to 3,000 revolutions per minute. The experiment is one of a number which have been conducted at the university under the supervision of Dr. W. F. Durand, head of the mechanical-engineering department.

Hughes declared, but in complete darkness the blood failed to make use of chemicals needed for producing eggs. The comb of the fowl is believed to be the "aerial" which catches the waves of the rays, transferring the effect to the blood.

**Movie Scenes in Pocket Case Are**  
*1212* **Enlarged by Lens**

Selected cuttings from travel films can be enjoyed at leisure with a new instru-

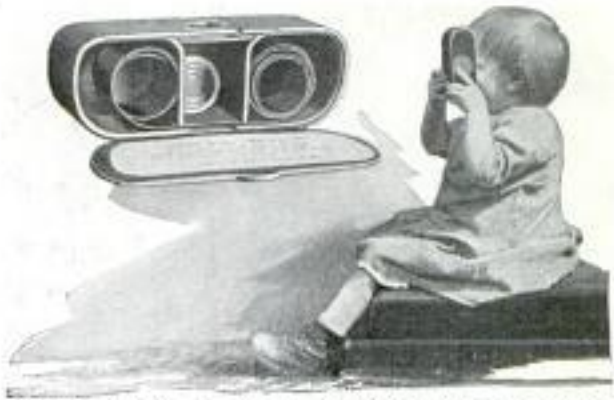

Method of Viewing Scenes in Pocket Movie Machine, and Case Open Showing Film

*1089*  
**Light Rays Increase Lay of Hens**  
**by Chemical Changes in Blood**

By exposing a number of hens to ultra-violet rays, Dr. J. S. Hughes reported at a recent meeting of the American Chemical Society, the lay had been increased from thirty eggs in January to 144 in February and 138 in March. These rays, or those of direct sunlight, unobstructed by glass, are believed to produce chemical changes in

*1709-20 St., N. W., Washington D. C.*

*New York Times*  
*4/23/24*

*Messia Pathé Cinema*  
*Service Pathéorama,*  
*20 bis, Rue Lafayette,*

*Paris, 9<sup>e</sup>, Av. France*



ment that greatly magnifies the pictures. The device consists of a small case made of wood-pulp composition, so that it is very light. The roll of film is inserted into it and can be moved in either direction by a small handle attached to a rubber wheel that bears against the strip. In front a magnifying lens is fitted and a greatly enlarged view of the scene is obtained when the instrument is held up to the eye. A diffusing screen equalizes the light on the pictures and with the aid of a small projector they can be thrown on a screen, appearing several feet high. Each strip contains forty scenes and a large variety can be obtained, ranging from fairy stories to travel scenes.

### Wool Made from Wood Keeps Homes Warm and Cuts Fuel Costs

120<sup>5</sup> When the early pioneers cleared the land and built their homes of tree trunks that were from twelve to fourteen inches thick, they knew nothing of insulation to protect them from the elements. Until recently, insulation in connection with modern building operations, suggested only the

the desire for more comfort in the summertime have shown the importance of insulating material. By careful attention to this matter, thousands of home owners are now saving from twenty-five to thirty-five per cent of their fuel bills each year, the size of heating plants is being reduced and the loss of heat through radiation is being lowered from ten to twenty per cent. What is said to be one of the most efficient kinds of insulating material now in use has been produced by a western inventor from balsam and spruce logs cut into chips and ground and shredded into a wool-like mass which is formed into narrow strips or "blankets." Nailed to the studding before the siding is put on, they effectively keep out wind and cold and prevent loss of heat from within. During the manufacturing process, the material is passed through a chemical bath to render it fire-resistant. It later is mixed with an adhesive and blown against a moving screen in such a way that it becomes filled with millions of dead-air cells which account for its resistance to heat and cold. The strips are covered on each side with an asphalt-coated paper, making them wind, water and dust-proof. No stitches

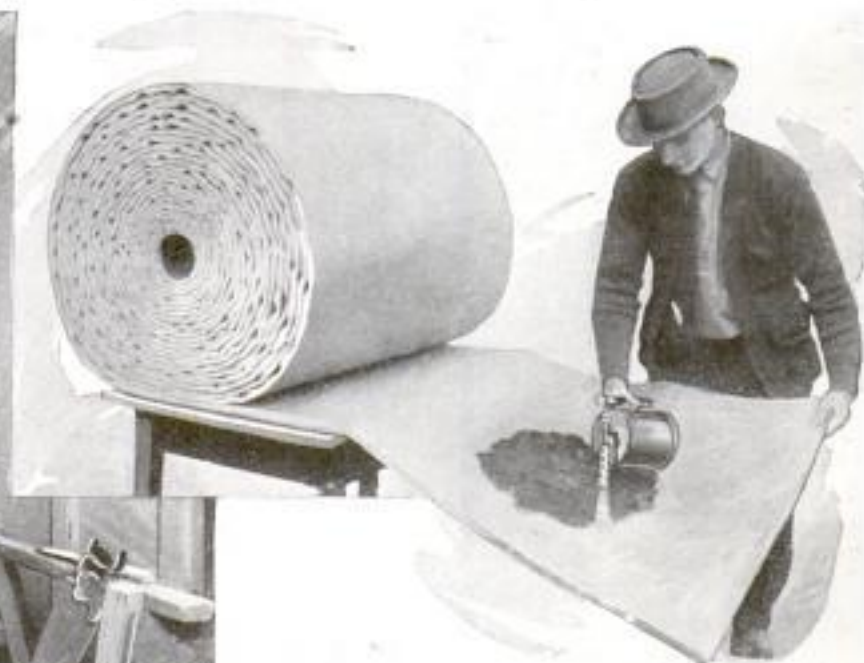

Trying Fireproof Qualities of Wood Wool for Building Walls with Flame of Blowtorch, and Left, Attaching the Sheets Inside of Frame for House to Prevent Entrance of Cold

precautions taken with electrical equipment and with fire-prevention methods. Today, it means much more, especially in northern states, since mounting fuel costs, the increased expense of home owning and

are taken; thus no holes which might impair the efficiency of the material are caused. The finished product is cut into various widths, wound on cardboard tubes and wrapped in bundles, each containing 250 square feet.

Wood Conversion Co. *Copyrighted material*  
Cloquet, Minn.





Wrapping Paper Tape around Cable Wire; Right, Diagram of Sheathing Machine

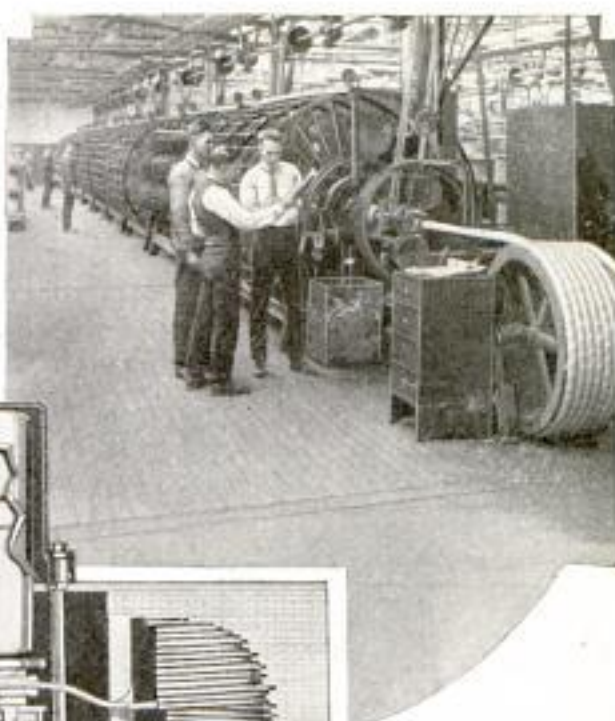

Some of Presses That Turn Out 10,000 Miles of Cable Every Year



© Western Electric Co.

**Millions of Feet of Phone Cable Turned Out Every Year** 1292

Making the huge spools of wire cables that are threaded below the streets and between poles to carry the human voice, requires millions of pounds of metal and paper yearly, many special machines and hundreds of skilled workers. One plant alone produces 53,000,000 feet of cable annually. After the various quantities of lead, copper, wire, antimony, tin and paper necessary for the manufacture have been assembled, the first step is to insulate the individual wires with paper. This is done in special machines that can put on 2,400 "wraps," or turns, a minute. Different-colored papers identify the two wires of each pair and also certain groups of pairs in the finished cable. The pairs are formed into a cable by a stranding machine, consisting of a number of revolving drums and reels, and at the same time, a heavy wrapping of paper is applied as additional insulation from the outside lead sheath, which is put on later. Stranding is necessary to provide flexibility, for if the pairs were run straight through, the cable could not be bent without stretching some of the wires and kinking others. The core, or unshathed cable, is then tested, to see that no wires have been broken, and dried in ovens. The sheathing, formed by forcing an alloy of lead and antimony through

a hydraulic press, is kept soft but not hot enough to char the paper when the core is drawn through it. The covering fits tightly, and when cooled, the finished cable is wound on the wooden spools and is given a final test to see that it is in perfect condition, electrically and mechanically.

**Modern Barbecue Serves Motorists with Sandwiches on Road** 1228

Electrically operated and using either gas or charcoal as fuel, a modern barbecue along the Lincoln highway in Ohio has proved popular with motorists desiring hot sandwiches while on the road. The



Roadside Barbecue That Roasts Meats with Gas or Charcoal on Electrically Turned Spit

*Western Electric Co.*

*Emil J. W. Schmidt  
355 1/2 St. Charles Place  
Hyde Park, Cincinnati  
Ohio*

*1213 Chestnut St.  
St. Louis, Mo.*

*Portable barbecue -  
Talbot Mfg. Co.*



meat is hung before an open grate in front of the hot coals or flames. An electric motor turns the spit, while a trough below catches the savory drippings which in turn are used for basting. Notches in the two supports that hold the rod on which the meat is suspended, permit hanging at five different distances from the fire.

### Swimming Vest Is Puncture-Proof, Weighs Only Eleven Ounces

For the use of swimmers, both expert and beginners, a rubber life-saving vest that has been specially treated to make it



Swimmer Wearing Rubber Life-Saving Vest That Has Four Puncture-Proof Air Chambers

puncture-proof, has been invented. Fitting snugly around the chest, it is held in place by two shoulder straps. There are four air chambers in the garment, each with a check-valve device to prevent the air from escaping. Two ordinary breaths are said to be sufficient to inflate the vest, which, it is claimed, will then support three persons weighing 175 pounds. Rolled up, it weighs only eleven ounces and can be carried in a pocket or handbag.

Whenever you find that you wish to know more about any article in the magazine, write our Bureau of Information.

### Four-Fifths of All World's Autos 699 Are Found in the U. S.

Out of the approximately 18,000,000 motor vehicles in operation in the world, four-fifths are in the United States, according to a survey. It is estimated that the total increase for one year is more than 3,500,000, eighty per cent of the number being taken up by American purchasers. Although there are 1,075,000 motorcycles included in these figures, only 171,000 are owned in the United States, where over three-fourths of the world's truck output is reported to be in use.

### 1208 When Tin "Catches Cold"

Extreme cold is known to have had disastrous effects on tin. In countries like northern Russia, it is declared that many utensils often become useless in winter. A whole shipload of blocks of the metal, stored in a Russian customhouse, was reported to have crumbled into dust during the cold months. It has frequently been found in mines in a gray-powder form which, when heated, turns into the shiny metal but, during sub-zero weather, may become dust again. When tin "catches cold," a tiny grayish spot that grows in size, and is joined by others, appears on the surface. In time the metal crumbles away.

### Tree Press 5/11/24 Embroidering in Home Made Easy by Miniature Textile Machine

To simplify the making of plastic embroideries, an easily operated machine for home use has been made in England. The material to be worked is first stretched over a frame or ring, right side down, so as to be under tension and perfectly flat. The wool or other material is threaded into the needle and, holding the device in the left hand with the needle over the part to be worked, a wooden knob is pressed down. Needle and thread are in this way carried through the material.



© C. A. Oldroyd

The E. J. Ol. Co. Prod.  
682 Holloway Road  
London, N. 19. Eng.

418  
Air Jacket - somewhat  
similar - sold by  
Van Lengerke &  
Antoine  
d. Walnut  
Chicago  
Mrs C. J. Purcell c/o A. E. Sharpe,  
Shoreham Hotel, Washington,  
D. C.



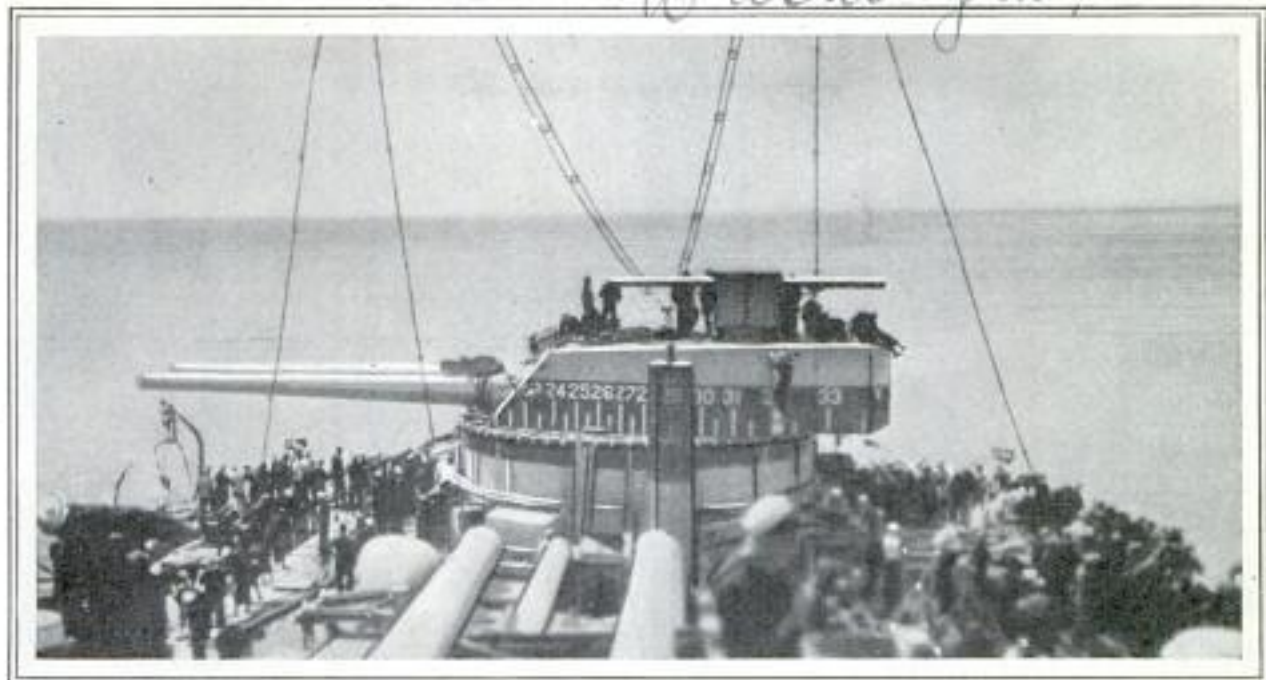

Gun Turret of Big War Vessel with Indicating Dial Set to Inform Gunners of Following Ship of Location and Identity of Target on Which Its Rifles Are Trained

## How Guns of Uncle Sam's Fleet Are Trained on Targets 812

Aiming the guns of Uncle Sam's warships has become an exact science in which numbers painted on the turrets play a leading role. For instance, suppose you are the thirteenth man in a line of twenty-five men, facing a similar line at a distance of 300 yards. You are ordered to shoot at the man who is number thirteen in the opposite line. How could you be sure that you were aiming at the right individual? This is the problem that confronts battleships in a battle between great fleets at sea, in which long lines of ships are firing at one another. In order to give information to the next ship behind, about their target, the turrets are marked with figures, reading from zero, which is dead ahead, around to the right to 360 degrees. A heavy painted white line acts as a marker or point of reference. Thus, for instance, if to the ship following behind, the figure nine, indicating ninety, is in coincidence with the white line, it means that its leader fires at the ship in the enemy column which bears ninety degrees.

## Art of Native Americans Inspires World Contest in Design 1193

To stimulate interest in creative art, Alfred C. Bossom, treasurer of the Architectural League of New York, has offered prizes in a world-wide contest in designs based on strictly American themes. Indian

totems, pottery and ancient forms of architecture are to be studied and compared in search for a distinctive note suitable to modern purposes. Suggesting the possibilities in the idea, a blanket with pattern adapted from the "Thunder Bird" grave totem found in British Columbia was shown as one way in which the weird and



Copyright, Underwood & Underwood  
 Comparing Design of Rug to Strange Grave Totem Figures That Inspired Woven Pattern

fanciful symbols associated with superstitions of the ancient artists could be employed as the decorative motif for an article of modern usefulness.



Cml. S. R. Winters, District  
National Bank Bldg.,  
POPULAR MECHANICS  
Washington,  
D. C.



Juvenile Poultryman with Valuable Chickens He Raised

Girl Farmer and Her Pure-Bred Cow

Contestant for Preserving Honors in Uniform at Local Exhibit

## Juvenile Farmers Improve Nation's Crops

### Half Million Youthful Agriculturists Engage in Raising Prize Cattle and Coaxing Better Yields from Soil

**E**NGAGED in tasks varying from growing of corn and wheat and raising of dairy and beef cattle to the household arts of making bread and clothing, almost a half million boys and girls of this country are devoting themselves to the study and practice of improving farm life and its products. This army of youngsters was organized a little more than a year ago from the great number of juvenile farm clubs under the supervision, instruction and direction of the department of agriculture. The organizations included in this vast body of youthful student-farmers number 32,673 separate units, representing every section and state of the union. And by demonstration or actual practice they have succeeded in coaxing from the soil larger yields of the staple crops or raising animals that contributed something to the quality and quantity of the nation's food supply. All of them, however, operate

with the assistance of government agents, state agricultural colleges or county agents, who give them instructions in scientific farming methods which are put into practice by the youngsters. Boys and girls living on farms were taught the improved processes of agriculture through the efforts of 3,412 instructors and home-demonstration agents. As a result, competitive programs of production were worked out and annual state and local contests decided on the best specimens of cattle, poultry and crops, and even sewing, preserving and baking prizes were offered for the household accomplishments. Field representatives of the government department and co-operating states conducted practical demonstrations on farms where boys and girls enrolled in the juvenile clubs lived. To these classes were shown the best ways to select seeds and to judge the worth of animals by va-



1318



Bureau Agent Teaching Boy Farmer the Art of Selecting Seed Corn in the Field, for Use during the Following Planting Season



By Keeping a Careful Check on Feed and Weights of His Herd, This Young Hog Raiser Weeds Out Undesirable Animals; Right, Filling the Bins with Measured Quantities of Feeding Grains



rious tests. Then, during the planting and growing seasons the farmer apprentices devoted their time to carrying out in actual practice the things they learned from the demonstrations. The young agriculturists went into the fields and selected seeds for the following spring planting, and girls interested in fruits and preserving chose the grades and kinds of materials they desired to use in putting up a supply of such things for future consumption. If these precautions are not taken, the results are apt to be faulty and will cut down the production or success of the undertakings.

Boys were shown the most profitable methods of hog raising and taught how to keep feed charts so they could learn what amount and character of feeds were to be preferred for producing animals of most desirable weights and species. The young dairyman, armed with milk pail and weighing balance, kept close check on his cows to find out just how much milk and butter they could produce under care and feeding planned for him by the teacher-agents. All of these important records were tabulated by the boy himself and resulted in the weeding out of poor producers at the end of the season, leaving for his next experiments only those which

in for a large amount of effort from both boys and girls, resulting in the production of highly graded hens with remarkable records of laying. The girls applying their time to live stock were responsible for a great number of pure-bred animals, winning attention from the inspectors who officiated at competitive gatherings where their judgment decided on the most noteworthy achievements for the year among some of the clubs.

In domestic arts, such as sewing, baking and preserving, special instructions were given to the club members by teachers who held classes both in the homes and at club gatherings. Processes for the most successful ways of canning fruits and preserving vegetables were taught. The action of the food chemicals was explained, and formulas for testing and inspection of finished products were illustrated by actual work on the part of the instructors. The making of dresses and millinery also came in for a large share of the girl clubs' attention, and patterns for attractive garments and decorative sewing were laid out and their making explained.

Frequently groups of juvenile farmers combined to operate poultry yards or plots where garden truck could be grown, each member accepting his share of the work and partaking in the profits derived from the sales of the products. Instances have been found where a boy or girl member of a club has succeeded in growing a certain crop in a section of the country where it was thought by experts to be impossible to raise such plants.



showed up on the score card as worthy of a place in the herd.

But the heavier outdoor tasks were not entirely in the hands of the boy farmers. Girls, too, took a wide interest in the fields and cattle yards and many notable achievements by them were registered in the records of the clubs. Poultry raising came



Quartet of Youngsters in Dresses They Made, and Boy Dairyman Charting Feed Allowances



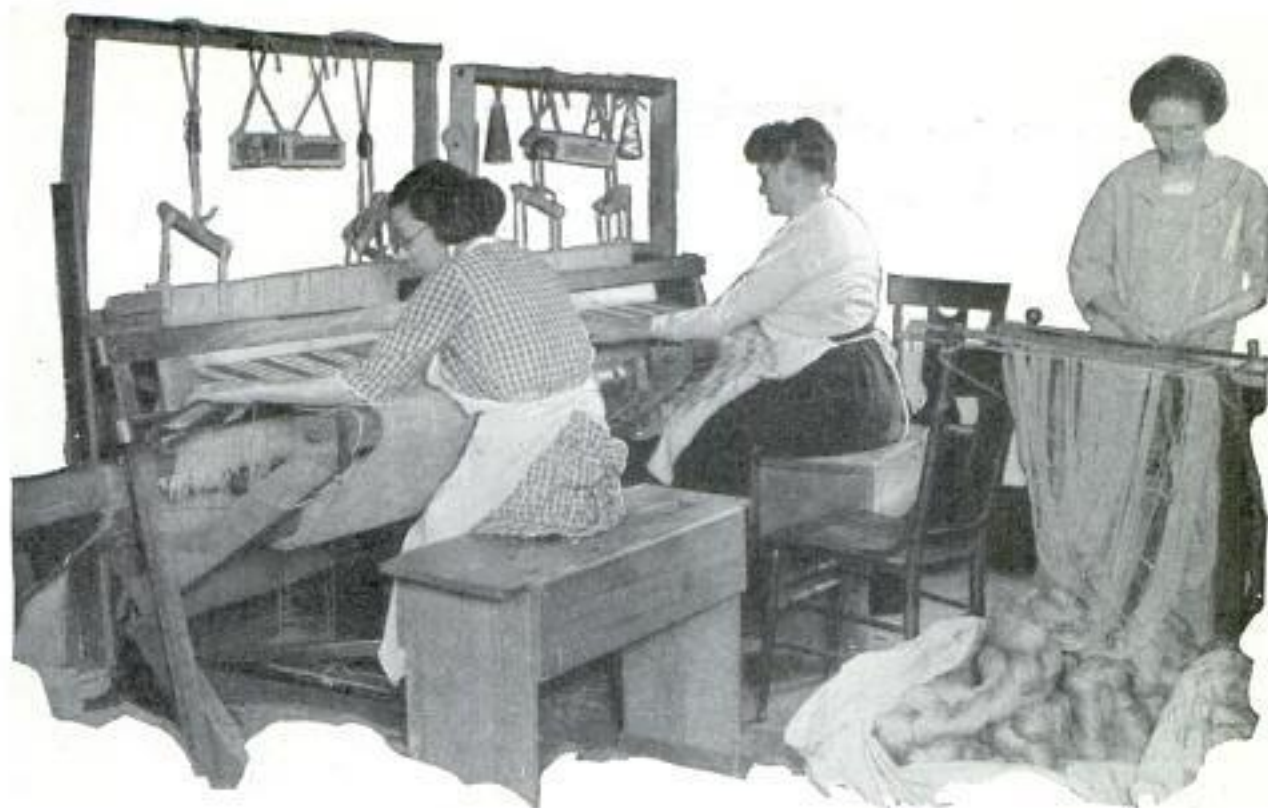

Blind Women Weaving Rugs on Handlooms after Having First Memorized the Intricate Patterns through a System of Mechanical Finger Training That Develops a High Degree of Skill

**Blind Are Taught to Weave Rugs by Mechanical Finger System**

Rug weaving and a variety of other handicrafts are being taught blind adults at the Chicago "Lighthouse" with considerable success. Mechanical finger training plays an important part in the work and enables many of the students to attain a remarkable degree of proficiency. With the assistance of Braille notes, intricate patterns are memorized and the textiles woven. The words "Chicago Lighthouse" printed over an archway to a narrow, wooden sidewalk, leading through a group of portable houses to an old-fashioned red-brick building at the back of the lot, bear a special significance, because the Lighthouse illumines the path for many of the blind. They come from dispensaries, doctors' offices, hospitals and the State School for the Blind, that is, those over sixteen who are Chicago residents. Rug weaving has been found to be a craft at which they show great skill. This work is especially adapted to women and eight to nine looms are kept going. Through the training, many students have been restored to industrial efficiency and financial independence.

By transforming the air into a liquid state, chemists are able to obtain various gases important to the commercial world.

**Auto on Railway Wheels Is Adapted to Fast Emergency Service 945**

Fitted to flanged wheels and equipped with a cowcatcher, a seven-passenger closed automobile has been adapted for inspection and emergency service on the Southern railway. It weighs 5,000 pounds, is sufficiently heavy to operate the block signals and has a maximum speed of eighty miles an hour. The engine is controlled by a switch and no steering gear is necessary, as the flanged wheels hold the car securely to the rails. Officials intend to dispatch it as a regular train, and it is expected to save considerable time in speed-



Automobile "Train," Adapted to Inspection and Emergency Service, Which Is Capable of High Speed

ing doctors and nurses to the scene of wrecks. The car is electrically lighted and is heated by exhaust gas from the muffler.

Ench. Jno. S. Sanford,  
Times Star, 1924

6th Walnut St. Cincinnati, Ohio

Copyrighted material



### Full-Size Model of Locomotive Used as Dinner Decoration

One of the features of a banquet of railway executives in Canada was a full-sized model of the latest type of Canadian Pa-

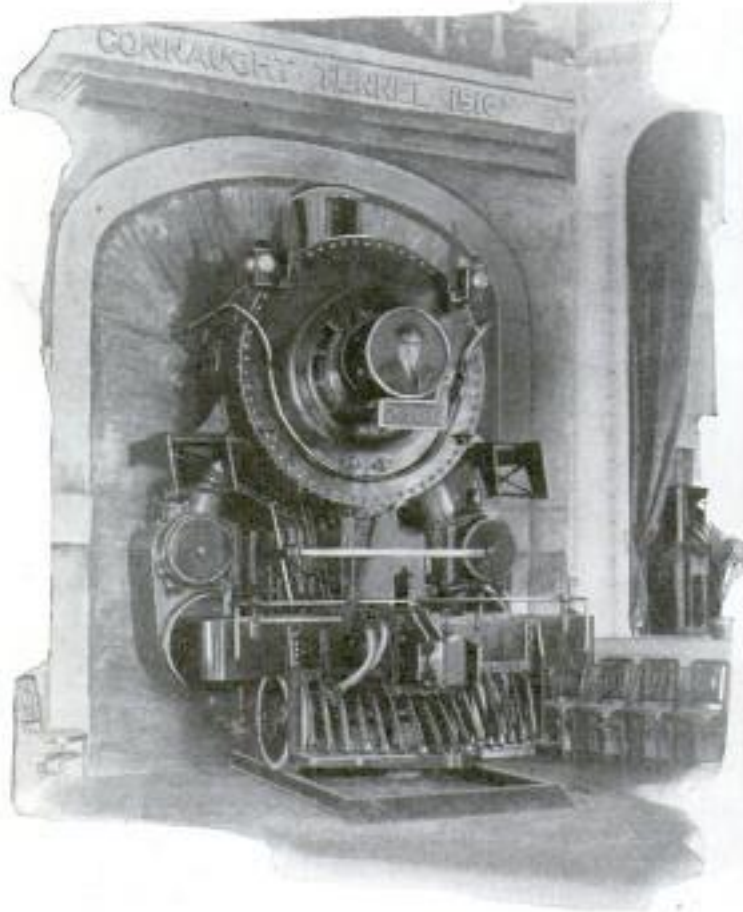

Model of Latest Type of Canadian Pacific Locomotive Built of Wood for Banquet Decoration

cific locomotives. It was built of wood and equipped with a bell, whistle and electric lights. Not a bolt or bar was lacking to complete the illusion of a perfect engine running on tracks into the room. In the headlight was a portrait of E. W. Beatty, president of the railroad.

### Automat Filling Stations to Cut the Cost of Gas and Oil

Is the gasoline automat next? The proposal that motorists drive up to a filling station, insert the necessary coins in a slot, fill the tank and replace the hose and tank cap without an attendant's presence, has been advanced in the interest of lower gasoline and oil prices by a special committee appointed by the state of Massachusetts to investigate the cost of commodities used in everyday life. The sound-

ness of the theory remains to be tested, although it is believed that the novelty of the idea would attract considerable trade from the beginning. The committee admitted that it was unable to "find any panacea for the present evils of gasoline business," and put forth the automat idea as a possible way of decreasing the cost of distribution. It has been estimated that there are in the United States something like 50,000 "drive-in" service stations, exclusive of the large number of garages and curb pumps at which gas and oil may be purchased. These have been built within recent years with the later ones established on a more and more attractive basis and with natural beauty and ever-improved service always in the mind of the owners. It is claimed that the automat plan is economically sound in that it would save the salaries of the thousands of station attendants, which saving could be passed on to the consumer in lower prices. The application of the self-service idea in motor oil, it is pointed out, would be more difficult, but could be worked out on a practical scale.

### Glass Made to Stop Bullets 1260 Will Not Break

Planned to provide an effective screen against rifle fire, a type of bullet-proof glass was given a severe test to show its toughness. Held by two workmen, a pane of it was struck with a heavy hammer. It cracked but did not break through. This kind of glass has been suggested as especially



Testing Resistance of Pane of Bullet-Proof Glass with Blows of Heavy Hammer

practical for bank and office windows where there is danger of holdups, and for automobile windshields.

*wife secretary of state Boston, Mass. for further info.*

*Chas. R. Shaver  
Pub. Co.  
20 E. Jackson Blvd.  
Chicago*

*Pacific & Atlantic  
Photo Co*

*Shatterable Glass Corp.  
New York City  
85 W. 43rd St. New York City*



Elton Lenham,  
Barton, Ohio.

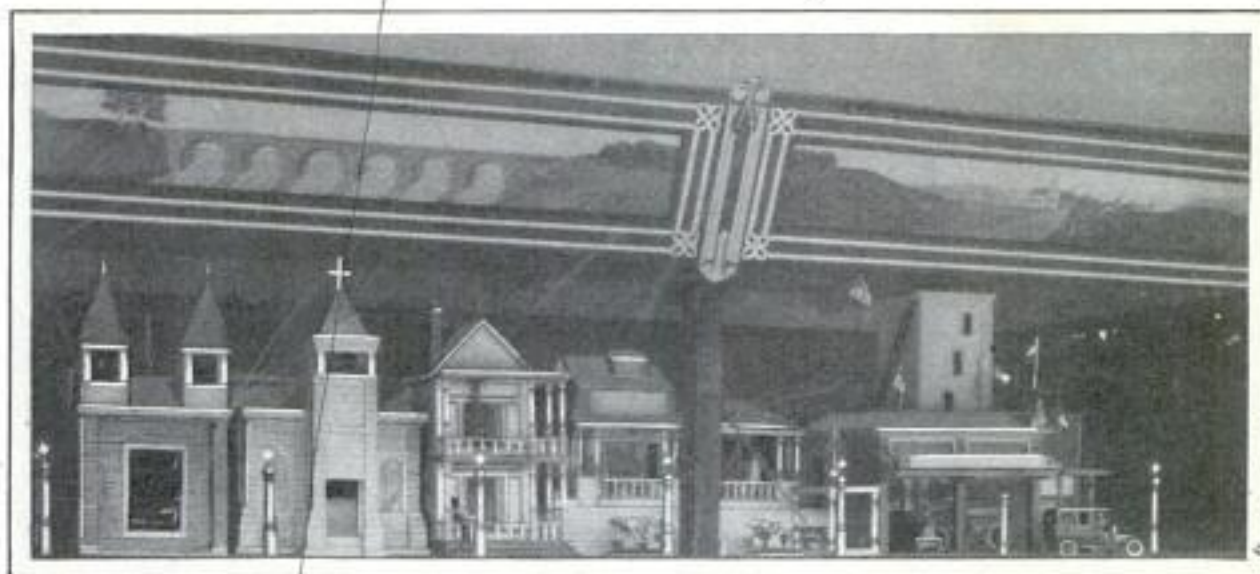

Street Scene in Toy Electric Village. Showing the Town Hall, Church, Realistic Dwellings and a Taxicab on Lighted Street; the Whole Display Rests on an Ordinary Wagon Gear

### Many Moving Figures in Toy Town Are Run by Electricity

With 150 figures which are moved by 3,000 pieces of gear, a toy town has been constructed by an Ohioan on the running gear of a wagon. The buildings include a church which contains a miniature pipe organ that will play, a dance hall with a tiny piano and drum that furnish music for couples moving about the little floor, a garage and various shops, all fitted with equipment closely modeled after real articles. Streets and buildings are all electrically lighted and automobiles travel about part of the exhibit. The power and light system includes generators, transformers and motors. Several years were spent in constructing the model.

### Eyeglass Cleaner That Fits Pocket Prevents Scratching Lenses

To prevent scratching and subsequent clouding of the lenses of eyeglasses, a cleaner and polisher has been introduced. It consists of a metal frame carrying two wash-leather pads facing each other. To use it, the frame is opened slightly with the finger and the pads passed over the edge of the lens. A few rubs suffice to clean and polish the glass thoroughly. The spring frame provides just the right



*make unknown.*

pressure so it is unnecessary to pinch it with the fingers. With this cleaner, lenses remain in good condition much longer than when polished in other ways, it is claimed. It can be carried in the pocket and is cleaned easily by passing a cloth between the pads to remove dust and dirt.

### Double-Walled Oven for Camping Requires But Little Fuel

Designed especially for campers, a double-walled oven with aluminum lining has been invented. It has a heavy iron base to withstand high temperatures, and heat is quickly radiated to the upper parts and retained in the lining, so that less fuel is needed than with other types of outdoor cookers. The device also operates successfully when placed on ordinary ranges or electric plates, and the aluminum inside jacket prevents rust. A metal-lath top is also provided for use when toasting and broiling.



☐ The Popular Mechanics' Bureau of Information offers its free service to all readers of our magazine. Names and addresses of manufacturers and dealers in articles described will be promptly furnished by addressing the Bureau.

*\$5.00. 7 1/4 in \$4.00  
\$4.50*

*10 1/2 in. 9 1/4 in.  
Home Industries Co.  
Box 159, Portland, Ore.*





Visitor to National Academy of Sciences Studying Sun's Spots through Instrument That Reflects Solar Body

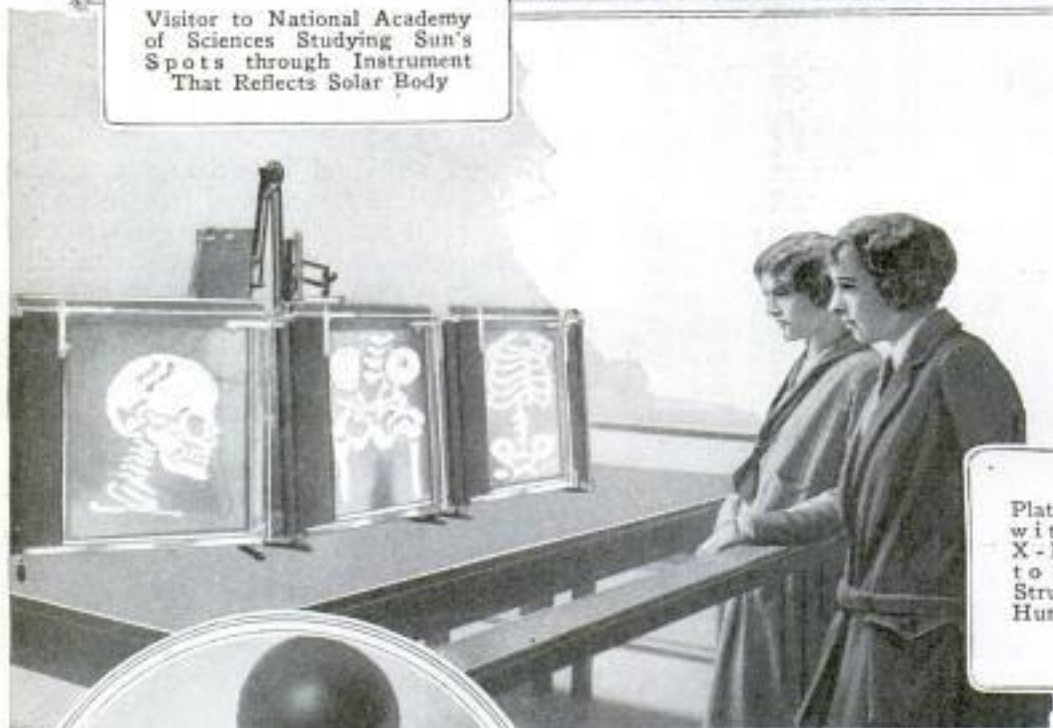

Plates Made with Special X-Ray Tubes to Reveal Structure of Human Skeleton

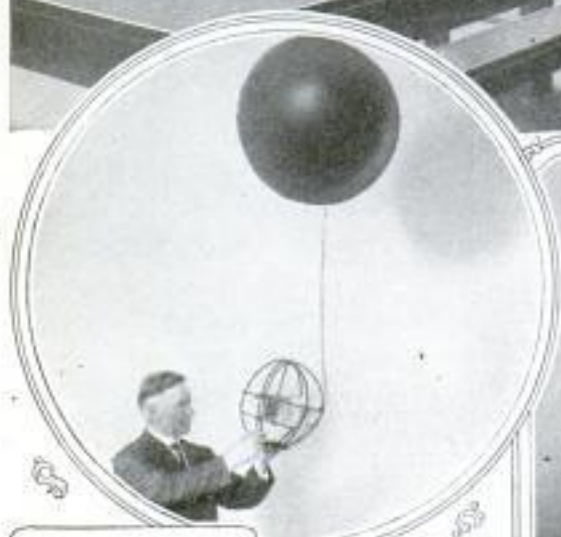

Launching Toy Balloon to Sound Atmosphere in Upper Air Strata



Taking Photographs of the Human Voice



1286

## SCIENCE WONDERS SHOWN IN NATIONAL ACADEMY

Presenting the wonders of science in such a simple way that even laymen can understand them, working models and exhibits in the building erected by the National Academy of Science and the National Research Council at Washington, D. C., have already drawn thousands of visitors of mechanical and scientific frame of mind. Within the spacious rooms and corridors of the structure, scores of intricate phenomena and many simpler facts are illustrated. For instance, the spectrum and spots of the sun are made visible to the casual visitor simply by pressing a button and looking through the eyepiece of a convenient stand in one of the halls. The sun's image is reflected from the dome of the building upon the apparatus in such a way that it can be easily studied, and if desired, the rotation of the earth may be observed at the same time by setting a pendulum going, which demonstrates this motion for two hours without further impulse. How the growth of plants is controlled by varying amounts of sunlight, moisture and other factors is illustrated in a series of cabinets; the voice is visualized by talking into a telephone mouthpiece which records the vibrations on a small rectangular screen by pressing a button, and how the human body looks under the X-rays is illustrated in a series of plates taken with special tubes. Among other exhibits is a delicate apparatus which shows the pressure exerted by light beams, and also a demonstration of the way toy balloons are used by the weather bureau to obtain data from air levels too high to be reached by other means.

The science building was erected at a cost of \$1,500,000 from a \$5,000,000 fund from the Carnegie foundation. Its pur-

pose is to "make possible the harnessing of science to lift the burdens and improve



Copyright, Underwood & Underwood

Guarded Shrine Where Originals of Declaration of Independence and Constitution of United States Repose in the Congressional Library

the conditions of all people of the United States." It was dedicated April 28 by President Coolidge with appropriate ceremonies. By many it is considered the masterpiece of Bertram G. Goodhue, famous New York architect, who died five days before it was completed.

1159  
 Diamond prices are going up according to dealers who attended a jewelers' association meeting in Chicago. They attributed this partly to the demand for the cheaper stones for drilling in gold and coal mines. Values of the various grades range from \$75 to \$70,000 a carat and are declared to have doubled in ten years.

Chicago Evening Post  
 5/5/24



**Automatic Black-Walnut Cracker  
Produces Uncrushed Halves—**

For cracking native American walnuts—the so-called black variety—a machine has been developed that automatically

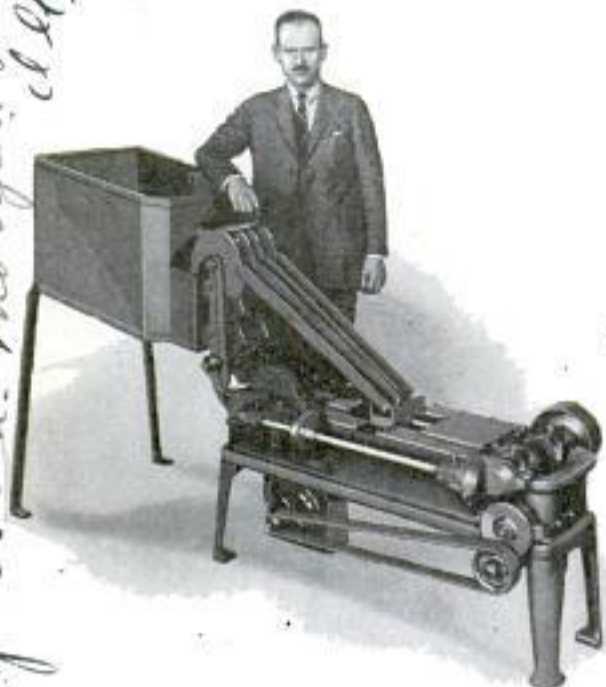

Machine with Capacity of Cracking 1,200 Pounds of American Walnuts in Eight Hours

produces 1,200 pounds of shelled nuts in eight hours, just as they come, big, small and medium. It is claimed that with the device about ten per cent halves are ob-

tained from a wild crop and eighty-five per cent from cultivated trees that yield a uniform product. These are said to bring about double the price of the standard grade, called pieces, which are utilized in making candy. Although millions of bushels of American walnuts are said to go to waste on the ground every year, the demand is declared to exceed the supply, and a million dollars a week is spent in the United States for imported food nuts. Grafted walnut trees are claimed to bear about as quickly as apple trees.

**Old Rubber Is Put to Many Uses  
with Aid of Handy Repair Kit**

With a handy repair kit now on the market, used inner tubes and other pieces of old rubber may be utilized in mending and in constructing dozens of useful articles for the home, automobile and camp. No vulcanizing is necessary, it is claimed, as a self-curing cement is provided with the kit, which includes squares of red and black sheet gum, sandpaper for making buffers, a pair of scissors and an instruction book which tells how to make many useful things. Little skill is required and the kit can be operated by boys to help them devise things for camping and for sport. Tube patching, repairing cuts on tire treads, making fan belts and other articles for the automobile, camera cases, holsters and shopping bags, are a few of the ways in which old rubber may be used.



Repair Kit Unpacked to Show Contents, and Sketches of Some of the Articles, Such as Funnel, Rubber Bucket and Cushion, Almost Anyone Can Make with Its Aid

*Reddy Rubber Co.,*  
*119 Marion St.,*  
*Chicago, Ill.*

1322  
 or. c/o H. R. Morgan  
 Prospect Ave. Morgan Park  
 Ill.

1243



Pacific + Atlantic Photos  
 25 Park Place  
 POPULAR MECHANICS  
 New York City 429

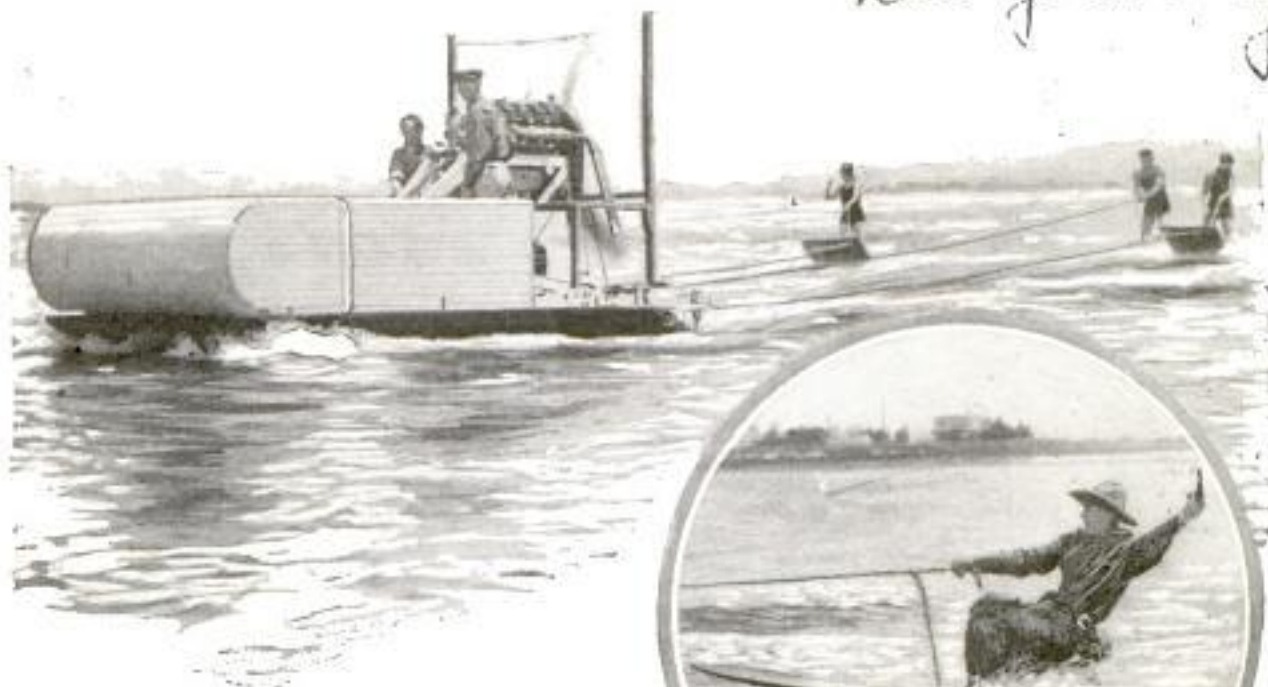

Hydrosled at California Beach Towing Surf Riders, and Cowboy in Full Regalia Riding a New Sort of Bucking Broncho



### Cowboy Rides Bucking Hobby Horse Mounted on a Surf Board

1393  
 "Ride 'em cowboy!" The familiar phrase of roundups echoed at a California beach as a "puncher," wearing the regulation attire of the dusty ranges, skimmed through the water while balancing himself on a narrow surf board that swayed and "bucked" in the wake of a speedy motorboat. Shots from his revolver answered the staccato stutters of the exhaust. The stunt was a variation of the sport that rapidly is gaining favor at many beaches. To provide additional thrills, a special hydrosled has been constructed at one resort for pulling adventure-seeking swimmers through the surf. It is capable of forty miles an hour, its inventors claim.

### Rabbit "Ranch" in Apartment House Nets Profit from Fur Sales

7038  
 Running a rabbit "ranch" in an apartment house is reported to have proved so successful for a Georgia man that he purchased a tract of land sixteen miles from Atlanta and now proposes to raise from 8,000 to 10,000 rabbits a year for their skins. The bunnies are of the chinchilla breed and their pelts are said to bring a top price of \$15 each and seldom less than \$2.50. The real chinchilla, a small rodent native to Peru and Chile, has become almost extinct, but the fur of these rabbits



Chinchilla Bunnies Also Proved Desirable Pets before Their Pelts Went to the Furriers

Breeder -> Mr. J. W.  
 940 Piedmont Ave

Herst, 414 Chamber of Commerce  
 Atlanta, Ga  
 Copyright material

Ad. Aug  
 P. 49  
 American Fur Farm, Inc.  
 Box 56, Holmes Park, Mo.  
 Anthony Gotta and  
 J. Clarkson, Nebr.



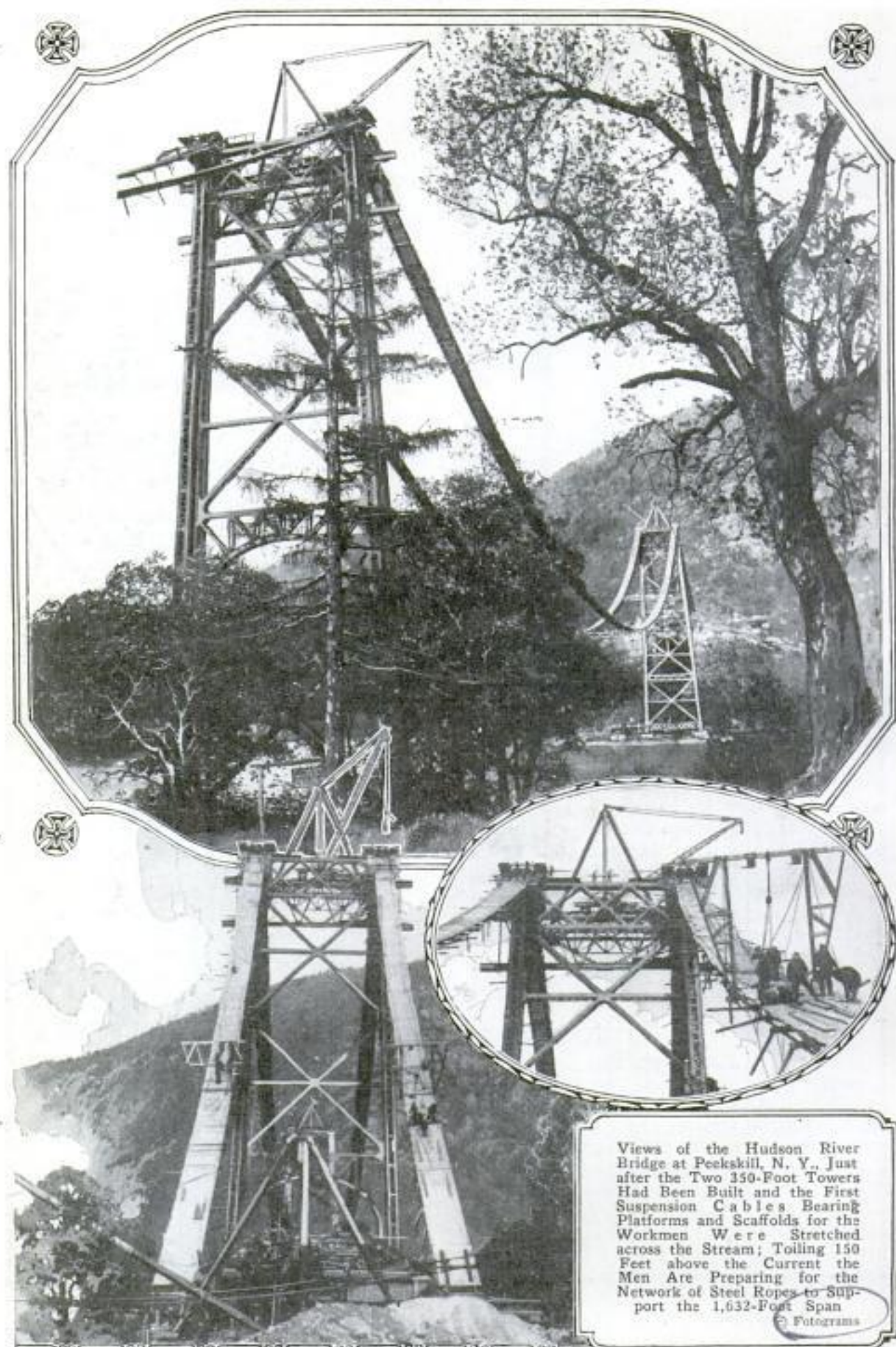

Views of the Hudson River Bridge at Peekskill, N. Y., just after the two 350-foot towers had been built and the first suspension cables bearing platforms and scaffolds for the workmen were stretched across the stream; toiling 150 feet above the current the men are preparing for the network of steel ropes to support the 1,632-foot span.

© Fotograms



1267

Pacific + Atlantic  
Photos, New York

## Huge Suspension Bridge Will Carry Five Thousand Autos Hourly

With a capacity of 5,000 motor cars an hour, a huge suspension bridge is being erected across the Hudson river between Bear Mountain and Anthony's Nose just north of Peekskill, N. Y. The single span will be 1,632 feet long, thirty-two feet more than that of the famous Williamsburg bridge. The total length between abutments will be 2,258 feet, the towers are 350 feet high and, at the center, the span will be 157 feet above the river. On each side of the thirty-eight-foot roadway, will be a walk for pedestrians. The structure is said to be the first of its kind ever designed especially for automobile traffic. One of the incidents of its construction was a radio concert for the workmen, the steel girders serving as aerials.

## Limit of Man's Endurance to Heat Is Set at Ninety Degrees

That the human body, in a state of rest and in still air, cannot endure indefinitely a temperature higher than ninety degrees Fahrenheit with 100 per cent relative humidity, is said to have been determined in experiments recently conducted by government scientists. In the course of the tests it was noted that the heavier and stouter men lost more weight than the lighter and thinner ones, but as a rule could endure the heat for a longer period and complained less of exhaustion. Loss of weight was found to gradually increase with higher temperature. Whenever the subject drank ice water he immediately gained in weight and in all cases, within twenty-four hours, regained entirely all he had lost. Those who drank ice water frequently felt no ill effects, tending to disprove the assumption that such action develops cramps. It was found that the exhaustion and weakness following subjection of human beings to a very high temperature and humidity for a short period are not so severe as confinement in air of moderate heat and moisture content for a longer time. The pulse rate apparently determines the extent of the discomfort. Subjects became very uncomfortable at 135 pulsations a minute and complained of unbearable and distressing symptoms at 160 a minute. The highest rate recorded was 184. No marked change in the respiratory rate was noted. Sweat was proved to be the chief factor in producing the inflammation of the eyes which accompanies exposure to heat.

New York Times  
5/31/24

## Chimes in Tower of War Memorial to Have Two Hundred Tones

Beauty to eye and ear is embodied in a carillon tower designed as a memorial to the sacrifices and ideals of the American



Monument to Be Erected That Will Have Bells in Tower for Playing Chimes

people during the World War. Containing fifty-four bells said to be able to produce 270 tones, the monument is to be erected in Washington by the National Carillon association at a cost of \$3,000,000. Columns near the top of the tower will provide openings so that the chimes may be heard at a considerable distance. It is planned to have masters in carillon performance give concerts on the set at appropriate occasions.



1101

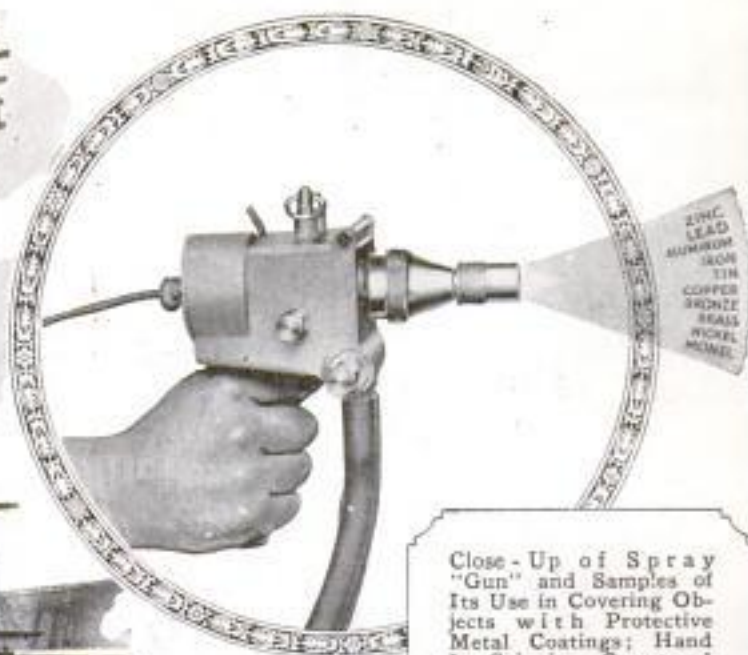
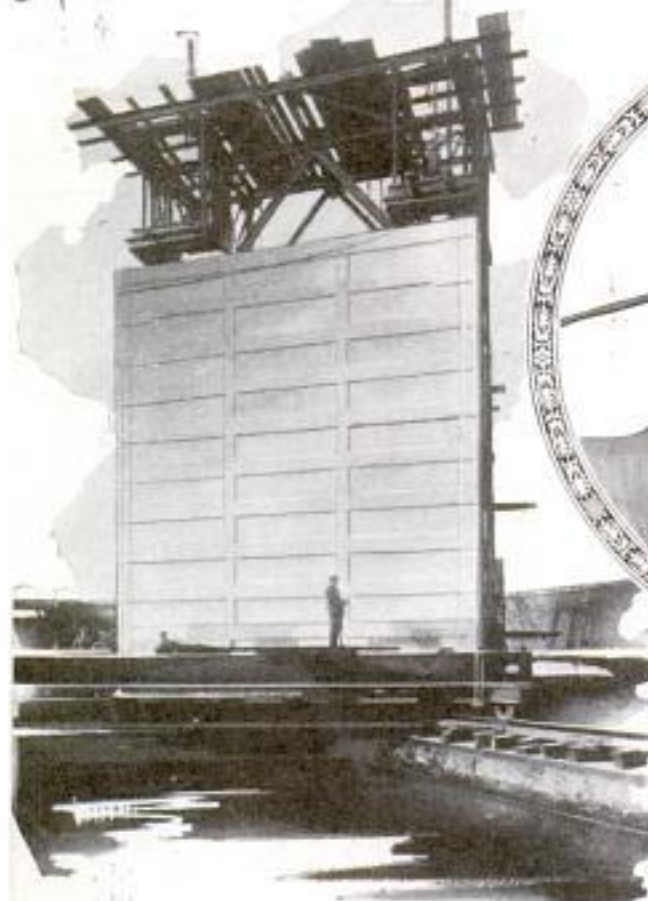

Close-Up of Spray "Gun" and Samples of Its Use in Covering Objects with Protective Metal Coatings; Hand Is Gripping Control Lever between Feed Wire and Oxyacetylene Gas Hose

1101 Molten Metal Sprayed Like Paint from Gun as Protective Cover

Spraying a protective or decorative coat of copper, brass, bronze, German silver, aluminum, zinc or lead over almost any kind of metal is possible with a portable "gun." Defects may be repaired, statues and ornaments coated, and various surfaces protected from chemical action and rust. The metal, supplied in the form of wire or dust, is reduced to a molten state by an oxyacetylene flame at the "muzzle" of the device. With the approximate speed of a rifle bullet, a fine blast of molten metal is blown by compressed air upon the surface to be treated. As thick or thin a coating as desired may be applied. The supply of "ammunition" and the amount of gas and air are all controlled in the gun, which is held just a few inches from the surface and moved about. The eye is able to detect the thickness of the layer deposited and any parts that may escape a first spray. The control is so accurate that a blast fine enough not to ignite a match, a stick of smokeless powder or the thinnest paper may be applied. Several small articles weighing from a few ounces up to ten pounds each may be treated simultaneously within a cabinet arrangement.

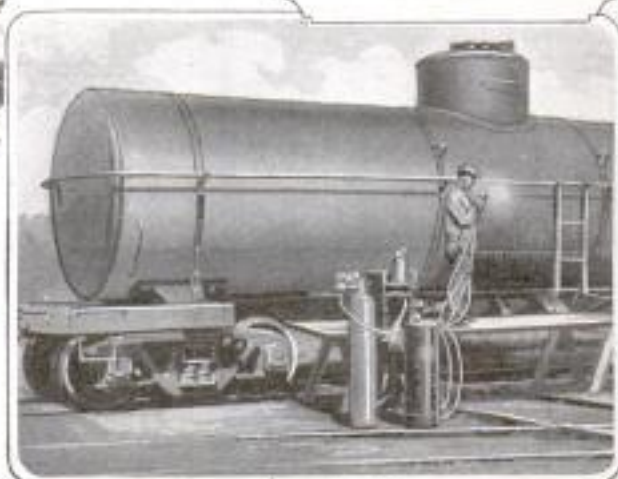

1292 <sup>manufacture</sup> Glass Industry Is Helped by Autos Which Use Half of Output

More than one-half of the plate glass consumed in this country is used by the automobile trade for windows and windshields, according to a survey of the industry. The growing popularity of closed cars is declared to be an important factor in the increased consumption. There are four general classes of glass, window, plate, wire and obscured, each having numerous varieties. Compared to the first two, the production of the others is said to be comparatively small. The making of window glass is being revolutionized by the use of newly invented processes. Instead of being blown into cylinders, the glass is drawn directly out of the melting pot tank in the form of a flat, continuous sheet.

New York Times 5/25/24



Eng. & Mining  
Journal Press  
3/22/24

no info. as to  
maker 433

**Electrical Prospecting Is Tested  
in Search for Metals 88/605**

Prospecting with electricity on the surface of the ground for minerals hidden in the earth is being tried by a large zinc company at its mines in New Mexico. The method is one worked out by H. Lundberg, a Swedish engineer, who claims that it has been used with good results in Norway. The presence of metals below is determined by the relative conductivity of the rock, as shown at many points for a given area between two parallel charged wires. Similar tests have been made in Wisconsin and the process is being closely watched by mining engineers, who believe, that, if it is successful, it may prove of great value.

Empire Zinc Co.,  
Hanover, N. W.

**Humidifier Spray Uses Same Water  
Continuously for Fountain 13/6**

Requiring no connections to a water pipe, an electrically operated humidifying fountain that can be used as a decoration in the home or office, pumps the same water over again through small nozzles in tiny jets. When working, the spray is illuminated by incandescent bulbs and a hidden motor does the pumping. As the water in the bowl evaporates it may be easily replenished. The height of the jets can be



Electric Humidifier Fountain for Home Which Pumps Same Water Continuously through Jet Nozzles

regulated. Power for operating the humidifier can be supplied by current from an ordinary light socket.

Dunersoll Co.  
200 E. Chicago  
Chicago

**Collapsible Canoe Carried on Auto  
Has Seats for Two Persons**

For the automobile tourist who likes to fish and paddle, a collapsible canoe has been imported from Germany which can

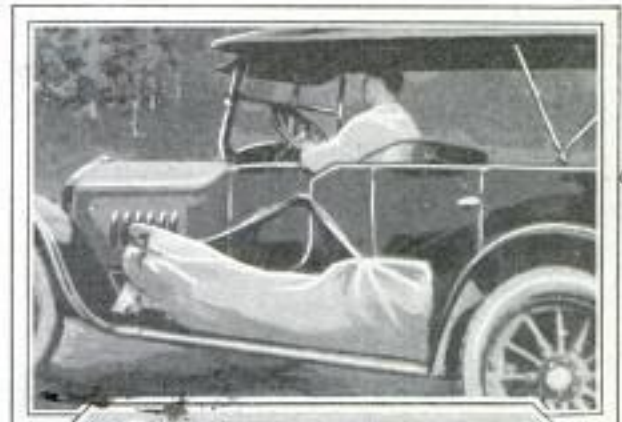

Collapsible Canoe Carried on Fender on Auto Trips, Which Can Be Assembled in Ten Minutes

be packed in a bundle, six inches in diameter and forty-eight inches long, and weighs only thirty-five pounds. When assembled, which can be accomplished in ten minutes, it is fifteen feet long, with waterproof spray shields at each end, and seats two people in comfort.

**Time-Saving Peanut Harvester Digs  
Vines and Piles Them in Rows**

Peanuts are harvested quickly and with considerably less labor than by hand with a horse-drawn machine that digs up the vines and piles them in rows where the nuts can be separated easily from the roots. When the digger is started, a flat, pointed shovel passes under the surface at a sufficient depth to catch all the nuts. As the roots are cut off, they pass up an endless slatted elevator where most of the dirt is shaken off. They may then be dumped directly into the furrow, or on either side of the machine, by a conveyor which runs transversely to the elevator. All parts of the machine are moved by the traction wheels and are easily controlled by the driver.

1216  
Wm. W. Ford  
Box # 3, Arringer, Tex  
Letter re id

Dunersoll Co. 200 E. Chicago  
 N. S. - Kayak Mfg. Co. 555 E. Wacker  
 8.22.24  
 Wm. W. Ford  
 Box # 3, Arringer, Tex



Kadel + Herbert  
 434 153 E. 42nd St  
 New York

announced at meeting of  
 Serrano Chemical Society

**Logging Is Taught by Miniatures  
 Run by Forestry Students**

With a miniature "donkey" engine and a toy railroad as "teacher," students in the

film strip contains from fifty to 500 separate views and can be moved backward or forward, making it possible to refer instantly to any one of them. On the other hand, it is pointed out, a hundred pictures may be thrown on the screen in less than a minute. Weighing less than five pounds, the whole apparatus, together with several thousand views, can be put in a desk drawer or carried in a handbag.

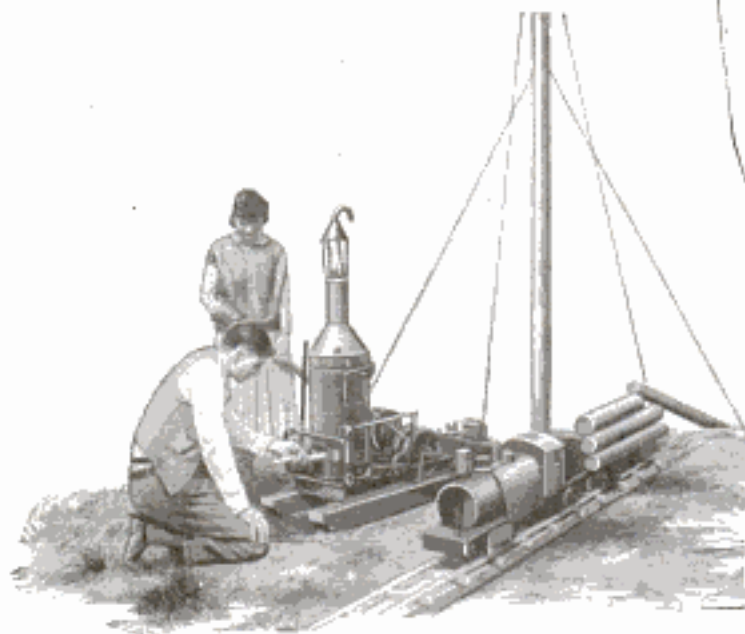

At the College-Campus Logging Camp; Firing Up Toy Engine for Hoisting Test

forestry department of the university of Washington receive practical demonstrations of the latest methods in logging operations before they face actual work in the deep woods. The tiny engine is complete in every detail even to a special spark catcher attached to the smokestack. It operates under its own steam and runs a hoisting tackle that puts small pieces of wood upon a model flat car attached to the "dummy" locomotive.

**Colorings of Butterfly  
 1312 Rivalled**

Science has outdone the paintbrush of nature, according to a recent announcement, in which the contention is made that by artificial means the coloring of butterfly wings can be reproduced with much more effect and richness than the originals themselves. The hues in real wings are brought about by light reflections on the same principle which causes soap bubbles to glisten, according to the discoverer. To get similar results artificially, he said that resin was used as the basis in the experiments.

Prof. Hans Zogher  
 Printing Cigars or Oranges Saves

**1139 the Cost of Labels**

Electrically operated, a machine that prints directly on round or cylindrical things, doing away with the expense of having labels, has been placed on the market. Trade-marks or names can be printed on cigars, oranges, tomatoes, nuts, apples, balls, mailing tubes, tin cans, glass or porcelain jars, and other round articles, without injury to

**1012 Glass Slides Replaced by Films  
 in Fireproof Stereopticon**

Designed to project still pictures from small strips of standard film instead of glass slides, a new type of stereopticon has

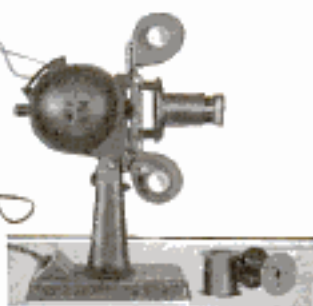

© Brayco Studios

been placed on the market. It is claimed that the machine can be operated from any electric-light connection. An insulating device protects the film from the heat. Pictures can be projected at any distance from thirty inches to thirty feet, it is said, and may be kept on the screen for hours, if need be, without any fire hazard. A

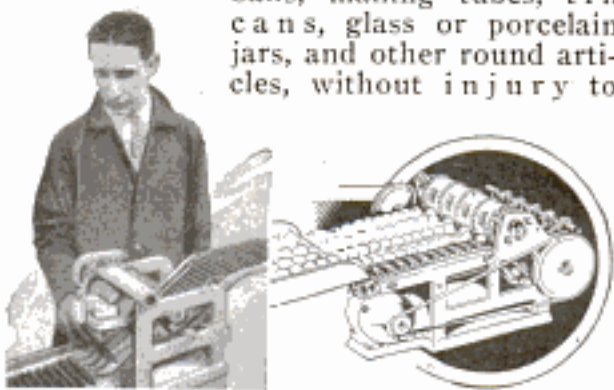

Machine Printing Trade-Marks Directly on Cigars and Oranges, Saving Cost of Labels

them, it is said, and at a speed of from 3,000 to 30,000 an hour. It is claimed that the press does in one operation what now takes two or more

J. J. Devigne  
 Nashua, N. H.  
 Copyrighted material

The Bray Studios  
 130 W. 46th St  
 New York City





Motor-Driven Knife That Cleaves Its Way through Several Layers of Cloth; Designer Inspecting a Sample Suit Model and Cutter Notching Cloth to Guide Sewers in Assembling Pieces

## Clothing the Men of a Nation

Power Sewing Machines and Motor-Driven Cutters Complete Thousands of Suits a Day in Tailoring Factories

**P**UTTING the men of this country into well-made clothing of up-to-date fashion equal in finish to the natty hand-worked attire of a half century ago when the neighborhood tailor was the sole source of dressy garments, is the task of hundreds of factories which now turn out thousands of suits of popular cuts, designed by their own style creators. Transforming bolts of cloth into men's ready-to-wear has become such a widespread industry that it is estimated to now employ more than 200,000 workers, most of whom are specialists in the various operations

which combine to keep the man and boy well dressed. Power-driven sewing machines that take a thousand stitches a

minute and keen, motor-operated knives that whirl at great speeds through stacks of cloth several layers thick, to trim the materials into shapes later assembled by hand, are but part of the inventions that help to relieve the tremendous demand for wearing apparel. College students, sportsmen and business and professional men, all are supplied with various styles of garments by artistic designers who arrange appropriate models for each class



Before Machinery Came, Spinning and Weaving Were Done in the Homes Where Most of the Clothing Also Was Made



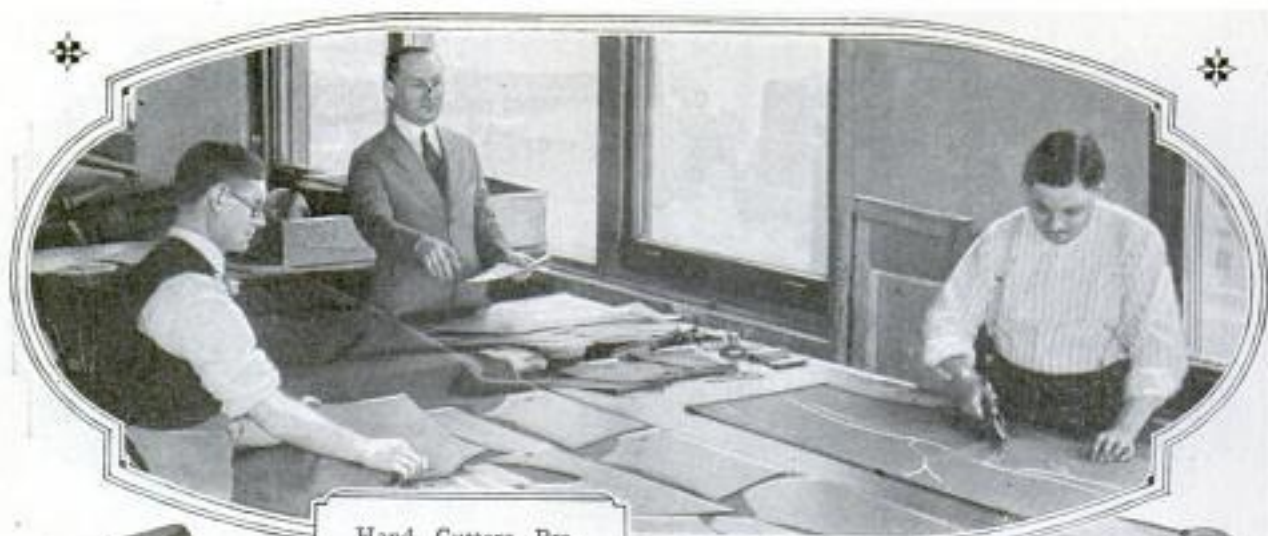

Hand Cutters Preparing High-Grade Woolens for the Tailors

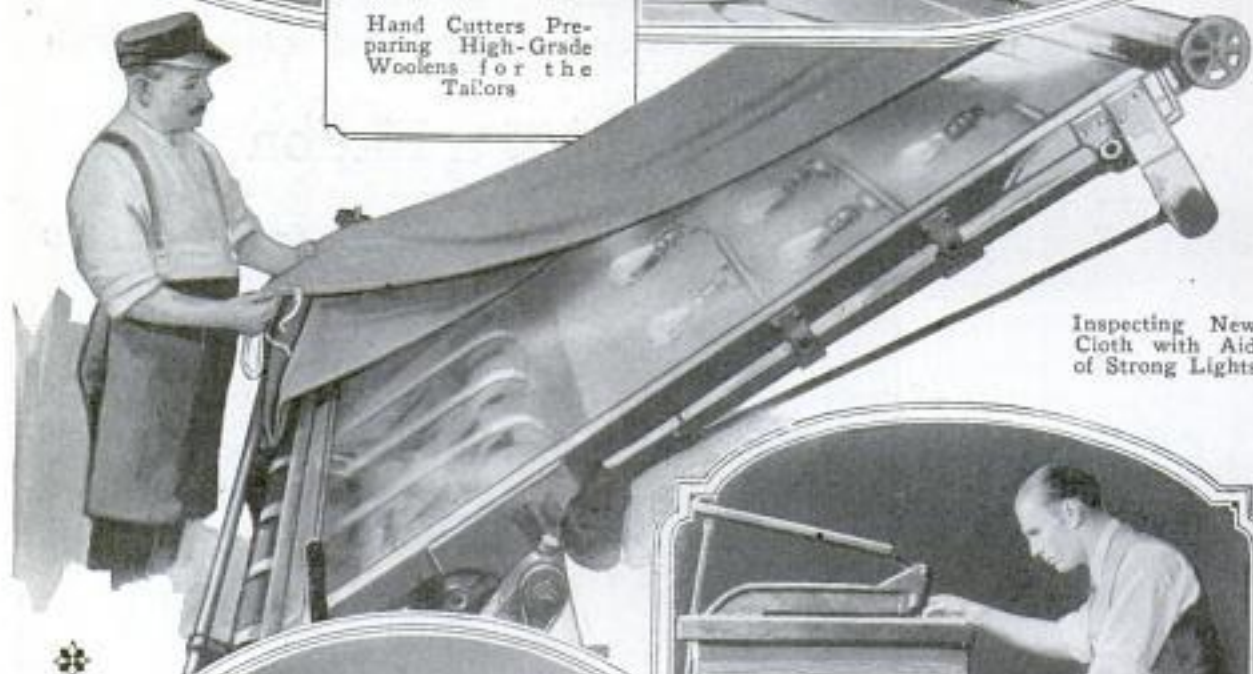

Inspecting New Cloth with Aid of Strong Lights

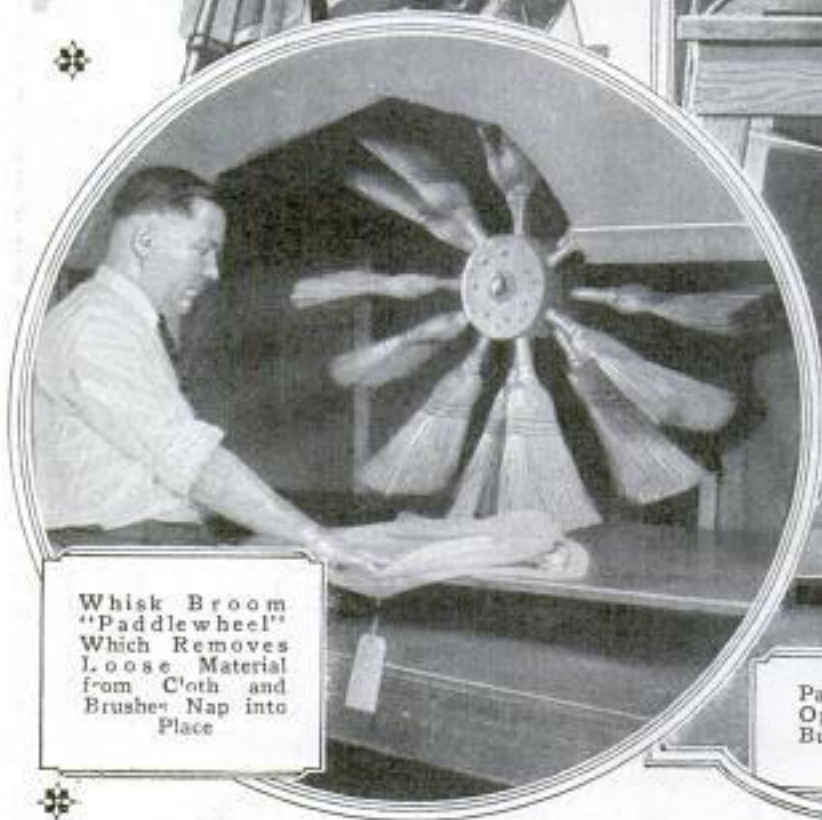

Whisk Broom "Paddlewheel" Which Removes Loose Material from Cloth and Brushes Nap into Place



Pattern Marker "Spotting" Openings for Pockets and Buttonholes on Cardboard Models



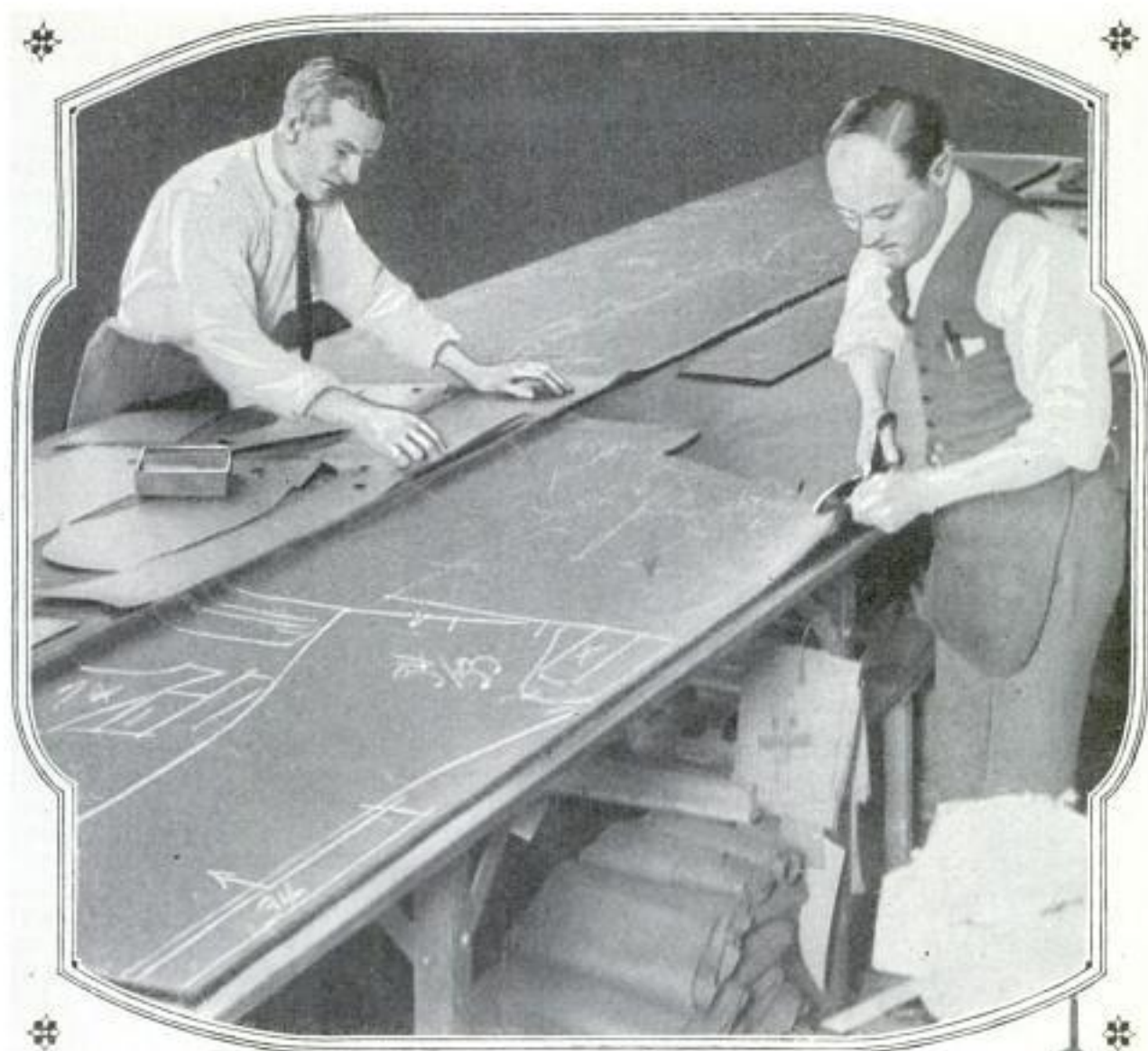

Above, Laying Out Suits; the Designs Are Traced from Paper Patterns Directly to Cloth Which Is Dissected into Shapes for Sewers; Below, Inserting Trimmings and Linings Which Must Be Accurately Applied to Insure Correct Form to the Garment



of buyers. By keeping a season or two ahead of the scheduled appearance of the fashions the designer is able to deliver to the humming factories, patterns that can be completed in time for seasonable buying in the retail stores.

After the model has been sketched on paper, special sample suits are made from the drawing and used as guides for selection by the manufacturers. When adopted as part of a "line," a master pattern is cut, and from this larger and smaller sizes are figured. Hundreds of bolts of cloth are unrolled, sponged, sorted and started through the process of cutting and assembling. If the cloth is of highest woolen grades, the operations are performed by hand, but with the more common grades machines are almost entirely used for the preliminary work. The cutter, equipped with a motor-operated knife, dissects the webs of material according to pasteboard patterns that have first been carefully measured for accuracy and fit. Laid out in piles of four to six layers the cloth is cut for as many suits at the same time. Special machines make the openings for buttonholes and mark the spots for the buttons. Shortly after a consignment of cloth from the woolen mills reaches the factories, it is subjected to a thorough test to insure its suitability to the requirements of tailoring standards. Its strength is tried in a pulling appliance where each bolt is unwound and

clamped in steel jaws that exert stretching strains upon the fibers. If the piece of cloth tears under certain stresses, it is rejected. All accepted material is sent to examiners where it is passed through apparatus equipped with a background of strong lights. By carefully watching the web as it slowly travels over these lights, experts detect imperfections in weaving or dyeing and any other faults, marking each spot by sticking a small white flag at the place to warn the cutters, who avoid such portions.

Having passed all inspections, the cloth is sent to the sponging room where it is treated with high-pressure steam which results in shrinking and pressing it before it is rewound into bolts. Even the tape used to hold the finished suit in shape is shrunk to conform with the woolen cloth. Linings are prepared in advance of the assembly of the suits, from more than thirty different kinds of fabrics, all cut by power cutters to accurate patterns. As it goes to the sewers, the suit is a ragged looking bundle of pieces of cloth, decorated with miscellaneous tags and instruction sheets which are to guide the assemblers in their work. When this assortment has all been put together, it goes to pressers who iron out all creases and wrinkles and remove any hanging threads or bulges along the seams. Inspectors carefully check up the finished garment with the guide slips and tags.



Marking and Cutting Pasteboard Patterns Which Are to Guide Cutters in the Shaping of Suit Pieces; Above, Presser Removing Creases and Wrinkles from Finished Garment



Clifford Thorne,  
716 Van Dyke Ave  
Detroit, Mich

**Diving for Gold Lost at Beaches  
Keeps Life Guards Busy**

Diving for rings and bracelets that slip from the hands of swimmers every year is one of the tasks of life guards at Belle Isle, near Detroit, Mich. With their eyes tightly covered with goggles to exclude the water, they are able to descend quickly to a depth of several feet by exhaling most of their breath before submerging. When the bottom is reached, the guard lies flat on his stomach, and taking care not to cloud the water with mud and sand, pushes himself slowly along with his hands. Sometimes, the lost article can be detected at once sticking up through the sand, but often repeated descents are necessary. With slight practice, the "sinking dive" can be mastered. It is especially valuable in this sort of work as it enables the diver to reach the exact spot where the lost article is supposed to be and does not greatly disturb the water, thus making clear vision possible. From twenty to thirty rings are found each season by the life guards at Belle Isle and occasionally, they are asked to recover sunken sets of false teeth, pins and other articles lost by swimmers.

Leu Pont Cellophane Co.,  
Allerton Hotel, Chicago 439  
U. H. Helwig  
Transparent "Overalls" Add Beauty to Dresses and Save Gowns 130 17

Quickly and easily slipped on, a transparent overdress which is said to transform the simplest looking frock into a

or 40 W. 40th St New York



Copyright, Underwood & Underwood  
Simple Frock That Has Been Transformed into Expensive-Looking Gown by Transparent Overdress

vision of beauty has been designed. It is also claimed to protect delicate gowns from dust and wear, keeping them looking fresh at all times and permitting them to be worn in offices without danger of soiling. Of a lacy substance and loose-fitting, the "overall" can be put on in a moment.

made up by Chicago Academy of Fine Arts, 81 E. Madison.

List Price - \$6.00. Large - \$10.00

**Automatic Cigar Lighter Serves as Handy Paper Weight**

Constructed of bronze so that it may be used as a paper weight, a cigar lighter has been marketed that ignites by pressing down a handle. It is claimed that there is practically no maintenance cost, as one filling of alcohol will last a year and there are no wires, coils or batteries to get out of order. Specially designed models for clubs, hotel lobbies, theater foyers and similar places are manufactured to harmonize with the furnishings. Equipped with ash tray, cigar rest, cigarette snuffer, automatic self-closing inkwell and places for two pens, other models are made for hotel-desk and office use. When the lighter is mounted on a square base that has its four sides fitted with transparent material, advertising matter may be inserted and changed as often as desired.



**Autos Take Lead over Telephones as Popular Utility**

For utility and convenience automobiles have become more popular than telephones in this country according to tabulations made by a motorists' club. At the beginning of 1924, 15,000,101 telephone instruments were in use, while the automobile "population" has grown to 15,221,153. The greatest stride in the increase of cars was made last year when the total registration numbered about twenty-three per cent more than for previous records.

A. E. Isuma Mfg. Co., Cincinnati, Ohio

New York Tribune  
3/30/24



*Ans. Bernard W. Hethell*

440

*14 Myrtle Ave.*  
*Brooklyn, N.Y.*

### POPULAR MECHANICS

#### Saw Filing and Setting Machine Is Operated by Crank

*1043*

To sharpen and set the teeth of saws quickly and accurately, a machine that does both operations at the same time in from one and a half to two minutes has been invented. The device is worked by turning a crank, filing both sides of the saw without the

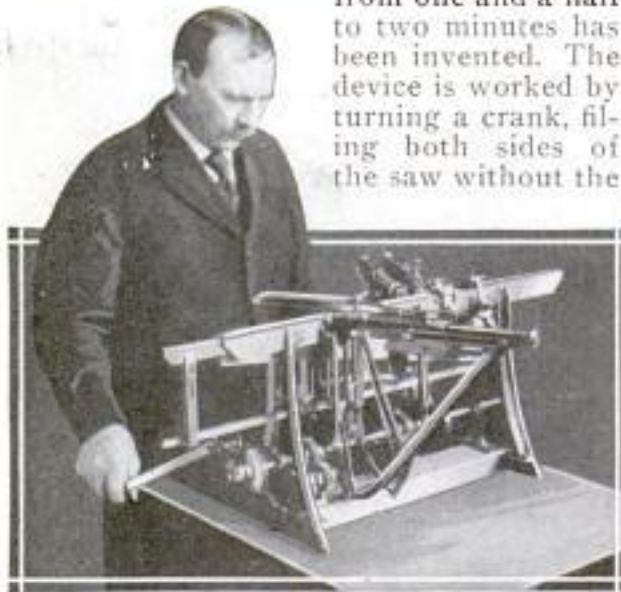

Inventor with Machine That Files and Sets Teeth of Saw at Same Time

necessity of changing its position in the vise. By connecting to a pulley, the largest teeth may be sharpened and set as easily as the smallest. The device may be placed either on a workbench or a special stand.

ment into position over the seat, and transforms the car into a cosy coupe. The top is easily returned to its original position and its front end fits upon the windshield. Special curtains attached to the doors and sides complete the coupe effect. Rods with which the top is raised, serve as braces when it is in use, and screws are provided to clamp it securely to the back of the car and keep it from rattling.

#### Swiftest Way to Girdle the Earth *1401* Is Still by Land and Water

Although the round-the-world airplane flight already has established new flying records, it will not break the existing speed mark for circling the globe. Before the participants were halfway on their journey, they had taken more than twice as much time as was required by John Henry Mears of the New York Sun who, traveling by land and sea, made the trip in 1913 in thirty-five days, twenty-one hours, thirty-five and four-fifths seconds, bettering the performance of the mythical hero of Jules Verne's story by more than forty-four days. He covered an average of 587 miles a day. Notable among other journeys are those of Capt. W. D. Seymour, who in 1876 made the trip in 117 days, Nellie Bly's record of seventy-two days, six hours, eleven minutes and fourteen seconds in 1889, lowered by about five days by George Francis Train the following year. His mark was bettered by nearly a week in 1901 by Charles Fitzmorris, of Chicago. This record was then lowered by Henry Frederick, Col. Burnley Campbell and by Andre Jaeger-Schmidt, a Paris journalist, who held the record until Mears made his notable trip.

*new York Times 6/15/24*

#### Disappearing Top Quickly Converts *1045* Roadster into a Coupe

Simply turning a crank in a cleverly designed roadster now on the market, raises a movable top concealed in a rear compart-



Roadster with Coupe Top Raised and Lowered; the Change Is Quickly Made with a Crank

#### Photographic Power of Wood

Experiments have shown that a section of a tree trunk, or of a branch, cut across the grain, possesses the power to impress upon a photographic plate in the dark a distinct image of itself, plainly showing the rings of growth. There is a great difference in the intensity of this power in different woods. The conifers—pines and firs—have it in high degree. The wood is placed either in contact with the plate or a short distance from it and the exposure varies from a half to eighteen hours. Boards long exposed to the air, an oak box 100 years old, a decayed stump and even bogwood have been found still photographically active.

*Cont. Edwin Larisse*  
*10 The Harriet*  
*Washington, D.C.*

*Ans. B. B. Ellerbeck*  
*42 S. 9th St. Each*  
*Ball Lake City*



### Folding Hunting or Fishing Boat Fits Auto Running Board

vania wrecking crew. The job consisted in getting rid of an old fifteen-span trestle and substituting for it two spans of deck-plate girders, each eighty-five feet long. The new structure was built in shops with

For fishing or duck hunting, a folding boat that may be carried on the running board of the automobile as a carrier for part of the camping equipment has been designed by an experienced Long Island yachtsman. It consists of two sections, each of which may be used as a separate boat, if desired, and will support the weight of a full-grown man. Extended, it is ten feet long, three feet wide and one

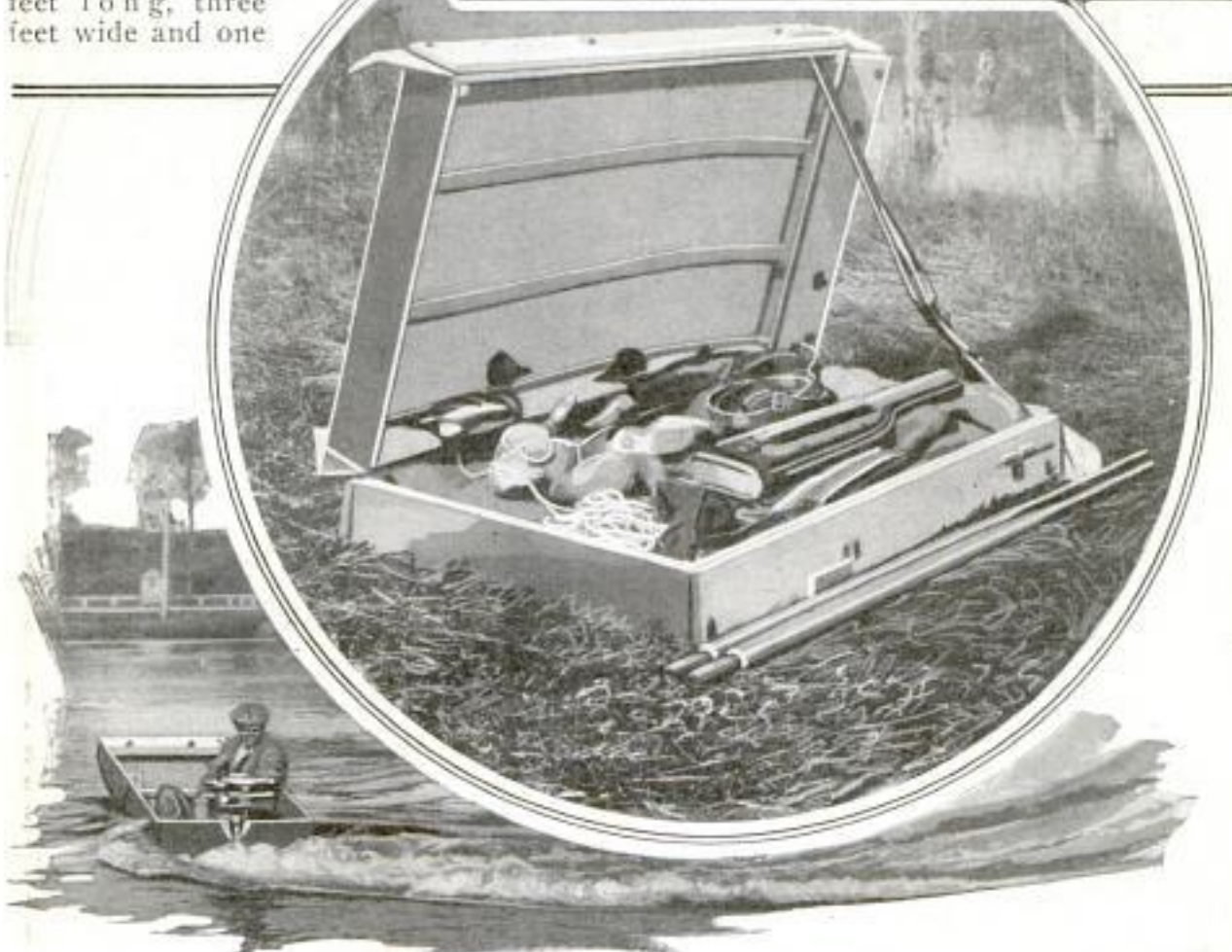

Cruising over Inland Lake in Folding Boats; How Craft Serves as Shipping Container for Camp Equipment, and Converted into Motorboat by Attachment of Small Gasoline Engine

foot deep. It is half that length when folded and may be used with a portable motor.

### Bridge Built on Wheels Installed in Place of Old in Four Hours

Building a railroad bridge on two sets of car wheels and transporting it to the site was the unusual engineering achievement recently accomplished by a Pennsyl-

blueprints as the only guide to accuracy. When completed, it was bolted to the wheels and moved to a sidetrack near the creek. The wrecking crew had four hours in which to make the substitution. With the aid of a derrick on both sides of the stream, the new bridge was lifted from the rails and held in mid-air over the old trestle spans as they were cut loose and pulled away. It was then lowered into place and was found to fit perfectly.

*Cont. Carl A. Jenkins, No. 104, 72 W. Adams*  
*St. Chicago*



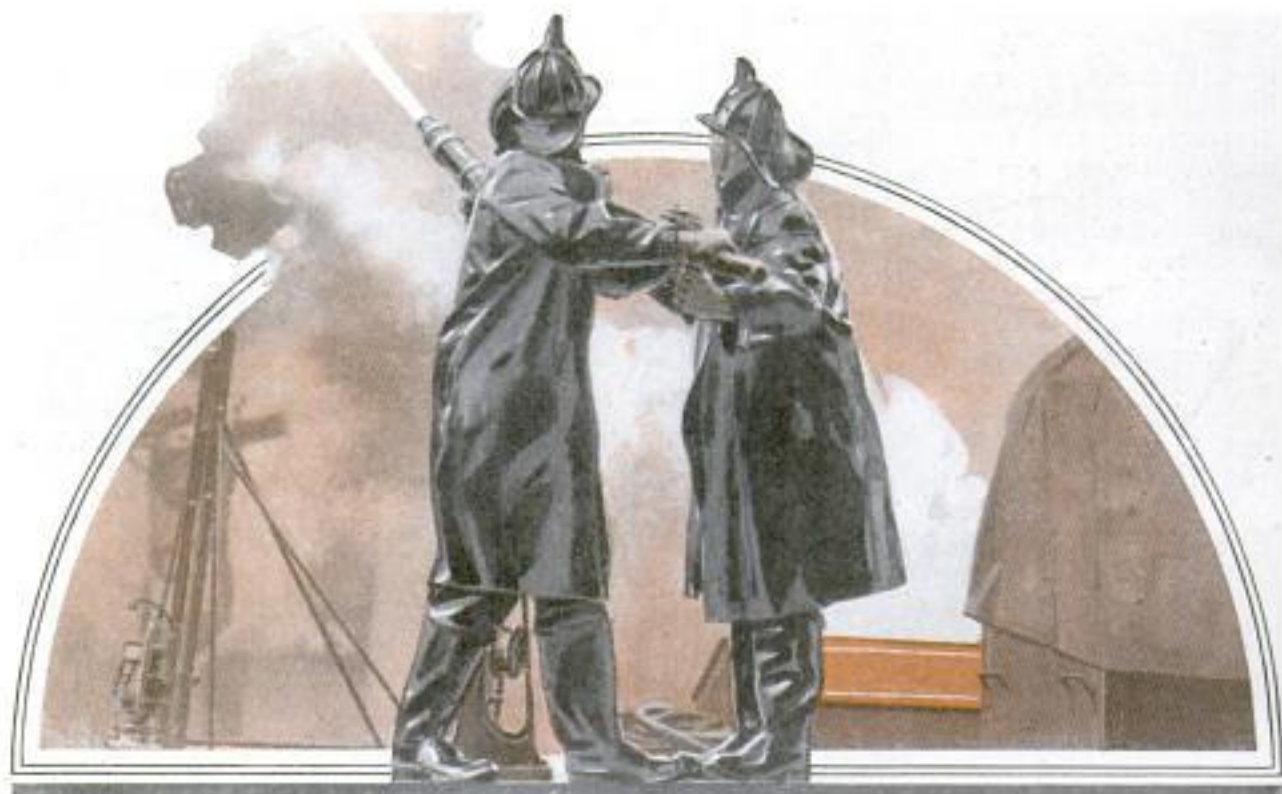

"Artillery" of the Fire Fighters: Sweeping the Flames in a Skyscraper Fire with a Powerful Stream from a Swiveled Nozzle Attached to a Lofty Water Tower

## The Passing of the Fire Horse

Motor-Driven Apparatus and Scientific Methods Answer Demand for Increased Efficiency Owing to Greater Hazards

FROM hand pumps worked by volunteers to the modern motor-driven fire apparatus is the record of considerably less than a century's progress in fire fighting. Steam-driven pumps did not begin to come into general use until the decade before the Civil War, and even then their advent was deeply resented by the volunteers, who protected their rights so devotedly that frequently the rival companies would let a fire burn while they fought among themselves. Chicago was a city of more than 90,000 population before it purchased its first steam pump in 1857. A fire chief of the time, in his memoirs, writes:

"In 1855, when we first started to agitate getting steam engines, the mayor appointed a committee to visit Cincinnati to see what they could do. We went down there and they got out their engines. But it was bad for them; they blew the steam chest off and killed the engineer, which put a damper on buying steam engines for the time. There was nothing done then

for two years, when the council ordered 'Long John,' named after Mayor Wentworth." The engine was stored in what is now Chicago's loop, but the four-horse team which was hired to draw it was stabled nearly a mile away.

The fire-alarm system, typical of American cities of the day, consisted of a bell in the courthouse tower, and a watchman who hung out flags by day and lanterns by night to indicate in what part of the city the fire lay. That, however, was a great improvement on the system in vogue a few years earlier, when a church bell was used to signal a fire. An early account says:

"Anyone who first saw a building on fire ran to the church and pulled the rope, which hung outside the belfry. In those days there was no gas, and torch lights were carried ahead of the engine by boys. When an alarm was rung at night citizens were instructed to place lighted candles in the windows of the stores or dwellings in



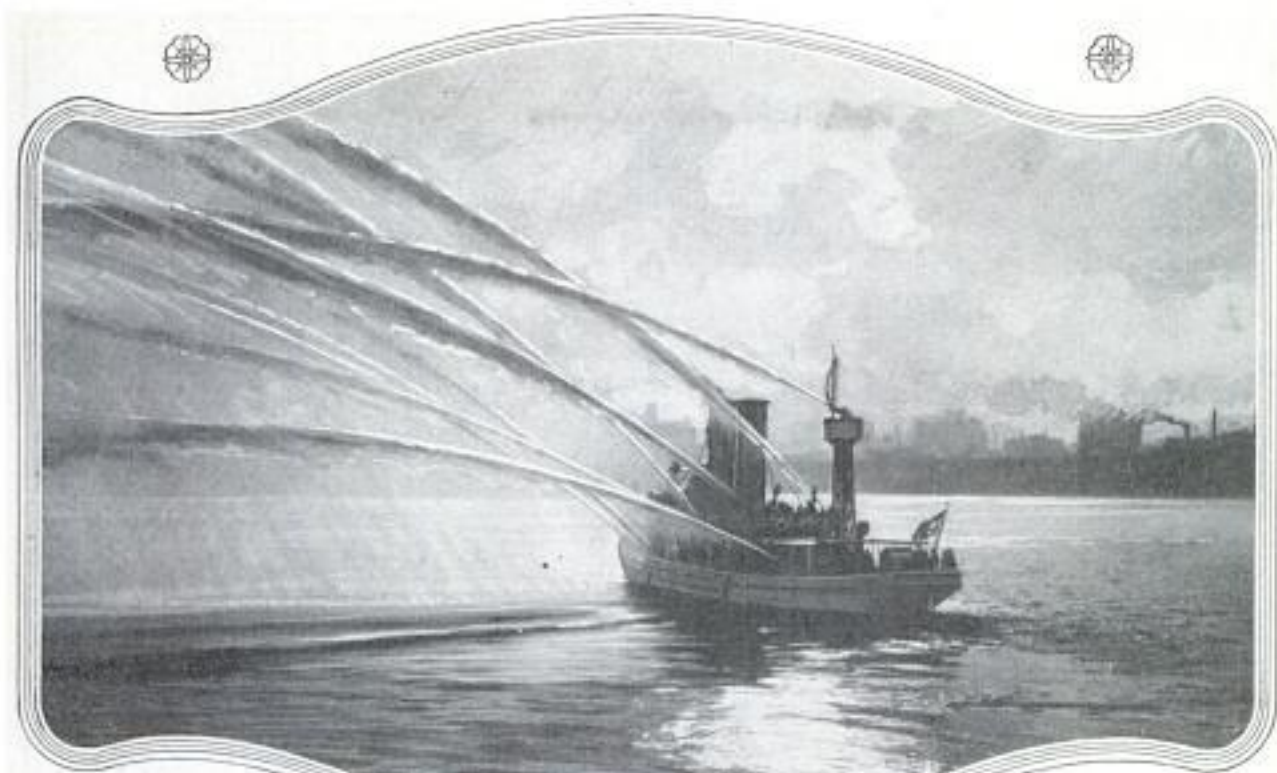

Fireboat Delivering Its "Broadside" during a Night Blaze; Below, Fighting Flames in Doomed Steamer off the Waterfront

Copyright, Underwood & Underwood

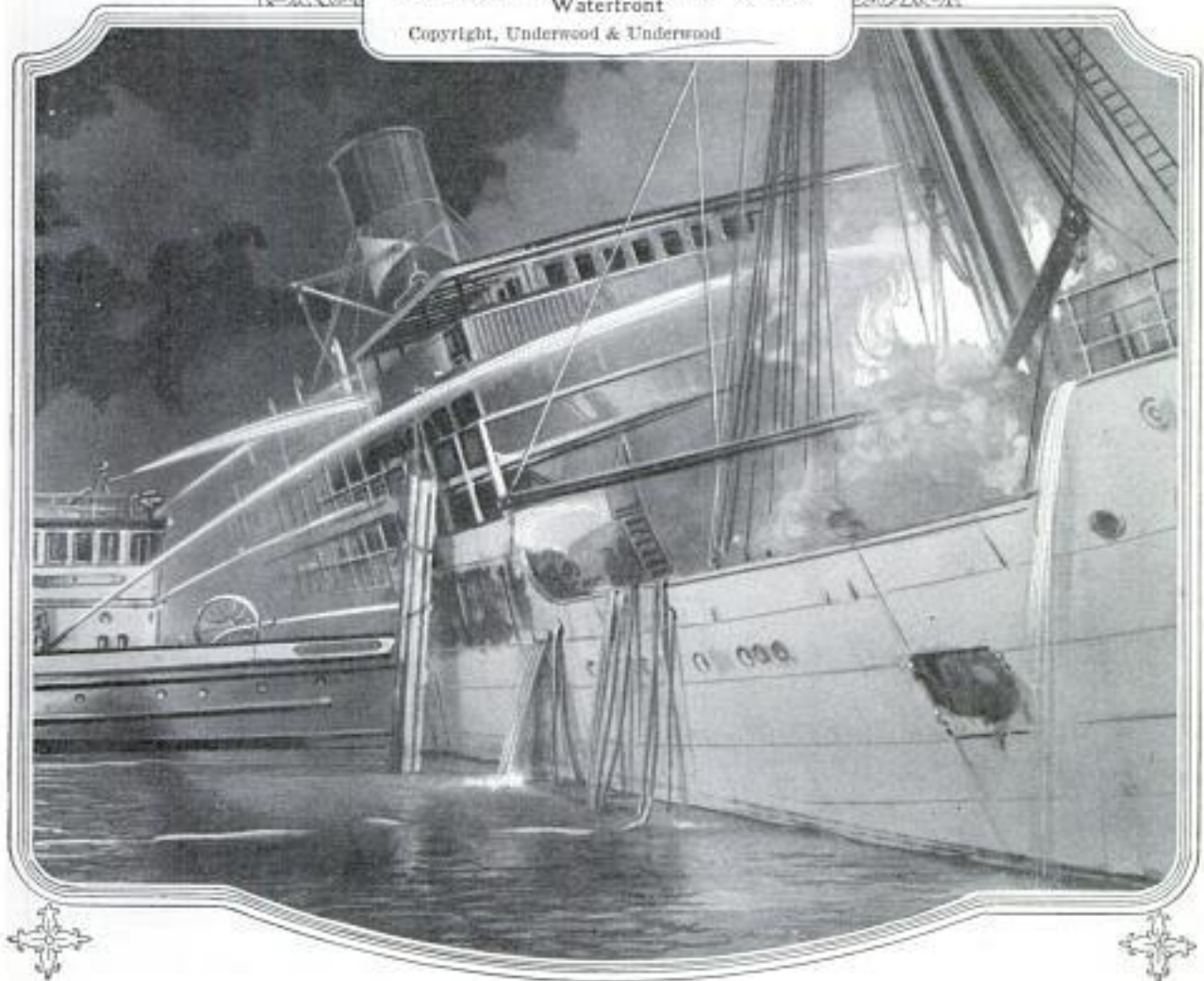



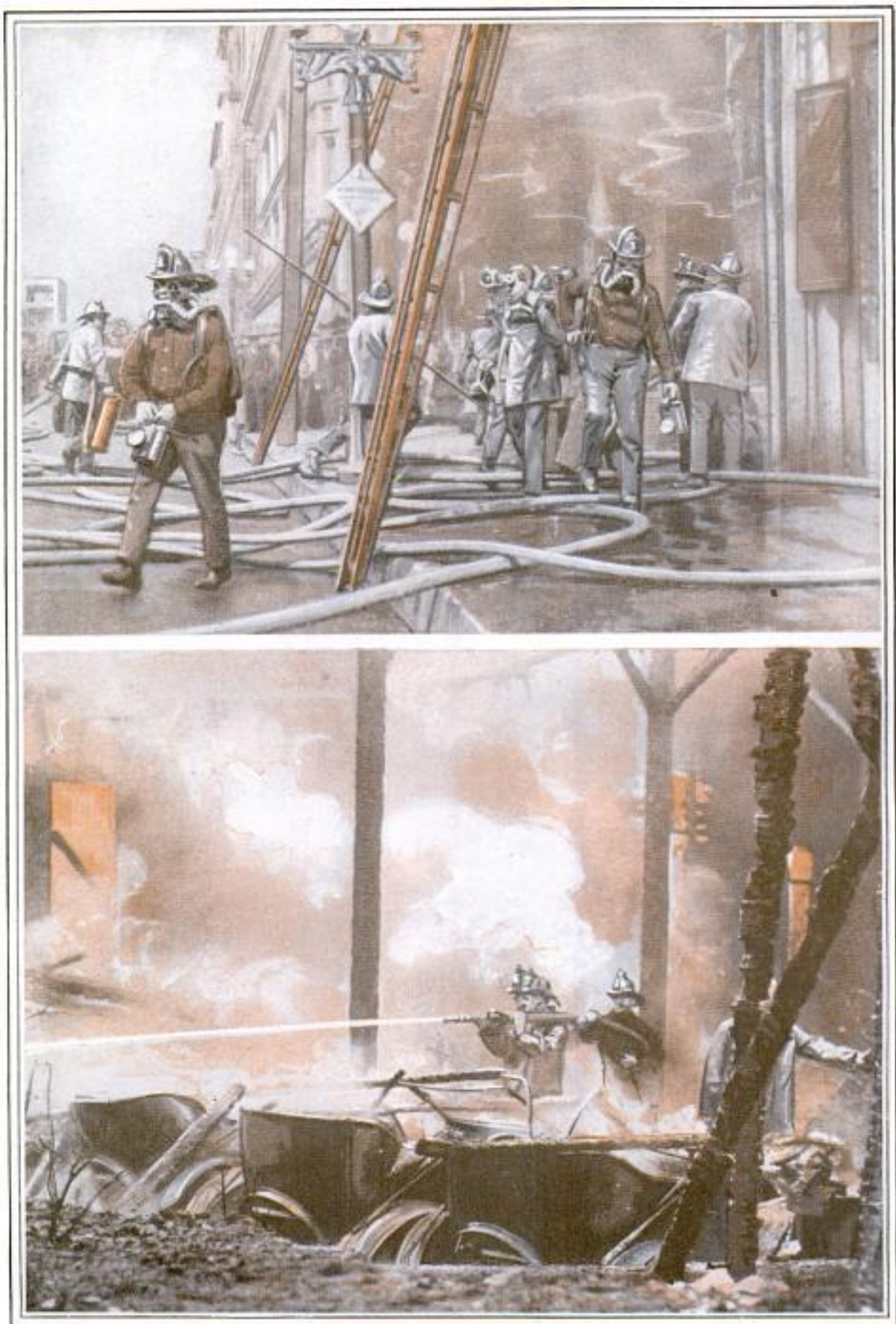

Defying Blasts of Flames Where Danger of Falling Walls and Roofs Is Forgotten in the Battle to Save Property; Above, Crew of Firemen Masked against Deadly Fumes and Smoke





Fleet-Footed Fire Crew and Hand-Drawn Motor Engine



Fire Engine of the Type Used in Constantinople



Alarm Box for Sweden's Fire Fighters; a Lusty Blast on the Horn Sounds the Call for the Neighborhood Company



Part of Apparatus That Fought Great Fire at Smyrna





Trying Times for the Daring "Smoke-Eaters" Struggling against a Night Fire That Turned a Peaceful City Block into a Seething Furnace and Drove Hundreds from Their Homes



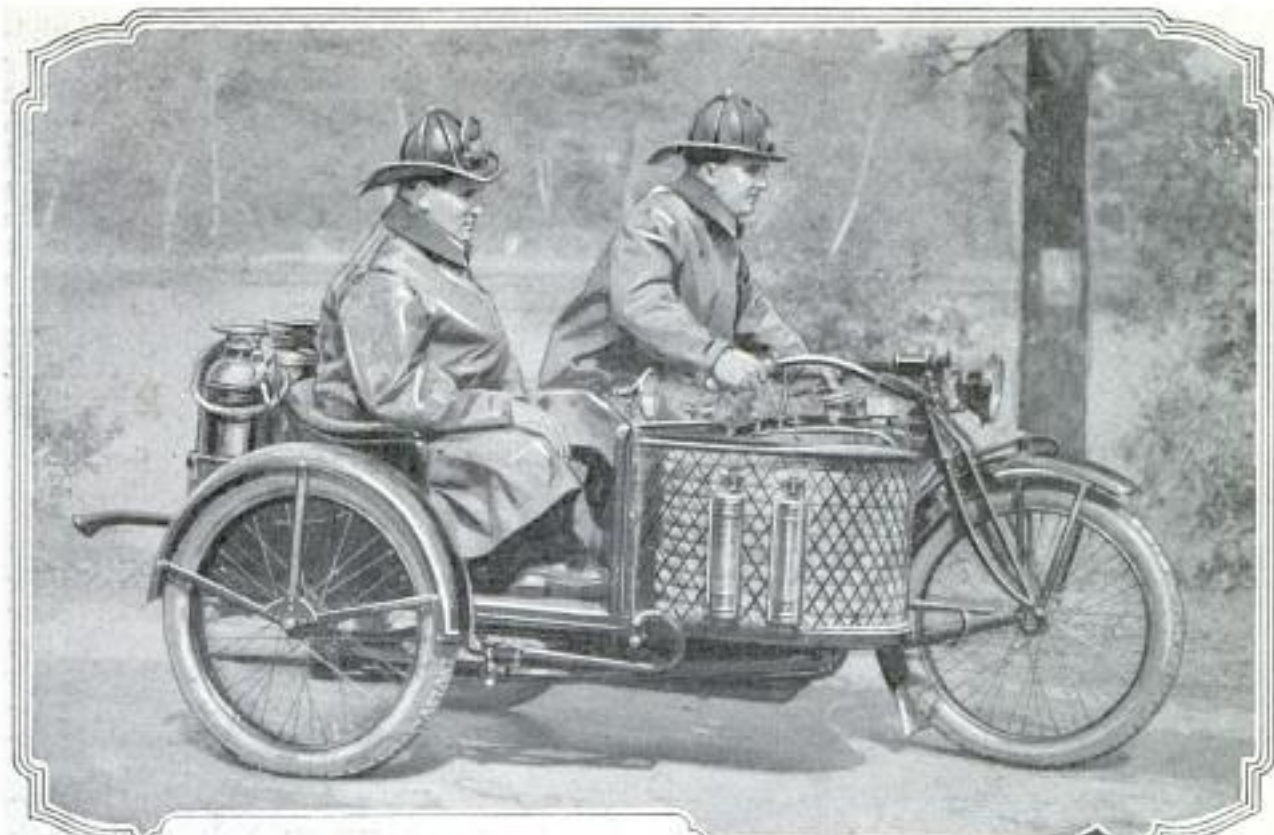

Motorcycle Patrol Whose Speedy Arrivals at Scenes of Fires often Stop Their Spread and Prevent Great Loss of Lives and Property



Life Net Drill Held by School Boys Who Are Taught Rescue Work by Fire Instructors, and "Human Flies" of Paris Fire Force Exhibiting Skill in Climbing

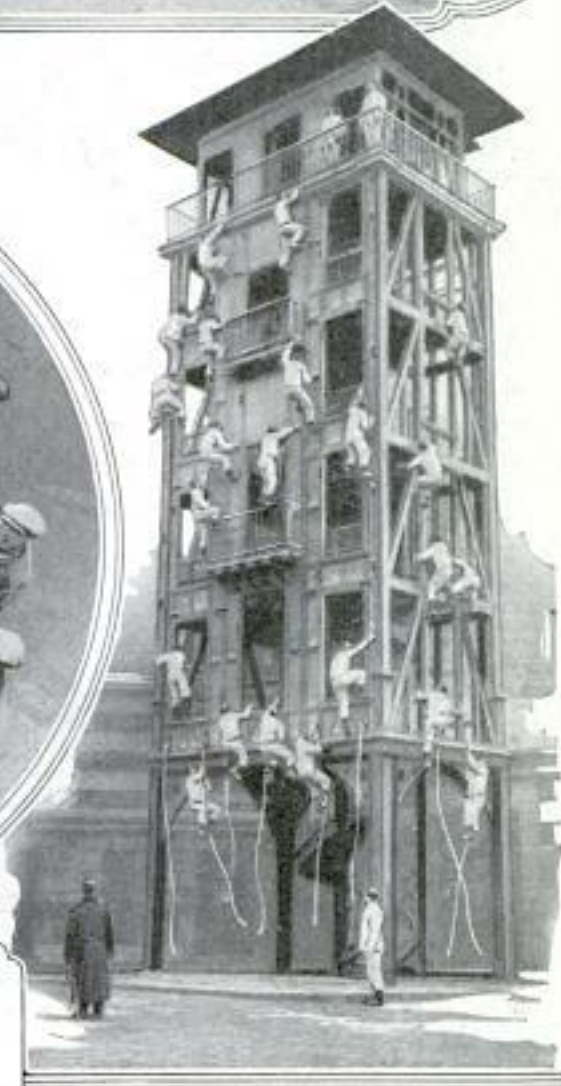



order that the firemen might be lighted on their way."

The horse, which made its advent into fire fighting so inauspiciously in the middle of the last century, held its place, however, for more than fifty years. The motor truck, introduced originally as a tractor to haul the apparatus, has likewise sounded the death knell of the old steam engine, with its spectacular stream of flying sparks. Modern motor apparatus, besides being lighter and more economical in operation, also makes possible higher pressures and greater streams of water, necessary to fight fires in lofty skyscrapers.

The science of fire fighting also has received some radical changes during the last two years as a result of a study made by the fire underwriters of what is known as the Burlington building fire, which occurred in Chicago in 1922. The name is somewhat of a misnomer, as twelve buildings were involved in the fire and the Burlington building, while the heaviest individual loser, was not strictly speaking, a part of the original fire. Eleven of the buildings destroyed or badly damaged embraced a series of old brick structures from one to eight stories in height, most of them dating from the years immediately following the great Chicago fire of 1871. The Burlington building, home of the Chicago, Burlington and Quincy railroad, was a modern fifteen-story terra-cotta-faced office structure, a half block to the west of the other buildings and separated from them by a wide street.

Fire starting in the group of old buildings sent columns of flame and heated air 200 feet above their roofs, where the heat met a fresh breeze blowing across the top of the Chicago loop district buildings, and was deflected westward to the Burlington offices. So intense was the heat high above the ground that the wired-glass windows of the big office building melted, while the terra cotta itself was badly fused, though no flames had come in contact with it. The intense heat from the fire a half block away raised the temperature of the office furniture and other woodwork to the combustion point, and the entire upper floors of the Burlington building, from the ninth to the fifteenth, burst into flames.

The lesson of the fire introduced a new element into fire fighting and may bring new arrangements to protect the exterior walls of tall buildings when exposed to the heat from fires in their smaller neighbors.

With all the improvements in fire fighting, the flames continue to take an enormous toll of life and property.

One thousand dollars' worth of property burns every minute, day and night, in the United States; forty lives are lost by fire each day; one dwelling house burns every four minutes; one farm building every seven minutes; one hospital each day; five school houses daily; five churches every day, and fifteen hotels in each twenty-four hours.

And so, despite the advancement of science, vigilance remains today the best protection against fire.



Crashing Walls and Flying Timbers Often Take Toll from the Ranks of Valiant "Knights of the Hose" Who Risk Their Lives to Stem the Tide of Fire



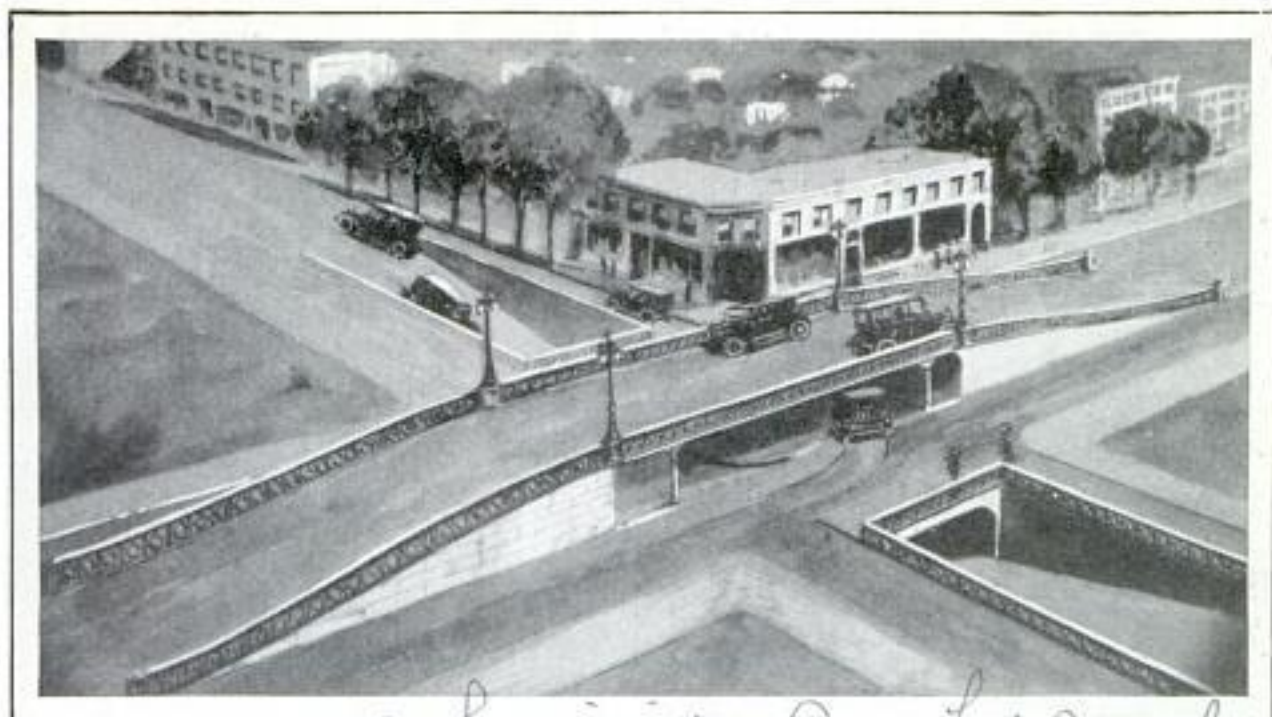

Copyright, A. T. Smith, 4589 Lexington Ave, Los Angeles, Calif.  
 Drawing of Triple-Deck Street-Crossing—Plan for Safety and Congestion Relief; Subway and Upper Level Allow Uninterrupted Through Traffic While Middle Is Left Free for Turning

### Triple-Deck Crossings to Protect Lives and Relieve Congestion

To relieve congestion and increase safety at crowded crossings, a Los Angeles engineer has designed a triple-deck street arrangement particularly for intersections outside the business districts, where the absence of traffic policemen and heavy high-speed travel are often a menace. In one direction, the highway passes through a subway while the cross street is elevated over it. The chief feature of the plan is a central deck which is exclusively for turning. This prevents slowing up through traffic in either direction, minimizes the likelihood of collisions and protects pedestrians, who cross only at this center level. The inventor claims that the plan can be adapted in business districts by eliminating the subway, elevating one of the cross streets and having ramps for turning on the upper deck. Cars can be parked beside the elevation.

### Wash Fountain Serves Ten Persons at the Same Cost as One

Attractively designed, a wash fountain that accommodates several persons around it at the same time, has been designed for use in factories and shops, hotels and clubs, and similar places. Equipped at the top with either a liquid soap container or dish for cakes, it furnishes a spray of clean, fresh water which drains off the

polished surfaces, carrying the dirt and suds away and keeping it sanitary with a minimum of care. When not being used, the water is shut off, and it is claimed that ten persons do not use any more than one would from a single faucet of the ordinary size. As fewer washstands are needed, floor space is also saved. With only one inlet and one drain, a multitude



Washing in a Spray of Clean, Fresh Water Emitted by Attractive Sanitary Fountain

of pipes and fittings are displaced, reducing repairs and replacements, and as there is no stopper to hold the water in, it cannot overflow.

Bradley Washfountain Co.,  
 Milwaukee, Wis.



~~Photograms 129 & 297~~  
New York City  
POPULAR MECHANICS

Kansas City Star  
6/19/24

### Weather-Vanes' Popularity Grows through Skill of Artists

1864

Commonly used in medieval times, weather vanes have become increasingly popular in recent years because of their artistic possibilities and the novel and decorative touch they add to many types of modern architecture. Several studios manufacturing them employ highly skilled artists to draw the designs and cut the

### Millions Saved for Diamond-Miners as Result of Chance Discovery

1425

Millions of dollars' worth of diamonds were saved to the world by a lump of grease dropped casually into a miner's pan in the Kimberley fields. It was this accident that resulted in the invention of a machine called a "pulsator," which picks diamonds out of material wherein they cannot be seen by the human eye. For years engineers had been seeking a method of saving the small gems which were being lost in the processes of hand sorting and washing because they could not be seen. Magnetic separating devices, sorting by electricity and other ways were tried without success. Then one day an old workman was oiling the bearings of the revolving arms in the washing pan when a lump of the lubricating grease slid from the flat stick and stuck to the bottom. A few days later, after the concentrates had been taken out and the muddy water drawn off as usual, a tiny diamond was found sticking to the black smear. Believing that he had stumbled onto the solution for the automatic separation of the precious gems, the workman reported his find to the engineer in charge. Experiments were carried out with a crude

Julius Barton  
414 Madison Ave. } New York City



In the Weather-Vane Artist's Studio. Where Graceful Silhouettes Are Cut from Metal to Show Which Way the Wind Blows

vanes from metal sheets. An eastern workman devotes his entire time to the making of these articles and his shop has become well known for its variety of patterns and the artistic quality of the product. Silhouettes of galleons with sails set as though plowing the seas, equestrian figures, processions of animals and other unusual designs are cleverly devised in metal and mounted on steel bars. From drawings on paper, the figures are marked on copper and brass sheets from two to nine feet long and are cut out with exacting skill. Great care is exercised to give the design perfect rigidity when mounted. Coloring and polishing enhance the appearance of the ornaments.

apparatus and water from a faucet. The diamonds stuck to the grease while pebbles and semiprecious stones rolled off. Thus came the discovery that there is some sort of affinity between the diamond and the grease, but the "why" is still a mystery.

### Oxygen to Cure Sea Sickness

Oxygen has proved successful as a cure and preventive for sea sickness, according to statements made at a convention of the Gas Products association following a test. It was pointed out that the gas could be put in containers small enough to be carried in a suitcase.

New York Times  
6/14/24

Statement made by C. J. Price  
Secretary, Gas Products Association



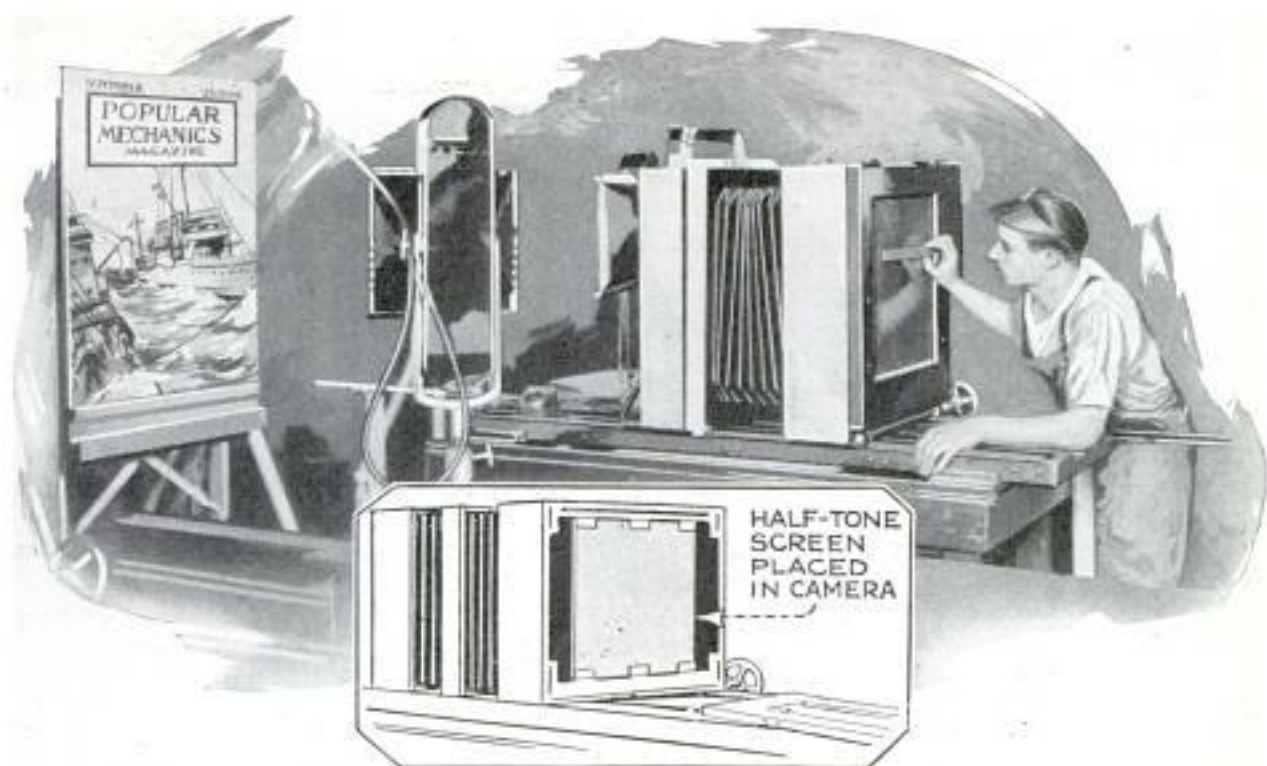

Carefully Focusing the Camera to Get a Sharp Picture of the Object in the Right Size for the Half-Tone Negative Is the First Step in the Process

## America Leading the World in Inventions

More Than \$143,000 Offered for Ideas to Help Solve Nation's Problems and Maintain Present Supremacy

Copyrighted, 1924, Popular Mechanics Co.

WITH only about one-sixteenth of the population of the world, one-half of the world's patents have been issued in the United States.

In the past ten years one person in each one hundred and fifty has asked that a patent be granted on some device or other. Approximately 80,000 applications were filed last year and 40,000 patents granted.

American patents mean something too, for since 1836 the patent office has made a careful search of all available records before passing upon applications. Great Britain and Germany did not institute the search plan until comparatively recently and France does not search even yet. A patent in France therefore means only an assertion of priority.

Probably none of the first inventions affected this country more than that of the cotton gin. Eli Whitney was one of the thirteen children in his family, and it was in the shop where the older ones worked that he became skillful in the use of tools. He began by repairing fiddles, and did it so well that soon inhabitants of

the whole countryside came to him. At the age of thirteen years, he made the first machine for manufacturing nails.

While in Georgia as a tutor, the mother of his pupils suggested that Whitney should try to invent a process for cleaning cotton. He could make or mend anything in the toy line, she knew from his demonstrations. At first he refused with the explanation that he did not know a cotton seed when he saw one, but later he was given a room where he could experiment. The model was completed in 1794 and was to be kept entirely away from the curious public until a patent could be obtained. Soon, however, the crowds about the house became uncontrollable and later the place was broken into and the result of all his efforts carried away. As a consequence, the planters began to use it without even a word of thanks, and it was not until 1800 that Whitney was able to obtain recognition. Then, in 1812, a renewal of his patent was refused and thus he failed to realize the amount to which his invention really entitled him.



While Whitney is one of the best known of American inventors, Walter Turner, who is credited with no less than 400 patents, the value of one of which has been set at \$28,000,000, is one of the least known to the general public. Nevertheless, it is to the genius of Turner that we are indebted for marvels of transportation that would be impossible without the railway equipment devised or perfected by him.

Turner came from one of the quiet shires of England, and took up sheep herding in Wyoming. During the panic of 1893, he was obliged to sell his sheep and found work as a wheel tapper on the Santa Fe line. One day he went to the boss of the shops and said he believed he had an improvement for the air brake. The railway company took out a patent and increased Turner's pay. A little later, he devised further improvements and was put under contract.

His efforts attracted the attention of George Westinghouse who offered him a

position in Pittsburgh, where more inventions came from his brain with remarkable regularity. The more he studied the air brake, the more he improved it. Westinghouse invented the air brake. His mechanism would hold a train of possibly fifty cars. Turner developed it so much further that now it is possible to control a train of one hundred or possibly 150 cars as easily as a train of ten cars.

All of which only goes to show that one of the first requisites for the solution of a problem is knowing what the problem is and that the lack of technical training need not be a handicap to the inventor.

It was to indicate clearly the industrial needs of the country as the first step toward their solution that Popular Mechanics Magazine obtained the co-operation of many of the nation's leading manufacturers. On the following pages you will find their problems clearly outlined with definite rewards offered for acceptable solutions.

## HOW PHOTO-ENGRAVINGS ARE MADE

**T**HOUGH practiced for generations, the art of photo-engraving with its magic power of reproducing realistic pictures on the printed page is still more or less of a mystery to the layman.

Beginning nearly a hundred years ago in the laboratory of a French scientist, Joseph Nicephore Niepce, who discovered a compound that became insoluble when exposed to light, amplified by the chance discoveries in chemical development by Daguerre and by the later experiments of Fox Talbot, who originated the process of breaking up the picture into little dots by photographing it through a fine-meshed screen, the art in recent years has developed to an amazing degree of perfection.

Briefly, it is the science of transferring a picture to a sheet of metal and then lowering all the area except the portions that are actually to touch the paper when the finished plate is placed in the printing press. Three main processes are essential. The picture must first be photographed to make a negative. It must then be transferred to the metal plate, and, finally, the copper or zinc sheet must be etched to leave only the lines and dots of the subject exposed to the ink.

A special camera and plate are employed to obtain the negative. The subject to be taken is fixed to a board and strong light directed upon it. The camera is then carefully focused so that, on the ground glass at the rear, the image

will appear in the exact size desired for the finished plate. The glass is coated with a sensitized preparation and immersed in a silver bath before placing it in the camera. If a half-tone is to be made, the picture is taken through a fine-mesh screen made up of two pieces of ruled glass, glued together and with the lines at right angles so that the resulting impression on the negative will be broken up into a number of dots of different size to give the high lights and shadows. Then the negative is developed and dried. As the image appears in the reverse of the original, the film is stripped off, turned around and placed on another glass for printing upon the metal plate.

Sheets of copper or zinc of carefully measured thickness and special quality are used for the plates and the printing is done in a press which holds glass and metal closely together. From three to five minutes under strong light are generally sufficient to transfer the image from the glass to the plate which has been covered with a sensitized coating. The surface is then treated in such a way that only the lines and dots that are to appear on the paper are left protected while the rest of the coating is washed away.

Routing machines remove extra metal more rapidly than is possible by acid, and hand etchers carefully go over the plate to bring out contrasting lights to better advantage. After it has been lined and





One of the Dark-Room Processes; Submerging Coated Plate in Silver Bath



Sensitized Plate in Position in Camera behind Half-Tone Screen to Make the Dots



Examining Negative with Microscope for Dot Values Given by Half-Tone Screen



Completing Negative by Giving It Washing with Sodium Sulphide



Lifting Film from Negative Glass after Soaking It in Bath of Acetic Acid



Cutting Out Surplus from Plate Which Is Not Wanted in the Finished Engraving



Drying Coated Copper Plate by Whirling It over Gas Flame in Dark-Room Cabinet



1236

*E. Weston Farmer*  
*3033 Tremont Ave*  
*3033*  
*Manchester, Minn.*

*Only entries*

beveled, it is placed upon a wooden block and is ready for the press.

Although the art has reached a remarkable degree of perfection, there are still problems to be solved, two of which are included among the following offers.

**\$5,000—Animated Drawings**

In engineering, especially naval architecture, dealing in the design and sale of designs of fast yachts and boats, there is a high sales resistance. The same is true of all engineering projects, and is due not so much to lack of money to enter the field but to overcautiousness and bargain shopping. Verbal appeals do not picture results adequately. It has been found that working models are helpful in selling projects, but models are too expensive for their limited field of advertising contact. The potential clientele is therefore severely limited. The present and usual weak appeal consists of neatly rendered drawings, coupled with photographic samples of past successes, and adroit salesmanship. For a means of animated drawings for screen reproduction which will smoothly animate drawings and renderings without any element of cartoonishness, the donor agrees to arrange for the payment of royalties amounting to \$5,000 within a year of the proven mechanical practicability of the invention, after which the donor is to pay for a controlling interest and is to be the sole licensee of the outstanding interest. While the present idea is to animate, bring to life in a realistic way, the proposed designs of yachts, ships and machinery, the field is not confined. Any suggestions will be witnessed by notaries with donor, and such leading to a solution will be generously rewarded.

**\$100—Ink Formula**

In naval architects' offices, the designing of ships with multitudes of detailed parts necessitates the use of tracing sheets printed with border lines and title blocks or stamped with conventional notations. Frequently these blocks must be changed as to wording and so forth, necessitating erasing which, with present inks, ruins the tracing cloth with blotches, scratches and faint ink marks. These do not interfere with printing always, but are apt to spoil all the work gone before, and at best, result in a lack of crispness and finish to the work. For an ink that can be used in a regular printing machine or with a stamp, on tracing cloth, which will be thoroughly opaque, dry fast, erase with a flick of a knife point, donor will give \$100 toward application of patent for same by entrant, or \$100 in cash. There is a crying need in 40,000 drafting offices today for an ink like this to save time, work and money for the man with the ruling pen who has not yet been emancipated from the handicraft stage.

**\$100—Drafting Improvements**

In any drafting room there is an enormous amount of time wasted in doing tasks that, for method, are

relics of darker ages. For the best list of salient and glaring faults which are now standard practice in drafting procedure, between the time the drawing is started and the last tracing made, the donor will pay the sum of \$100. Opposed to the faults should be recommended a remedy for each. Receipt of lists will be witnessed by a notary; all lists will be copied, returned as witnessed, and a mimeographed circular sent to all entrants. The foregoing three offers close May 1, 1925. Address Problem NA-1.

**\$20,000—Static Eliminator**

The National Company, Incorporated, makers of the "Perfect Vernier Condenser" and velvet vernier dials, offer to pay the sum of \$10,000 in percentage from sales profits for either of the following devices that will meet the approval of this company, who are to be sole judge of whether or not the said devices are acceptable to them:

A satisfactory static or interference eliminator, for work in conjunction with a radio-receiving set that can be manufactured on a commercial basis and sold at a nominal price, and,

A highly efficient fixed condenser of small size and large capacity with a rupturing voltage of at least 750 volts maximum. Said condenser to be entirely different from any other device of this nature now in use.

On acceptance by the National Company, of one or both of the above devices, an arrangement will be made with the inventor whereby a percentage of profits derived from the sales of same will be paid until such percentage aggregates the sum of \$10,000 for each device. This offer expires May 1, 1925. Models or drawings may be submitted, but in either case return postage must be included. Address, The National Company, Incorporated, Cambridge, 39, Massachusetts.

**\$5,000—New Product for Manufacture**

The Wollensak Optical Company of Rochester, N. Y., manufacturers of photographic lenses and shutters and makers of the Bioscope pocket binocular and Pockscope pocket telescope, are receptive to any suggestions for new merchandise which could most logically be offered for sale by dealers who are now handling their products. This concern would be most interested in suggestions for merchandise that could be sold through optical, photographic or sporting-goods stores.

They would only be interested in a product which could be handled to advantage by their present equipment. They are equipped to manufacture any sort of optical unit or any kind of small mechanical job involving the use of screw machines, presses and customary machine-shop equipment. For any such product as will prove acceptable to them, they will enter into a royalty agreement with the inventor or the one who offers the suggestion, awarding royalties until such time as the sum total of the royalties amounts to \$5,000, or a flat sum, agreeable to both parties, may be arranged.

No Wollensak employe nor any member of their families will be entitled to submit suggestions in this offer. The suggestion can be offered in the form of a drawing with complete description, in the form of a written suggestion or as a working model. This offer ends July 1, 1925. Address all entries to Wollensak Optical Company, 1415 Clinton Ave., Rochester, N. Y.

**\$1,000—Process for Hard-Glossed Candies**

The Happiness Candy Stores, Incorporated, will pay the sum of \$1,000 for the exclusive rights to a formula or method of manufacturing hard-glossed candies which will not impair in any way either the appearance or eating qualities of the candy, but will prevent it becoming sticky or losing its gloss when exposed to humid atmospheric conditions.

**\$1,000—Non-Discoloring Chocolate**

The sum of \$1,000 will be paid by the Happiness Candy Stores, Incorporated, for the exclusive

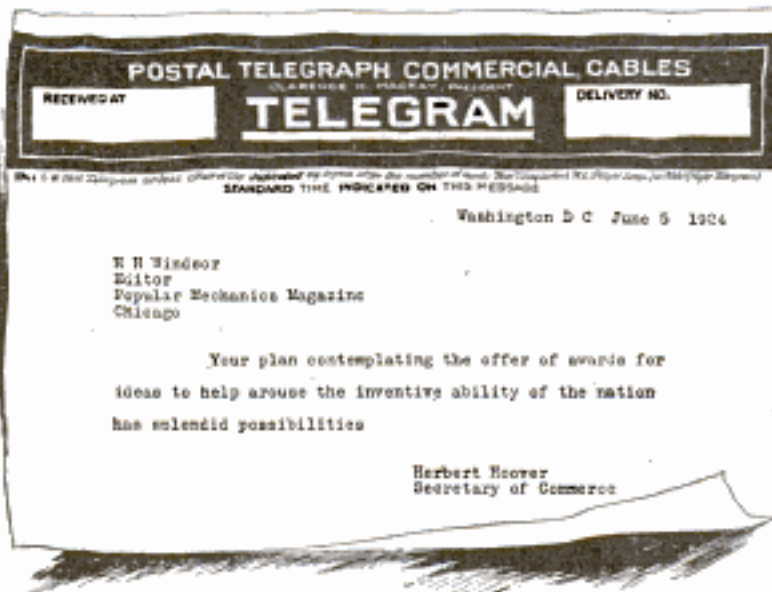





Printing the Photographic Impression upon Sensitized Copper Plate through the Negative Superimposed upon It and Exposed to Rays of Powerful Battery of Electric Lights

rights to a formula or method of manufacturing chocolate coating which will not impair either the appearance or eating qualities of the same, but will prevent it from turning gray or dull when exposed to atmospheric conditions. The above two awards or any one of them will be paid only if and when a sufficient trial of the formulas or methods submitted has proved them to be in every respect satisfactory and acceptable to Happiness Candy Stores, Incorporated, and that their use will neither violate any pure-food laws nor infringe upon the rights of anyone, of all of which the Happiness Candy Stores, Incorporated, will be the sole judge. The offers expire May 1, 1925. Address Happiness Candy Stores, Incorporated, 202 Harris Avenue, Long Island City, New York.

#### \$5,000—Hoist for Dump Trucks

The Continental Car Company of America will undertake the manufacture and marketing of an original design hoist for dump bodies operated by motor vehicle, said hoist to be operated from the driver's seat by power from the engine. This invention or improvement must be different from devices now in use for such purposes, must be simple in construction, inexpensive to build and efficient. It must do the work of a hoist satisfactory to our engineering department, and it must be acceptable to our distributors located in the principal cities throughout the United States. This hoist must be so designed that it can be used, by increasing the size of the parts, for dumping bodies of from one-ton to five-ton capacity. To the inventor of such a hoist which meets the approval of our engineering department, the donor offers the following proposition: The donor will enter into a contract to make and sell these hoists in connection with their truck bodies and will pay the inventor royalties, if a basic patent on the hoist is secured, aggregating the sum of \$5,000, in the following manner—royalties are to be paid the inventor in amount not to exceed one per cent of the net sales price of the complete body and hoist when and as the bodies and hoists are sold, until the full amount of the \$5,000 has been paid to the inventor, at which time payments shall cease and the invention or improvement becomes the sole property of the Continental Car Company of America, Inc., or its assigns. A working model of the hoist should be submitted so our engineering department can judge of its value. Written descriptions, drawings, sketches, etc., will receive consideration but we prefer to have a workable model.

#### \$1,000—Article of Furniture

This concern also will pay the sum of \$1,000 in an arrangement similar to that above outlined, for a new toy for a child, or a new useful article of household furniture made principally of wood parts formed from the lumber offal from manufacture of wooden truck bodies. We prefer that this article be something of use in connection with radio that would prove to be an attractive accessory to the public. This firm will be the sole judge of the article's merits.

#### \$5,000—Air Car-Dumping

For air-dumping equipment which meets with the approval of the Continental Car Company of America's engineers—and to meet with their approval, among other things, the dumping equipment must not only dump the car but right it to a horizontal position and lock it—the donor agrees to pay the inventor the sum of \$5,000, provided a basic patent can be secured, in the following manner: The donor is to pay a royalty of \$50 on each and every car sold with this equipment installed thereon when and as the cars are sold, until the full sum of \$5,000 in royalties has been paid to the inventor, at which time payment of royalties shall cease and the invention is to become the sole property of the Continental Car Company of America, Inc., or its assigns. If the dumping device is not patentable, but in the opinion of the donor is new and useful and is used by the donor, then a smaller amount is to be paid to the entrant, said amount to be fixed by the directors of the Continental Car Company of America. Detail drawings may be submitted to the donor instead of a model. In operating the projected car, it must be so designed as to dump on either side of a track and the act of dumping is to be accomplished with compressed air furnished by the locomotive and operated by the engineer from the cab.

No individual connected in any way with the Continental Car Company of America may participate in these offers, all of which will terminate May 1, 1925, unless extended by special arrangement between donor and any entrants. Address, Continental Car Company of America, Louisville, Kentucky.

#### \$1,000—Cost Reduction

This concern makes the Kirstin Fil-Gage for filling Ford automobile gasoline tanks under the seat without



need of removing the cushions. It has an indicating gauge in plain sight of the driver at all times and is attached to the tank opening in place of the cap. The Fil-Gage is made of black-finished sheet metal. Our factory operates in large production, and for any accepted improvements not yet tried out or developed which will increase the efficiency of this filler and gauge and decrease manufacturing costs, we will pay the sum of \$1,000. Or, we will pay this amount for any suggested changes, satisfactory to us which will reduce the production cost 20 cents on each article. No theoretical suggestions will be considered. To qualify, entrants must have actually tried their improvements in operation on one of the devices and have proved it practical and workable. The Fil-Gage containing the improvement must be sent to us by registered mail for testing and upon acceptance and the assigning to us of patentable rights, we shall pay the amount stated to the entrant whose ideas we adopt. This offer expires May 1, 1925. Address, A. J. Kirstin, General Manager, A. J. Kirstin Company, Kirstin Bldg., Escanaba, Michigan.

**\$5,000—Leather Scrap Uses**

This concern, the Eisendrath Glove Company, wants a new method whereby the scrap leather in our glove factory can be profitably utilized. Over thirty per cent of the leather, horsehide, cowhide, sheepskin, etc., that we cut is lost in scraps. Is there an automobile floor-board, composition floor covering or fabric capable of being developed from these waste pieces? The acceptable plan, process or method of some profitable utilization of this waste material is worth \$5,000 to us. We will pay this sum in cash to the person submitting the solution of this problem which we adopt. All ideas and suggestions are subject to the judgment of this firm alone. Our offer expires May 1, 1925. Address, Eisendrath Glove Company, 2001 Elston Avenue, Chicago, Illinois.

**\$200—Best New Use for Slate**

In line with the efforts of the National Slate Association to promote and extend the uses of slate as illustrated by their slogan, "Slate—Consider Its Uses," the association will pay the sum of \$200 for the best suggested new use received before May 1, 1925, the date of expiration of this offer. In addition to the above offer, cash payments in proportion to their value to our members in the industry, will be given for all suggestions having reference to the production, distribution, and use of slate and slate products, not already known to our members, and which they adopt. Address, National Slate Association, 761 Drexel Building, Philadelphia, Pennsylvania.



Tooling and Finishing Plate by Hand Removes Rough Edges and Secures Contrasting High Lights

**\$50—New Use for Ground Slate**

Owing to the tremendous use of crushed and ground slate in various construction and industrial processes, the Parsons Manufacturing Company is interested in extending such uses and will pay the sum of \$50 for the best suggested new use for ground slate received before May 1, 1925, the date of expiration of these offers. In addition to the above award, cash payments in proportion to their value will be given for all suggestions having reference to the production, distribution and use of crushed and ground slate not already known to us, and which we will adopt. Address, Parsons Manufacturing Company, Pen Argyl, Pennsylvania.

**\$500—Uses for Generators**

For three new uses for low-voltage generators, 2-10 volts, besides plating, electrotyping, and battery charging, that will produce \$50,000 additional sales volume to this concern, through such new uses, William H. Mitchell Company will pay the sum of \$500, one-fourth of the amount at the time we adopt the suggestions, and the balance in three equal payments, one every three months until full amount is paid.

**\$500—Motor Generator Set**

For a simple design of 2-kw. motor-generator set (or rotary converter) in which the single-phase synchronous motor obtains excitation from the 6-volt generator it drives, and one which is accepted by this concern, we will pay the sum of \$500. The outfit must have good starting torque and unity power-factor characteristics. These two offers will close on May 1, 1925. Address, William H. Mitchell Company, Troy, Ohio.

**\$500—Anti-Freezing Ingredient**

We have an emulsified asphaltic concrete which consists of 70 per cent petroleum asphalt of from 90 to 110 penetration and a 30 per cent water and soap solution. The addition of alcohol would keep the material from freezing out in the cold weather but would be highly expensive and the ingredient used for this purpose must not add more than 1 per cent to the present cost of the product. We will pay the sum of \$500 to the person who can give us an acceptable and satisfactory formula, process, ingredient, or method by which the freezing out of the emulsion can be prevented in cold weather. This offer expires May 1, 1925. Address, S. D. Hofheimer, Land Title Building, Philadelphia, Pennsylvania.

**\$500—Gasoline Mower**

The Granite State Mowing Machine Company will pay the sum of \$250 in cash and \$2.50 each royalty on the first one hundred machines sold for satisfactory working drawings of a gasoline motor lawn mower which we accept for manufacture and sale. This must be a practical walking type motor-driven lawn mower, 20 inches or 24 inches cut, with a simple compact power unit such as the small motors made by Briggs and Stratton Company, Milwaukee, Wis., that will drive and operate a lawn mower about the size and type of the ordinary 20-inch hand lawn mower, and that will be suitable for general use and can be manufactured complete for \$50 or less. Motor must propel both mower and cutter and operator must be required only to guide mower. This organization will be the sole judges in reaching a decision regarding the worth of the design to us. Our offer ends May 1, 1925. Address, Granite State Mowing Machine Company, Hinsdale, New Hampshire.

**\$300—Sheet-Metal Key Guide**

We make a key guide surrounded by an oval escutcheon plate. The oval plate is made of .035-inch sheet metal and the key guide is a die-cast article. Our plan is to design a key guide of sheet metal that will properly fit the oval plate or one of similar form. The guide is inserted through the center of the escutcheon and protrudes beyond it. For a satisfactory arrangement that will be as cheap as the die-cast guide we now use, and one that we accept, the National Brass Company will pay the sum of \$300. This offer ends May 1, 1925. Address, National Brass Company, Grand Rapids, Michigan.

**\$1,000—Improvements to Lathes**

In four awards of \$500, \$250, \$150, and \$100. These awards will be paid for the four best ideas for





After Copper Plate Is Printed, It Is Etched in Machine Where It Is Sprayed with Acid Bath to Produce the Relief Surface Necessary for Impression on Paper

new and practical attachments for a screw-cutting engine lathe. The mechanical application and the idea must, of course, be heretofore untried and original and may consist of a distinct improvement on an attachment now in use or a direct improvement on any part of a screw-cutting engine lathe. Value and merit of improvements or suggestions will govern the order in which the allotments of the four awards will be made. The offer expires May 1, 1925. Address all suggestions to South Bend Lathe Works, 423 East Madison Street, South Bend, Indiana.

**\$500—Anti-Carbon in Oil Burner**

The Aeroil Burner Company will pay the sum of \$500 in cash to the person who develops for them a practical inexpensive means by which carbonization can be prevented in portable oil burners of the vaporizing type such as we manufacture. Such a method may consist of different construction from that we now employ; a change in the design or the use of another kind of metal. The process may also include or consist of the use of an inexpensive chemical which could be mixed with kerosene. Whatever the plan, if it can prevent

carbonization in our oil burners and we accept the process after it passes our tests, we will pay the amount stipulated herein. This offer expires May 1, 1925. Address, Aeroil Burner Company, 266 Hudson Avenue, Union Hill, New Jersey.

**\$10—One-Dip Enamel**

For a white enamel which will satisfactorily cover black sheet steel in one application by the dipping process the Patent Novelty Company will pay the sum of \$10 in cash. The material will be subject to trial by our own organization before adoption. The offer ends May 1, 1925. Address, Patent Novelty Company, Fulton, Illinois.

**Many Additional Offers Will Appear in the OCTOBER ISSUE**

**OFFERS ANNOUNCED IN PREVIOUS ISSUES**

All of These Offers Expire May 1, 1925

NO. 1—THE YELLOW CAB MANUFACTURING Company offers an award of \$50,000 for a perfected plan of traffic and pedestrian correction and regulation, including mechanical devices, regulations, etc., for the promotion of greater street safety.

NO. 2—\$10,000 FOR A NEW MUSICAL INSTRUMENT which can be incorporated in any orchestra or brass band and will take a place among the present family of musical instruments accepted by the rank of players. Lyon and Healy, Inc. Chicago

NO. 3—FOR THE BEST SUGGESTED IMPROVEMENT on a gasoline-heated blowtorch and soldering and branding iron combined, an award of \$500 will be paid by the Everhot Manufacturing Company.

NO. 3A—\$200 WILL BE PAID BY THE ABOVE concern for the best suggested new use for the device named in Problem 3. Other cash awards in proportion.

NO. 4—PROCESS BY WHICH ZINC THAT oxidizes and is lost in brass foundries can be saved and used. Award \$500.

NO. 4A—PLAN BY WHICH LEATHER wasted in making of belting, etc., can be disposed of at profit to manufacturer. Award \$100.

NO. 5—AWARDS OF \$500 EACH WILL BE paid for a waterproofing process for a library paste and a method that will produce increased sales of this product. John J. Harris and Company.

*W. D. Dickerson Chicago*  
*W. D. Allen Chicago*  
*W. B. Allen Chicago*  
*Maywood Ill*

*4035 W. Kenzie St. Chicago*



*Benj. Elect. Mfg. Co.  
547 Michigan St. Chicago  
1236*

NO. 6—FOR PRACTICAL METHOD OF ANCHORING electric light clusters to vases, urns, etc., to convert them into lamp stands, \$250.

NO. 6A—FOR MOST WORKABLE PLAN whereby such lamps can be made from material found in shops of electrical contractors and dealers, \$150.

NO. 6B—BEST SALES SCHEME WHICH WILL promote business of making lamp stands for dealers, \$100. Above three problems by Benjamin Electric Mfg. Company.

NO. 7—WHAT CAN BE MANUFACTURED BY plant specializing in making bicycle wheel rims? Award \$5,000. *L. R. Rastetter, Fort Wayne, Ind.*

NO. 8—IDEAS SUGGESTING NOVEL, PRACTICAL and valuable uses for Hg ventilating fans, blowers and unit heaters. Proportionate awards aggregating a total of \$5,000 will be paid by Hg Electric Ventilating Company. *Alfred Ventilation Co. Chicago*

NO. 9—FOR A SOLUTION OR METHOD which will eliminate "dry effect" that occurs in the process of photo-engraving the sum of \$500 will be paid.

NO. 9A—PERFECT IMPROVEMENT IN COLOR separation process used by photo-engravers, \$500.

NO. 9B—PLAN BY WHICH A PERFECT etching could be made by a one-depth "bite" of etching acids reducing costs of this kind of engraving, \$500. Above three problems by John and Dillie Engraving Company, *354 W. Adams St. Chicago*

NO. 10—ELECTRIC HEATING ELEMENT which will operate and interchange with base and cover of Imperial self-heating gasoline iron, \$500. *Imperial Brass Company, 200 W. 19th St. Chicago*

NO. 11—\$100 FOR PLAN OF PROFITABLY disposing of chamois skin scraps. *Bassick Manufacturing Company, 2650 N. Crawford Ave. Chicago*

NO. 12—DISCOVERY OF NEW USES FOR carbon-dioxide gas or improvements to present uses. Award \$1,000.

NO. 12A—FOR AN AUTOMATIC FREEZE-proof soda cooler adaptable to "iceless" type of soda fountains, \$1,000. Above two problems by Liquid Carbonic Company, *3100 S. Kedzie Ave., Chicago*

NO. 13—\$2,000 WILL BE PAID IN SEVERAL awards for processes and machines for salvaging waste lumber. *National Lumber Manufacturers' Association, Washington, D. C.*

NOS. 14, 14A, 14B—FOR SKYROCKET STICK harmless in descent, \$1,000; bombshell with illuminated flag, \$250; chemical combinations to produce smokeless fireworks colors, \$250. *Thearle-Duffield Fireworks Company, 624 S. Michigan Ave. Chicago*

NO. 15—MOTOR-OPERATED HANDSAW FOR manufacture and sales; award, \$10,000 in royalties. *R. L. Barker and Company, 612 W. Washington St. Chicago*

NO. 16—\$500 FOR SALES PROMOTION PLAN for absorbent, non-heat-conducting powder that can be used with other materials. *The Keady and Mattison Company, Ambler, Pa.*

NO. 17—ROYALTIES OF \$15,000 WILL BE paid by the Aetna Industries, Incorporated, for improvements in their products or new articles they accept for manufacture and sales. *117 N. Dearborn St. Chicago*

NO. 18—THE GEMCO MANUFACTURING Company will pay \$250 for suitable article they can make in their general metal-working plant. *Milwaukee, Wis.*

NO. 19—\$25 WILL BE PAID FOR A SATISFACTORY means of making cast iron leakproof against kerosene by the donor represented by Problem SC-1. *Stacy & Co. Jersey City, N. J.*

NO. 20—FOR A PROCESS WHICH WILL make silver untarnishable and will not impair its value the Steiff Company will pay \$1,000. *17 N. Liberty St. Baltimore, Md.*

NO. 21—BUESCHER BAND INSTRUMENT Company will pay the sum of \$1,000 for successful saxophone reed of materials other than those now used. *Research Dept. Elphinstone, Pa.*

NO. 22—FOR AN IMPROVEMENT OVER present device for closing collapsible rubber nursing bottle Dr. Goddard Nerser Co., Inc. will pay \$1,000. *Fort Atkinson, Wis.*

NO. 23—FOR A NEW FORM OF VARIABLE condenser for radio reception the Phenix Radio Corporation will pay \$1,000. *5 Beckman St. New York, N. Y.*

NO. 24—WODACK ELECTRIC TOOL CORPORATION will pay the sum of \$500 for a satisfactory hammer arrangement for a portable electric hammer. *255 Jefferson St. Chicago*

NO. 25—FOR NEW IDEAS OR IMPROVEMENTS in present articles they manufacture of rubber, rubber and fabric or rubberized fabric, the Continental Rubber Company will pay \$2,500 in royalties. *Eric Pa.*

NO. 26—\$100 WILL BE PAID FOR AN ACCEPTED design of starting switch for alternating-current motors by the donor represented by Problem PD-1. *Peerless Elect. Co., Warren Pa.*

Full Details Regarding the Previous Offers Listed Above and Numbered from One to Twenty-Six, May Be Obtained by Addressing the Bureau of Information, Popular Mechanics Magazine.

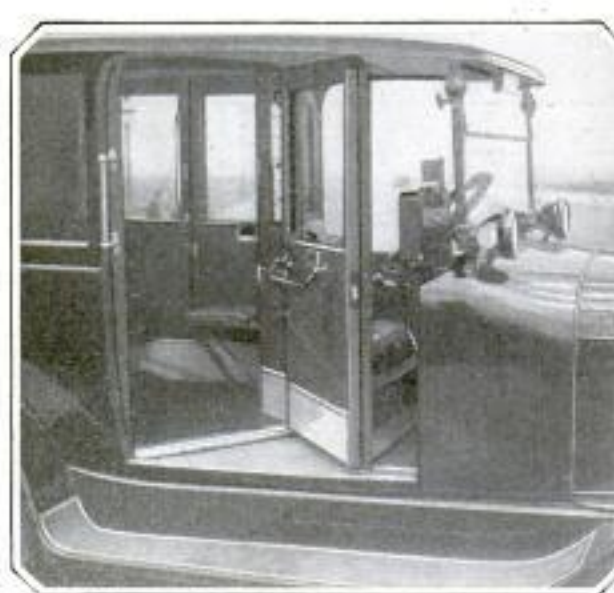

Taxicab of the Front-Door Design, Showing Interior

1186  
**Taxicab with Built-In Front Door  
Increases Ease and Safety**

Designed with a single front door instead of the usual two on the side, a taxicab which is planned to insure greater safety and more comfort and convenience both to the passengers and chauffeur has been adopted by a mid-western cab company. Set at an angle, the door is within easy reach so that the driver does not have to leave his seat to release the latch, and the passenger, before getting out of the cab, can pay the fare through an aperture in the glass. Absence of swinging doors is intended to decrease the likelihood of accidents, there is less difficulty in loading bulky packages and the wide opening toward the front permits better ventilation.

*Bauer Taxicab Mfg. Co.  
117 E 30th, Chicago*



Everice Sales Co.  
~~Prague, N.Y.~~

Engineering News Record 3/29  
 10th Ave + 36th

POPULAR MECHANICS  
 Sole agents. *Cholmer, N.Y.*  
 Ice-Making Machine for Tourists  
 Works over Camp Fire *1026*  
 New York City 459

Having no moving parts, a small machine designed for making ice on automobile camping and touring trips, has been placed on the market. It consists of two cylinders, one a generator and the other a freezer, connected by a metal tube that also serves as a handle. The generator is heated on a kitchen range, gas flame or over a log camp fire, a sliding signal moving up and down when the refrigerant is driven to the receiver or freezer. The generator is then immersed in water or cooled by coils. It now acts as an absorber, a partial vacuum being created in the generator which causes the refrigerant to be sucked back from the freezer into the absorber. The machine is sealed and welded so that the vacuum is maintained and the refrigerant sealed in the chamber. Larger models that cool ice chests are worked on the same principle. Because there are no valves, gauges

or other moving parts to cause trouble and no power, refilling or charging is necessary, it is claimed that the device can be operated in any place at small cost.

**"Gas-Concrete" Is Made for Sawing, Planing and Nailing** *13 45*

Light concrete that can be sawed, planed and nailed has been developed by a Swedish architect. It is made with cement and shale lime, together with a small amount of aluminum or zinc powder, which develops hydrogen when water is added, making the concrete porous. When set, it weighs forty to fifty pounds per cubic foot, or about one-third as much as ordinary concrete. The material is resistant to weather and fire in satisfactory degree for use in walls but not in chimneys, and has been approved by the building authorities of Stockholm for one and two-story dwellings.

*Arvid Eriksson  
 2001 Broadway, New York, N.Y.*

**Sugar in Water Adds to Life and Beauty of Cut Flowers** *1325*

Sugar solutions of varying strengths are being used by a French florist in preserving cut blooms. Except in the cases of lilacs, sweet peas and lilies, practically all well-known flowers are said to be susceptible to the treatment, although the former, it is claimed, will respond to it by improving in tint and living longer if a trace of manganese sulphate is added to a twelve-per-cent solution. Carnations are declared to last twice as long with fifteen per cent sugar, while roses require only half that amount.

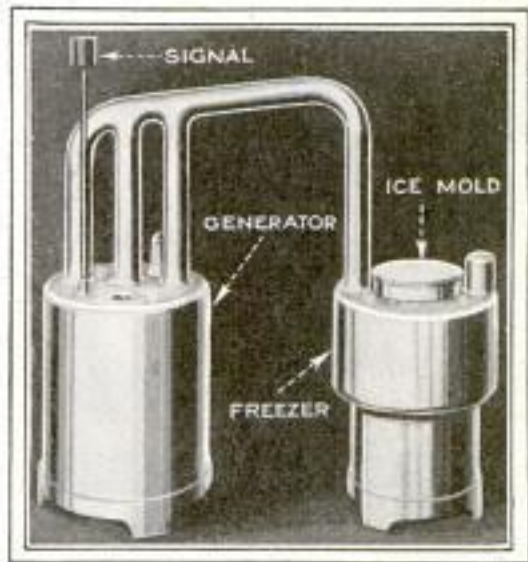

Above, Ice-Making Machine for Operating with Electricity; Below, Close up

no. I - \$25.00  
 " II - \$50.00



1209

# Time and Money-Saving Tools



Slipped On or Off in a Jiffy, the Waterproof, Stringless Apron Above Has No Buttons or Hooks to Catch or Come Loose and Effectively Covers the Dress

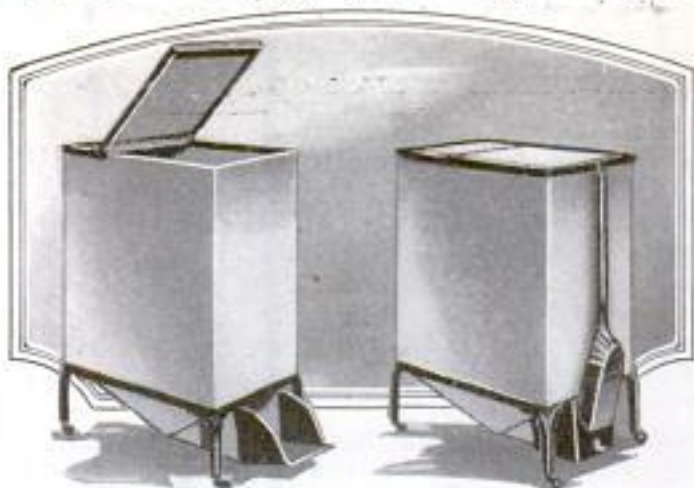

Where Coal Ranges Are Used, the Neat Fuel Box Shown Above, Eliminates Dust and Lifting of Heavy Scuttle

Below, Portable Reel with Crank Simplifies Winding Hose

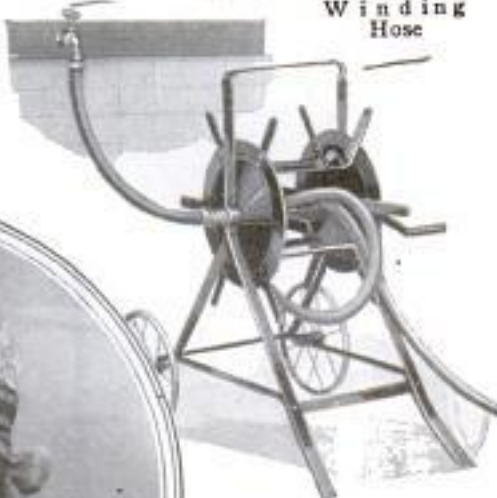

For Bobbed Hair and Other Coiffures, a Snugly Fitting Bandeau Net in Fiber Silk Is Practical for Outdoor Wear



Rubber Washboard to Ease Laundry Days



Smooth Edges That Will Not Cut the Hands Are Left by This Can Opener with Ratchet Wheel; Fits All Sizes of Cans and Works Easily

Suspended from Tripod, an Adjustable Folding Swing from Which the Baby Cannot Fall May Be Set Up in a Few Moments

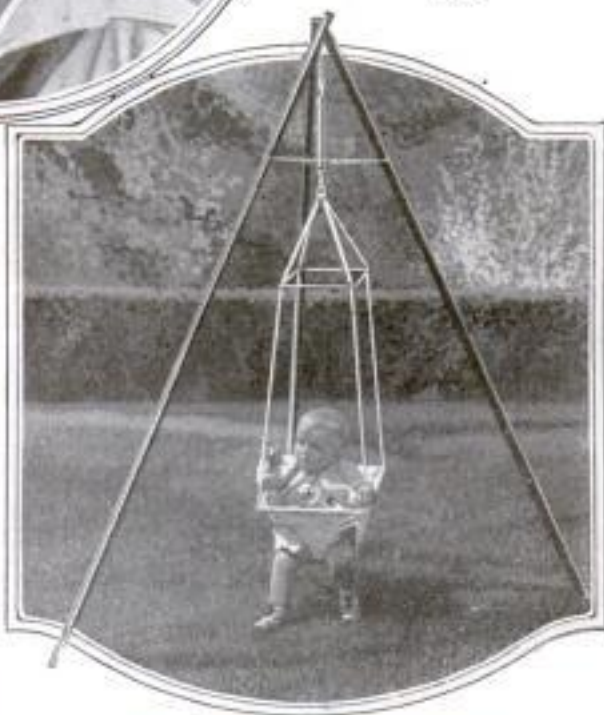

Anyone wishing further information on devices described in the editorial pages can



# for Woman's Workshop in Home

1209

- 1.
- 2.
- 3.
- 4.
- 5.
- 6.
- 7.
- 8.
- 9.
- 1.

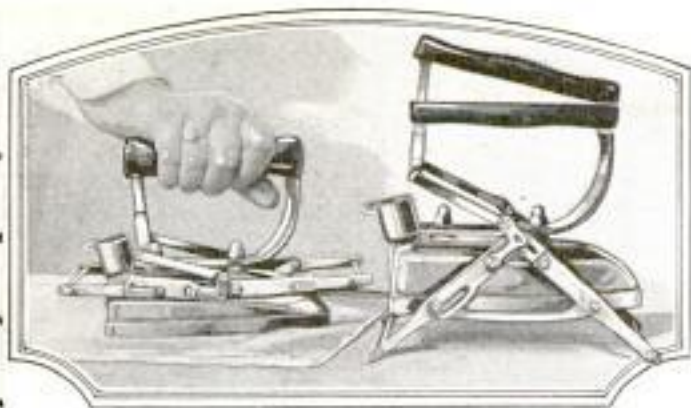

Folding Legs Operated by Grip Support the Electric Iron When It Is Set Down to Prevent Burns and Scorching; Below Is a Handy Heater That Converts Any Oven into an Electric Cooker

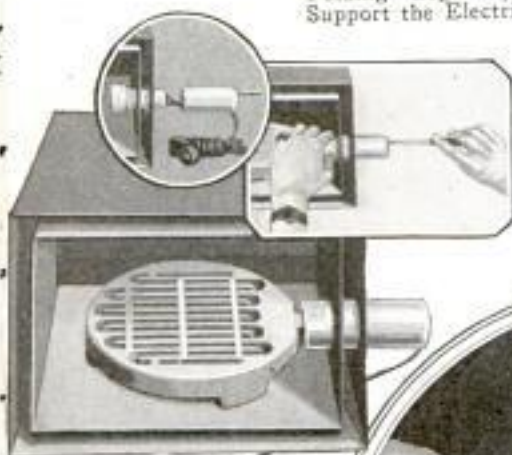

Easily Attached to the Buggy or Crib, This Nursing-Bottle Holder Saves Both Mother and Infant Trouble at Feeding Times. Prevents Breakages and Holds the Robe



Waxing Floors Is Simpler Task with Canvas Bag Weighted with Shot Which Holds Polishing Pad Firmly to Boards; May Be Operated with One Hand and Reaches under Radiators and Low Furniture

*Waxing*



Square Saucepans, Invented by a Woman, Permit Cooking Four Articles at Once over One Burner and Great Saving in Gas; Right, Bottle Cleaner Plant That Takes Out Spots



Space-Saving Glass Dishes for Cooking or Storing Foods in Ice Box, and Attractive Holder for Table Service



The *Planting* *Inf.* Co  
 462 2959 *Flora*  
 POPULAR MECHANICS

Shown at British  
 Empire Exposition

1081

*Saledgullio*  
**Beet Digger and Topper Saves Time  
 and Reduces Cost of Harvest**

Attached directly to the tractor, a farm implement that tops, digs and cleans beets, and piles them in the field, has been de-



Beet Harvester in Operation behind Tractor Showing One of the Revolving Augers and the Hopper

vised to save the grower's time and cut the cost of harvesting the crop. Power is supplied by a chain leading from the tractor's belt-pulley shaft, and the digger is supported in the rear by a single caster wheel. As the tractor is driven down the field, two revolving augers with digger points lift the beets, which have been topped by a bell-shaped disk on the other side of the machine, out of the ground. Digger and topper are controlled with levers by one man and work independently of each other on adjoining rows. As the beets travel to the hopper from which they are dumped upon the ground, they are cleaned by the revolving augers.

**Glass Tubes Cool Drinks Quickly  
 by the Use of Chemicals** 1175

Claimed to cool drinks in hot weather, a system has been devised by a European inventor to do away with ice. A large number of glass tubes are attached to a machine and filled with a preparation of nitrate of ammonia salts and water. After being corked tightly the outer walls of the tubes are cleansed and wiped dry. To cool the drinks, one of the tubes is then inserted in each glass and agitated by elec-

tricity until the salts are dissolved. In effect, the liquid in the drinking glass becomes almost instantly chilled, with the result that more than six times the quantity of iced drinks can be made in about the time occupied to ice one drink by the old method, it is claimed.

1224  
**Colored Aluminum for Wall Paper**

Specially treated aluminum is said to have been found practical as a substitute for wall paper, decorative panels, covering for automobile bodies and many other purposes. The material, it is declared, is proof against corrosion and at the same time holds colors indefinitely. Prepared in thin sheets for covering walls and ceilings, it is claimed that "repapering" will be necessary only at long intervals, and as water will not harm the designs, the aluminum can be kept clean. It is said that the same process will protect tubes of aluminum from the action of sea water.

**Milk Poured through Hole in Door  
 to Prevent Thefts** 725

To prevent the theft of milk from the doorstep, a knob and spout for pouring the liquid into a pail hung securely on the inside of the door are being made in England. The delivery man simply pulls out the

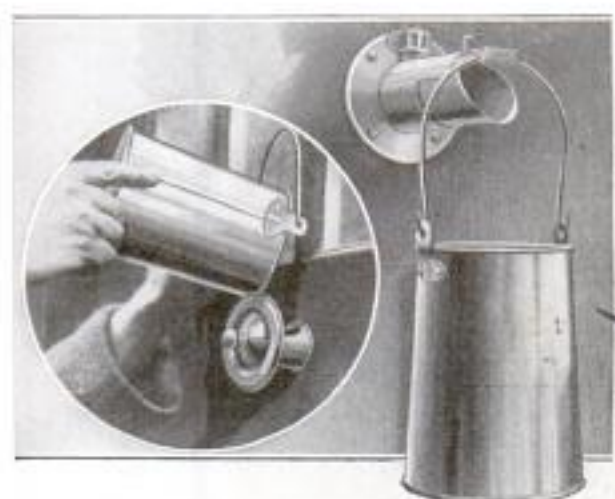

When Knob Is Drawn Out, Milk Is Poured into Pail through Door Spout

knob and empties his bucket into a little trough exposed in an opening through the panel. The knob is put back and the filled pail is removed at the purchaser's convenience. This eliminates the use of breakable bottles and keeps the milk from exposure to extremes of temperature and flying dirt.

*Com. George A. Holden Esq. Chesterfield  
 Hill Chest Lodge  
 Stapton View Road, England*

*maker unknown*

*Wide World Photos  
 229 W. 43rd St. New York*



Pacific & Atlantic Photos mfr Brown Instrument Co  
 25 Park Place  
 POPULAR MECHANICS  
 New York City  
 Wayne & Warrington, Philadelphia

**Fire Nozzles on Top of Skyscraper  
 Protect Outside of Building** 1196

In testing the strength of standpipes of the thirty-two-story Straus building in Chicago, firemen attached powerful en-

one end. This is known as a thermocouple. When exposed to heat, an electric current is generated which records the temperature. Another invention, at the same laboratory, measures

American & ...  
 27 S. Jefferson St. Chicago



nozzle  
 Piezometer  
 Gauge



Fireman Measuring Flow of Water from the Nozzle of a Skyscraper's Standpipe System: Left, Arrow Points to Tower Where Hose Outlet Is Installed

gines to the inlets at the street level and exerted tremendous water pressures on the interior system. The discharge flow, measured at nozzles on the roof of the structure, 495 feet above ground, attained a volume of about 1,000 gallons a minute. Although the building's fire-fighting equipment is designed to combat blazes occurring within, flames in near-by areas could be fought from the higher floors by attaching hose lines to the stationary nozzles. Pumps in the basement of the structure, operated by a 200-horsepower motor, begin to work when the pressure at any point in the system falls below fifty pounds.

electrically the gases in boiler flues to test the efficiency of various kinds of fuel. A third enables aerial navigators to tell just how fast gas escapes from the big dirigibles when emptying the bag for storage.

**Beads Easily Picked Up by Needle**  
 Passing through Stringer

Beads may be strung quickly and easily with a device made for home and shop use. A square metal holder is clamped to the edge of a table, desk or chair and filled with beads. Blotting paper or cloth may be used to prevent it from touching polished furniture. A needle is inserted at the bottom of a slot and raised quickly to the top. The point passing through the mass will pick up from five to eleven beads. When various colors are desired, separate stringers can be used.



**Heat That Melts Steel Like Butter  
 Is Measured by Electricity** 1160

So tough that it will resist the heat in an electric furnace hot enough to cause a bar of steel to melt like butter, and yet so delicate that it will register this temperature to the accuracy of one degree, an instrument has been perfected for the metal-making industry. Two wires of different material are wound around each other at

Wayne & Warrington  
 Philadelphia, Pa.

Phila. Pub. Ledger  
 5/2/24

Callendar & Co., St. Chicago  
 12 S. Jefferson St.



A. J. Sarsen  
 Cooper Oven Thermometer Co.  
 Pequotuck, Conn.

**Cost of Fertilizer Cut by Chemical in New Explosive**

Manufacture of fertilizer and explosives is expected to be greatly aided by a chemical lately developed which hastens the



Government Chemist Who Developed Process of Uniting Nitrogen and Hydrogen Atoms

union of nitrogen and hydrogen atoms for the production of ammonia. One effect of the discovery is the development of a powerful war weapon through the explosives which are made possible. Production costs are lowered by the process which will be put in use in government nitrate plants.

**Both Cooking Time and Oven Heat Are Given by Card Guides**

Inclosed in an attractive steel cabinet, a card index of printed recipes, including baking and cooking instructions and oven

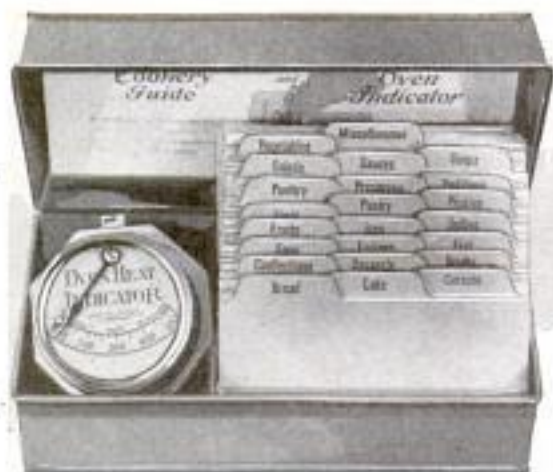

Metal Cooking-Guide Cabinet with Compartments for Card Recipe Index and Oven Thermometer

temperatures for preparing different articles, has been devised to assist the young

housewife. With the index is included an oven thermometer which shows temperatures from 100 to 500 degrees and is designed to be attached inside the door. It enables the cook to follow the printed instructions on the cards and avoid mistakes. Recipes are classified in groups and alphabetical order.

**Queer Jobs Undertaken by Women to Make Life Interesting**

New ways of making life interesting while earning a living are constantly being found by women whose tasks now range from observation and charting of the skies and planets to cooking food and feeding it to swarms of plant germs, which are kept for the purpose of scientific study in laboratories of the government. Although women have practiced law, medicine and dentistry for some time, it has been only in recent years that they were installed in large office buildings as elevator operators, as attendants in automobile filling stations and placed in other departments of industry formerly occupied entirely by men. In research lines connected with the study of natural specimens of insect and small-animal life, women are to be found recording the habits and structure of subjects in many museums. Posters and drawings of value to cattle raisers and dairy farmers are the result of observations made by women trained for the purpose, while horticulturists are aided by women experts who specialize in learning the secrets of developing fruits and vegetables of better qualities. A great number of exhibits to be seen in natural-history expositions are the work of women artists, who prepare and set up the specimens composing such groups and design the artistic foliage and landscapes which make up the lifelike backgrounds.

**"Loudest Noise" Deafens Persons Ten Miles from Blast**

What is believed to be the loudest noise ever made by man is reported to have deafened persons within a ten-mile radius in France. Ten tons of explosive were set off in order to observe the speed of sound and to discover the cause of the "zones of silence," first noticed during heavy barrages in the war, when cannon could be heard at long distances, yet the explosions were inaudible nearer to the guns. Observers were stationed in many of the principal cities, some 600 miles away.

Chicago Herald Examiner  
 5/16/24 righted material





Woman Scientist of National Museum Whose Specialty Is Studying Deep-Sea Life, Examining an Octopus



Tinting Wax Imitations of Choice Fruit Specimens for Exhibition Purposes in the Department of Agriculture



Painting Pictures of Cattle, Part of Instruction Charts for Use in Teaching Farmers Care of Animals



Astronomer in the Naval Observatory, Who Helps to Map the Skies and Prepare Information Charts for Guidance of Ships



In a Laboratory Kitchen Mixing Special Food Called Media, on Which Are Fed Millions of Live Germs Kept in the Agricultural Bureau for Inspection by Scientists



Making Large Drawings of Destructive Insects in Natural Colors for Use in Studying the Pests  
C. & U.



Rifle Range Target in Golf Net Improves Player's Accuracy

To teach accuracy in driving, a steel golf-practice net has been installed in a Los Angeles club. It has the bull's-eye



Metal Golf-Practice Net with Bull's-Eye to Teach Accuracy in Driving

and circles of a rifle-range target at which the ball is driven. "Slicing" or "pulling" is accurately shown, and distance also may be gauged by the spot the sphere strikes. Being of metal, the net will withstand much abuse and the strongest drives.

Footlights for Amateur Stage Vanish under Floor When Idle

For use in stages of schools, auditoriums and lodge halls, disappearing footlights



How Folding Footlights Are Replaced in Disappearing Box beneath Floor of Stage

that fold under the floor when not in operation are being manufactured. Built in five-foot sections, the apparatus is designed for platforms where theatrical illumination is needed only occasionally. After serving their purpose, the lights can be quickly folded beneath the floor, leaving a level surface. The appliance supplies illumi-

nation for almost any setting without casting shadows on the backwall, it is said. Inclosed in a strong box arrangement, it is protected from injury between performances and can be easily set up.

New Light on Holy Land History Revealed by Excavations

Excavations being carried out on the site of the City of David in the vicinity of Jerusalem, are said to have thrown new light on the early history of the country. The discoveries are believed to indicate that the origin of the city dates back much farther than had been supposed, that is beyond the time when the fathers of the Jewish race arrived in Palestine. Jerusalem was originally a stronghold of the Jebusites, and there are signs that it passed through many sieges before any that are recorded in the Bible or secular history.

Billion Dollars in Heat Wasted Every Year, Is Estimate

Heat losses of United States industries through radiation, conduction and convection, are equivalent to an amount of fuel costing \$1,000,000,000 annually, a nationwide survey has disclosed, according to a report made recently before a chemical society, which added that there are urgent problems to be solved in the field of heat economy. As one way to cut down the waste, the report suggested the use of insulated walls, which, it was declared, lose

only 40 per cent as much heat as the uninsulated walls. Savings through this method, it was said, would aggregate 480,000 pounds of coal a year for 1,000 square feet of wall surface. At \$5 a ton for coal, this represents a loss of \$1,200, which would actually have been saved by the use of two and one-half inches of insulation.

Los Angeles Athletic Club  
Calif  
Major Equipment Co. Inc  
360 N. Michigan Ave  
Chicago

Comp. F. Christy, 256 Union Station, Wash. D.C.

Chicago Evening Post  
Copyrighted material  
4/26/24



### Toy Balloons Help to Aim Big Guns by Showing Wind Direction

Toy balloons are being employed by the coast artillery corps to determine the condition of the air currents so that a higher average of accuracy in landing the shells of the big twelve-inch rifles may be obtained. The balloon is attached to a stout cord held in the hands of an observer on the ground. By this method it is said the strength, direction and speed of the cur-

sets of saws which trim the sides, and is reduced to boards by horizontal cutting ribbons beyond. The arrangement is said to be so simple that it can be set up in the woods, doing away with hauling of trees

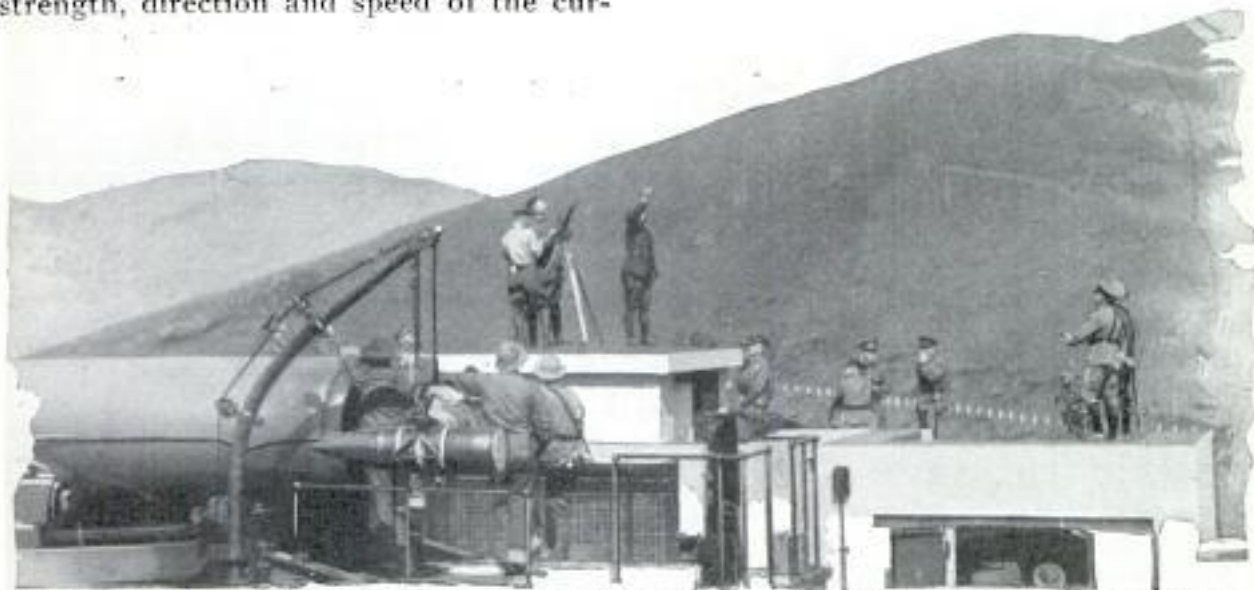

Coast Artillery Men Determining the Strength and Direction of Air Currents with a Toy Balloon to Obtain Greater Accuracy in Firing Their Twelve-Inch Rifle

rents can be ascertained and the aiming of the gun done accordingly.

### Voice Pictures as Nerve-Cure Aid Are Tested in London 909

Various kinds of nervous disorders are said to be detected by the use of an instrument, invented by Prof. E. W. Scripture and tested in England, to take "pictures" of the human voice. Vibrations of tones spoken into a tube are registered in lines on a revolving drum covered with smoked paper. Persons afflicted with certain nerve diseases are said to pronounce various words in a way which produces abnormal lines on the recording mechanism, thus enabling the physician to diagnose their trouble.

*The World 3/30/24*

### Several Boards Cut from One Log by Groups of Band Saws 464

To save time, labor and power in lumber mills, a patented system of band saws run over stepped pulleys is used to cut several boards from a log in one operation by a Memphis, Tenn., man. The timber, traveling on a carrier, first passes between two

over long distances to mills. In a test, it is claimed that 187 logs, fourteen feet long and twenty-four inches in diameter, were cut up in eight hours. The machine can be driven by a gasoline engine, and enough saws put on it to strip twelve one-inch boards from a timber at one time.

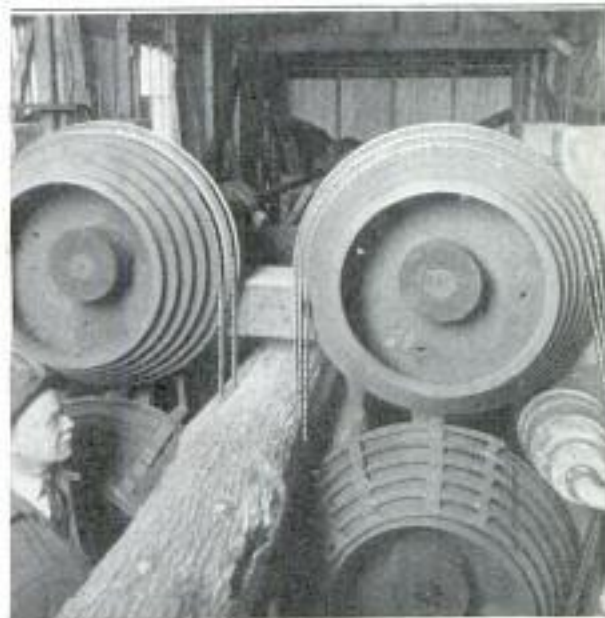

Multiple Band-Saw Ribbons That Cut Several Boards from a Single Log at Once

*No answer to letter 6/25/21*

*cl no. Louis Fritz Memphis, Tenn.  
% Louis J. Tibbs - News Scientist, Copyrighted material*



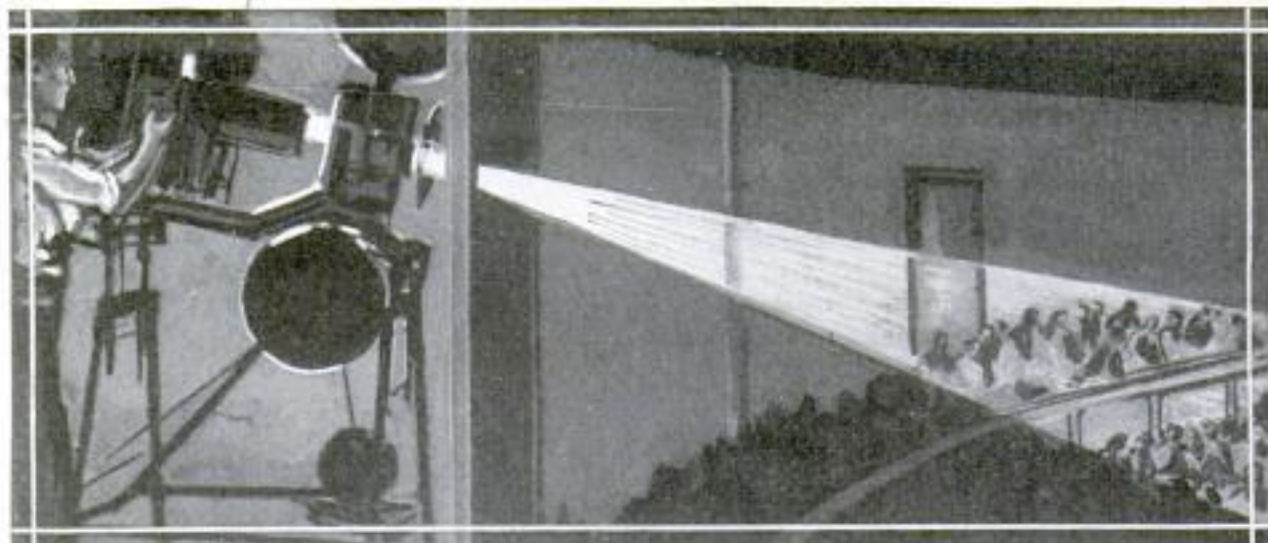

## Pulsated Light Gives Depth to Movies

Stereoscopic Effect of Leaping from Screen Is Produced  
without the Aid of Colored Spectacles

**M**OTION-PICTURE figures that appear to stand out from the screen, and which have all the features of living characters, have been made possible without equipping audiences with colored spectacles. Instead of using two separate films to produce these stereoscopic illusions, but one film is necessary, and it can be run off in an ordinary projecting machine.

Where formerly two separate sets of lenses in distinct registering devices were necessary to first get pictures which afterward had to be viewed through glasses, the new process results in registering all of the effect on one film. This "original" can then be used to make any number of copies that require no special arrangements of either screen or projector.

By means of what has been termed pulsated light, the two registering films are blended into one on a printing machine which produces the "third" dimension in combining the separate images. To convey the effects of the "pulsation" to the united image, a vibrating disk varies and harmonizes the illumination of the pictures thus eliminating any blur. When shown, these movies have not only width and length but also depth, the characters assuming the semblance of reality.

The special printing press is arranged to hold the two strips of film, one of which is the left-hand strip and the other the right-hand, under light waves directed on them while they are closely registered to make the final master film. This reel is of

standard size and contains all stereoscopic elements required, in addition to the proper degree of pulsation. The ordinary stereoscopic pictures are not identical and if treated in the usual way would result in a blurred double image on the screen. By making the illumination of the two series of pictures unequal during the uniting of the views, the effect of depth is procured in the projected image.

Only by close study of the nerve structures and workings of the human eye was the inventor of stereoscopy by pulsation, Demetre Daponte, a Roumanian, enabled to develop the process, which, it is predicted, will make possible the production of plays in a manner similar to that now in use on the speaking stage.

1625

### Fourteen Million for Recreation Spent in U. S. and Canada

More than \$14,000,000, over twice the sum spent for the same purpose ten years ago, was expended last year for public recreation in cities of the United States and Canada, according to reports of the Playground and Recreation association of America. Of the 680 cities that had community-recreation leadership, 660 maintained a total of 6,591 playgrounds under paid leaders. In 1906, when Theodore Roosevelt organized the association, there were only forty-four cities that had such centers. An average of 1,200,000 children and adults thronged the playgrounds each day last summer, the reports showed.

Chicago Evening Post

Copyrighted material

4/15/24



1190.

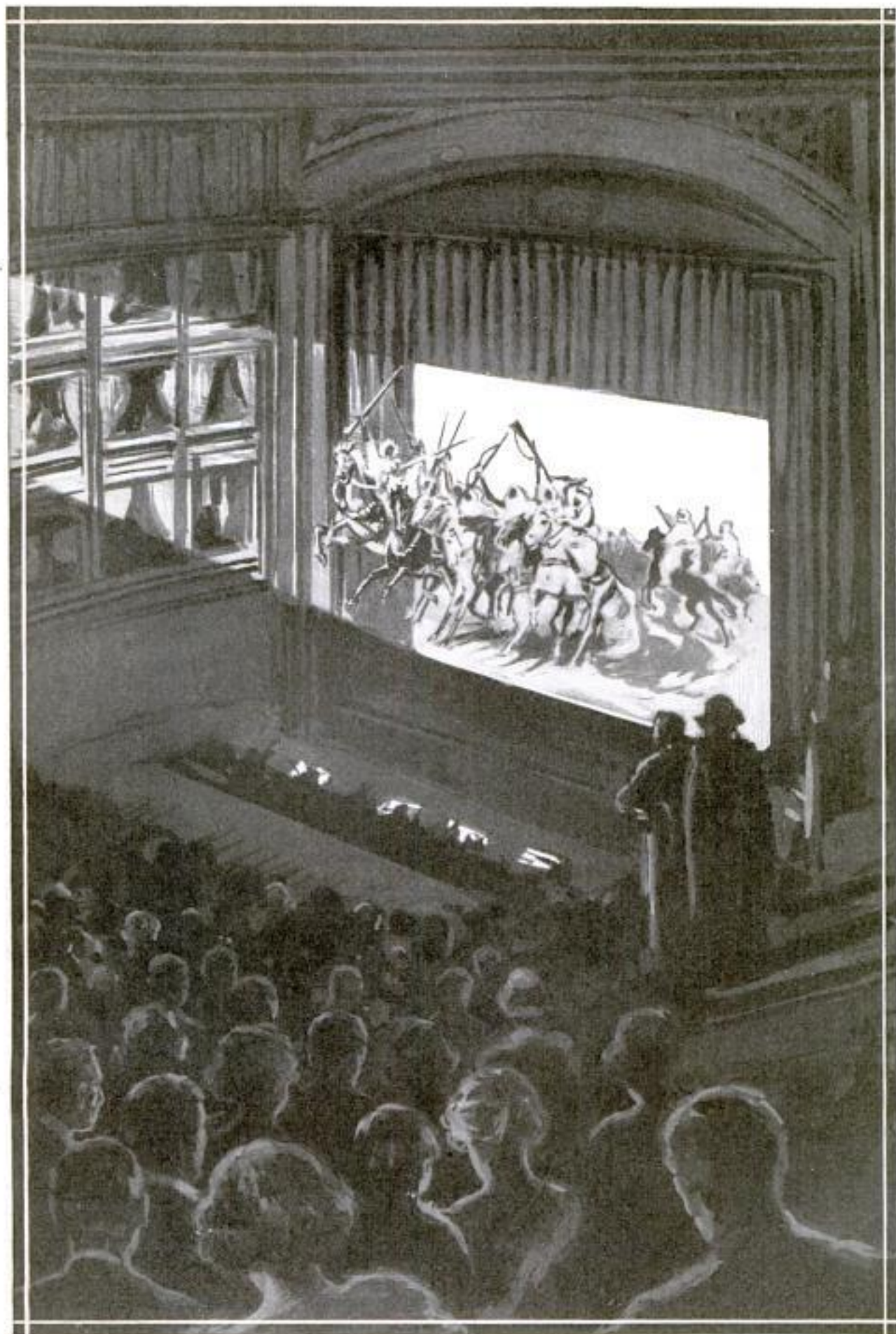

Courtesy The Sphere

How a Pulsated Motion Picture Appears on the Screen; Effects of Depth, Distance and Solidity Being Blended to Make the Figures Look as Though They Protruded into Space



990  
Giant Blockhead Bows When Coin  
Is Placed in Its Back

Electrically operated, a giant blockhead that bows and drops a stick of gum from its mouth when a coin is placed in its back,



Electrically Operated Head That Bows and Dispenses Gum When Coin Is Placed in Back

has proved a favorite with Spanish children at an American amusement park in Barcelona. Many of the popular attractions found in similar parks in this country are reproduced in Spain, retaining the names by which they are known here, such as the "Temple of Mirth," "Razzle Dazzle" and "Crack the Whip." Electricity supplied by an American company operates the devices, lights the city, runs the street cars, and even draws fishermen's boats up the beach of the Mediterranean sea.

1190  
Chance Aids Inventors and Leads  
to Many Useful Discoveries

Many of the most useful inventions have been due to accident. For instance, William Wouldhave, who discovered the principle of the self-righting lifeboat, was toying absent-mindedly with a wooden bowl that had fallen into a well. Although pressed beneath the surface, turned over

Kansas City Star  
4/28/24

and placed in various positions, it invariably bobbed back, right side up, and thus led to the design of the boat. A bothersome trickle of oil in a coal pit led to the manufacture of paraffin wax candles. Alfred Nobel, founder of the prizes associated with his name, noticed that a cask of nitroglycerine in his father's chemical works had leaked into some sand used as packing. The trivial mishap suggested a safe and manageable explosive, and the result was dynamite. The propeller was inspired by a spinning sycamore seed, the rotary motion of which attracted the attention of a young engineer, and from the arrangement of the projecting wings, he devised the instrument that sends liners across the seas and airplanes through the skies. Holding a sensitive diaphragm and a needle in his hand while experimenting with a new type of telephone receiver, Edison started a light-hearted song. He noticed that the vibrations of his voice caused the needle to prick his finger slightly. Picking up a strip of telegraph paper, he smeared it with candle wax and moved it gently forward under the needle, shouting "Hallo, hallo," into the receiver. Then he ran the paper back over the steel point and heard his voice faintly repeated. Thus, the principle of the talking machine was discovered.

1277  
Safety Oil Candle Burns for Hours  
at Little Cost in Metal Holder

Outwardly resembling an ordinary candle, an all-metal safety light that burns kerosene has been placed on the market in England. One of its greatest recommendations is its economy, as it is claimed



that it will burn for one hundred hours at a cost of about two cents. The upper part is a metal cowl fitted with a hinged glass window so that the flame is entirely inclosed. The candlelike central part is a tube carrying a wick of large capacity. The burner is fitted at the top end. To fill the lamp, a tablespoonful of oil is poured into the lower part. Danger of fire is lessened as the oil is quickly absorbed. The holder has a convenient loop for carrying.

Mess Aladdin & Industries  
Ltd 311 Aladdin Bldg  
136 Southward St.

London, S.E. 1, Eng. \$1.00



665 Cmh. Major W. R. Horan.  
 c/o Pulnam Syndicate  
 POPULAR MECHANICS  
 Pulnam Bldg. 2 W 45th 471  
 New York City

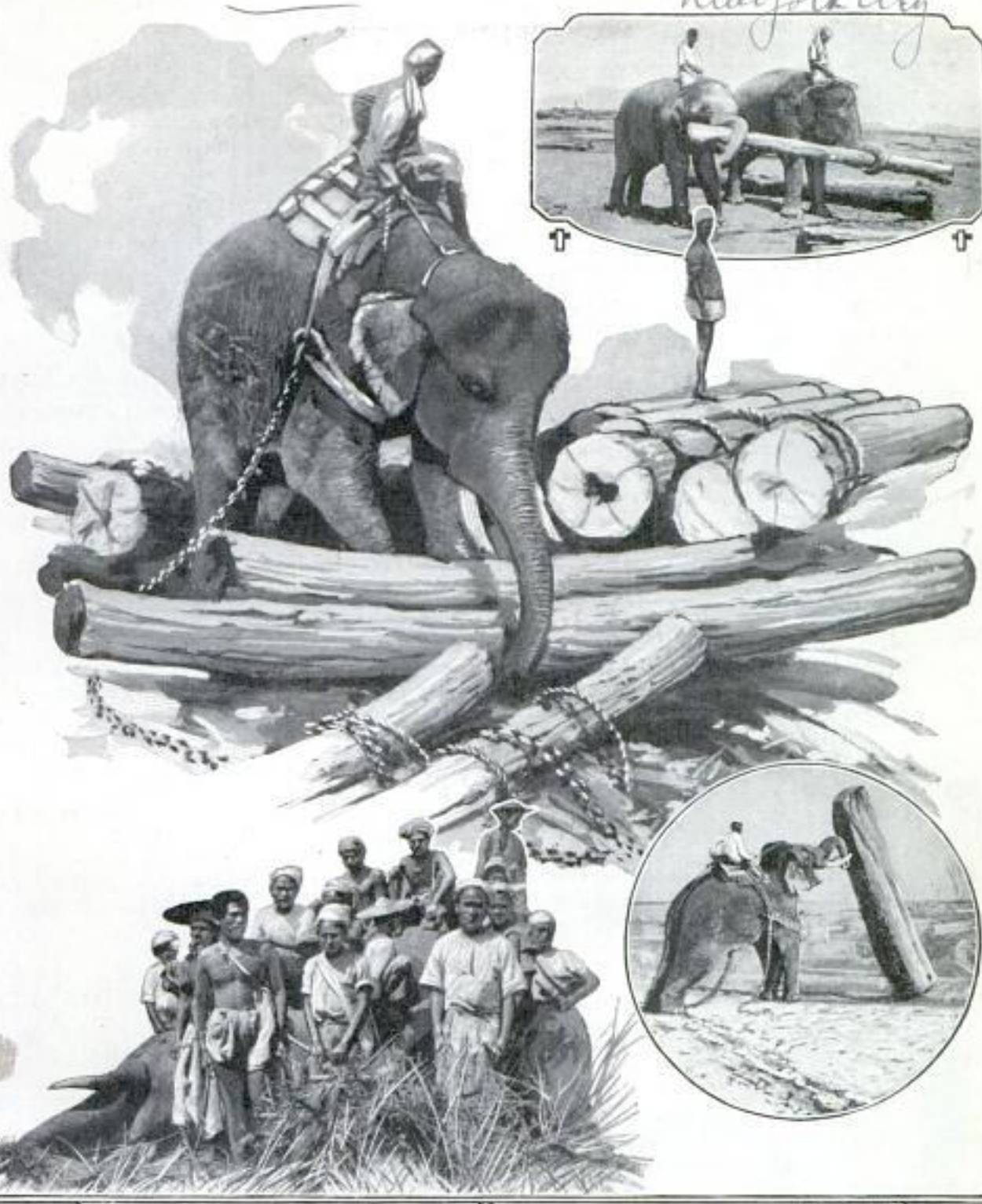

Elephants in Asia Are Taught to Perform Heavy Tasks and Are Seldom Hunted for Purposes Other than Training as Beasts of Burden; Untamable Animals Are Freed

As fierce as the tiger and more ferocious than the lion, the African elephant is known by many big-game hunters as the most dangerous of wild animals. Although its Indian cousin has been a servant of man for thousands of years and delights crowds at circuses throughout the countries where carnivals

are popular, there is not a single recorded instance of the African elephant being tamed. A training camp was established in Congo several years ago in the hope of teaching them to work, but the attempt failed. The African elephant sometimes bulks thrice as big as most Asiatic specimens seen at a circus, according to



*Industrial Research Laboratories*  
*220 W. Ontario*  
*Chicago*

hunters. Their intelligence and cunning are amazing. They also possess a keen sense of smell, being able to detect the presence of a man at least 1,000 yards away. At the crash of a gun, they stam-pede, fading almost noiselessly, in spite of their huge bulk, into the jungle grasses. Hunters usually try to get within twenty yards or so before firing, but are often

prevented from doing so by the savage charge of the cows. Recently, the eleph-ant has been regarded as a carrier of sleeping sickness. For this reason and because they annually do tremendous dam-age to the native farms, they seem to be marked for extermination and already have been driven back into the more re-mote sections of the jungles.

*1204* **Twenty-Four Mile Light Beacon**  
**near Site of Ancient Pharos**

Not far from the site of what is believed to have been one of the oldest lighthouses,

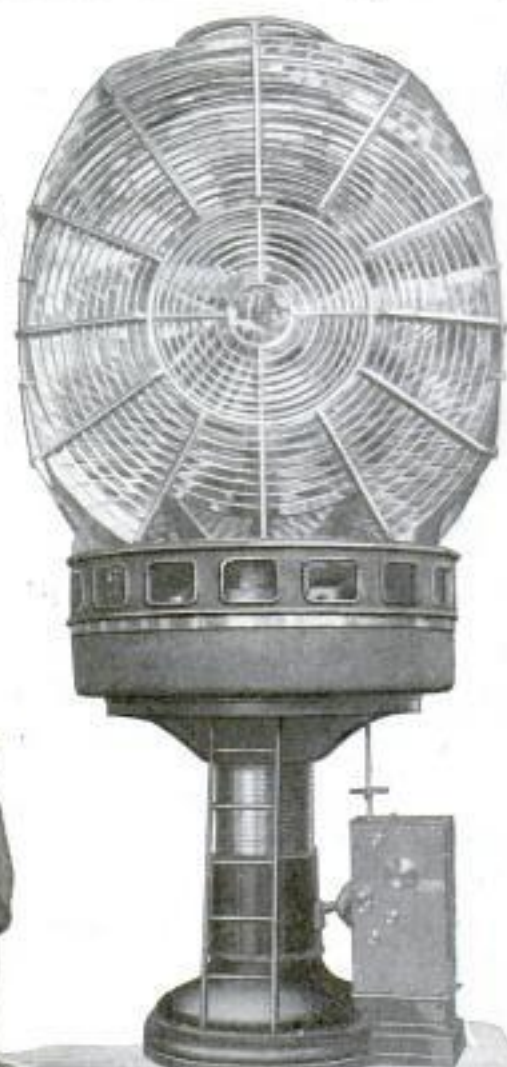

Port Said Light Compared with Size of Man; Revolving Mechanism in Box at Right

a tall structure which will house a beacon with a range of twenty-four miles is being erected to mark the Suez canal entrance at Port Said. The light will be nearly 200 feet above sea level and will rotate by means of clockwork, two times a minute, flashing once every ten seconds as it sweeps about the horizon. The revolving

part of the apparatus weighs nearly four tons and is supported by about 450 pounds of mercury to eliminate friction. There are 579 pieces of glass in the prisms.

*Bulletin 6/2/24*  
**Lemon and Orange in Powder Form**  
**Rival Taste of Fresh Fruit**

Lemons and oranges in a powder form may now be had for many purposes to which the fresh fruits are suited, and also for recipes where the natural product could not be used. The powders are said to contain not only the essentials of the juice but the solids as well, and as the entire fruits are employed in making them, they are declared to have a flavor and bouquet superior to those of the fresh article. In making ice cream, candy, cakes and cookies, they give a taste impossible with the fresh fruits, it is claimed, and are especially suited to making ices, cake fillings and pies. Soft drinks may also be prepared from them. They are easily kept fresh and retain their flavor a long time. Under the patented process of manufac-ture, considerable waste that now occurs in citrus-fruit regions will be avoided, it is believed.

*1304* **Oil Well Produces Pure Asphalt**

Said to be the only one of its kind in America, an Oklahoma oil well that is pro-ducing pure asphalt has attracted consid-erable attention. Asphalt-bearing sand was struck at a depth of 1,235 feet. The hole quickly filled up with the thick, sticky fluid which flowed over the top of the cas-ing. Storage facilities were hastily ar-ranged while pumping apparatus was erected. After the "head" of the well was off, however, and the initial pressure had subsided, it was found difficult to work the pumps. The substance was so thick that the machinery was nearly wrecked. By bailing out the asphalt and carrying it to a dump high up in a derrick, from which it is allowed to flow down into storage tanks, a production of about sixty barrels a day is obtained.

*no information on patent.*

*Cont. George H. Paul*  
*900 Ellsworth Bldg*  
*Chicago*

*Murray County*  
*South Central part of*  
*state*





All Shop Notes published in 1923, in book form—Fifty Cents—from our Book Department

## Homemade Portable Floor-Sanding Machine

By J. S. OFFERMAN

**M**ANY painters and carpenters do not use a floor-sanding machine often enough to justify the expense of purchasing one, but as they need one occasionally,

a homemade machine of the kind shown in the illustration will be found quite convenient. It can be improvised from an electric drill and some gas pipe, with little work

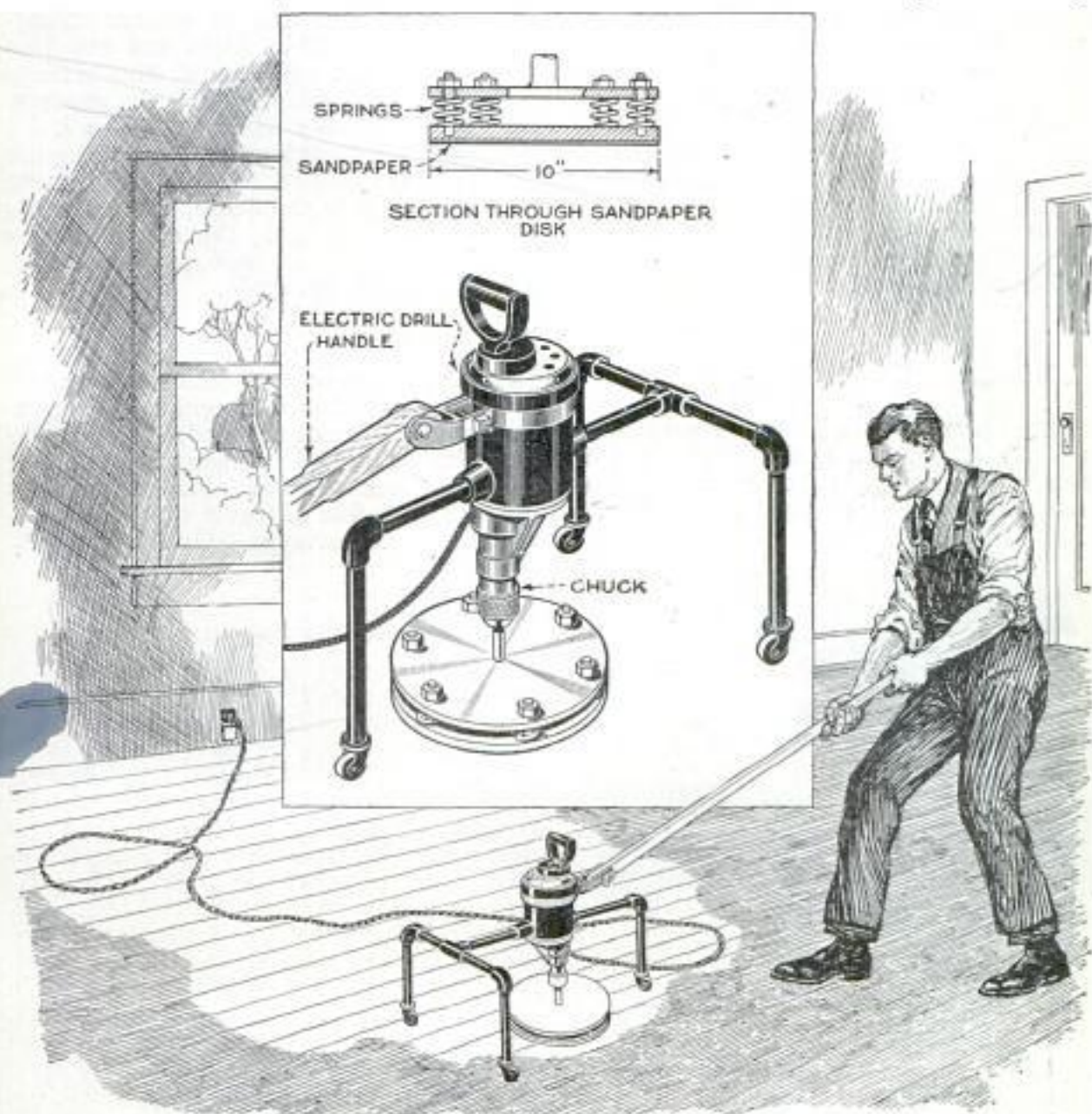

Portable Floor-Sanding Machine, Consisting of a Small Electric Drill and a Pipe Framework Mounted on Casters, Enables Carpenters and Painters to Sand Floors Quickly and Satisfactorily



and expense, provided, of course, the drill must not be purchased specially for this purpose. The outfit is so constructed that the drill can be detached from the gas-pipe framework and the handle in a moment. The sander can be used wherever electric current of the kind for which the drill is made, is available.

Most drills are fitted with two handles, which are screwed into tapped bosses on the sides. These handles are removed, and two 1-ft. lengths of pipe, of the same diameter and threaded to fit the bosses, are substituted. Other short lengths of pipe and fittings are then assembled to complete a three-legged framework, holding the drill as shown in the illustration. The legs should be about 8 in. high and are fitted with ordinary furniture casters to permit the outfit to be pushed over the floor. The pieces composing the frame should be of such a length that the edge of the sanding disk will project past a line drawn from the rear casters to the front one, so that the floor can be sanded close to the wall.

The sanding disk and shank are either in one piece, being turned down from a piece of flat steel, or the shank may be welded to the disk after both have been

turned separately. The best diameter for the disk is about 10 in. and its thickness about  $\frac{1}{4}$  in. The shank must, of course, be turned down to fit the chuck of the drill, in which it is held while in use. Six holes are drilled through the disk at equidistant points around the edge, as indicated, so that another disk of the same material, and turned to the same size, can be attached by means of studs threaded into holes corresponding to those in the first disk. The studs must be long enough to permit small coil springs to be held on them between the two disks and to allow nuts to be turned on the ends to hold the assembly together. The function of the coil springs is to give a certain degree of flexibility so that the whole surface of the lower disk will always lie flat on the floor and the pressure can be varied. Sandpaper is cut in 10-in. disks and glued to the bottom disk with elastic, non-hardening belt cement, which allows the paper to be pulled off easily when worn down. A handle of sufficient length, for pushing the machine, is clamped to the body of the drill as shown in the detail. When sanding close to the wall, the clamp can be loosened, the handle swung to one side, and clamped tight again.

### Turning a Corner on a Conveyor

In the plant of the Purcell Butter company, at Elgin, Ill., a simple method of transferring packages from one conveyor to another running at right angles is em-



A Simple Method of Making Packages Turn a Corner on a Conveyor

ployed. At the junction of the two conveyors, a thick wooden disk or roller, fitted on a vertical shaft, is mounted. The packages are placed on the first conveyor in such a manner that, when they reach the junc-

tion, the inner end of each package will press against the roller guide. This retards the motion of this end, while permitting the outer end to swing around, and thus the packages are turned at right angles to the line of travel and guided on to the second conveyor.—Orin C. Crooker, Wheaton, Ill.

### Keeping the Pop in Popcorn

When popcorn is first harvested it is too wet to pop well, but under proper storage conditions it can be brought to good popping condition in a relatively short time. With artificial storage the drying-out process may be accelerated, but there is always danger of getting the corn too dry, which is just as bad as having it too wet. The safest way is to store the popcorn in a place where the outside air will have free access to it, but where the corn will be protected from the rain and snow. New popcorn stored in this way will be in excellent popping condition by Christmas. Popcorn kept in a living room will soon become too dry for popping. In most cases where popcorn fails to pop well, the trouble is caused by the corn being too dry rather than too wet. For popcorn to pop at its best, it should contain from 13



to 14 per cent moisture; but corn stored in a dry room will drop as low as 8 per cent during the winter months.

When corn fails to pop as well as it should, the following procedure will be found quite helpful: Two pounds of popcorn are put in a 2-qt. fruit jar and from two to five tablespoonfuls of water added, depending on how much the corn has dried out as shown by the way it pops. Very dry popcorn will not give over a third of the normal yield of popped corn and should receive the maximum amount of water. After adding the water, the lid should be screwed on the jar tightly, using a rubber ring. The corn should then be thoroughly shaken and allowed to stand for two days. This method has been found very satisfactory with popcorn that was excessively dry.

### Concrete Hog Wallow

Hogs must have their mudholes. But the ordinary hog wallow in the barnyard soon becomes a filthy, reeking place, as a great quantity of straw, dirt and slops is continually dragged into it, which cannot be cleaned out. It is much better, therefore, to make a concrete wallow as shown in the photograph, which will permit the installation of a drain, down which the



Concrete Hog Wallow from Which Mud Can Be Easily Removed at Regular Intervals

mud can be washed at regular intervals. This will aid in making conditions more sanitary and help to combat disease.— J. C. Allen, West Lafayette, Ind.

### Protecting Roads from Drifting Sand with Poles

Automobile roads built through country where the soil is light and sandy present many problems, both in construction and



Preventing Sand Drifts on Hard Roads by Means of Poles Laid on the Banks

maintenance. Not the least of these is that of preventing sand from drifting onto the road, especially where grading has been done and a cut bank left along the side of the road. A simple method of overcoming this difficulty has been successfully used by road engineers in several places in Michigan.

Long, slender poles, laid on the bank, fairly close together and at right angles to the road, as shown in the photograph, prevent the wind from eroding the surface of the soft bank and sweeping the sand along to form drifts in the road. The poles are usually dead and worthless timber, so that the cost is practically nothing. In the course of time, the banks become sodded with natural growths of wild grasses, so that the poles need never be renewed. This method has been found to be the cheapest and most satisfactory that has been tried.

### Bushing for Accelerator Rod

Some foot accelerators used on Ford cars have a rod passing through the floorboard. The rod is liable to wear the hole larger, causing the rod to move out of its place and rattle. To remedy the trouble, a common tire-valve nut with a threaded sleeve can be turned down into the hole and fastened in place with a few small nails. The rod is then passed through the nut and connected. Such a nut has been in use on one machine for four years.



### Adjusting the Binder Hitch for Small Tractor

Many small tractors will easily pull a grain binder, but as they are built with the

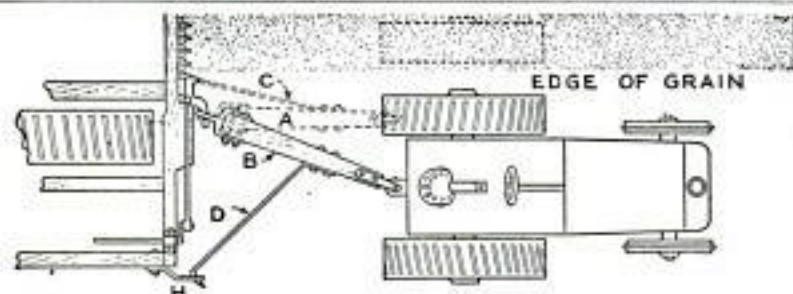

Arranging a Binder Hitch So That It Can Be Used with a Small Tractor, Enables the Farmer to Harvest More Effectively

idea of corn cultivation, they are found too wide to use with the binder when the regular tongue system of the latter is used. The wheel on the grain side crowds the crop down before the cutting bar can reach a full swath. Binder hitches are made, but for these small, wide-set wheel tractors they are of little use in correcting this trouble. The illustration shows how we overcome this difficulty.

On our binder, as on most, the brace rod that holds the stub tongue in line with the binder is on the side of the tongue next to the cutting bar, bolted to the tongue, and hooked into an eye on the binder frame at the end of the bar. This is shown in the drawing by the dotted lines. The brace rod C was removed when the binder was in position for a full swath, and the tongue pushed over until it met the drawbar of the tractor when the latter was in position to travel along the side of the standing grain. A short piece of flat iron, H, was then fitted to the binder frame next to the bundle carrier, in such a manner that it would not interfere with the crank driving the sickle. To this bracket a brace rod, D, was fitted, the other end running to the tongue, and fastened with the same bolts as those used for the shorter brace

originally used. A better bracing is provided for the tongue with this arrangement when turning corners, and there is no danger of kinking the brace, as it is in tension.

With one of these small but fast tractors a 40-acre field can be cut in a long working day, while with the same binder, used with horses, not more than 15 or 20 acres could be harvested.—G. G. McVicker, North Bend, Neb.

### Novel Milk-Delivery Cart

The dairyman operating on a small scale will find a cart of the type shown in the



Special Delivery Wagon That Will Prove of Value to the Dairyman

photograph of great value in peddling his wares.

The one shown is used by a man who sells his milk to the people of a small prairie town. A special box body is built on a light buggy frame and divided into compartments for the various sizes of bottles. It has room for forty quarts of milk besides several pint bottles of cream. On the back there is a small platform on which the dairyman stands when driving the horse.

☛ Tin or copper can be soldered in a heavy wind, or where ordinary flux has a tendency to slide off, by using a flux consisting of resin dissolved in gasoline. The resin is first melted and enough gasoline is added to make a thick sirup. This is applied to the tin.



### Novel Boat Hoist Made of Concrete

Many repairs on motorboats can be done without hauling the boat entirely ashore. Frequently it suffices to lift the bow or stern only out of the water as, for instance, in case of propeller repairs. Steel-girder hoists are sometimes used to lift the boat out of the water, but unless kept painted, the steel rusts rapidly. For this reason a concrete hoist is much more satisfactory. A hoist of this kind is shown in the photograph. It consists of two horseshoe-shaped members and a block and tackle is fastened under the center of each arch, a strong steel hook being set in the concrete, while it is poured, to hold the block and tackle. The lower part of each block carries a steel spreader from which the boat is suspended by chain slings when lifted. To afford easy access to the top part of the arches, steps, which are formed from lengths of  $\frac{3}{4}$ -in. iron rod, are set in the concrete as shown in the insert, and the whole rests on concrete platforms, a few feet above water level, so that every part of the boat is within reach. A hoist of this kind has been in use for nearly ten years.—C. A. Oldroyd, Barrow-in-Furness, England.

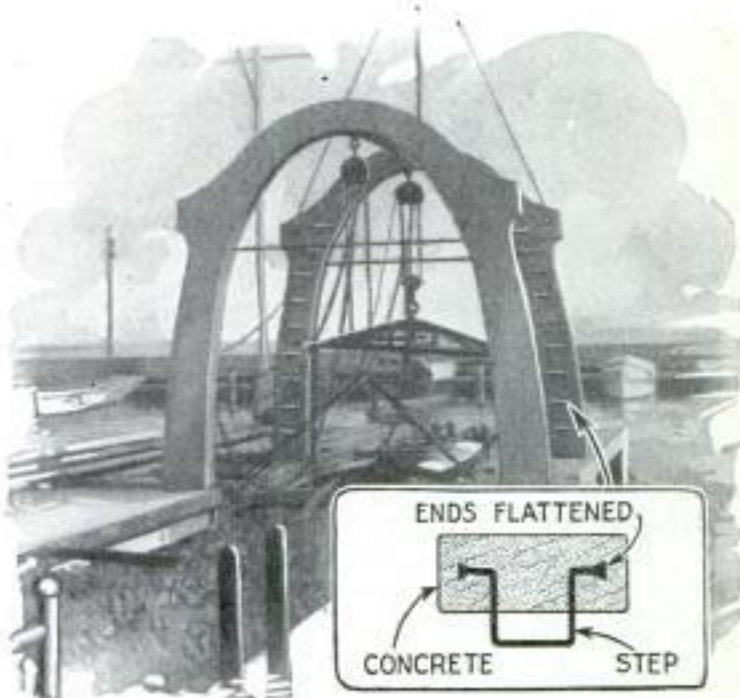

Useful Concrete Hoist, of Novel Design and Permanent Construction, for Lifting Small Boats Out of the Water

### Carrying Case for Dynamite Fuses

Dynamite fuses are not regularly equipped with detonating caps, but when block shots must be fired, it is necessary to



Carrying Case for Dynamite Fuses Prevents Accidental Explosion of Detonating Caps

have a large number of fuses already fitted with caps. As these are carried to the blasting place, there is more or less

danger of having them go off accidentally and injuring the workman who carries them. To eliminate this risk a quarry foreman provided a safety-first carrying bag, which is similar to an ordinary golf

bag, but longer. A large number of fuses equipped with detonating caps can be carried in it without any danger of getting tangled or striking against the rocks.

Another safety measure that works well in practice, where the fuses are cut progressively shorter so that the first fuse lighted will fire its shot at the same time as the last one, is to provide an additional fuse, which is cut shorter so that it will explode just one minute sooner than the first fuse. This additional fuse is lighted at the same time as the first one and is thrown down on the quarry floor. When this detonates it is a warning that the real shots will explode within the next minute.—Thomas J. Paxton, Chicago, Ill.

### Plunger Aids in Laying Tile

In a large building in Washington, D. C., foot traffic is so great that it is necessary frequently to replace tiles broken by constant wear and tear. After the old tile has been completely removed and the hole prepared with cement, the new tile is picked up by means of an ordinary force cup or plunger of the kind used for cleaning stopped drains. It is surprising how easily the tile can be placed in its proper position in this way.—Reuben Stafford, Jr., Washington, D. C.



### Cases for Small Tools

Handy cases for holding hacksaw blades, drills, files and other small tools that may be lost or damaged when lying around loose, can be made from metal molding, such as is used for interior wiring. This molding comes in two parts, the base and the capping that slips over the base. To make a tool case from this material, take a piece of the base of sufficient length and close one end as shown in the lower detail. The capping is cut in two pieces and the shorter one is closed at one end in the same manner as the base. The longer part of the capping is sweated to the base, while the other piece forms a sliding lid.—Thos. W. Benson, Philadelphia, Pa.

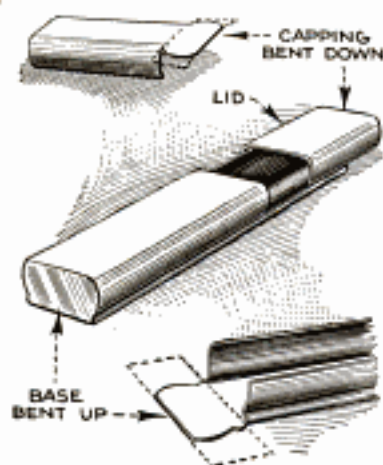

The large number of odd-fluted taps and reamers now on the market calls for some means of easy measurement as, obviously, these cannot be measured in the same way as the tools having an even number of flutes. The measurement of the odd-fluted tools is generally done by some more or less roundabout method, as by first reaming or tapping a hole and then measuring this to get the size. A useful tool can easily be made that will avoid uncertainty and delay, and, besides, will prove of great convenience in measuring the diameter of odd-toothed gears, although the latter require to be plugged for a center. The main part of the tool is made from  $\frac{3}{8}$  by  $\frac{1}{2}$ -in. stock slotted and tapped for an adjusting screw at the top and for a headless pointed screw near the bottom. Next, a

### Measuring an Odd-Fluted Reamer

The large number of odd-fluted taps and reamers now on the market calls for some means of easy measurement as, obviously, these cannot be measured in the same way as the tools having an even number of flutes. The measurement of the odd-fluted tools is generally done by some more or less roundabout method, as by first reaming or tapping a hole and then measuring this to get the size. A useful tool can easily be made that will avoid uncertainty and delay, and, besides, will prove of great convenience in measuring the diameter of odd-toothed gears, although the latter require to be plugged for a center. The main part of the tool is made from  $\frac{3}{8}$  by  $\frac{1}{2}$ -in. stock slotted and tapped for an adjusting screw at the top and for a headless pointed screw near the bottom. Next, a

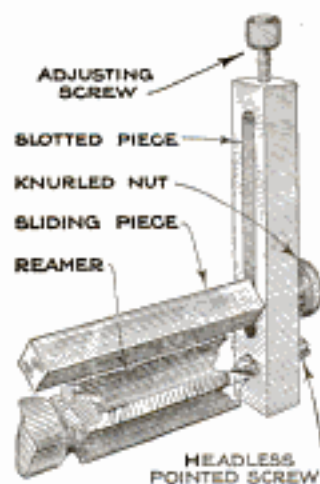

When a bushing has worn until there is an excessive amount of play in it, and a new one is not at hand, it may be repaired in the following manner: Carefully caliper the shaft and the bushing to determine the amount of wear, then slit the bushing lengthwise, making the width of the slit three times the amount of the play, as previously determined. The bush-

piece of  $\frac{1}{4}$ -in. drill rod is turned down on one end to fit the slot, and threaded for a knurled nut. This sliding piece is then filed or machined to the diamond-shaped cross section shown and the turned portion that enters the slot should be large enough to allow it to be flattened on opposite sides so that the sliding piece will remain in the position shown. The headless screw is ground to a conical point and this completes the gauge.

When measuring a tap or reamer, adjust the headless screw until it fits the center snugly when the tool is flat against the end. Then by means of the upper adjusting screw bring down the sliding piece until it just touches the nearest tooth and then tighten the knurled nut. Now swing the whole tool around on the center until it is exactly opposite a tooth on the reamer and measure over the whole in the ordinary manner with a micrometer. Subtract the thickness of the sliding piece (.25 in.), which leaves the diameter of the tool.

### Photographing Tracings

About the simplest job done in a professional photography shop is the copying of black and white drawings, but the job is more difficult if the drawing happens to be on gray tracing cloth. The best way of making a good black-on-white copy in such a case is to stretch the tracing cloth against a window, and then photograph it. If the shutter of the camera is set at F. 16, only a one-second exposure is required and the result will be entirely satisfactory.—J. G. Pratt, Washington, D. C.



the shutter of the camera is set at F. 16, only a one-second exposure is required and the result will be entirely satisfactory.—J. G. Pratt, Washington, D. C.

### Taking Up Play in Bushings

When a bushing has worn until there is an excessive amount of play in it, and a new one is not at hand, it may be repaired in the following manner: Carefully caliper the shaft and the bushing to determine the amount of wear, then slit the bushing lengthwise, making the width of the slit three times the amount of the play, as previously determined. The bush-



ing is then carefully hammered all around until the lips of the slit come together, and a piece of thin metal bent around the outside to serve as a liner or shim. The thickness of this liner will be equal to half the amount of play in the bushing. The latter is then pressed home, with the liner around it. It is not advisable to drive the bushing in with a hammer; it should be pressed in with an arbor press, or, lacking this, under the drill-press spindle, or even in a vise, if this can be done. If the inside of the bushing seat is well greased, no trouble will be experienced in pressing it and the liner in together.—Felix Helsmoortel, Saugerties, N. Y.

### Using Two-Wheel Hand Truck for Bulky Loads

The small two-wheel hand truck can be used to advantage for handling bulky loads, such as desks, cases, machines and a variety of other equipment, by arranging a wide plank on it as shown.

The plank, which should be 4 or 5 ft. long, is placed under the crossbar at the handles and over the lift bar forward of the wheels. The load to be moved is tilted and the truck moved under the center, so that it is balanced over the wheels. It is then possible to move the load or turn it about easily.

This kink has proved of value in a large office building, making it possible to rear-

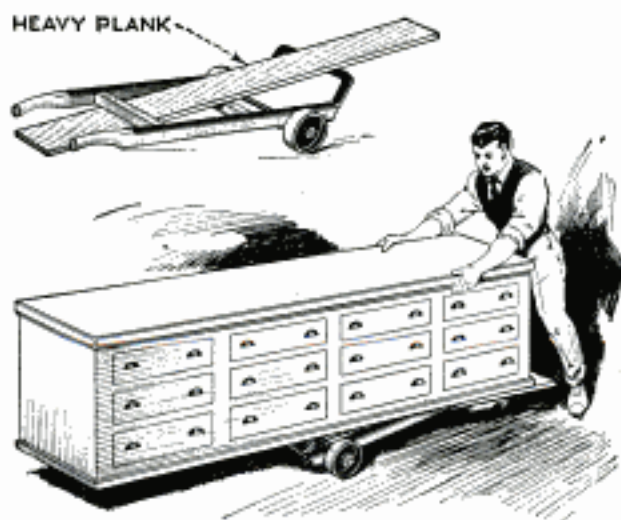

Utilizing the Two-Wheel Truck for Moving Cabinets and Other Heavy Equipment

range equipment without scarring hardwood floors as would be the case if the desks, etc., were pushed about on the bare floor. A further advantage of this method is that the hand truck can readily be pulled up steps, while with a four-wheel truck an elevator is necessary.

### Markers for Road Culverts

Many accidents are caused each year by automobiles running into ditches at the ends of small culverts on country roads.



Painted Markers Set at Ends of Road Culverts Protect Passing Motorists from Accidents

The culverts are usually from 16 to 20 ft. long and the ends are difficult to see, especially when the roadside is overgrown with grass and weeds. When two autos pass each other at these points, there is scarcely enough room and an accident is often the result. The danger can be eliminated by providing 7-ft. fenceposts as markers at the ends of the culverts. The drivers will not run into these very readily because they can easily be seen, especially if painted red and white.—Geo. G. McVicker, North Bend, Neb.

### Spark-Plug Cleaner

Stranded copper wire makes a spark-plug cleaner that can be used without taking the plug apart and is harmless to the porcelain. It will not clean the insulator as well as when the plug is taken apart and polished with steel wool, but will serve in an emergency. The best results are obtained when a length of lamp-cord is doubled over and both ends used. The insulation of the wire should not be removed for more than  $\frac{1}{2}$  in. as it stiffens the end of the wire if left on.





A Novel and Effective Sled for Transporting Cordwood

### Novel Cordwood Sled

When cutting and trimming a scattering grove of second-growth timber, which was made into cordwood on the ground, a Wisconsin farmer was considerably inconvenienced by the necessity of carrying the pieces to be piled to a place where they would be out of the way during the curing period. Loading and unloading with a team and wagon consumed too much time, and the sled illustrated was finally constructed for the purpose.

A pair of discarded buggy shafts were cut and hinged at the points indicated, and a large screweye or a ring and staple attached to the end of each. To the bow ends two lengths of  $\frac{1}{2}$ -in. rope were fastened, and provided with harness snaps; with a singletree chained to the crosspiece, as shown, the sled was complete.

In use, one horse is hitched to the sled, and, after the wood is piled upon it, the ends of the shafts are raised until the snaps can be hooked into the rings.

### Laying Out Work for Kerfing

Many woodworkers are puzzled when they have a piece to kerf for bending, as to the proper distance to space the kerfs. This is a simple matter, however; to determine the distance from kerf to kerf, take the piece to be bent, mark off from one end a distance equal to the radius of the required arc, and at this point saw one kerf to the desired depth. Then hold the piece firmly down on the bench, or other straight sur-



A Simple and Accurate Method of Spacing Kerfs in Work to Be Bent

face, and lift the end until the edges of the kerf pinch together. Whatever height the end must be raised is the required distance to which the kerfs must be spaced.

The illustration shows how simple this

method is. For convenience we have taken a radius of 2 ft. The kerf is made with a 10-point saw to the ordinary depth, which is about three-fourths of the thickness of the material. On lifting the end we find that it must be raised 2 in. before the edges of the kerf come together; this, then, is the distance from kerf to kerf. When the piece is bent to the circle it will be found that each kerf pinches equally, and that the bend is uniform.

It should be remembered that the depth of the kerfs makes considerable difference in the distance between cuts. The deeper the cuts, the shorter the distance between them. The kind of saw used also makes a difference, as a fine saw brings the kerfs closer together, a coarse one making the distance longer.—H. H. Siegele, Emporia, Kansas.

### Emergency Substitute for Broken Gland

When the gland on a 10-ton refrigerating machine broke it was found that there was no spare part among the plant supplies. An ordinary 2-in. pipe flange was obtained and a slot, large enough to fit over the piston rod, cut from the edge to the center. The flange bolt holes were then drilled out to fit over the studs and the improvised gland put in place. The time required for the slotting and reaming operations was only 20 minutes, and the flange gave just as good service as the regular gland.—J. J. Noble, Toronto, Ont.



# MECHANICAL POWERS

By CARL W. MITMAN  
*Curator*

DIVISIONS OF MINERAL AND  
MECHANICAL TECHNOLOGY  
UNITED STATES NATIONAL  
MUSEUM



Copyright, H. H. Windsor, Jr.

This is the seventh article of a series by Curator Mitman, explaining in simple language what every man who builds or designs a machine must know, and showing in detail just how to build a set of models of the mechanical powers that will exactly duplicate the set in the National Museum at Washington, D. C. The preceding articles appeared in the March, April, May, June, July and August issues.

## Part VII—Forces; the Screw



ALL of the forces dealt with in mechanics are definite quantities, and to determine them with precision, three things must be considered for each one: First, the point of application; second, the direction, and third, the magni-

tude, or the energy with which the force acts. Lines are generally used to represent forces; one end of a line representing the point of application of the force; the direction of the line indicating the direction of the force, and the length of the line its magnitude. By this assumption, a force

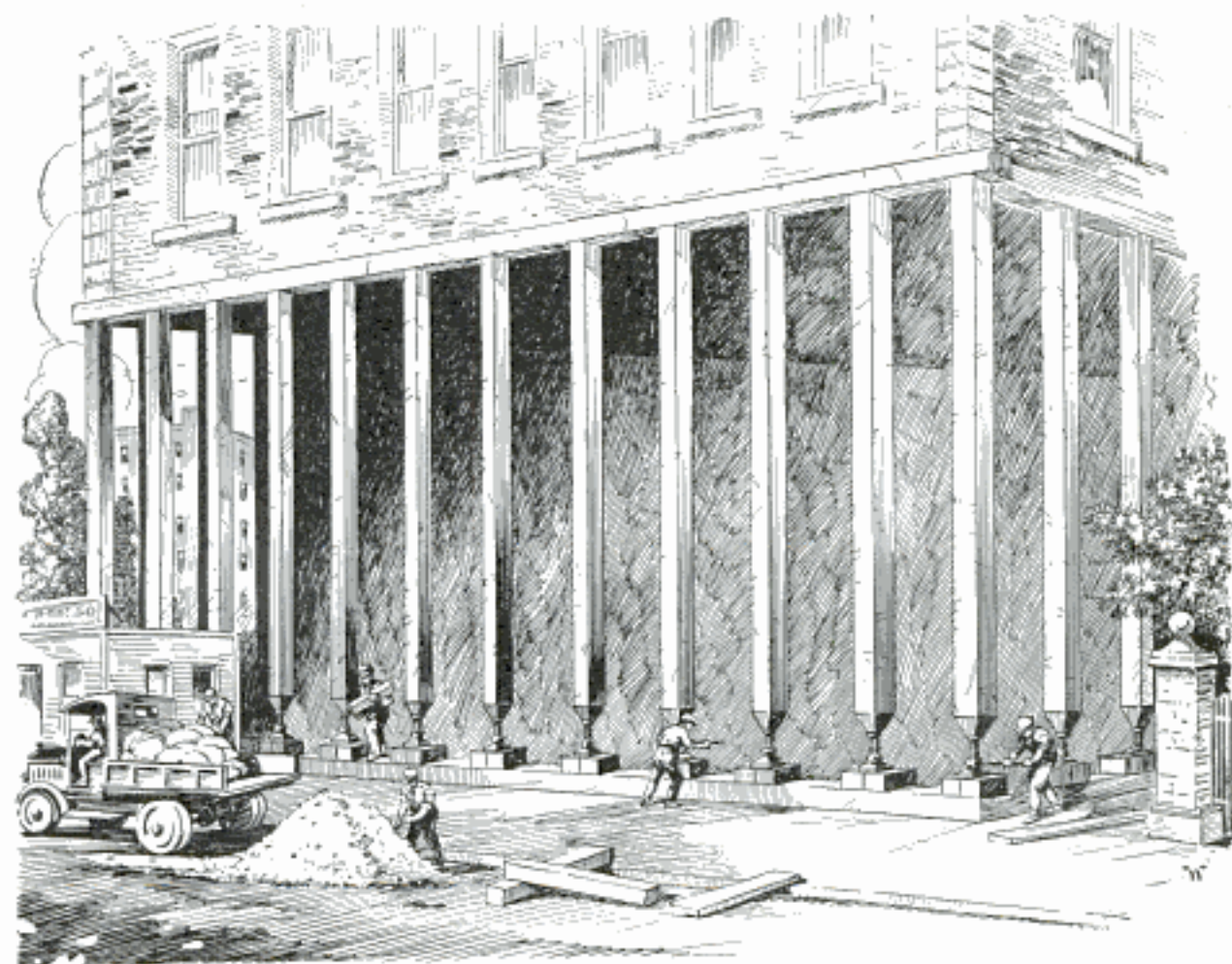

This Illustration Shows How the Screw Is Used in Putting a New Front in a Building; Jack Screws Are Fitted in the Bottom of the Vertical Posts to Support the Upper Stories



is defined in each of its three elements and is thus brought within the limits of mathematical analysis.

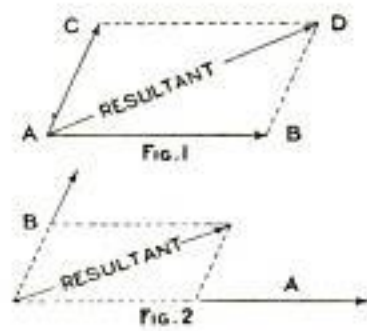

Whatever may be the number and direction of the forces acting upon one point, they can impart motion or pressure in only one direction. It is assumed, therefore, that there is a single force that can produce the same action as the whole group of forces, and which may replace them. This individual force is called the resultant, and the forces of which it is the equivalent are termed the components. Both the components and resultant may be interchanged without changing the condition of the body acted upon or the mechanical effect of the forces themselves. A force is, therefore, mechanically equivalent to the sum of its compo-

nents and, conversely, any number of forces are mechanically equivalent to their resultant. Since forces are known only by their effect in producing motion or pressure, any forces that produce equal motions or pressures are equal.

When several forces act upon a body they may be arranged in three ways according to their direction: All in one direction; in exactly opposite directions, and at some angle. In the first case, the resultant is the sum of all the forces and the direc-

tion is not changed; in the second, the resultant is the difference of the forces and takes the direction of the greater, and in the third case, the resultant is found by applying the law of what is called the parallelogram of forces. Thus, in Fig. 1, if

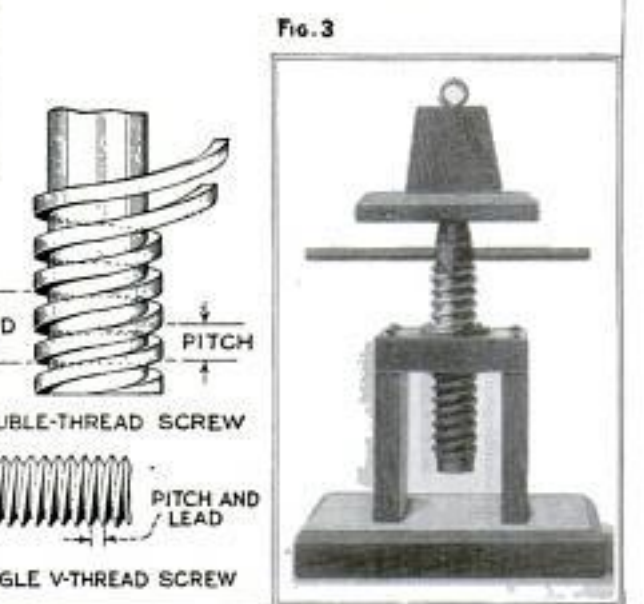
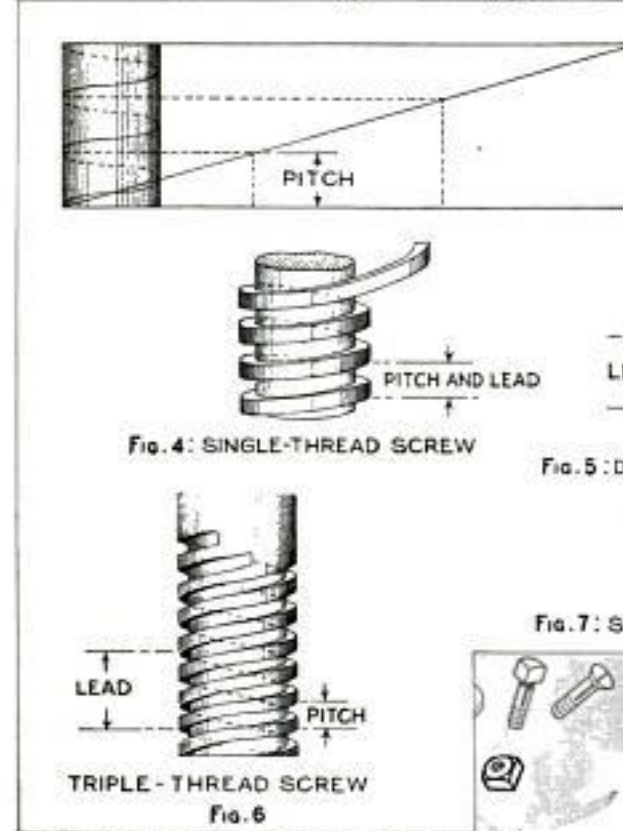
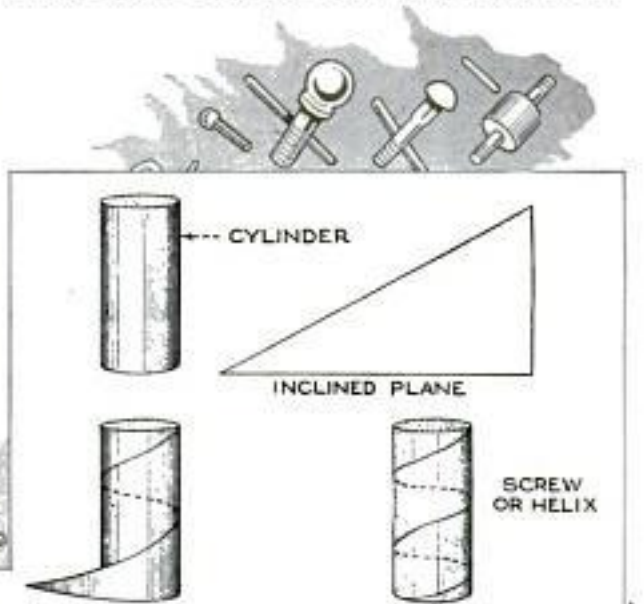

Diagrams Showing the Principle of the Screw, and Illustrating the Difference between Pitch and Lead in Single and Multiple-Thread Screws; Right, Model of Screw

tion is not changed; in the second, the resultant is the difference of the forces and takes the direction of the greater, and in the third case, the resultant is found by applying the law of what is called the parallelogram of forces. Thus, in Fig. 1, if





two forces applied at the point A are represented in direction and magnitude by the lines AB and AC (adjacent sides of the parallelogram ABCD) their resultant will be represented in magnitude and direction by the diagonal AD; or, in Fig. 2, if two forces A and B do not have the same point of application but it is evident that their directions intersect, the forces may be imagined as applied at the point of intersection and the resultant of the two forces may be found by constructing the parallelogram of forces, as shown, the lines being set off from the intersecting point in proportion to the magnitude as before. In mechanics the finding of the resultant of two or more forces is often desirable, and, in addition, the finding of the components of a single force is equally desirable. The solution of the former problem, as shown above, is called the composition



of forces and that of the latter the resolution of forces, which is carried out in a similar manner to the composition except that the work is done in the reverse order.

The screw bears the same relation to the inclined plane that a spiral staircase does to a straight one. Theoretically it is a cylinder surrounded by a spiral ridge or groove, every part of which forms an equal angle with the axis of the cylinder so that if the spiral could be unwound on a plane surface it would be an inclined plane. This is illustrated in Fig. 3.

There are a number of varieties of screw-thread forms, and also a variety of types. A single-thread screw is represented in Fig. 4, taking a screw with a square thread as an example. This may be considered, for our purpose, as consisting of a square bar wound in a helix or screw around a cylinder, and will illustrate, with Figs. 5 to 7, the difference between pitch and lead in a screw.

The pitch of a screw is the distance between the top of one thread and the top of the next, or, in the case of the square thread, from one edge of the thread to the corresponding edge of the next; and this

holds true regardless of the type of screw, or whether it has a single or a multiple thread. The lead of the screw, however, is the distance that the screw will advance



through the nut when turned through one complete revolution, and this varies with single and multiple threads.

In Fig. 4, the pitch

and lead are the same, that is, the screw will advance in one revolution, a distance equal to the pitch. Fig. 5 represents a double-thread or, as it is sometimes called, a "two-start" screw; this has, so to speak, two square bars wrapped around the cylinder, each starting 180° apart. In this case, while the pitch is still the distance from one thread edge to the next, the lead is double this distance, for the screw will advance, in one revolution,

a distance equal to twice the pitch. Similarly with Fig. 6, which shows a triple thread or "three-start" screw, where the ends of the threads are 120° apart, the lead is three times the pitch. This applies to all forms of screw threads.

Fitting the thread of the cylinder into a spiral groove cut in the interior of a block and attaching a lever to the head of the cylinder result in a combination of parts technically known as the screw and recognized as one of the mechanical powers. A conventionalized form of such a machine is shown in the first photo, reproduced from a model. The

screw is used in a variety of ways to do work, the most common and yet opposite applications probably being the lifting jack (Fig. 8) and the screw press. The jack operated by hand levers can be designed to lift loads up to about 20 tons or exert a pressure in the form of a press of almost that same amount. There are screw presses

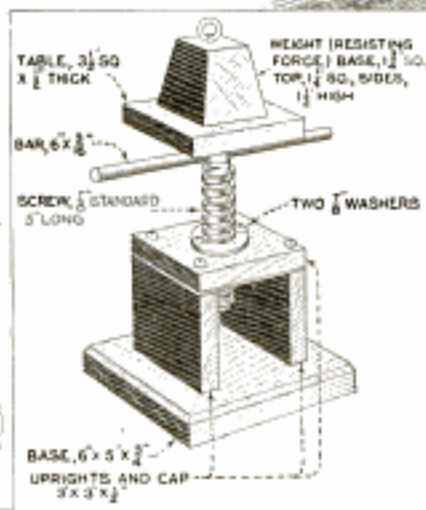

Detail Drawing for Constructing the Model of the Simple Screw with Illustrations Showing How It Is Used



FIG. 8



for clothes, oil and fruit; there are screw-arbor presses in the machine shop and hay balers and waste-paper balers which use the screw to pack the bale. The wood screws and clamps used especially in the carpentry trade do their work through the agency of the screw. The screw propeller on watercraft is so named because its action is that of a screw which utilizes the water as a nut and so pushes the boat forward. In calculations involving the screw and lever, as in the jack in Fig. 8, equilibrium will take place when the applied force is to the resisting force as the lead is to the circumference described by the lever arm. During each revolution the applied force describes a large circle but the end of the screw advances only the distance between two threads; in other words, in this, as in all cases of the use of machines, what is gained in power is lost in speed. From this statement, it is evident that its mechanical efficiency is augmented either by increasing the length of the lever or by decreasing the lead. For instance, if the

lead of a screw is  $\frac{1}{2}$  in. and the lever arm describes a circle of 5 ft. (equal to 120 half inches) circumference, an applied force of 1 lb. will balance a resisting force of 120 lb.; while with a lead of  $\frac{1}{4}$  in., 1 lb. will balance 240 lb. In other words, the efficiency is doubled. It follows, too, that fine screw threads are more powerful than coarse ones. Continuing in this fashion, theoretically, the mechanical advantage of the screw can be made as large as we please simply by decreasing sufficiently the lead. In practice, however, this is impossible, for, if the lead is decreased too much, the threads themselves will not be suffi-

ciently strong to bear the strain put upon them.

To overcome this difficulty, John Hunter, the celebrated English surgeon (1728 - 1793), invented the differential screw. This consists of two screws, the threads of which are of different pitch and mounted upon the same shaft, one unwinding as the other winds. The effective lift or pressure obtained is equal to the difference of the leads of the two threads, and by making this difference very small great power may be obtained without the weakness due to a very finely threaded

single screw. The second photo, reproduced from a model, incorporates Dr. Hunter's principle. The larger single-thread screw turns in a fixed beam. The inside of this screw is hollow and is tapped to admit the smaller

screw, which also has a single thread. This screw is free to move up and down, carrying with it a sliding table, but is restrained from rotating by the table. It also has more threads to the inch than the larger screw. When the larger screw makes one clockwise revolution, it moves upward a distance equal to the pitch, but at the same time the smaller screw goes into the large screw a distance equal to its pitch; hence the smaller screw with its sliding table and also the load

move upward a distance equal to the difference between these two distances. As in the cases of the Chinese or differential windlass and the differential pulley, the speed of operation of the differential screw is slow, but the mechanical advantage is enormous.

Figure 9 shows a slightly different application of this principle, and represents diagrammatically a part of a machine on which a very fine adjustment is required. Screw C, with a coarse pitch, works in the fixed bracket A, while D, which is a part of C, and has a fine pitch, works in the loose, sliding part B. When C is turned

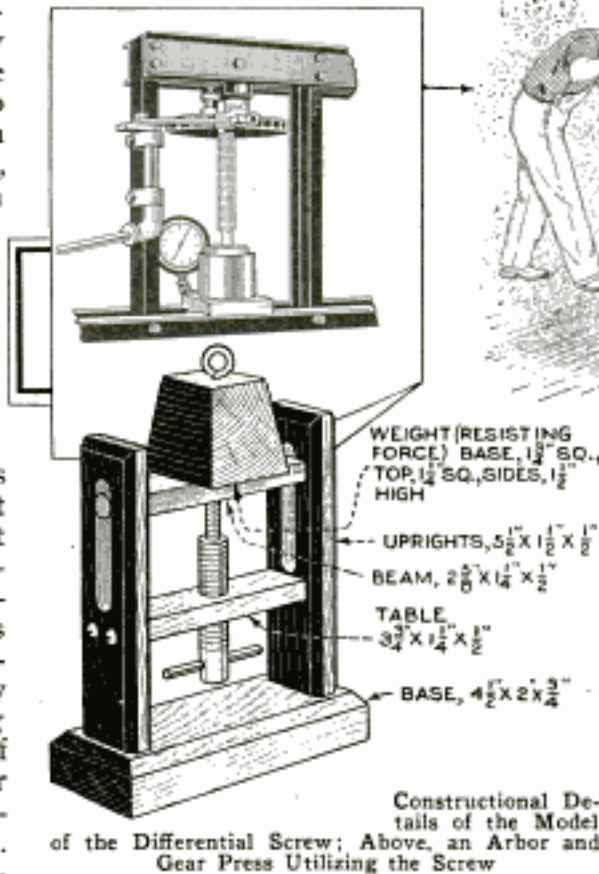

Constructional Details of the Model of the Differential Screw; Above, an Arbor and Gear Press Utilizing the Screw





the sliding part B moves a distance equal to the difference between the pitches of the screws.

Another common application of the differential screw, in a different form, is in taking up wear on the feed screws of planer toolboxes. Here the feed screw passes through a circular nut, which is finely threaded on the outside, the inside being threaded for the screw. This nut screws into a recess drilled in the toolbox casting, which is also threaded for the screw. Now, by screwing down on the nut, any backlash that has developed between the screw and the thread in the toolbox may be taken up very easily. The take-up nut is usually fitted with a locknut. A differential arrangement is sometimes used on a lathe tool slide, in which case the fine thread is used for feeding and the coarse for rapid withdrawal of the tool.

For making the simple-screw model the following material is required:

Base, 6 by 5 by  $\frac{3}{4}$  in.  
Two uprights and one cap, 3 by 3 by  $\frac{1}{2}$  in.  
Table,  $3\frac{1}{2}$  in. square by  $\frac{1}{2}$  in.  
Screw,  $\frac{3}{8}$  in. standard, 5 in. long, with nut.  
Two  $\frac{3}{8}$ -in. washers.  
Bar, 6 in. long by 3-16-in. diameter.  
Weight (resisting force), base  $1\frac{1}{4}$  in. square, top  $1\frac{1}{4}$  in. square, side  $1\frac{1}{2}$  in. high.

Square and face all wooden parts with a finish bevel on top of the base and table. Turn off the threads of the screw for 1 in. of its length at one end, rounding the extremity. Three-fourths inch from the end, drill a  $\frac{3}{32}$ -in. hole through the diameter and insert the rod therein. Locate the center of the cap and about this point chisel out the outline of the screw nut. Insert the nut in the space and retain it in position by bolting the washers on each face; thus, the walls of the cap prevent rotation of the nut and the faces of the washers prevent end movement. Form a bridge by screwing the cap to the top of the two uprights. Center this assembly on the base, securing it with screws and glue. Drill a No. 18 hole  $\frac{1}{2}$  in. lengthwise of the screw, in the rounded end. Drill a No. 29 hole in the center of the table and insert therein a 8-32 machine screw, 1 in. long, securing it with a nut. Place the extension of this machine screw in the end of

the large screw and insert this assembly into the nut, revolving same into suitable position by means of the rod. Rest the weight on the table. Finish as desired.

For the model of the differential screw use the following material:

Base,  $4\frac{1}{2}$  by 2 by  $\frac{3}{4}$  in.  
Two uprights,  $5\frac{1}{2}$  by  $1\frac{1}{2}$  by  $\frac{1}{2}$  in.  
Beam,  $2\frac{3}{8}$  by  $1\frac{1}{4}$  by  $\frac{1}{2}$  in.  
Table,  $3\frac{3}{4}$  by  $1\frac{3}{4}$  by  $\frac{1}{2}$  in.  
 $\frac{1}{2}$ -in. bolt and nut, 3 in. long.  
2-in. flat-head machine screw, 16-18.  
Brass rod, 3-16 in. diameter,  $2\frac{1}{4}$  in. long.  
Wood screws: four round-head, No. 6, 1 in.; four flat-head, No. 6,  $1\frac{1}{2}$  in.  
Weight (resisting force), base  $1\frac{1}{4}$  in. square, top  $1\frac{1}{4}$  in. square, side  $1\frac{1}{2}$  in. high.

Square and face the wooden parts with a finish bevel on the top of the base and on the edges and one end of the uprights. Drill two  $\frac{1}{2}$ -in. holes in the side of the uprights, with centers  $\frac{3}{4}$  in. and  $2\frac{1}{2}$  in., respectively, from opposite ends. Saw out the material between these holes, leaving long round-end slots,  $2\frac{3}{4}$  in. long. On

a line across the uprights, 2 in. from the flat end, center two  $\frac{1}{8}$ -in. holes  $\frac{5}{8}$  in. apart. In the center of the beam, chisel a hole to accommodate the  $\frac{1}{2}$ -in. nut. Saw out shoulders in each corner of the table blank, leaving  $\frac{1}{2}$ -in. central tenons. Drill and countersink a No. 6 hole in the center of this table and screw therein the 16-18 machine screw, sinking the head. Turn or saw off the head of the  $\frac{1}{2}$ -in. bolt and drill a hole laterally through the shank to accommodate the  $\frac{3}{16}$ -in. brass rod. In the other end of this bolt drill longitudinally a No. 6 hole, 1 in. deep and tap 16-18. Screw the  $\frac{1}{2}$ -in. bolt the full length of its threads into the nut in the beam. Screw the table screw into the hole in the opposite end of the bolt. Secure this differential assembly to the two uprights by round-head wood screws passing through the two  $\frac{1}{8}$ -in. holes in the uprights and into the beam, allowing the tenons to be guided by the upright slots. Center this assembly upon the base, securing with glue and screws from beneath. Place the weight on the table. Finish as desired.

☛ A mechanic who lost the nut from a hand emery grinder when on a job away from the shop, made a new one by bending a piece of tin into a square, about  $\frac{3}{4}$  in. across, laying this on the spindle and casting it full of babbitt.

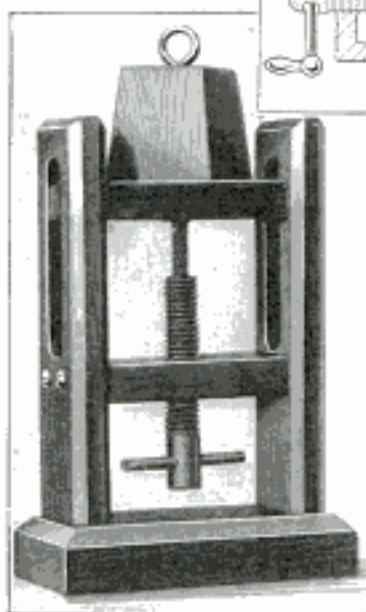

Model of the Differential Screw:  
Above, One Application  
of This Mechanism

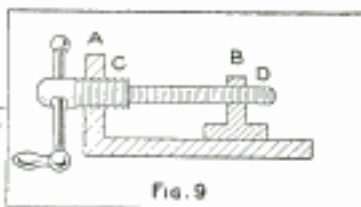



### Coping Serves Double Purpose

Stucco houses of Spanish type are becoming quite popular in many places. They are made without eaves, to imitate the adobe houses of early days. The top of the walls is usually made flat and a considerable amount of soot and dirt gathers on it, especially in cities. With every rain this dirt is washed off and runs down the walls, leaving ugly stains on them which

the strength of the wood for ordinary commercial purposes, no absolutely effective method of preventing it other than kiln drying has been found. Kiln tests have shown that a temperature of 140° F. for a period of six hours is sufficient to kill the blue-stain fungus in the center of test pieces up to 4 by 4 in. square. No chemical dip for green lumber has been found that is remedial, in periods of continued rain, during the warm months. Until a suitable method of prevention is found applicable in cases where kiln drying is not feasible, intelligent utilization of the discolored stock remains the only means of discounting the damage done by the blue-stain fungus, when the methods now available have failed to keep it out. Resurfacing does not help when the fungus has made substantial penetration.

As blemish in any degree destroys the beauty of the grain of the wood, bright stain-free stock is highly desirable for a large variety of uses requiring a natural finish. But for many purposes where the wood is to be covered up or painted, and where the use of sapwood is permissible, there is no reason for discriminating against blue-stained material, provided no wood-destroying fungi are associated with the stain.

As the conditions that favor the development of the blue stains in sapwood also offer the opportunity for infection with the wood-destroying fungi, the holder of such material should assure himself that no indications of these harmful fungi are present before recommending the use of badly blued stock.

Blue stain is freely accepted in rough lumber, lath, scantling, plank, and some of the larger sizes of dimension stock. More could well be used in the manufacture of sash, doors, millwork, and other products when the wood is to be painted or the discoloration otherwise hidden from view.

Greater confidence in decay-free blued stock can be built up if the dealer will make clear to the customer the fact that blue stain does not seriously affect the strength of wood, and will suggest specific uses. Efforts in this direction will be greatly reinforced when blue-stained lumber comes into wider use and justifies the claims made for it.—U. S. Forest Products Laboratory, Madison, Wis.

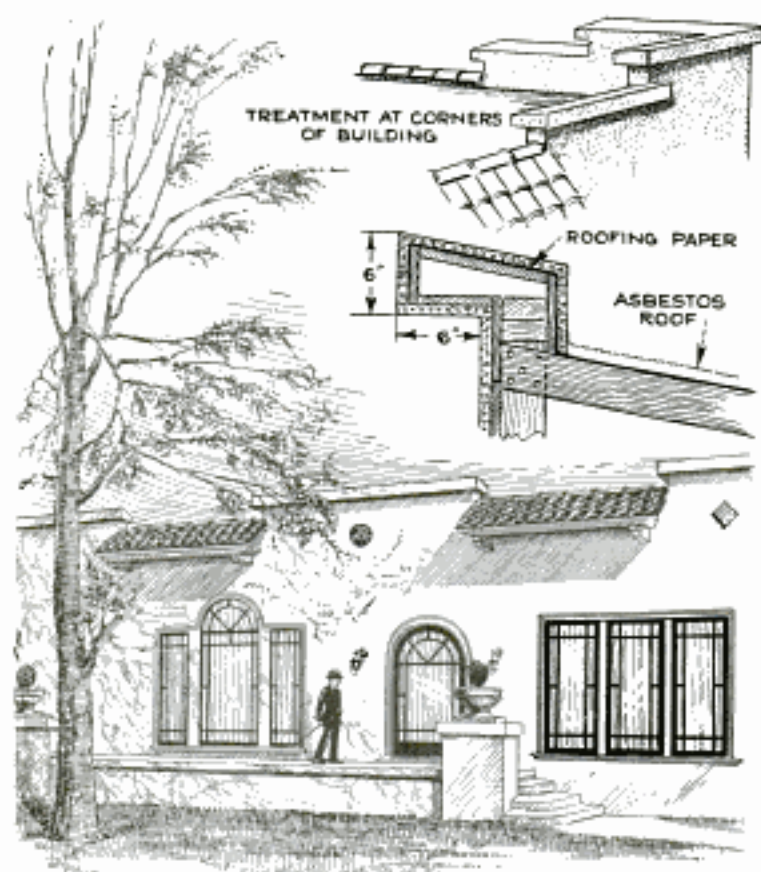

Wide Coping Slanting toward the Inside Prevents Rain and Dirt from Running Down the Outside Wall

greatly detract from the neat appearance of the building. This can be prevented by slanting the top of the coping toward the roof so that the water will run that way. A coping, 12 in. wide, slanting toward the inside with a 6-in. overhang and broken at regular intervals with tiled eaves as shown in the drawing, also gives a distinctive touch to the design of the building. The roof drains toward the center and then to one side, where the water is carried away by a single pipe.—A. May Holaday, San Jose, Calif.

### Using Blue-Stained Lumber

While blue stain in lumber is not an early stage of decay, but merely an indication of the presence in the sapwood of a fungus which does not materially affect



Bearings from hardware store or junk shop,  
 or can be made up at some  
 machine shop

# HOMEMADE CIRCULAR SAWS

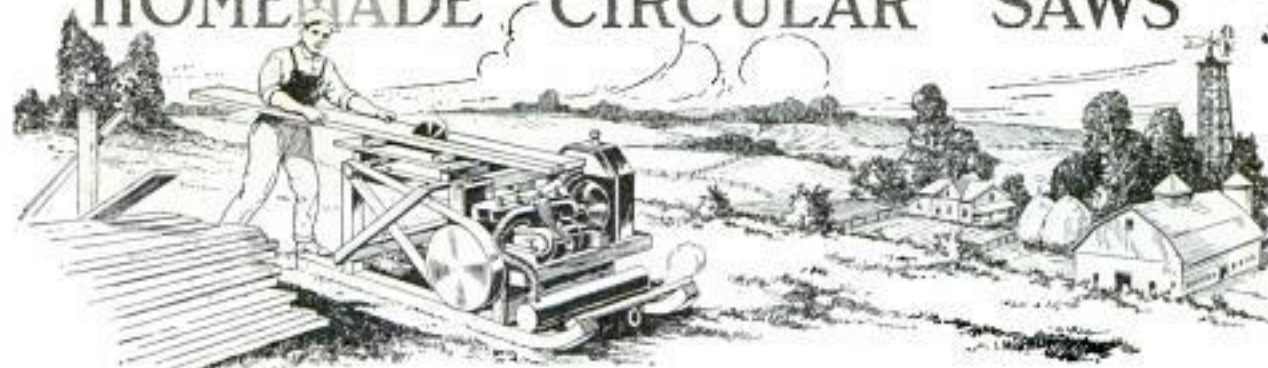

ONE of the handiest tools around the farm is a circular saw; uses will be found for this tool almost daily. Even the amateur woodworker can well spare the time to make a circular saw when the time and labor saved on subsequent work are taken into consideration. The saws described in this article can all be made by any man handy with tools, and will prove desirable additions to any workshop.

The power saw shown in Figs. 1 to 8 was built by a California carpenter. The power plant is one taken from an old automobile; the belt, lacing, 1-in. mandrel and 12-in. cut-off and rip saws were purchased from a mail-order house at a cost of \$12.50, and the cost of the bolts totaled \$2.00. Fir, 2 by 4 in. and 2 by 3 in., was used for the frame. The drawings give the actual dimensions of the original saw, but these, of course, can be readily modified to suit any

the 2 by 4-in. stock, 4 ft. 11 in. long, assembled with three cross sills, 18½ in. long, the cross sills being gained into the long ones. The height of the saw frame is 26 in., and it will be noted from the drawings that the two mandrel rails, as well as the third rail at the outside, are gained into the end rails, and that the legs are bolted in two directions through the inside corners with ¾-in. carriage bolts, 6 and 8 in. in length. To stiffen the mandrel rails, two 2 by 3-in. crosspieces are bolted edgewise on the underside with the same bolts that hold the bearings in place. The legs are braced by nailing 1 by 4-in. strips inside them, as indicated.

The detail of the saw table shows a form of construction productive of rigidity, while enabling the underside of the oak-flooring surface to lie close to the saw washers, thus providing for a maximum

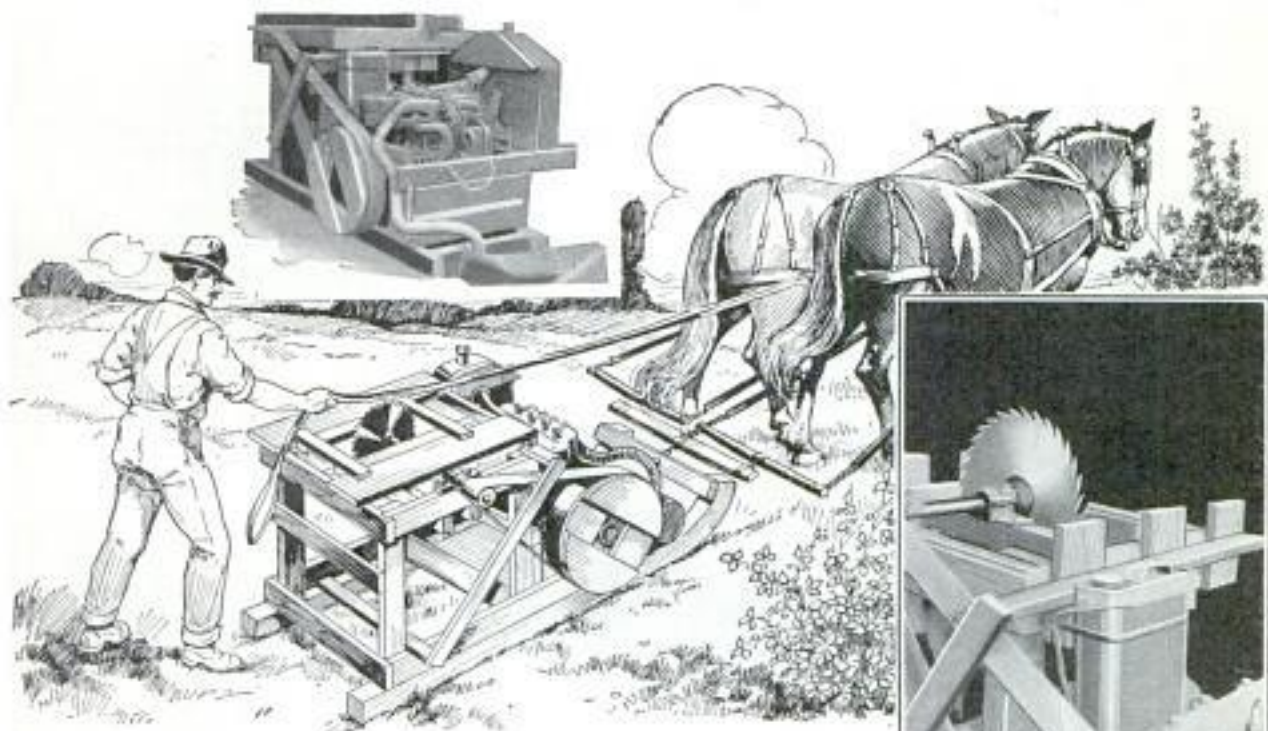

Above, Engine End of Saw Frame; Center, Saw Mounted on Skids for Farm Use; Right, Closeup of Table Guides and Gasoline Tank on Frame

type or size of engine and mandrel. The rise of the base of the frame consists of two sills of saw blade

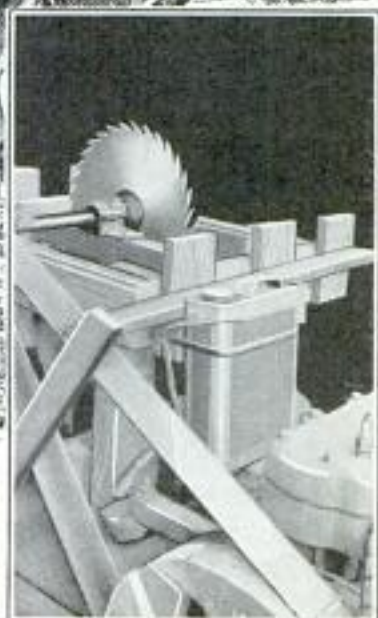



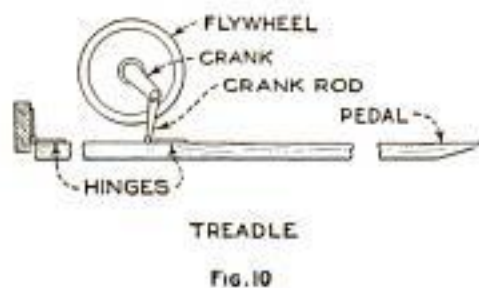
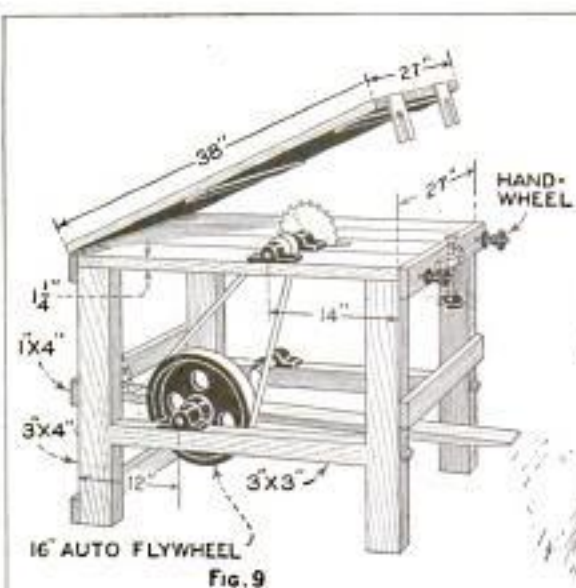

Figs. 9 to 11, Working Drawings for Building a Foot-Power Circular Saw, with Detail of Mounting of the Treadle and a View of the Saw in Use; Fig. 12, Saw Mounted on the Front End of a Ford Automobile for Contractor's Use



above the table. The oak flooring is run crosswise of the wide span between the rails, with the four end boards running full width, while the remaining space is filled with boards running lengthwise. The boards are toenailed with six-penny box nails and nailed through the surface with six-penny finishing nails, the heads being set in and the surface scraped flat and sanded smooth. A saw slit is cut as indicated, and widened for 6 in. along the center for dado-head clearance. To provide for accurate placing of the table, three pieces of 1 by 4-

against the 1 by 6-in. pieces of the dado table when the rider is put in position for use. Since these pieces act as stops against which pieces for cross dadoing are held, they are cut accurately square.

In use, the table is slipped over the vertical guides of the saw frame and tacked in place with small nails to prevent shifting. The rider is then placed between the guides, which have previously been waxed to reduce friction, and the stock to be dadoed is held firmly against the near stop while the rider is slid forward against the dado saw. For long

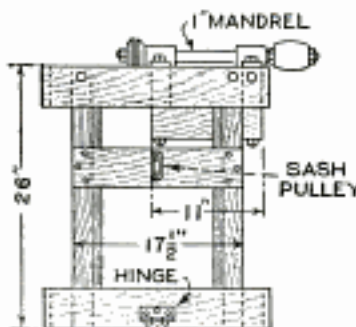

Fig. 1: FRONT VIEW

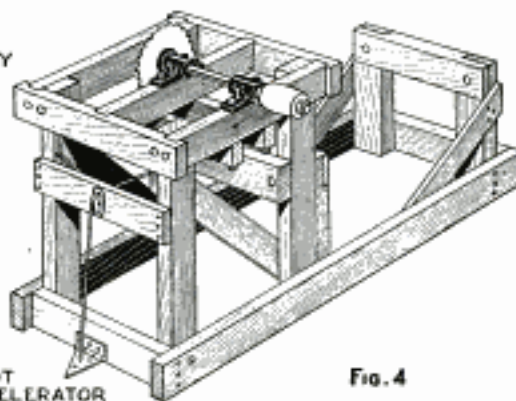

Fig. 4

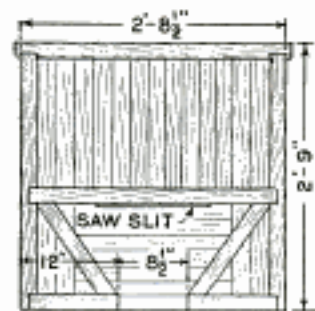

Fig. 3: SAW TABLE

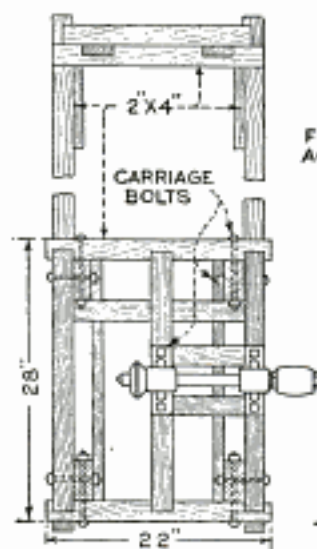

Fig. 2: PLAN

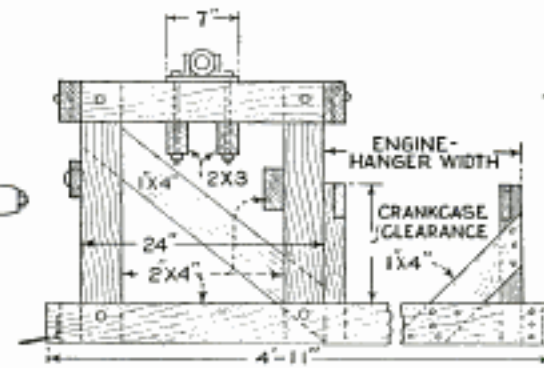
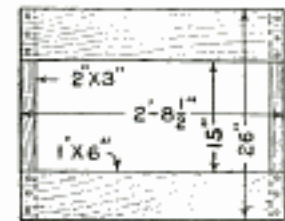
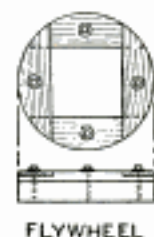

Fig. 5: SIDE VIEW

DADO TABLE AND GUIDE  
Fig. 6RIDER  
Fig. 7FLYWHEEL  
Fig. 8

Details of the Construction of the Power Saw; Figs. 1 to 5 Show the Construction of the Frame and Table; Figs. 6 and 7 the Dado Table and Its Rider, and Fig. 8 the Method of Building Up the Flywheel

in. stock, 7 in. long, are nailed vertically on the outside of the end rails of the mandrel frame, as shown in one of the photographs, and extend above the rails  $3\frac{1}{4}$  in. These bear accurately against the table rails and prevent sliding of any kind. For use with a dado head, the special table shown in Fig. 6 is used. It consists of two pieces of 1 by 6-in. fir, 2 ft.  $8\frac{1}{2}$  in. long, nailed to crossrails of 2 by 3-in. stock, leaving the distance between the 1 by 6-in. pieces exactly 15 in. These pieces form guides for the rider, Fig. 7, in which two slides of 1 by 3-in. material are held parallel, 15 in. apart (outside edges), by crosspieces 20 in. long. The projecting  $2\frac{1}{2}$ -in. lugs at each end of the crosspieces bear

work, it is useful to tack a strip of wood over the tops of the cross strips, so that a wedge or chisel can be driven between it and the work. Where it is desirable to dado at an angle, a suitable wedge-shaped piece is held between the stop and the work.

In mounting the engine, the automobile was stripped and the frame cut through behind the engine, and the assembly, complete with the radiator, mounted crosswise on the saw frame. The flywheel was thickened with two layers of wood, in the manner indicated, to form a drive pulley, which was belted to the mandrel. A gallon oilcan, with a feed pipe soldered to the lower end and held against the saw frame



with strips of thin iron, serves as a gasoline tank, and a stout cord brought under the table, through a sash pulley, and attached to a T-hinge on the base, as a foot accelerator.

It will be noted that no special provision is made for varying the height of the table. Since most dados in carpentry are only  $\frac{3}{8}$  in. deep, the dado rider is equipped with shims of suitable thickness under the cross strips to hold the stock at the right height, and as for tilting, the same effect is obtained by the use of guide strips tacked to the top of the table. The fence consists of a length of 2 by 3-in. stuff, nailed to the bar of a wooden clamp, which is screwed tight across the table wherever needed.

In measuring the belt, the length should be taken when stretched around both pulleys and 2 in. cut off before lacing. Friction tape wrapped around the mandrel pulley prevents slipping, but if the belt persists in coming off, two wooden strips can be nailed to the frame, above and below the belt, and connected with a third strip across the outer edges of the belt, and this will effectually prevent the loss of a belt that is properly fitted.

To make the saw still more useful to the farmer, a heavy sled or skid, made of 4 by 4-in. stock, can be fitted under the saw frame. The saw can then be drawn by a couple of horses or the tractor to the wood lot, or elsewhere it is required.

The saw shown in Figs. 9 to 11 is more suitable for the amateur woodworker than the one just described, and while it is operated by foot power, is every bit as practical for the small shop as the other one.

The legs of the frame in this case are made of 3 by 4-in. stock, and the cross-pieces or shaft-bearing rails of 3 by 3-in. stuff. The rails may be gained into the legs as before, but a simpler construction is to fasten them, as shown in the drawing, with lag screws. The bearings for the crankshaft and mandrel, the mandrel, belt and hinges can all be obtained from mail-order houses. The crankshaft and fly-wheel can be picked up at any auto junk yard, and the crankshaft can be used in some cases just as it is, without sawing it off to length, and using only one crank. The table top should be made of oak,  $1\frac{1}{4}$  in. thick—flooring boards will serve—and the hinged top of the same material. The auxiliary top is hinged to one end of the table proper, or rather to the top 1 by 4-in. cross brace at one end, and the other end of the table is fitted with two pieces of  $\frac{3}{8}$  by 2-in. iron or cold-rolled steel, drilled and countersunk for heavy screws and

slotted for the  $\frac{3}{8}$ -in. clamp screws. The clamp screws pass through the cross brace from the back, and are fitted with large handwheel nuts and washers. A table-raising screw is fitted to this end of the table also.

A foot lever is hinged to the center cross brace at the opposite end of the table, and connection made to the crank by means of a short connecting rod, as shown. The details of this rod are left to the maker, as the one on the original machine was made of scrap parts, and probably could not be duplicated; however, this is a part that is readily made. Care should be taken that the crankshaft is placed at such a distance from the pivot that the travel of the outer end of the foot lever will not be too great for convenience in operating it. The lever is made of 1 by 4-in. material.

Figure 12 shows a saw rigged up on the front of a Ford car by a contractor, for use on work away from the shop. The frame was attached to the axle and the crank handle removed, so that a sleeve could be fitted in its place. The inner end of the sleeve is slotted to engage the pins on the forward end of the crankshaft in the same manner as the crank handle, and a shaft carrying a pulley welded into the front of the sleeve. The front end of the shaft is carried in a bearing on the frame, and the pulley drives the saw mandrel in the usual way. Constructional details are not given for this saw, as the method of connecting the frame to the car differs with the automobile used, and also the method of driving the pulley shaft, but with the illustration given no great difficulty will be met.

### Replacing Broken Wood Inlays

Broken wood inlays can be neatly repaired as follows: Dissolve in ether a piece of gum arabic large enough to replace the missing piece, making a solution about the consistency of soft putty. Add some finely powdered wood of the same kind, color and shade as the missing piece. This powder can be made by simply filing a piece of wood. When the mixture matches the wood, it is worked into the depression left by the missing piece, so that every corner is filled, and tamped down tightly, but allowing the patch to project a little above the surface. The tamping can be done by pressing in the mixture evenly with a spatula or, in case a large quantity is used, with a putty knife. After the mixture has dried thoroughly, it is sandpapered down and polished.—Matt C. Roemer, Appleton, Wis.



### Emulsion for Spraying Fruit Trees

An emulsion of kerosene and water is effective for killing all leaf-eating or sap-sucking insects on fruit trees. One pound of wheat flour is mixed in 1 qt. of kerosene and then about 15 qt. of water are added. This mixture will remain emulsified for some time, but it is best to use it immediately.—J. W. Walker, Wellington, New Zealand.

### A Stanchionless Dairy Barn

There is a dairy barn near Omaha, Neb., which houses 76 cows without having a single stanchion, as shown in the photo. The owner claims that this arrangement gives the cows more freedom and costs much less than stanchions. The interior of the barn has a row of 6 by 6-in. posts on each side of the feed alley to support the roof. Near the bottom of each post an iron rod, bent to the shape shown, is provided to hold a chain, which is run along the posts the whole length of the barn and is securely fastened at both ends. A rope with a harness snap is put around the neck of each cow and then snapped to the chain. As the bars on the posts are 14 in. long, the chain can be moved vertically this distance, while lateral movement is limited by the length of the rope, so that the cows cannot crowd each other. Another advantage of the

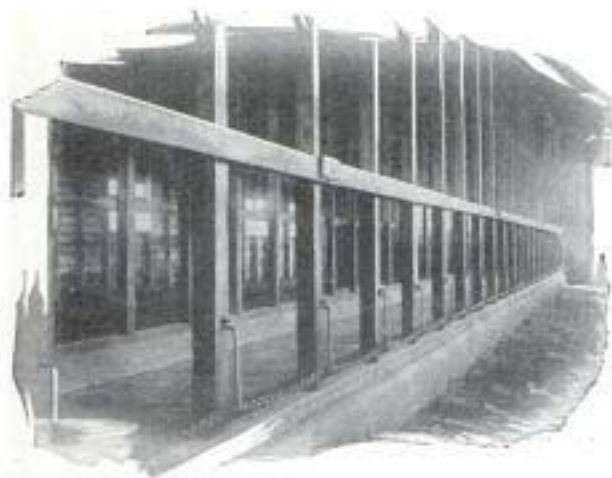

Stanchionless Dairy Barn Houses a Large Number of Cows and Can Be Cleaned Easily

freedom from stanchions is that the barn can be cleaned much more easily, a decided advantage in the average dairy.—Dale R. Van Horn, Walton, Neb.

### A Novelty in Cellar Excavation

Basements for large buildings are usually dug with steam shovels, or some similar type of excavating machine. In such cases, an inclined roadway is left in some

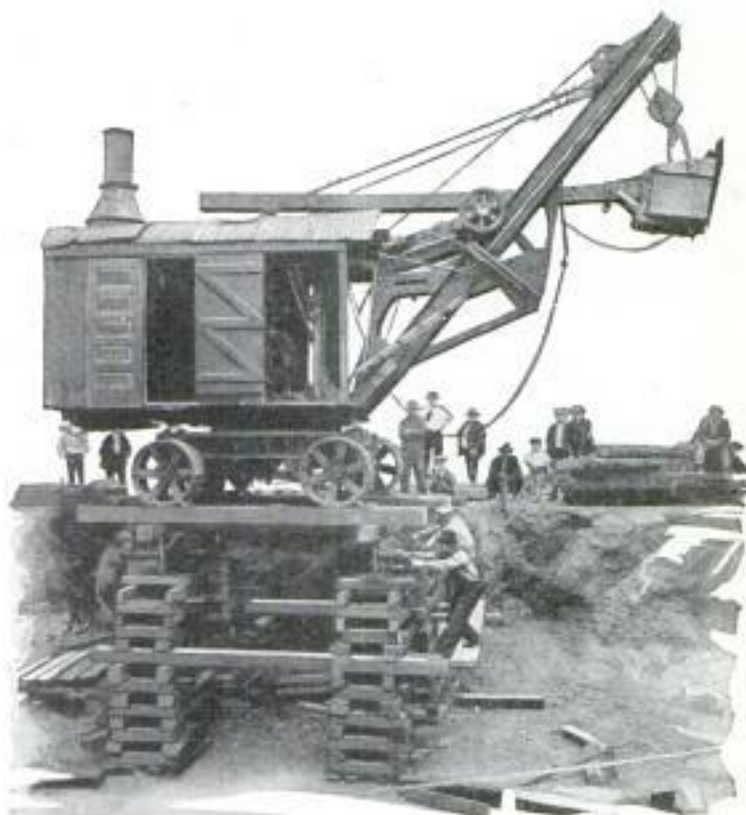

A Novelty in Small Cellar Excavation: the Shovel Was Jacked Up and Removed from the Hole on Rollers

part of the basement over which the machine pulls or pushes itself out of the basement when the job is finished. The roadway is then removed by men and teams. The complete excavation of all material in a comparatively small cellar by a steam shovel, and the subsequent removal of the shovel by raising it on jack screws and moving it out on rollers, is a distinctly novel performance.

The accompanying photo shows a 21-ton  $\frac{3}{4}$ -yd. shovel being removed in this manner, after having completed the excavating of a cellar, 12 ft. deep, in the congested district of Dayton, Ohio. The use of teams and wagons was impracticable on account of the small area of the excavation and the cramped quarters in which it was located. It required one day to dig the cellar, and one day to remove the shovel.—Ivan E. Houk, Dayton, Ohio.

☞ In making a mechanical drawing, the French curve was found too short. A length of  $\frac{1}{8}$ -in. wire solder bent to the desired curvature was found to be an excellent substitute.



### Novel Roof Economizes Lumber



Temporary buildings can be roofed much more quickly and with less lumber if the roofing boards are laid across the rafters diagonally, as shown in the illustration. Each board overlaps the one below it in order to shed rain, making the roof practically waterproof. Roofs made in this way have been found quite satisfactory.—Bunyan Kennedy, McCool, Miss.

### Stand for Tube Polishing

Anyone who has had the job of polishing brass tubes as commonly used for rail fittings will appreciate the method shown in the drawing, as it relieves the operator of most of the exertion required. By using this method large lots of tubes have been polished without undue fatigue, whereas it is a very tiring task when each tube must be held in the hands and pressed against the wheel by the operator.

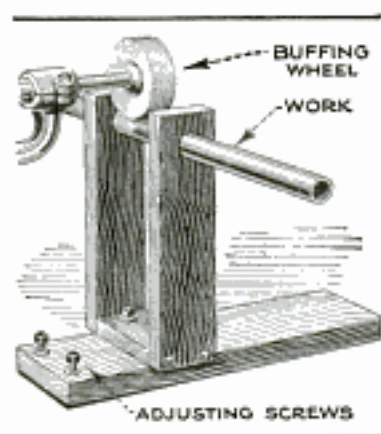

When using the method illustrated, the tubing is slipped through holes drilled in a wooden stand, made up of hardwood planks, the base being about 6 ft. long and fitted with two adjusting screws at one end. Two shorter sidepieces are bolted to a center piece, and this is in turn bolted to the base near one side, just tightly enough to allow it to be swung on the bolt without difficulty. Both sidepieces are drilled through near the top to take the tubes to be polished and the stand is set up under

the buffing wheel. The operator inserts the tube through both holes in the fixture and stands on the base while revolving the tube and pushing it along. To prevent a hollow being worn in the center of the wheel, the tube is worked back and forth sideways now and then. It is for this purpose that the bolt connecting the sidepieces to the plank on the floor is put off center, so that a slight side movement of the tube sweeps the latter across the face of the wheel. As the wheel wears down, the two screws in the end of the plank are turned to raise the stand, in order to attain the right pressure on the wheel.—Harry Moore, Montreal, Can.

### A Comfortable Machine Handle

In many instances the handles supplied on machines are not suitable for the conditions under which the machine is used. Handles for raising tables, for example, are usually made in such a way that they barely clear the edge of the table, and the operator's fingers are liable to be pinched. If the handles are bent outward to give good clearance they interfere with the free movement of the workman unless they are

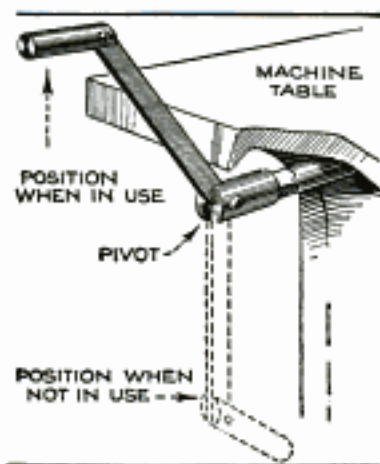

taken off the machine after use, which is also inconvenient. To overcome this trouble the handle shown in the illustration was devised and found entirely satisfactory, as it has the advantages of providing a

abundant clearance and being completely out of the way when not in use. The sleeve fitting the rod on the table screw is slotted on the end opposite the square to take a flat extension, which carries a round handle riveted tightly at an angle at the other end. The extension piece turns easily on a pin driven through the sleeve and is rounded at this end to permit it to drop down as shown. The slot in the sleeve is cut at about a 45° angle to the axis so that, when the handle is pressed up against the bottom of the slot while turning, it clears the table easily. The raising or lowering of the table is always finished with the handle up, and, when released, it drops completely out of the way.





## Storage Battery for Dry-Cell Tubes

By L. B. ROBBINS, *Harwich, Mass*

**D**RY-CELL tubes are very popular, especially those consuming only .25 amp. at  $1\frac{1}{2}$  volts, which require but a single dry cell. The only drawback to them is that when using three or four tubes, the replacing of as many dry cells every two or three weeks (if the set is used much) costs considerable money. At 40 cents each, for four tubes, it means \$1.60 each time new ones are purchased, and the old ones are practically good for nothing.

A storage battery for lighting these tubes can be built for less than \$2, and,

recharging, and that at a cost of not over \$1. The battery shown in the illustration has proved entirely satisfactory in use. First, an old automobile battery—6-volt, 100-amp.-hr. capacity—was dug out of the scrap at a battery-service station. Many such batteries—useless for their original purpose—can be picked up for next to nothing. One should be careful, however, to select one in which the posts are intact and the cells tight.

The battery having been obtained, it was set on the bench and the sealing com-

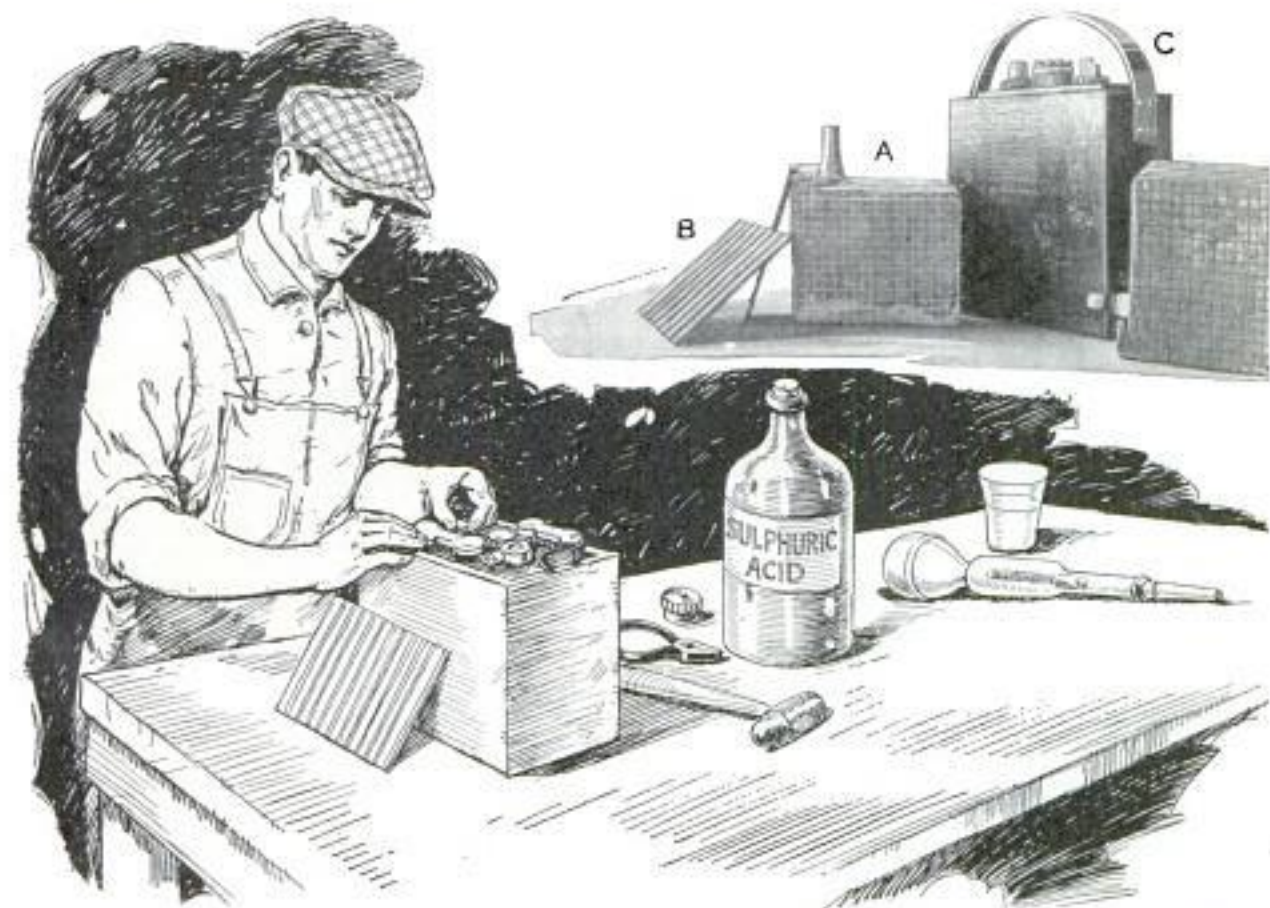

Set of Negative Plates as Taken from the Battery Shown at A; B Is the Separator and C the Finished Battery; This Cell Has the Original Filler Plug, but if This Is Spoiled, a Cork Can Be Used as Suggested

with proper care, should last four or five years. If of about 100-amp.-hr. capacity, it will light four .25-amp. tubes for between 300 and 400 hours before requiring

pound softened by pouring boiling water on it, so that it could be chipped and pulled away in large chunks. This was continued until the cells were clear. It



may be necessary, in some cases, to knock off the wood casing and saw through the lead connectors.

When the cells were clear, the sealing compound was cut away from the tops of the individual cells and the plates lifted out. The acid remaining in the cells was then cleaned out, and the sediment knocked from the bottom. Then the cells were thoroughly flushed out with warm water and set aside, upside down, to dry.

The plates were then examined, and the best set of negative plates—the light-colored ones—chosen and set to one side. The positive plates were found beyond use, as they usually will be. These were replaced with a new set purchased from a battery-service station to match the negative set, taking care to get just as many plates in the new assembly as in the old one. The positive plates should be one less in number than the negative ones.

The plates were assembled in exactly the same way as they were when removed from the cell, separators being inserted between them and the posts placed oppo-

site each other. They were then placed in a cell that had proved sound and tight. A piece was cut from one of the spare cells to fit in the top of the cell used and holes made in it for the posts. A 1/2-in. filler hole was bored in the center and a cork inserted in it. Sealing compound was next poured in until the cell top was completely filled to a depth of 1/2 in. Finally, a box was made, with a lifting strap, and the cell inserted and sealed in the box. When filled with electrolyte the battery was ready for service. In using the storage battery, be sure to take a hydrometer reading every two or three days, and recharge whenever the gravity gets below 1.250. A gravity of between 1.280 and 1.300 will insure a fully charged cell and give complete satisfaction.

With a home charger, the expense of recharging can be cut down considerably. The writer uses a Ford generator belted to a small pumping engine, cutting down the voltage by means of a wire rheostat to about 3 volts. Two hours' charging twice a week keeps the battery fully charged all the time.

### Radio Aids New York's Smallest Bookshop

The miniature bookstore shown in our photo is the smallest in New York, and is



New York's Smallest Bookstore Finds Radio a Great Help to Business

owned and operated by Miriam Rankine Blacker. It is equipped with a complete radio-receiving set.

Miss Blacker had the radio set installed when she discovered that the various stations were broadcasting stories, novels, household hints, etc., which created quite

a demand for the books and the magazines from which the stories and hints were taken. She now keeps these in a special section of the shop, and is able to furnish them immediately.

### Paint for Cardboard Panels and Coils

An insulating paint, which has been found serviceable for painting cardboard panels and coils in radio work, can be made by anyone at practically no cost. A pint of denatured alcohol is obtained, and an old phonograph record, which is broken up into many small pieces, is dropped into the alcohol. This can be done best in a fruit jar. The cap is screwed down tightly and the mixture allowed to stand for a few days until the pieces of record have been thoroughly dissolved. The mixture is stirred well before it is used and is applied with a brush. The work must be done fast, as the paint dries rapidly, leaving a black film on the surface. Two coats are sufficient for any material. The application stiffens the cardboard considerably and produces a fine dull finish. One pint of the mixture will cover from 15 to 20 sq. ft., and sometimes more.—David J. Morris, Weir, Tex.

*Rosehill Farm Co #1*  
 In the table on page 129 of the July, 1924, issue, for UC-301A and UC-302 tubes read C-301A and C-302.



Emb. Mrs. J. S. Coleman,  
3315 Montgall Ave.

Kansas  
City, Mo.

Radio Increases Vocabulary 235-R

The First Radio Wedding 266-R

Approximately five thousand new words have been contributed to the English language by the advent and wide dissemination of radio, according to Dr. Frank H. Vizetelli, editor of the New Standard dictionary since 1891. Ten years ago comparatively few people gave much thought to radio, never concerning themselves about radio-frequency problems or dreaming of such words as heterodynes, superdynes and autodynes, and others. But now many of these words are in common usage even among children, who surprise older people by their mental alacrity and aggressiveness in this new field.

Talking through Your Own Loud Speaker 231-R

Many radio fans are having fun talking through their own loud speakers. The trick is simple; connect the headset across the primary of the transformer of the first stage of amplification, the B-battery being connected and the tubes lighted as usual. Now, by talking into the headset as shown in the photo, the loud speaker will repeat whatever is said. This is one way of "getting dis-



The Wedding Ceremony of Wendell Hall, Well-Known Radio Singer, and Marion Martin, Which Was Broadcast from WEA F

for his radio concerts, was married to Miss Marion M. Martin, a Chicago newspaper woman. The ceremony took place at station WEA F, and was broadcast by WEA F, New York City, WCAP, Washington, D. C., WJAR, Providence, R. I., and WGN, Chicago. The officiating minister was Dr. F. S. Idleman, of the First Christian Church of New York City, and the attendants were Thomas Campbell, famous track star, and Dorothy Fullerton.

Pacific + Atlantic

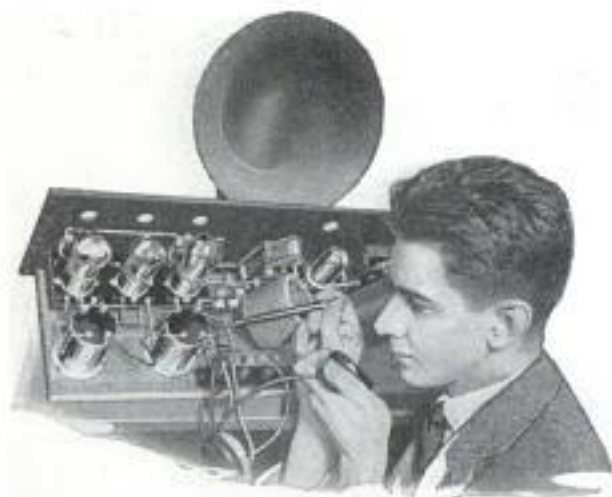

This Shows How the Headset May Be Used to Make the Loud Speaker Talk

tance"; put the loud speaker in another room and have the folks listen in while you talk into the headset. It is then possible to make the loud speaker say "This is 2-LO, London, England," or announce the name of any distant station, when in reality the set may not be capable of receiving over a range of more than a few miles.

Radio Carries Heart Throbs to 750 Physicians 270-R

Seven hundred and fifty stethoscopes, connected by radio, enabled as many physicians to study the heart beats of one patient in the lecture hall on the Municipal Pier, Chicago, at the recent convention of the American Medical association.

The essential part of the apparatus was an amplifier, designed for three stages of amplification of the current changes in a very sensitive transmitter. Three-element vacuum tubes were used, as in the ordinary receiver and transmitter. Radio ear-phones were used, but each physician brought his own stethoscope, which he held against the phones.

The listeners said that this device will enable a whole class of medical students to study heart action simultaneously.

Kadel + Herbert

Post 6/7/24



Photograms, 129 & 27th St  
 New York City

POPULAR MECHANICS

496  
 220-R

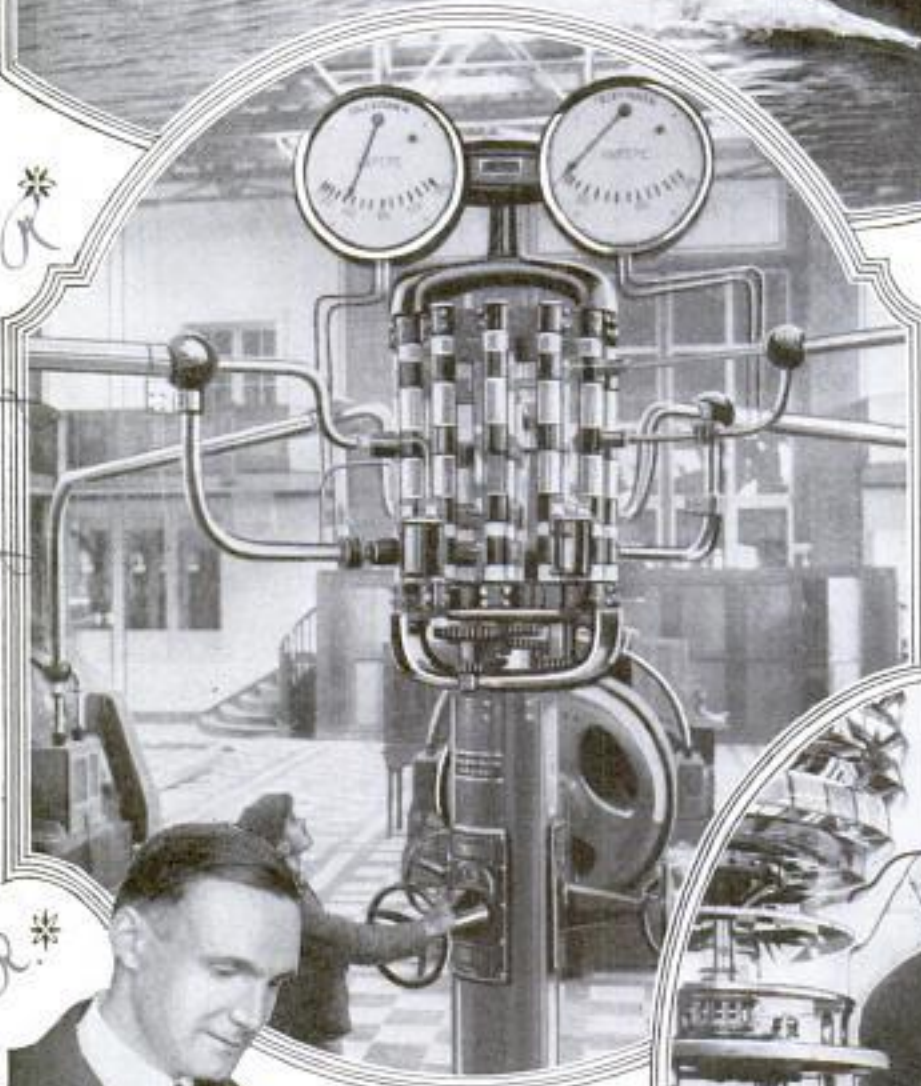
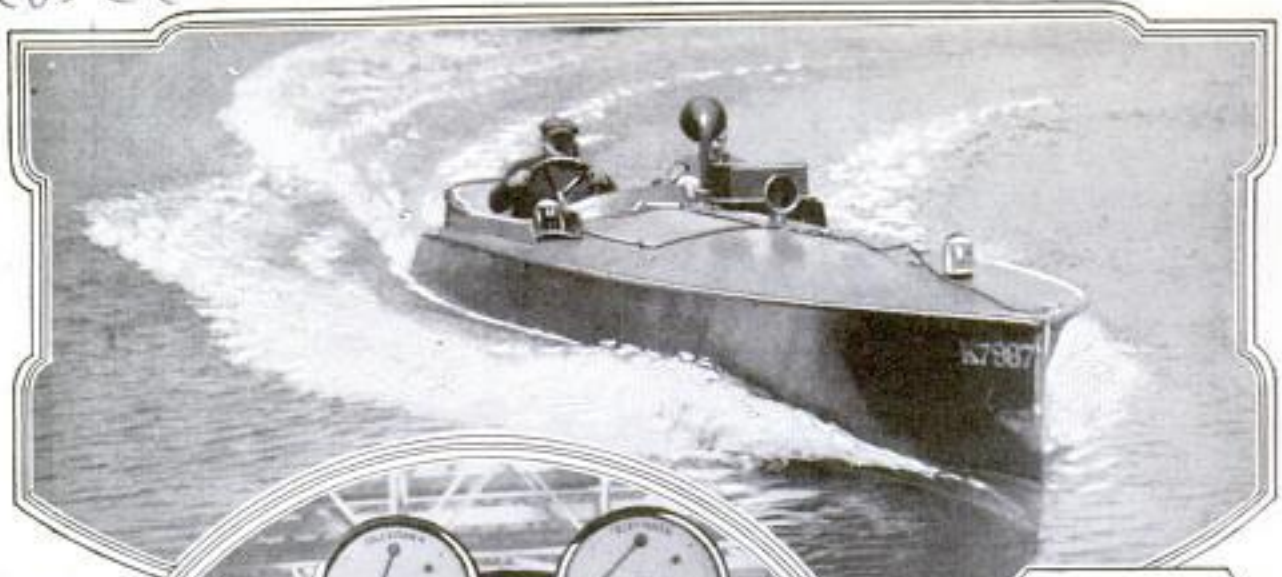

Up-to-the-Minute  
 Speed Boats Now  
 Carry Radio Sets;  
 Left, Giant Central  
 Distributor in the  
 Famous Station at  
 Nauen, Germany;  
 Lower Left, Alfred  
 H. Grebe, Well-  
 known Radio In-  
 ventor, with His  
 Latest Device,  
 Which is Designed  
 to Eliminate Squeals  
 and Howls; Lower  
 Right, Millard Caler,  
 Keeper of the Stony  
 Point Lighthouse on  
 the Hudson, with  
 His In-  
 separable  
 Companion

United Newspapers  
 R. 307, P. 100  
 461-8th Ave.  
 New York City

Wide World Photos  
 229 W. 43rd St.  
 New York City



Photograms  
 Copyrighted material



Wide World  
Photos

POPULAR MECHANICS

247-R  
497



249-R



Pacific - Atlantic  
Circuit

Above, Miss Virginia Smith, Star of "Lollipop," Knows a Lot about Dancing, but the Radio Keeps Her from Slipping by Supplying Her with Music at Home; Upper Right, a Combination of Outboard Motor and a Radio Set Spells Happiness for the Vacationist; Right, Mme. Georgette LeBlanc Accompanies the Broadcast Songs of Her Friends; Below, "Uncle" Phil Schwartz and Jerry Sullivan of WQJ.

© U. & U.





199 R.

Middel



240-R



James J. Davis, Jr. the Country's Youngest Broadcaster

WAZ

Bonnie MacLeary, Well-Known American Sculptress, Amuses Her Little Subject in the Modern Way

244-R



A. U.

Waiting for the Races to Start at Belmont Park, Jockey Burns Tunes In for His Friend Thurber

223-R



Miss Margaret O'Neil Makes Her Set Fit for the Boudoir

Kadel + Herbert



245-R

MSU



Ruth Dace Takes Her Morning Swimming Lesson at Home; the Lessons Are Broadcast from KYW



Marie Conkwright Charms Her Pet Snake by Radio

208-R  
S. Pictorial News  
145 W. 41st St.  
New York



227-R

Radio Is Even Replacing the Cookbook in the Modern Kitchen; Ann Stanford and Lillian Klein Making Candy to a Radio Recipe



Jocko, Stable Mascot at Jamaica Track, Takes a Lesson in Listening In

210-R

MSU



500  
224-R

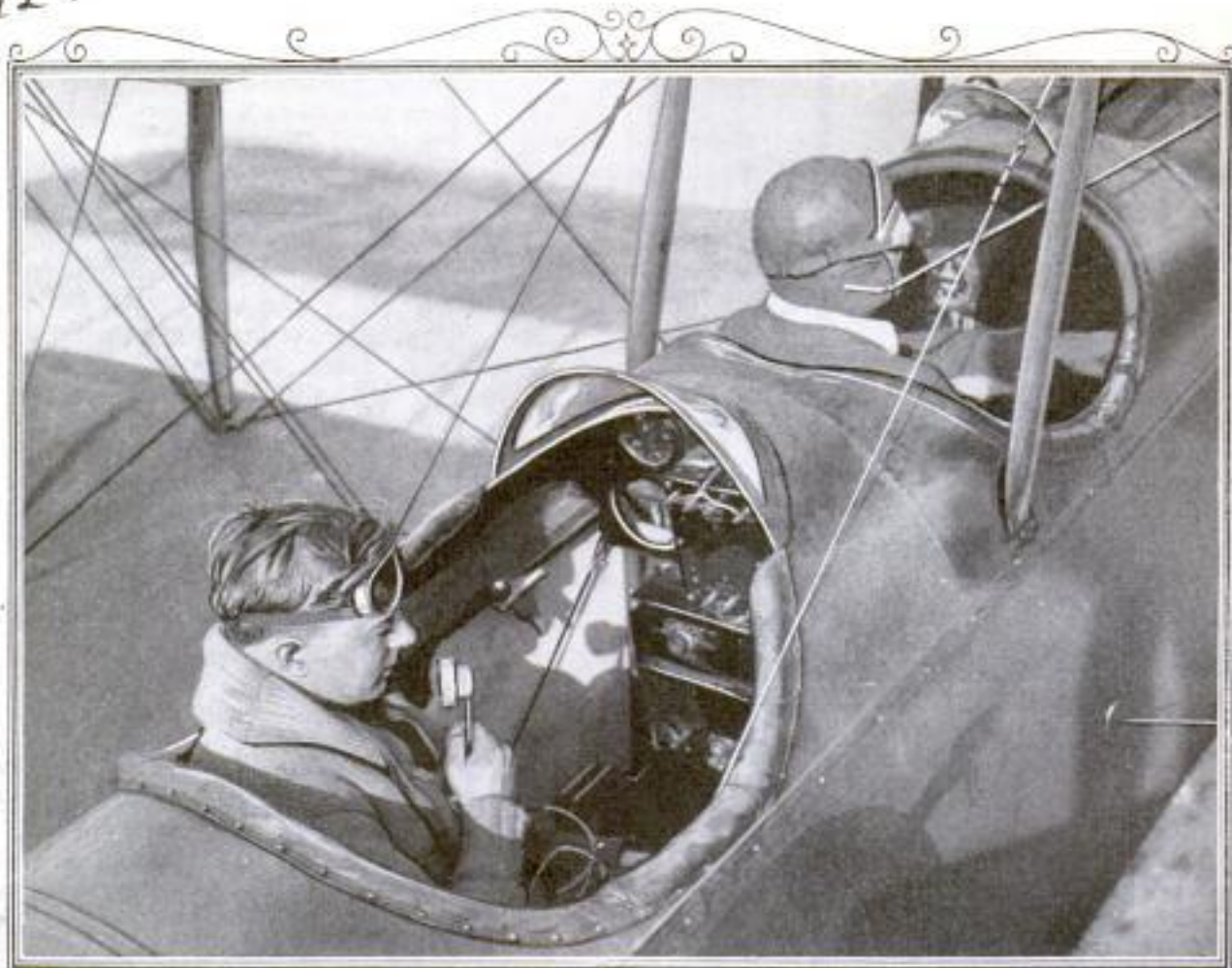

Captain Brower, Former War Ace, Pilots This Plane While a Radio Engineer Broadcasts a Talk on Army Life from the Sky in New York City

241-R



This Is Not a Coil for a Set, but a Very Efficient "Spider-Web" Aerial



Radio Pinch-Hits for Orchestra While Jane and Eva Novak Register Sisterly Affection

Kadel + Herbert





Madge Bellamy, Well-Known Screen Star, Whiles Away the Tedium of a Wait on Location in Nevada



Estelle Taylor Has Found the Radiator of Her Automobile an Effective Aerial



Broadcasting a Baseball Game Play by Play

217 A  
 J.R. Schryver  
 3557 St. Charles Place  
 Hyde Park  
 Copyrighted material  
 Cincinnati, O.



# Making a Push-Pull Amplifier

By F. L. BRITTIN

**B**UT a short time ago it was generally admitted that amplification beyond two stages was not desirable, as the third step would amplify tube noises, and distort the signals to a point where the tone quality was lost. A few experimenters obtained fair results with the third stage, but these were the exception rather than the rule. The addition of the push-pull amplifier to the ordinary audio-frequency amplifier solves the problem in a very simple manner, reproducing the signals with greater volume, but without distortion. This amplifier operates on both

halves of the cycle of alternating current passing through the audio-frequency transformers, the two tubes sharing the load equally. Until recently the transformers necessary for this purpose were not available, but there are now a number of good ones on the market.

The two tubes used may be either UV-201A or C-301A; these are practically placed in parallel, as their grid terminals are connected to the opposite ends of the secondary winding of the input transformer. It will be noted that one transformer is marked "input," the other

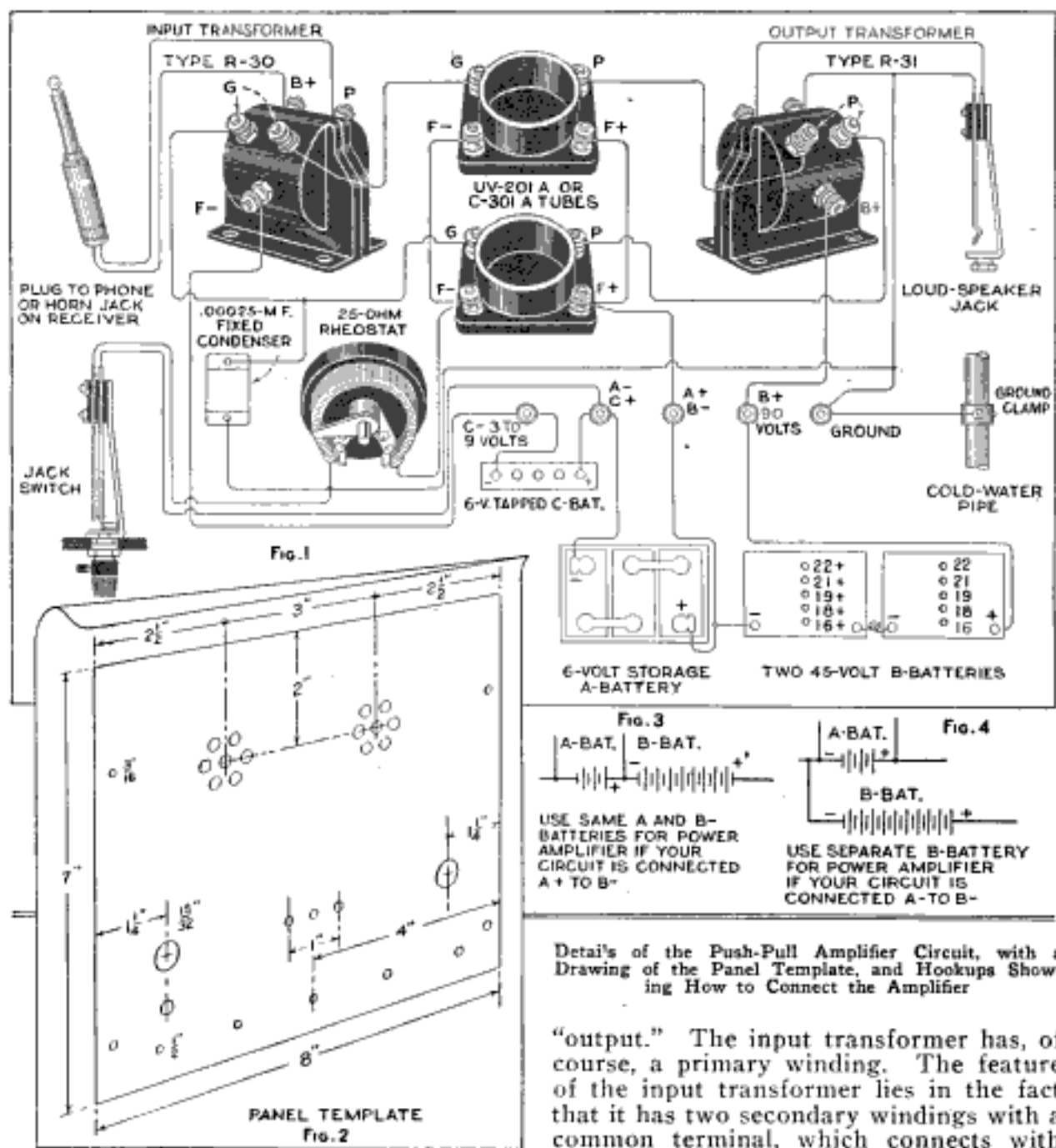

Details of the Push-Pull Amplifier Circuit, with a Drawing of the Panel Template, and Hookups Showing How to Connect the Amplifier

"output." The input transformer has, of course, a primary winding. The feature of the input transformer lies in the fact that it has two secondary windings with a common terminal, which connects with



the negative filament through the C or grid-biasing battery. The other ends of the double winding are used as the grid terminals in this particular transformer. The secondary winding is often referred to as a "split" winding, and sometimes has a center tap which serves the same purpose as the common terminal. The advantage of the double winding is that the impedance will be equal in both, which serves to maintain the balance action described later. The electromotive force applied to the grids of the two tubes is exactly  $180^\circ$  out of phase; in other words, one tube is in operation during one half of the cycle and the other during the second half. This permits a balancing action, and neutralizes the tendency to distortion of harmonics which is commonly produced when only one tube is used as a

however; use lugs under the terminals, and solder the wire to the lugs. This also applies to the tube sockets, and is a good plan to follow wherever lugs can be used, as at the terminals of the grid condenser, etc. The grid and plate lead especially should be as short as possible, to eliminate local feed-back effects.

Under ordinary conditions 90 volts will be found best for the plate potential (this, of course, refers to the B-battery). It is necessary to have a C-battery, and for the tubes specified a 6-volt battery is used. These batteries are provided with taps and the voltage can be varied to suit the particular tubes used. The C-battery can be made up of flat flashlight batteries if difficulty is encountered in obtaining the standard battery. The same 6-volt A-battery can be used as for the receiver, but it is recommended that a separate 90-volt B-battery be used for this amplifier.

In some circuits, as will be noted in Figs. 3 and 4, it is imperative that a separate B-battery be used, or a direct short will occur. It is well to ground the cases of the transformers

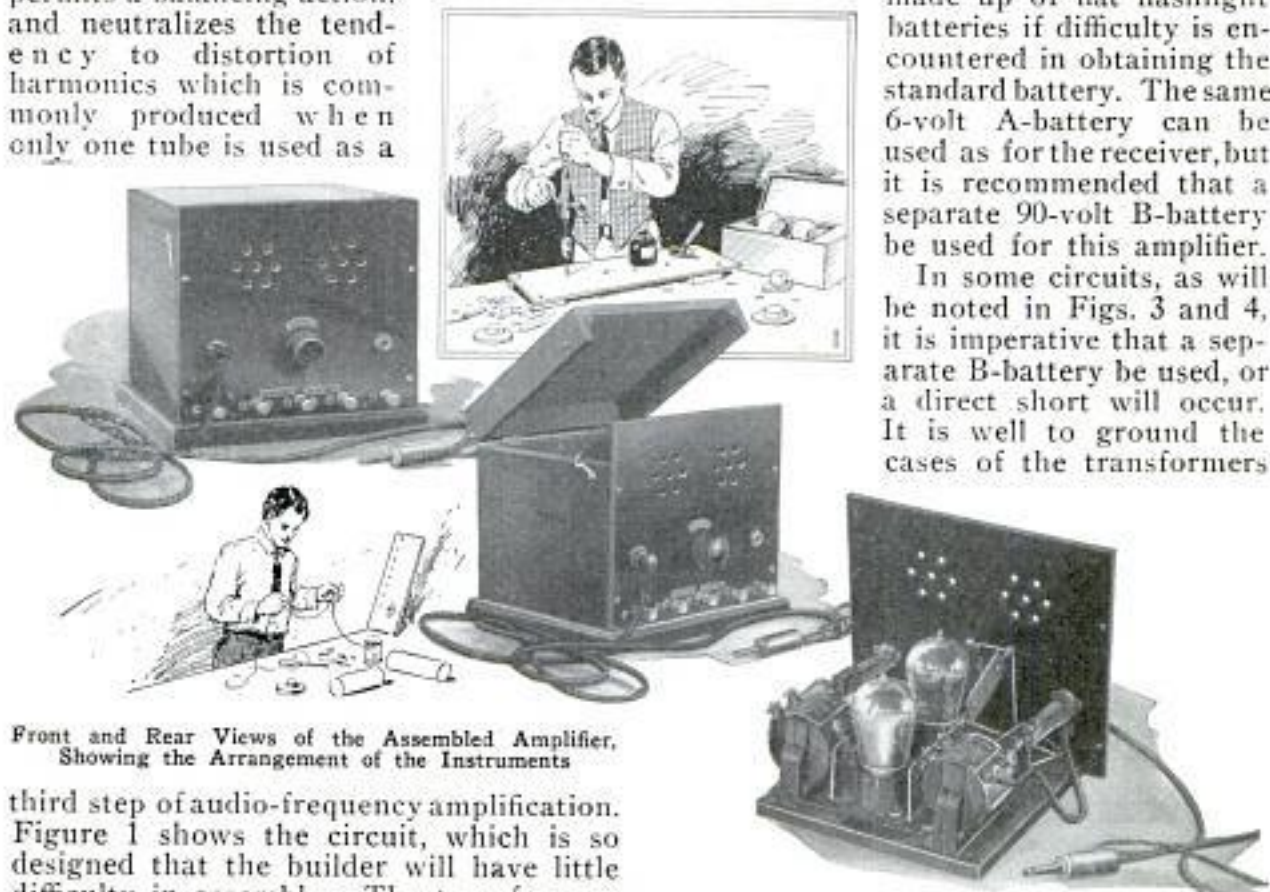

Front and Rear Views of the Assembled Amplifier, Showing the Arrangement of the Instruments

third step of audio-frequency amplification. Figure 1 shows the circuit, which is so designed that the builder will have little difficulty in assembly. The transformers are mounted on a  $\frac{3}{8}$  by  $6\frac{1}{2}$  by 7-in. base-board. The panel is of bakelite or formica,  $\frac{3}{16}$  by 7 by 8 in. in size. Drill the panel according to the template shown, and mount the rheostat, phone jack and binding posts on it. The on-and-off jack switch can be omitted if desired, as most rheostats have an off point on them. When the transformers and tube sockets have been screwed to the base, the latter can be screwed to the panel with two round-head nickelplated screws. The wiring is then soldered in place, care being taken to keep the leads as short as possible. Use only good parts, and carefully solder all joints. Do not solder the wire directly to the transformer terminals,

to the negative of the A-battery or to the ground.

The panel, base and cabinet can be any size elected, the sizes given being those used by the author, with a  $6\frac{3}{4}$  by  $7\frac{1}{4}$  in. (inside measurements) cabinet. A good feature of this hookup is the phone plug in the input circuit, which permits the placing of the amplifier immediately after the detector, first or second stage of audio-frequency amplification.

An increase in amplification proportionate to that attained by two more steps of audio-frequency amplification arranged in the common manner cannot be expected. The push-pull amplifier gives an increase in audibility slightly over that of



one tube. This amplifier has been used with success in all types of circuits and is recommended wherever a third step of amplification is desired.

## MATERIAL LIST

- |                                      |  |
|--------------------------------------|--|
| 1 bakelite panel, 3-16 by 7 by 8 in. | 1 jack switch (optional).                    |
| 1 baseboard, 3/4 by 6 1/2 by 7 in.   | 5 binding posts.                             |
| 2 UV-201A or C-301A tubes.           | 1 power-amplifying transformer, input type.  |
| 1 25-ohm rheostat.                   | 1 power-amplifying transformer, output type. |
| 1 .00025-uf. fixed condenser.        | 2 tube sockets.                              |
| 1 single open-circuit jack.          | 3 lengths tinned-copper busbar wire.         |
| 1 phone plug.                        | 2 B-battery units, 45 volts each.            |
| 1 single phone cord.                 | 1 C-battery, 6 volts.                        |

1 cabinet, inside measurements, 6 1/4 by 7 1/4 in.

Large-size blueprints of this circuit have been prepared, and can be obtained, price 25 cents, by addressing the Book Department, Popular Mechanics Magazine, 200 E. Ontario St., Chicago, Ill. Ask for Radio Blueprint No. 2.

## 205 R Selling Loud Speakers

Where a large number of different types of loud speakers are carried in stock, and a customer wants to hear all of them before making his selection, it is quite bother-



Selling Loud Speakers Is Easy with This Fixture; All Are Played in Turn by a Flick of the Switch

some to connect and disconnect each one in turn. One salesman in a radio store solved this problem in an ingenious manner. He wired a receiving set to a small distributing board, mounted on a shelf that carried one of every type of loud speaker in stock. The loud speakers were wired to the board, and a switch, with contact points for each instrument, mounted on the latter. Now, with a turn of the switch knob, all the loud speakers may be put through their paces in turn.

## 110 R Radio Industry Growing

"On the basis of figures for 1923, it is probable that the American people will spend about \$350,000,000 for radio equipment during the present year," says Roger Babson, noted statistical expert.

Mr. Babson goes on to say that a con-

Enl. Francis L. Coleman,  
3315 Montgall  
Kansas City, Mo.

servative estimate of the business in vacuum tubes alone is about \$50,000,000, and that at least five times as much, or \$250,000,000, will be spent for radio sets and parts. The sales of batteries will very likely amount to over \$45,000,000, and miscellaneous equipment, such as loud speakers, battery chargers, etc., may easily account for \$50,000,000 more.

Sales of radio equipment now are running nearly twice as large as on all classes of sporting goods. The value of radio business is also nearly twice as great as that of the carpet and rug business. For every dollar spent on furniture, 33 cents is spent for radio; for every dollar spent for boots and shoes, 25 cents is spent for radio, and for every dollar spent on musical instruments of all kinds, including pianos, phonographs, etc., 75 cents is spent for radio. These illustrations emphasize the growing importance of radio from a business standpoint.

229-02

## Rubber Mat for Storage Battery

Leaky storage batteries often cause damage to rugs and varnished floors, due to the action of the sulphuric acid contained in



the electrolyte. To eliminate this trouble heavy rubber mats of the kind shown in the illustration have recently been put on the market. The battery is placed on the mat and any electrolyte leaking out will be retained on it. It is shaped like a tray and is deep enough to hold all the electrolyte contained in one storage-battery cell of average size. The bottom is formed in a series of narrow ridges and grooves, to increase the capacity of the tray without making it clumsy.

Atlantic Radio  
Rubber Works  
1953 W. Van Buren  
Chicago





## How to Make a Table Fountain

By THOS. W. BENSON

A SMALL table fountain that works automatically can readily be made by anyone capable of using a soldering iron. The finished apparatus is very pretty in operation, and also serves to humidify the air. By adding perfume to the water, it acts as a deodorizer also, and all told, it makes a novel table decoration well worth making. The "works" of the fountain are inclosed in a tin can, 8 in. in diameter and 6 in. high. The dimensions can be varied somewhat, but the maker should not attempt to construct one much larger than that described. The principle of operation is as follows: The lower chamber is air-tight, and contains a carbon-filament electric lamp; when the lamp is lighted, it heats the air and forces the water up through the jet; this lowers the water level and the float falls, opening the switch and cutting off

the light. As the air in the container cools, a partial vacuum is formed, and water flows down the tube and through the valve on the left until the float rises and switches on the light again, thus causing the operation to be repeated.

The tin can used for the lower chamber should have a tight-fitting cover, and a pie plate is soldered to this as shown; the

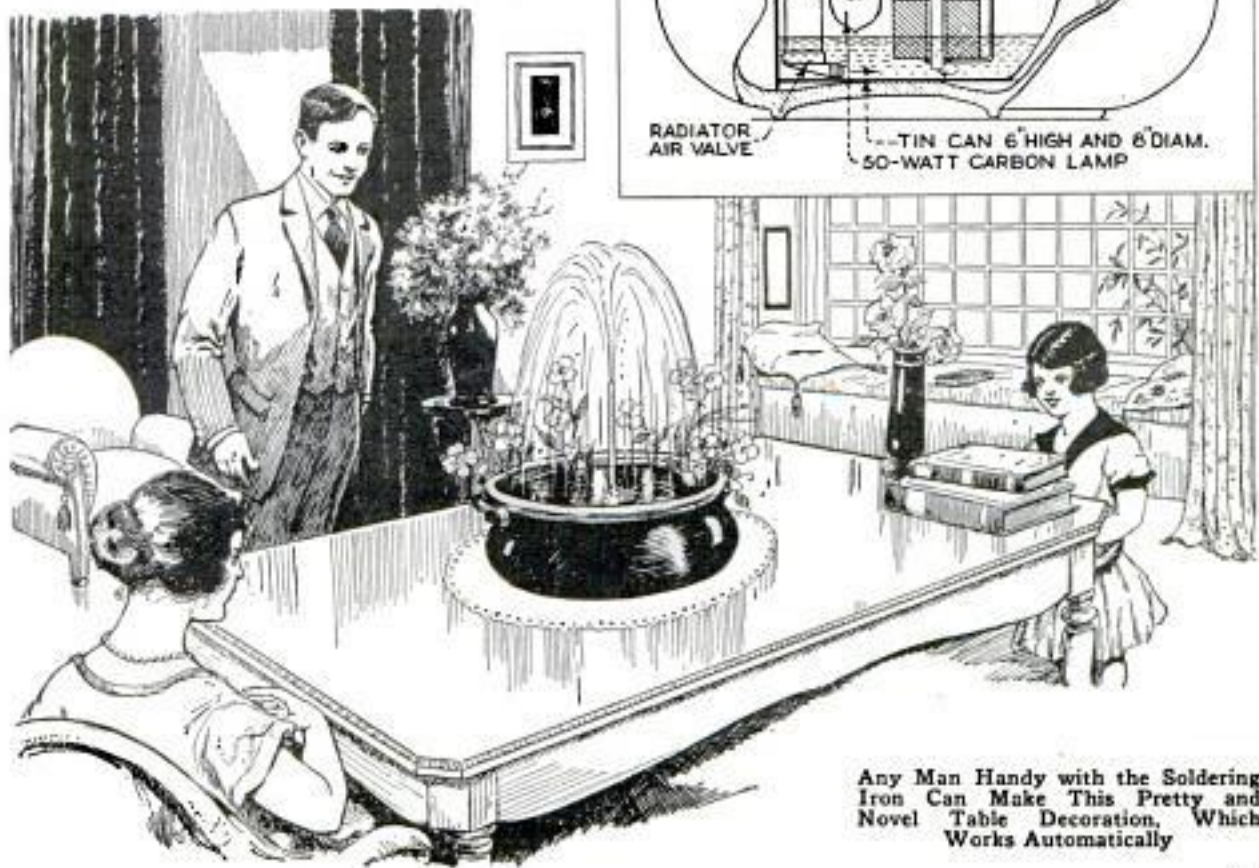
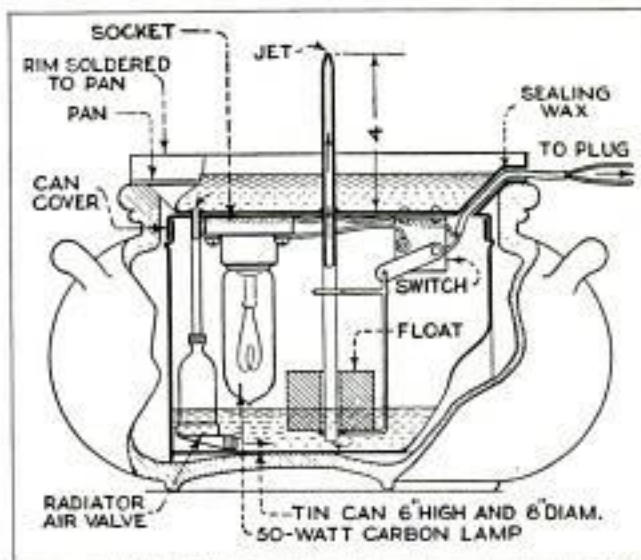

Any Man Handy with the Soldering Iron Can Make This Pretty and Novel Table Decoration, Which Works Automatically



depth of the plate may be increased by soldering a strip of tin around its edge. Through the center of the plate and cover is passed a copper tube  $9\frac{1}{2}$  in. long. At the upper end of this a jet is made by plugging the tube with solder and drilling a  $\frac{1}{2}$ -in. hole. If desired, a  $\frac{1}{4}$ -in. hole can be drilled in the center, and three other holes of the same diameter drilled at an angle to spread the spray. The pipe is soldered securely where it passes through the plate and cover.

A short piece of tubing is soldered into the bottom of the plate and cover to serve as a return pipe, and this must be fitted with a check valve. The simplest form is an old radiator valve, soldered to the end of the tube, and with the end just reaching the bottom of the can. The wires are led in through a tube soldered along one slanting edge of the plate and through the can cover, as shown. A porcelain socket is used for the lamp; it is bolted to the can lid and the heads of the bolts covered with solder.

The switch is simply a strip of brass, pivoted at one end and with a hole drilled at the other. This strip is mounted on a hard-rubber or bakelite strip, and a contact is so arranged that the circuit will be closed when the strip is pushed up. The float may be one taken from an old carburetor, or made from a small tin can with the lid soldered on tight and a tube soldered through the center. It slides on the lower end of the jet tube, and plays between two pieces of heavy brass wire bent to fit loosely around the jet. The lower one is bent to form a vertical arm, as shown. The upper wire is soldered to this arm at a point determined as described below, and the assembly connected to the switch by simply bending an eye in the

end to fit the hole in the lever. The lamp socket and switch are connected in series to the supply current.

The only difficult thing about the making of the device is the setting of the float. Determine how high the float rides in water, and mark the water line on it. Place the float on the jet tube with the bottom  $\frac{1}{2}$  in. from the end of the tube, and adjust the wire so that the switch is  $\frac{1}{4}$  in. open. Determine by measurement just how high the water must be in the lower chamber to hold the float in this (its lowest) position, and pour water into the chamber to that depth. Fill the top reservoir two-thirds full of water, and pour it into the lower chamber. Now raise the switch lever until connection is established between the contact point and the lever; then solder the looped top wire to the vertical branch of the lower one, level with the top of the float. By this means the travel of the float is limited between the off and on positions of the switch. The quantity of water need not necessarily be limited to the amount stated, however, for the upper loop can be soldered to the lower one at a higher point, provided always that the lamp bulb does not come in contact with the water and that the total quantity of water that can be ejected does not exceed the capacity of the pie pan.

The cover may now be pushed on tightly and the current turned on. In less than a minute the water will begin issuing from the jet, and it will continue to flow for 10 to 15 minutes according to the size of the jet. The flow will then stop, and after a short period will start again.

The can may be decorated in any manner desired, and a tiny rockery can be built up around the jet, using small pebbles. The can may also be set in a large flower-pot as shown in the illustration.

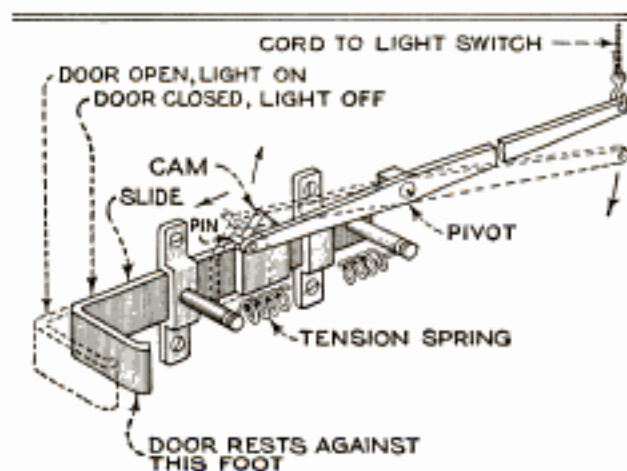

Attachment for Operating Electric Garage Light Automatically by Opening and Closing Door

### Automatic Switch for Garage

Being well versed in the art of forgetfulness, the writer installed an attachment to his garage door so that the electric light is automatically turned on when the door is opened and off when it is closed, thus reducing the lighting bill.

A strip of iron,  $\frac{1}{8}$  in. thick and 1 in. wide, was bent to the shape of the letter "L" and fastened to the inside of the wall with cleats, which permitted it to slide easily. This slide has screwed to it on the top edge a triangular cam and it also carries a pin at the end, which is connected by a coil spring to another pin on the first cleat. The spring pulls the slide forward. A lever is pivoted at its center on the wall



in the position indicated so that a pin provided at one end rests against the cam on the slide, and the other end is tied to the cord of a pull-chain socket. When closed, the door rests against the foot of the slide keeping it pushed in and when the door is open the spring pulls the slide out. The action of the slide moving in and out makes the pin on the lever ride over the triangular cam, which causes the other end of the lever to move up and down and pulls the light on and off. The width of the cam should be equal to or less than the distance between the rear pin and the nearest cleat, when the slide is pushed in.—R. H. Kasper, Philadelphia, Pa.

### Sanitary Fountain for Windmill Pump

The insanitary practice of having a common drinking cup at the windmill has been abolished by a Wisconsin farmer who substituted a bubbling fountain of the kind shown in the drawing. The pipe from the windmill to the stock-watering tank was 1¼-in. in size and had a 12-in. drop. At the lower end, near the tank, a tee and a long nipple were inserted in the pipe and an old harrow disk fastened on to serve as a bowl. A U-shaped assembly of ½-in. pipe was arranged inside the larger pipe, as shown in the drawing, to catch part of the water running to the tank. This water

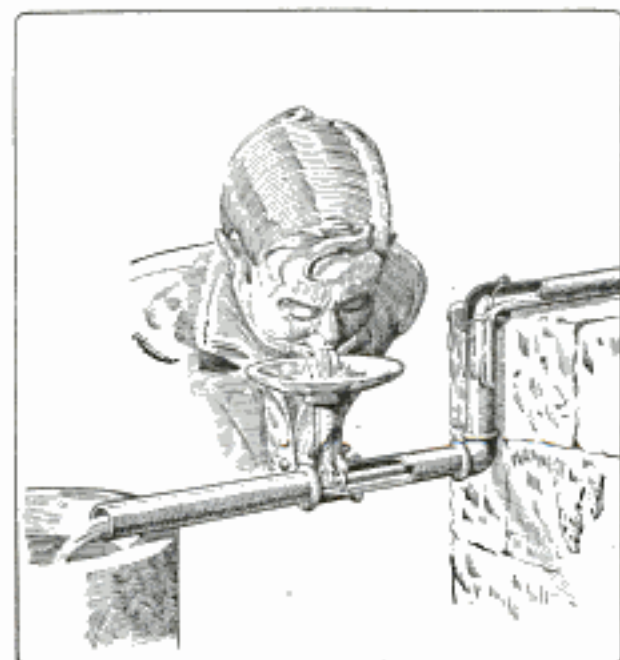

Simple Bubbling Fountain for Windmill Pump Eliminates the Common Drinking Cup

comes bubbling up out of the smaller pipe and flows into the bowl, which has holes drilled in the bottom near the center so that the water returns to the larger pipe.—G. E. Hendrickson, Argyle, Wis.

### Pulling Motorboat on Beach

At a summer cottage, where a regular dock is not available and where the only safe method of "docking" a boat for the night is to drag it up on the beach, the

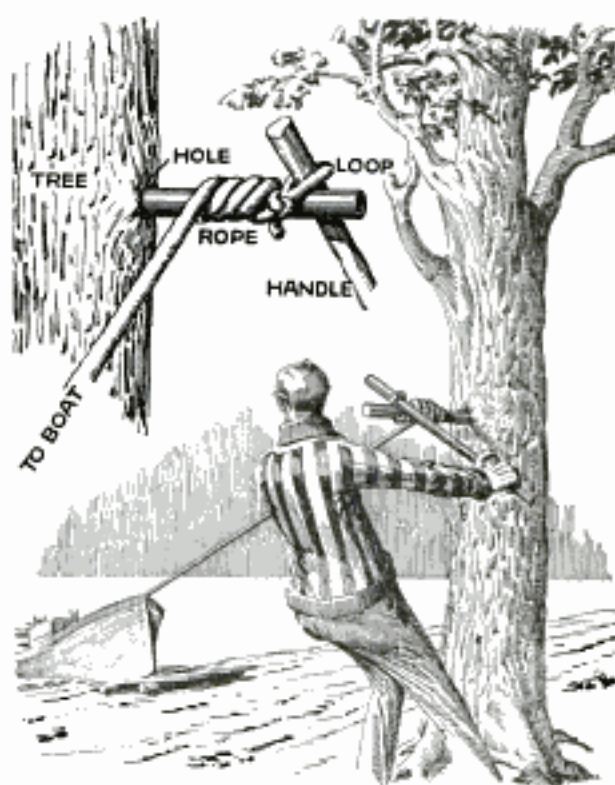

Use of Winch Enables One Man to Pull a Heavy Motorboat onto Beach

usual method of doing this is generally too much for one man; he can easily do it alone, however, by using a simple winch of the kind shown in the drawing. A point on the beach near a large tree is selected as a landing place. A deep hole is drilled into the tree, to receive a length of large pipe or heavy steel rod. If available, a piece of an automobile axle will do. A strong rope is tied to the prow of the boat and a loop is tied at the other end. By slipping a stout piece of lumber, or a crowbar if handy, through the loop and twisting the rope around the pipe as shown, the boat will be slowly pulled up on the beach. Skids under the boat will reduce friction and prevent damage to the bottom of the boat. This method has been used in actual practice and found entirely satisfactory.—Earl Tyre, Jacksonville, Fla.

ⒸA dash-lamp socket, screwed to the front of the dash under the hood, and wired into the regular lighting circuit, serves two purposes: It provides a place to carry a spare bulb without danger of breaking, and provides a light over the engine, in case of trouble at night.



### Novel Garage Floor

A Washington car owner has a rather novel floor in his garage, one that gives all



An Unusual Garage Floor, Which Is of Advantage in Cleaning the Car

the advantages of a pit, with several additional good features.

The sides of the floor are elevated above the remainder, to a height of about 12 in., thus forming what amounts to a depression in the floor, extending to within about 4 ft. of the walls. The depressed space is just long and wide enough to accommodate the car, which is a sedan. This places the working floor of the garage only a small distance below the running boards and several inches below the car axles; which is of particular advantage in cleaning a closed car, where it is necessary to wash windows, clean the top, and polish the paint. Drainage of wash water is also better, and the person cleaning the car is

out of the way of water dripping from the body to the floor.

While it is not so convenient to get under the car as with a common floor, yet, by jacking up the car, it is easy to support it by stout transverse beams, resting on the side platforms, and this gives a liberal working space underneath. It would be well, before making a floor of this kind in a garage, to find what the state law is with regard to pits in garages, as this construction may be held the same in effect as a pit.

### Decorative Push Plates

A clever decorative touch can be given to the swinging door between the dining room and kitchen by putting a piece of the dining-room wall paper under the glass push plates. This is particularly effective on a door painted ivory or white.—A. May Holaday, San Jose, Calif.

### Folding Hayrack Ladders

On the old-style hayrack the high end ladders have to be removed when the wagons are driven through orchards, under low trees, or when a hay loader is used. Ladders of the kind shown in the drawing, therefore, have many advantages over the stationary type as they can be folded down whenever necessary. As the front ladder can be placed up when loading, its folding part may be made higher than the rear one.

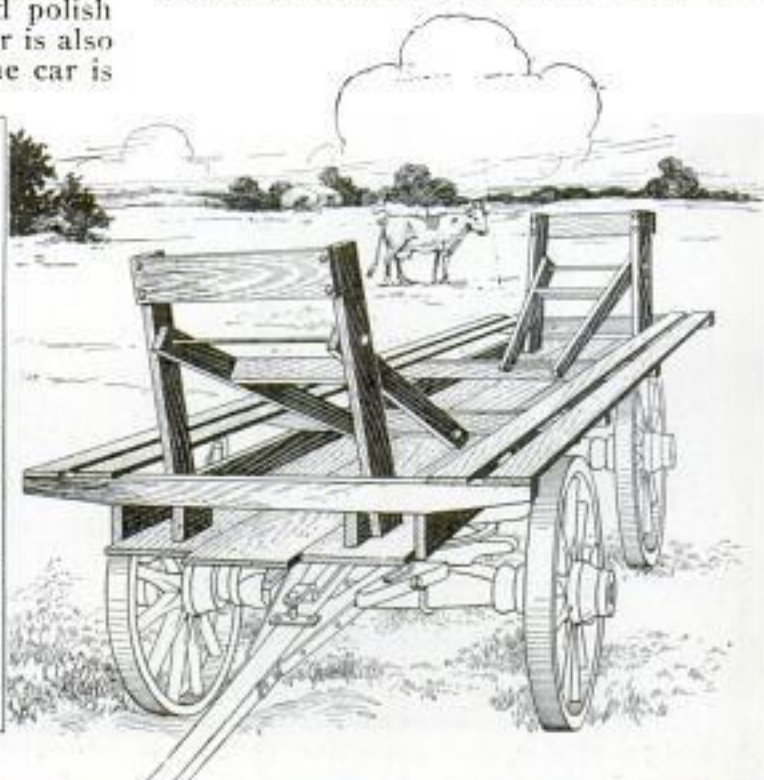

Folding End Ladders on the Hayrack Are of Considerable Convenience When Using a Hay Loader or When Passing through Orchards



### Washing Tank for Roll Films

With the aid of the tank shown in the illustration roll films can be washed in one-fourth of the time otherwise required. It is made of galvanized iron, copper or brass, and is about 8 in. high and 4 in. in diameter. A small overflow hole, about  $1\frac{1}{2}$  in. in diameter, is cut 1 in. below the top, and a short copper nipple is soldered in near the bottom, so that a length of rubber hose from the water faucet can be attached to it. The nipple is set at an angle so that the water entering the tank will flow with a swirling motion, giving an ideal circulation for washing purposes. The film is held on a wooden frame, as detailed at the upper left in the drawing, the endpieces being cut octagonal and  $\frac{3}{16}$ -in. strips nailed to the edges. The frame must, of course, be of smaller diameter than the tank so that it will fit loosely inside of the latter. The film is wound around the frame, as shown, with the emulsified surface on the outside, and the ends are fastened by means of thumbtacks. Several films may be treated at the same time, if they are not too long. Films from packs

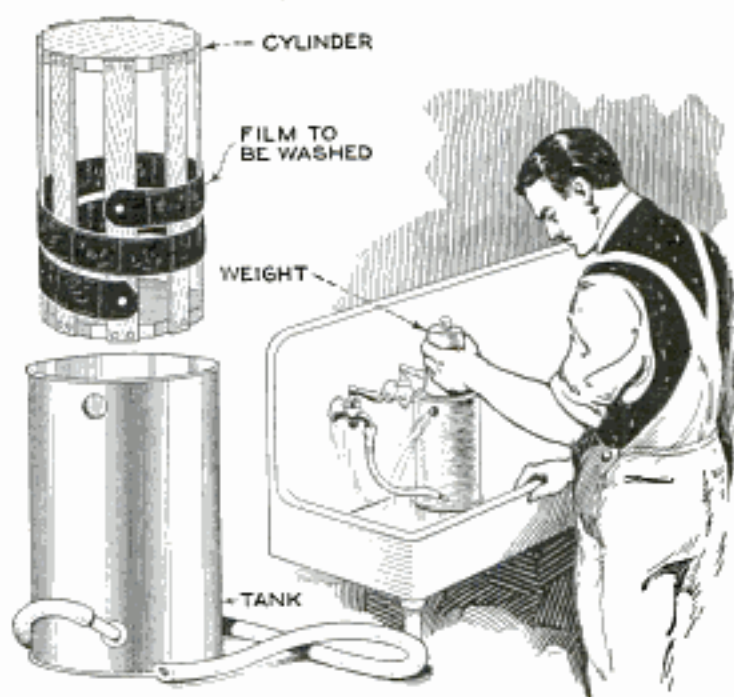

Handy Washing Tank for Roll Films Enables Work to Be Done in Fraction of Time Usually Required

also can be washed by tacking each film separately to the frame. As the frame has a tendency to turn or rock owing to the strong circulation of water, and as the films thus might be scratched, it is advisable to attach a weight to the bottom, or set one on top, so that it is held immovable. —John T. Daniel, San Francisco, Calif.

### Supporting Sagging Bookshelves

Long bookshelves are prone to sag at the middle, and this looks very untidy. To prevent this sagging, a neat and self-supporting strut can be made from a brass tube; it will need no nails or screws for fitting and can be removed at any time without leaving any ugly marks. A brass tube, about  $\frac{3}{8}$  in. in diameter, is cut to the proper length, and the ends squared. The ends may then be treated in two different ways to make them self-locating. The first method is to fit a wooden plug in one end, then to drive a nail into the plug, cut the head off, and

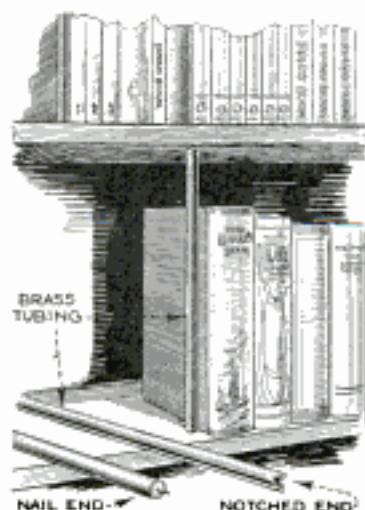

sharpen the projecting point, which should be about  $\frac{1}{8}$  in. long, with a file. To fit, lift the upper shelf and place the strut in position; when the shelf is released the weight of the books will force the point into the lower shelf. The second method is even more simple; here a file cut is made across the end of the tube, leaving two sharp points. Being of brass, these struts look much neater than wooden ones, and they can be removed and replaced at any time.

### Emergency Tire Patch

One night after discovering a flat tire I removed the casing and inner tube to repair the leak, and then found that I had no cement. Being a long distance from any auto-supply store I faced the necessity of driving along on the rim. But, finding a small roll of electrician's friction tape in the toolbox, I wound several layers of it around the tube and found it held as well as a patch. With this temporary repair, I rode around for two weeks before applying a regular patch.—Louis Latour, Plattsburg, N. Y.



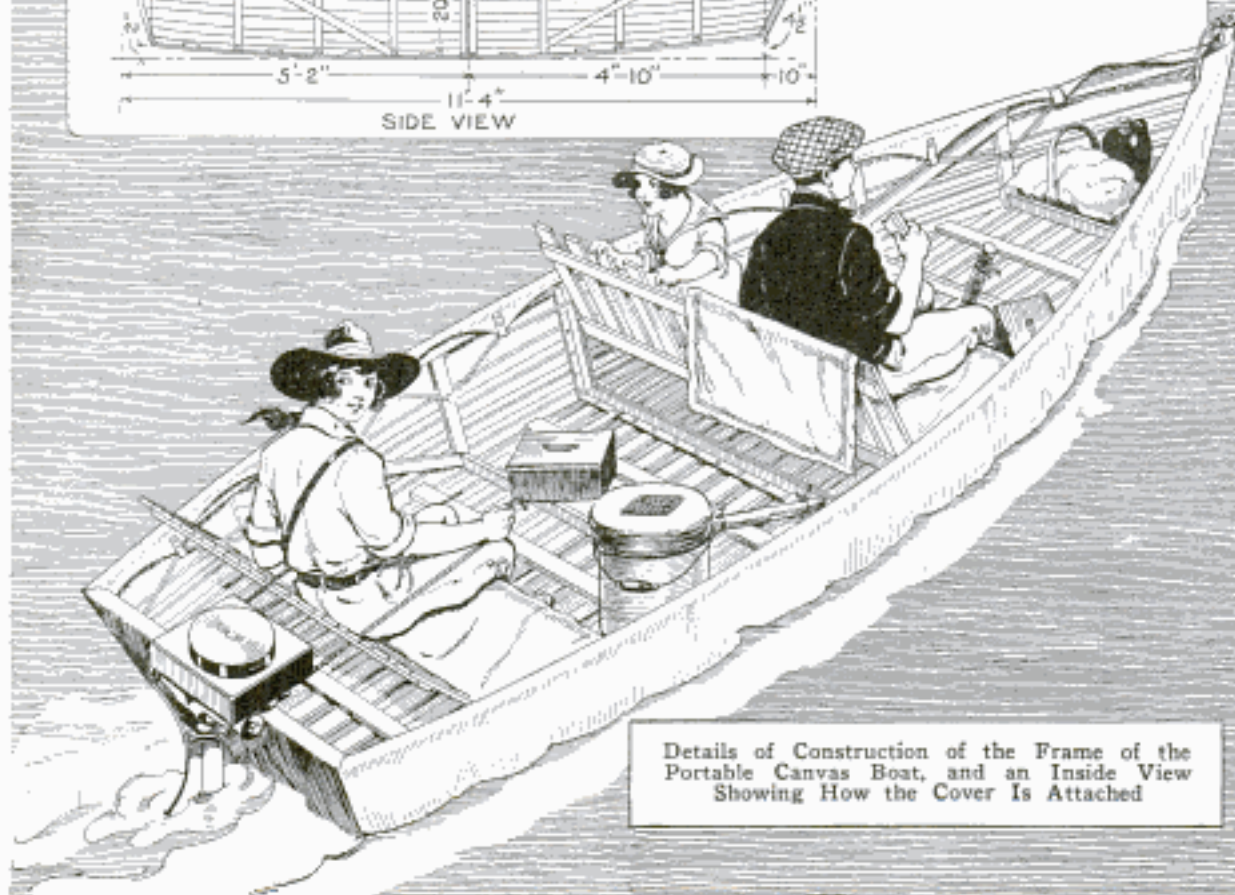
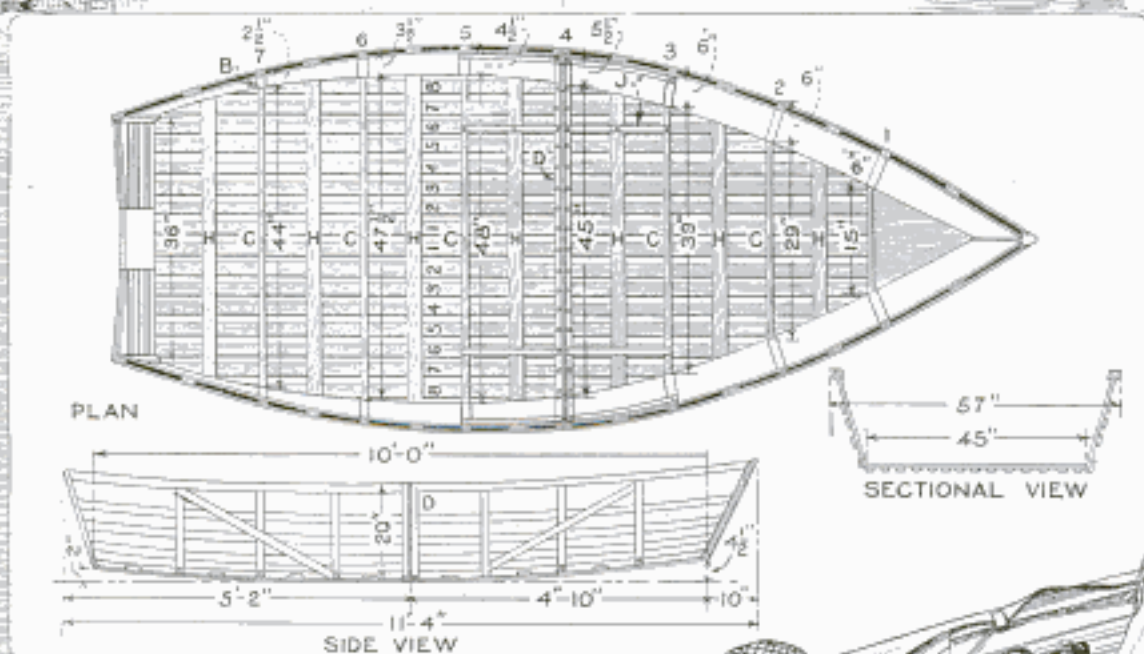

Details of Construction of the Frame of the Portable Canvas Boat, and an Inside View Showing How the Cover is Attached





## Building a Portable Canvas Boat

By D. M. SPENCER

**T**HE portable canvas-covered boat described in this article can be built by anyone at all handy with tools, and will prove an ideal craft for hunters and fishermen, especially those living at a distance from lakes and streams, so that they cannot keep a boat permanently in the water. As the total weight of the boat, including engine and battery but without fuel, is only 225 lb., it can easily be carried on the back of a small car.

The material for the bottom and sides is spruce—surfaced four sides—1 by 10-in. boards being ripped into five lengths and then ripped edgewise, making strips about  $\frac{5}{16}$  by  $1\frac{3}{4}$  in., and allowing one strip for every 3 in. in the bottom of the boat. The frame cross members are 1 by 2-in. spruce, braced with  $\frac{1}{4}$  by 1 in. iron at the joints. All cross members, except the iron ones (D), were made up first, then two full-length slats for the bottom of the boat were marked and cut, and the cross members nailed to them with small nails, to space the members

stern and bow are of 2 by 2-in. stock, cut to fit the angles. When all the slats were nailed on with small nails, they were all screwed to the cross members with No. 9 flat-head brass screws, preparing the holes for the screws with two drills and a countersink to prevent any possibility of splitting. The boat frame was next sawn in two at D, and the iron cross members put on; these were made of  $\frac{1}{8}$  by  $1\frac{1}{2}$ -in. angle iron, and welded at the corners



Four Views Showing How the Portable Canvas Boat Is Knocked Down and Mounted on a Small Car for Transportation

where the bottom pieces meet the side ones. The iron members are fastened to the slats with copper harness rivets, and these rivets are also used on the cross slats C, which are pine battens. Five matched holes are drilled through the angle irons to bolt the two sections of the boat together;  $\frac{5}{16}$ -in. bolts are used for this purpose.

The rivet holes in the angle irons are placed close to the edge so that the rivets will be as far as possible from the ends of the slats to prevent splitting. Four iron bands J,  $\frac{1}{8}$  by 1 in., are bolted to each angle iron and to the nearest cross member in each section of the boat, to prevent any possible separation of the boat in a rough sea. In screwing the slats to the cross members two screws were used to each lap.

An extra strip is placed around the inside of the top, with blocks between it and the outside strip to stiffen the top of the boat. The remainder of the bracing is quite clear from the drawings. The covering is 20-oz. double-filled waterproofed duck. It

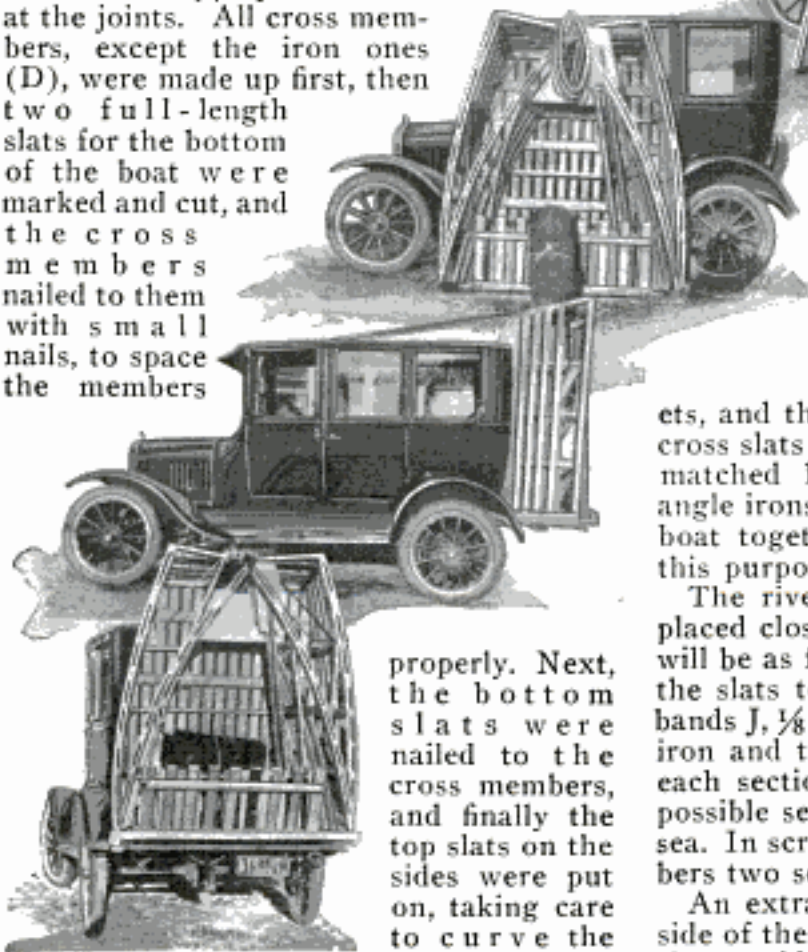

properly. Next, the bottom slats were nailed to the cross members, and finally the top slats on the sides were put on, taking care to curve the bottom enough

so that these would lie flat and true, as the flare of the sides governs the curve of the bottom. The corner pieces for the



must be well shrunk before cutting to fit the boat, and it should not be cut to fit too tight. The seams are all triple-sewn, and a reinforcing strip is sewed to the bottom edge around the front of the boat. Steel rings or canvas loops are riveted to the top edge of the cover, spaced halfway between the cross members, and hooks are placed 6 in.



notched blocks, or mounted in some other convenient manner, so that it can be removed and the front section nested into the rear for transportation. The two sections of the boat weigh 64 lb. each, and

the cover 21 lb.; with my wife's help I can remove the battery, cushions, gas can, etc., from the boat, unbolt it, and mount it



down on the vertical side members of the frame. The cover is laced to the boat by means of these hooks and rings, using good flexible rope for the purpose. The seats are easily fitted, and this detail can be left to the prospective builder. The back seat, however, should be fitted into



Two Views of the Completed Boat Afloat and Ready for Business

on the back of the car in 15 minutes. It makes about six miles an hour with two passengers, and I have had it in a rough sea, where it proved steady and safe. It

might be well to add that one should carefully inspect the cover for rips or tears before launching the boat into the water.

### Finishing Yellow-Pine Floors

When building a new house, if one does not care to use the more expensive solid oak for floors and finish, yellow pine that is well seasoned and dressed and properly oak-stained will make a pleasing substitute. It has a beautiful grain and is soft and porous enough to take stain well.

The floor must first be well dressed down and an oak-paste filler that dissolves in gasoline is then applied. Enough of the paste is dissolved to get the desired shade, which can be determined by trying it out on some waste pieces of the pine. A can of paraffin oil is obtained for polishing. Start in one corner of the room, beginning with four flooring boards at a time. Flow the

stain on with a wide brush, wipe quickly and then apply the paraffin oil to polish it; rub in all the oil that the wood will absorb, but no more. The work must be done rapidly in order to get a glossy finish. All the stain must be wiped off before the oil is applied, otherwise there will be a greasy finish. The oil can be applied conveniently by means of a flannel cloth saturated with it.

The work should always be done with the grain and not across it, as the finish will then be messy. Do not attempt to take more than three or four flooring boards at once or the stain already applied will dry before the next lap is covered. After the coat of stain and oil has been applied, use a heavy floor polisher to



rub in more oil—all that the wood will take up—but leave absolutely no excess on the floor. If a regular floor polisher is not at hand, a serviceable substitute can be made by padding the stub of an old broom, and fastening a piece of clean carpet over it.

A floor finished in this way will stand very rough usage and will last a long time, actually improving in appearance with age. In addition it is easily repaired. If, for instance, a piano is moved over it, leaving a track in the soft wood, this track can easily be removed by sandpapering, staining to match the rest and oiling. For cleaning the floor, which is occasionally necessary, use soap and water, then touch up any light spots with stain, and polish the surface again with paraffin oil.—G. O. Anders, W. Lafayette, Ind.

### Convenient Poultry-House Window

In large poultry houses, where maximum light and adjustable ventilation are desired, the sliding-window and hinged-screen arrangement



shown in the illustration will be found convenient. The windows are built in pairs so that the sash can be slid in opposite directions. Any size window can be used, but in most cases 12-pane windows will be found most suitable. The screens are arranged behind the windows on the inside; they are hinged at the top so that

they can be swung up against the ceiling and hooked there, thus giving free access to the interior. A lock is provided on the lower edge of the screens on the inside so that they cannot possibly be opened from the outside.

☞ To clean japanned trays, rub them with a mixture of vinegar and powdered whiting, applied with a soft flannel; wipe off with a clean cloth and polish with chamois.

### Novel Landing Net

It is unnecessary to purchase a landing net when one that is just as satisfactory can be made

in a few moments' spare time. It consists of a discarded tennis racket and a piece of seine or netting, or a net knitted out of fish cord—if a fisherman lives near by who is willing to show how this is done. The gut strings are first cut out of the racket and the holes in the frame cleaned out to permit the

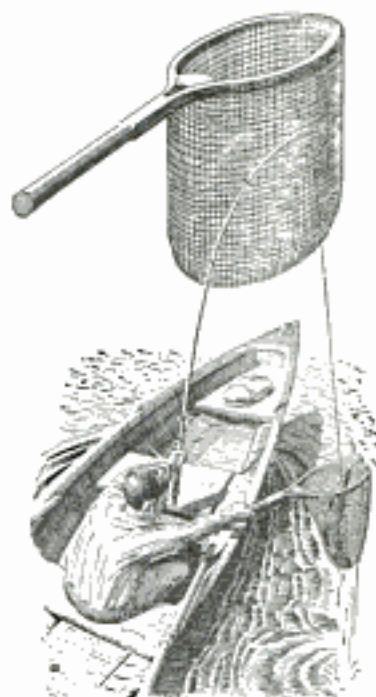

cord to be pushed through. The net is gathered up as desired, and the ends are tied to the frame through the holes. The frame is given an application of spar varnish to protect the wood from the water.—Dale R. Van Horn, Walton, Neb.

### Handy Milk-Card Box and Indicator

It is customary to put order tickets for milk and cream out on the porch, exposed to rain and snow. A better method is to use a card holder of the kind shown in the illustration; this card is practically weather-proof and its use is much easier than writing the order down. The card is circular and has lead letters and figures at top and bottom, as shown, to indicate the number of bottles wanted by means of two hands pivoted at the center. The whole is mounted on the front of a box in which the milk-record card is kept. When the cover is raised, it serves as a back rest for the card while the milkman is marking the amount of milk and cream delivered.—M. E. Duggan, Kenosha, Wis.





### Convenient Feeding Trough for Hogs

By arranging hinged gates over the feeding troughs for hogs, as shown in the

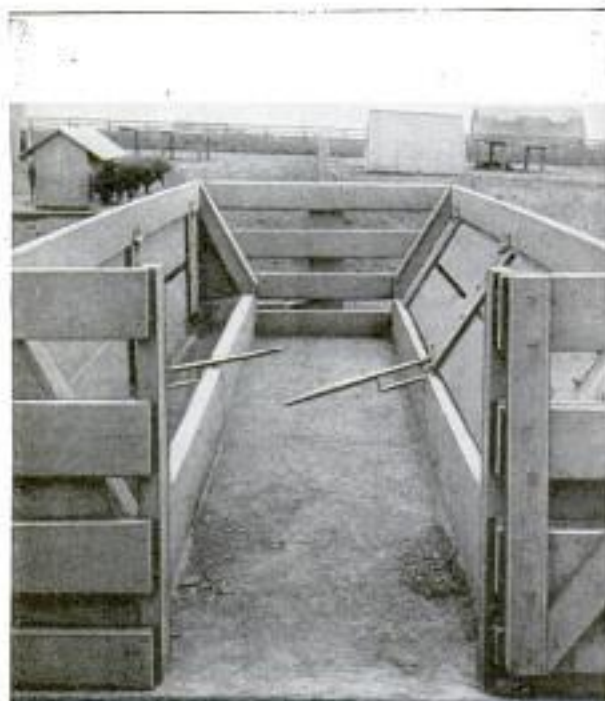

Gates on Feeding Troughs Keep Hogs Out until Troughs Are Filled

photograph, it is possible to put in feed or slops without interference from the hogs. The troughs are built in pairs and extend into the hog yard, as shown, a section being cut out of the fence and a gate fitted to permit easy access between them. The space at the other end is closed. The gates, which can be swung in or out to open or close the troughs, are made of 1-in. boards, cleated together and hinged to a 2 by 6-in. board. A strap-iron handle, bent as shown, is bolted to the inside of each gate. It is hooked over, or braced against, the edge of the trough to keep the gate closed or open.

### Preserving Toothpaste

Even though the cap is lost from a tube of toothpaste or shaving cream, it is unnecessary that any of the contents be wasted or allowed to dry in the opening. Very soft toothpaste in particular will run out of the tube if the latter is left on its side without the cap in place, resulting in waste and muss. It is only necessary to press on the tube at points opposite those where pressure was first applied to squeeze the paste from the tube. By so doing a vacuum is formed in the tube and the paste is sucked back to a point well beyond the opening. The short

neck of the tube is thus emptied, and the possibility of the material hardening is considerably reduced.

### Solid Comfort for the Fisherman

Sitting all day on the edge of the pier, or on bridge piling, may not tire the enthusiastic fisherman, but even the most devoted follower of Izaak Walton cannot pretend that he wouldn't like a more comfortable seat than that afforded by the wood or concrete. One Florida angler has solved the problem of comfort in an ingenious way by making a back and foot rest that can be attached to the stringers of the pier or bridge from which he is fishing.

As shown in the illustration, the rest is very simply made from pipe and fittings. The construction is quite evident from the drawing, and nothing further need be said except that the tees used on the horizontal members of the rest should be one size larger than the pipe composing the frame, so that they can be slid back and forth to make the rest fit various sizes of timbers. It would be easy, also, to fit additional cross members at back and front, and to put in a seat of canvas, so that the



The Fisherman's Comfort and Safety Are Both Promoted by This Simple Back and Foot Rest

device could be used as a seat where it cannot be slipped over a balk of timber.—Turner Nearing, St. Petersburg, Fla.

Some of the larger iron bedsteads often sag down on the rollers so that it is difficult to move them about. This can be cured by driving a hardwood plug into the bottom of each post and boring a  $\frac{3}{8}$ -in. hole in it, then putting in a regular roller intended for wooden beds.



### Foiling Petty Thieves

When attaching a padlock hasp to a garage door recently, I found that the construction of the door made it necessary to fasten the hasp on the outside with wood screws. Obviously such a method of fastening would offer little resistance to petty thieves, who could get in by merely using a screwdriver. To foil such an attempt, I applied hard solder to the screw heads, which were flat, and all over the surface of the hasp. This filled up the slots in the heads of the screws and also attached them to the hasp. Of course, a thief who really wanted to get in, could "jimmy" the hasp or padlock, but it seemed advisable to at least try to discourage the petty thief. —J. E. Hoag, Los Angeles, Calif.

### A Light Automobile Trailer

A light-running and sturdy trailer, of the kind shown in the photograph, is of service to contractors and others who need to transport tools and equipment. The chassis consists of an old Ford front axle and spring, and a Ford "wishbone" brace or radius rod, items that can be obtained at any auto-wrecking concern. The wishbone keeps the chassis rigid and prevents it from swaying sideways. The body is easily made; it consists of a floor and four sides screwed together securely and bolted to the spring. A railing, detachable or permanent, for larger tools may be added if desired. The trailer is attached to the rear end of any auto by means of a small



Light and Sturdy Trailer Can Be Built by Anyone from Old Automobile Parts to Carry Tools and Other Equipment

fixture, which is attached to the tongue, as shown in the lower left-hand detail.—C. M. Wagner, Newark, N. J.

### Gas Tank for Outboard Motor

Outboard motors used on rowboats and canoes are usually provided with a 1-gal. fuel tank, but this is not large enough for those who make long cruises, as it must



Auto Gasoline Tank in Boat Holds Large Quantity of Fuel for Small Outboard Motor

be refilled about every two hours when running continually. Furthermore, for use in such motors, the lubricating oil must be thoroughly mixed with the gasoline before filling, and this task becomes a constant annoyance. Refilling the tank so often also adds to fire hazard, especially if the water is rough enough to rock the boat and cause the gasoline to be spilled around. By installing an old automobile gasoline tank and connecting it to the small motor tank with copper tubing, this trouble is avoided. Air pressure is applied by means of an ordinary bicycle pump to force the gasoline up to the motor, a tire valve being soldered to the upper part of the tank to permit this. The copper tubing is connected with suitable fittings and a shut-off valve is inserted in the line so that the motor can be disconnected without losing the air pressure in the tank. With this outfit, a few strokes of the pump now and then will be found all that is necessary to keep the motor tank filled.



### Holding Ladders on Tile Floors

Smooth concrete or tile floors, especially if wet, are unsafe supports for ladders, as many workers no doubt have found out.



Danger of Slipping on Tile Floors Is Eliminated by Using a Plumber's Force Cup

To reduce the danger of slipping to a minimum, a plumber's force cup has been found of service. The handle is removed and a length of clothesline is brought through the top of the cup as shown. A stout hook is tied at one end and a wet rag to the other end, inside of the cup, to make it air-tight. The hook is attached to a rung of the ladder and the cup is then pressed tightly against the floor. As an additional precaution, rubber strips may be tacked to the sides of the ladder at top and bottom.—J. E. Noble, Toronto, Can.

### Limiting Speed of Autos

Automobiles and motor trucks not infrequently are in charge of irresponsible drivers who attempt to drive at high speed, to the detriment of the car and with constant danger of accident. Some form of governor is therefore desirable, but these are usually complicated and expensive, and it will be found that for ordinary purposes the much simpler device to be described will accomplish the same result.

Between the carburetor and the intake manifold a gasket is usually placed to insure an air-tight joint, and the hole in this gasket, through which the gasoline vapor passes, is, of course, the same size as the carburetor outlet. To prevent the driver

from running the engine at excessive speed, it is only necessary to remove this gasket and replace it with another having a smaller hole.

There will be no difference whatever in the operation of the car as far as ordinary speeds are concerned, but when a driver opens the throttle wide to get excessive speed, the attempt will fail because the amount of vapor fed to the engine cannot exceed that which the special gasket will allow to pass. No definite rule can be given as to the size of the aperture, as it will vary for different makes of cars and trucks, and must be determined by trial. About half of the original opening is a good point to start experimenting from. A decided advantage of this kink is that the car shows no outward evidence of a speed-control device.—V. A. Lyman, Casimaria, Calif.

### Renewing a Wafer Thermostat

When ready to start my chick brooder, I found that the wafer thermostat was empty and would not work. Having no ether, with which it was originally filled, I made a small hole in each part and poured about two teaspoonfuls of alcohol into each compartment. I then closed the holes with solder and the thermostat now works as well as ever.—William R. Hopkins, Ballston Lake, N. Y.

### Hiding the Radiator

The photo shows a neat method of hiding a steam or hot-water radiator. A cabinetmaker was employed to build a



slatted hardwood box to fit over the radiator as shown. Although this box has been used for over a year, it has not warped at all. The wood was neatly finished in harmony with other woodwork in the room—in this case an office—and the

space above the box was utilized for a filing cabinet. The appearance of the office was much improved.



# Toy Bombing Plane and Battleship

By CHAS. D. TENNEY

SEVERAL old battleships, recently discarded by the United States government, have served their last purpose as targets for bombing aeroplanes, and the actual destruction of the ships in this way was quite a spectacular and thrilling event. No doubt many boys who have read about this or seen it in the news reels of the "movies," will be greatly interested in a toy bombing plane and battleship, with which they can re-enact the scene themselves, imagining that they are the pilots of the bombing planes flying above the

dropping marbles down on it, which, if correctly aimed, hit the ship in the fatal spot and cause it to fly apart as shown.

The plane and ship are both made of wood. A convenient size for the ship is about 3 by 10 by 1½ in. The method of construction is clearly shown in the upper detail. It consists of a body, in which a recess is cut to hold an ordinary spring mousetrap; a deck of ¼-in. material, which is cut to the same pattern and fits over the body, and an upper deck, gun turrets and smokestacks, which are placed

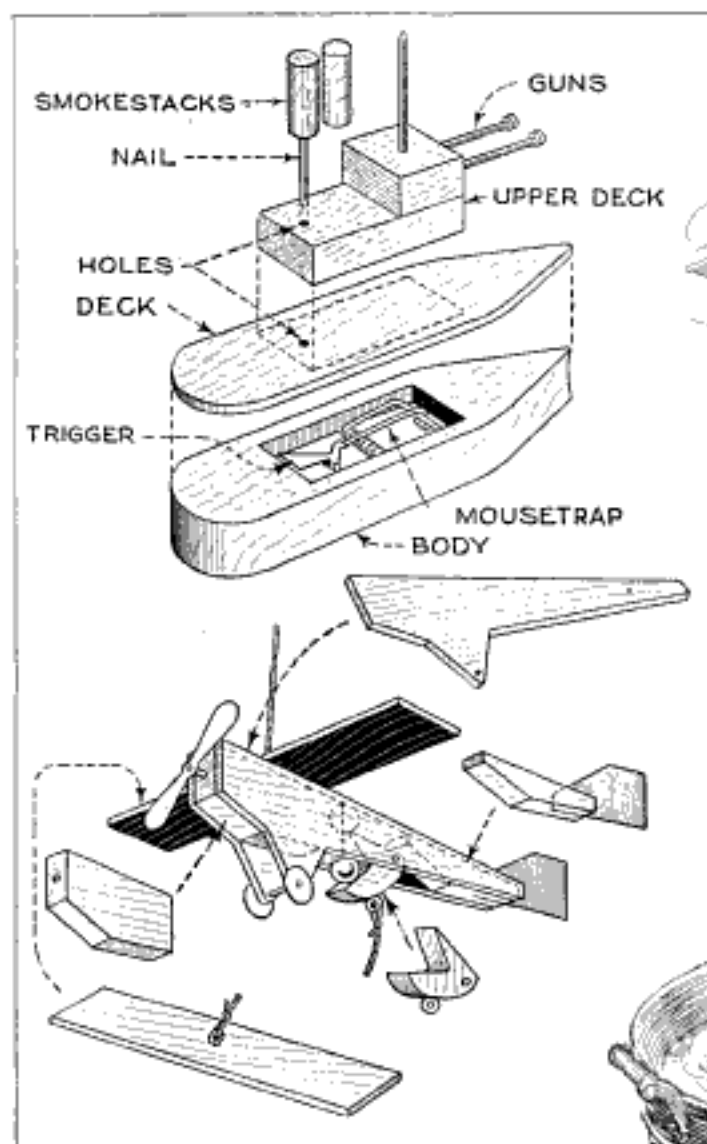

Amusing Toy Bombing Plane Suspended from Tree Hurls Marbles on Miniature Battleship, Floating in Tub of Water. If Aimed Accurately the Marbles Will Cause the Ship to "Blow Up"

ships and sending missiles down upon them. At least, an Idaho lad finds considerable diversion and amusement in directing the aeroplane over the miniature battleship, which floats in a large tub of water, and

on the deck, as indicated by the dotted lines. One of the smokestacks has a long



nail driven into the end to extend down through the decks to reach the trigger of the mousetrap, on which it rests, holes being, of course, drilled through the decks to permit this. Nails are also driven into the gun turret to resemble guns and a mast. In use, the mousetrap is set, the decks and smokestacks carefully put on the body and the ship then floated in the tub. The moment the rear smokestack is touched it trips the mousetrap and this shatters the ship. A coat of slate-gray is applied to make the ship appear more realistic and to protect it from the water.

The bombing plane is constructed according to the lower detail. It does not have to be light in weight as it is hung on the limb of a tree or other support under which the tub is set. The sides and wings are made of  $\frac{1}{4}$ -in. wood or wallboard, nailed to two small blocks of  $\frac{3}{4}$ -in. wood at the front and rear. A convenient length for the plane is about 8 in. The wing is tacked to the upper side of the body, and a small screweye is driven in

the center of the wing to permit a length of cord to be tied on, which holds the plane suspended from the limb. The propeller, rudder and wheels are cut from tin or light galvanized iron. Two marbles, which are used as bombs, are held in the space between the endpieces, and are dropped one by one by means of a trigger, which is pivoted between the sides as shown. When pulled down with a string, the trigger releases one marble, the other marble being held back. It is, of course, preferable to make a vertical magazine to hold several marbles. A length of metal tubing, about  $\frac{3}{4}$ -in. in diameter, attached just above the trigger, can be used for this purpose. A rubber band is fastened to the trigger to draw it up again as soon as the pull is released. In use, the aeroplane is guided by means of a string tied to the underside, as indicated. As the plane is swung over the ship the trigger is pulled down and a marble released. Accurate marksmanship is, of course, necessary in order to hit the rear smokestack, and this takes practice.

### Waterproof Battery Box

After being submerged for twelve hours, in a sunken boat, the dry cells stored in a battery box constructed according to the

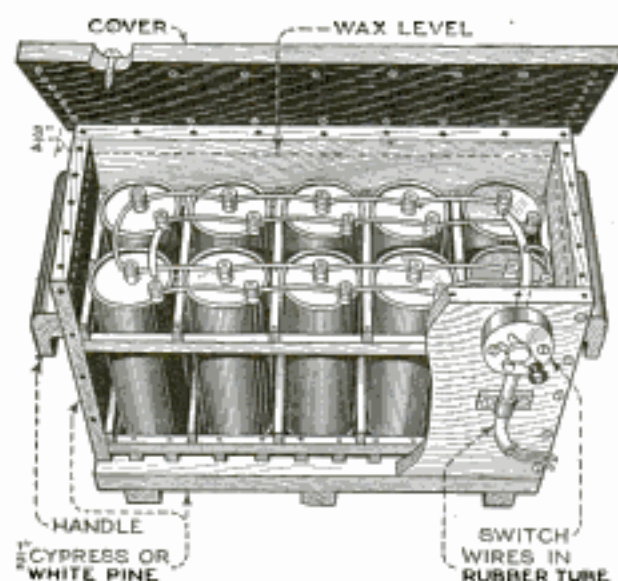

A Battery Box That Will Appeal to Motorboat Owners, as It Is Completely Waterproof

design shown in the illustration were still perfectly dry, proving that this box is really waterproof. It should therefore appeal to all motorboat enthusiasts. It is made of  $\frac{1}{2}$ -in. cypress or white pine. The parts must be cut accurately and are screwed together securely. Two handles

are provided on the sides to facilitate carrying. The inside is partitioned to hold the individual cells tightly, narrow slats being tacked to the bottom of the box to keep the cells clear of it. After the cells have been properly wired, the outgoing wires are pushed through a length of rubber tubing, which fits snugly in a hole drilled through one of the sides. A small single-pole ignition switch is mounted on the outside of the box just over the hole, and one of the wires is cut and the two ends thus formed are connected to it. The two leads coming from the switch on the outside are also protected by rubber tubing as shown. A small metal cleat, screwed to the box over the wires, takes all the strain and prevents the ends connected to the switch from being pulled out. Ordinary wax or paraffin is melted and poured between the cells and on top of them until it covers the wiring. The cover is then screwed on the box securely and this completes the work.—Henry S. Laraby, New Haven, Conn.

### Cleaning Automobile Headlamps

There are many cleaning compounds on the market, but it is a matter of careful selection to find something for cleaning the highly polished silver-plated reflectors of automobile lamps without producing a myriad of small scratches. Each scratch is insignificant in itself, but when the entire



surface of the reflector is covered with them the efficiency of the headlamp is seriously impaired. It has been found that high-grade rouge is an excellent cleaner and polisher for reflectors. It is used with alcohol and there is no danger of scratching. A clean, soft cloth is used and the rubbing should be done from the rim toward the center instead of around the center. Mud splashes on the headlight glass should be soaked off gently with warm water and a soft cloth or soft sponge.

### Novel Ash Trays

The novel ash trays shown in the drawing are made from discarded automobile pistons. The feet are steel balls,  $\frac{1}{2}$  or  $\frac{5}{8}$  in. in diameter, soldered to the base. The match holder in the right-hand figure was made from a discarded pressure-pump piston, a piece of an old flat file being sweated on to serve as a match striker. The cigar or cigarette holders are made from metal disks, bent and soldered to the edge of the tray. After the trays have been completed, they may be plated with copper or brass, or oxidized. Nickelplated piston rings snapped around them to fit in the grooves add considerably to the appear-

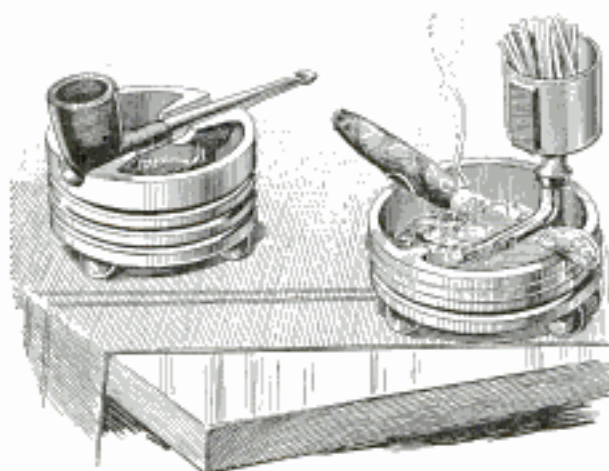

Attractive Ash Trays Made from Discarded Automobile Pistons

ance, or the grooves may be painted with a bright color.—C. W. Rose, Astoria, N. Y.

### Handy Pantry Step

Many housewives find it rather difficult to reach the top shelf of the pantry without using an old chair or box, and this usually has to be carried in from the kitchen. It is much better to keep a small box handy, with a handle provided on it as shown in the drawing. Any sturdy wooden box, obtainable at a grocery

store, will serve for this purpose. A hole is drilled in one side near the bottom to receive a length of broom handle or a sim-



Handy Pantry Step for the Busy Housewife Makes Reaching the High Shelves Easy

ilar stick, about 3 ft. long, which is nailed or screwed to the bottom. The method of using the step is obvious from the drawing.—Mrs. Laura B. Kurtz, Chicago, Ill.

### A Hayloader Timesaver

A southern Wisconsin dairy farmer uses a simple time and labor-saving device with the hayfork at the barn when unloading. Instead of using the ordinary double-trees, dragging them over the ground back to the barn and lifting them around for every trip with the elevating rope, he uses an ordinary harrow cart, with a grabhook chained around the axle under the seat; this hooks over a short chain attached to the end of the hayfork rope.

The farmer's small boy drives the team out and back, unhooking and hooking the chain as well as a man can do it. Besides saving labor, it is less annoying for the team, as it avoids stepping over traces, stripping tugs, and all other annoyances.

The harrow cart is homemade also, just two old corn-planter wheels with a gas-pipe axle and a pole from the woods, ironed and bolted together by the local blacksmith at a total cost of less than \$2, aside from the material picked up on the junk pile.—J. H. Deniston, Bayfield, Wis.



### Simple Toy That Provides Optical Illusion

The little toy shown in the drawing produces a convincing optical illusion. It consists of a spiral rod, twisted from thin

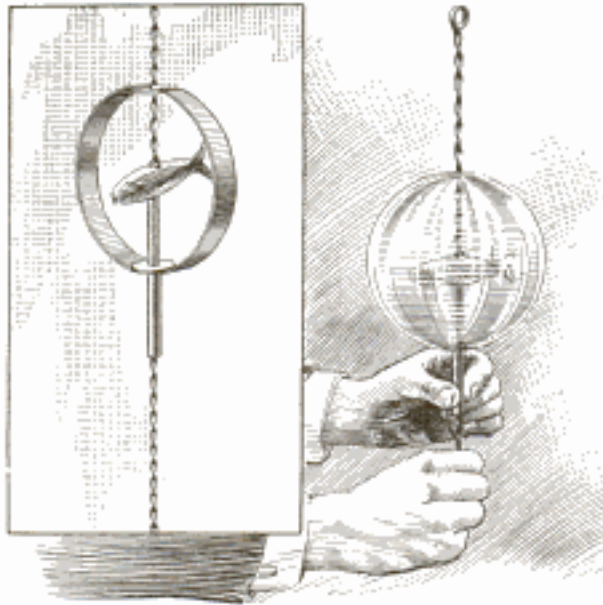

This Simple Toy Produces the Illusion of a Fish Swimming in a Globe of Water

brass strip, about  $\frac{3}{16}$  in. wide and 1 ft. 4 in. long; on this rod is fitted a flat-brass ring, about 4 in. in diameter, with slots cut in it at top and bottom to fit the brass strip, so that the ring will revolve when it is pushed along the spiral. A tin fish, with a hole drilled through its body to clear the spiral, is held at the center of the ring by means of a sleeve made of brass tubing, the bottom of the sleeve resting on a thin washer, which in turn rests on the ring. Another sleeve of the same material, slipped over the spiral below the ring, completes the toy.

By means of the lower sleeve the ring and fish are pushed up to the top of the rod. When the top has been reached, the lower sleeve is released, and the ring and fish drop down, the former spinning rapidly, while the fish remains still. The effect seen is that of a fish in a globe of water. The faster the ring is pushed up or down, the better the illusion.

### Repairing Worn Babbitt Bearings

Some well-known automobiles use very costly bronze-backed babbitt-lined bearings to carry the crankshaft and the connecting rods. Frequently, it is impossible to adjust these bearings, making it necessary to replace them when worn. However, they can often be repaired in the fol-

lowing way: Clean all grease and oil from the bearings thoroughly, which can be done with a solution of washing soda and hot water. Set the halves of the bearing in such a position that melted babbitt can be poured on the old babbitt surface, which is done until the old surface is completely covered. A soldering iron, already heated to a temperature just above red heat, is then applied to the babbitt to puddle the fresh babbitt into the old, care being taken not to run the babbitt out of the bronze. It is best to puddle it in a small spot at a time so that the babbitt can be controlled. As soon as this has been done and the babbitt allowed time to cool, the surface of the bearing can be scraped down to a proper fit, and the bearing should give just as good service as a new one. A repair of this kind can also be made on a bearing that has been badly scored. It is of great importance to use good babbitt and to make sure that the new and old babbitt are well fused together.—C. F. Worfolk, Royal Oak, Mich.

### Iceless Camp Refrigerator

While on a camping trip one member of the party carried a short length of stovepipe, two wooden disks of slightly smaller

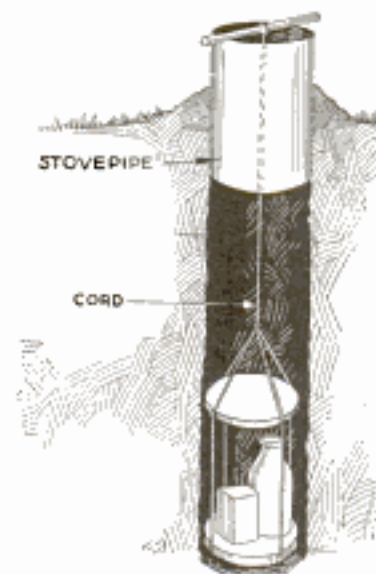

diameter than the pipe, and a length of stout twine, with which he made an iceless camp refrigerator for preserving milk and butter. He borrowed a post-hole auger from a neighboring farmer, to drill a hole in the ground. The hole was about four feet deep, and the length of stovepipe was pushed down into it to prevent the earth at the top from caving in. The pipe was allowed to project above the surface of the ground, and loose soil was banked around it, as indicated. The wooden disks and twine were arranged to form a miniature elevator. The food articles were wrapped up in a paper and put on the lower disk, and the device then lowered into the hole until it nearly reached the bottom. A stick was



to the upper end of the twine and laid across the top of the stovepipe to hold the food suspended in a hole and prevent the end of the twine from being dropped down into the hole accidentally. A piece of canvas thrown over the top of the pipe proved effective in keeping out bugs, and the food was kept in palatable condition.

### Hand Pump Made from Auto Oil Pump

When draining a number of lavatories in a summer hotel a hand-suction pump, made from an auto oil pump by simply reversing the washer on the oil pump and attaching a length of rubber tubing to the nozzle, was found of considerable assistance. The hose was inserted into the traps of the lavatories and only a few strokes of the pump were necessary to start a siphon action, which soon emptied the traps. A pump of this kind can also be used for numerous other purposes.—H. Klein, Parkersville, N. Y.

### Increasing Buoyancy of a Canoe

An ordinary canoe will, when capsized, sink if the occupants attempt to keep themselves afloat by holding on to it. To make it buoyant even when filled with water is a simple and inexpensive job. Two automobile inner tubes are cut in two and the ends vulcanized shut so that the tubes will hold air without leaking. After inflation to about 4 in. in diameter, the tubes are wrapped with tape for their en-

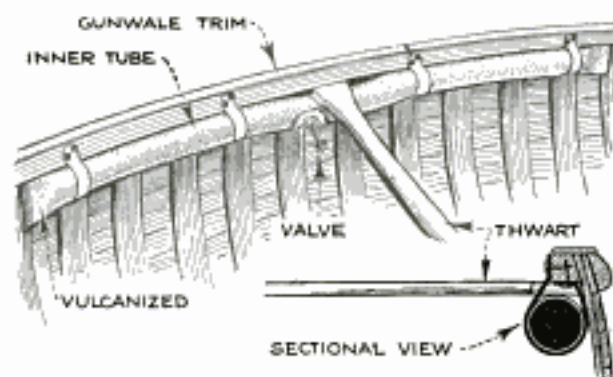

Inner Tubes Fastened to Gunwale Trim Keep Capsized Canoe Afloat

tire length to confine any weak part that may have bulged out. One tube is then tied under the gunwale on either side of the canoe, in the center, with strips of leather tacked to the gunwale, as shown.

☛ An excellent substitute for a rubber mallet is a rubber crutch tip slipped over the head of an ordinary hammer.

### Convenient Shingle Holder

A simple and convenient shingle holder can be knocked together in a few moments from a few boards and a wedge-shaped piece of wood. The construction is clearly

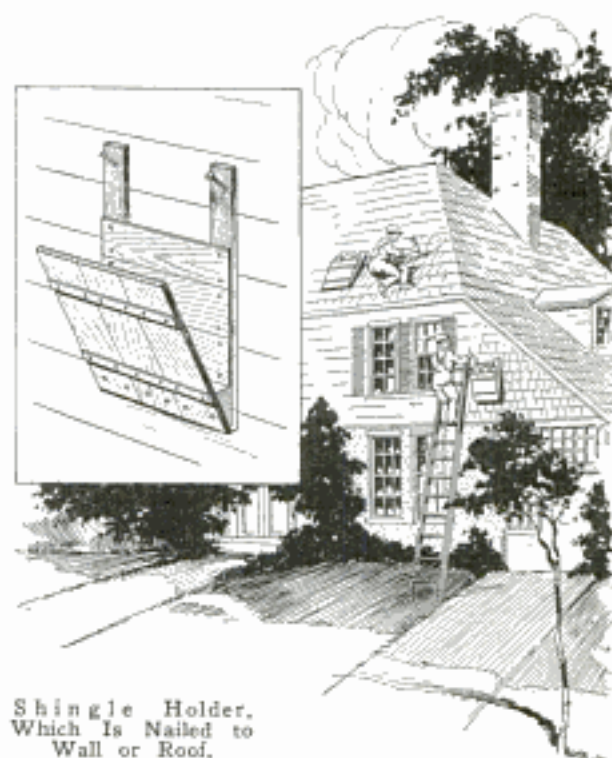

Shingle Holder, Which Is Nailed to Wall or Roof.

shown in the detail. Such a holder is especially convenient when shingling walls, but can also be used on the roof. It is large enough to hold several bundles of shingles. In use, it is attached to the wall or roof by means of 20-penny finishing nails.—L. A. Bull, Seattle, Wash.

### Ferrotyping Prints

Prints can be prevented from sticking to ferrotype plates by carefully observing the following instructions: Clean the plate carefully with soap and warm water; rinse and put away to dry. Then sprinkle a few drops of kerosene on the plate and rub the surface until the "bloom" disappears. This is best done with a flannel ball, made by wrapping a square piece of clean flannel around a core of cotton wadding, and tying the flannel corners with a cord.

To prevent air bubbles between the print and ferrotype plate, the latter should be immersed in water and the print applied under the water. Plate and print are then taken out and pressed together. For best results, cooled boiled water should be used, as most of the air in the water is removed by boiling. If the plate is very large, the surface may be flooded with water to avoid the use of large trays.



### Moving Heavy Furniture up Stairways

Pianos and other heavy objects can be moved up steep inclines, such as stair-



Simple Winch for Moving Pianos and Other Heavy Furniture up Steep Stairways

ways, very easily by means of the simple winch shown in the illustration. It consists of three lengths of  $1\frac{1}{4}$ -in. gaspipe, two floor flanges and two elbows, which are screwed together to form a shaft and crank. Two lengths of stout rope, one having a heavy iron ring at each

end, are also provided. The rope equipped with rings is brought around the piano as shown, the rings being slipped over the shaft. Heavy pads are, of course, provided around the corners to protect the varnished surface. A  $\frac{1}{4}$ -in. hole is drilled through the center of the shaft to receive an eyebolt, and one end of the second rope is tied to it, the other end being securely tied to some support at the top of the incline. In use, the operator moves the piano up the stairway by turning the crank. A floor flange is screwed on each end of the shaft, as shown, to prevent the rope from slipping off as it is wound on. A short length of rope near the crank holds it securely and prevents the winch from unwinding when the operator does not wish to turn it.—G. E. Hendrickson, Argyle, Wis.

### Battery Corrosion as Soldering Flux

When soldering iron with ordinary solder it is customary to coat the iron with copper-sulphate solution to make the solder adhere. Another substance that serves the purpose just as well is the bluish-green corrosion found on the positive terminal of storage batteries, which also contains copper and is easy to scrape off. It is rubbed on the iron after the latter has been cleaned and made bright, and the solder is then applied. This kink may be found handy when copper sulphate is not available.—V. A. Lyman, Casimalia, Calif.

### Increasing Garage Storage Space

Garage men who find their car space limited may profit by following the example of one resourceful proprietor who

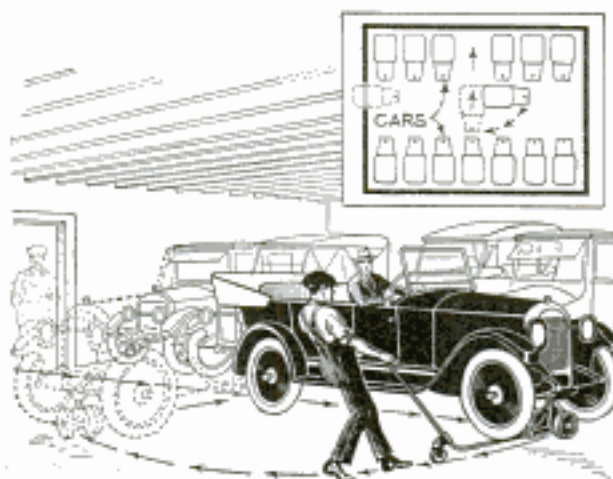

Utilizing all the Space in a Large Garage by Simple Method of Parking the Cars

practically doubled his storage capacity without the expenditure of a cent. He saved the usual 2-ft. space on each side of a car, ordinarily allowed for maneuvering it, in the following way: When a motorist drove his car up the center aisle he was stopped just past the car next to which he was to park. The front end of the car was then lifted upon a wheel jack and swung around until it was at right angles to the aisle, as shown by the dotted lines in the drawing. It was then backed into the parking space with only about  $\frac{1}{2}$  in. of clearance from the adjacent cars. The only requirement is that the aisle must be somewhat wider than the length of the biggest car one expects to shelter. Skillful manipulation of the wheel jack is soon learned by any garage attendant.—Myron Drachman, New York, N. Y.

Celluloid can be cemented to glass by means of a solution of equal parts, by weight, of gelatin and acetic acid.



# Electric Spotlight for Night Hunting

By AVERY E. GRANVILLE

FOR night hunting, such as trailing raccoons, opossums, skunks and the like with dogs, one needs a light that will leave the hands free as well as throw a powerful beam. A cap light of some kind is the most logical one to use, for a light over the hunter's eyes that throws a beam straight ahead enables him to see an animal's eyes much better than one held anywhere else, the reflection coming direct from the animal's eyes to the hunter's. Such a light will often enable him to see his game up a tree or amid dense foliage when it could not be detected otherwise. The right kind of a cap light is also excellent to shoot by, and one can hit almost as well as by daylight—sometimes better.

Many hunters use carbide lights of the miner's type, but these, while much better than oil lamps of any kind, diffuse the light too much for best results. Some carbide lamps are equipped with bull's-eye lenses, but even then they do not approach the efficiency of a first-class electric spotlight. To have a lamp that would throw a spotlight beam a long distance, and at the same time be convenient to carry and handle, I made the outfit shown in the illustrations. I used parts from two spotlights, one new and the other a broken one. The cap was a common miner's cap with fiber and metal plates in front to hold the light in place. The part attached to the cap was the lamp end of



Hunting 'Coons and 'Possums at Night Is Made Comparatively Easy with the Aid of This Electric Spotlight, Mounted on the Cap



the new spotlight, the screw cap from the old one being fitted to it at the back. Brass binding posts were soldered in place for the connecting wires, and the lamp terminals connected to them. The bulb was focused in the reflector so as to throw a beam as far as possible, and it was then fixed in that position, so



Left, Closeups of the Battery and Light on Cap; Right, Light and Battery in Place, Ready for Use

that no amount of jarring would change the setting. A screw at the back fastened the lamp to the support on the cap, and a heavy cord was used to anchor it to the

visor, to prevent it from tilting upward when in use. To get the light in the proper position, I shift the cap.

A double wire runs from the binding posts on the lamp to the battery, which is suspended by a strap around the neck. The strap is just long enough to bring the battery well down on the chest, where the switch can be operated easily. The battery is the regular three-cell type, the case being that of the new spotlight with the lamp end replaced by a plain screw cap, into which a binding post has been soldered. The lower binding post of the switch is connected to the lower screw cap by a short piece of insulated wire, securely soldered in place. Thus, when the switch is closed, the current has a free passage, and lights the lamp on the cap. The switch used is a cheap knife switch which can be bought at any electrical-

goods store, and is fastened to the battery case by drilling holes and running the binding-post screws through both the case and the switch ends. This type of switch will be found much more satisfactory than the switch originally on the case, as I have found that the sliding switch is too apt to go wrong at a critical time.

With this light I can spot a 'possum or a 'coon 200 ft. away, or up a tree amidst the densest foliage or tangle of limbs and brush, and every hunter knows that when once the animal is located the rest is easy.

### Drill Press Made from Small Watchmaker's Lathe

In the home modelmaker's workshop a precision drill press, driven by a small electric motor, is of considerable service. The photo shows how one amateur mechanic rigged up a drill press from an old watchmaker's lathe. The lathe was set up on end, and a clamp made to fasten a sewing-machine motor to the pedestal, using the regular pedestal clamp screw to fasten it. Another flat-steel clamp or bracket was fitted with two guide pulleys and attached to the lathe bed under the headstock, the toolrest clamp screw holding it in place. The motor is controlled by means of a foot rheostat in the usual manner, and the feed for drilling is obtained through the tailstock.

☞ Boil clothespins in salt water to prevent splitting.

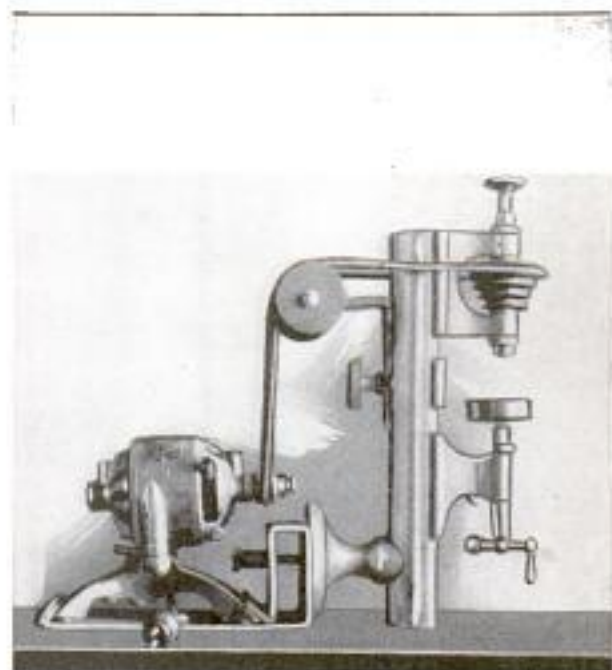

Discarded Watchmaker's Lathe and Sewing-Machine Motor Make Precision Drill Press



### New Use for Corn Cobs

Regardless of the customary banter on the farmers' numerous uses of the humble corn cob, I ran into another use for it and found it really worth while. After using a shovel, in damp clay and muck, much of which stuck to the blade, making it difficult to work with, I looked around for a small stick to scrape the shovel clean but happened to spy a corn cob. This I picked up as a substitute, tried it and got a pleasant surprise. It served the purpose much better than a stick; it was handy and scoured the shovel besides cleaning off the dirt. Since then I have tried cobs for cleaning everything used in ground work and found them very satisfactory. Cobs cost the farmer practically nothing and there are always plenty of them around.—J. R. Koontz, Bremen, Ind.

### Water-Tight Fixture Protects Light

Sometimes it is necessary to protect an electric lamp against moisture. This can be done by providing the water-tight fixture shown in the illustration.



It is made from a 1/2-pt. fruit jar with a screw cap; a 1/16-in. sheet-metal disk is soldered to the inside of the cap as shown, and a hole is drilled through the center and tapped for a short nipple. A bushing and coupling are screwed on the nipple, and the fixture can then be screwed

to a length of conduit, through which the electric wires are run, the joints on the conduit being made up with white or red lead, as in water or steam piping. The customary rubber ring serves as a gasket.—L. H. Georger, Buffalo, N. Y.

Distilled water can easily be poured into a storage battery from a milk bottle fitted with a good cork. Two notches are cut opposite each other in the side of the cork. The finger is pressed over the upper hole and the lower one is placed over the battery-cap hole. Upon releasing the finger, the water will flow. It is stopped by closing the upper hole.

### Spokeshave Made of Steel Pipe

The spokeshave is a very handy tool for rounding wooden plugs, dowel pins, handles, etc., but while it is used frequently

when available, the average home worker hardly feels justified in purchasing one. A good spokeshave can readily be made from steel pipe, however, as indicated in the drawing, which shows a tool made by a Virginia man. An 18-in. length of steel pipe, about 1/4 in. in diameter, is drilled and slotted; then the lips of the slots are filed to form cutting edges and sharpened with a small oilstone. Two slots may be cut in the pipe and filed to form two different kinds of cutting edges, as shown in the sectional views. The handles and edges are combined in this simple, inexpensive tool. Wrought-iron pipe should not be used, as it will not hold an edge.—G. A. Luers, Washington, D. C.

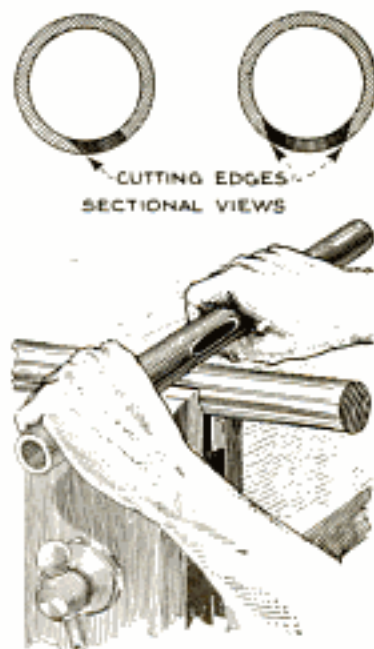

### Locking Barn Doors

Double doors on farm buildings are commonly fastened by means of a wooden bar resting on iron latches, as shown in the illustration. This method is not always reliable as the doors are often loose enough to allow the bar to be raised from the outside by means of a thin tool.

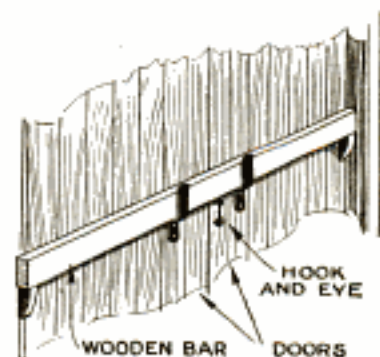

In order to prevent this, it is a good idea to provide a stout hook on one of the doors and a screw eye on the underside of the bar. This arrangement holds the bar down securely.—E. T. Gunderson, Humboldt, Ia.



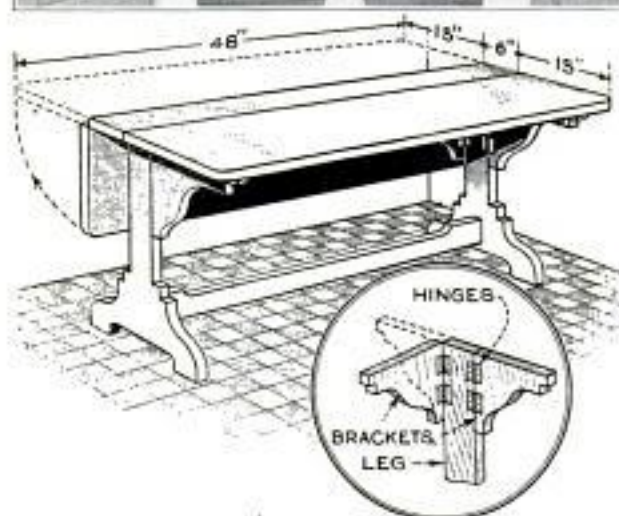

Breakfast Nook Comprising Two Benches and a Table Adds Coziness and Convenience to Apartment

### A Spacious Breakfast Nook

One apartment-house dweller replaced the single door between the kitchen and dining room with double French doors. On the kitchen side he provided a cozy breakfast nook as shown in the photo. It consisted of two benches and a table with a collapsible top, which afforded free passageway between the two rooms. One bench was built against the wall and a paneled partition,  $4\frac{1}{2}$  ft. high, was erected behind the other, to hide the gas range and other kitchen equipment. The dimensions of the table and its construction are given in the illustration. It has two leaves, 15 in. wide, hinged to a center piece so that they can be folded down, and in their open position supported by brackets hinged to the legs, as indicated. Comfortable cushions, made from four thicknesses of old comforters, covered with navy-blue burlap, are provided on the benches.—A. May Holaday, San Jose, Calif.

Places that are hard to reach with the oilcan may be lubricated by running a wire to the spot where the oil is needed and allowing the oil to flow down the wire; it will follow the wire if the latter does not touch any other part of the machine.

### Easily Constructed Beam Compass

Finding it necessary to scribe some large arcs but not having a beam compass, I devised one that proved entirely satisfactory and I have been using it ever since, even when regular beam compasses were at hand. The needle point of an old compass was pushed into the edge of a yardstick,

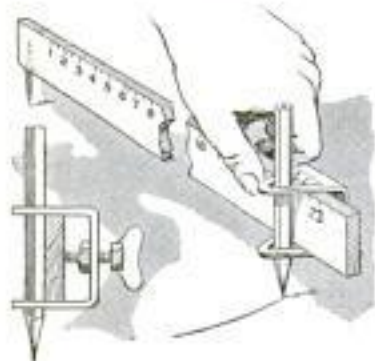

right under the zero point. The movable pencil holder was made of No. 11 gauge sheet steel, cut and bent to the shape indicated so that it could be pushed along the yardstick. The holes in the ears were given a triangular shape so that they would firmly hold a pencil or pen. A hole is drilled through the back part and an ordinary  $\frac{1}{4}$ -in. hexagon nut is soldered on the inside to provide threads for a thumb-screw, which is used to tighten the fixture

on the rule. The base of the upper triangular hole in the slide is beveled and a mark made in the center of the beveled edge to facilitate correct setting; it is an advantage always to use the same pencil.—J. H. Kay, Cleveland, Ohio.

### Making Adhesive Tape Stick

It frequently happens in the workshop that one gets his hand cut in a place where adhesive tape can hardly be made to stick, as for instance, over a joint, where movement of the finger soon causes the tape to work loose. By making a few slits in each end of the tape and spreading the ends out as shown, the tape will usually adhere anywhere, even on a joint. If wide tape is used, slits can also be made in the sides.—Jonas Byberg, Silverton, Ore.



Use passe-partout binding to paste canceled checks to the check-book stubs.



### Covering Frames with Screen Wire

When stretching screen wire, canvas or muslin over frames or panels, the method illustrated will produce a tension as uniform at the center as at the edges.

Two wooden strips are required; one of them is fastened to the porch floor or bench where the work is being done, to serve as a stop and the other is used to clamp the wire cloth. The latter strip is curved as shown in the drawing, so as to grip the screen tightly in the center. Fasten the screen wire to one end of the frame and butt the opposite end against the stop. Place a block of wood underneath the outer end of the screen, then draw the wire up taut and clamp it between the strips as shown. Remove the block from underneath the end of the frame, allowing the end to drop, thus pulling the wire taut; if the wire is not pulled up tightly enough, raise the frame and insert a narrow strip of wood between it and the stop. Place a weight on the outer end of the screen, to hold it down, and tack on the wire and molding, if any is used. The wire is cut with a tool made from an old file, similar to the one shown; this not only cuts the wire, but imbeds the

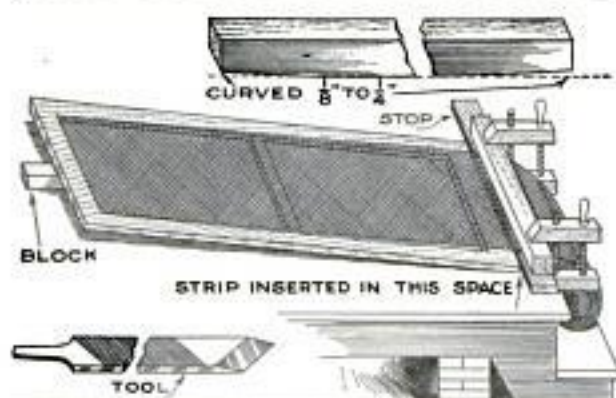

Covering Screen Frames with New Wire Cloth Is Greatly Simplified by the Method Illustrated

ends in the wood, where they are prevented from catching and tearing the hands or clothing.—Arthur W. Carpenter, Wilmington, Del.

### Handy Block Makes Can Opening Easy

Many women find it hard to hold cans firmly when opening them, and will therefore appreciate the simple device shown in the drawing.

A block of 1-in. wood is cut with a V-shaped opening, as shown, and the faces of the vee covered with strips of fine emery cloth, glued to the wood; the block is then screwed to the work top of the

kitchen cabinet. The can to be opened is pushed into the V-notch, where a very light pressure holds its securely. With the can held firmly in this manner, open-



Opening Cans Is Made Easy for the Housewife by the Use of This Simple Holder

ing it is a very simple operation, requiring no heavy exertion. The angle of the notch and the size of the block should be such that it will hold any size of can that is ordinarily used in the kitchen.—J. E. Hoag, Los Angeles, Calif.

### Anti-Rattling Doorstop

By providing the simple stop shown in the illustration the usual rattling of a door held simply with a hook can be eliminated. The stop consists of a wooden block a few inches square, and a heavy coil spring held in a hole drilled in the block, as indicated. The block is securely fastened to the floor near the wall, where the door will strike the spring when opened, and the door is held by an ordinary hook. On account of the tension of the spring, no rattling can occur nor can the hook become unfastened. A piece of rubber may be tacked to the door to prevent marring by the end of the spring.—S. H. Candy, Montreal, Can.



When the metal tip of a shoestring pulls off, roll the tip in a little glue or shellac



## From the Bureau's Mail Bag

It is with genuine pride that I advise you that my only grandson looks forward monthly to the receipt of *Popular Mechanics* with as much zest as I did in the old days to the penny dreadfuls. A healthy sign of the times. Ernest is 15 years old. The P. M. M. is great.—Jas. Johnston, Capetown, South Africa.

In regard to your magazine, I have been a regular subscriber since I first saw it on a railway bookstall. I find it very interesting, as there is not to my knowledge any English magazine which provides such information to those interested in mechanics.—Wm. Harland, Whickham, England.

In the December issue of your interesting magazine, of which I am still a reader, is an article on a new type of electric hammer drill. Being a mining engineer by profession, this is, of course, of great interest to me, and I would be much obliged if you would pass my name on to the makers of this particular drill, so that they can forward me their literature without further delay.—D. W. F. Hatelie, Ipoh, Federated Malay States.

Having read your November, 1922, issue, I found a moving picture projector for schools and homes which generates its own electricity. I am interested to purchase one for use of the students of the Kalibo Institute for educational purposes, and it would be a great favor you could do to the school if you could furnish information as to the price and the place where we could purchase such a projector.

We do not have electric current in this town of Kalibo and this is the reason why it has been impossible for the school to secure one of the small projectors for school use.

Hoping to receive your attention and thanking you very much for this favor, and assuring you that the Kalibo Institute students are enjoying very much to read the *Popular Mechanics*, which was the pioneer in the school, I am, Vicente Salas Reyes, Treasurer, Kalibo Institute, Inc., Kalibo, Capiz, P. I.

A short time ago, we wrote you regarding the address of manufacturers of articles, descriptions of which appeared in the columns of your magazine, and now wish to thank you for your attention, as we have heard from these firms, and have already secured a sample of their products, and hope to establish a connection with them.

For your information, wish to advise that we are dealing in novelties and household utilities only, and are always on the lookout for something new and useful, as there is a ready market in these countries for such articles; hence, your magazine is always welcome, and we find many things of interest in its columns.—Des Jardines & Company, Puerto Cortes, Honduras.

I may state that I am running a successful business with an article I am importing from Chicago, Illinois, through seeing an advertisement in the *Popular Mechanics*.—L. Kaufman, Liverpool, England.

As I follow with great interest the news from your country and especially what regards the machinery for agricultural purpose, I would trouble you for the names and addresses of the builders of the machines described in your review, motorized cultivator, and wagon that fills and dumps itself in short time.—Mario Mandell, Rome, Italy.

We have pleasure to say that the magazine published by your office is a great help and guidance to our busi-

ness, and we prize them very much. By this opportunity, we beg to say that we are engaged in the importation of bicycles and the like for years, and are in good connection with principal dealers of same throughout the country, and if the prices are right, we can assure the maker that large orders will be placed on him from time to time.—Taihei Yoko, Ltd., Osaka, Japan.

In your March issue, is illustrated a light railroad cycle, of a type which would seem most appropriate for use of track inspectors, etc., on our logging railroads, which are three feet gauge, measured inside to inside of rails.

Would you kindly ask the makers of these machines to send us price list and full description of these machines, and to state whether these could be equipped with a gasoline engine, as some of our grades are quite heavy ones, Shay locomotives being used on this account.—W. G. Phillips, Superintendent, The Suchi Lumber Company, El Oro, Mexico.

In your September, 1922, issue, you mention a paste that will seal a union, and page 381 of your same issue, you mention a paper on which a Japanese inventor holds a patent. I am interested and shall be glad to negotiate with the patentees. Probably they

have some literature, and will let me have a copy, also a specimen or two of the articles themselves.

I have a good knowledge of the patent laws, and I was the first to obtain a patent for a client of mine under the New Zealand patent laws. I am a solicitor of the supreme court here.—Jas. B. Graham, Auckland, N. Z.

Having arrived here from England a little over a year ago, I have been a regular reader of your magazine for the past ten months, and I can assure you I thoroughly enjoy its contents, which are most edifying.—L. Denbow, East Lyme, Somerset, Bermuda.

I was highly interested by the details and illustrations of two new small inventions which I found in your magazine for January, 1924. In

order to save time, I would be sincerely obliged to you if you would kindly put me in direct touch with the manufacturers of the comb made of paper and the fountain pen with transparent stem, so that I could, without delay, get acquainted with them and introduce these articles into Europe or at least Switzerland.—Mrs. J. Fleur de Lys, Geneva, Switzerland.

In your issue of December I was interested in the enclosed list of inventions, and would be glad if you would pass on an inquiry to the respective proprietors. If not an imposition on your generosity for the request, I would be pleased to have fuller information regarding each of these lines with a view of securing business on the New Zealand market with them.—Arthur L. Goldsuech, Wellington, N. Z.

I certainly appreciate your courtesy and thank you for the trouble you have taken to get me in touch with the maker of the small radio set. I am sure that I understand how you put the "popular" in your magazine.—Theodore Irwin, Anchorage, Ky.

We must thank you very much that you have informed two firms kindly very soon. And we mailed the two firms. We will advertise your publishing magazine for your kindness and we will order your books in your catalog in future.—K. Hashiba & Co., Tokyo, Japan.

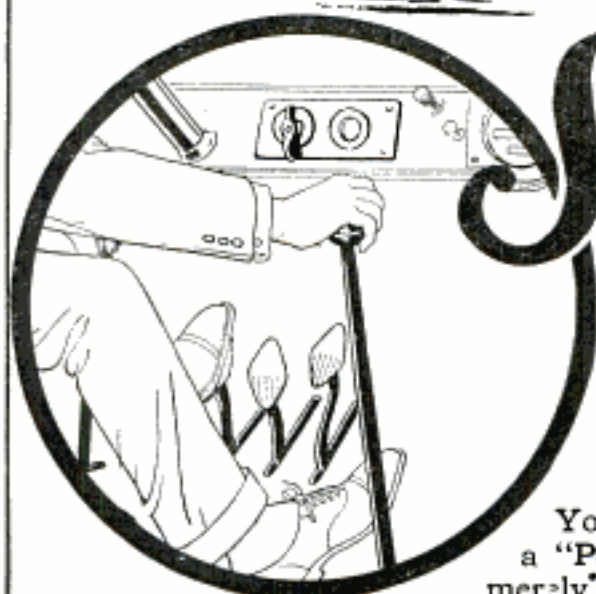

**SPEED POWER**

# Simply move this handy lever!

You can transform your light car or truck into a "Power" or "Speed" car or truck at will, by merely shifting the handy lever controlling the RUCKSTELL AXLE. Now, for the first time in the history of automotive engineering, it is possible to combine POWER and SPEED in ONE.

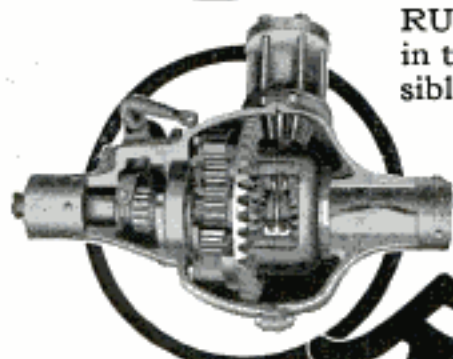

## Gives your light car or truck 55% to 60% Greater Power!

No hill too steep; no road too rough or muddy; The Ruckstell equipped car or truck goes through roads impassable for heavy, high priced trucks; climbs practically all hills, on "high"! If speed is a factor, you can have from 20% to 40% MORE. Get the full story NOW.

### The Only Two-Speed Axle in the World

Installed in the rear housing; becomes an integral part of the car or truck. Not an "accessory." Planetary in principle and operation. No welding, no cutting, no brazing. The drive shaft is not cut or altered. No added weight on parts not intended to carry added strain. See your nearest dealer in light cars and trucks for Free Demonstration, or write our nearest office AT ONCE.

Use the  
coupon  
below

### Ruckstell Sales & Mfg. Co. Dept. 20D

New York City  
522 Fifth Ave.

Kansas City, Mo.  
1302 Waldheim Bldg.

Berkeley, Cal.  
819 Snyder Ave.

In Canada: Ruckstell Axle Co., Ltd.  
Toronto and Montreal

**FREE**

This coupon good for Free Demonstration at nearest dealer, or for Free Booklet. (Dept. 20D)

Name.....

Address.....

Make of Car.....

# RUCKSTELL AXLE



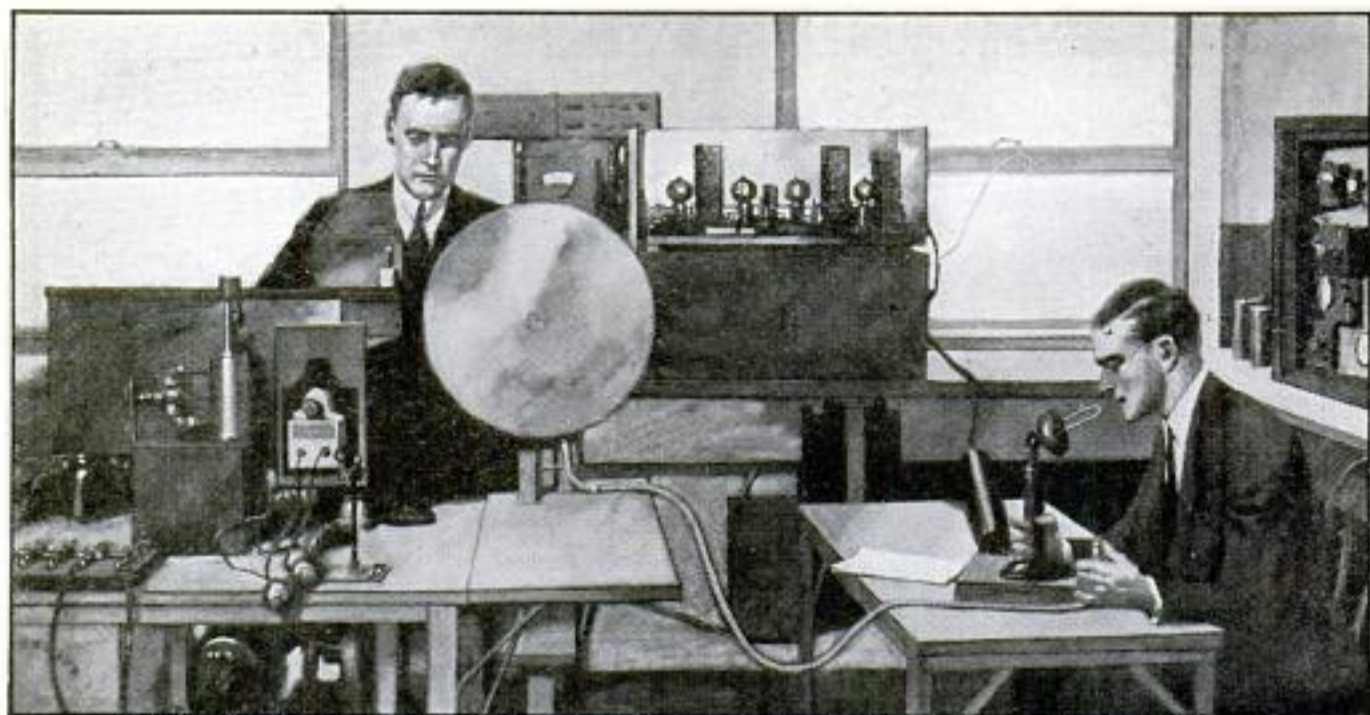

*In the Bell System laboratories speech sounds are recorded on the oscillograph with a view to their subsequent analysis*

## The service of knowledge

The youthful Alexander Graham Bell, in 1875, was explaining one of his experiments to the American scientist, Joseph Henry. He expressed the belief that he did not have the necessary electrical knowledge to develop it.

"Get it," was the laconic advice.

During this search for knowledge came the discovery that was to be of such incalculable value to mankind.

The search for knowledge in whatever field it might lie has made possible America's supremacy in the art of the telephone.

Many times, in making a national telephone service a reality, this centralized search for knowledge has overcome engineering difficulties and removed scientific limitations that

threatened to hamper the development of speech transmission. It is still making available for all the Bell companies inventions and improvements in every type of telephone mechanism.

This service of the parent company to its associates, as well as the advice and assistance given in operating, financial and legal matters, enables each company in the Bell System to render a telephone service infinitely cheaper and better than it could as an unrelated local unit.

This service of the parent company has saved hundreds of millions of dollars in first cost of Bell System telephone plant and tens of millions in annual operating expense—of which the public is enjoying the benefits.



**AMERICAN TELEPHONE AND TELEGRAPH COMPANY  
AND ASSOCIATED COMPANIES**

**BELL SYSTEM**

***One Policy, One System, Universal Service***





## In Tight Places!

Where you can move crank only an inch back and forth, "Yankee" DOUBLE Ratchet keeps the bit cutting continuously. No drill but a "Yankee" can do this.

In boring hard wood or light metal you save time and labor and do better work by using this speedy drill.

### "YANKEE" Ratchet Hand Drill No. 1530

Only 10½ in. long and weighs only 1¼ pounds—yet it has all five adjustments of big "Yankee" Hand Drills and Breast Drills. By touching Ratchet-shifter you can change to any of five adjustments: Plain Drill, Left-hand ratchet, Right-hand ratchet, DOUBLE ratchet, Gears locked. Drills any size hole up to and including  $\frac{3}{16}$  in.

#### Some Other "YANKEE" Tools

Spiral Screw-drivers  
Quick Return Spiral  
Screw-drivers  
Ratchet Screw-drivers  
Ratchet Hand Drills  
Plain Screw-drivers, 1¼  
to 30-in. blades

Ratchet Chain Drills  
Ratchet Bench Drills  
Plain Breast Drills  
Automatic Push Drills  
Ratchet Tap Wrenches  
Bench Vises—removable  
base

*Dealers everywhere sell "YANKEE" Tools.*

NORTH BROS. MFG. CO., Philadelphia, U.S.A.

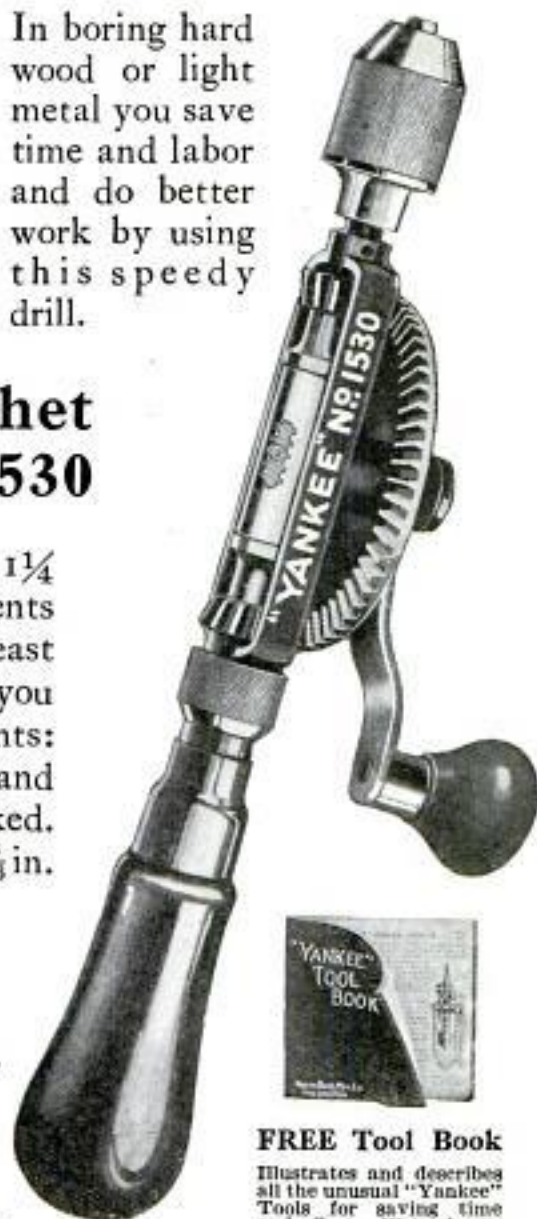

#### FREE Tool Book

Illustrates and describes all the unusual "Yankee" Tools for saving time and effort. Write for it.

# "YANKEE" TOOLS

*Make Better mechanics*



# The Pen of Accomplishment

## Waterman's Ideal Fountain Pen

"The Daddy of Them All"

**SPECIAL  
MOTTLED**  
Red & Black Rubber  
**\$7.50**

Uniquely beautiful in appearance. The blending of the red and black produces designs that do not duplicate. Ask your dealer to show it to you

Other Waterman's from \$2.50 to \$50.00 in barrel sizes and point tempers to fit the hand and preference of individual owners.

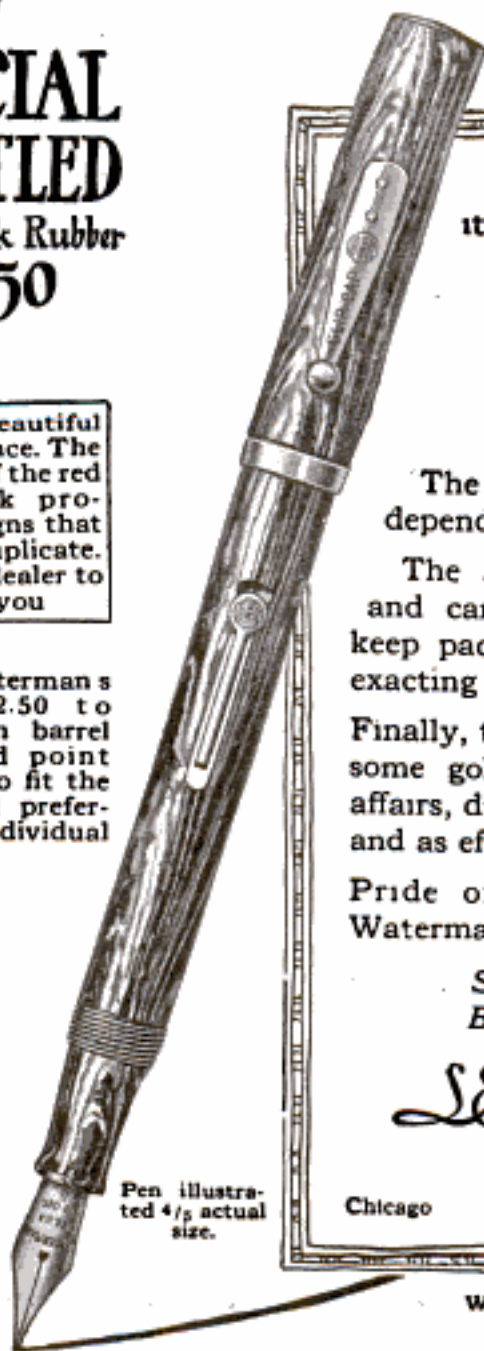

Pen illustrated 4/5 actual size.

Every age in pen-ownership has its appropriate

## Waterman's Ideal Fountain Pen

The sturdy pen of school day utility, dependable aid to neatness and accuracy

The appreciated companion of office and campus hours—a pen selected to keep pace with growing hands and more exacting employment.

Finally, the insignia of success—the handsome gold mounted pen of the man of affairs, dignified as his treasured time piece and as efficiently ready for instant call.

Pride of possession goes with every Waterman's Pen that's sold.

*Selection and Service at  
Best Dealers Everywhere*

*W. L. Waterman Company*

191 Broadway, New York

Chicago

Boston

San Francisco

Montreal

Waterman's Ideal Ink—Best for fountain pens and general use. Writes blue, dries black.





## How Henry Disston Made "The Saw Most Carpenters Use"

**T**ODAY or tomorrow, perhaps, you will buy a saw. Before you buy any saw, you will want to know the story of "The Saw Most Carpenters Use."

Disston D-8, shown above, is the world's standard for all-around work.

Among many other Disston favorites are these:



Disston D-115, the finest saw that Disston makes. For those who want the utmost in finish and service.



Disston D-23. For those who want a narrow blade.  $1\frac{1}{4}$ " wide at the point,  $6\frac{1}{4}$ " at butt.

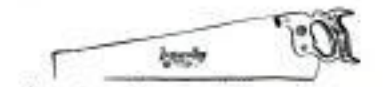

American Boy. A handy 20-inch 9-point saw for the home.

Your hardware dealer has the right Disston Saw for your special work.

In 1840, Henry Disston opened his own saw shop, in a cellar in Philadelphia. Carpenters then wanted foreign-made saws. Henry Disston knew he had to make saws better than any ever made before.

With his own hands he fired his furnace, smithed his saws, tempered, ground, set and filed them.

Around him he gathered saw makers and trained them in his own methods. First he made saws with his own hands; then he made saw makers.

Carpenters — the men who make their living by using saws — told one another to get a saw with Disston's name on it. Before long, even Europe was sending to Disston for saws.

Finer workmanship was impossible, but better steel for saws was possible.

So Disston in 1855 made his own steel—the first crucible saw steel ever cast in America.

And Disston Saws of Disston steel won the world! The Disston Hand Saw is known everywhere as "The Saw Most Carpenters Use."

Henry Disston's spirit lives on in the Disston Saw Works.

First his sons and then his grandsons served their seven years in the shops. They worked side by side with the sons and grandsons of the men who learned saw-making from Henry Disston himself.

The Disstons make saws today as Henry Disston would make them. As long as there is a Disston left, the standard will be the same.

For the Disston Hand Saw that you buy must run true, cut straight, have the right clearance and stay sharp. It must be balanced right for your wrist, easy on your arm. It must give you a life-time of faithful service.

Ask Disston. Whatever you saw, in wood, metal, bone, fibre, or other material, Disston has the saws for you.

Ask us about them.

HENRY DISSTON & SONS, INC.  
Philadelphia, U. S. A.

# DISSTON



# Ingersoll



The  
**NEW INGERSOLL**  
 Improved YANKEE \$1.75

**A**ROUND the world for rich and poor alike Ingersoll Watches keep good time and good faith.

Ingersolls are doing service as work watches for millions; and as all-around watches for millions more.

*They cost little and keep reliable time.*



The New Improved YANKEE is dependable, as always, but in addition it is a very handsome watch—with new features of grace and beauty.

It has the antique bow and crown, new hands and dial, damaskeened back plate, it is more closely cased and in general it has the appearance of a higher priced watch.

You can never appreciate what we are saying unless you see and examine the New YANKEE—at any Ingersoll dealer's.

## Reliable Watches at Low Prices





## ... and the head stays tight

**Y**OU can feel the joy of using a Plumb Nail Hammer, with the red handle and the black head.

Your Plumb sets right, hefts right and swings true. Face, neck and claws are different, to make your work easier.

And the head stays tight. Your troubles with loose handles are gone—forever. For the Plumb Patent Take-up Wedge retightens the handle with a turn of the screw.

You can get your Plumb Hammer wherever good carpenters trade.

Price, \$1.30 (except in Far West and in Canada)

FAYETTE R. PLUMB, Inc., Philadelphia, U. S. A.

THE RED HANDLE  
with the  
BLACK HEAD  
(Trade Mark Reg.  
U. S. Pat. Off.)  
EXCLUSIVELY  
PLUMB





# New BROWN & SHARPE Tools

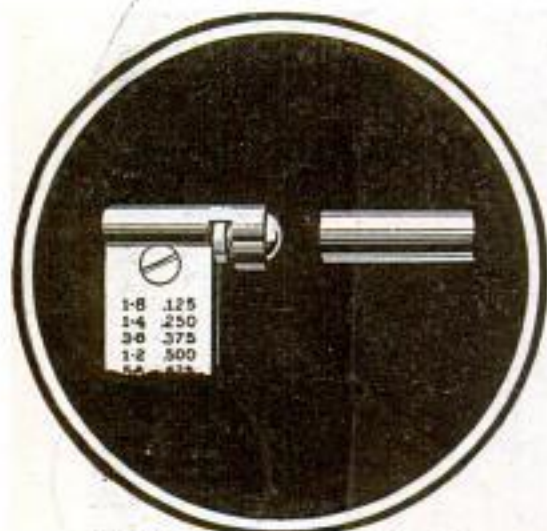

Ball Anvil Attachment No. 226



to  
complete your  
kit



Combination Bevel No. 500

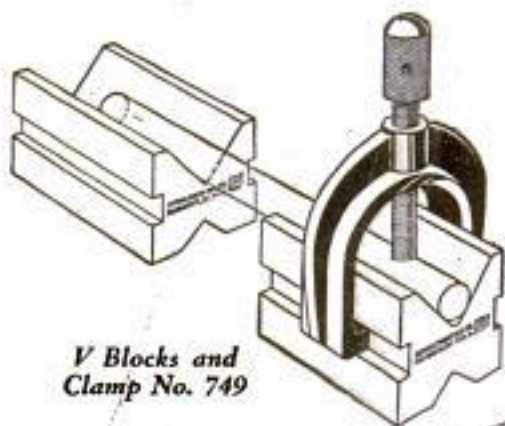

V Blocks and  
Clamp No. 749

The New No. 29  
Small Tool Catalog

The new size catalog is most convenient, slips right into the pocket, easy to handle, and above all, it lists the best tools you can buy.



You should see these tools. They're beauties. A mechanic would enjoy handling them, for somehow he would instinctively realize that they "feel" right. The design, balance, clean-cut graduations and immediately recognized utility are features by which the skilled mechanic knows them to be tools made by master workmen.

Furthermore, the name and trade mark of Brown & Sharpe assure him of the accuracy and durability expected of Brown & Sharpe Tools.

Stop at your dealer's, see and handle these tools. You, too, will feel their "personality" and will be proud to have them in your kit.

**Brown & Sharpe Mfg. Co.**  
PROVIDENCE, R. I.

Send today for your copy  
of this catalog

## BROWN & SHARPE TOOLS

"The Standard of the Mechanical World"



**WURLITZER**  
PLANNED MADE PERFECTED  
 THE WORLD'S LARGEST MUSIC HOUSE

## Try Any Wurlitzer Instrument in Your Own Home

**E**XAMINE IT, show it to your friends, play it as much as you wish. A week's free trial — no obligation to buy. We make this liberal offer because we want you to see for yourself this superior quality of Wurlitzer instruments, the result of 200 years' experience. Noted musicians praise them for unusual tone quality, artistic workmanship and ease of playing. They are used in the finest bands and orchestras throughout the country.

### Easy Payments

If you decide to buy, payments are arranged in small monthly sums. A few cents a day pays for your instrument. Special offers on complete musical outfits.

## SEND FOR New Catalog

The greatest musical catalog ever published! Over 3,000 articles—every known instrument described and illustrated; many of them shown in full colors. Gives you lowest prices and all details of Free Trial, Easy Payment plan. All sent FREE—no obligation. Send coupon below.

Clip  
and  
Mail

**THE RUDOLPH WURLITZER CO., Dept. 1776**

120 W. 42nd St., New York 117 E. 4th St., Cincinnati  
 329 S. Wabash Ave., Chicago 250 Stockton St., San Francisco  
 Send me, absolutely free, new illustrated catalog, with prices  
 and details of Free Trial Easy Payment plan. No obligation.

Name \_\_\_\_\_

Address \_\_\_\_\_

City \_\_\_\_\_ State \_\_\_\_\_

Instrument \_\_\_\_\_

(State instrument in which you are interested)



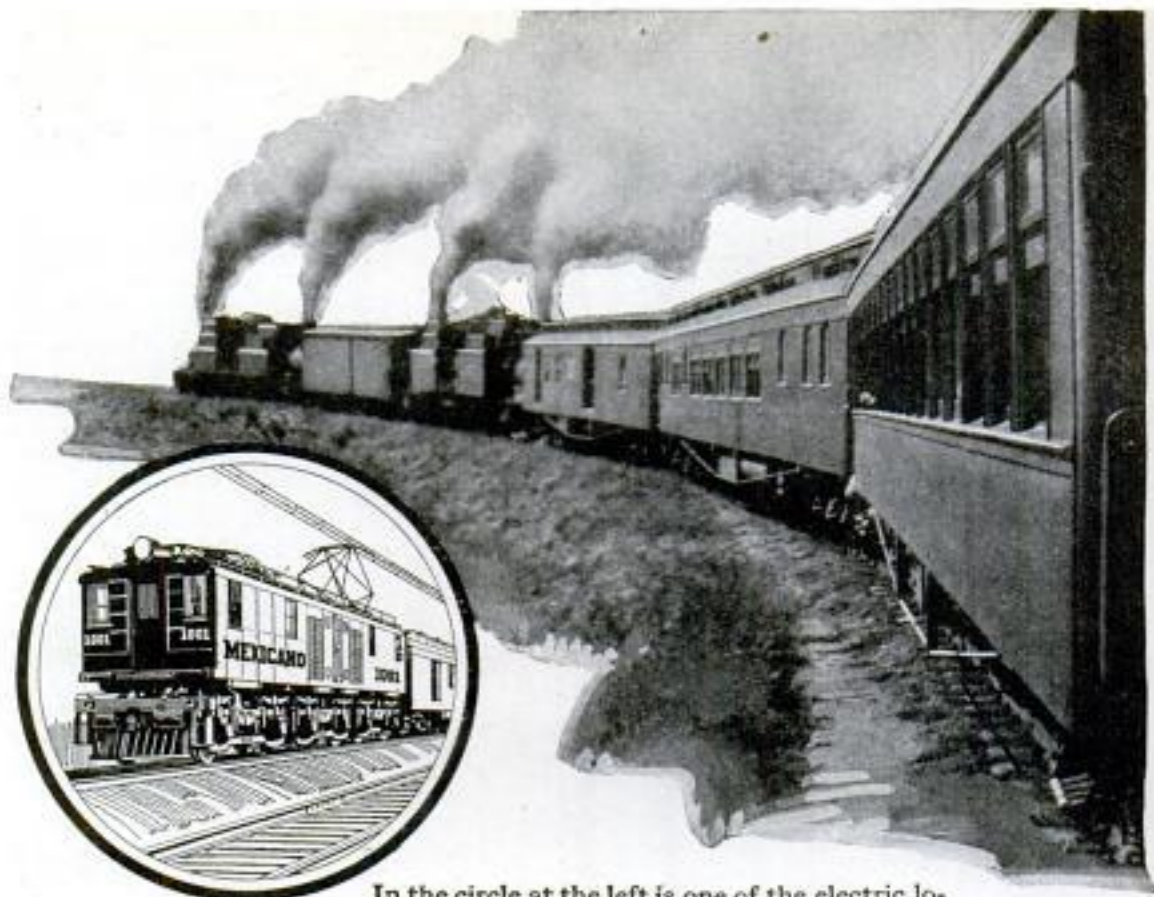

In the circle at the left is one of the electric locomotives that will replace the steam engines.

## 10 locomotives will take the place of 25



Electric locomotives draw long trains 650 miles over the Rocky Mountains on the Chicago, Milwaukee and St. Paul. Eventually most of the railroads in America will be electrified—engineers estimate that this will save more than a hundred million tons of coal a year.

The General Electric Company is electrifying the Mexican Railway between Orizaba and Esperanza. On the first section—with many curves and heavy grades—10 *electric* locomotives will take the place of 25 *steam* locomotives.

Economies resulting from electrification will repay the cost of the improvement within five or six years.

# GENERAL ELECTRIC



6

# reasons why Remington Portable

is the recognized leader  
in sales and popularity



### Durability and Reliability

The Remington Portable has won the endorsement of the world by its unequalled durability and reliability. You can count on it for years and years of faithful service.



### Compactness and Portability

The Remington Portable is the most compact of all writing machines. When encased it is only 4 inches high, so it can be tucked away in a desk drawer or bookcase. It weighs but 11 pounds. It carries its table on its back, which makes writing easy and convenient in any place or position, even on your lap.



### Four-Row Standard Keyboard

For fifty years the four-bank keyboard has been recognized as standard. The Remington Portable has always had the standard keyboard, with four rows of keys—no shifting for figures—exactly like the big machines—the keyboard universally adopted by business as the best.

*Keyboards in thirty-two languages and for every occupational requirement.*



### Ease of Operation

You will be surprised how quickly you can master the operation of the Remington Portable. The four-row, standard keyboard, and the simplicity in design and construction of the entire machine make it incomparably easy to learn and to operate.



### Beautiful Work Always

The writing of the Remington Portable is exceptionally beautiful. Even a beginner turns out work that is a revelation. This, of course, is due to the fine construction of the machine, and its habit of always being in perfect alignment.



### Universal Service

Wherever language is written—on the six continents—you will find Remington service, for there are over 700 Remington offices throughout the civilized world. A Remington Portable owner knows that wherever he goes Remington service is near at hand. This feature is one that no portable typewriter buyer can afford to overlook.

ON every count—whether work, wear or service—the superiority of the Remington Portable is decisive. Sold by over 5,000 dealers and Remington branches everywhere. You can buy one on easy terms, if you wish. Write for our illustrated, "For You—For Everybody." Address Dept. 12.

### REMINGTON TYPEWRITER CO.

374 Broadway, New York

Remington Typewriter Company of Canada, Limited  
Main Office, 68 King Street W., Toronto

*We believe we make the best typewriter ribbon in the world—and its name is PARAGON*

*Take any user's advice and  
buy a Remington Portable*



# OXO-GAS

## OIL BURNERS

### OXO-GAS OIL BURNERS

For

Furnaces  
Cook Stoves  
Large Ranges  
Heating Stoves  
Base Burners  
Shipmates  
Bake Ovens  
Vulcanizers  
Hot Water Heaters  
Hot Plate Heaters  
Water Coil Heaters  
Camp Stoves

And many other  
purposes

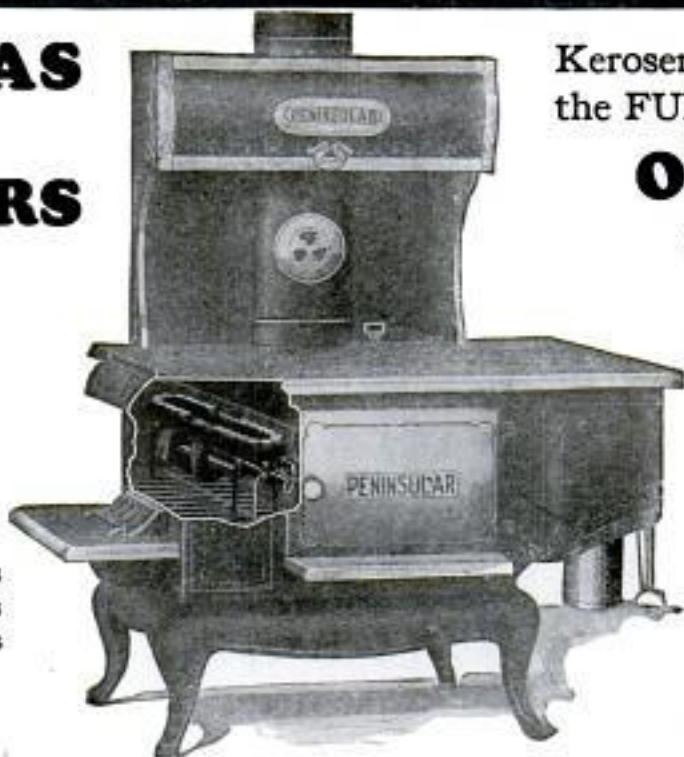

Kerosene or Distillate and Air  
the FUEL.

### OXO-GAS the RESULT!

A pure blue flame of  
high heating efficiency.

Burns as silently as city  
gas. The cheapest,  
cleanest and most  
efficient fuel known to  
science.

*Illustrating OXO-GAS Burner  
in Cook Stove—installed in a few  
minutes—lasts a lifetime—pays  
dividends in money, health and  
happiness.*

**OVER A MILLION IN EVERY DAY USE**



Hot water in any  
quantity—The simplest  
method of heating water  
ever conceived. Just  
light the heater, then no  
more bother. Its price  
within the reach of all.



The BIG FOUR Furnace  
Burner will operate per-  
fectly in any standard  
furnace for heating homes  
up to twelve rooms. Easily  
and quickly installed with-  
out any change in the furnace. No noisy motors  
or other machinery. Will give a lifetime of  
clean, cheap, efficient service. So low in price  
that anyone can afford it.



Heat, plenty of it, in  
base burner or heat-  
ing stove. Clean,  
satisfactory, econom-  
ical, convenient as  
steam heat. Brings  
happiness, plus.

**Agents Wanted** Some  
territory for OXO-GAS agencies still open  
to thoroughly responsible parties. Your  
own locality may yet be unassigned. Just  
write and ask us for our agent's proposition,  
and we will discuss the matter with you  
either by mail or in person.

## Gloria Light Company

[Established 1906]

111-9 North May Street

CHICAGO, ILLINOIS



# At Last!

## A PRACTICAL

### HAND BOOK for the MOTOR MACHINIST and AUTO REPAIR MAN

*The Book you've been looking for*

Here it is—the Starrett Book for Motor Machinists and Auto Repairmen; first and only book of its kind ever published. Over 200 pages of data on the maintenance and repair of autos and trucks and when you look it over you'll say three loose quarters never brought more value.

This Handbook has been prepared by authorities in the automotive world. Written for the man in the shop. Profusely illustrated. Diagrams. Tables. Well printed. Bound in handsome red Athol-leather. Handy size (4 $\frac{3}{4}$ " x 7 $\frac{3}{4}$ "") for carrying in pocket. In every way Volume III of the Starrett Books is a fitting companion to Volumes I and II (The Starrett Book for Machinists' Apprentices and The Starrett Data Book for Machinists) of which nearly 100,000 copies have been bought by skilled machinists as well as those learning the metal working trades.

If you work on a car this Starrett Book will pay for itself a hundred times over. Get it for 75c. at any hardware store selling Starrett Tools. If there is no dealer near you, send 75 cents and we will mail you a copy with charges prepaid. Whichever you do—ACT PROMPTLY. The first edition is limited and these practical handbooks will go fast.

Write for the new Starrett Catalog No. 23 "M" describing over 2200 fine Precision Tools for Machinists, Auto-Repairmen, Carpenters and Mechanics.

0644

#### THE L. S. STARRETT CO.

*The World's Greatest Toolmakers*  
Manufacturers of Hacksaws Unexcelled  
ATHOL, MASS.



# The Starrett Book for MOTOR MACHINISTS AND AUTO REPAIR MEN

**The Book that shows  
how to do it right!**

#### Partial Table of Contents

LAYING OUT WORK  
DRILLING (selecting speeds and feeds, grinding drill points, counterboring, etc.)  
TAPPING (regrinding taps, removing broken taps, use and care of dies, etc.)  
REAMERS AND REAMING  
FILING  
HACKSAW CUTTING  
GRINDING (wheel selection, mounting, dressing, lapsing, etc.)  
LATHE WORK (rare, indication, adjusting, locating centers, setting tools, testing, turning, checking)  
HOW TO READ AND THE ADJUSTMENT OF MICROMETERS  
MILLING AND MILLING MACHINES  
THREAD CUTTING  
FITS AND FITTING  
GAGING CYLINDER BORES  
PISTON GRINDING  
FITTING PISTONS AND PINS  
CYLINDER HONING  
LAPPING CYLINDERS  
VALVE FITTING  
FITTING CRANKSHAFT AND CON-ROD BEARINGS  
ADJUSTING TAPPETS  
SHIM FITTING  
DECARBONIZING  
THE ACETYLENE TORCH  
WELDING, SOLDERING AND BRAZING  
CHAIN DISCOUNTS (how to figure)  
DEFINITION OF ELECTRICAL TERMS

#### Tables Covering

Decimal equivalents of Fraction of an Inch  
Depth of drilling necessary to remove given weights of different metals when balancing machine parts, etc.  
Assortments of Drills for Tapping  
Melting Points of Metals  
Piston Displacements  
Wire and Sheet Metal Gages  
Wood Screw Specifications  
How to tell Carburetor sizes  
Anti-Freezing Solutions  
Maximum Power Required to Drive Machine Tools  
Equivalent Angular Ball Bearings  
Horsepower Table by N. A. C. O. Formula  
Grades of Grinding Wheels  
Grain Numbers Commonly used in various polishing operations  
Woodruff Key Sizes  
Rules for Figuring Tapers  
Cutting Speeds and Feeds for Turning Tools  
U. S. Standard Screw Threads  
Tap and Die Drills  
Taper Reamers for Standard Taper Sockets  
Wrench Sizes for Bolts, Nuts and Cap-Screws  
Continuous Drill Table  
Definitions of Symbols used on Wiring Diagrams





Write for your  
free copy  
of

# Ward's Radio Catalogue

**MONTGOMERY WARD**  
Chicago Kansas City St. Paul Portland, Ore. Oakland, Cal. Ft. Worth

**A Valuable 68-Page Reference Book on Radio—a Market Place for the Best in Sets and Parts**

We want you to have a copy of Ward's new Radio Catalogue. You will find it to be an encyclopedia of information on Radio, the liveliest topic of the day. It contains a new Radio map—diagrams of the best hook-ups—descriptions of complete sets, and standard parts for building sets.

#### *Headquarters for Radio*

Montgomery Ward offers you all types

of Radio Equipment at a saving. We sell direct to you only merchandise of highest quality. Everything you buy from us, carries our 52-year-old guarantee—"Your money back if you are not satisfied."

#### *Enjoy the Long Winter Evenings*

Every form of entertainment can be brought into your home by Radio. Keep in touch with the world—Sports—Election Returns—Dance Music—Speeches—Sermons—Current Events—you can enjoy them all by Radio.

Write today for your copy of this complete Radio Catalogue. Address our house nearest you: Dept. 6-R

ESTABLISHED 1872  
**Montgomery Ward & Co.**

*The Oldest Mail Order House is Today the Most Progressive*

Chicago Kansas City St. Paul Portland, Ore. Oakland, Cal. Ft. Worth





# \$3 and it's YOURS

**DOWN**

## The Greatest Typewriter Bargain Ever Offered

Right now we are making you the greatest typewriter offer you ever dreamed of—an eye opener. This wonderful standard Shipman-Ward Rebuilt Underwood only \$3.00 down. Ten days' free trial and the easiest monthly payments, shipped direct to you from our big factory.

### 10 Days' Free Trial From Factory to You

Yes, only \$3.00 down puts this genuine late model Shipman-Ward Rebuilt Underwood in your home. You can try it, test it, and then decide. See for yourself how new it is, how it writes. You must be satisfied. Your \$3.00 unconditionally returned if at the end of ten days you are not satisfied. The entire transaction will not cost you one cent.

### EASY Monthly Payments

Little more than rental. Balance of payments so small you will hardly notice them, while you enjoy the use of this wonderful machine. You don't have to scrimp and save to pay cash. All at a big saving to you.

### 5 Year Guarantee

With every typewriter we give a written guarantee. These machines are rebuilt like new by the famous SHIPMAN-WARD PROCESS. Equipped with late improvements. You can't tell them from a new machine. The world's standard typewriter, the same models as sold by the Underwood Typewriter Company today, at a big saving to you. Act now! Get this splendid offer and save money.

These machines are shipped direct from our factory—the largest typewriter rebuilding plant in the world. They are rebuilt by the famous SHIPMAN-WARD PROCESS. Developed through 30 years in the typewriter business. Through our money saving methods of rebuilding and elimination of a large expensive sales force we are able to make this wonderful money saving offer to you. ACT TODAY, take advantage of it and you will SAVE MONEY. ACT NOW! Mail this coupon today.

### Free Book of Facts

Write for this free book of facts explaining Shipman-Ward's wonderful system of rebuilding typewriters. We show you exactly how it's done. How you are able to buy them. Complete and valuable information about the typewriter industry, both instructive and educational.

### FREE with Every Typewriter

A complete course in touch typewriting. You don't have to know how to operate a typewriter. You can learn to operate this machine in one day. We also give free a waterproof cover and all tools that come with a typewriter.



All Shipments made direct to you from our modern factory—the largest typewriter rebuilding plant in the world.

### FREE BOOK COUPON

**SHIPMAN-WARD MFG. CO.**  
2126 Shipman Bldg.  
Montrose and Ravenswood Aves.  
CHICAGO

Send by return mail your wonderful offer of Shipman-Ward Standard Rebuilt Underwood, also your book of facts. (This is not an order and does not obligate me in any way.)

NAME.....

STREET.....

Post Office.....STATE.....

## SHIPMAN-WARD MFG. CO.

2126 Shipman Bldg., Montrose and Ravenswood Aves., Chicago





W. L. Douglas  
PRESIDENT

# W. L. Douglas

## \$5, \$6, \$7 & \$8 SHOES

BOYS AT \$4.50 & \$5.00

Women of fashion should know that we have in our stores a most attractive display of distinctive, up-to-date Women's shoes in exclusive styles which appeal to those who desire stylish and comfortable shoes at reasonable prices.



### Fall Style for Women

In Cherry Red Russia.  
Also in Velour Calf for women  
who prefer Black leather.

\$6.00



W. L. DOUGLAS PEGGING  
SHOES AT 7 YEARS OF AGE



### New Brogue for Men

A late broad-toe last  
with soft box in Black Velour  
Calf. Also in light Russia Calf.

\$7.00

### WEAR W. L. DOUGLAS SHOES AND SAVE MONEY

FOR 38 YEARS, W. L. Douglas' name and portrait have stood for quality, for economy and for satisfactory service. W. L. Douglas shoes are exceptionally good values. Only by wearing them can you appreciate their superior qualities. *Such quality, comfort and service are rarely found in other makes at our prices.*

THE EXCLUSIVE, smart models, designed especially for young men and women, are the leaders. *Seldom have you had the opportunity to buy shoes of such wonderful value as you will find in the W. L. Douglas \$7.00 shoes in our retail stores in the principal cities, and in good shoe stores everywhere.*

WHEREVER YOU LIVE, demand W. L. Douglas shoes. They are sold in 120 of our own stores and by over 5,000 shoe dealers. For economy and dependable value, *wear shoes that have W. L. Douglas' name and the retail price stamped on the soles.* The stamped price guarantees the value. If they are not for sale in your vicinity, write for catalog.

W. L. Douglas Shoe Company, 128 Spark St., Brockton, Mass.

## SHOTGUN or RIFLE

Dept. 575

There's remarkable gun value in a Stevens. Write for the interesting catalog describing our line.

J. STEVENS ARMS COMPANY  
Chicopee Falls, Mass.

Owned and Operated by the Savage Arms Corporation

**FREE!** DIAMOND, WATCH AND JEWELRY CATALOG, showing latest designs and highest quality jewelry at lowest prices and EASY CREDIT TERMS. Ten months to pay. Prices from \$10 to \$1000. Legal guarantee bond with every article. Don't buy until you see it for this Free Catalog. **Baer Bros. Co., Dept. 926, 6 Maiden Lane, N. Y.**



## Summer Home in Maine

A gentleman's estate of 175 acres on the Maine coast, with frontage on a lake 9 miles long; master's house; large bungalow; caretaker's house; large garage; barns; private electric light and inexhaustible water works, and every modern improvement. Forty acres very large trees. Golf and yacht clubs only a few minutes away; good markets in the town.

The scenery of mountains, lake and ocean is pronounced one of the best five in New England. House and bungalow both completely furnished; steam heat.

*Will be sold at a great bargain.*

Address OWNER

206 East Ontario Street

CHICAGO, ILL.



# Sent on Approval

No  
Money  
Down

## 21 Jewel Santa Fe Special

Without one penny of advance payment let us place in your hands to see, to examine, to inspect, to admire, to approve, a real masterpiece in watch creation.

Our determination to this year double our sales of the world famous *Santa Fe Special* and *Bunn Special* Watches prompts this matchless offer.

While other watch dealers are raising their prices, asking you for larger monthly payments, and making payment terms harder for you to meet, we are offering you our new model *Santa Fe Special*, no advance in price, no money down, easier terms and smaller monthly payments. WE realize the war is over and in order to double our business we MUST give you pre-war inducements, better prices, easier terms, and smaller payments.

### Page 12 of Our Watch Book Is of Special Interest to You!

Ask for our Watch Book free—then select the watch you would like to see, either the famous *Santa Fe Special* or the 6 position *Bunn Special*, and let us explain our easy payment plan and send the watch, express prepaid, for you to examine. NO money down.

**REMEMBER** No money down—easy payments buys a master timepiece—a 21-jewel guaranteed for a lifetime at about half the price you pay for a similar watch of other makes. No money down. A wonderful offer.

### SANTA FE WATCH COMPANY

96 Thomas Bldg.

TOPEKA, KANS.

MAIL COUPON TODAY

SANTA FE WATCH CO.,  
96 Thomas Bldg.,  
Topeka, Kansas

Please send prepaid and without obligation your Watch Book free, explaining your "No Money Down" Offer on this *Santa Fe Special* Watch.

Name.....

Address.....





*Cunningham*

## RADIO TUBES

*Give Clearest Reception for Summer Broadcasting of Presidential Oratorical Battles*

This year, for the first time in history, it is possible for millions of United States citizens to hear every word of our statesmen in their oratorical battles for the honor of the presidential nomination.

It is the privilege of every American citizen to avail himself of this wonderful opportunity of radio broadcasting, made possible by the development of the radio tube.

**Patent Notices** Cunningham tubes are covered by patents dated 2-18-08 and others issued and pending. Licensed for amateur, experimental and entertainment use in radio communication. Any other use will be an infringement.

*The care and operation of each model of Receiving Tube is fully explained in our new 40-page "Radio Tube Data Book." Copies may be obtained by sending ten cents to our San Francisco office.*

### Prices on Cunningham Tubes Now in Effect

C-301A—5 Volts 1-4 Ampere filament....	\$5.00
C-299—3 Volts .06 Amp. Dry Battery Det. and Amp.....	5.00
C-300—5 Volts Gas Content Detector....	5.00
C-11—1.1 Volts .25 Amp. Dry Battery Det. and Amp. Special Base.....	5.00
C-12—Similar to C-11 with Standard Base	5.00

*E. J. Cunningham Inc.*

Home Offices:  
182 Second St. 154 W. Lake St. 30 Church St.  
SAN FRANCISCO CHICAGO NEW YORK

There's  
a **DIFFERENCE**  
in  
**Blow Torches**

PRESENT day gasoline or kerosene can be used in the Turner No. 45 Master Line. The "Baffle" (Turner Patent) makes it possible—the Safety Valve and one-opening in the tank are guardians of safety—the Shut-Off and Adjusting Needles are separate, entirely preventing the enlarged orifice (so common an occurrence on ordinary torches.) Pistol Grip Handle is comfortable and convenient. FEARLESSLY GUARANTEED. Get one now!

**TURNER BLOWTORCH**  
*Safe as a Candle*

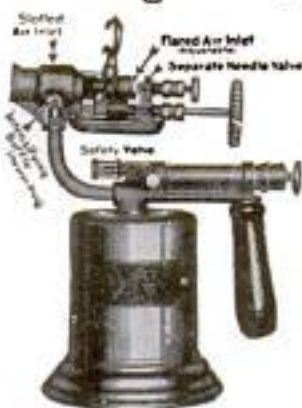

CAPACITY—1 Quart

**\$8.25**

**THE TURNER BRASSWORKS**  
Industry Ave., Sycamore, Illinois

*The World's Largest Exclusive Manufacturers  
of Blow Torches, Fire Pots and Brazers*

TOWERS'S

**TOWERS'S Scientific**  
WITH ONLY ONE \$2.95  
plus a few cents postage

Buy a Headset you'll be proud of  
**RADIO TOWERS'S SCIENTIFIC HEADSETS**

**OUR \$200,000.00 COMPANY**  
STANDS SQUARELY BACK OF EVERY HEADSET

WORLD'S GREATEST HEADSET VALUE

Now \$2.95, with notable improvements  
Longer Cord (24 1/2 feet), Stronger Magnets, Higher Resistance, Increase of Sensitivity, Perfect Tone Mutes  
EVERY SET TESTED BY LICENSED RADIO OPERATORS

Send no money - Order on a Post-Card  
THE TOWER MFG. CO. Dept. P, 38 BROOKLINE AVENUE, BOSTON, MASS.

Scientific

**21 Jewels**  
Nothing less than 21 Ruby and Sapphire Jewels is good enough for the Burlington masterpiece.

**Quality and Style**  
Adjusted to the second—temperature—synchronism—positions. 25 year Gold Strata Case, in 100 exquisite designs. Only \$1 down. Balance in small monthly payments. Send for free book.

**Burlington Company**  
19th Street and Marshall Boulevard  
Dept. 13-56 Chicago, Illinois

**\$1 DOWN**

**"Lighting Fixtures"**  
READY TO HANG  
(Direct from Manufacturer)  
Completely wired, including glassware. Send for Catalogue No. 26. Just Off the Press. Special proposition to DEALERS.

**ERIE FIXTURE SUPPLY CO.**  
STA. A ERIE, PA.



# Radio Headquarters



Everybody is interested in Radio. If you would keep in step with the progress that has been made in this greatest of all discoveries, you should have our NEW RADIO Catalog just now off the press.

You can get the latest and best equipment from RADIO HEADQUARTERS. We have everything that anybody needs to enjoy the entertainment, news and education that are waiting to be brought right into your home.

Don't be without the comfort of Radio this fall and winter when reception is so fine.

The World's Largest Store—RADIO HEADQUARTERS—can save you money on everything you need.

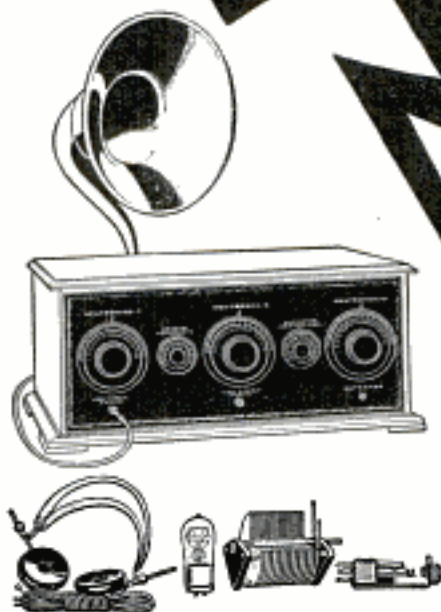

The World's Largest Store is RADIO HEADQUARTERS. Here you can get the famous SILVERTONE neutrodyne receiving set or the smallest radio part—at the lowest prices in America.

Mail the coupon TODAY to the store nearest you.  
50P71.

Sears, Roebuck and Co.  
Chicago Philadelphia Dallas Seattle

Send New Radio Catalog.

Name .....

Postoffice..... State.....

Rural Route..... Box No.....

Street and No. ....

## Sears Roebuck and Co.

The World's Largest Store owns and operates Station W.L.S. Wavelength 345 Meters. Tune in

**Como Duplex Transformers** "The World's Standard Push-Pull Transformer"  
Maximum Volume without Distortion  
Price \$12.50 per pair At All Leading Dealers  
COMO APPARATUS CORP., 447 Tremont Street, BOSTON, MASS.

### The Fansteel Balkite Battery Charger

for Radio "A" Batteries is noiseless, bulbless, and practically indestructible. It has no moving parts. Price \$19.50 (\$20.00 post of Rock).  
FANSTEEL PRODUCTS CO., Inc., North Chicago, Ill.



### Save 1/2 Cost of New Tubes

#### VACUUM TUBES REPAIRED

Guaranteed equal to new. Send in your burned out or broken tubes by P. P. All repaired tubes returned P. P., C. O. D. We try to repair and return within 48 hours.

Harvard Radio Laboratories  
200-204 Old Colony Ave., So. Boston, Mass.



**YOU CAN CLEAR \$150 to \$300 PROFIT EVERY MONTH WITH 8 HOUR BATTERY CHARGING**

Just \$35 cash puts this HB 80 Ampere Constant Potential Battery charging outfit in your shop—complete with bench, bus bars, resistance leads, connectors, cables, etc.—all ready to set up and operate. Easy terms on balance. This HB is the lowest-priced complete outfit on the market. 30 days' trial on money-back guarantee. 90 days in which to exchange for larger HB. This is the ideal equipment for the small battery shop, or the shop that wants to get the big profits that battery charging pays. Push battery charging, increase your profits, beat competition. Write for free bulletin.

**HOBART BROS. CO.**

**Box M 9**

**Troy, Ohio**

**THE LOWEST-PRICED COMPLETE OUTFIT ON THE MARKET**





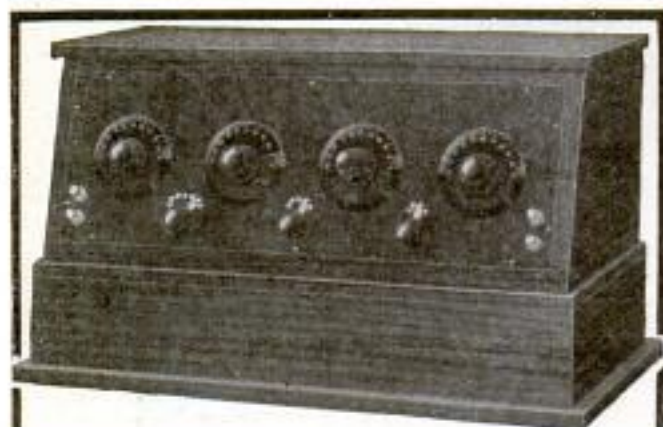

## MAKE MONEY—SELL RADIO!

Radio offers the biggest money-making opportunity on earth today. And the *Ozarka Plan* opens the door to this big opportunity. Look at the picture of this beautiful Radio Receiver. This picture was made from an actual photograph. By the *Ozarka Plan* that Radio Instrument can be the product of your own making—easily, simply and surely. It will be yours to make, to sell and to reap a rich reward in cash profits.

No experience necessary. You need not have much cash. All you need is spare time, determination and action. If you're that kind of a chap, the *Ozarka Plan* will start you on a straight line toward a real money-making business of your own. It can be as big and as profitable as you are ambitious to make it. We want good men in every county. Exclusive territory is going fast. Be sure and give us the name of your county. Write today for the *Ozarka Plan*. A wonderfully interesting book, of facts, particulars and proofs. It is FREE. Act now.

**OZARKA, INC.**

**851 Washington Blvd. CHICAGO**

## RADIO TEXT BOOK & CATALOG FREE



Contains—  
75 Radio "Hook-Ups"  
300 Illustrations  
556 Articles  
84 Pages

"Build Your Own with RASCO Parts"

**RADIO SPECIALTY CO.**  
90-E Park Place, NEW YORK, N. Y.

## "ROLLS-ROYCE" RADIO TUBES



Like their name, significant of quality. Durable and powerful. Bring in distance with a maximum of volume and clearness.

Type 200....5 Volts, 1 Ampere Detector Tube.  
Type 201A....5 Volts, .25 Ampere Amplifier and Detector.  
Type 199....3-4 Volts, .06 Ampere Amplifier and Detector.  
Type 199....3-4 Volts, .06 Ampere With Standard Base.  
Type 12....1½ Volts, .25 Ampere Platinum Filament.  
"The Rolls Royce of Radio Tubes." ALL TYPES \$2.50 Amplifier and Detector.

Type 202....5 Watt. Transmitters \$3  
ALL TUBES GUARANTEED to work in Radio Frequency. Especially adapted for Neutrodyne, Reflex and Super-Heterodyne Sets.

Shipped Parcel Post C. O. D. When Ordering Mention Type

**ROLLS ROYCE TUBE CO.** 21 Norwood St. (Dept. P) NEWARK, N. J.

# Send No Money

## Ladies' Solitaire Examination Free

This perfectly cut Diamond will be sent free of charge for your complete examination and approval. No money in advance. If satisfied, pay only \$2.00 on arrival and keep it. Price \$30.00.

### 10 MONTHS TO PAY

The balance you send in 10 small monthly payments—only \$2.00 a month. Take advantage of this amazing offer today.

**FREE** De Luxe Catalog in colors. Write for details of Great Diamond Offer and Book to Dept. 64-P  
Capital \$1,000,000



**\$2.80 a month**



THE HOUSE OF QUALITY

AUTHORIZED CAPITAL \$1,000,000.

## L.W. SWEET INC.

Dept. 64-P | 660 BROADWAY, NEW YORK



## PILLIOD Tool Cases Excel

Machinists, Tool Makers and Carpenters find them most satisfactory in construction, appearance, service and price. Immediate shipment.

Booklet describing 20 styles on request.

**THE PILLIOD LUMBER CO.**  
Dept. 1 Swanton, Ohio

## AGENTS \$72 A WEEK

A wonder lamp of age. For use in every home. **300 Candle Power.** Brilliant, white light—soft, restful to eyes. Equals safety, brilliancy of electricity. 1/10th the cost. 20 times brighter than wick lamps. More healthful. Easy to operate. No smoke. No odor. Low priced. Guaranteed.

**FREE** Outfit to workers. New plan starts you without capital. Full or spare time. No experience needed. Profits start first day. Vision, Minn., made \$400 in 20 days. You can do as well. No charge for territory. Write for **Free Outfit Offer.**

**AKRON LAMP CO., 109 Lamp Building, AKRON, OHIO**



If on your feet more or less all day apply Absorbine, Jr. You almost see that hot, tired aching feeling disappear as the muscles relax their tension. A soothing, cooling sensation comes quickly—and affords lasting relief.

All druggists', \$1.25 or postpaid.  
Liberal trial bottle 10c., postpaid.

**W. F. YOUNG, INC.**  
347 Lyman St. Springfield, Mass.



## Absorbine, Jr.

THE ANTISEPTIC LINIMENT

for Cuts Bruises Insect bites  
Strains Sunburn Pimples



## How Good The Bristles Feel!

The first thing you notice about a WHITING-ADAMS BRUSH is how good the bristles feel. How strong and springy they are! Then you notice what a clean-cut, perfectly-balanced, and "usable" article the whole brush is. Ask your dealer to show you one.



### WHITING-ADAMS BRUSHES

Send for Illustrated Literature

Making a Brush to Last a Lifetime is a Lifetime Job



**JOHN L. WHITING-J. J. ADAMS CO.**  
Boston, U. S. A.

Brush Manufacturers for Over 116 Years and the Largest in the World

Self-Filler DE LUXE Style Pen

### "INDEPENDENT"

All the best features of a Fountain. Lasts longer. Writes smoother. Improves handwriting. Eliminates fatigue. GUARANTEED.

**\$2.00**

By Mail

14 Kt. White Gold Point. Chased Rubber Holder. Lever Filler. Pocket Clip.

Your Name in Gold Inlay, 25c.

Write for Pen Catalog. Agents Wanted, J. C. Ulrich & Co., 161 Washington St., New York

Known the World Over for 40 Years.

## Factory to Rider

Saves \$10 to \$25 on the Ranger Bicycle you select. You can have your choice of 44 Styles, colors and sizes. Delivered free on approval, express prepaid, for 30 DAYS' FREE TRIAL. Bicycles, \$21.50 up. \$5 a Month if desired. Possession and use at once on our Liberal Easy Payment plan. Parents often advance first payment.

Best quality, at factory prices, express prepaid. Tires, lamps, wheels and equipment, low prices. Send No Money, do business direct with makers.

**Mead CYCLE COMPANY**  
DEPT. W CHICAGO

Write today for free Ranger Catalog, factory prices and marvelous easy payment terms



## \$5.50 on every sale!

For only \$29.50 you can sell the man who likes to dress well an all-wool tailored-to-measure suit or overcoat, with the style, fit, wear, and distinctive appearance which usually cost him \$10 to \$15 more. 200 beautiful patterns to show. Your commission \$5.50. Our men live well, make good money, and build real business because their customers get more for their money than they expect. Write today as our fall-winter sample lines are fast being taken out.

Tailormode Clothes, 114 Anderson Bldg., Cincinnati, O.

**TAILORMODE**  
Clothes



## We've Made You

*A unique Shaving Cream*  
*Will you please accept a test?*

By V. K. CASSADY, Chief Chemist

GENTLEMEN:

Here is a Shaving Cream which millions are discussing.

It does five things which men desire in a surpassing way.

### The history is this:

Palmolive Soap, through its effects on the skin, had become the world's leading toilet soap. We desired to bring men those same effects in shaving. So we asked 1,000 men to tell us what they wanted most.

Then we worked 18 months to meet their requirements as no one else had done. We made up and tested 130 formulas to attain the utmost in a Shaving Cream.

The result surprised us no less than others.

### Five astonishing results

- 1—Palmolive Shaving Cream multiplies itself in lather 250 times.
- 2—It softens the beard in one minute.
- 3—Its lather maintains its creamy fullness for ten minutes on face.
- 4—The extra-strong bubbles support the hairs for cutting.
- 5—The palm and olive oil content makes the cream lotion-like in its effect.

It has been a sensation.

To add the final touch to shaving luxury, we have created Palmolive After Shaving Talc—especially for men. Doesn't show. Leaves the skin smooth and fresh, and gives that well-groomed look.

There are new delights here for every man who shaves. Please let us prove them to you. Clip coupon now.

THE PALMOLIVE COMPANY (Del. Corp.)  
360 N. Michigan Ave., Chicago, Ill.

**PALMOLIVE SHAVING CREAM**

© P. Co. 1924



### 10 SHAVES FREE

and a can of Palmolive After Shaving Talc. Simply insert your name and address and mail to: Address for residents of Wisconsin, The Palmolive Company (Wis. Corp.), Milwaukee, Wis., Dept. 8-845. Address for residents other than Wisconsin, The Palmolive Company (Del. Corp.), 360 North Michigan Avenue, Chicago, Ill., Dept. 8-845. 2075A



# A Good Bookcase for the price of a good book!



**\$2.50** Per Section  
without Doors

With Disappearing  
Glass Doors **\$3.25** Per Section

On Approval—Direct to User

## Lundstrom

IT GROWS WITH YOUR LIBRARY

### SECTIONAL BOOKCASE

Endorsed by Over 100,000 Users

Made for and universally used in the finest homes and offices throughout the country. Made in sections of different sizes, combining utility, economy and attractive appearance. Style shown above is beautifully finished in SOLID OAK. Price complete as shown with top, base and three book sections with non-binding, disappearing, felt-cushioned glass doors, \$13.75; without doors, \$11.50. In mahogany finish, with doors, \$16.25; without doors, \$13.25. Other styles in different grades and finishes at correspondingly low prices. Shipped direct from factory ON APPROVAL at a considerable saving TO YOU. Write for new catalog No. 21.

The C. J. LUNDSTROM MFG. CO., Little Falls, N. Y.  
Manufacturers of Sectional Bookcases since 1899

## MINT VENDING MACHINE

Pays \$10 to \$20 Day Profit

Pays Rent for Store Owner

Install one in your store or any public place and get this easy money. Requires no attention. Always works. Machine's profits pay the rent. Write us about rebuilt penny and nickel machines. Finished like new. In excellent running order. Pay their cost in 10 days.

Write or wire today for full particulars. \$25 down payment. Balance C. O. D. Export orders full down payment. Mints \$15 per case, 1,000 5 cent packages. Single boxes, 100 5 cent packages. \$1.50. **SILVER KING NOVELTY CO.**  
400 Williams Bldg. Indianapolis, Ind.



## Magnified 225 Diameters

This is what the tip of a fly's leg is like when seen thru the

## Wonderful New Ultralens Microscope

At last the high powered microscope is within the reach of all who wish to study, observe and experiment with the vast world of minute objects that are invisible to the naked eye.

Any amateur can immediately start using his Ultralens to examine the edge of a razor, the mesh of a cotton shirt, the bacteria in dirty water. No technical training required yet

hundreds of scientists and teachers are using this instrument today. It is at once interesting, instructive, and scientific. Gives enormous magnification and perfect definition.

Order direct from this advertisement and get your Ultralens Microscope now. Fully guaranteed. If, however, you desire more information before purchasing, we will gladly send free descriptive literature.

**Order Today**



**\$7.50**  
for  
Complete  
Outfit Prepaid

**SCIENTIFIC APPARATUS CORP.**  
Dept. 209 MILTON, PA.

**READY NOW** The best job you ever had. Selling Style-Center all-wool, tailored-to-measure Suits and Overcoats for \$23.50. Beginners make \$75 to \$150 a week—easy. Thousands of pleased customers. 200 attractive samples to work with. Fall Lines Ready. Write us today.

**STYLE-CENTER TAILORING CO.**  
Dept. 502, Sixth and Broadway, Cincinnati, O.

## MOVIES BROADCASTING

Send without delay for our free illustrated 64 page catalogue of Moving Picture Machines—Cameras—Stereopticons—Optical Specialties—Finest Radio Sets—Complete Radio Parts. We also sell best standard movie film and have a film exchange service for home users. Consult us—Every Mail Box Our Branch Office



**PARAMOUNT MFG. COMPANY** Dept. M4  
Boston, Mass.

## AGENTS 200% PROFIT

Make \$10 to \$20 daily selling Premier Knife and Scissors Sharpeners.



or more. 9 out of 10 women buy. Produces keen edge quickly. Sells for 50c.

**PREMIER MFG. CO.**  
Dept. 29, DETROIT, MICH.

## Prices Reduced

On All Standard Make Typewriters  
Lowest Prices in Years



We will ship any make you choose for one week's trial, Underwood, Royal, L. C. Smith, Remington, Oliver, etc.

**Easy Terms** Pay less than rent each month and own a typewriter. Guaranteed good as new. Perfectly rebuilt by experts—the famous "Young Process."

Send for our free trial offer and new low price list now. Write today.

**Young Typewriter Co.**  
654 W. Randolph St., Dept. 1109, CHICAGO, ILL.



## BE YOUR OWN FIXER WITH SMOOTH-ON No. 1

—and save your repair money for bigger things.

Cracked heating boilers, radiators, waterpipes, tanks, leaky ovens, furnaces, stove pipes, loose handles, leaky automobile radiators, hose connections, gas tanks, cracked water jackets and gear cases, loose nuts, grease cups and hub caps are usually a

snap to repair with Smooth-On No. 1—and with a saving of anywhere from 25c to \$25 each time.

Get a 6-oz., 1-lb., 5-lb., or 10-lb. can of Smooth-On (from any live supply store) and you'll find that, for the few cents spent, you'll save many dollars.

The repair booklet which we send free if you mention this magazine, will help you to get good results.

**SMOOTH-ON MFG. CO.**  
Dept. 37, 574 Communipaw Ave.  
JERSEY CITY, N. J.

Get this Booklet Free

**SMOOTH-ON REPAIR BOOK**

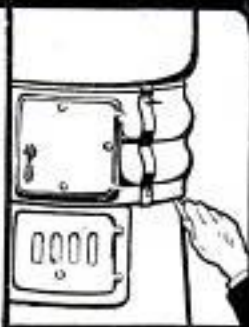

## Beautiful HOUSES \$900 and BUNGALOWS CAN BE BUILT FOR AND UP

This and many others in my new book, Building Plans for Modern Homes, will save you hundreds of dollars. One of the most complete and comprehensive books of plans ever published by any architect. New edition just off the press. Nearly 500 floor plans and photographs of bungalows, Colonial houses, etc., costing from \$200 up; gives sizes and cost to build. Sent postpaid for \$2.00.



**FREDERICK H. GOWING ARCHITECT**  
101 Tremont St., BOSTON, MASS.



## CAMERAS

Over a Hundred Styles and Sizes  
Send for new illustrated catalog showing latest reduced prices. It's Free.  
**10 days' trial given**

**SENECA CAMERA MFG. COMPANY**  
300 Central Avenue Rochester, N. Y.

## SWEATERS SAVE 20%-30%



Any Style or Design for Men, Women, Boys, Schools, Clubs, Teams

Order direct from mill. Save from 20% -30%. Pick any style, any color, size or design from our regular stock or special to order. Finest virgin wool and pure worsted only. Custom tailored workmanship of highest grade. Closely knit. Warm, soft, snug. Real beauties you will be proud to wear.

**FINEST QUALITY AT BARGAIN PRICES**



**FREE Catalog** Always holds shape. Most customers get from 3 to 5 years wear easily. Can endure severe wear and retain bright, fresh appearance. Biggest values in history. Workmanship guaranteed. Prices slashed. Unusual chance to save. Special offers to schools, clubs, teams. Write for free illustrated catalog.  
**AMERICAN KNITTING MILLS** Dept. 26 CHICAGO

They are not Keds unless the name Keds is on the shoe

Keds are a complete line of canvas rubber-soled shoes, varying in price according to grade, size and style—from \$1.25 to \$4.50. Below—a popular athletic-trim model.



## A great motion picture director makes a record with Keds

"If there's anything harder on shoes than a cement tennis court I haven't seen it!" said William C. De Mille recently.

And he placed on a desk in our office a pair of Keds which he had brought all the way from Hollywood to New York for our inspection.

"I've already worn these for 101 sets on my own cement court—and they're easily good for 50 more. That's three times the amount of wear I generally get. I thought you would like to know about it."

Another instance of the amazing wearing quality of Keds! Keds are not only the leading sport shoes today. They're especially built to stand the games, hikes and camping trips of vacation time, and hard, every-day wear.

It is important to remember that not all canvas rubber-soled shoes are Keds. Keds are made only by the United States Rubber Company. And every Keds shoe has the name Keds on it. It will pay you to look for the name.

The 1924 Keds Hand-book for Boys is full of things every boy will want to know about. How to make things—rules for games—woodcraft, etc. Sent free if you address Dept. 436, 1790 Broadway, New York City.

**United States Rubber Company**



# Keds

Trademark Reg. U. S. Pat. Off.

Please Mention Popular Mechanics





## For that Jolly Beach Party

Pack your week-end bag, say goodbye to the hot, noisy city and set out for a day or two of real fun and healthy sport at the lake or sea. And don't forget to take along your pocket orchestra so there'll be plenty of good music for those who want to dance. If you want to be the hit of the party, be ready with a Hohner Harmonica—

## The World's Best

There's nothing like good music for happiness and there's nothing like a Hohner for good music. Hohner Harmonicas are true in tone, accurate in pitch and perfect in workmanship. Get a Hohner Harmonica today and play it tonight. 50¢ up at all dealers.

Ask for the Free Instruction Book. If your dealer is out of copies, write M. Hohner, Inc., Dept. 181, New York City.

# HOHNER HARMONICAS



### DIVINE RED DEVIL Water Motors

Simple—strong—durable. Wonderful little workers for all sorts of household and shop uses. Thousands in use. For all light power purposes. Attaches to faucet.

Two sizes: 4" — \$4.25  
6" — \$6.75

The higher the water pressure the more work they do.

Send today for catalogue.  
Divine Water Motor Company  
Utica, N. Y.

## Different from all others—the NEW BENJAMIN

### AIR RIFLE

Made on a different principle from all other Air-Rifles.

The Benjamin is really a strong air-pump used to compress the air in the air chamber to any degree of power desired. From one to six strokes of the pump give all the force necessary. Each additional stroke gives increased power. The Benjamin works on the same principle as all air-drills and air-hammers—with this difference:

You control the shooting force as you desire. Look at this block of hardwood. It shows how Benjamin power is regulated as you wish.

You can't have accidents with a Benjamin. It's safe, always, because you control the power. The Benjamin never loses shooting force, and has no springs to get out of order or shake your aim. Write us for an interesting folder about this wonderful air-gun.

If your dealer does not handle same, send direct to factory.

(PRICE \$5)  
(POSTPAID)

BENJAMIN AIR-RIFLE & MFG. CO., 615 N. Broadway, St. Louis, Mo.

Ask your dealer for demonstration.

Pacific Coast Representatives  
THAYER & BOWEN  
Los Angeles, Calif., and San Francisco, Calif.



## SQUAB BOOK FREE!

Squabs are selling at highest prices ever known. Greatest market for 23 years. Make money breeding them. No mixing feed, no night labor, no young to attend. Start small, grow big. Start now. Read how our customers sell squabs for \$12 a dozen. We have been established for 23 years. Better look into this. Let us send you, at no cost to you, our big, illustrated free book telling how to make money breeding squabs. Address

Plymouth Rock Squab Co., 634 H St., Melrose Highlands, Mass.

## I Offer You \$48 a Week and a

**Buick**  
TOURING CAR

We want men and women as local representatives to demonstrate and take orders for Comer All-Weather Raincoats. New offer enables you to earn \$48 a week and Buick touring car. No experience necessary. Write quick.

Comer Mfg. Co., Dept. BW-598, Dayton, O.



## Sell Shirts



Sell Madison "Better-Made" Shirts, Pajamas, and Nightshirts direct from our factory to wearer. Nationally advertised. Easy to sell. Exclusive patterns. Exceptional values. No experience or capital required. Large steady income assured. Entirely new proposition.

WRITE FOR FREE SAMPLES.  
MADISON SHIRT CO., 803 B'way, N.Y. City



"If I hadn't been all through it myself, I wouldn't have the assurance to say to you 'cheer up.'"

ERICKSON.

Those who wear them say:  
**ERICKSON LEGS** are Wonderful because they do not chafe, overheat or draw end of stump.



If you have had a recent amputation send for new booklet on TEST LEGS for beginners.

E. H. ERICKSON CO.  
38-A Washington Av. N.  
MINNEAPOLIS • MINN.



# LOFTIS

BROS. & CO. F239

## DIAMONDS WATCHES

### CASH or CREDIT



**Genuine Diamonds GUARANTEED**  
We import Diamonds direct from Europe and sell direct by mail.

**Send For Free Catalog**  
Over 2,000 Illustrations of Diamond-set Jewelry, Watches, Wrist Watches, Pearls, Mesh Bags, Silverware, etc. Sent prepaid for your **FREE EXAMINATION**

**TERMS:** Goods delivered on first payment of one-tenth of purchase price; balance in equal amounts within eight months, payable weekly, semi-monthly, or monthly at your convenience. **Money back if not satisfied**

**No. 17** Blue White, perfect-cut Diamond. The ring is Solid 18-k White Gold. Price \$109. Terms: \$10 down, then **\$2.50 A Week**

**No. 28** Blue White perfect-cut Diamond. The ring is Solid 18-k White Gold. Price \$57.50. Pay \$3.75 down, then **\$1.00 A Week**

**WEDDING RINGS**  
All Platinum, \$25 up. With Diamonds: Three Diamonds, \$65; five Diamonds, \$80; seven Diamonds, \$95; nine Diamonds, \$110; surrounded by Diamonds, \$225. Solid White or Green Gold, \$5.00 up.

**Railroad Watches—Guaranteed to Pass Inspection**  
HAMILTON No. 992, 21 Jewels, Adjusted to 5 positions. Gold \$55  
Silled 25-Year Case

**ELGIN'S LATEST RAYMOND**, 21 Jewels; 8 Adjustments. Blue \$55  
40 hours one winding. Gold filled 20-Year Case

**NO. 16**—Wrist Watch, Solid 18-k White Gold, 17 Jewels, \$29.75.  
14-k, 15 Jewels, \$24.85

**LOFTIS** THE OLD RELIABLE ORIGINAL  
BROS. & CO. F239 CREDIT JEWELERS  
Dept. D 894 108 N. State Street, Chicago, Illinois  
Stores in Leading Cities

# I PAY MEN \$75<sup>00</sup> a Week and up

I pay men \$75.00 a week and up by my plan which I want to send you at once. Be your own boss, work where and when you like. You can do fine even without previous experience. **Biggest values—positively sell on sight.**

## Profits in Advance

My plan pays biggest profits and commissions in this line, paid in advance, we attend to delivering orders and collections.

# Sell fine Tailoring

Astonishing values get orders easy when you show samples of our tailored to order, all wool, suits and o'coats, all one price \$31.50. Our advertising helps you take orders quick.



# FREE

This big, fine sample outfit furnished free, contains 100 all wool big samples, all one price \$31.50, fine colored, fashions, stationery, supplies, tape, etc. All in classy fine carrying case. Also complete sales manual, we place you in Big Money class.

# \$31<sup>50</sup> ONE PRICE

## W.Z. Gibson

W. Z. GIBSON, Inc., CHICAGO, ILLINOIS  
161 West Harrison Street, Dept. J-11

Please send me your plan for \$75 a week and up, also FREE outfit and sales manual.

Name \_\_\_\_\_  
Address \_\_\_\_\_  
City \_\_\_\_\_ State \_\_\_\_\_

# AGENTS 500% PROFIT

## GENUINE GOLD LEAF LETTERS

**S** guaranteed to never tarnish. Anyone can put them on stores and office windows. Enormous demand, large profits. Paul Clark says: Smallest day \$28.70. R. L. Reel made \$920 in two months. Write today for free sample and liberal offer to general agents.

**METALLIC LETTER CO., 433-B N. Clark St., CHICAGO**

**FREE THE BIG 3 FT. TELESCOPE**

See people and objects miles away just like they were close; see Moon and Stars as never before. Brass bound, in five sections. Useful and entertaining. Thousands pleased. Full color of aeroplane 4 miles away. "Yerboough," "Sea Light House 28 miles away."—Clyde Scribner.

**FREE** Leatherette Carrying Case. Don't send a penny; on arrival of 3 ft. Telescope and Case you receive only \$1.25 plus a few cents postage. Satisfaction guaranteed or money back. Perry & Co., Dept. 1776, Chicago, Ill.

# WORLD'S GREATEST Bargain Book FREE

## Hosiery and Underwear—Direct from Mill

Take this money-saving step today. Send for this FREE catalog and see for yourself the wonderful values offered in **World's Star Hosiery and Klean Knit Underwear**. A big, beautiful book in colors. Most complete of its kind printed. Accurately and truthfully pictures and describes more than 5,000 bargains. It offers you the easiest, best way to buy your season's needs and make certain of getting the very best, long wearing quality at the lowest possible prices.

**Amazing Savings** Every page of this wonder book is a bargain surprise. You can hardly believe such values are possible. Big hosiery bargains by the hundreds in silk, wool, mercerized, cotton, for men, women and children. Scores of underwear bargains in all weights, grades and kinds for every member of the family. Don't miss this opportunity. Write today. Send postcard or letter now.

**World's Star Knitting Company** 279 Lake Street  
BAY CITY, MICHIGAN

### AGENTS, \$90<sup>00</sup> A Week!

Men and Women! If you earn less than \$50.00 a week I can place you in a position with a wonderful opportunity. With new plans you can make \$2.00 to \$5.00 an hour spare time, up to

**\$15.00 a Day!** Pleasant, dignified work. No experience necessary. No delivering or collecting. No capital required. If interested address me personally. Say—"Send me Free Outfit Offer." L. M. Nixon, General Manager.



# GET FACTORY PRICES ON GALVANIZED ROOFING



## EDWARDS "REO" Metal Shingles

Absolutely rust-proof — edges as well as sides. Not the space of a pin point exposed to weather. Also fire and lightning proof. Reduces insurance. Outlast buildings. Need no repairs — end all roofing expense. Easy to lay — one man can do the work — hammer and nails only tools needed. Lay over old shingles if desired. Patent interlocking device makes water tight seams — all nail heads covered — no rust or leaks possible.

### Exclusive "Tightcote" Process

Put all Edwards Galvanized Roofing in a class by itself. Bend, twist, strike it with a hammer as much as you like — you can't loosen or scale off the galvanizing — due to our "TIGHTCOTE" process which gradually makes zinc covering a part of the metal sheet. No other galvanized roofing can withstand this test.

**FREE Roofing Book** Don't buy roofing until you get our big free book, describing Edwards famous "Tightcote"



Roofings, Sidings, and Ceilings, and our lowest factory prices. We sell you direct and save you in-between dealers' profits. Write for Roofing Book No. 150.

### Low-Priced Garages

Lowest prices on Ready-Made Fire-Proof Steel Garages. Get up any plan. Send postal for Garage Book showing styles.



Corrugated



Patent Side Lock No nail heads in sight or exposed to the weather



Brick Siding



THE EDWARDS MFG. CO. 900-950 Pike St. CINCINNATI, O.

## RE-MANUFACTURE FORDS

Start a FORD Service Station The MOST PROFITABLE BUSINESS ON EARTH

FORDS REMANUFACTURED BY THE FACTORY PROCESS

SQUARE DEAL GARAGE



**\$14,355.00 Profit on 300 Jobs**

Facts and figures from hundreds of KRW Equip Shop Records.

**9,000,000 Fords Need Repairs**

Are you getting your share of that business?

**\$850 Completely equips your shop to RE-MANUFACTURE Fords**

We can furnish entire equipment for cash or on easy payment plan. Ford Motor Co. recommend these tools. Catalog.

K.R. WILSON, 12 Lock St., Buffalo, N. Y.



### THE AV-A-CO VALVE ACTION FOR FORD MOTORS

INCREASES THE VALVE LIFT, WHICH MEANS MORE POWER, MORE SPEED, SMOOTHNESS AND GREAT ECONOMY IN FUEL CONSUMPTION. NOT ONE CAN INSTALL - BETTER AND LONGER LASTING. MUCH CHEAPER THAN OVERHAULING. NO EXCESSIVE WORK ON CAM SHAFTS. ECONOMY - NO SPECIAL TOOLS. 15 MINUTES TO BE CHANGED. NO NEED FOR PERFORMANCE. PRICE \$15.00. ULTIMATE IS WORTHFUL. FOR FORDS AND OTHER MOTOR TYPES. YOU CAN BUY BY MAIL. AUXILIARY VALVE ACTION COMPANY. 712 N. W. 11th St., Miami, Fla.

## Tire AGENTS WANTED

Use and Introduce MELLINGER CORD TIRES 12,000 MILES GUARANTEED

Lowest Wholesale Prices in America. Shipped prepaid on approval. Make big money all or part time. No capital or experience. Sample sections furnished.

**YOUR TIRES FREE!** Simply send name today for valuable FREE BOOK, tells how thousands have gone into big business. SPECIAL AGENTS OFFER Wholesale Prices and FREE SAMPLE KIT.

MELLINGER TIRE & RUBBER CO. 1769 Grand, Kansas City, Mo. \$600,000 Capital



## Tires With 500 Nail Holes Leak No AIR



A new puncture-proof inner tube has been invented by a Mr. M. E. Milburn of Chicago. In actual test it was punctured 500 times without the loss of air. This wonderful new tube increases mileage from 10,000 to 12,000 miles and eliminates changing tires. It costs no more than the ordinary tube. Mr. Milburn wants them introduced everywhere and is making a special offer to agents. Write Sales Manager, H. J. Hansen, 336 West 47th St., Chicago

MILBURN PUNCTURE PROOF TUBE

WRITE FOR FREE BOOKLETS describing and illustrating complete line of IVER JOHNSON Bicycles, Velocipedes, Revolvers and Shot Guns.

IVER JOHNSON'S ARMS & CYCLE WORKS 4 River Street FITCHBURG, MASS.

## TOPS

Ford Touring Top and Back Curtain

32 oz., \$5.25; 36 oz., \$6.25; Side Curtains, \$5.95; Door-Opening type, \$6.95; Back Curtain, regular, \$2; Gypsy type, \$4. Ford One-Man Top, fits 1915 to 1922 model, all new bows and side curtains, \$25. Chevrolet, Dodge, Overland 4 tops, 34 oz., \$9.75; double texture, \$12.25. 6x18 glass Gypsy Curtain extra, \$2. Tacks, etc., furnished ready to put on. Delivered 1000 miles. Vanderpool's Top Factory, Dept. 9P, Springfield, Ohio

## MOTORCYCLE BARGAINS

Save 25% to 65%

on Slightly used and Rebuilt Motorcycles, Side Cars, Johnson Motor Wheels, Evans Power Cycles, Bicycles. Send for Free Bargain Bulletin and Money Saving Message, listing hundreds of Bargains in used, rebuilt and new machines, supplies, accessories, etc.

AMERICAN MOTOR CYCLE CO. Dept. 927, 2047 W. Chicago Avenue. CHICAGO



## 8 HOUR BATTERY CHARGING PAYS BIG YOU CAN CLEAR \$150 to \$300 MONTHLY PROFITS

Start now to build your own money-making business Charging Auto Batteries. No experience needed. Buy an HB One-Day Constant Potential Battery Charger on long easy terms, more than paid by big monthly profits. Small cash payment puts HB outfit in your shop. 30 days' free trial on money-back guarantee. Only \$20 monthly pays for your outfit. No repairs, no expensive renewals. More HB outfits in use than any other make. Write today for Bulletin 724.

HOBART BROS. CO., Box M99, Troy, Ohio

Profits Easily Carry Small Monthly Payments





## Makes Autos Go 40 Miles on Gallon of Gas

The perfection of an amazing device is announced which is enabling car owners all over the country to double their mileage from each gallon of gasoline used, and remove every particle of carbon from their motors. When the device is attached, automobiles have made over 40 miles on a gallon, increased their power and pep tremendously and eliminated all spark plug difficulties. This inexpensive little device is entirely automatic and self-regulating and can be easily attached by anyone in a few minutes without tapping or drilling.

**Free Proof Offer** In order to introduce this startling new invention the manufacturers are willing to send a sample at their own risk to one car owner in each town who can show it to neighbors and handle the big volume of business which will be built up wherever it is shown. Just send your name and address to the Western Specialty Co., 901 Lacotah Bldg., Sioux Falls, S. Dak., and get their free sample offer.

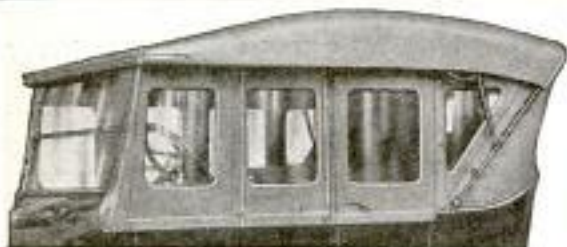

## Make Your Ford a Closed Car!

Limo weather-proof sections will change your 1923-1924 Ford Touring or Roadster, into classy limousine-style closed car. Doors open from outside. Sliding front panels for ventilation. Three ply, double covered veneer frames. Color matches your top. Easily, quickly installed. Guaranteed. Low priced. Fine for bad weather. Write for prices.

**BUOB & SCHEU, Dept A-8, 216 Webster St., Cincinnati, O.**

**DENINGER WILL TRUST YOU**

SEND 10c IN STAMPS FOR CATALOGUES  
**BIG MONEY SAVING FOR YOU**

Used and rebuilt motorcycles \$25 to \$110,  
used bicycles \$9.50, tandems \$20.  
All machines fully guaranteed.  
New bicycles and motorcycles  
at factory prices, save dealers'  
profits. Motorcycle and auto-  
mobile tires \$3. Complete line  
frames, engines, accessories.

**DENINGER PRICE CUTTER, ROCHESTER, N. Y.**

**PAY AS YOU RIDE**

\$40

## SHAW MOTOR ATTACHMENT MAKES YOUR BIKE A MOTORCYCLE!

A high grade 2 1/2 H. P. motor attachment quickly clamped on any bike frame. Speed 4 to 40 miles an hour. 90 to 125 miles per gallon of gas.

**Special Low Price Now!** Write today for Complete Description and Special Low Prices on SHAW Motor Attachments and the SHAW Complete Motorbicycle.

**SHAW MANUFACTURING COMPANY**  
Dept. 37  
Galesburg, Kansas

## MOTORCYCLES



**RELIABLE STANDARD MAKES** that you can **DEPEND** on. Enjoy the greatest experience of going wherever you like—wherever you like. The price is within your means—35% to 60% less than others. These machines are slightly used, thoroughly overhauled or rebuilt. See our catalogues.

**MYEROW BROS.,**  
15 Berkeley St., Boston, Mass.

## MAKE YOUR FORD INTO THIS SPORT CAR—SAVE \$50 to \$150 WITH **Red-i-Kut** Life-Size Patterns \$6.40

Famous **Red-i-Kut** life-size patterns and picture-by-picture instructions show you how you can easily convert your Ford into this Fast, Snappy, Sport Car as thousands have done, with easily obtained materials. No need to lay up the car. **LOOK AT WILFRED ENO'S PAL** Eno says, "I had material cut with steel and paint for my Pal only \$14.51. It took me just 5 Sundays to build it and I sure am proud to hear them say, 'He built that snappy sport car.' I never cut any steel or did any woodwork before but one can't do wrong with Kennebec patterns." Overland City, Mo. Louis, Mo. The "Pal" with gressed metal streamline rear.

Life-size patterns for each part of the body so you can't go wrong, picture instructions and **CONICAL DISK WHEEL PATTERNS** Only \$3.43 delivered. Order now while we can make good delivery, and really enjoy these wonderful days in your "Pal." Kennebec, Glassy, Up-to-the-minute. You can build it. Over 11,000 in use. Don't hesitate. Swing Lo "Underlying" trans, no frame cutting kind, only \$6.50. Send 5c coin for new manual of other distinctive sport body patterns from \$3.50 up — "RKO" Steel, "Swing-Lo" Irons, "Jiffy" Tops and "Garwin" Windshields. Order Right Now. Kennebec Co., 52 Kennebec Bldg., Guttenberg, Iowa

Easy-to-Understand Instructions and Tail Delivered

**6 COMPLETE**

38-inch, Easy-riding seat

GLASS GRAB BAR

# Diamonds

**Here at 60% of Market Price**

Never in three quarters of a century have we offered such amazing bargains. Hundred of money-saving opportunities in latest Diamond Bargain List, equalling those shown here.

Here's why we can offer such remarkable values: This 75 year old firm—rated at over \$1,000,000.00 capital—the largest and oldest diamond banking institution of its kind in the world has made loans on Diamonds, Watches, and other jewels in excess of \$25,000,000.00.

**Why Pay Full Prices**  
**Costs Nothing to See**

Thousands of unpaid loans. Must sell now. Diamonds, Jewels, Watches and other Gems of unusual qualities—at an entirely different price basis—viz: loan values not market values. At our risk we send you any bargain you wish for absolutely free examination. No red tape. No obligation. Don't buy unless satisfied you can not match the bargain at 50 per cent more. Diamonds of desirable quality at \$125 per carat. Yes, some even lower priced—also, finest gems obtainable at higher per carat—but proportionately low bargain prices. Our bargains have guaranteed low values also, unlimited exchange privilege at full prices.

**Latest List**  
**Diamond Loans**

Send at once for latest list. Thousands of unpaid loans and other special advantage bargains. Many from our cash deals direct with European diamond cutters. Every gem described in full detail with exact weight, color, quality, etc. Get details of Free Examination offer. No obligation. List is free.

**MAIL COUPON NOW**

Only Through Post Office

Without obligation, send me free, your latest Bargain List of Diamonds, Watches and other jewelry.

Name.....

Address.....

City..... State.....

**Jos. DeRoy & Sons,**  
1924 DeRoy, Bldg., Pittsburgh, Pa.

Name.....

Address.....

City..... State.....

## Reline Your Ford Transmission — in a Jiffy



The **QUIKON** provides an easy method for relining your FORD transmission. Made in one piece, it can be readily installed without removing the transmission cover or self-starter.

**Anyone Can Install the QUIKON**  
No previous experience is necessary. Mechanical changes or additional accessories are not required. It is built to fit the FORD. Ask your garageman for the QUIKON—if not in stock, order from us. Price \$3.50. Send for circular.

**Harrison Auto Products Corp'n**  
820 Hamilton Street, Harrison, N. J.

**Quikon TRANSMISSION LINING for Fords**  
ONE PIECE



## HERE'S A WINNER

A High Grade Miniature Boiler  
at a Special Low Price

ADAPTED FOR  
VULCANIZERS  
GARAGES  
LAUNDRIES  
CREAMERIES  
FARMERS  
CANDY MAKERS  
BUTCHERS  
DAIRIES  
PLATERS  
BAKERS

### SPECIFICATIONS

Diameter of shell 10½ in.  
Height over all 29 in. No.  
of tubes, 7—1¼ in. Steam  
outlet, 1¼ in.  
Made from high grade steel  
heavily riveted. For work-  
ing pressures up to 15 lbs.  
per square inch. Tested  
for 100 lbs.



Price Complete as Illustrated **\$37.50** F. O. B. Milwaukee  
Terms C. O. D.

**MILWAUKEE** *Reliance*  
ESTABLISHED AND  
REPUTATION SINCE  
**BOILER WORKS**

General Office and Works, 32nd and Hadley Sts.



### A Gerstner CHEST

is the right Chest for your needs.  
Toolmakers and Machinists—  
select your Cases and Chests  
from our free catalog.

*The Gerstner Sons*

409 Columbia St., DAYTON, OHIO

## SARGENT PLANES

See them at your hardware store.

Write for booklet.

SARGENT & CO., 49 Water Street, New Haven, Conn.

**Imperial  
Sanitary  
Floor**

Base  
and Floor  
one solid piece

Put on like Plaster  
Wears like Iron  
-waterproof  
fireproof  
resilient  
noiseless  
dust-  
less

A composition material easily applied in plastic form  
over practically any kind of floor. Laid about ¼ inch  
thick. Imperial floor does not crack, peel or come loose  
from foundation. A continuous, fine-grained, smooth,  
non-slipping surface. No crevices to gather grease, dirt,  
dust, disease germs or moisture.

Ideal Floor for Kitchen, Pantry, Bath Room, Laundry,  
Porch, Garage, Restaurant, Theatre, Hotel, Factory,  
Office Building, Railroad Station, Hospital—wherever a  
beautiful, substantial floor is desired. Several practical  
colors. Full information and sample FREE of your first  
and second choice of colors.

Imperial Floor Co., 334-336 Halstead St., Rochester, N.Y.

A Success for 15 Years

At Last! A 100% Woodworker  
ONLY

**\$225.00**



Complete  
with motor

8 inch circular  
rip saw  
8 inch circular  
cross cut saw  
11 inch band saw  
4 inch jointer  
Shaper  
10 inch sander  
Lathe—14 inch  
swing

### Parks Cabinet Shop Special

is absolutely the most complete small shop equipment  
you can buy! Everything in one compact unit with  
motor!

Just the machine for your home shop—for the cabinet  
maker—novelty and toy maker—special furniture  
builder—for the farmer who makes his own crates, bee-  
hives, etc. No end to its usefulness!

Complete or without motor and attachments to suit  
your needs. Write for circular.

The Parks Ball Bearing Machine Co.  
1500-1540 Knowlton Street, CINCINNATI, OHIO  
Canadian Factory: 200 Notre Dame East, Montreal, Canada

**PARKS**  
WOODWORKING MACHINES

New ¼ H. P. 110 volt A. C. Guaranteed Motors  
60 cycle, complete with cord, plug and pulley



Gen. Elec. 1725 speed ..... \$14.75  
Gen. Elec. ¾ H. P. Rep. Ind. .... 39.00  
Master ¾ H. P. Rep. Ind. .... 52.50  
Master 1 H. P. Rep. Ind. .... 60.00

Special values in rebuilt motors.

**HYRE ELECTRIC CO.**

615-T S. Dearborn St., Chicago, Ill.



It is the well known quality of  
CRESCENT machines that  
justifies you in selecting one of  
them each time you have need for  
wood working machinery. The  
CRESCENT line is better than ever  
and will always give you satisfaction  
in every particular. Ask today for  
catalog of band saws, saw tables,  
jointers, shapers, planers, borers,  
planers and matchers, swing saws,  
disk grinder, cut off table, hollow  
chisel mortiser, variety wood work-  
er, Universal wood workers.

THE CRESCENT MACHINE CO., 83 Columbia Street, Leetonia, Ohio

**\$25.00 a DAY-CLEAR**

**SURFACING  
FLOORS**

Write  
Quick  
for  
Details



Scores  
of inexpe-  
rienced men  
whom we started  
as American Univer-  
sal Floor Surfacing Con-  
tractors are making up to  
\$10,000 a year in this wonderful,  
new, uncrowded field. Electrically driven  
American Universal Machines do 500%  
more work and 100% better work than  
most expert hand scraper, and earn six  
men's pay. Work is plentiful, fascinat-  
ing, immensely profitable. Experience  
unnecessary. Small amount starts you.  
We furnish everything, teach you, help  
you succeed. Opportunity of lifetime to  
be your own boss and make big money.

**AMERICAN FLOOR SURFACING MACHINE CO.**  
523 So. St. Clair St. TOLEDO, OHIO



Don't forget  
your pliers\*



Give your wife a pair of Bernard Pliers (No. 102) for the kitchen. She will find a hundred uses for them from drawing the tendons of poultry or binding and cutting the cords of a roast, to twisting the key of a sardine can. Bernard's grip like a vise and bite through metals that have other pliers baffled. Ask for

## \* BERNARD

Standard High-Power Cutting  
PLIERS



No. 120 Bernard Round  
Belt Punch Pliers

Catalog "P" free  
on request from

WM. SCHOLLHORN CO., New Haven, Conn.

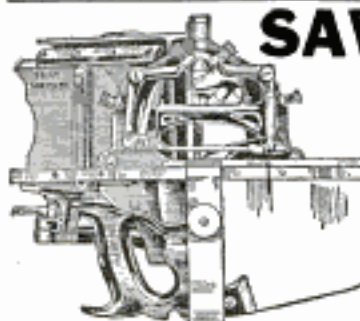

## SAW FILING PAYS

Buy a Foleysaw Filer and Setter and establish an independent, profitable business. Prices and catalog on request. Territory open to interested parties.

**FOLEY SAW TOOL CO.**  
3627 Portland Ave., Minneapolis, Minn.

### THE SCREWDRIVER THAT HOLDS THE SCREW

As Good as a Third Hand in Assembling anything from a Watch to an Automobile



Appeals Especially to Radio amateurs and professionals. A wonderful (patented) Improvement. Jobbers, Dealers and Agents. Favorable discounts

\$1.60 Postpaid THE COBURN TOOL CO., Inc., 739 Boylston St., Boston, Mass.



## Do Your PRINTING

Cards, circulars, labels, tags, book, menus, paper, Press, \$12, Larger \$35, Job Press \$150 up. Save money. Print for others. BIG PROFITS. All easy, rules sent. Write factory TODAY for press catalog. TYPE, cards, paper. THE PRESS CO. D-37, MERIDEN, CONN.

## BURN YOUR NAME ON TOOLS WITH ARKOGRAF

Protect your tools from theft. Write any name, engrave any design on metal with electricity like writing on paper with pen or pencil. Complete outfit \$3.50, prepaid anywhere. Interesting descriptive circular free. Write today. Agents Wanted. Arkograf Pen Company 1171 East Stark St. Portland, Oregon



Red Devil Tools  Better Made

## "Red Devil" Tools Pay for Themselves Over and Over Again

THOUGH slightly higher in price, they give added service and value out of all proportion to their cost. An investment in "Red Devil" Tools is money well spent.



### "Red Devil" Glass Cutters

The only cutters made with hand honed wheels—cut clean and sharp, with the lightest pressure. No. 024, for home glazing jobs, 20c each.

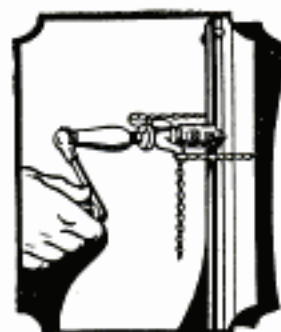

### "Red Devil" Chain Drill

Makes easy work of drilling iron or steel, the truck frame, engine cylinder, angle irons and for all-around drilling purposes. It's automatic and portable. No. 2018 \$4.95 ea.

"Red Devil" Tools are sold by all dealers—if not in stock send dealer's name.

Mechanic's tool booklet free.

## SMITH & HEMENWAY CO., Inc.

Manufacturers of "Red Devil" Tools

260 Broadway

New York, N. Y.



"Red Devil" Rapid Boring Auger Bits are 33 1/2% easier boring, have 10% greater clearance, and bore with or against the grain of any wood. Style 2400 —10/16 in., shown here, 80c.



# CEE TEE CO PLIERS

*"Here  
is a real plier  
for 30¢"*

Drop-forged, hardened, oil-tempered just the same as our higher priced pliers but special rust-proof machine finish instead of hand finish process cuts cost so it retails at 30c. Guaranteed, "Satisfaction or money back."

Ask your hardware or accessory dealer.

**CRESCENT TOOL CO.**  
210 Harrison Street  
JAMESTOWN, N.Y.  
*Originators of the  
Crescent  
Wrench*



## CRESCENT TOOLS

### Why Burn Coal

or wood when you can burn gas in your stove or heater by installing a Uni-Hete Kerosene Burner (with exclusive 1924 features) in five minutes time. It gasifies common kerosene to the hottest and cheapest fuel known. Does away with dirt and high fuel cost. Heat regulated to any degree by valve. Increases stove efficiency 100%. Has brought joy and economy to thousands. **FREE TRIAL.** Saves its cost in 30 days. Write quick for full particulars and introductory price.



#### Special Offer to Agents

Today's fuel prices make the Uni-Hete a big money maker for agents. We have made oil heating devices for 33 years. **Acorn Brass Mfg. Co., 967 Acorn Bldg., Chicago, Ill.**

## \$2 Brings This Genuine DIAMOND RING

No Red Tape  
No Delay

#### SET IN PLATINUM

Think of it—seven brilliant genuine diamonds massed in setting of solid platinum so closely together that only close inspection will distinguish it from a \$750 solitaire.



#### 10 DAYS' FREE TRIAL

Simply send \$2.00; if you can duplicate this diamond ring for less than \$65 your deposit will be refunded. Guarantee bond accompanies each ring. After trial, pay balance \$4.65 a week for ten months. Price only \$48.50.

#### FREE ROYAL CATALOG

Illustrates thousands of special offers in Diamonds, Watches and Jewelry from our \$2,000,000 stock. Write Dept. 1106

**ROYAL DIAMOND  
& WATCH CO.**  
170 Broadway, NEW YORK

### Six Machines in One

Combines bench saw, sander, drill, grinder, polisher and buffer for working in wood and soft metals

#### Boice-Crane Pony Bench Saw

—a precision machine especially adapted to rapid and accurate work. Handles 6" saws, 6" and 8" sand discs, 3/4" chuck, and 4" or 5" emery wheels. Saws 1 1/2" wood. Top 10"x12" easily removed. Screw adjustment elevates table for grooving. Easily driven by 1/2 or 3/4 h. p. motor. Especially suited for Private Shops, Laboratories, Shipping Departments, Printers, Cabinet Makers, Furniture Repairmen, Radio Mfrs., etc.

**Sold with a Money Back Guarantee**

Write for descriptive literature and prices on the Boice-Crane Pony Bench Saw, 4" Jolster, 14" Bench Band Saw, 1/2 and 3/4 h. p. ball-bearing motors, and larger bench saws.

**W. B. & J. E. BOICE, Dept. P. M. 9, Toledo, Ohio**

### DO YOU LIKE GOOD TOOLS?

You will like this one, the Simore magazine tool. Three blades in the handle, always ready, blades can be changed in two seconds, the ideal tool for the sportsman or for household use.

Model No. 12 has a keen steel knife blade as shown and two screwdriver blades. Strong, handy, practical. Handle blued to prevent rust. You'll like it. Sent postpaid for only **\$2.25.**

Model No. 11 same as No. 12 except has three screwdriver blades. Sent postpaid for only **\$1.80.** Send money order or your check. Ask your dealer or write direct.

Dealers are asked to write for information on this tool and the Simore Automotize Trysquare.



**The  
Tools  
That are  
Different**

**THE SIMON & SKIDMORE MFG. CO.**  
Dept. 4-9  
**SANTA ANA, CALIFORNIA**

### Saw Books FREE

"Saws in the Shop," "Saw Sense," "Saws on the Farm;" just send your name and address, and say which of these helpful books you want—FREE. Do it today.

**E. C. ATKINS & CO., Dept. P, Indianapolis, Ind.**

### Interlox

INSIDE MASTER SLIDE RULE OUTSIDE

Here is the rule you want. Takes inside or outside measurements, quickly and accurately. Very strong and non-folding—it slides. Any size 2 to 8 ft., 20¢ per lined ft. If not at dealer's, sent postpaid.

**MASTER RULE MFG. CO., 841-43 East 136th Street, NEW YORK**

Dealers and Agents: Request attractive proposition.

### TURN WASTED TIME INTO MONEY



Every purchaser finds numerous uses for

**Torit Acetylene  
Torch No. 13**

Uses nothing but acetylene. No oxygen or air pressure required. Tips suck in air. Simply connect to Presto auto tank, light gas, and outfit is put to work.

Beats anything you ever tried for soldering, heating, melting, and light brazing.

Outfit consists of 4 tips for different kinds of work, soldering copper, 5 ft. tubing, tank connection, and full instructions.

**\$7.50** in U. S. A.

**\$10.00** in Canada

**ST. PAUL WELDING & MFG. CO.**  
177 W. Third Street  
**ST. PAUL, MINN.**



# \$14.95 Suit

Made to Order Now

SEND NO MONEY

To introduce unbeatable values, classy style, perfect fit of PROGRESS tailoring we offer, for \$14.95 tailored to measure any style suit of your choice, delivered post-paid. We Guarantee Satisfaction or Money Back. Other wonderful values up to \$39.50.

AGENTS WANTED

Earn \$9 to \$18 Daily spare time showing our samples to friends and neighbors, we explain how, no experience needed. Big Outfit, agent's wholesale prices, real wool pieces, fashion styles, tape measure, etc. Complete outfit and simple directions FREE, write at once, SAMPLES

FREE

The PROGRESS TAILORING CO. Dept. J-145 CHICAGO



## HANDS UP!

GET one of these little beauties right now, and protect yourself against hold-up thugs, rowdies, etc. and at the same time it serves as the best novelty cigarette case ever invented.

Made exactly like the real thing! Just pull the trigger, back flies the lid showing a full package of your cigarettes. Lots of fun scaring your friends and at the same time useful and a great protector.

Made of light weight metal, gun metal finish, 4 3/4 inches long. Sold exclusively by us. Order at once, supply limited. Special introductory price \$1.75 each. PAY POSTMAN on delivery our price plus postage. Money back if not satisfied.

PATHFINDER COMPANY  
Dept. NK53 534 Sixth Avenue New York



Pat. Pending



## MATHEMATICS

can be easily mastered with the Midget 5 in 1 Slide Rule. With this calculator you can instantly add, subtract, multiply and divide any combination of decimals, fractions, whole and mixed numbers. Also obtain all roots, powers, Logs, and Trig. Functions.

It is used at all colleges, 200 at Harvard, 300 at Cornell, etc. The Engine-Divided Scales are on white collodion, mounted on aluminum and are grease and waterproof. Diameter 4 inches. Price with Instruction Book, \$1.50. Leather Case 50c extra, Catalogue Free. Your money back if you are not satisfied. GILSON SLIDE RULE CO., Niles, Mich.



## California Bathing Beauty

transparent handled pocket knives sell on sight. You will want one when you see our illustrated price list. Finest quality. Satisfaction guaranteed. Special offer tells how to get one free. Cash Commission to agents. Write us today. NATIONAL CUTLERY CO., Sta. B, LOS ANGELES, CALIF.

you see our illustrated price list. Finest quality. Satisfaction guaranteed. Special offer tells how to get one free. Cash Commission to agents. Write us today. NATIONAL CUTLERY CO., Sta. B, LOS ANGELES, CALIF.

Clear-Tone FOR PIMPLES

Your skin can be quickly cleared of Pimples, Blackheads, Acne Eruptions on the face or body, Enlarged Pores, Oily or Shiny Skin. \$1,000.00 Cold Cash says I can clear your skin of the above blemishes. WRITE TODAY for my FREE Booklet—"A Clear-Tone Skin"—telling how I cured myself after being afflicted for fifteen years.

FREE

E.S.GIVENS, 129 Chemical Bldg., Kansas City, Mo.



# Must Men Fear 40?

MEDICAL authorities agree that 65%, or nearly two-thirds, of all men past middle age, are afflicted with a disorder of the prostate gland. Here is the known cause for many of the ailments commonly ascribed to declining years—including aches in back, feet and legs, frequent nightly rising, sciatic pains, nervousness and lack of vitality. But now, science knows that thousands suffer needlessly.

For a member of the American Association for the Advancement of Science has discovered a remarkable new drugless hygiene that usually restores the prostate gland to its normal functioning. Already it has been used by more than 15,000 men—Doctors, Statesmen, Teachers, Bankers, Lawyers, men in every walk of life—with amazing results.

"I know too plainly the effects of prostate gland disorder when it is allowed to continue unabated," says the scientist mentioned above. "I know of the operations and the common saying among many that the average life after this operation is only two or three years. That is why I am doing everything possible to let people know of this important discovery."

## FREE BOOK

If you have prostate trouble, if you suffer with any of the ailments mentioned above, you should not lose a day in finding out about this wonderful new method.

If you will mail the coupon below you will get, in plain wrapper, a free copy of an interesting book describing this new method. It centers facts every man should know. But send immediately, for the edition of this book is limited; address



THE ELECTRO THERMAL COMPANY  
2137 Main Street, Steubenville, Ohio

Please send me Free, and without obligation, a copy of your booklet, "Why Many Men Are Old at 40." Mail in plain wrapper.

Name.....

Address.....

City.....State.....

Western Office—Dept. 21B, Los Angeles, Cal.



**MAKE MORE MONEY!****\$3,000  
PROFIT IN  
4 MONTHS!****CRISPETTES**

**GEORGE ALEXANDER** of Pennsylvania made \$3000.00 in 4 months making and selling CRISPETTES with this outfit. (Nov. 7th, 1923).

Jacob Gordon, New Jersey, (November 2nd, 1923), says: "Profits over \$4000.00 in 2 months"! Mesner of Baltimore \$250.00, in one day! M. L. Cronen, Ohio, (November 3rd, 1923), writes: "Doing big business—sold over 200,000 packages Crispettes last year". Mrs. Lane, Pittsburgh, says: "Sold 8,000 packages in ONE day".

**We Start You In Business**

Crispettes easy to make, easy to sell. We furnish everything—complete outfit, secret formulas, raw materials, full directions, wrappers, etc. No experience needed. Little capital starts you on road to wealth. Open a retail store of your own. Sell wholesale to groceries, drug stores, etc.

**Build a Business of Your Own**

Crispettes sell fast everywhere. Everybody likes them. They're a delicious confection. We'll tell you how to build a business of your own. Start now, in your town.

**Profit \$1,000 a Month Easily Possible**

Send for illustrated **BOOK OF FACTS**. Tells how many people in small towns and big cities are making big successes of Crispette Business. Shows how, when and where to start. Full of valuable information. It's **FREE**. Write now. Postal brings it.

**LONG BAKINS COMPANY**  
928 HIGH STREET SPRINGFIELD, OHIO

**FREE Book of Newest Styles** just out. Women's, men's, children's clothing on credit and at bargain prices, less than cash prices everywhere. Very latest fashions; best materials. Open a charge account with us. Buy on credit and save money! Dress in newest styles. Send for Style Book absolutely **FREE today!** Elmer Richards Co., Dept. 1776, W. 35th Street, Chicago



**Only 12¢ a Day**  
*Pays for This Beautiful*  
**GENUINE DIAMOND RING**

You are wasting enough money every day to pay for a Diamond Ring. A small first payment and 12¢ a day buys this wonderful ring with seven Blue-white Diamonds set to look like brilliant \$100 solitaire. Dainty 18 Kt. White Gold mounting. Free examination—not one penny in advance. Protective guarantee insures you 5 per cent yearly dividends—also 5 per cent bonus.

Write for full details of this offer; also Million Dollar Bargain Book. Everything sold on amazingly easy terms. Buying a diamond this way makes you save money. Diamonds are always worth more than you pay. Write for book now—free. Address  
**J. M. LYON & CO., Inc.**  
2-4 Maiden Lane Dept. 1776 New York City

*Almost  
a year  
to pay*

**An Attractive Floor  
for Your Enclosed Porch**

To make an unusually attractive and comfortable porch lay an Everlasbestos Floor. Permanent—sanitary—jointless—inexpensive.

**Everlasbestos  
Flooring**

Lay over Old Floors as well as for New Work Superior ingredients and perfected formula for laying make satisfaction certain. Ideal for bathrooms, schools, stores, churches, offices, factories.

Write for catalog and  
free sample.

**EVERLASBESTOS  
FLOORING CO.**

Dept. P. 35 North St.  
ROCHESTER, N. Y.

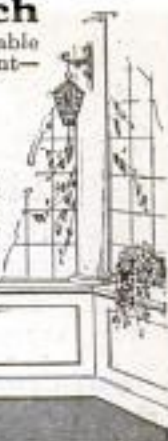
**Shot Guns Breech Loading \$4.50**

Like Cut



U. S. Cal. 45 B.L. Rifles.

Barrels cut to 22 inch length. Rebored smooth for Bird shot.

Bird shot Cartridges for these guns, \$3.00 hundred Rifle Barrels, interchangeable, same length \$2.00 extra Ball Cartridges..... \$3.00 hundred

**Best Gun in the World for the Price**

Leather Scabbard to Krag Sporting hold this gun..... \$1.50 Rifles..... \$14.00 Krag Rifles..... \$12.50 Cal. 45 Cartridges... 3.50 Utility Bags for Bait, Lanches, etc., Parcel Post Prepaid, 50c

Send for Catalog

**W. STOKES KIRK** 1627-PM North 10th St.  
Philadelphia, Pa.

**AGENTS MAKE \$100.00 A WEEK**

Write at once for newest, greatest money maker ever offered. Wonderful article—quick seller—big profits. Can be sold in every home. Tateishi of California made \$200 weekly—other agents cleaning up. If you mean business, here's the chance of your life! Address Mr. Lloyd Sales Mgr., Dept. 1-Y, 119 S. 14th St., St. Louis, Mo.

**Be Independent!**

Own a Grape Fruit and Orange grove—Truck or Poultry Farm. Increase your income. You can start a grove today under our new plan and have a Home and Income in Sunny Florida on the easiest terms imaginable. Any size Farm. Groves developed for Non-Residents. We raise our own guaranteed Citrus Trees in our own Nurseries. We have the Right Land—in the Right Location—at the Right Price, and on the easiest terms. Write for Book "The Call of the Southland"—It's Free.

**NORTH TAMPA LAND CO., 404 Zack St., Dept. 9-24, Tampa, Fla.**

**NEW VEST POCKET  
ADDING MACHINE**

Adds as rapidly and accurately as a \$300 machine, yet fits the vest pocket. Mechanically perfect. Easy to operate. Everybody who uses figures should own one.

**COUNTS UP TO 999,999,999**

**\$2.95**

Total visible at all times. A pull of the finger clears it. Don't carry a pocket full of pencil stubs and scrap paper to do your figuring. Carry a Ve-Po-Ad.

**10 DAYS TRIAL SEND NO MONEY.**

Just name and address and we will send machine postpaid. Pay postman on delivery \$2.95. Use it for 10 days to prove it does all we claim. If not perfectly satisfied we will refund your money. Limited supply. Order today.

**RELIABLE ADDING MACHINE CORP.**  
170 C West Washington Street CHICAGO, ILL.

**AGENTS**

Here's a money maker for you. Everybody wants one. Splendid profit. Write for special offer. **DO IT NOW.**



**70% PROFIT**

Add to your profit with a

*Kingery***Pop Corn Popper or  
Peanut Roaster**

Every man, woman and child likes peanuts and popcorn. Dimes and nickels pile up fast. Small down payment. Easy terms. Write today for FREE BOOK.

**KINGERY MFG. CO.**

420 E. Pearl St. Dept. B Cincinnati

**\$30<sup>00</sup> Suit FREE**

I'll make you a \$30.00 suit free of charge. My wholesale price is \$30.00 but you can get it free. I'll even pay delivery charges. On top of that I'll pay you from \$37.50 to \$110.00 in cash for a little of your spare time for the next few months. I make this liberal offer because I want a man in each community to wear, advertise and take orders for my fine tailoring.

**Agents Wanted** Just send me a postal or a letter and I will send you the best suit proposition you ever heard of by return mail. Your local store would charge you \$50.00 and my wholesale price is \$30.00 but you can get one of these fine all wool suits, tailored to your order free. Just write "Send me your great suit offer." Address—E. A. Allen, Manager.**AMERICAN WOOLEN MILLS COMPANY**  
Dept. 5019 Chicago**SPORT BODIES \$34<sup>50</sup> UP**  
*For Ford or Chevrolet*

We can furnish you with the latest style roadster or racing body at prices that will surprise you. These bodies may be used with or without top or windshield or fenders, and may be underlug if desired.

Write  
For Our Book  
**HOW TO  
BUILD A  
FORD RACER**  
25¢**CENTRAL AUTO SUPPLY CO.** Dept. 120 LOUISVILLE KENTUCKY**30 Days' Free Trial**Select from 44 Styles, colors and sizes, famous **Ranger** bicycles. Delivered free on approval, express prepaid, at **Factory Prices**. You can easily save \$10 to \$25 on your bicycle. Prices \$21.50 and up. \$5 a Month on any Ranger if desired. Parents often advance first deposit. Boys and girls can easily earn small monthly payments. Pay as you ride. Best quality, at factory prices, express prepaid. Lamps, wheels and equipment, low prices. Send **No Money**, do business direct with makers.**Mead CYCLE COMPANY**  
DEPT. 108 CHICAGOWrite today for free  
Ranger Catalog, fac-  
tory prices and mar-  
velous easy payment terms.**Saws Logs—Falls Trees—  
Buzzes Branches  
—Does Belt Work**  
10-Year Guar-  
antee—Cash  
or Easy Terms.**One Man****Saws 15 Cords a Day!**—Easy with the **OTTAWA Log Saw!** Wood selling for \$3 a cord brings owner \$45 a day. Use **4 H. P. Engine** for other work. Wheel mounted—easy to move. Saws faster than 10 men. Shipped from factory or nearest of 10 Branch houses. Write for **FREE Book**—"Wood Encyclopedia"—today.**OTTAWA MANUFACTURING CO.**1741-T Wood Street, Ottawa, Kansas  
Room 1741-T Magee Bldg., Pittsburgh, Pa.

# Great *New* Invention for seekers of Health Power Beauty



Elco Health Generators at last are ready for you! If you want more health—greater power to enjoy the pleasures and delights about you, or if more beauty is your desire—write! Ask for the book on these inventions which has just been prepared. It will be sent to you without cost. It tells you how Elco Health Generators aid you in leaving the lethargy and hopelessness of bad health and weakness behind forever. Re-vitalize yourself. Bring back energy. Be wholly alive. Write today!

**10 Days Free Trial—Write for FREE BOOK**These great new inventions generate *High Frequency Violet Ray, Mechanical Vibration, Medical Electricity and Ozone*. Combined or separate.

They operate on the electric light in your home or on their own motive power at less than 50 cents per year. Elco Health Generators are positively the only instruments which can give you in one outfit Electricity, Violet Ray—Vibration and Ozone—the four greatest curative agents. Send coupon below. Get the Free Book NOW!

**For All These:**

Rheumatism	Asthma
Gout	Hay Fever
Lumbago	Sore Throat
Neuralgia	Catarrh
Sciatica	Deafness
Headache	Insomnia
Neuritis	Pain
Nervousness	Development
Circulation	Skin Diseases
Weakness	Pimples
Paralysis	Scalp Disorders
Eye Trouble	Obesity

**MAIL the COUPON  
for FREE Book!**

Do not put this paper down without sending the coupon. Don't go on as you are with pains and with almost no life and energy. You owe it to yourself to be a better man or woman. You were put here to enjoy life—not just to drag through it. So do not rest another day until you have put your name on the coupon here. That will bring the whole story of these great new inventions. Do it today—now.

**Lindstrom & Company**

30 W. Lake St. Dept. 13-56 Chicago, Ill.

Please send me your free book, "Health—Power—Beauty" and full information on your 10-Day Free Trial Offer.

Name .....

Address .....

State your ailment and receive our expert advice  
**REPRESENTATIVES WANTED**



# PATENT TRADE MARKS PROTECT

ANY NEW article, machine, design or improvement thereof, or any combination of parts or improvements in any known article which increases its efficiency or usefulness, may be patented, if it involves invention.

## IF YOU HAVE ANY NEW IDEAS

which you feel are useful, practical and novel, take prompt action to protect your rights. If you have invented any new machine, or new combination of parts or improvement, or any new design or process, SEND DRAWING, MODEL OR DESCRIPTION of it for information as to procedure to secure protection.



DRAFTING and SPECIFICATION ROOM of CLARENCE A. O'BRIEN, Registered Patent Lawyer, Washington, D. C.

**All Communications** are held in strict confidence. My personal, careful and thorough attention is given to each case. I offer you efficient, reliable and prompt service—based upon practical experience. **Highest references.**

**NO CHARGE FOR ABOVE INFORMATION**

# Clarence A. O'Brien

REGISTERED PATENT LAWYER

Member of } Court of Appeals, District of Columbia, United States Court of Claims;  
Bar of } Supreme Court of United States, Supreme Court, District of Columbia

**Practice Confined to Patents, Trade Marks and Copyrights**



# NTS

## COPYRIGHTS YOUR IDEAS

WRITE TODAY FOR FREE BOOKS,

### "How to Obtain a Patent" and "Invention and Industry"

These books will give you valuable information, and they may save you much time and effort. **Send for them, NOW.** My practice is devoted **exclusively** to United States and Foreign Patents and Trade Marks. Write me freely, frankly and with full confidence; it is very probable that I can help you.

WRITE TODAY FOR **BLANK FORM** "RECORD OF INVENTION"

USE THE COUPON attached, and immediately upon its receipt I shall send you this form to be returned to me with drawing, description or model of your idea; promptly upon receiving your idea I shall write you as to procedure and costs.

## FREE COUPON

**CLARENCE A. O'BRIEN**

**Registered Patent Lawyer**

706 Security & Savings & Commercial  
Bank Building

Directly Across Street from Patent Office

**WASHINGTON, D. C.**

Please send me your free books, "HOW TO OBTAIN A PATENT" and "INVENTION AND INDUSTRY" and blank form, "RECORD OF INVENTION," without any obligation on my part.

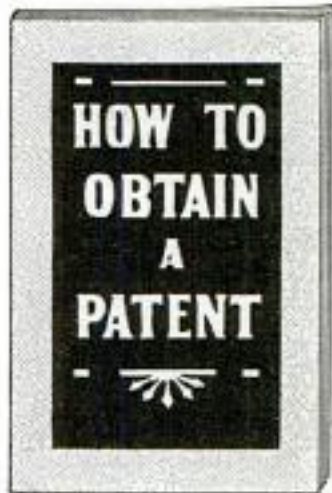
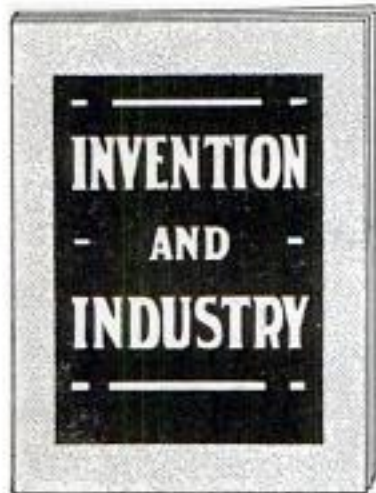

Name.....

Address.....

**IMPORTANT** — WRITE OR PRINT NAME CLEARLY.



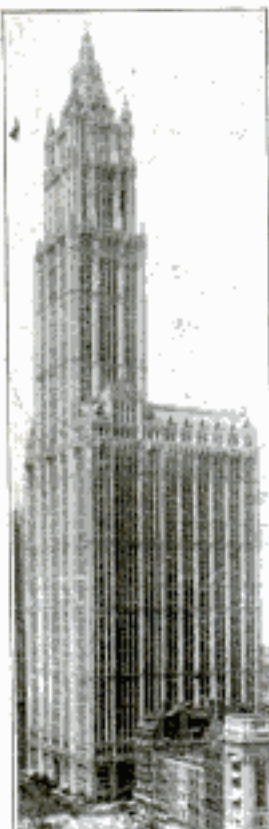

Our New York Office  
Suite 1007 Woolworth Bldg.



Our Philadelphia Office  
Suite 714-15 Liberty Bldg.



Our Washington Office  
Victor Building

# PATENTS TRADE-MARKS AND COPYRIGHTS

## Have You An Idea?

**Our Offer:** No Charge for Examination  
and Instructions

### Protect Your Invention

Your first step before disclosing or submitting your invention to anyone either for entry in a prize competition or for sale should be to write for our blank form,

### "RECORD OF INVENTION"

This should be signed and witnessed and returned to us together with model or sketch and description of the invention for examination and instruction and to establish Evidence of Conception.

*No charge for the above information.*

### Our Four Books Mailed Free to Inventors

*Our Illustrated Guide BOOK*

### How to Obtain a Patent

Full instructions regarding U. S. Patents. Our Methods, Terms, and 100 Mechanical Movements illustrated and described.

### Our Trade Mark Book

Shows value and necessity of Trade Mark Protection. Information regarding *Trade Marks and unfair competition in trade.*

### Our Foreign Book

We have Direct Agencies in Foreign Countries, and secure Foreign Patents in shortest time and lowest cost.

### Progress of Invention

Description of World's Most Pressing Problems by Leading Scientists and Inventors.

*We Regard a Satisfied Client* as our best advertisement, and furnish anyone, upon request, lists of clients in any state for whom we have secured patents.

*Highest References—Prompt Attention  
—Reasonable Terms*

## VICTOR J. EVANS & CO.

### PATENT ATTORNEYS

Main Offices: 956 9th St., N. W., Washington, D. C.

*Opposite U. S. Patent Office*



# PATENTS TRADE-MARKS AND COPYRIGHTS

## IMPORTANT

Do not submit your invention to anyone before you furnish proof that the invention is patentable or application has been filed. In order to have **YOUR CASE MADE SPECIAL TO AVOID DELAY** you should take the precaution of having your case made **Special** in our office to secure protection, save correspondence and secure early filing date in Patent Office. To secure special preparation of your case send \$25.00 on account with model, sketch and description.

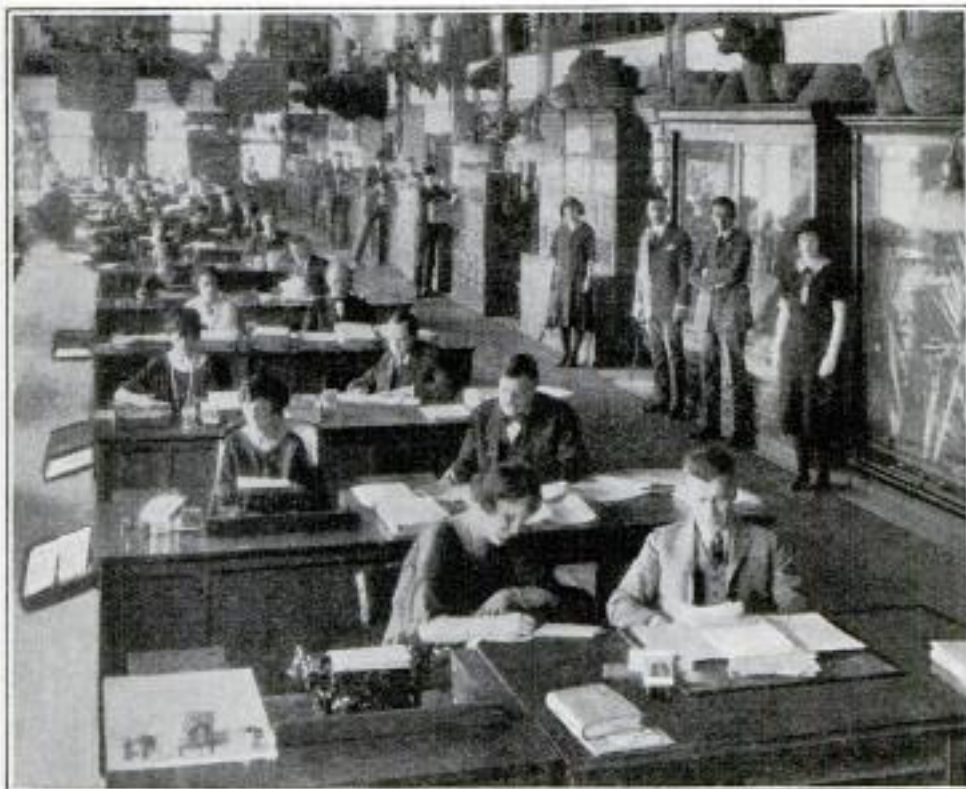

MAIN OFFICE, VICTOR J. EVANS & CO.—VICTOR BUILDING, WASHINGTON, D. C.

All Communications and  
Data Strictly Confidential.  
Interference and Infringe-  
ment Suits Prosecuted

### OUR ORGANIZATION OFFERS PERSONAL SERVICE

by registered and practical attorneys and draftsmen of long and varied experience, who will give your patent business special attention, the whole being under the supervision of Victor J. Evans.

**FREE  
COUPON**

**VICTOR J. EVANS & CO.  
PATENT ATTORNEYS**

NEW YORK OFFICES  
1007 Woolworth Bldg.

CHICAGO OFFICES  
1114 Tacoma Bldg.

PHILADELPHIA OFFICES  
714-715 Liberty Bldg.

PITTSBURGH OFFICES  
514 Empire Bldg.

SAN FRANCISCO OFFICES  
Hobart Bldg.

MAIN OFFICES: 956 9th Street, N. W., WASHINGTON, D. C.

Gentlemen: Please send me *Free of Charge* your books as described on preceding page.

Name .....

Address .....



Our Chicago Office  
Suite 1114 Tacoma Building



Our Pittsburgh Office  
Suite 514 Empire Building



Our San Francisco Office  
Suite 1010 Hobart Building



# PATENTS

*Seventy-eight  
Years of Practice*

**T**HE firm of Munn & Company filed its first application for a patent in 1846, and for seventy-eight years has endeavored to keep pace with the inventive genius of the United States.

An experience of many years is at your disposal. If you have an invention which you wish to patent, send your sketches or model together with a description of your device, explaining its operation, and you will receive prompt, courteous attention.

*Write for our Handbook on*  
**PATENTS**

A full and complete booklet on Patents, Designs, Trade-Marks, Foreign Patents, Copyrights, Labels and Patent Office Practice with an explanation about our methods, terms, etc.

*All communications strictly confidential.*

Keep in touch with the inventions of the world by reading

## SCIENTIFIC AMERICAN

The MONTHLY MAGAZINE with a special appeal to every man of inventive genius. Recent rulings of the Patent Office, descriptions of the latest patented inventions, legislation and court decisions affecting patents, are noted in this authoritative publication.

## MUNN & COMPANY

*Patent Attorneys*

672 Woolworth Building, New York  
Scientific American Bldg., Washington, D. C.  
1301 Tower Bldg., Chicago, Ill.  
Hobart Bldg., 582 Market St., San Francisco, Cal.  
Van Nuys Building, Los Angeles, Calif.

# U.S. PATENTS



## DON'T LOSE YOUR RIGHTS TO PATENT PROTECTION

Before disclosing your invention to anyone send for blank form "EVIDENCE OF CONCEPTION" to be signed and witnessed. A sample form together with printed instructions will show you just how to work up your evidence and establish the same before filing application for patent. As registered patent attorneys we represent hundreds of inventors all over the United States and Canada in the advancement of inventions. Our schedule of fees will be found reasonable. The form "Evidence of Conception," sample, instructions relating to obtaining of patents and schedule of fees sent upon request. Ask for them—a post card will do.

PATENTS AND TRADE MARKS  
**LANCASTER & ALLWINE**

480 Ouray Bldg. Washington, D. C.  
Originators of forms "Evidence of Conception."

## Have You An Invention?

If so the WORLD PROGRESS will show you how to **PROTECT AND PROFIT FROM YOUR IDEAS**  
Sample copy free. One year's subscription \$1.00.  
Send for free book,

### "WHAT TO INVENT"

containing SUGGESTIONS TO INVENTORS as to Inventions Needed. We invite manufacturers to address us regarding inventions they want.

**WORLD PROGRESS PUB. CO., Inc.**  
Room 203 Victor Bldg. WASHINGTON, D. C.

## PATENTS

### Trade-Marks, Copyrights and Patent Litigation

Write for advice and instructions how to proceed, costs, etc. Hand Book with illustrations of 100 Mechanical Movements sent free on request.

### ALBERT E. DIETERICH

*Patent Lawyer and Solicitor*  
Successor to Fred G. Dieterich & Co. 621A Ouray Bldg., Washington, D. C.

## PATENTS

REGISTERED PATENT ATTORNEY SINCE 1905  
**CHARLES W. LOVETT** SECURITY BLDG. LYNN MASS.  
(SEND FOR FREE BOOKLET)

## BLUE BOOK ON PATENTS

gives instructive information and candid advice.  
**MONROE E. MILLER, PATENT LAWYER**  
411-2 Ouray Building WASHINGTON, D. C.  
ELECTRICAL AND MECHANICAL EXPERT



# PATENTS

## To the Man with an Idea

I offer a comprehensive, experienced, efficient service for his prompt, legal protection and the development of his proposition.

Send sketch, or model and description, for advice as to cost, search through prior United States patents, etc. Preliminary advice gladly furnished without charge.

My experience and familiarity with various arts frequently enable me to accurately advise clients as to probable patentability before they go to any expense.

*Booklet of valuable information and form for properly disclosing your idea free on request. Write today.*

**Richard B. Owen, Patent Lawyer**  
9-303 Owen Building, Washington, D. C.  
2276-E Woolworth Bldg., New York City

## PATENTS Patent Litigation Trade Marks Copyrights

Handbook of instructions, "How to Protect Inventions," sent free on request.

**R. H. FRAVEL, Patent Lawyer**  
Formerly of the U. S. Patent Office Examining Corps  
Room 1503, McLachlen Bldg., WASHINGTON, D. C.

## PATENTS C. L. PARKER Formerly Member Examining Corps, U. S. Patent Office PATENT LAWYER MCGILL BLDG. WASHINGTON, D. C.

Patents, Trade Marks, Copyrights, Patent Litigation  
Handbook for Inventors, "Protecting, Exploiting  
and Selling Inventions," sent free upon request.

## CASH FOR PRACTICAL IDEAS

of some new and useful WAY to utilize Pressed Metal in place of other materials. The advertiser pays cash for every acceptable suggestion approved by our Engineering Advisory Board. Free book gives you the facts.

**PRESSED METAL TRADE COUNCIL**  
EXTENSION  
27 QUINCY STREET, SUITE 1705, CHICAGO

**PATENTS** As one of the oldest patent firms in America we give inventors at lowest consistent charge, a service noted for results, evidenced by many well known Patents of extraordinary value. Book, *Patent Sense, Free.* Lacey & Lacey, 646 F St., Wash., D. C. Estab. 1869.



## PATENTS

Send us sketch or model for free patentability opinion and exact cost of patent. Our book "How to Obtain a Patent" sent free on request. It tells how to apply for Patents, Trade Marks, Foreign Patents, Copyrights, etc.; gives information on Patent Procedure; tells what every inventor should know. Thousands of inventors, who are our clients, are our references.

**CHANDLEE & CHANDLEE, 25 Years' Experience**  
473 7th St. Washington, D. C.

# INVENTIONS WANTED!

**Y**OU can now learn how to train your mind along scientific inventive lines. No longer need you let your mind wander in unprofitable fields. You can learn how to think of worth-while ideas and make your ideas pay you money. The trouble with most people is that they do not know what to do with their ideas. Millions of dollars go to waste because of these undeveloped ideas. Now for the first time you can learn to harness your thoughts and make them work for you! One little invention, properly developed, may make you independent for life!

## \$128,400 in Prizes

The world wants hundreds of new inventions, and will pay big money for them. Even simple inventions—little things like crimped hairpins, the tin bottle-cap, the snap-fastener, the suspenders—have brought fortunes to their inventors. Popular Mechanics Magazine this month publishes an article which shows that manufacturers are offering \$128,400 in prizes for inventions they want now. You have a glorious opportunity to get one of these prizes—some of them thousands of dollars—if you only learn how to invent.

## You Can Do It At Home

If you have ever had an idea for an invention, or if you would like to become a sparetime or professional inventor, see what this fascinating new course can do for you. Fifteen famous inventors now teach you at home the secrets of invention; show you how to get the information you want, how to perfect your ideas quickly, what to invent, and (just as important) what not to invent. You also learn how to avoid the mistakes which cost many inventors thousands and thousands of dollars. This complete course teaches you everything you want to know—how to get a patent, how to protect your patent rights, how to dispose of your invention to get the greatest possible profits, and hundreds of other facts about invention worth a fortune to you.

## Write for This FREE Book



RAYMOND F. YATES

A wonderful book explaining this fascinating course will be sent to you free. It explains the course in detail, and proves that you can easily train your mind to think inventively so you may become a successful inventor. It shows how this course gives you, in short time, a wealth of information which other inventors learned only after years of hard work and bitter experience. Get the advice of these fifteen famous inventors. Send for this book today. There is no cost or obligation. This bureau is not connected with patent attorneys or manufacturers. Our only work is to teach you how to develop your ideas so they will bring you big money.

**BUREAU OF INVENTIVE SCIENCE**  
Dept. 39, Wisner Bldg. ROCHESTER, N. Y.

**Bureau of Inventive Science**  
Dept. 39, Wisner Bldg., Rochester, N. Y.

Please send me, without cost or obligation, your free book, "The Science of Invention."

Name .....

Address .....

City..... State.....



# PATENTS

Booklet Free

Highest References

Promptness Assured

Best Results

Send drawing or model for preliminary examination

**ALL BUSINESS GIVEN PROMPT AND PROPER ATTENTION**

**WATSON E. COLEMAN, Patent Lawyer, 644 G St., Washington, D. C.**



*"Been on a  
vacation  
Bill?"*

"No, Jim — I've stopped smoking. Gained six pounds in a week. You know how I used to smoke—a package of cigarettes and a cigar or two a day—it sure had some hold on me. But I'm cured—

took a scientific home tobacco treatment—fixed me up in two weeks.

"Wasn't hard on me at all—noticed improvement the first day—I feel like a new man. It didn't interfere with my work—didn't leave any druggish after-effects—the money I saved in the last two weeks has paid for the treatment alone.

"Why don't you take it! It has cured men like you and me for over forty years—it is a doctor's individual prescription that sure fixes you up. Just send the coupon for full information NOW. No obligation. All correspondence is strictly confidential."



*A Doctor's  
Prescription*

**The Keeley Institute, Dwight, Ill.**

Please send me, without any obligation on my part, your free booklet which will tell me how to rid myself of the tobacco habit.

Name.....

Town.....

Street..... State..... P. M.-D



## Mount Birds

We teach you by mail to stuff and mount all kinds of Birds, Animals, Game Heads. Also to tan skins and make rugs. Be your own taxidermist. Decorate your home with your beautiful trophies or increase your income selling specimens and mounting for others. Easily, quickly learned in spare time by men and women. Highest endorsements by thousands of students. Write today for our great free book "How to Mount Birds and Animals" Free—write today, N. W. School of Taxidermy, 9776 Elwood Bldg., Omaha, Neb.

## Build This Real Auto!

A sturdy, dependable motor car. Any handy man or boy can build it. Power supplied by famous 2½ H. P. SHAW Motor. Send for illustrated Circulars, 2c postpaid. Complete Illustrated Book of Building Plans 25c postpaid. Write today.



SHAW MFG. CO.  
Dept. P. M. 5-5, GALESBURG, ILL.

Book  
of  
PLANS  
25c

## RAISE BELGIAN HARES

New Zealand Reds — Finnish Giants — American Blues  
FOR US—BIG PROFITS—WE SUPPLY  
STOCK AND PAY \$2 TO \$8 EACH. Also other  
fur bearing animals; easily raised anywhere.  
Large Catalog and Contract **FREE!**  
Big Illustrated Rabbit Book,  
and copy of our large small stock magazine 10c.  
OUTDOOR ENTERPRISE CO., 1005 D. S. Bldg., Kansas City, Mo.



**\$25 A DAY**  
Selling Suits

Fifth Ave.  
New York  
Custom  
Tailors

want agents to sell advertised brand all wool tailored to measure suits and overcoats direct to wearer. **Lowest Prices in America.** Sell on sight. No capital or experience required. Big line swatch samples Free. **Biggest Commissions** paid daily. Permanent positions. \$75 to \$100 weekly. Also Free to Agents.  
MONARCH TAILORING CO., 100 Fifth Ave., Dept. F-2, NEW YORK

# INVENTORS PROTECT YOUR IDEAS

Send for our Guide Book, **HOW TO GET A PATENT**, and Evidence of Invention Blank, sent Free on request. Tells our terms, methods, etc. Send model or sketch and description of your invention for our Examination and Instructions without charge.

**RANDOLPH & CO.**  
300 Victor Bldg., WASHINGTON, D. C.

NAME.....

STREET.....

CITY..... STATE.....





**GET THIS WONDERFUL RING**

IF YOU CAN TELL IT FROM A GENUINE DIAMOND SEND IT BACK  
 These Amazingly Beautiful CORODITE Gems match the scintillating beauty of GENUINE DIAMONDS in every way. They have the same gorgeous blazing flash and dazzling play of living rainbow fire. Standing the terrific Acid Test of direct comparison. Life time experts need all their experience to see any difference. Prove this yourself.

**Make this Test** Wear a Genuine CORODITE and a Diamond side by side on the same finger. If you and your friends can tell the difference send it back, you won't be out a penny. That's fair enough. If you keep the ring, price printed here is all you pay. Remember CORODITES also have the same facet cutting as Genuine Stones.

- No. 1 Ladies Solitaire 14K Gold Filled Ring - \$2.84
- No. 2 Ladies Pierced Filigree 4 Post Ring, Platinum effect - \$4.19
- No. 4 Ladies Hand Carved Basket Ring, Platinum effect - \$3.96
- No. 5 Ladies Bridal Blossom Engraved Solitaire - \$3.54
- No. 7 Ladies Heavy Bridal 14K Gold Filled Ring - \$3.68
- No. 8 Mens Massive Hand Carved Hexagon Gray - \$4.28

Carat Size Gems. Beautiful Hand Carved and Engraved. Mountings of most modern design bearing an unqualified 20 year guarantee. Art Leather, Silk Silk and Velvet Lined Gift Case Free with each ring.

**SEND NO MONEY** Keep your money right at home. Just send name, address and number of ring wanted and size as shown by slip of paper fitting end to end around finger joint and your ring will come by return mail. Deposit amount shown above with postman. You do not risk a penny as our binding legal guarantee to refund your money in full is attached to every ring we send. **SEND TODAY.**

**E. RICHWINE CO., Dept. 156** 19 West Jackson Blvd. CHICAGO, ILLINOIS  
 Sole Importers Genuine Corodite Gems

**"The Torpedo"**

The Model D—popular Torpedo type body equipped with a complete Fiat style Radiator. The body is sturdy and guaranteed to stand up under any kind of strain (generally used for professional racing).



Gas tank in tail end, door on right side with inside lever lock. **Champion Racing Body Co., Dept. PM, 7-9 E. 28th St., Chicago, Ill.**

**TYPEWRITERS**



**\$50** buys a brand new Corona, the Personal Writing Machine. Latest model with many improved features.

Write for free booklet No. 8. **Corona Typewriter Co., Inc. GROTON, N. Y.**

**200 Sheets — 100 Envelopes**

**\$1.00**  
 Postage Prepaid



High grade, clear, white bond paper — unusually smooth writing surface. Size 6 x 7 inches with envelope to match. We give you much superior quality stationery at this low price as we sell this item only. Special handy box keeps paper and envelopes in order and easily reached, preventing waste.

**Your Name and Address Printed FREE**

on every sheet and envelope, in rich dark blue, up to 4 lines. (Note—our low price does not allow any variation in printing. Top center of sheet and flap of envelope only). Type is Plate Gothic, designed especially for clearness and good taste. Make a personal stationery you will be delighted to use. An ideal gift printed with your friend's name. Just send your name and address (write or print clearly) with \$1.00 (west of Denver and outside the U. S. \$1.10) and this generous box of stationery will come to you neatly packed, postage prepaid. Money refunded if you are not more than satisfied. Order today!

**National Stationery Co. 1776 Lincoln Highway, Easton, Illinois**

**Heats Home for 25c a Week!**

"I can run my Bulldog furnace steady for fourteen days in normal weather conditions on the actual cost of fifty cents." So writes F. R. Redetzke, of Cleveland, North Dakota. He adds: "Hard to believe is it? That's what some of my neighbors thought until I showed them! We have an unlimited amount of grain screenings in this country. That's the fuel I am using."

That's what the Bulldog does with about the lowest grade fuel you can think of! Here's what it does with coal: "There is no heater to compare with the Bulldog. I burned 2 1/2 tons of coal last winter and heated 5 rooms and bath."

—Walter Geary, Gloucester, Mass.



If you are even thinking of a pipeless furnace, or any furnace, write for our free catalog. The Bulldog is one furnace you MUST investigate. Comes completely erected. Fits any height of basement and you install it yourself.

**No Money Down**

The Bulldog is sent for free inspection. Then, if satisfied, you make only small monthly payments at our amazingly low price. Factory connections in both East and West. We ship from nearest point. Don't consider buying any furnace until you find out about the Bulldog. Write at once for our special offer and our free catalog together with the wonderful record of Bulldog success. Mail this coupon today.

**Babson Bros.**

19th and California Ave., Dept. 13-56 Chicago

Without obligating me in any way please send me your free catalog and special offer on the Bulldog Pipeless Furnace.

Name .....

Address.....



## 5-Room \$548 ALADDIN



**We Pay the Freight**

You can buy all the materials for a complete home direct from the manufacturer and save four profits on the lumber, millwork, hardware and labor.

## 4-Room \$414 ALADDIN



Here's your opportunity to avoid high apartment rentals. Build this home yourself. Two men can build it in a week. Instructions explain every step. Five plans shown in Aladdin catalog.

## 7-Room \$975 ALADDIN



Aladdin catalog contains seven different plans of this house; some with inset porches, grade and inside cellar entrances, two and three bedrooms.

## 7-Room \$1,208 ALADDIN

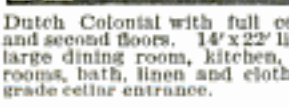

Dutch Colonial with full ceilings first and second floors. 14' x 22' living room, large dining room, kitchen, three bedrooms, bath, linen and clothes closets; grade cellar entrance.

## 12-Room \$1,932 ALADDIN



Dutch Colonial for wide inside lots or narrow corner lots. Full ceiling heights entire second floor, sewing room, columned and inset front entrance.

Price includes all lumber cut to fit; highest grade interior wood-work, siding, flooring, windows, doors, glass, paints, hardware, nails, lath, roofing, with complete instructions and drawings. Freight paid to your station. Permanent Homes—NOT PORTABLE. Many styles to choose from. Write nearest mill today for FREE Money-Saving Aladdin Catalog No. 954.

**The ALADDIN Co.,** BAY CITY, MICHIGAN  
Wilmington, North Carolina; Portland, Ore.; Toronto, Ont.

## "I Would Not Part With It for \$10,000"

So writes an enthusiastic, grateful customer. In like manner testify over 100,000 people who have worn it. Conserve your body and life first.

## The Natural Body Brace

Overcomes **WEAKNESS** and **ORGANIC AILMENTS** of **WOMEN** and **MEN**. Develops an erect and graceful figure. Brings restful relief, comfort, energy and pep, ability to do things, health and strength. Does away with the strain and pain of standing and walking; replaces and supports misplaced internal organs; reduces enlarged abdomen; straightens and strengthens the back; corrects stooping shoulders; nervously lungs, chest and bust; relieves backache, curvatures, nervousness, ruptures, constipation, after effects of Flu. Comfortable and easy to wear.



For Children Also

### Costs You Nothing to Try It

Write today for illustrated book, free, with full information and measurement blank. Address **HOWARD C. RASH, Pres. Natural Body Brace Co.** 223 Rash Building, SALINA, KANSAS

## Only \$985 DOWN

Improved New Model

1½ H-P PULLS OVER 2 H-P

(Burns Kerosene or Gasoline)

You can get any size OTTAWA from my factory at lower prices and on easy monthly payments. Earn its cost as you use it.

**No Interest to Pay** 30 days Free Trial on your farm. Thousands in use today. Easy engine to start. Sizes 1½ H-P. to 22 H-P. Write for new Free Book, "How to Know Better Engines." Send name on card today. **OTTAWA MFG. CO.** 531-B King St. Ottawa, Kan. Desk 531-B Meigs Bldg., Pittsburgh, Pa.

## WE CHALLENGE COMPETITION!

Lowest Prices

Ford Sport-Speed Bodies

FLYER \$23.50

Discs, Under-stand Fixtures \$6.50

Large "Specialty" Catalog Free

Aero and 14 other favorite models

PRICES SLASHED!

A. D. FORDSPEED BODY MFRS., 250 W. 54th St., NEW YORK

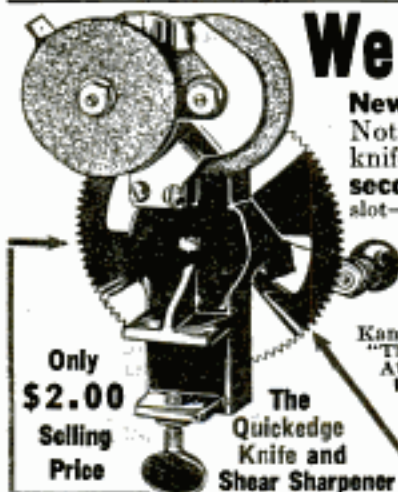

Only \$2.00 Selling Price

The Quickedge Knife and Shear Sharpener

## We Want Agents at \$50 to \$90 a Week

**New Invention—Just Out.** Needed in every home every day. Patented. Nothing else like it. Low priced—**Sells on sight.** Sharpens any kitchen knife, paring knife, carving knife, bread knife, or shears and scissors in **ten seconds.** Mechanical masterpiece. A child can use it. Just put knife in slot—turn crank—sharpens both sides at once automatically. **We want representatives at once—men and women hustlers.** Get this position where **profits start first day.**

### No Experience Necessary—200% Profit

Make as much money next week as these men are making now. J. C. Lewis, of Kansas, says: "I have sold one hundred sharpeners in four days." Hobart Kerr, of Md., writes: "The women can hardly wait till they get them." Herbert Cain, of Ky., sold nine after supper. At the end of the first day, J. W. Gordon, of Pa., writes: "I sold two dozen and I sold to everyone I saw." Wm. G. Hall, of N. J., says: "I think it is great. I sold six in about one-half hour. The machine is a mighty fine proposition. I am a mechanic and I know what I am talking about." You can make this money. **WRITE TODAY. TERRITORY FREE. Get busy at once.**

**QUICKEDGE SHARPENER CO.** 110 Sharpener Bldg. 159 West Pearl St. Jackson, Mich.



# KERMATH

BOAT ENGINES



## Summer On the Water

Summer on the water—and not only beside it! Don't sit on the beach—get out on the water and raise your own spray-washed breeze!

There isn't any fuss about motor-boating if your boat is engined with a dependable Kermath motor. Kermath starts at the first turn and keeps going without attention for long periods of time and with remarkable economy. And no Kermath has ever worn out.

80% of the good boat builders use them as standard equipment—that's why you will find them on the best boats wherever you go.

Write to Kermath for any information about boats and motors. We'll gladly help you in any way we can.

3 to 50 horsepower \$135 to \$1050

**KERMATH MANUFACTURING COMPANY**

5886 Commonwealth Ave. Detroit, Mich.  
Canadian address: 11 E. Wellington St. Toronto, Ontario

*A Kermath Always Runs*

## AGENTS WANTED!

Salesmen—Distributors

to use and introduce attachment that makes Fords run on 94% air. THERMOSTAT on exhaust automatically turns down needle valve as engine warms, exactly as Ford Manual says do by hand.

### BLANCKE AUTO THERMO

An Automatic Carburetor Control

Makes Fords start easier winter or summer—saves half gas and oil—cuts repair bills one-half—reduces carbon formation one-half. Sells on sight to every Ford owner as easily as giving him a \$100.00 bill, because it saves \$100.00 every 10,000 miles.

**CADILLAC NOW USES AS STANDARD EQUIPMENT THERMOSTATIC CARBURETOR CONTROL UNDER BLANCKE LICENSE.** You can make Big Money selling this wonderful proven device. Experience not necessary. Blancke plan will start you without capital in a business of your own that makes you from \$250 to \$2000 a month profit. Write for free circulars Now!

**A. C. BLANCKE & CO.** Dept. 464, 602 W. Lake Street CHICAGO, ILLINOIS



## Write For Book About the Elto

3 H.P.—The Fastest "Light Twin"

Designed and built by Ole Evinrude  
Weights less than 17 lbs. per H. P.

Gives half more power, much more speed, yet easy to carry. Instant starting without spinning. Safe rudder steering. Trouble-proof carburetor. Push button reverse, without danger of tipping boat. The ideal family motor. Fits carrying case without taking apart. Write for catalog.

**ELTO OUTBOARD MOTOR COMPANY**

Manufacturers' Home Bldg.,  
Dept. AA, Milwaukee, Wis.



1/2  
More  
Power—  
Much  
More  
Speed



How  
did  
your  
garters  
look  
this  
morning?



Keep step with the times with fresh, clean Bostons. Wide web, narrow web, single or double grip, they have no equal in comfort and service. Ask for and insist on getting Bostons.

**GEORGE FROST COMPANY, BOSTON**

MAKERS OF VELVET GRIP HOSE SUPPORTERS  
FOR ALL THE FAMILY

## Turn Your Spare Hours Into Real Money

HAVEN'T you often wished for a spare-time way of making more money than comes in the regular pay envelope? Of the various ways which present themselves none is more pleasant or profitable than playing engagements in a Band or Orchestra.

### Send the Coupon

For particulars of our Easy Payment Plan that tells How You Can Pay While You Play. Free Trial—We want you to try out a "King" in your own home, without obligation, and if you do not find the "King" the very best instrument you ever played—return it.

Trade-in-Proposition—Turn in the instrument you now own as part payment on a new "King". Our latest catalogs show many new model "Kings" and tell why they are the best instruments to learn on and play on. Use the coupon to order your copy.



**THE H. N. WHITE CO.**  
5211-55 Superior Avenue, Cleveland, Ohio

Please send me free, your latest catalog on \_\_\_\_\_

Instrument.

Name \_\_\_\_\_

Address \_\_\_\_\_

City \_\_\_\_\_

State \_\_\_\_\_

Please Mention Popular Mechanics





## LUMINOUS PAINT

**Make Your Watches, Clocks, Etc., Visible by Night**

The very latest discovery in the scientific world, hitherto, practically unobtainable LUMINOUS PAINT, which, applied to the surface of any article, emits rays of white light, rendering it perfectly visible in the dark. **THE DARKER THE NIGHT, THE MORE BRILLIANT IT SHINES.** Quite simple to use. Approx.—you can do it. A little applied to the dial of your watch or clock will enable you to tell the time by night. You can coat the push buttons or switch plates of your electric lights, match boxes, and innumerable other articles; make your own Luminous Crucifixes, Luminous Rosaries, etc. Small bottle, price 25c. Larger sizes, 50c and \$1 postpaid.

## Serpent's Eggs

Box contains 12 eggs. When lit with a match, each one gradually hatches itself into a snake several feet long, which curls and twists about in a most life-like manner. Price per box, 10c postpaid, 3 for 25c.



## The Dying Pig



The most laughable novelty yet produced. Made of rubber, and you have only to blow it up and stand the pig on his feet, when he begins to squeal as he slowly collapses and finally lies down and dies in the most natural manner. You can blow him up as often as desired, and each time he will go through the same performance to the great amusement and delight of your friends. Price, 15 cents; 3 for 40 cents; one dozen \$1.35, mailed.

## Potmend



Meets Ironware Enamelware, kettles, pots, pans, boilers, tin, copper, Aluminum, tin bases, iron pipes, cracks in stores, broken china, porcelain, bisque, crockery, woodenware, marble, etc. Comes in powdered form. Just mix with water and apply. **MAKES LIKE IRON.** Meets a big hole or a small crack. PRICE 15c, 3 for 40c, postpaid.

## Midget Bible

**GREAT CURIOSITY** Smallest Bible in the World. Size of a postage stamp. 200 Pages. Said to bring good luck to the owner. A genuine work of art. Must be seen to be appreciated. Lane good money selling them to friends, church acquaintances, etc. PRICE 15c each, 3 for 40c, 12 for \$1.35, 100 for \$7.50.



## STAGE MONEY



With a bunch of these bills, it is easy for each person of limited means to appear prosperous by flashing a roll of these bills at the proper time and peeling off a genuine bill or two from the outside of the roll, the effect created will be found to be all that can be desired. Prices, postpaid: 25 Bills 15c, 50 Bills 25c, 125 for 50c, or \$1.50 thousand.

## Wonderful X-Ray Tube

A wonderful little instrument producing optical illusions both surprising and startling. With it you can see what is apparently the bones of your fingers, the lead in a lead pencil, the interior opening in a pipe stem, and many other similar illusions. A mystery that no one has been able to satisfactorily explain. Price 10c, 3 for 25c, 1 dozen 75c, Johnson Smith & Co.



## Good Luck Ring

Quaint and Novel Design

A VERY striking and uncommon ring. Silver finish, skull and crossbones design, with two brilliant, flashing gems sparkling out of the eyes. Said by many to bring Good Luck to the wearer, hence its name, **Good Luck Ring.** Very unique ring that you will take a pride in wearing. **ONLY 25 CENTS.**

Address orders for all goods on this page to

**JOHNSON SMITH & CO.**  
Dept. 166  
RACINE, WIS.

Our large catalog (429 Pages) of all the newest and best novelties, unobtainable elsewhere, free with every order.

## BLANK CARTRIDGE PISTOL

Protection against Burglars, Tramps & Dogs

Prices  
50c  
\$1.00



Well made and effective; modeled on latest type of Revolver; appearance about as though to seem a burglar. When loaded it may be as effective as a real revolver without danger to life. It takes standard 32 Cal. Blank Cartridges obtainable everywhere. Price 50c, superior quality, \$1.00 postpaid. Blank Cartridges, by express, 50c per 100.

Johnson Smith & Co., Dept. 166, Racine, Wis.

## DANCING BEAUTIES

Get a Kinemograph and see the picture move. Franor's latest sensation. A great surprise. Is worth twice what they cost. Are made of solid brass, highly nickel-plated and very durable. Satisfactory or your money back. Price 50c

Johnson Smith & Co., Dept. 166, Racine, Wis.

## BOYS! BOYS! BOYS!

## THROW YOUR VOICE

Into a trunk, under the bed or anywhere. Lots of fun fooling the teacher, policeman or friends.

**THE VENTRILO**  
a little instrument, fits in the mouth out of sight, used with above for Bird Calls, etc. Anyone can use it.

Never Fails. A 32 page book on ventriloquism, the Ventrillo, ALL FOR 10 CENTS

**1000 Silk Remnants** for patching Crazy Quilts, Sofa Cushions, Head Rests, Pin Pads etc. Large pieces, all colors and shades. Sure to delight you.

**For 10 Cents** stamps, a large package and Book of quilt designs. 3 packages, 25c. 1 pound makes a lovely large quilt. Price 75c postpaid. Our silk is the best.

JOHNSON SMITH & CO., Dept. 166, RACINE, WIS.

## LOOK 35c Look

Wonderful instrument. Greatest thing yet. Nine separate articles in one. Everybody delighted with it. Odd, curious and interesting. Lots of pleasure as well as very useful. It is a double Microscope for examining the wonders of nature. It is also an Opera Glass, a Stereoscope, a Burning Lens, a Reading Glass, a Telescope, a Compass, a Pocket Mirror, and a Laryngoscope—for examining eye, ear, nose and throat. It is worth all the cost to locate even one painful cinder in the eye. Folds flat and fits the pocket. Something great—you need one. Don't miss it. Sent by mail, with 420 page Novelty Catalog. **Only 35c or 3 for \$1.00**

## Resurrection Plant

One of the most wonderful plants known. Possesses the strange power of turning in a few minutes from an apparently lifeless, dry herb to a

**BEAUTIFUL LIVING FERNLIKE PLANT** of a dark green color. Simply place the plant in a saucer of water, it will open up and start to grow in 20 minutes. When taken out it will dry up and go to sleep until placed in water again. Fine house plant—summer or winter. 10 cents each or 3 for 25c. **AGENTS WANTED** post paid.

JOHNSON SMITH & CO., Dept. 166, RACINE, WIS.

## Popular Watch Charms

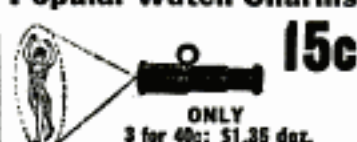

Very pretty little curiosities and decidedly novel. Fitted with Magnifying Lenses that enlarge the pictures to a very surprising degree; in fact, it seems almost incredible that a clear picture could be possible in such a small compass, and how sharp and distinct they show up when you look through. Come in assorted views—Actresses, views of Panama Canal, Lord's Prayer in type, etc.

## Mystic Skeleton

A jointed figure of a skeleton 14 in. in height, will dance to music and perform various gyrations and movements while the operator may be some distance from it.

**NEW BOOK ON ROPE SPLICING**  
Useful Knots, Hitches, Splices, etc.

A most practical handbook giving complete and simple directions for making all the most useful knots, hitches, rigging, splices, etc. Over 100 illustrations. All about wire-rope attachments, lashing, blocks, tackle, etc. 27 Heavily Illustrated. Of great value to mechanics, riggers, carpenters, boatmen. Price 20c postpaid.

## MAGIC FLUTE

Wonderfully Sweet Toned and Musical

The Magic Flute, or Hummer-trumpet, is a unique and novel musical instrument that is played with nose and mouth combined. There is just a little knack in playing it which, when once acquired after a little practice will enable you to produce very sweet music that somewhat resembles a flute. There is no fingering, and once you have mastered it you can play all kinds of music with facility and ease. When played as an accompaniment to a piano or any other musical instrument, the effect is as charming as it is surprising.

Post Paid 25c



# Swear Off Tobacco

## Tobacco Habit Banished Let Us Help You

### Quick Results

Trying to quit the tobacco habit unaided is often a losing fight against heavy odds, and may mean a serious shock to your nervous system. So don't try it! Make the tobacco habit quit you. It will quit you if you will just take **Tobacco Redeemer** according to directions.

It doesn't make a particle of difference whether you've been a user of tobacco for a single month or 50 years, or how much you use, or in what form you use it. Whether you smoke cigars, cigarettes, pipe, chew plug or fine cut or use snuff—**Tobacco Redeemer** will positively remove all craving for tobacco in any form in a few days. Your tobacco craving will usually begin to decrease after the very first dose—there's no long waiting for results.

**Tobacco Redeemer** contains no habit-forming drugs of any kind and is marvelously quick, scientific and thoroughly reliable.

### Not a Substitute

**Tobacco Redeemer** is in no sense a substitute for tobacco, but is a radical, efficient treatment. After finishing the treatment you have absolutely no desire to use tobacco again or to continue the use of the remedy. It helps to quiet the nerves, and will make you feel better in every way. If you really want to quit the tobacco habit—get rid of it so completely that when you see others using it, it will not awaken the slightest desire in you—you should at once begin a course of **Tobacco Redeemer** treatment for the habit.

### Results Absolutely Guaranteed

A single trial will convince the most skeptical. Our legal, binding, money-back guarantee goes with each full treatment. If **Tobacco Redeemer** fails to banish the tobacco habit when taken according to the plain and easy directions, your money will be cheerfully refunded upon demand.

### Let Us Send You Convincing Proof

If you are a slave of the tobacco habit and want to find a sure, quick way of quitting "for keeps" you owe it to yourself and to your family to mail the coupon below or send your name and address on a postal and receive our free booklet on the deadly effect of tobacco on the human system, and positive proof that **Tobacco Redeemer** will quickly free you from the habit.

**Newell Pharmacal Company**  
Dept. 300 St. Louis, Mo.

### Free Book Coupon

**NEWELL PHARMACAL CO.,**

Dept. 300

St. Louis, Mo.

Please send, without obligating me in any way, your free booklet regarding the tobacco habit and proof that **Tobacco Redeemer** will positively free me from the tobacco habit or my money will be refunded.

Name.....

Street and No.....

Town..... State.....



Tobacco Tells on  
Nervous System



Tobacco Ruins  
Digestion



Tobacco Stunts  
Boy's Growth



Tobacco Robs  
Man of Vitality



Tobacco Steals  
from You the  
Pleasures, Com-  
forts, Luxuries  
of Life





# Install a South Bend Lathe

## Under Our Easy Payment Plan

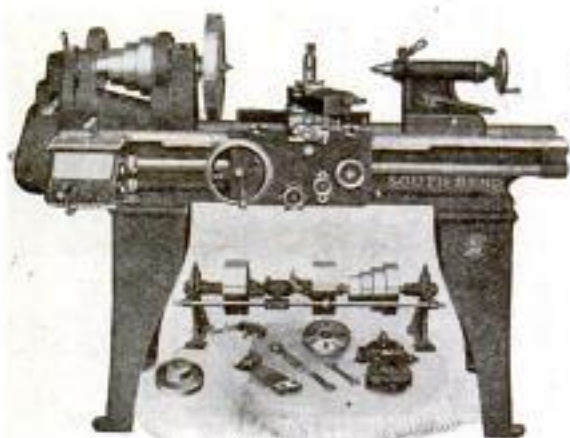

13' x 6' South Bend  
Quick Change Gear Lathe \$366.00

Prices of some of the popular sizes:

Size of Lathe	Standard Change Gear	Quick Change Gear
9' x 3' Lathe.....	\$211.00	\$241.00
11' x 4' Lathe.....	248.00	288.00
13' x 5' Lathe.....	304.00	354.00
15' x 6' Lathe.....	376.00	431.00
16' x 8' Lathe.....	438.00	498.00

**South Bend Lathe Works** 559 East Madison Street  
ESTABLISHED 1906 SOUTH BEND, IND., U. S. A.

Our Easy Payment Plan allows you to install a South Bend Lathe in your shop by making one payment with the order; the balance to be paid month by month, the amount depending upon the size of the lathe.

The South Bend Lathe has been on the market for over eighteen years and you can buy it under our co-operative Easy Payment Plan at the regular price. There is no advance in price in buying a lathe under our plan.

You can put in your lathe—the lathe helps you to pay its own way; it increases your business; and it advertises your shop.

Ask your dealer about it, or write us, mentioning the size lathe that you think is best for your work, and we will send you an itemized quotation and the terms of our Easy Payment Plan.

Over 31,000 South Bend Lathes in Use

**Buchstein's Fibre Limb**  
is soothing to your stump—strong, cool, neat, light. Easy payments. Braces for all deformities.  
**D. BUCHSTEIN CO.**  
609 3rd Ave., So., MINNEAPOLIS, MINN.

Send for Catalog Today

SEND \$2 DOWN PAY \$6.70 PER MONTH

Seven brilliant, blue white, perfectly cut diamonds are set in platinum. Looks like 2 ct. solitaire worth \$300. Fully guaranteed to stand any test.

**TWO BLUE SAPPHIRES** are set in the shanks of this 18 kt. solid white gold engraved and pierced ring to add beauty and style.

FREE TRIAL NO RED TAPE

Just send \$2.00 deposit to show your good faith (or pay postman \$2.00 on delivery) and we will send this handsome diamond ring. The balance you can pay in ten small monthly installments of \$6.70 each—total price, \$68.00. Former price, \$100.00. Give finger size.

**ALL DEALINGS CONFIDENTIAL**  
No one knows you are buying on our dignified credit system unless you tell them yourself. A written guarantee accompanies each ring. You can return the ring within ten days if not satisfied. Send order today.

**Write for Bargain Catalog**  
It brings our large jewelry store right into your home. It tells the exact weights and quality so you can buy like an expert. See valuable information on page 6.

**STERLING DIAMOND & WATCH CO.**  
(Diamond Importers—\$1,000,000 Stock—Est. 1879)  
63 PARK ROW, Dept. 1733, NEW YORK

### SEND for the INTERNATIONAL CATALOG

FOR FORD—PRICES FROM \$27.85 UP.

Factory to Consumer direct—Pay only one profit.



Our net price list. Full line of auto bodies and accessories for Fords at Wholesale Prices

Save big money on bodies by buying direct from factory.

INTERNATIONAL BODY WORKS, Dept. 7, 914 W. Ohio Street, CHICAGO, ILL.

### FREE 1000 Illustrations ELECTRIC FIXTURE CATALOG!



Write today for your copy. Save 50% direct from Manufacturer. No Middleman's Profit. OUR SPECIAL: 8 Room Electric Set, ready to hang, \$24.50—Other bargains.

**UNITED LIGHTING FIXTURE CO.**  
280 Bowery Dept. P.M. New York



### Agents! This Suit FREE also \$45 in Cash Part Time or Full Time!



I must have a live Agent in your locality immediately. If you're ripe for a steady position at top pay write for my sensational offer. Even if you have never sold clothing before, I will teach you how to sell, how to make money fast.

**All-Wool Suits and Overcoats, \$23.75**  
**Boys' 2-pants Suits, \$11.75**

Enormous demand, no competition. Simply show your samples, write the order, collect your commissions in advance! We deliver and collect balance. You make \$25 to \$50 a week spare time. \$25 to \$125 a week full time. 91% repeat orders mean a steady income, \$5,000 to \$10,000 a year for you!

**BIG OUTFIT FREE!**

Tell me what you have sold before and territory wanted. I will immediately send you big free sample outfit and special offer of \$45 in cash and your own suit price. No deposit needed, no waiting, write quick!

**John G. Longworth & Sons, Dept. M-1000 CHICAGO**  
1351 to 1381 W. CONGRESS STREET



# HEAT Without Coal!

An amazing new invention that does away with Coal and Wood in Stoves, Ranges, and Furnaces. Manufactured by the old, reliable INTERNATIONAL HEATING CO. Cost surprisingly low. Without waste, it burns Instant-Gas, a safe, superheated mixture of cheap fuel-oil and air.

## THE FIRST INEXPENSIVE FURNACE OIL BURNER WITH LOW OPERATING COST

Here is a Furnace Oil Burner that is "different!" Does all the work of the complicated, high-priced Burners, but at far less cost. Thousands of delighted users all over the country hail it as the greatest Oil Burning Device of the age. Hundreds more are enthusiastically installing it every day because of its amazing simplicity, efficiency, and unequalled economy.

### Write for 30 Day Free Trial

The new INTERNATIONAL Burner fits any hot air, steam or hot water furnace, and is the cheapest to install and operate. Burns without waste most economical fuel known, 96% air and 4% oil. The new INTERNATIONAL has no noisy motors, no moving parts, nothing to get out of order; action purely automatic, eliminating odors and smoke. The new INTERNATIONAL is always ready and safe. Cost unbelievably low. Installation quick and easy without damage to furnace. Can be moved if you move. Try the new INTERNATIONAL, and you'll never use any other. Low introductory price and 30 day free trial offer to those who write at once. This offer is for limited time only.

## FITS ANY STOVE, RANGE OR FURNACE

Recommended and endorsed by leading institutions. Given highest rating.



Thousands of testimonials from 48 states.

It's amazing what this new burner can do. Four special models of this wonderful invention are made to fit any heating stove or range. Simply sets in firebox, and transforms oil and air into Instant-Gas, giving three times the heat of coal, and cheaper. Can be turned on or off in a jiffy. Better cooking and baking. Installed in five minutes; no damage to stove. Absolutely safe; lasts a lifetime. Sold on money-back guarantee. Over 60,000 INTERNATIONAL Burners in use. Write today for 30 day free trial offer and Free Book, "Scientific Oil Burning." Specify whether for stove or furnace. Use coupon for quick action.

## INTERNATIONAL HEATING CO.

Dept. 2-Y, 117 So. 14th St.

ST. LOUIS, MO.

## Drive This Beautiful Raceabout Instead of Your OLD FORD



Choice of Four Colors: Fiat or the Ballet Nose Radiator Shell. Send for 1924 Free Catalog of New Auto Accessories, Bodies and

Speed Equipment. Direct from Factory.

AMERICAN TOP AND BODY CO., Park Ave. DELPHI, IND.

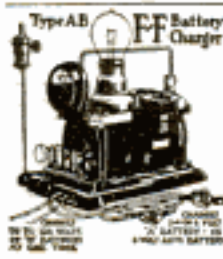

## The Triple Duty Charger

Charges radio 2, 4 or 6 volt "A" battery, radio "B" battery up to 120 volts and auto batteries from lamp socket. Average cost per charge about a nickel. Solidly built—will not get out of order. Fool-proof and simple. The first successful charger—introduced over ten years ago. Type A, B., price \$20; West of Rockies, \$22. Type C for 6 volt "A" or auto batteries, price \$16; West of Rockies, \$18. "B" battery charging attachment, \$2.50 extra. Write for literature and name of dealer who will supply you with the genuine FF charger.

FRANCE MFG. CO.

10424 Berea Road

CLEVELAND, OHIO



The International's combination safety and indicator valve, approved by Underwriters Laboratories of National Board of Fire Underwriters.

## AGENTS WANTED

Agents, distributors and salesmen wanted at once. Write or wire for exclusive free territory quick. Now is the time to get started—jump into this immediately for a big season. Hundreds of men and women are making big money with the new INTERNATIONAL Burner. Adrian of Pennsylvania made \$150 the week after he started, Fleurant of Rhode Island made \$90 the first week, so did Clark of Nebraska. Palley of Iowa made \$65 in three days. Bible of Wyoming earned \$30 in two hours. Meade of Mexico made \$126 in one day. Arnel of California runs up \$40 in two days, and hundreds of others are cashing in big with the new INTERNATIONAL Burner. Highpowered salesmanship not necessary. The new INTERNATIONAL practically sells itself. Write at once for free sample offer and special agents' proposition.

INTERNATIONAL HEATING CO., Dept. 2-Y, 117 So. 14th St., St. Louis, Mo. Mail me, postpaid, your Free Book, "Scientific Oil Burning" and further information about your burner for:—

.....Stoves For agent's sample offer, place (x) below.

.....Furnaces (Check style desired)

Name.....

Street or P. O. Box.....

City..... State.....



## 5 SIZE AUTOMOBILE TAP AND DIE SET, ONLY \$3.00

DIRECT FROM THE FACTORY TO YOU!

Our No. 12 Automobile Set furnished by our highly finished chestnut box contains 5 each taps and dies (1-4, 5-16, 3-8, 7-16 and 1-2"), in the S. A. E. thread, 1 die stock, and one tap and reamer wrench.

Our No. 11 Set is the same as No. 12 except that the thread is U. S. S. instead of S. A. E. You are purchasing a splendid set at a very low figure.

Send us your order at once and be one of our many satisfied customers. Let us also send you one of our circulars illustrating our full line of Handy Tools. Worcester Steel Products Co., Dept. T, 25 Union St., Worcester, Mass., U.S.A.



“the superior tone quality of Erla Duo-Reflex circuits, as well as their unmatched range and volume, stamp them as the most advanced types yet developed”



Erla Selectoformer imparts to novices expert skill in tuning, easily bringing in long range signals through local interference. List \$5

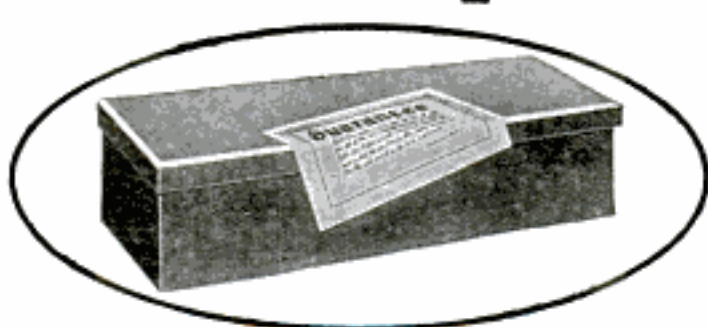

**F**ACTORY sealed cartons of complete parts now make child's play of assembling time-tested Erla Duo-Reflex circuits, tube for tube, the most powerful ever built.

Synchronizing reflex and audio transformers, tested capacity condensers, balanced crystals, these and other factory-packaged units assure proper materials, while correct construction is made equally certain through a stenciled baseboard, drilled and lettered panel, and full-size blueprints showing exact location of every wire. Even soldering is eliminated, through Erla solderless connectors.

Examine a completed Erla demonstrating receiver at your nearest dealer's. See how easy it is to build. Your dealer will gladly co-operate. Or get in touch with us direct, giving your dealer's name.

Electrical Research Laboratories  
Dept. J 2500 Cottage Grove Ave., Chicago

**ERLA**



Gold, nickel or black Erla bezels enhance any receiving set 100%. Telescoping patented rim fits  $\frac{1}{8}$ " to  $\frac{1}{4}$ " thick panels. List, 20c-30c

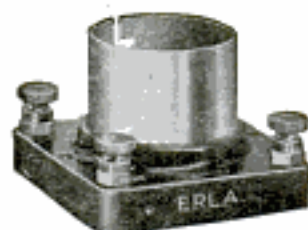

Wiping contact of diagonal, tilted springs exclusive to Erla sockets assures clean, positive engagement, eliminating current loss. 65c-75c



Erla reflex transformers alone amplify at maximum both received and reflexed radio frequency currents, without distortion. List \$5



Unique ability to amplify three stages without trace of distortion proves conclusively the superiority of Erla audios. List price, \$5



The words "tested capacity" found exclusively on Erla fixed condensers, guarantee accuracy unapproached. Made in 11 sizes, 30c to 75c ea.





## The next time you are stuck in the mud

—this book will be worth more than twice its cost to you. It tells how to apply chains easily when your wheels are sunk deep in mud or sand. It tells how to lock your car so that a thief cannot steal it. It tells how to judge a second-hand car. It tells how to quiet squealing brakes. It tells how to stop the rattling of car doors.

## 286 Ideas on 13 Subjects of Importance to All Drivers

- |                                 |                                    |
|---------------------------------|------------------------------------|
| 19 ideas on oiling and greasing | 12 ideas on caring for springs     |
| 16 ideas on starting balky cars | 8 ideas on non-skid equipment      |
| 22 ideas for road emergencies   | 16 ideas for the home garage       |
| 18 ideas on radiator repairs    | 6 ideas on cleaning cars           |
| 15 ideas on handling gasoline   | 10 ideas on non-freezing solutions |
| 33 ideas on lights and ignition | 78 ideas on miscellaneous repairs  |
| 24 ideas for tire repairs       |                                    |
| 9 ideas on foiling thieves      |                                    |

The next time the devil causes you trouble miles from a garage, what a surprise it will be to him if you take this book out of the door pocket and fix the car yourself! **50c**

**POPULAR MECHANICS PRESS**  
Room 507, Popular Mechanics Bldg., Chicago, Ill.

### MECHANICS FOR YOUNG AMERICA

Plain and complete directions for building boats, water motors, wind mills, searchlight, burglar alarm, ice boat, water bicycle, cabins, camps, kites, etc. 6x9 in. Illustrated. 25c, postpaid. Popular Mechanics Book Dept., 209 E. Ontario St., Chicago.

### Automobile Repairman's Handbook

The latest addition to Popular Mechanics fast selling 50 cent handbooks.

Contains 334 ideas for those who repair automobiles. All practical plans discovered by practical mechanics. 337 illustrations. 40 ideas on valves, 16 ideas for special tools, 26 ideas on bearings and bushings, 21 ideas on pistons and piston rings, 15 ideas on cylinders and cylinder heads, 10 ideas on fender and body repairs, 12 ideas on carburetor and vacuum tank, and definite suggestions for repairing the other parts of all makes of cars. Fully indexed. Send 50 cents to

**POPULAR MECHANICS PRESS**  
Room 707 Popular Mechanics Building Chicago, Ill.

## Automobile Tourist's Handbook

Tells how to keep food cool and free from dust while on the road; how to provide sleeping quarters inside the car; how to provide plenty of room for baggage; how to avoid car trouble on the road; how to build a combination bed and luggage carrier; how to cook food without carrying a big stove; how to make tents, cots, and stools, how to build a radio set for touring, and dozens of other practical articles needed when you are on a trip. 96 pages, thoroughly illustrated. **50c**

**POPULAR MECHANICS PRESS**  
Room 707 Popular Mechanics Bldg., CHICAGO, ILL.



## Swinging, Swaying Tantalizing Tunes

The lure of jazz is yours with a Buescher True-Tone Saxophone. Young folks are enamored by these tantalizing tunes. They love that syncopation.

If you want to be popular—if you want to be admired—favored, get this wonderful instrument. At home, at parties, everywhere, the Saxophone player is the center of attraction.

# BUESCHER

TRUE-TONE Saxophone

Easy to Play  
Easy to Pay

You don't have to "study" the Saxophone as you do other instruments. There's no practice drudgery. You don't have to be "talented." Three lessons sent free with the instrument start you. In a week you can play popular airs. No teacher needed.

It's all fun, and even though you're only out for pleasure now, you can, in 90 days' time, if you wish, join a band or orchestra.

First class Saxophonists make big money. Try it out free for six days in your own home.

### Free Saxophone Book

Send the coupon! Or a postal for full particulars and copy of Saxophone Book. Mention any other instrument in which you may be interested. No obligation. Do this today. (112)

**BUESCHER BAND INSTRUMENT CO.**  
Everything in Band and Orchestra Instruments  
172 Buescher Block Elkhart, Ind.

Buescher Band Instrument Co.,  
172 Buescher Block, Elkhart, Ind.

Gentlemen: I am interested in the instrument checked below:

Saxophone..... Cornet..... Trombone..... Trumpet.....  
(Mention any other instrument interested in)

Name .....

St. Address.....

Town..... State.....



## AGENTS \$200 PER WEEK



**Latest Heating Burner  
Fits any Stove,  
Boiler or Furnace**

Agents and distributors wanted at once—full or spare time—to introduce the **NEEDHAM OIL BURNER** for heating-stoves, boilers or furnaces. Eliminates coal and wood, ashes, dirt, dust and grime. No more cleaning of furnaces, building of fires or frozen pipes. Gives three times the heat of ordinary coal or wood fires. No noisy motors, no moving parts, no need of gas or electricity for operation. Fits any heating stove, boiler or furnace converting it into a modern oil heating plant. Easily installed. No fuss—no muss. No worry about machinery getting out of order. Money back if not satisfied after trial.

## BIG MONEY in advance

Sales are easily made. Every home needs one of these burners. You can sell two or three each day. You get your big profit right when you take the order. Pleasing, dignified work. Get started today. Distributors, Sales Agents and Spare-time workers earn from \$100 to \$250 a week easy. Some choiceterritory still open. Write at once and ask for free sample offer and Agent's proposition.



**NEEDHAM OIL BURNER CO.**  
337 W. Madison St., Dept. A, Chicago, Ill.

## The Traffic Cop of the Air



Add a **Ferbend Wave Trap** to your set and "Police" your reception. Regulate the Traffic! Guaranteed to tune out any interfering station. Sent postpaid on receipt of \$8.50, or C. O. D. plus postage. Send for free booklet. **Ferbend Electric Co.** 15 E. South Water St., Chicago



**For the Boy Mechanic**

To securely fasten charts and drawings to walls, use

## MOORE PUSH-PINS

Glass Heads—Steel Points

For anything heavy, use

**Moore Push-less Hangers**

"The Hanger with the Twist"

10c pkts.

Sold Everywhere.

**MOORE PUSH-PIN CO., Philadelphia, Pa.**



## Save \$38.80

Take advantage of the great saving we offer on the genuine world-famous ball-bearing, long wearing L. C. Smith Typewriter. Late model machines, standard size, up-to-date in every way, at remarkably low prices.

**TEN DAYS' FREE TRIAL**

Test it thoroughly—no obligation

**A YEAR TO PAY** LOW PRICES EASY TERMS

Guaranteed Five Years

**SEND NO MONEY**

We do the most perfect and highest class job of rebuilding known to the typewriter industry. Our machines do perfect work and last for years and years. Just like new. The L. C. Smith is the easiest machine to operate and you can easily type your own letters. Complete lessons on typewriting, also our 5 Year Guarantee with every machine.

**FREE**—Send today for Free Booklet of Valuable Typewriter Information. Big Catalog and our Special Offer.

**SMITH TYPEWRITER SALES CO.**

300-360 East Grand Avenue

Chicago, Illinois



Tapestry or Velour

## 17c

a Day  
Pays for  
this  
Beautiful  
Rocker

Over 1000 other bargains, Furniture, Rugs, Lamps, Silver, China, Blankets, Stoves, etc. Save big money at our Factory-to-Family prices. Pay as little as \$3 down; up to a year and a half to pay balance. Get all your Furnishings at once—pay as you use. Thousands buying this new way.



## Big Catalog FREE

New Fall "Larkin Book of Better Homes." Shows everything for parlor, porch, dining-room, bedroom, kitchen. **Bargain Prices** on famous Symphonola Phonographs. Also Symphonola Pianos, Player-Pianos in genuine Mahogany, Walnut, Fumed Oak. Free trial. Up to 4 years to pay. Satisfaction or money back. Check below article interested in.



- Home Furnishings
- Pianos or Players
- Phonographs

Cut out this adv.—write TODAY for FREE Book.

*Larkin Co Inc.*

Dept. 939 BUFFALO, N. Y.  
Peoria, Ill. Chicago, Ill.

## NO MORE PUMPING UP TIRES

An air-tight valve cap which prevents all loss of air in tires has been put on the market by F. C. Hughes. With this valve cap one inflation lasts the life of the tire and doubles tire mileage. Tested and approved by leading automobile manufacturers. We furnish proof of tests. Retail price \$1.25 for set of five. Great demand. Wonderful opportunity for agents. Write at once to F. C. Hughes, 2514 W. Monroe St., Chicago, Ill

## Thrilling Fun Every Minute With the New Indian Scout



Gets away as quick as a flash. Goes 60-75 miles to the gallon. Tires good for 10,000 to 15,000 miles. 100 pounds lighter than average motorcycles yet powerful and perfectly balanced. Ask your Indian Dealer about it or write us for free literature and name of your Dealer.

**INDIAN MOTORCYCLE CO.**  
Dept. P-9 Springfield, Mass.

## NEW KIND OF TRUSS

No more steel springs, weighty cushions, or chafing leg straps. Amazing new kind of support, weighing less than 1-25 of an ounce, prevents coming out of rupture, which leads too often to strangulation—yet requires no tight strapping like old-fashioned ineffective devices. Offered to ruptured people on a guarantee of instant satisfaction or no cost. Free details if you will simply drop us a postcard or letter with your address to **NEW SCIENCE INSTITUTE, 2104 City Street, STEUBENVILLE, OHIO**

## Build a Boat

You can do it. You will save many dollars and have a lot of fun besides. Popular Mechanics Boat Book tells how to make 21 kinds of boats, from a row-boat to a high-speed hydroplane. It also tells how to make docks, bumpers, and many other things you will need in connection with your boat. Price, **50 Cents**

**POPULAR MECHANICS PRESS**

Room 709 Popular Mechanics Building CHICAGO





- How to choose a trade or profession
- How to plan a course of home study for your chosen vocation
- How to develop a method of study that will be most effective
- How to avoid the study of books that are out of date
- How to select necessary books and study helps without duplication
- How to get individual books or libraries on any subject at the lowest prices
- In short, how to get ahead whether you have chosen a vocation or not

This is a new service offered by Popular Mechanics Press to everyone who will take advantage of it. This little magazine is designed to help everyone who has any ambition to get ahead. Read it and you will be inspired to greater success. Read it and you will be able to decide wisely upon a trade or profession in which you can succeed. Read it and you can save yourself time and money in planning your preparation for a successful career. Read it and you can increase your usefulness to your present employer. Read it and you can pave the way to a bigger salary and greater responsibility.

## Thousands Were Benefited By the First Issue

Although 300,000 copies were printed of the first issue, this big edition was quickly exhausted. Letters poured in so rapidly congratulating and thanking us that answers were delayed for many days. It is plain that this new magazine has met a need. We propose, therefore, to increase its distribution by offering it free for a year to all those who will write for it. The first issue inspired many requests for special books on various subjects. Our own extensive library, and our corps of editors, technicians, and librarians has made it possible to supply complete information to each inquiry.

The second issue is now ready for mailing and an extra supply has been printed to supply those who are learning of Personal Advancement for the first time through this announcement. Send your own name at once, and tell your friends about it too. They don't need a coupon in order to get the magazine. If it is easier or more convenient to write a postal card, do that. Just say, "Send me Personal Advancement for a year free."

### Books Are Listed in This Issue

For those who want help in choosing a vocation.  
 For teachers who want to help their scholars make the right start in life.  
 For those who want libraries on various trades.  
 For mechanics who want shop kinks.  
 For boys who like to make things.  
 For those who are interested in travel.  
 For those who want the modern "Best Sellers" of fiction and literature. Sign your name to the coupon or write a request on a postal card and mail today.

## Personal Advancement is Free

### Clip the Coupon

POPULAR MECHANICS PRESS,  
 Room 709, Popular Mechanics Building, Chicago, Ill.  
 Please send me Personal Advancement for one year absolutely free and without any obligation on my part.

Name .....

Town .....

State .....

Street .....

If you have some friends who would like to have this magazine too, write their names and addresses on a piece of paper and inclose with this coupon.

## WONDERFULLY PROFITABLE Whether You USE IT or SELL IT The PLIERENCH KIT

— Patented —

You get the \$50 worth of UNIVERSAL TOOL SERVICE of these 3 RATCHET and SPEED WRENCHES —with the 1000-POUND JAW-GRIP, when you buy the Plierench Kit!

With its UNIVERSAL JAWS it is a Parallel Pliers and Ratchet and Speed Wrench for all sizes 0" to 1 1/4".



The Plierench MANUAL shows how it makes coil SPRINGS of all sizes in all sizes of Wire; and bends Loops on 1" x 1/8" steel bars!

It easily TURNS OFF the round heads of rusted Vender Bolts.



2 You can coil a 1/4" Stove Bolt as shown in "3," with a Plierench and a board. Could you do it with any other tools you know of?

The WIRE JAW, plus the 10-to-1 POWER-GEAR TRANSMISSION, Does the Work.

A Combined END GRIPPING Pipe WRENCH and PLIERS, with a HALF-TON LOCKING, Pressure-Grip. It holds! Removes Battered Nuts in tightest places when all else fails—instantly Adjusted all sizes to 1 1/2".



The PLIERENCH KIT consists of ONE OPERATING FRAME—8 1/2" Size, with the 3 Instantly Changeable Jaws pictured above. (1) Universal Jaw, (2) Pipe Jaw, (3) Wire Jaw. All in a Handy Holster with the 64-page Plierench Manual of Mechanics. See the COUPON!



It fits your pocket

This Plierench KIT is Guaranteed to DO THE WORK of 60 pounds of the best other tools costing \$50.00 — Better—Quicker—Easier!

WITH EACH KIT A VALUABLE BOOK



Why wonder or speculate, or hesitate one minute—The Plierench will make \$5.00 for you in the 2-week Free Trial Period!

For the Home—Car—Shop—Farm—Everywhere!

### MAKE BIG MONEY SELLING—WRITE TODAY!

USE a Plierench KIT for 2 WEEKS; if not Worth \$25.00 to YOU—Return it and get Money Back!

## THE FLASH SALES CORP'N

4809-P3, N. Ashland Ave. Chicago, Ill.

Send me the KIT, \$5.00 ( ) or, No. 1 only, \$3.75 ( )

N. O. enclosed ( ) or, I will pay Postman ( )

Send FREE. Propositions for — Dealer ( ) ; User ( ) ;

Distributor ( ) ; Salesman ( ) ; Agent ( ) ; Part Time ( )

Name .....

No. ....

P. O. City .....



## RADIO'S LATEST DEVELOPMENT

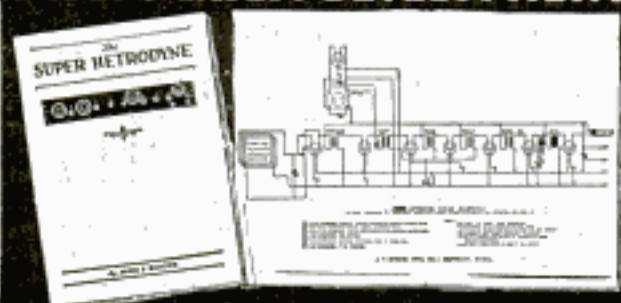

## Super - Hetrodynes

\$50 worth of wiring charts and hook-ups for only \$1

This valuable book gives you a series of over thirty super-hetrodyne wiring diagrams and hook-ups which would easily cost more than \$50 if purchased separately. Not a catalog, but a thoroughly scientific text book with a wealth of data on every phase of super-hetrodyne equipment. Sixty-four pages of worth while information, with more than fifty illustrations. Only \$1.00 postpaid. Get it today—at your dealer's or use the coupon below.

J. T. BOONE RADIO CORPORATION  
BOONE SUPER-HETRODYNE TRANSFORMER KITS  
BOONE SUPER FOLDING LOOP AERIALS  
BOONE SUPER VARIABLE CONDENSERS

From your dealer or direct from our factory.

J. T. BOONE RADIO CORP.,  
3469 E. Jefferson, Detroit, Mich.

- Enclosed is \$1.00 for your text book, "The Super-Hetrodyne."  
 Please also send me information on your Super-Hetrodyne Transformer Kits—Folding Loop Aerials—Low Loss Variable Condensers.

Name .....

Address .....

**AGENTS** *Some Seller* At **\$2.00**  
*Looks Like \$5.00 Worth Gives You \$1.10 Profit!*



**\$12 AN HOUR!**

W. H. Marion, a beginner, made 36 sales in three hours, first day, \$36 profit! How? Our representatives introduce our products with a first sale of beautiful combination sets of Toilet Articles, Soap, etc. You sell at half store prices—no fancy talk—sell on sight. Make 20 to 30 sales a day with \$1.10 profit on each. Easy to average \$100 a week. Could you ask more while introducing line, establishing a permanent business for yourself? Another plan calls for no deliveries, no investment, no delays. You bank immediate profits. Also a plan with winning premium to each sale. Write quick for full details.

**FORD FREE!** No contest. Every producer gets a Ford Car absolutely free. Most amazing offer ever made. Don't waste a minute. Write TODAY for illustrated circulars explaining our **Unique Plans** including 30 other packages. ACT NOW.

**E. M. DAVIS CO. Dept. 5621 Chicago**

# Amazing Tests

## Hard to Believe

3/4" Cornwell flat chisel can be driven clear through 1 1/2" cold-rolled machinery steel without damaging blade. Plain or drift punches can be driven through steel 1 1/2 times as thick as their face. Pin punches can be driven through steel as thick as their face. Screw drivers will twist off heads of screws without injuring tool. Bearing scrapers will cut shavings off vise handles without injuring cutting edge. Wrenches will break any other wrench when locked size for size. These tests show amazing strength of Cornwell Tools.

# CORNWELL Hand Made Tools FINEST IN THE WORLD

Cornwell Tools made of finest Swedish Charcoal Process Molybdenum Steel, from our famous Cornwell secret formula. Forged, heat treated, and hardened and tempered in oil. Bearing scrapers made of finest high carbon Swedish Steel. All tools made by hand, NOT drop forged and case hardened.

## Money-Back Guarantee

If you ever saw tools as good as these, return your order and get your money back. Guaranteed superior to any tools made anywhere in the world. Any tools that do not stand amazing tests described, instantly replaced or money refunded.

## FREE BOOKLET - Write Today

Write for this wonderful booklet, illustrating complete line and describing remarkable tests which no other tools in the world will stand. **WRITE TODAY.**

CORNWELL QUALITY TOOLS COMPANY, Dept. A, CUYAHOGA FALLS, OHIO

**DRESS UP  
\$3.85 YOUR CAR  
AND UP** A seedy looking topspoils CUSTOM MADE its appearance. Get a Liberty Custom Made Top. It's fun putting it on; simple directions furnished. Save a big labor bill. We are manufacturers of tops, side curtains and seat covers, for any make or model car. Amazing values. Special proposition for Fords, Chevrolets, Dodges and Maxwells. Write today for big money saving catalog.

**Liberty Top & Tire Co., Dept. E-7, Cincinnati, Ohio**

**NEW AUTOMATIC ADDER, \$3.50**

Makes adding easy. It's accurate, quick, durable and easily operated. Capacity 8 columns. Saves time, brain work and errors. 75,000 pleased owners. Fully guaranteed. Price \$3.50 delivered, W.I. metal operating bands, \$5.00 delivered. Agents wanted.

**J. H. BASSETT & CO., Dept. 244, 1458 Hollywood Ave., Chicago, Ill.**

**Try This on Your Hair 15 Days** Then let your mirror prove results.

**Write Today for FREE Trial Offer!** Your hair need not thin out, nor need you become bald, for there is a way to destroy the microbe that destroys the hair. This different method will stop thinning out of the hair, lifeless hair, remove dandruff, itching, darken gray hair and threatened or increasing baldness, by strengthening and prolonging life of the hair for men and women. Send your name now before it is too late for the 15 days' free trial offer.

**AYMES CO., 3932 N. Robby Street, M 390, CHICAGO**

# No Joke To Be Deaf

**—Every Deaf Person Knows That**  
I make myself hear, after being deaf for 25 years with my Artificial Ear Drums. I wear them day and night. They are perfectly comfortable. No one sees them. They stop head-noises. Write me and I will tell you a true story, how I became deaf and how I make you hear. Address  
**GEO. P. WAY, Artificial Ear Drum Co. (Inc.)**  
50 Hoffman Bldg., 2529 Woodward Ave., Detroit, Mich.



# RADIO

THREE IMPORTANT  
contributions to your  
Radio Enjoyment

## HOLTZER-CABOT

has built into these superior instruments the refinements resulting from over 35 years experience in the manufacture of electrical instruments.

All combine to the highest degree the essential factors of:

Quality of Tone  
Volume  
Sensitiveness



WRITE FOR BOOKLET

Dept. PM

THE HOLTZER-CABOT ELECTRIC CO.  
125 Anson Street BOSTON  
661 65 South State St. CHICAGO

*Holtzer-Cabot*  
ESTABLISHED 1878

# AMPLION

The World's Standard Loud Speaker

WRITE TODAY for  
Our 168-PAGE  
FREE BOOK on **Deafness**

and learn how Perfect Hearing is now being restored in every condition of deafness or defective hearing. Our "Little Wireless Phones for the Ears" require no medicine, but effectively replace what is lacking or defective in the natural ear drums. They are simple devices, which the wearer easily fits into the ears, where they are invisible. Soft, safe and comfortable.

**WILSON EAR DRUM CO., Incorporated**  
111 Inter-Southern Bldg. LOUISVILLE, KY.

# Turn Your Ideas Into Money

Develop your creative ability; make money with your genius and mechanical skill; put your ideas into practical use. It matters not whether you are interested in light manufacturing, repairing, or experimental work; whether you are a mechanic, engineer, inventor, amateur or student, this machine will help you.

The New Model "B" **Baby Grand Lathe**

Sturdily built of best quality materials. Produces precision work with wide speed range. Operates same as large lathes. Thousands in use. Highly recommended by skilled mechanics. Practical and dependable—not a toy. Sold only direct to user on money-back guarantee. We also make Bench Drills and Grinders.

Write for illustrated story, complete description and prices.

**Watson  
Mfg. Co.**  
109 Watson Bldg.  
Toledo, Ohio

# FREE

To Each  
Purchaser  
of a  
**World Battery**



A 24-Volt "B" Storage Battery positively given, FREE with each purchase of a WORLD "A" Storage Battery. The WORLD Battery is famous for its guaranteed quality and service. Backed by years of Successful Manufacture and Thousands of Satisfied Users. You save 66%.

Prices That Save and Satisfy

Auto Batteries	Radio Batteries
6-Volt, 11 Plate \$12.25	6-Volt, 80 Amps. \$10.00
6-Volt, 13 Plate 14.25	6-Volt, 100 Amps. 12.50
12-Volt, 7 Plate 17.00	6-Volt, 120 Amps. 14.50
	6-Volt, 140 Amps. 16.00

Shipment Express C. O. D. subject to examination. 5 per cent discount for cash in full with order.

2-Yr. Guarantee Bond in Writing  
With Each World Storage Battery

proves satisfactory World performance. Mail this ad with your name and address—we will ship battery day order is received; and give you your choice of "B" Storage Battery or a handsome nickel finish Auto Spotlite, FREE. Write TODAY.

**WORLD BATTERY COMPANY**

1219 So. Wabash Ave. Dept. G, CHICAGO, ILL.

This FREE "B" Storage Battery takes the place of dry cell "B" batteries. Can be recharged and will last indefinitely. To be sold retail for \$6.00. It is the only battery of its kind equipped with solid rubber case—and in granular against acid and leakage. Take advantage of this remarkable introductory offer NOW. (To those who prefer it, we will send FREE a handsome nickel finish Auto Spotlite, instead of the "B" battery. Be sure to specify which is wanted.)

GIVEN  
FREE

To introduce this new and superior World "B" Storage Battery to the Public.



# MORE PROFITS

To Dealers Who Buy Nationally  
Advertised Radio Goods from Our  
Bargain Catalog! Write for It Today!

**AMERICAN RADIO MFG. CO.**  
DEPT. O 6 WEST 14th ST. KANSAS CITY, MO.

\$75.00 to \$100.00 a week  
for you

AN EXCEPTIONAL OPPORTUNITY to build a permanent business right in your own locality! PAYS right from the start, in proportion to the amount of time you can spend. Previous experience unnecessary. If you want to earn from \$75 to \$100 a week regularly, mail coupon today for particulars to

**DOUBLEWEAR SHOE CO.,**  
Minneapolis, Minnesota

MAIL THIS  
COUPON NOW

NAME \_\_\_\_\_  
ADDRESS \_\_\_\_\_  
STATE \_\_\_\_\_



# Guaranteed HEATING Systems



**Save 25% on Your Heating System by Ordering Now!**

If you're going to build, improve, or remodel, buy now while material is plentiful and low prices prevail. Avoid costly delays, material shortages and high prices. Don't wait until the snow flies to do your planning.

**Expert Engineers**

Practical men are waiting here to help you solve your plumbing and heating problems. They will aid you in adding comfort and health in your home at lowest possible expense.

**See What You Save!**

Some idea of our low prices can be had on the following guaranteed efficient heating systems for an average sized bungalow with five rooms and bath.

\$93	\$125	\$315
Single register warm air heating system.	Warm air pipe heating system.	Perfection Hot Water Heating System.

**Plumbing Systems**

We furnish every needed item to completely install guaranteed plumbing systems. The bathroom outfit shown includes bathtub five feet long, white porcelain enameled on the inside, low pattern white tank closet outfit and white porcelain enameled lavatory complete with all fittings above \$70.00. Door line, special \$100.00.

**HARRIS BROTHERS CO.**  
Dept. WC-7  
35th and Iron Streets  
CHICAGO, ILL.

**A LINE FROM YOU WILL BRING FULL DETAILS**

## Play Big Jazzy Sax at Once

No knowledge of music required, no lessons. Play tunes right away on this big imported Jazzy Sax without practice. Play by numbers instead of notes. Sweet, clear, jazzy tone. Delightful harmony. Looks like regular saxophone. Solid metal—handsome polished finish. 20 in. long. Create sensation. So popular at dances, parties, everywhere. A. H. King writes: "Use Jazzy Sax as lead instrument in 5-piece orchestra." H. M. Vinson says: "Could play several old saps in an hour. The gang was delighted." Supply limited—Send Rev.



## AGENTS! CAR OWNERS! AGENTS! CAR OWNERS! AGENTS!

Make \$50 daily! Automotive invention sells for \$3.00! ALL CARS! OFFICIAL TEST by M. A. C. shows gasoline mileage INCREASED 63%! Flottmann sold 1,500! Kimble 1,200! Other agents equally well and better! Agents mopping up BIG MONEY! You can't help making a success—because we furnish you with FREE DISPLAY NEWSPAPER ADVERTISING over your name as agent and exclusive territory! MOST ASTOUNDING OFFER EVER MADE! This startling invention known as the PHILIS-BUSTER has already won thousands of friends and is going to sweep the country like wildfire! We need live wire agents in every city, town and village to take care of the tremendous business. ACT NOW—get the cream! Write quick for particulars of this AMAZING opportunity and proof of your ability to make \$100.00 to \$200.00 a week at the start! GUARANTEED to increase mileage, eliminate carbon, give more power, and make motor run smoother! Ford owner writes: "I am getting 40 MILES per gallon!" Buick owner says: "50% more miles—increased power!" Oldsmobile owner: "No more carbon—50% increased mileage!" Another Ford owner says: "Got 100% increase!" Johnson Editor, Ford Co. says: "Our fleet is now completely with PHILIS-BUSTERS, and we are getting 30% more miles per gallon gasoline, due alone to the fact that the PHILIS-BUSTERS have been installed."—Traffic Manager.

**DON'T LOSE ANY TIME! WRITE FOR DETAILS AND AGENTS' SPECIAL PRICES! TERRITORY GOING FAST! REMEMBER! FREE NEWSPAPER ADVERTISING FOR YOU!** The Buster is easily installed in a few minutes—no holes to drill—no changes. **HURRY! HURRY! HURRY!** Write or wire to **PHILIS MFG. CO., 4330 Chouteau, St. Louis, Mo.**

## STOP USING A TRUSS

Do Away With Steel And Rubber Bands

# FREE TRIAL

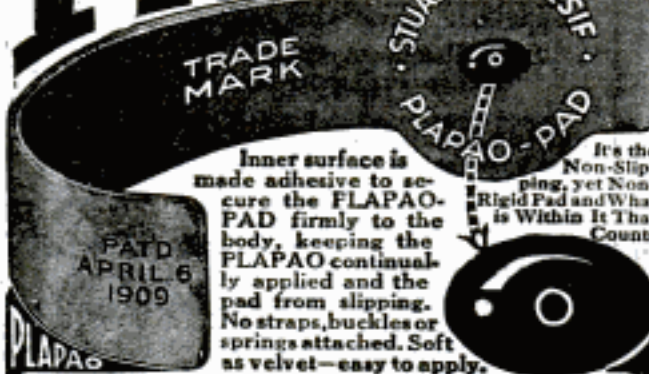

Inner surface is made adhesive to secure the FLAPAO-PAD firmly to the body, keeping the FLAPAO continually applied and the pad from slipping. No straps, buckles or springs attached. Soft as velvet—easy to apply.

It's the Non-Slipping, yet Non-Rigid Pad and What is Within It That Counts

## FREE to 5,000 Truss Sufferers

To the extent of 5,000 sufferers who may apply I will send, ABSOLUTELY FREE, a sufficient quantity of the Flapao to positively convince them that this is the only logical, common-sense way of treating rupture. Flapao is a highly astringent medication placed within the Flapao-Pad and being absorbed through the skin, creates a wonderful feeling of relief and at the same time tends to strengthen the weakened muscles and thus permanently close the rupture opening. The process of recovery is natural, so you'll have no use for a truss—you can throw it away forever! Old and young have testified under oath that the Flapao-Pads cured their rupture—many of them long-standing, aggravated cases—without delay from work, Patent allowed in U. S. and foreign countries. Awarded Gold Medal at Rome and Grand Prix at Paris.

**Send No Money**—for a sufficient quantity of the Flapao is sent without charge to enable you to give it a thorough test; you pay nothing for this trial now or ever. Write for it and full information today. Address: Flapao Laboratories, Block 1427 St. Louis, Mo.

## DEAFNESS IS MISERY



I know because I was Deaf and had Head Noises for over 30 years. My invisible Antiseptic Ear Drums restored my hearing and stopped Head Noises, and will do it for you. They are Tiny Megaphones. Cannot be seen when worn. Effective when Deafness is caused by Catarrh or by Perforated, Partially or Wholly Destroyed Natural Drums. Easy to put in, easy to take out. Are "Uneen comforts." Inexpensive. Write for Booklet and my sworn statement of how I recovered my hearing.

A. O. LEONARD, Suite 226, 70 5th Avenue, New York City

## NO MORE BALD HEADS



WHEN our VACUUM CAP is used a few minutes daily. We accept no pay until you have tried the Cap 30 days and are satisfied. The Vacuum Cap is an appliance that draws the blood to the Hair Roots and starts a new healthy crop of hair. It stops Dandruff, stops the hair from falling out.

Bought by Doctors and men who know that it is the only reasonable HAIR GROWER known to science. No Drugs Used. Write for application blank, testimonials, and booklet on "HAIR," sent sealed in plain envelope. FREE.

**THE MODERN VACUUM CAP CO.**

Z 559 BARCLAY, DENVER, COLO.



# I Want Agents

## Salesmen—Distributors

### For My Marvelous Device



I have perfected a Gas-Saver and Carbon Remover that is meeting with phenomenal favor from auto owners and agents all over the country. It is enabling auto owners to double their mileage from each gallon of gasoline used, and remove every particle of carbon from their motors.

# Makes Autos Go 40 Miles On Gallon of Gas

When the device is attached, automobiles have made over 40 miles on a gallon of gas, increased their power and pep tremendously and eliminated all spark plug difficulties. This inexpensive little device is entirely automatic and self-regulating and can be easily attached without tapping or drilling.

## HERE'S PROOF What Users Are Saying:

**Gets 44 Miles On A Gallon**

New Boston, Ohio.  
"Received the Wesco and am well pleased. I gave it a test and made 44 miles on a gallon of gas."—DEWEY S. KAGG.

**Wesco Proves 20% Better Than A More Expensive Gas Saving Device**

Des Moines, Ia.  
"Took a \$10.00 gas saving device off a car and put on a Wesco—result was a 20% further reduction in gas used, more power, better getaway and a satisfied customer."—GLEN E. MORRIS.

**Made 35 Miles On 3 Quarts of Gas**

New Holstein, Wis.  
"I made 11 miles on a quart of gas on one test and 35 miles with three quarts of gas."—CHRIS. LUTZEN.

**Drove 20 Miles On 1/2 Gallon of Gas**

Plattsmouth, Nebr.  
"I tried the Wesco Gas-Saver. Drove 20 miles and only used 1/2 gallon of gas, and my car has more pep, runs like new, and spark plugs do not dirty so fast."—FRANK A. CHEVAL.

**Made 41 Miles On Gallon of Gas**

S. Jacksonville, Fla.  
"I made 41 miles off a gallon of gas and know I can make 45 on a trip."—ARTHUR N. SOLLEE.

## What Agents Are Doing:

**Sells 50 in Half-day. Profit \$2.25 Each or \$112.50**

Cincinnati, Ohio.  
"Received lot of 100 Wescos this morning. Before noon had personally sold 50. There's a wonderful field for your article, and when we get organized will be able to sell 500 to 1,000 per week."—A. O. GALLOWAY.

**Sells Itself**

Ennis, Texas.  
"You were right when you said the Wesco sells itself. I have placed every one I ordered. Your article will make me independent."—P. M. VON KARLOWITZ.

**Sells Wescos Fast**

Lenox, Iowa.  
"Am getting along fine—sell them faster than I can order them."—GLEN SPOONHORE.  
**Sold 3 in 3 Minutes**

Shaw, Ga.  
"I received my Wescos O. K.—was well pleased. Sold 3 in 3 minutes."—JESS H. PETTYJOHN.

## Car Owner Agents Wanted

part or full time, to sell and demonstrate this amazing device. Interests every auto owner immediately and each one sold sells others. It makes no difference what car they drive, I have a Wesco to fit it.

## Get Yours FREE

Equip your own car without a penny of cost and you will find it easy to take orders everywhere with my free trial and money back offer. Don't wait, be the first from your territory to distribute this quick seller.

## Earn \$5,000 to \$10,000 a Year

My Wesco Gas-Saver and Carbon Remover practically sells itself. Wherever it has been shown, the demand has become so great that my representatives are practically besieged with orders. Previous selling experience is not necessary. If you have no automobile don't let this hold you back, for one of our best state distributors had no car when he started. My plan will start you practically without capital in a business of your own that should make you big profits. Send coupon now for my SPECIAL FREE WESCO DEVICE OFFER and further details.

## MAIL COUPON NOW

*This is a big opportunity,  
so don't delay.*

**WRITE TODAY**

**JAS. A. MAY, President**

**WESTERN  
SPECIALTY CO.  
901 Lacotah Building  
Sioux Falls, S. D.**

Western Specialty Co., 901 Lacotah Bldg., Sioux Falls, S. Dak.  
Attention: Jas. A. May, President: I am interested in your Wesco Gas-Saver and Carbon Remover. I would like to try out a sample at your risk. Without obligation, send me information about your big Money Making Proposition to distributors.  
(Print name plainly)  
Name.....  
St. or R. F. D.....  
Post Office.....  
State.....



# They're ALL Local Stations

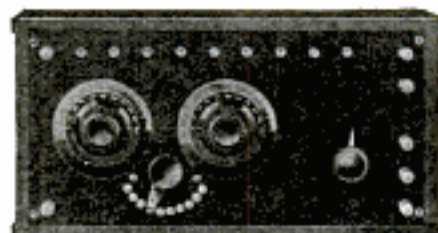

with a  
**"SHEPCO" "ALL PURPOSE"**

Trade Mark—Patents Granted and Pending

## RECEIVING SET

Selectivity excellent. No difficulty separating WGN from WDAP, WGY, Schenectady, heard while WGN was operating (in Chicago). KYW heard 50 ft. from loud speaker. An efficient set.

From report of Chicago Herald and Examiner Radio Laboratories test.

Hook-up chart with each set or sent for 10 cents in stamps to cover mailing cost.

**A** LOW price one tube receiving set with all the distance, volume and selectivity of expensive, many-tubed outfits. Brings in the finest radiocast programs loud and clear, without interference. A child can tune it. Operates loud speaker on nearby stations.

Finely made of highest quality parts, including "Shepcos" "All Wave" Jr. Coupler, "the finest tuning unit in existence." Genuine mahogany cabinet.

Exclusive arrangement of terminals permits rapid change of hook-ups without tools. May be used in or as part of any desired circuit. Ideal for experimenting.

Get the utmost out of radio at low cost.

**You Can Pay More But You Can't Buy As Much**

Made and Backed by an Absolute Money Back Guarantee by

**SHEPARD-POTTER CO., Inc.**

55 Bridge St.

Plattsburgh, N. Y.

At radio dealers or sent prepaid on receipt of \$21 price. **\$21** Without Accessories

# Spencerian Personal Steel Pens

No. 42—Gold and dome pointed, smooth action.



One of  
 50 styles

**SPENCERIAN Personal Steel Pens** differ from ordinary kinds just as tailored clothes differ from "ready-mades." They are hand-built from the finest Spencerian steel. They are perfect in finish, with just the proper flexibility and smoothest possible points. One of the fifty different styles and sizes was built especially for your handwriting! It will prove a revelation in writing-ease. It is worth any two ordinary pens. It costs no more.

Send 10c for 10 sample pens and free booklet, "What your handwriting reveals."

SPENCERIAN PEN CO.  
 349 Broadway New York

**all free!** **RADIO LIBRARY**

**JUST SEND A POST CARD YOU GET** absolutely free—the A-K "Library of Latest Radio Literature," written by foremost radio authorities. Contains HUNDREDS of valuable wiring diagrams, HOOK-UPS, illustrations, articles, data, etc.

**EXPLAINS** in clear, understandable language the popular new circuits: reflex, neutrodyne, phono, "nanobios," super-heterodyne, etc., and how to build sets. Covers long and short wave amplification, push-pull and audio amplifiers. Latest information on substitutes of other radio subjects. LOG BOOK INCLUDED FREE. Also our latest Radio Catalog featuring NATIONALLY ADVERTISED lines at attractive savings. Write today—offer limited. Address

**ATWOOD-KING, INC.**  
 Dept. C 9 163 W. Washington St., Chicago

**ATWOOD KING**  
 INC.

**MIRACO**  
**GETS 'EM FROM COAST TO COAST**

PRICE ONLY \$29.50

At rock-bottom prices you get the efficiency of sets costing three times as much. Users tell us that Miraco Radio frequency receivers pick up stations from coast to coast. Operate either on dry cells or storage battery. Solid mahogany cabinets—finest workmanship throughout. Order direct or send for bulletin.

Two tube outfit . . . . \$29.50  
 Four tube outfit . . . . \$4.50

DEALERS—AGENTS—Write for proposition quickly—if you will

**THE MIDWEST RADIO COMPANY**  
 807 Main Street, Cincinnati, Ohio



# Headquarters for Heating

## Easy Payment Terms If You Wish

How are you going to heat your home next winter? Surely you are not going through another winter using old and out of date heating methods.

You know what that means—carrying coal and ashes over your rugs and carpets, the smoke, soot, dust and gas.

A complete modern heating system is now within reach of all. We can furnish you a complete steam, hot water or a warm air heating system, or a modern pipeless furnace at a remarkably low price.

If you hold title to the building we can arrange easy payment terms so that you can be enjoying this great comfort and convenience while paying for it in small monthly payments easily within your means.

Our engineers design the system to suit your building and we furnish full plans and instructions.

By installing the plant yourself you will make a big saving in the labor cost as well as in the purchase price of the material.

## Buy Direct From The World's Largest Store

A Complete Line of Modern Plumbing and Heating Supplies at Prices Which Mean a Big Saving to You. We Cut and Thread Pipe to Measure. Write for Our Plumbing Instruction Book.

Bath Tubs  
Lavatories  
Closet Outfits  
Laundry Tubs

Kitchen Sinks  
Range Boilers  
Water Heaters  
Water Supply Systems

Soil Pipe  
Pipe Fittings  
Valves  
Pumps

Heating Boilers  
Pipe Furnaces  
Pipeless Furnaces  
Heat Regulators



Genuine Hercules  
Pipeless Furnace

**\$72.95**

These are  
just a few  
sample  
bargains  
from our  
Catalog.

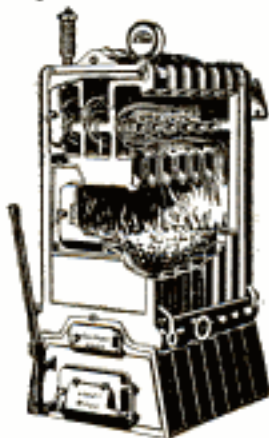

Seventeen-Inch Heating  
Boiler for Hot Water

**\$96.65**

Let us send  
you an esti-  
mate on a  
Complete  
Modern  
Heating  
System.

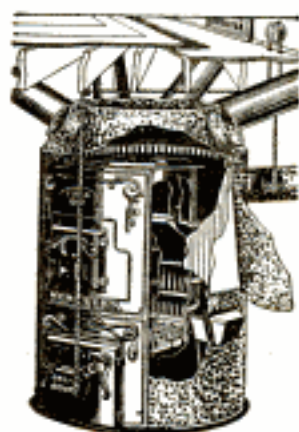

Volcano Warm Air  
Pipe Furnace

**\$62.85**

# Sears, Roebuck and Co.

Modern Plumbing  
and Heating Systems

Fill out this  
coupon and return  
it to us. Our Com-  
plete Plumbing  
and Heating  
Catalog will be  
promptly sent to  
you postpaid.

Mail the coupon **TODAY** to the store nearest you.

Sears, Roebuck and Co.

80P09.

Chicago Philadelphia

Send New Plumbing and Heating Catalog.

Name .....

Postoffice ..... State .....

Rural Route.....Box No.....

Street and No.....



## LEPAGE'S mends for keeps



COMPARED to the value of the article mended, the cost of the glue you use is practically nothing. Then while you are about it, why not use the best glue—LePage's? Have the satisfaction of knowing that the article is mended *for keeps* and that it won't come apart in a little while and have to be mended over again. Insist on LePage's.

# LEPAGE'S GLUE

## Pulls Hills in High Saves Gallons of Gas

Mr. W. W. Henderson, a Kansas City mechanic, has perfected an amazing invention that goes on the carburetor of any car. Three minutes to take on or off—no boring or mechanical work to do. But changes whole performance of your car. Not only runs better, has more power, less carbon, but delivers 50% increased mileage. **AGENTS WANTED.** Mr. Henderson wants to send one driver in each locality this amazing vaporizer to try on his own car. See for yourself how fine it works and how easy to drive around in your spare time and pick up \$80 to \$100 a week. No capital, mechanical skill or sales experience needed. Just send name today. **W. W. HENDERSON, Pres., SAFETY MFG. CO., 1812 WALNUT ST., KANSAS CITY, MO.**

## HEAT WITH COMFORT

### Without Coal or Wood



New remarkable invention does away with coal or wood and saves money, time and labor. Simply sets in firebox of any range, heating stove or furnace. Most economical Oil Burner on market. Burns 90% air, 4% cheap oil and gives three times the heat of coal. Easy to install and operate. Absolutely safe. No noise, no dirt, no odor. Sold on money-back guarantee. 30 days free trial and special low price to first

user in each locality. Write today for free book on Home Heating. Agents: Write for sample offer and protected territory.

OKAY MFG. CO., Dept. 18 East St. Louis, Ill.



A GENUINE SELF STARTING **REMINGTON NO. 10**

CUT TO  
**\$38.65**



LIKE NEW  
**30 DAYS FREE TRIAL**

Save more than half your cost on a machine literally like new! This is the latest Model No. 10, with the exclusive Remington "Self-starting" feature, the most popular typewriter ever built.

The best buy of the year—the biggest typewriter value ever offered. Actual cash saving, \$64 on new machine—\$20 to \$45 on rebuilt. Like new; perfect appearance and working condition. All late improvements: column selector, 2-color ribbon (automatic reverse), back spacer, variable platen release, latest style paper fingers and guide. Up to date in every way.

Standard keyboard; 84 characters. All visible. Will write on a postage stamp. Guaranteed 5 years. 30 days FREE TRIAL. Satisfaction or money refunded. Write for details. A postcard will do.

Cut Prices on All Standard Makes

**LINCOLN TYPEWRITER CO., Inc.**

*America's Leading Independent Typewriter House*

Dept. 45, 298 Broadway, New York City

## A Library of 5,600 Ideas for SHOPMEN and HANDYMEN

In 14 compact, thoroughly illustrated and indexed volumes you may have nearly 6,000 ideas that will prove of many dollars value to you. Single ideas from these books have made profits for some readers amounting to many times the cost of the entire library. Some have learned how to make things to sell. Others have learned how to make a device that lessened labor to such an extent that expense was greatly reduced.

These are books for  
**Shopmen  
Mechanics  
Machinists  
Home Owners  
Farmers  
Boys**

There are 14 volumes that make up **Popular Mechanics Shop Notes Library**. The price for the entire library is only **\$6.50**.

Single Volumes **50 cents**



**POPULAR MECHANICS PRESS**

Room 507, Popular Mechanics Bldg., Chicago, Ill.



# Easy Sales! Big Profits!

Anyone,—regardless of sales experience, can sell the Kirstin Fil-Gage. The demand is increasing so rapidly and from so many parts of the country at the same time, that we are in need of additional salesmen at once, to sell Fil-Gages to the people who want them.

**NO COMPETITION**

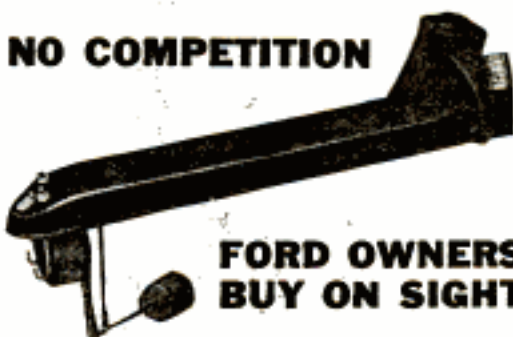

**FORD OWNERS  
BUY ON SIGHT**

## This Is Your Opportunity



*Clamps into  
tank opening*

There is no limit to the Profit Possibilities of the

# Kirstin Fil-Gage

FILLS YOUR TANK GAUGES YOUR GAS



*Gas Gauge as  
seen from  
driver's seat*

You can establish a big paying business of your own right in your territory if you line up with us at once. Fil-Gage is a combination gasoline gauge and tank filling device indispensable to Ford driving comfort. Gas gauge always in plain sight from the driver's seat. Fill the tank without lifting the cushion! Eliminates necessity of climbing out in rain,

mud and snow, or disturbing passenger. The only device of its kind on the market today. No competition! Guaranteed for One Year and backed to the limit by a \$300,000 concern, 12 years old. Entirely covered by Patents. Sells for \$6.00. 25c extra in West. Less than the cost of a good gauge alone. Attached in 10 minutes.

### What Others Have Done, You Can Do! These easy sales mean tremendous profits

W. W. Lefan, of Texas, sold 550 Fil-Gages in 20 days. Albyn Latour, Vermont, sold 12 in 2½ hours. H. Douglas, of La., sold 75 from

samples. Fuller, of Pa., writes "Enclosed find order for 300 Fil-Gages in addition to the 400 ordered last week."

### Don't Delay!—Act Now!

Don't let someone else step in ahead of you! Territories are going fast! Make sure you get yours by sending in the attached coupon today! To be absolutely sure of your territory, better wire us at once. It will bring you our complete selling outfit with 1 Fil-Gage, Leatherette Carrying Case, and all the necessary helps and advertising to set you up in business for your-

self. The small charge of \$6.00; 25c extra in West, will be returned to you upon receipt of your order for 1 doz. Fil-Gages. Selling Outfit absolutely Free immediately if you order a dozen now. If you decide not to sell Fil-Gages, return Selling Outfit in good condition within 10 days and we will refund your deposit without delay.

#### COUPON

A. J. Kirstin Co.,  
901 First St., Escanaba, Mich.

Gentlemen:

Enclosed find (Check the plan you wish to pursue)

\$6.00 in full payment

\$1.00 deposit (balance C. O. D.)

for which you will send me complete Fil-Gage selling outfit.

It is understood that the \$6.00 will be returned to me upon ordering 1 doz. Fil-Gages or upon return of outfit within 10 Days.

Send me additional information

Territory wanted.....

Name.....

Address.....



# Only 198 Motors



Left at  
**\$10**  
Each

Ideal for home-made phonographs, experimental purposes and combination **phonograph-radio** sets.

We have 198 small motors which are greatly under-priced for quick clearance. You will never again equal this low price, when this lot is sold.

They are universal motors, 110 volts, 60 cycle single phase, complete with turntable, cord and socket for immediate use. 1400 R. P. M. Motor has 1" pulley with flange for  $\frac{1}{4}$ " flat belt. Housed in highly polished, nickel-plated shell.

Don't lose out on this remarkable offer. Order your motor today. Tomorrow may be too late. **DO IT NOW!** Price in U.S.A., \$10.00 f. o. b. Steger, Illinois. Foreign \$12.50.

**Industrial Division**

**Steger & Sons Piano Manufacturing Company**  
Dept. 50, Steger Building CHICAGO, ILLINOIS

**SEND 5 CENTS**

and get our 48 p. catalogue of **IDEAL Model Aeroplanes, Parts and Supplies.** Tells how to build Models of famous Aeroplanes that fly like real ones; and describes all parts needed.  
**IDEAL AEROPLANE & SUPPLY CO.**  
408 W. Broadway, Cor. Spring St., NEW YORK CITY



## "DARN-IT-ALL"

**The Magic Mender**

Darns stockings, mends clothes, patches all fabrics, rubber and leather. Does away with drudgery of darning and mending. Does the work cheaper, easier, quicker. Stands repeated washings. Send 50c for full size tube. Money back if not satisfied.

**Agents** Get our generous offer.

Dept. P. M.

**DARN-IT-ALL COMPANY**

1524-34th St., Des Moines, Iowa

**AGENTS HOT SELLER JUST OUT**

**STOPS HEADLIGHT GLARE OF APPROACHING AUTOS**

A simple, inexpensive device called "Glaroff" protects auto-drivers from the blinding headlights of the other fellow's car or a low, direct sun. Prevents serious accidents. Applied to inside of windshield instantly; held fast without bolts or screws; will not work off on rough roads. Try one on your own car a week; if it does not make driving easier, safer, **trial costs you nothing.**

**SPECIAL OFFER TO AGENTS** to use and introduce Glaroff. Enormous, uncrowded field. Sets like wild fire — every car owner buys.

**\$12 A DAY** up to \$7,500 a year to agent who gets your county. Territory going fast. Write for **SPECIAL FREE GLAROFF OFFER** and further details. This is a big opportunity, so don't delay, write today.

**GLAROFF MFG. CO., 100 Plumbers Bldg., Sioux Falls, S. Dak.**



**Free**

Those are the points on which you need help.

## HOW TO SELECT A TRADE

**How to Advance in Your Present Position**

The new booklet pictured above will help you select a profitable trade, or will help you develop in the work in which you are now engaged. It will provide you with help for developing your knowledge on any important subject. It will show you the easy way to increase in knowledge and ability. It represents the experience of hundreds of successful men and women, and gives you aid in selecting those experiences that are likely to benefit you most.

**This Guide to Success is FREE**

Simply write your name on a postal and say, "Send me a free copy of An Easy Way to Master 176 Practical Subjects." Address the postal to

**POPULAR MECHANICS PRESS, Chicago, Ill.**

## CONCRETE HOW TO USE IT

It is the most plastic building material and so is easy for anyone to use. Even boys find it easy to make things of concrete and schools are teaching its use. The dozens of things you may have wished for about your home can probably be made of concrete at very little expense if you have Popular Mechanics Concrete Handbook No. 1. This book not only tells how to make forms and molds, but how to make equipment for mixing concrete. Nothing to buy but sand and cement. Most of the equipment can be made of scraps. **50¢**  
Book costs only.....

Send your order to **Room 508, Popular Mechanics Building**  
**Popular Mechanics Press, Chicago, Ill.**



**Save Expense**

Do the work yourself instead of hiring it done. The book will make this easy. Walks, curbs, and building blocks can be made easily as well as over 100 other items.



*Just like taking money out of a pay envelope*

**ONLY 50 CENTS**



# FREE Tapestry Table Scarf

This beautiful, richly colored, large size 60x14-in. Tapestry Table Scarf comes to you absolutely FREE with Library Set. It is prettily edged with fancy mercerized cotton all around. Accept this handsome Scarf as a gift from Hartman with the Library Set. Pay nothing for it at any time. Send today. Offer is good for limited time only.

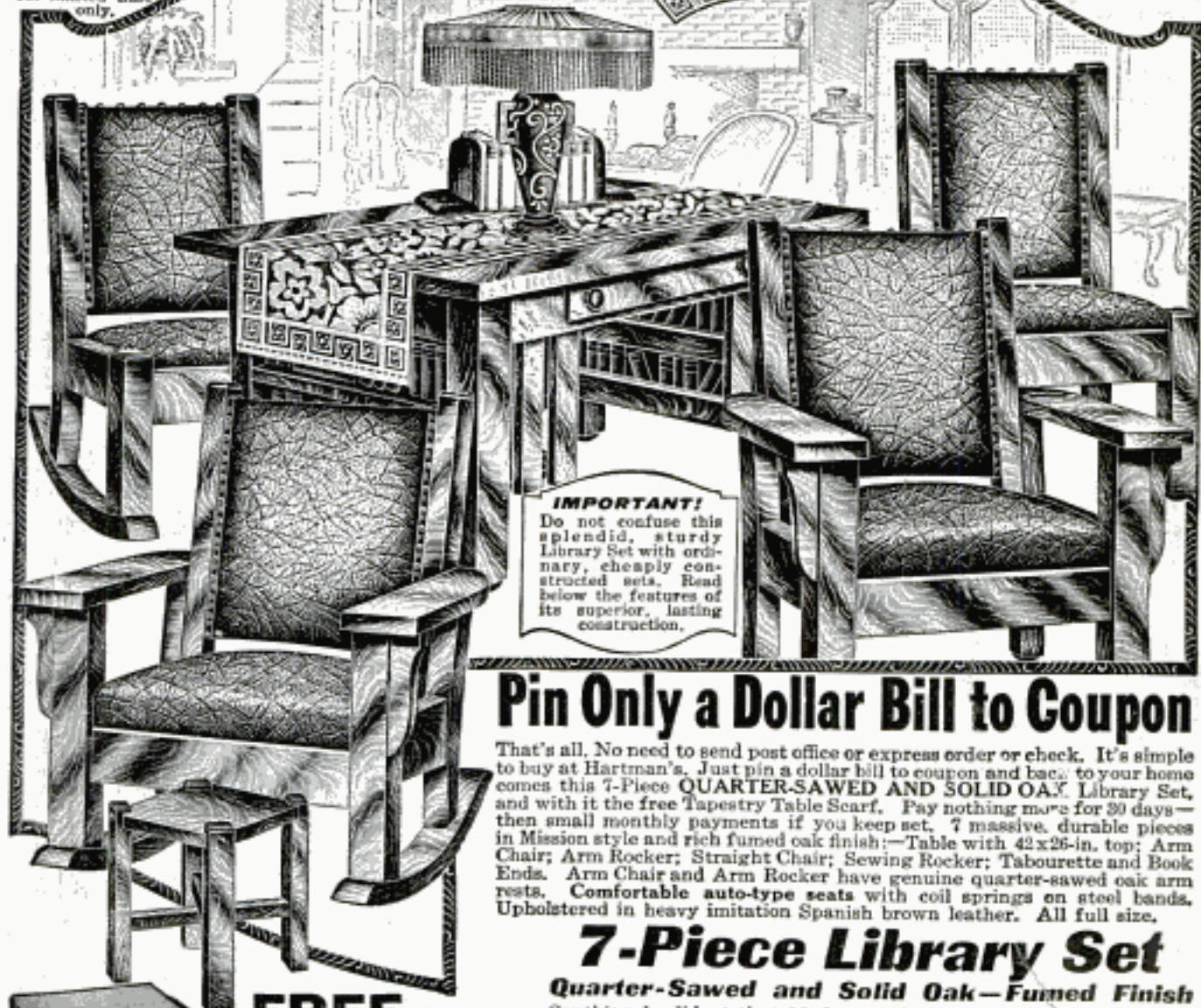

### IMPORTANT!

Do not confuse this splendid, sturdy Library Set with ordinary, cheaply constructed sets. Read below the features of its superior, lasting construction.

## Pin Only a Dollar Bill to Coupon

That's all. No need to send post office or express order or check. It's simple to buy at Hartman's. Just pin a dollar bill to coupon and back to your home comes this 7-Piece **QUARTER-SAWED AND SOLID OAK** Library Set, and with it the free Tapestry Table Scarf. Pay nothing more for 30 days—then small monthly payments if you keep set. 7 massive, durable pieces in Mission style and rich fumed oak finish:—Table with 42x26-in. top; Arm Chair; Arm Rocker; Straight Chair; Sewing Rocker; Tabourette and Book Ends. Arm Chair and Arm Rocker have genuine quarter-sawed oak arm rests. Comfortable auto-type seats with coil springs on steel bands. Upholstered in heavy imitation Spanish brown leather. All full size.

## 7-Piece Library Set

Quarter-Sawed and Solid Oak—Fumed Finish

See this splendid set, the table decorated with the rich Scarf, in your own home before you decide whether to buy or not. Just mail the coupon with a \$1 bill, and we ship all on 30 days' Free Trial. If not satisfied for any reason whatever, send everything back and we will refund your \$1 and pay transportation charges both ways. Otherwise pay balance due on Library Set only—a little every month. Take nearly a year to pay. Tapestry Scarf costs you nothing. It is FREE. Don't miss this amazing bargain. Mail coupon—today.

**Just Pin a Dollar Bill to Coupon—Mail Today!**

**Hartman Furniture & Carpet Co.**  
Dept. 6643  
Chicago, Illinois

I enclose \$1. Send the

**7-Pc. Library Set No. 110FFMA19, Price \$49.95,**

as described, and with it the Tapestry Table Scarf, absolutely FREE. I am to pay nothing further for the goods on arrival—only the freight charges. I am to have 30 days' free trial. If satisfied, I will send you \$4.50 monthly until full price of the Library Set, \$49.95, is paid. Will pay nothing at any time for the Table Scarf. Title remains with you until paid in full. If not satisfied after 30 days' free trial, I will ship all the goods back and you will return my \$1 and pay transportation charges both ways.

Name.....

R. F. D., Box No.

or Street and No. ....

Town..... State.....

## FREE Bargain Catalog

Most complete book of its kind ever issued. Over 300 pages (of which 98 pages are in actual color) of the world's greatest bargains in Furniture, rugs, carpets, draperies, aluminumware, sewing machines, silverware, watches, etc. 30 days' free trial. Easy monthly terms on everything you buy. Opening an account with us is like opening a charge account at your local store, but you have nearly a year to pay at Hartman's.

Ask for Catalog No. E 6643  
**FREE GIFTS**

Book also explains about Hartman's wonderful gift plan which brings you, absolutely Free with purchases, many splendid articles, such as glassware, dishes, silverware, toilet sets, jewelry, table linens, etc.

"Let Hartman Feather YOUR Nest"

Order No. 110FFMA19. 7-Piece Library Set. Our Bargain Price \$49.95. \$1.00 with Order. \$4.50 Monthly. Table Scarf is FREE.

**HARTMAN Furniture & Carpet Co.**  
Dept. 6643 Chicago  
Largest Home Furnishing Concern in the World



Over 300 Pages  
Send Post Card Today for Your FREE Copy





Bench Vice  
No. **161**

Price, \$2.40

## A small vise—with jaws like a bulldog's

**F**IND a vise with jaws that meet flush and true, won't wobble or loosen, hold with equal strength at all points and with the tenacity of a bulldog—and you've found a vise that will be a real helper for all the years to come.

This Goodell-Pratt Vise is that kind.

Clamps to any bench of less than 1½-inch thickness. Operated by an accurately cut steel feed screw. The two steel guide rods hold the jaws rigid.

Width of jaws, 2 inches; jaws open, 2 inches; weight, 3⅞ pounds.

### *Other tools for the small workshop*

In the Goodell-Pratt family of 1500 Good Tools are many other such tools made specifically for the small workshop. The catalog shows them all. Write for it. Just ask for Catalog No. 15.

GOODSELL-PRATT CO., GREENFIELD, MASS., U. S. A.

*Toolsmiths*

Makers of Mr. Punch

# GOODSELL-PRATT

## 1500 GOOD TOOLS



**EVEREADY**  
FLASHLIGHTS  
& BATTERIES  
*-they last longer*

Light where you need it—*use your flashlight!*



No. 2624  
Eveready 2-cell  
Broad-beam  
Flashlight

Eveready Unit  
Cells fit and im-  
prove all makes  
of flashlights.  
They insure  
brighter light and  
longer battery life.



**F**OCUS right on the spot where you're working. Use your flashlight. Burrow right into dark or dimly lighted places. Use your flashlight. Your Eveready is ever ready to help you with those odd jobs. Indoors or out.

Reload your flashlights and keep them on the job with fresh, strong Eveready Unit Cells. And if you haven't a flashlight, see the nearest Eveready dealer at once.

Be sure to see the improved Eveready line. New designs. New features. Eveready standard features remain, as do the old prices—65c to \$4.50, complete with battery — anywhere in the U. S. A.

Buy the improved Eveready Flashlights from electrical, hardware and marine supply dealers, drug, sporting goods and general stores, garages and auto accessory shops.

Manufactured and guaranteed by  
NATIONAL CARBON CO., INC.  
New York San Francisco  
Canadian National Carbon Co.,  
Limited, Toronto, Ontario



**FREE**

## Book on Wood Finishing

Gives complete instructions for finishing all wood—hard or soft—old or new. Explains just what materials to use and how to apply them. This book is the work of experts—illustrated in color. Contains a hundred wood finishing hints.

Tells how inexpensive soft woods may be finished so they are as beautiful as hard wood. Includes color charts—gives covering capacities, etc. Contains many practical suggestions on making your home more artistic, cheery and inviting.

## JOHNSON'S WOOD DYE

(PENETRATING)

S. C. JOHNSON & SON, Dept. P.A. 9, RACINE, WIS.

Please send me, free and postpaid, your instruction book on Wood Finishing and Home Beautifying.

Name .....

Address .....

City and State .....

Dealer's Name .....



Johnson's Wood Dye is for the artistic coloring of all wood. It is very easy to apply—dries in four hours and will not rub off or smudge—penetrates deeply, bringing out the beauty of the grain. Made in seventeen popular shades, all of which may be easily lightened or darkened.

S. C. JOHNSON & SON, Racine, Wis.  
 "The Wood Finishing Authorities"  
 (Canadian Factory—Brantford)



# Ten Mistakes in English

Thousands of persons will make ten mistakes in the simple test shown below. Try it yourself.

## How many will YOU make?

HERE is a simple test of your ability to speak and write English correctly. In the panel at the right you will find thirty simple points of English that come up every day. Yet the average man or woman will make TEN mistakes! Test yourself now. Then compare your answers with those shown in the panel below and see actually just where you stand in your knowledge of English.

### Your English Reveals You

Every time you speak or write you show just what you are. Mistakes in English cause others

to judge you as a person lacking in education and refinement. Lack of language power prevents you from presenting your thoughts in the strongest possible way. In business and in social life faulty English is an almost insurmountable handicap. No one can afford to make mistakes in spelling, punctuation, or grammar.

### Sherwin Cody's New Invention

Why are so many persons deficient in the use of English? Sherwin Cody discovered the reason through scientific tests, which he personally gave to tens of thousands of people. Most persons do not write and speak good English, simply because they never formed the habit of doing so! Good English can be made a habit—and like all habits it can be made so instinctive that you will use flawless English at all times.

For many years Mr. Cody, probably the best-known teacher of practical English in America, has studied the problem of creating instinctive habits

### Here is the Test

Check the form you believe correct. Then compare with the correct answers below.

#### 1. Would You Write—

Between you and I	or Between you and ME
I DID it already	or I HAVE DONE it already
WHO shall I call	or WHOM shall I call
It's just AS I said	or It's just LIKE I said
The river has OVERFLOWED its banks	or The river has OVERFLOWN its banks
I WOULD like to go	or I SHOULD like to go
I LAID down to rest	or I LAY down to rest
Divide it AMONG the three	or Divide it BETWEEN the three
The wind blows COLD	or The wind blows COLDLY
You will FIND ONLY one	or You will ONLY FIND one

#### 2. How Do You Say—

evening	EV-en-ing	or	EVE-ning
ascertain	as-see-TAIN	or	AS-see-tain
hospitable	HOS-pli-ta-ble	or	hos-PIT-able
abdomen	ab-DO-men	or	ab-DO-men
majority	MAY-or-al-ty	or	may-OR-al-ty
amenable	a-ME-na-ble	or	a-MEN-able
acclimate	AC-climate	or	ac-CLIMATE
profound	PRO-found	or	pro-FOUND
beneficiary	ben-e-fi-SHEE-ary	or	ben-e-FISH-a-ry
culinary	CU-li-na-ry	or	CU-li-na-ry

#### 3. Do You Spell It—

superCede	or superSeDe	replEtition	or replItition
receIve	or reeIve	sepaRate	or sepErate
repreIve	or repreIve	accoModate	or aCCoMMoDate
donkEYS	or donkIES	traffIcIng	or traffICKIng
factoRIES	or factoRYs	ACcesSible	or ACCeSSible

of using good English. After countless experiments he finally invented a simple method which actually finds and corrects your mistakes in English and by which you can quickly acquire a real command of English in only 15 minutes a day.

### Only 15 Minutes a Day

One of the most striking features of Mr. Cody's method is the speed with which his habit-forming practice drills can be carried out. You write the answers to fifty questions in 15 minutes, and correct your work in 5 minutes more. There is no drudgery, no tiresome studying

of rules. Mr. Cody's method is as fascinating as playing a game. You concentrate on your mistakes and your mistakes only, until it becomes "second nature" to speak and write correctly.

### New Book on English Free

A book explaining Mr. Cody's remarkable method is ready. If you are ever embarrassed by mistakes in grammar, spelling, pronunciation, or punctuation, if you cannot instantly command the exact words with which to express your ideas, this new free book, "How to Speak and Write Masterly English," will prove a revelation to you. Send the coupon or a letter or postal card NOW.

SHERWIN CODY SCHOOL OF ENGLISH  
59 Searle Building Rochester, New York



SHERWIN CODY

SHERWIN CODY SCHOOL OF ENGLISH  
59 Searle Building, Rochester, New York  
Please send me your new Free Book, "How to Speak and Write Masterly English."

Name.....  
Address.....  
City..... State.....

### ANSWERS

1.	2.	3.
Between you and me	EVE-ning	supersede
I have done it already	as-see-TAIN	receive
Whom shall I call	HOS-pli-ta-ble	relieve
It's just as I said	ab-DO-men	donkeys
The river has overflowed its banks	MAY-or-al-ty	factories
I should like to go	a-ME-na-ble	repetition
I lay down to rest	ac-CLIMATE	separate
Divide it among the three	pro-FOUND	accommodate
The wind blows cold	ben-e-FISH-a-ry	trafficking
You will find only one	CU-li-na-ry	accessible



Tells How to  
Get Good  
Jobs

60,000 Men  
Learned about  
Autos from  
this Book

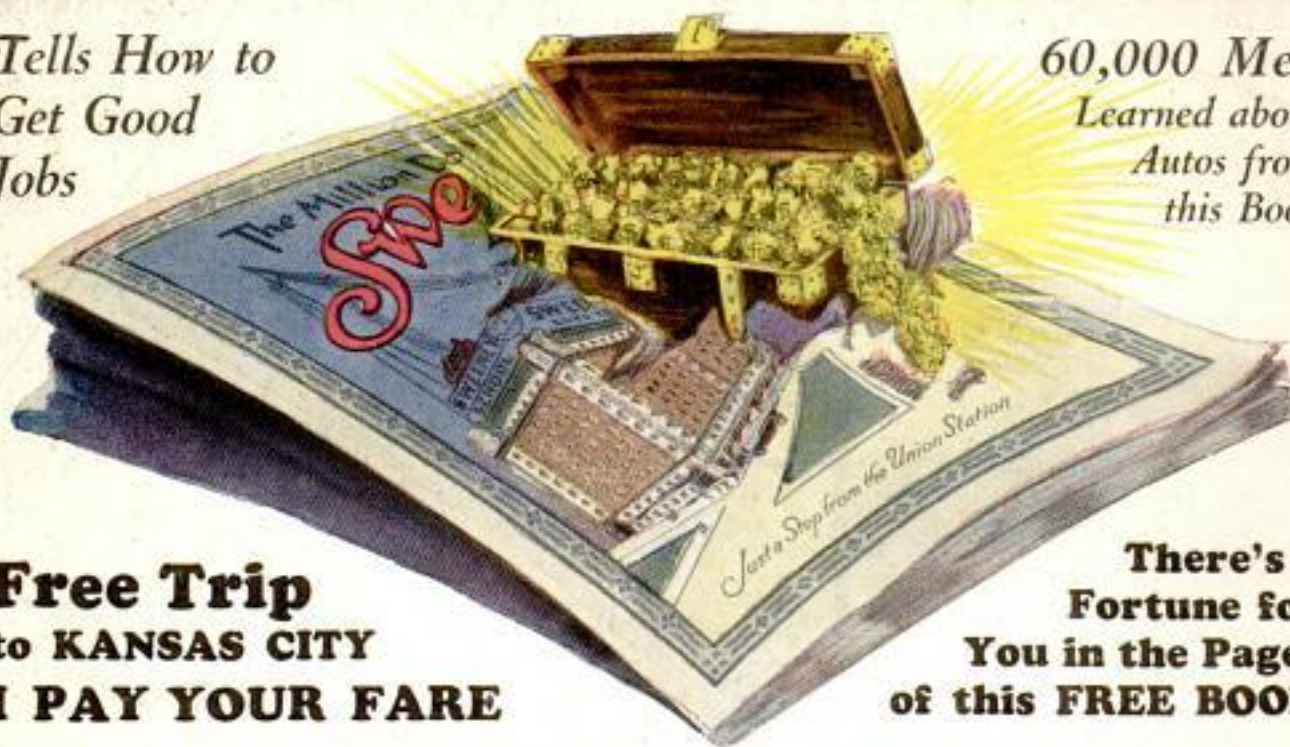

**Free Trip  
to KANSAS CITY  
I PAY YOUR FARE**

**There's a  
Fortune for  
You in the Pages  
of this FREE BOOK**

# MEN WANTED MECHANICALLY INCLINED

Here's a free trip to Kansas City—to the million dollar Sweeney School. Trained auto mechanics are wanted. Are you looking for a job at \$50 a week and up? Then write me today. Do you want a driving job, run a garage, be an auto repair man? Do you want to travel or open your own repair business? Tell me what you want. Sixty thousand Sweeney men say: "Tell it to Sweeney." These men are now doing work they like for good pay. I figure 20,000 of them are owning their business. Now listen: No experience is needed. I teach with top's not books. Sweeney men are sure of jobs because they have learned by doing with their hands. If I didn't fix my boys up so they got jobs right away and made good I WOULDN'T BE IN BUSINESS TODAY AND HAVE MY WORLD-WIDE REPUTATION.

**The First Step is to Send for  
this FREE BOOK**

The most important thing you can do today is to clip the coupon and mail it right now. Get my big FREE 64-page catalog. It shows hundreds of actual photographs of men at work in my magnificent new school. Tells all about wages, profits, opportunities in Auto and Tractor business. Explains step by step how you learn. Interesting letters from graduates telling how they made good. Shows how men came from all over the world to this big school. Makes you want to join the crowd. Tells everything you want to know. I will gladly send you a copy beautifully illustrated. Also a copy of the Sweeney School News, a most interesting monthly school paper published here. Get my free trip certificate! My big special low cost tuition offer. Mail the coupon today or post card will do. No colored students accepted.

**MAIL THE  
COUPON  
TODAY!**



E. J. SWEENEY, President.

## MAKE A START NOW!

You have a right to make a success of your life. Make a start now. I'd like to show you what thousands of men just in your position have done as a result of the Sweeney System of Practical Instruction. It's a shame for you to stick in a rut or work at jobs you don't really like. Ask any Sweeney Man. They are in good positions all over the country. Repairing and selling autos. Driving cars and trucks. Mechanics, running Garages, Tire Shops, Battery Shops, Welders. Handling Radio Supplies. Learning is a real pleasure in the Sweeney School. World's finest equipment. Fine Associates. Healthful surroundings. Entertainment after working hours. Instructors who take a personal interest in you.

## The Sweeney System of Practical Instruction

Is the ONLY WAY to learn if you want to save time and money and be properly trained. You get this at the WORLD'S greatest trade school, the Million Dollar Sweeney School and you get it nowhere else.

## BUSINESS IS ALWAYS GOOD

Over 15 million cars are running. You can't go anywhere without seeing the demand created for servicing these cars. Other industries have strikes, lockouts, labor troubles, factories close down; men are out of employment. But did you ever hear of a shut down in the mechanical service business? The man who is trained can travel, see the world, be independent, command employment, open his own shop, start in business anywhere and make good. Sweeney Men Make Good. I want to give you proofs. I want to open your eyes to what YOU can do in the automotive business.

**Send this -  
NOW**

Sweeney School  
Dept. 1 200  
Kansas City, Mo.  
**Send Me  
Free  
Catalog**

EMORY J. SWEENEY, President  
1 200 Sweeney Bldg., Kansas City, Mo.  
Send me, free, your 64-page catalog  
and free trip offer and proof I can get  
a good job right away.

LEARN A TRADE -  
**Sweeney**  
AUTOMOTIVE & ELECTRICAL SCHOOL  
1 200 SWEENEY BLDG., KANSAS CITY, MO

Name.....  
P. O. ....  
State.....  
Copyrighted material.