

POPULAR MECHANICS

MAGAZINE

WRITTEN SO YOU CAN UNDERSTAND IT

REG'D. TRADE MARK GREAT BRITAIN, No. 40420

REG. U.S. PAT. OFF.

CLASS OF SERVICE	SYMBOL
Telegram	TL
Day Letter	DL
Night Message	N.M.
Night Letter	N.L.

If rate of three times regular applies after the check number is written; this is a telegram. Other rates to be observed after the check number appearing after the check.

RECEIVED AT

H H Windsor
Editor
Popular Mechanics Magazine
Chicago

I congratulate you upon your practical and conservative plan to awaken and direct the inventive genius of the nation. The offers of specific awards for specific ideas will induce practical results.

James J Davis
Secretary of Labor

John J. Harris, President,
John J. Harris & Co.

SEE PAGE 177

Form 1204

CLASS OF SERVICE	SYMBOL
Telegram	TL
Day Letter	DL
Night Message	N.M.
Night Letter	N.L.

If rate of three times regular applies after the check number is written; this is a telegram. Other rates to be observed after the check number appearing after the check.

Washington D C May 22 1924

**WESTERN UNION
TELEGRAM**

GEORGE W. E. ATKINS, FIRST VICE-PRESIDENT

NEWCOMB CARLTON, PRESIDENT

POSTAL TELEGRAPH-COMMERCIAL CABLES
CLARENCE H. MACRAY, PRESIDENT

RECEIVER'S NUMBER
CHECK
TIME FILED

WESTERN UNION
RECEIVER'S NO.
CHECK
TIME FILED

COMMERCIAL CABLES
AM

material



Electrical Expert

Big Demand for Auto & Electrical EXPERTS



Tractor Expert

\$800 Month

DEAR MAC:

Before going to your school I was working on a farm for fifty dollars a month and did not have steady work nor a bright future. Now, as a result of your training, I have my own garage and sales agency and average \$800 per month. I owe it all to your training.

(signed) GEORGE SMITH,
West Alexandria, Ohio.

And Fred Pendley, Blowing Rock, N. C., writes: "McSweeney training made me Chief Mechanic of a big plant in three months." These two are typical of many we could quote to prove that McSweeney training paves the way to better jobs and bigger pay.

Auto Salesman or Demonstrator



Automotive and electrical fields growing by leaps and bounds. A hundred thousand more expert mechanics needed now. I can fit you in fifty days to fill a big job. McSweeney trained men earn from \$50 to \$250 per week. Read on for proof of this—

Guarantee

To whom it may concern:

I, J. B. Dudley, will state under oath that I am now attending the McSweeney School and find everything as represented. In fact, better than expected. The course of instruction is practical and the McSweeney method of learning by actually working with real tools on real jobs under experienced instructors enables a fellow to learn a powerful lot in a few days.

(signed) J. B. DUDLEY,
McSweeney School Student.

What more could you ask than this guarantee of satisfaction — sworn testimony of a student!

Garage Owner or Manager



NOW Two Big Schools to train You for a Big Job!

I now control the former Rahe School of Cincinnati, Ohio, and the former Cleveland Auto School of Cleveland, Ohio. Chances are you can reach one of them by a day's trip. Two fine schools advantageously located—nearest the masses of population, the most autos and most jobs.

Railroad Fare Paid Board 8 Weeks FREE

Lack of space prevents full details.

Write for complete information about my special tuition offer with railroad fare paid and board for eight weeks free.

McSWEENEY

Auto, Tractor & Electrical
Operating former Rahe School of Cincinnati and Cleveland School, Cleveland, Ohio
9th & Walnut **Schools** 1815 E. 24th
Cincinnati, O. Cleveland, O.

McSweeney Auto, Tractor & Electrical Schools

Dept. 147 (Address School Nearest You)

Send me your Big Free Book on auto and tractor business, and send me information on special reduced tuition offer with railroad fare and board paid, now in effect for short time.

Name.....

Street or R. R.....

City or Town..... State.....

NO FACILITIES FOR COLORED STUDENTS



Radiola Regenoflex, with Radiola Loudspeaker, and 4 Radiotrons WD-11; with space for batteries inside; (complete except batteries and antenna)

\$206

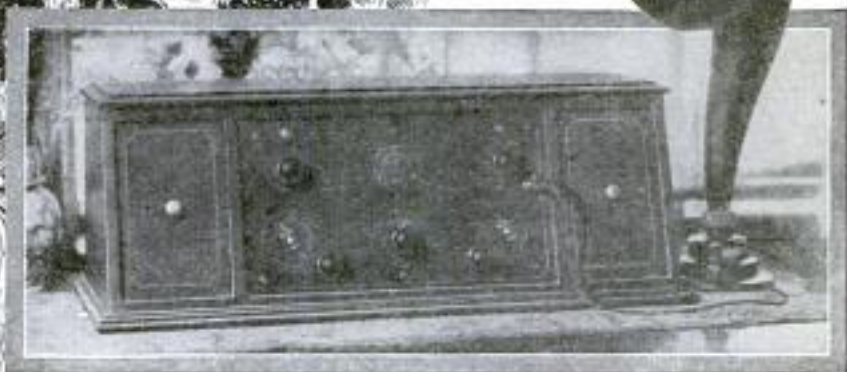

With a Radiola on the Front Porch

All the jazz of the big orchestras in faraway big towns comes through clearly for dancing. The fine music is true, sweet toned, undistorted. The sports news rings out with all the thrill of bleachers or ringside. The Regenoflex is a leader among the new Radiolas that are making this a great radio summer!

A Radiola Regenoflex on the front porch—and that porch can be way up in the mountains, or off at the seashore—but it's not too far away to be in on the fun.

The improvements in its mechanism offer greater sensitivity and greater selectivity; clearer tone; and complete simplicity. Where *quality* of reception counts as much as distance, the Regenoflex is the receiver for this summer's fun!

This symbol
of quality



is your
protection

"There's a Radiola for every purse"

Radio Corporation of America

Sales Offices

233 Broadway
New York

10 So. LaSalle Street
Chicago, Ill.

433 California Street
San Francisco, Cal.

Radiola

REG. U.S. PAT. OFF.

Send for the free booklet that
describes every Radiola.

RADIO CORPORATION OF AMERICA
Dept. 518 (Address office nearest you.)
Please send me your free Radio Booklet.

Name _____

Street Address _____

City _____ R. F. D. _____

State _____



1UD5-TP9-Y2HU

Material

If you want insurance against repair bills, specify

"TIDEWATER"

CYPRESS. It is not enough to say "Cypress." It is necessary to

CYPRESS, THE WOOD ETERNAL

AND THEN say YOUR Cypress must be "TIDEWATER."
Then, you identify it by this  Cypress Arrow trade-mark.

This is important to your investment and to your permanent satisfaction **BECAUSE** there is a species of "upland" Cypress that grows far inland, that is not in a swamp and that consequently lacks the historic rot-resistant trait of the true "Wood Eternal."

Only responsible mills can apply the
Cypress Arrow to their products.

With this protection you cannot be misled and will avoid loss and disappointment. It is a good idea to "let your dealer know you know." He will respect you—and supply you.



Write us if you have any trouble getting
the Genuine Identified "Wood Eternal."



SOUTHERN CYPRESS MANUFACTURERS' ASSOCIATION

1219 Poydras Building, New Orleans, La., or
1219 Graham Building, Jacksonville, Fla.



Popular Mechanics Magazine

200 E. Ontario Street, Chicago, U. S. A.

H. H. WINDSOR, Founder

H. H. WINDSOR, Jr., Editor and Publisher

London: Hachette & Cie.,
16-17 King William Street, Charing Cross, W. C. 2

Paris: Hachette & Cie.,
111 Rue Reumour

Melbourne, Australia
The Australasian News Co.

ISSUED MONTHLY

SUBSCRIPTION:

SINGLE COPY, 25 CENTS

In United States and its possessions, also Canada, Cuba, and Mexico, per year, postpaid - \$2.50

To all other countries in the Postal Union - - - - - 3.00

All subscriptions are discontinued at expiration. Please examine the date printed on your wrapper.

Entered as Second Class Matter Sept. 15, 1903, at the Post Office at Chicago, Illinois, under Act of March 3rd, 1879.

Entered as Second Class Matter at the Post Office Department, Canada.

Published monthly by POPULAR MECHANICS CO.

Copyright, 1924, by H. H. WINDSOR.

Copyright in Australia. Copyright in France

Vol. 42

Contents for August, 1924

No. 2

Alaska—desert sands in sun reveals	241	Forests and Forestry	
Animals		field for skilled workers in	256
camel, steering gear through nose of	285	timber crops to replace nation's trees	259
dog travels 3,000 miles to home	276	Games—play horseshoe "pitch" with cards	291
Ants—Pillars of church honeycombed by	214	Gas—gun, safety, for lighting	209
Architecture—buildings in form of plants, spiritual science expressed by	219	Gases—deadly war gas, ornaments made of	214
Army—seven-foot ball helps in drive for recruits	199	Glass—unbreakable, art of revived in Germany	255
Automobiles		Goat—dairy run by woman	291
automatic primer for	240	Gold—seekers revive camps of forty-nine	236
cast-off bodies hold bank of river in place	255	Golf	
chains put on without leaving car	196	balls marked to aid players	289
cripple, one-armed man, drives	292	holder on table simplifies cleaning of clubs	226
laboratory tests for used	223	Greenland—sheet of ice covers	197
lamp on oil engine of Ford	226	Grinding and Polishing	
luggage rack and tent pole combined	233	coke dust substitute for emery	252
one-man engine stands for	291	jewelry, hard coal as substitute for jet in making	273
sidewalk motor car seats thirty persons	289	Guns (ordnance)	
trunk rack changed into luggage carrier	242	Panama, has thirty-five mile range	265
Avalanche—easy to start	251	with 300-ton barrel for Boston harbor	277
Aviation		Hammer Blows—girl held on spikes unharmed by	266
aircraft mother ship "Hermes"	284	Hats—Panama, rings in crown reveal quality of	292
airplane service in gold fields	273	Horse—blind, lifted from ocean with block and tackle	240
night mail marks new era in	267	Horses—tests measure pulling power of	234
Bakers and Bakeries—pies, baking millions for nation	279	Household devices	286
Bearings—oil-absorbing metal perfected for	193	chair, stool and table combined	225
Bible—ruins, unearthed, bear out bible stories	194	Houses	
Birds		latest, beauty and utility combined in	243
ostriches do not hide heads in sand	276	stars, disappearing, space saved by	247
pigeon breeding hobby of many Americans	218	turntable, space in homes saved by	253
Boats and Boating—lifeboat on voyage of 16,000 miles	241	Humidifiers—fits in cigar box	251
Boilers—scale prevented by electric current	285	Ideas—prizes for	177
Building—platform, extension, for worker	251	Information Bureau—mail bag	352
Cameras		Insects	
clock, camera, records race victor	277	bugs, heavy loss caused by	223
like telescope, has dummy front lens	241	Chinese mantis, to combat grasshopper	257
speed lens, needs no flasher or searchlights	264	Iron—stainless, may replace steel	263
Cancer—experiment with animals as cure for	196	Lighter, cigar lighter for auto worked with one hand	258
Canning Industry—rapid growth of	242	Lincoln—capitol, Nebraska, built over old	273
Chicago—station, passenger, nearing completion	282	Locomotives	
Churches		electric, 8,000 built by one company	253
gospel mission on motor truck	285	steam, rival to electric in pulling power	248
lighthouse is substitute for spire of	224	Manual Labor—rich and poor enjoy	221
City—of the future, double decked	227	Matches—machine cuts wood into	289
Clock—biggest in world	248	McKinley (mountain)—sinking two feet every year	265
Cork—puller, two pronged	251	Mines and Mining—muse, asphalt rock taken from	235
Derrick—on tractor, towers built on ground raised by	226	Models	
Domestic Science—girls taught home management in school	214	dishes, tiny, queen's doll house has	258
Electricity		miniature, of San Francisco fair	257
claims more victims than lightning	256	statues modeled from memory by crippled children	263
current, invisible-wire gauges strength of	249	Motor Truck—small, for home and shop	266
death-dealing "ray"	189	Moving Pictures	
Engine—donkey, pulls self across river	252	film, daylight, reruns automatically	265
Eraser—ink, shaped like spoon	218	skill of moving-picture engineers	201
Exposition—British, acts of empire shown in	210	Muscle Shoals—what it means	293
Fashion		Music	
fads and fancies of beauty	274	gingerbread opera helps in study of	251
paper dress models, of fashionable gowns	225	rack turns sheets as player presses pedal	224
Flooring—wedge-shaped tongue and grooves, economy of	266	Musical Instruments	
Flowers		"jazz" effects produced with	291
orchid growth hastened with salts and sugar	285	one-man "jazz" band	218
poppies, how to keep awake	234	orchestra, one-man, has xylophone, cymbal and chime attachments	257
Foot and Mouth Disease—disinfecting automobile troughs	263	violin, change in construction results in better tone	222
		violin, ukulele and mandolin combined	282
		Natatorium—flying rings over pool is sport for	289

[Continued on Page 4]

Store-self - are grocery, on wheels - 288

[Contents—Continued]

Pearls—fortunes won by deep-sea seekers for	233	Drain—nonreversible	324
Petroleum		Drill Presses	
oil pools, freak shadows in	277	production work on	315
oil refinery on wheels	188	worm gear attachment for	325
Photography		Electric Fuse—compact tester	320
airplane, six miles high, city photographed from	192	Fan—exhaust, unusual	313
photographs sent over telephone	187	Fence posts—steel	330
Plants—heads turned toward sunlight	225	Gauges—depth, for drilled holes	330
Porpoises—oil for watches obtained from	224	Glass	
Poultry—club, boys	288	carrier, handy	329
Radio		circular cutter	323
Australian sets are sealed	310	Hopper—refuse, for fruit screen	321
bloodless surgery with radio knife	297	Jack—lumber, adjustable	314
broadcasting nightingale's song	299	Lock—keyless, for tool cabinet	32
compact storage B-battery	310	Lockers—used in garages	31
double-grip battery clip	306	Mechanical Powers—part VI—the inclined plane and	
headset, testing for sensitiveness	298	wedge	316
making electricity speak	307	Nameplates—stamping	322
manufacturers, distributors and jobbers of, in U.		Painting—safety pot for	329
S., number of	297	Photography—washing the tank for films and prints	311
new method of broadcasting	306	Pulleys—heavy, easy method of turning	313
novel window-shade antenna	299	Rust—iron stains, preventing on buildings	315
phonograph loud speaker uses novel principle	306	Scraper—prolonging life of	327
"pinch hits" for orchestra	299	Screws	
protective unit prevents shorts	307	short head, buffing	312
receiver, building a honeycomb coil	308	square head, gripping	326
ship's operators play chess by	306	Shafts—short, centering	328
soldering radio leads	309	Trapdoor—control for roof	327
stations logged on dials	298	Turntable—for cash register	329
switch for both batteries	299	Typewriter—pad for oiling bars	329
telephone connects studio in Boston, Mass., with		Valves	
Springfield, Mass.	307	oiling valve stems	322
tester for filament circuit	306	wire bracket holds spring	327
transformer is adjustable for wave length	307	Water—cooling kink	320
Radio Application—beacons to guide airmen	298	Window—frames for small buildings	322
Rapid Transit—trains, three-car surface line, in Detroit	256	Wrench—automobile magazine nut	324
Razor—electric light on	199		
Reservoirs—underground, springs and wells fed by	247		
Roads—mountain road, surveyors locate	249		
Rubber—lighter than cork rivals air in expansion	276		
Safety Devices—bathers, endangered, better holds and			
grips aid in rescue of	199		
Safety Movement			
mine engineering students study underground			
rescue work	255		
parade, safety, floats in	188		
signal, stop, school children guarded by	256		
Salesmanship			
store, serve-self, on wheels	283		
tobacco store carried on back of owner	200		
Salvage—ship, treasure, tunnel under ocean to	253		
Sea Lions—shot with machine gun to preserve fish	197		
Self Defense—art, Japanese, mock duel shows	235		
Ships			
boat, fortune spent in cleaning	289		
"Leviathan," repair nose of	222		
Soot—washed from hotel	226		
Star—sounds heard from with instrument	201		
Stones—from the sky	222		
Sunshine—chemical makes fatal to man	197		
Superstition—statue, wooden, nails driven in signify			
prayers for revenge	242		
Surgery—sleepless, predicted	248		
Teeth—old, market for	209		
Telephone—several listen or talk at same time through	234		
Telescope—micro-telescope, range from insects to stars	209		
Tennis—racket with folding legs	252		
Tile—mother-of-pearl	283		
Tokyo—earthquake damage, cubist art and sheet metal			
repair	248		
Tourists—Gypsy life lures	215		
Toy—golfers imitate open-air game	233		
Tractor—guided like wheelbarrow, used as switch			
engine	247		
Typewriters			
minus individual keys is operated by pointer	264		
soundproof cabinet on	240		
Walking Stick			
flashlamp concealed in	220		
World War			
memorial for military park, Newark, N. J.	200		
memorial, searchlights reveal beauty of	235		

SHOP NOTES

Acid—holder for pan	314	Acids—cleaning fluid, safety container for	344
Automobiles—Ford, connecting the universal joint	328	Aluminum—oil pans, repairing	333
Braiding Machine—guide for special work	328	Automobiles	
Bridges—guard gates used as	320	avoiding locking of steering gear	349
Cables—stranded wire, making	324	brakes, adjusting	350
Collars—making in one operation	327	gasoline tank cap, preventing loss of	336
Desk—and bookcase built in closet	323	preventing draft in touring car	334
Draftsman—two kinks for	313	Automobiles—Equipment and Supplies—two conven-	
		iences for	332
		Automobiles—Starting Devices—cranking a stiff car	341
		Ax—causing to cut easily	347
		Baseball—retriever for lone pitcher	349
		Birds—chicken-proof feeder for	347
		Boathouse—for small canoe club	345
		Boots and Shoes—heating shoe patches	334
		Butterfly—art work	337
		Carbon Monoxide—poisoning	342
		Cement—flexible filler	336
		Clips—emergency for electric battery	334
		Cooking Utensil—camp grate, folds up	341
		Curtain—top ornamental cover for	333
		Electric Batteries—battery terminals, corroded, loosen-	
		ing	350
		Filing Boxes—made from old book covers	336
		Garage—doorway, three-door arrangement of	351
		Hose—garden, easy method of storing	350
		Household Devices—tables, half-round, space conserved	
		by	343
		Ice	
		box, detachable running board	348
		drip pan for ice box	350
		Insects—around electric lights, fly paper used to catch	348
		Ladder—orchard	342
		Lamps—electric, broken chain pull sockets used	347
		Lanterns	
		stand, barnyard, portable	335
		wagon, bracket for	336
		Linoleum—how to lay	346
		Mail Box—and gatepost combined	334
		Mule—making a kicking	331
		Rubbers—non-skid	346
		Rust—cleaning from gun	333
		Scales—small, made from test tube	348
		Signs and Signboards—windproof hanger for	344
		Tables—storing leaves	335
		Toy—locomotive, reversing switch for	344
		Tripod—safety first for	334
		Typewriter—portable, rigid holder for	351
		Umbrella—rib bow	333
		Ventilator—window, self-adjusting	342
		"Walking Stick"—combination of stilts and "pogo"	
		stick	335
		Washing Machine—drain pipe for	342
		Wood—porch columns, preventing from rotting	348

DRAKE'S PRACTICAL MECHANICAL BOOKS

THEY WILL RAISE YOUR PAY—

ORDER ON 5-DAY TRIAL

The books listed below will perfect you in your chosen trade—pave the way to the big positions. Written in non-technical language—easy to read and understand. **Every book covers its subject completely. An entire course of instruction condensed into one volume.** Your choice sent postpaid—you benefit 5 days—money refunded in full if not entirely satisfactory. Order direct from this page.



Automobile Books

Automobile Starting, Lighting and Ignition, by Manly. [Pub. Jan. 1924.] 700 pp.	Leatherette	\$3.00
Brooks' Automobile Handbook, 1924 Edition.	Leatherette	\$2.00
Ord Motor Car, Truck and Tractor, by Manly.	Cloth	\$1.50
Starting and Lighting Troubles, Remedies and Repairs, by Manly.	Leatherette	\$3.00
Automobile Battery, Care and Repair, by Manly.	Leatherette	\$2.00
Automobile Catechism and Repair Manual.	Leatherette	\$1.50
Tires and Vulcanizing, by Tuford.	Cloth	\$2.00
Gas and Oil Engine Handbook.	Cloth	\$1.50
Automobile Upkeep and Care, by Manly.	Cloth	\$1.50
Motorcycle Handbook, by Manly.	Cloth	\$1.50

Shop Practice Books

Sheet Metal Workers' Manual.	Leatherette	\$2.00
Oxy-Acetylene Welding and Cutting.	Cloth	\$1.25
Slide Rule and Logarithmic Tables.	Leatherette	\$2.00
Handbook for Millwrights.	Cloth	\$2.00
Modern Blacksmithing.	Cloth	\$1.25
Machine Shop Practice.	Cloth	\$2.00

Mechanical Drawing and Machine Design.	Cloth	\$2.00
Pattern Making.	Cloth	\$1.50

Carpentry Books

Cloth Binding

Modern Carpentry, 2 vols.	\$3.00
The Steel Square, 2 vols.	\$3.00
Wooden Boat and Shipbuilding.	\$1.50
Modern Estimator.	\$1.50
Timber Framing.	\$2.00
Buller's Architectural Drawing.	\$2.00
Concrete.	\$1.50
Practical Bungalows.	\$1.00
Low Cost Homes.	\$1.00
Roof Framing, by Van Gasbeek.	\$1.50
Stair Building and Hand Railing.	\$1.50

Electrical Books

Telephony, Including Automatic Switching, by Smith. [Pub. Jan. 1924.] 500 pp.	Leatherette	\$2.50
Practical Applied Electricity.	\$2.00	
Alternating Current.	\$1.50	
Electric Motor Control Systems.	\$1.50	
Wiring Diagrams and Descriptions.	\$1.50	
Electrical Tables and Data.	\$1.50	
Armature and Magnet Winding.	\$1.50	
Modern Electrical Construction.	\$1.50	
Modern Electric Illumination.	\$1.50	
Electricians' Operating and Testing.	\$1.50	
Motion Picture Operation.	\$1.50	
Drake's Electrical Dictionary.	\$1.50	
Electric Motors, D. & A.	\$1.50	
Electrical Measurements and Meter Testing.	\$1.50	
Drake's Telephone Handbook.	\$1.50	
Easy Experiments.	Cloth	\$1.25
Wireless Telegraph and Telephone Handbook.	Cloth	\$1.25
Telegraphy Self-Taught.	Cloth	\$1.25

Steam Engineering

Swingle's Handbook for Steam Engineers and Electricians.	Leatherette	\$4.00
Examination Questions and Answers for Marine and Stationary Engineers.	Leatherette	\$2.00
Steam Boilers.	Leatherette	\$2.00
Swingle's Catechism of Steam, Gas and Electrical Engineering.	Leatherette	\$1.50

Painting Books

The Mixing of Colors and Paints, By Vanderwalker.	Cloth	\$2.00
Scene Painting and Bulletin Art.	Cloth	\$4.00
A Show at Show Cards.	Cloth	\$4.00
Sign Painting.	Cloth	\$4.00
Strong's Book of Designs.	Leatherette	\$4.00
Strong's Art of Show Card Writing.	Cloth	\$4.00
Signals' Alphabets.	Cloth	\$1.50
Modern Painter's Cyclopedia.	Cloth	\$2.00
Automobile Painting.	Cloth	\$1.50
Estimates, Costs and Profits, Painting and Decorating.	Cloth	\$1.50
New Hardwood Finishing.	Cloth	\$1.50
The Amateur Artist.	Cloth	\$1.50
New Stencils.	Cloth	\$1.25
Chalk Talk and Crayon Presentation.	Cloth	\$1.25

Farm Books

Farm Mechanics.	Cloth	\$1.25
Farm Buildings.	Cloth	\$1.25
Farm Engines.	Cloth	\$1.25
Traction Farming.	Cloth	\$1.50

Business and Reference Books

Better Business Letters.	Cloth	\$1.00
Better Business English.	Cloth	\$1.00
Better Advertising.	Cloth	\$1.00
Finger Prints Simplified.	Cloth	\$1.25
Practical Bookbinding.	Cloth	\$1.25
Practical Instruction for Detectives.	Cloth	\$1.00
Practical Plumbing.	Cloth	\$1.50
Hot Water Heating.	Cloth	\$1.50
Elementary Chemistry.	Cloth	\$1.50
Courses in Civil Service.	Cloth	\$1.50
Cyclopedia of Recipes.	Cloth	\$1.50
American Star Speaker.	Cloth	\$1.50

Modern Languages

By Prof. P. S. Allen, U. of Chicago		
French without a Teacher.	Cloth	\$1.25
Spanish without a Teacher.	Cloth	\$1.25
German without a Teacher.	Cloth	\$1.25
Everyday French.	Cloth	\$1.25
Everyday Spanish.	Cloth	\$1.25

ORDER DIRECT FROM THIS PAGE—ON OUR MONEY-BACK PLAN

The books listed above are only a few of the many in our catalogue, which you will receive promptly after billing out and mailing us the attached coupon. For quick action order direct from this page—cross name of each book wanted and send in with price quoted. We prepay postage and send the books on our money-back plan.

FREDERICK J. DRAKE & CO.

PUBLISHERS

1008 Michigan Ave., Chicago

Drake Books Are For Sale at All Book Stores

Mail Coupon For Free Catalogue
Your Guide to Home Study

FREDERICK J. DRAKE & CO.
1008 Michigan Avenue
Chicago, Ill.

GENTLEMEN:—Please send me free, postage paid, your illustrated catalogue which lists and describes over 100 Practical Mechanical Books for Home Study.

My name is

and my address



SUCCESS—

Will You Pay the Price?

If you are a normal man, you want the comforts and luxuries which are the by-products of success—a home of your own—a new car—the leisure to read—the means to travel.

You want these things very much. It's right that you should.

But—you are keen enough to perceive that experience and facility in handling *routine* work will never get them for you.

What, then, are you doing to gain that *specialized* experience—that *trained* ability—which business firms are willing to pay real money for?

* * *

During the past fourteen years more than 450,000 men have asked themselves that question and have found the answer in home-study training under the LaSalle Problem Method.

Evening after evening, they have seated themselves, to all intents and purposes, at the desks of men in high-salaried positions, and have squarely faced the *problems* of those positions.

Evening after evening, they have been shown the *principles* involved in the solution of such problems—and how those principles were being applied by highly successful business houses.

Evening after evening, they have tackled actual concrete problems, lifted bodily from business life, and under the direction of some of the ablest men in their respective fields *have worked those problems out for themselves*.

That they have been *well rewarded* for their foresight and their earnestness is witnessed in the fact that during only three months' time as many as 1193 LaSalle members reported salary increases totalling \$1,248,526—an *average increase per man of 89%*.

* * *

Many men, *knowing* what home-study training under the LaSalle Problem Method can do for them, nevertheless prefer to think that there's "nothing in it." That's the excuse they make for neglecting their futures.

If you—knowing these facts—are content to drift, you will not profit by reading further.

If on the other hand you have imagination enough to *visualize* the goal you are working toward—to actually see yourself in a home of your own, enjoying the comforts and luxuries of life—if, in short, you are a man of *purpose*, the coupon just below this text may shorten your journey to success by many years.

Note, please, that the coupon outlines many different lines of training and that it will bring you not only full particulars of the training which appeals to you, together with details of LaSalle's *convenient payment plan*, but also your copy of that most inspiring book, "Ten Years' Promotion in One"—all without obligation.

If you want success, and are willing to pay the price, ACT!

LaSalle Extension University

The Largest Business Training Institution in the World

Dept. 864-R Chicago, Illinois

Please send me catalog and full information regarding the course and service I have marked with an X below. Also a copy of your book, "Ten Years' Promotion in One," all without obligation to me.

- | | |
|---|--|
| <input type="checkbox"/> Business Management | <input type="checkbox"/> Modern Business Correspondence and Practice |
| <input type="checkbox"/> Modern Salesmanship | <input type="checkbox"/> Modern Foremanship and Production Methods |
| <input type="checkbox"/> Higher Accountancy | <input type="checkbox"/> Personnel and Employment Management |
| <input type="checkbox"/> Law—Degree of LL. B. | <input type="checkbox"/> Expert Bookkeeping |
| <input type="checkbox"/> Traffic Management | <input type="checkbox"/> Business English |
| <input type="checkbox"/> Railway Station Management | <input type="checkbox"/> Commercial Spanish |
| <input type="checkbox"/> Commercial Law | <input type="checkbox"/> Effective Speaking |
| <input type="checkbox"/> Industrial Management | <input type="checkbox"/> C. P. A. Coaching |
| <input type="checkbox"/> Efficiency | |
| <input type="checkbox"/> Banking and Finance | |

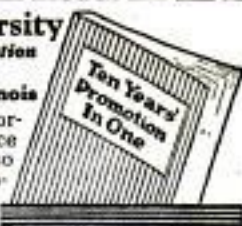

Name.....

Present Position.....

Address.....

CARPENTERS

GUIDES THAT SOLVE PROBLEMS

A Complete Course in Practical Carpentry and Building Work

POCKET SIZE—
FLEXIBLE
COVERS—
3100 ILLUS-
TRATIONS
—1000
PAGES

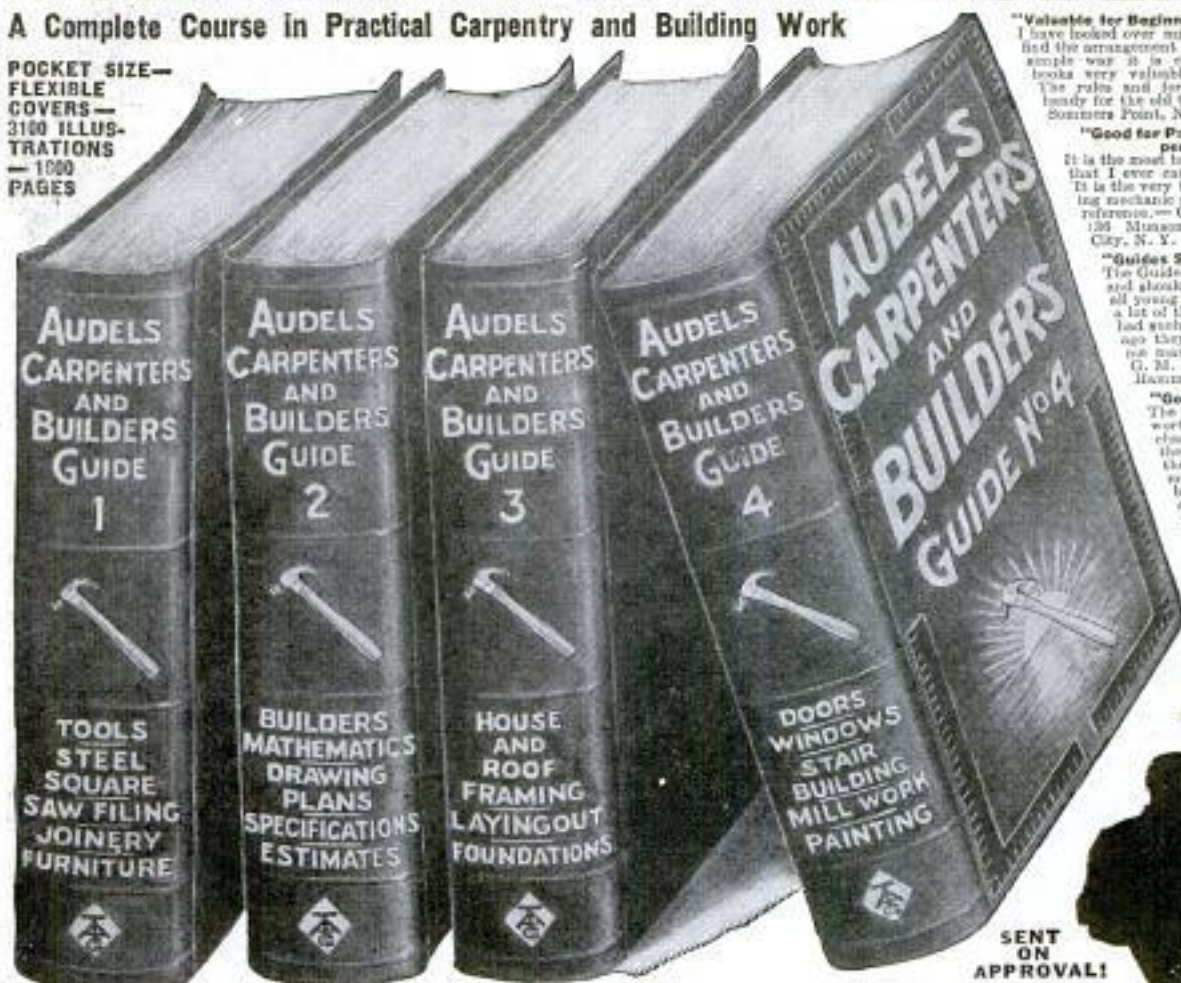

"Valuable for Beginners or Old Timers"
I have looked over my Audel Guides and find the arrangement of subjects and the simple way it is explained make the books very valuable for the beginner. The rules and formulas are mighty handy for the old timers.—Rosa Smith, Summers Point, N. J.

"Good for Professional Carpenters"

It is the most handy reference work that I ever came in contact with. It is the very thing that the building mechanic needs every day for reference.—George H. Watson, 136 Mission St., Long Island City, N. Y.

"Guides Save Hard Knocks"

The Guides are truly wonderful and should be in the hands of all young carpenters as well as a lot of the older heads. If I had such information 20 years ago they would have saved me many a hard knock.—G. M. McJannet, R. R. 1, Hammond, Ind.

"Good for Amateurs"

The books are surely worth more than the cover price; especially as they serve as a guide to the nonprofessional like myself who is trying to build himself a home at the least expense.—Otto F. Schuler, P. O. Box 142, Westmont, Ill.

\$1

PER MONTH



SENT ON APPROVAL!

NEW IDEAS—MODERN METHODS—SHORT CUTS

This course, "Audel's Guides for Carpenters and Builders," consists of 4 handy volumes of over 1500 pages with thoroughly illustrated charts, diagrams, graphs, pictures with calculations for every job from making the excavation to constructing the entire building. You will find these new Guides most complete and comprehensive in addition to being both timely and practical. There are 3700 actual examples of efficient construction work with new, methods, ideas, solutions, plans, systems, short

cuts, time and labor saving suggestions, new ways that cover the entire theory and practice of the subject illustrated by sketches and forms all specific and practical. Audel's Guides give you the short cut, professional information you want. No need to guess or take chances. Every day you have before you in this set the exact, practical, useful information that will help you with every job that comes up in your daily work.

HOW To Handle the Job That Puzzles YOU

There are thousands of examples of modern construction and building work—new methods, new ideas, proved efficiency plans, short cuts, time saving suggestions, new ways that cover the entire theory and practice of modern carpentry. Every point is easy to read and understand and clearly illustrated with sketches and forms. Inside Trade Informa-

tion for Carpenters, Builders, Joiners, Building Mechanics and all Woodworkers on—Care and Use of Tools—How to Use the Steel Square—File Saws—Make All Kinds of Joints—Draw and Read Plans—Write Specifications—Make Estimates—How to Frame Roofs and Houses—Lay Out Work—Put in Foundations—Full Instruction on In and Outside Building Work—Stair Building—Saw Mill Work—Practical Painting—Thousands of Short-Cuts that save time and money—Information usually obtained only by hard experience.

NO MONEY!

MERELY SEND COUPON AND LOOK THE SET OVER AT AUDEL'S RISK

FREE

EXAMINATION

Not a cent to pay until you see the books. No obligation to buy unless you are satisfied. Fill in coupon in pencil. Send now—today—get this great help library for carpenters and builders.

THEO. AUDEL & CO., 72 5th Avenue, NEW YORK CITY

Send me for free examination 4 volumes. If satisfactory I will send you \$1 within 8 days and mail \$1 monthly until set is paid.

Name.....
Address.....
Occupation.....
Employed by.....
Reference.....
S T 20

Be a
**Cooke-Trained
AUTO EXPERT**



**Earn
\$75 to
\$200
a Week!**

*I will train you
AT HOME*

R. W. COOKE
Directing Engineer
CHICAGO AUTO SHOPS

World's biggest, most fascinating business needs you! Unlimited opportunities, **BIG PAY** waiting for you when you are a **Cooke-Trained AUTO EXPERT**. I train you right in your own home to **Boss** the job or go into business.

Complete, PRACTICAL Training! As Directing Engineer of the great **CHICAGO AUTO SHOPS** I know what training you need to succeed, **AND I GIVE IT TO YOU!** Practical training in **EVERY** branch.

FREE! For a limited time, I will give every student **TWO** big, costly, practical **Repair and Testing Outfits**.

Money Back Guarantee! I don't care if you're young or old, educated or not, I guarantee that my original, copyrighted, personal **JOB-WAY** training will put you in the **\$3,000 to \$10,000** a year class! **FREE** Employment Service, **FREE** Life Consultation Service, **FREE** Shops Laboratory Service and other **FREE** features. Money-back guarantee protects you!

Earn While You Learn! Many of my students have started to make extra money within a few weeks after starting my training. Almost at the very beginning, I show you how to do actual jobs and make money doing it! Any ambitious fellow can make this wonderful instruction **PAY FOR ITSELF**. Let me show you how **YOU** can, too. Send for **FREE** Book.

Big AUTO Book FREE!

Hundreds of successful Auto Experts call my book "**THE PAY-RAISER**." Send for **YOUR** copy today. It's **FREE!** Address me personally. Mail the coupon **TODAY!**

**B. W. COOKE, Directing Engineer
CHICAGO AUTO SHOPS**

Dept. C16 1916 Sunnyside Ave. Chicago, Ill.

B. W. COOKE, Directing Engineer,
CHICAGO AUTO SHOPS
Dept. C16—1916 Sunnyside Avenue, Chicago

Please send me facts about the opportunities for Cooke-trained Auto Experts and reserve **TWO** Repair and Testing Outfits for me **FREE**. Send at once your **FREE** book, "**THE PAY-RAISER**."

Name

Address

City..... State.....

Age..... Occupation.....

Look Here!



**I will make
you a**

Drafting EXPERT!

If you're earning less than \$75 a week, **GO INTO DRAFTING!** I guarantee to train you **AT HOME** the "**JOB-WAY**"—with actual Drafting Room Jobs. Drafting **EXPERTS** are close to the boss—are **first** in line of promotion for executive positions.

\$250 to \$400 a Month!

Common schooling all you need! My graduates are **successful**—employers ask for **COYNE-trained Drafting EXPERTS**. So I **GUARANTEE** satisfaction or to refund every penny you pay me.

**FREE EXPERT'S
DRAFTING
OUTFIT**

"**JOB-WAY**" training makes you a Drafting **EXPERT** quick. You do actual **JOB**s with the same instruments you use when employed at a big salary. To encourage you to start **RIGHT NOW**, I give you this complete **EXPERT'S** outfit **FREE**. Coupon brings full information.

**LEARN
AT HOME!**

Thousands of big-salaried jobs all over the country looking for Drafting **EXPERTS!** Railroads, factories, builders, architects, shipyards, auto plants, Cities, Counties, States and the U. S. Government all calling for Drafting **EXPERTS!** Mail the coupon to me personally!

**CHIEF DRAFTSMAN
COYNE SCHOOL OF DRAFTING
Dept. C-19, 1920 Sunnyside Ave., CHICAGO**

Without obligation, send me your book, "Drafting, the Foundation of Industry," absolutely **FREE**. Also, special offer of **FREE** instruments and other big **FREE** features.

Name.....

Address.....

City..... State.....



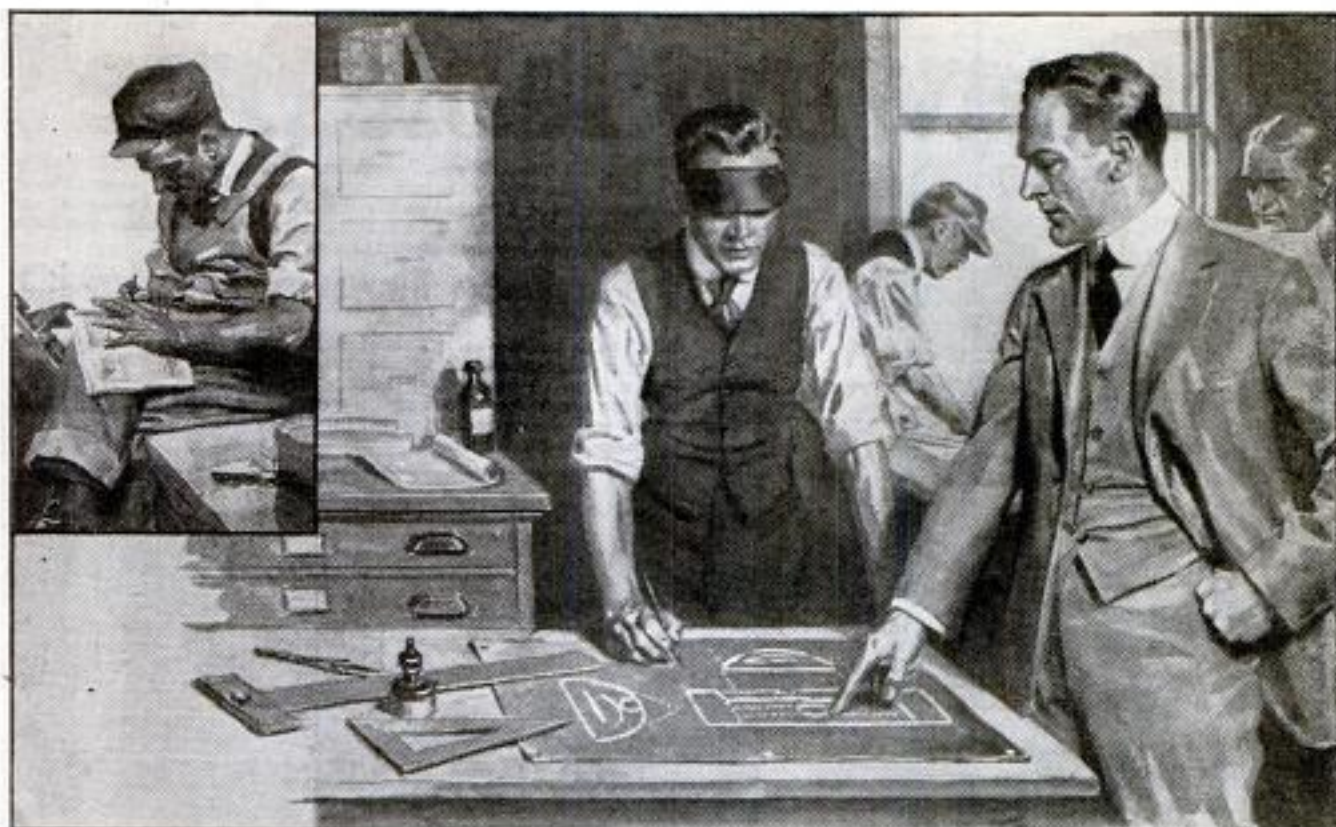

He Gets \$100 A Week Now

A LITTLE over a year ago he was just a hand—an untrained worker doing ordinary work and getting an ordinary salary.

He saw other men—younger men—getting better positions and larger salaries, and he wondered why. And the more he thought about it, the more clearly he realized that it was because they were trained and he was not. He was being paid only for the work of his hands. His brain didn't count.

So he determined that he, too, would take up a course with the I. C. S. He studied at home in the evenings and in spare moments during the day.

And success came, as it always comes, to men who really study their work. In three months he was assistant foreman—then foreman—and then one day they called him into the head office to supervise all blue-print work.

He's earning \$100 a week now, and to quote the head of the firm—"That's only a start. He has the brightest future of any man in the organization."

TRAINING! That's what did it! Training that taught him how to do things that the other men could not do. Training that made his work stand out and brought him to the attention of the firm. Training that fitted him to undertake larger responsibility when Opportunity came.

How much longer are you going to wait before taking the step that is bound to bring you advancement and more money?

No matter where you live, the International Correspondence Schools will come to you. No matter what your handicaps or how small your means, we have a plan to meet your circumstances. No matter how limited your

previous education, the simply written, wonderfully illustrated I. C. S. text-books make it easy to learn. No matter what career you may choose, some one of the 300 I. C. S. courses will surely suit your needs.

This is all we ask: Without cost, without obligation, put it up to us to prove how we can help you.

Mail the coupon to-day

INTERNATIONAL CORRESPONDENCE SCHOOLS Box 5618-D, Scranton, Penna.

Without cost or obligation, please tell me how I can qualify for the position or in the subject before which I have marked an X:

BUSINESS TRAINING COURSES

- | | |
|--|---|
| <input type="checkbox"/> Business Management | <input type="checkbox"/> Salesmanship |
| <input type="checkbox"/> Industrial Management | <input type="checkbox"/> Advertising |
| <input type="checkbox"/> Personnel Organization | <input type="checkbox"/> Better Letters |
| <input type="checkbox"/> Traffic Management | <input type="checkbox"/> Show Card Lettering |
| <input type="checkbox"/> Business Law | <input type="checkbox"/> Stenography and Typing |
| <input type="checkbox"/> Banking and Banking Law | <input type="checkbox"/> Business English |
| <input type="checkbox"/> Accountancy (Including C.P.A.) | <input type="checkbox"/> Civil Service |
| <input type="checkbox"/> Nicholson Cost Accounting | <input type="checkbox"/> Railway Mail Clerk |
| <input type="checkbox"/> Bookkeeping | <input type="checkbox"/> Common School Subjects |
| <input type="checkbox"/> Private Secretary | <input type="checkbox"/> High School Subjects |
| <input type="checkbox"/> Spanish <input type="checkbox"/> French | <input type="checkbox"/> Illustrating <input type="checkbox"/> Cartooning |

TECHNICAL AND INDUSTRIAL COURSES

- | | |
|---|--|
| <input type="checkbox"/> Electrical Engineering | <input type="checkbox"/> Architect |
| <input type="checkbox"/> Electric Lighting | <input type="checkbox"/> Architects' Blue Prints |
| <input type="checkbox"/> Mechanical Engineer | <input type="checkbox"/> Contractor and Builder |
| <input type="checkbox"/> Mechanical Draftsman | <input type="checkbox"/> Architectural Draftsman |
| <input type="checkbox"/> Machine Shop Practice | <input type="checkbox"/> Concrete Builder |
| <input type="checkbox"/> Railroad Positions | <input type="checkbox"/> Structural Engineer |
| <input type="checkbox"/> Gas Engine Operating | <input type="checkbox"/> Chemistry <input type="checkbox"/> Pharmacy |
| <input type="checkbox"/> Civil Engineer | <input type="checkbox"/> Automobile Work |
| <input type="checkbox"/> Surveying and Mapping | <input type="checkbox"/> Airplane Engines |
| <input type="checkbox"/> Metallurgy | <input type="checkbox"/> Navigation |
| <input type="checkbox"/> Steam Engineering | <input type="checkbox"/> Agriculture and Poultry |
| <input type="checkbox"/> Radio | <input type="checkbox"/> Mathematics |

Name.....

Street.....

Address..... 3-6-24

City..... State.....

Occupation.....

Persons residing in Canada should send this coupon to the International Correspondence Schools Canadian, Limited, Montreal, Canada.

Drawing Table Free!

Yes, this is exactly what I am doing. I am giving this drafting table free to you when you enroll as my student. I do this because I want you to have the right kind of Draftsman's Working Outfit—because I want to help ambitious men and boys get ahead. This is the kind you will use when you have completed my course and have become a regular draftsman.

Complete Drawing Outfit FREE

Besides the drafting table I also furnish free the set of regular working instruments shown here. You get both table and instruments free if you enroll at once. I will do everything possible to help you get ahead.

Mail Free Coupon Below

Also FREE \$90 Drafting Course

I Guarantee

to instruct you until competent and in a permanent paying position at a regular draftsman's salary of at least \$250 per month and guarantee to furnish you free, complete draftsman's working outfit, free, "Chief's Own" drawing table and all the instruments you need just as soon as you become my student.

To my students enrolling now I give an opportunity of getting a \$90 drafting course absolutely without cost to them. This means you need not pay me for my personal instructions or for the complete working outfit.

Salaries up to \$250 and \$300 a Month

Positions paying up to \$250 and \$300 a month which ought to be filled by skilled draftsmen are vacant everywhere. There are in every part of the country ambitious men, who with practical training and personal assistance will be qualified to fill the positions. I can now take and train a limited number of students, guarantee to train them by mail UNTIL placed in a permanent position at a salary up to \$250 and \$300 a month.

The Well-Trained Man Always Has a Job

No time like the present to get training in draftsmanship. Even when jobs are hard to find, the trained man is seldom out of work. His income goes on in good times and bad. Be a skilled draftsman. Don't lose a single week.

Mail Coupon For Free Book

Mail coupon at once for full information how you can get the table and working instruments Free, also how you can get the \$90 drafting course Free. Even if you don't send in a copy of the sketch send for this information.

Chief Draftsman, Engineers' Equipment Co.
1951 Lawrence Ave., Div. C-135 Chicago, Ill.

Chief Draftsman, Engineers' Equipment Co.
1951 Lawrence Ave., Div. C-135 Chicago, Ill.

Without any obligation to me please mail your book "Successful Draftsmanship" and full particulars of your liberal "Personal Direction" offer to a few students. Also full information as to how I can get a \$90 Drafting Course Free.



Name

Address

Age

Be a BIG PAY EXPERT!

Earn \$200 to \$800 Per Month—Learn Electricity in 12 Weeks

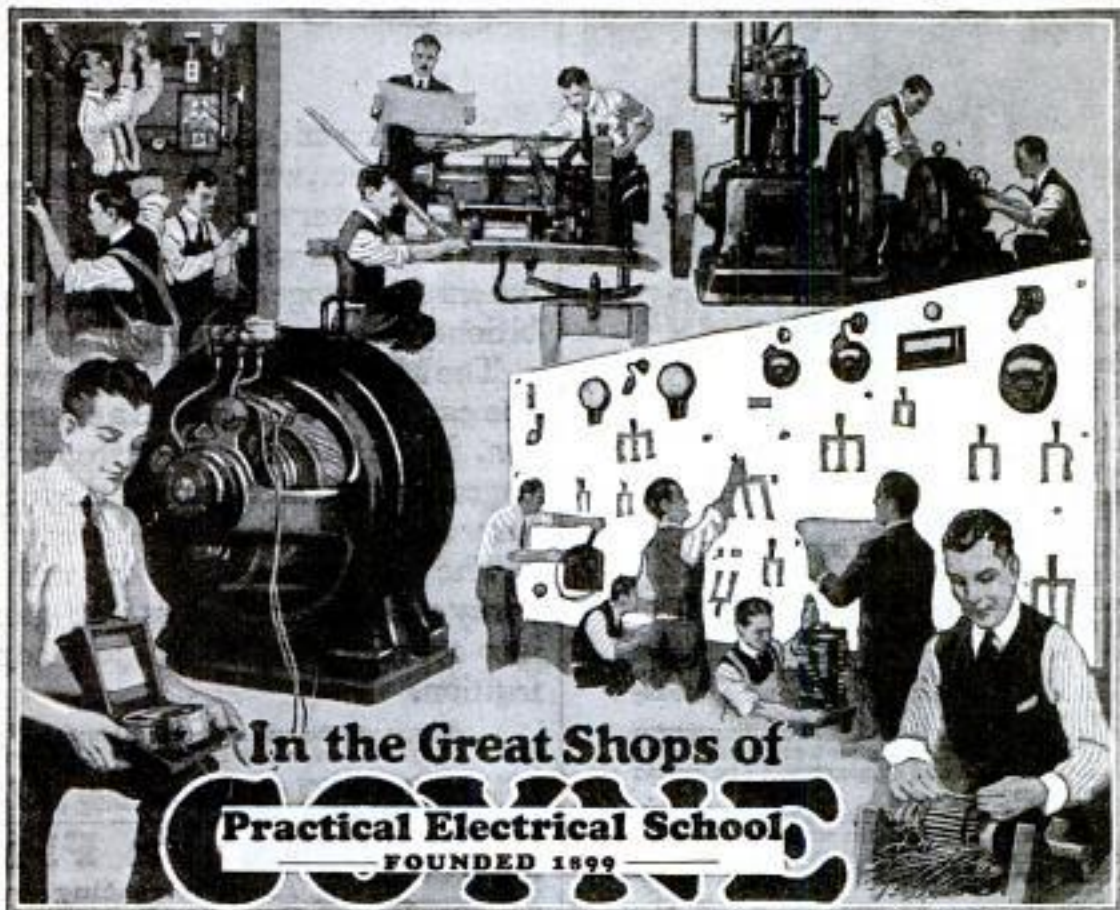

Complete Electrical Training in 12 Weeks

Make this the most profitable and enjoyable summer of your life. Come to Chicago, the greatest summer resort city in the country on beautiful Lake Michigan, and greatest electrical center in the world. We pay your railroad fare from any place in United States. See the country at our expense. Become a skilled electrical expert in great shops of Coyne.

NOT A CORRESPONDENCE SCHOOL

No books or useless theory—everything is practical. You are trained on mammoth outlay of electrical equipment. Big, newly enlarged course now ready. Everything from door-bells to power plants. You work on motors, generators, house wiring, autos, batteries, radio, switchboards, power plants.

Great Summer Resort City

Chicago, on beautiful Lake Michigan, is the Nation's summer playground. Free bathing beaches, beautiful parks, excursion boats and the great Municipal pier, zoos, ball parks. Coyne is near lake and bathing beaches.

One of
Chicago's
Many Big
Pleasure
Boats



FREE Railroad Fare to Chicago! Send Coupon Now

This is the greatest offer ever made by a school and it is for a limited time only. Don't delay a single minute. Send coupon in right away for big free catalog and full particulars of this wonderful offer. Act now. We pay your Railroad Fare.

COYNE 1300-10 W. Harrison St.
Electrical School Dept. C-135 Chicago, Illinois

You DON'T Need Education or Experience

A Coyne trained man is trained completely. He can take his place anywhere in the electrical world. He doesn't need education or experience to start with, because he gets both at Coyne and becomes a \$50 to \$200 a week expert in just twelve weeks!

Radio and Auto Courses FREE!

Besides paying your railroad fare, we include FREE a course in Radio—the marvel of the age. Also, a complete course in auto, truck and tractor electricity and storage batteries.

Coyne Trains You for Life!

You get FREE a Life Membership which enables you to stay longer if you want or to come back at any time and take up any new work which is constantly being installed to make our school the most modern at all times.

Earn While You Learn

Our employment department helps you get a job to earn a good part of your expense while here.

COYNE ELECTRICAL SCHOOL, Dept. C-135
1300-10 W. Harrison St., CHICAGO, ILL.

Please send me free your big new book and full particulars of your special offer of FREE RAILROAD FARE and TWO EXTRA courses FREE.

Name

Address



"Here's an Extra \$50!"

"I'm making *real* money now! Yes, I've been keeping it a secret until pay day came. I've been promoted with an increase of \$50 a month. And the first extra money is yours. Just a little reward for urging me to study at home. The boss says my spare time training has made me a valuable man to the firm and there's more money coming soon. We're starting up easy street, Grace, thanks to you and the I. C. S."

Today more than ever before, money is what counts. You can't get along on what you have been making. Somehow, you've simply got to increase your earnings.

Fortunately for you there is an unfailing way to do it. Train yourself for bigger work, learn to do some one thing well and employers will be glad to pay you real money.

You can get the training that will prepare you for the position you want in the work you like best, whatever it may be. You can get it at home, in spare time, through the International Correspondence Schools.

It is the business of the I. C. S. to prepare men for better positions at better pay. They have been doing it for 32 years. They have helped thousands of other men and women. They are ready and anxious to help you.

Mail the Coupon To-day

INTERNATIONAL CORRESPONDENCE SCHOOLS Box 5621-D, Scranton, Penna.

Without cost or obligation, please tell me how I can qualify for the position or in the subject before which I have marked an X:

BUSINESS TRAINING COURSES

- | | |
|--|---|
| <input type="checkbox"/> Business Management | <input type="checkbox"/> Salesmanship |
| <input type="checkbox"/> Industrial Management | <input type="checkbox"/> Advertising |
| <input type="checkbox"/> Personnel Organization | <input type="checkbox"/> Better Letters |
| <input type="checkbox"/> Traffic Management | <input type="checkbox"/> Show Card Lettering |
| <input type="checkbox"/> Business Law | <input type="checkbox"/> Stenography and Typing |
| <input type="checkbox"/> Banking and Banking Law | <input type="checkbox"/> Business English |
| <input type="checkbox"/> Accountancy (including C.P.A.) | <input type="checkbox"/> Civil Service |
| <input type="checkbox"/> Nicholson Cost Accounting | <input type="checkbox"/> Railway Mail Clerk |
| <input type="checkbox"/> Bookkeeping | <input type="checkbox"/> Common School Subjects |
| <input type="checkbox"/> Private Secretary | <input type="checkbox"/> High School Subjects |
| <input type="checkbox"/> Spanish <input type="checkbox"/> French | <input type="checkbox"/> Illustrating <input type="checkbox"/> Cartooning |

TECHNICAL AND INDUSTRIAL COURSES

- | | |
|---|--|
| <input type="checkbox"/> Electrical Engineering | <input type="checkbox"/> Architect |
| <input type="checkbox"/> Electric Lighting | <input type="checkbox"/> Architects' Blue Prints |
| <input type="checkbox"/> Mechanical Engineer | <input type="checkbox"/> Contractor and Builder |
| <input type="checkbox"/> Mechanical Draftsman | <input type="checkbox"/> Architectural Draftsman |
| <input type="checkbox"/> Machine Shop Practice | <input type="checkbox"/> Concrete Builder |
| <input type="checkbox"/> Railroad Positions | <input type="checkbox"/> Structural Engineer |
| <input type="checkbox"/> Gas Engine Operating | <input type="checkbox"/> Chemistry <input type="checkbox"/> Pharmacy |
| <input type="checkbox"/> Civil Engineer | <input type="checkbox"/> Automobile Work |
| <input type="checkbox"/> Surveying and Mapping | <input type="checkbox"/> Airplane Engines |
| <input type="checkbox"/> Metallurgy | <input type="checkbox"/> Navigation |
| <input type="checkbox"/> Steam Engineering | <input type="checkbox"/> Agriculture and Poultry |
| <input type="checkbox"/> Radio | <input type="checkbox"/> Mathematics |

Name.....
Street..... 3-6-24
Address.....

City..... State.....

Occupation.....

Persons residing in Canada should send this coupon to the International Correspondence Schools Canadian, Limited, Montreal, Canada.



Some men and women seem to attract success, power, wealth, health and attainment with very little conscious effort; others conquer with great difficulty; still others fail altogether to reach their ambitions, desires and ideals. Why is this so?

The Master Key will tell you why. No one can read it and not be a changed person. None but will emerge from its magic pages with a firmer grasp of the future—a surer understanding of what he can do.

The Master Key is a key with which many are converting loss into gain, fear into courage, despair into joy, hope into fruition.

A copy will be sent to you without cost or obligation of any kind if you will address

CHARLES F. HAANEL, 214 Howard Bldg., St. Louis, Mo.

FREE BOOK Learn Piano!



This Interesting Free Book

shows how you can become a skilled player of piano or organ at quarter usual cost. It shows why one lesson with an expert is worth a dozen other lessons. Dr. Quinn's famous Written Method includes all of the most important modern improvements in teaching music. Brings right to your home the great advantage of conservatory study. For the beginner or experienced player. Highly endorsed. Successful graduates everywhere. Scientific yet easy to understand. Fully illustrated. All music free. Diploma granted. Write today for free book.

Quinn Conservatory, Studio P.M.88, 598 Columbia Road, Boston, 25, Mass.

BE AN ARTIST

Comics, Cartoons, Commercial, Newspaper and Magazine Illustrating, Pencil Crayon Portraits and Pastels. Our simple method quickly develops your talent in spare time. By Mail or Local Classes. Write for terms and list of successful students. ASSOCIATED ART STUDIOS Dept. 8-100 W. 23rd St., NEW YORK

Ride A Ranger

The finest bicycle ever built. 44 Styles, colors sizes; made in our new factory. SAVE \$20 to \$25 by direct from the factory purchase. Delivered free on approval, express prepaid, for 30 Days' Free Trial. Easy Payments, if desired.

Tires best quality, at factory prices, express paid. Lamps, wheels, horns, equipment and repairs at unusually low prices. Send No Money, do business direct with makers.

Mead CYCLE COMPANY
DEPT. 108 CHICAGO

Write today for free Ranger Catalog, factory prices and marvelous easy payment terms



I WANT YOU!

MEN—WOMEN, 18 UP
\$1140 to \$3000 a Year

Hundreds U. S. Government Jobs now obtainable. Steady work. Experience not necessary. Common Education sufficient.

Mail Coupon Immediately
DO NOT DELAY

COUPON
FRANKLIN INSTITUTE
Dept. M180, Rochester, N. Y.

Send me, at once, free of any charge, a list and description of Government Jobs now obtainable.

Name.....
Address.....

Try

**America's
Greatest
Home Study**



AUTO COURSE

Ten Days

Think of it!—Ten days' training free! Here's the chance to prove to yourself that the Automotive business is the field for you—that our course of training is the best in existence.

Try it—study it, use it—ten days free—then decide. Make this sure-fire test right in your own home. Prove to yourself that this sensational offer is even better than you could hope to expect. See how simple, and how fascinating the study of Automotive Mechanics has been made by the 20 Master Experts who prepared this course.

**WRITE!
QUICK!** Get the facts on this great course. See it, try it! Use it! You can't afford to pass up the opportunity offered in this wonderful ten-day test. Mail the coupon today, **NOW!**

FREE!

Set of Fine Tools
Auto Library
Other Special
Features

Write
Today!

American School
A.C.74 Automotive Division
Drexel Ave. & 58th St.
CHICAGO

© A. S. 1924



**FREE
Test
Coupon**

American School
Dept. A.C.74 **CHICAGO**

Please rush 10-day test offer. I understand that this request obligates me in no way.

Name

Address

Learn at Home to Boss the Job
EARN \$ 3500 to \$ 10000 a YEAR

BE A RAILWAY TRAFFIC INSPECTOR



POSITION GUARANTEED

PAYING

\$110⁰⁰ a Month
and Expenses
Upon
Graduation

Earn Up to \$250 per Mo. in this Uncrowded Profession

MANY favorable opportunities for trained Railway Traffic Inspectors—advancement rapid with experience. Fascinating, out-door work; opportunities for extensive travel; report direct to railway executives.

Prepare at home in spare time. Upon graduation, position is GUARANTEED paying at least \$110 a month and expenses or your money is refunded.

Appreciates Value of Training

Mr. Solomon Burstein writes: "I thank you for the diploma and also for your kind assistance rendered to me while studying your course in Traffic Inspection."

"There were some lessons easy and some difficult but taking it all in all your course was presented to me in such a way that even the difficult lessons were not so hard after all. I also appreciate your extra assistance you gave me on subjects I did not understand in your lessons."

"I have recommended two of my friends to take this course."

Hundreds of Openings

Railways need more trained Traffic Inspectors. We must supply them. YOU can qualify, quickly, easily. Cost moderate; easy terms. Send coupon today.

**Standard Business Training
Institute**
BUFFALO, N. Y.

Standard Business Training Institute
Buffalo, N. Y.

Send me, entirely free, Booklet No. D-63, giving full particulars about course in Railway Traffic Inspection.

Name _____

Street _____

City _____

**LEARN
BY DOING**
Every phase of all branches of
ELECTRICITY
taught by
Actual Practice
In America's foremost
and oldest institution
for trade training
No Books Used
Individual Instruction
Start Any Day
Write for FREE 64-page catalog
**THE NEW YORK
ELECTRICAL SCHOOL**
44 West 17th St., New York City
Open All Summer

*I will teach you
penmanship
by mail*

Small Cost, Spare Time; Easy Lessons. Write for my Free Book, "How to Become an Expert Penman." It contains specimens and tells how others became expert writers by the Tevis Method. Your name will be written on a card if you enclose stamp. Write today. T. M. TEVIS, Box 288, Chillicothe, Mo.

T. M. Tevis

Do You Make Mistakes in English?

Wonderful new way to improve your English. No rules to learn. No hard study. Grammar, spelling, punctuation, and expression, taught in 15 minutes a day—at home. Self-Correcting feature makes it fascinating as a game. Write today for Free Book "How to Speak and Write Masterly English" and 15 minute test which you can take in your own home. The answers are given so that you can tell at once just where you stand. Address

SHERWIN CODY SCHOOL OF ENGLISH
58 Searle Building ROCHESTER, N. Y.



CHARLES ATLAS
They pronounced the World's
MOST PERFECT Man, re-
ceiving the \$1000.00 FIRST
PRIZES. No other living
man can claim this title.

EXERCISE!

But do it Scientifically and have a Development you are proud of
Through my course of instructions you can take off or put on weight wherever you desire. Muscles that are powerful—yet beautiful and symmetrical—will make you the admired instead of the pitied.

FREE Send NOW for my amazing 64-page book full of extraordinary pictures that will thrill you and make you want to be the man or woman you should be. Enclose a dime to cover wrapping and mailing. Grasp this opportunity of learning the rare secrets of becoming physically perfect and do it now. Address

CHARLES ATLAS
96 Fifth Avenue Suite 447 NEW YORK CITY

Please Mention Popular Mechanics

Copyrighted material

\$3500 to \$5000 a YEAR

3 Months' Training

Will Qualify You for Success in the Professional Trade—

MECHANICAL DENTISTRY

The very best opportunity for men who like to use tools. There is need right now for 2500 more Dental Mechanics and the demand is rapidly increasing. Why such a demand? Just step into any Dentist's office. He is busy with his patients every hour of the day and has no time to make the plates, bridges, crowns, etc., he needs. So he employs a Dental Mechanic to do this work or else sends it to dental laboratories, often hundreds of miles away. And just think for a moment—there are approximately 56,000 practicing Dentists in the U. S. and only about 4000 full-fledged Dental Mechanics!

Good Paying Profession

Search where you will, you will not find any other line in which you can rise to professional earnings in so short a time or at so little expense. Dentists pay well to have their mechanical work done. They can well afford to do so, for they can earn still more by devoting their entire time to their patients. Salaries for Dental Mechanics range from \$35 to \$45 a week to start, with advancement up to \$125 a week. Pleasant, dignified work. Steady income—no "slack seasons" as in most other trades.

You Learn by Doing

We train each student individually—no classes whatever. Instruction is practical from the very beginning. From the start you use the tools of the trade and work on regular dental work. But we do not make the serious mistake of depending on practical work alone. You are given a definite theoretical training as well, so that you become familiar with both the theory and the practice of Mechanical Dentistry and also with the methods and terms used throughout the profession.

Why Bodee-Trained Men Lead the Field

For over 30 years the Bodee Schools have been the chief source of supply for well-trained Dental Mechanics. The Dental Profession is constantly calling for graduates of this institution. Ask your own Dentist to examine the course we give and tell you just how thorough and valuable it is. A great many of our students come through the direct recommendations of Dentists. Compare also the cost of our course with the charges of other schools offering to teach Mechanical Dentistry.

Quit Wishing and Worrying—Investigate!

FREE PARTIAL SCHOLARSHIPS

In order to meet the urgent demand for the men we train, we are offering for a limited time Free Partial Scholarships. Be sure to ask immediately for this exceptional offer. It will very much reduce the cost of your training. Remember, this offer will be discontinued soon—so act NOW while it is still in effect.

SEND FOR CATALOG AND SCHOLARSHIP OFFER

Catalog No. 2 fully describes the field and why the demand. Shows how students "Learn by Doing" actual work through practical, individual instruction, day or evening sessions. Shows how you can "Earn while Learning." This catalog is your First Step to Success in Mechanical Dentistry. IT IS FREE. SEND THE COUPON TODAY.

BODEE DENTAL INSTITUTE

136 West 52d Street, NEW YORK

PHILADELPHIA 1305 No. Broad St. BUFFALO 1226 Main St. BROOKLYN 85 Court St.

SEND THIS COUPON

TODAY

BODEE DENTAL INSTITUTE:

Without obligation to me send me a Free Copy of your catalog and complete details of the Free Partial Scholarship Plan No. 2.

Name.....

Address.....

OPPORTUNITY UNEQUALED

Just compare your own present earnings with what you could be receiving after only a very short period of training. Can you afford to waste any more time before getting started in this profitable field? Remember that the demand is rapidly increasing. The sooner you begin your training, the sooner you increase your earning power. Take full advantage of your opportunity and get started NOW

FOR MEN

Men who like to work with tools—

Men who are ambitious enough to want to become financially independent—

Men who want to get into a profitable field which is not already overcrowded—

Men who are unwilling to always be under a "boss" and want a chance to start a business of their own—

Men who have enough "pep" to investigate this opportunity thoroughly and then act.

MAKE YOUR WAY UP





High School Course in Two Years!

You Want to Earn Big Money!

And you will not be satisfied unless you earn steady promotion. But are you prepared for the job ahead of you? Do you measure up to the standard that insures success? For a more responsible position a fairly good education is necessary. To write a sensible business letter, to prepare estimates, to figure cost and to compute interest, you must have a certain amount of preparation. All this you must be able to do before you will earn promotion. Many business houses hire no men whose general knowledge is not equal to a high school course. Why? Because big business refuses to burden itself with men who are barred from promotion by the lack of elementary education.

Can You Qualify for a Better Position

We have a plan whereby you can. We can give you a complete but simplified high school course in two years, giving you all the essentials that form the foundation of practical business. It will prepare you to hold your own where competition is keen and exacting. Do not doubt your ability, but make up your mind to it and you will soon have the requirements that will bring you success and big money. YOU CAN DO IT.

Let us show you how to get on the road to success. It will not cost you a single working hour. Write today. It costs you nothing but a stamp.

American School

Dept. HC74 Drexel Ave. and 58th St., Chicago

American School

Dept. HC74 Drexel Ave. and 58th St., Chicago

Send me full information on the subject checked and how you will help me win success.

- | | |
|-----------------------------|---------------------------|
|Architect |Lawyer |
|Building Contractor |Machine Shop Practice |
|Automobile Engineer |Photoplay Writer |
|Automobile Repairman |Mechanical Engineer |
|Civil Engineer |Shop Superintendent |
|Structural Engineer |Employment Manager |
|Business Manager |Steam Engineer |
|Cert. Public Accountant |Foremanship |
|Accountant and Auditor |Sanitary Engineer |
|Bookkeeper |Surveyor (& Mapping) |
|Draftsman and Designer |Telephone Engineer |
|Electrical Engineer |Telegraph Engineer |
|Electric Light & Power |High School Graduate |
|General Education |Fire Insurance Expert |
|Vocational Guidance |Wireless Radio |
|Business Law |Undecided |

Name.....

Address.....

CHICAGO TECHNICAL COLLEGE *

*Drafting
Engineering
— MECHANICAL,
CIVIL, STRUCTURAL
AND ELECTRICAL.
Architecture*

21ST YEAR

* Technical training insures your future. It puts you immediately in a high-salaried position. So great is the demand for trained men in Chicago that many of our students are placed in responsible part-time positions before graduation.

Short, Intensive Training

Two-year Diploma Courses. Degree of B. S. conferred in three years. Special short courses for special students. In all cases, the course is adapted to meet the special needs of the individual. Instruction is largely personal and instructors are experts, actively engaged in their professions.

52-Page Blue Book, FREE

This illustrated book states inspiring facts about the great demand for trained men. It explains how students support themselves while studying. It tells what others have accomplished. Write for it now—without obligation.

CHICAGO TECHNICAL COLLEGE

18 Chicago Tech. Building, CHICAGO

Why Miss Half the Fun in Life?



BE POPULAR—Learn to dance well! Arthur Murray, World's greatest dancing teacher, has invented a remarkable new easy method which enables anyone to learn all the newest dances at home—in a few hours—at very little cost! No music or partner needed. Success positively guaranteed! "120,000 learned dancing by mail."

FREE 5 DANCING LESSONS—

To prove you can learn easily and quickly, Arthur Murray will send you Five FREE lessons, including Fox Trot, Secret of Leading, and How to Gain Confidence. To pay cost of mailing, printing, etc., enclose 10c. Act NOW and be a good dancer soon.

Arthur Murray, Studio 241
801 Madison Ave. New York

LEARN SPANISH on your phonograph

Learn to speak Spanish as if you were living in Spain. Records fit any phonograph. New Conversational Method evolved in Europe and introduced in America by the I. C. S. School of Languages. Endorsed by the Spanish Embassy.

Write to-day for Booklet and Free Sample Record

International Correspondence Schools, Box 5627-D, Scranton, Penna.



If You Want Bigger Pay *Make This* **FREE TEST**

There's a sure way to increase your earning power. And here is such an opportunity. Look into it—you may recognize it as your one chance to earn the biggest money of your life.



ARE you ready for a shock? Then, let me tell you that if you have average intelligence and can read and write, there is a quick and easy way for you to earn enough money to satisfy any average ambition. And after reading this offer, if you do not quickly make more money, you have no one to blame but yourself.

Don't take my word for it. By a simple test—you can make in the privacy of your home—you will know that every word I say is true—or otherwise. The test does not obligate you or cost you one penny. But make it! Then judge for yourself. It has proved to be THE opportunity for thousands. They have found the way to bigger pay—are now earning from five to twenty times as much as formerly. And the beauty of it is they enjoy every minute in the day's work. They are their own bosses.

The thousands who have made this test before you, and who are now making the money you would like to make, are now salesmen. Ninety-five per cent once thought they were not "cut out for selling," that salesmen were "born" and not made. They found it was a fallacy that had kept them in the rut. They discovered that anyone with proper training can sell, and they are making from \$5,000 to \$10,000 a year, because they had the vision to recognize opportunity.

Thousands Have Proved It!

For instance, Ellis Sumner Cook, 58 Superior St., Oak Park, Ill., left a \$25 a week job and last year made \$9,000! H. D. Miller, a Chicago boy, was making \$100 a month as a stenographer in July, 1922. In September, 3 months later, he was making \$100 a week as a salesman. W. P. Clenny of Kansas City, Mo., stepped from a \$150 a month clerkship into a selling job at \$500 a month. He is making \$850 a month now. M. V. Stephens of Albany, Ky., was making \$25 a week. He took up this training and now makes 5 times that much. J. H. Cash of Atlanta, Ga., exchanged his \$75 a month job for one which pays him \$500 a month. O. H. Malfrout of Boston, Mass., stepped into a \$10,000 position as a

SALES MANAGER—so thorough is this training. All these successes are due to this easy, fascinating and rapid way to master certain invincible secrets of selling.

Simple as A B C

Sounds remarkable, doesn't it? Yet there is nothing remarkable about it. There are certain ways to approach different types of prospects to get their undivided attention—certain ways to stimulate keen interest—certain ways to overcome objections, batter down prejudices, outwit competition and make the prospect act. If you will learn these principles there is awaiting you a brilliant success and more money than you ever thought of earning.

As you will see by the affidavit to the left thousands of reputable selling organizations in America turn to this Association for their Salesmen. We can never take care of all the de-

mands made on us for this better type of trained salesmen.

Make This Free Test at Once

Don't turn this page until you have clipped the coupon, filled it out, and sent it on its way. The test is contained in a free book, "Modern Salesmanship," which we will gladly send you without obligation. After reading the book through you will ask yourself the questions it brings up. The answers will prove whether this is your opportunity or not. So mail the coupon NOW.

NATIONAL SALESMEN'S TRAINING ASS'N

53 W. Jackson Blvd. Dept. 12-K Chicago, Ill.

National Salesmen's Training Ass'n
53 W. Jackson Blvd., Dept. 12-K, Chicago, Ill.

Please send me without obligation on my part your free book, "Modern Salesmanship," which will enable me to test my ability at home, and full information about the N.S.T.A. System of Salesmanship Training and Employment Service.

Name

Address

City..... State.....

Age..... Occupation.....



MECHANICS' HANDBOOK



330 PAGES

More than 300,000 sold

HANDIEST book of its kind ever written. Prepared by experts under the direction of the International Correspondence Schools. Written in language that you can understand. Note this partial list of subjects:

Weights and Measures; Easily Understood Mathematics; Formulae; Mensuration; Belting; Hydro-mechanics; Strength of Materials; Boiler Design; Care and Inspection of Boilers; Horsepower of Boilers; Chimneys; Exhaust Heating; Machine Design; Horsepower of Engines; Boilers and Pumps; The Slide Valve; Belt Pulleys; Rope Belting; Cylinders and Steam Chests; Electricity; Currents; Wiring; Dynamos and Meters; Batteries; Cable Testing; Compass Surveying; Curves; Leveling; Etc.

Just mail this advertisement with a dollar bill and your name and address, and this 330-page I. C. S. Mechanics' Handbook or any of the other I. C. S. Handbooks that you want will come to you by return mail.

Only
\$1

INTERNATIONAL CORRESPONDENCE SCHOOLS
Box 5624-D, Scranton, Penna.

I enclose \$..... for which send me, post-paid, the Handbooks marked X, at \$1.00 each. It is understood that if I am not entirely satisfied I may return any or all of them within five days and get my money back.

MECHANICS' HANDBOOK

- | | |
|---|--|
| <input type="checkbox"/> Automobile Handbook | <input type="checkbox"/> Radio Handbook |
| <input type="checkbox"/> Electrical Handbook | <input type="checkbox"/> Salesman's Handbook |
| <input type="checkbox"/> Chemistry Handbook | <input type="checkbox"/> Advertising Handbook |
| <input type="checkbox"/> Building Trades Handbook | <input type="checkbox"/> Bookkeeper's Handbook |

Name.....

Address.....

Learn to Write

I Teach by Mail

I can make a good penman of you at your home during spare time, no matter how you live or how poorly you now write. My simplified system has shown thousands the way to good penmanship during the past twenty-five years — it CAN and WILL do the same for YOU.

My beautifully illustrated 32-page Book

"How to Become a Good Penman" FREE!!

It contains many beautiful specimens of penmanship showing what others have accomplished by the Tamblin System, with testimonials and general information about our courses. (Your name elegantly written on a card if you enclose stamp for postage.) Ladies taught successfully as men. Write Today. Address

F. W. TAMBLIN
418 Ridge Bldg. Kansas City, Mo., U. S. A.

F. W. Tamblin

MUSIC LESSONS FREE



IN YOUR OWN HOME

You can read music like this quickly

Piano, Organ, Violin, Mandolin, Guitar, Banjo, etc.
Beginners or advanced players. One lesson weekly. Illustrations make everything plain. Only expense about 25¢ per day to cover cost of postage and music used. Write for FREE booklet which explains everything in full.

AMERICAN SCHOOL OF MUSIC, 51 Lakeside Building, CHICAGO

STAMMER

If you stammer attend no institute till you get my large FREE book entitled "STAMMERING, Its Origin and The Advanced Natural Method of Treatment." Ask for special tuition rate and a FREE copy of "The Natural Speech Magazine," published monthly in the interest of those afflicted with stammering, stuttering and other speech impediments. Largest, best equipped and most successful school in the world for the cure of stammering. Established 20 years. No sing-song or time-beat. Write today. Millard Institute of Normal Speech, 2317 Millard Bldg., Milwaukee, Wis.



"BECOME A LIGHTNING TRICK CARTOONIST"

HAVE MONEY CHALK TALKING. SEND \$1.00 FOR SHADY. MASTER OF TRICK DRAWINGS WITH INSTRUCTIONS BY A PROFESSIONAL CARTOONIST. SEND FACTS FROM GUARANTEED CIRCULAR FREE. BALDA ART SERVICE, 91. OSHKOSH, WIS.

LEARN ENGINEERING

Great Demand for Practical-Technical Engineers. Big Salaries. Wonderful Opportunities. Thousands of our graduates holding responsible high-salaried positions. Practical-Technical Courses from 3 Months to 2 Years in Electrical and Mechanical Engineering. Simple and Condensed Method. Faculty of Trained Experts. New Building. Extensively Equipped Laboratories and Shops. Department of Architecture. Structural and Mechanical Drafting. Degrees Awarded. Positions Secured. Day and Night Sessions. 22nd Year Begins September 17. Write for Catalog D.

FINLAY ENGINEERING COLLEGE, Kansas City, Mo.

Learn Expert Auto Painting



There is Big Money in auto painting and refinishing. Our Home Study Course in Practical Auto Painting will enable you to do the finest work and earn big wages. Wonderful opportunity for new money-making business of your own.

FREE circular tells all about this big new business. Be first. Write quick.

CHICAGO COLLEGE OF AUTO PAINTING
Dept. 84, 140 S. Dearborn St., CHICAGO, U.S.A.

About Getting That Raise in Pay

**Will the Work You Are Doing Ever Pay You Much?
Perhaps You Should Change Your Vocation!**

By Erwin Greer

TODAY, thousands of first class men the country over are wasting their lives away in jobs that lead nowhere. Yesterday—today—tomorrow—all are the same to these men who slave for a bare living, wearing away the energies of their youth in some vocational "blind alley." These men are "bossed" from morning till night. They haven't enough money ahead to assert their manhood or risk their overlord's displeasure for fear of being "fired" on short notice. Yet these same men, properly trained in the automobile business, could steadily earn big money, or soon become independent in a business of their own.



Erwin Greer

The trained automobile mechanic isn't particular about wearing a white collar during working hours. But he *does* earn enough extra money to dress as he likes when the day is done.

Perhaps *you* can tell me why this highly profitable profession goes begging for trained men while other vocations with lower pay are overcrowded! If you think it is because of a lack of opportunity there is a message here for you that it will pay to read over and over again. Pay close attention, please.

A Vision of Your Opportunity

In the United States right now there are over 16,000,000 automobiles. Thousands more are being manufactured daily. Every one of these cars will need repair work—perhaps several times a year. It requires thousands of trained men to do this work. There are now approximately 35,000 garages and sales agencies who employ such men. More men are needed. Why don't YOU qualify and get into this business of unlimited opportunity? Once you become proficient you can earn big money the rest of your life. You can find employment anywhere you go, or go into business for yourself and be independent.

Your Chance to Get the Training

47,781 men have taken their training in automotive work under my personal direction. Of this total, 30,245 are in business for themselves. Some have tire repair shops, some operate bat-

tery stations, others own and operate garages, service stations, or sales agencies. All achieved independence through my thorough course of training in the big Greer Shops.

An Offer

Now there is offered an even bigger and better training opportunity than was available to these men who forged through to success before you. Whatever your present vocation—whatever your present earning power (if you are working for somebody else) I can show you the way to bigger earnings and better conditions in the Automobile Business.

This proposition to you is summed up in a big automobile Book "How to Succeed in the Automobile, Truck and Tractor Business." I am ready to see that you get this book FREE. You are not asked to spend a single, solitary nickel. Just get this book, consider thoroughly the information it gives you—and then make your own decision.

You are reading this article because it concerns "Getting That Raise In Pay." To you that's a deep question and a vital problem. Otherwise you would not be interested. This book offers you the answer FREE OF CHARGE. One more ounce of action and the answer is yours. Fill out and mail the coupon appended here. The return mail will bring you facts that have already led to prosperity and happiness for nearly 50,000 men. Tear out this coupon now—and mail it to me. It will have my immediate personal attention.

ERWIN GREER, President,
2024 S. Wabash Avenue, Dept. 801, Chicago, Ill.

Please send me your FREE BOOK "How to Succeed In The Automobile & Tractor Business." As per terms of your offer I am not to be obligated in any way.

Name.....

Address.....

.....



**The Big Greer
Shop Building**



"I Made Myself HEAD

"I used to be one of the hands.

Look? Pull? There's no such thing in business! Training is everything. Only three years ago I had your very job! A. T. S. books put me where I am today!

"Take a tip from one who knows. Buy a set of A. T. S. books and let them fit you for a big job, as I did. They're crowded with paying facts written by noted experts. They are easy to read, too—charts, diagrams and illustrations make them as simple as A. B. C.

"But don't take my word for it. Investigate for yourself—it won't cost a cent!" Pick the set you want, mail the coupon and the books will be shipped to you for 7 days' free inspection.

PAY RAISING BOOKS at Greatly Reduced Prices

Automobile Engineering, 6 volumes, 2600 pages, 2000 pictures. Was \$45.00.....	Now	\$21.00
Carpentry and Contracting, 5 volumes, 2158 pages, 1000 pictures. Was \$37.50.....	Now	19.50
Civil Engineering, 9 volumes, 3900 pages, 8000 pictures. Was \$67.50.....	Now	34.50
Business Management, 8 volumes, 2500 pages, well illustrated. Was \$52.50.....	Now	29.50
Fire Prevention and Insurance, 4 volumes, 1500 pages, 600 pictures. Was \$30.00.....	Now	14.50
Electrical Engineering, 8 volumes, 3800 pages, 3000 pictures. Was \$60.00.....	Now	29.50
Machine Shop Practice, 6 volumes, 2300 pages, 2500 pictures. Was \$45.00.....	Now	21.50
Steam and Gas Engineering, 7 volumes, 3300 pages, 2500 pictures. Was \$52.50.....	Now	24.50
Law and Practice (with reading course), 13 volumes 6000 pages, illustrated. Was \$97.50.....	Now	49.50
Telephony and Telegraphy, 4 volumes, 1725 pages, 2000 pictures. Was \$30.00.....	Now	14.50
Sanitation, Heating and Ventilating, 4 volumes, 1454 pages, 1400 pictures. Was \$30.00.....	Now	14.50
Drawing, 4 volumes, 1578 pages, 1000 pictures, blue-prints, etc. Was \$30.00.....	Now	14.50
Employment Management and Safety Engineering, 7 volumes, 1800 pages, 540 illustrations, charts and diagrams. Was \$32.50.....	Now	24.50

SEND NO MONEY Shipped for 7 Days' Trial

You be the judge of these books. Don't send us a penny, but mail the coupon and we'll ship you any set you want for 7 days' free examination. Use them a whole week. If you don't want them, return the books at our expense. If you decide to keep them, remit only \$2.50 at the end of the week and \$1.00 a month until the balance is paid. Take the step toward bigger pay today. Mail the coupon—NOW!

American Technical Society, Dept. XC-19 Chicago, U. S. A.

American Technical Society,
Dept. XC-19 Chicago, U. S. A.

Please send me set of.....

for 7 DAYS' examination, shipping charges collect. I will examine the books thoroughly and, if satisfied, will send \$2.50 within 7 days and \$1.00 each month until I have paid the special price of..... If I decide not to keep the books I will return them at your expense at the end of one week. Title not to pass to me until the set is fully paid for.

Name.....

Address.....

Employed by.....
(Please fill out all three lines)



FREE!

—The Book that is Showing Thousands the Way to Big Money in ELECTRICITY

Establish yourself as an Electrical Expert. Find out how the New Shop Type training fits you at home in a few weeks. Thousands are taking this short cut to bigger positions. Remarkable method guaranteed by famous Lincoln Institute of Technology. Learn all branches without previous experience. Free Employment—unlimited advice—legal binding guarantee of satisfaction or money back. Write at once for information about complete Electrical apparatus and instruments given. Also big new book. No obligation.

S. & H. ENGINEERING COMPANY

Affiliated with the Lincoln Institute of Technology

1422 W. Monroe St. Dept. H-1 CHICAGO, ILL.

Music Lessons At Home With Celebrated TEACHERS

Lessons specially prepared for home study. Endorsed by Paderewski. Not a new method. Long established school now celebrating its 20th Anniversary.

Any Instrument Write naming course you are interested in—Piano, Harmony, Voice, Public School Music, Violin, Cornet, Mandolin, Guitar, Banjo or Reed Organ—and we will send FREE CATALOG. SEND FOR IT NOW!

UNIVERSITY EXTENSION CONSERVATORY
950 Siegel-Myers Building Chicago, Illinois

Be a Taxidermy Artist Marvelous Book Sent FREE

You can now learn Taxidermy, the wonderful art of mounting birds, animals, tanning skins, etc. Learn at home, by mail. The free book tells how. Mount your own trophies. Decorate home and den. Hunters, trappers, nature lovers, you need taxidermy. Interesting, fascinating, big profits. Join our school. 25,000 students. Success guaranteed. Get our free book without delay. Send right now—today.

N. W. School of Taxidermy, C 977 Elwood Bldg., Omaha, Neb.

LEARN WATCHMAKING AND ENGRAVING

ENGRAVING, JEWELRY REPAIRING BY OUR PROFIT-SHARING PLAN
OUR GRADUATES SUCCEED

One of our Iowa students started in a very small way—now doing over \$30,000 a year. Another in Wisconsin, over \$10,000 the first year. Day or night classes. Call or write for FREE BOOK.

CHICAGO SCHOOL OF WATCHMAKING Dept. 20 4844 Lincoln Avenue, CHICAGO

FREE Finger Print Outfit

Everything you need to gain practical experience in finger print work while you are training to become a great Finger Print Expert. The Big Money Finger Print Experts and secret service men are ones who know the finger print branch of this profession. Easy to learn in spare time at home. Write now for Free Offer.

U. S. SCHOOL OF FINGER PRINT, Dept. C-135, 7003 N. Clark St., CHICAGO, ILL.



BRICK

CONCRETE—TILE—PLASTER

Audels new set for Masons and Builders is a practical, up-to-the-minute trade assistant for **Bricklayers**, **Plasterers** and all **Cement Workers**. A complete course and trade-teacher for the apprentice; a working companion for the Journeyman; a ready reference for the boss builder; a practical instructor for the home builder. These Guides for Bricklayers, Stone masons, Cement workers, Plasterers and Tile setters are based on modern practice. They explain in practical, concise language and clear illustrations, diagrams, graphs and pictures, the methods, principles, advances and short cuts—including instructions on How to Figure and Calculate various jobs.

AUDELS MASONS & BUILDERS GUIDES

EASY TERMS

ONE DOLLAR PER MONTH

Complete set, 4 vols., price \$6.

Pocket size, flexible covers

Gilt edge, clearly printed

1080 Pages—all easy to read

2067 Trade Illustrations

Shipped for free trial, test and examination

\$1



Audels Guides Tell You All About:—

BRICK (GUIDE No. 1) Brick laying, classifications, strength tests, different kinds of mortar; classification of tools, scaffolding, Brick Designs, Bonding, walls, veneering, corners, openings, setting frames, Foundation walls, piers, chimneys, underpinning, repairing old work, arches.

TILE (GUIDE No. 2) Tile Setting, hollow tile, porous terra cotta partitions, shell wall tiles, clay roofing tiles, sizes, sorting and grading, concrete setting beds, reinforcement, mortar beds, troweling, beating in, straight edge test, ceramic mosaic; ESTIMATING—How to figure brick work, examples, tables, labor estimating.

CONCRETE (GUIDE No. 3) Materials, aggregates, cement, mixing, placing forms. Reinforced Concrete, metal systems, bonding, anchoring, how to figure concrete work, costs of materials and carpenter work; Stucco, application on new and old buildings, concrete block and tile walls, foundations.

PLASTER (GUIDE No. 4) On wood and metal, wall boards, plasterers' materials and tools, plastering on stone, brick or concrete. Stone Masonry, selection and strength of stone, cutting, finishes, classification of masonry, derricks and rigging, Steel Construction, Outline of, structural shapes, beams with girders, riveting rules; Building Suggestions, garage, pavement, ice house, etc.

FREE TRIAL OFFER

If you want to know the advancements in building progress—save mistakes—save work—save materials—solve your problems, it will pay you to send in this coupon NOW. Examine and test out the Guides for yourself. No obligation to buy unless satisfied. No money now. Nothing to pay post man. Fill in in pencil and send TODAY!

THEO. AUDEL & CO., 72 Fifth Ave., New York City

Send me the set, for free examination. AUDEL'S MASONS AND BUILDERS GUIDES 4 numbers. If satisfactory I will mail you \$1 within 5 days and \$1 monthly until \$6 is paid.

NAME _____

ADDRESS _____

OCCUPATION _____

EMPLOYED BY _____

REFERENCE _____

ST30

BLISS ELECTRICAL SCHOOL



A special technical school with concise but comprehensive course in Electrical Engineering. Non-essentials eliminated. Thorough knowledge of underlying principles emphasized. Theory and practice closely interwoven.

Electrical Engineering in One Year



The course is designed for earnest, ambitious young men of limited time and means. Curriculum includes mathematics, mechanical drawing and intensive shop work. Students construct motors, install wiring, test electrical machines. Graduates are qualified to enter the electrical field at once.

Bliss men hold responsible positions throughout the world. Thoroughly equipped fireproof dormitories, dining hall, laboratories and shops. Established 1893. Prepare for your profession in the most interesting city in the world. Send for catalog. Address

BLISS ELECTRICAL SCHOOL,

104 Takoma Avenue, Washington, D. C.

ARTIST'S OUTFIT FREE

Write quick for our remarkable offer. Learn **NOW** at home, in spare time, by our new instruction method. Commercial Art, Cartooning, Illustrating, Designing. Delightful, fascinating work in big demand. \$50.00 paid for one drawing. Hand-some book free explains everything. **SEND FOR IT TODAY.**
WASHINGTON SCHOOL OF ART, Inc.
Rm. 308, 1115-15th St. N.W., Washington, D.C.

LEARN WATCH REPAIRING

Be a watchmaker—you can learn this profitable trade by correspondence in a few weeks in your own home by the DeSelm's Chart System. After you complete the course you will know a watch from A to Z. You will know just what the matter is and how to repair one. When you graduate you will be a practical watchmaker and repairer and competent to fill any position. Positions for our graduates. Ask for our Free Book. It explains our system and terms.

THE DeSELMS WATCH SCHOOL
23 Perry Street ATTICA, INDIANA



"THERE'S MONEY IN IT"

LEARN TELEGRAPHY

AT HOME MORSE AND WIRELESS AT HOME

TEACH YOURSELF

in half usual time, at trifling cost, with the wonderful Automatic Transmitter, **THE OMNIGRAPH**. Sends unlimited Morse or Continental messages, at any speed, just as an expert operator would. Adopted by U. S. Government, and leading Universities, Colleges and Telegraph Schools. 3 Styles. Catalog free. **OMNIGRAPH MFG. CO., 16-22 Hudson St., NEW YORK**
If you own a Radio Phone Set—and don't know the code—you are missing most of the fun.

STAMMER NO MORE

Kill the fear of stammering. Re-education the key. The widely famed Hatfield Method fully outlined in an accurate, dependable, worthwhile book—"HOW TO STOP STAMMERING." It has inspired thousands. Free copy today.

THE HATFIELD INSTITUTE, 109 N. Dearborn, Chicago, Ill.

LEARN TO PITCH

Lessons by "MATTY" WALSH, WHITE, JOHNSON, RUCKER, WOOD—PITCH THE FADE-A-WAY, SPITTER, KNUCKLER, SMOKE BALL, etc., clearly described and illustrated by 56 Pictures. Entire COURSE OF LESSONS sent p.p. for 25c.

J.C. DORN, 721 S. Dearborn St., Dept. 65, Chicago, Ill.

WANTED—RAILWAY MAIL CLERKS

\$1600 to \$2300 a Year for Life

Every second week off with full pay—no "lay offs" because of strikes, poor business, etc.—sure pay—rapid advancement to higher positions. City and country residents stand same chance. Common sense education sufficient—no political influence.

TRAVEL—SEE YOUR COUNTRY

DON'T DELAY—ACT AT ONCE

Mail Coupon today—sure. Every day's delay means so much less chance of appointment from the next examinations—so write at once.

FRANKLIN INSTITUTE, Dept. M177, ROCHESTER, N.Y.

Take this First Step for a U. S. Government Job
Use Coupon Before You Lose It

COUPON

FRANKLIN INSTITUTE, Dept. M177, Rochester, N. Y.
Kindly send me, entirely free of charge, (1) A full description of the position checked below; (2) Sample examination questions; (3) Free copy of illustrated book "Government Positions and How to Get Them;" (4) A list of U. S. Government Jobs now obtainable; (5) Tell me how to get the position here checked.

..... Railway Mail Clerk (\$1600 to \$2300) Customs Positions (\$1100 to \$2000)
..... Post Office Clerk (\$1400 to \$1800) Internal Revenue (\$1100 to \$2000)
..... City Mail Carrier (\$1400 to \$1800) Rural Mail Carrier (\$1800 to \$2500)
..... Income Tax Auditors..... (\$2040 to \$3000)

Name

YOU CAN PLAY THE HAWAIIAN GUITAR

Just Like the Hawaiians!

Because Our Native Hawaiian Instructors Will Show You How!

Be the Most Popular Member of Your Set. Play "Once in a Blue Moon," "Raggedy Ann," "Linger a While," "Shanghai Lullaby." ALL the Late Song and Dance Hits. You can play First Selection in Half an Hour—and Harmonious Chords AT ONCE.

Here is your chance to get in the swim—to learn to play the most fascinating of all instruments, the Hawaiian Guitar, just as the Hawaiians do, and in an amazingly short time. Our method is so simple, plain and easy that you begin a piece your first lesson. In half an hour you can play it! Thousands of successful students prove this to be true. It is quite astonishing to find the ease with which you can master the Hawaiian Guitar—no matter how little your knowledge of music may be you can positively learn to play by our plain and easy method.

Expert Hawaiians Teach You to Quickly Master Their Secrets of This Fascinating Music

The instructions you receive from such world famous experts as Lawrence Kabatuki, Walter Kōmoku, Frank Ferrer, Carl Sevilla and others are invaluable. No other Conservatory can even begin to give you the expert teaching and knowledge you gain through us. And remember, while it is conceded that the Hawaiian Guitar produces the sweetest music, yet its mastery by you will be simple and quick, since there are

ONLY 4 EASY MOTIONS

to learn to enable to play any music—popular, dance, classical, native Hawaiian, or old time melodies and hymns. Just think of it! You need never have read a musical note in your life! For that matter, even though you haven't the slightest knowledge of any musical instrument we guarantee to teach you how to play just like the Hawaiians!

A Complete Conservatory Course!

Never before has such a complete and easily understood Conservatory Course in Hawaiian Guitar been offered. We are able to grant you this opportunity of quickly learning how to play the Hawaiian Guitar through acquiring the services of real Hawaiians to teach you.

How well this has been accomplished is proved by the fact that this is the only Conservatory teaching Hawaiian Guitar exactly as played by the Hawaiians. It is your good fortune as well as ours, that these Native Masters of Hawaiian Guitar come to this Conservatory to teach—and best of all

We Furnish Everything

When you enroll as a student in this Conservatory you receive FREE a handsome, sweet toned Genuine Hawaiian Guitar—valued at \$15.00—52 especially arranged lessons and 52 carefully selected pieces of music, as well as all necessary picks, Steel Playing Bar, etc. There is nothing extra to buy, everything is furnished.

SEND FOR DETAILS TODAY

of this remarkable course—simply fill in the coupon, mail to us and we'll gladly send you full details of our complete Conservatory Course and FREE Hawaiian Guitar Offer! We know you will not let another day go by without enrolling as a student in this Conservatory, once you learn how quickly and easily you can master this most popular of all instruments—the Hawaiian Guitar—So mail the Coupon NOW.

First Hawaiian Conservatory of Music, Inc.
Dept. 48 233 Broadway (Woolworth Bldg.) N. Y.

Special Courses Under Famous Teachers: TENOR-BANJO
VIOLIN, BANJO-UKULELE and UKULELE

FREE

This Genuine
HAWAIIAN
Guitar—

A Real
\$15.00
Value

MAIL THIS COUPON NOW!

First Hawaiian Conservatory of Music, Inc.,
Dept. 48 233 Broadway, (Woolworth Bldg.), New York
Please mail at once full details of your 52 easy lessons and
FREE Hawaiian Guitar offer. This, of course, does not obligate
me in the least.

Name _____
Address _____
City _____ State _____

(Please PRINT name and address clearly)



Men Needed in Electricity

NO PROFESSION offers greater opportunity to-day than Electricity. Salaries of \$12 to \$30 a day are not uncommon and the opportunity for advancement is unlimited.

As Forrest Crissey said recently in *The Saturday Evening Post*—"The demand for electrical work is increasing immensely and electrical contractors assert that the supply of electrical workers cannot overtake the demand for several years."

Now is the time to prepare for a good position in this profitable, interesting profession. You can study right at home in spare time through the International Correspondence Schools—just as so many other men have done. The I. C. S. Electrical Courses have been endorsed by Thomas A. Edison and Charles P. Steinmetz—the late electrical wizard of the General Electric Co.

Just mark and mail the coupon printed below and full information about Electrical Engineering, Electric Lighting, Electric Wiring, Electric Railways, Radio or any other work of your choice will come to you by return mail.

Mail the Coupon To-day

INTERNATIONAL CORRESPONDENCE SCHOOLS

BOX 5623-D SCRANTON, PA.

Explain, without obligating me, how I can qualify for the position, or in the subject, before which I mark X.

- | | |
|--|---|
| <input type="checkbox"/> ELECTRICAL ENGINEER | <input type="checkbox"/> CHEMICAL ENGINEER |
| <input type="checkbox"/> Electrician | <input type="checkbox"/> Pharmacy |
| <input type="checkbox"/> Electric Wiring | <input type="checkbox"/> SALESMANSHIP |
| <input type="checkbox"/> Electric Lighting | <input type="checkbox"/> Show Card and Sign Painting |
| <input type="checkbox"/> Electric Car Running | <input type="checkbox"/> RAILROAD POSITIONS |
| <input type="checkbox"/> Heavy Electric Traction | <input type="checkbox"/> ILLUSTRATOR |
| <input type="checkbox"/> Electrical Draftsman | <input type="checkbox"/> DESIGNER |
| <input type="checkbox"/> Electric Machine Designer, | <input type="checkbox"/> BUSINESS MANAGEMENT |
| <input type="checkbox"/> Telegraph Expert | <input type="checkbox"/> Private Secretary |
| <input type="checkbox"/> Practical Telephony | <input type="checkbox"/> Business Correspondent |
| <input type="checkbox"/> MECHANICAL ENGINEER | <input type="checkbox"/> BOOKKEEPER |
| <input type="checkbox"/> Mechanical Draftsman | <input type="checkbox"/> Stenographer and Typist |
| <input type="checkbox"/> Toolmaker | <input type="checkbox"/> Cert. Public Accountant |
| <input type="checkbox"/> Machine Shop Practice | <input type="checkbox"/> Traffic Management |
| <input type="checkbox"/> Gas Engineer | <input type="checkbox"/> Commercial Law |
| <input type="checkbox"/> CIVIL ENGINEER | <input type="checkbox"/> GOOD ENGLISH |
| <input type="checkbox"/> Surveying and Mapping | <input type="checkbox"/> Common School Subjects |
| <input type="checkbox"/> Reading Architects' Blue Prints | <input type="checkbox"/> CIVIL SERVICE |
| <input type="checkbox"/> METALLURGY | <input type="checkbox"/> Railway Mail Clerk |
| <input type="checkbox"/> ARCHITECT | <input type="checkbox"/> STATIONARY ENGINEER |
| <input type="checkbox"/> Architectural Draftsman | <input type="checkbox"/> Textile Overseer or Supt. |
| <input type="checkbox"/> PLUMBING AND HEATING | <input type="checkbox"/> AGRICULTURE <input type="checkbox"/> Speech |
| <input type="checkbox"/> Sheet Metal Worker | <input type="checkbox"/> Navigator <input type="checkbox"/> Math'm's |
| <input type="checkbox"/> Automobiles | <input type="checkbox"/> Poultry Raising <input type="checkbox"/> RADIO |

Name _____ ' 3-6-24

Present Occupation _____ Business Address _____

Street and No. _____

City _____ State _____

Canadians may send this coupon to International Correspondence Schools Canadian, Limited, Montreal, Canada

Become an Expert in DRAFTING

in Spare Time at Home

Master Drafting and a big job will be waiting for you. Not enough really able men are available to fill the high salaried positions offered by railroads, manufacturers, architects, contractors, electrical works, etc. Chicago Tech. will train you by mail—make you an expert—through practical instruction by experienced men. Moderate fees. Easy terms.

FREE Trial Lesson Find out before you enroll or pay a penny how well qualified you are to follow Drafting. Other schools ask fee and enrollment at once. Chicago Tech. sends the free lesson first. Write today.

Chicago Technical College, 830 Chicago Tech. Bldg., Chicago

LEARN Wrestling Secrets at Home by Mail



Yes, learn the secrets of World's Champions—how to wrestle expertly—how to handle big men with ease—how to win. Be athletic, be strong, be healthy. Learn how to defend yourself.

Farmer Burns

the world's most scientific wrestler, who trained the undefeated Champion Frank

Getch—who also trained six other World's Champions, will now train you. Investigate today his wonderful methods—the secrets of Champions. Every man and boy in the world, no matter what age, needs this information on SCIENTIFIC WRESTLING—PHYSICAL CULTURE—JU-JITSU—SELF DEFENSE.

Free Book Send your name and get my splendid 32 page illustrated wrestling and athletic book—absolutely free—no obligations of any kind. Write NOW.

FARMER BURNS, 6177 Ry. Exchange Bldg., Omaha, Neb.



FREE \$20 Musical Instruments

We have a wonderful new copyrighted system of teaching note music by mail! To first pupils in each locality we will give free a \$20 superb Violin, Tenor Banjo, Ukulele, Hawaiian-Guitar, Banjo, Mandolin, Banjo-Ukulele, Banjo-Mandolin, Cornet or Banjo-Guitar, absolutely free. Also teach Piano and Organ. Very small charge for lessons only. Four lessons will teach you several pieces. Over 100,000 successful players. We guarantee success or no charge. Complete outfit free. Write today, Dept. 367. No obligation. SLINGERLAND SCHOOL OF MUSIC, 1815 Orchard Street, CHICAGO, ILLINOIS

"STAMMERING

Its Cause and Cure"

You can be quickly cured if you stammer. Send 10 cents, coin or stamps, for 288 page cloth bound book on Stammering and Stuttering. It tells how I cured myself after Stammering and Stuttering for 20 years. BENJAMIN N. BOGUE

6912 Bogue Building, 1147 N. III. St. Indianapolis

Tri-State College of Engineering

Makes you a Civil, Mechanical, Electrical or Chemical Engineer in two years. 48 weeks each. No entrance examinations. High school Diploma not required. Compact courses made up of essentials only. Expenses low. For catalog address, Box M-8, Angola, Ind.

FREE Book on Auto Opportunities in California

Hundreds of big-pay auto jobs open in California. Be an auto mechanic, electrician or demonstrator salesman. Learn by actual shop practice—earn living expenses while learning. Write today for the FREE auto book—explains everything. Dept. 61

NATIONAL Automotive School 4004 So. Figueroa St. Los Angeles, Cal.

Earn \$50 to \$200 a Week as Traffic Manager

An excellent salary and unlimited opportunity for advancement—that is your prospect if you are trained in the modern science of Traffic Management. Big manufacturing concerns, railroads and steamship companies, Chambers of Commerce and Boards of Trade—these are merely three of the highly profitable fields in which a trained Traffic Manager can win advancement. *There are four others!*

What does the future actually hold out?

Here is the comment of Hubert T. Parsons, president of F. W. Woolworth and Company. He says: "I do not think \$10,000 a year is a large salary for a Traffic Manager;

in fact my company pays a great deal more than that."

At least three of the big automobile manufacturers in Detroit—not to mention the big packing houses and export companies—are known to pay their Traffic Managers in excess of \$20,000 a year. Indeed, the heads of some of the largest business houses in America got their start thru a mastery of Traffic Management.

Of course it takes time to work up to these bigger salaries, but the wonderful thing about Traffic Management is that the field is so wide and so varied that a man can always "break in" and thus get in line for an excellent position.

Moreover, under the LaSalle Problem Method it is now possible for a man to acquire quickly a more thorough understanding of this branch of business than many a man with years of day-to-day experience in the shipping and traffic departments is able to demonstrate. —And to *cash in* on that understanding!

Here, for example, is a typical letter from a LaSalle-trained man (name on request), showing how he is making his start toward the big-pay positions:

"I want to take this opportunity to write and tell you what the Placement Department of your University has done for me.

"Prior to taking your course in Traffic Management, I was receiving a flat salary of \$66.00 a month. That salary may seem small, but at that time it was considered a pretty good wage.

"I enrolled, and studied hard for a year or so. Shortly after receiving my hard-earned diploma, your Placement Department notified me that they had a position that would pay me double my present salary. I accepted the first position at \$157.50 a month and after serving in the capacity of Traffic Manager for two years, I notified your Placement Department that I had prepared myself for larger and broader responsibilities. Within a period of two months, your Placement Department notified me that the Commercial Club of _____ needed a Traffic Commissioner. I accepted the position at \$3,600 a year.

"I trust this exposition of actual facts may be of interest to you."

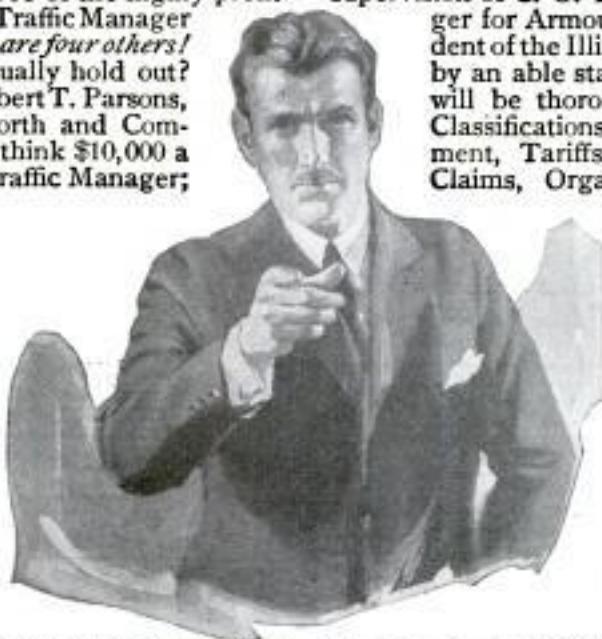

Why content yourself with the slender earnings of the routine man, when right in your own home by the LaSalle Problem Method you can quickly prove your title to the big mahogany desk?

LaSalle training in Traffic is under the direct supervision of C. O. Frisbie, former Traffic Manager for Armour & Company, former President of the Illinois Tunnel Company, assisted by an able staff of 150 traffic experts. You will be thoroly trained in Freight Rates, Classifications, Regulations and Management, Tariffs, Bills of Lading, Routing, Claims, Organization, Laws of Carriers,

Interstate Commerce Rulings, R. R. Accounting, Statistics, etc. You will receive the personal attention of experts who will answer your questions, direct your training, give you suggestions.

The cost is reasonable; deferred payments can be arranged if desired.

Mark and mail the coupon now, and we will send you all the facts regarding the attractive opportunities in this field.

— INQUIRY COUPON —

LaSalle Extension University

The Largest Business Training Institution in the World

Dept. 864-TR Chicago, Ill.

Please send me catalog and full information regarding the course and service I have marked with an X below. Also a copy of your book, "Ten Years' Promotion in One," all without obligation to me.

Traffic Management—
Foreign and Domestic

Training for position as Railroad or Industrial Traffic Manager, Rate Expert, Freight Solicitor, etc.

Other LaSalle Training Courses

LaSalle is the largest business training institution in the world. It offers training for every important business need. If more interested in any of these courses, check here:

- | | |
|--|--|
| <input type="checkbox"/> Business Management | <input type="checkbox"/> Banking and Finance |
| <input type="checkbox"/> Modern Salesmanship | <input type="checkbox"/> Modern Foremanship and Production Methods |
| <input type="checkbox"/> Higher Accountancy | <input type="checkbox"/> Personnel and Employment Management |
| <input type="checkbox"/> Railway Station Management | <input type="checkbox"/> Expert Bookkeeping |
| <input type="checkbox"/> Law: Degree of LL. B. | <input type="checkbox"/> Business English |
| <input type="checkbox"/> Commercial Law | <input type="checkbox"/> Commercial Spanish |
| <input type="checkbox"/> Industrial Management Efficiency | <input type="checkbox"/> Effective Speaking |
| <input type="checkbox"/> Modern Business Correspondence and Practice | <input type="checkbox"/> C. P. A. Coaching |

Name.....

Present Position.....

Address.....

Free **HEALTH Beauty**
TRIAL at Home *for Men and Women*

Free trial proves that Wonder Mist revitalizes every cell and works miracles over-coming pain and sickness. Physicians and plain folks explain how "Wonder Mist" has made them well, strong and happy in our 64-page book. Actual photographs, scientific charts and diagrams. It's Free.



Wonder Mist New Improved Violet Ray

"Wonder Mist" works quickly; it's scientific; goes after the cause. That's why results are quick and permanent. Dr. Duncan, Kewanee, Ill., writes, "Wonder Mist" is the finest thing to relieve pain, treatments are so pleasant all my patients like it. "Use it at home. Save doctor bills. Brings the natural magnetic beauty of health, no dieting, exercise or drugs.

SEND FOR FREE BOOK

Explains how Nikola Tesla discovered "Wonder Mist," how it works, why it heals. Tells how to conquer pain, disease and nervous trouble.

Reveals Marvelous Scientific Discovery. Shows charts of human body and explains where pains start, how to banish them. Offered Free for a limited time only to introduce "Wonder Mist." Send for a Free Copy today.

VI-REX CO., 211 S. Peoria St., Dept. 28, Chicago

— Mail Coupon — Send No Money —

VI-REX CO., 211 S. Peoria Street, Dept. 28, Chicago, Ill.

Please send me without cost or obligation your free 64-page book describing your Vi-Rex "Wonder Mist" outfits, and details of your FREE trial offer.

Name.....
 Address.....
 City.....

Can you afford to

STAMMER?

or STUTTER

It ruins many chances for promotion. Send postage for large free book "The Correction of Stammering and Stuttering." Methods successful for over a quarter-century. THE LEWIS INSTITUTE, 33 Lewis Bldg., 77 Adelaide St., Detroit, Mich., U.S.A.

We Teach COMMERCIAL ART

Meyer Both Company, the largest Commercial Art Organization in the World offers you a practical training based upon twenty-five years of success. This nationally known organization each year produces and sells to advertisers over 15,000 commercial drawings. This well paid profession equally open to men and women. Home study instruction.

Get Facts Before You Enroll in Any School

Ask the Advertising Manager of the leading newspapers in your city about Meyer Both Company—let them tell you about us. Send four cents in stamps for illustrated book telling of the success of our students.

MEYER BOTH COMPANY
 Department of Art Instruction
 CHICAGO, ILL.
 Michigan Ave. at 21st St. Dept. 18
 Note—To Art and Engraving Firms: Secure artists among our graduates. Write us.

Learn Watchwork, Jewelrywork and Engraving.

A fine trade commanding a good salary, and your services are always in demand. Address Horological, Dept. P, Bradley Institute, PEORIA, ILL., for our latest catalog.

PIMPLY SKIN made WELL

When a few applications of this wonder-working lotion has cleared faces of **pimples, blackheads, acne eruptions** on the face or body, **barbers itch, eczema, enlarged pores, oily or shiny skin**, you can realize why CLEAR-TONE has been tested and approved in over **100,000 Test Cases**. The simplicity of the treatment, and *The Story of How I Cured Myself* are all explained in my free booklet, "A Clear-Tone Skin." Write for your copy today and learn of the results gotten by thousands of men and women.



E. S. GIVENS, 128 Chemical Bldg., Kansas City, Mo.



send
birth date

Are You Reaching for the Truth?

I will tell you
FREE

Under which Zodiac Sign were you born? What are your opportunities in life, your future prospects, happiness in marriage, friends, enemies, success in all undertakings and many other vital questions as indicated by **ASTROLOGY**, the most ancient and interesting science of history?

Were you born under a lucky star? I will tell you the most interesting astrological interpretation of the Zodiac Sign under which you were born.

Simply send me the exact date of your birth in your own handwriting. To cover cost of this notice and postage, enclose **12 cents in any form (coin preferred)** and your exact name and address. Your astrological interpretation will be written in plain language and sent to you securely sealed and postpaid. A great surprise awaits you!

Do not fail to send birth date and to enclose **12 cents**. Print name and address to avoid delay in mailing. Write now—**TODAY**—to the

ASTA STUDIO, 309 Fifth Avenue, Dept. 138, NEW YORK

FACTS

That Every Man Interested In

ELECTRICITY

27 Years Service

Leaders for more than a quarter-century. Our instruction papers approved for classroom use by many leading resident schools.

Complete Training

This is not a short course in practical Electricity but a Complete Course in Electrical Engineering.

Should Read

22 Experts Train You

No one man can teach all branches of Electricity. 22 noted authorities give our students America's finest electrical training.

From the pages of nearly every magazine a multitude of Schools, Institutes and Engineering Works bid for your attention. Pretty hard to choose between them, isn't it?

In the side panels of this advertisement, the leading points that decide the issue are given. These are FACTS. Measure any school against them.

Complete Service

Consultation Service with a staff of experts—Employment Service of the best class—plus other features not found elsewhere.

Big Concerns Endorse

Western Union, Commonwealth Edison, All-America Cables, and other big concerns endorse our training.

Write! Get all the Quick! FACTS!

Get the full facts on this great course before deciding. Learn WHY and HOW this course

exceeds all others.

Get our special *free tuition* offer and full information on EXTRA FEATURES found in no other school or course. Write quick for big free book—"Be a Power in Electricity." No obligation whatever. Rush the coupon or a postal today.

American School

E C 74 Electrical Div., Drexel Ave.
and 58th Street, Chicago, Ill.

© A. S. 1924



AMERICAN SCHOOL
Dept. E C 74 Chicago, Ill.

Without a penny's expense or obligation, send me FREE ELECTRICAL BOOK and complete FACTS on your Electrical Course.

Name.....

Address.....

Learn at Home to Boss the Job
EARN \$ 3,500 to \$ 10,000 a YEAR!

LEARN CARTOONING

Successful cartoonists earn big salaries. Many of the most popular cartoonists of today learned to draw in their spare time, at home, through the Landon Course of Cartooning and now earn \$75 to \$200 a week.



The Landon Picture Chart Method of teaching ORIGINAL drawing makes cartooning easy to learn. Hundreds of sketches like the above explain every step in creating ORIGINAL heads, figures, animals, etc.

Write today for Sample Landon Picture Chart, long list of successful Landon students and full information showing possibilities for you. Please state your age. The LANDON SCHOOL, 738 National Building, CLEVELAND, OHIO

Four Successful Landon Students From One Village

Here is the record of four boys—all from Nappanee, Ind. (2200 population)—who, after taking the Landon Course, won national reputations:

Merrill Blosser is now nationally famous as creator of "Freckles and His Friends."

Henry Maust's work appears in Saturday Evening Post, Cosmopolitan, etc.

Francis Parks, following their advice, is now a cartoonist for the Omaha News.

Fred Neher is comic artist with the Universal Feature Co.

Learn Photography at HOME

Make \$75.00 a Week on the Side

Establish yourself as a Photographic Expert quickly—during your spare time—under a leading photographer. I'll show you how to start your own business—on command a large salary. Send for my unusual offer—It's really temporary. Act at once. A postal will do. H. R. VANT, INTERNATIONAL STUDIOS, Inc., Dept. C-135, 3601 Michigan Ave., Chicago, U.S.A.



Become An Auto Expert in Spare Time.

Drye's celebrated Automobile and Gas Engine Encyclopedia gives complete course of instruction. 1236 pages, 4142 illustrations, 16,000 photos cover every problem of construction and operation. FREE Automobile Manual. Shows all parts. Send now. Pay postman \$7.50 plus postage on arrival. Mosaic binding. If not satisfied return in 10 days and get your money back. GOODHEART-WILCOX CO., 2009 Michigan Avenue, CHICAGO

PIANO JAZZ

By Note or Ear. With or without music. Short Course. Adult beginners taught by mail. No teacher required. Self-instruction Course for Advanced Pianists. Learn 67 styles of Bass, 180 Syncopated Effects, Blue Harmony, Oriental, China, Movie and Cafe Jazz, Trick Endings, Clever Breaks, Space Fillers, Sax Blurs, Triple Bass, Wicked Harmony, Blue Obligate, and 247 other Subjects, including Ear Playing and Musical Invention. 110 pages of REAL Jazz, 25,000 words. A Postal brings our FREE Special Offer.

Waterman Piano School, 259 South Main Bldg., Los Angeles, Cal.

LAW STUDY AT HOME

Become a lawyer. Legally trained men win high positions and big success in business and public life. Greater opportunities now than ever before. Lawyers earn \$3,000 to \$10,000 Annually. We guide you step by step. You can train at home during spare time. Let us send you records and letters from LaSalle students admitted to the bar in various states. Degree of LL.B. conferred. Thousands of successful students enrolled. Low cost, easy terms. We furnish all text material, including fourteen-volume Law Library. Get our valuable 120-page "Law Guide" and "Evidence" books FREE. Send for them NOW.

LaSalle Extension University, Dept. 884-1, Chicago, Ill.

TELEGRAPHY

Office and Wireless and RAILWAY ACCOUNTING taught thoroughly. Big salaries; great opportunities. Oldest, largest school. Endorsed by Telegraph, Railway, Radio, and Government officials. Expenses low—opportunities to earn large portion. Catalog free. DODGE'S INSTITUTE, Jones St., Valparaiso, Ind.

LEARN WATCHMAKING

and become independent. Good-paying positions secured. Easy to learn. Send for FREE CATALOG. ST. LOUIS WATCHMAKING SCHOOL, Dept. 5, ST. LOUIS, MO.



Dhassi Will Tell You FREE

Do You Know? Are You Lucky?
Under which Zodiac sign you were born?
What significance it has in shaping your life?
IN LOVE
MARRIAGE
FRIENDS
INHERITANCE
SUCCESS

Send Birth Date

I have made Astrology my life's work and offer the most interesting astrological interpretations of the Zodiac sign under which you were born. Send exact name, address and exact date of birth in own handwriting and receive your astrological interpretation in plain sealed envelope, post paid. A great surprise awaits you. Enclose 12c to cover cost of this notice and mailing. Address me personally—DHASSI.

TARA STUDIO, 1133 Broadway, Desk 44, NEW YORK

WANTED

RAILWAY MAIL CLERKS
\$1600 to \$2300 Year
MEN—BOYS, 18 UP

WRITE IMMEDIATELY

Steady work. No layoffs. Paid vacations
Travel—see your Country

Common education sufficient. Mail coupon today—SURE



FRANKLIN INSTITUTE, Dept. M-178, ROCHESTER, N.Y.

Sirs: Send me without charge, (1) Specimen Railway Mail Clerk Examination questions; (2) List of government jobs now open to men, 18 up; (3) Send list of examination places; (4) Send free illustrated book, "How to Get Government Positions."

COUPON

Name.....
Address.....

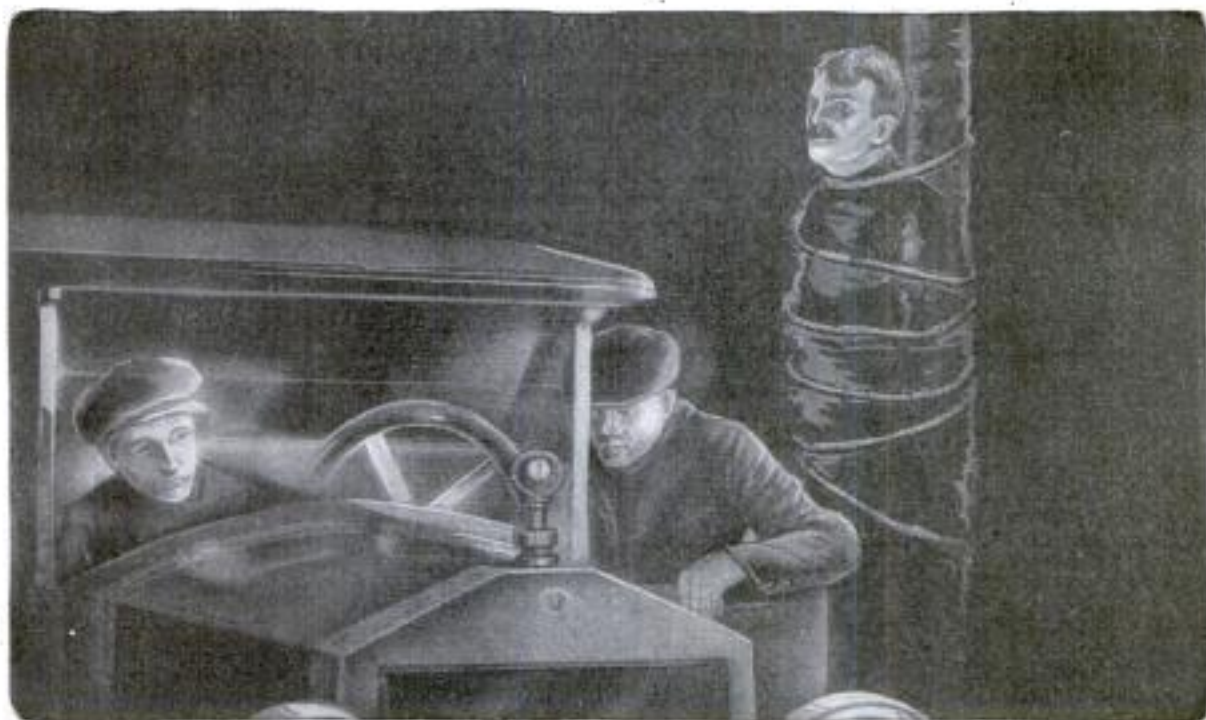

FREE!

Actual Reports of Secret Service Operator 38

HERE is something money can't buy. More fascinating than detective stories. Confidential reports of a real operator—No. 38—to his Secret Service Bureau, headed by the most famous operator in America. Absolutely Free. No cost. No obligation. Don't fail to send for them.

They may point the way to Big Money for you. See how the modern operator works. Read these inside stories of the solution of great mysteries. See what possibilities this most fascinating and eventful of all professions offers to you—and how you may fit yourself for it.

Be a Finger Print Expert

To command the highest fees, the Secret Service man must also be a Finger Print Expert. These reports show why. This profession may be easily learned at home, in your spare time. Wonderful opportunity in this **UNCROWDED, PROFITABLE** field.

Cases of 12 Famous Finger Print Experts

Stories and pictures of *real* crimes solved by Finger Print evidence. Pictures and life stories of famous experts—many, graduates of my school. True facts, but better than fiction.

Also Sent Free
Send the Coupon →

Make \$5,000 to \$10,000 a Year

The unfiled demand for trained Finger Print men is increasing daily. Opportunity is waiting for YOU. No time to lose. Send today for these reports, also our big Free book on Finger Prints. Gives all particulars and success stories of our graduates. Brilliant future ahead of you if you act now.

Special Offer—Limited Time

Everyone getting these Free Reports will also receive my Special Offer of a Professional Finger Print Outfit, absolutely Free. Made for limited time only. Send coupon today—sure. Reports, Finger Print Book, and special outfit offer, all Free and Prepaid. Don't delay, and perhaps forget. Do this right now.

T. G. COOKE, Pres., University of Applied Science
Dept. C-135 1920 Sunnyside Avenue, Chicago, Illinois

T. G. COOKE, Pres., University of Applied Science
1920 Sunnyside Avenue, Dept. C-135, Chicago Illinois

Dear Mr. Cooke:—Please send me **FREE** and prepaid, Reports of Operator 38, your new illustrated book on Crime and Crime Detection and your Special Outfit Offer. It is fully understood that I assume no obligation.

Name Age

Address

Town.....State

FIVE GOOD BOOKS



for readers of
"Popular
Mechanics"
Only \$1
Each

I. C. S. Building Trades' Handbook

A convenient pocket manual for everyone in the building trades. Tells you everything you want to know about arithmetic, weights and measures, formulæ, mensuration, geometrical drawing, structural design, masonry, carpentry and joinery, roofing, plastering, plumbing, heating, ventilation, gas-fitting, estimating, elements of architectural design, etc. 372 pages. 189 illustrations. A wonderful bargain at \$1.

I. C. S. Plumbers' and Fitters' Handbook

The only book of its kind ever published. Filled with sound, practical knowledge and information that you need every day. A condensed encyclopædia of the art and practice of plumbing, heating, ventilating, gas-fitting, etc. Contains much new material. More than 50,000 copies sold. 375 pages. 148 illustrations. Only \$1.

I. C. S. Concrete Engineers' Handbook

A handy reference book worth many times its small cost of \$1. *Contents*—Useful tables, mathematics, loads in structures, mechanics, homogeneous beams, columns, sands and cements, plain concrete, steel reinforcement, foundations, building details, form work, building laws and specifications, etc. 368 pages. 230 illustrations. Only \$1.

I. C. S. Business Man's Handbook

175,000 sold. A handy business book that no builder should be without. Tells all about business forms, card systems, bookkeeping, correspondence, postal information, definition of financial terms, money and the money market, corporations, business law, contracts, partnerships, commercial paper, law of landlord and tenant, etc. 315 pages. 57 illustrations. Only \$1.

I. C. S. Automobile Handbook

Tells all about gasoline engines, transmission and control systems, carburetors, self-starters, bearings, electric ignition, tires, automobile management and maintenance, horsepower calculations, how to make quick repairs, how to anticipate trouble, digest of automobile laws, and other useful information that will save you time and money. 301 pages. 156 illustrations. Only \$1.

These five books, containing 1731 pages and 780 illustrations, represent the greatest book value ever offered for the money. They will be sent anywhere—postage prepaid. Mail the coupon to-day with \$1 for each book you want. You run no risk. Money back if not satisfied.

INTERNATIONAL CORRESPONDENCE SCHOOLS

Box 5625-D, Scranton, Penna.

I enclose \$..... for which send me, post-paid, the Handbooks marked X, at \$1.00 each. It is understood that if I am not entirely satisfied I may return any or all of them within five days and get my money back.

- BUILDING TRADES' HANDBOOK
 PLUMBERS' AND FITTERS' HANDBOOK
 CONCRETE ENGINEERS' HANDBOOK
 BUSINESS MAN'S HANDBOOK
 AUTOMOBILE HANDBOOK

Name.....

Address.....

PLAY TEN-TEN-TENNESSEE!

ON HA HA

THE TENOR BANJO

JAZZ

No Previous Musical Knowledge Necessary—Quick—Easy—Positive
Prof. Barker's method is so simple and easy that you quickly play any and all of the popular dance hits just as you have heard them played in dance or orchestra, on the stage—everywhere.
**JAZZ NEW ORCHESTRA STYLE
NEW EASY WAY—FUN GALORE**

Just Mail a Post Card for Details of our remarkable FREE Tenor Banjo Offer—simply write: "I am interested"—BUT DO IT TODAY.

First Hawaiian Conservatory of Music, Inc.
Desk 60
233 Broadway
(Woolworth Bldg.)
New York City

Special courses under famous teachers:
Violin—Guitar—Piano—Drums—
Instruments—Free

FREE
A Beautiful
Tenor
Banjo

Wonderful, new device, guides your hand; corrects your writing in few days. Big improvement in three hours. No failures. Complete outline FREE. Write C. J. Osmont, D-34, St. Louis, Mo.

BE AN ARTIST

WE CAN TEACH YOU DRAWING in your own home during your spare time. Twenty-five years of successful teaching proves our ability. Artists receive large salaries.

Write Today for Art Year Book

SCHOOL OF APPLIED ART

ROOM NO. 2 BATTLE CREEK MICH.

CHIROPODY

—a well paying, dignified profession for men and women. Opportunities for big practice all cities. Faculty of physicians, surgeons and chiropodists. Largest foot institution in the world. Eleventh year. Degree Doctor of Surgical Chiropody. Write for catalog, Dept. 67, Illinois College of Chiropody, 1327 N. Clark St., Chicago

Try before you Buy

Your choice of 44 styles, colors and sizes in the famous Ranger line. Write for our marvelous prices and terms. Shipped on approval and 30 DAYS FREE TRIAL, express prepaid.

\$5 a Month You can get immediate possession and use of your choice from Ranger or Pathfinder bicycles on our liberal easy Monthly Payment plan. Best quality at factory prices, express paid.

Tires Lamps, wheels, horns, equipment and accessories at unusually low prices.

Mead CYCLE COMPANY

DEPT. 106 CHICAGO

Write today for free Ranger Catalog, factory prices and marvelous easy payment terms.

LEARN WATCH REPAIRING

You can learn by our modern and original system of instruction every part of the Watch Repairing Trade at home as good or better than at a shop. You can earn money while learning and secure a well paying position or start in business after completing our course of instruction. Good watch repairers are always in demand and earn from \$15 to \$70 per week. For particulars apply to the Wisconsin School of Watch Repairing 166 Mason St., MILWAUKEE, WIS.

Repair Any Auto or Auto Truck

Examine These NEW AUTO BOOKS FREE

Be an expert auto repair man. You can have the skill that makes every complicated trouble as easy to fix as taking out a spark plug. Learn every detail of all makes of cars and trucks. Know exactly how to find what's wrong and how to make all repairs quickly. These great new Auto Books show you how.

Make Money Repairing Autos

Over 9 million cars are in operation and thousands of men are needed to keep them in good going condition. There are more jobs open than there are good men to fill them. Never before have expert auto repair men been in such great demand and made so much money. Now is your great money-earning opportunity in the auto repair business. Every mechanic, every chauffeur, every car owner needs this great New Library of Automobile Engineering.

Tells About

Explosion Motors, Welding, Motor Construction and Repair, Carburetors and Settings, Valves, Cooling, Lubrication, Fly-Wheels, Clutch Transmission, Final Drive, Steering Frames, Tires, Vulcanizing, Ignition, Starting and Lighting Systems, Shop Kinks, Public Garage Design, Equipment and Operation, Electrics, Storage Batteries—Care and Repair, Steam Cars, Motorcycles, Commercial Trucks, Glossary, More than 100 blue prints Wiring Diagrams.

75c a Week If You Decide to Buy

Let us send you the complete six-volume set of Automobile Engineering for one week's examination. Read the simple directions for repairing every automobile trouble. Six thick volumes 5½x 8¾ inches, flexibly bound and stamped in gold, 2,650 pages, 2,100 illustrations, wiring diagrams, etc. Everything in plain, every-day language simple to understand. If you decide to keep them, send only \$2.80 in seven days, and \$3 a month thereafter until the special introductory price of \$21.80 has been paid. The regular price is \$45.00, so you save \$23.20 by acting at once.

Send No Money

Don't send a penny! Your name and address in the coupon brings the six books to you at once for seven days' trial.

Mail Coupon NOW

American Technical Society
Dept. A-C19 Chicago, U. S. A.



Starting and Lighting



Welding

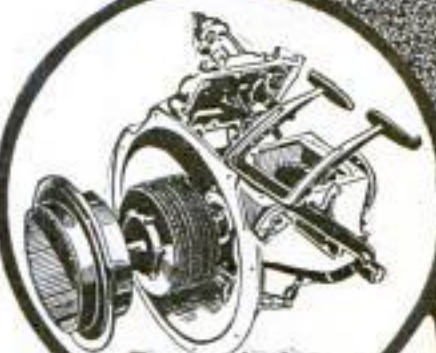

Transmission

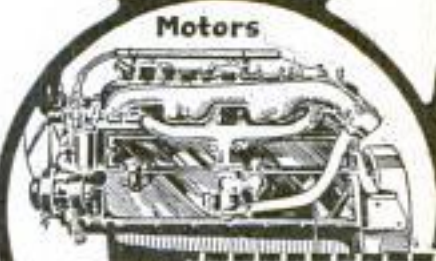

Motors

AMERICAN TECHNICAL SOCIETY

Dept. A-C19 Chicago, U. S. A.

Please send me the six-volume set of Automobile Engineering for seven days' examination, shipping charges collect. If I decide to buy, I will send \$2.80 within seven days and balance at \$3.00 a month until \$21.80 has been paid. Then you will send me a receipt showing that the set of books are mine and fully paid for. If I think I can get along without the books, I will return them, after 7 days, at your expense.

To insure prompt shipment fill out all lines.

Name _____

Address _____

Employed by _____



Be a Certificated "Electrical Expert"

You, too, Can Learn
to Boss This Job

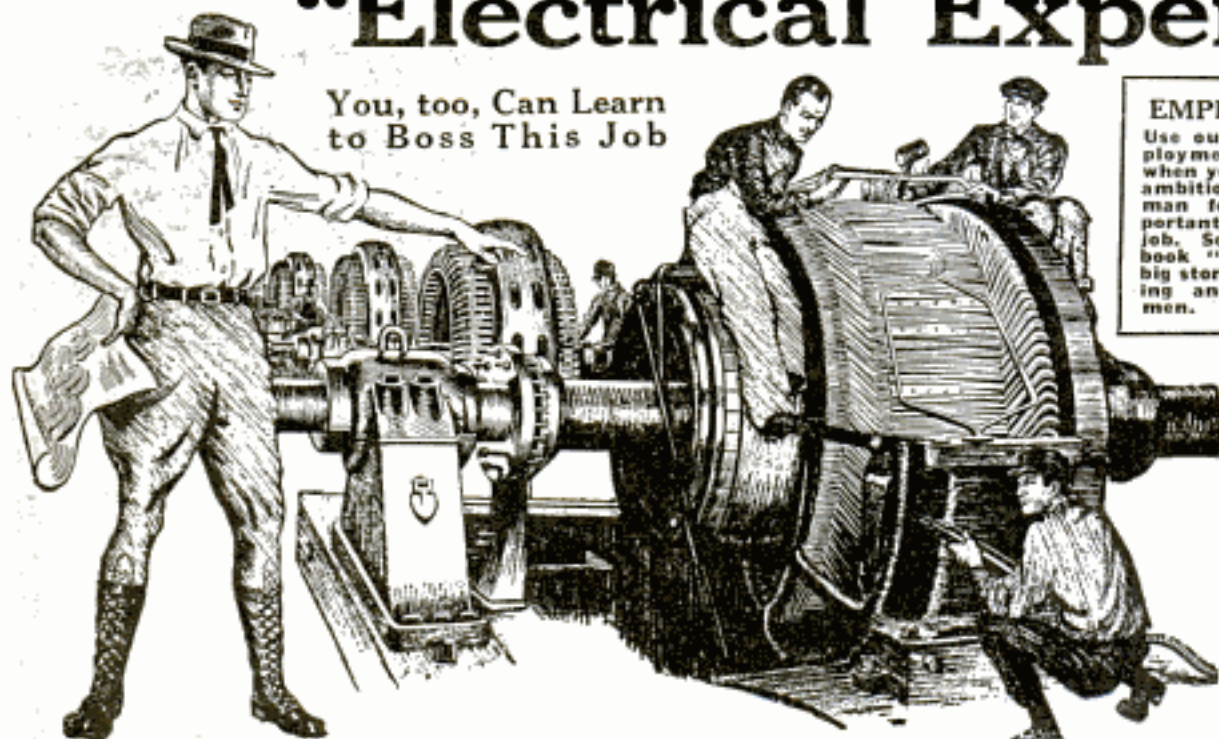

EMPLOYERS

Use our free employment service when you want an ambitious, trained man for an important electrical job. Send for our book "Men"—the big story of selecting and training men.

"Electrical Experts" Earn \$12 to \$30 a Day WHAT'S YOUR FUTURE

Now you earn \$15 or \$20 or \$30 a week. In the same six days as an Electrical Expert you can make \$70 to \$200 a week, and do it easier—not work half so hard. Why then remain in the small-pay game, in a line of work that offers no chance, no big promotion, no big income? Fit yourself for a "Bossing" job—

Be an "Electrical Expert"

Today even the ordinary Electrician—the "screw driver" kind—is making money—big money. But it's the trained man—the man who knows the whys and wherefores of Electricity—the "Electrical Expert"—who is picked out to "boss" the ordinary Electricians—to boss the Big Jobs—the jobs that pay

\$3,500 to \$10,000 a Year

Get in line for one of these "Big Jobs" by enrolling now for my easily learned, quickly grasped, right-up-to-the-minute, Spare-Time Home-Study Course in Practical Electricity.

Age or Lack of Experience No Drawback

You don't have to be a College Man; you don't have to be a High School graduate. As Chief Engineer of the Chicago Engineering Works, I know exactly the kind of training you need, and I will give you that training. My Course in Electricity is the most simple, thorough, and successful in existence, and offers every man, regardless of age, education, or previous experience, the chance to become, in a very short time, an "Electrical Expert," able to make from \$70 to \$200 a week.

FREE—Electrical Working Outfit—FREE

With me, you do practical work—at home. You start right in after your first few lessons to work at your profession in the regular way. For this you need tools, and I give them to you absolutely free—a whole kit, a complete outfit, one that would cost you \$12 to \$15.

Your Satisfaction Guaranteed

So sure am I that you can learn Electricity—so sure am I that after studying with me, you, too, can get into the "big money" class

in electrical work, that I will guarantee under bond to return every single penny paid me in tuition, if, when you have finished my Course, you are not satisfied it was the best investment you ever made.

Guarantee Backed by a Million Dollar Institution

Back of me in my guarantee, stands the Chicago Engineering Works, Inc., a million dollar institution, thus insuring to every student enrolled, not only a wonderful training in Electricity, but an unsurpassed Student Service as well.

It's this Service that makes "Cooke" training different from any other training. It's this service plus "Cooke" training, that makes the "Cooke" Trained Man the "Big-Pay Man," everywhere.

Be a "Cooke" Trained Man and earn \$12 to \$30 a day—\$70 to \$200 a week—\$3,500 to \$10,000 a year.

Get Started NOW—Mail the Coupon

This coupon entitles you to my Big Electrical Book, and sample lessons Free—use it—get in on the ground floor of the nation's biggest and most fascinating industry. Be a Cooke Trained Man, and a Big-Pay Man. Let me show you how.

Mail the Coupon To-Day!

L. L. COOKE, Chief Engineer

CHICAGO ENGINEERING WORKS
Dept. 1-C 2150 Lawrence Ave. CHICAGO

Use this "FREE OUTFIT" Coupon

L. L. COOKE,

The Man Who Makes "Big-Pay" Men
Dept. 1-C, 2150 Lawrence Ave., Chicago, Ill.

Dear Sir: Send at once Sample Lessons, your Big Book, and full particulars of your Free Outfit and Home-Study Course, the Free Radio Course—all fully prepaid—without obligation on my part.

Name.....

Address.....

Occupation.....

The "Cooke" Trained Man is the "Big Pay" Man

Classified Advertisements

WORLD'S BEST WANT AD MEDIUM

Advertisements in this section, 25 cents per word, each insertion, minimum 10 words, payable in advance.
To be inserted under proper classification in September issue, copy should be in our office July 18th.

ADVERTISING AGENCIES

ADVERTISEMENTS designed and written by successful professionals and inserted in any newspapers, magazines, etc., at publishers' regular rates. Our advice, help and service costs you nothing extra. Refs.: any prominent publisher. Now serving many leading advertisers. Shuman-Hays Advertising Co., Third floor, Pelouze Bldg., Chicago.

TO secure agents or salesmen or for selling farms and reaching investors, use classified (want) ads in largest newspapers and magazines. Price list No. 30 sent free. Ankrum Advertising Agency, 20 W. Jackson Blvd., Chicago, Ill. The largest classified advertising agency in the U. S.

25 WORDS—355 Rural Weeklies \$14.20. Ad-Meyer Agency, 4112-M Hartford, St. Louis.

28 WORDS—80 Rural Newspapers \$3.40. Shaw, 221 A St., Northeast, Washington, D. C.

FOR ADVERTISERS

OUR Best Offer—24 words—17 Best Sunday papers \$26.00—proof guaranteed. Keator, Hartford Bldg., Chicago.

INCH Display 100 magazines thrice \$8. Beck, 5406 Alaska, St. Louis.

ADVERTISE in 24 Big Sunday Newspapers, 24 words \$15.00. Catalog listing 1,000 leading Dailies, Weeklies, Magazines, 4c stamps. Union Advertising, Baltimore Bldg., Chicago.

ADVERTISE, hundred magazines, three issues, 10c word. Pennell-Company, Covington, Ky.

SALES PROMOTION

\$50 TO \$50,000 Daily Sales developed during twenty-six years for clients by my direct-mail plans, copy, campaigns. Ten years Sales Promotion Manager Larkin Co. Submit sales problems, free diagnosis. James C. Johnson, 118A Woodbridge Ave., Buffalo, N. Y.

MANUFACTURERS! Inventors! Jobbers! Sales slow? Consult us. Sales analysis and opinion free. If your product is "there" and you are ready to manufacture, we are ready to do the selling. Write Beebe Co., Yonkers, N. Y.

AUTOMOBILE SUPPLIES

AUTO Parts at cut prices! All kinds of new and used, for all cars. Engines, Clutches, Transmissions, Axles, Radiators, Magnets, Generators, Batteries, Shafts, Gears, Bearings, Springs, etc., etc. If you have never known the houses of Warshawsky, you had better write us and get acquainted. Think of buying the Shaler lens for \$3c a pair, and rims for any car at \$2.00 each. Windshields from \$3.00 to \$10.00. Spotlights \$1.75. Welding outfits at a low price. Specify make and model of car when writing. "Ask for Bargain List." Warshawsky & Co., 1935 S. State St., Chicago, Ill.

REPLACEMENT Parts all cars: Valves, Pistons, Pins, Rings, Bearings, Timing Gears, King Bolts, Spark Bolts, Bushings, Gears. Lawrence Company, 6328 Euclid, Cleveland, Ohio.

FORD Touring Top and Back Curtain \$5.25. Back Curtain \$2.00. Chevrolet, Dodge, Overland 4, \$9.75. Double Texture \$12.25. Delivered 1,000 Miles. Vanderpool's, Springfield, Ohio.

BATTERY recharging pays \$100 to \$100 monthly with new Eight Hour Charging System. Easy monthly terms let outfit pay for itself. Thirty days' trial, money back guarantee. Particulars free. Hobart, Troy, Ohio.

AUTOMOBILE parts for all cars. Lowest prices. Save money; get our wholesale catalogue. State make of car, model and parts wanted. Parts shipped immediately from stock. We refund your money if not satisfied. Mechanics Gear Co., 3706 No. Halsted St., Chicago.

OWN Your Own Garage. We'll train you. Free Catalogue. Standard Trade School, 416 Woodward Avenue, Detroit, Mich.

BEST Gas Saver on the market; absolutely no gas wasted—prepaid \$1.00. Gay Stewart, 3011 University Ave., S. E., Minneapolis, Minn.

EDSON Valve Stem Lubricators prevent sticky valves; easily installed; complete for Ford automobile, tractor or Chevrolet motors. Sent on receipt of 75c. Wm. Edson, 210 West 82nd Street, New York City.

REPAIRING Ford Cars, Trucks and Tractors in the most proper and efficient way is explained in a new 229-page book by the former director of the Ford Motor Co. Service School. This information is otherwise unavailable outside of the Ford plant. Written more especially for the mechanic and repairman. Price \$2 postpaid. Popular Mechanics Book Dept., 206 E. Ontario St., Chicago.

AUTOMOBILE Parts—Used parts for most any car at half factory list prices. Allen, Briscoe, Buick, Cadillac, Chalmers, Chevrolet, Dodge, Dort, Grant, Hudson, Hupmobile, Oakland, Overland, Oldsmobile, Reo, Studebaker and many others. Send list of parts wanted. Maxwell Bros., 4106 Olive St., St. Louis, Mo.

AIR Compressors, Automatic, Twin Cylinder, Guaranteed. Easy payments. Free Air service increases business and profits. Particulars free. Hobartco, Troy, Ohio.

BARGAINS—Radiators—Sport Bodies built to order—send sketch. All standard makes radiators furnished at bargain prices. State make and model. We guarantee satisfaction. Independent Radiator Co., 1119 Wabash Ave., Chicago.

HANDIEST thing for the car. Send \$2.50 for magnetic troublelight. Sticks anywhere on car. Cord attaches dashlight socket. State whether single or double contact. E. Bisschmeyer, 1222 Alhambra St., Chicago.

MOTOR Life, gives engine more pep; formula \$1, with simple decarbonizing instructions. O. B. Mowery, Box 208, Weehawken, N. J.

CARBURETORS rebuilt. Any make made like new. Don't buy a new one. 24-hour service. Low prices to garages and service stations. Carburetor Depot, 793 Washington St., Buffalo, N. Y.

LIGHT, speedy, twin cylinder cyclocar, \$75.00. Four-cylinder Saxon roadster, \$85.00. Earl Danks, West Union, Iowa.

AUTOMOBILES

PATENTS Procured. Send sketch or model today for examination, prompt report and advice. No charge for preliminary advice. Write for free booklets "How to Obtain a Patent" and "Invention and Industry" and blank form on which to disclose your idea. Highest references. Promptness assured. Clarence A. O'Brien, Registered Patent Lawyer, 585 Security Bank Building, Directly across the street from Patent Office, Washington, D. C. See pages 148 and 149.

AUTOMOBILE Guide Books. MacNair's Motorway Guides, best roads, best hotels, reliable text, accurate detailed maps. Fifty cents each; stamps, coin; Midland Motorways, Mississippi-Atlantic routes, 11,000 miles; Seaside Motorways through New England, 8,000 miles. Metropolitan Motorways around New York. Address, Motorways, Breckw Building, New York.

A REAL trouble shooter motor book. Shows the car owner how to make adjustments and minor repairs in every case where the services of an expert repairman are not actually required. \$1 postpaid. Popular Mechanics Book Dept., 206 E. Ontario St., Chicago, Ill.

PATENTS—Write for our Guide Books and "Record of Invention Blank" before disclosing inventions. Send model, or sketch and description of your invention for our free Examination and Instructions. Highest references. Reasonable terms. See advertisement on pages 146 and 147. Victor J. Evans & Co., 185 Ninth, Washington, D. C.

FREE Catalogue for men interested in learning Auto Repairing. Standard Trade School, 416 Woodward Ave., Detroit, Mich.

WHAT do you need? We have it. Gray's Auto Parts Company, 3212 Brighton Road, Pittsburgh, Pa.

RACING Bodies for Fords and Chevrolets 490. Send for free particulars. Our book "How to Build a Ford Racer" sent on receipt of 25c. Central Auto Supply Company, Dept. 120-C, Louisville, Ky.

DYKE'S Automobile Encyclopedia. 13th edition, new, greater than ever, entirely rewritten and rearranged. Contains greatest array of automobile facts ever published in one volume. Separate books containing same information cost \$21. Over 1200 pages and 4100 illus. Cloth \$6. Flex. Amer. Morocco \$7.50 postpaid. Popular Mechanics Book Dept., 206 E. Ontario St., Chicago.

FOR FORD OWNERS

KIM-DIMS for Ford cars eliminates the use of dimmers and gives you full bright headlights in two positions. Straight ahead and tilted down. Gives you best of light when you need it most. Complies with the laws in all states. Write for circular. Kim-Dim Specialty Works, Taylorville, Ill.

\$5.00 RENEWS Your Ford. C. O. D. Trial Money Back Guarantee. Extraordinary Results. Windsor Support & Stabilizer Corp., 730 Fifth Avenue, New York City.

FORD Repair Book Free: A very complete and well illustrated book explaining how to make repairs on most every part of your Ford. We offer this book free with a nine months' subscription to Ford Owner and Dealer Magazine—at only \$1.00. Everyone interested in the Ford car should read this big magazine of about 200 pages monthly. It clearly explains the things you want to know about cutting down the cost of operation, the engine, ignition, transmission, carburetor, etc. Send today and get the valuable Repair Book Free. Ford Owner and Dealer Magazine, 544 Montgomery Bldg., Milwaukee, Wis.

WIZARD-IZED "Fords" Guaranteed—Four Miles More Every Gallon. Marvelous Instrument Quickly Installed. Owner-Representatives \$50.00 Weekly. Investigate. "Wizard" Mfg. Company, Rochester, N. Y.

H & B ALL Year clear Vision glass enclosure for 1923 and 1924 Ford touring cars and roadsters. Comfortable as a closed car. No rattles or squeaks. Special offer to live Ford dealers. Prices on request. Holmes & Beutrom Co., Dept. P., 365 17th Ave., Milwaukee, Wis.

SPARK Plugs for your Ford, Four for a Dollar, postpaid. Regular price \$1.00 each. Volk, Dept. PM, Sixteenth St., Bloomfield, N. J.

TWO-DOOR Ford Sedan beds \$8.50. Particulars, Milligan & Chrey, Bremerton, Wash. UNDERSLING with "RKO" Swing Lo Irons. See "Red-I-Kut" ad page 137.

LUBRICATORS for Ford Springs. The old reliable Van Spring Oilers—guaranteed. Complete set of four prepaid on receipt One Dollar. Sizes for all other cars thirty-five cents each. Gayne E. Baylis, 177 North State Street, Chicago.

SPORT and Speedster Bodies for Fords built to order, \$36.00 and up. Write for particulars. Keller Auto Body Co., Inc., Dept. 42., 317 W. Winkler Ave., Louisville, Ky.

TOURISTS and Campers! You need my extension on your Ford. Write for particulars. Graff, Cherrydale, Va.

MOTORCYCLES, BICYCLES AND SUPPLIES

SEND for our Bargain Bulletin and Money Saving Message. It will save you money on Motorcycles, Side Cars, Motor Wheels, Repair Parts and Accessories. Some used parts at less than half. Cleveland and Ace Motorcycles our specialty. See our ad on page 135. American Motor Cycle Co., 2043-5-7 W. Chicago Ave., Chicago.

BARGAINS in reconditioned Motorcycles at 20 to 30% off former list prices. Buy Now. Send stamp for free list. Tulsa Motor & Cycle Co., Tulsa, Okla.

MOTORCYCLES \$15-\$75. Engines \$3-\$25. Frames 50c. Knight's, 1512 Locust, St. Louis, Mo.

USED parts for all motorcycles, cheap. State wants, Schuck Cycle Co., 1922 Westlake, Seattle, Wash.

MOTORCYCLES! Every machine rebuilt—tested; send 2c for bulletin of Rebuilt motorcycles at a 50% saving. Western Supplies Co., 359 Hayutin Building, Denver, Colo. "The Largest Cycle and Motor House in the West."

MILEOMETER for your bike or motorcycle. \$2.50 C. O. D. Absolute accuracy. Guaranteed one year. State make and size tire. Mileometer, 793 Washington St., Buffalo, N. Y.

SAVE Money on motorcycle accessories and salvage parts; all leading makes. Big discount. Send for catalogue. Tulsa Motor & Cycle Co., 202 So. Lansing, Tulsa, Okla.

1922 HARLEY-DAVIDSONS, \$135; 1921, \$115; 1920, \$85; 1919, \$65; 1917, \$50; 1916, \$45; 1915, \$40; 1914, \$35. Guaranteed. Money refunded if not satisfied. Circular free. Wisconsin Cycle Sales Co., 726 National Ave., Milwaukee, Wis.

DON'T buy a Bicycle Motor Attachment until you get our new catalogue and prices. Also runs washers, pumps, and shop machinery. Shaw Mfg. Co., Dept. 27, Galesburg, Kans.

SEND for big list of slightly used motorcycles on the easy payment plan. Howard Cycle Co., Trenton, N. J.

NEW and used parts for Motorcycles and Bicycles. Get our prices on parts needed. Kingshighway Motor Co., 1168 N. Kingshighway, St. Louis, Mo.

AVIATION

"**LEARN** to Fly." \$100-\$164. Airplane Bargains: Curtiss \$500. Hisco—Standard three passenger \$900. Sportplane \$350. Rotary motor \$75. Plans for Builders; Motorcycle Engine Monoplane \$1. Sportford Biplane \$2.50 Sportplane Propellers \$8. Circular Free. Aviation Engineering Co., Lawrence, Kans.

SEND 10c for our latest aeronautical catalog listing a complete line of airplane goods at reduced prices; Propeller circular 4c. Ford Airplane, or Motorcycle Airplane circulars, 4c each. Resistal goggles \$2.90. Heath Airplane Co., Chicago, Ill.

COMPLETE Scale Plans, with Building-Flying Instructions for following 3 ft. Model Aeroplanes, 25c each postpaid: JN4D-2; De Havilland; N. C.-4; Curtiss Tractor; Bleriot; Nieuport or Taube Monoplanes; Cecil Peel Racer. Complete 48 pp. catalogue 5c. Ideal Aeroplane Co., 105½ Spring St., New York.

AIRPLANES, Flying Boats, Motors, aircraft supplies; New Curtiss Jenny airplanes complete \$1650; OX5 Motors \$250; Liberty Motors \$2750; Leather Helmets \$4.50; unshatterable goggles, Jumbo \$3.50 or wide-visor \$5. Compass \$15; spark plugs 40c; Gradometers \$2.50; 24 by 4 wire wheels \$6.50; cord tires \$4; inner tubes \$2. Berlin magnetos \$17.50. Floyd Logan, 716 West Superior, Cleveland, Ohio.

PATENTS Procured. Send sketch or model today for examination, prompt report and advice. No charge for preliminary advice. Write for free Booklets "How to Obtain a Patent" and "Invention and Industry" and blank form on which to disclose your idea. Highest references. Promptness assured. Clarence A. O'Brien, Registered Patent Lawyer, 585 Security Bank Building. Directly across the street from Patent Office, Washington, D. C. See pages 148 and 149.

TEN lessons in the air, of twenty minutes each, will make you a pilot, by our advanced method of training. This, together with our five-week shop course at \$100.00, makes America's oldest aircraft factory the most popular flying school. Work after class hours guaranteed. Heath Airplane Co., Chicago, Ill.

AIRPLANE Engineering, under the Western Airplane Corporation method of practical home training, offers you a chance to be Successful and become a Leader in this newest industry. Written for the Airplane industry by Airplane men, this Up-to-date Course is offered to you for the first time after training hundreds of successful Mechanics and Engineers. Write for catalog. Western Airplane Corporation, Monadnock Block, Chicago.

THE American School of Aviation announces a new correspondence course in Mechanics of Aviation. A thorough training in Practical Aeronautics. American School of Aviation, Dept. 1865, 2601 Michigan Ave., Chicago, Ill.

BOYS get a three-foot model aeroplane free. Nothing to sell. Write to Aero Shop, 2050 Hurbit Ave., Detroit, Mich.

WELDING

WELDING Encyclopedia—New Third Edition. Complete training course for operators in all welding processes; oxyacetylene, electric arc, electric resistance and thermit. Welding of all weldable metals fully discussed. 437 pp., 690 ill. The accumulated experience of the welding brains of America is yours for \$5. Money back if not satisfied. Popular Mechanics Book Dept., 206 E. Ontario St., Chicago.

BOOKS AND PERIODICALS

STRICKLAND'S Battery Guide gives the care and operation of the automotive storage battery. Written in understandable language, for automobile owners, mechanics, battery men. This country lost \$1,000,000.00 last year because batteries didn't receive proper attention. Latest edition \$1. Last previous edition 50c. C. J. Strickland, Box 542, Norfolk, Va.

ARTS-CRAFTS Library—How to make lamps, decorative handles, metal etched articles, and many other useful art objects. Three cloth-bound pocket-size books. Only \$1.50. Popular Mechanics Press, Room 867, Popular Mechanics Building, Chicago, Ill.

RARE Book printed 1615, splendid condition. Fernandez, Box 241, Santurce, Portorico.

HINDU Psychology, Secret Sciences. Illustrated Catalogue, lesson 25c. Adaros, 116 South Michigan, Chicago.

PRACTICAL Psychology Teaches Hypnotism, Personal Magnetism, Magnetic Healing, Auto-Suggestion, Cure Habits and Disease. Easy Lessons. Send for Booklet, 4 cents stamps. Fernando, Dept. M, Springfield, Mass.

LEFAX—"Facts on Leaves." You make your own handbook, loose-leaf. From our complete list of Lefax data sheets you select only those that you actually need, then fill in your own notes or diagrams on extra blank sheets which come in 100 different styles. These in loose-leaf binder make up a book covering your individual needs. Send for complete information and price list to Popular Mechanics Book Dept., 206 E. Ontario St., Chicago.

FREE. Send for my book on Big Pay Trades. Standard, 416 Woodward Ave., Detroit, Mich.

HYPNOTISM Astoroids, Controls, Inures wealth and fame. 25 easy lessons \$1.00. "Mindreading" (Any distance) Wonderful. Success Guaranteed 60c. "How to Win in Business, Love, and Society." 400 pages \$3.00. Popular Institute, 11014 Belmont, Chicago.

176 PRACTICAL Subjects, how to master any of them. A new booklet giving reliable advice on how to study 176 subjects at home is free. Write your name and address on a postal and say, "Send me 'An Easy Way to Master 176 Practical Subjects'" and mail to Popular Mechanics Press, Room 597, Popular Mechanics Building, Chicago, Ill.

25c EACH, Success-Happiness, Hypnotism, Clairvoyance, Cune's System, Astrology, Phenology, Success-Key, Bargain Catalog (stamps). Phipps Library, 1014 Belmont, Chicago.

WRITERS: Study at home; 30 text books; criticism and advice regarding markets for manuscripts. Catalogue free. Correspondence invited. James Knapp Reeve (former editor The Editor), 50 Alexander Bldg., Franklin, Ohio.

WAS Jesus Christ a Prohibitionist? Read "Prohibition and The Bible." A Remarkable book. Copyrighted. 50c postpaid. G. O. Shaver, Box 115-P, Norphlet, Ark.

"NATURE'S Finer Forces": Vibrations; Lights; Colorisms; Electromagnets; Oculicuras; Radio; Coldlights; Inventions; Wonderful Opportunities; Fifty Lessons; Marvellous Cures; Illustrated. Satisfaction Guaranteed. 270 pages, \$2.00. DeLuxe \$3.00. M. Stevens, 242 Powell, San Francisco, Calif.

HYPNOTISM Dr. Braid's wonderfully successful methods \$1.10. "Mesmer's" 5,000 Secrets \$1.10. "Automagnetism" Generates vital energy and personal magnetism \$1.10. "The Way to Win" 10c. "How to Live Right" 10c. Baker Specialty Co., PA4213 Carroll Ave., Chicago.

MAGAZINE Guide—Subscription Catalog, Dime, Smith, Box 1032, Rockford, Ill.

INDUSTRIAL Alcohol. Wright's book. Full directions for making drawings. \$2.50. Spoon & Chamberlain, 129 P. M. Liberty Street, New York, N. Y.

FREE—Send for my Neuthought, Self-culture, Occult, Mystic and Scientific book literature. Martens Publisher, Burlington, Iowa.

HYPNOTISM easily learned. Lessons guaranteed. Postpaid \$1.10. Smith Pub. Co., Dept. 3, Springfield, Mass.

PICTURES AND POSTCARDS

FINE Oil Paintings from Nature. Artist of experience. \$10.00 up. Descriptive catalogue. Satisfaction guaranteed. Pupil of G. W. Whitaker, Chas. H. Battey, 284 Lloyd Ave., Providence, R. I.

JOIN Live Postcard Club. Membership lists, including catalog, 10c. Harvey Teeple, Decatur, Ind.

NOVELTIES, CURIOS, ETC.

NEW Novelties from Japan, Germany, \$20 a day easy. Write for free selling plans. Sports Co., Lesueur Center, Minn.

GAMES, ENTERTAINMENTS AND PLAYS

ENTER Vaudeville—Mystifying stunt, Side-splitting. Information 25c. Greenwalt, Box 430 E. E., Pittsburgh, Pa.

VENTRILOQUISM taught almost anyone at home. Small cost. Send 2c stamp today for particulars and proof. George W. Smith, Room M-867, 125 N. Jefferson Ave., Peoria, Ill.

SUMMER Sports—Devices for golf, tennis, fishing, swimming, hunting, and all sorts of outdoor sports. Full instructions for making all devices. Well illustrated. Only 50 cents. Popular Mechanics Press, Room 807, Popular Mechanics Building, Chicago, Ill.

MAGIC TRICKS, BOOKS AND JOKER NOVELTIES

BOOK of magic tricks, 10c. Book of card tricks, 10c. Book of coin tricks, 10c. Princess of Yogi. Wonderful card trick, creates a sensation, 10c. Geo. Fenner, Louisville, Ky.

MAGIC—Tricks, Books and Supplies. For Amateurs as well as the great professionals. Anyone can learn through our instructions. Feature Acts in Mind Reading, Spirituality, Rope Ties, etc. Large illustrated Professional Catalog, 20c. Chicago Magic Co., 140 E. Dearborn St., Dept. R, Chicago, Ill.

MAGICIAN'S Nicked Pistol \$1.00. Seven tricks and four catalogs 25c. Gilmagico, Morgan Park, Chicago.

DIMINISHING Billiard Ball, 50c. Secrets, Pocket Tricks, Small Magic. Lowest Prices. Catalogue free. C. Peniz, Minneapolis.

MYSTIFYING Illusions. Entertain, astonish your friends. Make money, giving exhibitions. Particulars for stamp. Geo. Fenner, Louisville, Ky.

TRICKS, puzzles, jokes, magical apparatus, plays, stage supplies, mind-reading, sensational escapes, large illustrated professional catalog, 10c. Oaks Magical Co., Dept. 548, Oshkosh, Wis.

STAMP COLLECTING

BOYS! How would you like a nice pocket stock book, filled with good stamps from Africa, Iceland, White Russia, Gold Coast, Dominican Republic, Bosnia-Herzegovina, etc.? This fine outfit for only 5c to approval applicants! Extra this month: 2 fine triangle stamps and perforation gauge free with each order! M. P. Berry, Box 756, Wrentham, Mass.

ANCHER'S \$\$\$ Outfit—only 12c! Fine triangle stamp; set German stamps with (pre-war) value forty million dollars (interesting); perforation gauge, same scale; small album; 2 approval sheets; airmail set; scarce stamp from smallest republic on earth; newspaper set; pocket good stamps from Travancore, Johore, Dutch Indies, etc. Entire outfit for 12c to approval applicants! (Nice pocket stock book, value 25c, with every order!) Ancher Stamp Co., 148½ Clerk St., Jersey City, N. J.

FAMOUS Fenway Outfit — 2 triangle stamps, small album, 5 blank approval sheets, 250 hinges, perforation gauge, 5 large French Colonials, 2 special deliveries, animal set, red cross set, packet 55 different, including Abyssinia, Azores, Cape of Good Hope, Bosnia, Crete, Congo, etc., 16-page price list, all for 12c to new approval applicants. Fenway Stamp Co., Fenway Station, Boston, Mass.

NYASSA Giraffes and packet of 52 different scarce stamps, Flume Triangle, large \$1.00 U. S. Rev., millimetre scale, perforation gauge and ruler for only 9c. To introduce our Sudden Service approvals. Fenell Stamp Company, Dept. P, Pullerton Bldg., St. Louis, Mo.

DANZIG Free—Nice Set Danzig Stamps with Biggest Lists Issued. 2c postage. Midland Stamp Co., Station E2, Toronto, Canada.

MYSTIC'S "Mysterious" Packet! Contains stamps from the lands of cannibals, heathens, sun worshippers, and wild savages. Included are Travancore, Malay, Dutch Indies, Liberia, Slam, Africa, Abyssinia, North Borneo, Nyassa, Congo, etc. This wonderful packet containing 110 all different (mostly unused) for only 8 cents to approval applicants. Mystic Stamp Co., Dept. 8, Camden, New York.

\$3.00 FOR 12c! 100 different Newroupe. Catalogued \$2.00 Red Cross set, Airplane set, Perforation gauge, Millimetre scale, Fine wallet, 3 approval sheets, 250 hinges, scarce packet from Nyassa, Abyssinia, etc., price list and approvals—all for 12c to approval applicants. Atlanta Stamp Co., Box 532, Atlanta, Ga.

PACKET of 23 stamps, no two countries alike. Packet hinges. Set of \$1 and \$2 U. S. Rev., all for 5c. P. M. Miami Stamp Co., Toledo, Ohio.

START a Stamp Collection—70 different stamps from 70 different foreign countries, including Africa, Asia, Australia, Europe, West Indies, etc. Our pamphlet which tells "How to make a collection properly," and price list of albums, packets and sets all for only 16 cents. Queen City Stamp Co., Room 36, 604 Race St., Cincinnati, O.

"TEN for a Cent." 100 varieties stamps 10 cents; 200 varieties 20 cents; 300 varieties 30 cents; 500 varieties 50 cents. Send reference for approvals. 60% off list. F. H. Holman, Box 222, Lewiston, Maine.

100 DIFFERENT New Europe Free to approval applicants sending return postage. Anvelink Stamp Company, Milwaukee, Wis.

100 DIFF. Foreign, 8c; 35 Diff. U. S., 15c; approval reference. Mountain City Stamp Co., Box 335, Mannington, West Va.

2,000 DIFFERENT stamps, \$5.25; 1,000 \$1.35; 500, 35c; 300, 25c. Michael, 5353 Calumet, Chicago.

FRENCH Colonies, 150 different \$1.00. Nice Morocco set free. Biggest values on 1/2 cent approval. Something new. Georges Stamps, 4133 Second, Detroit, Mich.

LAST Chance! Free, 10 beautiful Rhein-Ruhr stamps to approval applicants. Penna. Stamp Co., Manor, Pa.

SOMETHING different! 65 Balkan States 40 cents, 25 Belgian 15 cents to approval applicants. Davies Stamp Co., Box 108, Toledo, Ohio.

STAMPS on approval 1/2 cent up. Free Premium. Herbert Kelgwin, Middletown, N. Y.

100 STAMPS 10c. David Hokanson, Greeley, Colorado, Route 7.

250 MIXED stamps and souvenir photo, 10c. Phil Lunsted, Cape Cottage, Maine.

100 RARE Stamps, all different; bargain list. Stamp Magazine, everything only 7c. Stanton, Niantic, Conn.

STAMPS sent on approval at 75% discount. Reference required. Emory Benoit, Hanover, Pa.

GOOD Stamps on Approval. They will Satisfy. Cole, 3019 Wallace St., Chicago.

TEN Large Showy Stamps Free, in order to introduce our fine List of Sets, and 50% Approvals. Postage 2c. Payn Stamp Co., 945 Vista Drive, Los Angeles, Calif.

FREE! World's smallest stamp. Approvals. Postage 2c. Cannon Company, Davenport, 7, Iowa.

WONDER Offer. 2 Egypt, 2 Cuba Maps, 1 Cameroon Tiger Stamp, 50 Diff. Stamps, Big List, Etc., 7c. Fore Stamp Company, Dept. M, Detroit, Mich.

105 CHINA, etc., stamp dictionary, list, 2c. Album (500 illustrations), 3c. Bulhard, Sta. A, Boston.

BIG Variety Packet Foreign Stamps Free for 2c postage. Gray Stamp Company, Station E10, Toronto, Canada.

FRENCH Colonies Free.—Pretty Picture Set, Native Chiefs, Tigers, 2c Postage. Empire Stamp Company, 342 Lippincott, Toronto, Canada.

999 MIXED U. S., old and new, 10c; Album, 15c; 1,000 hinges 10c. Free stamps to approval applicants. Weatherby, Medina, Ohio.

BIG \$4.00 outfit and premium to approval applicants 10c. Buckley, 712 Bowen, Dayton, Ohio.

POSTAGE Stamps. 200 Mixed Foreign 10c; 50 U. S. Each different, 10c. Marie Stamp Exchange, Villa Park, Ill.

20 UNUSED stamps free. All different. Postage, 2c. P. M. Fisk Stamp Co., Toledo, Ohio.

FOREIGN Stamp Collection Sent Free. Cornish Co., Schenectady, N. Y.

FREE! Loose Leaf Postage Stamp Album at rate of 8 pages each month given with subscription to monthly Journal. Send 2c stamp for prospectus. United Stamp Co., Marquette Bldg., Chicago, Ill.

FREE—50 varieties to approval applicants sending 2c. Richard P. Lamprecht, Valparaiso, Ind.

STAMPS, 50 varieties, Africa, Brazil, Peru, Cuba, Mexico, etc., 10c. 50 different U. S., 25c; 1,000 mixed, 40c; 1,000 hinges, 10c. List free. C. Stegman, 5948 Cote Brillante, St. Louis, Mo.

ZAMBESIA, Zanzibar, Abyssinia, Herzegovina, Allenstein stamps, menagerie collection, album, 10c. Liberty, 3974 Arsenal, St. Louis, Mo.

FREE—25 different U. S. Stamps with 60% approvals to reliable parties, 75 different U. S. Stamps 25c. C. Seidenberg, Merton, Wis.

FREE—Two sets Nyassa, 20 Diff. British Colonies Barbados and Jamaica pictorials and a packet of hinges—all for a request for my 1, 2 and 3c not approvals, none better. Chas. T. Egner, 4821 Frankford Ave., Frankford, Phila., Pa.

30 DIFFERENT Newroupe, German Air Mail Set. Free to applicants for my 1, 2, and 3c net approvals; also my high-priced stamps at 50% discount. Chas. W. Schmidt, 3227 Benner St., Wissinoming, Philadelphia, Pa.

24 VARIETIES Cuban stamps, 10 cents. List of 6,000 low-priced stamps free. Address Chambers Stamp Co., 111P, Nassau St., New York City, N. Y.

STAMPS, 100 all different, Postage 2c. Lists free. P. M. Quaker Stamp Co., Toledo, O.

158 GENUINE Foreign Stamps, Mexico War Issues, Venezuela, Salvador and India Service, Guatemala, China, etc., only 5c. Finest approval sheets 50 to 60%. Agents Wanted. Big 72-p. Lists Free. We Buy Stamps. Estab. 20 years. Hussman Stamp Co., Dept. 54, St. Louis, Mo.

RARE COINS

OLD Money Wanted. Have you an odd or old coin or bill? It may be worth several dollars. Get posted. Send 4c for Coin Circular. May mean much profit to you. Send now. Numismatic Bank, Dept. H, Fort Worth, Texas.

40 OLD coins, all different, \$1.00. 300, all different, German City Bills, \$1.50. Claud Denney, Box 315, Dallas, Texas.

CONFEDERATE \$5 and \$10 bills, 25c. Durno, 25 Mulberry, N. Y. City.

OLD Coins for Sale—Everett Granville, Numismatist, West Fitchburg, Mass.

RARE Coins, Medals, Paper Money, United States, Foreign and Ancient Mexican Bill and New Catalogue, 10c. Alexis Mengelle, Box 387, Colorado Springs, Colo.

OLD Coins, Large Spring selling catalogues of coins for sale, free. Catalogue quoting prices paid for coins, 10c. William Hesslein, 101 A Tremont St., Boston, Mass.

CALIFORNIA gold, 1/4 size, 27c; 1/2 size, 53c; three-cent-piece and catalogue, 10c. Norman Shultz, Colorado Springs, Colo.

GET Profit and Pleasure in collecting Old Coins. Send 10c for Sample Old Coin, together with my Large Illustrated Coin Catalogue. You'll be delighted with it. Send for it right now. B. Max Mehl, Professional Numismatist, Mehl Bldg., Dept. P, Fort Worth, Texas. Largest Rare Coin Firm in U. S.

FOR BOYS

MOUTH-ORGAN Instructor (16 big pages), 25c. Play in one hour. Eighteen good selections of music, including "Mocking Bird," with complete instructions for playing immediately. Thousands sold. Order today—become popular. Boxing Instructor, 25c; 150 Song Parodies, 10c. 250 Magic Tricks, 10c. Ford Joke Book, 10c. "Ventriloquism," 10c. Boy Electrician, 10c. Toy-maker Book, 1c. All for \$1.00. G. Eisen, Bowling Green, Ohio.

THE Boy Mechanic—The best book in the world for boys who like to make things. Tells how to make playthings such as kites, airplanes, merry-go-rounds, and a thousand other devices. You can earn the cost of the book in a few days by selling some of the articles you make. Price \$2 postpaid. Popular Mechanics Press, Room 807, Popular Mechanics Building, Chicago, Ill.

200 FEET Fine Film \$1.00 Postpaid. Northern Theatre Supply Company, Duluth, Minn.

BOYS! Sell our needle books. Sample ten cents. Universal Sales Company, Dept. D, Box 152, Springfield, Ill.

SUMMER Sports—How to make devices for summer sports. Kites, airplanes, wind wagons, swimming accessories, and dozens of other things every live boy wants in summer time. An 84-page book, jammed with ideas. Instructions are complete and can be followed by any intelligent boy. Only 50 cents. Popular Mechanics Press, Room 807, Popular Mechanics Building, Chicago, Ill.

CAMERAS AND PHOTO SUPPLIES

CLEAR, bright prints that will never fade; 3c each for vest-pocket size; Brownie No. 2 and No. 2A, 4c each; larger sizes, 5c each. 8x10 enlargement 55c from any kodak film. We develop any roll film for 10c; film packages 25c, mailed back same day. Satisfaction guaranteed. Leon Lambert, 539E So. Volusia, Wichita, Kans.

AMAZING Trial Offer! Your Kodak Films developed; 6 fine glossy prints; only 15c. Associated Photo, Box 1463-W, Cincinnati, Ohio.

IF you are interested in pictures you are interested in Camera Craft (15c a copy), 703 Market Street, San Francisco, Calif.

PHOTOGRAPHIC equipments and accessories of every description are listed and illustrated in our 178-page catalogue. It will pay you to secure a copy which is issued free, as our prices are low. We also deal in used goods which are sold under the same guarantee as new goods. Ask for our Bargain Book. Central Camera Co., Dept. E-84, 124 S. Wabash Ave., Chicago, Ill.

FILMS Developed Free—Write for proposition. Lens cleaner free. Mack's Photo Shop, Waterloo, Iowa, Box 26.

BIG Money Saved on Photographic Lenses and Apparatus—goods exchanged; repairing done. Ralph J. Golsen, 1128 Argyle St., Chicago, Dept. P.

FILMS developed, Prints made. Write for Price List and Free sample print today. Z. Koscielnik, Box 1361, Detroit, Mich.

KODAK Films—Special trial offer; your next kodak film developed, 3c—prints, 2c each. Moser & Son, 1917 St. James Ave., Cincinnati.

MODERN Photography in all its branches now taught by mail. New Successful Method. Students earning \$300.00 while learning. Big opportunity. Write for particulars and unusual offer open for short time. Dept. 3131, International Studios, Inc., 2601 Michigan Ave., Chicago.

FILMS Developed, Printed. Neer fade gloss prints. Lightning service. Something new. Write for prices. F. R. B. Photographers, 1503 Lincoln Ave., Cincinnati, Ohio.

HAVE You a Camera? Write for Free sample of our big magazine, showing how to make better pictures and earn money. American Photography, 116 Camera House, Boston, 17, Mass.

FILMS Developed, Special Trial Offer. Any Size Kodak film developed 5c, prints 3c each. Trial 6x10 Enlargement in handsome folder 40c. Overnight Service. Roanoke Photo Finishing Co., 209 Bell Ave., Roanoke, Va.

FILMS Developed 5c—Prints 3c each. The new Davo finish. Davis Photo Shop, Dept. A, Cincinnati, Ohio.

HAND colored slides from your negatives, 50c. Art Slide Studio, 52 Niagara St., Buffalo, N. Y.

FILMS, 5c each; Prints, 3c each. Any size. One hand-tinted Free with each order. Azubynen, Bristol, Vt.

SUPERIOR quality finishing and enlarging. Trial offer: Any size 6 exposure roll developed and printed, 25 cents. 8x10 enlargement unmounted, 30 cents. Carthoff Photo Finishing Co., 2129 W. Van Buren St., Chicago, Ill.

MOTION PICTURES

O BOY! The Bass "Bargaingram" for this month will astonish you. Think of a complete Professional Motion Picture Camera, Tripod, Film, ready to start in a news weekly studio or commercial motion-picture film for only \$74.50. Dozens of other items just as good. Write for your copy at once. Hundreds of Bass' customers have become financially independent making motion pictures. The 575-page "Cinema Handbook" for only \$3.00 postpaid. The 52-page "Bass Catalogue" is free! Write or wire at once! Bass Camera Company, 105 North Dearborn St., Chicago, Ill.

AMERICA'S Greatest Fortunes made in the Motion Picture business. We furnish complete theatre equipment on easy payments. Openings everywhere. Catalog free. Monarch Theatre Supply Co., Dept. A, 724 So. Wabash Av., Chicago, Ill.

BIG Money Nightly—Good assortment. Complete outfits, installment plan. Splendid Home Outfit, \$25.00. Ralph J. Golden, Dept. M, 1128 Argyle St., Chicago.

MOTION PICTURES

EVERYTHING for "Movie Man"—lowest prices. Catalogs Free. Grobarick, Eldridge Park, Trenton, N. J.

MOVIE Films for Home, School, Church, and Theatres. Comedy, Drama, Cartoon, Cowboy, Indian, Jungle, Religious, Historical, Fairy, Travel, Vederil and Educational subjects. \$5.00 per reel up. Complete List. Monarch Theatre Supply Co., Dept. G, Memphis, Tenn.

\$35.00 PROFIT nightly. Small capital starts you. No experience needed. Our machines are used and endorsed by government institutions. Catalog free. Atlas Moving Picture Company, 482 Morton Bldg., Chicago.

\$\$\$ FOR Ideas. Photoplay plots accepted any form; revised, criticized, copyrighted, marketed. Advice free. Universal Scenario Corporation, 206 Security Bldg., Santa Monica and Western, Hollywood, Calif.

MAKE money writing photoplays; details free to beginners. No correspondence course. Producers League, 230 Wainwright, St. Louis.

ELECTRICITY—Make it yourself with our auto generator. Write for particulars. Menzies Theatre Supply Co., Dept. 7, 724 So. Wabash Ave., Chicago.

MOVIE Camera, F. 3.5 lens \$50. Tripod, with Panorama and Tilt, \$25. Home Movie Projector \$25. Motor-Driven Projector \$50. New \$150 Motor-Driven Suit Case Projector \$75. Road Show Projector \$50. 3,000 Films, \$3 and \$5 a reel. Fine Kodaks \$7. Anamigmatic lens Kodaks \$15. Graflex F. 4.5 lens \$40. Ray, 324 5th Ave., New York.

WONDERFUL Opportunities for Making Fortunes in this Business. No Experience needed. Complete Theatre Outfits sold on Easy Terms. Free Catalog. Monarch Theatre Supply Co., Dept. P, Memphis, Tenn.

SCENERY TO RENT

SETTINGS for Opera, Plays, Minstrels, Plush drops. Address Amelia Grain, Philadelphia.

EDUCATIONAL AND INSTRUCTION

USED books and educational matter bought, sold, exchanged. List 1,000 items free. Students' Exchange, 47-A West Forty-second Street, New York, N. Y.

CARTOONISTS—Improve your style by following the work of the greatest cartoonists found in the bound volumes of Cartoons Magazine. Three volumes, each covering six months. Jan.-June 1919 to Jan.-June 1920, inclusive. 1200 cartoons, 900 pages to a volume, 7 by 9 1/2 in., 3 in. thick. New books, durable and attractive binding. Sold separately at \$2 per vol. postpaid. Supply limited. Send at once. Popular Mechanics Book Dept., 206 E. Ontario St., Chicago.

DOUBLE Entry Bookkeeping mastered in 60 hours with 8 keys; guaranteed; diplomas. International Bookkeeping Institute, Dept. 8, Springfield, Mo.

SHOWCARD writing made easy. Instruction book and complete outfit \$1.00. D. A. Gale, Box 315, White Plains, N. Y.

BOOKKEEPING in a Week, \$2 complete. Dukes, 1857 Walton Av., New York.

POPULAR Mechanics Handbook for Women has 294 ideas for those who keep house. 50 cents. Home Mechanics contains 328 ideas for making things at home. 50 cents. Popular Mechanics Concrete Handbook No. 1 has 173 articles on the use of concrete about the home, in the shop, and on the farm. 50 cents. The three books for \$1.25. Popular Mechanics Press, Room 807, Popular Mechanics Building, Chicago, Ill.

FREE. Send for my book on Big Pay Trades. Standard, 416 Woodward Ave., Detroit, Mich.

BASHFULNESS, fear and timidity quickly banished through mirth, merriment and instruction or your \$2.00 for "The Personal Liberty Course" refunded in 10 days. H. L. Juhnke, Dept. A, Box 834, Sacramento, Calif.

ARTIFICIAL Marble, sanitary flooring instructions, ornamental casting, concrete plaster, papier-mache decorations, garden furniture, stoneware. Rubber-moulds, Electrometallurgy, particulars and 200 illustrations free. Chris Mahler, Box 122, Huntington, N. Y.

ROPP'S Calculator and Short-Cut Arithmetic shows the answer as quickly as a watch shows the time to all problems likely to occur in office, store, shop, bank, farm or factory. Price, pocket size, paper 35 cents; cloth 50 cents; leatherette \$1. Desk size, cloth \$1.50 postpaid. Popular Mechanics Book Dept., 206 E. Ontario St., Chicago.

"WHAT to Invent for Profit" free. Patent News-N, Washington, D. C.

CARTOONING and Comic Art made easy. Get Kite's adjustable comic models to draw from; wonderful help. Write Kite, Barber-ton, Ohio.

YOU can have a business profession of your own and earn big income in service fees. A new system of foot correction; readily learned by anyone at home in a few weeks. Easy terms for training; openings everywhere with all the trade you can attend to. No capital required or goods to buy, no agency or soliciting. Address Stephenson Laboratory, 1 Back Bay, Boston, Mass.

WRITE articles, stories, news, in spare time for newspapers and magazines. Big pay. Copyright book free. Press Syndicate, 281, St. Louis, Mo.

USED educational matter, books, etc., sold, rented and exchanged. Big list free. Lee Mountain, Pisgah, Ala.

VEST-POCKET Bookkeeper—Complete instructions for the correct keeping of books of accounts. Shows an entire set of books based upon actual transactions. 160 pp. Leatherette. \$1. postpaid. Popular Mechanics Book Dept., 206 E. Ontario St., Chicago.

RADIO OUTFITS AND SUPPLIES

CRYSTAL Radio Set. Remarkably loud and clear. Satisfaction guaranteed. \$2.00 prepaid. Wonderful value. Radio House, 1409 Helen Avenue, Detroit, Mich.

DO Local Stations Bother You? You can tune them out or separate one from another with my wave trap. Simple, inexpensive, always works. Send 50c for copyrighted instructions; never before published. Leon Lambert, 539-C South Volusia, Wichita, Kans.

KNOW Radio. Send \$3.00 for Cameron's "Text Book on Radio," indorsed by authorities. No amateur or radio fan should be without it. It tells everything—better than a lifetime subscription to a radio magazine. Postpaid on receipt of \$3.00 anywhere in U. S. A. and Canada. Department-Radio, Bass Camera Company, 109 N. Dearborn, Chicago.

RADIO Map of the U. S.—Government Radio Stations, Broadcasting Stations, Commercial Stations, Call Letters, Wave Lengths, etc., 35c postpaid. Popular Mechanics Book Dept., 206 E. Ontario St., Chicago.

STORAGE "B" Batteries. Build your own. Save money. 100 volts with regulating panel, parts, plans complete—\$12.50. Edison elements—\$4.00 per pair. Dealers—stock parts for our beautiful battery. Big demand. Lane Manufacturing Company, 2941 W. Lake Street, Chicago, Ill.

WHY Not Beach Out with your crystal set? There's music on your aerial every night from stations far away! I have shown thousands of people how to hear long-distance programs without tubes. Write me today. Leon Lambert, 539-A South Volusia, Wichita, Kans.

RADIO Generators—500V, 100 watt \$28.50. Battery Charging Generators \$8.50. High Speed Motors—Motor Generator Sets, all sizes. Motor Specialties Co., Crafton, Penna.

2,650 MILES Distance with one tube. Any Notice understands our Simplified Instructions, including Panel Layout and Photo 25c. Vesco Radio Co., Box PM-117, Oakland, Calif.

LOUD Speaking Crystal Set. Broadcastings heard throughout house. Easily constructed. Instructions complete 25c. Catalog free. Stelmets Wireless Mfg. Co., Eastend, Pittsburg, Pa.

DEMONSTRATORS. Radio. Wanted. Amateurs, Professionals. See Radio Shack advertisement, page 144.

RADIO Sets—\$30 to \$300. Super Heterodynes. Neutrodyne and other types. All makes, at 50% off list. Why pay more? Send for Bulletin 244. Radio Exchange, 925 Broadway, New York.

DICTIONARY of Radio words and terms, electrical symbols, wiring diagrams, radio diagrams and complete electrical dictionary, new, up-to-the-minute, just published. 188 pages, cloth cover, vest-pocket size. 35c postpaid. Popular Mechanics Book Dept., 206 E. Ontario St., Chicago.

TELEGRAPHY

TELEGRAPHY—Both Morse and Wireless—taught thoroughly and quickly. Tremendous demand. Big salaries. Wonderful opportunities. Expenses low; chance to earn part. School established fifty years. Catalog free. Dodge's Institute, H St., Valparaiso, Ind.

TRADE AND TECHNICAL SCHOOLS

PAINTERS are making \$10 to \$20 per day. A few weeks' training at this big school will fit you for one of these Big Paying Jobs. Write for one of our Big Free Catalogs of sign painting, show card writing, decorating, paperhanging, auto painting, graining and marbling. Chicago Painting School, 147 W. Austin Ave., Chicago, Ill.

CHICAGO Technical College offers short, intensely practical courses in Drafting and Engineering—civil, mechanical, electrical, structural—Architecture, Building Construction, Plan Reading, etc. Courses fitted to your needs. No time wasted. Instructors are experts. Graduates in demand at big salaries. Opportunities for part-time work while studying. Day and evening classes. 21st year. Enter any time. No special preliminary training required. Low tuition—easy terms. Write for 52-page illustrated Blue Book, describing opportunities open to our graduates. Chicago Technical College, 25 Chicago Tech. Building, Chicago.

BE a Bricklayer. Attend a School operated by Building Contractors. Three Months' Day Course \$75.00. Associated Building Employers, 112 A. B. E. Building, Grand Rapids, Mich.

FREE. Send for my book on Big Pay Trades. Standard, 416 Woodward Ave., Detroit, Mich.

BUSINESS OPPORTUNITIES

UNPATENTED Ideas Can Be Sold. I tell you how and help you make the sale. Free particulars (Copyrighted). Write W. T. Greene, 810 Jenifer Building, Washington, D. C.

A TEA Room or Cafeteria will make you a fortune—you can operate one of your own or manage one for others. We teach you in a few weeks and put you in touch with positions and money-making opportunities—earn \$5,000 a year—be independent. Write today for book "Pouring Tea for Profit." Lewis Tea Room Institute, Bureau E-31, Washington, D. C.

AGENTS: \$11.80 daily in advance (send for sworn proof) Introducing New Insured Hosiery—47 styles—35 colors—guaranteed seven months—Fall line now ready—No capital or experience required—You simply take orders—We deliver and collect—(or you can deliver, suit yourself)—Credit given—Pay You Daily—Monthly bonus besides—We furnish samples—spare time will do. Macoshee Textile Company, Room 2588, Cincinnati, Ohio.

GET Money in Your Mail! You will find facts never before published in "Lambert's Mail Order Secrets." Send self-addressed envelope for further information. Leon Lambert, 539-D South Volusia, Wichita, Kans.

REPRESENT Us in Your Home Town. A responsible bond house (Established 10 years) desires a local representative in each town and city, to sell bonds that are exempt from Federal Income Taxes. Good opportunity to make from \$100 to \$1,000 per month. No previous training necessary. References required. Address Box 36, Austin, Texas.

\$6 TO \$15 daily—year around position, monthly bonus besides. Groby made \$489.50 in 30 days, Cregan \$443.00, Whiteside \$435.00, Robey \$352.00, Bickel \$320.91. No experience or capital required. Exclusive patented necessity. Millions of prospects, homes, stores, schools, factories, auto and truck owners. Spare time satisfactory; we deliver and collect, also carry accounts. Cash in on our advertising and approval by National Board and big users. Our original new plans produce results. Write quick for full details. The Fyr-Fyter Co., 196 Fyr-Fyter Bldg., Dayton, Ohio.

MIX twenty articles to sell by mail or locally. Valuable information, red stamp. Brace land, 1435 So. Ninth, Philadelphia, Pa.

\$120 STARTS profitable mail order agency business; no soliciting; can make \$40 weekly part time; everything supplied. Free book. Marvel Co., 6092 Market, Philadelphia, Pa.

A BUSINESS Offering larger returns than usual lines, \$100 starts you. Dept. M. Paul Kaye, 149 Broadway, New York.

MONEY! Shivering Autolights, Radiators, Mirrors, tableware, stores, Outfits, Methods Free. Sprinkle, Plater, Dept. 28, Marion, Ind.

"I MADE \$10,000 as Realty Specialist." Free information tells how. American Business Builders, Dept. A-448, 1133 Broadway, New York.

MONEY Getter—Attractive refreshment, patented. Get busy; machines ready. Small Capital required. Write Inventor, 1323 W. 101 St., Los Angeles, Calif.

COUNTY Distributors Wanted—Sell New Thermostatic Automatic Carburetor Control Attachment for Fords. Big Profits, full or part time. Burns 95% air. Doubles Mileage. Attached in 2 minutes. No drilling. Does automatically exactly what Ford Manual says do by hand. Cadillac now using Thermostatic Carburetor Control under Blanche license. Write today. A. C. Blanche & Co., Dept. 351-B, 602 W. Lake St., Chicago.

SECURING business is my specialty. Why not employ me? Boss, 20 Depew, Nyack, N. Y.

FREE Book—Start Little Mail Order business anywhere; home employment evenings; beginner's complete Working Outfit furnished; 500 circulars, samples, things to sell; you deal direct with manufacturers; no stock to carry; instructive booklet free. Pier, 781 Cretland St., New York.

NEW Book Explaining the wonderful Mail Order Business and where to buy thousands of articles wholesale. 25c. Circular free. H. F. v. Teonic, Deratur, Ind.

PATENTS Procured. Send sketch or model today for examination, prompt report and advice. No charge for preliminary advice. Write for free booklets "How to Obtain a Patent" and "Invention and Industry" and blank form on which to disclose your idea. Highest references. Promptness assured. Clarence A. O'Brien, Registered Patent Lawyer, 585 Security Bank Building, Directly across the street from Patent Office, Washington, D. C. See pages 148 and 149.

FARMER'S Handbook—Filled with discoveries made by farmers who have found ways to save time and labor. 270 pages, containing 861 discoveries on all phases of farm work. 683 illustrations. Only \$1. Popular Mechanics Press, Room 807, Popular Mechanics Building, Chicago, Ill.

PATENTS—Write for our Guide Books and "Record of Invention Blank" before disclosing inventions. Send model or sketch and description of invention for examination and instructions. No charge for the above information. See advertisement on pages 146 and 147. Victor J. Evans & Co., 192 Ninth, Washington, D. C.

BE a manufacturer. Own your own business. We start you and furnish everything. Enormous profits. Steady demand. Free booklet. Men and women write today. Dept. R, Box 691, New Orleans, La.

3,384 MONEYMAKING Plans, Formulas, Trade-Secrets, "Encyclopedia Business Opportunities," 3 Volumes \$1. "Ideal," 5591-V8, North Rober, Chicago.

SIGNS, Banners, Showcards, Easily Painted with the aid of Letter Patterns. Sample for Stamp, John F. Rahn, A2423 Greenvale Ave., Chicago.

ADVERTISE 24 words 50 Southern Country newspapers \$2.00. Proof guaranteed. Keator, Hartford Bldg., Chicago.

EVERYONE knows of the remarkable success of the 10c Stores. Now comes the 25c and 50c Mail Order Business. Write for free circular. Taber Bros., 311 Fifth Avenue, New York.

START Mail Order Business—Practical information concerning its wonderful opportunities obtainable through The Mail Order News, America's leading mail trade publication. Yearly subscription \$3.00. Sample 25c. Booklet free. Mail Order News, 1636 Bristol Bldg., N. Y.

ATTENTION!! You can have a business of your own. Establish and operate New System Real Estate Business, brokerage and insurance agency in your community. Office at home. Earn \$5,000 year. Representatives wanted everywhere. Send stamp for free booklet. Hayes Realty Association, Cincinnati, Ohio.

EARN money spare time or evenings. No peddling. Permanent. Work in your own home. Write Downs Co., 2323 Myrtle, St. Paul, Minn.

INK powder in bulk. Frank Shilling, 1017 Dasher, Canton, Ohio.

VALUABLE information free. All about tested money-bringing formulas and mail-order method. Portland Service, Two Thames Ave., Norwalk, Conn.

MEN, women, children, make the Artcor. Pleasant and profitable pastime. Particulars free. Artcor Mfg. Co., 284 Seymour Ave., Newark, N. J.

SUCCEED With Your Own Products—Formulas, Processes, Trade-Secrets. Different, dependable, profitable. Catalog free. B. Thaxly Co., Washington, D. C.

MONEY Getter—Attractive refreshment, patented. Get busy, machines ready. Small capital required. Write October, 1322 West 101 St., Los Angeles, Calif.

PATENTS Procured; Trade Marks Registered—A comprehensive, experienced, prompt service for the protection and development of your ideas. Preliminary advice gladly furnished without charge. Booklet of information and form for disclosing idea free on request. Richard B. Owen, 30 Owen Bldg., Washington, D. C., or 2276-R Woolworth Bldg., New York.

\$120 STARTS profitable mail order agency business; no soliciting; can make \$10 weekly part time; everything supplied. Free book, Marrell Co., 6962 Market, Philadelphia, Pa.

SIGN work made easy with "Perfect" Letter Patterns. Beautiful and exact gold-leaf lettering on glass now easy. We teach you. Samples and information free. Ross System, 2152 Alice Place, Chicago.

FOR territory and machine to manufacture 20,000 Eclipse Rubber Wrapping Bands per hour of inner tubes, address C. B. Martin, 1129 6th, N. W., Canton, Ohio. Small investment required.

BIG money writing photoplays, stories, poems, songs. Send for free copy America's greatest magazine for writers. Tells you how to write and sell. Writer's Digest, 693 Butler Bldg., Cincinnati, Ohio.

ENTER a new business. Earn \$3,000 to \$5,000 yearly in professional fees making and fitting a foot specialty, openings everywhere, with all the trade you can attend to; easily learned by anyone at home in a few weeks, at small expense; no further capital required, no goods to buy, job hunting, soliciting or agency. Address Stephen-Lyon Laboratory, (1) Back Bay, Boston, Mass.

INVENTORS—Write for our Guide Book, "How to Get Your Patent" and Evidence of Invention Blank. Send model or sketch of your invention for our free Examination and Instructions. Randolph & Co., Dept. 435, Washington, D. C.

"GET into the Specialty Manufacturing Business" or "Why Work for Others?" may sound good to you, but you won't succeed in that business unless you possess Formulas that are absolutely reliable, the same required by leading manufacturers supplying the Best. Don't be lousy into buying a Collection of cheap "Formulas" and expect to succeed. Send today for my valuable literature and Formula Lists and Real Money-Makers in the Specialty Manufacturing Business. 25 years supplying the Best. Miller, Chemist, 805 De Leon St., Tampa, Fla.

EXCEPTIONAL Opportunity for Sales Manager capable of handling state distribution. Marvelous new Adding Machine. Retail \$15. Work equals \$350 machine. Tremendous possibilities. Unlimited Profits. Write quick for details. Lightning Calculator Co., Dept. B, Grand Rapids, Mich.

MAIL Order Business is your opportunity. Brenner's Famous Handbooks teach how to start small, grow big. Sell merchandise, service, ideas; enormous profits. Spare time to begin. Get complete set, 11 books, \$3.00, and be posted. Brenner, 335 Walnut, Philadelphia. Descriptive Catalog and big batch interesting mail order information, 25c. None free.

\$3,000 TO \$5,000 Yearly. Want it? Others are making it. Send check or money order today for our invaluable books "How to Sell Real Estate," \$3.00—and "How to Conduct Real Estate and Insurance Business," \$1.50. Absolute satisfaction guaranteed. Free catalogs. Realty Book Co., Dept. 52, Cleveland, Ohio.

"HOW to Sell Patents" free. Patent News-H, Washington, D. C.

START and Operate Your Own Business. Our System proprietary specialty manufacturing offers wonderful opportunity to make \$100 to \$500 weekly. Openings everywhere. Either men or women. We furnish everything and show you how. Big explanatory book, "The Open Door to Fortune" free. Write for it now. National Scientific Laboratories, 298 Monroe, Richmond, Va.

MAKE Money at Home—making toys. We show you how. Send \$1 for complete working drawings and instructions. Dekalb Designing Co., Deratur, Ga.

GOLD Window Sign Letters. Manufacture them at home. Unlimited profits and business opportunities. Complete instructions and patterns. No experience required. Particulars, Witterding, 1144 Pleasant Street, Oak Park, Ill.

LEARN the collection business. Good income, quick results. Interesting booklet, "Skillful Collecting" free. National Collectors Assn., Long St., Newark, O.

PATENTBOOK, 129 mechanical movements and illustrations, sent free. Labinere, 3 Park-row, New York.

100,000,000,000 GERMAN Mark free with 100,000 Polish Mark for 60c; 10,000 Austrian Kronen 35c, and 10,000 Hungarian Kronen 30c. Don't send us any Money, but write for Dealer's Terms. Arrow Sales, 1748 North Park Ave., Chicago.

MAKE money. Start mail business. 20 Gilt-Edged Plans Free. Star Bureau, 1918 North St., Philadelphia, Pa.

DOLLARS Yearly in your Backyard. No mushroom dope. Particulars free. Meta, 313 East 89th, New York.

CEMENT Masons, Plasterers, Contractors. Build successful business, succeeding old and new buildings with Everlastone Indestructible Stucco; also installing Corkstone Floors over worn-out flooring. Write immediately for agency proposition. Everlastone Corporation, 828 W. Pratt St., Baltimore, Md.

EARN \$10 daily silversmith mirrors, plating and refinishing metalware, autos, chandeliers, bedsteads, headlights. Outfits furnished. E. Dele Laboratories, 1133 Broadway, New York.

MARBLE mixing instructions, covering wood or cement flooring 1/2 in. thick, fire-proof, waterproof, low cost, sanitary, all colors. Particulars, 200 illustrations free. Chris Mahler, Box 122, Huntington, N. Y.

"SCHEMER Magazine," Alliance, Ohio, prints big profit schemes; one subscriber making \$25,000 from three; another \$10,000 from one. Try your luck. Year, only \$1.00; three months, 25c.

START a Real Estate Office of your own. Earn from \$3,500 upwards. Our course of 21 lessons tells you how. Booklet, M on application. Frederick Jenkins, Corlaer Heights, Schenectady, N. Y.

120 MONEY-MAKING Plans Free! Wolverine Bureau, 64, Muskegon, Mich.

MAKE toys and novelties at home. Big profits. Instructions and 200 illustrations, 25c. Australite Company, Sharpshoore, Pa.

WE Start You in Business, furnishing everything; men and women, \$30.00 to \$100.00 weekly operating our "New System Specialty Candy Factories" anywhere. Opportunity lifetime; booklet free. W. Hilyer Ragsdale, Drawer 4, East Orange, N. J.

GOOD Money easily earned at home spare time silversmith mirrors, Glass Embossing, Chipping, Frosting, Gold Leafing, etc. G. L. Patterson & Co., Brooksville, Ky.

BIG Money made at home. Information free. 429 Hildreth Bld., Lowell, Mass.

I MADE \$30 a Week Home. French Breadmaking. 15 years' experience; Free booklet tells. Ashbrook 67, Marengo, O.

CHEMICAL Expert will furnish Formulas and Trade Secrets. All lines. Lists Free. W. L. Cummings, Ph. D., 228 Gordon Ave., Syracuse, N. Y.

BAISE guinea pigs. Pay better than poultry or rabbits; easy to raise; little space required. We guarantee market. Particulars and booklet how to raise free. Cavies Distributing Co., 3102 Grand Ave., Kansas City, Mo.

GO into the Crispette business. Everybody likes Crispettes. You can make a lot of money. We start you. Write for facts. Long Eskins, 1929 High St., Springfield, Ohio.

"WHAT to Invent for Profit" free. Patent News-C, Washington, D. C.

GREATEST Fortunes in Motion Picture Business. Small Capital Starts you with Complete Outfit. Details Free. Monarch Theatre Supply Co., Dept. F, Menphis, Tenn.

COST \$5.00. Your profits \$101.75, transferring monograms on autos, trunks, bags, etc. No skill required. Samples and information free. World Monogram Co., Dept. 16, Newark, N. J.

INCH Display Advertisement 166 Magazines Three \$15. Year \$50. Page \$100. Wood's Popular Services, Atlantic City, N. J.

SIGNS—make your own. New easy process. Big money in business. Complete instructions \$5.00. Signcraft School, Tacoma, Wash.

WANTED—BUSINESSES FOR SALE

IF You Want to Sell Your Business for Cash quickly and privately, we take the prospective buyer directly to you at our expense, no matter where located. We specialize in selling out-of-town businesses. If your business is worth \$5,000 or more, write us The Mutual Security System, 68 W. Washington St., Chicago.

CHEMISTRY

YOUR chemical problem solved and working process furnished Five Dollars. Write me, W. Steadman Richards, Consulting Chemist, address, Box 2102, Boston, Mass.

ABSOLUTELY guaranteed chemical analysis of any product so that it may be duplicated, our charge \$3.00. Manufacturing products formulated. Correspondence invited. Doris Chemical Laboratories, East Cleveland, Box 59, Cleveland, Ohio.

EXPERIMENTERS—complete supplies for the chemical laboratory. Catalogue 5c. National Scientific Supply Co., 241 Pa. Ave., Washington, D. C.

CHEMICAL Processes, Analysis, Research, Technical Information, Consulting Chemist, Madison, Maine.

FORMULAS AND TRADE SECRETS

ATTENTION—Plumbers, Stop Leaks permanently; Bellows, Radiators, Pipe, Castings, Etc. 15c at the Drug store, enough for average job. Several Formulas instructions \$1.00. Plumbers, 3208 No. Lyndale, Minneapolis.

500 FORMULAS, including Luminous Paints—Renewing Dry Batteries—Mechanics' Soap—Gas Tonic—25c. Catalog Free. Ideal Book Shop, 5501-P8, North Robey, Chicago.

FORMULA for making unharmed dipping solution for cleaning brass. Guaranteed to make it shine like new, \$5.00. Acid-proof paint formula \$1.00. C. J. Strickland, Box 542, Norfolk, Va.

FORMULAS—Best that Chemical Science can devise. Not "Better Sort" Formulas, but Guaranteed Reliable processes in all lines. Stamp brings Valuable Literature and Latest Summer Sellers from an Analytical Chemist. Miller, Chemist, 807 De Leon, Tampa, Fla.

10,000 SELECTED chemical, technological and practical recipes and processes, including hundreds of so-called trade secrets for every business, alphabetically arranged in one large volume of 800 pages. Price \$4 postpaid. Popular Mechanics Book Dept., 206 E. Ontario St., Chicago.

500 VALUABLE Formulas 25c. Literature free. Harvey Teeple, Decatur, Ind.

HOW to manufacture hundreds of articles in daily use. Full directions in trade edition book of formulas. Price 50 cts. postpaid. Pentland Service, 2 Thames Ave., Norwalk, Conn.

\$3.00 WILL furnish you with working formula for manufacture of any article. Work guaranteed. Chemical analysis of any nature. Chemical Technical Laboratories, Allston, Mass.

BIG, interesting formula catalog free. National Scientific Laboratories, 208 Monroe Street, Richmond, Va.

1,000,000 FORMULAS, 1,016 pages, \$2.50 Formulas Free if you order quick. Ideal Book Shop, 5501-M8, North Robey, Chicago.

AGENTS WANTED

BEATS Owning a Store. "This new way of selling beats owning a store. Any earnest worker can easily make \$4,000 to \$5,000 a year net without investment or financial risk," says Wm. Garden, former merchant who started with us two years ago. Other former merchants now happy and prosperous with us are De Longe, Pack, Carter, Bogen, Lee, and Peck. They earn as much or more than ever; have no investment or financial worries and are building a constantly growing business. We are now making the best suit that we ever produced retailing at \$31.50. Our values are remarkable. Our fit and style so good that you can sell the best trade. Every fabric is virgin wool. Every garment tailored to order. We have openings for men who are looking for a chance to build a steady, profitable business. Such men will find a wonderful opportunity with us. Write for new sales plan, full information. Dept. 951, J. B. Simpson, Inc., 843 Adams St., Chicago.

GET into the tailoring game—one of the most profitable of all lines in the selling field. Experience isn't necessary, and spare time will do. We teach you how to sell our line, and supply you with everything necessary to go out and make from \$10 to \$20 a day from the very first day. Our selling outfit is the finest ever gotten together and shows more than 100 large samples of finest quality Virgin Wool Suitings, many of them our own exclusive patterns. Also a big showing of high-class heavyweight overcoatings. You do no delivering with our line. You just write your orders. We do the rest. Your profits run big and you get them cash with order. If you want to get into this most profitable business, write us quick. Address Dept. 117, Goodwear Chicago, Inc., Chicago.

\$20.00 DAILY taking orders, patented work shirts factory to wearer below store prices. Pay daily. We deliver. Patent Shirt Co., 514 Pancoe Bldg., Chicago.

TAILORING Agents—Double your profits with one big line men's and boys' suits. Complete outfit makes selling a cinch. Men's suits and overcoats \$31.50. Boys' 2-pants suits \$11.95. Your chance for big money. Write quick and get secret memo, book Free. Wright & Co., Dept. ZZ-2, Congress and Harrison Sts., Chicago.

EARN \$40 to \$45 extra every week taking orders for our high-class tailoring—made-to-measure suits from \$14.95 to \$29.50. Your own clothes at low wholesale prices. No experience necessary. Write for our Big Free Sample Outfit. Progress Tailoring Company, Dept. H-142, Chicago, Ill.

\$12 DAILY easy—Introducing Ladies' and Men's sweaters in silk, wool and artificial silk—23 colors—Latest novelties—Going like wildfire—You simply show samples we furnish—take orders—We deliver and collect. Your Pay Daily. Mascoche Textile Company, Form 1168, Cincinnati, Ohio.

WHY Work for others? Start and operate your own business. Our system proprietary specialty business offers wonderful opportunities to make \$100 to \$500 weekly. Openings everywhere. We furnish everything and show you how. Booklet free. National Scientific Laboratories, 208 Monroe, Richmond, Va.

CALIFORNIA Rosebuds selling like hot cakes. Agents rolling money; new stuff. Big profits. Catalog free. Mission Factory PM, 519 No. Halsted, Chicago, Ill.

DUSTLESS Sponge Cloth. New Invention. (1) Rub—Dusts, Cleans and Polishes Automobiles, Furniture, Planes. Retail (50c)—Costs (16c). "Sample Free." NuLife (E) Sponge, Hartford, Conn.

\$60-\$200 A WEEK. Genuine Gold Letters for store windows. Easily applied. Free samples. Liberal offer to general agents. Metallic Letter Co., 438-D North Clark, Chicago.

300% PROFIT: Whirlwind Seller. Tremendous repeater. "Kleanrite." Marvelous Discovery. Washes clothes without rubbing. Premiums for customers. Sells 25c. You make 18c. Free samples make easy sales. Write quick. Bestever Products Co., 1941-K8, Irving Park, Chicago.

HOW'S This Offer? We Will Send Prepaid, no money down, 12 bottles of guaranteed rarest French Perfume made by Renaud, Paris, world's finest Perfumers. One of these odors was made exclusively for Czarina of Russia before the war. Others have sold as high as \$100 an ounce. Today you sell these 12 bottles assorted odors 50c each and remit to us after selling a total of \$2.50. If you want to represent us give three references or cash in advance. Glee Products Co., Importers, Leicester, Mass.

AGENTS—Sell Combination Salt and Pepper Shakers. Sanitary. Moistureproof. Orrenore Co., 542 W. Jackson, Chicago.

ADVERTISE in 75 Country newspapers; 24 words \$2.50. Proof guaranteed. Keator, Hartford Bldg., Chicago.

AGENTS: 500% profit. "Happy Home Maker Shampoo" builds your own big business. Martin of Indiana made \$75.00 in one day. Missouri man made \$750.00 one month. Exclusive territory. Geo. A. Schmidt & Co., 236 W. North Ave., Chicago.

AGENTS, \$20 to \$40 daily selling Handy Knife Sharpener. Best on market. 150% profit. Sample 35c. Harnell Specialty Co., 1533 Belmont Ave., Chicago.

GENERAL Distributors everywhere earning \$50-\$75 weekly with "Mago Blueing," the every-week necessity; sells to every home on sight; quick cash sales; steady orders; we start energetic men and women in business; 10c brings 25c package. Gar-Mar Mfg. Co., York, Penna.

AGENTS, Salesmen, Demonstrators, you will have the devil's own time trying to find a better seller than "Zippos." If there was such a thing we'd have it. Splendid profit on 50c "Go Getter" repeat article that sells on ten second demonstration. Works While You Watch It. Demonstrates value, while others waste time making claims. New Discovery! Greatest Scientific Triumph of the age. It's the berries. Haven't rosen to tell our story here. Write immediately. Karam-Smith Co., 608 Bezan St., Ft. Wayne, Ind.

WONDERFUL Invention eliminates all needles for phonographs. New, different, lasts for years. Preserves records. 12,000,000 prospects. \$15 to \$20 daily easy. Carry day's supply in pocket. Everplay, Desk 7-H, McClurg Bldg., Chicago.

AMERICAN Woolen Mills Co., Dept. 2075, Chicago, are making a free suit for one agent in each community to introduce their fine tailored to order suits at \$18 and up. Write them today for their offer.

CASH in on this quick seller. Wings cleared \$1,080 with Never Fail Razor Sharpener in six weeks; Purely, \$40.50 first day. Applewhite, also inexperienced, six orders in thirty minutes. No end to ready buyers. Exclusive territory for quick workers. Be first. Address Never Fail Company, 166 Allen Bldg., Toledo, Ohio.

AGENTS: \$60 a week selling guaranteed hosiery for men, women and children. Must wear 12 months or replaced free. All styles and colors, including finest line of silk hose. Mrs. McClure makes over \$2,000 a year. Mrs. Schurman averages \$60 a month working spare time. Geo. Noble made \$35 in one day. Write for sample outfit. Thomas Mfg. Co., Class 562, Dayton, Ohio.

\$100 WEEKLY easy selling Oriental Perfumes and Cosmetics. Highest profit. Sample Case and Illustrated catalogue absolutely free. Romola Parfumerie, Inc., 6546 Cottage Grove Ave., Chicago.

AGENTS—200% Profit. Wonderful Little Article. Something new; sells like wildfire. Carry in pocket. Write at once for free sample. Albert Mills, Manager, 1798 American Building, Cincinnati, Ohio.

GOODYEAR Mfg. Co., 1746 Goodyear Bldg., Kansas City, Mo., is making an offer to send a handsome raincoat free to one person in each locality who will recommend it to friends. Write today.

AGENTS—\$15 a day—Easy, quick sales—Free Auto—Big Weekly Bonus—\$1.50 premium Free to every customer. Simply show our Beautiful 7-piece Solid Aluminum Handle Cutlery Set. Appeals instantly. We deliver and collect. Pay daily. New Era Mfg. Co., 883 Madison St., Dept. 21-BC, Chicago.

OUR "Better Plan" assures you—a permanent business, substantial profits,—automatic repeats and success positively. We make one line only—better quality toilet preparations that sell and resell all year round on their genuine superior merit. Affinity Company, Division and Weston, Grand Rapids, Mich.

AGENTS will make fortune. New safety device. Send postal. J. Estock, 42 Mulberry St., Yonkers, N. Y.

AGENTS: Men and women, in spare or full time, make big money selling household necessity. Every home a prospect. Quick sales, big profit. Territory open. Write for particulars. Judd & Leland Manufacturing Company, Box 21, Clifton Springs, N. Y.

MONEY! Shivering Autolights, Radiators, Mirrors, tableware, stoves, Outfits, Methods Free. Sprinkle, Plater, Dept. 28, Marlon, Ind.

MAKE \$75.00 a week and up selling our fine made-to-measure, all-wool suits at \$31.50 retail, direct to wearer. Biggest values—positively sell on sight. Biggest commissions, paid in advance. We attend to delivery and collections. 6x9 swatch samples furnished Free. W. Z. Gibson, Inc., Dept. H-8, 161 W. Harrison St., Chicago.

AGENTS—Mosco Corn and Callous Remover will build you a steady repeat business. Send today for pocket size trial outfit. The Moss Company, 207 Searle Bldg., Rochester, N. Y.

SUCCESS With Your Own Products—Formulas, Processes, Trade-Secrets, Different, dependable, profitable. Catalog free. B. Thaxly Co., Washington, D. C.

AGENTS: Big Money Selling Great Household Necessities. Sample 25c. Webster Co., 629 Wellington Ave., Chicago, Ill.

AGENTS make big money selling Wallace Rim Tools, \$25.00 per day easily made. Means \$150.00 weekly to you. Wallace Rim Tools Co., 12 S. Jefferson St., Chicago, Ill.

AGENTS sell Electric Glass Cleaner, 150% profit; thoroughly cleans Windows, Windshields, Showcases, etc. Retail 35c. Sample 25c. 3 Doz. \$5.00. Electric Glass Cleaner Co., Sandusky, Ohio.

NEEDLES—Self threading, sell easy, 100% profit. Sample free. Other fast sellers, P. Miller, Box 3, Tremont Station, New York.

SELL "Quick Mend" wire solder. No acids needed. Every home, farmer, autoist, needs it. Exclusive territory. Sample ten cents. "Middleswart," Piqua, Ohio.

WANTED. Agents to handle recording golf tally. Liberal commission. Sample \$2.00. M. & S. Mfg. Co., Box 334, Hartford, Conn.

AGENTS—Best seller; Jem Rubber Repair for tires and tubes; superseded vulcanization at a saving of over 800 per cent; put in cold, it vulcanizes itself in two minutes, and is guaranteed to last the life of the tire or tube; sells to every auto owner and accessory dealer. For particulars how to make big money and free sample, address Amazon Rubber Co., Philadelphia, Pa., Dept. 503.

SOMETHING New—Imported Seeds Grow beautiful houseplant without soil or gravel. Everybody buys. 50c seller. Big profits. Agents wanted. Sunshine Co., Dept. 48, 502 Baker Bldg., San Francisco, Calif.

CAN you sell to colored people? Write, Stratene Co., Dept. 101, 2500 Second Avenue, Birmingham, Ala.

BIG Money selling new Household cleaner. Washes and dries windows. Sweeps, scrubs, mops. Complete outfit less than brooms. Over 100% profit. Harper Brush Works, 132 2nd St., Fairfield, Iowa.

AGENTS, Men and Women: Sell Photo-Pillow-Tops, the old reliable money maker for live agents. \$1.50 for sample roll starts you in business for yourself. Sales waiting for you everywhere. Write today. Canvasograph Company, 6215 Wentworth Ave., Chicago.

PORTRAITS, photo pillow tops, frames, sheet pictures, medallions, merchant's signs, water-proof and tea aprons, guaranteed hose, toilet requisites, luminous crucifixes. Catalog 50 specialties free. 30 days' credit. Jas. C. Baile Co., Desk A-8, Chicago.

OUR Pocket Knife Sharpener is Thoroughly practical; sells rapidly everywhere at 25c. Good profit to agents. Send 1c for sample. Maniero Co., 52 Der Street, New York.

AGENTS Make Big Money selling new auto invention. Hoffenberg's sold 900 in 2 months. Profit \$2,700. For full particulars write Stransky Co., Dept. 8-11, Pukwana, S. Dak.

MARVELOUS Radio Gas Lighters sell instantly; retail 25c. Cost \$10.00 gross—\$25 profit. Send \$1.00 for sample dozen with self-selling plans. W. Masterlite Co., 110 East 43rd, New York.

AGENTS—Make Big Money Quick. \$4.00 to \$8.00 profit on each order paid in advance, taking orders for our fine tailoring from friends and neighbors. Finest all-wool samples, fashions, stationery, etc. Entirely new and different style outfit. Pulls Orders On Sight. Sent Free. Write at once. Washington Tailoring Co., Dept. H-342, Chicago.

A RARE Opportunity to make large profits. Can make \$15-\$30 daily. Particulars free. Address Empire Novelty Co., Amsterdam, N. Y.

TERRITORY Managers, Salesmen, Agents,—you can earn \$10 to \$35 a day demonstrating No-Cord Electric Iron. Sells itself. New sales plan. Profits without waiting. No Cord Sales, 224 W. 63rd St., Chicago, Ill.

MEN'S Shirts. Easy to sell. Big demand everywhere. Make \$15.00 daily. Undersell stores. Complete line. Exclusive patterns. Free Samples. Chicago Shirt Manufacturers, 229 W. VanBuren, Factory 211, Chicago.

AGENTS: \$11.80 daily in advance (send for sworn proof) Introducing New Insured Hosiery—47 styles—35 colors—guaranteed so on months—Fall line now ready—No capital or experience required—You simply take orders—We deliver and collect (or you can deliver, suit yourself). Credit given—Pay You Daily—Monthly Bonus besides—We furnish samples—spare time will do. Maceohee Textile Company, Room 2568, Cincinnati, Ohio.

AGENTS—Write for Free Samples. Sell Madison "Better-Made" Shirts for large Manufacturer direct to wearer. No capital or experience required. Many earn \$100 weekly and bonus. Madison Mills, 564 Broadway, New York.

AGENTS—Brockton shoe factory distributor wants agents to sell men's shoes direct to wearer. Unrequired capital. Commission \$1.00 pair. Carter Shoe Co., Brockton, Mass.

AGENTS! Where to buy 250,000 articles wholesale. Most complete directory published. Everything rock bottom prices. Save time, money. Directory \$1.00. Ste e Supply House, 4290-M Bangor, Detroit, Mich.

AGENTS—Our Felt Bags, Waterproof Aprons and 3-1 Hand Bags sell at sight in every home. Splendidly made goods at below the usual price. Get our catalog of quick sellers. Buy direct from makers. Central Mail Order House, 221-AB Commercial St., Boston, Mass.

AGENTS—Experience unnecessary. 35 Hosiery and Neckwear Styles; as High as 120% Commission. 10% Bonus. Send reference for samples. Lexington Co., Dept. 1318, Lexington, Ky.

TAILORING Agents: \$30 week and steady job taking orders for Longworth All-Wool Suits and Overcoats \$23.75, boys' suits \$11.75. Special offer \$45 cash and free suit for 3 days' spare-time work. Postal brings big outfit free—no waiting, no deposit. John G. Longworth & Sons, Dept. 22-2, 1301-11 W. Congress St., Chicago.

SUIT Free to Agents. Tailoring agents, raincoat men, and salesmen of other lines—get in touch with us at once. We have most powerful selling proposition in field. Our line offers finest quality suits made to order all at one amazing low price, including big profit for agent. We supply finest swatch line outfit showing big cloth samples in hand—some carrying case and give every active agent his own suit absolutely free. Lines are going fast. Write for yours at once. Address Dept. 501, Knickerbocker Tailoring Company, 131 So. Peoria St., Chicago.

\$6 TO \$15 daily—year around position, monthly bonus besides. Groby made \$499.50 in 30 days, Cregan \$443.03, Whiteside \$435.00, Robey \$352.00, Bickel \$320.91. No experience or capital required. Exclusive patented necessity. Millions of prospects, homes, stores, schools, factories, auto and truck owners. Spare time satisfactory; we deliver and collect, also carry accounts. Cash in on our advertising and approval by National Board and big users. Our original new plans produce results. Write quick for full details. The Fyr-Fyter Co., 195 Fyr-Fyter Bldg., Dayton, Ohio.

BIG Profits—Rubber Specialties. Fifty fast sellers. Everybody needs and buys. Fifty Dollars weekly easily made. B. G. Rubber Co., Dept. 611, Pittsburgh, Pa.

AGENTS Wanted—for Red Dog Tube Patch. Repairs largest blow-outs or punctures without heat or cement. Startling demonstration sells it. 300% profit. If you can't stand "big money" don't answer. Exclusive territory. Free Samples. Auto Products Co., Marion, Ind.

CLEAN your car for 5c. Dri-Klean-It removes mud, dirt, dust. No soap or water. We have made over 1,000 customers in 90 days. Agents wanted. Write Amer. Accessories Co., Dryclean 178, Cincinnati, Ohio.

BIG Profits with Exclusive Territory—\$50 to \$100 weekly easy. More has often been made in one day's work. A hot or cold running water bath equipment for any home at only \$7.50. No plumbing or water works required. Investigate. Send no money. Write today. Sanitary Supply Co., 721 Allen Building, Toledo, Ohio.

AGENTS: \$50 to \$100 a week guaranteed. World's greatest value, tailored to order all wool suits and overcoats—\$31.50, none higher. Fall line greatest ever. Write for new sales plan. Details free. J. B. Simpson, Dept. 952, 813 Adams, Chicago.

MOST Wonderful Seller. 96c profit every dollar. No stock to carry. License unnecessary. Sample free. Mission Factory PM, 519 No. Halsted, Chicago, Ill.

GENUINE Gold Leaf Letters anyone can put on store windows. Guaranteed to never tarnish. Large profits. Enormous demand. Free samples. Write today. Metallic Letter Co., 438-A North Clark, Chicago.

FREE Sample. "Rain Shield Wiper." Retail \$1.00—Costs (25c). Sold, Clear and Rainy Days. No Cloth—No Paste—No Attachment. (1) Rub keeps Windshield Clear (48) Hours. Experience unnecessary. NatLife Corporation, Hartford, Conn.

WHY Work for others? Start and operate your own business. Our system proprietary specialty business offers wonderful opportunities to make \$100 to \$500 weekly. Openings everywhere. We furnish everything and show you how. Booklet free. National Scientific Laboratories, 208 Monroe, Richmond, Va.

GERHART made \$21.00 the first hour selling our new auto necessity. Our money back guarantee makes sales easy and does the trick. Agents, distributors, write for proposition. Manager, Box 105H, Brockton, Mass.

EARN \$40 to \$60 weekly selling our beautiful umbrellas. Splendid values make rapid sales. Every sale nets big commission. Write for particulars. A. E. Erasmus Specialty Co., 565 Broadway, New York.

BIG profits selling our practical patented specialties. Write for particulars. Welch Brothers Co., North Chicago, Ill.

PORTRAIT and Medallion Agents—Our Goods Will Make You Big Profits; delivery guaranteed; prompt shipments; low prices; send for latest catalog. Adam J. Kroll & Co., 59 East 18th St., Chicago.

EVERY Ford Owner in the World Wants This! The Hamer Visible Vaporizer guarantees increased mileage (3 to 8 miles per gallon), more power (20% and better), quicker pickup, no carbon, smooth running motor, less heat, longer life, more driving comfort. Sells \$4.50; your commission, \$3. Exclusive territory. Details and proofs. Visible Vaporizer, Dept. 19, Chamberlain, S. D.

GOLD Leaf Sign Letters; make and sell; 1000% profit; particulars free. Johnston Co., Quincy, Ill.

THESE Advertisements of mine have appeared in Popular Mechanics for sixteen years. Hundreds of Successful Manufacturers today owe their success to my formulas and valuable information. Majority started with practically nothing. You can do the same—write today for my valuable literature relative to my Guaranteed Manufacturer's Formulas for making Non-Thermic Ice-Saving Cloths, Delicious Beverages for Home, Hostlers and Fountain sale, Pure Food Products, Non-Alcoholic Flavors, Laundrite Washing Marvel, Zest, greatest stain remover, Sta-Combed, Mared Hair Curler, and latest Toilet specialties. Mexican Yucca Soap, Laundry Soaps, Firmox, Sencol, and all latest disinfectants. Amazon Tire Repair, Toy Rubber Ballons and all latest selling goods in all lines. Don't compare these with "junk" commonly offered. Analytical work carefully done. Highest references. Miller, Chemist, Tampa, Fla.

25,000 AGENTS Wanted. Men—Women—Boys—Girls, work for us. Big money. Something new. Sells on sight. We mail post-paid outfit; You pay when received \$3.00. Money refunded if you are not pleased. L. E. Polhemus Arms Co., Miami, Arizona, Dept. 116.

AGENTS. Salesmen—Sell New Thermostatic Automatic Carburetor Control Attachment for Fords. Big Profits, full or part time. Burns 95% air. Doubles Mileage. Attached in 2 minutes. No drilling. Does automatically exactly what Ford Manual says do by hand. Cadillac now using Thermostatic Carburetor Control under Blawie license. Write today. A. C. Blawie & Co., Dept. 350-C, 692 Lake St., Chicago.

LATEST Invention—Radio Callog—sells 25c; send 2c for sample and offer. 918 Garrick, Chicago.

EASY money applying monograms on Automobiles; anyone can do it. Simply transferring gold Decalcomania Initials. Takes five minutes, make \$1.50; cost 5c. Sample Free. Balco, 323 Harrison Ave., Boston, Mass.

AGENTS—Control your territory on fast-selling specialties. Earn \$40.00 to \$50.00 Weekly. Huber Rubber Mfg. Co., Dept. B, 708 Penn Ave., Pittsburgh, Pa.

ARE you old at forty? See our advertisement on page 152 of this issue. The Electro Thermal Company, 2136 Main St., Steubenville, Ohio.

PATENTS Procured. Send sketch or model today for examination, prompt report and advice. No charge for preliminary advice. Write for free Booklets "How to Obtain a Patent" and "Invention and Industry" and blank form on which to disclose your idea. Highest references. Promptness assured. Clarence A. O'Brien, Registered Patent Lawyer, 535 Security Bank Building. Directly across the street from Patent Office, Washington, D. C. See pages 148 and 149.

\$38.00 DAILY. \$22.00 Eastman Kodak free. Lucky Six line combination topcoats, raincoats \$1.98 up. \$1.00 gift makes sales easy. We deliver, collect. Eagle Raincoat Co., 645 Mid City Bank Bldg., Chicago.

ENORMOUS demand. Big repeater. Costs 5c, sells 25c. Dime brings full size sample. Utility Co., Chipewa Falls, Wis.

LIGHTING Worm—Latest invention; fast Dime seller. Master Works, 710 Wyandotte, Kansas City, Mo.

MAKE \$10.00 to \$30.00 a day. New radio or phonograph device stops all noises and scratching. Sells on sight or money refunded. Mail us \$1.00 for two sets—Sells for \$1.00 a set. Extra discount on repeat orders. Illinois Mercantile Laboratories, Dept. C, 2210-2214 Michigan Ave., Chicago, Ill.

AGENTS, big Profits Selling Our Guaranteed Skin Remedy. Cera Chemical Co., Junction, Wis.

AGENTS, Sell the New Lawn Mower Sharpener. Sample fifty Cents. Wisconsin Made Mfg. Co., Junction City, Wis.

BIG Money—Selling Fiber House Brooms. Sure-Fire Seller and Repeater. Biggest Season Here. Write Today. Bartlett, Van Tine & Jones, Hillsdale, Mich.

SALESMEN — Sell "Amenz" Radoux Shirts, guaranteed to wear a year. Very liberal commissions. Get our proposition first. Menzies Shirt Co., 481M East Tremont Avenue, New York.

PORTRAIT men, use the best bromide print for your portrait work; it will repay you in better deliveries. United Print Co., Station D, Chicago, Ill.

S. L. Plate-Too. 200% Profit. Get our Proposition and Free Sample of Work. Plate-Too Company, 6017 South Racine, Chicago.

WHY Work for others? Start and operate your own business. Our system proprietary specialty business offers wonderful opportunities to make \$100 to \$500 weekly. Openings everywhere. We furnish everything and show you how. Booklet free. National Scientific Laboratories, 208 Monroe, Richmond, Va.

WE Start You in Business—No Capital Required. Monogramming Automobiles, Luggage, Windows, Wagons. Six Initials Bring \$1.50—Costs You Only 60c. Transferred as Easy as Applying Stamps on Envelopes. No License. No Experience. "Samples Free." Nulife (E) Monogram Works, Hartford, Conn.

AGENTS—Good salary and commission selling "Ratskyl," new rat and mouse exterminator; ready for use; no bait required; non-poisonous; rodents die outside premises; no odor. Empire Specialties Co., 1449 N. Wells, Dept. 301, Chicago, Ill.

TAILORING Agents! Biggest, Finest Outfit Free by return mail—no deposit—no C. O. D. Fastest selling, biggest profit making line in America. All-Wool Suits and Overcoats. \$5 to \$7 commissions in advance. Agents make \$90 a week. Write Today. Fred Kauffman, Dept. 22-2, 1309 W. Harrison St., Chicago.

MEN to introduce the Finest Combination Kitchen Cutlery Set—Housewife's Friend—Sells on sight—Prospects in every house and office—Wonderful seller—New Plan—\$1.25 premium with each set. Can sell separate pieces also. Samples free. Maceoche Cutlery Company, Stand 1168, Cincinnati, Ohio.

NEW Hand Cleaner, removes dirt like magic. A positive hit, making good everywhere at 25c a can. 100% profit. C. P. Winegar, Mfr., West Fort Ann, N. Y.

AGENTS—Make 300% profit handling "See-Well," the greatest 50-cent article ever cut. Write quick for particulars. S & W Mfg. Co., Desk P, 463 Diamond Ave., S. E., Grand Rapids, Mich.

MAKE \$35.00 Profit on \$1.50 Outfit; Gold Initials for Automobiles, Etc. National Station D, Brooklyn, N. Y.

MONEY from start. Household necessity. Invaluable adhesive. Mends any cloth. Sensational seller. Repeats. 185% profit. Carson Supply Co., 332 Shubert Bldg., Kansas City, Mo.

AGENTS \$300-\$500 month who reach Ford owners selling a new device. Only proposition of this kind ever offered. Manufacturer, 9 Greenleaf Ave., Medford, Mass.

NEWARK Manufacturer wants agents and distributors everywhere for automobile whistles of all kinds, also glare shields. Exclusive territory to experienced accessory man. For particulars—Interstate, 350 Mulberry Street, Newark, N. J.

AGENTS—Big Money and Fast Sales. Wide-awake men and women are making \$50 weekly, and up, representing us. Our Polish—for windows, mirrors, aluminum, brass, nickel, silverware, etc.—sells fast, at 50c, to housewives, auto owners and others, and repeats. A two-minute demonstration gets the money. Exclusive territory and free sales helps to hustlers. Write at once for full particulars and free sample. The Mallard Chemical Company, Dept. E., St. Louis, Mo.

EASY, pleasant work for Mechanics, Shop Men, Clerks, during spare hours; will add many dollars to their salaries. Also want persons who can give full time. Big wages assured. Novelty Cutlery Co., 67 Bar St., Canton, Ohio.

POLMET—The Wonderful Polishing Cloth that cleans all metals without liquid, paste or powder. Approved by "Good Housekeeping" and "Modern Priscilla"—sells fast at 25c. Sample free. Gale & Co., Inc., 15 Edinboro St., Boston.

WE want agents specializing on Toilet Preparations. Face Creams, Hair Gloss, Toilet Soaps, 150 fast sellers. Colonial Chemical Co., 631 Penn Ave., Pittsburgh, Pa.

SELL Komik Display Kards, Price tickets, card holders, display stands, etc. Big Demand. Komik Advertising Co., Cambridge, Ohio.

AGENTS—Men's Moccasin Work Shoes. Your commission \$1.00 pair. We carry stock. Direct to wearer. Exclusive territory open in various counties. Big repeat business. Write now. Charles Kellert Co., 115 Bedford St., (Dept. 501), Boston, Mass.

ASTOUNDING invention. Ferds use kerosene, start instantly. Mileage doubled. Big profit. Super, 1306 Fondulac, Milwaukee, Wis.

DIAMOND Sensation at Last! Amazing discovery of Rajah Gem starts Jewelry World. \$100 weekly introducing these magnificent gems. Sample case free. Write quick! Rajah Company, Dept. F7, Salisbury, N. C.

125% CLEAR profit selling neckties; 2 samples \$1.00; satisfactory or money refunded. Raymond Mfg. Co., 132nd St. and Madison Avenue, New York.

AGENTS. Household necessity. Sells rapidly. Large Profit. Square deal. Premier Mfg. Co., Dept. 813, Detroit, Mich.

MAKE \$17 daily—Finest Extracts, Food Products, Toilet Preparations, Household Necessities. Credit: Sample Case Free. Write for amazing offer. Perkins Products, B-6, Hastings, Nebr.

AGENTS: Big returns, fast office sellers; particulars and samples free. One Dip Pen Co., 2 Daily Record, Baltimore, Md.

AUTO owner tire agent wanted each locality to use and take orders for handmade Mellinger fabric and cord tires; guarantee bond 8,000 and 12,000 miles (no seconds); shipped prepaid on approval; get your tires free; no capital or experience required; make \$100 to \$300 weekly. Write for wholesale prices and sample kit. Address, Mellinger Tire Co., Dept. 290, Kansas City, Mo.

AGENTS—Clever Invention! Inkspoon makes every pen a fountain pen. Fast office seller; big profit, demand increasing everywhere. Exclusive territory offered. Sample free. H. Marul Company, Tribune Bldg., New York, N. Y.

AT Last—World's Greatest Adding Machine. Almost human. Retail \$15; work equals \$200 machine. \$500 monthly easily made, demonstrating to stores, offices, garages, factories. Simple, easy; adds, subtracts, multiplies, divides automatically. Speedy, accurate, durable, handsome. Five year guarantee. Tremendous demand, amazing profits. Liberal trial offer. Protected territory. Write quick. Lightning Calculator Corp., Dept. F, Grand Rapids, Mich.

GET Our Free Sample Case—Toilet articles, perfumes and specialties. Wonderfully profitable. La Derma Co., Dept. A, St. Louis, Mo.

AGENTS—Stamping names on Pocket Key Protectors; sample Check with your name and address, 25c. Stamping Outfits, Emblem Checks, Check Fobs, Name Plates. Hart Mfg. Co., Desk 2, 303 Degraw St., Brooklyn, N. Y.

AGENTS—Steady income. Exceptionally useful household article. Handycap Co., Newark, N. J.

AGENTS—Three neckties boxed singly for \$1.00. Retail \$2.00, cash with order. Address 401 Searle Bldg., Rochester, N. Y.

AGENTS—Sell "Instant Shine" Metal Polishing Cloth, 2-c; costs 7/8c. Sample free. Instant Shine Polish Company, Utica, N. Y.

AGENTS: Big Money Monogramming by Transfer Method. Catalog Showing Over 50 Styles and Particulars Free. Motorists' Accessories Co., Mansfield, Ohio.

"HOW to Sell Patents" free. Patent News-O, Washington, D. C.

TAILORING Agents—50 good men wanted, who can earn \$50 weekly and up. Our line contains 220 big-value all-wool fabrics to retail at \$25 to \$47.50 for suits and overcoats. Your profit \$5 to \$9.50 in advance. Big 6x9 swatch outfit free. Ref. req. R. B. Ferrin, Mgr., P. O. Box 1097, Chicago

AGENTS: Big Profits. Best and cheapest window letters made. Easily applied. Dime brings five samples. Particulars free. Stalbrite Co., 1115 Second Ave., New York.

WANT Distributing Agents everywhere for Hanslick, the new original powdered handsoap. Removes grease, grime, ink, paint, and most anything from the hands without injury to the skin. Every mechanic and auto-owner, everybody who gets his hands dirty will be a customer. A great opportunity for a hustler to get in business for himself. Full information free. Send 10 cents, coin or stamps, for liberal sample can. Solar Products Company, 122 West Lake Street, Chicago.

YOU can make \$75.00 to \$100.00 a week selling our big line of 150 articles, used constantly in every home. Write us, we will send you our handsome \$15.00 Sample Case Outfit on trust. Federal Pure Food Co., Dept. PP, Chicago.

SELL Pearl Necklaces. 500% Profit. Everybody wants one. Easy to sell. Write for Rock-Bottom Prices. Star Import Company, 43 Second Avenue, New York.

AGENTS to handle easy selling article used by every Ford owner. Ten dollars a day selling dealers. Teuscher Pulley & Belt Co., St. Louis, Mo.

BEST proposition in the Specialty field. Perry Lykall Paintings, Photo Medallions, and Novelties have no equal. Every interview means a sale. 600% profit. Write for details. Perry Photo Novelty Corporation, Sect. PM7, 300 Bowery, New York.

AGENTS—\$10 to \$25 daily. No investment. Free outfit. Best values. Largest commissions. World Raincoat, 639-B Morris Park Ave., New York.

MAKE \$25 to \$50 Week, representing Clow's Famous Philadelphia Hoists, direct from mill—for men, women, children. Every pair guaranteed. Prices that win. Free book "How to Start" tells the story. George Clow Company, Desk 31, Philadelphia, Pa.

MAKE Big Money Easy in your spare time. Double profits. New Self-Wringing Mop, Eastway Company, 405 St. Paul, Baltimore, Md.

SELF-THREADING Needles, Needle Books, Machine needles, find sales in every home. Fine side lines, easily carried, big profits, sample and catalogues free. Premiles Lee, 145 East 23rd St., New York.

YOU can be your own boss with our Key-Check outfit. Good for \$5 a day stamping names on pocket key checks, fobs, etc. Sample check with your name and address. 20 cents. Pease Die Works, Dept M, Winchester, N. H.

INSTANT Weld. Repairs largest punctures without cement or heat. Leon's profit one day, \$56. Write quick. Free sample; territory going fast. Tourists' Pride Mfg. Co., Desk T, Minneapolis, Minn.

EARN \$10 daily silvering mirrors, plating and refinishing metalware, autos, chandeliers, bedsteads, headlights. Outfits furnished. E. Deete Laboratories, 1133 Broadway, New York.

\$10-\$25 DAILY Selling Men's and Women's shoes direct to wearer; exclusive territory; sales come easy. Lyman B. Musser Shoe Co., 207 Palace Bldg., Kansas City, Mo.

AGENTS sell Wolverine Laundry Soap. Wonderful repeater and good profit maker. Free Auto to hustlers. Wolverines Soap Co., Dept. B17, Grand Rapids, Mich.

EVERYBODY uses extracts. Sell Duo Double Strength Extracts. Complete line household necessities. Big repeaters. Write today. Duo Co., Dept. El, Attica, N. Y.

PATENTED Cigar Lighters with Glass Advertising Front. Also Electric Cigar Moisteners. Wonderful Sellers. No Competition. Big Steady Profits. Proof, Cuts, Sales Plan Free. Drake Mfg. Co., Dept. M, Milwaukee, Wis.

\$8.00 TO \$20.00 per day. A wonderful seller. Any man, woman, boy or girl can make big wages Selling Crimp Grip Clothes Line Fasteners. It is a perfect rope holder and can be used for many purposes. Crimp Grips are a simple, time-saving device. They last a life time and will not rust; it holds the line tight, and saves time on wash days. Every buyer is a booster. Send 5c for Mounted Sample and one pair of Crimp Grip Clothes Line Fasteners. Write for particulars. Crimp Grip Company, Belvidere, Ill.

AGENTS: You can coin money selling our new Fabric Table Covers, require no laundering. Size 56 x 56, prepaid \$1.50. 13-piece Luncheon set included Free. Write for sample and special offer. P. Condon, 77 Bedford St., Boston, Mass.

AGENTS clear \$50.00 weekly selling Quinine Portraits. Expense money advanced. Credit given. Big line now ready. Samples and Catalog free. Consolidated Portrait Co., Desk 2, Chicago.

CAN you sell Ford size tires at \$3.50 each? Write for plan. Details free. American Accessories Co., Dept. 178, Cincinnati, Ohio.

MAIL-ORDER houses and distributors; we pack big profit beauty creams, face powders, perfumes, toilet preparations with your label. Chemist, 944A No. Clark, Chicago.

WE Start You Without a Dollar. Soaps, Extracts, Perfumes, Toilet Goods. Experience unnecessary. Carnation Co., Dept. 201, St. Louis.

BIG Profits. New \$3.50 Automatic Adding Machine. Quick Sales. No competition. Ten daily easy. Absolutely accurate. Fully guaranteed. Pocket size. Business people everywhere positive customers. Exclusive territory to workers. Act quick. Bassett Company, 1458-J Hollywood Ave., Chicago.

IF you want good live agents—fellows who can get the business—ask me how others are doing it. I'll gladly render the necessary assistance. Gen. F. Baker, Mgr. Classified Advertising, Popular Mechanics Magazine, Chicago.

BUILD permanent business. Men's, Women's, Children's guaranteed shoes direct to wearer. A. P. Condon, Sales Manager Allen Shoe Co., 116 Summer, Boston.

NEW Invention beats vacuum sweeper and all its attachments. No electricity required. All complete only \$2.85. Over 100% profit to agents. Write O. P. Morgan, Mgr., 228 Grimes St., Fairfield, Iowa.

PORTRAIT Agents! Get busy on the biggest profit proposition you've ever seen! The new sensation in the portrait field—Artroll Portrait Paintings—exactly like oil paintings. Easy, big seller, great for "repeats." A "clean-up" in combination with famous P. & G. Medallions. Write now. Puddin' & Goldstein, Dept. "A," 259 Bowery, New York.

MOTOR tires sell easy. Address, 807 Milwaukee St., Menasha, Wis.

\$32.40 COMMISSION on three sales. Snappy auto necessities—real "kick." Sample \$1.50. Some rich territory open. Write quick. Specialties, 1403 New York Ave., Washington, D. C.

MAKE money silvering mirrors, all kinds plating, knives, spoons, auto headlights. Outfits furnished. Free booklet. International Laboratories, Dept. 25, 311 Fifth Ave., New York.

AGENTS—Send for free sample "Fretnot"—washday wonder. You can clear at least \$20 to \$100 weekly, according to spare or whole time. You don't have to talk; if she doesn't buy at sight, leave sample; she will be looking for you long before you are able to make the rounds again. Samples furnished free. Premiums for your customers. Exclusive territory. Credit given. Empire Specialties Co., 1549 N. Wells, Dept. 101, Chicago.

BIG Money and Fast Sales—Everybody—Everywhere—Everyday finds hundreds of uses for Darn E-Z Universal Fabric Cement—Good exclusive territory still open. Darn E-Z Laboratories, Dayton, Ohio, Dept. P. 8.

AGENTS: A sale in every home for our beautiful dress goods, silks and general yard goods. Quick sales! Big profits. Large book of nearly 1,000 handsome fabric samples furnished to agents. Write today. National Importing & Mfg. Co., Dept. 6X, 573 Broadway, New York, N. Y.

NEW 1924 Specialty. 200% Profit when sold at 50c. Real \$1.00 value. Sells in every home. No competition. \$1.00 to \$3.00 an hour, full or spare time. Thirty other big sellers. Free sample case offer. Send post card today for particulars. General Products Company, Dept. T, Newark, N. J.

AGENTS—Men and Women. Establish permanent business. 31c money order brings can of Gray Crystals, a wonderful Gray and Stew Improver. Try it and convince yourself. Every Store and Home a prospect. New product with big future. Exclusive territory to live representatives. Smith & Gray, Manufacturers, Guinda, California.

\$75 WEEKLY Selling Nustile Guaranteed Hosiery. Your pay daily. All styles and colors; also Pure Silk, 4 pairs, \$5.50. Special monthly bonus. Sample outfit furnished. Nustile Hosiery Mills, Dept. 175, Philadelphia, Pa.

\$10 DAILY easy. Experience unnecessary. Complete line fancy aprons and house dresses. Something new. Nothing like them. American Braiding Co., Dept. P, 329 Monroe, Chicago.

A DIFFERENT Oil-Gas Burner. Separate flame-control valve, bronze generator. No noise, no carbon. Sells to tourists, campers, farmers, hot-dog stands, anywhere. Install in any stove. 87% profit. Write for agency. E. R. Caldwell & Son, Syracuse, N. Y.

WILLIAMS No Water Hand Soap. In tubes, has taken Auto owners by storm; washes dirtiest hands perfectly clean without water. Easy demonstration makes quick sales; 156% profit. Williams Co., Box 245, Montclair, N. J.

YOU Can Easily Make \$60 Weekly selling new, popular Perflex Fibre Brooms. Outlasts four ordinary brooms. 100% profit. Get agent's Special Introductory Offer. Brooklyn Perflex Corp., 145-C New Jersey Ave., Brooklyn, N. Y.

SALESMAN V. W. Crawley writes: "For six months, April to October, 1923, my net earnings have been \$1688.02." You can do as good or better with our line. 60% profit, best brushes made and other striking advantages. Write for best brush story ever told. Queen City Brush & Specialty Co., Dept. G, Cincinnati, Ohio.

WONDERFUL! Startling! Amazing! Our Ex-Cel Luminous Crucifix and Magical (Luminous) Necklace shine brilliantly in the dark. Sell on first demonstration. Big profits to you. Write for further particulars, or better still, send for sample and territory protection immediately. Crucifix \$1.50, Necklace \$1.00, postpaid. W. G. Hannan Co., Dept. B, 57 E. 18th St., Chicago.

LIVE Agents make \$10 day selling Eureka Strainer and Subash Preventer for every water faucet. Takes on sight. Widely advertised and known. Get details today. A. B. Seed Filter Company, 73 Franklin, New York.

TO secure agents or salesmen or for selling farms and reaching investors, use classified (want) ads in largest newspapers and magazines. Price list No. 30 sent free. Ankrum Advertising Agency, 20 W. Jackson Blvd., Chicago, Ill. The largest classified advertising agency in the U. S.

A BUSINESS of Your Own. Make Sparkling Glass Name and Number Plates, Medallions, Checkerboards, Signs, Big Illustrated Book Free. E. Palmer, 512 Wooster, O.

BIG Money and Fast Sales. Every owner buys Gold Initials for his auto. You charge \$1.50; make \$1.35. Ten orders a day easy. Write for particulars and free samples. American Monogram Co., Dept. 46, East Orange, N. J.

EVERYBODY Needs and Buys the "Business Guide." Wells cleared \$1,150 in 35 days. Send for Sample. It's Free. Nichols Co., Dept. 4B, Naperville, Ill.

MAN in each town to plate auto parts, reflectors, bathroom fixtures, refinish beds, mirrors, chandeliers; by new method. No capital or experience required. Simple plan of manufacturing at home starts you in big money-making business. Outfit furnished. Free particulars and proofs. Gun Metal Co., Ave. H, Desatur, Ill.

EXCLUSIVE agents \$225 weekly. Genuine gold letters for store windows. Free samples; selling instructions. Chicago Window Sign System, 6226-A Kimbark Avenue, Chicago.

EARN big money fast applying gold initials to autos. Every owner buys—\$1.35 profit on \$1.50 sale—particulars and samples free. Write quick. Lithogram Co., Dept. 17, East Orange, N. J.

WHY Work for others? Start and operate your own business. Our system proprietary specialty business offers wonderful opportunities to make \$100 to \$500 weekly. Openings everywhere. We furnish everything and show you how. Booklet free. National Scientific Laboratories, 208 Monroe, Richmond, Va.

BIG money and fast sales—every owner buys gold initials for his auto. You charge \$1.50, make \$1.44, 10 orders daily easy. Samples and information free. World Monogram Co., Dept. 73, Newark, N. J.

AGENTS—Big Profits Genuine Gold Leaf window letters and scripts; anyone can put us. Consolidated Sign Letter Co., 632 S. Dearborn, Chicago.

DISTRICT Managers and Agents Wanted. Experienced, for a fast-selling line of hosiery, underwear and silk knitted neckties. Volume sales and liberal commission means satisfactory incomes. State full particulars in first letter. Penna. Hosiery Mills, Dept. E, 24 S. 17th St., Philadelphia, Pa.

SELL the Livest, Quickest Selling Specialties Ever Known—Famous "Hahway" self-lighting pocket Cigar Lighters and Gas Lighters. Low Prices. Easily Demonstrated. Sell to Dealers. Employ Sub Agents. Exclusive Territory. Make over 100% Profit. P. Bernhardt, 148 Chambers Street, New York.

LARGE Manufacturer Wants Agents. Make \$100 weekly Outfit free. Sell made-to-measure genuine Crayonette Gabardines, \$14.50. Whitecoats, \$12.50. Reversible Raincoats, \$9.75. Standard Raincoat Co., 131 West 17th St., New York.

HIGH-GRADE SALESMEN WANTED

SALESMEN: Sell tailoring. It's a great staple that sells the year around. You don't have to look for prospects; every man is a possible customer, and with a good line at the right price you sell him again and again. Our line is a good line. It offers an assortment of more than 100 Virgin Wool fabrics of the finest quality made up in suit or overcoat to special order for only \$31.75. This price is \$25 lower than store prices. It is this that enables our men to make the big money they do. Earnings of from \$75 to \$125 a week are common with our men and in season many of them make even more. Our selling outfit is a winner; the fabric assortment is powerful and impressive and the advertising helps contained are tremendously effective. Write at once for the full facts about what we believe to be the greatest selling opportunity in the field today. When you write, tell us about yourself. It will help us to give you action. But write at once. Now's the time to get started. Address Dept. 118, Goodwear Chicago, Inc., 814 West Adams Street, Chicago.

HIGH-GRADE men wanted as distributors for nationally-advertised article. Not a temporary job but the opportunity to establish an ever-expanding business with generous and steady profits. Write giving details of your past business experience. Applications considered in order of receipt. CFSKO, 21 N. 10th, Richmond, Ind.

SALESMEN with real sales ability to sell dealers and garages a leading advertised line of aluminum Accessories, Accelerator Pedals, Signal Lamps, Illuminated Kick Plates, Step Plates, Roof and Cowl Ventilators, etc., for all cars. Attractive dealer discounts. New selling plan reduces unfruitful calls to the minimum. Year 'round demand. Liberal commission. Earnings warrant the attention of big caliber men. Write for the plan today. National Aluminum Co., Box No. 5, Racine, Wis.

SALESMANAGER Wanted to sell drug, hardware, and cigar stores Keen Edge Strop Dressing, which sharpens straight razors and safety blades and renews old razor strops. Each dozen displayed on beautiful four-colored stand. Quick seller. New. Repeats. Retail price \$3.00 dozen. Dealers price \$1.50 per dozen. Costs Salesmanager only 50 cents per dozen. You make \$1.00 dozen profit, or 200 percent. Order today. Wonderful opportunity and sideline. Exclusive contract. We sell you, and you sell dealers and salesmen. Send order with application. Keen Edge Mfg. Company, Dallas, Texas.

\$6 TO \$15 daily—year around position, monthly bonus besides. Groby made \$489.50 in 30 days, Cregan \$443.03, Whiteside \$325.00, Hobery \$352.00, Bickel \$320.91. No experience or capital required. Exclusive patented necessity. Millions of prospects, homes, stores, schools, factories, auto and truck owners. Spare time satisfactory; we deliver and collect, also carry accounts. Cash in on our advertising and approval by National Board and big users. Our original new plans produce results. Write quick for full details. The Fyr-Pyter Co., 197-Fyr-Pyter Bldg., Dayton, Ohio.

SELL men's high grade shoes direct to wearer. The most permanent, profitable, and satisfactory proposition in the direct selling field. Every working man a prospect. Not sold house to house. 85% of orders repeated. We have one hundred men making from \$75.00 to \$150.00 per week. If you are ambitious, want to make money, and are willing to work you can do the same. A postal written this minute will bring you full details. Carson Shoe Co., 21-24 Lincoln St., Boston, Mass.

WANTED—Tailoring Salesmen, make \$60 to \$125 per week. Biggest merchants in many towns have started with our line. We are the largest made-to-measure tailoring house in the country, furnishing elaborate sample equipments, including 500 all-wool fabrics. You make your own profits from \$8.00 to \$15.00 on each order. Guaranteed absolute satisfaction, perfect fit, best workmanship, or no sale. Write for line and all accessories to be sent free. Tell us all about yourself. Address N. O. Perry, Sales Manager, Box 483, Chicago, Ill.

STOP Right Here. Make real money this summer. Week's salary often made on one sale. Look at our salesmen's monthly averages: N. Y. man, \$680.00; N. Dakota man, \$500.00; Ind. man \$750.00, and so on. You call on business men only. Introduce entirely new proposition. No competition. Rich territory open. No collections. No deliveries. You take orders—we do the rest. Write—get complete dope. National Advertising Service, Inc., P. O. Box 73, La Grange, Ind.

MAKE \$100 Weekly in Spare Time. Sell what the public wants—long distance radio receiving sets. Two sales weekly pays \$100 profit. No big investment, no canvassing. Sharpe of Colorado made \$955 in one month. Representatives wanted at once. This plan is sweeping the country—write today before your county is gone. Ozarka, 802 Washington Blvd., Chicago.

EVERYONE Buys Every Day some part of our line. You can take orders for complete line of groceries, paints, roofing, motor oils, tires and radio sets, from institutions, boarding houses and private families. We deliver and collect. Our goods are nationally known and guaranteed quality; just show samples and secure large orders. No capital or selling experience necessary. Heavy re-orders make a steady profitable business. Address Hitchcock-Hill Company, Dept. 226, Chicago. Reference: any bank or express company.

DON'T Look at This—if you are looking for a side line. Selling Motion Picture Publicity service to leading merchants throughout the country is a man-sized job, pays a man-sized income and offers a man-sized opportunity. Will you give us a chance to prove that this is what you have been looking for? Fascinating? Paying? Growing?—Nothing else but—! Alexander Film Company, 3189 So. Broadway, Denver, Colo.

SELL advertising pencils. Liberal commission. Peerless Novelty Works, 740 Hedapp, Dayton, Ohio.

HIGH-GRADE Salesmen Wanted—Experienced traveling salesmen to call on Hardware and General Store trade. High-grade Popular Priced line of Aluminum Cooking Utensils. Commission basis. You can make \$100 weekly. Will consider producers carrying non-conflicting lines. American Aluminum Mfg. Co., Leont, Ill.

\$50.00 TO \$75.00 weekly selling printed advertising gummed tape rapidly replacing twine. Part or full time. All merchants prospects. Attractive proposition. Write The Ad-Lee Company, 825 Wabash, Chicago, Ill.

TAILORING Salesmen: Oldest established wholesale tailors on earth pay the Largest Commission and give Liberal Bonus taking orders for union made \$15.00 all wool suits at \$32.50. Big outfit and advertising furnished free. Exclusive territory. Experience unnecessary. Wilson Tailoring Co., 934 W. Jackson, Chicago.

AGENTS—Best seller; Jen Rubber Repair for tires and tubes; supercedes vulcanization at a saving of over 80% per cent; put it on cold. It vulcanizes itself in two minutes, and is guaranteed to last the life of the tire or tube; sells to every auto owner and accessory dealer. For particulars how to make big money and free sample, address Amazon Rubber Co., Philadelphia, Pa., Dept. 510.

SALESMEN—Sell Four-Square Work custom-made shirts at ready-made shirt prices. 125 latest patterns; prices \$2.95 up. Shirts individually cut. Unconditional guarantee. Jacobs' Custom Blit Shirt Company, 538 Broadway, New York.

SALESMEN: Earn \$50.00 weekly selling suits \$12.50; guaranteed two years. Profits in advance; \$3.00 to \$3.50 each sale. Complete line. Coat, vest, pants, riding pants, cap. District territories open. Stone-Field Corporation, A2556 Wabash, Chicago.

TAILORING Salesmen—profits in advance, bigger commissions and bonus. America's fastest selling line, union made to measure All Wool suits, overcoats \$12.50. W. D. Smith & Co., Established 1895, Chicago.

SALESMAN: If You Think In Terms of \$5,000 the First Year, Write Me Personally. Strong line for retail stores. Nationally advertised. Established concern has unusual opportunity. Liberal weekly advance to producer. Geo. R. Williams, Mgr., 1922 Euclid Avenue, Cleveland, Ohio, Dept. 200.

TAILORING Salesmen and Merchants everywhere write for Fall and Winter, 1924, line. Our double pants suits at \$28.50 and up, are the biggest money-making values in the tailoring market—\$5.00 to \$12.00 profit on each order. We supply large swatch line showing over 250 samples. Write today giving full details and secure exclusive territory. Jay Rose & Co., Dept. 83, 411 So. Wells, Chicago.

LIVE Salesmen—Make \$35 daily selling aluminum electric table stores to Drug, Hardware, Grocery and Electrical stores. Best and cheapest on market. Write today for detailed proposition. Gem Mfg. Co., Inc., 463 Stevens Bldg., Detroit, Mich.

SALESMEN given protected territory to sell Doublewear Shoes direct from factory to wearer. Our new measure board insures perfect fitting. Write for particulars and list of open counties. Doublewear Shoe Co., Manufacturers, Minneapolis, Minn.

SIDELINE Salesmen—Lewis Improved Motor Oil Conveyors. Fastest, Cleanest, Most Efficient in Use. Conforms with Law. Sells to All Oil Stations and Garages. Liberal Commission. No Delinquencies. D. D. Lewis Company, Kalamazoo, Mich.

\$20,000.00 YEARLY. State Distributor. Amazing newly invented Pricing System. Retail \$4.99 only. No competition. Tremendous demand! Millien Mfg., Dept. AS, Colonial Bldg., Boston, Mass.

STATE Manager. Envelope Sealer Seals 2,500 envelopes hour. Amazing invention. No competition. Retail \$5 only. \$20,000.00 yearly. Red-E Co., Dept. AE, 100 Boylston, Boston, Mass.

\$19.50 DAILY from three \$10.00 sales. General Protection service universally demanded. Federal Detective Association, New Orleans, La.

SALESMEN: Make big money selling our attractive radio agency-advertising proposition. Sells as well in summer as in winter. All dealers. No knowledge radio needed to sell. E. Main Co., Cedar Rapids, Iowa.

SALESMEN—Become Independent. Own your business; experience unnecessary; selling our \$7,500 Accidental Death, \$50 Accident, \$25 Sick Weekly Benefits; \$12.50 yearly; other amounts proportionate. Guaranteed steady income from renewals. \$750,000 Deposited Insurance Department. Registration Dept. A, Newark, N. J.

TRAVELING Salesmen calling on retail stores wanted by large manufacturer to sell unique line of business-boosting articles. Year round, fast selling, main or side line. If not earning \$150 weekly, address Eliazer Works, 222 Charles St., Boonville, N. Y.

SALESMEN sell sales and order books, auto, reg. rolls and bill findings. Large demand. Liberal commission. Wirth Sales Book Co., Dept. PM, Chicago.

SALESMEN—Sideline pays five to ten dollars a day taking orders for Specialty printed gummed advertising and Match Box Stickers. Write for proposition, samples, etc., today. Beardsley's Printery, Rock Island, Ill.

WHY Work for others? Start and operate your own business. Our system proprietary specialty business offers wonderful opportunities to make \$100 to \$500 weekly. Openings everywhere. We furnish everything and show you how. Booklet free. National Scientific Laboratories, 208 Monroe, Richmond, Va.

SIDELINE Salesmen making small towns—\$25 to \$100 weekly extra. New Idea. No sale. No collection. No samples to carry. State line carried and territory covered. Keeney & Sons Co., Dept. 504, 700 E. 40th St., Chicago.

\$4.00 PROFIT on Every \$5.00 sale. "Free Sample"—New Specialty. (Money Getter.) Every Storekeeper, Doctor buys quickly. Experience unnecessary. Territories open. Box 596, Hartford, Conn.

SALESMEN Can make \$5.00 a day selling our Calendars, Pencils, Signs, Advertising Novelties, Yardsticks, Whistles, etc. Liberal terms. Sells entire year. Fine side line. Local and traveling agents. Mohel Calendar Co., Dept. 226, South Bend, Ind.

CALIFORNIA Rosebuds selling like hot cakes. Agents coinng money. Absolutely new. Big profits. Catalog free. Mission Factory SP, 319 No. Halsted, Chicago, Ill.

\$60-\$200 A WEEK. Genuine Gold Letters for store Windows. Easily applied. Free samples. Liberal offer to general agents. Metallic Letter Co., 438-B North Clark, Chicago.

A WONDERFUL Seller! Any man, woman, boy or girl can make big wages. Some agents make from \$8.00 to \$20.00 per day. Crimp Grip Clothes Line Fasteners are a simple, time-saving device for holding a rope—also used for many other purposes. It pays for itself quickly in time saved on wash days. No knots—it fastens and releases quickly. Every home a prospect. Every housewife who uses Crimp Grips—and there are thousands of them—is a booster. There is but one Crimp Grip. Write for particulars, or send 50¢ for one pair and a mounted sample, with full particulars to agents. Crimp Grip Company, Belvidere, Ill.

BOOKKEEPERS and Accountants—U. S. Civil Service examinations for assistant income tax auditors, \$2,500; auditors, \$3,000; resident auditors, \$2,400; traveling auditors, \$3,500; will be held soon. The Federal Auditors' Institute is holding test examinations made up of questions given in other Government examinations. Your work will be graded and coaching given. You will be coached and examined by former civil service examiners. Income tax auditors' salaries range from \$50 weekly, which is lowest pay, up to \$1,500 and over. Coaching is conducted up to time of Government examination. Age limits, 23 to 50. The entire cost to bookkeepers is only \$5. Mail application now. Absolutely not a penny more. For particulars write Dept. P-7, Federal Auditors' Institute, Washington, D. C.

FORCEFUL—Appealing—Convincing letters specially drafted for applicants for positions. Send full particulars and one dollar. Scruggs, Box 420, Memphis, Tenn.

AGENTS: \$11.80 daily in advance (send for sworn proof) Introducing New Insured Hosiery—47 styles—35 colors—guaranteed seven months—Fall line now ready—No capital or experience required—You simply take orders—We deliver and collect (or you can deliver, suit yourself). Credit given—Pay You Daily—Monthly bonus besides—We furnish samples—spare time will do. Maccochee Textile Company, Room 2608, Cincinnati, Ohio.

EARN \$20 to \$70 daily easy—Repairing, Rebuilding Typewriters. Great opportunity; no competition; openings everywhere; tools free. Write today. Dea's Typewriter Mechanical School, Ada, Okla.

RAILWAY Mail Clerks. Steady work. \$123 month. List positions—free. Franklin Institute, Dept. M-19, Rochester, N. Y.

75 MEN—boys, 18 up, wanted immediately to prepare for U. S. Government Positions. Railway Mail Clerks. City Mail Carriers. Post Office Clerks. Income Tax Examiners. \$117 to \$250 month. Steady work. Short hours. Paid vacation. Influence unnecessary. Write immediately for schedule of examinations. Franklin Institute, Dept. M-3, Rochester, N. Y.

FIREMEN, Brakemen, Baggage-men. Sleeping car, train porters (colored). \$140-\$200. Experience unnecessary. 810 Railway Bureau, East St. Louis, Ill.

SALESMEN, we pay larger commissions than any other Brush House in the Country to men selling our line of Sanitary twisted-in Wire Brushes, Sanitary Wire Grip Brush Co., 15 Mercer St., New York.

FINGER Print Experts—Excellent paying positions; particulars free. Finger Print Headquarters, 188 East 79th, New York.

\$100 TO \$300 weekly. Men with slight knowledge of motors who can reach car owners can earn \$200 weekly without making a single sale. If they can also make sales, profits may reach \$25,000 yearly. Only proposition of its kind ever offered. S. A. Phillips, 235 West 27th, New York.

LOCOMOTIVE Firemen for railroads nearest their homes—everywhere; beginners \$150-\$250 monthly. Railway Association, Desk M-1, Brooklyn, N. Y.

U. S. GOVERNMENT wants men 18 up. Railway Mail Clerks—City Mail Carriers. \$117-\$192 month. Steady. Information free. Write immediately. Franklin Institute, Dept. M-19, Rochester, N. Y.

WANTED—Railway Mail Clerks, Post-office Clerks and Carriers, Customs, Internal Revenue, and many other classes of Government help. \$1,100 to \$2,000 yearly. Our 36-page Booklet shows how to obtain these desirable life positions. Write Chicago Civil Service College, A-41 Kesner Building, Chicago.

ARE You Old at Forty? See our advertisement on page 152 of this issue. The Electro Thermal Company, 2134 Main Street, Steubenville, Ohio.

MEN: We will establish you in a permanent business paying big income. Your credit is good for merchandise; people must buy every day. No special experience necessary. Write today for free booklet "McConnon's System." McConnon & Co., Factory M9, Winona, Minn.

SILVERING Mirrors, French plate. Easily learned; immense profits. Plans free. Address, Wear Mirror Works, Excelsior Springs, Mo.

OUR genuine gold window sign letters are an excellent money-making proposition for handy men. Slann Sign System, Bethune Ave. E., Detroit, Mich.

MAKE money writing Photo-plays; details free to beginners. No correspondence course. Producers' League, 230 Wainwright, St. Louis.

BOYS—Men, \$35 week. Become Automobile Experts. Learn while earning. Write Franklin Institute, Dept. M-401, Rochester, N. Y.

MONEY! Silvering Mirrors, Autolights, Radiators, tableware, stove. Outfits. Methods free. Sprinkle, Plater, Dept. 28, Marion, Ind.

WHY work for others? Start and operate your own business. Our system proprietary specialty business offers wonderful opportunities to make \$100 to \$500 weekly. Openings everywhere. We furnish everything and show you how. Booklet free. National Scientific Laboratories, 208 Monroe, Richmond, Va.

EARN \$10 daily silvering mirrors, plating and refinishing metalware, autos, chandeliers, headlights, headlights. Outfits furnished. E. Dele Laboratories, 1133 Broadway, New York.

MEN wanting forest ranger, postal clerk and other govt. positions; particulars free. Write Mokano, Dept. A12, Denver, Colo.

MEN—Boys 18 Up. \$123 month. Railway Mail Clerks. List examination places—free. Franklin Institute, Dept. M-19, Rochester, N. Y.

GET a United States Government Position. Good Pay. Short Hours. Vacation. Sick Leave. Pension, etc. Prepare for Railway Mail, Post Office, Custom House, Internal Revenue, Rural Carrier or other branches. Examination all the time. Common education sufficient. Let our expert (Former U. S. Civil Service Secretary-Examiner) train you. Guaranteed Preparation. Write today for Free Booklet. Patterson Civil Service School, Dept. 8, Rochester, N. Y.

RAILWAY Postal Clerks: Start \$123 month. Railroad pass; expenses paid; questions free. Columbus Institute, E-2, Columbus, Ohio.

YOU Are Wanted. U. S. Government Jobs. \$100-\$250 month. Bonus opens hundreds positions. List free. Franklin Institute, Dept. M-19, Rochester, N. Y.

INVENTORS desiring to secure patents should write for our book "How to Get Your Patent," tells our terms and methods. Send sketch for our examination and instructions without charge. Randolph & Co., Dept. 418, Washington, D. C.

WHITE articles, stories, news, in spare time for newspapers and magazines. Big pay. Copyrighted book free. Press Syndicate, 982, St. Louis, Mo.

ALL men, women, boys, girls, 17 to 65, willing to accept Government Positions, \$117-\$250 travelling or stationary. Write Mr. Ogmont, 101 St. Louis, Mo., immediately.

\$10-\$200 A WEEK. Genuine Gold Letters for store windows. Easily applied. Free samples. Liberal offer to general agents. Metallite Letter Co., 438-C, North Clark, Chicago.

EARN \$1.20 an hour cutting blanks at home; spare time. Men only. Send addressed reply envelope. Goodyear St., 147 W. 23d St., New York.

STORIES, poems, plays, etc., are wanted for publication. Good ideas bring big money. Submit manuscripts or write Literary Bureau, 522, Hannibal, Mo.

MEN—Age 18-40, wanting Railway Station-Office positions, \$115-\$250 month, free transportation, experience unnecessary. Write Baker, Dept. 74, Walnut St., St. Louis.

INFORMATION

CALIFORNIA—Know conditions here before you come. We furnish accurate, unbiased information. Help you secure employment. Advise where to locate, start business, etc. Particulars free. E. P. Tyler, 500 Stinson Bldg., Los Angeles, Calif.

EXPERT will supply information, advice or formula, any subject. One dollar. Modern Research Bureau, Box 875, Chicago, Ill.

GUARANTEED information, any subject, strictly confidential, \$1.00. Deris Chemical Laboratories, East Cleveland, Box 59, Cleveland, Ohio.

COMPLETE, accurate, information on any subject. \$1. National Information Bureau, 1429X Milton St., Grand Rapids, Mich.

LEGAL questions answered, guaranteed correct \$1.00. Edgar Keller, Augusta, Montana.

BUSINESS SERVICE

MANUFACTURERS' Agent with wide acquaintance purchasing public desires additional accounts commission basis in Pacific coast territory. Only reputable concerns having lines with proven merit considered. Reference, Manufacturers' Agent, 401 Rialto Building, San Francisco, Calif.

ADVERTISE in 300 country newspapers, 24 words \$7.50. Proof guaranteed. Keator, Hartford Bldg., Chicago.

DELAWARE Incorporator. Charters; Fees Small; forms. Chas. G. Geyer, 901 Orange St., Wilmington, Del.

TYPEWRITERS AND SUPPLIES

TYPEWRITERS All Makes. Save one-half. Thoroughly rebuilt in our factory by the famous "Young Process." Fully guaranteed. Free Trial. We handle all standard makes. Cash or sold on easy terms. Write for Catalog. Young Typewriter Co., Dept. 5628, Chicago, Ill.

UNDERWOOD Typewriters — only \$3.00 down. Easy monthly payments. Low prices at less than manufacturers. 10 days' free trial. Rebuilt, all worn parts replaced. Just like a new machine. 3-year guarantee. Write for big free catalogue C-151. Shipman-Ward Mfg. Co., 1514 Shipman Bldg., Chicago, Ill.

TYPEWRITERS all makes; real bargains; guaranteed. Dee Typewriter Rebuilding Co., Ada, Okla.

TYPEWRITERS \$3.50 - \$24.50. Rebuilt \$28.00 - \$48.00. Knight's, 1512 Locust, St. Louis, Mo.

TYPEWRITERS All makes, \$15 up. Guaranteed. Write for our bargain price list and Free Trial offer. Department 16, Manufacturers Typewriter Clearing House, 193 N. Dearborn Street, Chicago.

TYPEWRITERS all standard makes, \$10 up. Fully guaranteed. Free trial. Write for complete illustrated lists. Northwestern Typewriter Exchange, 121 N. Francisco Ave., Chicago.

TYPEWRITING

MATERIAL typed perfectly. 30c 1000 words. Carbon, postage free. V. Glenn Coover, Remton, Ky.

TYPING Solicited—50c per 1,000. Perkins, 741 Brady, Davenport, Iowa.

PRINTING, ENGRAVING AND MULTIGRAPHING

"TELL Your Story in Pictures." Bergfeld Engraving Co., Box 303, Effingham, Ill.

QUALITY stationery printed, your name and address, 200 sheets, 100 envelopes, \$1.50 postpaid. E. J. Dunne, 6831 Jeffery Ave., Chicago.

250 BOND Letterheads, 250 Envelopes, both for \$3.00; 500, \$4.50; 500 cards \$2.00. Samples. Midland Press, 543 West Hickory Street, Kankakee, Ill.

SUPERIOR Printing—250 Letterheads, Envelopes or Cards \$1.25. Collins Press, 658 Baxter, Louisville, Ky.

BUSINESS Stationery printed to please. 500 letterheads \$1.50. Place, Harding, Mass.

98 CENTS—200 Double Sheets, 150 Envelopes match, your name and address in script lettering on both. Colors white, blue, russet. Wessling, 352 New York Ave., Jersey City, N. J.

GUMMED Labels, Name and Address, 500, 2 lines 30c, 3 lines 40c. Catalogue. Eastern Label Co. A, Clintonville, Conn.

5,000 FOLDERS 3 1/2 by 6, \$12. Citizen, Jeffersonville, Ohio.

OUR Specialty is Letterheads, Envelopes, Circulars, Pamphlets and Catalogues. Write for Prices. The Shenandoah Press, Dayton, Va.

2,000 LETTERHEADS or Envelopes \$6.25 prepaid. 3rd zone. Samples Free. Quality Printshop, Marietta, Ohio.

1,000 CIRCULARS 6x9, Limit 150 Words, \$2.40; 1,000 Bond Letter Heads or Envelopes, \$3.00 Prepaid. National Press, Dept. 49, 516 E. 75, N. Y. City.

EVERYTHING Printed! Write requirements. Franklin Press, B-34, Milford, N. H.

5,000 HAMMERMILL Bond Letterheads, 8 1/2 x 11, \$15.00. Shipment in three days. Other printing equally as low. Auxiliary Service, Riverside, New Jersey.

100 EACH Letterheads and Envelopes, \$1.00. Culpepper Press, Faith, Ark.

QUALITY Printing! Reasonable Prices! Tell us your wants and let us quote our Money-Saving prices. Best Work. We print anything. Ernest Fantus, 525 South Dearborn Street, Chicago.

250 LETTERHEADS, 250 white envelopes, printed and mailed, \$3.00. Samples printing free. Sunco, Mohawk, N. Y.

PRE-USED Printing Presses, Type and supplies. List for stamp. Popular Bargains, Richland, Pa.

PRINTING Outfits—Presses, type supplies, type novelties. Send stamp for catalogue. Model Press, York, Penna.

WE print Stationery, Booklets, Catalogs, Circulars, Campaign printing. Samples. Commercial Press, Batavia, Ohio.

20 LB. Hammermill Bond Letterheads, 500 \$2.30—1,000 \$3.00—3,000 \$8.50—5,000 \$13.75. Postage prepaid. Envelopes 10 per cent less. We print anything. Work guaranteed. Samples furnished. National Printing Company, Goshen, Ind.

1,000 LETTERHEADS or Envelopes, \$3.00. Sent Prepaid. Samples Free. Monitor Press, Morrisville, Pa.

150 EACH Letterheads; Envelopes, C. O. D. \$2. Jacobus Service, Irvington, N. J.

225 BOND letterheads, envelopes, billheads, cards, \$1.25 each. Combination, \$4.00. Economic Press, Leonia, N. J.

ADDING MACHINES

FREE Trial. Marvelous new Adding Machine. Adds, Subtracts, Multiplies, Divides, automatically. Work equals \$350.00 machine. Price only \$15.00. Speedy, durable, handsome. Five-year guarantee. Used by largest corporations. Write today for catalogue and free trial offer. Lightning Calculator Co., Dept. E, Grand Rapids, Mich.

NEW \$3.50 Automatic Adding Machine. Adds, Subtracts, Multiplies. Absolutely accurate. Capacity \$999,999.99. Fully guaranteed. 75,000 pleased users. Makes adding easy, positive, quick. Eliminates mistakes. Saves Time. Postpaid \$3.50. Bassett Co., 1458-K Hollywood Ave., Chicago.

DUPLICATORS AND DEVICES

STENCIL Duplicating Outfit—Typewriting, Handwriting. Letter \$4.00, Note \$3.00, Card \$2.00. Returnable. Primos Specialty Co., 3-M, Primos, Pa.

YOU can make 50 to 100 copies of a letter, notice, etc., at a cost of three cents on a Hoyer Quality Duplicator. Write for free trial offer. The Hoyer Duplicator Co., 14 S. Wells St., Chicago, Ill.

"MODERN" Duplicators save Time, Labor, and Money. Gets business. Reproduces Type-written or Penned Letters, Drawings, Lessons, Music, Menus, Bids, Notices, Specifications, Maps or anything in one or more colors. Prints Two per minute. Special Sale On 30 Days' Free Trial, \$2.25 Up. Booklet Free. J. E. Durkin-Reeves Co., Pittsburgh, Pa.

BOATS AND LAUNCHES

REBUILT Evinrude Motors—Only \$60. Factory rebuilt Evinrude Rowboat Motors—priced, for quick sale, as low as \$60.00. Same guarantee as new motor—same power and speed. Stock selling rapidly—write or wire your order today. Evinrude Sales & Service Station, Dept. A, 224 6th St., Milwaukee, Wis.

BOATS that always go are propelled by Ford Engines. Ford Engine Booklet free to boat owners. Harry Rider, 206B Commercial Bldg., Norwalk, Conn.

NEW Boat Book telling how to make 21 kinds of boats. Also many other helpful ideas for those who like boats. Profusely illustrated. 50 cents. Popular Mechanics Press, Room 807, Popular Mechanics Building, Chicago, Ill.

16-FOOT Rowboat—easily made. Construction blueprint 35c. Weesha-Uco., West Market, Detroit, Mich.

"HOW to make your boat leakproof." Send for booklet. L. W. Ferdinand & Co., 152 Kneeland St., Boston, Mass.

MAKE rowboats sail, \$5.00. Graham Centerboard Mfg., Harbor Springs, Mich.

RAZORS AND BLADES

TWO Razor Blade Sharpening Machines for \$100.00; cost \$500.00. L. Stine, Tacoma, Wash.

\$5.00 AUTO-STROP razors 65c complete outfit. Send stamps or money order. Sherman Wholesale Co., 50 No. Broadway, Aurora, Illinois.

SAFETY Blades resharpened—single edge 2c, doubles 3c, regardless condition; work guaranteed. Louis Stuckwisch, 426 N. Colorado Ave., Indianapolis, Ind.

BLADES resharpened, 3c any make; guaranteed service. Standard Safety Razor Corp., Pittsburgh.

GUNS, SPORTING GOODS, ETC.

SELL—100 Guns, List 10c; Trade \$25.00, New Dictionary for Shotgun. N. P. Frayser, Milan, Minn.

DIAMONDS, WATCHES AND JEWELRY

FOR Sale at a Bargain, a Complete Set of Watchmaker's Tools. R. Jaegermann, 3815 Easton Ave., St. Louis, Mo.

FOR THE HOME

LOOMS—Only \$9.90—Big money in weaving rugs, carpets, portieres, etc., at home, from rags and waste material. Weavers are rushed with orders. Send for free loom book, it tells all about the weaving business and our wonderful \$9.90 and other looms. Union Loom Works, 480 Factory St., Rossville, N. Y.

HOMEMADE Furniture—Popular Mechanics Mission Furniture Library tells how to make all kinds of furniture in the easiest way. It is not only cheaper to make your own furniture, but you have a lot of fun making it. The library consists of three cloth-bound volumes and the entire library is only \$1.50. Popular Mechanics Press, Room 807, Popular Mechanics Building, Chicago, Ill.

HOME oil burner—you can make—save one-third fuel, made from standard fittings. Dennis, 217 E. Ontario St., Chicago.

CONCRETE Handbook—How to make all sorts of devices with concrete. Directions anyone can follow. 173 articles, mostly illustrated. Tells how to make everything from a sidewalk to a concrete safe. Directions for ornamental as well as useful devices. Only 50 cents. Popular Mechanics Press, Room 807, Popular Mechanics Building, Chicago, Ill.

MAKE Inexpensive Iceless Refrigerator; Blueprint, 35c. William Quemore, Camden, N. J.

HOME Mechanics—A new Popular Mechanics Handbook containing 329 discoveries that will be of value to anyone who has a home. 96 pages—203 illustrations, 50 cents. Popular Mechanics Press, Popular Mechanics Building, Room 807, Chicago, Ill.

ANTIQUES, WAR AND INDIAN RELICS

HUNTING Bows, relics, minerals, geology, stamps, butterflies. Thousand Indian articles. Catalogue 10c. Indiancraft—P—Co., 450 Connecticut, Buffalo, N. Y.

FOR DONS—War Relics collected from Europe's battlefields. Weapons, medals, helmets, etc. Illustrated catalogue and sample war photographs, 25c. Lieut. Welsh, 2117 Regent Place, Brooklyn, N. Y.

PHONOGRAPHS AND RECORDS

RECLAIM your discarded records with this preparation which is permanent, not temporary. Proves its worth in one minute. Guaranteed. Two sizes, 50c and 75c. Sample to agents. Reconditioner Mfg. Co., Box 217, Salina, Kans.

BUILD your own Phonograph. We furnish everything. Write for Phonograph and Radio Parts Catalog. American Phonograph Co., 3752 Belmont, Chicago.

BUILD Your Phonograph. Quality phonographs. Quality Sorenado motor and motors of other types. Electric Motors, tonearms, reproducers, amplifiers, case materials, accessories. Free blueprints and building instructions. Big saving. Wonderful results. Prompt delivery. Catalog mailed for ten cents. Hoosier Manufacturing & Supply Co., 313 Baldwin Block, Indianapolis, Ind.

BUILD your own phonographs. We can supply you with motors, tone arms and all accessories at wholesale prices. Write for catalogue AX. Pleading Sound Phonograph Co., 204 East 112th St., New York, N. Y.

MUSIC AND MUSICAL INSTRUMENTS

MAKE Combination Violin-Piano; Details Free. William Quenore, Camden, N. J.

SEND 25 cents for a copy of the big song hit, "Love's Dreaming." A wonderful song. Everybody likes it. Klear Tone Co., 27 Thimess St., New York.

WRITE Songs. Big money and reputation. Write for information. J. Gordon Pub. Co., 201 N. Hoyne Ave., Chicago.

A \$500 CASH Prize is offered for the best second verse to "I'll Be Waiting." Those wishing to compete may receive a free copy of this song and rules of contest by addressing Knottable Music Corp., 1658 Broadway, New York.

VIOLINS. Deep, Mellow, Soulful—on credit. Easy terms for wonderful instrument. Get details today. Gustav F. Henning, 2424 Gaylord St., Denver, Colo.

"MUSIC Composed" to words. Bauer Bros., (Formerly of Sousa's Band), Oshkosh, Wis.

I WANT Song Poems. Casper Nathan, 1252 Bryn Mawr, Chicago.

CORNETISTS—Trumpeters—Saxophonists—Clarinetists. Get "Free Pointers." Name instrument. Virtuosi School, Concord, Mass.

PATENT ATTORNEYS

PATENTS—Write for our Guide Books and "Record of Invention Blank" before disclosing inventions. Send model or sketch of your invention for Examination and Instructions. No charge for the above information. See advertisement on pages 146 and 147. Victor J. Evans & Co., 354 Ninth, Washington, D. C.

PATENT SENSE—The book the inventor keeps. Free. See *Lawyer ad*, page 151.

PATENTS Procured. Send sketch or model today for examination, prompt report and advice. No charge for preliminary advice. Write for free booklets "How to Obtain a Patent" and "Invention and Industry" and blank form on which to disclose your idea. Highest references. Promptness assured. Clarence A. O'Brien, Registered Patent Lawyer, 585 Security Bank Building. Directly across the street from Patent Office, Washington, D. C. See pages 178 and 149.

PATENTS—Send for Booklet. Contains valuable information for inventors. Our charge for search of Patent Office records \$5.00. Prompt service, twenty years' experience. Talbert & Talbert, 308 McGill Building, Washington, D. C.

UNPATENTED Ideas Can Be Sold. I tell you how and help you make the sale. Free particulars (Copyrighted). Write W. T. Greene, 805 Jenifer Building, Washington, D. C.

PATENT Procured. Prompt Service. Personal, careful and efficient service. Highest references. Moderate fees. Send sketch or model for actual search and advice. George P. Klumel, Master of Patent Law, 51-H I. and T. Bldg., Washington, D. C.

PATENTS—Let me assist you in obtaining your Valid Patent Rights. Personal service. Promptness assured. George Van Den Berg, Barrister Bldg., Washington, D. C.

MILLIONS spent annually for ideas! Hundreds now wanted! Patent yours and profit! Write today for free books—tell how to protect yourself, how to invent, ideas wanted, how we help you sell, etc. American Industries, Inc., 500 Kresge Bldg., Washington, D. C.

H. F. LOWENSTEIN, Registered Patent Attorney, Technical Expert. McLachlen Building, Washington, D. C.

PATENTS, patent litigation, trademarks, copyrights. Handbook of instructions "How to protect inventions" free on request. R. H. Fravel, Patent Attorney, formerly of the U. S. Patent Office Examining Corps, Room 503 McLachlen Bldg., Washington, D. C.

PATENTS and Trade-Marks obtained. Prompt service. Write for our new book on patents. Established in 1889. D. Swift & Co., 369 7th St., Washington, D. C.

INVENTORS—Send for form "Evidence of Conception" to be signed and witnessed. Form, fee schedule, information free. Lancaster and Alwine, 221 Ouray Bldg., Washington, D. C.

PATENTS Trade-Marks, Copyrights and Patent Litigation. Write for advice and instructions how to proceed, costs, etc. Hand Book with illustrations of 100 Mechanical Movements sent free on request. Albert E. Dieterich, Patent Lawyer and Solicitor, 621-B Ouray Bldg., Washington, D. C.

MONROE MILLER, Ouray Bldg., Washington, D. C., Patent Attorney; Mechanical, Electrical Expert. Free Blue Book gives candid advice.

ESTABLISHED 1864. Milo B. Stevens & Company, Registered Attorneys (No. 830). Patents, Trade Marks, Copyrights. Full information upon request. Moderate fees. Offices: Barrister Building, Washington; Leader Bldg., Cleveland; Monadnock Block, Chicago.

PATENTS, Trade-Marks, Designs. This firm has 27 years' experience and gives expert personal service at reasonable rates. We properly protect your invention. Write for free information and exact cost of procuring patent before proceeding. John B. Thomas & Co., 902 F St., N. W., Washington, D. C.

THE PATENTOFFICE. Impartial advice to Inventors and Manufacturers. Mailed on request. Anderson & Son, Patent and Trade Mark Lawyers, Established 1865, 635 F St., Washington, D. C.

PATENTS Procured; Trade Marks Registered — A comprehensive, experienced, prompt service for the protection and development of your ideas. Preliminary advice gladly furnished without charge. Booklet of information and form for disclosing idea free on request. Richard B. Owen, 30 Owen Bldg., Washington, D. C., or 2276-B Woolworth Bldg., New York.

PATENTS, Trademarks secured. Send for free opinion. F. Hoffman, 6014 Washington, St. Louis, Mo.

INVENTORS—Write for our Guide Book, "How to Get Your Patent" and Evidence of Invention Blank. Send model or sketch of your invention for our prompt examination and instructions free. Randolph & Co., Dept. 430, Washington, D. C.

"**INVENTOR'S** Advisor," the valuable Patent book with 129 mechanical movements and illustrations, sent free upon request. M. M. Labiner, Patent Attorney, 3 Parkrow, New York.

PATENTS. Booklet free. Highest references. Best results. Promptness assured. Send model or drawing for preliminary examination. Watson E. Coleman, Patent Lawyer, 644 G Street, Washington, D. C.

PATENTS. Trade marks, copyrights. Prompt, personal, reliable service. Over 36 years' active practice. Write for terms. Book free. Address E. G. Siggers, N. V. Bldg., 918 F St., Washington, D. C.

HERBERT JENNER, patent attorney and mechanical expert, 606 F Street, Washington, D. C. I report if patent obtainable and exact cost. Send for circular.

HORACE L. WOODWARD — Efficient, conscientious service. Send sketch for preliminary advice. Established 1906, 704 Ninth, Washington, D. C.

PATENTS. My fees in installments. Advice book free. Frank Fuller, Washington, D. C.

INVENTORS: Send sketch or model of invention for free opinion concerning patentable nature and exact cost of patent. Book "How to Obtain a Patent," sent free. Tell what every inventor should know. Established twenty-eight years. Highest references. Prompt service. Reasonable charges. Address Chandler & Chandler, 456 Seventh, Washington, D. C.

PERCY S. WEBSTER, Savings and Loan Building, Stockton, California. Long established organization. Send for free book on Patents.

"**INVENTORS' Guide**" sent free on request; this book contains illustrations of patented inventions and gives valuable information and advice for all who have original ideas or improvements. Frank Ledermann, Registered Attorney and Engineer, 15-P Park Row, New York.

PATENTS, Trade-Marks, Designs. This firm has 27 years' experience and gives expert personal service at reasonable rates. We properly protect your invention. Write for free information and exact cost of procuring patent before proceeding. John B. Thomas & Co., 902 F St., N. W., Washington, D. C.

FOR INVENTORS

PATENTS. If you have an invention which you wish to patent you can write fully and freely to Munn & Co., for advice in regard to the best way of obtaining protection. Please send sketches, or a model of your invention and a description of the device, explaining its operation. All communications are strictly confidential. Our vast practice, extending over a period of seventy-eight years, enables us in many cases to advise in regard to patentability without expense to the client. Our Hand-Book on Patents is sent free on request. This explains our methods, terms, etc. in regard to Patents, Trade Marks, Foreign Patents, etc. "Scientific American" contains Patent Office Notes, Decisions of interest to inventors and particulars of recently patented inventions. Munn & Company, Solicitors of Patents, 623 Woolworth Building, New York; Scientific American Bldg., Washington, D. C.; Tower Bldg., Chicago, Ill.; Hobart Bldg., 582 Market St., San Francisco, Calif.; Van Nuys Building, Los Angeles, Calif.

LARGE well-equipped manufacturing company with own sales organization will take on manufacture and sale of additional lines on outright or royalty basis. Automotive accessories preferred, but will consider anything easily marketed through hardware trade. What have you? Write full particulars to Genco Manufacturing Company, Milwaukee, Wis.

INVENTORS, before applying for Patent, send for our free circular "Advance Confidential Service for Inventors," designed to save you money and increase your opportunities for success. Custon Guay Engineers, 30 Sixteenth Street, Southeast, Washington, D. C.

INVENTORS' Educator: 900 Mechanical Movements, 50 Perpetual Motions. How to procure and sell patents. Mechanical Movements greatly assist inventors, suggest new ideas. Explains how to select an attorney and avoid Patent Sharks. Price \$1.50. Postage Free. Albert E. Dieterich, 621 Ouray Building, Washington, D. C.

MONROE MILLER, Ouray Bldg., Washington, D. C., Patent Attorney; Mechanical, Electrical Expert. Before proceeding, read free Blue Book.

WANT to Buy Patented Article. Will purchase outright or on Royalty basis, patented article that can be sold by mail. Give full details in first letter. James Lugg, Ryan, Okla.

PATENTS Procured; Trade Marks Registered — A comprehensive, experienced, prompt service for the protection and development of your ideas. Preliminary advice gladly furnished without charge. Booklet of information and form for disclosing idea free on request. Richard B. Owen, 30 Owen Bldg., Washington, D. C., or 2276-B Woolworth Bldg., New York.

CASHING In—If you have a practical, useful invention to sell, write us promptly, stating whether patented. American Patents Corporation, Barrister Building, Washington, D. C.

INVENTORS, Am interested in ideas and inventions of practical use to the manufacturer of men's suits and overcoats. Louis Sussman, 8 E. Cor. 17th and Dickinson Sts., Philadelphia, Pa.

UNPATENTED Ideas Can Be Sold. I tell you how and help you make the sale. Free particulars (Copyrighted). Write W. T. Greene, 805 Jenifer Building, Washington, D. C.

PATENT applications filed with drawing \$20; deferred \$15; strongest claims; priority rights guarded. Inventors' Service, 11 Broadway, New York.

To sell your Patent. Write me; experienced handling, immediate action. Address Arthur S. Billings, Suite 401 Dekum Bldg., Portland, Ore.

INVENTORS—Write for our Guide Books and "Record of Invention Blank" before disclosing inventions. Send model or sketch of your invention for our free examination and instructions. See advertisement on pages 146 and 147. Victor J. Evans & Co., 157 Ninth, Washington, D. C.

LACEY Patent Sense. See page 151.

PATENTS Procured. Send sketch or model today for examination, prompt report and advice. No charge for preliminary advice. Write for free Booklets "How to Obtain a Patent" and "Invention and Industry" and blank form on which to disclose your idea. Highest references. Promptness assured. Clarence A. O'Brien, Registered Patent Lawyer, 585 Security Bank Building. Directly across the street from Patent Office, Washington, D. C. See pages 148 and 149.

PATENT Application Blanks free to inventors. Patent News-D, Washington, D. C.

SPECIALIZED service for inventors. You furnish the idea, we'll work it out. Expert machine designing. Drafting. Opinions given on practicability of ideas. Confidential dealings. Your ideas fully protected. Write for full particulars. Otis Engineering Co., Desk C D, Omaha, Neb.

WE Develop your ideas into commercial shape for presentation to purchasers, making working models, drawings, experiments or tests. Courtesy, efficiency, secrecy and ample equipment; 30 years' experience. Ducorron-Rich Engineering Co., 501 Pacific Mutual Bldg., Los Angeles, Calif.

GET your own patents. Application blanks, complete instructions \$1. Cutting Sons, Campbell, Cal.

PATENTS—Send for Booklet. Contains valuable information for inventors. Our charge for search of Patent Office records \$5.00. Prompt service, twenty years' experience. Talbert & Talbert, 560 McGill Building, Washington, D. C.

I SELL Patents. Established in 1900. My Service is employed by inventors who are also Bankers, Lawyers, Patent Attorneys, Mechanics. Men in all walks of life—and Corporations with patents to sell. Why not you? Charles A. Scott, 773PM Garrison Avenue, Rochester, N. Y.

HAVE you an invention? If so, write for our free book, "How to Get Your Patent," tells our terms and methods. Send model or sketch for our free examination and instructions. Randolph & Co., Dept. 144, Washington, D. C.

PATENTS FOR SALE

PATENT Pending. Improved tapping machine for light manufacturing. Write for particulars. Baum's Metal Specialties, Kansas City, Mo.

FOR Sale—Patent on a Wall Paper Hanging Machine. Something new; fits any roll of paper. Can easily be operated by anyone. Made very simple. Weighs three pounds. Will sell for cash or royalty. P. B. P. O. Box 221, Jackson, Mich.

PATENT 1,324,323, Compound Tool; nothing like it. \$560.00 outright. Edwin J. Searsoth, Galeville, Wis., Route 2.

FOR Sale—New and useful improvements in freight car-door constructions. U. S. Patent number 1,496,190. Filed also in England and Canada. David D. Scott, 409 N. Linden Street, Marshall, Mich.

PATENT pending on Combination Cigar and Cigarette Holder, United States and Canada. Cash or Royalty. For particulars address Geo. C. Leibfried, P. O. Box 263, Yakima, Wash.

WINDOWSASH Patent for Sale Outright. Unlimited Demand; circular showing diagram, mailed on request. Write today—this means millions to right party. A. W. Kern, 307 So. Flower St., Los Angeles, Calif.

CAN Opener, labor saving, quick action. Outright or royalty. P. Nagano, 837 Geary St., San Francisco, Calif.

ROYALTY Wanted. Folding Ironing-Board. Mailable. No wabbling. Manufactured cheap. Convertible into table. Detachable from wall. Trade-Marked. Earl Sanders, Panama, Ill.

FOR Sale. United States and Canada Patents, Outright or Royalty. Steering Rod Protector. Automobile Safety Device. Inexpensive to Manufacture. Address, "McNeill," Box B, Hamlet, N. C.

NICKEL-IN-THE-SLOT Fieldglass. Successfully operated for past three years. Canadian and American patent for sale, royalty or outright. Also nickel-in-the-slot radio, patent pending. American Fieldglass Service, Washington, D. C.

PATENT 1,486,931, sale or royalty, simple venter rheostat, one control. Gordon Ream, 2540 Cortland, Detroit.

PATENTS For Sale: To sell, buy or obtain patents, write Patent News-P, Washington, D. C.

FOR Sale, Outright or Royalty. United States and Canada Patents, Wheel Retainer, Automobile Safety Device. Inexpensive to Manufacture. Address, "McNeill," Box B, Hamlet, N. C.

PATENT pending on combined floor scrubber and squeegee dryer. Handle cannot loosen accidentally. Also window cleaner. Winiarski, 163 Essex St., New York.

PATENT No. 1,481,464, Automobile Curtain Fastener; Outright or Royalty. Similar to "Lift the Dot." Better Constructed. Ross Benson, Glasgow, Kan.

PATENTS pending automobile combined shock absorber and snubber. Spring and hydraulic types. Adaptable for any machine from Ford to Rolls Royce. R. B. Johnson, 428 N. Vermont Ave., Atlantic City, N. J.

WATER circulator cooling systems. Wonderful automobile accessory. Automatic. No mechanical movements. Cheap. Write today. Victor Forslund, Route 1, Clay Center, Kans.

PATENT for Sale on improved method for skinning cattle. More sanitary and efficient than any other system. Write for particulars. Wm. S. Callery, Dixon, Calif.

TOY invention. Patent Pending. Very amusing, young and old; details on request. Harry J. Gable, 219 E. 7th Ave., Denver, Colo.

OUTRIGHT or Royalty—"Combination Temperature and Water Indicator." Indicates amount of water as well as heat of Automobile. Great demand. Simple and attractive. U. S. and foreign patents. Write William H. Growall, Garrett, Pa.

PATENT No. 654,669, just granted, Jar Lid Opener. Three parts, sheet stampings. Few cents to manufacture. Walter Ball, 65 N. Diamond St., Mansfield, Ohio.

THE Neatest Soft Collar Made. Joseph M. Lukars, Pawnee, Ill.

ATTENTION Mfgs. "Fire Alarms" Invention. Automatic Apparatus. For Sale; number of them needed in every building. S. Michalak, 2403 Albion St., Toledo, Ohio.

PATENT Pending. Bill, Bulletin Holders, cheap to manufacture, very useful. Also Trunk and desk cover holders. No. 1,096,964. If interested write Frank C. Temple, Brunswick, Maine.

FOR Sale, Utility Case; Patents Pending. Sells to Theatres, Stores, etc.; great for advertising. Investigate. Nugent, 308 Sterling Bank, Winnipeg, Canada.

PATENT on non-freezing water pipe system for all types of buildings. Wonderful future if properly handled. Outright or royalty. Thomas H. King, P. O. Box 1168, Charlotte, N. C.

FOR Sale, U. S. and Canada Patent. Pneumatic Tire Protector; goes between shoe and inner tube; in sections; made of pressed steel. Puncture impossible. C. Taylor, 15 Cross St., Newport, R. I.

YOU have a worth-while patent, haven't you? Why don't you tell our two million readers about it? Most of them are specially interested in patents and new inventions. Ask me to tell you how other inventors successfully sold their patents. Geo. F. Baker, Manager Classified Advertising, Popular Mechanics Magazine, Chicago, Ill.

SURVEYING INSTRUMENTS

LARGEST stock of new and used surveying instruments in the country direct from factory. Satisfaction guaranteed or money refunded. Wissler, 619 N. Broadway, St. Louis.

MODELS AND MODEL SUPPLIES

EXPERT modelmaking, modern equipment, moderate prices. American Patents Corporation, 625 F St., Washington, D. C.

HULT & CO., 625 W. Jackson, Chicago, Ill. Experimental Machinists, Tool and Die Makers. Complete General Machine Shop Models. Ex-Lamson Electric Co.

PATENTS Procured. Send sketch or model today for examination, prompt report and advice. No charge for preliminary advice. Write for free Booklets "How to Obtain a Patent" and "Invention and Industry" and blank form on which to disclose your idea. Highest references. Promptness assured. Clarence A. O'Brien, Registered Patent Lawyer, 585 Security Bank Building. Directly across the street from Patent Office, Washington, D. C. See pages 148 and 149.

SEND Sketch and get lowest prices on Model and Experimental work. Ideal Company, 165½ Spring St., New York.

INVENTORS—Write for our Guide Books and "Record of Invention Blank." Send model or sketch of invention for our free examination and instructions. See advertisement on pages 146 and 147. Victor J. Evans & Co., 163 Ninth, Washington, D. C.

WE make working models for inventors and do experimental work and carry a complete stock of brass gears and model supplies. Send for catalogue. The Pierce Model Works, Tinley Park, Ill.

DIES, Tools and General Manufacturing. Models and Manufacturing of new inventions our specialty. Logan Machine Co., 126 S. Clinton St., Chicago, Ill.

MODEL steam engine ½" x ¾" \$8.50. Finished parts for same, \$1.25. Other engines, boilers, blowlamps. Catalog for 10c stamp. Model Machine Shop Co., 417 East 71 St., New York City.

SPECIAL machine builders, tool and die makers, inventors' models, production work of all kinds. Dept. L, Quality Hardware & Machine Co., E. Ravenswood and Thorndale Avenues, Chicago, Ill.

THE Modelmaker. For those interested in making working models. Send 10 cents. Address P. M. 126 Liberty Street, New York.

MANUFACTURING

PATENTED Articles, Models, Brass Work, Machine Construction; Dies Made. Baum's Metal Specialties, Kansas City, Mo.

WOOD Finishing in stain, varnish or enamel. George Conway, 43 North Front St., Columbus, Ohio.

METAL-CRAFT—Eventually Metal-Craft. Competent Engineers, Designers, and Producing Organization want your commands on dies, stamping, die-casting, deep pressing, screw-machine and wire products. Plating, Enameling, Burnishing, Wrapping and Packing to your specifications. Very reasonable. Large, completely equipped plant. "Your problem is our challenge to serve." Metal-Craft Manufacturing Company, Box 259-W, Chicago.

EXPERIMENTS developed, dies, models and manufacturing machine designing. Estimates and information promptly given. Address Schreier Bros. Machine Works, 512 East 25th St., Kansas City, Mo.

LET us manufacture it for you. Can quote low prices and can furnish a product you would be proud of. Ideas worked out and simplified. Models made. Metal parts made to drawings or sample. Simplex Tool Co., Woonsocket, R. I.

WIRE goods made to order. Cooley Mfg. Co., 524 N. Western Ave., Chicago.

SCREWS, nuts, screw machine products, all metals. Autoscrew Works, 355 West Broadway, New York City.

LONG established manufacturer of auto accessories which are daily sold by practically all wholesale and retail accessory houses will consider manufacturing and distributing new automobile products, capable of equally wide sale through same channels. Patented articles preferred. Address Auto Accessory Manufacturer, Room 2164, 310 S. Michigan Ave., Chicago, Ill.

IRON, Brass, Aluminum Castings, Models, Patterns, Light Manufacturing. Welch Brothers Co., North Chicago, Ill.

BOLTS, nuts, rivets. O. L. Dickey, 48 Trask, Bayonne, N. J.

OUR factory will make your models, manufacture your articles as well as build your tools, dies and fixtures. Standard Die & Specialty Co., 817 W. Washington Blvd., Chicago, Ill.

PATTERNS, wood and metal. Models, tools and dies. Brass, bronze, aluminum and iron castings. Screw machine work, production work of all kinds. Write Modern Machine & Pattern Co., Terre Haute, Ind.

MACHINERY, TOOLS AND SUPPLIES

CONCRETE Building Block Machines and Molds. Catalogue free. Concrete Machine Co., 303 South Third St., St. Louis, Mo.

SPECIAL labor saving machinery designed and built. Punches and Dies and other special tools furnished for manufacturing work. Simplex Tool Company, Woonsocket, R. I.

FOR Sale Rebuilt No. 60 Heald Cylinder Grinder. Lucas & Son, Bridgeport, Conn.

SOME Bargains: One No. 3½ Garvin Milling Machine \$185.00; one 16" Gould and Everhard 8hp \$210.00; one 20" Drill Press \$30.00; one 12"x5" Engine lathe \$125.00. Complete line of machinery. Cincinnati Machinery Supply Co., 218 E. Pearl St., Cincinnati, Ohio.

ENGINES, MOTORS AND DYNAMOS

CHEAPEST Place to Buy Your Electric Fans and Motors at Wholesale Prices. Alternating or Direct Current. 16" Oscillating, \$25.00. 12" Oscillating, \$20.00. 16" Non-Oscillating, \$19.00. 12" Non-Oscillating, \$14.00. 9" Non-Oscillating, \$10.00. 1/2 HP single phase, 110 Volts, 1,750 RPM Motor, complete, \$12.00. 1/2 HP—same as above, \$35.00. These are brand new—all leading makes—and complete with standard cord and plug. Cash with order FOB Chicago. General Motor & Machinery Company, 55 W. Randolph St., Phone Dearborn 1668.

MOTORS—Manufacturers' Surplus Sale: 1/2 hp. \$8.50. 3/4 hp. \$12.50. 1 hp. \$14.50. 8-volt Charging Generators \$8.50. Complete Lighting Plants, Generators, Light Machinery. Write for Catalog. Motor Specialties Co., Crafton, Penna.

GENERATOR 32 Volt, 300 Watt \$16.00, 500 Watt \$22.50, 1,000 Watt \$35.00. 1/2 Horse Alternating Motor connected to 25 Volt 5 ampere Generator \$20.00. Also bargains in other Motors, Generators and Motor Generators. Queen City Electric Company, 1735 West Grand Avenue, Chicago, Ill.

BIJUR Generators, brand new, 6 volts, maximum output 22 amperes at 2,000 r. p. m. Government paid \$45.00 each, our price \$10.00. General Sales Company, 1919 S. Michigan Avenue, Chicago, Ill.

AUTO Engines for Power. Let us show you how to fix yours up to sell or use. Cando-Smith Governor Co., Springville, N. Y.

FOR MECHANICS

PATENTS—Write for our Guide Books and "Record of Invention Blank" before disclosing inventions. Send model or sketch of your invention for examination and instructions. No charge for the above information. See advertisement on pages 146 and 147. Victor J. Evans & Co., 184 Ninth, Washington, D. C.

SPEED counter. Counts revolutions of shafts, motors, etc. With clutch \$3.50; without \$2.50. C. O. D. 792 Washington, Buffalo, N. Y. Guaranteed. Carry it in your vest pocket.

MECHANICS, 25c will get goods for 1/2 gal. Hand Cleaner. Box 22, Waverly, N. Y.

1,000,000 INDUSTRIAL Facts, Calculations, Receipts, Processes and Trade Secrets for every business are contained in the 1014-page book "Moore's Universal Assistant and Complete Mechanic," 500 Engravings, Cloth. Price \$2 postpaid. Popular Mechanics Book Dept., 205 E. Ontario St., Chicago.

FOR THE SHOP

MECHANICS! You will seldom if ever get stuck on a job if you keep on hand for quick reference a 15-volume set of Popular Mechanics Shop Notes. At the price of 50 cents a volume, any one of the several thousand time and labor-saving kinks may save you the cost many times over. Any of the volumes may be purchased separately at the same price. Popular Mechanics Book Dept., 205 E. Ontario St., Chicago.

ELECTRICAL

MOTORS—Experimental—for grinders, sign-flashers, tools; 115 volts alternating direct current, 1-20 horsepower \$3.98. Hamilton-Beach Drink Mixers, complete, used but Good Condition, fine for heating eggs, household use \$7.95. Special Sale. Order Now. Pay Postman. Perry Trading Co., 815 Lake, Racine, Wis.

ELECTRICAL Experimenters—Here is the book you have been waiting for—"How to Make Things Electrical." 256 articles, 427 pages, 353 illustrations. Price \$2 postpaid. Popular Mechanics Book Dept., 205 E. Ontario St., Chicago.

BLACKSMITHS

BLACKSMITHS, Listen! Make more money doing hard jobs easy with Toy's Modern Methods of Master Machine Blacksmithing, Forging and Solid Welding, Tool Dressing and Tempering to a standard with colored tempering charts. All for One Dollar. Samples Free. W. M. Toy, Sidney, Ohio.

FOR SALE—MISCELLANEOUS

LATEST Self-filling bamboo, stylus pen. Year's Guarantee. On approval \$1.00, Henry Schooler, 4045 University Way, Seattle.

ADDRESSOGRAPHS. Letter Folders, Multigraphs, Envelope Sealers, Duplicators, less than half price. Guaranteed. Fruit Co., 179 N. Wells, Chicago.

BUY—Exchange—Sell! Many of our readers have for sale or exchange the articles you are looking for—and lots of them are looking for the very items you want to turn into cash. Get together! Let our two million readers know your wishes—they'll help you! Send your ad today to Geo. P. Baker, Manager Classified Advertising, Popular Mechanics Magazine, Chicago.

WANTED—MISCELLANEOUS

WANTED: Light Machinery—Lathes—Drill Presses—Model High-Speed Gasoline and Steam Motors. Best Cash Prices Paid. Motor Specialties Co., Crafton, Penna.

REAL ESTATE, FARM AND ORCHARD LANDS

73-ACRE Riverside Farm with 200 Fruit Trees, Stock, Implements, crops; 45 acres tillage; 6-room house, barn, garage. All \$1750, part cash. Details page 6 Bargain Catalog. Copy free. Strout Farm Agency, 1507 Nassau St., New York City.

FLORIDA Orange Grove for \$1,650. An association of orange growers and nurserymen, not land men, but residents wishing to rapidly develop this beautiful section, will sell you ten acres of fine, young orange or grapefruit grove for only \$1,850, or \$185 per acre, about one-fourth cost elsewhere. Terms, \$750 cash and \$10 a month. Pine trees and fine land in Florida's great highland lake region. No swamps, palmetto or malaria. Save all agents' or middlemen's profits; buy from owners. No time for curiosity seekers or tourists, but if you want a grove, write for free book of actual facts and photos. Lake County Land Owners' Association, 93 Nursery Avenue, Fruitland Park, Fla.

FOR Sale—Three full sections in McKenzie County and two sections in Billings County, North Dakota. Each section contains land suitable for crops, balance for cattle. Each section has valuable deposits of lignite which some day will alone be worth many times the present value of the land. This part of the state is developing very rapidly with good schools within easy access. As owner cannot use this land himself, will sell one or more sections at a price which almost anyone can afford to pay. Address W. care Popular Mechanics, 205 East Ontario St., Chicago.

SELL your property quickly for cash, no matter where located. Don't pay big commission. Particulars free. Real Estate Salesmen Co., Desk B, Lincoln, Neb.

\$10 DOWN buys 20 to 80 acres good agricultural land in Mich. at \$20 per acre, bal. long time; near good towns, schools and markets. 52-page book free. Swigart Land Co., P-1229 1st Natl. Bank Bldg., Chicago.

\$5.00 DOWN, \$3.00 monthly; 10 acres unimproved poultry, fruit, stock, woodland; \$190; Ozarks. Fishing, hunting, trapping. Alfred Zimmerman, 1890 N. Fifth, Kansas City, Kans.

ATTENTION—"Get acquainted" Cash for your property, Farm, Hotel or Retail Store, no matter where located; confidential service. Hayes' Business Agency, Cincinnati, Ohio.

WANTED—I want farms for cash buyers. Give description, price. R. McNow, 312 Wilkinson Bldg., Omaha, Neb.

WANT to hear from owner having farm for sale; give particulars and lowest price. John J. Black, Chippewa Falls, Wis.

"Real Estate Educator"—The most valuable, concise and comprehensive work on real estate selling, buying, advertising, appraising, investing, leasing, sub-letting, transferring, insuring, mortgaging, etc., ever compiled. 208 pp. Cloth, \$2 postpaid. Popular Mechanics Book Dept., 205 E. Ontario St., Chicago.

ROOTS AND HERBS

GINSENG, \$12 lb.; grow in back yard. Free particulars and planting instructions. O. Tritchell, Berlin, N. H.

DOGS AND PETS

BEAUTIFUL registered bull pups cheap. Bulldogs, 501 Rockwood, Dallas, Texas.

SILVERBLACK Foxes \$350.00. Time Payments. Arthur Schwanacher, Lockland, O.

FOR Sale: Registered English Bulldogs. Monte Kennels, Huntington, Ind.

POULTRY

CHICKS; 6 1/2 up. Leading kinds. Catalog free. Colonial Farms, Windsor, Mo.

PERSONAL

"KNOW Yourself"—Wonderful Three-Page Horoscope—your talents, character, love, friends, enemies, business. Send birth date, year, specimen of handwriting and 10c. Garzills, Box 2771-DD, Boston, Mass.

SEND 25c and your date of birth for statement of your vibrations for 1924. Arzel Seydars, Numerologist, Astoria, Ore.

YOUR Horoscope, Business, Health, Character, Friends, enemies, changes. Send birth date and ten cents (stamps) for remarkable test reading. Zanya, 200-C W. 70th St., New York.

TOBACCO or Snuff Habit cured or no pay, \$1.00 if cured. Remedy sent on trial. Superior Co., TP, Baltimore, Md.

UNUSUAL Horoscope—Six pages, 2,500 words, consisting of extensive four-page Special Horoscope, Astro-Analysis, and two-page valuable guide giving daily and monthly advice covering entire year. Send 50c and birthdate. Money returned if dissatisfied. Prof. Boiles, Box 125, Cranford, N. J.

TOBACCO Kills many Vigor. Quit easily. Cigarettes, chewing, smoking, snuff conquered or no charge. Small sum if satisfactory. Stops craving; harmless. Full treatment on trial. Perkins Co., 34-A, Hastings, Neb.

LUCKY Charms, Lodestones, Secrets, Occult Books. Catalogue 5 cents, Box 55-P, Station 1, New York.

FREE—Information of a scientific nature that has brought happiness through perfect health to thousands. No charge, no obligation. Enclose stamp for reply. Fair Sales Co., Dept 248-O, Colorado Springs, Colo.

FREE—Stop using tobacco. We will give free information how to conquer habit easily and permanently. Results guaranteed. Anti-Tobacco League, Box K, Omaha, Neb.

MISCELLANEOUS

HANDSOME metallic key tag with your name and address on it with patented key chain ring. Price \$3.55, cash with order; satisfaction guaranteed. Ernest Schmidt, 2142 W. Grand Ave., Chicago, Ill.

BEAUTIFUL Child's China Cabinet Patterns. Instructions 25c. Circular Free. Rogren, 2951 8th Ave., New York.

LOCKSMITHING, complete 500 tricks of the trade, new edition, many added features. \$1.50, money back if dissatisfied. H. Romson, 3408 Andover St., Oakland, Calif.

ARE You Old at Forty? See our advertisement on page 152 of this issue. The Electro Thermal Company, 2136 Main Street, Steubenville, Ohio.

MONEY! Silvering Mirrors, Autolights, Radiators, tableware, stove, Outfits, Methods Free. Sprinkla, Plaster, Dept. 28, Marion, Ind.

ROCKS and Minerals for sale—hundreds of varieties—Price List Free. Peter Zedac, 157 Wells St., Peekskill, N. Y.

ARTIFICIAL Eyes, \$1. Booklet free. Denver Optic, 559 Barclay, Denver, Colo.

FORMS to cast Tin Soldiers, Indians, Marines, Trappers, Animals, 142 kinds. Send for Catalogue. Henry Schlercke, 1034 72nd St., Brooklyn, N. Y.

CUTS anybody can make, Simple, cheap process, \$1. Specimens, particulars, 2c stamp. M. Day, Windfall, Ind.

SIMPLIFIED Photo-Engraving Process. Line and half-tone cuts easily made. \$2.00. Particulars 2 cents. Horton & Fisher, Box 42, Princeton, Ill.

HOMEOPATHIC and Biochemic preparations sent postpaid to all parts of the world. Manual and booklets free. Halsey Bros. Co., 111 N. Wabash Ave., Chicago, Ill. Established 1835.

ART Metal Workers—You will find our book "Metal Work and Etching" a complete manual on making book ends, desk sets, pad corners, paper knives, letter openers, stationery racks, rocking blotters, desk calendars, arts and crafts jewelry, etc.; 96 pp., illus. Price 50 cents postpaid. Popular Mechanics Book Dept., 205 E. Ontario St., Chicago.

PERSONAL Advancement—The new magazine published by Popular Mechanics Press for all who want to get ahead. Inspiration, education, entertainment, advice. Will help you to decide upon a vocation, to get help in preparing yourself for that vocation, to get the best books on travel, mechanics, and on related subjects. One year free. Send your name and address on a postal to Popular Mechanics Press, Room 897, Popular Mechanics Building, Chicago, Ill.

LATHE Handbook—The experiences of 104 lathe operators in handling special jobs. A brand new book that is selling like hot cakes. Only 50 cents. Popular Mechanics Press, Room 897, Popular Mechanics Building, Chicago, Ill.

\$30⁰⁰ Suit FREE

We make this amazing offer because we want a man in each community to wear and advertise and take orders for our fine tailoring. The suit we furnish agents costs \$30.00 wholesale. Your local tailor would have to charge you \$50.00 but you can get it without a dollar of expense. We even pay delivery charges.

Agents J. R. Thompson, Ky. writes: "Received my free suit. **Wanted** Thanks. I feel like I stole it. Made \$110.00 the first month." Mail us your name and address today. Just write "Send me without obligation, measuring chart and full information about our wonderful free suit offer."

AMERICAN WOOLEN MILLS COMPANY
Dept. 5018 Established 1888 Chicago

\$50⁰⁰ a Week and More

Prepare yourself for a big pay job in the Automobile business after a few weeks training in New York. Learn with tools, not books. Personal instruction. Founded 1909. Thousands of successful graduates. Our Employment Dept. helps you to earn while you learn and can place you in a good position after you graduate.

Free Book Write today for new illustrated catalogue describing in detail the Stewart School and the opportunities in the Automotive Industry.

STEWART AUTOMOBILE SCHOOL
225 W. 57th St. Dept. C-175 New York

Make \$100 a Day

Be a Jaffin Sales Specialist. Make the biggest money of your life. Others are doing it. So can you. No canvassing, peddling or ringing door-bells. You do business only with established retail merchants. No experience or capital required. We teach you the business and back you up with our co-operation. Send for free book containing positive proof of big money others are making and telling how you can double and triple your earnings.

JAFFIN ASSOCIATES, J-448, 1133 Broadway, New York

WRITE TODAY for
Our 168-PAGE
FREE BOOK on Deafness

and learn how Perfect Hearing is now being restored in every condition of deafness or defective hearing. Our "Little Wireless Phones for the Ears" require no medicine, but effectively replace what is lacking or defective in the natural ear drums. They are simple devices, which the wearer easily fits into the ears, where they are invisible. Soft, safe and comfortable.

WILSON EAR DRUM CO., Incorporated
1277 Inter-Southern Bldg. LOUISVILLE, KY.

YRAISE MONEY HARES

New Zealand and Chinese Rabbits. PROFITS LARGE. Easily raised everywhere. We supply stock, and market for all you raise, paying up to \$6.50 each. 32-page INSTRUCTION BOOK, CATALOG, MARKET AGREEMENT and FUR ANIMAL MAGAZINE gives all information, 10 cents. Address: **AMERICAN FUR FARMS, Box 100, Holmes Park, Missouri.**

FREE Book of Newest Styles just out. Women's, men's, children's clothing on credit and at bargain prices, less than cash prices everywhere. Very latest fashions; best materials. Open a charge account with us. Buy on credit and save money! Dress in newest styles. Send for Style Book absolutely **FREE** today! **Elmer Richards Co., Dept. G177, W. 36th Street, Chicago**

Build This Beautiful 24-in. Miniature
BY NEW EASY METHOD
Plans with directions.....60 cents
Viking ship plans (coin).....60 cents
A. F. BICK, 1496 Farwell Ave., Milwaukee

Fibre-Lite Limbs
Easy Payments—Do Nature's Work.
AGENTS WANTED who use Artificial Leg. **GOOD PAY.**
FREE Fibre Sample. **WORMAN CO. 252-P HENNEPIN AVE. MINNEAPOLIS, MINN.**
DESCRIBE STUMP TO

FOR YOU—MR. SIGN PAINTER
It's the very newest and latest help for Sign Painters and Showcard Writers. Letter Patterns. Helps the inexperienced and aids the finished expert. Make Sign Painting and Showcard Writing as easy as A, B, C. Sample for stamp. **John F. Rahn, A 2433 Greenview Ave., Chicago**

Perfect Health Absolutely FREE through a Natural Law

Address **ALOIS P. SWOBODA**
1261 Berkeley Bldg. NEW YORK

**Are You the Boss?
—or Are You Riley?**

THE BOSS gives the orders—Riley takes them and does what he is told. Both started the same, had equal ability to begin with. Riley works harder than the BOSS and gets less money. What is the answer?

Training did it. Your brain is an engine that needs fuel. Study and training supply the fuel that makes it go. And when you mix brains with your work you **SIMPLY CANNOT HELP BUT GET AHEAD.**

Be a Contractor or Builder

Fit yourself for a big job in the Contracting or Building business. Train for it right at home. The Course is easy to learn, is simple but thorough, is taught by experts who have made it their life study. We teach you Estimating, Blue Print Reading, Building Regulation, Use of Steel Square, Water Supply and Drainage, Heating and Ventilating, etc.

The cost is low, terms easy, results quick and sure. Our money-back guarantee insures satisfaction. Thousands are earning **BIG MONEY** in this business today. Get ready to get yours. Fill out the coupon now. Check the Course you are interested in. It costs you nothing but a 2c stamp for full information. It will mean much for your future.

**"Riley—Take up These Bricks"****"All Right Boss"**

AMERICAN SCHOOL,
Dept. G-C74, Drexel Ave. & 58th St., Chicago
Send me full information on the subject checked.

- | | |
|-------------------------------------|--------------------------|
| .. Architect | .. Business Law |
| .. Building Contractor or Carpenter | .. Lawyer |
| .. Automobile Engineer | .. Machine Shop Practice |
| .. Automobile Repairman | .. Photoplay Writer |
| .. Civil Engineer | .. Mechanical Engineer |
| .. Advertising Manager | .. Shop Superintendent |
| .. Business Manager | .. Employment Manager |
| .. Financial Manager | .. Steam Engineer |
| .. Sales Manager | .. Foremanship |
| .. Cert. Pub. Accountant | .. Sanitary Engineer |
| .. Accountant & Auditor | .. Surveyor (& Mapping) |
| .. Bookkeeper | .. Telephone Engineer |
| .. Draftsman & Designer | .. Telegraph Engineer |
| .. Electrical Engineer | .. High School |
| .. General Education | .. Fire Insurance Expert |
| .. Personal Analysis | .. Wireless-Radio |
| | .. Undecided |

Name

Address

Occupation

Choose as Your Profession ELECTRICAL ENGINEERING

Electricity offers a brilliant future to the young man who is about to choose his career. Never before has there been such wonderful opportunity in this great field. Big paying positions in electrical work the world over are open to trained men.

B. S. Degree in 3 Years

Come to School of Engineering of Milwaukee. Here you are trained in both theory and practice by a faculty of experts. You learn in large, finely equipped laboratories. If you have 14 high school credits or equivalent, you can become an Electrical Engineer with a Bachelor of Science degree in 3 years. If you lack these credits they can be made up in our institute of Electrotechnics in a short, intensive course.

A Complete, Practical, Electrical Education

Learn by the thorough approved scientific methods which our seventeen years of specializing enable us to give you. In addition to Electrical Engineering, the following complete courses are given: **A. C. and D. C. Armature Winding—Wiring and Testing—Practical Electricity—Drafting—Electrotechnics—Commercial Engineering—Automotive Electrical Engineering and Automotive Electricity.**

EARN WHILE YOU LEARN

You can earn money to help defray your expenses while learning. Our wonderful co-operative plan brings an Electrical Career within the reach of every ambitious man. Our Free Employment Department secures positions for those students who wish to earn part or all of their expenses. In addition, the Department will help you get a good position in the Electrical Industry when your training is completed. The new Students' Loan Fund offers financial aid to worthy men. Daily Broadcasting WIAO.

Big Book FREE Mail the coupon today for our big new illustrated catalog. Mention the course that interests you most and we will send you special information. Read about the school that trains men for practical and quick success. See how easy it is for you to get the training that will enable you to step to a splendid position and a handsome income. Mail the coupon right now. No cost or obligation.

SCHOOL OF ENGINEERING OF MILWAUKEE

Dept. X 1008. 415 Marshall Street. Milwaukee, Wis.

School of Engineering of Milwaukee
Dept. X 1008, 415 Marshall St., Milwaukee, Wis.

Please send me your free illustrated catalog; also details of your "Earn While You Learn" plan.

Name.....

Address.....

Town.....State.....

Age.....Education.....

Course Wanted.....



AGENTS: Make \$15 a Day —or Quit!

Agents and spare time distributors wanted at once for an amazing new invention for stoves and furnaces that does away with coal or wood. The new INTERNATIONAL Oil Burner with automatic features is the easiest selling article of the year. Simply sets in fire-box of stove, range or furnace; transforms 96% air and 4% oil into Instant-Gas, the cheapest fuel known. Absolutely safe. Gives three times the heat of coal, and cheaper. Better cooking and baking. Easily and quickly installed; no damage to furnace or stove. Over 100,000 INTERNATIONAL Burners already in use. Sold on money-back guarantee and 30 day free trial.



BIG MONEY FOR SPARE TIME



"Heat Without Coal"

Oil Burning" and \$50 a week spare-time plan to test yours in locality.

Manufactured only by the old reliable

INTERNATIONAL HEATING CO., Dept. 2-H, 119 So. 14th Street ST. LOUIS, MO.

AT HOME LEARN TO PLAY

Free Book and Illustrated Folder—Discloses secret which makes Music intensely interesting and easy. Explains how to become an accomplished player on any instrument—quickly—in your own home without a teacher. Make Money Through Music. Write for book and folder today. Mention Instrument. U. S. SCHOOL OF MUSIC, 78 Brunswick Bldg., New York City

Joy—STOMACH for SUFFERERS

I positively guarantee Macerated Wheat to relieve the worst cases of stomach trouble and banish constipation or it costs you nothing. Soothing to a weak stomach as a poultice to inflammation. Stays down and nourishes. Testimonials without number. My reputation of 25 years backs my guarantee. Write for proof.

BYRON TYLER 172 Gibraltar Bldg. KANSAS CITY, MO.

"What Shall I Be?"

You cannot attain real success and happiness unless you enjoy your work. We show you what occupation you are best fitted for, and guide you step by step until you succeed—eliminating all guess work. Write for free information. BUREAU OF VOCATIONAL RESEARCH, 296 Broadway, Dept. 101, New York City



Make Money Drawing Cartoons

It's Easy To Learn When Shown In The Right Way

Some of the cleverest cartoonists and comic artists in America today learned to draw during their spare time by following CARTOONIST EVANS' SIMPLE AND EASY METHOD. This school is recommended by foremost cartoonists because they know the students are handled right. If you like to draw, send a sample of your work, either an original or a copy, and we will send you a portfolio of cartoons and full details. The course is NOT EXPENSIVE.

The W. L. Evans School of Cartooning 821 Leader Building CLEVELAND, OHIO

Whatever Your Question;—be it the pronunciation of Fascista, the spelling of a puzzling word, the location of Esthonia the meaning of soviet, realtor, vitamin, etc., this Supreme Authority—

WEBSTER'S NEW INTERNATIONAL DICTIONARY

contains an accurate, final answer. 407,000 Words, 2700 Pages, 6000 Illustrations. Regular and India-Paper Editions. G. & C. MERRIAM CO., Springfield, Mass.

Write for specimen pages, prices, etc. and FREE Pocket Maps per POPULAR MECHANICS



LEARN Modern Barbering NEW EASY WAY Earn \$50 to \$150 EACH WEEK



NO matter what you are now doing, no matter how much you earn, our amazing new system of training for the barbering profession enables you to step into this clean, pleasant, profitable business in a few short weeks. Start right in earning \$50 to \$150 a week.

J. E. McGregory, of New Orleans, writes: "I have never been out of a job since you got me to be one from the Post Graduate department a year ago. I have saved up a nice bank account. I am glad I learned Modern Barbering with you."

F. Erbst, of Chicago, writes: "I own my own home and have my own automobile! I am independent! Have been all since graduating from your school five years ago."

What Moler System Means to You

Our national advertising educates the public to the safety, comfort and economy of Moler post-graduate work. It makes you the sought-after barber in your locality. It keeps your chain-shed and turns profits into your pocket. You as graduate are a part of a national institution which assures steady, profitable business. Through no other method can you get this.

We Equip Your Shop on Easy Terms

If you own your own shop your success is assured. If you are a renter you are assured of steady employment.

Send for This
Free Book
Today

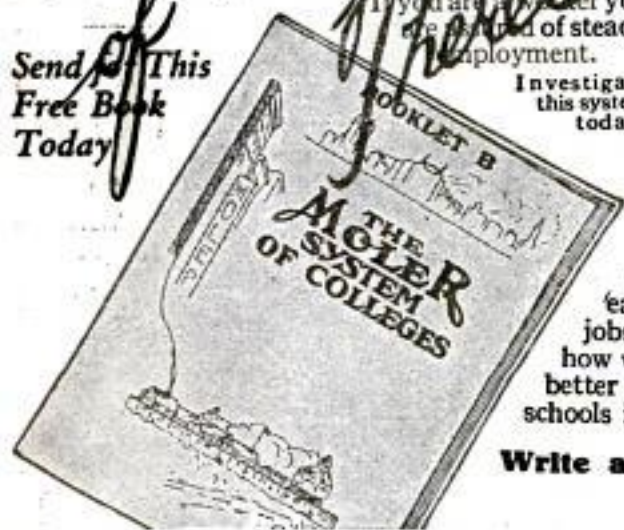

The Moler System of Colleges

157 Third Ave. New York, N. Y.	215 Huron Rd. Cleveland, Ohio	23 N. Forsyth St. Atlanta, Ga.
105 S. Wells St. Chicago, Ill.	1045 Cass Ave. Detroit, Mich.	80 N. 2nd St. Memphis, Tenn.
810 N. 6th St. St. Louis, Mo.	1229 17th St. Denver, Colo.	910 Main St. Dallas, Texas
544 Main St. Kansas City, Mo.	110 S. 14th St. Omaha, Nebr.	712 Franklin Ave. Houston, Texas
206 E. 4th St. Cincinnati, Ohio	513 E. Water St. Milwaukee, Wis.	430 W. Houston St., San Antonio, Texas
	1005 Canal St. New Orleans, La.	

We Train You to Be An Expert IN A FEW WEEKS

You want to get ahead—you want to make more money—big money. Our short, practical course gives you a complete training in modern barbering, including the electric hair cutter, the mechanical massage and scientific treatments. It also affords a specialty, if one desires, on hair and skin—it makes you an expert and expert barbers are always in demand.

Easy Work Always Busy BIG PAY

uates are in great demand and have no trouble in securing good jobs.

A trade that enables you to travel and see the world—one that pays in tips and commissions in addition to salaries. Moler System graduates are in great demand and have no trouble in securing good jobs.

Write for Free Book

Our catalog that we mail free tells how we enable you to earn while learning, how we put you into the best city jobs, how we equip your shop on easy payments. In fact, how we take you just as you are, make your life's work easier, better paying and more independent. We have 33 branch schools in leading cities. We have one near you.

Write anyone of the following addresses for our booklet B. Do it today.

MOLER SYSTEM OF COLLEGES

← Address Nearest Branch

Please send me without obligation on my part your Booklet B.

Name.....

Address.....

City.....State.....



The Hour That Counts!

When you see a man putting in his noon hour learning more about his work, you see a man who won't stay down. He'll never be satisfied until he hits the top. And he'll get there!

In shops, factories, offices, stores, in every line of industry, men are holding splendid positions won through spare time study with the International Correspondence Schools. Today they are earning four or five times—yes, some of them ten times as much money as when they started.

Employers everywhere are looking for men who really want to get ahead. If you want to make more money, show your employer that you're trying to be worth more money.

For 32 years the International Correspondence Schools have been training men and women right in their own homes.

Thousands of men have stepped up in just this way. More than 180,000 are studying now. Can you afford to let another hour pass without making your start toward something better? Here is all we ask—without cost, without obligation, mark and mail this coupon!

INTERNATIONAL CORRESPONDENCE SCHOOLS Box 5619-D, Scranton, Penna.

Without cost or obligation, please tell me how I can qualify for the position or in the subject before which I have marked an X:

BUSINESS TRAINING COURSES

- | | |
|--|---|
| <input type="checkbox"/> Business Management | <input type="checkbox"/> Salesmanship |
| <input type="checkbox"/> Industrial Management | <input type="checkbox"/> Advertising |
| <input type="checkbox"/> Personnel Organization | <input type="checkbox"/> Better Letters |
| <input type="checkbox"/> Traffic Management | <input type="checkbox"/> Show Card Lettering |
| <input type="checkbox"/> Business Law | <input type="checkbox"/> Stenography and Typing |
| <input type="checkbox"/> Banking and Banking Law | <input type="checkbox"/> Business English |
| <input type="checkbox"/> Accountancy (including C.P.A.) | <input type="checkbox"/> Civil Service |
| <input type="checkbox"/> Nicholson Cost Accounting | <input type="checkbox"/> Railway Mail Clerk |
| <input type="checkbox"/> Bookkeeping | <input type="checkbox"/> Common School Subjects |
| <input type="checkbox"/> Private Secretary | <input type="checkbox"/> High School Subjects |
| <input type="checkbox"/> Spanish <input type="checkbox"/> French | <input type="checkbox"/> Illustrating <input type="checkbox"/> Cartooning |

TECHNICAL AND INDUSTRIAL COURSES

- | | |
|---|--|
| <input type="checkbox"/> Electrical Engineering | <input type="checkbox"/> Architect |
| <input type="checkbox"/> Electric Lighting | <input type="checkbox"/> Architects' Blue Prints |
| <input type="checkbox"/> Mechanical Engineer | <input type="checkbox"/> Contractor and Builder |
| <input type="checkbox"/> Mechanical Draftsman | <input type="checkbox"/> Architectural Draftsman |
| <input type="checkbox"/> Machine Shop Practice | <input type="checkbox"/> Concrete Builder |
| <input type="checkbox"/> Railroad Positions | <input type="checkbox"/> Structural Engineer |
| <input type="checkbox"/> Gas Engine Operating | <input type="checkbox"/> Chemistry <input type="checkbox"/> Pharmacy |
| <input type="checkbox"/> Civil Engineer | <input type="checkbox"/> Automobile Work |
| <input type="checkbox"/> Surveying and Mapping | <input type="checkbox"/> Airplane Engines |
| <input type="checkbox"/> Metallurgy | <input type="checkbox"/> Navigation |
| <input type="checkbox"/> Steam Engineering | <input type="checkbox"/> Agriculture and Poultry |
| <input type="checkbox"/> Radio | <input type="checkbox"/> Mathematics |

Name.....
Street..... 3-6-24
Address.....

City..... State.....

Occupation.....

Persons residing in Canada should send this coupon to the International Correspondence Schools Canadian, Limited, Montreal, Canada.

\$20 A Day
for Dental Laboratory EXPERTS!

Enormous demand right now for McCarrie-trained Dental Laboratory EXPERTS at \$65 to \$150 a week! Only profession that's not over-crowded—only kind of professional work that you can master in 4 months!

70,000 Dentists Need Laboratories

At Chicago and Detroit I direct the largest Dental Laboratory Schools in the world. Personal, individual instruction. **Learn by doing actual Dental Laboratory Jobs.** My training prepares you quick for expert's pay averaging \$3 per hour. No classes, no text-books.

\$50.00 Outfit FREE!

If you write at once! For a limited time I will give every student a complete \$50 outfit of tools, materials and supplies. Write for free offer today.

Open a Laboratory

of your own. Little capital needed when you are McCarrie trained. My instruction includes Laboratory management. \$15,000 a year profits made easily by Dental Laboratories.

FREE R. R. Fare to Chicago or Detroit for a limited time.
GET MY OFFER QUICK!

Big, New Book FREE!

Tells you all about the surprising opportunities waiting for you when you are a McCarrie-trained Dental Laboratory Expert. Explains my rapid, practical method of training you for high-pay positions or to open your own laboratory. Contains my free offers of R. R. fare and \$50 outfit. Write me personally right away!

H. A. McCARRIE, Director,

McCarrie School of Mechanical Dentistry
Dept. 1101H 1338 S. Michigan Ave., Chicago



EARN \$35 TO \$100 A WEEK



AS A MECHANICAL DRAFTSMAN. Write today for Free Book telling how we train you in spare time, at home, and help you secure a position. Free set of professional Drafting Instruments furnished Free. Write today.

COLUMBIA SCHOOL OF DRAFTING

Dept. H-14, 14th & T Sts., N. W., Washington, D. C.

If I Send You A Suit



made to your measure, in the latest style, would you keep and wear it, show it to your friends,

let them see our beautiful samples and splendid new styles?

Could you use \$3.00 an hour for a little spare time? **Every tailoring agent, send for our wonderful new proposition.** Just write a letter or postal or fill out and mail coupon below.

I will send you our big new book of samples and styles to pick from and my new, special offer, **all free.** Even if you don't care to be agent, send anyway, and learn how to get all your own clothes FREE.

Send Name and Address on This Coupon

To L. E. ASHER, President
BANNER TAILORING CO., Dept. 261, Chicago, ILL.
DEAR SIR: Please send me your new special offer, all FREE.

Name.....

R. F. D. Box. Postoffice.....

St. & No. State.....

Rip Off Your Shirt

and get on the job. Work up a sweat and chase those disease bugs out of you. Gee! but they're happy with the chance you're giving them. Are you going to loaf around and let them eat up all your pep? Snap out of it, fellows. You're just digging your own grave when you refuse to exercise. Sitting back in a rocking-chair and smoking your old jimmy pipe may feel fine to a lazy man, but it sure raises havoc with your chances for a long life or a successful one.

Who Will Help You?

I know you think you know all about it. Most everyone you meet tries to tell you how, but they can teach an oyster how to sing quicker than they can show you anything about muscle building. If you are in legal trouble, you seek a lawyer. If you are wise, you get the best, for they are the cheapest in the long run. Now, how about that body of yours? Do you realize it is the choicest possession you have on earth? Don't be a plain dumb Dora! Use your head. This is vital with you. Muscle building is one of the trickiest studies on earth. I've worked at it ever since the day I left High School, so I ought to know. I've seen many a poor chap literally ruined by the wrong kind of guidance. On the other hand, I've seen human wrecks transformed into human Hercules by being started in the right direction.

I've Got the Works

Come to me and I'll shoot you so full of strength and vitality you'll think it's your birthday. I'm the man who first guaranteed one full inch on your arm in 30 days. And I'm the man who does it. I'll fill out that chest so that it will take a man's size load of oxygen, shooting life into your blood and building up your whole body. I'll put a pair of arms and shoulders on you that will carry the kick of a mule. I'll shoot a quiver up your old spine and put a spring into your step so that you will feel like fighting a wildcat. This is no idle prattle, fellows. I don't promise these things—I guarantee them. You don't take any chances with me. I've got the works and I'm willing to prove it. Come on, then—let's go.

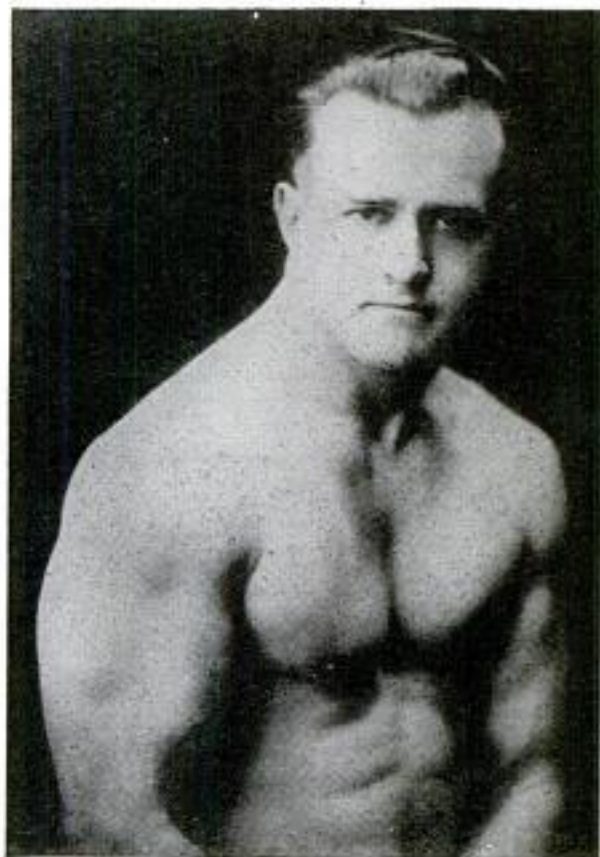

EARLE E. LIEDERMAN
The Muscle Builder

Send For My New
64 Page Book
"Muscular Development"
IT IS FREE

It contains forty-three full-page photographs of myself and some of the many prize-winning pupils I have trained. Some of these came to me as pitiful weaklings, imploring me to help them. Look them over now and you will marvel at their present physiques. This book will prove an impetus and a real inspiration to you. It will thrill you through and through. All I ask is 10 cents to cover the cost of wrapping and mailing and it is yours to keep. This will not obligate you at all, but for the sake of your future health and happiness, do not put it off. Send today—right now before you turn this page.

EARLE E. LIEDERMAN
Dept. 2008, 305 Broadway, New York City

EARLE E. LIEDERMAN

Dept. 2008, 305 Broadway, New York City

Dear Sir: I enclose herewith 10c for which you are to send me, without obligation on my part whatever, a copy of your latest book "Muscular Development."

Name.....

Street.....

City..... State.....

(PLEASE WRITE OR PRINT PLAINLY)



Hotels Start You With Salaries up to \$3500 a Year — with your living

HOTELS, restaurants, clubs, apartments, everywhere need trained men and women—salaries to start up to \$3500 a year with your living. Over 70,000 high-class positions paying up to \$10,000 a year are open every year in the hotels of the United States. Today this is the 1st INDUSTRY IN AMERICA—with over \$992,394,968 in new hotels being built in 1924—exceeding by \$200,000,000 the next largest industry. These new hotels, restaurants, etc., will need over 60,000 trained men and women.

You can have one of these high-class big-pay positions, with luxurious meals and apartment and fascinating work. No previous experience necessary. The Lewis Schools guarantee to give you the valuable knowledge that it has taken some of the most successful hotel men years to obtain—men who are now making \$5,000 to \$50,000 a year. We train you by mail in your spare time at home with the Lewis Simplified Study Plan, and we put you in touch with big opportunities. Our students employed, our methods endorsed by leading hotel men everywhere.

Send today for Free Book, "YOUR BIG OPPORTUNITY," showing how we can train you for one of these splendid positions in 20 weeks, or less, and explaining our Money-Back Guarantee.

LEWIS HOTEL TRAINING SCHOOLS
Room E-388 Washington, D. C.

***** FREE BOOK COUPON *****
LEWIS HOTEL TRAINING SCHOOLS, Room E-388, WASHINGTON, D. C.
Send me without obligation the Free Book, "YOUR BIG OPPORTUNITY."

Name

Address

City..... State.....

How to Get A Position with the U. S. Government

Thousands of appointments are made yearly. Good salaries—short hours—liberal vacations (as much as 30 days in some branches of the service). Positions open now in Washington and other cities and in Alaska, Porto Rico, Hawaii and the Philippines.

"Pull" and influence unnecessary. Common school education sufficient as groundwork for most positions. The International Correspondence Schools will prepare you right at home to pass your Civil Service examination with a high mark.

Mail the coupon to-day for 48-page Free Civil Service booklet.

INTERNATIONAL CORRESPONDENCE SCHOOLS
Box 5828-D, Scranton, Penna.

Without cost or obligation, please send me a copy of your 48-page CIVIL SERVICE BOOKLET, which tells how I can secure a good-paying position with the U. S. Government.

Name.....

Address

STOP USING A TRUSS

Do Away With Steel And Rubber Bands

FREE TRIAL



Inner surface is made adhesive to secure the PLAPAO-PAD firmly to the body, keeping the PLAPAO continually applied and the pad from slipping. No straps, buckles or springs attached. Soft as velvet—easy to apply.

It's the Non-Slipping, yet Non-Rigid Pad and What is Within It That Counts

FREE to 5,000 Truss Sufferers

To the extent of 5,000 sufferers who may apply I will send, ABSOLUTELY FREE, a sufficient quantity of the Plapao to positively convince them that this is the only logical, common-sense way of treating rupture. Plapao is a highly astringent medication placed within the Plapao-Pad and being absorbed through the skin, creates a wonderful feeling of relief and at the same time tends to strengthen the weakened muscles and thus permanently close the rupture opening. The process of recovery is natural, so you'll have no use for a truss—you can throw it away forever! Old and young have testified under oath that the Plapao-Pads cured their rupture—many of them long-standing, aggravated cases—without delay from work. Patent allowed in U. S. and foreign countries. Awarded Gold Medal at Rome and Grand Prix at Paris.

Send No Money—For a sufficient quantity of the Plapao is sent without charge to enable you to give it a thorough test; you pay nothing for this trial now or ever. Write for it and full information today. Address Plapao Laboratories, Block 1427 St. Louis, Mo.

HOW TO BECOME A PROFESSIONAL PHOTOGRAPHER



EARNING \$35 TO \$125 A WEEK

Three to six months' course. Motion Picture, Commercial, Portraiture. Practical instruction. Day or Evening Classes. Ask for Catalog No. 49.

N. Y. INSTITUTE OF PHOTOGRAPHY
NEW YORK CHICAGO BROOKLYN
141 W. 36th St. 630 So. Wabash Ave. 505 State St.

Be a Bricklayer! Attend a School Operated by Building Contractors. Three Months' Day Course \$75.00.
ASSOCIATED BUILDING EMPLOYERS
1120 A. B. E. Building Grand Rapids, Mich.

Imported Japanese Bamboo Self-filling



FOUNTAIN PEN. Stylus point improves with use—longer used, the smoother it writes. Capillary attraction controls the ink, no blotter necessary. Written guarantee—satisfaction guaranteed for one year. Retail \$1.25. Sample 60c. Dozen pens, \$5.00.

TOKYO IMPORTERS, 608 1/2 Vine Street, CINCINNATI, OHIO

No Joke To Be Deaf



—Every Deaf Person Knows That

I make myself hear, after being deaf for 25 years, with my Artificial Ear Drums. I wear them day and night. They are perfectly comfortable. No one sees them. They stop head-noises. Write me and I will tell you a true story, how I became deaf and how I make you hear. Address

GEO. P. WAY, Artificial Ear Drum Co. (Inc.)
80 Hellman Bldg., 2523 Woodward Ave., Detroit, Mich.

MEN WANTED!

If you are mechanically inclined, why not do the work you like? Let me show you jobs, both in city and country. Jobs as mechanics, chauffeurs, truck drivers, tractor engineers, garage men, repair men, battery and tire stations, paying \$50 a week up. No doubt about the fact I can, in a few short weeks this summer, fit you to step into one of these good jobs. Over sixty thousand men whom I have trained, 20,000 of whom are now running their own business, prove it. You don't need experience. I teach with tools, not books. I make trained mechanics. Here is the quick, **PROVEN** short cut to independence and success.

Earn \$50 a Week and Up!

If you are looking for work at \$50 a week and up, if you would like to get into something sure and solid that will give you success and independence, and can put in a few weeks this summer in **TRAINING**, write me today.

With over **FIFTEEN MILLION** automobiles running, the demand for mechanics, demonstrators, chauffeurs, truck drivers, garage men, etc., is greater than ever before. Countless opportunities in cities and towns and even remote places. Grab one of these good jobs now. Make real money; own your own business anywhere, or travel where you like, sure of good, interesting, high paid jobs.

FREE CATALOG AND SPECIAL OFFER

Get my big **FREE** 64-page catalog. It shows hundreds of actual photographs of men at work in my magnificent new school. Tells all about wages, profits, opportunities in auto and tractor business. Explains step by step how you learn. Interesting letters from graduates telling how they made good. Shows how men come from all over the world to this big school. Makes you want to join the crowd. Tells everything you want to know. I will gladly send you a copy beautifully illustrated. I'll tell you how to get into business for yourself. No colored students accepted.

E. J. SWEENEY, President

LEARN A TRADE-
Sweeney
AUTOMOTIVE & ELECTRICAL SCHOOL
 1-11 SWEENEY BLDG. KANSAS CITY, MO.

Send this NOW!

FREE TRIP To Kansas City

I agree to pay your railway fare to Kansas City, no matter what point in the United States you come from. I want you to make this trip and look over my million dollar school. I want you to see the hundreds and hundreds of happy young men working in these great shops where they are getting **REAL, PRACTICAL TRAINING**. I have paid the railway fare of thousands of men to come here, and they were certainly all glad they came. It's a wonderful experience. I have your fare ready for you. **WHY NOT COME?**

Free Radio Course

This summer I will give free a special radio course. It isn't hard. It is simple in a few extra hours to pick up a thorough knowledge of radio because we have here one of the world's greatest broadcasting stations, Sweeney, W. H. B.



SWEENEY System of Practical Instruction

is the **ONLY** way to learn if you want to save time and money and be properly trained. You get this at the famous trade school, the **MILLION DOLLAR SWEENEY SCHOOL**, and you get it nowhere else. I have helped 60,000 men to success. The way to learn is easy. You don't need any experience; age makes no difference. I teach with tools, not books. You learn by actually doing the work. I am making a **Special Thirty Day Offer**. That is why you should not delay. The first step is to send for my big Free Catalog. Save money by getting my free trip and special reduced tuition offer **NOW!**

EMORY J. SWEENEY, President
 Dept. 1-H, Sweeney Building, Kansas City, Mo.

Send me free, without any obligation on my part, your 64-page catalog and Special Offer!

NAME

GIVE AGE

P. O.

STATE

FREE

The BOOK of HAPPINESS

**'Do
It
With
Muscle!'**

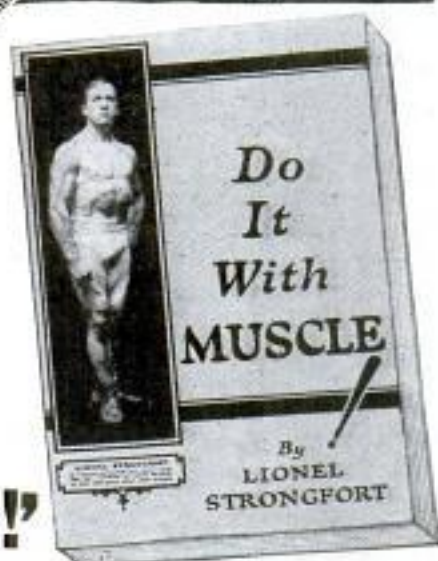

Health and Strength, Personality, Wealth and Romance . . . who can possess these treasures and be miserable? Who can lack a single one of them and enter into the Kingdom of Happiness?

"Do It With Muscle!" piteously "shows up" the vegetable existence that most of you call life. In fresh, frank, fascinating style it tears away the shams of prudery and tells you in plain words why you have failed, and how and where. It takes apart the wheels of life and shows what's wrong with YOU in swift, crisp words that you can't help but understand.

Truth never told before leaps out of every page of **"Do It With Muscle!"** It absolutely proves that every living mortal must stand or fall, succeed or fail, rejoice or agonize in exact proportion to the strength, soundness and wholesomeness of his external and internal muscular performance. And, reader, that means YOU!

"Do It With Muscle!" is a healthful, plainly worded discussion of the methods by which the writer became the **PHYSICALLY PERFECT MAN** and attained world-wide professional eminence, prosperity and happiness. Under this writer's guidance, thousands of men, youths and boys have achieved shining lives through the intelligent conquest of constipation, world-weariness, fear, debility, and the whole horde of ugly physical and mental disorders resulting from ignorance and neglect. Lavishly illustrated with scores of heretofore unpublished superb camera studies of myself and pupils.

In presenting your complimentary copy of **"Do It With Muscle!"**, I ask nothing in return, only that you read it with an open mind and do your duty by yourself in the light of your own conscience. No obligation, no charge, merely one dime (10c) as an evidence of your genuine interest and to help defray my mailing costs.

LIONEL STRONGFORT Physical and Health Specialist for 25 Years
Dept. 1475 NEWARK, N. J., U. S. A.

FREE BOOK COUPON

Lionel Strongfort, Dept. 1475, Newark, N. J., U. S. A. Send me free my private copy of **"Do It With Muscle!"** for which I enclose one dime (10c) toward mailing expense, assuming no obligation whatsoever. It may explain my failure to attain complete success and happiness.

Name

Street No.

City.....State.....



A Great New Field of Highly Paid Specialists

Experts in electric starting, lighting, ignition and storage batteries earn \$150 to \$400 a month and more. You can qualify quickly for a big paying position as electrical expert on automobiles, motor trucks, tractors, motorcycles, aircraft, farm lighting plants, etc. Trained men are needed everywhere by manufacturers, service stations and garages. Our Free Employment Bureau helps you to a good position.

EARN WHILE YOU LEARN

Come to America's greatest institution of electrical education. Learn by practical work in our big electrical laboratories under expert instructors. 13 weeks' intensive, full time training makes you a master of all types of electrical equipment—starting, lighting, ignition and storage batteries. You can earn your own way by half time work. We find you position. Low tuition fee.

Big Book Free Write for handsome, illustrated Book, telling about the great opportunities for trained Automotive Electrical Experts, our quick method of training you and our Earn While You Learn plan. Send postcard or letter today.

SCHOOL of ENGINEERING of Milwaukee

A908, 415-417 Marshall St. Milwaukee, Wis.

Keynote To Popularity

Popularity is yours. Everyone will seek your company. If you play tenor horn. Enroll for my course. I start you with an \$18 professional gift tenor horn. I am director of Glee and Instrumental Clubs at N. Y. University. My picture, diagrams and phonograph record method is so simple, you play immediately.

Don't Send a Single Cent
Write me for particulars about my course and I will reserve an \$18 gift tenor horn for you. Write now.

Prof. Harry S. Six, N. Y. Academy of Music, Studio 18, 212 Fifth Ave., N.Y.C.



Be An Automotive Electrician

Men are needed by the hundreds in the larger cities to take care of automobile electrical repairs. 78% of automobile repairs are electrical, yet only a few men are qualified to take advantage of the openings that pay from \$150 to

\$500 a Month

Now, by a new easy method you can learn this interesting work by a few weeks training in Chicago, or right in your own home. Write for particulars to Ambu Engineering Institute, Dept. 18, 2632 Prairie Ave., Chicago, Ill.

LEARN VIOLIN 3¢ A DAY

New Easy Way. Violin Furnished. Marvellous new Master Method teaches you by mail in 1/2 time and at 1/10th cost. No numbers or trick music. Costs only 3¢ a day. Play a real piece by note in fifth lesson. Easy as A B C. All music free. Diploma awarded. Beginners or advanced players. Money back guarantee. Send today for free booklet. Will be sent in plain wrapper. Please write plainly. **MASTER VIOLIN SCHOOL** 51 E. 42 St., Cor. 704, New York, N. Y.

A Great Career!—BOOK FREE

BE A PAINTER

Learn by actual practice—sign and pictorial painting, show card writing, house painting and calcimining, paper hanging, marbling and graining.

Earn \$10 to \$20 a Day No previous experience necessary. You learn under practical men in 6 wks. Enter any time. **WRITE!** Full information sent free.

SUPERIOR SIGN SCHOOL 2139 S. Wabash Avenue Dept. 12, CHICAGO, ILL.



LUMINOUS PAINT

Make Your Watches, Clocks, Etc., Visible by Night

The very latest discovery in the scientific world, filters, practically unobtainable except at an exorbitant price, we have at last succeeded in producing this remarkable LUMINOUS PAINT, which, applied to the surface of any article, emits rays of white light, rendering it perfectly visible in the dark. **THE DARKER THE NIGHT, THE MORE BRILLIANT IT SHINES.** Quite simple to use. Anyone—you can do it. A little applied to the dial of your watch or clock will enable you to tell the time by night. You can coat the push buttons or switch plates of your electric lights, match boxes, and innumerable other articles; make your own Luminous Crosses, Luminous Rosettes, etc. Small bottle, price 25c. Larger size, 50c and \$1 postpaid.

Serpent's Eggs

Box contains 12 eggs. When lit with a match, each one gradually hatches itself into a snake several feet long, which curls and twists about in a most life-like manner. Price per box, 10c postpaid, 3 for 25c.



Poliment

Mends Ironware. Agate-ware, bottles, pans, boilers, etc. of iron, copper, aluminum, tin, brass, iron pipes, cracks in pipes, cracks in bricks, broken china, porcelain, broken crockery, woodenware, marble, etc. Comes in powdered form. Just mix with water and apply. **HARDENS LIKE IRON.** Makes a big hole or a small crack. PRICE 15c, 3 for 40c, postpaid.

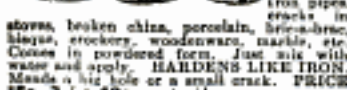

Midget Bible

GREAT CURRENTY Smallest Bible in the World. Size of a postage stamp. 200 Pages. Said to bring good luck to the owner. A genuine work of art. Must be seen to be appreciated. Make good money selling them to friends, church acquaintances, etc. PRICE 15c each, 3 for 40c, 12 for \$1.35, 100 for \$7.50.



STAGE MONEY

With a bunch of these bills, it is easy for each person of limited means to appear prosperous by flashing a roll of these bills at the proper time and peeling off a genuine bill or two from the outside of the roll, the effect created will be found to be all that can be desired. Prices, postpaid: 25 Bills 15c, 50 Bills 25c, 125 for 50c, or \$3.50 thousand.



Wonderful X-Ray Tube

A wonderful little instrument producing optical illusions both surprising and startling. With it you can see what is apparently the bones of your fingers, the lead in a lead pencil, the interior opening in a pipe stem, and many other similar illusions. A mystery that no one has been able to satisfactorily explain. Price 10c, 3 for 25c, 1 dozen 75c. Johnson Smith & Co.



Good Luck Ring
Quaint and Novel Design
A VERY striking and uncommon ring. Silver finish, skull and crossbones design, with two brilliant, flashing gems sparkling out of the eyes. Said by many to bring Good Luck to the wearer. Hence its name, Good Luck Ring. Very unique ring that you will take a pride in wearing. **ONLY 25 CENTS.**

Address orders for all goods on this page to
JOHNSON SMITH & CO.
Dept. 152
RACINE, WIS.
Our large catalog (420 Pages) of all the newest and best novelties, unobtainable elsewhere, free with every order.

The Dying Pig



The most laughable novelty yet produced. Made of rubber, and you have only to blow it up and stand by on his feet, when he begins to squeal as he slowly collapses and finally lies down and dies in the most natural manner. You can blow him up as often as desired, and each time he will go through the same performance to the great amusement and delight of your friends. Price, 15 cents; 3 for 40 cents; one dozen \$1.35, mailed.

Popular Watch Charms

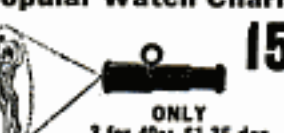

Very pretty little curiosities and decidedly novel. Fitted with Magnifying-glasses that enlarge the pictures to a very surprising degree; in fact, it seems almost incredible that a clear picture could be possible in such small compass, and how sharp and distinct they show up when you look through. Come in assorted views—Antares, views of Panama Canal, Lord's Prayer in type, etc.

Mystic Skeleton

A jointed figure of a skeleton 14 in. in height, will dance to music and perform various gyrations and movements while the operator may be some distance from it.



NEW BOOK ON ROPE SPLICING

Useful Knots, Hitches, Splices, etc.
A most practical handbook giving complete and simple directions for making all the most useful knots, hitches, rigging, splices, etc. Over 100 illustrations. All about wire rope attachments, lashing, blocks, tackles, etc. 37 Illustrations. Knobs illustrated. Of great value to mechanics, riggers, campers, boatmen. Price 20c ppd.

MAGIC FLUTE

Wonderfully Sweet Toned and Musical
The Magic Flute, or Harmonium, is a unique and novel musical instrument that is played with nose and mouth combined. There is just a little knack in playing it which, when once acquired, will enable you to produce very sweet music that somewhat resembles a flute. There is no fingering, and once you have mastered it you can play all kinds of music with facility and ease. When played as an accompaniment to a piano or any other musical instrument, the effect is as charming as it is surprising.



BLANK CARTRIDGE PISTOL

Protection against Burglars, Tramps & Dogs



Well made and effective; model of latest type of Revolver; appearance alone is enough to scare a burglar. When loaded it may be as effective as a real revolver without danger to life, it takes standard .22 Cal. Blank Cartridges obtainable everywhere. Price 50c, superior quality, \$1.00 postpaid. Blank Cartridges, by express, 50c per 100.

Johnson Smith & Co., Dept. 152, Racine, Wis.

DANCING BEAUTIES

Get a Kinetograph and see the picture move. France's latest sensation. A great surprise. Is worth twice what they cost. Are made of solid brass, highly nickel-plated and very durable. Satisfactory or your money back. Price 50c.

Johnson Smith & Co., Dept. 152, Racine, Wis.

BOYS! BOYS! BOYS!

Into a trunk, under the bed or anywhere. Lots of fun fooling the teacher, policeman or friends.

THE VENTRILO

a little instrument, fits in the mouth out of sight, used with above for Bird Calls, etc. Anyone can use it. Never Fails. A 32 page book on ventriloquism, the Ventrilo, ALL FOR 10 CENTS

1000 Silk Remnants

for patching Crazy Quilts, Sofa Cushions, Head Rests, Pin Pads etc. Large pieces, all colors and shades. Sure to delight you. For 10 Cents stamps, we send a large package and Book of quilt designs. 3 packages, 25c. 1 pound makes a lovely large quilt. Price 15c postpaid. Our silk is the best.

JOHNSON SMITH & CO., Dept. 152, RACINE, WIS.

LOOK 35c LOOK

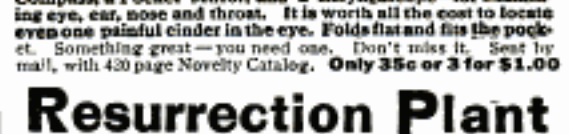

Wonderful instrument. Greatest thing yet. Nine separate articles in one. Everybody delighted with it. Odd, curious and interesting. Lots of pleasure as well as very useful. It is a double Microscope for examining the wonders of nature. It is also an Opera Glass, a Sereoscope, a Burning Lens, a Reading Glass, a Telescope, a Compass, a Pocket Mirror, and a Laryngoscope—for examining eye, ear, nose and throat. It is worth all the cost to locate even one painful cinder in the eye. Folds flat and fits the pocket. Something great—you need one. Don't miss it. Sent by mail, with 420 page Novelty Catalog. **Only 35c or 3 for \$1.00**

Resurrection Plant

One of the most wonderful plants known. Possesses the strange power of turning in a few minutes from an apparently lifeless, dry herb to a beautiful living fernlike plant of a dark green color. Simply place the plant in saucer of water, it will open up and start to grow in 20 minutes. When taken out it will dry up and go to sleep until placed in water again. Fine house plant—summer or winter. 10 cents each or 3 for 25c. **AGENTS WANTED**

JOHNSON SMITH & CO., Dept. 152, RACINE, WIS.



An Easy Way to Learn PHARMACY AT HOME

Graduate pharmacists are always in demand. The work is interesting and pleasant and salaries are good. Many young men open drug stores of their own and become independent.

There's an easy way to learn pharmacy right in your own home in spare time, without losing a day or a dollar from your present work.

The International Correspondence Schools course in Pharmacy supplies the knowledge which it will be necessary for you to have in order that you may pass your State Board Examination.

Just mark and mail the coupon printed below to the International Correspondence Schools, Box 5622-D, Scranton, Pa., and full particulars about the Pharmacy Course or any other work of your choice will come speeding to you by return mail.

INTERNATIONAL CORRESPONDENCE SCHOOLS Box 5622-D, Scranton, Penna.

Without cost or obligation, please send me full information about the subject before which I have marked an X in the list below:

TECHNICAL AND INDUSTRIAL COURSES

- | | |
|--|---|
| <input type="checkbox"/> PHARMACY | <input type="checkbox"/> Civil Engineer |
| <input type="checkbox"/> Chemistry | <input type="checkbox"/> Surveying and Mapping |
| <input type="checkbox"/> Automobile Work | <input type="checkbox"/> Mine Foreman or Engineer |
| <input type="checkbox"/> Navigation | <input type="checkbox"/> Steam Engineer |
| <input type="checkbox"/> Agriculture and Poultry | <input type="checkbox"/> Gas Engine Operating |
| <input type="checkbox"/> Mathematics | <input type="checkbox"/> Wireless <input type="checkbox"/> Airplane Engines |
| <input type="checkbox"/> Electrical Engineering | <input type="checkbox"/> Architect |
| <input type="checkbox"/> Electrician | <input type="checkbox"/> Contractor and Builder |
| <input type="checkbox"/> Mechanical Engineer | <input type="checkbox"/> Architectural Draftsman |
| <input type="checkbox"/> Mechanical Draftsman | <input type="checkbox"/> Concrete Builder |
| <input type="checkbox"/> Machine Shop Practice | <input type="checkbox"/> Structural Engineer |
| <input type="checkbox"/> Railroad Positions | <input type="checkbox"/> Plumbing and Heating |

BUSINESS TRAINING COURSES

- | | |
|---|---|
| <input type="checkbox"/> Business Management | <input type="checkbox"/> Salesmanship |
| <input type="checkbox"/> Industrial Management | <input type="checkbox"/> Advertising |
| <input type="checkbox"/> Personnel Organization | <input type="checkbox"/> Better Letters |
| <input type="checkbox"/> Traffic Management | <input type="checkbox"/> Foreign Trade |
| <input type="checkbox"/> Business Law | <input type="checkbox"/> Stenography and Typing |
| <input type="checkbox"/> Banking and Banking Law | <input type="checkbox"/> Business English |
| <input type="checkbox"/> Accountancy (including C.P.A.) | <input type="checkbox"/> Civil Service |
| <input type="checkbox"/> Nicholson Cost Accounting | <input type="checkbox"/> Railway Mail Clerk |
| <input type="checkbox"/> Bookkeeping | <input type="checkbox"/> Common School Subjects |
| <input type="checkbox"/> Private Secretary | <input type="checkbox"/> High School Subjects |
| <input type="checkbox"/> Business Spanish <input type="checkbox"/> French | <input type="checkbox"/> Illustrating <input type="checkbox"/> Cartooning |

Name.....

Street.....

Address.....

City..... State.....

Occupation.....

Persons residing in Canada should send this coupon to the International Correspondence Schools Canadian, Limited, Montreal, Canada

RADIO Wants You! Earn \$100 a Week

Radio, the wonderful new growing profession, offers you a glorious opportunity—big money, fascinating work, easy hours, a real future! Wonderful new course prepares you quickly in spare time at home. Famous radio experts help to give you practical work. Instruments supplied free. Write for Free Book, "Rich Rewards in Radio" National Radio Institute, Dept. 15HA, Washington, D. C.

AVIATION Information FREE

Send us your name and address for full information regarding the Aviation and Airplane business. Find out about the many great opportunities now open and how we prepare you at home, during spare time, to qualify. Our new book "Opportunities in the Airplane Industry" also sent free if you answer at once.

AMERICAN SCHOOL OF AVIATION

Dept. 119-C 3601 Michigan Ave. CHICAGO

RAISE POULTRY FOR PROFIT

We teach you how. Easily learned at home. Our guaranteed methods make success certain—indorsed by leading Agricultural Colleges. Send TODAY for FREE BOOK—"How To Raise Poultry For Profit."



National Poultry Institute
Dept. 312 Washington, D. C.

NOTICE—All men, women, boys, girls, 17 to 65, willing to accept Government Positions, \$117-\$300 monthly, traveling or stationary write Mr Ozment, 111, St. Louis, Mo AT ONCE

Become An Expert In the Auto or Building Trades

STANDARD TRADE SCHOOL TRAINING guarantees to make you a BIG PAY EXPERT in a few short weeks. The only difference between you and the man who earns \$10 to \$18 per day is TRAINING. STANDARD TRADE SCHOOL TRAINING IS BEST. Our EXPERT instructors give you ACTUAL "ON THE JOB" experience and qualify you as an EXPERT.

To have a TRADE is to have CAPITAL. It is the foundation of SUCCESS. Don't let lack of money stop you. If you have the will, we'll supply the way. Our "FREE EMPLOYMENT BUREAU" has hundreds of requests for men. Possibly one of these EARN AS YOU LEARN jobs is just the thing you need. Hundreds of our graduates are in business for themselves, and others are earning big pay—so can you. Write TODAY for our big, brand new catalog just off the press. Clip the coupon NOW

Standard Trade School 416 Woodward Avenue, Detroit

Learn One of These Big Pay Trades

Auto Repairing <input type="checkbox"/>	Auto Metal Finishing <input type="checkbox"/>
Auto Painting <input type="checkbox"/>	Auto Battery Building <input type="checkbox"/>
Auto Trimming <input type="checkbox"/>	Auto Electrician <input type="checkbox"/>
Bricklaying <input type="checkbox"/>	Plastering <input type="checkbox"/>
Plumbing <input type="checkbox"/>	Construction Electrician <input type="checkbox"/>

Name.....

Street..... City.....



Tobacco Is Hurting You

Look at the facts square in the face, Mr. Tobacco User. You may think tobacco is not hurting you.

That is because you haven't as yet, perhaps, felt the effects of the nicotine poison in YOUR system. For you know that nicotine, as absorbed into the system through smoking and chewing tobacco, is a slow working poison. Slow, yes—but sure.

Tobacco is lowering your efficiency. It slows a man down. Makes it harder for you to concentrate your mind on your work. You haven't near the amount of "pep" and energy you would have if you stopped using it. There's many a man twice as old as you in years who's twice as young in energy, simply because he lets tobacco alone.

Some day you will realize to what an alarming extent tobacco has undermined your system.

When your hands begin to tremble—
and your appetite begins to fail—
and your heart seems to "skip a beat" now and then—
and slight exertion makes you short of breath—
then you have a right to suspect that
TOBACCO is getting the upper hand.

Any well-informed doctor will tell you that these are only a few of many symptoms of tobacco poisoning.

And YOU know that the use of tobacco in any form is an expensive, utterly useless habit. You know you ought to quit.

Tobacco Habit Banished Let Us Help You

It doesn't make a particle of difference whether you've been a user of tobacco for a single month or 50 years, or how much you use, or in what form you use it—whether you smoke cigars, cigarettes, pipe, chew plug or fine cut or use snuff—Tobacco Redeemer will positively remove all craving for tobacco in any form in a very few days. Not the slightest shock to the nervous system. Your tobacco craving will usually begin to decrease after the very first dose—there's no long waiting for results.

Tobacco Redeemer contains no habit-forming drugs of any kind and is marvelously quick, scientific and thoroughly reliable.

It is in no sense a substitute for tobacco. After finishing the treatment you have absolutely no desire to use tobacco again or to continue the use of the remedy. It helps to quiet the nerves and make you feel better in every way.

Results Guaranteed A single trial will convince you. Our legal-binding, money-back guarantee goes with each full treatment. We will refund every cent you pay for the treatment if after taking it according to the easy-to-follow directions, it should fail to banish the tobacco habit completely.

SEND Free Proof Let us send you our free booklet on the deadly effects of tobacco, together with testimonial letters from men all over the country telling how they have been absolutely freed from the tobacco habit by this simple home treatment. You could not ask for stronger proof that Tobacco Redeemer will free you from the habit than the evidence we will gladly send on request. Just mail the coupon—or a postal will do.

NEWELL PHARMACAL CO.

Dept. 300

St. Louis, Mo.



Free Book Coupon

NEWELL PHARMACAL CO.

Dept. 300

St. Louis, Mo.

Please send, without obligating me in any way, your free booklet regarding the tobacco habit and proof that Tobacco Redeemer will positively free me from the tobacco habit or my money will be refunded.

Name

Street and No.

Town..... State.....



He Climbed . . . from \$60 a month to \$10,000 a year

Ten thousand a year! That is what a North Carolina man is averaging—even in dull years—as partner in an independent firm of Certified Public Accountants. Yet six years ago, when he started the study of Higher Accountancy under the LaSalle Problem Method, he was earning only \$60 a month, was married and had also a little daughter to provide for.

Lots of men would have thought they were hopelessly up against it. But this man was made of different stuff—there was nothing of the quitter about him! He accepted LaSalle's offer of easy terms, and started to study Higher Accountancy at home in his spare time. Today, he has the great satisfaction of knowing that he has *made good*. He is able to live the way he wants to live—to give his family the comforts and luxuries he has always longed to provide for them. He has proved his right and title to *success*.

The experience of this man (name furnished on request) is not an isolated example. Hundreds of men have won rapid advancement thru LaSalle Higher Accountancy training. They got their start by signing just such a little coupon as appears directly below this text. Mark that coupon, sign and mail today—and get the facts. We will promptly send you complete information regarding the opportunities for men trained in Higher Accountancy, also a copy of that inspiring book, "Ten Years' Promotion in One." "Get this book," said a prominent Chicago executive, "even if you have to pay five dollars for it." We will send it *free*. Remember, the cost of LaSalle training is small and can be covered in easy monthly payments, if you so desire. The *decision* that you make this moment is *important*. Mail the coupon *now*.

—INQUIRY COUPON—

LASALLE EXTENSION UNIVERSITY

The Largest Business Training
Institution in the World

Dept. 864-HR Chicago, Illinois

Please send me your book, "Accountancy, the Profession That Pays," and full information regarding the course and service. Also a copy of your book, "Ten Years' Promotion in One," all without obligation to me.

Higher Accountancy

Training for Position as Comptroller, Auditor, Certified Public Accountant, Cost Accountant, etc.

Other LaSalle Training Courses

LaSalle is the largest business training institution in the world. It offers training for every important business need. If more interested in any of these courses, check here:

- | | |
|--|--|
| <input type="checkbox"/> Business Management | <input type="checkbox"/> Banking and Finance |
| <input type="checkbox"/> Modern Salesmanship | <input type="checkbox"/> Modern Foremanship and Production Methods |
| <input type="checkbox"/> Railway Station Management | <input type="checkbox"/> Personnel and Employment Management |
| <input type="checkbox"/> Law—Degree of LL.B. | <input type="checkbox"/> Expert Bookkeeping |
| <input type="checkbox"/> Commercial Law | <input type="checkbox"/> Business English |
| <input type="checkbox"/> Traffic Management | <input type="checkbox"/> Commercial Spanish |
| <input type="checkbox"/> Industrial Management Efficiency | <input type="checkbox"/> Effective Speaking |
| <input type="checkbox"/> Modern Business Correspondence and Practice | <input type="checkbox"/> C. P. A. Coaching |



Name

Present Position

Address



SHOP WORK with a

CARNES ARTIFICIAL ARM

This wonderful substitute for the human arm not only makes it possible for mechanics to follow their regular occupations, but it is equally efficient in all trades, professions or vocations.

The Most Lifelike Arm Ever Invented

You can handle a knife and fork, dress, tie your tie, carry a grip, use a telephone, and do dozens of daily tasks with a Carnes Artificial Arm. We would like to send you our catalog containing pictures of men and women using Carnes Artificial Arms to do things that you perhaps think cannot be done. We would like to have you read the letters of praise and commendation from these men and women.

This book is *FREE*. Send for it today.

CARNES ARTIFICIAL LIMB CO.

66 Carnes Bldg., 904 East 12th St., Kansas City, Mo.

LEARN TO GET DOLLARS OUT OF WATCHES.

WATCH-REPAIRING, ENGRAVING, JEWELRY REPAIRING.



WRITE NOW.

ENICAR

TRADE

SCHOOL

530 W MONUMENT SQUARE,

RACINE, WIS.

YOU Too Can Make \$125⁰⁰ A WEEK



"I had no experience in selling before going with GOODWEAR. Now I make \$125 a week regularly. I believe that any man who'll work can do the same, and would advise every man who wants a fine paying job to write to GOODWEAR."

Peter Birdakis

To earnest men everywhere we offer a wonderful opportunity taking orders for our fine, pure wool suits and overcoats, regular \$35 values, all at the one low price of \$31.75. Our values are so remarkable they sell on sight. You get your commissions in advance; simply take the orders, and we deliver and collect. Our salesmen are making \$50 to \$125 a week and even more.

No experience is needed and spare time will do. We teach and train you, supply the finest selling outfit in America, big 6x9 cloth samples and everything else you need, all packed in a beautiful carrying case. If you want to get into a high-class business, make big money, and be independent, write for full information today. Address Dept. 116.

GOODWEAR Chicago, Inc.

West Adams Street at Peoria

CHICAGO

Please send me complete information about your Line and the opportunity you offer. 116

Name

Address

Town..... State.....

Learn the Auto Mechanic Trade by the RAHE SHOP METHOD



YOU EARN

\$150 to \$400 a Month

Why work for small pay? You earn big pay as a Rahe trained auto mechanic. 14,000,000 autos and tractors in this country must be kept in repair and the men who are trained to do the work receive big pay in steady jobs. Join the ranks of high pay men thru the Rahe Auto School.

Personal Training by Rahe Shop Method

You are quickly trained in my school by the world famous Rahe shop method of personal training. Expert instructors teach you in a very short time to repair and rebuild motors, transmissions, differentials, generators, batteries and all parts of automobiles. You are quickly made a trained auto mechanic and can demand big pay in a steady job or get in business for yourself.



Practical Experience

One of the Rahe students rounding out his course by actual work with tools and motors.

You Learn by Actual Work With Tools and Motors

You learn in my school by work with tools and motors, NOT BOOKS. By actual rebuilding and repairing all parts of automobiles, you quickly become an expert. No jobs too hard for a Rahe trained mechanic because you learn to repair the hardest jobs thru practical experience in our shop. Rahe trained men are always in demand. Every day calls come from garages, automobile factories, etc. for men to fill big pay jobs.

E. A. Hogue Earns \$6500.00 in Own Business

E. A. Hogue a Rahe trained mechanic, of Jonesboro, Ark., clears \$6500 in his own garage business. Before he received his Rahe training he was



making \$900 a year. You can succeed just like Mr. Hogue and thousands of others of my successful graduates. Enroll now and secure my special offer and FREE catalog for this month only.

Railroad Fare Paid to Either of the Famous Rahe Schools

I pay your railroad fare to my nearest school, and pay your board during the entire course. Take advantage of my offer to earn really big money as an auto mechanic or in business for yourself. You can become one of this ever growing class which must repair the 14,000,000 automobiles in this country.

Rahe Auto and Electrical School

916 FORBES ST.
PITTSBURGH, PA.

11th & LOCUST
KANSAS CITY, MO.

"You must learn so that you can earn."

—Henry Rahe

Mail This Coupon NOW!

HENRY J. RAHE, President,
Rahe Auto & Electrical School,
Address Nearest School

PMA

Without any obligation on my part, please send me your booklet and full particulars, explaining your course in automobile and electrical mechanics, and your special offer.

Name.....

Address.....

City.....



"Good-bye, Boys!"

"Today I dropped in for a last word with the boys at the office. And as I saw Tom and Dave there at the same old desk it came to me suddenly that they had been there just so the day I came with the firm four years ago.

"When I started here I was put at a desk and given certain routine things to do. But after a few months I began to realize that I was nothing but a human machine—doing things that any one could do.

"So I wrote to Scranton and arranged for a spare-time study course that would give me special training for our work. Why, do you know, it gave me a whole new interest in our business? In a few months I was given more responsibility and more money. Since then I've had three increases. Six months ago I was put in charge of my department, and now my big chance has come—I'm to be manager of our Western branch at \$5,000 a year! It just shows what spare-time training will do."

If you want to make more money, show your employer you are trying to be worth more money. If you want a bigger job, show him you are willing to prepare for it.

There's a simple, easy way to do it. For 37 years the International Correspondence Schools have been training men and women right in their own homes whenever they had a little time to spare. More than 180,000 are studying now. Ten thousand are starting every month.

Can you afford to let another priceless hour pass without finding out what the I. C. S. can do for you? Here is all we ask—without cost, without obligating yourself in any way, mark and mail this coupon.

INTERNATIONAL CORRESPONDENCE SCHOOLS Box 3629-D, Scranton, Penna.

Without cost or obligation, please tell me how I can qualify for the position or in the subject before which I have marked an X:

BUSINESS TRAINING COURSES

- | | |
|--|---|
| <input type="checkbox"/> Business Management | <input type="checkbox"/> Salesmanship |
| <input type="checkbox"/> Industrial Management | <input type="checkbox"/> Advertising |
| <input type="checkbox"/> Personnel Organization | <input type="checkbox"/> Better Letters |
| <input type="checkbox"/> Traffic Management | <input type="checkbox"/> Show Card Lettering |
| <input type="checkbox"/> Business Law | <input type="checkbox"/> Stenography and Typing |
| <input type="checkbox"/> Banking and Banking Law | <input type="checkbox"/> Business English |
| <input type="checkbox"/> Accountancy (including C.P.A.) | <input type="checkbox"/> Civil Service |
| <input type="checkbox"/> Nicholson Cost Accounting | <input type="checkbox"/> Railway Mail Clerk |
| <input type="checkbox"/> Bookkeeping | <input type="checkbox"/> Common School Subjects |
| <input type="checkbox"/> Private Secretary | <input type="checkbox"/> High School Subjects |
| <input type="checkbox"/> Spanish <input type="checkbox"/> French | <input type="checkbox"/> Illustrating <input type="checkbox"/> Cartooning |

TECHNICAL AND INDUSTRIAL COURSES

- | | |
|---|--|
| <input type="checkbox"/> Electrical Engineering | <input type="checkbox"/> Architect |
| <input type="checkbox"/> Electric Lighting | <input type="checkbox"/> Architects' Blue Prints |
| <input type="checkbox"/> Mechanical Engineer | <input type="checkbox"/> Constructor and Builder |
| <input type="checkbox"/> Mechanical Draftsman | <input type="checkbox"/> Architectural Draftsman |
| <input type="checkbox"/> Machine Shop Practice | <input type="checkbox"/> Concrete Builder |
| <input type="checkbox"/> Railroad Positions | <input type="checkbox"/> Structural Engineer |
| <input type="checkbox"/> Gas Engine Operating | <input type="checkbox"/> Chemistry <input type="checkbox"/> Pharmacy |
| <input type="checkbox"/> Civil Engineer | <input type="checkbox"/> Automobile Work |
| <input type="checkbox"/> Surveying and Mapping | <input type="checkbox"/> Airplane Engines |
| <input type="checkbox"/> Metallurgy | <input type="checkbox"/> Navigation |
| <input type="checkbox"/> Steam Engineering | <input type="checkbox"/> Agriculture and Poultry |
| <input type="checkbox"/> Radio | <input type="checkbox"/> Mathematics |

Name.....
Street.....
Address..... 3-6-24

City..... State.....

Occupation.....

Persons residing in Canada should send this coupon to the International Correspondence Schools Canadian, Limited, Montreal, Canada.

Catalog No. 6
FREE

LEARN TO PAINT
BIG MONEY IN IT

WHY PAINTERS ARE ALWAYS IN DEMAND

A painted job is never permanently finished! Time and weather see to that. The finest work of today must be done over again months hence. Painting therefore represents the steadyest labor market known.

It is a splendid trade; commands high wages; many of our graduates make from \$10 to \$20 a day; and this school is the place to learn the trade or increase your earning power by mastering several branches.

You make a small investment from which big returns will surely come. This is the world's leading school of painting. We teach sign and pictorial painting, decorating, graining, marbling, show card writing, paperhanging, auto painting, etc. Highly skilled instructors. Write for details and illustrated Catalogue No. 6. Free fare to Chicago if you enroll. Address Harry Gilek, Principal.

CHICAGO PAINTING SCHOOL
148 W. Austin Ave., Chicago, Ill.

Get Your
Copy of the
NEW GIBSON BOOK
Free



Stringed instruments are more popular than ever—offer great opportunity for profit and pleasure.

The Gibson Book illustrates and describes The NEW Gibson Master-tone banjo, with its many exclusive features—marvelous tone, easy to play. Also gives complete information on all other Gibson "easy to play" instruments—mandolin, mandola, mando-cello, guitar, mando-bass.

Easy Payments. Write today.

GIBSON, Inc.
811 Parsons St.

Kalamazoo, Mich.

YOU CAN BE A \$5000 AUTO EXPERT

Here's the quickest way to big pay work. Takes only an hour a day of your spare time for a few months. Robinson jumped from \$25 to \$100 a week in six months. You, too, can boss Auto Job. I'll show you how. Learn at home. Learn by "Job-Way" Plan. Send for big illustrated book, explaining "Job-Way" course. Tells about money back guarantee, free tools offer, low price and easy terms. Book is free. No obligation. A postal will do. Write NOW.

J. R. BAYSTON, Pres., CHICAGO AUTOMOTIVE INSTITUTE
Dept. C177 536 South Clark Street, Chicago, Illinois

Cheapest Way to Go

to work or school and recreation is on a Ranger bicycle. You can have your choice of 44 styles, colors and sizes. 30 DAYS FREE TRIAL. Express prepaid. Factory-to-Rider bicycles from \$21.50 up.

\$5 a Month easily meets the small monthly payments. Parents often advance first payment.

Tires best quality, at factory prices, express prepaid.

Lamps, wheels and equipment, low prices. Send No Money do business direct with makers.

Mead CYCLE COMPANY
DEPT. T-108 CHICAGO

Write today for free Ranger Catalog, factory prices and marvelous easy payment terms.



BECOME A RAILWAY MAIL CLERK

Examinations coming. \$1600 to \$2300 a year. Steady life-time job. Common education sufficient. No "pull" necessary. Mail coupon for Catalog.

Patterson Civil Service School

Dept. 88 ROCHESTER, N. Y.

Sms: Send me without charge your Catalog, describing this and other U. S. Government positions.

Patterson Civil Service School

Dept. 88
Rochester,
N. Y.

Name.....

Address.....

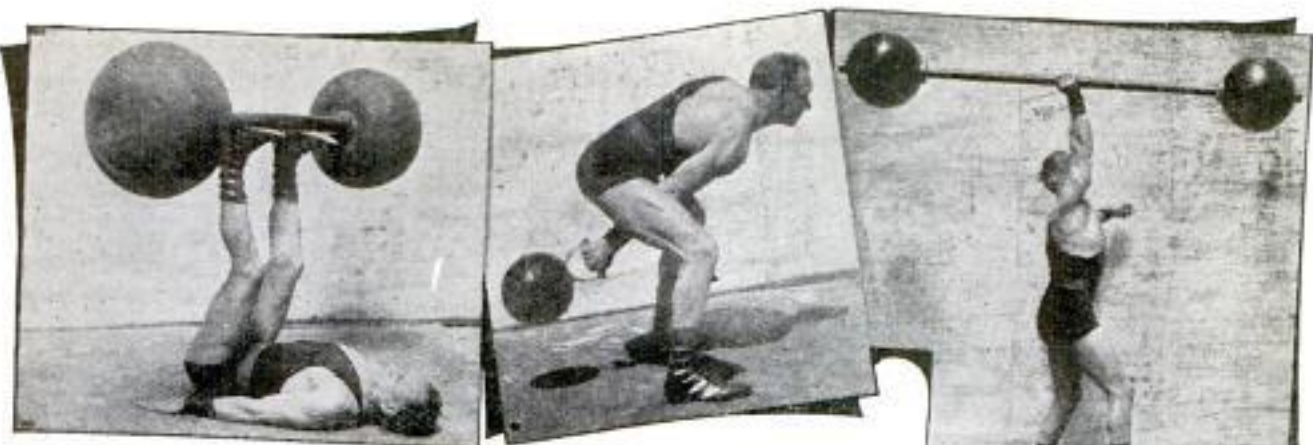

A Book That Will Fascinate You

We take pleasure in announcing the publication of a new book called

"SUPER-STRENGTH"

written by Mr. Alan Calvert, whose name has for years been prominently associated with body-building, muscular development, and allied subjects.

OVER 180 SPLENDID ILLUSTRATIONS

Never before have there been so many beautiful pictures of such magnificently developed athletes published between the covers of one book. Among the illustrations there are pictures of the most famous professional and amateur lifters and "Strong Men"; together with fascinating poses by many of the athletes whose bodily proportions and muscular development had earned them the title of "Perfect Men."

FEATS OF STRENGTH—RECORDS—LIFTING

The author devotes several chapters to telling how to perform the recognized "standard lifts," and other feats of strength which you have seen performed by professionals. He tells you the records in the various lifts, and the names of the men who made the records.

YOU CAN ACQUIRE SUPER-STRENGTH

The most interesting part of the book is the section which Mr. Calvert has devoted to body-building and muscle-developing exercises, many of which have *never before been published* in any book, magazine article, or course of instruction. These are not the kind of exercises which give you only moderate development, but the ones which will show you how to make your chest six or eight inches bigger, and to add two or four inches to the girth of your arms and legs. The author has devoted considerable space to his original theories, regarding the possibility of *remolding the body*; that is, of making the chest bigger by increasing the size of the rib-box, and increasing the breadth of the shoulders in direct proportion to the increased size of the chest.

ANALYSIS OF PHYSIQUE AND DEVELOPMENT

Physical culturists who are interested in heroic muscular development, will gain much valuable information from the chapters in which Mr. Calvert analyzes the proportions and development of the celebrated "Strong Men," whose pictures appear in this book; and then proceeds to tell you just how you can get such development.

Mr. Calvert is much more interested in *making men* than in making lifting records. In this book he shows how the average man (*you*, for instance) can, by (first) altering the bodily proportions, and (second) by *rapidly increasing* the muscular development, become super-strong, by virtue of the increased vitality and development. This book is the very last word—the highest authority—on the subject of strength, development, and supreme bodily beauty.

Not written for professional "Strong Men," but for those thousands of physical culturists whose dearest wish is to become as strong, and as shapely, as Sandow, Saxon, and their illustrious compeers.

The book contains 225 pages of text, and 95 pages of illustrations. Many of the pictures were taken especially for this volume. The book is about as big as the average-sized novel. Remember the name:

"SUPER-STRENGTH," by Alan Calvert

320 Pages Cloth Bound Lavishly Illustrated

PRICE \$2.50 POSTPAID

Send Cash, Check or Money Order to

THE MILO PUBLISHING CO.

Book Dept.

2735 N. Palethorpe St. PHILADELPHIA, PA.

THE MILO PUBLISHING CO., Book Dept.
2735 N. Palethorpe St., Philadelphia, Pa.

P.M. 8-84

Dear Sirs: Enclosed find { cash { for \$2.50, for which send me,
check { post-paid, one copy of the
money order { book, "Super-Strength," by
Alan Calvert.

Name

Street

Town.....State.....



Get Into This

You Can

15,000,000
Automobiles in U.S.
70,000,000
Tires to be repaired.
15,000,000 Batteries,
15,000,000 Ignition
Systems and only
50,000 Garages.

Follow in the lead of Bradley, shown on the opposite page, and scores like him who have taken advantage of the amazing money-making possibilities in the automobile, truck and tractor business. Here is a chart of facts—authentic figures which point out the opportunities. If you are ambitious and seeking a money-making opening, here's your chance—a chance to cash-in to a degree that will satisfy your highest aims.

Thousands of competent garages, battery shops, auto electrical shops, tire and welding shops are needed now. Trained men can run them.

Learn Autos, Trucks and Tractors in the Heart of the Industry

Without any previous experience—just a liking for mechanics—you can learn the auto business from A to Z in a few weeks at the Michigan State Automobile School—the factory endorsed school in Detroit—the heart of the industry. Then step out, equipped with knowledge and training, to a future of certain, big money making. You have distinctive advantages, learning the business here. It's the fountain head of the automotive industry. You are taught under factory endorsed methods. You learn both theory and practice on latest equipment. Go through the great Ford plants. Visit the other auto factories—learn their methods first hand—and it all means greater opportunities and more certain success. The Michigan State Automobile School, in Detroit, the automobile center, is the logical place to learn the automobile business.

Learn in a Few Weeks—Start Now

A thorough training in Detroit, at the Michigan State, is the thing that fattens the pay envelope if you are working for others, or puts more profit in business for yourself. You can take a full Automotive Course, or specialize in any one of its money-making branches; you can be an Auto Electrician; a Tire Expert; a Battery Service Man; a Repair-Man; a Welder; a Machinist; or specialize in motorized farming, with truck, tractor and farm electric-lighting and farm engine training. Course includes training in Garage Management, Business Methods and Selling. Classes are always open. You need make no special arrangements—you can start at once—now—and that's the thing to do.

Endorsed by Big Factories Read These Letters

DODGE BROTHERS
INCORPORATED
DETROIT, U. S. A.

"We believe the Michigan State Automobile School of this city to be an exceptionally high class school, and no doubt a diploma from this school would assist materially in obtaining employment with high class automobile dealers."



BUICK MOTOR COMPANY

"We believe the MICHIGAN STATE AUTO SCHOOL, Detroit, would best meet your requirements, as its course of technical training is most thorough and complete in every detail."

THE STUDERBAKER CORPORATION
OF AMERICA

"We do not know of a better automobile school than the MICHIGAN STATE."

More Money Spent for Repairs Than for New Cars

I wonder if you realize what an enormous business the repairing of cars really is. Last year the selling price of all the new automobiles sold was \$2,500,000,000, on which the dealers made a net profit of 3%, or \$75,000,000. But look at this: the selling price of parts used on repair jobs was \$2,900,000,000 or \$400,000,000 more than the price of the new cars, and the profit on these repair parts was 15%, or \$435,000,000. Nearly six times as much profit on service as on new cars. But look again: this is only on the parts used in repair jobs; it doesn't include the charges for the work, which run as high or higher than the parts and materials. When you add that, you see that the money spent for repairs is many times greater than the money spent for new cars. **The repair business is the business to get into.** And now is the time to get into it.

Life Scholarship Your enrollment entitles you to a life membership, with privilege of our service any time you want it. Many students come back to brush up on latest automotive ideas and new equipment. It doesn't cost a penny extra. The position of the Michigan State (The Detroit Auto School) in the heart of this industry, insures most thorough, most practical, systematic training, at a cost so low and terms so easy that any man, anywhere, can afford it.

Earn While You Learn If necessary we can assist students to secure part time work to earn a small amount each week. Or students who wish to take our evening course will be assisted to full time day jobs. Ask for details, and when writing please explain your circumstances fully.

MICHIGAN STATE

308 Auto Building

Detroit, Mich.

Big Money Business

Have Success Like This

Here is H. A. Bradley—merely one of thousands of Michigan State students who have achieved success far beyond their fondest hopes. What these men have done you can do. The opportunities are now greater than ever. There are more autos—more trucks—more tractors and every year adds to the money-making possibilities. You have ambition—you want success. Success is certain if you are willing to work for it. You can have independence—be your own boss—stop the plodding and get into work you like. You can earn big money, be prosperous, happy and independent. Bradley is no exception, we have graduates who have made as high as \$10,000 in less than a year. These records may seem amazing, but they are true. It is all done through head and hand training at the Michigan State. Decide now to give yourself the training that will pay you big and establish you in a successful life work.

Spend Your Summer at Detroit "The Summer Resort" City

Where business is always good. Where weather is always fine. Detroit's location in center of the Great Lakes gives it ideal climate, not too cold in winter, not too hot in summer. Get away from the burning sun into the cool breezes of Michigan. After school hours, enjoy boat trips, swimming, fishing, sailing, canoeing on the lakes and river. See Major League baseball games—see Ty Cobb, Babe Ruth, Eddie Collins, Tris Speaker, Walter Johnson, George Sisler—all the stars. Spend a pleasant summer and improve yourself at the same time. We work hard up here but we believe in some good times too.

Detroit-Trained Auto Men Earn More Money

Detroit-trained men are preferred. Your diploma from the Michigan State is a valuable money-making asset—an advantage that you can get from no other school. The Michigan State Automobile School is known the world over. Wherever autos are used—Detroit-trained men get the best jobs, highest pay. Auto, truck, tractor factories employ M. S. A. S. graduates. Leading factories, dealers, service stations, garages, shops and farms want men who have trained their heads as well as their hands—the M. S. A. S. Detroit-kind.

Good Positions Open

The demand for men who know automotive mechanics and electric is greater than the supply. We have more calls than we can fill. The training in Business Management and Salesmanship included in our courses makes our graduates especially valuable. The years ahead are predicted to be the biggest years of the industry. That means certain money-making advantages to men who start in the business now.

Mail This Coupon

Get all the interesting facts from our big catalog. It's a book of information concerning your future that you must not fail to get. It gives complete information about all courses. It's illustrated with photos of school, equipment and graduates. It tells you how you can get a good paying job—how you can go into business for yourself with little capital. Let us send it to you FREE without obligation. Mail the coupon or send us a postcard today. Write now. (We do not enroll colored students, except for our Home Study Course.)

AUTOMOBILE SCHOOL
3729 Woodward Avenue, Detroit, Mich.

From \$1200 a Week
to
\$5000
a Month



H. A. BRADLEY

BRADLEY GARAGE
CLEVELAND, OHIO

Distributor Vesta Storage Batteries
ALEMITE LUBRICATOR SERVICE
Automobile Repairing

Michigan State Auto School, Detroit, Mich.

Gentlemen: I wish to state that before going to your School I was employed as shipping clerk with a well-known concern at the enormous salary of \$12 per week. Incidentally, this included overtime. I knew absolutely nothing about an automobile. I couldn't even drive one and didn't know the difference between a carburetor and a wheel-base; in fact, I didn't know they had a wheel-base.

After leaving the School I worked as service repairman for the Oakland Motor Company of Pontiac, Michigan. I left the Oakland to accept a position as night service foreman for the Studebaker Company at Detroit and was later connected with such firms as the Northway Motor and Manufacturing Company, and the Continental Motor Manufacturing Company. I have since been service-manager for two large concerns—one in Detroit and one in Cleveland. The salary mounted all the time—the last position paying me \$300 per month.

I, then, decided to go in business for myself, which business I have successfully built and maintained up to the present time and expect to maintain for a long time to come. I estimate the present earnings of my business at \$500 per month clear and growing all the time.

I believe that the M. S. A. S. is by far the best School of its kind in the country. For the man who will apply himself to the work and to the studies I can safely say that the Michigan State Auto School is the best place to learn the automobile business.

Yours very truly,
H. A. BRADLEY.

FREE CATALOG
MICHIGAN STATE
AUTO SCHOOL

Mail Coupon To Day

Michigan State Automobile School 308 Auto Building
DETROIT, MICHIGAN

Send me FREE and without obligation your illustrated catalog and complete information about Detroit-training to make the most money.

Name

Street or R. F. D.

City State

Do you prefer to start your training at home or at our School in Detroit?



Landing of the Night Air Mail Amid Beams of Powerful Lamp That Make Daylight of Darkness; Insert, Closeup of 460,000,000-Candlepower Beacon—See Page 267

Popular Mechanics Magazine

REGISTERED IN U. S. PATENT OFFICE

WRITTEN SO YOU CAN UNDERSTAND IT

Vol. 42

AUGUST, 1924

No. 2

More Than \$128,400 Offered for Your Ideas ¹²⁹⁶

New Awards Widen Field and Afford Greater Opportunity for All in Seeking Solutions of Problems

Copyright, 1924, by H. H. Windsor

WITH new offers for ideas bringing the total to more than \$128,400, words of praise for the Industrial Award Plan originated by Popular Mechanics Magazine continued to be received from all parts of the nation.

Heads of great educational institutions, high government officials and industrial leaders everywhere united in approval of the effort to awaken the inventive genius of the country and to bring about a new era of closer co-operation. A few of the letters read in part as follows:

"Without doubt there are many industrial problems that could be solved if they were given proper publicity and there are many bright men who fail to receive recognition because of inability to place their ideas before the public. It seems to me that nothing but good can come of your Plan."—Dexter S. Kimball, Cornell University.

"One of the first requisites for the solution of a problem is knowing what the problem is. You have set forth certain important problems. This is the first step toward their solution. I feel you are to be congratulated."—J. Lewis Howe, Washington and Lee University.

"Your Plan of seeking out the latent ability possessed by everyone should prove a tremendous success. You are doing a great good in bringing out this ability and at the same time are giving the public that one needed thing—perfection of all manufactured articles."—L. B. Ivey, Editor, Money-Making.

"I take pleasure in commending it as a means of bringing readers and manufacturers into a co-operative and mutually beneficial union."—K. G. Matheson, Drexel Institute, Philadelphia.

"It seems to me that it is of such a character

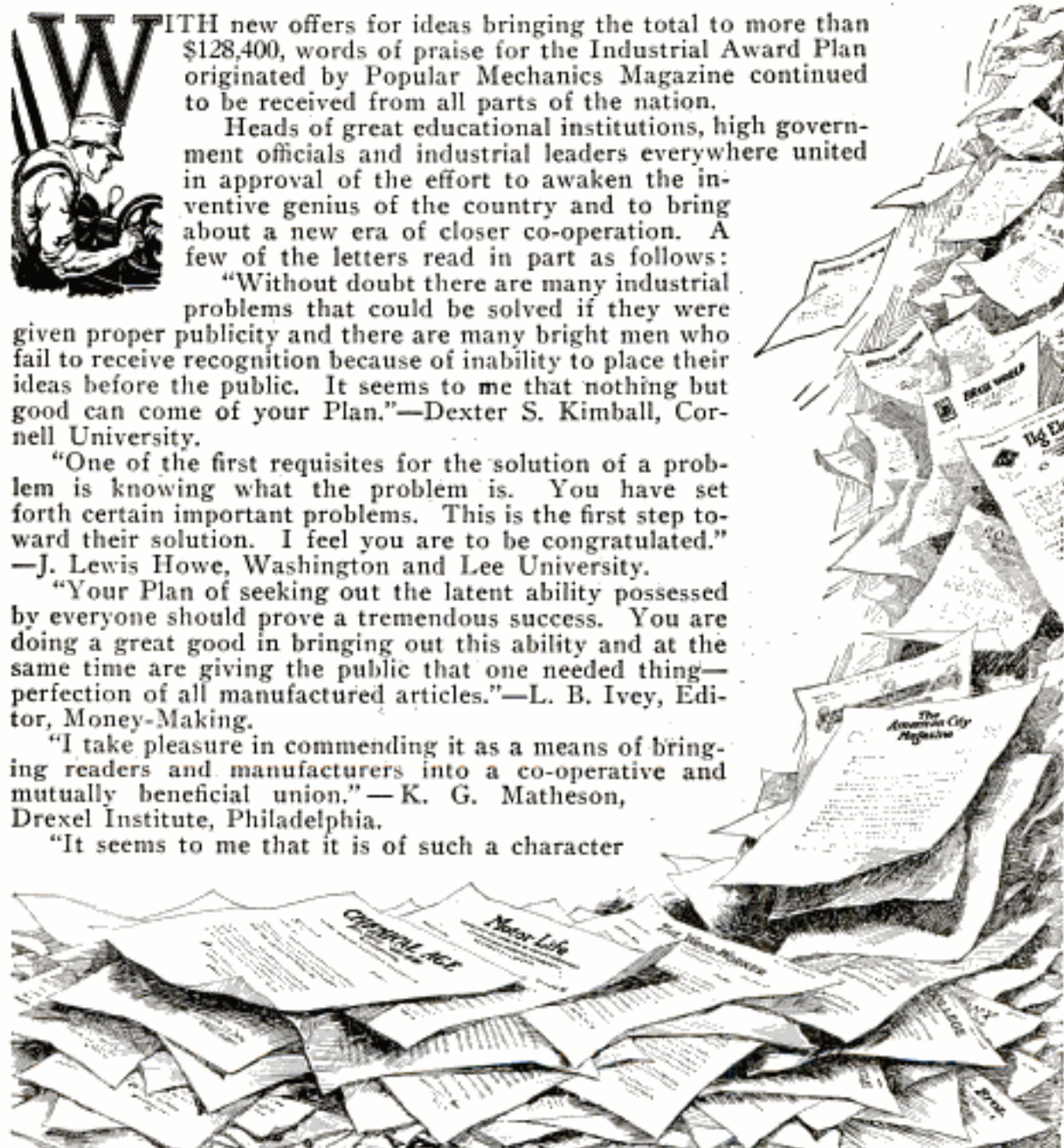

as to offer encouragement in a more substantial and general and protected way than almost any other plan which might be devised."—E. T. Stiger, Editor, Printing Art.

"Popular Mechanics Magazine, always a favorite with men who use their heads as well as their hands, is performing a most valuable service to industry and mankind by encouraging men to do things better. You have my sincere congratulations."—J. A. Gary, Editor, Furniture Age Magazine.

"You are rendering the industries of this country a useful service in making your splendid publication the focal point at which important problems and their solutions are brought together."—Ernest Coler, Editor, Motor Life.

"Your enterprise will bring the manufacturer and the inventor together to their mutual advantage and the entire nation will profit."—John M. Glenn, Secretary, Illinois Manufacturers' Association.

"Your Plan will lead to considerable benefit and it will not be at all surprising if some rather radical improvements result from it."—L. D. Crain, State Agricultural College, Fort Collins, Colo.

"Your Plan provides a number of definite lines along which there is a need of investigation and invention and ought to

yield useful results."—O. M. Leland, The University of Minnesota.

"It seems to me that your Plan should produce excellent results. Anything that will encourage investigations and discoveries is certainly worth while."—Charles H. Warren, Yale University.

"It is an interesting proposition which you are placing before the public. It constitutes an incentive to some who might never think of developing their idea in form to go to the patent office."—P. F. Walker, University of Kansas.

"I am glad to see your magazine working along such constructive and edifying lines."—A. M. Soule, University of Georgia.

"I think that this kind of competition opens up a wide field of interest and frequently results in useful and sometimes very valuable suggestions."—H. J. Hughes, Harvard University.

"Many people with inquiring and active minds will welcome these definite suggestions to which they may direct their efforts."—H. S. Evans, University of Colorado.

"This seems to me to be a very good means of bringing inventors and those who have problems which they would like to solve together for the mutual advantage of both."—C. D. Marx, Stanford University.

ABOUT THE LATHE—THE KING OF ALL TOOLS

THE screw-cutting engine lathe is the oldest of all machine tools. It was the first developed and without it the locomotive, the steamboat, the electric motor, and, in fact, all the machinery used in industry, would be impossible.

The earliest screw-cutting engine lathe

known was built in France about 1740. The name of the builder is unknown. There was not much further development until 1797, when Henry Maudslay, an Englishman, designed and built one with about a ten-inch swing, fitted with a lead screw geared to the spindle. Although only a few lathes were built until after 1830, nevertheless they have made the United States the greatest manufacturing country in the world today.

It was on the lathe that the pioneer mechanics got their early training and developed special tools for cutting costs, increasing production and improving products. Now many of the vocational and industrial schools offer an opportunity to learn the fundamentals of machine-shop work. The lathe, of course, is the basis of these courses, and the average boy who spends two years in the machine shop of a vocational or industrial school is sought by the manufacturer.

But the boy who takes up such work is not expected to spend the rest of his life as a machinist, for he has received a training that will give him an opportunity to



Two-Man Hand-Power Lathe of the Orient



become a foreman, superintendent or manufacturer. George Westinghouse, Henry Ford and the Studebaker brothers were all mechanics.

While there are excellent mechanics and skilled workmen in the large industrial plants contributing their part in improvements and inventions to industry, there are also a great many unknown craftsmen in the smaller shops and communities throughout the country who are doing their bit, as the following story will serve to illustrate:

In 1890, a young tool and die maker entered the employ of one of the largest brass manufacturing concerns in Connecticut. An order came in for a large amount of curtain brackets. The foreman and the die maker worked out a set of tools for making the bracket in quantities, and at the end of two months, the tools were set in operation and a production of 8,000 brackets a day was obtained. The young die maker's reputation was made in that

community. Later he became a machine-tool salesman and visited a small shop, the equipment of which did not cost more than \$4,000. On the floor was a horizontal machine for the turning out of the very same curtain brackets that he had worked on ten years before in New England, except that this bracket was made of steel instead of brass; and this machine had a production capacity of 40,000 brackets a day.

The machine was crudely built, of poor design, but the dies and tools did the work. The mechanic who built it did not realize what ability he had. He did not seem to think it much of a job, but he had developed alone a machine which had five times the capacity of that built in the eastern plant with all its equipment and experience of the builders.

This goes to show that in the United States there are a great many people of unusual mechanical ability if they only had the opportunity to develop it. They

do not always know they have this ability, and it is to stimulate it and show the way to constructive achievement that the following problems, including several on the lathe, are presented:

No. 14—\$1,000—Harmless Skyrocket Stick

The Thearle-Duffield Fireworks Company, producers of fireworks displays and spectacles, will pay to the designer of a skyrocket equipped with a stick absolutely harmless in its descent after explosion in the air, the sum of \$1,000. Models or clearly defined ideas are acceptable to this company, who will be the sole judge of the article and its value to them.

No. 14A—\$250—Bombshell with Flag

This concern will pay the sum of \$250 for a satisfactory night bombshell that will release, at an altitude of 600 to 800 feet, a large silk American flag attached to a parachute together with an illuminating compound that will function in such a manner as to safely and satisfactorily illuminate the flag so that it may be clearly seen as it floats in the air.

No. 14B—\$250—Smokeless Colors

For a combination of chemicals that will produce smokeless, or nearly smokeless, colors when burning, the Thearle-Duffield Fireworks Company will pay the sum of \$250. The colors produced are to be in solid reds, blues, yellows, greens and white. The main object is to secure a smokeless combination that will prove acceptable to this organization. Offers 14, 14A and 14B close May 1, 1925. Address Thearle-Duffield Fireworks Company, 624 South Michigan Avenue, Chicago, Illinois.

No. 15—\$10,000—Motorized Handsaw

With the person who designs a successful and acceptable means of motorizing the ordinary handsaw, R. L. Barker and Company will enter into an agreement to manufacture and market such device and award to the inventor royalties from the sales until such time as the royalties aggregate the sum of \$10,000, when the payments shall cease and all rights to and ownership of the implement will pass to R. L. Barker and Company. The saw must be of the reciprocating type. We have in mind three sizes; one driven by a ½-hp. motor, with 16-inch blade, 14-inch stroke, to cut 12-inch timbers, and weighing about 25 pounds; another driven by a ¾-hp. motor, with 6 or 8-inch blade, with 4 or 5-inch stroke, to cut 4-inch timbers; this would be the most popular size, selling in almost every field where handsaws are used. The third size should take a smaller motor, about a 4-inch blade with stroke of 2 or 3 inches, to cut very light materials, such as veneer and wallboard, or for shaping showcards and stage scenery. The difficulty in properly designing the implement, it seems, would be to get uniform pressure on the saw blade while it is being drawn back and forth by the motor. R. L. Barker and Company will be the only authority to judge of the suitability for their purpose of all designs submitted. This offer will terminate on May 1, 1925. Address R. L. Barker and Company, 642 West Washington Street, Chicago, Illinois.

No. 16—\$500—Sales Promotion Plan

The Keasby and Mattison Company has a neutral product which is very light and fluffy, and of use as an absorbent, as a non-heat-conducting powder, as a neutral powder to be mixed with arsenite of lead or other insecticides, or for any sort of disinfectant, for air supplying, dusting, etc. We desire a price of about three cents a pound for this material. It is mainly of a very light and fluffy chalk and is exceedingly bulky. A large sugar barrel can be made to hold about 100 pounds of the powder, 95 per cent of which will pass through a 400-mesh screen. For a satisfactory plan that will aid in largely increasing our sales of, and assist us in marketing, the product, we will pay the person submitting the plan, the sum of \$500, Keasby and Mattison Company alone to determine the value of the method. The offer will end on May 1, 1925. Address Keasby and Mattison Company, Ambler, Pennsylvania.

No. 17—\$15,000—Mechanical Devices

The Aetna Industries, Incorporated, manufacturers of mechanical and labor-saving appliances, such as automatic oil burners, camp stoves, rivet heaters, illuminating lamps, portable shower baths, burglar-proof window locks, lawn sprinklers, rotary pumps for air and liquid, and hand drills for steel, iron, etc., will undertake the manufacture of an entirely new and original device either in the line of their own products aforementioned or any other labor-saving devices, mechanical or electrical, that are practical and will gain the endorsement of this organization. To the inventor submitting such article, this concern offers the following terms: They will enter into a contract to make and sell the new or improved device and award to the inventor royalties from the sales until such time as the royalties will aggregate the sum of \$15,000, when payments shall cease and the improved or new device shall become the sole property of the Aetna Industries, Incorporated. No person connected with this concern will receive any consideration under this offer. All ideas must be submitted in form of models, as no sketches, plans or blueprints will be accepted. Examining committee will be R. S. Brandt, president, A. Pettersson, vice president, of this organization, and J. J. Berggren, technical superintendent of the Essanay Film Manufacturing Company. The offer closes May 1, 1925. Address Aetna Industries, Incorporated, 117 North Dearborn Street, Chicago, Illinois.

No. 18—\$250—Article for Manufacture

The Gemco Manufacturing Company will pay the sum of \$250 in cash to the person submitting to them a fairly well developed article that can be manufactured in an ordinary general metal-working plant equipped with a line of medium-heavy punch presses, screw machines, automatic machinery, polishing and plating departments, and complete tool and die-making and experimenting departments, etc. This also applies to the one submitting a suggestion that leads to the acquirement of such article by this concern. We are in search of some good live accessory to manufacture and sell to the automotive trade, or an article that will market readily through the hardware trade and which may be applicable to almost any field—to the farmer and any other large class of users. Value of the article to us will be determined entirely by members of our organization, and its merits will be largely measured by its adaptability to our sales organization. The award, as offered here, means a payment over and above any agreements into which we might enter with an owner of the rights to such accepted article for manufacture in case he is the one to submit the idea we adopt. Our offer will be closed on May 1, 1925. Address Gemco Manufacturing Company, Milwaukee, Wisconsin.

No. 19—\$25—Leakproofing Cast Iron

This donor will pay the sum of \$25 in cash for a satisfactory, simple and inexpensive method by which they can make cast-iron vessels, about 4 inches wide, 9 inches deep, and of ¼ to 3-16-inch metal, proof against leakage of kerosene. It seems that the metal is open sufficiently in the grain to allow seepage, and so far their efforts to apply a coating on the inside of the vessel to close the pores and resist the action of the kerosene have been unsuccessful. Their offer expires May 1, 1925. Address Problem SC-1, Popular Mechanics Magazine, Chicago, Illinois.

No. 20—\$1,000—Untarnishable Silver

The Stieff Company, silversmiths, will pay the sum of \$1,000 in cash for a perfected process or method whereby finished silver can be coated by some transparent material of a permanent and satisfactory character which will not in any way detract from its appearance or use and which will prevent tarnish. Or, the plan may be such that some alloy could be introduced into the composition of the metal which will not be detrimental to its quality, appearance or use, and yet will permit it to retain a fixed and permanent brilliance and luster absolutely immune to tarnish. The plans, methods, and processes submitted must necessarily be proven by qualified tests and demonstrations on the part of our concern, and the one selected by us must be only of such character as will warrant its adoption. This offer will terminate May 1, 1925. Address The Stieff Company, 17 North Liberty Street, Baltimore, Maryland.

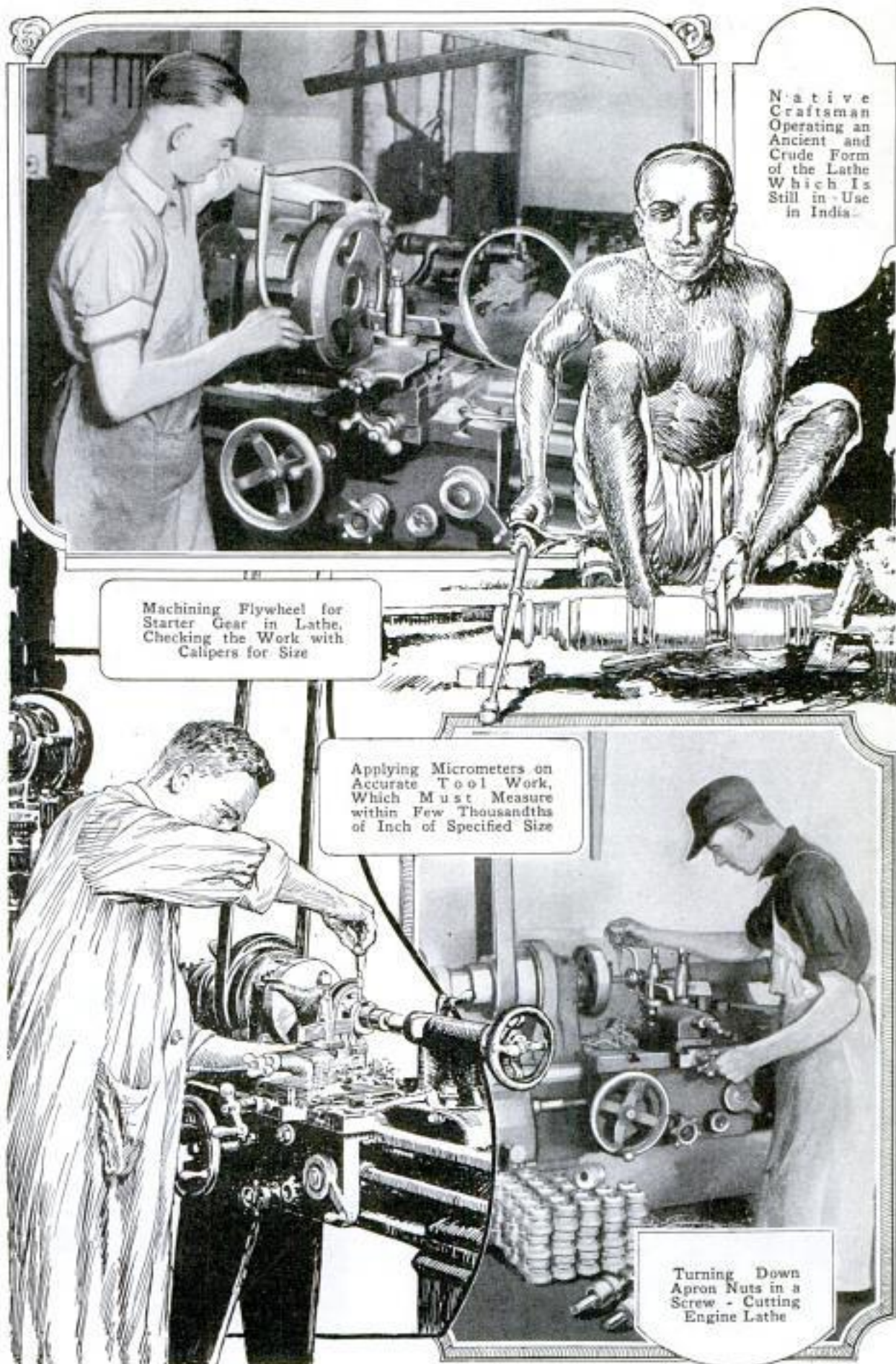

Native
Craftsman
Operating an
Ancient and
Crude Form
of the Lathe
Which Is
Still in Use
in India.

Machining Flywheel for
Starter Gear in Lathe,
Checking the Work with
Calipers for Size

Applying Micrometers on
Accurate Tool Work,
Which Must Measure
within Few Thousandths
of Inch of Specified Size

Turning Down
Apron Nuts in a
Screw - Cutting
Engine Lathe

No. 21—\$1,000—Saxophone Reed

The Buescher Band Instrument Company will pay the sum of \$1,000 in cash to anyone who will produce for them a reed for a saxophone that will give the same results as the present reed but which must be indestructible in so far as ordinary care is concerned. This idea has received a great deal of attention in the past from many people, but nothing has been developed to satisfactorily replace the present cane reed. All kinds of metal, ivory, wood, rubber, celluloid, and other materials have been tried without success. All entries must be in the hands of this company, who will act as sole judge of their worth, by May 1, 1925, the date on which this offer closes. Address Buescher Band Instrument Company, Research Department, Elkhart, Indiana.

No. 22—\$1,000—Clamp for Rubber Bottle

Dr. Goddard Nurser Co., Inc., manufactures a collapsible all-rubber nursing bottle for babies. It has been in the market for some time and has proved a success. However, this firm is desirous of procuring an improvement over the present clamp used to close the bottom of the bottle. While our device is satisfactory for its purpose, it is difficult for many lady folks to remove without great effort. We will pay the sum of \$1,000 to the person submitting a device that will satisfactorily perform this service and which will be easy to remove and replace without becoming damaged under ordinary usage. Any device or plans submitted must be passed upon by Dr. Goddard Nurser Co., Inc., representatives who alone will decide on the merits of the suggested appliances. Persons interested in working on this clamp are to write us at once for particulars. This offer ends May 1, 1925. Address, Dr. Goddard Nurser Co., Inc., Fort Atkinson, Wis.

No. 23—\$1,000—New Variable Condenser

The Phenix Radio Corporation will pay the sum of \$1,000 in cash for the design of a new form of variable condenser for radio reception. It must be a departure from the common rotary plate type, the mercury type and the type relying on the decrease of distance between two conducting surfaces for an increase of capacity. The variable condenser must be no larger than the rotary plate type, for a given capacity, and preferably smaller. It must have a gradual straight line curve and have its entire variation through 180 degrees. The new device must not be so complicated in design that the cost of manufacture would exceed that of the present forms of rotary plate condensers. All submitted designs are subject to sole judgment of the Phenix Radio Corporation, who will decide on the value of the device to their organization. May 1, 1925, is the closing date for this offer. Address the Phenix Radio Corporation, 5 Beekman Street, New York, N. Y.

No. 24—\$500—Portable Electric Hammer

Wodack Electric Tool Corporation desires a hammer arrangement for an electrically driven portable hammer drill other than a lifting cam and spring. The idea is to secure an electric drill strong enough to drill holes, $\frac{1}{4}$ to 1 inch in diameter and from $\frac{1}{2}$ to 6 inches deep, in stone or concrete. Such a tool should weigh less than 25 pounds. What we need primarily is a motion that will strike a powerful hammer blow. Our present hammer delivers 2,000 blows a minute, but they are not hard enough. To enlarge the spring of the lifting cam and spring arrangement would call for a larger motor than that used. Perhaps some combination could be introduced to increase the force without such a change. The purpose of the tool must be to drill a 1-inch hole in concrete at the rate of $1\frac{1}{2}$ or 2 inches a minute. For a practical, workable plan or model of a portable hammer drill arrangement that we accept and which proves satisfactory, we will pay the sum of \$500. The offer will expire May 1, 1925. Address Wodack Electric Tool Corporation, 23 South Jefferson Street, Chicago, Illinois.

offer withdrawn
No. 25—\$2,500—Rubber Products

Continental Rubber Works, manufacturers of a nationally known line of automobile accessories, are interested in ideas or suggestions for any new accessories or improvements on existing accessories which are made from rubber, rubber and fabric, or rubberized fabric. Articles to be acceptable must preferably be simple in construction and application, of general appeal and subject to wide use to insure volume sales, and should possess sufficient originality to make them patentable. Continental Rubber Works is to be the sole judge in determining what suggestions are acceptable to this concern, and in the event of the adoption of any suggestion, will enter into a contract to make and sell the article and will pay to the inventor royalties of five per cent of the sales until such time as the royalties amount to a sum ranging up to \$2,500, according to the possibilities of the article; whereupon such payments to the inventor shall cease and the article together with all patent rights thereto shall become the sole property of Continental Rubber Works. Our offer expires May 1, 1925. Address Continental Rubber Works, Erie, Pennsylvania.

No. 26—\$100—Switch for A. C. Motor

This donor will pay the sum of \$100 for an accepted design of a starting switch for an alternating-current motor. The switch must operate so as to open the starting winding of split-phase, alternating-current electric motors at a predetermined speed. It must break quickly a current of about fifteen amperes at a speed of approximately 500 r. p. m. The diameter cannot exceed $\frac{1}{8}$ inches by about $1\frac{1}{2}$ inches in length. Operating

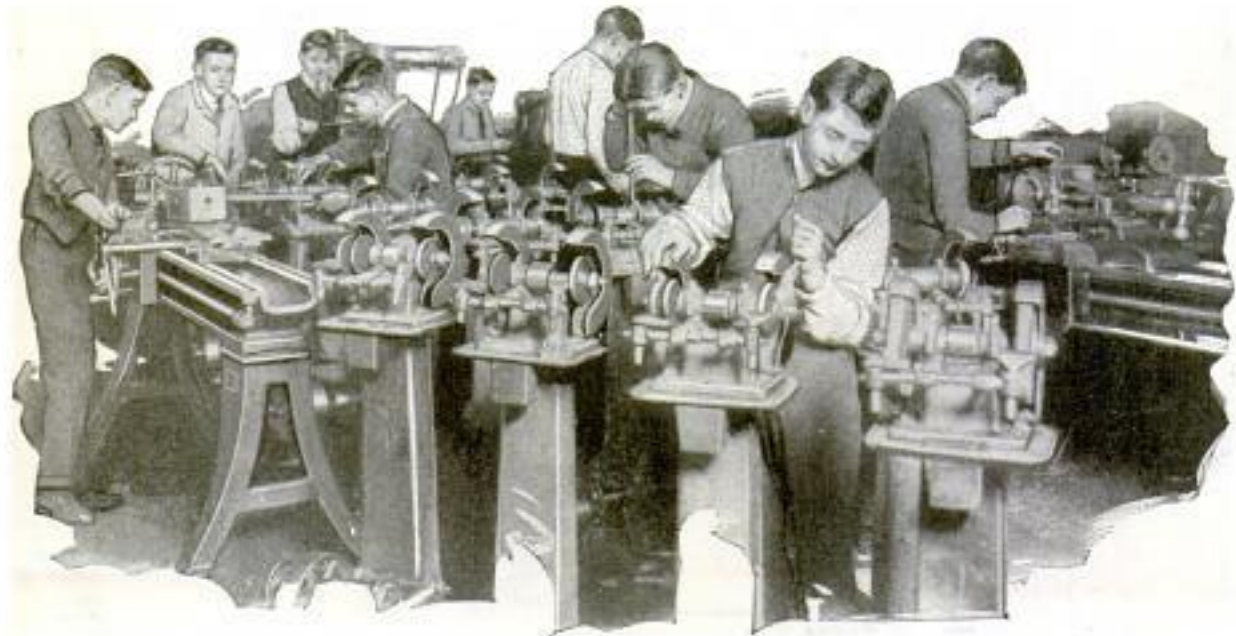

Youthful Students of the Boston Continuation School at Work in One of the Lathe Classrooms

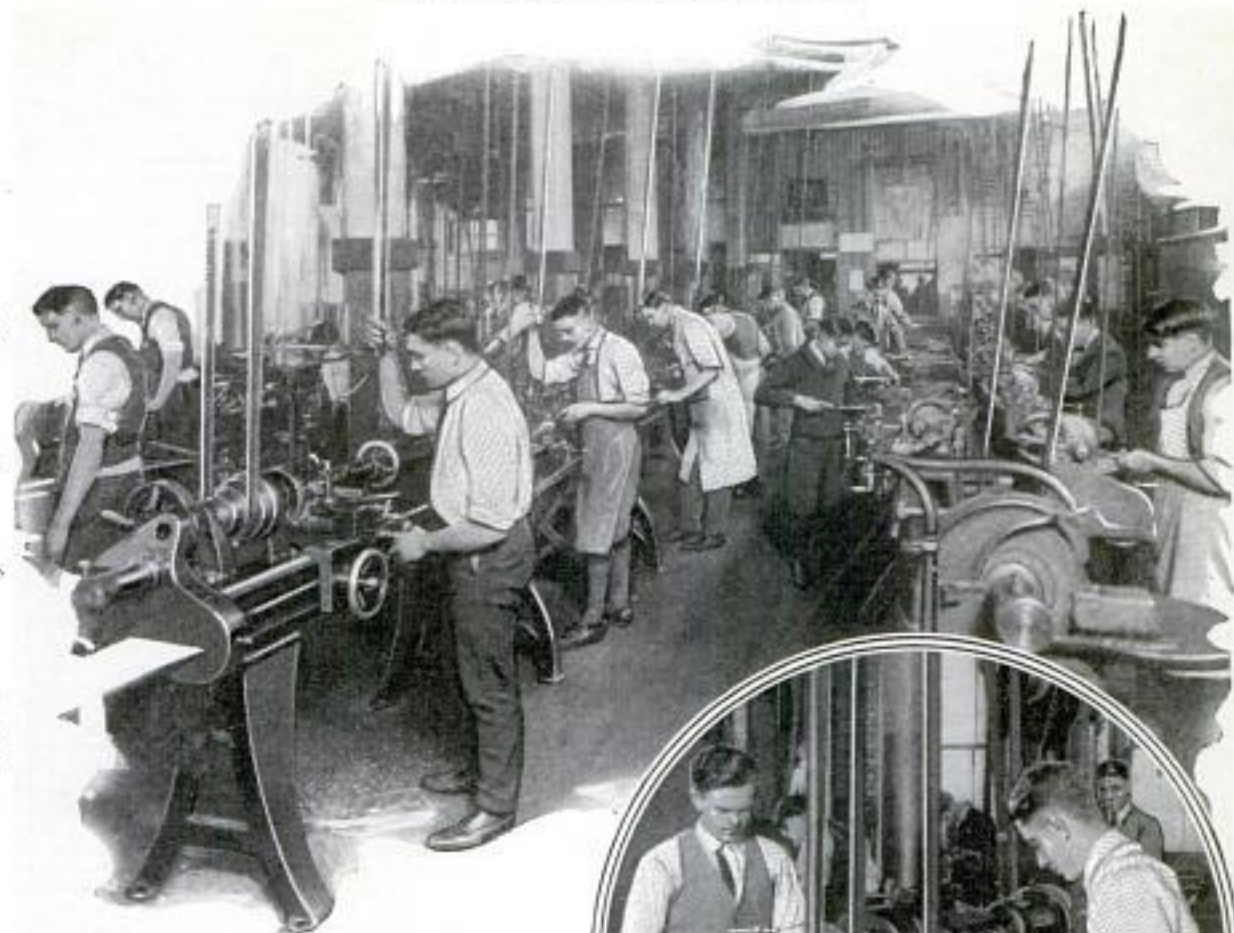

Lathe Section of Springfield, Mass., High-School Machine Shop

speed must be adjustable to some extent. Submit drawings and descriptive explanation. Closing date for this offer is May 1, 1925. Address Problem Number PD-1, Popular Mechanics Magazine, Chicago, Illinois.

No. 27—\$5,000—Leather Scrap Uses

This concern, the Eisendrath Glove Company, wants a new method whereby the scrap leather in our glove factory can be profitably utilized. Over thirty per cent of the leather, horsehide, cowhide, sheepskin, etc., that we cut is lost in scraps. Is there an automobile floor-board, composition floor covering or fabric capable of being developed from these waste pieces? The acceptable plan, process or method of some profitable utilization of this waste material is worth \$5,000 to us. We will pay this sum in cash to the person submitting the solution of this problem which we adopt. All ideas and suggestions are subject to the judgment of this firm alone. Our offer expires May 1, 1925. Address, Eisendrath Glove Company, 2001 Elston Avenue, Chicago, Illinois.

No. 28—\$200—Best New Use for Slate

In line with the efforts of the National Slate Association to promote and extend the uses of slate as illustrated by their slogan, "Slate—Consider Its Uses," the association will pay the sum of \$200 for the best suggested new use received before May 1, 1925, the date of expiration of this offer. In addition to the above offer, cash payments in proportion to their value to our members in the industry, will be given for all suggestions having reference to the production, distribution, and use of slate and slate products, not already known to our members, and which they adopt. Address, National Slate Association, 761 Drexel Building, Philadelphia, Pennsylvania.

No. 29—\$50—New Use for Ground Slate

Owing to the tremendous use of crushed and ground slate in various construction and industrial processes, the Parsons Manufacturing Company is interested in

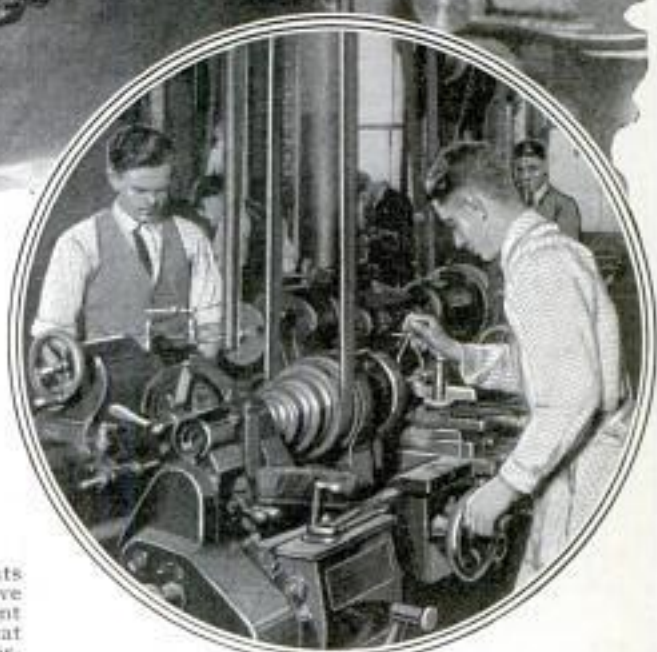

Teaching Student Proper Method of Adjusting Lathe to the Work

extending such uses and will pay the sum of \$50 for the best suggested new use for ground slate received before May 1, 1925, the date of expiration of these offers. In addition to the above award, cash payments in proportion to their value will be given for all suggestions having reference to the production, distribution and use of crushed and ground slate not already known to us, and which we will adopt. Address, Parsons Manufacturing Company, Pen Argyl, Pennsylvania.

No. 30—\$500—Uses for Generators

For three new uses for low-voltage generators, 2-10 volts, besides plating, electrotyping, and battery charging, that will produce \$50,000 additional sales volume to this concern, through such new uses, William H. Mitchell Company will pay the sum of \$500, one-fourth of the amount at the time we adopt the suggestions, and the balance in three equal payments, one every three months until full amount is paid.

No. 30A—\$500—Motor Generator Set

For a simple design of 2-kw. motor-generator set (or rotary converter) in which the single-phase synchronous motor obtains excitation from the 6-volt generator it drives, and one which is accepted by this concern, we will pay the sum of \$500. The outfit

Peerless Electric Co.,
Warren, Ohio.

must have good starting torque and unity power-factor characteristics. Offers 30 and 30A will close on May 1, 1925. Address, William H. Mitchell Company, Troy, Ohio.

No. 31—\$500—Anti-Freezing Ingredient

We have an emulsified asphaltic concrete which consists of 70 per cent petroleum asphalt of from 90 to 110 penetration and a 30 per cent water and soap solution. The addition of alcohol would keep the material from freezing out in the cold weather but would be highly expensive and the ingredient used for this purpose must not add more than 1 per cent to the present cost of the product. We will pay the sum of \$500 to the person who can give us an acceptable and satisfactory formula, process, ingredient, or method by which the freezing out of the emulsion can be prevented in cold weather. This offer expires May 1, 1925. Address, S. D. Hofheimer, Land Title Building, Philadelphia, Pennsylvania.

No. 32—\$500—Gasoline Mower

The Granite State Mowing Machine Company will pay the sum of \$250 in cash and \$2.50 each royalty on the first one hundred machines sold for satisfactory working drawings of a gasoline motor lawn mower which we accept for manufacture and sale. This must be a practical walking type motor-driven lawn mower, 20 inches or 24 inches cut, with a simple compact power unit such as the small motors made by Briggs and Stratton Company, Milwaukee, Wis., that will drive and operate a lawn mower about the size and type of the ordinary 20-inch hand lawn mower, and that will be suitable for general use and can be manufactured complete for \$50 or less. Motor must propel both mower and cutter and operator must be required only to guide mower. This organization will be the sole judges in reaching a decision regarding the worth of the design to us. Our offer ends May 1, 1925. Address, Granite State Mowing Machine Company, Hinsdale, New Hampshire.

No. 33—\$5,000—Hoist for Dump Trucks

The Continental Car Company of America will undertake the manufacture and marketing of an original design hoist for dump bodies operated by motor vehicle, said hoist to be operated from the driver's seat by power from the engine. This invention or improvement must be different from devices now in use for such purposes, must be simple in construction, inexpensive to build and efficient. It must do the work of a hoist satisfactory to our engineering department, and it must be acceptable to our distributors located in the principal cities throughout the United States. This hoist must be so designed that it can be used, by increasing the size of the parts, for dumping bodies of from one-ton to five-ton capacity. To the inventor of such a hoist which meets the approval of our engineering department, the donor offers the following proposition: The donor will enter into a contract to make and sell these hoists in connection with their truck bodies and will pay the inventor royalties, if a basic patent on the hoist is secured, aggregating the sum of \$5,000, in the following manner—royalties are to be paid the inventor in amount not to exceed one per cent of the net sales price of the complete body and hoist when and as the bodies and hoists are sold, until the full amount of the \$5,000 has been paid to the inventor, at which time payments shall cease and the invention or improvement becomes the sole property of the Continental Car Company of America, Inc., or its assigns. A working model of the hoist should be submitted so our engineering department can judge of its value. Written descriptions, drawings, sketches, etc., will receive consideration but we prefer to have a workable model.

No. 33A—\$1,000—Article of Furniture

This concern also will pay the sum of \$1,000 in an arrangement similar to that above outlined, for a new toy for a child, or a new useful article of household furniture made principally of wood parts formed from the lumber offal from manufacture of wooden truck bodies. We prefer that this article be something of use in connection with radio that would prove to be an attractive accessory to the public. This firm will be the sole judge of the article's merits.

No. 33B—\$5,000—Air Car-Dumping

For air-dumping equipment which meets with the approval of the Continental Car Company of America's engineers—and to meet with their approval, among other things, the dumping equipment must not only dump the tar but right it to a horizontal position and lock it—

the donor agrees to pay the inventor the sum of \$5,000, provided a basic patent can be secured, in the following manner: The donor is to pay a royalty of \$50 on each and every car sold with this equipment installed thereon when and as the cars are sold, until the full sum of \$5,000 in royalties has been paid to the inventor, at which time payment of royalties shall cease and the invention is to become the sole property of the Continental Car Company of America, Inc., or its assigns. If the dumping device is not patentable, but in the opinion of the donor is new and useful and is used by the donor, then a smaller amount is to be paid to the entrant, said amount to be fixed by the directors of the Continental Car Company of America. Detail drawings may be submitted to the donor instead of a model. In operating the projected car, it must be so designed as to dump on either side of a track and the act of dumping is to be accomplished with compressed air furnished by the locomotive and operated by the engineer from the cab.

No individual connected in any way with the Continental Car Company of America may participate in offers 33, 33A and 33B, all of which will terminate May 1, 1925, unless extended by special arrangement between donor and any entrants. Address, Continental Car Company of America, Louisville, Kentucky.

No. 34—\$1,000—Cost Reduction

This concern makes the Kirstin Fil-Gage for filling Ford automobile gasoline tanks under the seat without need of removing the cushions. It has an indicating gauge in plain sight of the driver at all times and is attached to the tank opening in place of the cap. The Fil-Gage is made of black-finished sheet metal. Our factory operates in large production, and for any accepted improvements not yet tried out or developed which will increase the efficiency of this filler and gauge and decrease manufacturing costs, we will pay the sum of \$1,000. Or, we will pay this amount for any suggested changes, satisfactory to us which will reduce the production cost 20 cents on each article. No theoretical suggestions will be considered. To qualify, entrants must have actually tried their improvements in operation on one of the devices and have proved it practical and workable. The Fil-Gage containing the improvement must be sent to us by registered mail for testing and upon acceptance and the assigning to us of patentable rights, we shall pay the amount stated to the entrant whose ideas we adopt. This offer expires May 1, 1925. Address, A. J. Kirstin, General Manager, A. J. Kirstin Company, Kirstin Bldg., Escanaba, Michigan.

No. 35—\$300—Sheet-Metal Key Guide

We make a key guide surrounded by an oval escutcheon plate. The oval plate is made of .035-inch sheet metal and the key guide is a die-cast article. Our plan is to design a key guide of sheet metal that will properly fit the oval plate or one of similar form. The guide is inserted through the center of the escutcheon and protrudes beyond it. For a satisfactory arrangement that will be as cheap as the die-cast guide we now use, and one that we accept, the National Brass Company will pay the sum of \$300. This offer ends May 1, 1925. Address, National Brass Company, Grand Rapids, Michigan.

No. 36—\$1,000—Improvements to Lathes

In four awards of \$500, \$250, \$150, and \$100. These awards will be paid for the four best ideas for new and practical attachments for a screw-cutting engine lathe. The mechanical application and the idea must, of course, be heretofore untried and original and may consist of a distinct improvement on an attachment now in use or a direct improvement on any part of a screw-cutting engine lathe. Value and merit of improvements or suggestions will govern the order in which the allotments of the four awards will be made. The offer expires May 1, 1925. Address all suggestions to South Bend Lathe Works, 423 East Madison Street, South Bend, Indiana.

No. 37—\$500—Anti-Carbon in Oil Burner

The Aeroil Burner Company will pay the sum of \$500 in cash to the person who develops for them a practical inexpensive means by which carbonization can be prevented in portable oil burners of the vaporizing type such as we manufacture. Such a method may consist of different construction from that we now employ; a change in the design or the use of another kind of

Indemnity by Kentucky Way
 July 6. 2010 3rd Inmate 296

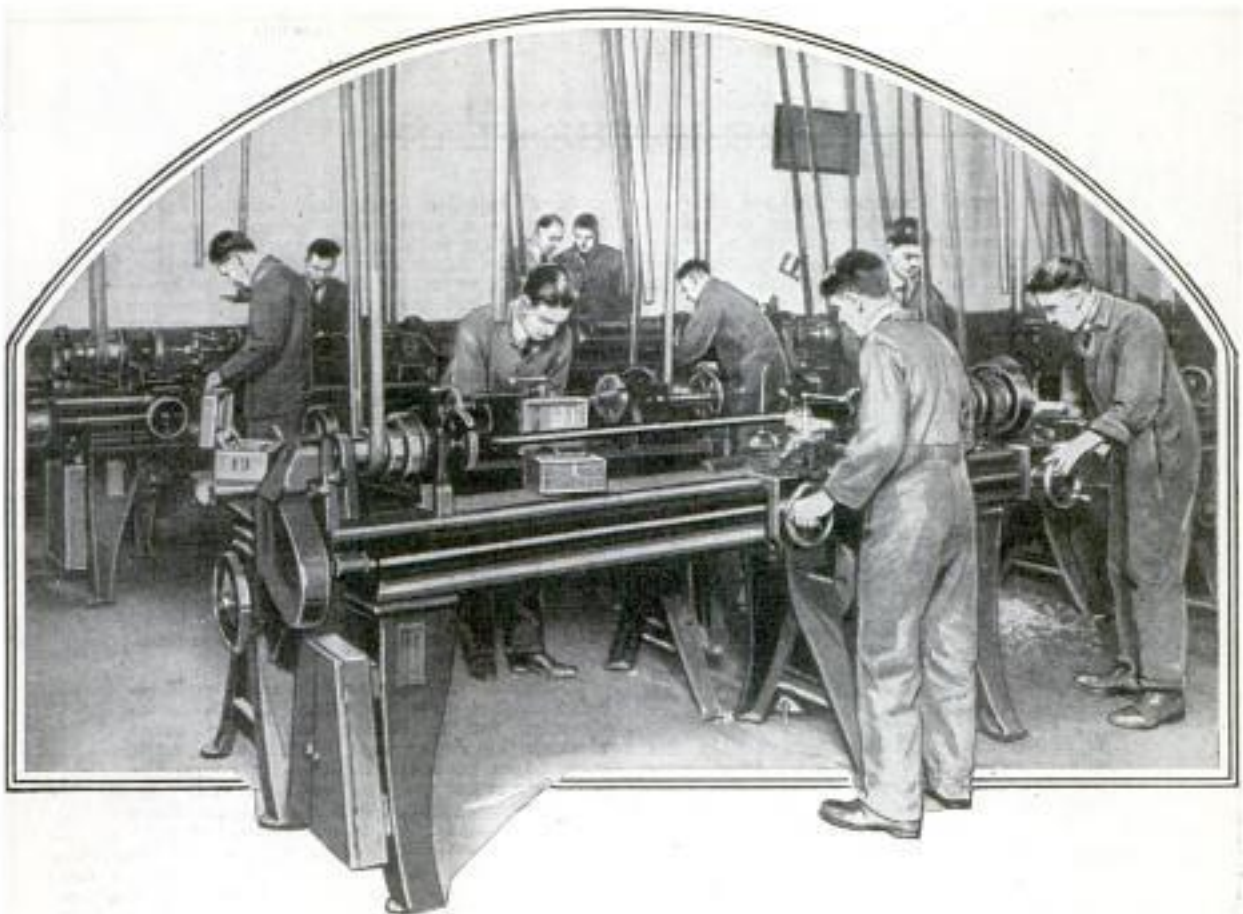

Scholars Taking Instructions in Lathe Operations in Lakewood, Ohio, High School

metal. The process may also include or consist of the use of an inexpensive chemical which could be mixed with kerosene. Whatever the plan, if it can prevent carbonization in our oil burners and we accept the process after it passes our tests, we will pay the amounts stipulated herein. This offer expires May 1, 1925. Address, Aeroil Burner Company, 266 Hudson Avenue, Union Hill, New Jersey.

No. 38—\$10—One-Dip Enamel

For a white enamel which will satisfactorily cover black sheet steel in one application by the dipping

process the Patent Novelty Company will pay the sum of \$10 in cash. The material will be subject to trial by our own organization before adoption. The offer ends May 1, 1925. Address, Patent Novelty Company, Fulton, Illinois.

Many Additional Offers Will Appear in the SEPTEMBER ISSUE

OFFERS ANNOUNCED IN PREVIOUS ISSUES

All of These Offers Expire May 1, 1925

NO. 1—THE YELLOW CAB MANUFACTURING Company offers an award of \$50,000 for a perfected plan of traffic and pedestrian correction and regulation, including mechanical devices, regulations, etc., for the promotion of greater street safety. *3801 W. Lechere Ave. Chicago*

NO. 2—\$10,000 FOR A NEW MUSICAL INSTRUMENT which can be incorporated in any orchestra or brass band and will take a place among the present family of musical instruments accepted by the rank of players. *Leon and Healy, Inc., 4110 Fullerton Ave. Chicago*

NO. 3—FOR THE BEST SUGGESTED IMPROVEMENT on a gasoline-heated blowtorch and soldering and branding iron combined, an award of \$500 will be paid by the *Everhot Manufacturing Company, Maywood, Ill.*

NO. 3A—\$200 WILL BE PAID BY THE ABOVE concern for the best suggested new use for the device named in Problem 3. Other cash awards in proportion.

NO. 4—PROCESS BY WHICH ZINC THAT oxidizes and is lost in brass foundries can be saved and used. Award \$500.

NO. 4A—PLAN BY WHICH LEATHER, wasted in making of belting, etc., can be disposed of at profit to manufacturer. Award \$100.

NO. 5—AWARDS OF \$500 EACH WILL BE paid for a waterproofing process for a library paste and a method that will produce increased sales of this product. *John J. Harris and Company, 4035 W. Kenzie, Chicago*

NO. 6—FOR PRACTICAL METHOD OF ANCHORING electric light clusters to vases, urns, etc., to convert them into lamp stands, \$250.

NO. 6A—FOR MOST WORKABLE PLAN whereby such lamps can be made from material found in shops of electrical contractors and dealers, \$150.

NO. 6B—BEST SALES SCHEME WHICH WILL promote business of making lamp stands for dealers, \$100. Above three problems by *Benjamin Electric Mfg. Company, 847 W. Jackson Blvd. Chicago*

NO. 7—WHAT CAN BE MANUFACTURED BY plant specializing in making bicycle wheel rims? Award \$5,000.

W. U. Allen Mfg. Co. 566 W. Lake Chicago

Louis Rastetter Sons Ford Wayne Ind.

Attn. W. J. Kirk

Kenzie, Chicago Adv. Sept.

J.R. 2

1296

HERE IS THE PLAN

1. All offers of awards made, and all solutions of problems submitted, are subject to these terms and conditions, except where they are in conflict with or modified by the terms of the offer. In that case the offer controls.

2. The one offering the award is hereinafter called the "Donor," and the one submitting a solution the "Entrant."

3. All proposed solutions shall be mailed or delivered as directed in the offer.

4. The donor shall pay the award to the entrant who submits a solution of donor's problem which is complete, practical and economically sound and satisfactory, to, and not already known to, the donor.

5. The donor shall have the period of one year from the receipt of any proposed solution to pass upon it, and, in case it be regarded as a partial solution, to agree with the entrant as to the amount of the award. During that one-year period the entrant shall not offer or submit said solution, or any part thereof, to any one else.

6. If the donor shall not have paid the whole or any part of the offered award mutually satisfactory to any entrant within said one-year period, unless entrant agrees to an extension of time, the donor shall return to such entrant by mail the solution submitted by him. If the entrant had the right to sub-

mit such solution, donor shall make no use of such or the information given, provided, however, that nothing herein contained shall prevent the donor from using any solution, idea, device or information which donor knew about and had the right to use before the receipt by the donor of such entrant's solution.

7. Any patent on, or any patentable feature of any entrant's solution accepted and paid for as herein provided, shall belong to the donor, and entrant shall assign to the donor any such patent already issued and any invention for such a patent on which applications shall have been made. And entrant, at donor's request shall execute all such applications, assignments and other documents as may, in donor's judgment, be necessary or expedient for the purpose of obtaining a patent on entrant's solution, or any feature thereof, such patent to be issued in the name of, and to be the sole property of the donor.

8. Popular Mechanics Magazine shall receive no fees or commissions, directly or indirectly, for publishing any offer made through this department, nor for anything it may do in connection therewith. And the publisher is not and shall not be held responsible for the performance of any obligation either of a donor or an entrant. The publisher's responsibility ceases with the publication of the offer.

Entrants may sign and accompany their solution with the following:

To.....
(Here write name of firm to whom your solution is offered.)

CITY....., STATE.....

Dear Sirs:

Enclosed find my solution of your problem, published in Popular Mechanics Magazine. I hereby submit my solution to you for examination, subject to the terms and conditions published in said magazine, in connection with your offer.

NAME

ADDRESS

NO. 8—IDEAS SUGGESTING NOVEL, PRACTICAL and valuable uses for lig ventilating fans, blowers and unit heaters. Proportionate awards aggregating a total of \$5,000 will be paid by Ilg Electric Ventilating Company, 2550 N. Crawford Ave Chicago

NO. 9—FOR A SOLUTION OR METHOD which will eliminate "dry effect" that occurs in the process of photo-engraving the sum of \$500 will be paid.

NO. 9A—PERFECT IMPROVEMENT IN COLOR separation process used by photo-engravers, \$500.

NO. 9B—PLAN BY WHICH A PERFECT etching could be made by a one-depth "bite" of etching acids reducing costs of this kind of engraving, \$500. Above three problems by Jahn and Ollser Engraving Company, 554 W. Adams, Chicago

NO. 10—ELECTRIC HEATING ELEMENT which will operate and interchange with base and cover

of Imperial self-heating gasoline iron, \$500. Imperial Brass Company, 1200 W. Harrison, Chicago

NO. 11—\$100 FOR PLAN OF PROFITABLY disposing of chamois skin scraps. Bassick Manufacturing Company, 2650 N. Crawford Ave Chicago

NO. 12—DISCOVERY OF NEW USES FOR carbon-dioxide gas or improvements to present uses. Award \$1,000.

NO. 12A—FOR AN AUTOMATIC FREEZE-proof soda cooler adaptable to "iceless" type of soda fountains, \$1,000. Above two problems by Liquid Carbonic Company, 3100 S. Kedzie Ave Chicago

NO. 13—\$2,000 WILL BE PAID IN SEVERAL awards for processes and machines for salvaging waste lumber, National Lumber Manufacturers' Association, Washington, D.C.

Full Details Regarding the Previous Offers Listed Above and Numbered from One to Thirteen, May Be Obtained by Addressing the Bureau of Information, Popular Mechanics Magazine.

Photos Sent over Telephone Wire Are Accurately Reproduced

Transmission of photographs from Cleveland to New York City over long-distance telephone lines was recently accomplished in a demonstration by laboratory experts of the American Telephone and Telegraph company. The method, achieved after several years' work, was described by officials of the company as a "simple, rapid and accurate transmitting system." It will be installed on the company's various long-distance lines, it was announced, as demand may arise for this type of service. Cleveland was selected as the place for the transmitting station so that pictures taken at the Republican national convention might be sent

to New York within a few minutes. The tests showed that photographs could be transmitted and made ready for producing newspaper plates within ten minutes from the time the original picture was put on the machine. Messages in handwriting were also sent, the copy received being a facsimile of the original. In sending a picture, the original is placed around a cylinder within which there is a photoelectric cell. On another cylinder in the receiving office an unused film is placed. Both cylinders revolve in synchronization.



Machine Which Receives or Sends Pictures by Telephone, and Photographs of Baseball Players and of President Coolidge That Were Received on It

During the operation a very small but intense beam of light is thrown on the original photograph, passing through it to the photoelectric cell with an intensity proportionate to the lights and shades of the picture. By the aid of a new device known as a light valve, a beam of light, varying in intensity in exact correspondence with the original beam received by the photoelectric cell, is thrown on the film in the receiving office. The receiving cylinder revolves and the ray of light gradually moves from one end of it to the other. Then the film is ready for development.

Floats in Safety Parade Teach Dangers of Carelessness

Calling attention to the dangers lurking in carelessness and disobedience of traffic rules, floats in a "safety day" parade in New York depicted penalties resulting from neglect of vehicle drivers and pedestrians to observe the laws governing the streets of the city. The displays pointed out the extent of the annual death list due to accidents occurring on thoroughfares within the limits of the city, and portrayed

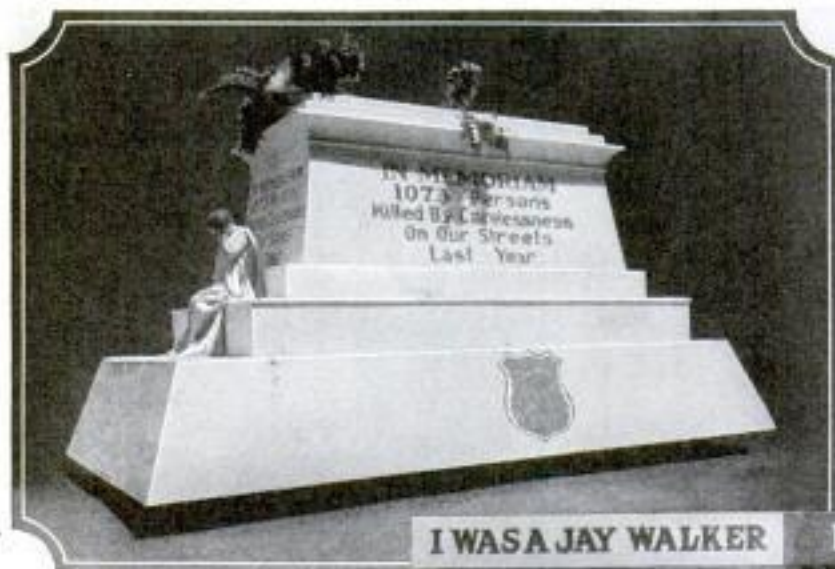

Copyright, Underwood & Underwood
Floats of Safety Parade That Portrayed Penalties of Carelessness and Disregard of Traffic Rules by Pedestrians and Drivers

various types of careless citizens and automobile drivers undergoing hospital treatment and severe jail sentences as a result of failure to abide by traffic rules. Most of the floats were entered by business firms.

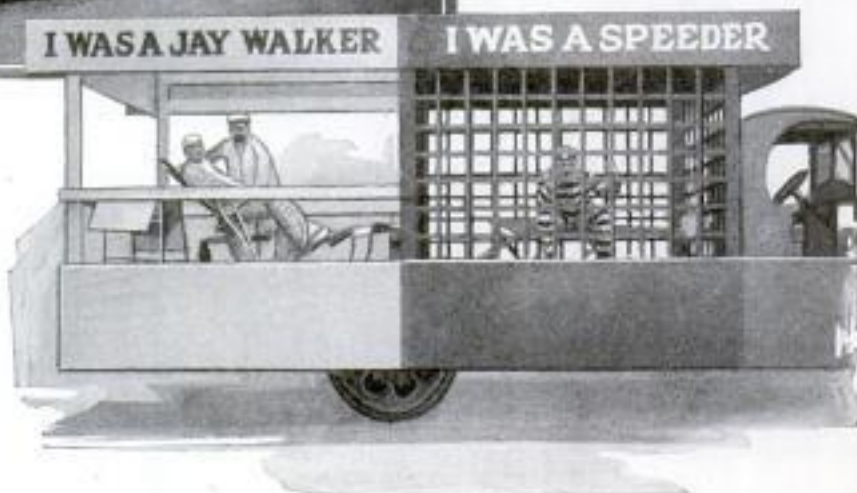

Oil Refinery on Wheels Cuts Costs and Is Easily Moved

Increased efficiency and a saving in operating and building expenses are claimed for a portable oil refinery recently put into use in Texas. The equipment is carried on two specially built steel railway cars, being permanently attached to and operated from them. The process of moving consists simply in dismantling the detachable equipment, such as pipe connections, smokestack and rectifying tower, placing that apparatus in regular freight cars and consigning the plant to its new destination. The refinery can be placed in operation within eight or ten days after the arrival of the cars, while only four or five days are required to prepare it for shipment again. One of the most revolutionary features of the plant is said to be the process used in condensing vapors. Air instead of water cools the condenser, being drawn through the space between the coils by a suction fan, seventy inches in diameter. Air also reduces the fuel oil into a fine spray for the burners and for combustion. A seventy-horsepower oil engine drives the generator that furnishes

the current for the pumps and lighting system, the use of steam being entirely eliminated. The refinery has a capacity ranging from 1,000 to 3,500 barrels of crude oil each twenty-four hours, depending upon the percentage of distilled product in the raw material. Before the plant is placed in operation, the cars are jacked up and lowered on concrete foundation beams which are laid across the tracks.

1295 Ave. H. Grindell Matthews,
London, England.

"Death Ray" Is Carried by Shafts of Light

Beam Is Said to Act as Cable for Transmitting Powerful Energy to Bring Down Enemy Aircraft

ACTING as a carrier for energy made up of high-tension electric currents, a new ray invented by H. Grindell-Matthews of London, is claimed to practically destroy aircraft on which it might be directed. The beams, similar to shafts of light, are claimed to render the air they include within their limits highly conductive to electricity.

Tests have been reported where the ray has been used to stop the operation of automobiles by arresting the action of the magnetos, and a quantity of gunpowder is said to have been exploded by playing the beams on it from a distance of thirty-six feet. It is pointed out that the discovery may result in the development of entirely new fields and methods of warfare. Where aerial attacks are to be combated, the rays could be guided from a battery of transmitters on the ground and a barrage of high voltages loosed upon the craft in a fraction of the time necessary to bring a series of guns to bear on the targets. With the ability to control the ray and make it visible or invisible, a property which it is said the inventor has devel-

oped, the "spotting" of a target would be greatly simplified. Where attendants have crossed the path of the ray during tests, they have been rendered unconscious by violent shocks.

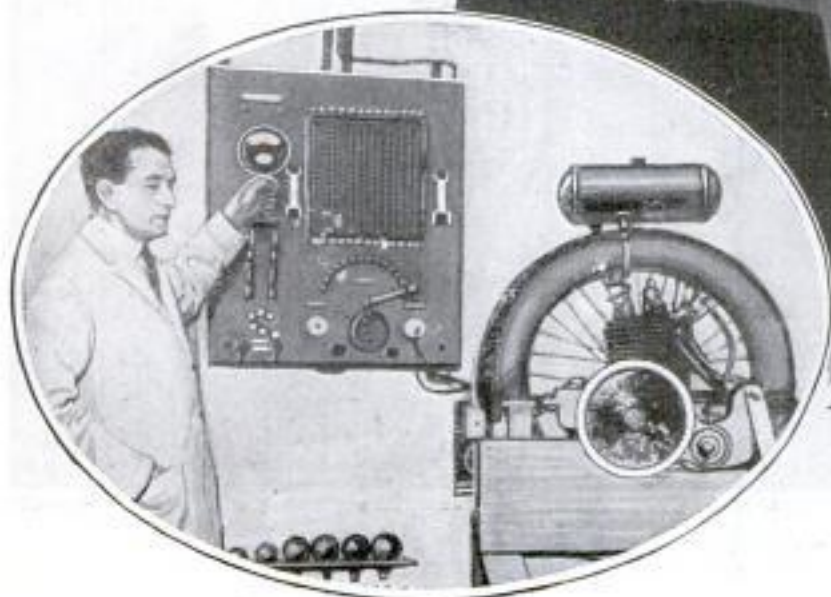

How Batteries of the "Death Ray" Might Destroy Enemy Airplanes by Passing Electric Energy into Them through Shafts of Powerful Light; Below, Mr. Grindell-Matthews, Inventor of the Ray, Using It to Stop a Motorcycle Engine in His Laboratory



Artist's Conception of Aerial Attack on New York Being Repelled by "Salvos" of "Death Rays" Directed on Enemy Craft from Batteries of Transmitters Installed on High Buildings

1295



Should the Power of the Ray Be Multiplied to Convey Sufficient Destructive Energy to Its Targets, Future Wars May Find Air Fleets Combated by Barrages of Deadly Light Beams

1295
 Other cases are reported where intense burns were received on occasions when the workers came into contact with it. Experimental sending stations have been equipped with special protective and safety devices in order to guard against injury to those called upon to operate the transmitting mechanism during the trials.

Throughout its development and testing stages the utmost secrecy was observed by the inventor to conceal the method of generating and directing the rays. Other engineers and scientists claim that similar discoveries have been made in the past in several different countries with electric energy that can be directed along invisible paths, and the "death ray" has been made the subject of court action by those disputing the inventor's right to dispose of it.

1191
Invisible Plane Photographs City from Six-Mile Altitude

What is declared to be a new record in aerial photography was made when Lieuts. John A. Macready and A. W. Stevens of McCook field succeeded in taking pictures of Dayton, Ohio, from an airplane at a height approximately six miles above the city. The ability to take pictures at high altitudes has long been the aim of aviators, but difficulties in the way of lens and airplanes that could carry a heavy camera and an operator besides the pilot have been many. It was only the lessons taught by many tests that enabled the flight at 31,540 feet with the required weight to be made. A new supercharger was used to increase the engine power, and

the aviators covered their faces with grease to prevent sunburn. The sun burns with pitiless intensity in the rarefied air and some protection against the rays is necessary. The camera lens also had to be protected with a special film to prevent moisture from collecting and obscuring the view. The chief advantage of high-altitude photography lies in the larger territory that can be covered. The usual way of photographing extensive areas is by the "mosaic" process. In photographing a city, for example, as many as one hundred different pictures may be made of the various sections and these are placed together like a puzzle. But at 21,000 feet, only two or three photographs are required to include quite a large city.

Another advantage of high-altitude photography lies in the safety it affords during war. An airplane cannot be seen with the naked eye at 21,000 feet, therefore it is less apt to be shot down from earth. This is important where the fate of nations hangs upon a true knowledge of the enemy's ground such as photography affords.



Aerial Photo of City Taken from Airplane Six Miles Up; Left, Cameras and Operator Garbed for Trip into Cold Upper Air Strata

"Wide World Photos" 229 w. 43rd, New York

Lt. C. P. McHarmen, Hotel Gordon,
 16th + Eye Str, Washington, D.C.

Ohio.

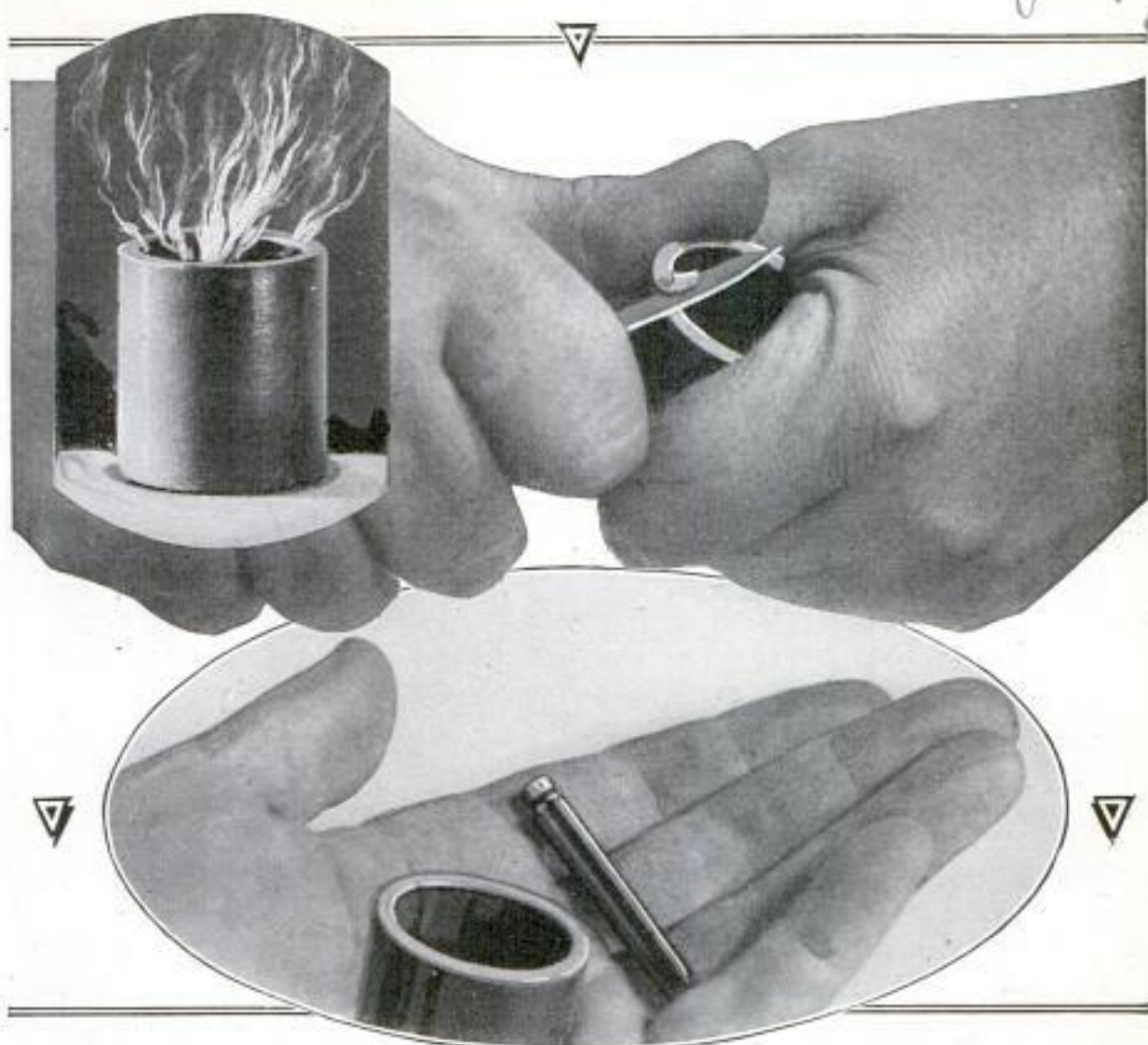

Oil-Absorbing Bushing Doing Service as a Wick; Chipping Piece of the Unannealed Metal with Ordinary Penknife, and Volume of Lubricant the Porous Tube Will Hold

Metal That Absorbs Oil Like Sponge Is Perfected for Bearings

Imagine a substance so hard that it will turn a lathe tool, and yet so porous that it will soak up oil like a sponge, and you have a fair idea of a brand-new metal that has been perfected in the laboratories of the General Motors corporation and will soon be found in many installations that have heretofore lent themselves only with difficulty to efficient lubrication. In composition it is a copper-tin bronze in which graphite has been incorporated. Thousands of tiny pores, uniformly distributed throughout the structure of the metal, give it the absorptive qualities of a blotter. An interesting demonstration of this characteristic can be made by fitting an ordinary old-fashioned kerosene lamp with a bushing in place of the usual cotton wick. The bushing can be lighted and will burn as long as kerosene remains in the lamp. The quantity of oil the metal will absorb

amounts to twenty-five per cent of its own mass, and a peculiar feature is that the oil does not drain out again but is held no matter how dry the surface may be wiped. The metal is designed for bearings in the generators and starting motors of automobiles, in laundry machinery, where the leakage of alkaline water makes lubrication a difficult problem, as well as in installations where thorough lubrication is required on account of heavy loads and high speeds, or both. It is stated that it is practically impossible to gall a shaft running in such a bearing, even though no lubricant is fed to the bearing for a long time.

Old leaves are being utilized in France for making paper, fuel and cattle food. They are crushed and chemically treated so that the powdered portion easily separates. The fibrous ribs and veins are then pulped and made ready for use in the manufacture of paper, while the powder is converted into fuel and cattle food.

1176
 Cmt. George H. Holder, Esq.
 Hill Crest Lodge, Dayton
 Five Road, Cincinnati, Ohio.



Dore's Portrayal of the Destructive and Pestilential Plagues Sent Down upon the Egyptian Pharaoh and His People to Compel Them to Free the Israelites from Bondage

Unearthed Ruins Bear Out Bible Stories

Canaanite Pottery and Altar of Worship Found near Dead Sea Point to Civilization of Abraham's Time

BEARING out the Bible stories of the destruction of Sodom and Gomorrah, the wicked "Cities of the Plains," long buried evidence of their existence and fall has been unearthed by an expedition under Dr. Melvin G. Kyle, of Saint Louis, according to reports.

The party found a plain where the Arabs, making excavations in a cemetery, had discovered specimens of elaborately wrought bronze pottery believed to have been made forty centuries before, during the time in which Abraham is supposed to have lived. These relics, together with an ancient structure once used as a place of worship by the tribes of Canaan, which has been uncovered near the shores of the Dead Sea, the explorers say, point to a civilization that, according to Biblical history, existed in that region thousands of years ago.

The sites of the old cities that fell under a rain of fire, as told in the Old Testament, are thought to have been long since buried beneath the waters of the Dead Sea, but the spot on which stood Zoar, the city that gave refuge to Lot when he fled from the doomed towns, is said to have been discovered by members of the searching party. Strata of rock salt, marl and sulphur occupying the district close to the sea, according to the accounts of the expedition, show that at some time in the remote past, a subterranean explosion had taken place, forcing these substances above ground. The ancient cities are supposed to have existed close to this territory and to have been consumed by gases that ignited as they poured from the ground when it burst open. Suggestions have been made that divers be sent down into the Dead Sea to search for ruins.



Patriarch Jacob Delivering His Prayer for Guidance; Reproduced from One of Dore's Masterful Drawings in Which He Depicted Scenes and Incidents Described in the Old Testament

c/o Eschig Pub. Co. 285 Fifth Ave. New York City

Seek Cure for Cancer by Causing It to Grow in Animals

1020 Scientists who are constantly seeking a cure for the dread malady cancer, have been attempting to find a solution for



Dr. M. B. Krumbhaar of Philadelphia General Hospital Who Is Seeking Cure for Cancer

their problem and to learn more of the nature of the growth by producing it in animal specimens. Experiments with rats and mice have shown that a certain kind of tar will cause cancerous formations six

months after it is applied to the living tissue of the animals, and it was also found that cancers were produced in the stomachs of the specimens after they had eaten cockroaches infested with a certain kind of worm. While the cure is being sought, efforts are constantly in progress to improve existing methods of treatment, by radium and other means, to allay the ravages of the mysterious affliction.

Typing Is Taught by Phonograph Lessons Set to Music

1077 Typewriting is being taught and the speed of writing increased by lessons set to music embodied in twelve phonograph records that have recently been placed on the market. The music, it is claimed, prevents the student from following the slow pace he may set for himself, by forcing him to work faster. Each record starts out with a few words of instruction, and then at the words "Ready; Go!" a stirring march begins. The beats are especially accentuated so as to be heard above the noise of the typing with the idea that a key is to be struck at each beat. The range of the records increases gradually from fourteen words a minute in the first lesson to 103 in the twelfth. Two of the advantages claimed for the method are that the music relieves the lessons of their monotony and that the student's speed is unconsciously accelerated.

Dr. Rupert Sorella

CHAINS ARE PUT ON AUTO WITHOUT LEAVING CAR

556 To enable tire chains to be placed on the rear wheels of an automobile by a driver while seated in his car, a spring-reel device has been patented. The links are wound in two boxes on the running boards. Near the driver's hand is a small lever with which clamps attached to the chains are engaged with the tires. As the car is run

slowly forward, the chains are wound tightly to the tires and locked in place by another spring clamp that snaps the ends together. A smaller chain, used to hold the tire chain taut while it is being put on, is released automatically when the operation is completed and is rewound when the spring in the reel recoils.

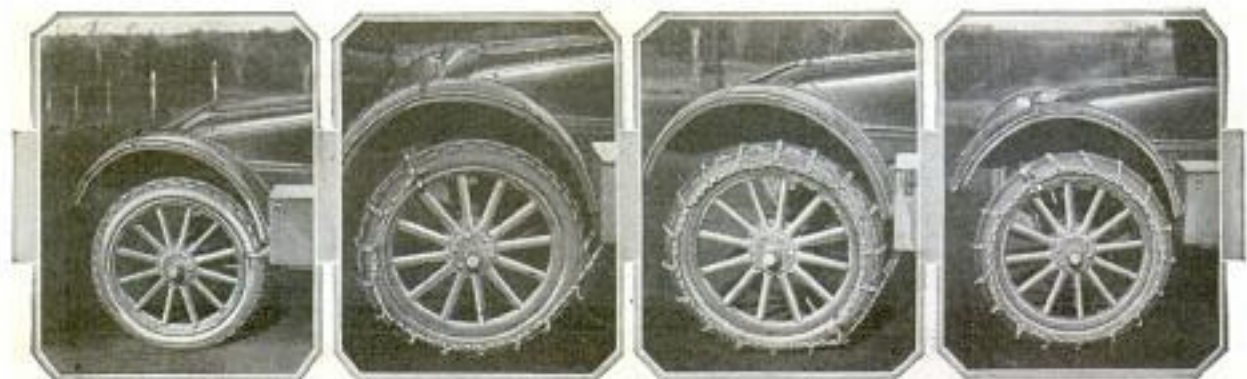

Views of Rear Wheel While Chain Is Being Put On as Car Proceeds. Clamped to Tire (left) It Unwinds from Box and Automatically Locks in Place

Dr. E. E. Pezzer, Hulton, Mo.

Sea Lions Shot with Machine Guns to Preserve Edible Fish

952

Hunters armed with machine guns, rifles and pistols were dispatched by the Canadian government not long ago to attack the sea lions that annually devour large numbers of edible fish off the northern coast of British Columbia. After a two-days' hunt through dangerous and

Sunshine May Be Made Fatal to Man by Use of Chemical

939

That the human body may be so sensitized by certain substances that even a brief exposure to ordinary sunshine is dangerous or fatal is the claim of a German chemist, Herman von Tappeier. In testing a certain coal-tar dyestuff, called acridine, he dropped a small amount of it into

munich

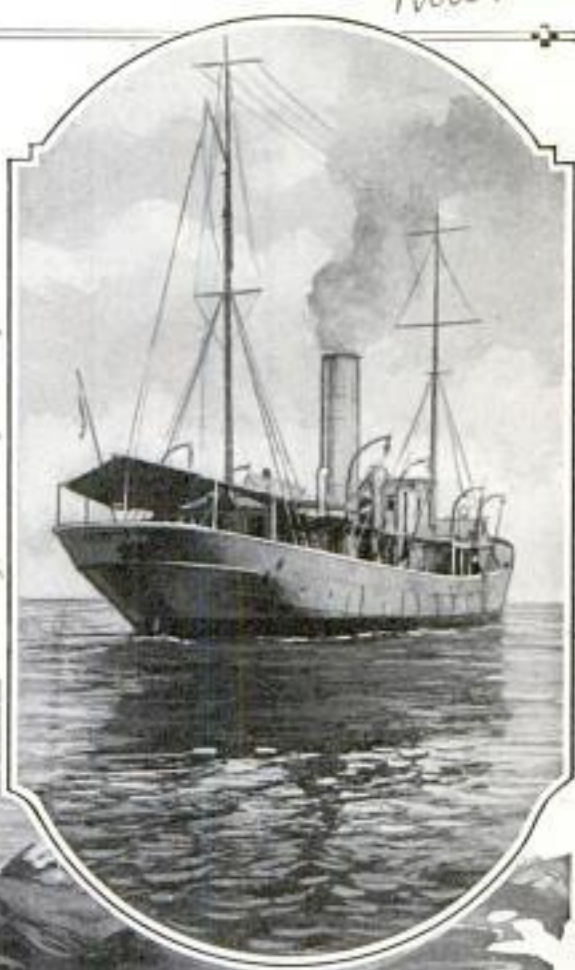

newspaper clipping

Cruiser "Givenchy" and Scenes from the Sea-Lion Hunt: Above, Machine Gunner with Pup Kept for Pet; Below, Two of Crew and Part of Kill

almost uncharted waters in the cruiser "Givenchy," 1,884 of the animals were killed. Following investigations in 1913 and 1915-16, the government decided to keep the number of sea lions in check, but not to exterminate them, as they are an enemy of the vicious dogfish. They are hunted by native fishermen for their hides and oil.

¶ Nearly three times the size of California, a sheet of ice covers most of the country of Greenland.

water containing some small organisms, which immediately died when exposed to light, although they were unharmed if left in the dark. After experimenting on animals, another substance was injected into the arm of a physician. He felt no ill effects while in the shade, but when he exposed himself to sunlight, was quickly overcome. As a result of these tests, the belief was expressed that it was possible to sensitize a human being to sunlight just as a photographic plate is so sensitized that even red light will fog it.

1155

Emb. Clifford Thorne,
716 Van Dyke Ave,
Detroit Mich

POPULAR MECHANICS

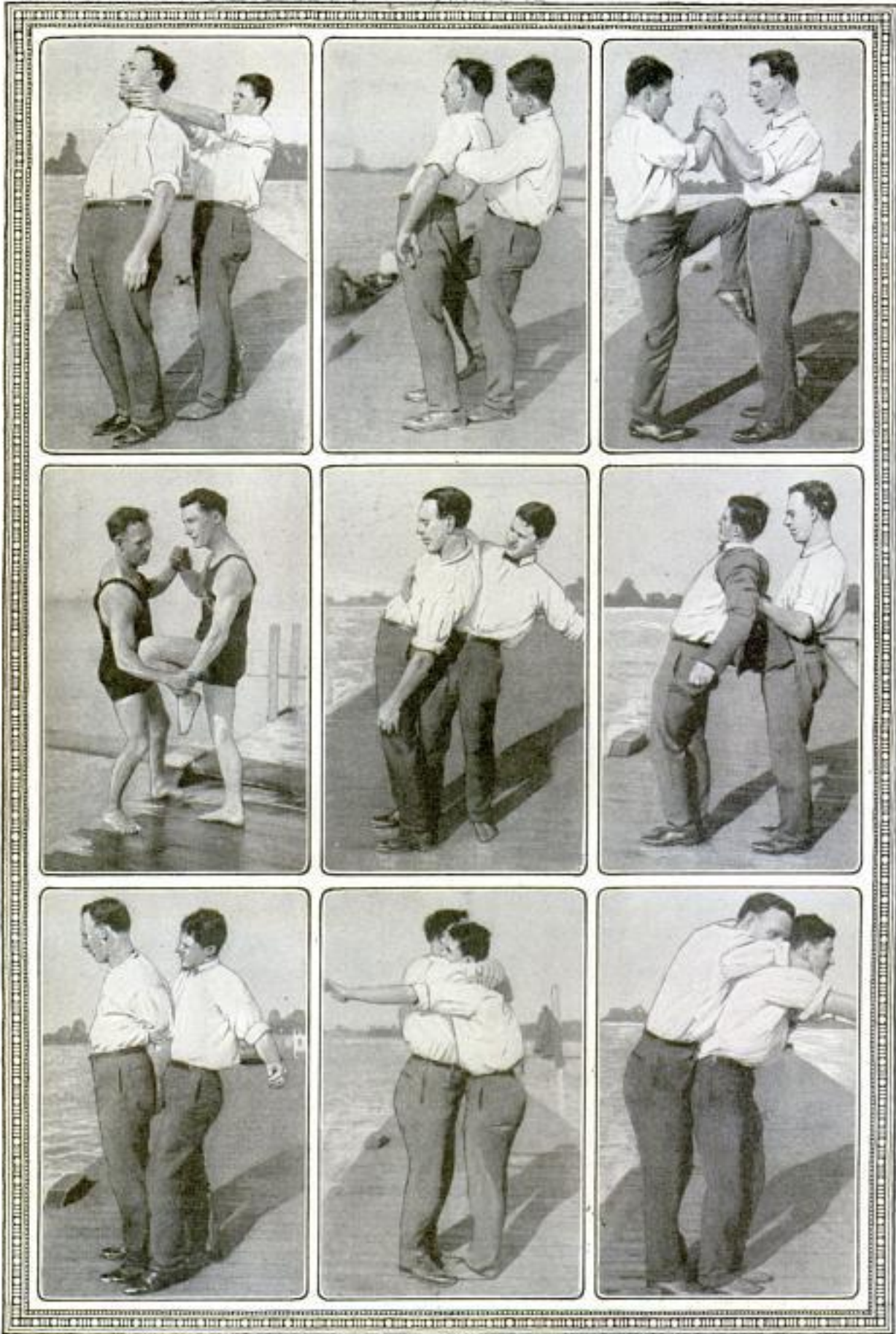

Illustrations of Positions and Grips by Which Life-Saver Can Rescue Drowning Person and Avoid Dangerous Holds of Victim That Often Lead to Disaster for Both

Better Holds and Grips Aid Rescue of Persons Near Drowning

Improved ways of saving endangered bathers result each year from the activities of life guards at beaches and summer resorts. Better grips and holds have been worked out so that the rescuer may be able to swim more freely and safely, and more efficient methods of starting natural respiration and ridding the lungs of water also have been devised. With a cool head and application of tactics depicted in the illustrations, many emergencies can be met successfully and lives saved. Getting a tight hold and escaping the victim's often fatal clutch are the first essentials, and to do this, it is advisable, if possible, to approach from the rear, swimming under water a short distance if necessary. Holds can often be broken by bringing the knee up sharply and pushing the drowning person away. Even if the rescuer should be grasped from the front or from behind, if his "wind" is not shut off and his hands are free, he will sometimes be able to tow the victim for a short distance. Rolling on barrels to free the lungs of water is considered a loss of time. Resuscitation should be attempted at once by turning the subject's head to one side and placing it on one of the arms. In the illustrations on the opposite page, beginning at the upper left-hand corner and reading across, the first shows a good hold for a tow if the rescuer can swim on his back. Subject is lifted to a horizontal towing position as shown in next picture. The following two illustrate methods of breaking a hold if clutched by the victim. A towing hold with hip under the victim and use of a side stroke is next shown, followed by an example of the "coat towing hold" useful in many emergencies. Picture seven gives a grip that leaves one arm free for swimming, the next depicts how rescuer can swim even if grasped from the front and the last, if clutched from behind, both valuable for short distances.

Roll Seven-Foot Ball across Nation in Drive for Camp Recruits

When citizens' military training camps open August 1, scores of "rookies" will probably ascribe their presence there partly to the seven-foot push ball, weigh-

ing 350 pounds, that was rolled from Chicago to New York and Washington and then across the country to enlist recruits. Started on its unique journey March 15, the huge red, white and blue sphere of waterproof leather, lumbered through towns and cities before the vigorous



Giving Huge Push Ball a "Lift" on Its Cross-Country Journey for Recruits for Citizens' Military Training Camps

shoves of recruiting officers who walked behind it. Whenever a halt was called, the advantages and plans of the training camps were explained to the crowds that gathered around the ball, and applications for enlistment were received. It bounded into New York City in time for the opening baseball games and was then rolled down to Washington, where General Pershing officially "welcomed" it. Officers declared that the ball was one of the most effective enlistment devices ever used.

Shaving in the Dark Is Made Easy by Electric Light on Razor

As an aid to shaving where other light is not available, a small electric lamp for attaching to the handle of a safety razor has been devised. Fastened to a clamp it can be easily fixed in position with a thumbscrew. The bulb throws its rays directly on the path of the blade, permitting the user to readily guide the razor. Connected to a small battery, the light is of advantage to campers and tourists.



Probably. Mess. Holtzapfel
Co., 53 Haymarket St
London, W. I. Eng

242
**Portable Tobacco Store Carried
 on Back of Its Owner**

Shaped like a cigarette and constructed so that it can be rolled up and carried home on the back of the proprietor when the



Shopping at Tiny Cigarette Store that Proprietor Takes Home When Day Is Done

day's business is done, a unique street-booth for the sale of tobaccos has made its appearance in Berlin. The distinctive shape of the little shop advertised its wares and its portable feature enabled the owner to move whenever trade slackened in any one locality. Interior space was sufficient for the clerk and a fair-sized stock. Painted canvas on a collapsible frame was the material used in the construction of the booth.



Model Cast of a Battle Group for Gigantic Bronze Memorial Which Will Contain Forty-Four Figures and Will Depict Scenes from Revolutionary, Civil and World Wars

Indianaapolis News
 April 30, 1924
 1124
**Grape Seeds and Skins Converted
 into Oil and Stock Feed**

Seeds and skins of grapes left over in making wine, are being used in France to make stock feed and lubricating oil. Mixed with the silage of wine residue, cakes are formed which are fed to cattle with profitable results. The oil, extracted from the seeds by crushing them, is said to be a satisfactory substitute for castor oil in the lubrication of high-speed internal-combustion engines.

920
**Great War Memorial Figures Are
 Eight Feet in Height**

Plaster casts for what is said to be one of the largest bronze war memorials in the United States have been completed by Gutzon Borglum, the sculptor, at his studio in Stamford, Conn. The group will include forty-four figures, each eight feet high, depicting battle scenes from the revolutionary, civil and world conflicts—"the three wars of preservation," according to the sculptor. In style and massiveness, it will suggest the huge Confederate group which Mr. Borglum is chiseling on the face of Stone Mountain, near Atlanta, Ga. The memorial will be placed in Military park at Newark, New Jersey.

1002



One Method by Which Movie Directors and Cameramen Keep Characters in Speeding Autos Always in Full View of Audiences When Pictures Are Shown on the Screen

Skill of Movie Engineers Rivals Reality

Disasters of Sea and Land Produced with Pocket-Size Settings While Spectacular "Props" Touch Almost Every Industry

TURNING bare plains and barren wastes of sandy ground into large communities of majestically arched buildings crowned with graceful domes and lofty spires, or changing hillsides and mountain tops to terraced splendors that recall the gorgeousness of the old Orient, movie engineers vying with reality in producing impressive settings for motion-picture spectacles, draw upon practically every art and trade in the performance of stupendous tasks they complete almost overnight. Whether portraying serious drama, the most farcical comedy or enacting some great tragic story of history, appropriate backgrounds are faithfully copied from old paintings or descriptive writings or worked up from detailed models by skilled artisans, who often possess the combined talents of

architect, photographer, actor, and director. Drawing on workshops that cover acres of land, the "hot-dog" engineer, as he is known in and about the studios, directs the erection of huge structures on the "lot" or supervises the construction of miniature scenes in his laboratory with a mathematical perfection that insures a perfect

"stage" to the performers who enact the plays. In producing great disasters on sea and land for the movies, the engineer avoids the dangers and expenses of actually staging such scenes with life-size material by resorting to the employment of toy-sized objects and landscapes. Some of the most realistic marine catastrophes seen on the screen are the result of carefully placed cameras and tiny vessels propelled across small tanks of agitated water. Close atten-



Sunlight Arc Lamps Used to Illuminate Large Interior Sets Where Many People Are Congregated

Emr. W. B. Mackwell
319 Monroe Bldg. Chicago

1002

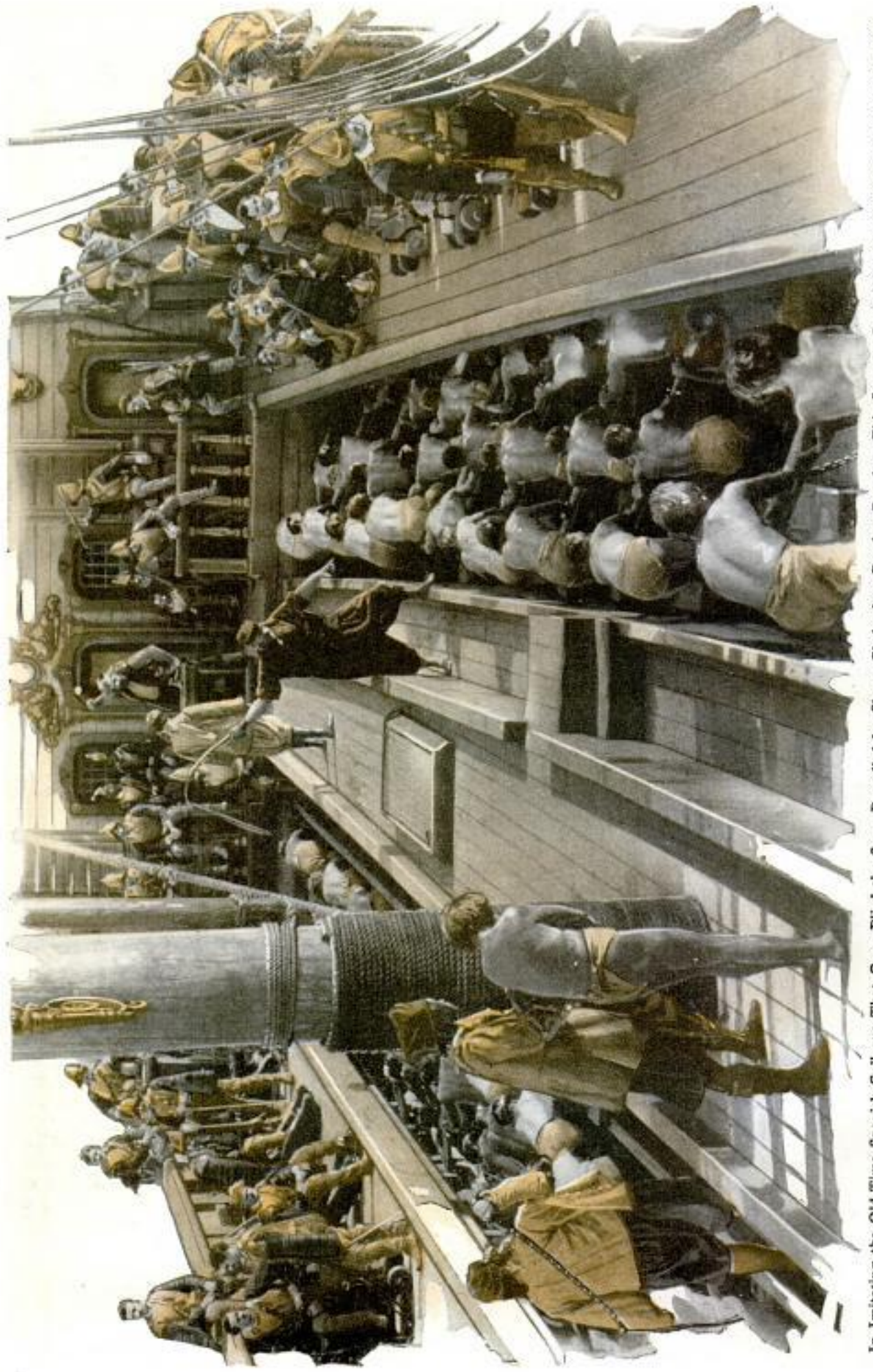

In Imitating the Old-Time Spanish Galleons That Once Plied the Seas, Propelled by Slaves Chained to Rowing Benches, This Strange Craft Was Reconstructed from a Cast-Off Sailing Ship by Engineers Who Spared No Effort to Fit the Vessel into a Romantic Spectacle of the Silent Drama

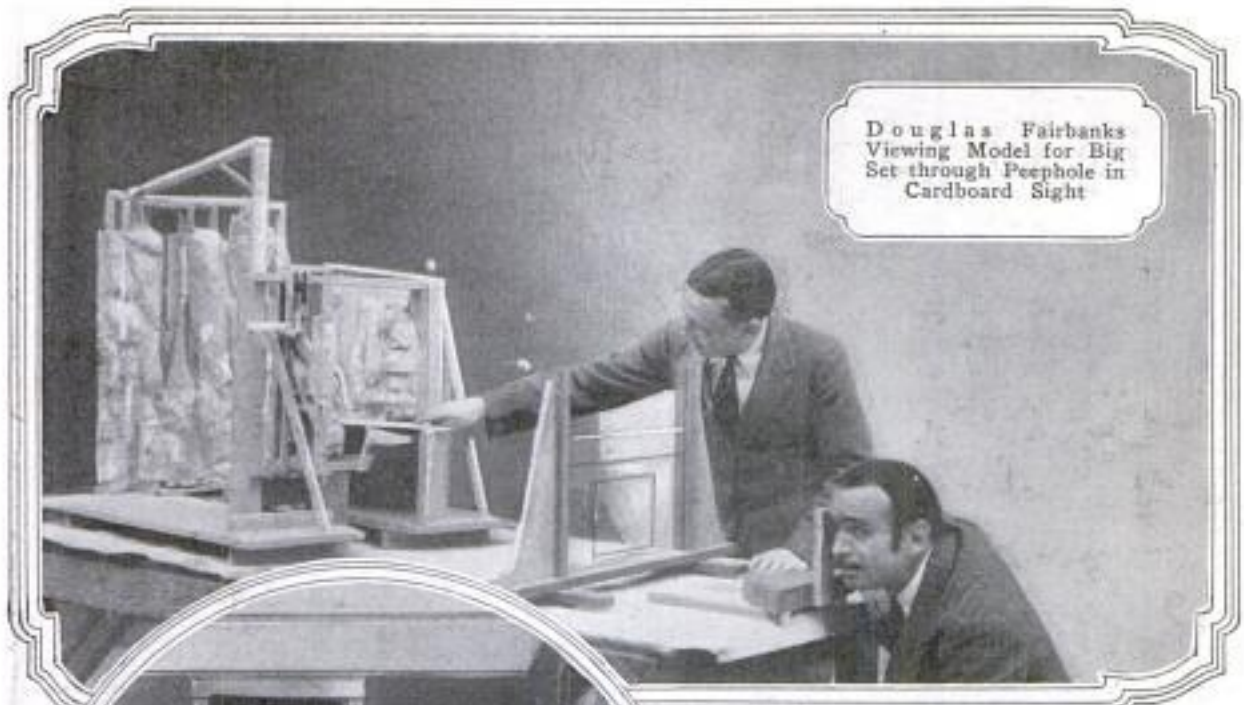

Douglas Fairbanks
Viewing Model for Big
Set through Peephole in
Cardboard Sight



Educating
Child Movie
Actors in Holly-
wood School-
room
© U. & U.



Picture Designed Solely for
Wall Decoration of Interior
Colonial-Mansion Setting



Artist Painting Atmospheric Back-
ground in Front of Which Subtitles for
Big Motion-Picture Feature Will Ap-
pear When Reels Are Shown on Screen

100²

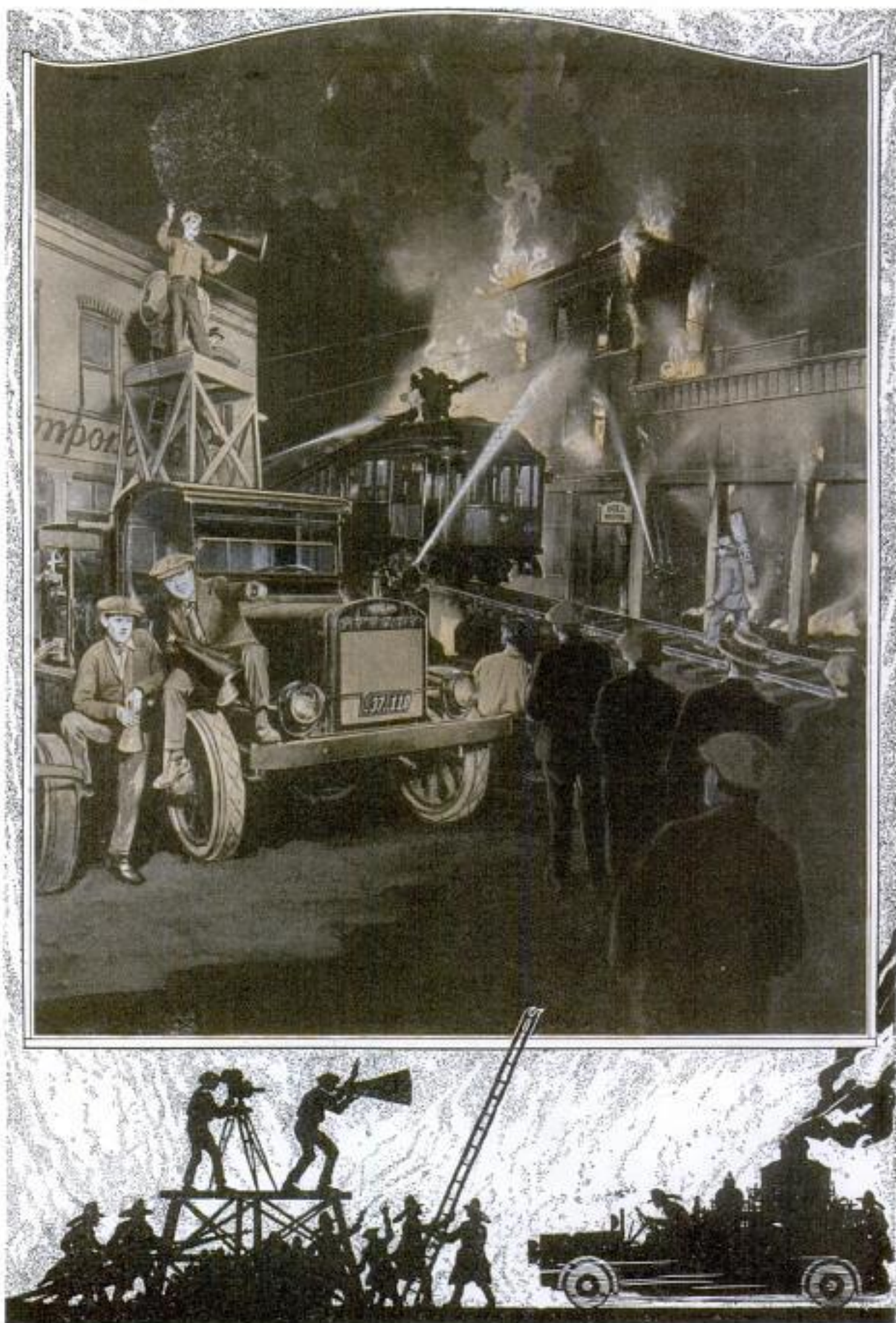

Enactment of Fire Scenes for the Movies Requires Close Attention to Every Detail of Realism; the Properties Are Designed to Prevent Their Burning Too Rapidly for the Camera's Purpose

1882



Modeled from a Picture of the Original, This Old-Time Railway Train Is Run by a Hidden "Gas" Engine



Actors Posing amid the Debris of Crashed Airplane Arranged by the Movie Builders: Left, How Studio Aircraft Is Put Safely through Wild Maneuvers

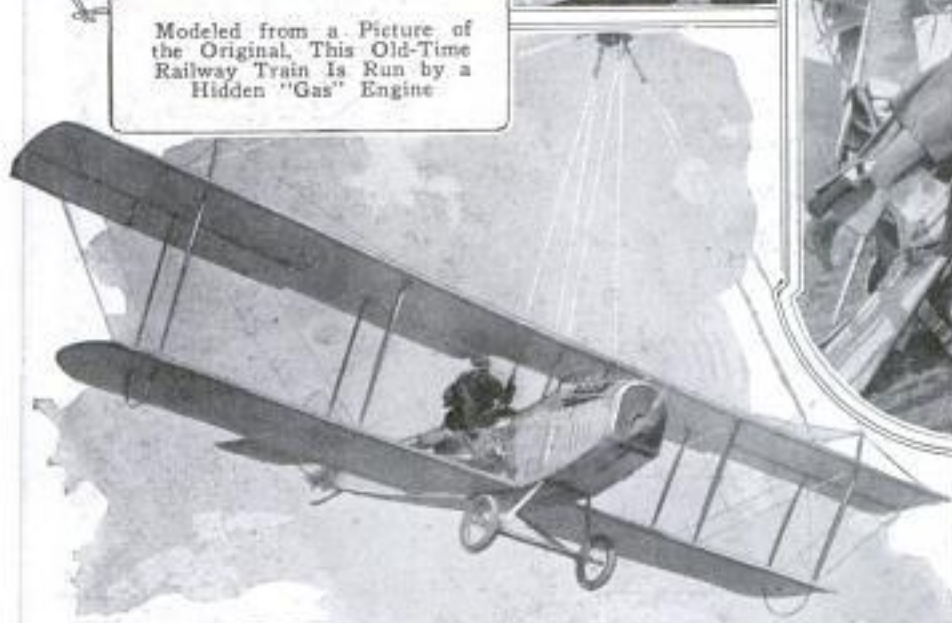

Auto Wreck Staged in Property Car by Actors Who First Rehearse the Scene



Comedian Swinging from Trolley of Street Car Going Thirty-Five Miles an Hour



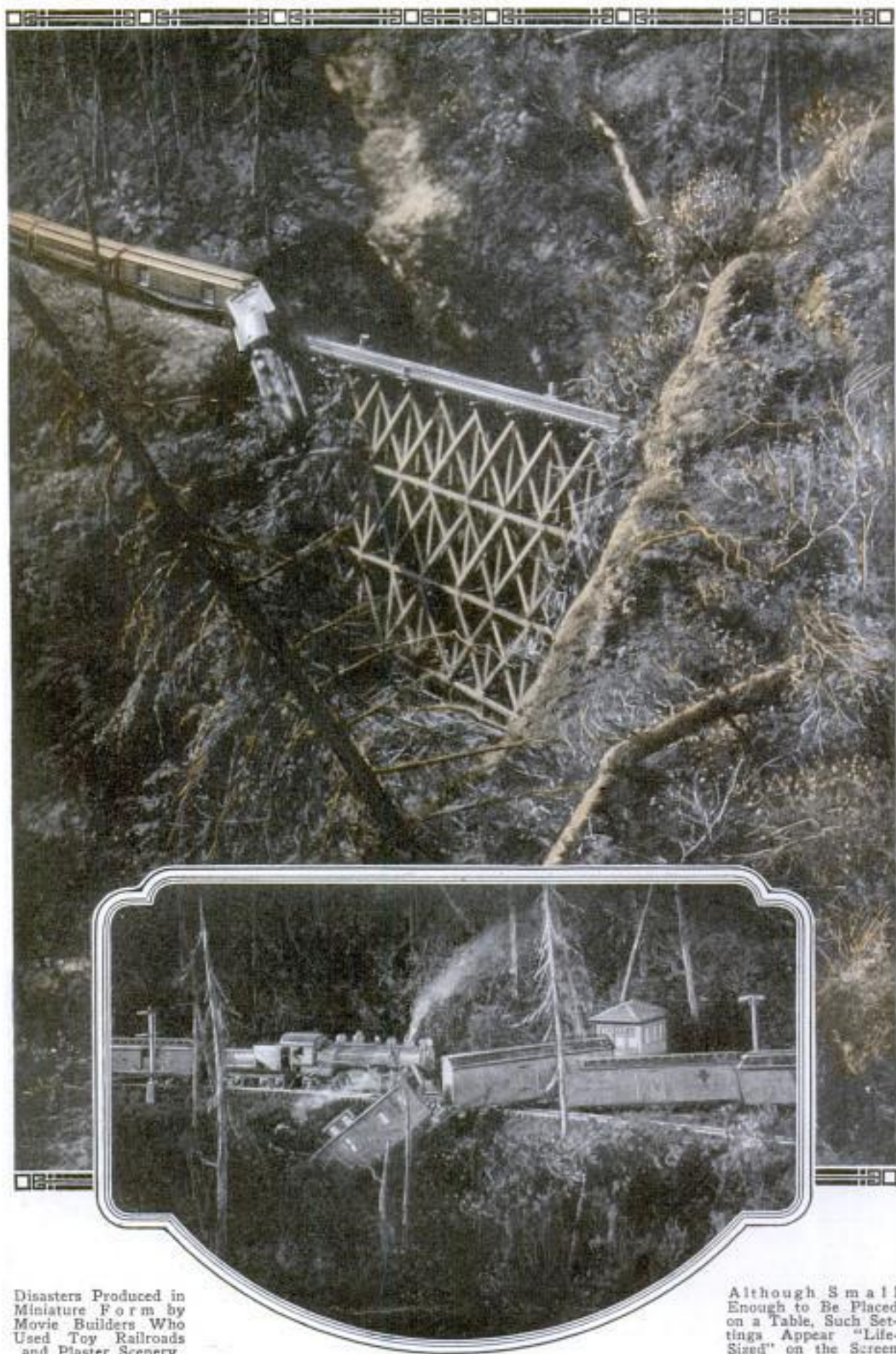

Disasters Produced in Miniature Form by Movie Builders Who Used Toy Railroads and Plaster Scenery

Although Small Enough to Be Placed on a Table, Such Settings Appear "Life-Sized" on the Screen

1002



All Ready for a Subway Act; How Movie Folks Imitate Familiar Scenes of Everyday Life in Public Conveyances

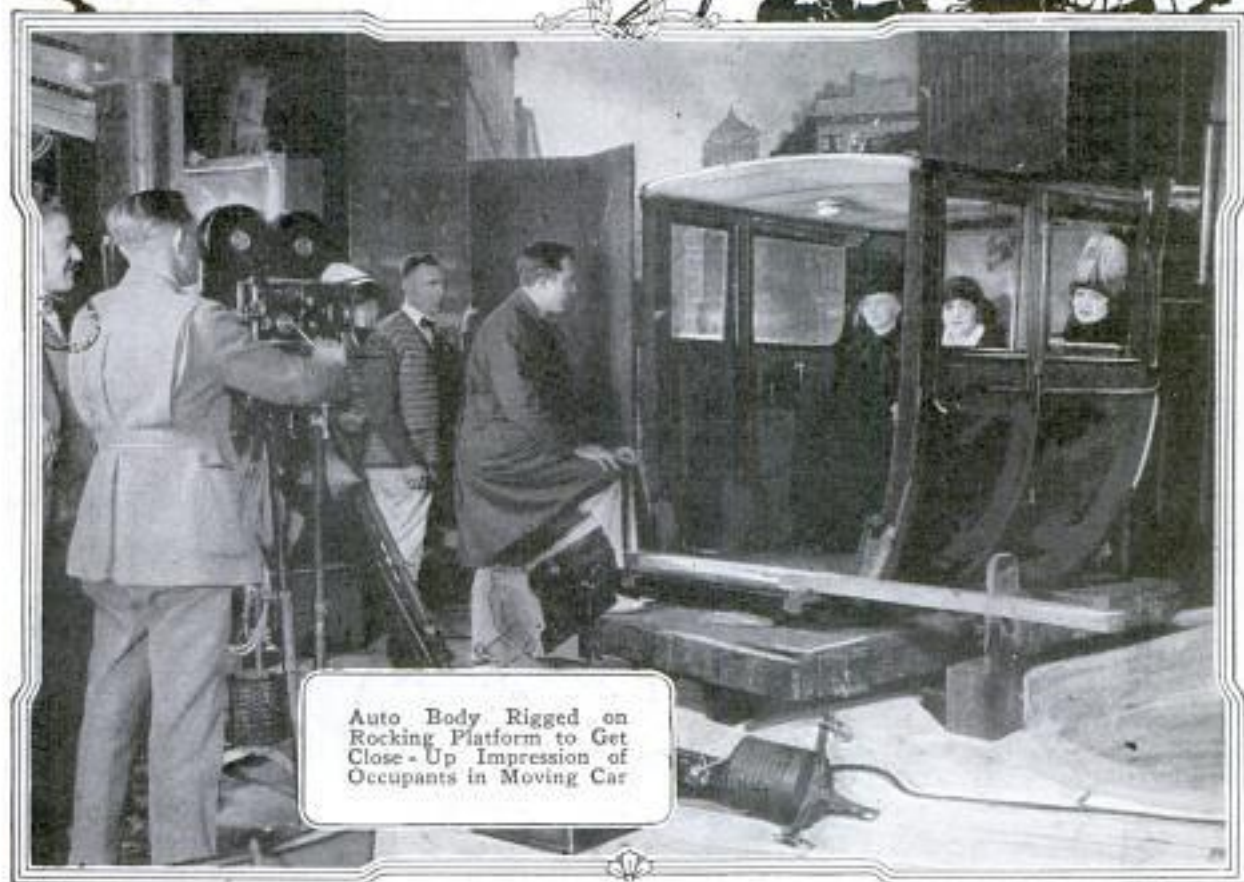

Auto Body Rigged on Rocking Platform to Get Close-Up Impression of Occupants in Moving Car

tion is paid to every detail of the action in order to imitate as nearly as possible the characteristic roll of ships and the heavy swells of the sea. The camera used for these scenes is of a special rapid type that takes five pictures to the one of ordinary machines. Usually but a few days' time is allowed the movie builder to produce some needed "trick" property or mechanical arrangement by which screen illusions are to be carried out. And in addition to his knowledge of architecture, mechanics and art of almost every period of the world's history, the hot-dog engineer is called upon for information dealing with styles of clothing, domestic customs, military ethics and even social manners, of bygone centuries.

Where locations for scenes are selected at great distances from the studios, it is often necessary that the engineer and his staff transport large amounts of properties to the places, sometimes employing two or three lengthy railroad trains, resembling the modern caravan of a big circus. If the field of action covers a wide expanse of ground, a telephone system is required to connect the various directors and their assistants with important sta-

tions scattered over the area to govern the proper sequence of the performance. For this purpose complete portable electrical

equipment is included in the properties when current cannot be secured from commercial power plants. Much so-called trick photography is often resorted to in constructing the sensational and hazardous-looking performances frequently seen carried on high over crowded streets in the screen thrillers. This is made

possible by erecting faked parts on the roofs of buildings and setting the camera at fixed positions for taking the pictures. When a dam is planned to burst and cause great volumes of water to sweep away railroad bridges, houses and log jams, vivid productions can be arranged by the artisans with miniature landscape models, using dolls moved by hidden strings to represent people being overtaken by the rush of "mighty waters" that are poured into the beds of tiny streams



Constructing Huge Plaster Head of Egyptian Statue, Part of Background of Historical Motion-Picture Production

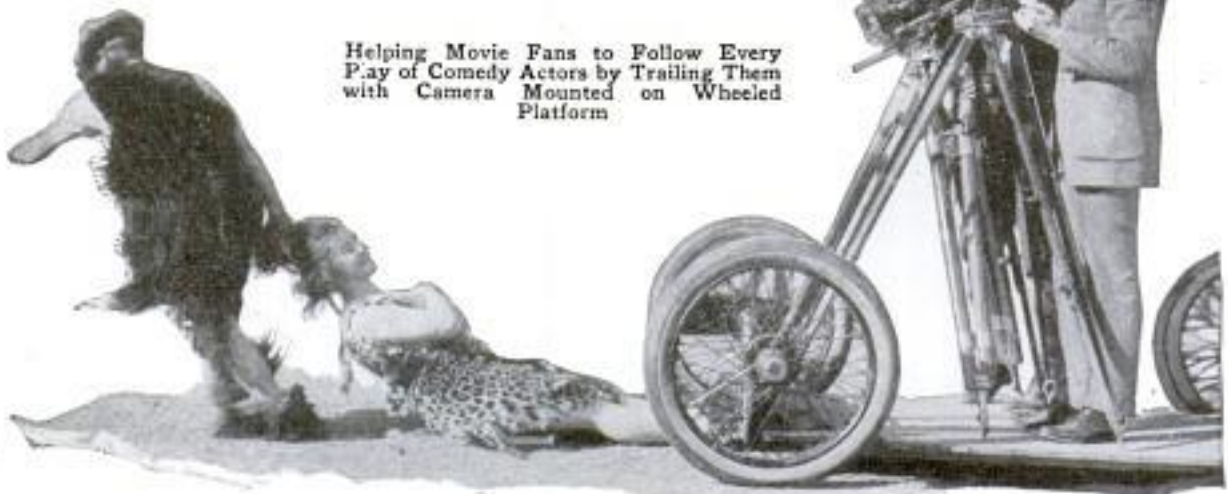

Helping Movie Fans to Follow Every Play of Comedy Actors by Trailing Them with Camera Mounted on Wheeled Platform

Messrs. H. Davidson & Co., 29, Great

POPULAR MECHANICS 299
Portland St., London, W.1, England.

From Insects to Stars Is Range of Combined Micro-Telescope

By mounting a telescope in front of a magnifying instrument, an apparatus has been devised in England, that can be used to study objects within a few inches or at distances of many miles. Employed by astronomers, it greatly enlarges views of the

ordinary microscope, the instrument causes the subjects to appear in relief, instead of giving them a "flat" look when seen through the lens. Glasses for both near and far observations can be attached to the device, which also may be connected with a camera when photographs of the objects under study are desired. A picture of some mountains was taken in this way over a

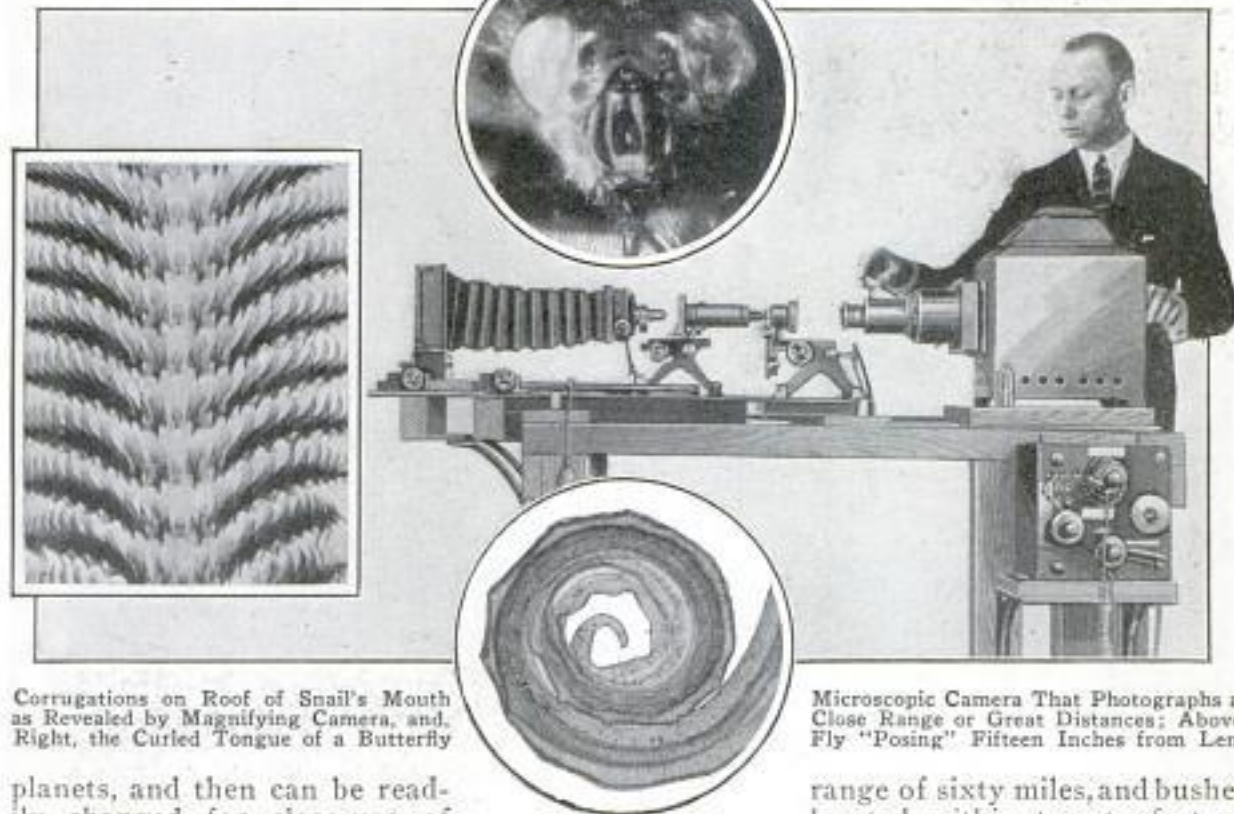

Corrugations on Roof of Snail's Mouth as Revealed by Magnifying Camera, and, Right, the Curled Tongue of a Butterfly

Microscopic Camera That Photographs at Close Range or Great Distances; Above, Fly "Posing" Fifteen Inches from Lens

planets, and then can be readily changed for close-ups of near-by minute bodies. The implement, it is said, is also of advantage in reading thermometers at great distances or for watching the melting of substances in furnaces which are too hot to be approached. No larger than the or-

range of sixty miles, and bushes located within twenty feet of the lens showed up with as much detail and as clearly as did the distant point on which the instrument was trained. It is claimed that magnifications above 5,000 are possible, and that they can be altered without optical change.

Even Old Teeth Find Market 899

To reclaim the silver used in rivets that hold sets of false teeth together, shopkeepers on the East Side of New York City buy cast-off "plates" from the owners. It is said that a considerable amount of the metal is thus purchased by the dealers at low cost. After the silver is extracted, it is melted into a solid nugget.

new York Times 3/30/24

Safety Spark Gun for Lighting Gas Eliminates Danger of Matches 806

For lighting gas, a safe and simple igniter that shoots a shower of hot sparks

over the burner when a spring trigger is snapped, has been invented. Friction of a



Pressing Igniter Trigger with Thumb Sends Spark Shower into Gas from Notched Wheel

notched wheel against a bit of stone material produces the sparks. The lighter is operated easily with one hand, is long enough to keep the fingers away from the blaze and requires no care except to renew the sparking stone occasionally.

myr - M. E. Bernhardt, 148 Chambers St. New York City

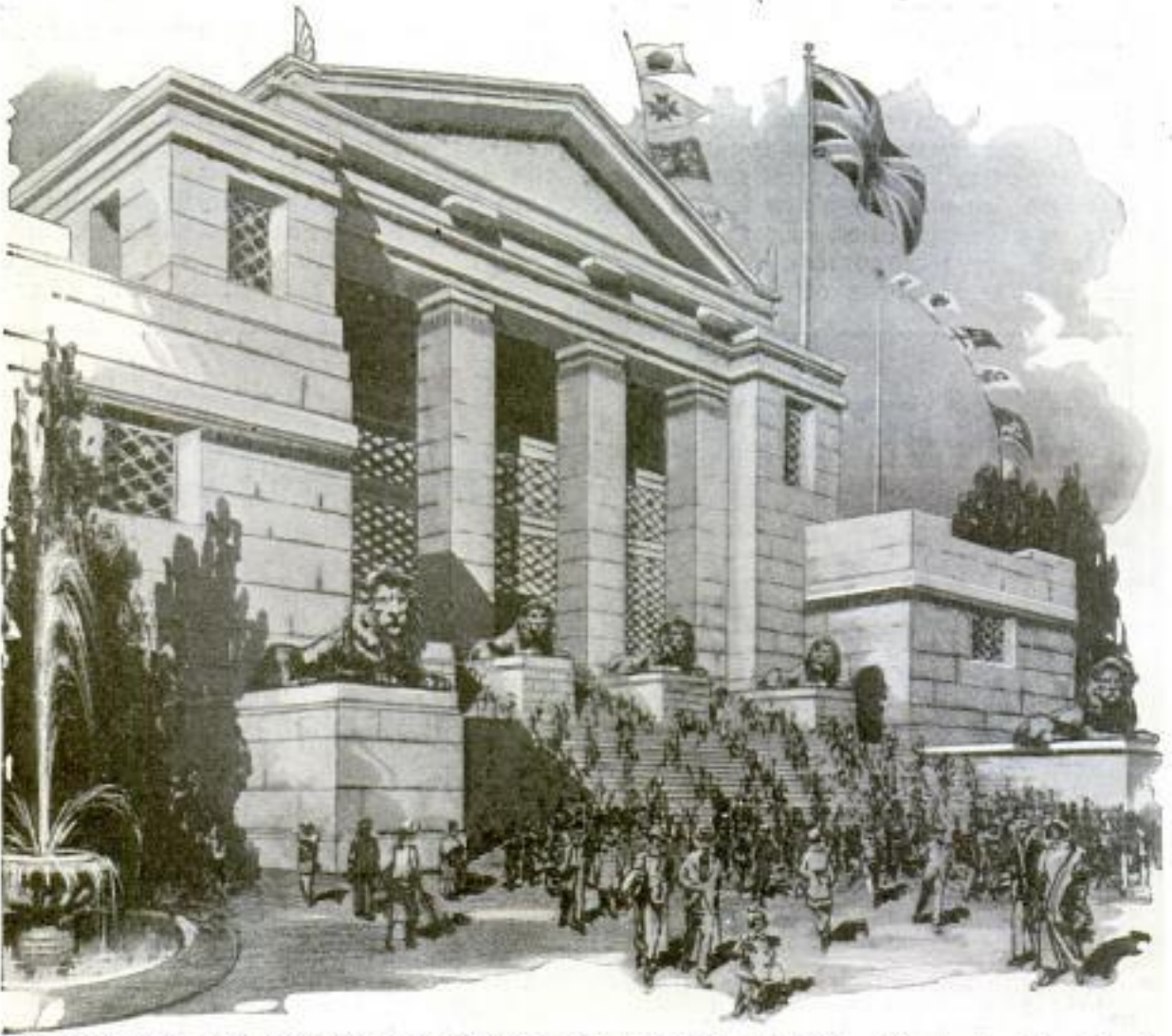

British Government Pavilion at Wembley in Which Historical Naval and Military Episodes Are Reproduced on a Changeable Water and Platform Stage Operated by a Novel Mechanical Arrangement

Arts of Empire Shown in British Exposition

Products of Industry, Architecture and Domestic Life of Overseas Provinces Collected in Trade Exhibition of Motherland

BRINGING together exhibits of the products of art and industry from every part of the British empire, the exposition at Wembley park, in the London area, occupies 216 acres and is conveniently reached by practically every railroad in England. A half dozen special stations adjoining the grounds receive passengers from approximately 1,500 street cars and 3,000 motor busses each day.

Circling the grounds is a non-stop railroad with trains that travel twenty-four miles an hour, slowing down at loading platforms to a speed equal to a 'walking pace, so passengers can alight from or board the coaches without need of bringing the cars to a dead halt. Within the area, the

total length of the roads on which the various spectacles front is estimated at fifteen miles. On some of these avenues, motor coaches and electric cars are operated to carry visitors between the more prominent points. Embracing almost every known form of architecture—both ancient and modern—the buildings, most of which are constructed of concrete, represent the greater part of the \$60,000,000 spent to erect the gigantic displays. Practically the entire affair is planned on the ground level, with the exception of a realistic copy of a coal mine, made of clay, with subterranean workings that total more than a quarter mile in length. Colonies of dark-skinned peoples transplanted from

Cont. Stafford Kanzone, Esq.
6. Perry Road, Ken, Surrey, England

1108



Canada Building Containing Complete Range of Natural and Manufactured Products of That Country



Right, "Old London Bridge," Replica of Famous Old Span;
Left, Burma's Fretted Pavilion

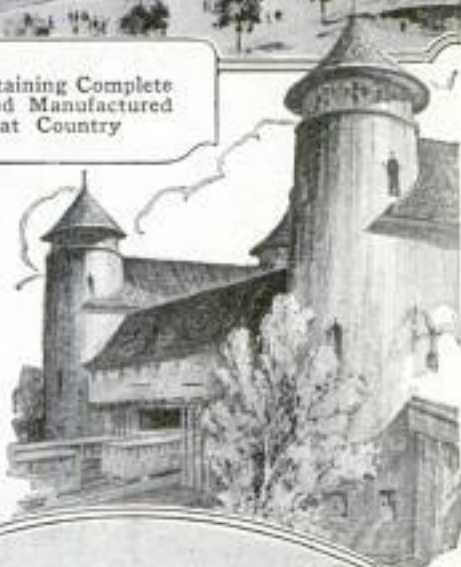

Pillared Facade of Gorgeous Ceylon Building



Hongkong Building Displaying Wonders of the Orient



Red Front of Nigerian Inclosure Where African Arts Are Shown



Arranging Models of Vessels around Docks of Miniature Seaport for Display at Wembley, and Replica of Giant Crane; Below, "Bird's-Eye" View of Toy Harbor and Workman Touching Up Merchant Fleet

their native lands in the tropics may be seen living in villages built by themselves within the grounds, and indulging in pastimes and rude industries, indifferent to the swirling thousands of visitors who daily attend the exposition. Oriental countries are represented by small communities of their peoples housed in quaint artistic homes their own workmen planned and erected for the purpose. With each native unit, the things they make for trade and home are shown in neatly arranged dis-

plays, while those who produce the articles ply their crafts in full view of the observer. During the period of the exposition, meetings of commercial, architectural, scientific and engineering leaders from all over the empire will be held, to study and discuss various subjects touching the industrial and domestic advancement of the provinces. In the Palace of Engineering, claimed to be one of the largest concrete structures ever erected, instructive and interesting collections of

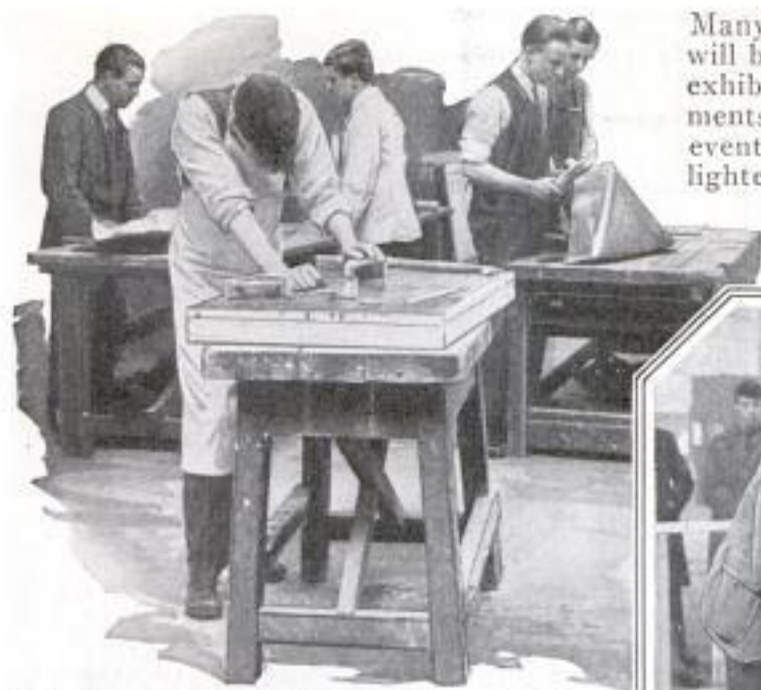

Trade Apprentices Competing in Plastering, Plumbing and Bricklaying Contests at Wembley Exposition

Many of these, it has been pointed out, will be attracted not only by the trades exhibitions but by the novel amusements, pastimes and important sporting events which have been designed for lighter entertainment of the guests. Among the more prominent displays are many miniature



the most modern achievements are set in vast series that mark the progress of the mechanical world. Near by, the Industrial Palace, covering about thirteen acres of ground, contains displays of manufacturing methods of numerous industries that affect the everyday life of modern civilization. Estimates of the number of visitors who will attend the gigantic fair in the six months it will be in progress have been placed at 25,000,000.

groups. Gorgeous palaces, great industrial establishments and miles of busy seaport areas have been artistically reproduced by skilled craftsmen with toylike models.



British Empire Exposition as Seen from an Airplane, Showing the Artistic Ground Plan and the Monster Stadium in Which Various Performances and Spectacular Contests Are Held



Buying the Food, Cooking and Serving Their Own Meals, Girls Learn by Actual Practice Essentials of Domestic Economy



Cottage Schoolhouse Which Senior Girls in Domestic Science Operate as Home



Exterior and Interior Views of "Laboratory" at Rhode Island State College That Trains Girls for Home Careers

980
Girls Are Taught to Manage Homes by Going to School in Cottage

To teach young women the science of home management, Rhode Island state college has erected a completely equipped cottage where girls in the senior classes live for part of the year and handle all its affairs. Under the direction of instructors, they plan their own meals, do all the marketing, cooking, dishwashing and housework, keep the books and even do their own washing if they desire. Practical training, gained in this way, is expected to prove a valuable supplement to laboratory work and enable the girl to decide more easily if she desires a home career.

Deadly War Gas Now Being Turned into Peace-Time Ornaments 696

French chemists have succeeded in turning one of the deadly gases developed during the war into umbrella handles, cigaret

holders, paperweights and all sorts of ornaments. These objects are beautifully yellow, as transparent as amber, harder than ebonite and nonconductors of electricity. The same chemists also have evolved sweet perfumes from ill-smelling acetylene, and another liquid from the same source has the property of preventing the oxygen in the air from combining with oils and turning them rancid.

1154
Ants Honeycomb Pillars of Church

Ants boring into the wooden supports, joists and flooring of a church in southern Illinois, did damage estimated at nearly \$25,000. The falling of a fragment of a rafter during a service revealed the fact that the lower part of the building, and even some of the pews, had been honeycombed by the insects. It was necessary to replace the wooden pillars with iron ones and to make other extensive repairs before the building was pronounced safe again for service.

Chemists in Laboratory
 College de France / Washington, D.C.
 Paris, France

Chicago Herald Examiner
 3/1/24

St. B. ...
 Church
 Edwards ...

Copyrighted material

1150 Wide World Photos, 229 W. 43rd St
New York City

Gypsy Life in Autos Lures Tourist Hosts

Understands & understands
205 W. Washington St., Chicago

Good Roads and Convenient Camp Equipment Lead Millions of Motorists to "Rough It" in Nation's Great Outdoors

AS evidence that the outdoor sport of automobile camping is growing by leaps and bounds, it is estimated more than 5,000,000 people toured the country with their cars last year and that a great increase over that number will be found this season to have "hit the rubber trail" to resorts and camp grounds.

Invading the most remote wilds of the forest lands and traversing the barest wastes of sand that cover many parts of the west, the motor tourists stream over

From convenient chests and boxes strapped to running boards, cooking utensils, folding chairs, tables and small stoves are taken. In a few minutes, with these accessories of outdoor life, the open-air home is in full swing, sleeping quarters are arranged, and after an overnight stop, the travelers pack their equipment again and are away for another jaunt on their gypsy journey. Refinements in motor-vehicle construction, laying of improved roads and the establishment of thousands of automobile-provision stations throughout the country are combining to make this a nation of outdoor enthusiasts. The value of the pastime to the health of the people alone is said to be beyond any attempt to

Mealtime at the Roadside; the Auto Tourists Set Up a Kitchen with Stove and Utensils That Fit in One Package

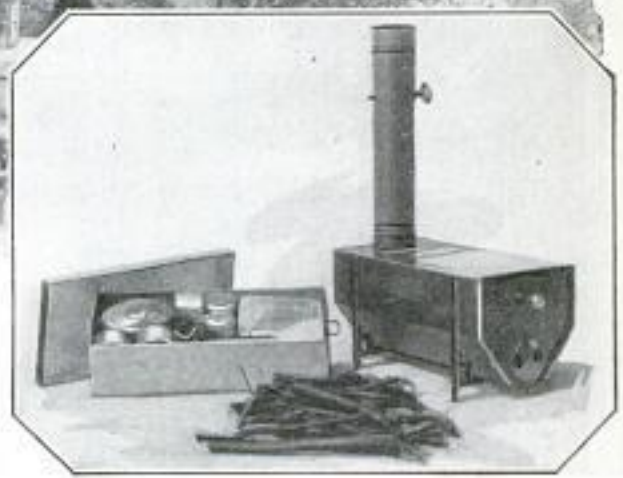
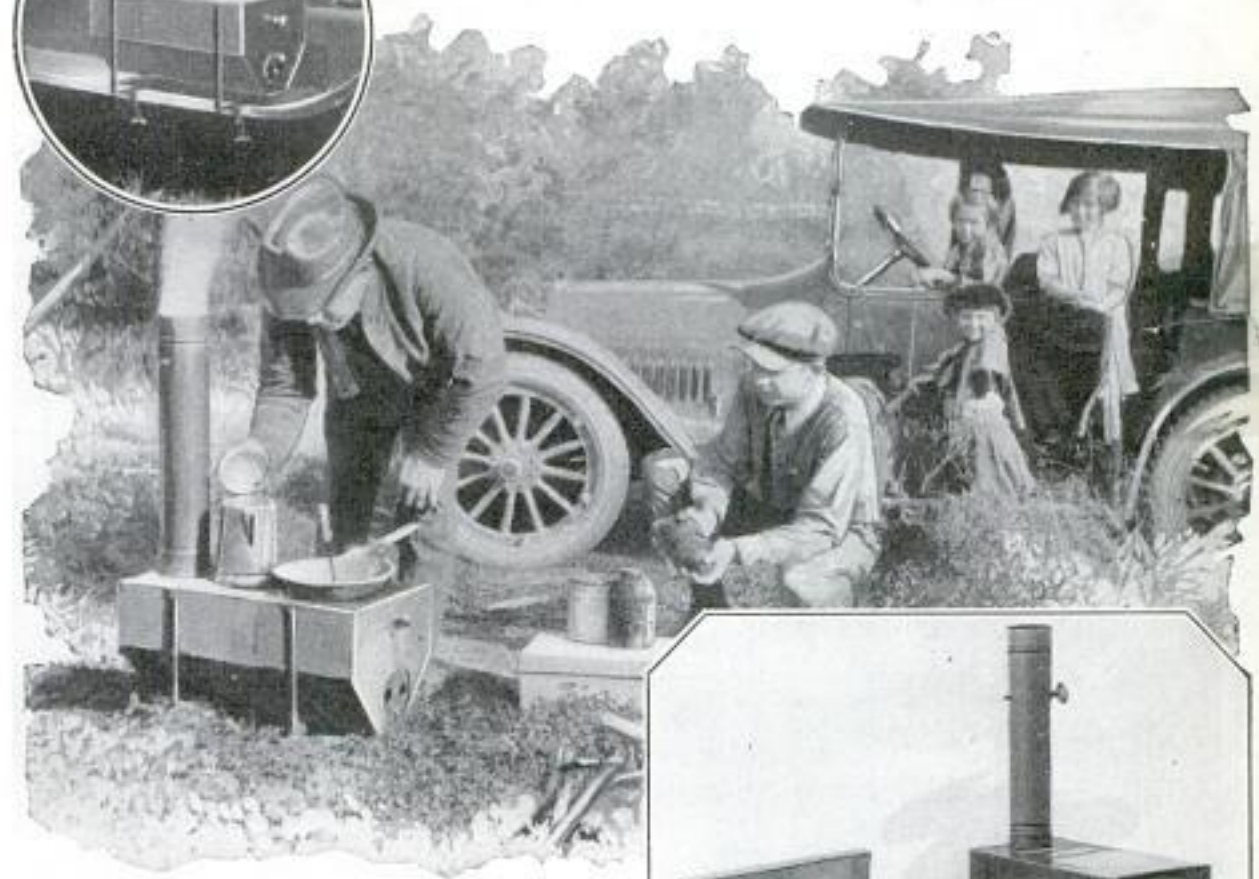
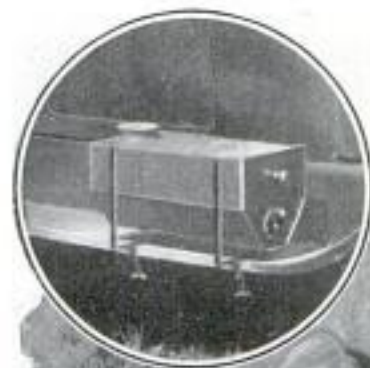

the continent, crossing the paths first used by pioneer settlers and roads that were the nation's only highways of travel long before the days of steamboats and railroads. Tents are snugly packed on the outsides of the cars and entire families speed into quiet, open country where temporary canvas homes are set up in a short time.

estimate. Woods, fishing streams, lake resorts and national parks, are all receiving



Tourist Group Washing Up at Municipal Camp in California; Left, around Campfire in National Forest



"Hikers" Who Motor to Woods for Tramping and Community of "Auto Gypsies" in Camp



Orchestra Pavilion in Tent Colony of Outdoor Fans



Guide Map for
Tourists and a
Lake Fishing
Camp



Portable Auto Camp
with Two-Story Tent
on Car



Cross-Country Motor
Caravan and a Way-
side Stop



thousands of these gypsy tourists. The average sojourn lasts about two weeks, and to care for the great army of those who are out to "rough it," national, state and even municipal and village governments have erected camping sites, summer hotels and information stations to accommodate the throngs of "gasoline wanderers."

One-Man Jazz Band Gives Effects of Fourteen Instruments

Shaped like a guitar with double sets of strings, an instrument with which it is claimed that one man can produce the ef-

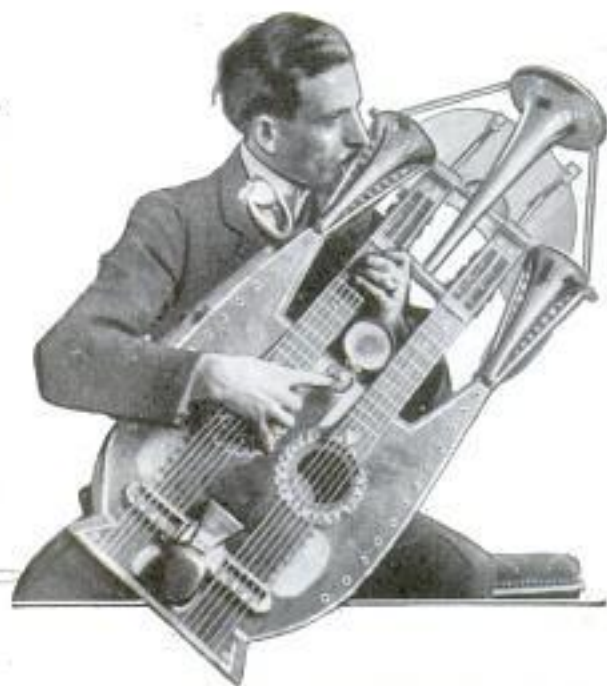

Inventor Playing Odd Guitar That Has Horns, Cymbal and Flutes for Orchestral Effects

fect of a fourteen-piece orchestra has been invented. Various horn, cymbal and flute attachments are provided within easy reach of the player's hands and lips so that several combinations of sounds may be obtained at the same time. Solo parts can also be played if desired.

Pigeon Breeding, Centuries Old, Hobby of Many Americans

Centuries old, pigeon breeding today is said to be the hobby of a million Americans. Beginning with the humble, wild blue rock dove in the days of the Egyptian and Roman empires, inbreeding and crossbreeding have continued until now there are some 300 varieties of fancy pigeons recognized. Particularly responsive to experiments, these birds are being im-

proved and trained as carefully as thoroughbred race horses. It is claimed that a prize winner is more often the result of years of work on the part of some far-seeing fancier than an accidental discovery. So important is heredity accounted that a blue-ribbon bird will bring hundreds of dollars or even a thousand or more. Throughout the centuries, the pigeon has proved to be a steadily increasing factor in the military operations of nations. The development and training of the reliable, sturdy homing pigeon with its keen eyes and powerful wings is now a part of the programs of many countries, for use when other means of communication fail. Built on racing lines, the homer is trained by slow stages to fly unswervingly to a given point from great distances.

Waterwheel on Floating Raft Rises or Falls with the River

Because continual changes in the level of the Orange river in South Africa interrupts the operation of ordinary waterwheels, a device has been invented that rests on a raft. Whether the stream is in flood or at low stage, the wheel is always kept working by being at the proper depth in the current. The invention, which protrudes through the center of the float, is expected to achieve great savings in the irrigated agricultural districts, where extreme changes in the river's height often stop the operation of fixed pumping machinery and interfere with the steady flow of water to arid land.

Steel Ink Eraser Shaped Like Spoon Fits in Any Penholder

Resembling an ordinary steel pen, a spoon-shaped ink eraser designed to be attached to any holder has been introduced by a European manufacturer. It has ground and hardened edges for scraping out the marks, and when inserted until only the rounded section projects, but slight pressure is required to remove the ink. It is not likely to tear the paper and is especially adapted for making erasures on tracings.



Signor Miguel Ivan, Belgrade, S.S. 2012

Chicago Daily News
May 8, 1924

Heinze + Blancherty
Habrlik, Berlin
No. Georgenbuckstr. 44

Buildings in the Form of Plants Express "Spiritual Science" 113

Striving to express the teachings of spiritual science in buildings, a group of scholars in the little town of Dornach, Switzerland, has erected a number of structures of weird and fantastic design,

usually of one pane of thick, colored glass, so arranged that various combinations of tones are caused when the light shines through them. The rooms are built in the form of plants and leaves, so far as pos-

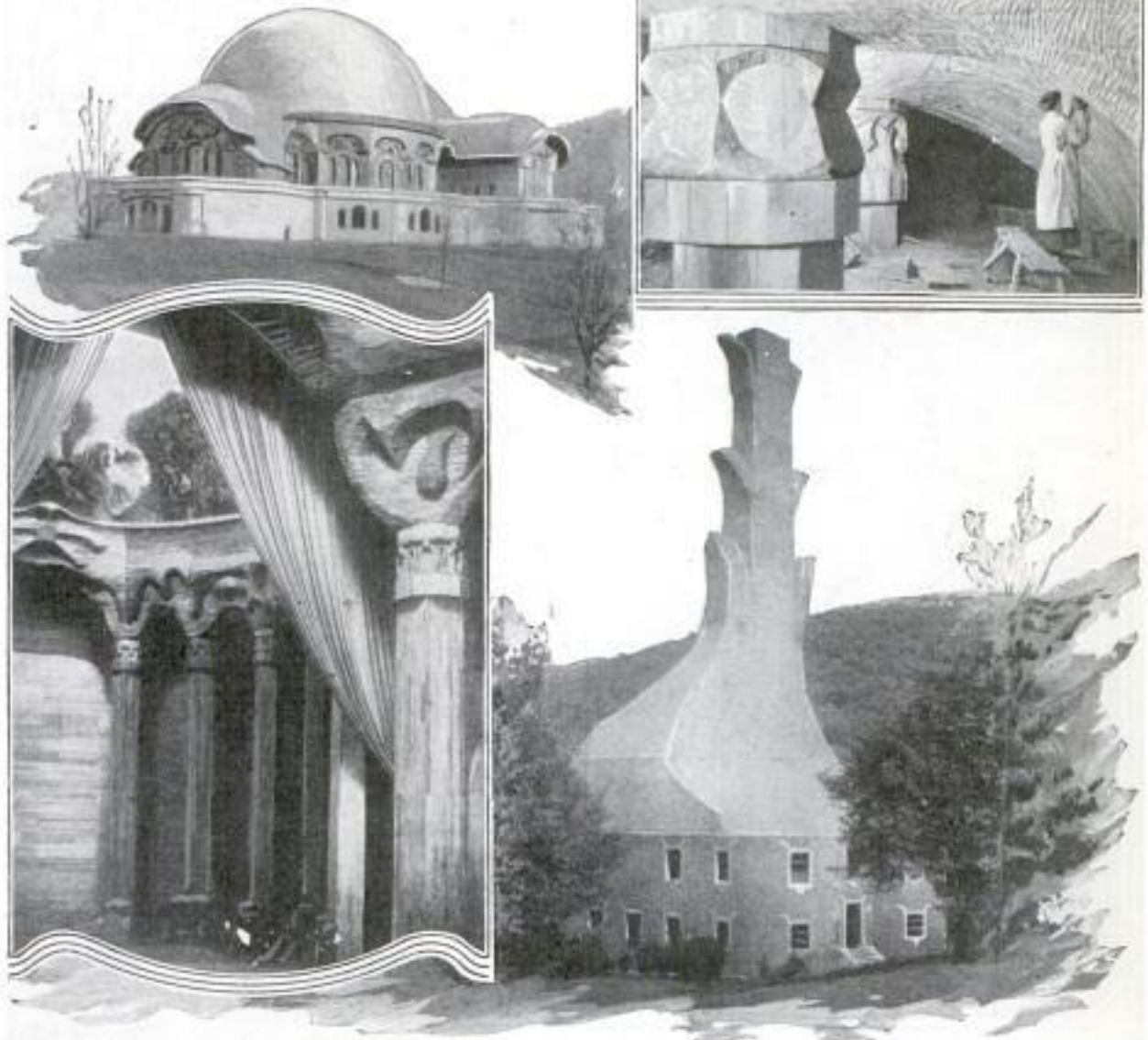

Interior and Exterior Views of Weird Buildings Patterned after Plants and Leaves That Members of a Swiss School Have Erected to Express Teachings in "Spiritual Science"

achieving what critics call a new movement in architecture. Plants and growing things furnish the motifs not alone for the decorations but for the forms and shapes of the buildings and rooms as well. Consequently, they have a power house with a tall smokestack with "buds" on it like a gigantic pussy willow; a main building with a bulbous roof similar to the contour of a plump mushroom, and other structures of odd design. There is little attempt at symmetry. Simplicity and bulk, in mass and detail, are apparent. Windows are

sible, and are decorated on walls and columns with curious wood carvings and with futuristic paintings. The school, originated by Dr. Rudolf Steiner, also propounds theories in other arts, and in music and drama.

☞ Popular Mechanics Magazine does not publish the name of maker or seller of any device described in its pages, but this information is kept on file and will be furnished free by addressing our Bureau of Information.

Ton of Soot Washed from the Face of Hotel by Sand Blasts

Washing the faces of city skyscrapers to remove accumulations of soot and dirt is a task that costs thousands of dollars



Magic Worked by Sand on Screened Scaffolds: Scoured and Unscoured Sections of Chicago Hotel

each year and requires the services of many workmen. To clean the tile front of a single large building in Chicago last spring with an acid solution cost \$2,000, and considerably more was spent in scouring another with sand blast. The workers, wearing special suits and goggles to protect themselves, with the aid of two large sand-blasting machines, dug more than a ton of dirt from the structure, leaving the stone in its native color, almost pure white. The task was done on tightly covered scaffolds, and refuse and

sand were filtered to the street in long canvas tubes connected to aprons below, so that none of the material would fall on pedestrians.

Eighty Billion Dollars Is Latest Estimate of World-War Cost

Eighty billion six hundred and eighty million dollars is given as the cost of the great war in figures compiled by a New York banking concern. This sum, it is pointed out, would reproduce all of the railway mileage in the world with more than twenty billion dollars left. To give an idea of the huge sum by comparisons, the report declares that the cost of running the United States government from 1791 through the year 1913, was \$24,500,000,000. And this amount includes the expenses of fighting England in 1812, Mexico in the '40's, the Civil war, several Indian campaigns and the Spanish-American war. In 1914 economists estimated the wealth of the people of Great Britain to be about \$70,000,000,000. This figure included property of every kind in England, Wales, Scotland and Ireland, factories, the great navy, coal, tin and iron mines, the shipping industry, in short, all tangible property.

Kansas City Star 11/20/24
104³
Holtz apfelfelt & Co., 53 Haymarket London, S. W., England.

Electric Light in Walking Stick Is Hidden under Band

By turning the ferrule of a walking stick in which a flashlamp is concealed, the bulb may be exposed and lighted ready for use. The device is helpful in dark theaters, to disclose a keyhole at night or to read small print where other illumination is not sufficient. It is also convenient in reading the dial of a watch in the darkness and eliminates the necessity of fumbling in pockets for matches or other means of lighting. When not required, the globe can be protected from injury by sliding the metal guard, which serves as an ornament to the cane, over the opening.



☛ Weighing 1,168 tons, there is an obelisk in Egypt which has never been raised.

Cont. John W. Keane, Bureau of Navigation, Navy Dept., 4496
Rich and Poor Find Joy in Work with Hands

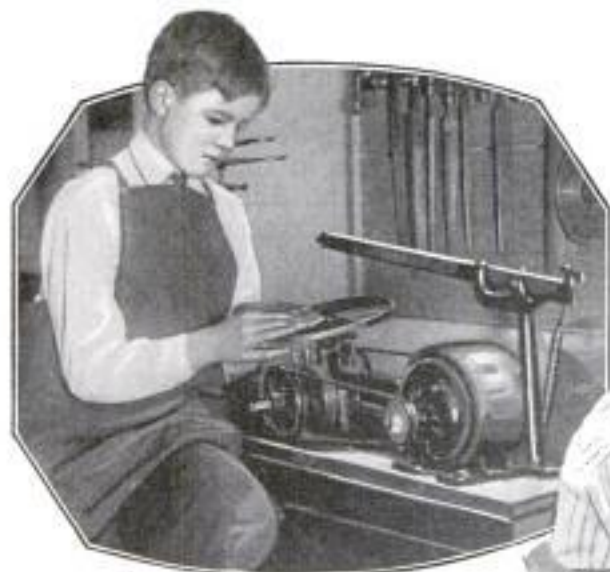

DEVOTING their leisure hours to practical work of the hands in making everything from toys to useful instruments and models of machinery and big boats, many men occupying high positions in professional and business life vie with toilers in factory and field in pursuit of interesting hobbies. Between innings of baseball games "Frankie" Frisch of the New York Giants worked on the model of a toy he had invented. A prominent official of a large eastern city has for years turned his spare time to the carving and assembling of violins which he sells cheaply or gives away to his friends. Only recently he learned to play the violin,



Amateur Woodworker and a Specimen of Elaborate Geometrical Chip Carving He Made in Spare Time

Washington, D. C.
although his three children are finished performers on the instrument.

Some of the best boat models made are those created by prominent men who pursue the art as a pastime and have become skillful wielders of carving utensils simply through their own efforts in applying a love of tools to the performance of useful

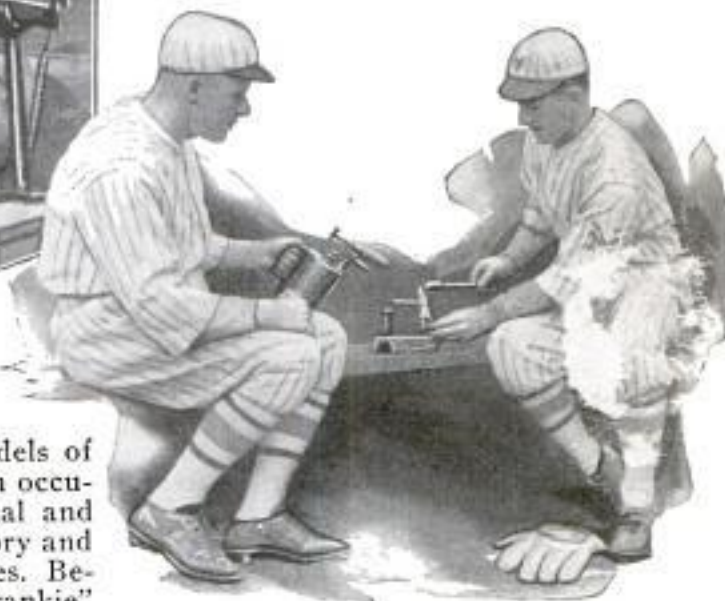

Professional Baseball Players Tinkering with New Toy between Innings, and Son of Frank A. Vanderlip in His Home Workshop

tasks. Franklin D. Roosevelt, former assistant secretary of the navy, specializes in building miniature sailing boats. Beginning with making toy craft for his children, interest in the work brought adeptness in the handling of tools and material and gradually expertness and originality. From a pastime the hobby with the modeler became a study and now, according to Mr. Roosevelt, he designs various types of sailboats for the sake of experimenting with weights, sail form, speed and other features.

Many members of the highest courts in the land, railroad presidents and bankers in all parts of the country are known to have home workshops where they spend the time away from business grind in doing light lathe work, woodturning, cabinetmaking and the like. The son of a nationally known multi-millionaire of a mid-western city spends a great portion of his time in tearing down old automobiles, which he buys, in attempts to discover their weaknesses or defects. However, the "riding" of hobbies requiring work with the hands is not confined solely to those who practice callings of totally opposite characters. Toilers in shops and mills derive much enjoyment in doing on

J. L. Schere, 4204 Botanical Ave
St. Louis, Mo.
POPULAR MECHANICS



Copyright, Underwood & Underwood
Franklin D. Roosevelt, Former Assistant Secretary of
Navy, and Model of a Fleet Naval Vessel

their little home workbenches the same kind of things at which they are employed every workday of the year, and many adepts at furniture making not only provide tasty articles for their own dwellings, but dispose of their pastime products to dealers who eagerly pay high prices to obtain original and durable designs.

In St. Louis a millionaire lumberman has become a master of geometrical chip carving, using mahogany, oak, walnut and other hardwoods to obtain artistic creations which are looked upon by the neighborhood as an exhibit worth study.

Change in Construction of Violin Results in Better Tone

1022

By following a slightly different principle of construction, an Austrian is reported to have designed a violin with tones that are said to rival in volume, strength and quality those produced by the almost priceless instruments of the old masters. According to the inventor, the body has been made to resound to its full capacity by connecting one of the feet of the bridge with the belly and carrying the other through on a pier which rests on the back. In this way, both sides are brought into vibration, and the air inclosed in the surrounding chamber is animated. This is said to cause a better tone in every way.

Earth Is the Target for Stones of Many Varieties from Sky

Varying from tiny particles to huge masses weighing tons, more than 20,000,000 meteorites according to the estimates of astronomers, are drawn into the earth's atmosphere every twenty-four hours.

Kansas City Times
May 2, 1924

Rarely, however, does one reach the ground, as they are burned up by friction as they rush through the air. In 1492, a meteorite weighing 260 pounds fell in Alsace; one, the shape of a man's head and weighing fifty-four pounds, fell in Provence, France, in 1637, and in 1654, a small one struck and killed a man at Milan, Italy. One of the largest recorded in recent times fell in 1917 at Perth, Scotland. It weighed thirty-eight pounds. The British Museum now contains more than 500 specimens of meteorites and over 300 of them have actually been seen to fall. Masses of iron, believed to be of meteoric origin and weighing several tons have been found in Greenland and in Mexico.

Giant "Nose" of Liner Is Repaired \$76 after Accident in Harbor

After repairs necessitated by having run aground last fall, the "Leviathan," pride of the American merchant marine, has returned to service. Six feet shorter than

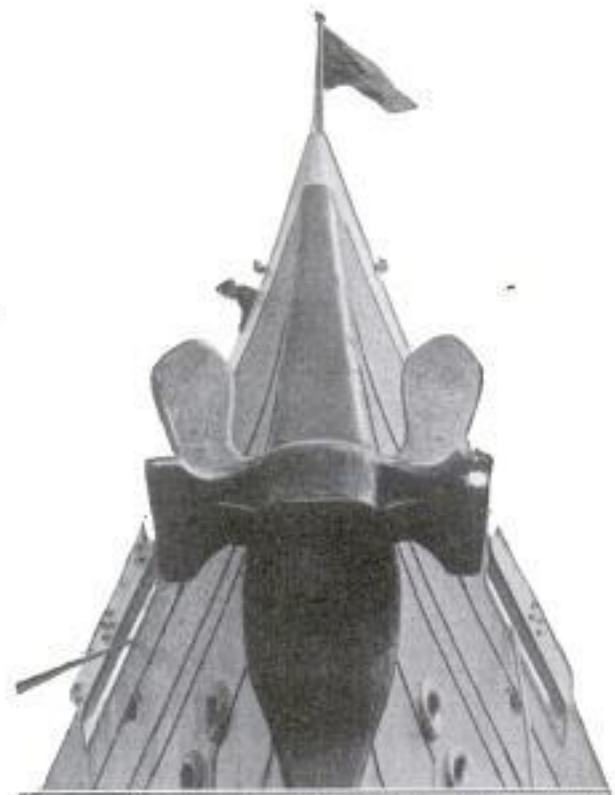

Narrow "Nose" of the "Leviathan" and One of the Gigantic, Pronged Anchors

the "Majestic" and with only 700 tons less displacement, the gigantic liner, before she was fitted for commercial service, carried 150,000 soldiers to France during the war and brought an equal number home again. She was remodeled for passengers at a cost of more than \$8,000,000.

Pacific & Atlantic Photos
25 Park Place
New York

Chicago Evening Post
9/15/24
Thomas

DATE		CAR MAKE		OWNER		TEST NO.	
MODEL		SERIAL NO.		ENGINE NO.		MILEAGE	
CYLINDERS	BORE	STROKE	CUBIC INCHES	WHEEL DIA.	GEAR RATIO		
HORSE POWER-TORQUE X $\frac{R.P.M.}{1,000}$		MILES PER HOUR - WHEEL R.P.M. X WHEEL DIA. X .00297.			M.E.P. @ 1000 R.P.M. X TORQUE T.B. X 798		CONDITION REPORT MOTOR BRAKE H.P.M 1000 MOTOR
					DISPLACEMENT		

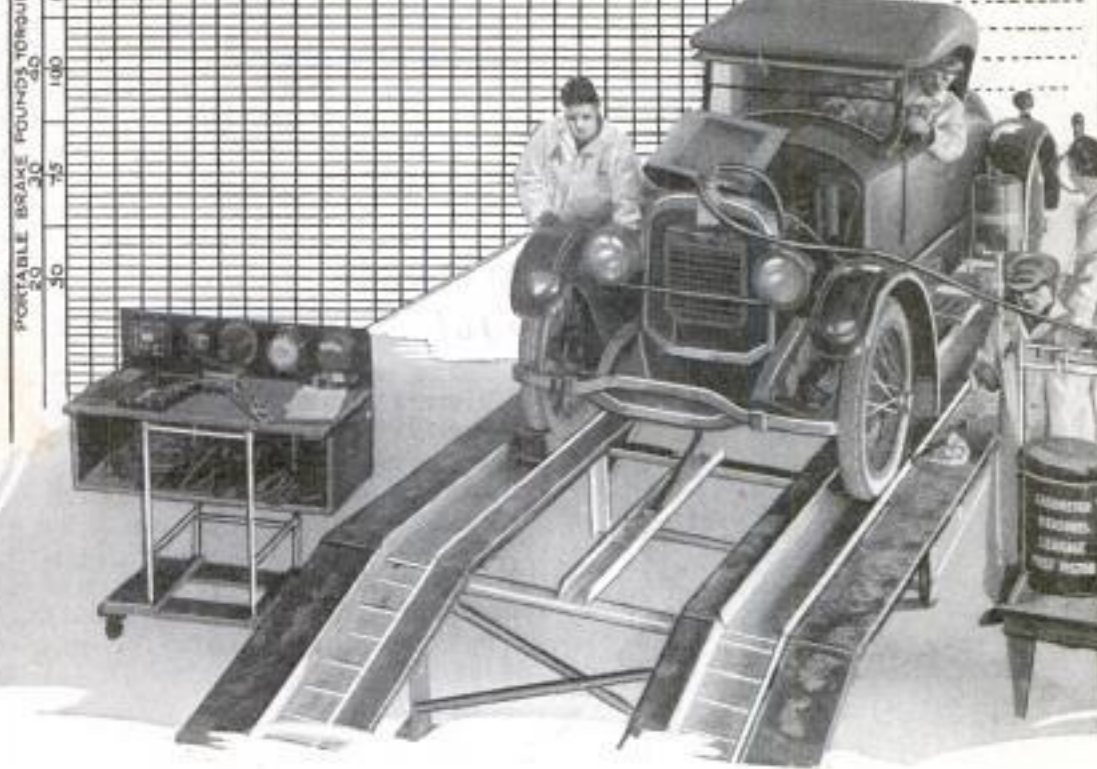

*Wascam Motor Check.
S. H. O. Engineering Co., Newark, N.J.*

"Sounding" a Used Automobile in Laboratory Where All Parts Are Tested and Recorded to Guide Repairmen Who "Condition" the Car; Above, Indicating Chart

Used Cars Tested in Laboratory to Find Exact Value 1126

So that Chicago automobile dealers may know the condition of a used car taken in trade, a laboratory has been established in which every part of the machine is examined in thirty minutes. When the car leaves the test stand, it is said that every fault is known and its value can be exactly appraised. Special meters reveal any leaks in the electrical connections, the performance of battery and motor is compared with standards, a grounding gap shows the condition of spark plugs and ignition, a connection between the crankcase and a gasometer indicates the amount of gas escaping past the pistons, and under its own power the motor operates a brake to show the horsepower, while a specially devised flow meter measures the amount of fuel consumed. When all mechanical and electrical tests have been given, an examination for defects in the chassis and springs is made. The complete data tell the dealer how much it would cost him to overhaul the automobile. After it has been

put into shape, it is sent through the "mill" again and then, if it meets the requirements, it is certified. This service is expected to speed up the resales of used cars, as it is claimed that the buyer can be certain the automobile he is getting is in first-class shape.

Bugs Are Called Man's Worst Foe; 1169 Cause Heavy Yearly Loss

Bugs are listed among mankind's most dangerous enemies by Dr. Leland O. Howard, a government scientist. Every year, it is estimated, they cost the American farmer \$2,000,000,000. The United States, according to figures, pays more insect damage than any other country, as its climate and soil conditions favor the propagation of nearly a hundred destructive species. Almost all of them have been imported, despite the fact that there are now seventy-five investigating stations scattered throughout the country and one abroad, where experiments are constantly being made with the latest modes of warfare against the pests.

*Kansas City Times
5/1/24 Copyrighted material*

Music Rack Turns Sheets as Player Presses on Foot Pedal

844

To turn sheets of music without need of interruption to the player, a rack has



Music Stand that Turns Sheets when the Player Presses a Foot Pedal at the Bottom

been invented that reverses the pages when a foot pedal at the bottom is pressed. Resembling the ordinary type of stand, the device is adjustable to different heights and operates with very little effort from the player. The appliance can also be made to turn the scores to either the right or left, enabling the reader to follow the composition with ease. After reversing a leaf of music, the swinging arm is returned by a spring to the starting position ready for another movement.

Playful Porpoises Aid Punctuality by Oil Supply for Watches

From the playful porpoise to the delicate springs and balances of an expensive watch may appear to be a long leap, but the connection is direct for the porpoise plays an important part in helping man to be on time. From the spongy fat in the jaw pans of these creatures is extracted the best known oil for watches. It does not get too thin or too thick, keeps up lubrication at all degrees of temperature, and in almost every particular has proved superior to other kinds tried. To supply the demand, some 3,000 porpoises are caught each year, the principal fisheries

being established on the coast of North Carolina near Cape Hatteras. The season usually begins the first of November and lasts until the following April. Lookouts give the signal when a school of porpoises is sighted. Then a crew of fishermen puts out with heavy seines, and carefully approaching, surrounds them with the nets. Then follows the hazardous task of pulling in the catch over rough breakers while scores of fighting 500-pound porpoises, each about seven feet long, struggle for escape. After they are killed, the oil is extracted and prepared for shipment.

Model Lighthouse on Church Roof 106' Is Substitute for Spire

Rising several feet from the roof of a California church, a model of a lighthouse, equipped with a revolving searchlight that has changeable colors, is an unusual substitute for the ordinary spire. Rocks around the base are representative of the "Rock of Ages," and the entire structure gives the suggestion of serving as a beacon against the shoals of spiritual disaster. The "steeple" is said to be the only one of its kind in the world.

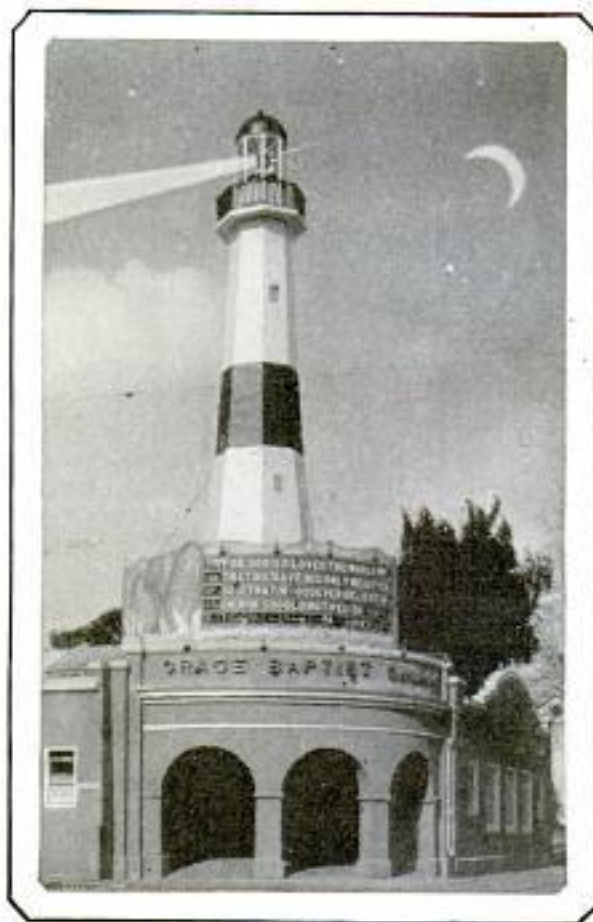

Model of Lighthouse That Is Substitute for Spire on Roof of California Church

The Grace Baptist Church, San Jose, Calif.

Compressed Air
1124 109
April 1914

Copyrighted Material

1114

Paper Dresses on Models Display Latest Fashions in Gowns

Gorgeous-looking gowns and frocks that were made entirely of paper and worn by models, were features at a New York

ing could be manufactured in the top even after the plant had been decapitated. It also is said to have shown that the specific chemicals manufactured by the sun in plant tops could be stored up in the part and later released into the sap, retaining



Arrayed in Gorgeously Colored Paper Replicas of Fashionable Gowns, These Models Displayed the Beauty of the Original Dresses with Imitations Costing Less than a Dollar Each

fashion show. Designed in different colors of various grades of paper, each dress looked like the expensive creation of a modiste, but even the most dazzling cost less than one dollar. The dresses were worn by the models as a novel method of displaying the latest fashions in gowns.

Kadet & Herbert, 15 38 43 rd St. New York

the power to affect cells in all parts of the growth and cause remarkable distortions in the branches.

Sun's Energy Stored Up by Plants Turns Heads toward Light 1076

Some unusual chemical effects of light on plants have been described by Dr. W. T. Bovie, of Harvard, who declares that his experiments have proved it possible to determine the direction of growth by cutting off tops, exposing them to light from given directions and then reattaching the tops by a gelatin cement. After regrafting the top, following its special treatment by light, the whole plant would bend in the direction from which the rays had been directed at the amputated part, it was declared. While it has been well known that a growing plant would twist itself into a position so that the top would receive the maximum of direct light, this experiment indicated that the chemical "steering apparatus" which regulated the plant's bend-

Chair, Stool and Table Combined 1028 to Save Apartment Space

Constructed so that it can be converted quickly into a music stool or table, a comfortable and strongly built armchair has parallel bars at the sides to support the upholstered seat at any desired height.



Convertible Chair with Seat Raised to Form Stool, and Placed as Table Top

A table is formed by placing the cushion, bottom side up, on the top bar below the horizontal chair arms. The article is manufactured in mahogany, is covered with various kinds of fabrics as desired and can be satisfactorily used in almost any room of the house.

New York Times 4/24/24

Utilities Supply Co., 186 Norwood Road, London, N. 6. 27, 28, 29

742
Derrick on Tractor Raises Towers Built on the Ground

To raise heavy structural-steel transmission towers into position after they are built on the ground, a combined tractor

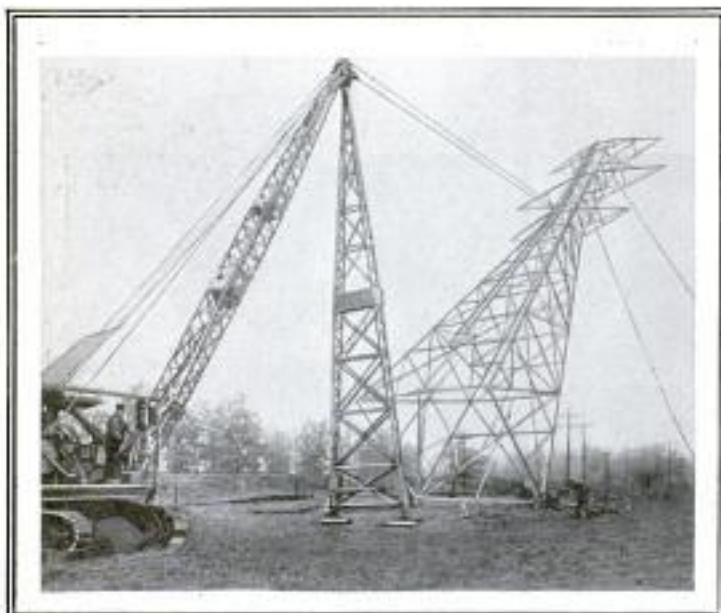

Tower-Raising Machine Lifting Steel Transmission-Line Support into Position after Assembly on Ground

and derrick has been devised that can easily move along the routes of power lines. It is said that, by erecting the cable supports before they are set up, much time and expense may be saved. The structures may be assembled close to their anchorage and when ready for elevation, are hauled upward by cables reeled in by the lifting machine. Tank treads on the tractor enable it to move over almost any character of land, and the derrick girders can be quickly put up for use or dismantled.

1036
Cleaning of Golf Clubs Made Easy by Novel Holder for Table



Keeping golf clubs clean is simplified by a small holder that has been introduced in England. It consists of a metal frame that has two jaws lined with a soft material, permitting a firm grip without risk of damage. The club can be turned by releasing the jaws slightly, so that all parts may be reached without farther change.

Messrs. Richard Mitchell, Ltd., 50, 51, Fetter Lane, London, E.C. 4, England.

700
U. S. Wealth Rises Seventy Per Cent during Last Ten Years

Wealth of the United States is now placed at \$320,803,862,000 according to reports of the census bureau, an increase of 72.2 per cent since 1912. On this basis, every man, woman and child in the country is worth \$2,918, a sum 49.6 per cent greater than was reported as the per-capita wealth little more than a decade ago. Most of this enormous total is represented by real property and improvements, and all classes of property show an increase in value except live stock, which decreased 6.9 per cent. Rises in prices, it is stated, largely explain the increases in money values. Taxed real property and improvements are valued at \$155,908,652,000, an increase of 60.9 per cent; gold and silver coin and bullion, \$4,278,155,000, an increase of 63.5 per cent; farm implements and machinery, \$2,604,638,000, an increase of 90.4 per cent.; manufacturing machinery, tools and implements, \$15,783,260,000, an increase of 159.1 per cent, and railroads and their equipment, \$19,950,800,000, an increase of 23.5 per cent.

601
Lamp to Light Ford-Car Oil Gauge Aids Proper Lubrication

For the convenience of Ford-car owners, an inventor has designed a small electric light fitted in a bracket back of the oil gauge. Current is supplied from the car

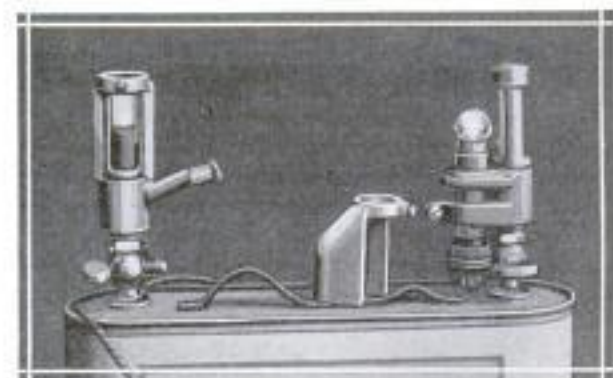

At Left, Lamp Is Lighted behind Gauge; Side View of Bracket at Right

batteries and a metal shield incloses the bulb, which is lighted when desired by the pressure of a button. Use of the lamp eliminates guesswork when filling and insures the exact quantity for best results.

Copyrighted material

420. Wm. H. Churchard, President,

Board of POPULAR MECHANICS

Public Land Commissioner ²³⁷
Milwaukee
Wis

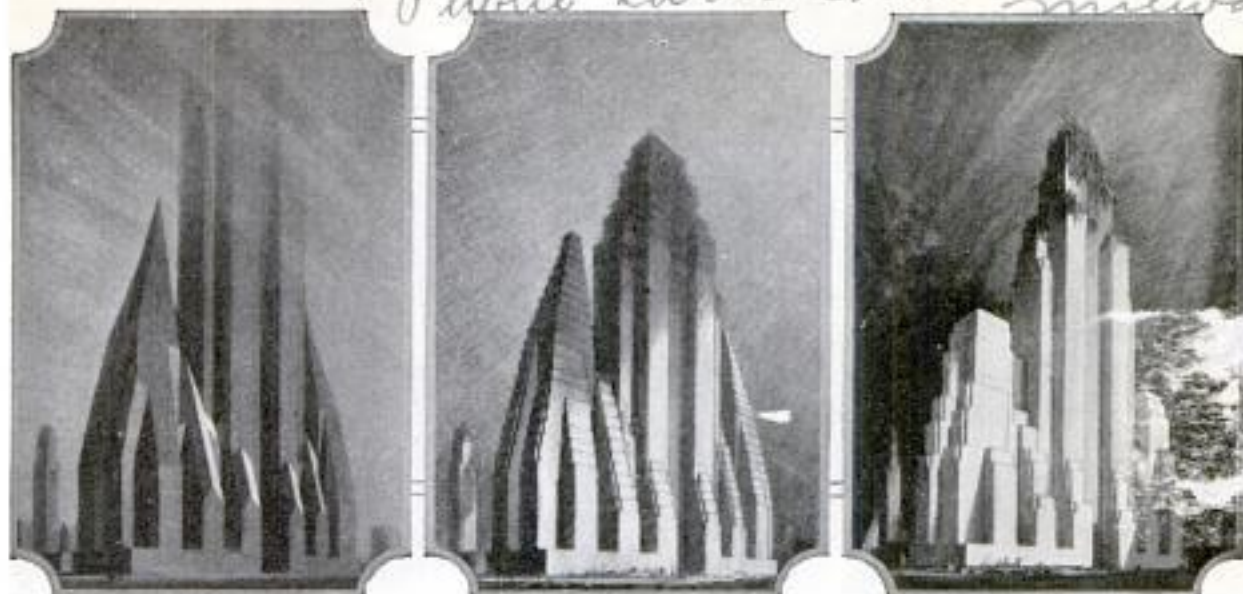

Illustrating New York's Building Restrictions: Possible Cubical Mass Permitted under Law: Artist's Application of It to Actual Construction, and Its Development by Architects into Pleasing and Efficient Structure

The City of the Future

Terraced, Receding Walls to Open Canyons of Business Districts and Double-Deck Streets to Speed Traffic

TAPERING from wide massive bases into terraced floor levels that gradually recede from the streets, modern architecture is expected to abolish the dark canyons that trace somber chasms across the crowded business districts of the city of today. Beginning with a provision in the recently adopted building laws of New York, which requires the stepping back of buildings from the street line, architects and builders have turned their attention to the designing of structures that will insure greater access to air and sunlight and provide a greater degree of safety from fire hazards. Because the law governs the air line as well as the ground lines of property within certain city divisions, architects are called upon to plan structures af-

fording the greatest possible amount of space within the bulk of building permitted. The maximum bulk allowable is

that nearest the ground. Above this "base," and decreasing with each few feet upward, the plan shrinks inward toward the center, providing apertures between buildings that grow wider with the height of the structures. Around this cubical air "plan" the designs of the buildings must be laid, generally resulting in gracefully tapered, stepped-in or pyramidal forms. Departing from the traditional forms of architecture, designers have already produced office buildings, lofty church edifices and even hotels with a certain regard for the circulation of air and access of more light



Old Oriental Temple of Pyramidal Design Somewhat Located to Architectural Trend of Modern Building

than ordinarily provided, to the benefit of those whose work-days and lives are spent in the confines of such structures. And although the buildings retain many of the general lines seen in earlier architecture, the tendency is toward the tapered type, and points to the future office building that will rise majestically in tiers without the customary scrolled masonry at the eaves and cornices. To use the words of an authority, "the scheme sought is to follow as nearly as possible the shape of the steel construction which lends its strength to the structure." At certain measured heights of the terraced buildings the levels may be spread out and used for gardens, open-air theaters and churches, while around the larger structures promenades might be provided far above the din of busy humming thoroughfares. Combined with these ideas in building are suggested plans of elevated sidewalks and sunken streets, that are expected to relieve congestion of traffic in crowded districts. Not only would such arrangements aid in solving problems of civic development, but, it is claimed, would also permit greater value in show-window space, because second-floor displays could be made possible to merchants, thus adding further to the bene-



Somber Canyon of Building Walls Where Terraced Architecture Would Give Access to Light and Air

fits derived from more efficient traffic control. In New York, triple-deck streets diverting vehicle, foot and street-railway traffic into three separate levels, have been proposed to gain greater freedom in the business districts for all classes of conveyances and the pedestrians. According to one of the sponsors of the plan of decking the streets, the idea instead of being of modern origin, is said to date back to olden times, when Leonardo da Vinci made a number of drawings, which are still preserved, for double-decking the streets of Milan. On the lower plane he planned to keep the horses, cattle and peasants, while the upper street was to be reserved for the aristocracy. Arcades have also been incorporated in proposed plans to eliminate store and shop entrances from the path of pedestrians along the sidewalks, thus creating expansive arched promenades on the floors of large buildings, and connecting with the streets from the lower levels. Other big cities, traversed by or bordering on waterways and which purpose improvement in present-day methods of providing adequate traffic movement, have made allowances in their plans for wharves submerged below the streets and connecting with distributing centers by means of a

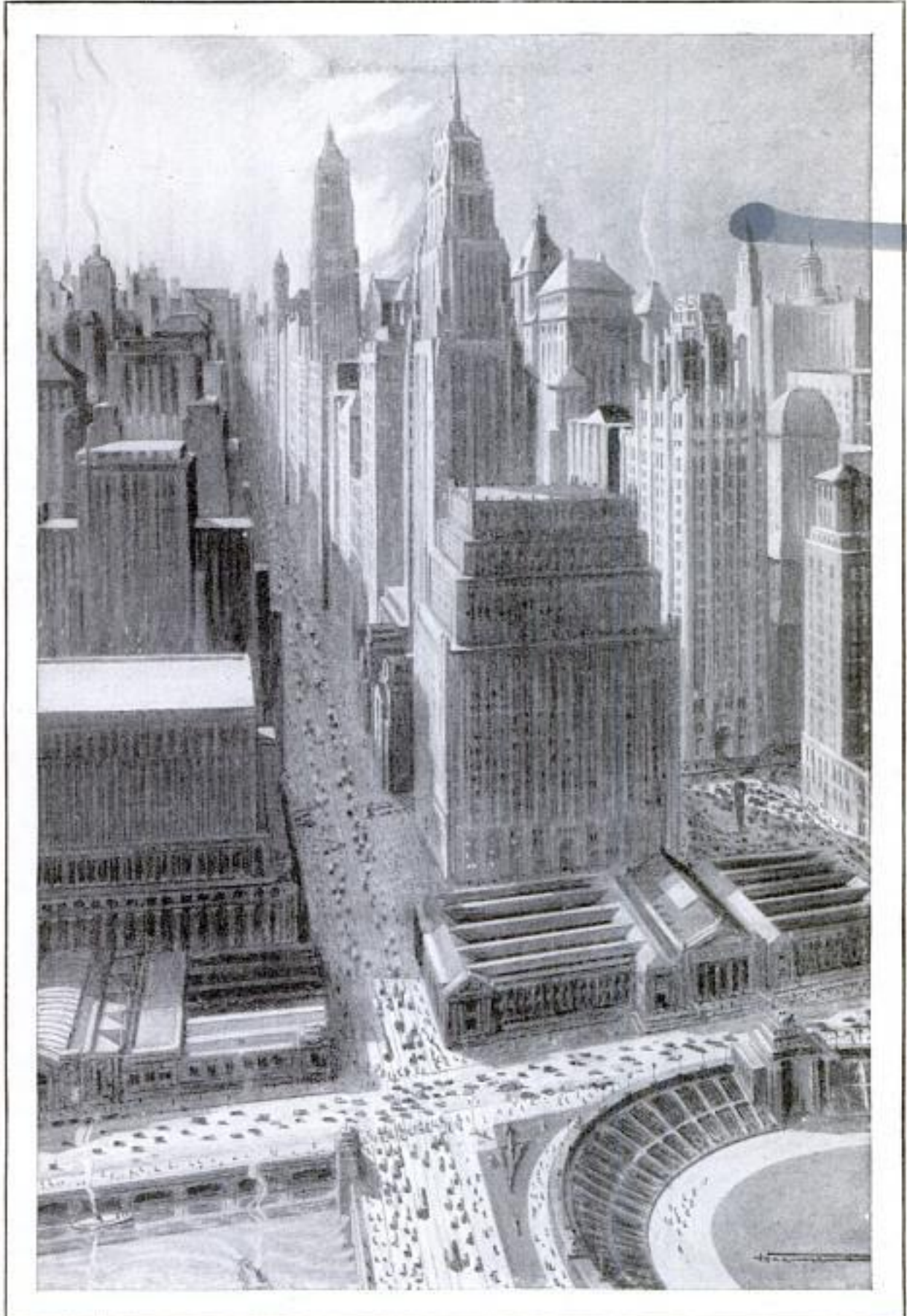

Artist's Grouping of Recently Completed and Proposed Skyscrapers of Several American Cities, Showing the Tendency of Modern Architecture Toward the Receding, Terraced Design of Building Construction

420



Glimpse of New York a Half Century from Now, as Seen by Hugh Ferriss, Architectural Artist, Which Illustrates the Plan Adopted by the Metropolis to Insure Light and Air Space

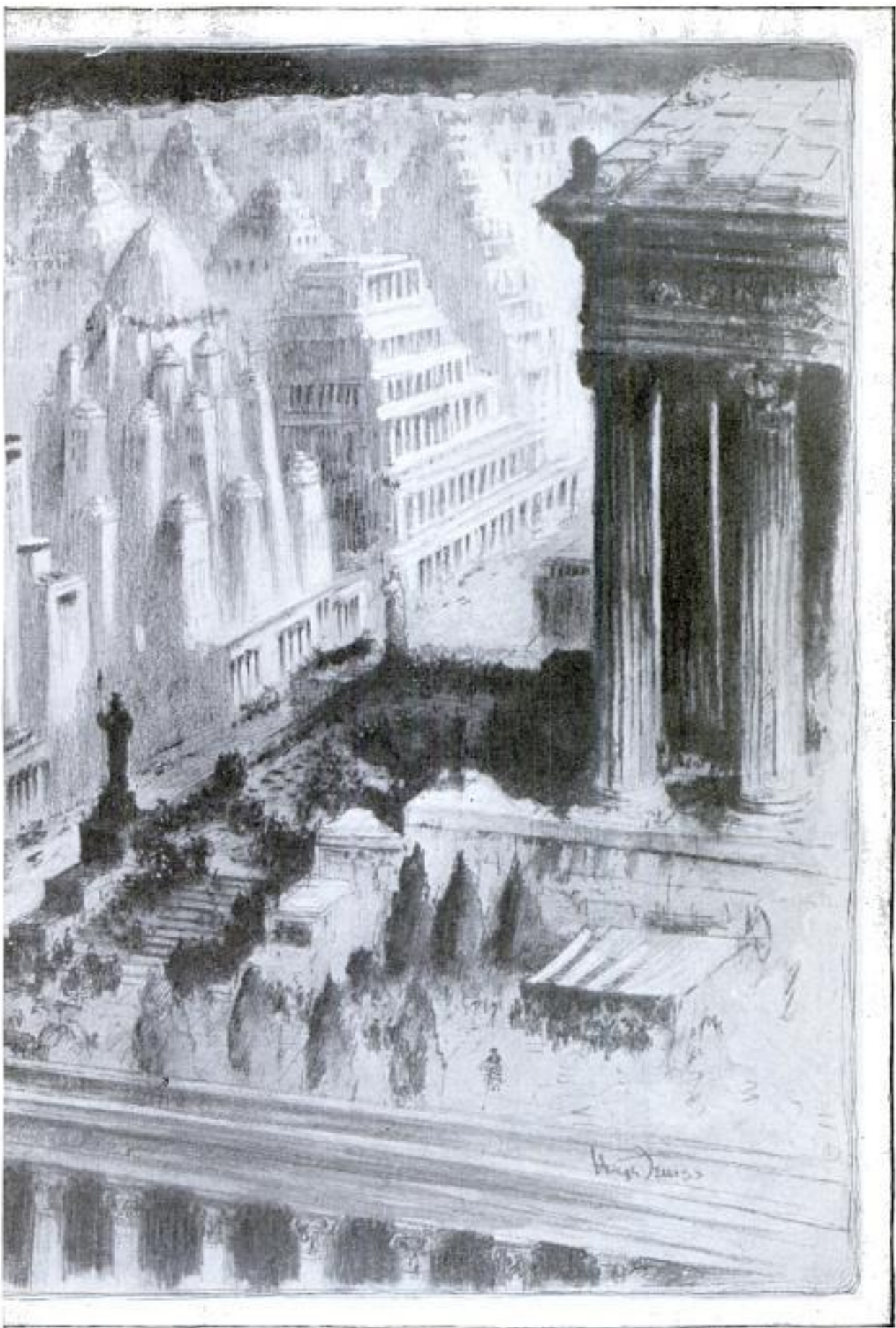

It Is Predicted That, with This New Pyramid Form of Structures for Big Cities, the Terraced Levels Will Permit Development of Gardens and Open-Air Theaters Hundreds of Feet above the Sidewalks

series of tunnels passing under the buildings. Both land and water traffic in these ideas are to be assisted by drawbridges spanning the rivers and inlets at convenient points, whereby shipping and lighterage service can be accommodated with passage close to loading places.

While the change from the straight severe wall of the familiar skyscraper to the terraced-block building is taking place, greater heights are being sought for future structures with corresponding efforts in beauty of form. Where formerly twenty or thirty stories have been considered a fairly substantial height, now mas-

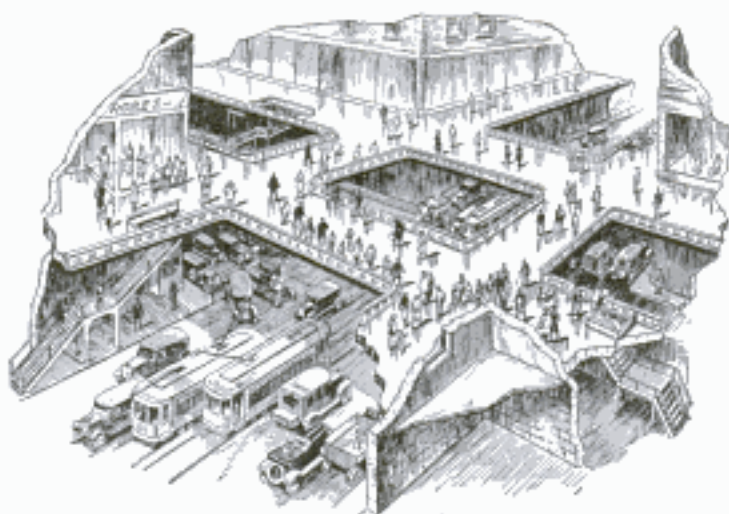

System of Elevated Sidewalks Suggested for Chicago's Business District to Relieve Pedestrian and Vehicle Traffic

sive business blocks of forty to fifty stories, able to accommodate the population of a good-sized city, are being planned. To care for the additional weight foundations and bases are to sustain, the gradually decreasing width of upper floors within specified heights has been designed.

This arrangement also affords a better supply of air and more sunlight than the older forms of architecture found in the cities of this country. Inner courts have given way to outside "free spaces" while hazards from fire are greatly decreased and at the same time the artistic appearance of the structure is improved.

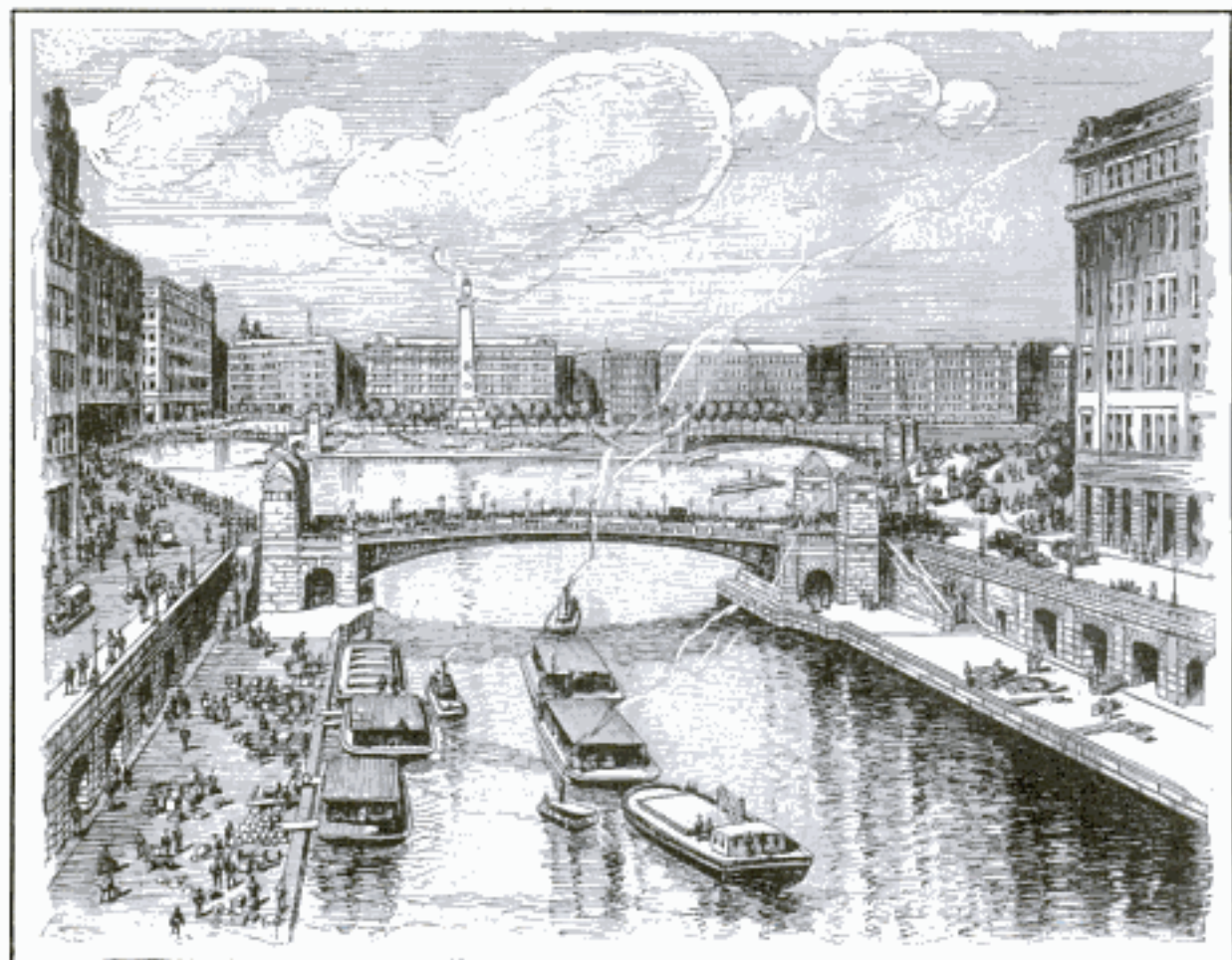

Venetian-Like Plan Submitted as Means of Solving Chicago's Problems of Civic Improvement by Building Roomy Underground Tunnels for Shipping beneath Structural Combinations of Art and Utility

Edw. S. Burdick
and W. H. Blovin
Portland, Ore

Toy Golfers on Miniature Course Imitate Open-Air Game 880

Moved with a spring released by a player, a mechanical toy man strikes a ball in an indoor golf game resembling that played over an open-air course. The imitation greens contain nine holes with small "hills" and "water hazards" to make the contests difficult. Skill of the player in setting and posing the "golfer" decides the accuracy of the pellet's flight after the stroke. The miniature fairway is seven

feet long and three feet wide, and can be easily set up or put away in a few minutes.

manufacture of articles made from mother-of-pearl. The finest shells for this purpose are said to be found in the warm waters off northern and western Australia, where approximately 3,000 men are engaged in gathering them.

— Carrel

Tent Poles and Auto Luggage Rack 534 Are Combined for Tourists

Carried conveniently in a rack clamped to the running board of the automobile

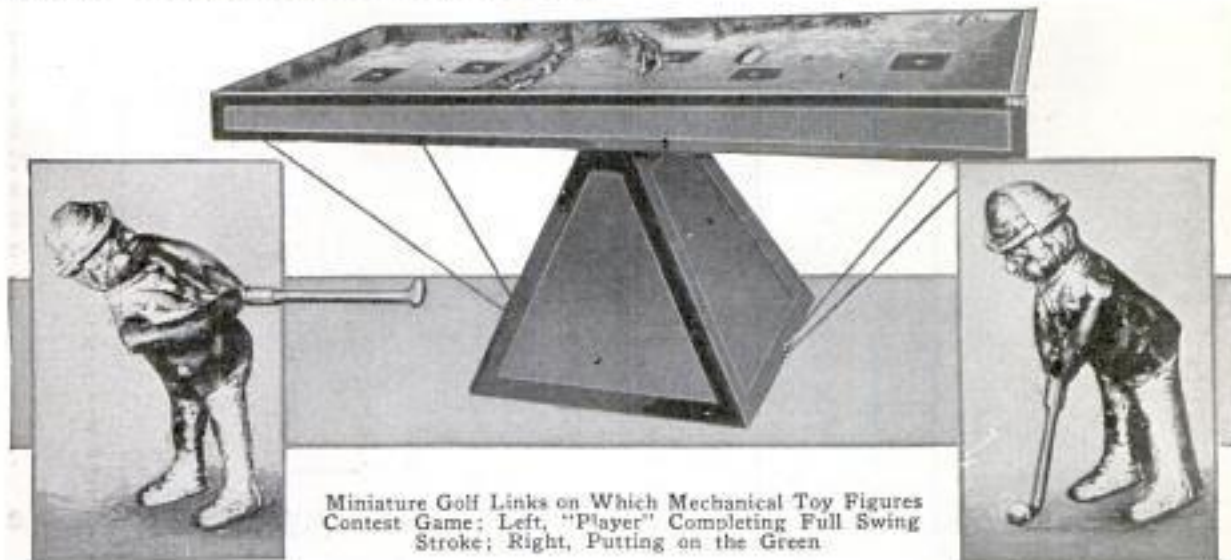

Miniature Golf Links on Which Mechanical Toy Figures Contest Game; Left, "Player" Completing Full Swing Stroke; Right, Putting on the Green

feet long and three feet wide, and can be easily set up or put away in a few minutes.

Deep-Sea Seekers for Pearls Win Fortunes from Ocean Bed 944

Scientific methods of diving for pearls in Australian waters have resulted in increased profits, it is reported. Steam-driven boats are used and the latest diving suits permit the searchers to remain below a considerable time instead of the few minutes that were the limit of the natives. The depth in which the men work varies from sixty to 144 feet. Two or more divers can descend from a single boat, each equipped with a bag. When the container is filled it is attached to a rope, the signal given and it is hauled to the surface to be emptied and sent down again. The shells are opened in the presence of the skipper. The oyster is removed, and although edible, is thrown back. The shells are searched for pearls and, if any are found, the captain takes charge of them. Pearl diving and pearl fishing are separate industries. The efforts of those engaged in the latter work are directed primarily toward collecting pearl shells used in the

where they form a handy luggage carrier, a set of metal tubes with couplings so arranged that they can be fitted together to form poles and supports for tents of various sizes and styles has been manufactured. Wooden poles can be carried inside the hollow metal ones to form additional lengths. In place on the car, the

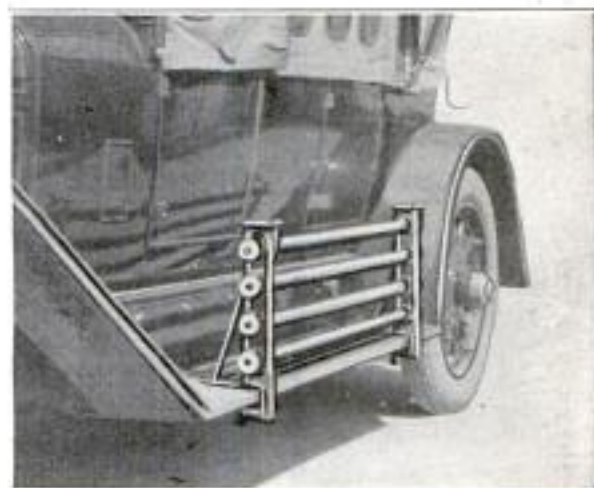

Metal Tent Poles in Rack That Forms Handy Luggage Carrier on Running Board

tubes are locked between the sides of the bracket holder so that they cannot fall out.

Feb. Bits, '24
March 29, 1924

A. C. Merriman & Co.,
White Plains, N. Y.
Copyrighted material

Cannot locate maker

971

Phone Permits Several to Listen or Talk at Same Time

To save time in large offices and eliminate the necessity for making repeated calls on the telephone, a small switchboard,



Party Telephone Instrument in Use; Keys Below Connect Offices in Any Combination Desired

transmitter and receiver have been combined into one compact instrument that can be placed on top of a desk or in any other convenient position. With it, the speaker can communicate with a number of offices and receive replies at the same time. It is designed especially for executives and managers.

Pulling Power of Horses Measured by Tests with Weighted Wagon

To measure the pulling power of horses, a testing wagon geared to heavy weights has been invented at Iowa state college.



Pull-Measuring Wagon in Operation; When Team Is Started, Weights in Front Are Raised on Hydraulic Platform While Operator in Rear Controls and Observes Their Action

When the team is started, the weights, the number of which can be changed at will, are lifted and the exact amount of force exerted is registered. Lifting a 1,600-pound weight on this wagon is figured as the equivalent of pulling the same burden out of a hole in the ground or starting a load of more than 20,000 pounds on a granite-block pavement. In the opinion of experts, this will eliminate much guesswork as to the actual work value of farm horses and will also show what sort of roads are best suited to hauling heavy traffic. Some of the interesting facts already revealed by the apparatus are that loads are most easily pulled on steel rails and that level granite blocks, set firmly in cement, offer the next easiest path; that good roads practically treble the pulling capacity of draft teams and that horses and mules possess reserve power sufficient to exert six or eight times as much tractive pull as is required in ordinary work. It is estimated that the use of the device will enable farmers and others to reduce by nearly one-third the expense of hauling by placing horses and mules where they can do the most efficient work.

1156

Finds Way to Keep Poppies Awake

Poppies and other flowers that close their petals at sundown can be made to open them at night, according to Luther Burbank, the plant wizard. The flowers should be cut before daybreak while their petals are still closed, he says, and then placed on ice for the day. In the evening, arranged in a vase filled with water and exposed to the warm air of a room, they respond to the heat by blooming.

Chicago Evening Post 5/5/24

*Kadel & Herbert
153 E. 42nd St.
New York City*

*Prof. E. V. Collins Agricultural
Department Iowa State College
Ames, Iowa*

*es.
e.
re-
hin
ion
we
e
ec-
fed.
9*

Capt. C. A. Aldridge, Esq. 127 Abbey Road



Memorial and One of the Searchlights That Illuminates It, Built into Miniature Rockery

War Memorial's Beauty Revealed by Battery of Searchlights

So that a war memorial erected on a hill in the center of a large park in an English town could be illuminated without having the searchlight apparatus detract from the beauty of the view during the day, the four lights were built into miniature rockeries on the ground that blend with the general plan of the park. They were mounted in specially constructed steel casings for protection, and during the day the glass faces are covered by metal doors. Under this plan the memorial is illuminated by a total of 12,000 candle-power with no objectionable framework supports visible.

and the sword. The "military party" was thus established and many systems of combat sprang up and were eagerly studied. The important feature in all of them was to tire out an adversary with a minimum of effort and to be prepared

Japanese Art of Self-Defense Is Shown in Mock Duel

Clad in strange armor, a number of Japanese gave a demonstration of the art of self-defense in London, in which the combatants, equipped with rounded clubs, engaged in a number of duels. Centuries ago, the samurai or bushi as the military men called themselves, gained great power in Japan by the use of the bow and arrow



Japanese in Native Armor Illustrating System of Self-Defense by Mock Duel

for any emergency. Jujitsu developed from study of swordsmanship.

☐ In southwestern Kentucky is a mine where asphalt rock is taken out like coal.

See World Photos
229 W. 43rd St
New York



Gold Seekers Revive Camps of Forty-Nine

Modern Processes Reclaiming Mine Dumps and Deserted Shafts Abandoned by Old Trail Breakers of Boom Days

RECALLING the days of '49 when the contagious germ of gold fever urged heroic pioneers to brave the hardships of a raw and unknown country and to face death at the hands of hostile bands of Indians, abandoned mine workings and "dumps" they deserted as exhausted operations, are being revived into producing fields yielding rich deposits of metal that escaped the crude processes of the old days. Modern cities and towns that have grown up on the sites of the camps that once dotted the mountain regions of the west are in many cases assuming appearances resembling the thriving "boom" days, when toil-worn prospectors gathered to swap yarns and experiences in dimly lighted shacks that answered as hotels, stores and even banks. Instead of consigning the glittering mineral to the care of "shotgun" messengers, sworn to the service of their employers in defense of the treasured shipments, the gold, melted into

bars, is now transported to collecting centers in swift and well-guarded cars.

The tobacco-chewing, swearing, knotty-handed but loyal stage driver has gone before the irresistible march of a civilization that banished the western road agent and train bandit of the sixties. His place has been taken by trustworthy men in employ of the railroads which carry the products of the gold fields safely to markets.

With the coming of "hell diggers,"—dredges—into more general use than ever before and the discovery of better processes of recovering the metal, renewed activity points to another series of booms in the heart of the gold-mining country. Old "tailings" are being cleared from abandoned shaft openings and cleaned of their metal contents which has remained often for more than half a century unsought and hidden in the piles of cast-off soil and rock dug from the depths of surrounding hills. New tools have come in place of the



Hydraulic Mining Where the "Pay Dirt" Is Washed into Sluices That Carry It to Mills to Be Treated for Its Gold

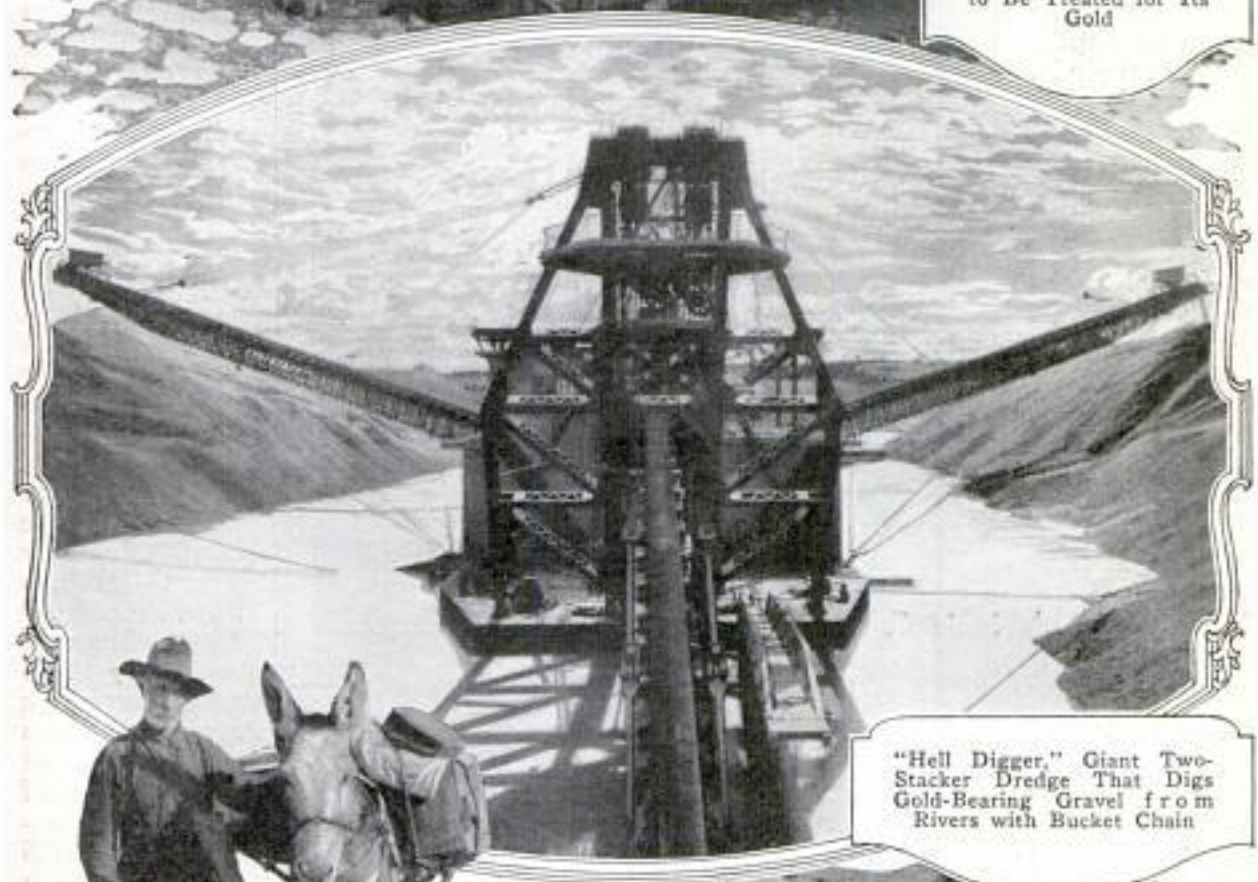

"Hell Digger," Giant Two-Stacker Dredge That Digs Gold-Bearing Gravel from Rivers with Bucket Chain



Prospector of the Early Days of the West with His Kit and Provisions Packed "Aboard" a Sturdy Sure-Footed Burro, an Animal Still in Demand for Transport Duty in Rough Mountainous Lands of the Gold Fields; Right, Miner with Pneumatic Drill Boring Opening in Rock for Blasting



inadequate pick and shovel and familiar blasting powder. Test drills are sunk thousands of feet below the ground in search of veins or leads that may have been overlooked or unsuspected by those who combed the regions of gold-bearing rock in the past. Expansive workings which have been producing for more than sixty years are sounded anew in the hope that they might reveal some trace of an untapped, hidden lode. Shafts driven to depths considered to be at the limit of the mineral-laden soils have been extended hundreds of feet beyond, resulting in the opening up of strata offering yields of gold undreamed of by old-timers who would have derided such efforts a short few years ago. Tumble-down shack camps, weed-choked drift mouths and old trails long since abandoned to the ravages of time by those

who believed the districts they occupy to be drained of pay dirt, have taken on a new attraction to the modern gold seeker who comes into the field with equipment designed to salvage the tiniest particles of the yellow dust. Workings and chambers filled with water seeping from the ground over many years have been pumped dry, cleared of fallen rock, the roofs supplied with new proppings, and digging begun again with tools operated by humming motors. Tracks are laid to the crushers and stamping mills run by electric power carried on lines that traverse the mountains for miles, and soil once scorned as useless from the viewpoint of

the miner is made to give up yields of gold averaging high returns.

While many mines that operated forty to sixty years ago have been abandoned as worked out, a number of large operations put in at the same time have produced

steadily ever since. In the northern part of the Black Hills in South Dakota is the Homestake mine, first worked in the spring of 1876. From a claim of ten acres this property has spread to include thousands of acres of land containing timber stands, mineral deposits and watercourses. This mine has produced nearly three-fourths of the \$190,000,000 worth of gold and silver taken from the district in forty years. It has approximately fifty miles of underground railway track and requires about two and a half tons of dynamite to assist the 575 drills which daily bite their

ways into the flintlike rock. Hundreds of tons of refuse dirt lay for a long time around the mine openings, considered worthless because no means of salvaging the fine particles of valuable metals they contained was known. Then a new method of smelting was developed and the heaps were reclaimed and gleaned of hundreds of pounds of gold once thought impossible of recovery. Despite almost a half century of continuous digging, there is said to be still twenty years of work left to be done in the mine, and no apparent indication of the ore veins diminishing is in sight. However, new ore leads and cheaper mining methods are still sought there.

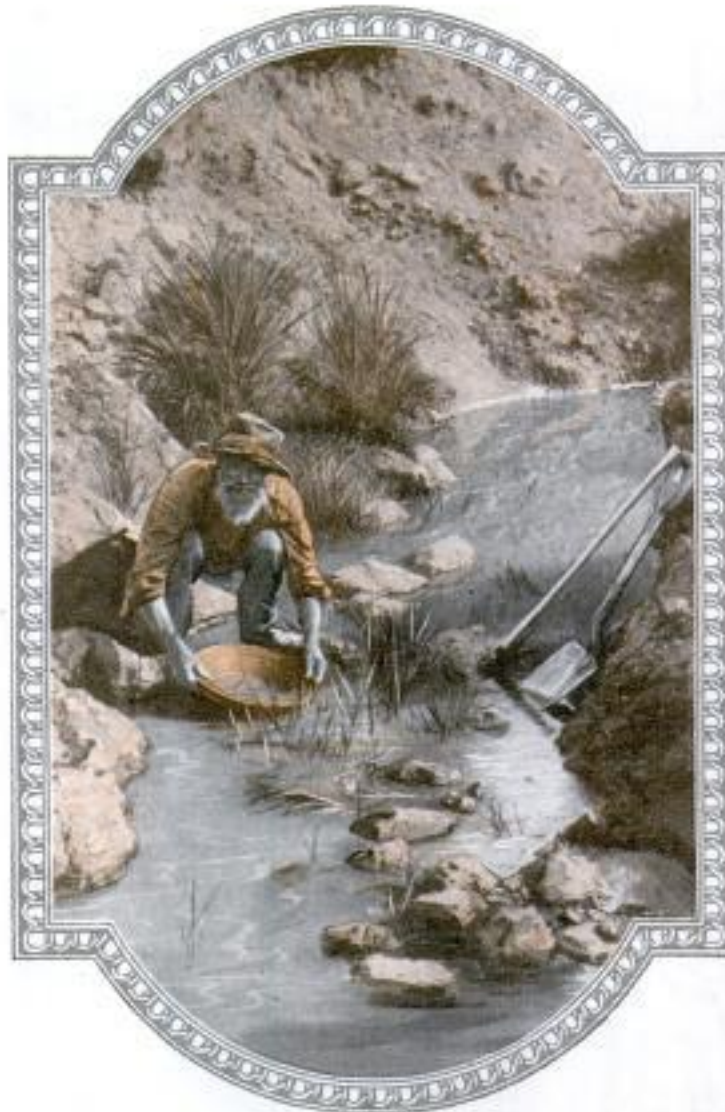

Old-Time Prospector, of the Days of Forty-Nine, Panning the Sands of a Mountain Stream in Search of Gold

558



Gold Miners "Going on Shift" Awaiting Elevator Cage Which Carries Them Underground



Monument to James W. Marshall, Discoverer of Gold in California

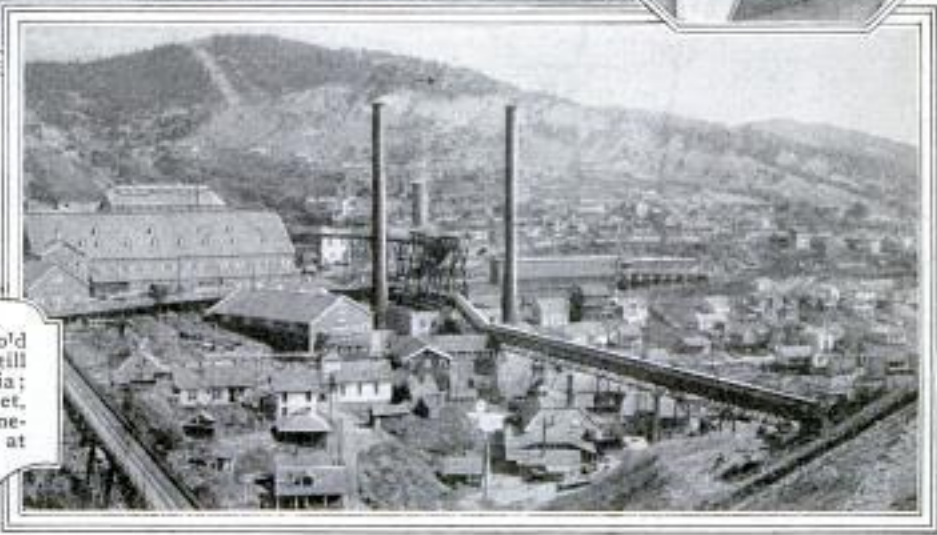
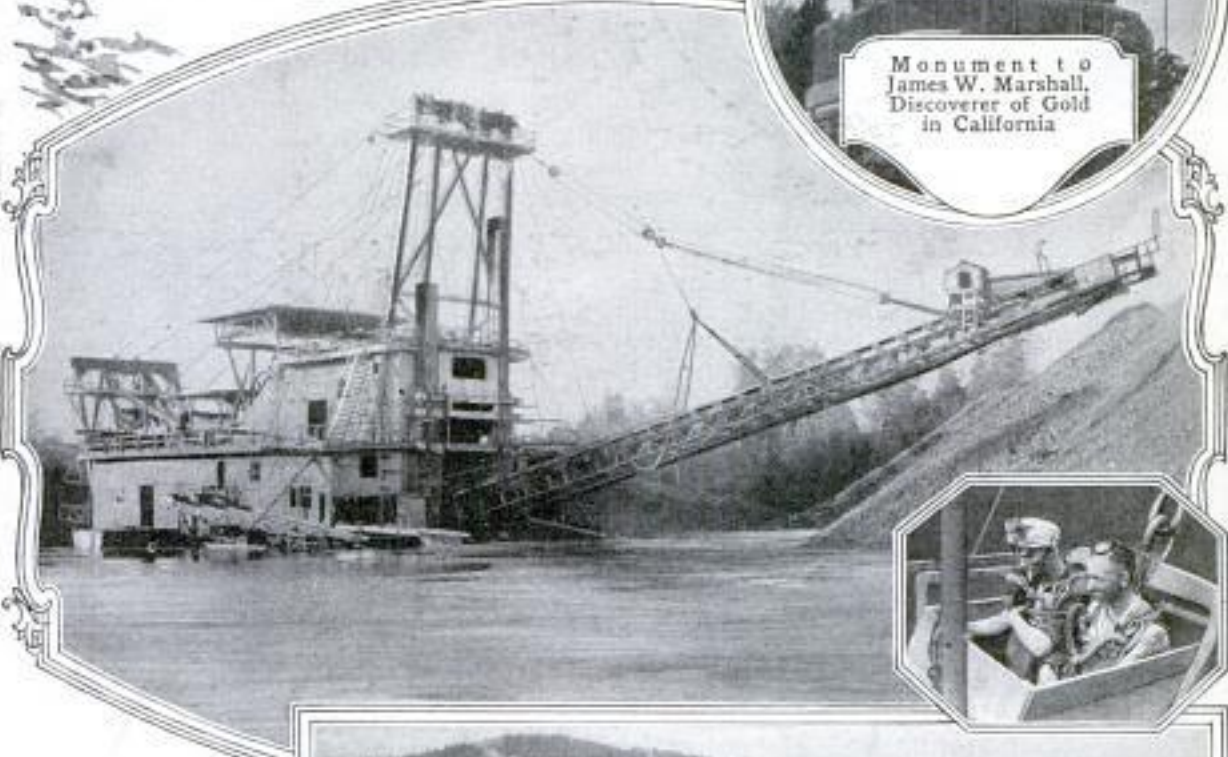

One of Earliest Gold Dredges Which is Still Operating in California; Miners in Its Big Bucket, and Right, Part of Homestake Mine Properties at Lead City, S. D.

Soundproof Cabinet on Typewriter
Decreases Noise in Offices

Soundproof cabinets which inclose all but the keyboard, carriage-reversing and

the cylinders as a whirling vapor, easily ignited. Less carbon, longer life for the batteries and greater ease in starting the engine in cold weather are also claimed for the invention, and it can be installed with little trouble.



Typewriter Silencer Cabinet Adjusted; Work Seen through Top Glass, Levers and Keyboard Exposed

line-spacing levers of a certain make of typewriter, have been designed to decrease noise in offices and to protect the machine. They are manufactured of metal, grained to harmonize with other furniture, and are lined with thick, sound-absorbing felt inside. The slanting top is of glass so that the typist can see the work, and the cover is raised automatically at the touch of a small button.

Automatic Primer Saves Gasoline
and Makes Car Easy to Start

To save fuel and facilitate starting, a device that atomizes the priming charge of gasoline has been designed to fit any make

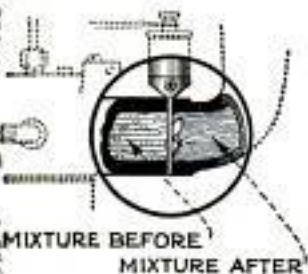

of automobile or truck. It is installed between the carburetor and the intake manifold and works automatically.

When the starting pedal is pressed, a valve operated by a magnetized coil throws a jet of gasoline against a set of stationary blades. These break up the globules of the liquid which is sucked into

1110 Making Wood from Corn Cobs

Corn cobs are said to have been turned into a good substitute for wood by Prof. Darling of Milliken university. The cobs are ground into a pulp, mixed with a substance that binds the product together and compacted by powerful hydraulic pressure. When the process is finished, it is said the wood is so hard that it can be whittled, shaved or turned in a lathe without danger of chipping.

The Targit, N.Y. 2/26

Blind Horse Is Pulled from Ocean
with Block and Tackle

Frightened by attempts to rescue it from danger, a blind horse plunged from the edge of a pier in Boston and then started to swim out to sea. Police followed in a



Blind Horse that Plunged from Pier Being Lifted Out of the Water with Block and Tackle

boat and finally succeeded in towing the animal back to the dock where it was lifted out of the water with a block and tackle.

Whitehead Metal Products Co,
261 Canal St New York

D. E. H. O.

International
newsreel Copyrighted material
326 W. Madison, Chicago



British Engineer and His Wife on Their Ocean-Going Lifeboat Which They Have Fitted with Sails and Engine for 16,000-Mile Cruise to Australia

Lifeboat Fitted for Ocean Voyage of Sixteen Thousand Miles

Equipped with sails and a seventeen-horsepower engine, an open lifeboat has been rigged by a British engineer to take him and his wife on a 16,000-mile ocean cruise. Starting from Penzance, near Land's End, England, the navigators will guide their craft to Australia, taking turns at the wheel by day and night. The engine will be used in times of calm.

Summer Sun Reveals Desert Sands in the Wilds of Alaska

Shifting sands, having all the characteristics of the Great American desert and constituting a menace to inexperienced travelers, have been discovered in Alaska, according to reports from prospectors. The reason this desert of the far north has not been found before, the miners say, is that trips over it have always been made in winter when heavy snows conceal the true nature of the country. Last summer, however, some prospectors started back over the route when they encountered conditions that made them apprehensive. Where, in the winter, the old trail had appeared to lead across a level plateau, they reported finding immense sand dunes and the entire landscape changed. In summer

the winds start the sands moving in the same manner as on the American desert and changing of landmarks makes it difficult to travel.

Detective Camera Like Telescope Has Dummy Front Lens

Shaped like a small telescope, a pocket camera that takes pictures at right angles to the line of vision, has been designed especially for the use of detectives, or others who desire to obtain photographs without the knowledge of the subjects. A dummy lens at one end resembles that of a field glass. Thus the user is able to take a picture at right angles to the ostensible line of vision. The view finder is contained in what appears to be the eyepiece. The camera can be focused to less than a yard or to "infinity," and uses plates or film.



High-grade paper is being manufactured from waste cotton.

New York Times
 May 5, 1924

U. S. Agent
 Is. Isenbergh
 133 N. Wabash, Chicago

New York Times
 May 5, 1924
 248 W. 43rd St.



Each Nail and Point in Wooden Statue Is Congo Tribesman's Prayer for Vengeance

Prayers for Revenge Said by Nails Driven in Wooden Statue

One of the latest additions to the University Museum at Philadelphia is a curious wooden statue bristling with many nails and sharp metal points. It is one of the fetiches commonly found in western Africa not far from the mouth of the Congo river where natives practice weird religious rites. Each nail and point represents a prayer to the spirit believed to dwell in the figure for vengeance on some enemy of the tribe. A priest and a party of followers go into the forest and cut the statue from a live tree. While it is being prepared, only the names of persons whose death they desire and whose spirits they wish to enter the statue, are spoken. As soon as it is dedicated with proper rites, the figure is supposed to become the dwelling of spirits that award justice.

Rapid Growth of Canning Industry Aided by War's Demands

Due to the tremendous demand for foods packed so that they could be easily shipped, the world war with its huge orders for "corned willie" and many other goods, was the greatest impetus the canning industry has had since its introduction in America in 1815, according to an official of the Sacramento, Calif., chamber of commerce. In 1914, the value of all canned food products here was placed at \$243,000,000. Today, it is well above the \$600,000,000 mark. Peaches are said to be the most popular of canned fruits and salmon leads among the sea foods. Nicholas Appert, a Frenchman, invented the process of hermetically sealing food products. His idea was to use the plan for sailors at sea, but the French government purchased the invention and Napoleon allowed manufacturing plants in England and France to use the process. When Ezra Daggett, an American, introduced the business into this country, cans were made by hand, sixty being considered a big day's work for one man. With the invention of the stamped can, in 1847, the growth of the industry has been rapid.

Chicago Daily News 4/15/24

Auto Trunk Rack Easily Changed into Luggage Carrier

By simply lifting two hood fasteners, an attractive trunk rack now on the market may be turned into a luggage carrier. Neat in appearance and yet durable and rugged, it may be installed in half an hour without drilling, tapping or fitting of any kind. The

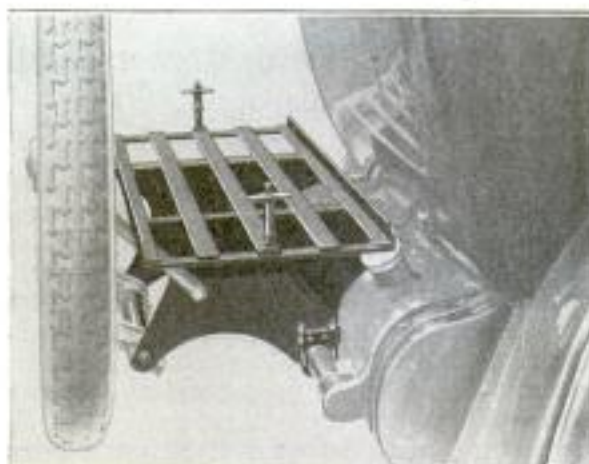

Automobile Trunk Rack Which May Be Converted into a Luggage Carrier by Lifting Two Fasteners

trunks are built of kiln-dried lumber, covered with long-grain, black material and bound with aluminum edges.

Bradley's World Products Co., Hastings, Neb.
Copyrighted material

0-18

Chas. H. H. Lunn, Jr.
2722 Prince St.
Berkeley, Calif.

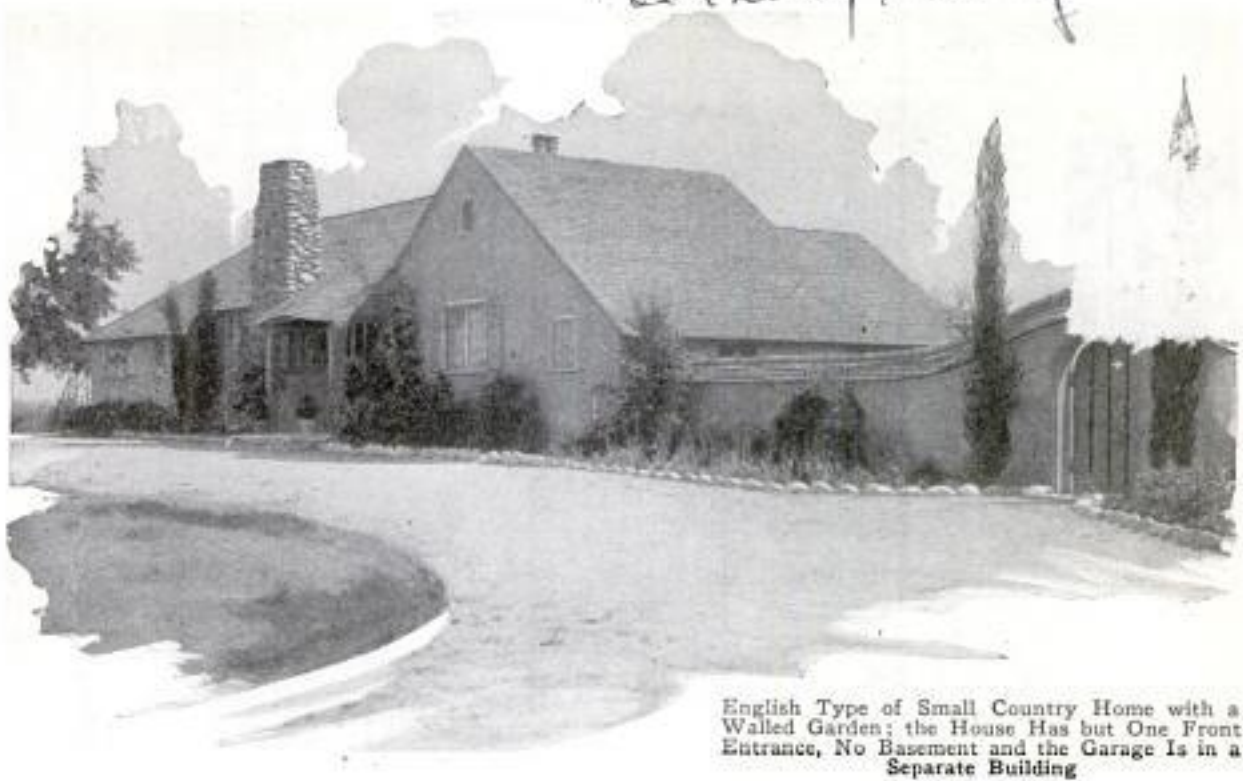

English Type of Small Country Home with a Walled Garden; the House Has but One Front Entrance, No Basement and the Garage Is in a Separate Building

Beauty and Utility United in Latest Homes

Ornate Houses Occupy Small Space and Combine Art and Comfort with Labor-Saving Equipment That Cuts Building Costs

EQUIPPED with built-in beds, dressing tables and chiffoniers concealed behind paneled doors and mirrored walls, in rooms that can be changed in a twinkling from cozy living rooms to comfortable sleeping and dressing chambers, houses of the four and five-room bungalow type are now being designed with conveniences equal to larger buildings put up two and three years ago.

Where larger and less modern homes are furnished with out-of-the-way sun porches, garden promenades and detached garages, the later type of small home has all such conveniences carefully worked into the limited ground plan in such a manner as to leave plenty of space for outside decorations. Instead of the "square" plan usually found in the designs of small dwellings, U-shaped and L-shaped buildings are now being erected, and the areas of free ground within the angles are being occupied by garden plots and shrubbery, greatly adding to the attractive appearance of the domicile.

Where formerly a distinct type of architecture marked the general design of the structure, builders are now combining the romantic lines of old Dutch, English and

French styles with the smooth, simple walls of harmonized Spanish, Mexican and Moorish construction. By adapting the long French window to the sway-backed roof, squat chimney and turfed yard of the English manor house, a home is evolved that fits a small lot but gives an impression of being much larger than it really is.

Entire blocks of bungalows, no two of which are of the same design, have been built within ornamental walls which contain complete conduits for all wire and pipe necessary to carry required service of water, gas and electric current to the houses. This is only one of the methods employed by the architects to reduce the cost of construction and at the same time prevent exposure of anything that might detract from the neat beauty of the finished structures. The appearance of size and spacious surroundings is also furthered by the employment of built-in equipment in the interiors. Today, in some parts of the country, it is possible to get homes with kitchen, dining-room, bedroom, laundry and garage fixtures already provided, leaving only a few articles of furniture and personal needs to be bought by the owner. Kitchens in other labor and space-saving



Small House of
English Design:
Right, Toilette
Cabinets Joined in
Linen Closet

Left, Handy Kitchen
Accessories That Open
from Wall; Above,
Cozy Concrete House
with Rear Garage

Electrically Operated Home That Has Chimney Lines Filled by Graceful Peaks

1048



Concrete House with Window Balcony Overlooking Lawn; Below, Novel Telephone Cabinet behind Panel



Convenient Breakfast Table That Forms Door of China Closet; the Bench Collapses beneath Window Sill

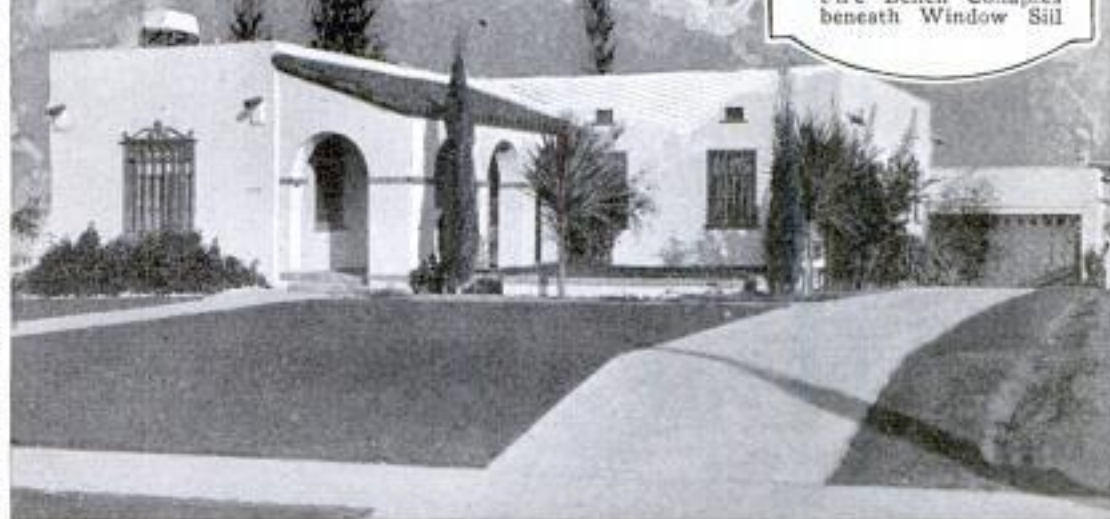

Flat-Roofed Home of Mixed Moorish and Spanish Model with All Rooms on One Floor

homes are furnished with tables and seats, accommodating several persons, which fold against the wall and are controlled by push buttons. When opened out, the table reveals a china closet handily arranged to care for the storing of the services and cutlery.

In the dining room, percolator, toaster, waffle iron and broiler are all carefully hidden behind elegantly finished walls and can be extracted in a moment and spread upon a table that folds against the side of the room until needed at meal time.

Despite the luxuries and conveniences that in recent years have been developed to assist the housewife and home owner, costs of homes provided with such improvements are said to be remarkably low. And in their use the occupants are relieved of the task of selecting and purchasing ordinary furnishings that would be required in houses not so equipped. Besides, there is more space available for various purposes. For instance, an entire case of shaving accessories can be inclosed in a small aperture in the wall of a bathroom. Merely by pressing a button or turning an ornamental latch, the device may be opened out and becomes a nicely arranged table on which all of the articles can be placed. Sometimes this appliance is combined with a medicine chest and the whole arrangement concealed in the rear

of a mirror in the wall. Out of the door of a linen closet a shoe-shining stand can be made to open, and a wall heater with three heats is provided to keep the bathroom at any one of the temperatures desired. A series of electric push buttons in the bedroom controls the operation of the heater, so that the room can be made comfortable in advance of the hour at which it may be needed.

Outside the windows of such homes, miniature, yet perfect, gardens can be planted in inclosures that make it possible for the owners to enjoy the flowers on rainy days as well as in clear weather. Sun porches, built to extend back into the rear of the lot, may be surrounded on three sides with flowers and vines, making the backyards as attractive as the front lawns. Pleasing combinations of windows overlooking tiny balconies and ornamental doors opening upon narrow but graceful walks are planned to serve as convenient entrances as well as to harmonize the houses with their grounds.

With the introduction of electricity for heating and cooking in the household, dwellings are now being planned without chimneys on the roofs. In their place attractive gables and turreted peaks are built, allowing more space for storage purposes in small rooms that can be put under the angles. Elimination of flues leaves added freedom on the interiors where larger chambers result from the absence of juted walls. The value in material and labor thus saved represents no small fraction of the expense to the house owner. And besides, the room gained can be devoted to built-in accessories.



Two Views of a Home of Unusual Mexican Design, Built of Flat, Hollow Tile and Concrete; Resembling Two Buildings, It Has a Large "Patio" and Three Fireplaces

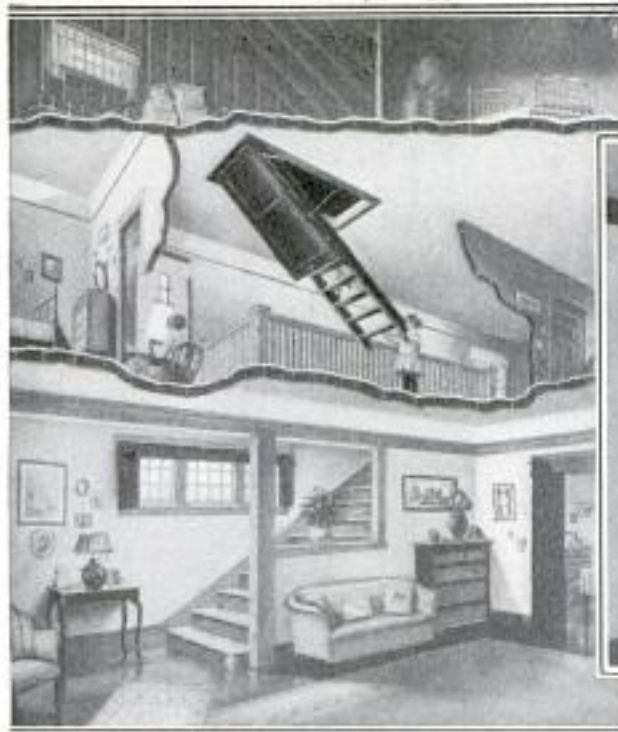

Trapdoor Stairs Lowered and View Showing How They Leave Hall Space Clear



Stairs That Pull Out of Ceiling Save Floor Space in Home 498

Sliding stairs fitted to an overhead trapdoor so that they can be pushed up out of the way when not in use, have been designed to save floor space in hallways. When the door is opened by pulling down on a chain hanging within convenient reach, the stairway, supported by cables and attached to rollers, automatically slides to the floor. It is easily raised and pushed back again, and as it lies flat on top of the door, it takes up but little space in the attic. A handrail at one side insures safety, the steps are spaced at comfortable height and the stairs slant at an easy angle.

Big Underground Water Reservoirs Feed Springs and Wells 1130

Feeding springs and wells with their subterranean supplies, pores, tiny holes and vast caverns in the solid rocks of the earth's crust, guard against water famines when rains are scant. These water-bearing openings are the result of processes that have been at work for ages. By careful study of the dip and slope of formations and the character of the rocks, drillers are often able to forecast the presence of water, and to assist them the United States geological survey has published more than 200 reports on the ground-water

Chicago Evening Post
Mar 1, 1924

conditions of various sections of the country, stating what conditions are most favorable to its occurrence and furnishing other information valuable to the well digger.

Tractor Guided Like Wheelbarrow Takes Place of Switch Engine 650

Run by storage batteries, a small electric truck for switching cars and towing lighters on canals has proved successful in Germany. It is guided somewhat like a wheelbarrow with two long handles between which are the starting and control levers. The tractor has power sufficient to pull or push seven small freight cars.



Pulling a Freight Car with Electric Tractor Truck; Spring Bumpers Are for Pushing

Copyrighted material
Chicago Evening Post
Mar 1, 1924

Cml. H. Sakata, 40
Mr. Katayama, 605 7

248

American
Locomotive Co
30 Church St
New York

Japan

Li-machi com. surr.

Cubist Art and Sheet Metal Repair
953 Quake Damage in Tokyo

In the rebuilding of the sections of Tokyo destroyed by the earthquake, oriental and western styles and materials are being combined. Nearly 1,000,000 buildings were destroyed but, according to an official report, not one structure of modern type was a complete loss. Impressed



Store Built to Replace Structure Destroyed by Quake, Showing Odd Trend in Architecture

by this fact, the Japanese have ordered vast quantities of improved building materials and have asked the assistance of many foreign engineers and architects. Many of the temporary buildings have been constructed in queer forms of sheet metal.

1220 Huge Steam Locomotive Is Rival to Electric in Pulling Power

Supremacy in hauling railroad freight, claimed recently for an electric locomotive, is to be challenged soon with the introduction of a steam engine operating at 350 pounds' pressure and incorporating

features of design upon which engineers have been working four years. It bears slight resemblance to modern engines. The smoke box is small and the boiler can scarcely be seen under a maze of huge steam pipes. The heating apparatus is of the marine type and the tubes carrying the circulation water are placed outside the fire box. Incased in extra-heavy asbestos, the tubes give the fire box an unusual width, so that it is only a few inches narrower than the cab, which itself is of the maximum width permissible for railroad use. The steam is admitted under high pressure first to the cylinder on one side and then passed, under slightly decreased pressure, to the cylinder on the opposite side, larger in diameter to produce the same power. It then is exhausted through the stack. A pair of small forward wheels but the usual trailers are missing, the idea being to concentrate the weight to provide greater traction. The usual "booster" is attached to the forward truck of the tender. Steam is carried through steel pipes to this, which, with its small wheels and consequently lower gearing, is used in starting the train, after which the pressure shuts off automatically. Greater efficiency in freight haulage at less expense than the average engine is claimed for the locomotive.

Used by Delaware & Hudson RR

1223 Sleepless Surgery Is Predicted

Prediction that a majority of surgical operations of the future will be performed while the patient is conscious, was made before a recent medical convention.

By "blocking" the nerve group that controls the part of the body to be operated upon through the agency of a local anaesthetic, it was said that pain would be eliminated without the necessity of putting the patient to sleep. Considerable research work in nerve blocking has already been done, it was declared, and certain major operations have already been performed.

Chicago Daily News 5/15/24

With a dial fifty feet across, the minute hand twenty-seven feet six inches and the hour hand twenty feet long, a clock that, it is believed, will be the biggest in the world is being made for a Jersey City factory; the two hands will weigh a ton.

made by Seth Thomas Clock Co., Thomaston Conn.

New York Times May 15, 1924

Cmt. George H. Paul
900 Elsworth Bldg,
539 S. Dearborn

Surveyors Battle Snow and Cold
to Locate Mountain Road 950

Battling stiff gales and plunging through deep snowdrifts at sub-zero temperatures, a party of five surveyors fixed the location for the Warren G. Harding highway, a continuation of the Mt. Evans road, high among the Colorado Rockies. At times, the wind blew so hard that two men were required to hold the level rod. Four-foot stakes frequently were used because of the depth of the snow. Several trips were made over perilous country for supplies

the task was finding the location for three tunnels that are to pierce great rock bluffs, 1,500 feet high, above a lake.

Invisible Wire Gauges Strength
of Electric Currents 1890

Strands of wire so fine that they can be seen by the naked eye only as they reflect a streak of light are now being manufactured from tungsten and copper-nickel alloy for the tiny filaments that measure minute alternating currents. It would take 100 of them to make the thickness of a



When Snow Banks Were Encountered, the Pack Horses Needed Aid



Digging Their Way through Deep Drifts, Surveyors Planted Their Transit on Wind-Swept Summits to Mark Path of Highway



and sometimes the men were tied together like Alpine climbers. In all, the party ran a line twenty-five miles long with a maximum grade of six per cent, dropping 5,000 feet in elevation. One of the difficulties of

single human hair, some of them being only one five-thousandth inch in diameter. A microscope is needed to aid in handling them. The tungsten or alloy is first drawn through dies made of pierced diamonds and then eaten down to the desired size in an electrolytic bath.

Western Electric Co., 463 West St. New York City.

new York Times 4/21/24
Copyrighted material



Pupils and Teacher about Group of Sand-Box Settings from the Operas



Fashioning a Lovers' Forest by Sticking Real Sprigs in Sand



Wooden Blocks for Pyramids Added Realistic Touch to "Aida"



NUTCRACKER BALLET



Gingerbread House and Fantastic Ballet of Tiny Dolls in Lively Poses



Sums and "Three R's" Forgotten in the Fascination of Modeling Music

*Chas. Gardner Wilson
145 3/4 W. Madison
Chicago
Change Building*

Patent #1,471,734

**Gingerbread Operas Help Pupils
in the Study of Music**

By staging miniature replicas of operas in gingerbread, ballet suites in sand with doll dancers and interpreting Verdi and Mendelssohn in rags, pasteboard and colored paper, grade-school children of Cicero, Ill., have made a game out of the study of music.

The plan was devised primarily to assist the pupils in a music-memory contest and in their study of English. Instructors explained the idea, but the children did all the work on the models, which were constructed and arranged in the schoolroom sand boxes.

Tiny electric-light globes added to the realism of the miniature stages. Bricks painted on paper and red lamps reproduced the effect of a burning castle. Stores were ransacked for cheap dolls of all descriptions, and even the boys took delight in helping to costume them. Pyramids were devised of rough blocks of wood, sprigs were placed in the sand to represent a dense forest and a gingerbread house was roofed with cookies.

**Two-Pronged Puller Removes Corks
without Breaking Them**



Corks are pulled easily, and without breaking or jamming them into the bottle, by a small handle to which are attached two narrow, grooved spring prongs. These are inserted between the cork and the neck and a twist withdraws the

stopper. The prongs may be bent in or out to fit bottles of different sizes.

no injur
Easy to Start an Avalanche

Avalanches have sometimes been started by trivial causes. The tinkle of sleigh bells or even a whisper, has been known to set them off in the Alps, and many lives have been lost by a climber shouting to his companions. Several years ago, a caravan of sleighs was overwhelmed by a sliding mass of snow and ice, supposedly started by the sound from the bells. Thick stone barriers have been erected high on the mountain slopes to protect travelers.

*Chicago Daily News
9/1/24*

**Extension Platform on Wheels Is
Run and Steered by Worker**

So that work may be done at an inaccessible elevation without the building of a scaffold, a vehicular extension support has been patented. It consists of a platform on wheels which may be easily raised or lowered. Even when extended to its greatest height, it may be propelled by hand or electric power and steered to any posi-

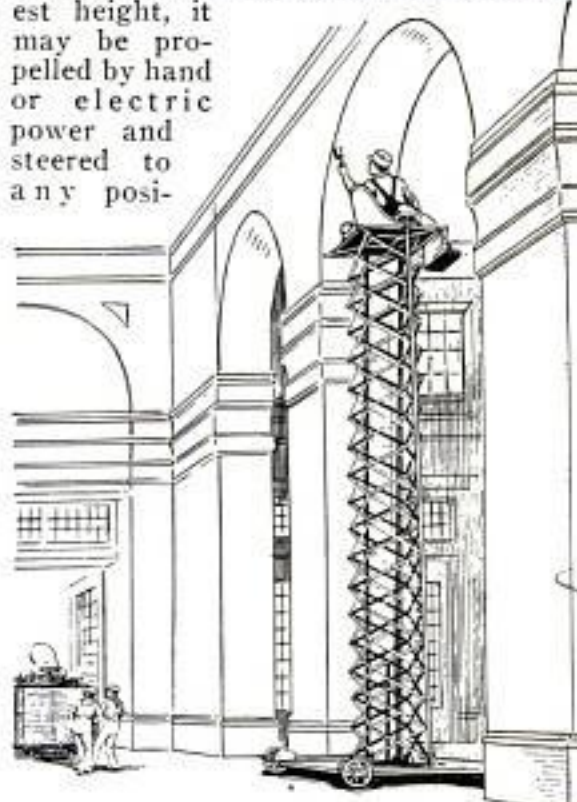

Extension Support Which May Be Propelled by Hand or Electric Power to Any Desired Spot.

tion. Collapsible when not in use, it occupies little space.

1058
**Cigar-Shaped Humidor of Glass
Fits in Box with Smokes**

To keep cigars fresh and moist, a small glass humidor, the size and shape of a cigar so that it will fit the box, has been placed on the market. It will also prevent cigarettes and tobacco from becoming dry. The tube is filled with a preparation simi-



Glass Humidor Shaped Like a Cigar That Fits in Box to Keep Tobacco Fresh

lar in appearance to mineral wool. The contents are kept moist by dropping water into two holes in the humidor about once a week.

*Paper Hospital
wash + Adam
sin this one.*

*Cl. W. Peter M. Jansen
Riversell, New York*

*Chicago
of
Hearborn,
008*

Copyrighted material
Chicago 90

*Cont. George H. Hilden,
Hill Crest Lodge, Tipton
New Road, Chesterfield,
Coke Dust Is Pressed into Blocks
95% as Substitute for Emery England*



Copyright, Keystone View Co., Inc.

Combination Tennis-Racket Press and Seat Attached;
Note Wire Legs Folded on Handle

Tennis Racket with Folding Legs Becomes Seat for Player

Tennis players who have to wait for courts will be aided by a racket press that can be used as a chair. The sides are formed by the back and seat which clamp on each side of the frame. In carrying, the legs are easily folded out of the way.

Volcanoes Yield Fortunes

Volcanoes are said to have yielded sizable fortunes to Italians who have built factories around the craters to obtain commercial by-products. Boric acid is one of the most important of these. Ammonia is also present in sufficient quantities to permit its separation at a profit. The volcanic region near Naples bubbles and seethes with smoke and fumes. If the gas of any of the small craters is ignited, puffs of smoke appear in a dozen places on the surrounding hills. Over a large area, the ground gives a hollow sound when tapped with a cane as it is only a relatively thin crust under which is a veritable inferno.

"Donkey" Engine Attached to Cable Pulls Itself across River

Working against the odds of a sub-zero temperature and water that threatened to extinguish his fires, an ingenious and plucky engineer in northern Idaho rigged his "donkey" logging engine to pull itself across the St. Joe river. A cable, run through a pulley block on the opposite side, was attached to the engine at the winding drum. Then the donkey, securely fastened to a log raft, was fired to 150 pounds' pressure and moved across the ice by applying power to the drum. Luckily for the engineer, the river was only four feet deep at a point where the "steamer" left the ice, for water flooded the fire box and only by sticking steadfastly to his post, was he able to put the engine across the

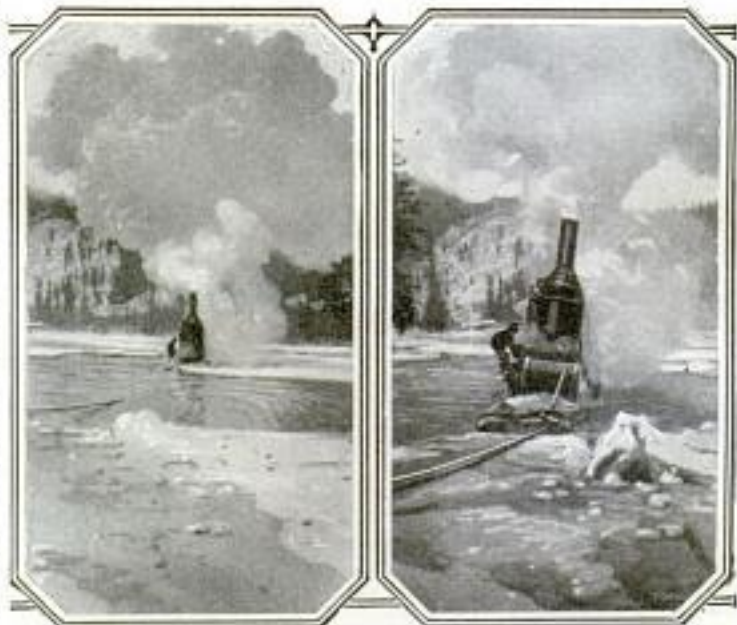

Snaps of the "Donkey's" Gallant Voyage across the St. Joe River;
Clouds of Steam Arose When Water Reached the Fire Box

stream. He finally arrived at the opposite bank with only ten pounds of steam.

*Marble Creek Station,
Idaho.*

*nd mfor
Kansas City
4/25/24*

Turntable Rooms to Help Save Space in Homes 850

Several different rooms may be made from one in a turntable house built in Germany. Each floor in the two-story

and a syndicate of Johannesburg mining engineers has devised an ingenious method of obtaining the treasure. A spot has been selected on the shore and from it a tunnel is being driven down through the solid rock of the sea bed to the gully where the



Exterior and Interior Views of Unique German House Showing Rooms Built on Turntable

structure has one large room. Behind draperies on one side is a turntable divided into several sections. Each of these forms an addition to the big room when the platform is moved. One section may have a piano, another a card table and a third a kitchen. Doors are placed at convenient intervals.

old treasure ship is known to lie, a distance of more than 400 yards. Previous attempts have resulted in several of the ship's cannon and metal fittings being saved, and since the present syndicate has been on the spot, gold coins

and articles of jewelry have been found in the sand of the seashore or have been obtained from the natives. Apart from the enormous wealth known to be in the "Grosvenor's" cargo, it is reported that many of the passengers who were lost with the vessel, were merchants on their way back to England with fortunes in jewelry that they had amassed during a lifetime in the Indies. In connection with the wreck, when the first white explorers penetrated Pondoland, about a century ago, it is said light-colored people were met with. These were supposed to be descended from the passengers of the wrecked ship who escaped with their lives only to be taken prisoners by the savages.

Tunnel under Ocean to Treasure Ship Wrecked Centuries Ago 956

One of the most romantic treasure hunts ever undertaken is being made on the Pondoland coast, S. E. Africa. During the latter part of the eighteenth century, an English-owned sailing ship, the "Grosvenor," was wrecked on the Pondo coast while homeward bound. The cargo, which consisted of gold and silver in bars and coin, was valued at \$12,000,000 in those days. Several attempts have been made since at salvage, but owing to the wreck being close to the line of enormous breakers, no vessel can safely anchor on the spot near enough to be of any use. It has been ascertained, however, that the hull, which is believed to be still intact, lies in a rocky gully covered to a great depth by sand,

Ⓞ About 8,000 electric locomotives for mining and industrial service have been built by the General Electric company since the firm began making engines, almost half of them in the last eight years.

Emb. Harry Edw. Carter
Box 49, Elliott, South Africa

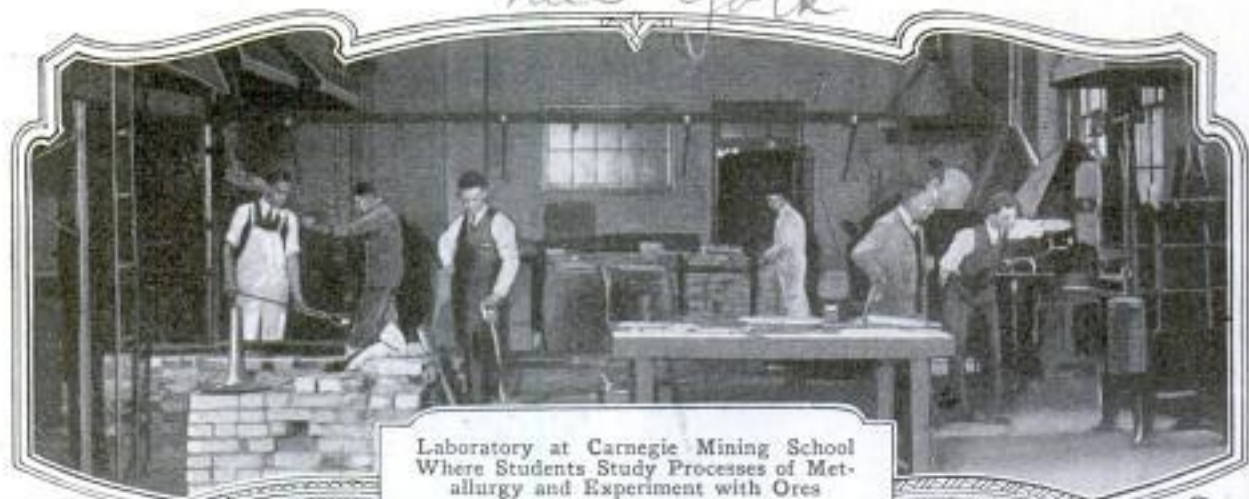

Laboratory at Carnegie Mining School
Where Students Study Processes of Met-
allurgy and Experiment with Ores



Studying Me-
chanical Mining
Equipment in
Machinery Room



Getting Knowl-
edge of Drills
and Their Uses
by Operating
Tools in Mine



Constructing
Models of Mine
and Properties
to Show Plans



Ore-Dressing and Coal-
Washing Department of
Mining School Where
Minerals Are Separated
from Soil Particles

Actual
**Mine-Engineering Students Study
Underground Rescue Work**

To prepare students in the mine-engineering school of the University of California for aiding and directing first-aid and rescue crews during mine disasters, a course composed of such study and practice is given them. Drills are held in which the pupils, equipped with pulmotors, stretchers and gas masks, go through the processes of rescuing and reviving victims of accidents underground. Tours through neighboring mines are made by classes of



Students in Mine-Engineering Holding Rescue Drill under Conditions Similar to Those Met during Disasters; Above, Group Equipped to Enter Mine Prepared in Imitation of Rock-Filled Chambers and Passages That Confront Searchers after Explosions or Cave-Ins Occur in Workings



the Carnegie Institute of Technology school of mining to acquaint them with the nature of subterranean surroundings and to teach them handling of tools and machinery employed.

**Lost Art of "Unbreakable" Glass
Is Revived in Germany 984**

"Unbreakable" glass manufactured from quartz, is being used in Germany for various scientific purposes in chemical and electrical laboratories and for



Pair of Tongs for Use in Scientific Laboratory with Ends of "Unbreakable" Glass

melting pots, tubes, clubs, flasks, and many other articles. It is said to have twelve times the durability of ordinary glass, and because it contracts and expands but little under extremes of tem-

perature, it is well adapted for various kinds of scientific experiments. The quartz is melted in special apparatus under 2,000 degrees Centigrade with the aid of an oxyhydrogen flame and treated to give it its extreme hardness. Unbreakable glass is said to have been discovered in the days of the Romans, but inventors of the process were put to death or their laboratories were demolished so that their product would not detract from the value of metals.

**Cast-Off Auto Bodies Sunk in River
986 to Hold Bank in Place**

For temporary protection of a river bank being undermined by floods and strong currents, approximately 2,000 discarded automobile bodies were sunk in depths of from twenty to forty feet. Placed in a barrier along the shore line, the cast-off vehicle hulks formed a "mattress" to hold the land from slipping into the stream. Many that did not readily submerge were filled with rock. It is said that the plan checked erosion of the bank, until permanent dikes could be installed.

*Carl Albert Neuberg
neue Winterfelder Str. 24,
Breslau W. 38. Germany.*

*Engineering News
Copyrighted material
3/17/24*

1094 made by Alfred Lee,
2274 Grand St.,
San Francisco, Calif. 257

POPULAR MECHANICS

Exact Miniature of Frisco Fair
Takes Eight Years to Build

Wired for day and night illumination, a model of the Panama-Pacific International Exposition of 1915, has been accurately constructed of wood, galvanized iron, tin, glass, lead and a white marblelike stone by a San Francisco jeweler and watchmaker on an area of seven by twelve feet. Every detail of design, color and lighting that made the original famous for its beauty, has been reproduced in the model by the amateur sculptor, from Machinery Hall on

of the state entomologist. As the mantis increases in size, it feeds on larger and larger insects. When full-grown it is winged and measures almost four inches in length and more than five inches across the outstretched wings. "Praying mantes" have received their name because they keep their front legs folded un-



Amateur Sculptor with Exact Model of the Panama-Pacific International Exposition He Constructed on an Area of Seven by Twelve Feet after Working for Eight Years

the east and the Palace of Fine Arts on the west, to the people, flowers, trees, wheel chairs, trains, electroliers, automobiles, horses and turnstiles at the entrances. The telegraph poles and wires and the city street-car lines are shown outside the wall. When illuminated, the same sparkling effect that marked the Tower of Jewels as one of the wonders of the fair, is produced in the miniature. Other lights, flooding through glass domes, windows and open doors of palaces and halls, are reflected in the water of the Fine Arts lagoon in which small, live goldfish have been placed. Aided by sketches, drawings and photographs, the jeweler worked for eight years to complete his model.

1166

Chinese Insect Imported to Fight
Farm Pests in South Dakota

To combat the grasshoppers, caterpillars, crickets, flies and the host of other pests that annually cause huge losses to farm and orchard crops in South Dakota, mantes—distant relatives of the grasshoppers—have been imported from China. The insects capture and devour the destructive pests but will not attack any crops grown in the state nor do harm to man, farm animals or birds. Egg masses for propagation purposes are to be placed in different sections under the direction

derneath their "pious-looking faces" as if in prayer. These legs are very spiny and are used to hold any insect which may be seized.

"One-Man Orchestra" of Four Pieces
Played by Keyboard 649

Xylophone, chime and cymbal accompaniments can be played with a "one-man orchestra," the attachments of which are fitted to the piano keyboard and under the

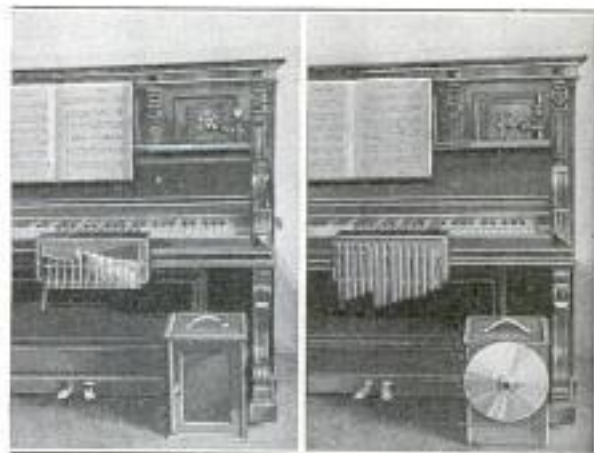

Xylophone, Cymbal and Chime Attachments in Position for Pianist to Play with Piano

instrument. They are operated by the player's left knee and right foot.

H. C. Jensen, State College, Pennsylvania, N. D.

New York Times
5/5/24

Alphons Bergt & Co.,
Breda, Holland
5 Paul, Germany.

*Trade World Street
229 W. 43rd St.*

8-72 **Tiny Dishes for Queen's Doll House Show China Maker's Skill**

The dishes, so small that a whole set can be placed easily in a woman's hand, were made by an English pottery for the queen's doll house, shown at the British



Exquisitely Monogrammed and Figured, These Tiny Dishes Adorned Queen's Doll House at English Exposition

Empire exhibition at Wembley. The gold-band, Greek-key pattern is said to have been selected by the queen herself, and every piece down to the minute egg cups, less than a quarter of an inch high, bears the royal monogram. The set is made from the highest grade of china and modeled after dishes of ordinary size.

Cigar Lighter That Fits in Any Auto Can Be Worked with One Hand

Designed so that it can be attached quickly to the instrument board of any automobile, a simple cigar or cigarette



By Pressing Button with One Finger, Cigar Is Lighted Quickly against Heat Coil

lighter has been placed on the market. Within a flat metal bracket there is a heating coil which becomes red-hot in a few seconds when contact is made by pressing a small button. Current is automatically switched off when the button is released. It may be worked with one hand. Contact and ground wires are easily attached and the lighter has a curved shelf below for a holder or ash tray and to prevent sparks falling on the car carpet or on the clothing.

Calculator on Typewriter Solves Problems and Writes Answers

Algebraic problems, computation of foreign exchange, discount, interest, multiplication, addition, subtraction and many

other similar mathematical problems are solved almost miraculously on a typewriter by a calculator that is geared to the machine. With the device it is said that, in writing bills, the correct total prices for each and all of the articles will be shown instantly, and that bookkeeping and similar work can be done, all without a second operation on an adding machine. When the typist has finished copying something, such as an invoice or statement, the keys automatically tap off the answers on the same sheet of paper, with all of the subordinate problems correctly solved. Addition, multiplication or subtraction is performed as each line is finished, the answer appearing in the proper column. Then at the end, the debit and credit items are summed up by the calculator without any further action on the part of the operator. If the result is a credit, the answer appears in red. One of the accomplishments of the machine is said to be its ability to instantly compute foreign exchange. Any sum in pounds, shillings and pence, francs, lire or marks may be instantly translated into the equivalent in United States currency by merely typing the amount and the exchange rate.

Barbel

*Cigar, Cigarette Parts, Co.,
Chicago, Ill.*

949 Corn & Ellsworth Chapby
Lewistown, Pa.

Sowing Timber Crops to Save Nation's Trees

Loggers, Rangers and Government Experts Unite to Guard and Replace Virgin Forests of the Lumberlands

SEEKING to conserve and replace the rapidly disappearing forests of the nation's timberlands, government experts of the forestry division are raising millions of young trees to take the place of those felled for industry or consumed by destructive fires that yearly sweep their tolls from the wooded areas.

While the present timber stands of the United States are estimated at 463,000,000 acres, this figure represents but a little more than half of the original lumber resources of three centuries ago when settlement of the territory first began to make inroads on the forests. With the constant demand for lumber stirring the industry to renewed efforts to supply sufficient material for the country's needs, attention has been turned to the development of seedling crops in large nurseries scattered over the nation. From these growths, saplings are taken from time to time for replanting over cut areas by crews working under direction of the forestry service.

Added protection to the matured stands of virgin timber, now found mostly in the far west and south, serves to prolong the supply, about two-thirds of which is saw timber. Trees that formerly were consid-

ered of little or no value in the lumber industry have been utilized for profitable purposes solely through the efforts of laboratories established to find ways in which such growths could be used as substitutes for more valuable trees.

Through the watchfulness of the forest rangers, who patrol the thickly wooded regions night and day in search of smoldering fires or conflagrations set up by lightning, millions of dollars' worth of trees are saved from destruction. Campers entering these territories are cautioned as to dangers that lurk in the carelessly tossed firebrand or cigar end, and thousands of blazes caused by lack of forethought on the part of sojourners in the summer-dried forests, are subdued each year by the "police of the woods." In logging camps where the horse and ox of the pioneer logger have been replaced by wood-burning engines or gasoline tractors, extreme care is exercised to



Through Rough and Dangerous Country and over Jagged Mountain Ranges Lie the Trails of the Ever-Watchful Forest Rangers Who Guard the Nation's Forests from Fire

949
260



Taking Lockers of Fire-Fighting Tools to Their Places in the Woods Where They Can Be Easily Reached



Forest Ranger Making Boxes to House Wild Birds among Big Trees They Help to Guard from Insect Pests



"Guardian of the Trees" Taking an Observation of a Forested Valley from a Lookout Post on a Lofty Mountain Top



Traveling Chain Moved by Electric Power Which Transports Logs along Steel Skidway



"High Climber" Ascending Tall Spar Tree to Be Trimmed for Support of Aerial Cable

949

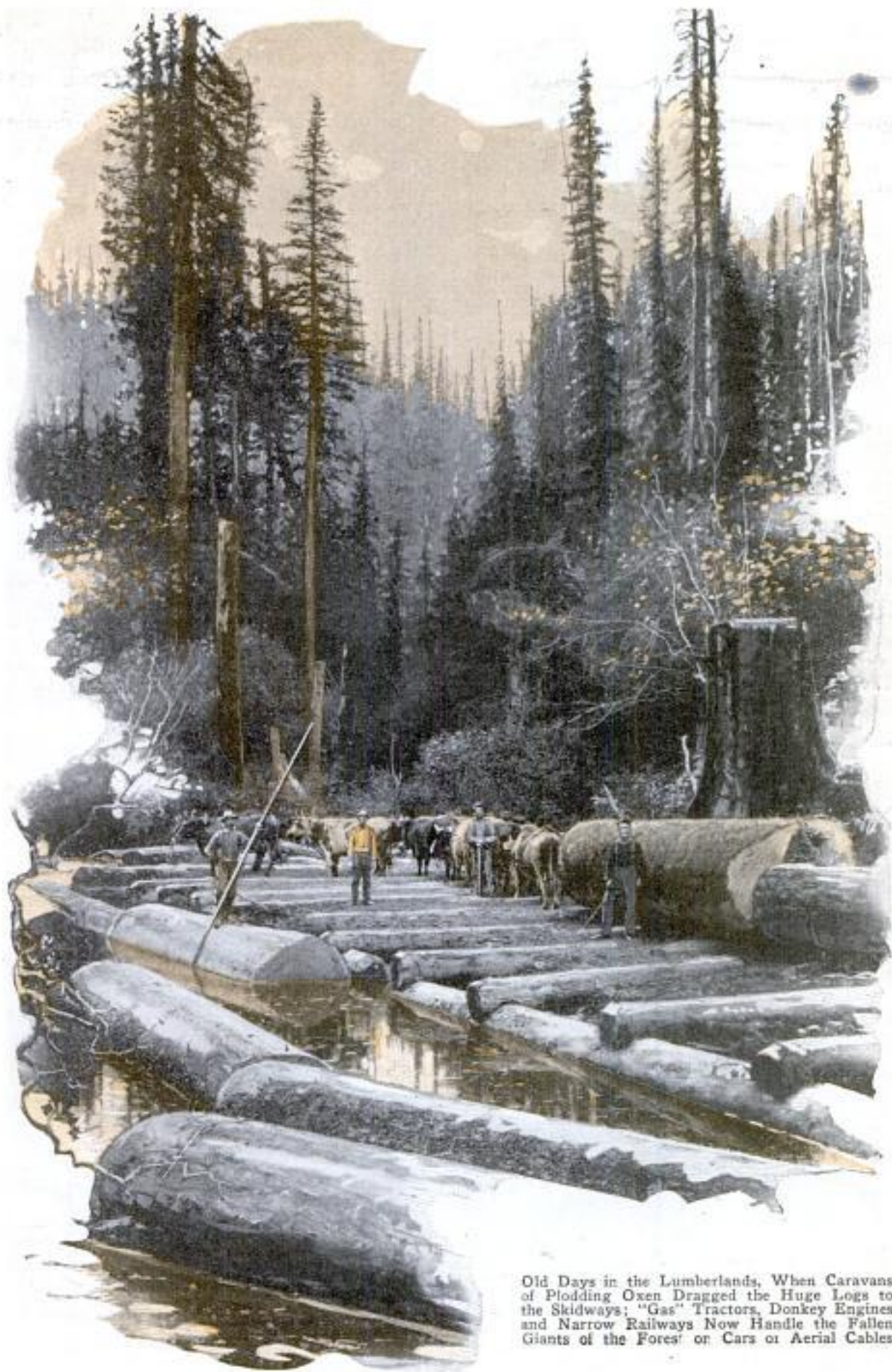

Old Days in the Lumberlands, When Caravans of Plodding Oxen Dragged the Huge Logs to the Skidways; "Gas" Tractors, Donkey Engines and Narrow Railways Now Handle the Fallen Giants of the Forest on Cars or Aerial Cables

prevent sparks and dripping oil from endangering the tinderlike vegetation and the safety of the workmen. More than he fears the falling giants of the forests that sometimes crash unheralded under the ax of the chopper into the midst of a toiling crew, the woodsman dreads the curling wisp of blue smoke that warns him of the presence of fire. And it usually means a loss of acres of big trees matured after years of steady growth, unless quickly subdued. While engineering science aids the loggers of today in harvesting the stands in remote fastnesses or at the tops of high, steep mountains, only by studied regard for the younger shoots is a future crop assured. With motors and tractors supplying power for transportation and the barking donkey engine performing the task of "shooting" the trimmed logs to the temporary railroads that often lie far down a hillside, less damage is done to surrounding trees than in the old days of rolling or dragging the weaving loads through the woods. Spirelike spar trees selected for their convenience to the scenes of action are trimmed by adventurous "high climbers" into tall bare masts that support moving cables from which the speeding logs swing as they race downward to the loading place or sawmill. Hanging from the traveling line, their departure from the choppers'

position is announced by shrill warning blasts of the "donkey's" whistle and, brushing noisily through the foliage lining the pathway, they race along the aerial track. Though there are few scenes of more utter desolation than those offered by wide areas of logged-off land where great stretches of jagged debris mark the spots once occupied by splendid trees, the problem of replenishing the waste with valuable timber is being met to a great extent by tireless efforts of those struggling against a constant harvest that goes on at a rate four times as fast as the majestic woods can grow.

Although many immense tracts of virgin timberland still remain untouched by the woodsman's saw, it is only a question of a few years when they will be invaded by crews of bustling swampers and choppers.

Hardwoods have been scarce for a long time and so great is the shortage of well-seasoned lumber such as walnut, cedar and similar woods that dealers go about some parts of the country buying up old barns and farm buildings merely to salvage the valuable heavy timber they contain. One concern is known to make a practice of purchasing fences constructed from cedar rails, often replacing them with modern inclosures of the steel-wire variety as an inducement to the owners to sell them.



Cutting a Fire Line across the Path of a Forest Blaze to Stop the Spread of Creeping Ground Flames by Clearing Away Dry Brush on Which They Feed

School Children, although Cripples, Model Statues from Memory

Although handicapped by crippled bodies, several children in a Chicago school have shown considerable skill in modeling small statues from memory after visits to

tage claimed for the metal is that it maintains a brilliant polish similar to silver under all conditions and does not need reburnishing. In America it is proposed to manufacture the stainless iron on a large scale, making pipe, sheets, bridge material and other forms. One element which has



Copyright, Underwood & Underwood. 205 W. Washington St. Chicago
Two Youthful Sculptors Whose Models Show That Skill and Good Memories Can Conquer Handicaps

the Art Institute. Returning to their classrooms, they strive to reproduce in clay replicas of the works of the great masters. Guided only by their mental notes and by a suggestion now and then from an instructor, their deft fingers fashion groups and single pieces that are said to show remarkable fidelity to the originals.

Stainless Iron May Replace Steel and End Ravages of Rust 885

To do away with the tremendous waste caused by the ravages of rust and eliminate the necessity for painting steel bridges and other structures to prevent their rotting away, a process has been developed for making what is known as stainless or rustless iron. It is said to be somewhat newer than stainless steel, which is suitable almost exclusively for cutlery and surgical instruments. Rustless iron, however, is a material which can be rolled or formed into a great many different shapes. It is essentially an alloy of iron and a metal known as chromium. Considerable pioneer work has been done on the product in Great Britain. Quite a number of ocean liners are being equipped with electric fans, hardware of many kinds, frames for grates and any other objects exposed to the corroding action of the sea air, as one advan-

interfered with the wide introduction of the metal is the cost of chromium, but it is believed that this will ultimately be overcome.

Disinfecting Troughs for Autos to Stop Cattle Plague 921

To prevent automobiles from spreading the dreaded hoof and mouth disease in California, disinfecting troughs have been constructed alongside roads in a section



Running a Car through Disinfecting Trough to Kill Germs on Tires and Wheels

visited by the plague. After passing through the infected area, cars are halted by officials and the drivers ordered to run them through the troughs, where a chemical bath cleanses the tires and wheels.

Carl E. A. Cone,
& Ash St. New York
N.Y.

Pacific & Atlantic
Photos & Maps
25 Park Place
New York

Mt. McKinley Sinking Two Feet Every Year, Is Claim

Mt. McKinley, highest peak on the American continent, sinks about two feet each year from its altitude of 20,300 feet, according to residents in the vicinity. They declare that there is an average of four earthquake shocks annually, and contend that with each tremor, the mountain settles about six inches. To confirm their belief, they refer to the Aleutian islands. According to scientific reports, no one can state the location or altitude of many of the small islands in the group, as a body of land may appear well above the water one day and under it the next.

New Nose on "Shenandoah" Fits Ship for Further Sky Voyages

By putting a new nose on the "Shenandoah" and making a few other repairs, damage done when the gigantic dirigible

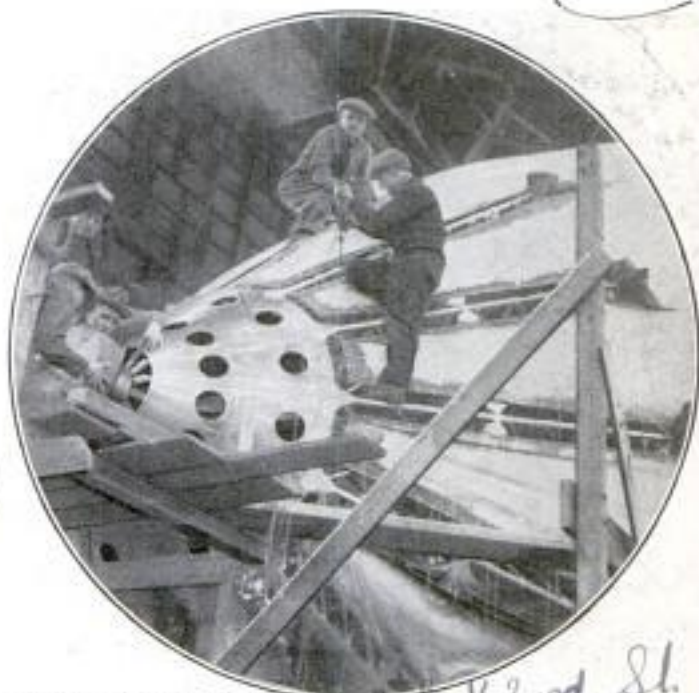

Copyright, Kadel & Herbert
Putting Finishing Touches on "Shenandoah's" Tip and Mooring Coupling That Holds It to Mast

Daylight Motion-Picture Film Reruns Automatically

Fitting compactly within a small suitcase, a daylight motion-picture projector has been invented especially for advertising purposes in show windows. It is run by an electric motor, and the film is re-wound automatically and shown again, giving a continuous performance without the attention of an operator. The entire outfit folds together, occupying little space. The screen is twelve by sixteen inches.

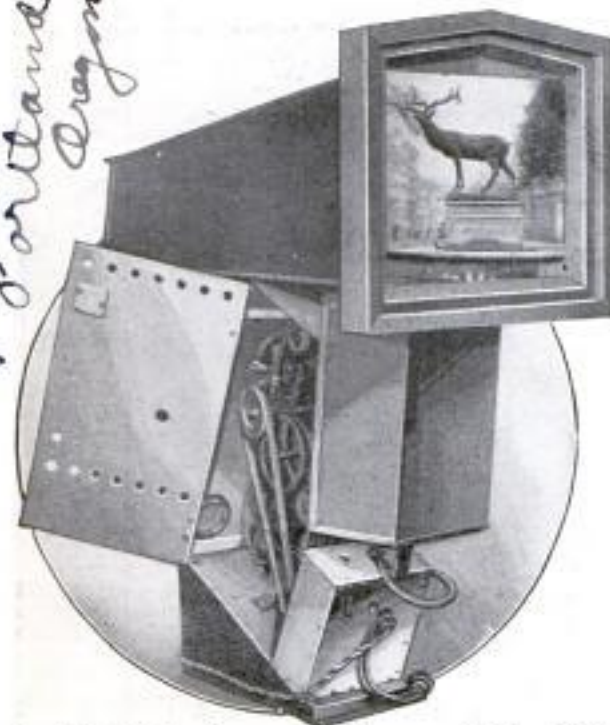

Daylight Movie Camera with Screen and Hood Adjusted; Whole Outfit Folds into One Package

tore loose from her moorings, some time ago, was quickly mended, and the ship was pronounced ready for further voyages. To replace the parts torn away from the framework when the ship was wrenched from her anchorage, light aluminum girders and plates were riveted on, the ripped fabric was taken off and freshly painted and stitched widths put on. The accident, according to engineers and navy officials, demonstrated the solidity of the ship, as little damage was done to any other part.

Panama Gun Hurls a Ton of Metal over Thirty-Five Miles

Uncle Sam's latest weapon of defense—a sixteen-inch gun for the fortification of the Panama Canal—has a range of approximately thirty-five miles. About seventy feet in length, it will fire a shell or bullet weighing a ton. The powder charge totals 750 pounds. The barrel is made of specially treated steel tubing wrapped with miles of piano wire. Over this a metal shell is shrunk after being heated to cause its expansion. The life of such a piece is comparatively short, the rifling being destroyed by the force of the charges necessary.

The Adroscope Co., 305 1/2 Ave. S., Portland, Oregon

St. Paul Herald Co. Wash. D.C. 1924

Copyrighted material Navy Yard, Washington, D.C.

Girl Held on Spikes by Anvil Is Unharmed by Hammer Blows



Reclining on Spikes, Young Girl Withstands Blows upon Anvil Supported on Her Chest

Lying on a board filled with six-inch spikes, a young Italian girl allows two men to strike sledge-hammer blows on an anvil resting on her chest. The spikes are driven closely together and are of equal height. Most of the force of the blows is spent on the anvil, although the young performer is careful to distribute her weight equally and brace herself against slipping to an angle where the sharp spikes would pierce her. Nevertheless, the act is sufficiently hazardous to provide a never-failing thrill.

⁷⁶⁹ Cut with wedge-shaped tongues and grooves, a style of flooring has been invented to permit great economy in lumber. The wedge is said to draw the boards more tightly and the bulk of the wood is left above the joint where it is available for use when nailed down.

POCKET TRUCK SAVES WORK IN HOME AND SHOP

As an aid in moving heavy boxes, barrels and articles of furniture about the home, a small two-wheeled truck that can be easily handled by one person is being manufactured. Weighing only one and a half pounds, the contrivance may be quickly slipped under the edge of the object as it is tilted. Ball-bearing wheels permit the burden to be moved with little effort

Strongly made, the cart can support loads up to three or four hundred pounds and may be pulled almost any distance without damage to the running gear. Inverted on the corner of a table or bench, the device can act as a roller for sliding trunks or crates onto the higher level. Of advantage to expressmen, storekeepers, offices and in all needs where cumbersome packages are

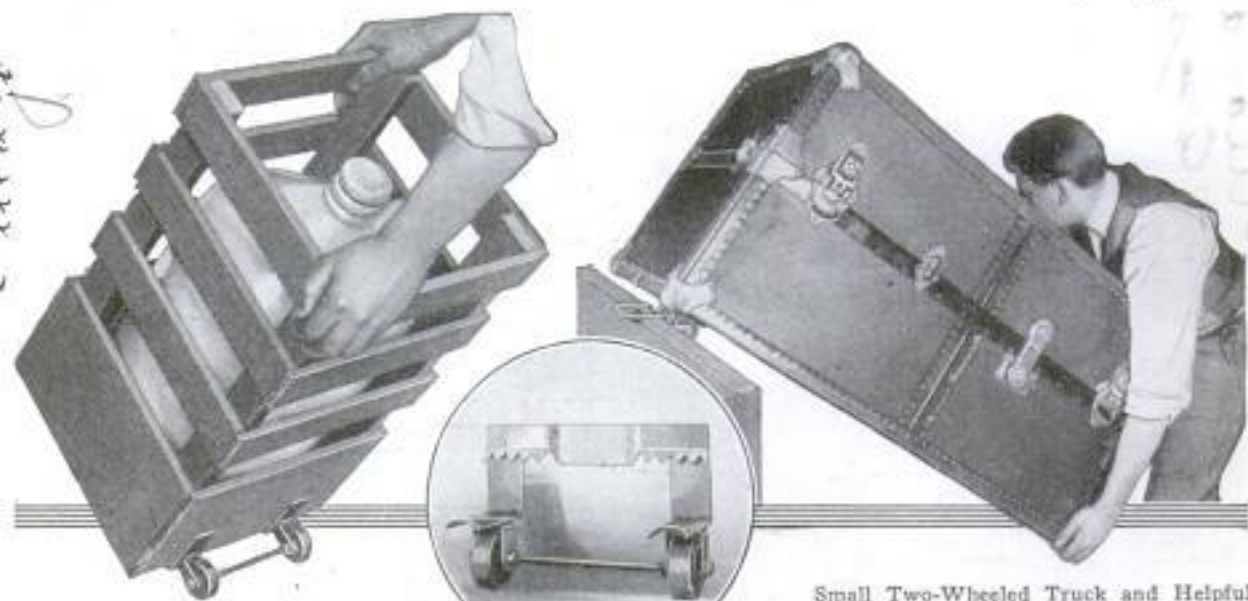

on the part of the worker. As it eliminates the need of assistance in shifting heavy chairs and similar articles, the housewife can readily perform such tasks, when necessary, in a few moments with the truck.

moved around by hand, the little truck effects great saving in time and labor and can be kept in the tool chest.

Small Two-Wheeled Truck and Helpful Service It Renders in Moving Trunks and Crates without Damage to Loads or Floors

1013
U.S. 10 Commerce
3114 N. Paulina St.
Chicago

4607
Two, three, four, five, six, seven, eight, nine, ten, eleven, twelve, thirteen, fourteen, fifteen, sixteen, seventeen, eighteen, nineteen, twenty, twenty-one, twenty-two, twenty-three, twenty-four, twenty-five, twenty-six, twenty-seven, twenty-eight, twenty-nine, thirty, thirty-one, thirty-two, thirty-three, thirty-four, thirty-five, thirty-six, thirty-seven, thirty-eight, thirty-nine, forty, forty-one, forty-two, forty-three, forty-four, forty-five, forty-six, forty-seven, forty-eight, forty-nine, fifty, fifty-one, fifty-two, fifty-three, fifty-four, fifty-five, fifty-six, fifty-seven, fifty-eight, fifty-nine, sixty, sixty-one, sixty-two, sixty-three, sixty-four, sixty-five, sixty-six, sixty-seven, sixty-eight, sixty-nine, seventy, seventy-one, seventy-two, seventy-three, seventy-four, seventy-five, seventy-six, seventy-seven, seventy-eight, seventy-nine, eighty, eighty-one, eighty-two, eighty-three, eighty-four, eighty-five, eighty-six, eighty-seven, eighty-eight, eighty-nine, ninety, ninety-one, ninety-two, ninety-three, ninety-four, ninety-five, ninety-six, ninety-seven, ninety-eight, ninety-nine, one hundred

993

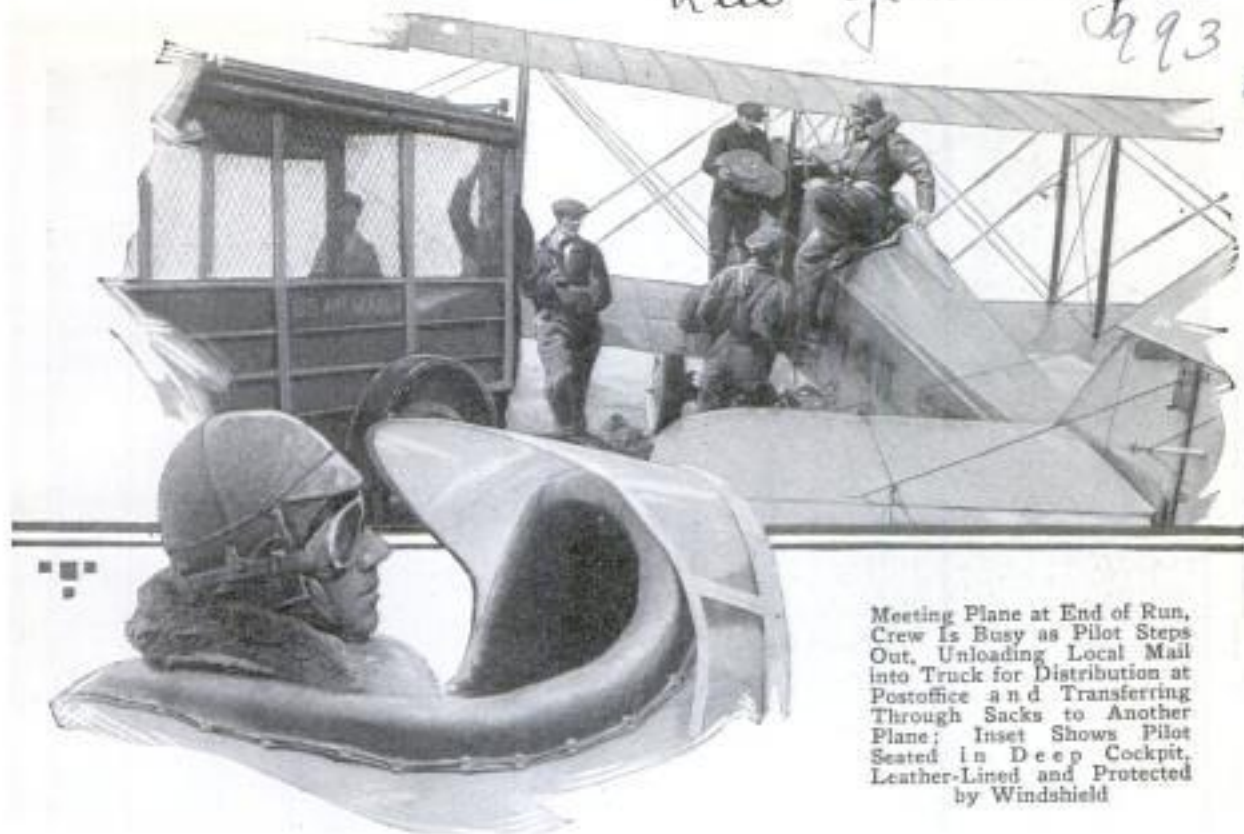

Meeting Plane at End of Run, Crew Is Busy as Pilot Steps Out, Unloading Local Mail into Truck for Distribution at Postoffice and Transferring Through Sacks to Another Plane; Inset Shows Pilot Seated in Deep Cockpit, Leather-Lined and Protected by Windshield

Night Mail Marks New Era in Aviation

Time of Flight from Statue of Liberty to Golden Gate to Be Cut to Twenty-Four Hours

INAUGURATION of daily, regular and permanent air-mail service between the Statue of Liberty and the Golden Gate marks a new era in the history of transportation. Experiments conducted last August when mail planes crossed the continent eight times, flying at night over a lighted pathway a thousand miles long between Chicago and Cheyenne, demonstrated to the postal officials the practicality of the new service. Under the present schedule the east-bound flights from the Pacific to the Atlantic will occupy thirty-two hours

while the west-bound fliers will take thirty-four hours and forty-five minutes for the trip. Later it is expected to reduce this time to twenty-four hours. Letters require eighty-seven hours between New York and San Francisco by train. Special air-mail postage has been arranged and stamps in three denominations, eight-cent, sixteen-cent and twenty-four-cent, have been distributed to all the principal cities of the country for use on letters specially designated to go by plane. These stamps will carry letters from any city for transmission to



Successive Light Paths Made by Revolving Roof Beacon That Guides Fliers at Night

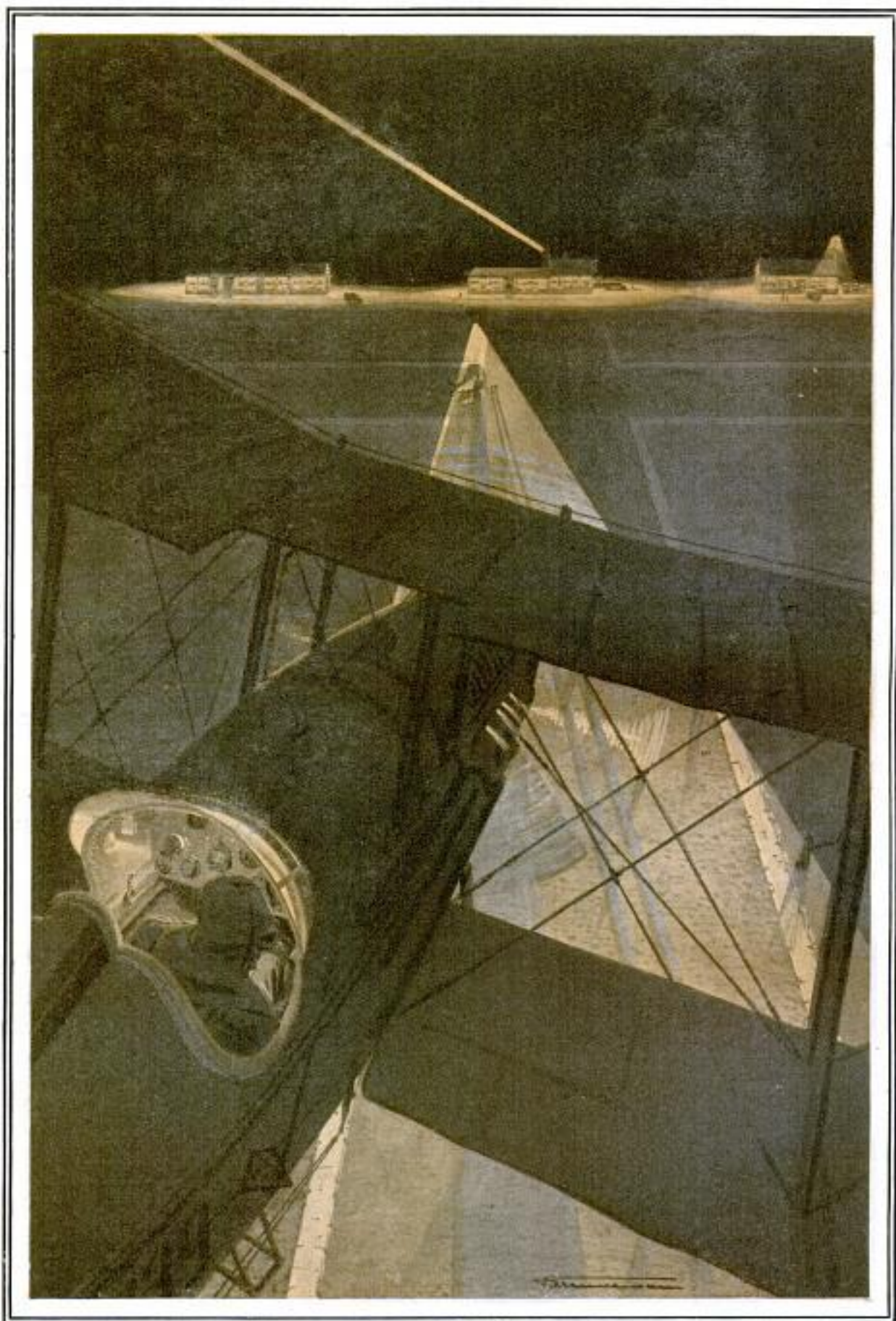

Night Mail Plane Preparing to Alight at the End of the Air Trail Where Massive Shafts of Light Guide the Pilot to the Illuminated Landing Ways of the Field



After a Hundred Hours' Running Time, the Big Liberty Motors Are Removed and Given an Overhauling



With a Twist or Two of His Wrench, Mechanic Removes a Propeller That Needs Repairing

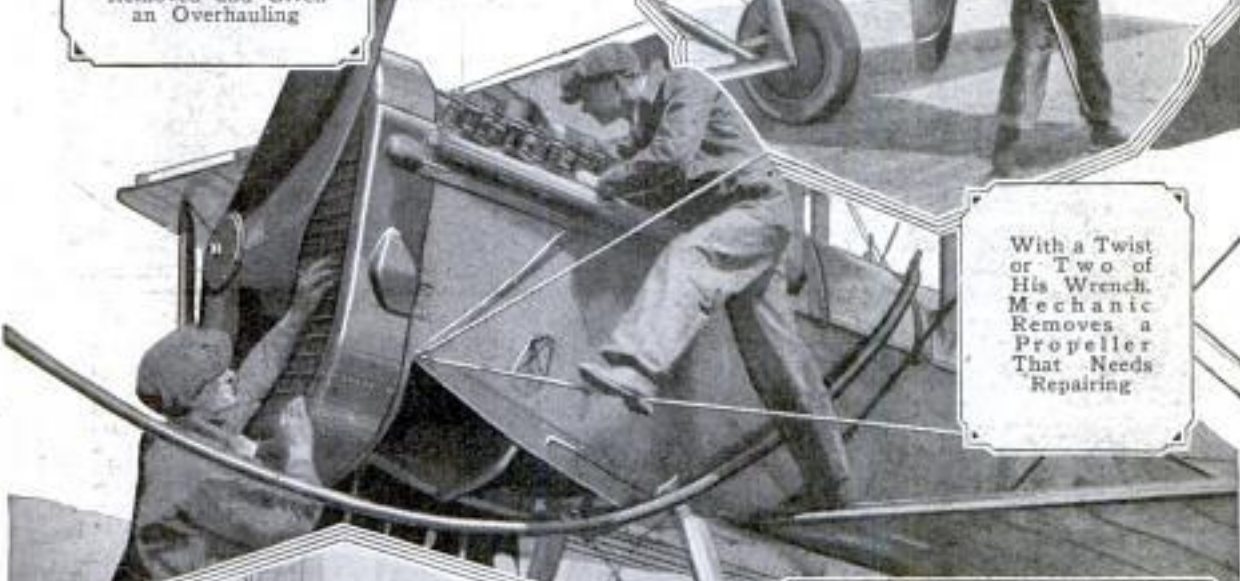

At End of Run, Mechanics Remove Engine Cowl to Inspect Motor, Radiator and Running Parts; Hose in Foreground Is Replenishing Tank

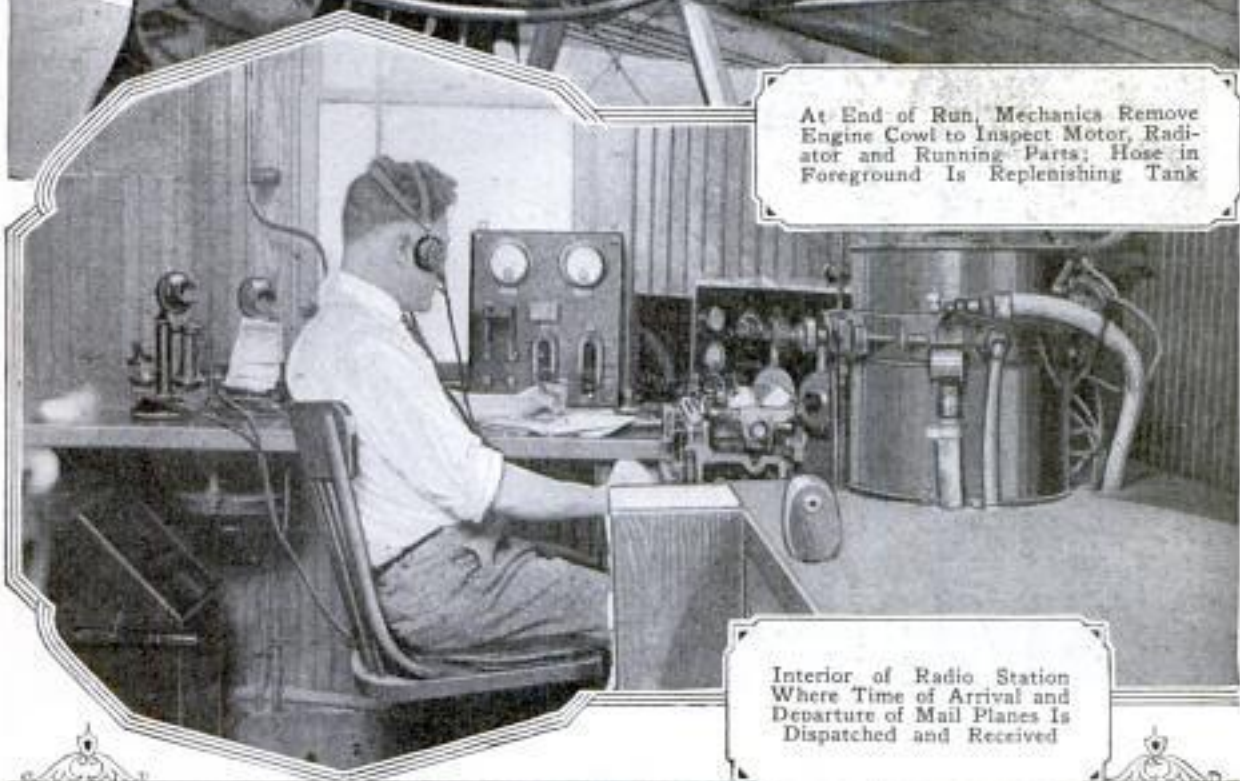

Interior of Radio Station Where Time of Arrival and Departure of Mail Planes Is Dispatched and Received



Left, Inspecting Valve on Heating System; Right, Uncle Sam's Mail Waits While Pilot Kisses Wife



Taking Off Lens That Diffuses Rays of Powerful Portable Searchlight at an Angle of Thirty Degrees to Form a Broad Path of Light into Which Planes May Glide When Arriving on Field at Night



Form 100 Post Office Department
U. S. DEPARTMENT OF COMMERCE
PILOT'S FLIGHT REPORT

Date *August 1st*
 Pilot *R. B. Pa.*
 Plane No. *374*
 From *Quincy*
Lowell
 Started *7:00*
 Weather *Fair*
 Oil pressure *50*
 Air pressure *60*
 Compass reading
 Average S. P. *50*

Copying Radiogram of Pilot's Flight on Wall Chart; a Report Card and Instrument Board of Unfinished Plane

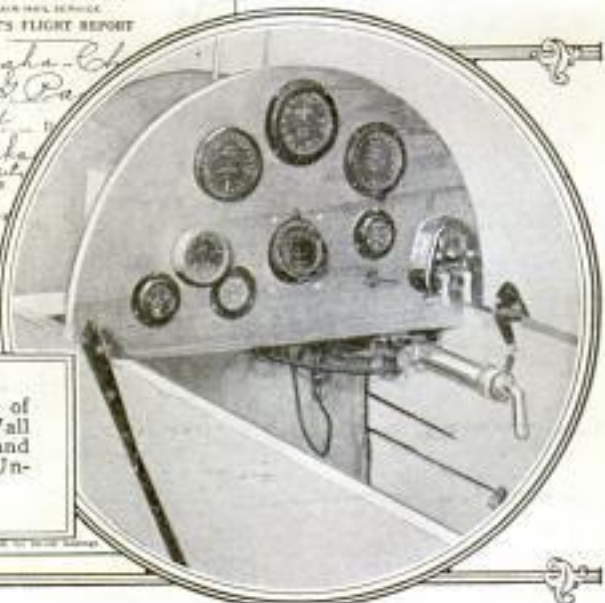



In Case He Must Leap from Plane, Pilot Is Protected by Parachute That Unfolds at Pull of Hook and Opens as He Drops; All Air-Mail Pilots Carry These Parachutes for Emergencies



Pilot Dressed in Flying Suit for Run with Mail; Parachute Is Folded at Hips as Cushion; Releasing Ring Is Seen Just below His Left Elbow

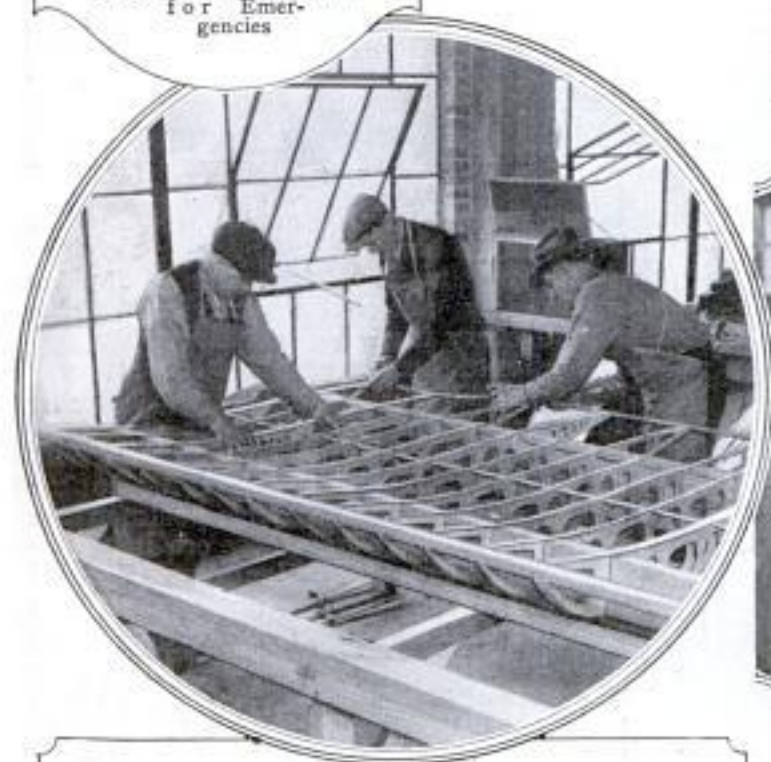

At Work on Wing Frame in Factory, and Rigger Checking Inspection Chart as He Examines Struts





Looking Directly into the "Tunnel" Produced by Rays of 460,000,000-Candlepower Beacon; Below, Adjusting Angle of Portable Light

either coast by air. Parcel-post packages also will be handled.

In their night flights, the pilots are guided by automatic acetylene lights placed every three miles. Every twenty-five miles of the night air lane has an emergency landing field provided with powerful searchlights and at about every 250 miles there is a regular landing field with searchlights visible for from 100 to 150 miles. "Uncle Sam's flying postmen are truly the pioneers of a new era in transportation," Col. Paul Henderson, second assistant postmaster-general, declared in speaking of the new service. "I have great faith in the ability of mankind to so perfect aircraft as to make it an essential part of our general transportation schemes of the future. The courageous pioneering work being done by the pilots of the airmail service is each day contributing its share toward that Utopia. They are entitled to the respect and admiration of the nation."

Chicago Evening Post
April 8, 1924

POPULAR MECHANICS

Cunningham's
Coal Novelties
Summit Hill, Pa. 273

Cont. George N. Golden, Jayston View Road, Chesterfield, England
E. G. Hill, West Lodge

**Gold Fields Are Tapped by Planes
Run by Canadian Railroad** 959

Airplane service, operating on regular schedule into a territory heretofore untouched by steam or electric transportation, has been instituted in the gold-field district of the province of Quebec in Canada. With a capacity of five passengers and a limited amount of supplies, the planes meet all trains at a town at present the farthest point north in the district tapped by a railroad. The service is said to have opened up virgin timber, hunting and mining districts and has reduced the trip from the railroad into the gold fields from two days to about fifty minutes. The rush of prospectors into the fields is said to have prompted the railroad company to provide the added transportation.

**Hard Coal Is Substitute for Jet
in the Making of Jewelry** 958

Polished hard coal as a substitute for jet in the production of rings, necklaces, watch fobs, ornamental hat trimmings and similar articles, is being experimented with by a German inventor. Selected hard coal is used and after the substance is cut as near to the required dimensions as possible, it is finished off with fine files and then polished. Monogram rings inscribed with initials inlaid in white enamel present a smart appearance, and few are said to be able to guess the nature of the substitute.

**New Capitol Built over Old Saves
Rent for State Offices** 1003

Replacing the old Nebraska state capitol with a \$5,000,000 structure on the same site, while government work goes on unhampered in the present one, is a feat being

accomplished at Lincoln. When the new building is near completion, the old one inside will be torn down. The wrecking promises to be an interesting engineering operation, as the present capitol is built entirely of stone and has a dome that rises 300 feet from the ground. Just enough room is being left between the new walls and the old building for a railroad track to carry away the debris. While six or seven years will be required to complete the project by this method, the contractor expects to save the state two or three years' rent on offices.

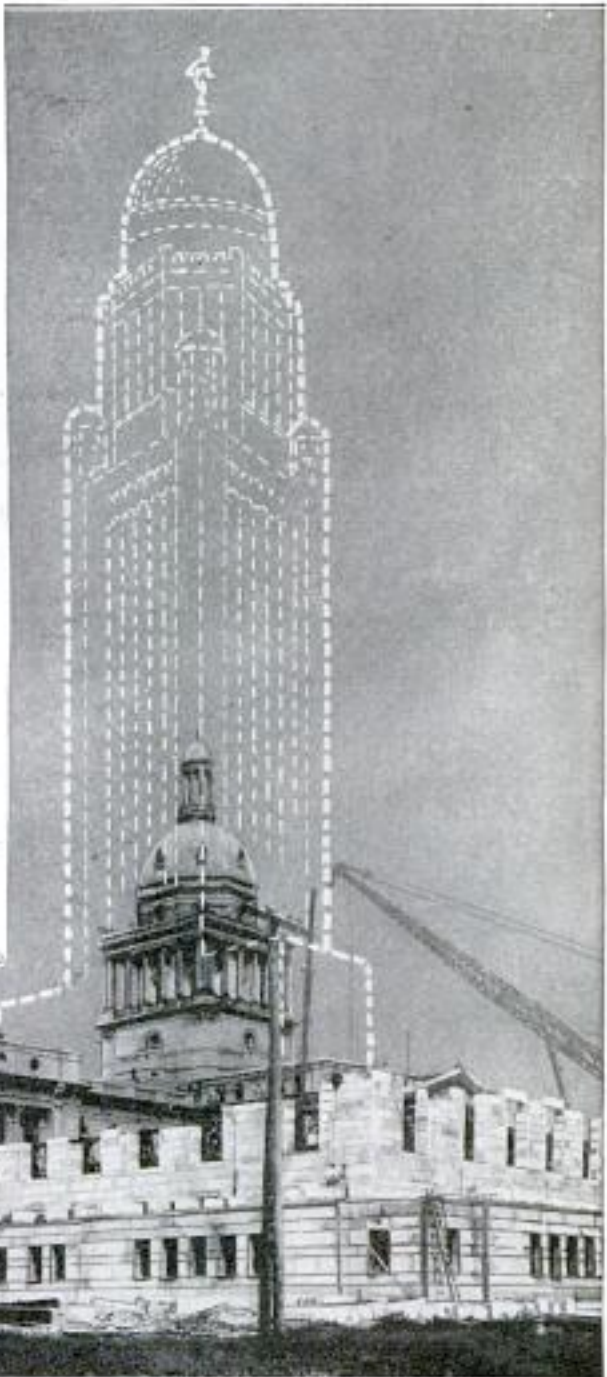

Photo-Diagram Showing How the New Nebraska State Capitol Is Being Constructed over and around the Present Building, Which Will Be Wrecked When the Other Is Near Completion



Belle of Samoa
Dressed for a
Dance



Young Papuan Widow Decked
in Mourning "Robes"



Egyptian Daughter
of the Nile in
Cairo



Hindu Princess
in Her Wedding
Dress



First Lady of African
Tribe in Holiday Attire



One of China's Fairest
Members of Cultured Class



Dancing Lady of Tahiti in
South Sea Festive Gown

of the World to Outposts of Civilization



Austrian Maiden of the Tyrol Region



American Girl Athletes Set for Running Contest



Mexican Senorita as Queen of a Festival



English Beauty, Winner in a Competition



Jewelry-Clad Girl of Nepal Dressed for a Feast



One of France's Renowned Screen Stars



Fashionable Lady of East Africa with Tattooed Face

Dog Travels Three Thousand Miles to Home and Gets Medal

Bob, a Scotch collie, recently traveled approximately 3,000 miles to return to his home in Oregon after having been lost in

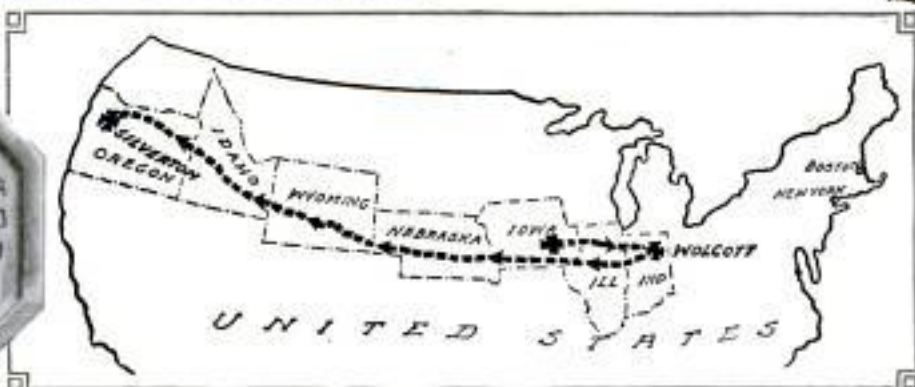

Map Showing Three-Thousand-Mile Route Traversed by Collie in Finding Its Way Half across Continent to Reach Home; Photographs of Dog and Medal It Received

the middle west. Its owners had taken it with them on an automobile trip, and while they were crossing Iowa, Bob strayed away. After an unsuccessful search, they went on to Indiana and then drove back to the Pacific coast, never expecting to see their pet again. Six months after their return, Bob came trotting home, weak from fatigue, footsore and with claws worn short. It developed that the animal had trailed the automobile from Iowa to Indiana and then had started back on the long trip to Oregon. The state humane society, after investigation, presented the dog with a medal and school children petitioned the village council to give it the freedom of the streets for the rest of its life.

Rubber Lighter than Cork Rivals Air in Expansion after Squeeze

More buoyant than cork, a rubber product being manufactured in England is said to have a resiliency almost equal to that of air. After long compression under a load of about seven tons a piece of the material regained its shape within a few seconds. The substance floats and a small sheet of it an inch thick can easily support a heavy man on the water. Owing to its non-absorbent qualities, it is believed it may be used for mattresses and chair cushions aboard ships, thus insuring greater life-saving facilities in case of wrecks. The material consists of rubber expanded by gas, but can be compressed to the hardness of wood, with equal strength and lighter weight. It is also claimed that it can be used to add strength

905
Quartzite Colliery Co. 501 State Bldg. Silverton Ore.
Mr. Quartzite Co. 501 State Bldg. Silverton Ore.
Great Power Co. London

to metal tubing by employing it as a closely packed filler inside the hollow cylinders. As the material can be made in several degrees of hardness it is expected that interiors for dwellings can be made from it.

Ostrich Legend Is Called Untrue

Despite the popular belief, ostriches do not hide their heads in the sand when fear afflicts them, according to Vilhjalmur Stefansson, the arctic explorer. The legend has persisted for nearly 2,000 years, but naturalists agree that it has doubtless resulted from the actions of the big birds when they are pursued. Even in storms, scientists say, they stick their heads under their wings until the blast is over.

1128
Chicago Daily News
Copyrighted material

Freak Shadows Stay in Oil Pools After Object Has Moved

Curious shadows that remain after the object has been removed, are produced on the surface of pools of crude petroleum in the great oil fields of California, according to residents of the regions. If, when the sun is shining, a person stands so that his shadow falls across the surface of the oil and then moves, the first reflected image remains on the pool, while a second is cast from the new position. The longer the individual has been standing by the pond, the longer will the original shadow remain. The hot rays of the sun produce gas in the oil which rises to the surface in the form of millions of bubbles, far too minute to be seen by the human eye. When a shadow is cast over the surface, the temperature is reduced, and this has the effect of checking the production of bubbles. The result is that the shaded area looks different from the part that is exposed to the sun. When the person moves, the temperature of the oil which has been shielded, does not at once go back to its former warmth. It takes a little time to heat, and until this has actually happened, the curious effect remains.

108 17

to the harbor. A flat car with twenty-four wheels was provided for transporting the monster gun, which was supported and bound to the car with specially designed anchors and straps of steel.

Camera Clock Records Race Victor as Finish Line Is Crossed

683

Capable of registering to the one-hundredth part of a second, a combination clock and camera has been invented to

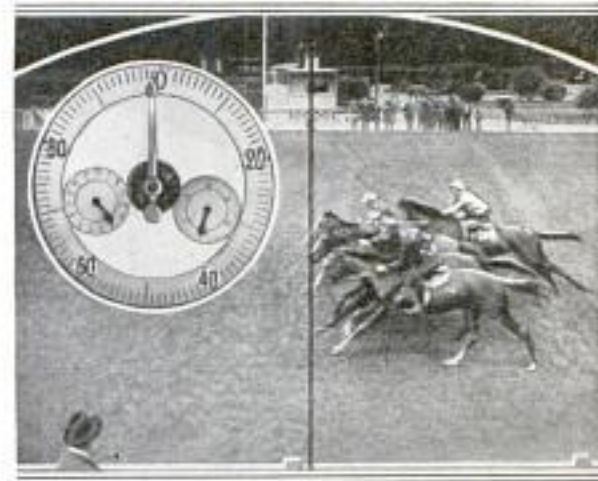

Big Dials of Speed Clock and a Close Race Finish Caught by Camera

Maurice Branger

Gun with Three-Hundred-Ton Barrel to Defend Harbor

125

Weighing 320 tons without its carriage, a sixteen-inch coast-defense gun was completed at the Watervliet arsenal not long ago and shipped to Boston, where it is to be mounted to help defend the approaches

avoid mistakes in timing races. As the winner crosses the line, he breaks a thin string connected with the camera. This releases the shutter and, as the lens is pointed directly on the finish, the exact position of the runners is obtained. At the same instant, the clock mechanism is stopped and the exact time registered.

Am.

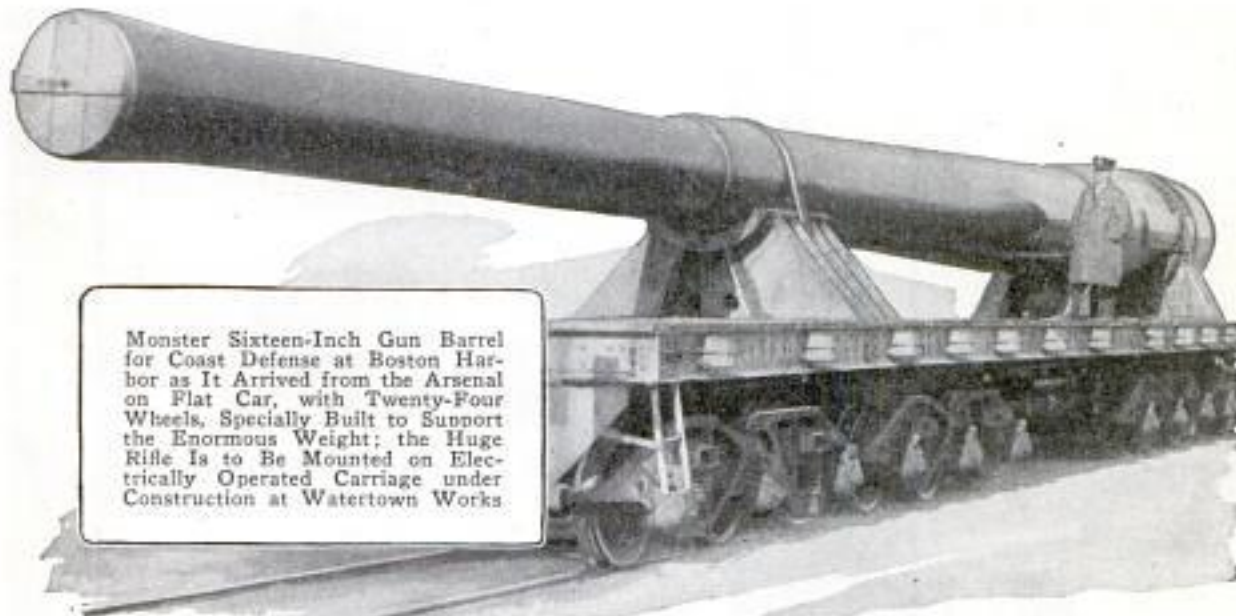

Monster Sixteen-Inch Gun Barrel for Coast Defense at Boston Harbor as It Arrived from the Arsenal on Flat Car, with Twenty-Four Wheels, Specially Built to Support the Enormous Weight; the Huge Rifle is to Be Mounted on Electrically Operated Carriage under Construction at Watertown Works

United Newsfeatures
461 S. 7th
New York City

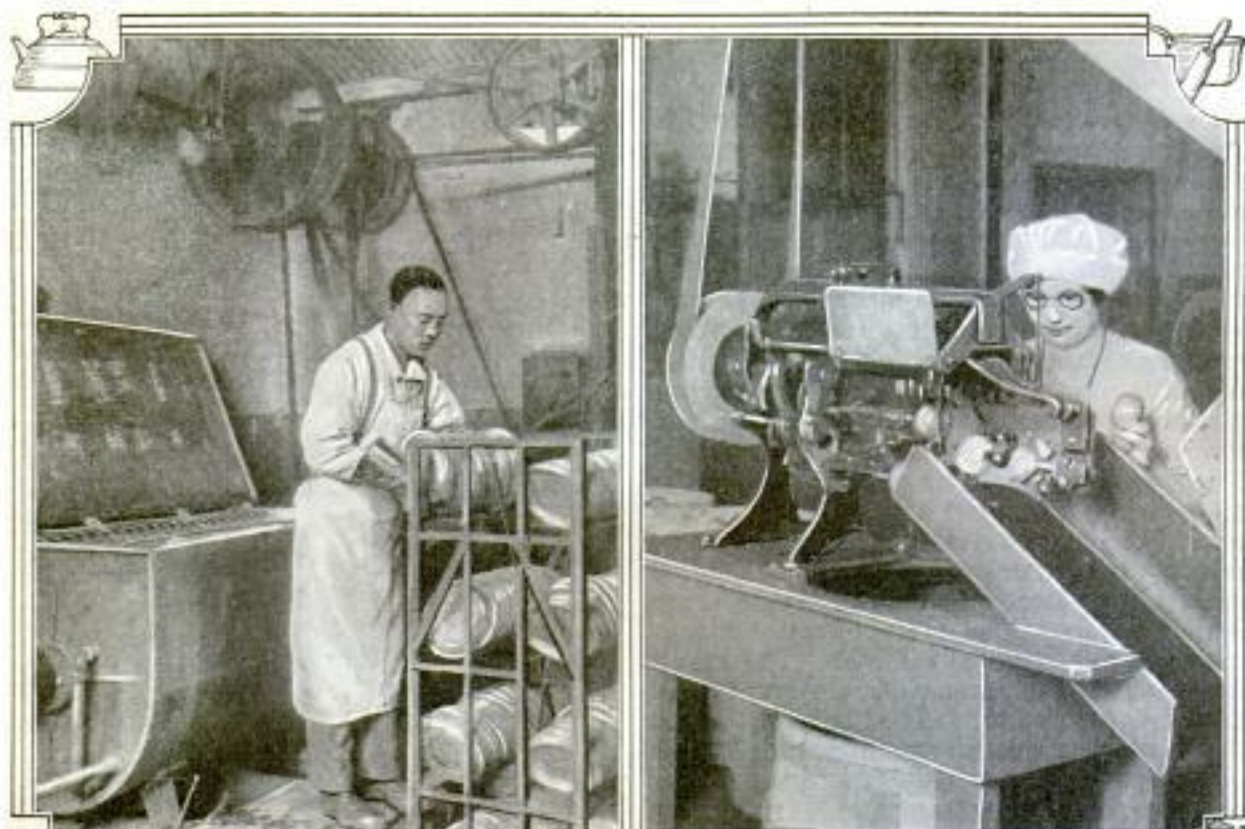

Washing and "Rack-
ing" Baking Pans,
after Which They Go
to Drying Cells;
Right, Automatic
Peeler at Work Paring
Apples; the Fruit
Drops onto a Travel-
ing Belt and Is Car-
ried to Cookers



Pastry-Molding Machine That Makes
"Open" Pies and Crusts for the Custard
Varieties



Courtesy Case & Martin

Baking the Nation's Millions of Pies

Large Factories, Where Machines Perform All Work Free from Human Hands, Turn Out Pastry "Like Mother Makes"

ONLY a little while ago, Saturday morning generally found mother in the kitchen busy with the weekly pie baking for a hungry household. But the picture

ings are made ready and cooked during the daytime, and are set aside in huge vats to cool in time for use in the evening, for most pie factories do their baking at night

Extracting Finished Pies from Huge Factory Oven. Four at a Time, and Replacing Them with Unbaked Material, a Process a Thousand Times Faster than That of the Kitchen Method

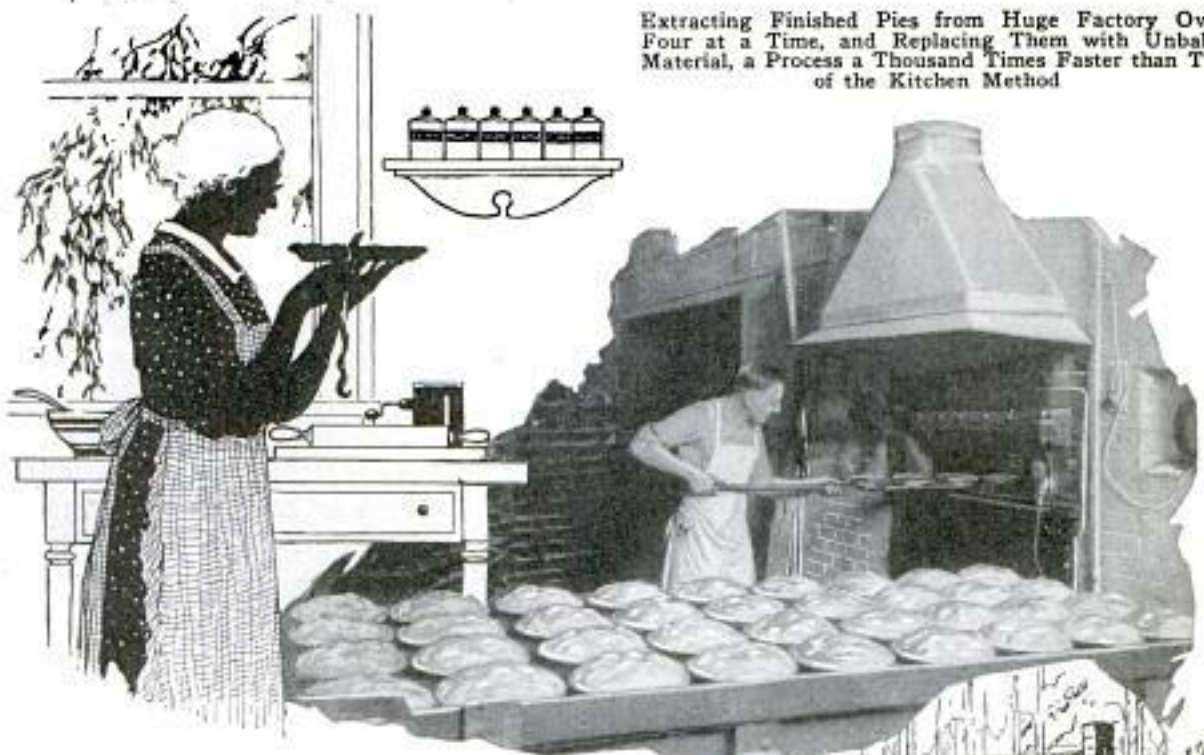

is changed today. Now electrically driven machinery does the work in large, clean plants, turning out pies by the tens of thousands every day. And they are palatable and pure pies, made from just the same materials that mother used.

One of the principal machines employed in the manufacture of pies in the present-day baking factory is a device into the hopper of which many barrels of fresh apples are emptied. From this magazine they are fed onto a series of revolving spindles where keen knives pare and core them before they drop on a traveling belt. Passing in front of a line of women operators who inspect the fruit, any specks or imperfections in the apples are cut out as they move along on their way to the tubs in which they are packed for the cooking caldrons.

Bananas are treated in a similar manner, being prepared by a machine that slices them in lots of a dozen at a time. Each individual piece of this fruit must also pass a rigid inspection before it is permitted to go into the slicers. All fruits for pie fill-



to insure an absolutely fresh product to the consumer for the following morning.

Fresh fruits are used the year around in many of these baking plants. Bought in season direct from orchards and vineyards, they are stored in immense refrigerating rooms for future needs. Only the choicest grades are selected and these must be taken to the cold chambers as soon as possible after being gathered. Here they are stacked in their original containers, and are not allowed to thaw after they are once frozen, until made ready for the cooking vessels. A single large factory handles more than 60,000 cases of blackberries, blueberries, cherries, pineapples,

*Allen Martin, Chicago
Walnut Wood.*

Colborne Machine Co., 159 W. Harrison Chicago

strawberries and raspberries in this way every year without impairing the flavor of the fruits. In sifting the flour and kneading the dough for the crusts, large flour sieves and dough mixers do the work of many hands. A crust machine receives the supply of dough, cuts it into definite circular portions and delivers it on a belt traveling to a set of rollers where one piece is dropped into a waiting pan to form the lower crust. The other part is rolled, dropped on a flat surface where it is stamped with the indicating mark of the pie, and as the pan with the bottom half into which filler has been poured, passes that point, the cover crust is placed in position on the top. It is then carried to the knives which trim the surplus dough from the edges and on the same conveyor is sent to the ovens. These huge, heated vaults contain moving trays, holding about 560 pies. Twenty minutes are required for a pie to complete its baking cycle, being kept constantly in motion during that period. When properly baked, the pastry is removed to big racks and from these loaded onto delivery trucks. Large fleets of "pie wagons," now mostly motor vehicles, with their contents neatly housed and protected from dust and dirt of the streets, deliver the night's baking to customers.

Where canned fruits are used, the empty cans are smashed by a special machine into solid round lumps of metal and are sold to be manufactured into window weights. Empty flour sacks are cleaned by compressed air and returned to the mill. Used baking pans are placed in large closed tanks where clear hot water is poured on them to soften any particles of the crust adhering to the surfaces. After scrubbing with soapy water, they are rinsed in hot water and put in a steam room to dry. Following each day's operation in the bakery the entire equipment is given a thorough cleansing to comply with the sanitary rules of the food industry.

In addition to paring and slicing machines, most factories have apparatus to beat eggs and mix cream fillings, and others to stem and seed cherries, while devices are to be seen filling the crusts of pies of the custard type and pouring on the meringue top in artistic designs. In a mid-west pie-baking plant, a year's supply of ingredients is represented by 10,000 barrels of flour, 2,000,000 pounds of sugar, 1,000,000 pounds of shortening and 3,000,000 fresh eggs. It also consumes 65,000 gallons of milk, 50,000 bushels of apples and almost as many peaches, lemons, raisins and other popular fruits.



In the Olden Days Every Member of the Household Assisted in the Annual Task of Peeling, Slicing and Stringing Fruits to Be Dried for Future Pie Making

apple Cutting, Cherry Pitting
Vegetable & Graining
POPULAR MECHANICS
machinery

884

281



Large Traveling Oven of Modern Bakery Where 500 Pies at One Time Are Kept Constantly Moving as They Bake

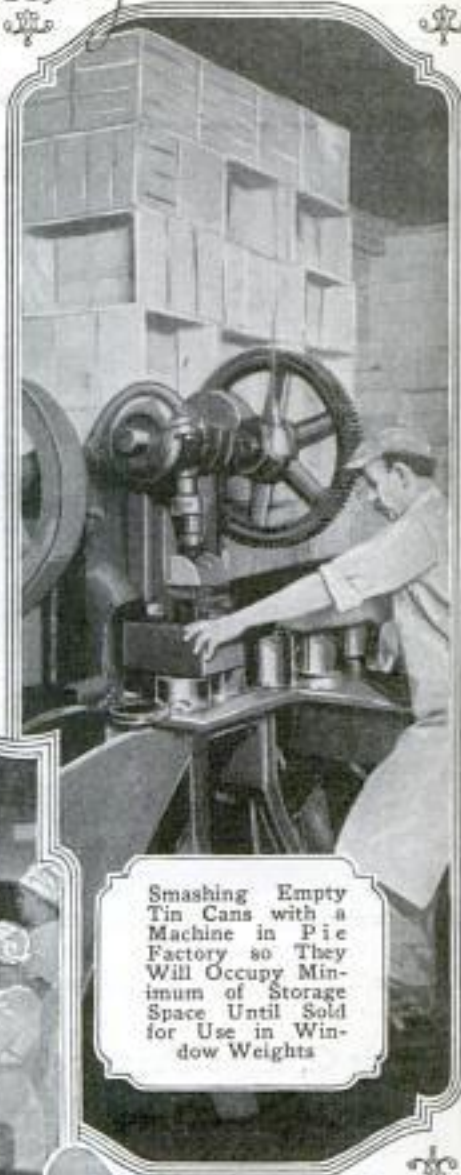

Smashing Empty Tin Cans with a Machine in Pie Factory so They Will Occupy Minimum of Storage Space Until Sold for Use in Window Weights

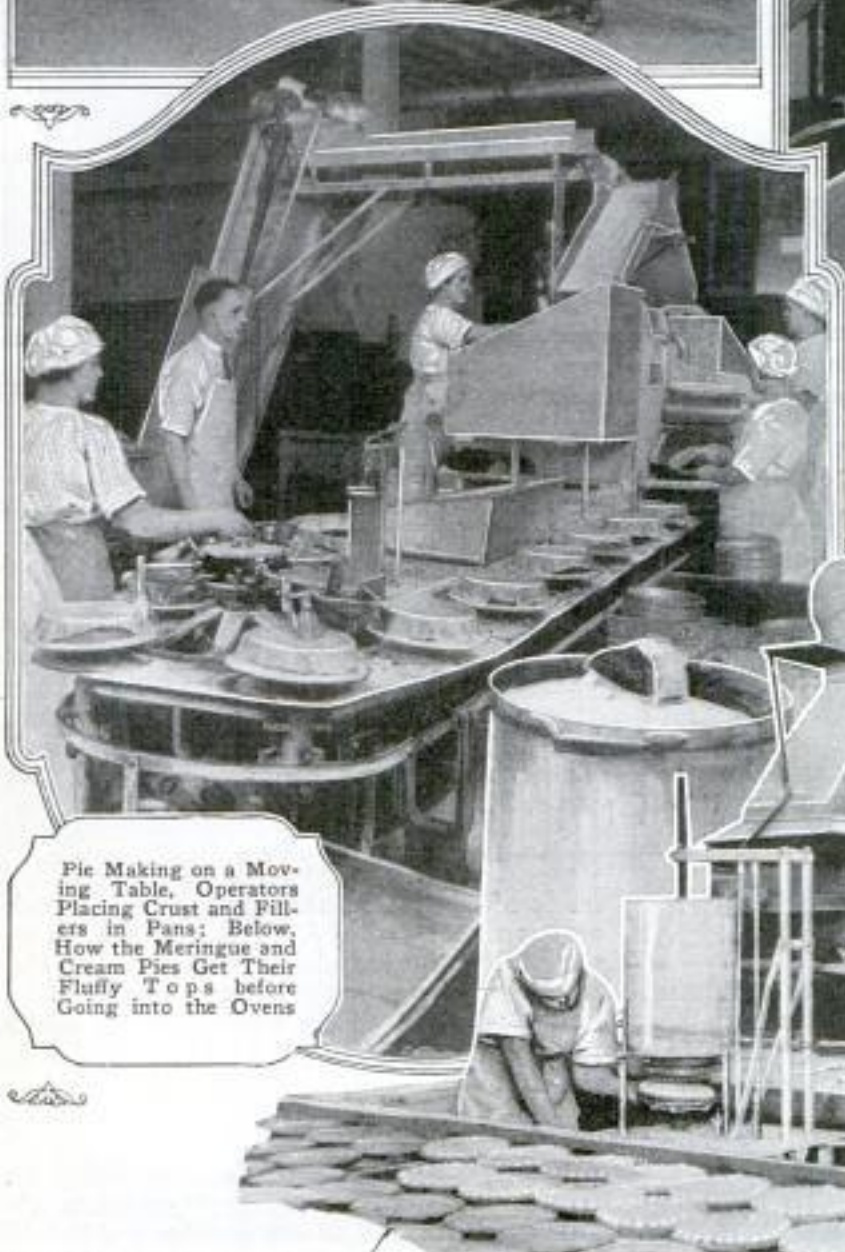

Pie Making on a Moving Table, Operators Placing Crust and Fillers in Pans; Below, How the Meringue and Cream Pies Get Their Fluffy Tops before Going into the Ovens

Callhome Mfg. Co., 157 W. Division St. Chicago

Machine made by Case & Martin
copyrighted material

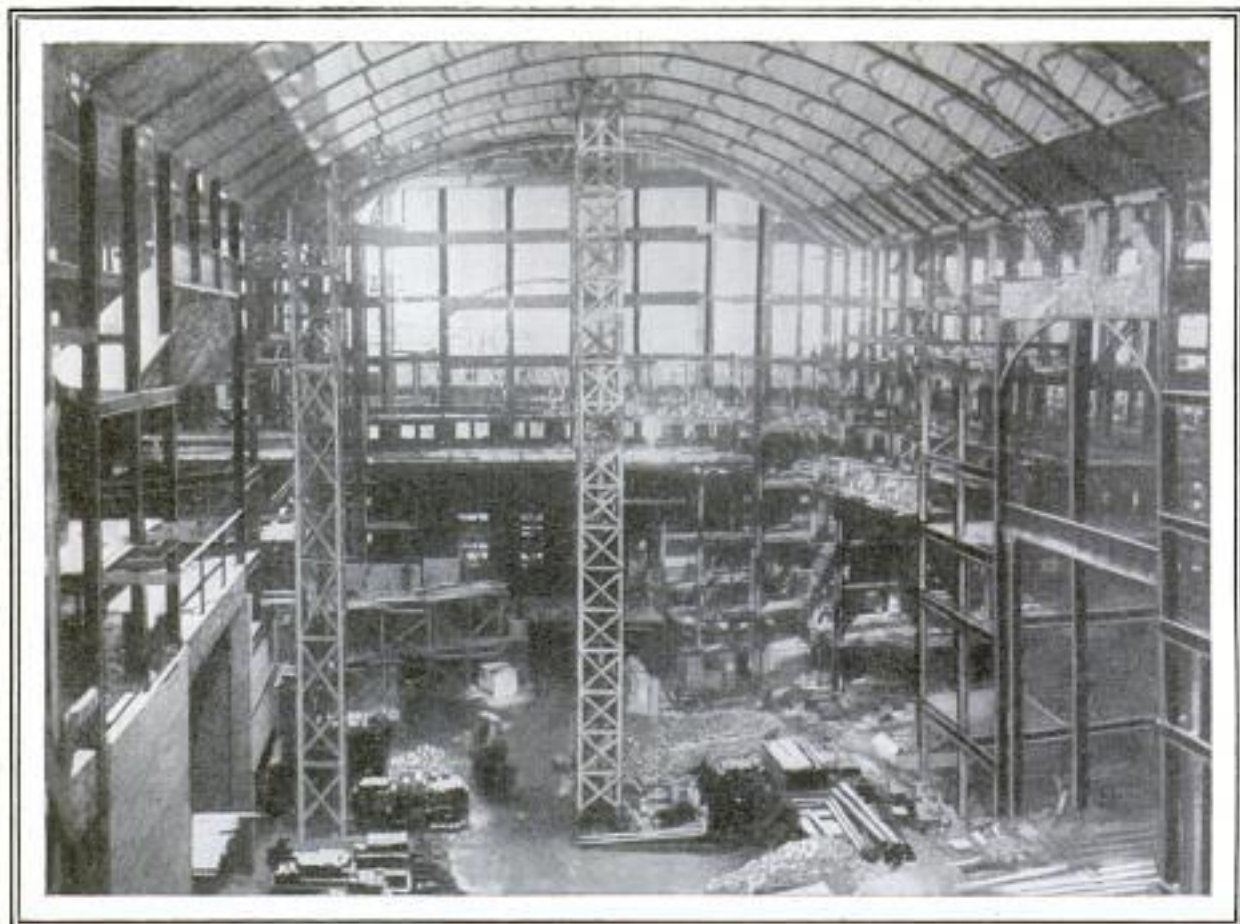

Copyright, Underwood & Underwood

Where Busy Hammers Prepare for Thousands of Hurrying Feet; Constructing Chicago's Union Passenger Station Waiting Room, 114 Feet High

Great Chicago Passenger Station Is Nearing Completion

Chicago's \$75,000,000 Union station, work on which was started in 1914, is expected to be ready for use by the first of next year. When completed, the building will provide accommodations for more than 100,000 passengers daily. The great concourse and the main part of the structure cover 180,000 square feet of ground space. More than 17,000 tons of structural

steel have already been used. The building rests on concrete piers sunk to bedrock and from four to nine feet in diameter. Above the station, an eight-story office building has been erected. This will be increased to twenty-two stories later. Separate platforms for handling baggage and passengers, stands with space for 120 cabs at one time, stores, lunch and dining rooms, and a large cafeteria are to be installed. The main waiting room will be 100 feet wide, 217 feet long and 114 feet high.

Violin, Ukulele and Mandolin in One Plays as Any of Three

With the tonal qualities of a mandolin, a small, compact musical instrument has been imported from Germany, which can also be played as a violin or ukulele. It is

made of mahogany and Pernambuco wood, and is finely finished. The bulky bowl of the violin and mandolin is eliminated, the thickness through the center being barely two inches. A patent tuning device keeps the eight strings in perfect line, and aids the tone and pitch.



Compact Musical Instrument which Can Be Played as a Mandolin, Violin or Ukulele

☐ We want all our readers to write us freely and often whenever they wish additional information on articles published in this magazine. Address Bureau of Information, Popular Mechanics, Chicago.

C. H. Taylor
1855 W. Wabash
Chicago

*dr. Albin + Caesar - 1410 Montrose St.
 Philadelphia, Pa.
 751 Watts* POPULAR MECHANICS

Mother-of-Pearl Tile Adds Beauty and Novelty to Design

Adapted to all forms of architecture and design, a method of forming tile or slab of mother-of-pearl has been patented. Crushed shell mixed with cement is formed into blocks, the surfaces of which are then smoothed and polished. If desired, the pieces may be arranged in the molds in fanciful shapes and figures, such as star designs, and a cement mixed with color used so that the finished surface will present an artistic finish resembling a mosaic. Formed in this manner, the tile may be used for various purposes, such as furniture tops, baseboards and border work. If desired, the mother-of-pearl may be confined merely to the surface layer of the tile or brick.

672

Serve-Self Store on Wheels Saves Time for Housewives

Taking the grocery store to its customers is the service rendered by an automobile truck that carries a full stock of food products, meats and vegetables and is capable of making 400 calls a day on purchasers of its wares. Operated by a driver who is also the clerk, the motorized "food shop" has shelves and bins of goods placed within easy reach of the buyers, who gather their supplies in "trolley" baskets suspended from an overhead track. As the patrons leave the store on wheels, bills are paid and packages unloaded from the container, leaving it ready for the next purchaser at the entrance of the truck. So convenient is the arrangement that it is said to occupy only a small frac-

tion of the time generally necessary for a housekeeper to buy the day's food needs at ordinary stores, besides doing away with the necessity of traveling any distance to attend the task. The interior of the affair is well lighted and heated, and affords sufficient room for several persons to move around. A refrigerator is carried, neatly built into a compartment, for the accommodation of fresh meats and perishable products during hot weather. A show window at the rear of the car displays green groceries and fruits, while ventilators in the roof insure good air circulation. On the ceiling is a large panel containing the list of materials carried, and each rack has a large tag showing the price of the article it contains. The machine covers an average of forty blocks in a day's travel, and because it cannot be affected by severe weather, insures its customers of well-filled larders if they do not care to go out.



Patrons at Door of Store on Wheels Which Saves Time for Busy Buyers

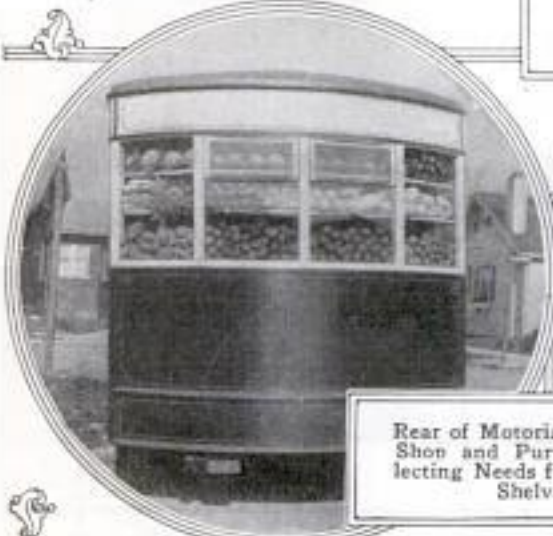

Rear of Motorized Grocery Shop and Purchasers Selecting Needs from Handy Shelves



*Federal Motor Truck Co., Inc.
 Detroit, Mich. Copyrighted material
 Watson*

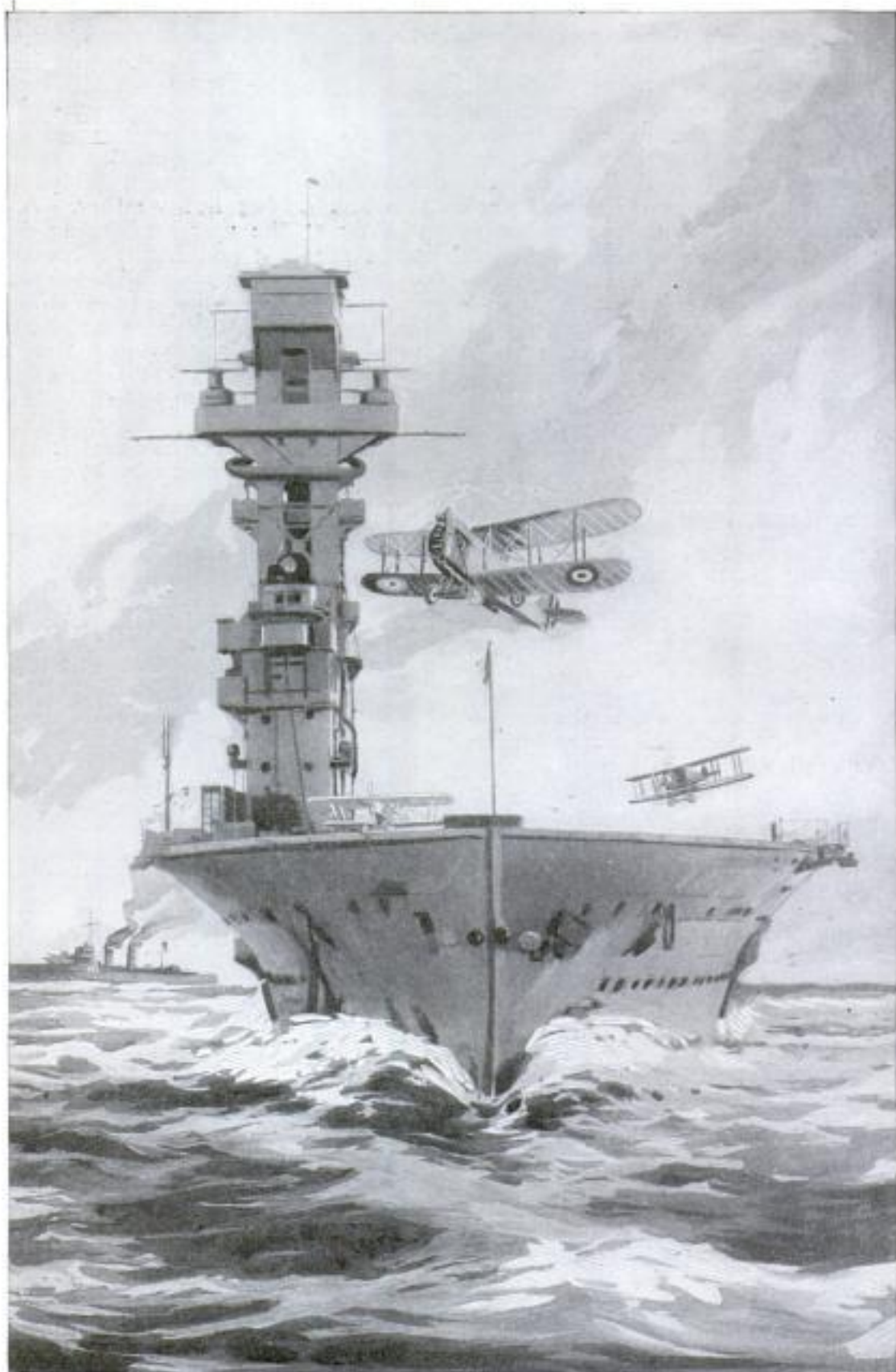

Aircraft Mother Ship "Hermes," of the British Navy, Built to Carry Twenty Planes Which Are Lifted Aboard by Electric Cranes and Launched from the Deck Landing Field

*Cornell University
College of Agriculture
Prof. Louis Knudson*

*New York Times
May 7, 1924*

*Wide World Photos
229 W. 43rd St.
New York*

**Orchid Growth Hastened Two Years
by Feeding Salts and Sugars**

Orchids that are maturing two years sooner than under natural conditions and treated bacteriologically so as to obtain practically 100-per-cent germination, are being grown by a botanist in an eastern university. The flowers were planted in sterilized tubes five years ago. By feeding them essential salts and sugars and eliminating the bacteria which ordinarily would prove destructive, the botanist is hopeful of almost perfect germination. After a few months' growth in these tubes, the seedlings are transferred to large flasks containing the same culture medium. Under such favorable conditions, the plants grow rapidly and when they have five or six leaves and roots an inch or two in length, they are transplanted to open pots. In addition to the rapid growth, it is pointed out that there is no danger from insects or parasite fungi during the early life of these "bottle-fed" flowers.

Mission on Motor Truck Has Radio and Phonograph as Gospel Aids

Equipped with a radio outfit and a talking machine, a mission on a motor truck is used by an eastern evangelist on tours



Evangelist Fred L. Strickland and His Traveling Mission Showing Radio and Music Box

about the country. The pulpit is placed on the endgate, which serves as a platform for the preacher, and adjustable shelves at the sides hold the radio loud speaker and the music box. They have been found useful in leading the hymns and in drawing crowds. The truck interior is furnished as an apartment in which the minister lives while traveling.

Steering Gear for Camel Is Rope Through Nose of Animal

Desert travelers who ride to their destinations on camels, guide their animal by a rope pulled through its nose. One end of the rein is tied around the animal's neck and the other run up behind one of the ears and down the face into a hole pierced in the upper part of the nose. A

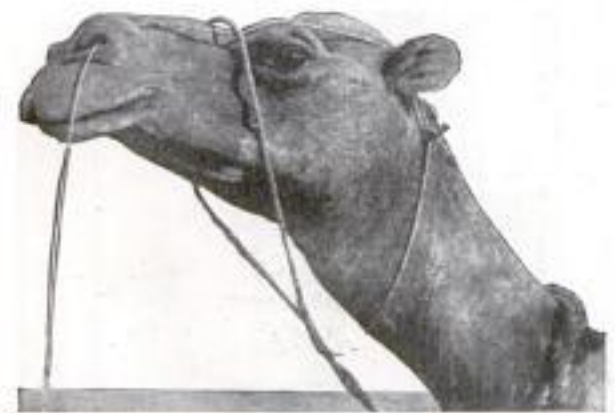

Camel with Rope and Nose Rein by Which the Rider Guides Animal over Desert Wastes

heavier rope is looped around the long face of the camel. With this arrangement, the rider becomes master of his conveyance and can make it go wherever he pleases.

Boiler Scale Is Prevented by Use of Electric Current

Scale formation on the walls and tubes of boilers is prevented by the use of electricity. The negative pole of the source of current is connected to the wall of the boiler while the positive is connected, through an insulated part of the shell, to a piece of iron hanging in the water. The action between the two poles deposits hydrogen on the sides of the boiler that are under water and the hydrogen decomposes the calcium sulphate of which the scale is mainly formed. There remains only a muddy and loose substance that does not influence the transmission of heat and which may be easily flushed out. If the feed water contains acid that may corrode the walls, the dissolved metal is redeposited at the sides so that the influence of the acid is neutralized. The current must be small in order not to decompose more water than is necessary to prevent the formation of scale.

*Siemens Schuchert
Werk, Eschsch
Techn. Büro, & Fabrik*

Dr. Ing. Carl Commeny, Eschsch, Hamburg 8, Germany, Conk

*Wide World Photos
229 W. 43rd St.
New York*

Time and Money-Saving Tools



Wire Spring Clips on Dress Hangers Keep Garments Neatly Stretched and Prevent Their Falling Off



For Traveling, a Clothes Brush with Bristles That Fold Down Flat in Pocket Holder Is Found Convenient

Soaked in Kerosene in Handy Jug, a Fire-Clay Ball Will Sometimes Start Obsolete Coal Fires Blazing



Baby May Travel in Comfort in Well Ventilated Wicker Cradle Handled like Suitcase



Folding Sewing-Basket Stand Saves Space and Is Decorative

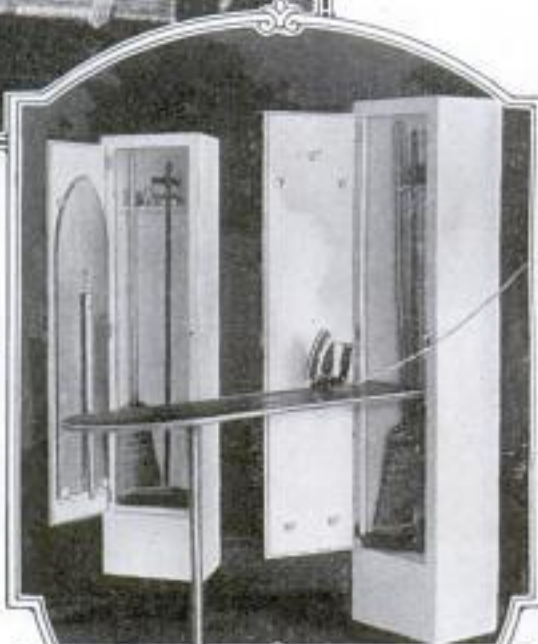

When Space Is Limited, Combination Ironing Board and Broom Closet Solves Household Problem

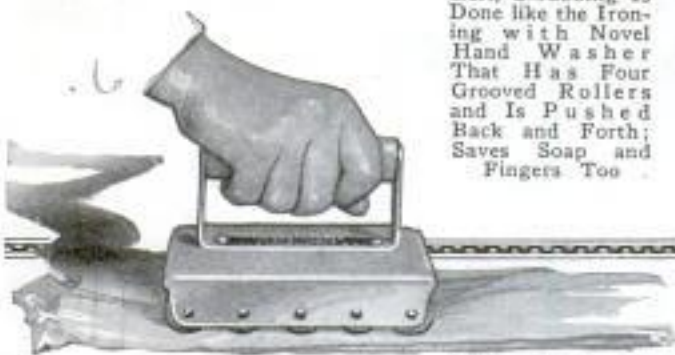

Left, Scrubbing Is Done like the Ironing with Novel Hand Washer That Has Four Grooved Rollers and Is Pushed Back and Forth; Saves Soap and Fingers Too

for Woman's Workshop in Home

- 2.
- Mess.
- 3.
- 4.
- 5.
- 6.
- m
- 7.
- 8.
- 9.
- 10.
- 11.
- 12.
- 13.
- 14.



One Stroke of Novel Cutter Quarters an Apple and Removes Core; Knife Edges Are Protected by Wooden Platter That Holds Fruit



Modish Belt and Purse Combined Add Attractive and Useful Touch to Street Costume



Strainer Holder Helps in Making "Jell"



Rubber Nursing Bottle Can't Break and May Be Turned Inside Out for Easy Sterilizing



Sprayer Nozzle with Anchor Spike Keeps Hose in Steady Position



Right, Floor Waxer and Polisher Run like Carpet Sweeper

Below, Draining and Drying Dishes Are Quickly Done in Oblong Rack with Wire Basket for Silver Attached; Specially Suited for Small Kitchens

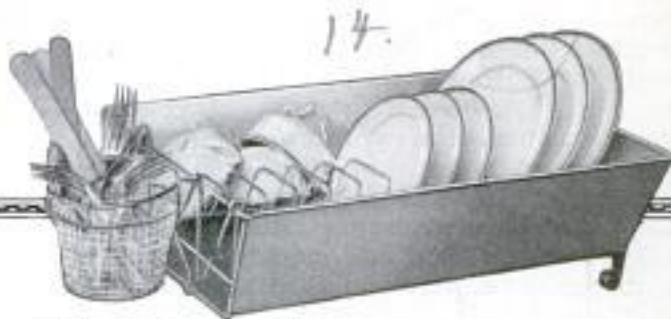

obtain it by addressing Bureau of Information, Popular Mechanics Magazine, Chicago



Working Group Drawing
Chicken Feed from Farm
Warehouse



Supervisor
Candling Eggs
Before They
Are Sent to
Buyers



Seal of Club That
Appears on Boxes;
Right, Feeding Time



Boy Workers Delivering
Eggs to Central Store-
room for Inspection and
Packing



Boys' Poultry Club Serves Egg Market from Farm They Run

Composed of a group of boys interested in the collective production and marketing of chickens and eggs, the Early Riser poultry club of Durham, Conn., has worked out a modern system for selling and distributing their products. In a recent contest, held with many other such organizations, the youthful poultrymen won the championship position for judging chickens. With a flock of 1,000 hens, to which close attention must be paid if they are to be kept in good condition, the club performs practically all work necessary to provide the farm with feed mix-

tures and equipment. New houses for the fowls and repairs to old ones are all attended to by the members. Grain feeds are sorted and mixed at a central point and, when needed by the various sections of the club, are parceled out and recorded to show actual costs at the end of the season. In selling the eggs, almost the entire twelve months' supply is marketed directly to homes. All product is graded by candling and the highest prices are received. In some cases eggs are sold in wholesale lots to dealers, and at times the boy salesmen carry on selling campaigns in order to create outlets for their wares throughout neighboring cities. All boxes and crates are labeled with the club seal.

Feb. 1924
March 5, 1924

Fortune Spent in Cleaning Liner for Paint and Polish *682* **Thrills Added to Swimmers' Sport by Flying Rings over Pool** *708*

Every time a liner arrives at its home port, a small fortune is spent in cleaning the ship. All the linen is bundled ashore to be washed in the company's own laundry. In one such plant, close to 6,500,000 pieces are handled in a year. Carpets are taken up, floors scrubbed and mattresses either aired or sterilized. For washing and scrubbing a steamer such as the "Olympic," it is said that in the course of a year nearly 20,000 gallons of liquid soap, 70,000 pounds of soft soap, 22,000 pounds of soap powder and 15,000 pounds of soda are used. All the paint work is gone over and the brass polished. For this latter work, more than 5,000 pounds of paste are needed each twelve months. Once a year the ship is laid up for painting.

Suspended from a long pole over one of the pools at Sulphur Springs, Fla., is a pair of flying rings and a chain on which



Copyright, Underwood & Underwood
Performing Aerial Stunts with Wellings Waters of "Bottomless" Spring as Life Net

Trackless Sidewalk Auto Seats Thirty Persons *211*

Carrying thirty passengers, an automobile has been made to run on sidewalks as an aid in solving city traffic problems. An open and a closed compartment provide easy means of entrance or exit. The car is only twenty-three feet long and a little more than six feet wide and weighs about two and one-half tons. It is propelled by an engine mounted in the rear of the driving axle. Cushion tires, double in the rear, and special springs assure comfortable riding.

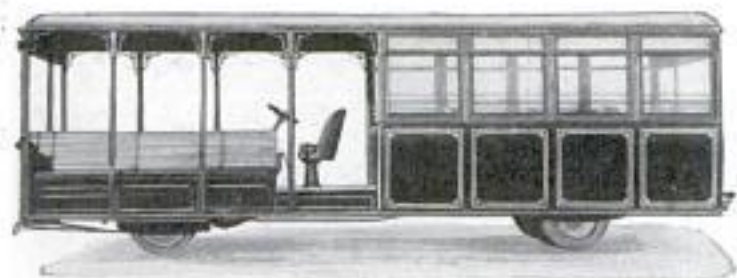

Sidewalk Motor Car with Open and Closed Compartments, Offered as Aid to Traffic Problems

ing. It is especially designed for parks and waterfronts and other places where there is a long stretch of walk.

So fast does a machine that cuts up wood into matches operate, that in a single minute it will turn out 40,000 splints.

swimmers perform various stunts before dropping into the water. Variations of fancy diving are attempted, and the exercise is found to be invigorating after a long swim. The pool is continually welling up with sulphur water from a "bottomless" spring at the rate of nearly 60,000 gallons a minute. Because of the great depth, only expert swimmers are allowed in it.

Golf Balls Marked to Aid Players *519*

Players often confuse their balls when using the same kind, and to remedy this, manufacturers are marking the balls with numerals or with colored dots. Those identified by figures are numbered from one to four, so that each member of a foursome readily can claim his own. Similarly, red, blue, orange and black dots are imprinted on the surface of the balls to provide distinguishing marks.

Chas. W. G. St. Meister, Box 656, Sacramento, Cal.



Alfalfa and Dairy Maid's Call Summon an Eager Flock at Feeding Time



Loading "Goat-airy" Motor Truck for a Morning's Delivery to City Customers

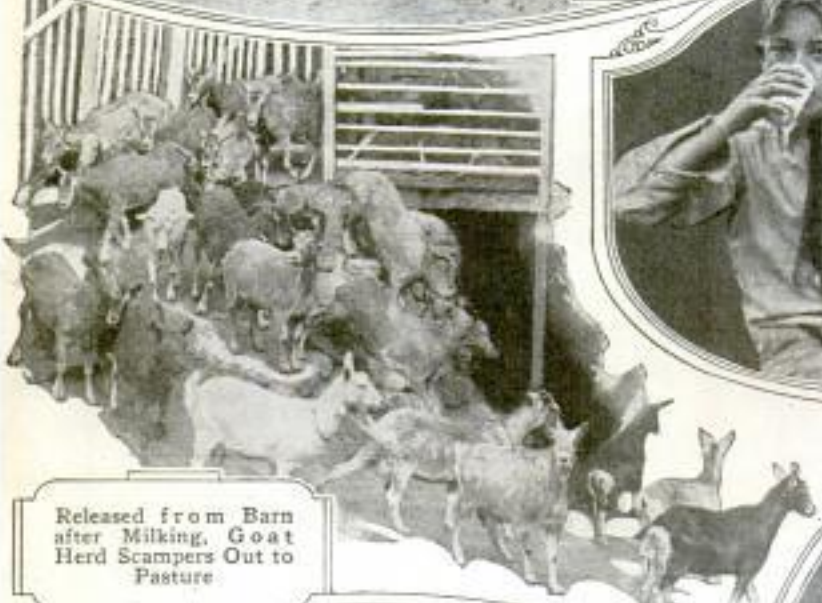

Released from Barn after Milking, Goat Herd Scampers Out to Pasture



"Good for All Kids," Is Verdict of Food Experts on Goat's Milk



Inside Milk Cooling and Bottling Room Where Pints and Quarts Are Filled for Delivery



Straining Milk into Supply Tank Connected to Cooler on Floor Below

Underwood's Underwood

Stevens & Co., 375 Broadway, New York City, 291

Goat Dairy Run by Woman Pioneer Supplies City with Milk

Goats, long cultivated in Europe, are gaining in popularity in the United States because of the excellence of their milk. Near Los Angeles, a woman pioneer in the business manages a goat dairy. The animals are given a thorough washing every day. They are milked in the morning and afternoon and the product is strained, sterilized and bottled in modern dairy apparatus and delivered by motor truck. The milk is in special demand for infants and invalids, and makes good cheese and butter. The cost of keeping the animals is said to be moderate. They are fed on alfalfa and grain. In many parts of Europe, goats are driven through the streets and milked at the door of the customer.

254

Play Horseshoe "Pitch" with Cards

To afford indoor amusement for horseshoe pitchers and others interested in that pastime, a deck of cards containing the various points of the game has been devised. Each pasteboard square bears an illustration of a peg and shoes in position to represent an actual play that commonly occurs in outdoor competitions. A set of rules governs the scoring.

Price - 60¢ per deck

"Jazz" Effects Are Easily Produced with Steel Hand Instrument

Adapting the principle of the "musical saw," a steel hand instrument has been made to produce unique "jazz" effects. It consists of a steel band fitted to a frame holder and struck by two hammers. Various notes of flutelike quality and tremolos, loud or soft, may be produced by flexing the band with the thumb. The instrument is said to be adapted equally to solos or accompaniments and anyone can learn to play it with little practice.



836

One-Man Engine Stands for Autos Save Time and Repair Costs

To save time and reduce the cost of making automobile repairs, stout steel stands with which one man easily can raise the motor from the floor or lower it, have been designed. They are attached by four bolts through the manifold stud holes. By pressure on the crank and on one of the stand's skids, the engine can

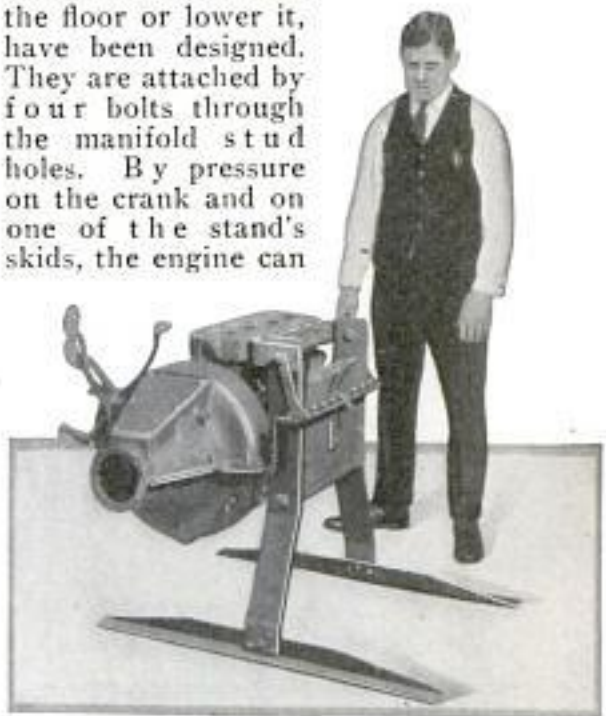

Engine Bolted to Stand and Raised from Floor by One Man; Note Broad Supports

be "walked" to an upright position with little trouble. A patented retaining rack is provided, which has spring plungers fitting over the valves to press them against the push rods and keep them from falling out or from buckling or bending. The stand allows the mechanic to get close to his work at a convenient height, weighs only 89 pounds, will not tip over, it is claimed, and has a removable tool tray within easy reach. A similar stand is designed for work on the axle assembly.

"Song of Stars" Is Heard as Light Is Changed into Sound

Light rays from Capella, a star many millions of miles from the earth, are reported to have been turned into audible sounds by means of apparatus invented in France. The experimenters started with the known fact that, under the action of light, cells of selenium give off a feeble electric current. Instruments were therefore devised for amplifying the current produced by light from the star to such an extent that it could be heard by listening in with head phones.

Law. Gen. Paris Observatory Herrie, Paris

The Daytonian 836 Dec 25 New York

Chicago Daily News

Legless, One-Armed Man Conquers Obstacles in Driving Automobile

What may be accomplished in overcoming physical obstacles is shown by the feat



How Ingenuity of One-Armed, Legless Man Has Conquered Physical Obstacles in Driving Car

of Andrew W. Cromshaw, of Alliance, Ohio, who has become a skilled automobile driver despite the fact that he has lost both legs and one arm. Specially devised attach-

ments to the brake, clutch, gear shift and steering wheel enable him to manage his car with almost as much ease as the ordinary driver. So adept has he become, despite his handicap, that he has won the reputation of being one of the most skilled drivers in the city.

Quality of Panama Hats Revealed by the Rings in Crown

Counting the number of rings of strands in the crown reveals the quality of Panama hats, according to dealers. The more of these there are, the better the grade. Color, texture and shape are important factors, too, they say, and if any broken straws are revealed, the value is decreased. Furthermore, a good Panama hat is never bleached after being woven. Those of superior grade are the original color of the little strips of leaves from a dwarf palm-tree plant that grows in Ecuador and other South and Central American countries, where natives weave the best hats. It takes three months or more to finish those of the highest quality. All the work is done by hand and only the best and longest fiber is used. Reports that the most expensive hats are woven only by candle-light or under water are said to be erroneous. However, the straw is kept damp and at night the unfinished hats are hung where they will be exposed to the dew, so they can be worked on without danger of breaking the strands the following day.

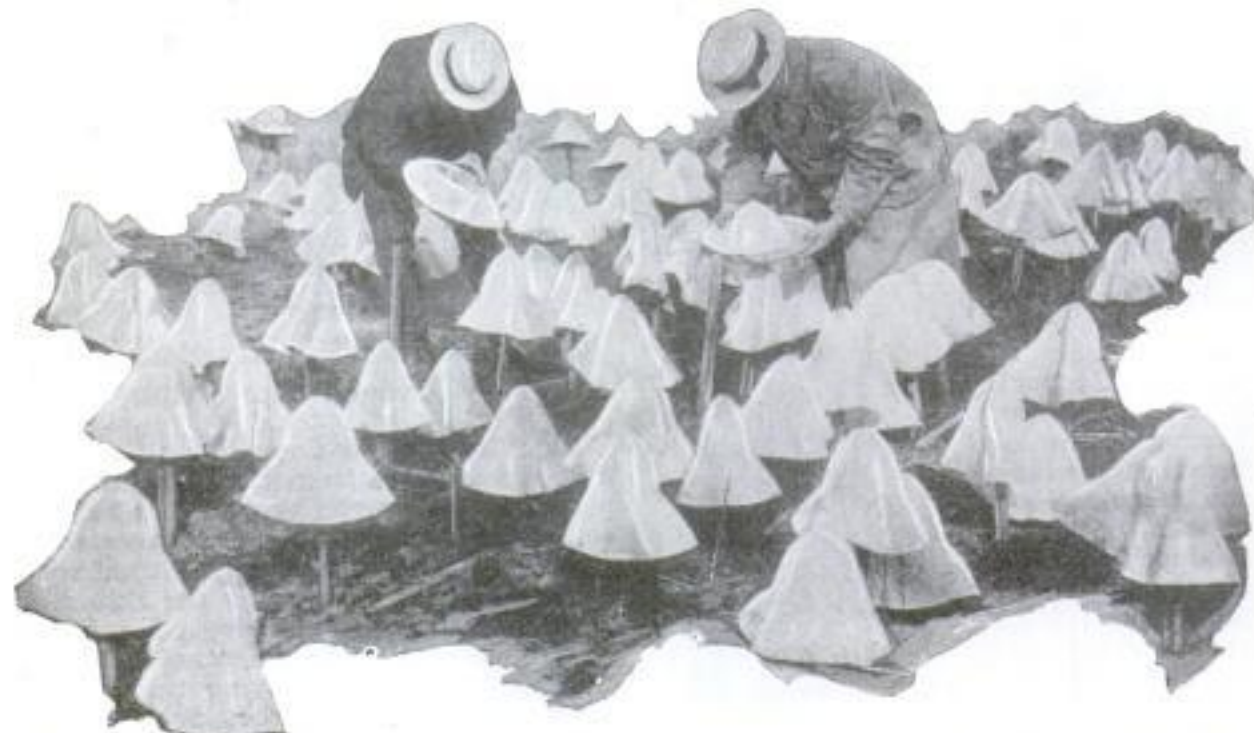

Putting Out a Cheaper Grade of Panama Hats to Dry on Pegs in the Sun after the Bleaching Process, a Step Unnecessary in Manufacturing Better Qualities

In three bleaching works
in three, England



Airplane View of Muscle Shoals in Northern Alabama Where Wilson Dam Extends for a Mile across the Shallow, Broken Bed of the Tennessee River

What Muscle Shoals Means

World's Greatest Hydraulic Undertaking Started in War Days to Become Immense Factor in Aid of Farms and Industries

WHILE almost everyone has become more or less familiar with the name Muscle Shoals, but few people seem to have a clear understanding as to the location, size and purposes of the project which the name has come to designate.

At present the greatest hydraulic development in the world, and a task of engineering second only to the Panama canal, the undertaking, started in the summer of 1918, was planned to be the source of supply for the large amount of nitrates demanded in the manufacture of high explosives for the American armies in the great war. The site of the immense plants is on the Tennessee river in northern Alabama, and the erection of the entire structures of the operation is in the hands of engineers employed by the government under whose supervision the project is being carried on.

Since the need of nitrogen compounds for war material is no longer a pressing one, the plants erected for that purpose are to be devoted to the manufacture of nitrates required in the composition of fertilizers. The first one of these completed, nitrate plant number 2, has a capacity of 150 tons a day.

In connection with the production of much needed fertilizing substances, a great supply of which has usually been imported for use on the farms of the country, an im-

mense electric power plant is also under construction at the same point. The first structure of this group, the Wilson dam, when finished is expected to generate from 200,000 to 600,000 horsepower of electric energy. Although power is the prime reason for the existence of the dam, it is planned with a view to make navigable the river in which it stands for all-year-round commerce over this section. The shoals which give the place its name are so formed that the stream varies between a flow of 7,350 feet a second during low stage to almost 500,000 feet in flood seasons. Such changes in the volume of water usually take place in remarkably short spaces of time.

Other dams included in the designs for the project are intended to act as auxiliary structures to the Wilson dam, which will serve as a barrier to the entire width of the river. It is approximately one mile in length, covers twenty acres of ground, and the lake it creates will extend upstream for a distance of eighteen miles. Concrete and masonry contained in the gigantic dam comprise 36,000,000 cubic feet, sufficient material for a solid concrete road, sixteen feet wide and six inches thick, stretching from New York to Chicago. The main wall of the barrier rises to a height of 137 feet above the foundations. Besides the structures already under way, power plants

1080

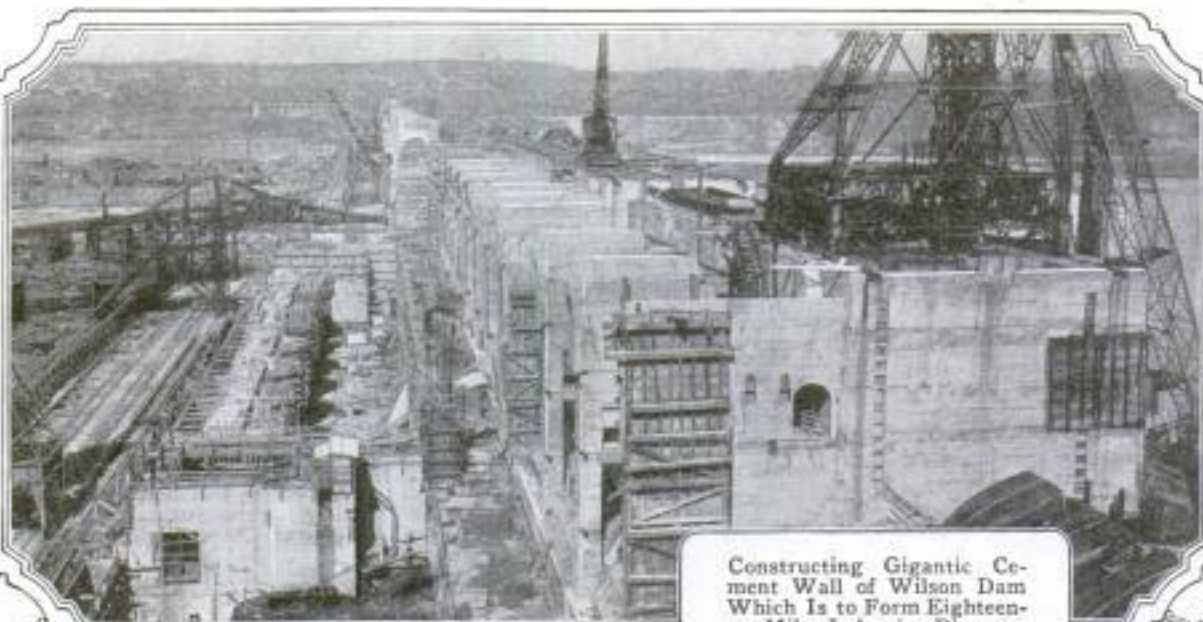

Constructing Gigantic Cement Wall of Wilson Dam Which Is to Form Eighteen-Mile Lake in River

One of Immense Concrete Cones on Tips of Which Turbines Revolve; Water Pours Down Pillar and Spreads Out for Discharge

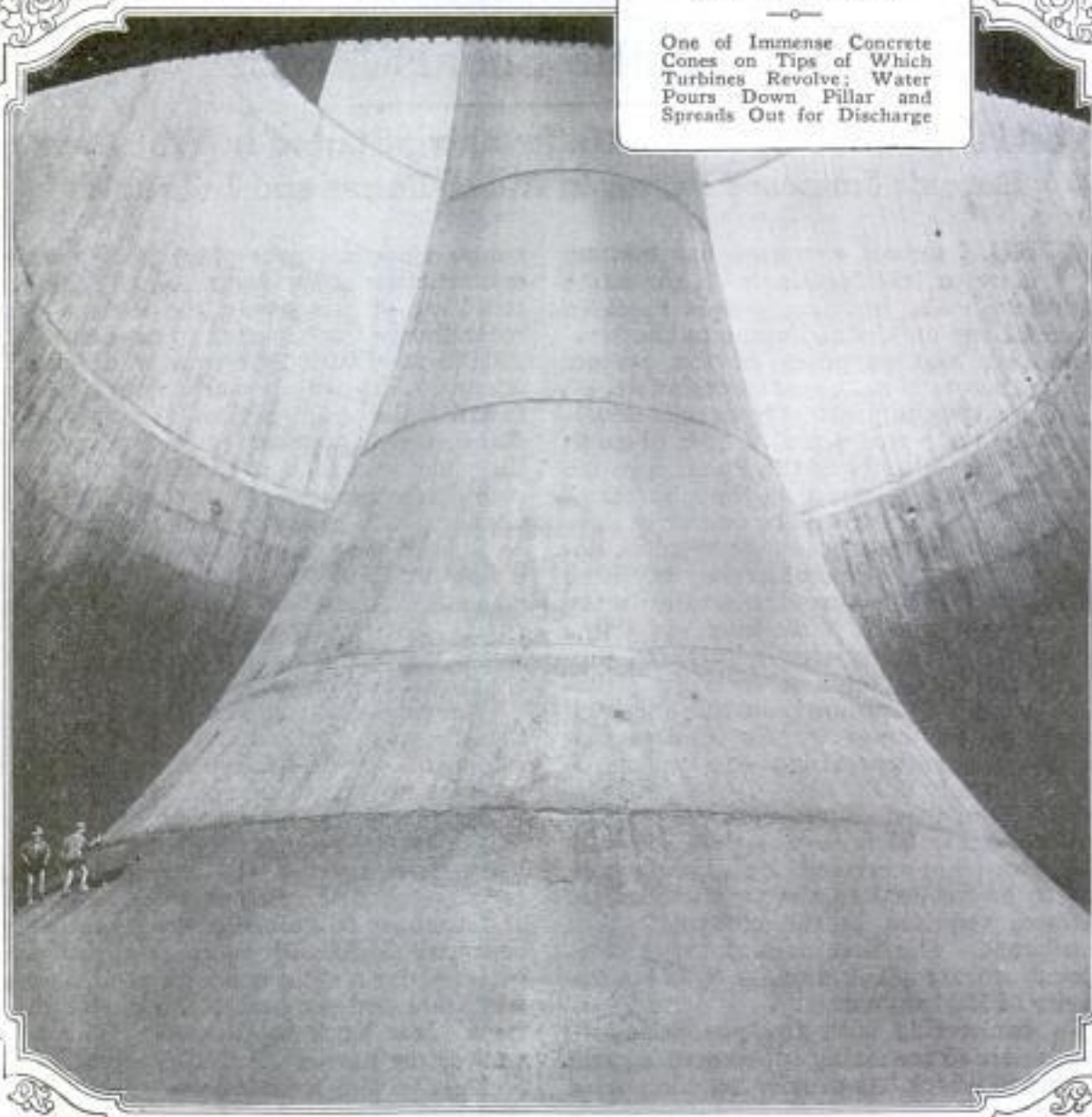

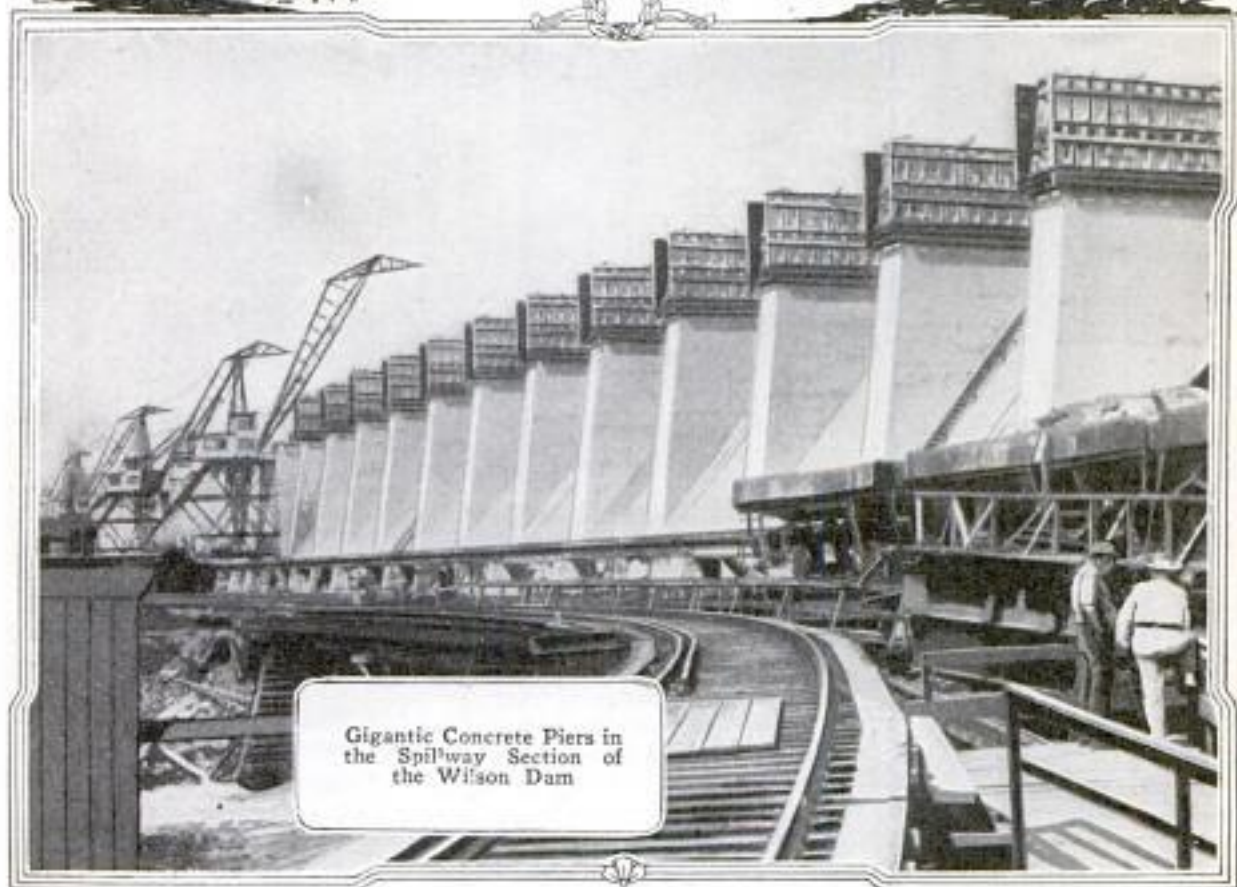
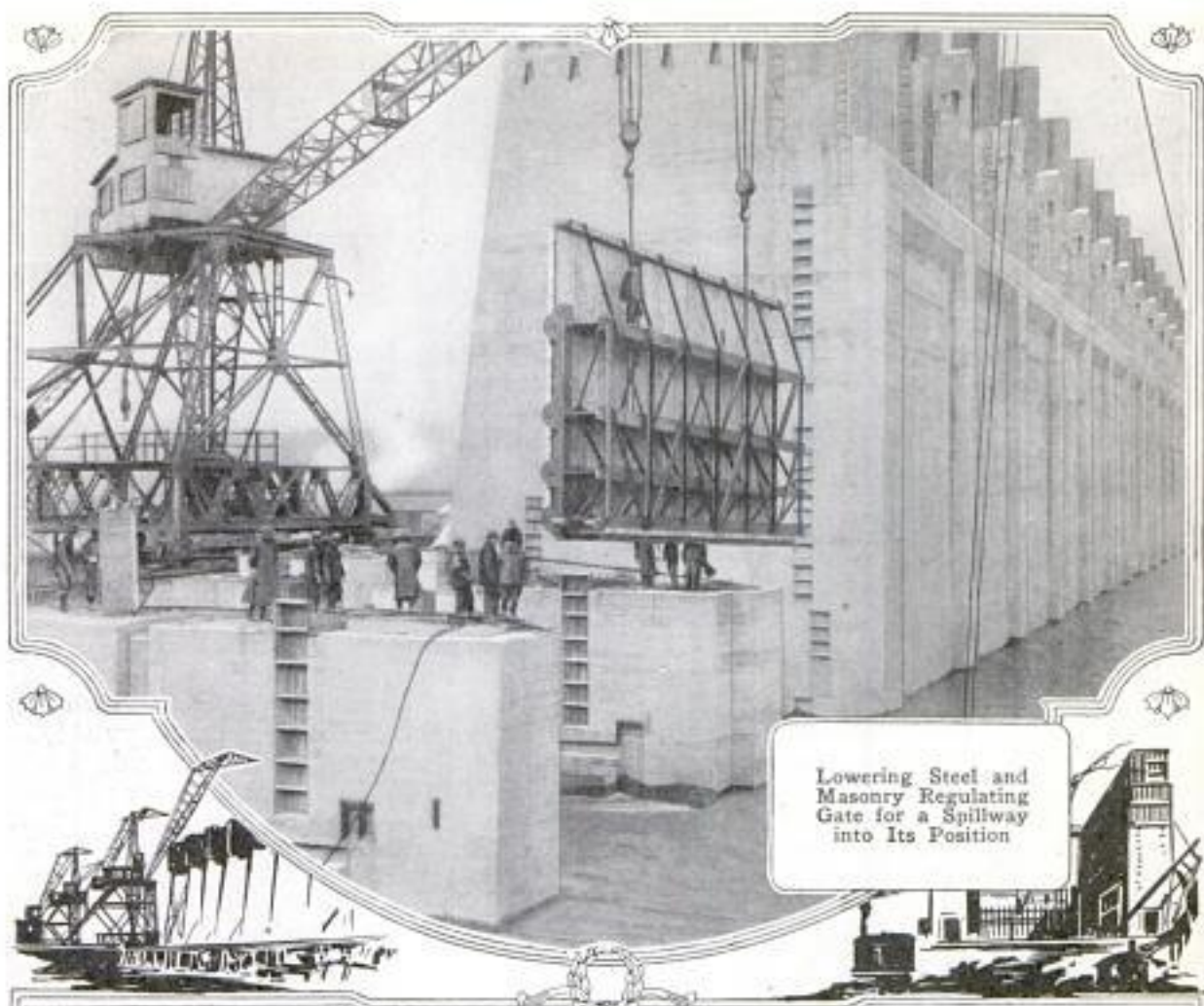

run by an upper dam are designed to add greatly to the output of the main plants at the Wilson dam, bringing an estimated production of 800,000 horsepower of electric energy that could supply the needs of about twelve surrounding states. In the nitrate plants two processes, one mainly dependent on the supply of air, the other using coal, limestone and air, are believed to be sufficient in production of fertilizing materials for the needs of almost any demand. To house the workers employed in the industries two large villages have been built at a cost of \$16,000,000. These communities are well equipped with schools, hotels, hospitals, public utilities and all modern improvements found in the most up-to-date cities. Besides, eighty-five miles of navigation improvements will make possible further development of the upper reaches of the river country by bringing water transportation to the aid of industries and agriculture.

Although efforts to plan profitable improvements in the Tennessee river at Muscle Shoals and adjacent areas traversed by the stream have been made for the last hundred years, it was not begun until science, searching for methods of making nitrates from materials abundant in that locality, discovered a

means to turn the natural resources and formations

of the river to valuable uses. Government engineers had already surveyed and reported on the availability of Muscle Shoals district for a dam and power plant when the necessities of the great war inspired the beginning of the work. With slight changes and additions to the original plans, these experts have turned the development from a source of essential explosive chemicals to one whereby not only agriculture can be greatly assisted, but also neighboring cities and industries for many miles around the gigantic project may be benefited. One striking operation in the performance of the work of preparing the ground for the big Wilson dam, consisted of what has been termed "geological dentistry." In sounding the soils underlying the rocky bluffs which abut on the river, it was found that large "pockets" or deposits of absorbent clays were so situated as to assist the seepage of water, that might result in disaster to the success of the project. Tunnels were driven into the walls of the bluffs, one being run 1,400 feet beneath the top of the ground. From these drifts the clay pockets were reached, the soft soil removed from its beds and the holes filled with concrete, much as a dentist fills a tooth cavity. This treatment resulted in a considerable strengthening of the earth at that point, besides providing a watertight and resistant barrier against dangerous seepage or leakage of water around the dam abutments or the powerhouse foundations on the land end of the work. This is but one of the huge engineering tasks whose results will be concealed when the project is completed.

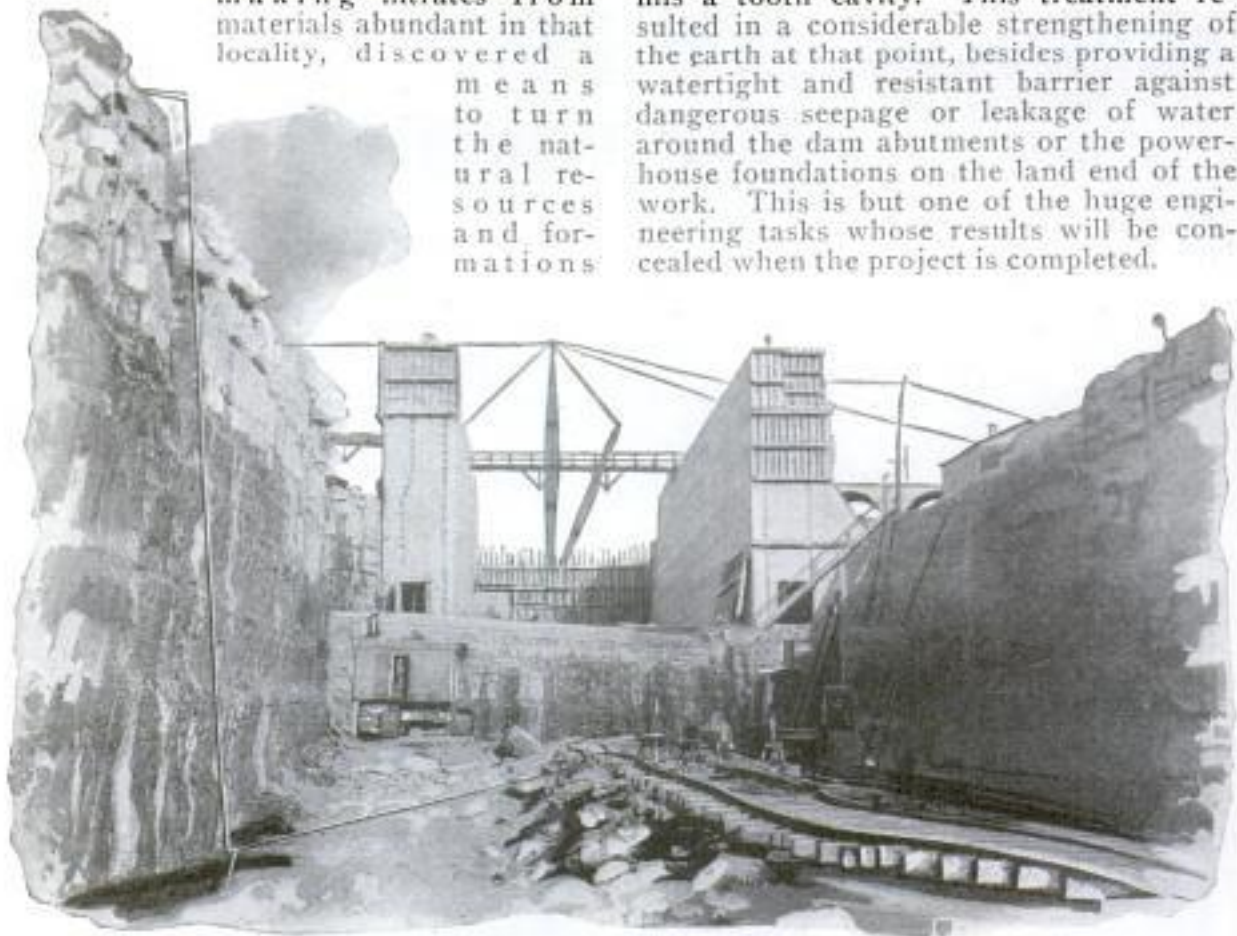

One of the Locks of Wilson Dam That Will Be the Means of Putting the Upper Reaches of the Tennessee River into a Great System of Water Traffic

122-26 Underwood's Underwood
205 W. W. Washington, Chicago



Bloodless Surgery with Radio "Knife"

Radio has entered a new field—that of surgery, and bids fair to find a permanent place there. Recently, in a Chicago hospital, an entirely new instrument, the radio "knife," made its appearance, and, in the hands of the inventor, a well-known surgeon, demonstrated its ability to sever human tissue with the minimum loss of blood. As explained by a representative of the laboratory in which the new device was developed, the theory is very simple.

its way through skin, fat and muscle as easily and with as little necessity for pressure as though it were passing through butter instead of flesh.

The inventor, in the course of the demonstration, operated on two men afflicted with cancer of the bladder, and the blood resulting from the severing of the tissue might have been caught in a few tablespoons. It is anticipated that the new instrument will cause a small revolu-

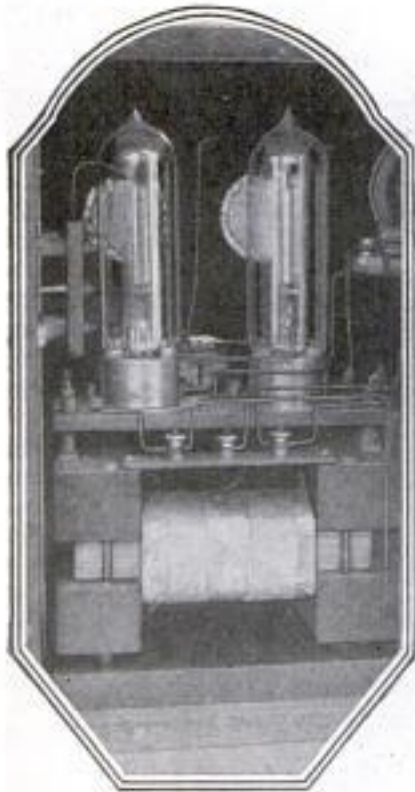

Above, Interior View of Instrument; Upper Right, Testing Radio Knife on a Piece of Meat; Lower Right, Surgeon in Chicago Hospital Using Knife in Operation

A low-power radio transmitting set is employed to generate the high-frequency current used. The knife, which really is not a knife at all, but looks more like a heavy knitting needle, forms one terminal. The other terminal is a plate on which the patient is laid. The human tissue offers resistance to the passage of the current when the knife is applied, and the resulting heat, it is said, causes the knife to burn

tion in the operative treatment of certain diseases, especially cancerous growths.

■ In the United States there are 3,000 manufacturers of radio supplies, 1,000 wholesale distributors and jobbers, and 25,000 retail dealers.

Alexian Bros. Hospital
1200 Ogden Ave Chicago

Inventor: Dr. Louis Schmidt, 528 Wabash, Chicago

Stations Logged on Dials

Radio fans will welcome the calibrating device shown in the photo by which the various stations can be logged on the dials so that tuning is made much easier. The device consists of a cardboard disk about 1/2 in. larger in diameter than the dials. It has radial slots cut along the edge so that small pieces of paper marked with the various stations can be inserted. The

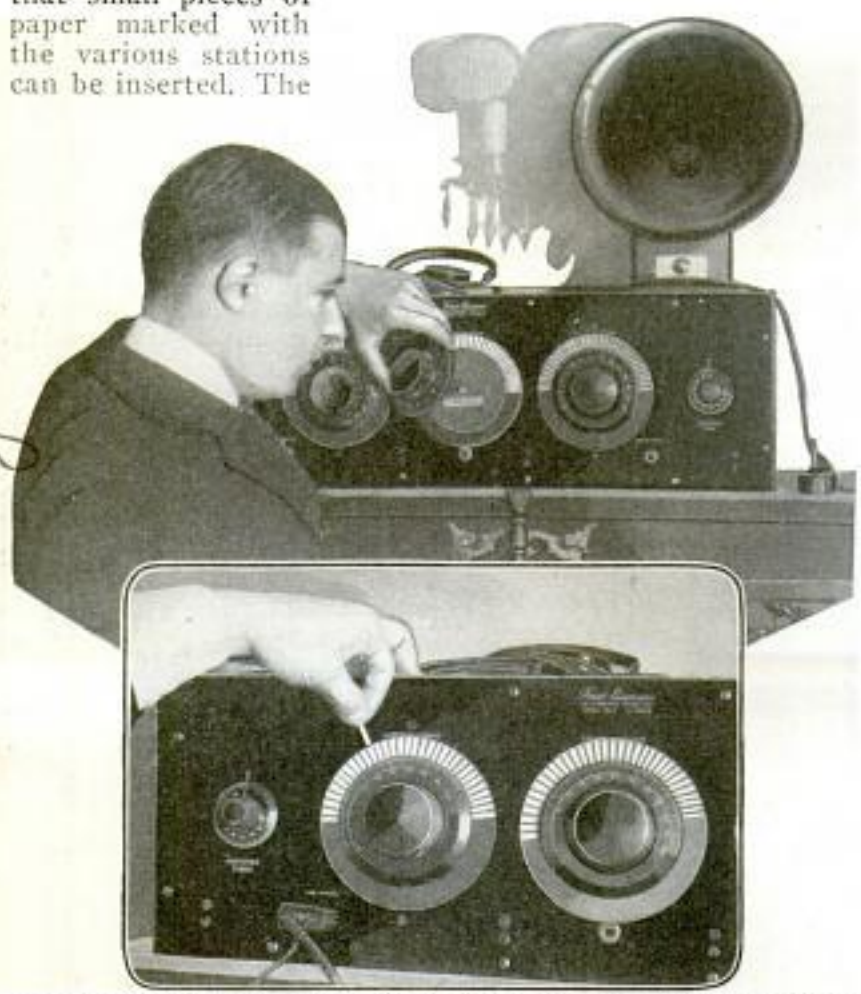

New York Radio Fan Invents Novel Calibrating Device Which Enables Stations to Be Logged on Tuning Dials

face is covered with thin transparent celluloid and the disk is fastened to the underside of the dial. Of course, the tuning varies with different sets as well as with distance and location, and therefore each must be calibrated by its owner. This is done by first tuning in a station and, using the zero mark as a pointer, noting over what slot it lies. A small strip of paper with the call letters of the stations printed on it is inserted in this slot and the same thing done to all the dials. In this way a permanent record is made, and the stations thus logged should readily be tuned in at any time; there is, however, always the possibility that atmospheric conditions may be encountered that will make slight changes in the settings necessary.

Radio Beacons to Guide Airmen

Recently the bureau of standards, in cooperation with the U. S. signal corps and the air service, has developed a means of increasing the safety of both aerial and marine navigation which is of special value in fog, when lights are practically useless.

The method is briefly as follows: At lighthouses, in the case of marine navigation, or at stations along a particular route, in aerial navigation, ordinary radio transmitting sets are installed. Two antennae of the coil or loop type are used with each set. These antennae consist of single turns of wire, each in the form of a vertical rectangle about 100 ft. long and 50 ft. high, crossing each other at an angle of 135 degrees. The transmitting set is connected alternately to each coil. As this type of antenna transmits a maximum signal in one direction, and practically no signal in a direction at right angles to the first, a receiving set located along the line bisecting the angle formed by the crossed coils will receive signals of equal intensity from each antenna. If the receiving set is on an airplane or ship, a straight course can be maintained by navigating so that the two signals always remain equal in intensity. Such a course evidently may be steered regardless of visibility.

The system has been found quite reliable and offers great promise, especially for cross-country aerial navigation. An airplane was recently guided into Dayton, Ohio, from a station 100 miles away, by means of the signals from a "beacon" of this type. The new invention can also be used on rivers and crooked channels, to supplement the range lights now employed.

The simplest method of testing a radio headset for sensitiveness is to fit the phones over the ears in the usual way, and place the cord terminals on the tongue. Good phones will respond with a loud click, but inferior ones will not.

no street address. Chicago, N.Y. 195. R. Underwood, charging L. Holland

109-5
Card
33/30 m. gally
Nanasa's E. m. gally
Coleman
Conb. Frances

Com. U. C. Cole,
Box 449, Chicago

Switch for Both Batteries *112-U*

Filament batteries should be turned off and the phone or loud-speaker plugs pulled out of the jacks when the set is not in use. This is often forgotten at the close of the evening's entertainment, with the result that the battery is discharged, sometimes overnight, and the fact is not discovered until it is too late. Many sets are fitted with a filament switch on the panel and it is a simple thing to use it. On sets having no such switch, a single-throw double-pole knife switch should be installed to cut off both A and B-batteries, one side of the switch being used for each battery circuit. This arrangement also permits making adjustments and repairs without danger of blowing tubes.

Radio "Pinch Hits" for Orchestra *185-R*

Radio came to the rescue when the orchestra failed to appear for a dancing performance at Aeolian Hall, New York, recently. Florenz Tamara and Addison



Florenz Tamara and Addison Fowler Dance to Radio Music at Public Performance When Orchestra Fails to Appear

Novel Window-Shade Antenna *183-U*

An unusual and effective indoor aerial may be made by sewing the wires around the edges of an ordinary window shade, as shown in the photo. The ends of the wires terminate in binding posts attached to the slat in the bottom hem of the shade, and connection to the set is made as with any loop aerial. The antenna can be hung in the window like a shade, where it will be inconspicuous, or, as in the case shown in the photo, it may be mounted on a special stand. An aerial of this type takes up very little space when not in use,



Copyright, Underwood & Underwood
Aerial Sewed on Window Shade Is Latest Fad in Indoor Antenna

Fowler, originators of the "Tamara Tango," who were the artists on the program, were not defeated when it was discovered that there was no music. They communicated with station WJZ and made arrangements to have the station orchestra broadcast a program of dance music. They then installed a radio set and loud speaker on the stage, and, in spite of the fact that they did not know what numbers the orchestra was going to give them, danced to the complete satisfaction of the huge audience. This is said to be the first time that radio has been employed in this manner on the public stage.

Broadcasting Nightingale's Song *197-R*

One of the latest innovations in radio entertainment is the broadcasting of songs and cries of wild birds and other animals, a feature begun in England by a British broadcasting company. Microphones are placed in the groves frequented by the nightingales and their song is relayed from London. The birds were induced to begin their "concert" by an artist playing a few soft notes on a cello.

and is said to be very efficient. The wires selected should, of course, be as flexible as possible, so as not to interfere with the rolling of the shade.
*Made by W. H. Bullock,
Talking Machine Journal
Island Central Terminal*

*Com. H. H. Du...
2927 Prince...
Berkeley, Calif*

151-R

Radio Man Replaces Organ Grinder

156-R



Radio Man Replaces Organ Grinder; Left, Radio Hat - Latest Summer Fad
© New York Times



Radio in Car Finds Power-Line Trouble



Listening to Radio Concert in Tunnel 120 Feet Underground in Coal Mine

Rocky River, Ohio.



Left, a Truly Portable Set; Right, Love's Young Dream

© U. & U.



400-R
200-R

103-R

149-R

Photogram

166 *Q.*



Crippled Children Enjoy Radio Concerts; Right, Crystal Set on Pipe

© U. & U.



Key Stone

*Harry Friedenberg, 175 Q
Washington, D.C. Q*

*201-Q
made by
H. L. Mather
405 S. Ashland
Blvd.
Chicago*



Children in This School Find Instruction in Radio Much More Interesting Than Three "R's"

© U. & U.



Small Crystal Set Mounted on Ring



Left, Broadcasting Heartbeats; Right, Elevator Man Listens In



Wide World Photos

Pacific & Atlantic

153-R

Mr. Chief Electrician Scott
661 S. Carolina Ave.
Washington, D.C.

303

Henry Mueller New
Service
514-13th St., N.W.,
Washington, D.C.

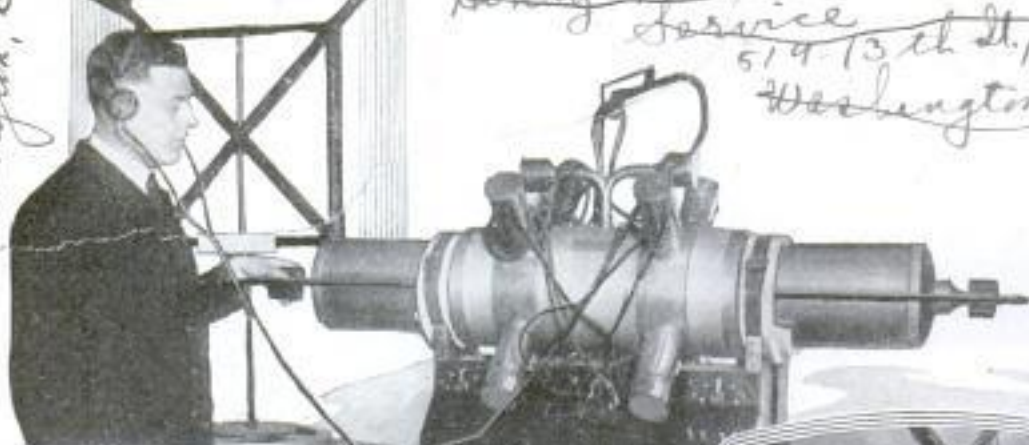

E. L. Luke Dem-
onstrates the
Scotch "Clari-
phone," the Only
Absolute Static
Eliminator Known



400 R
201
200 R



Radio Is Now Being Ex-
tensively Used by Police
Departments, and Has
Proved Invaluable in
Crime Prevention

Captain West
and L. Morrow
in the Station
at Briggis Hill,
Kent, Used for
Relaying Brit-
ish Concerts to
the United
States

© U. & U.



Enjoying a Radio Concert in the Pull-
man En Route to California; the Win-
dow Screen Serves as Aerial

© U. & U.

advertising
material
photo

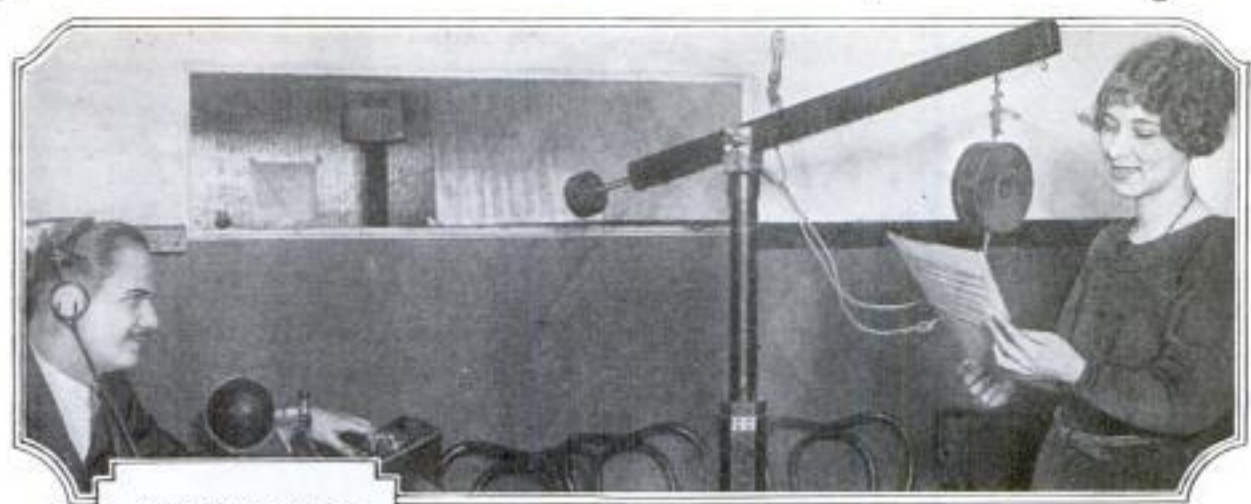

The Control Table at KYW, by Means of Which the Operator Can Amplify or Reduce the Volume of the Voice

142-R



This Life-Saver Keeps 'Em on the Beach with His Radio Set, So That They Can't Drown

Photograms
129 E 27th
New York



146-R
New York
Times

127-R
New York Times
229 W. 43rd St
New York

Left, the "Radio Girl" at the University Forum Ball in New York; Center, the Radio Necklace, a New Fad That Should Prove Popular with Fair Fans; Right, Mary Pickford and "Doug" Fairbanks, the Nation's Foremost Movie Celebrities, Making Their Radio Debut
© Underwood & Underwood

193- a
*Handy photo
 mostly*



MG R.



Pacific & Atlantic

This "Radio-Mad" Orang-Utan in the Bronx Zoo in New York Hopes the Folks Back Home in Africa Hear His Musical Voice



Pacific & Atlantic

"Oranges and Lemons, Say the Bells of St. Clement's"; Broadcasting the Famous Chimes in London (U. & V.)

Harry Dufony, of Jersey City, Is Deaf, but He "Hears" the Radio Concert through His Finger Tips



Violators of the Radio Laws Had Better Beware. Radio Inspectors Now Use Direction-Finding Equipment Mounted on an Auto to Detect Transgressors

144-R
Pacific + Atlantic

181-R

Radio
novelty photo

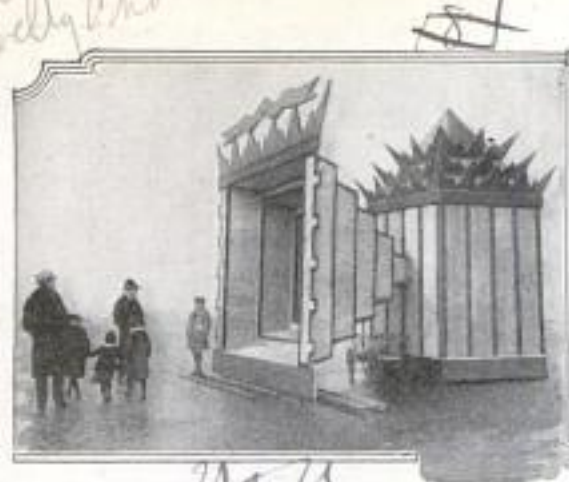

Loud Speaker for Open-Air
Concerts at Leipsic Fair



Theresa Smith, Flo
Chaumont and Hazel
Stanley Dancing to
Music by a Monster
Loud Speaker at the
New York Show

© U. & U.



The Famous Or-
chestra of the
Hotel Cecil, Lon-
don, Heard Re-
cently by Radio
Fans in This
Country

100-R



Above, the Latest Novelty—the "Felix the Cat"
Crystal Set; Right, Miss Frances Meyer Accom-
panies the Music Received on Her Loud Speaker
on the Piano



102-R

Keystone
91-7th Ave
New York
Copyrighted material

New York
Ship's Operators Play Chess
by Radio

F. E. Black, chief operator of the steamship "America," has solved the problem of how to pass the hours off watch, by in-



Playing a Game of Chess at Sea with an Operator on Another Ship

dulging in a friendly game of chess with the operator on another ship.

The procedure is simple. He simply announces his play by code, the other operator shifts the men on his board to suit, studies the situation, then announces his move. Here is a hint for shore-going "hams"; when all the traffic is "off the hook," and the night is still young, call up a brother and indulge in a game of chess.

204-R
Phonograph Loud Speaker Uses Novel Principle

Heretofore, when the radio fan desired to use his phonograph as a loud speaker, it was necessary for him to remove the

reproducer, and to apply special fittings to enable him to connect his ear phones to the tone arm. Now, however, an instrument is available that makes it unnecessary even to remove the reproducer and dispenses with the phones also. The

new instrument is really a phone playing through the needle of the phonograph. It is simply laid down on the turntable of



J. J. Has. Champaign, Illinois
Electro-Tech
500 E. Woodbridge St.

the machine and the needle of the reproducer set down on its center exactly as it is usually set in the grooves of the record. The tone vibrations are transmitted through the reproducer disk in the same manner as are those of the record. As the new instrument has no thin metallic diaphragm, it is said that it is free from harsh metallic notes. No external battery or special hookup is required; a cord is furnished with each unit and is attached to the set in the same way as a headset.

211-R

New Method of Broadcasting

Radio broadcasting and receiving may be influenced considerably by a new method of broadcasting being tried out by station WRM, the University of Illinois, Urbana. Recent tests have brought responses from all over the United States to the effect that the signals came in loudly and clearly, without the usual interference caused by static and "strays." The efficiency of the new method is due to the elimination of the "carrier wave," and the advantages claimed for it are greater selectivity, greater range and clearer reception.

Chicago Tribune 5/10/24

Double-Grip Battery Clip *174-R*

Durability and convenience are the two outstanding features of a novel battery clip now on the market. It has no delicate connections to get out of order but is of rugged construction throughout, consisting of two pieces punched and bent as shown, with a stout coil spring between them to keep the ends tightly together. To attach the clips the center portion is compressed.



Mr. Eugene P. ...
Schenectady, N.Y. 75-R
Tester for Filament Circuit

Insertion of vacuum tubes into the sockets of homemade radio sets is always dangerous to the tubes the first time, as the circuit wiring may be incorrect, bringing a high voltage to the filament prongs of the sockets and causing the tubes to blow out. It is therefore advisable to protect the tubes by testing the filament circuit before inserting the tubes in the sockets.

A simple tester for this purpose can readily be made from the base of an old burned-out tube and a miniature electric-

A.C. Cole,

*Williams Service
32 Union Square
New York
Making Electricity Speak 186 OK*

lamp socket, the terminals of which are wired and soldered to the filament prongs of the tube base. The miniature socket can, if it is small enough, be fitted inside of the base shell and held in place by means of sealing wax. Flashlight lamps of different voltages, corresponding to the filament voltage of the tubes to be tested, are used in the socket, and the device is inserted into the tube socket on the set and the current turned on. Too high voltage will then burn out the small lamp, which is much cheaper to replace than a vacuum tube.—A. C. Cole, Chicago, Ill.

*Kanter Mfg. Co.
120 Broadway
New York City 203 4*
Protective Unit Prevents Shorts
Blowing out of tubes, due to accidental short circuits while tinkering with the set, may be prevented by the use of a simple



signal and protective unit now on the market. The unit is made in two types; one to take the place of a regular binding post, the other to replace an ordinary A-battery

switch; both types are mounted on the front of the panel and contain a small lamp that lights as soon as a short circuit develops, thus warning the operator immediately. By using these units it is said that the necessity for protecting the filaments by means of fuses is avoided, as one unit will protect any number of receiving tubes, of any type.

**Transformer Is Adjustable
for Wave Length** *H18 OK*

Heretofore radio-frequency transformers have been made only in the fixed style, that is, they were fixed at a certain wave length by the manufacturers, and although they were supposed to cover a wave band of 200 to 600 meters, they actually were efficient only at the wave length to which they were adjusted. Now, however, comes a transformer by means of which maximum amplification can be obtained at any wave length merely by adjusting the instrument by means of a wave-length dial mounted on the top.



*Radio Frequency Laboratories
Boston, U.S.A.*

The greatest difficulty has generally been experienced in making any mechanism that will successfully imitate the human voice (leaving out of consideration the

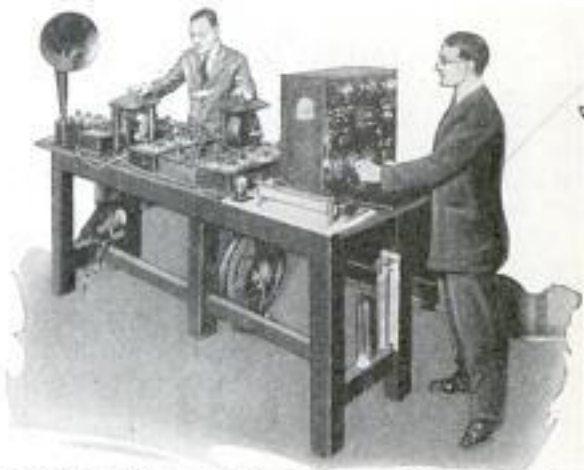

Electrical Equipment Using Vacuum Tubes to Produce Artificial Speech

phonograph, which reproduces mechanically a real voice). Although many attempts have been made in the past to produce a voice by mechanical means, none have been entirely successful. Toward the close of the tenth century, Pope Sylvester II is said to have constructed a brazen head which answered questions, and similar inventions are ascribed to Albertus Magnus, Roger Bacon and others. In the first half of the seventeenth century the philosopher Descartes made a speaking figure, which he called his daughter Franchina, but the superstitious captain of a vessel had it thrown overboard. In the latter part of the eighteenth century, a speaking machine made by Fabermann of Vienna closely imitated the human voice, with a fairly good pronunciation of various words.

This problem now seems to be nearing solution with the assistance of the vacuum tube. A new machine, invented by Dr. Harvey Fletcher of New York, uses a combination of oscillator and amplifier, and with it a loud speaker is made to pronounce the vowel sounds "A, E, I, O, U" and the words "papa" and "mama" in an unmistakable manner. The inventor hopes soon to be able to operate the instrument so as to speak whole sentences.

☛ A telephone line 100 miles long connects a radio studio in the Hotel Brunswick, Boston, Mass., with station WBZ, Springfield, Mass. This is the first studio to be located at such a distance from the broadcasting station.

*Dr. H. S. Harvey Fletcher, and Dr. Steinberg
Research Laboratories American Telephone Co.
Western Electric Co.*

196 R

Building a Honeycomb-Coil Receiver

By F. L. BRITTIN

A HONEYCOMB-COIL receiver has one decided advantage over other receivers for experimental purposes, in that the coils are interchangeable, permitting the operator to tune to any desired wave length. In addition to this, the circuit will receive both damped and undamped waves, and the coils take up much less room than other types, and are very efficient. Each coil is mounted on a plug, designed to be used with a coil mounting; these mountings are obtainable in various styles, the one used in the circuit described here being of a standard type, in which the center coil is stationary, and the two outer ones fitted with trunnions, permitting the operator to move the coils, for the proper coupling and without body-capacity effects, by means of the handles.

The instruments are mounted on a bake-

lite panel, $\frac{3}{8}$ by 8 by 14 in. in size. This panel is mounted on a $\frac{1}{2}$ by 6 by 14-in. wooden base by means of two angle irons. The completed instrument can, of course, be fitted in a cabinet if desired; in this case, however, the base board should be made a little shorter than the panel. At the upper right-hand corner will be noted the machine-screw terminals for the honeycomb coils; immediately below is the primary-

condenser switch—a double-lever switch with eight contact points, for the purpose of switching the primary condenser from a series to a parallel connection to the ground, and thus enabling the condenser to be used for both short and long waves. The primary condenser itself is shown at the left of the switch, and the variable condenser that

is connected across the secondary coil, at the left of the primary condenser. Immediately above these condensers the grid condenser and grid leak are mounted; the grid condenser is of .00025-mf. capacity, and the leak of 2-meg. resistance. If one has not a standard leak at hand and does not desire to purchase one, a satisfactory one can be made by making a mark with a soft lead pencil on a small strip of cardboard or fiber, and mounting the strip by means of two small machine screws in the same manner as the standard leak; the pencil mark, of course, should make contact with the screws. It is much better, however, to use a standard leak, preferably a variable one.

At the left of the grid condenser is the switch for tapping off the B-battery; this has six points, one being the off point. The switch lever should be kept on this

point when the instrument is not in use. The wires should be soldered to the contact points on all switches. The rheostat is shown at the left side of the panel, and is an ordinary 6-ohm rheostat of the panel-mounting type. The phone binding posts are mounted just below the rheostat, and at the left edge of the panel the binding posts for the 6-volt A-battery are placed. The tube socket is placed on the base just at the rear of the rheostat. The

aerial and ground binding posts are placed at the right side of the panel. The wiring is done with No. 18 insulated fixture wire; bare, tinned copper wire may be used, and covered with "spaghetti" tubing, if desired. The tubes best adapted for this circuit are the UV-200 or C-300, 6-volt detector tubes.

All joints in wires should be soldered, using a good non-corrosive flux. After the

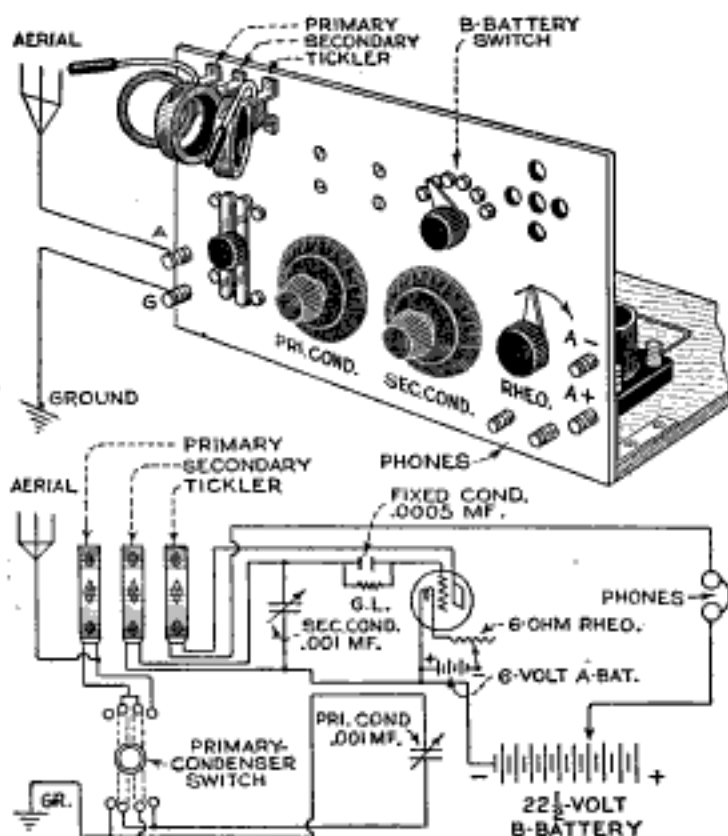

Above, Front View of Panel, Showing Mounting of Honeycomb Coils; Below, Wiring Diagram for Checking Purposes

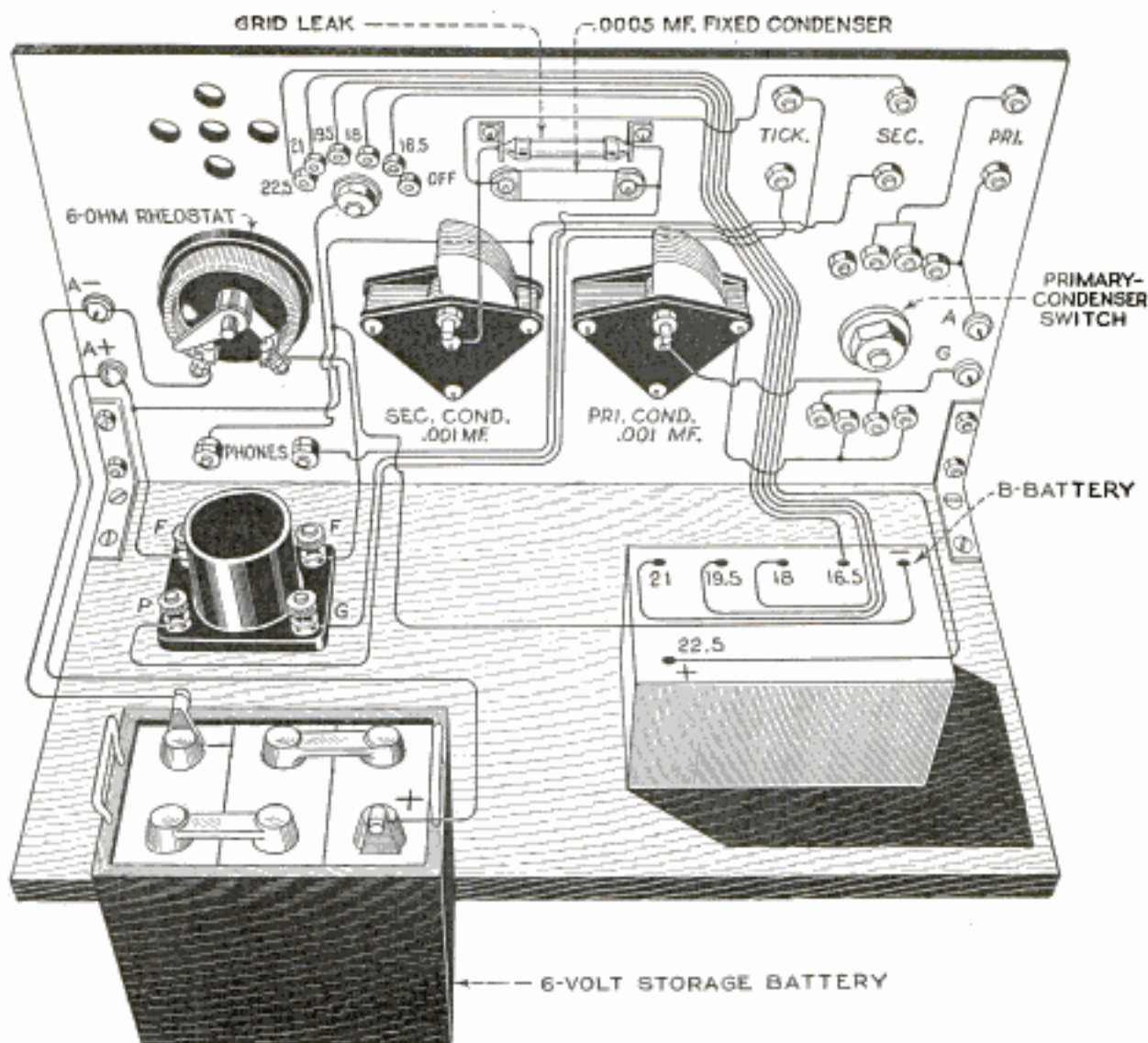

Back View of Panel and Baseboard, Showing All Connections and Position of the Instruments; Note Particularly the Wiring of the Primary-Condenser Switch

instrument has been tested, and found to work satisfactorily, the connections of the wires to the screws of the binding posts should be made permanent by soldering them also.

The various coils to use for the different wave lengths are as follows:

Wave Length	Primary	Sec.	Tickler	Condenser
150-350	50	50	25	Series
450-1,050	150	150	75	Series
835-1,950	250	250	150	Series
1,760-4,000	500	500	250	Series
5,200-12,500	1,500	1,500	600	Series
12,000-20,000	1,000	1,000	1,250	Shunt

The best type of aerial to use with this receiver is one or two wires 125 to 150 ft. long, and from 35 to 50 ft. from the ground.

The materials required consist of:

- 1 bakelite panel, 3-16 by 8 by 14 in.
- 1 base, 1/2 by 6 by 14 in.
- 1 set of honeycomb-coil mountings.
- 2 .001-mf. variable condensers.
- 1 .00025-mf. fixed condenser.
- 1 2-meg. grid leak.
- 1 6-ohm rheostat.

- 1 UV-200 or C-300 tube.
- 1 tube socket.
- 1 primary-condenser switch, double-blade type, with contact points.
- 1 switch lever.
- 6 contact points.
- 6 binding posts.
- 2 angle irons.
- 1 6-volt storage A-battery.
- 1 22 1/2-volt B-battery.
- 1 pair 2,000-ohm headphones.
- Honeycomb coils as indicated in text.

Soldering Radio Leads

In soldering the leads on my radio set, I found it rather difficult to hold the wire securely at the proper height and angle while applying the solder, as both hands were occupied, one holding the solder, and the other the copper. The difficulty was easily overcome, however, by building up a stack of books and slipping a part of the wire between the leaves of the topmost book to hold the end in position.—H. E. Benedict, Chicago, Ill.

Compact Storage B-Battery

Compactness and simplicity are the features of the B-battery shown in the illustration. It consists of a number of concentrically grooved lead disks separated by narrow hard-rubber rings cut from rubber tubing $\frac{1}{8}$ -in. thick and 2 in. in diameter, as shown. The grooves on one side of the disks are filled with a paste made of red oxide of lead moistened with a 10-per-cent solution of sulphuric acid, forming the positive plate, and those on the other side with yellow oxide of lead moistened in the same way, forming the negative plate. Thus each disk is the positive and negative plate of two adjacent cells and also serves as a wall separating these cells. This construction does away with external connections between the cells and with binding posts on each of them. The grooves can be made in the lathe, but if a large number of disks are to be made it is better to cast them in a mold.

The battery of cells is held together in a frame, consisting of a slate base with wooden endpieces and three $\frac{1}{4}$ -in. rods covered by glass tubing and screwed into the endpieces, by means of a clamping screw at one end, a mica disk and a brass plate being provided at both ends as shown. This assembly is practically acid-proof. A binding post is mounted on each of the end disks, one being the positive and the other the negative terminal of the battery.

A $\frac{1}{4}$ -in. hole is drilled in the top of each separating ring so that hydrometer readings of the electrolyte can be taken and distilled water added as needed. This hole is tapped for a small screw, which in turn has a pinhole drilled through it to allow gas to escape from the cell.

The electrolyte consists of 1 part sulphuric acid and $1\frac{1}{2}$ parts water, by volume, which will give a specific gravity of approximately 1.400. Enough distilled water is then added to reduce this to 1.300. The solution should be mixed in a stone or porcelain jar, the water being poured in first and the acid added slowly. This order should be strictly observed as it is dangerous to mix acid and water in any other manner.

Each cell will give a potential of approximately 2 volts so that only half as many cells are necessary as the number of volts desired.

The size of the cells can be made very small by reducing the width of the hard-rubber rings. Varying the size of the cells

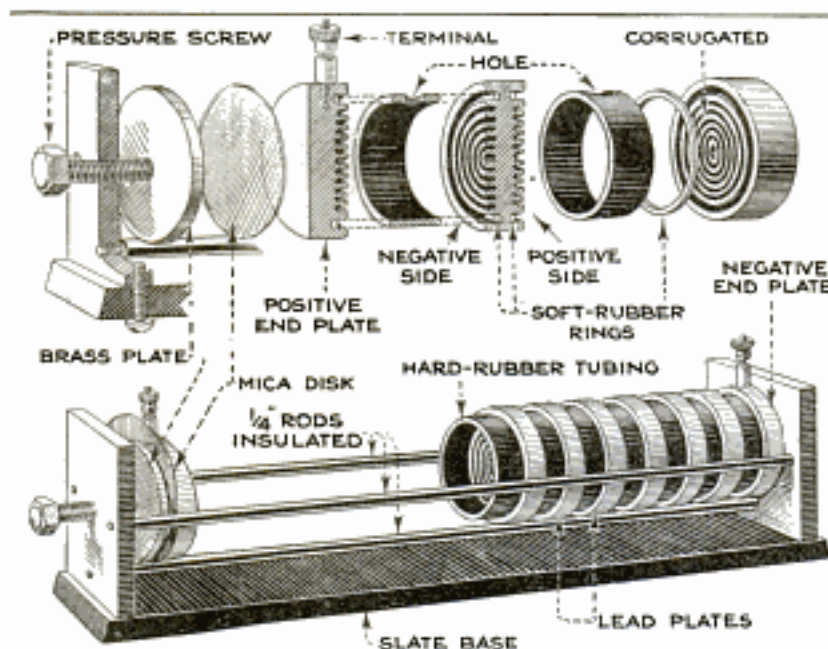

Construction and Details of Homemade B-Battery Which Does Away with External Connections between the Individual Cells

by decreasing or increasing the plate area does not affect the voltage of the battery but it does determine its life, that is, the number of ampere-hours it will yield. After assembling, the battery should be filled with electrolyte and given a 1-amp. charge for 10 hours, then immediately discharged through a resistance. This should be repeated four or five times, when the battery will be ready to hook into the circuit.

McClure, J. J. Re.
Australian Sets Are Sealed

To protect broadcasting stations, the Australian wireless authorities require all radio sets to be sealed after they have once been correctly adjusted for the wave length of the broadcasting stations they are to receive. In order to purchase a receiving set in that country, the prospective owner must first subscribe to the service of a broadcasting station, for which he is charged a certain fee, and then present his certificate of subscription to the radio dealer from whom he buys the set so that it can be adjusted and sealed. If he desires to listen in to additional stations on other wave lengths, he can have the set adjusted and sealed to cover the different ranges, provided, of course, he shows subscriptions to each station.

Chas. Francis J. Coleman
3315 Montgomerie
Kansas City, Mo.



All Shop Notes published in 1923, in book form—Fifty Cents—from our Book Department

Washing Tank for Films and Prints

By EDW. H. FLAHARTY

VERY often the photographer, even the professional worker on a small scale, encounters difficulty in finding a suitable method of washing his films, plates and prints in running water without danger of scratching or creasing them.

A washing tank, as shown in the accom-

panying illustration, has solved the problem for one photographer. This tank can be made of any desired size and capacity to meet individual requirements and particular conditions, although the dimensions given below will be found suitable for most purposes. First a tank is made of gal-

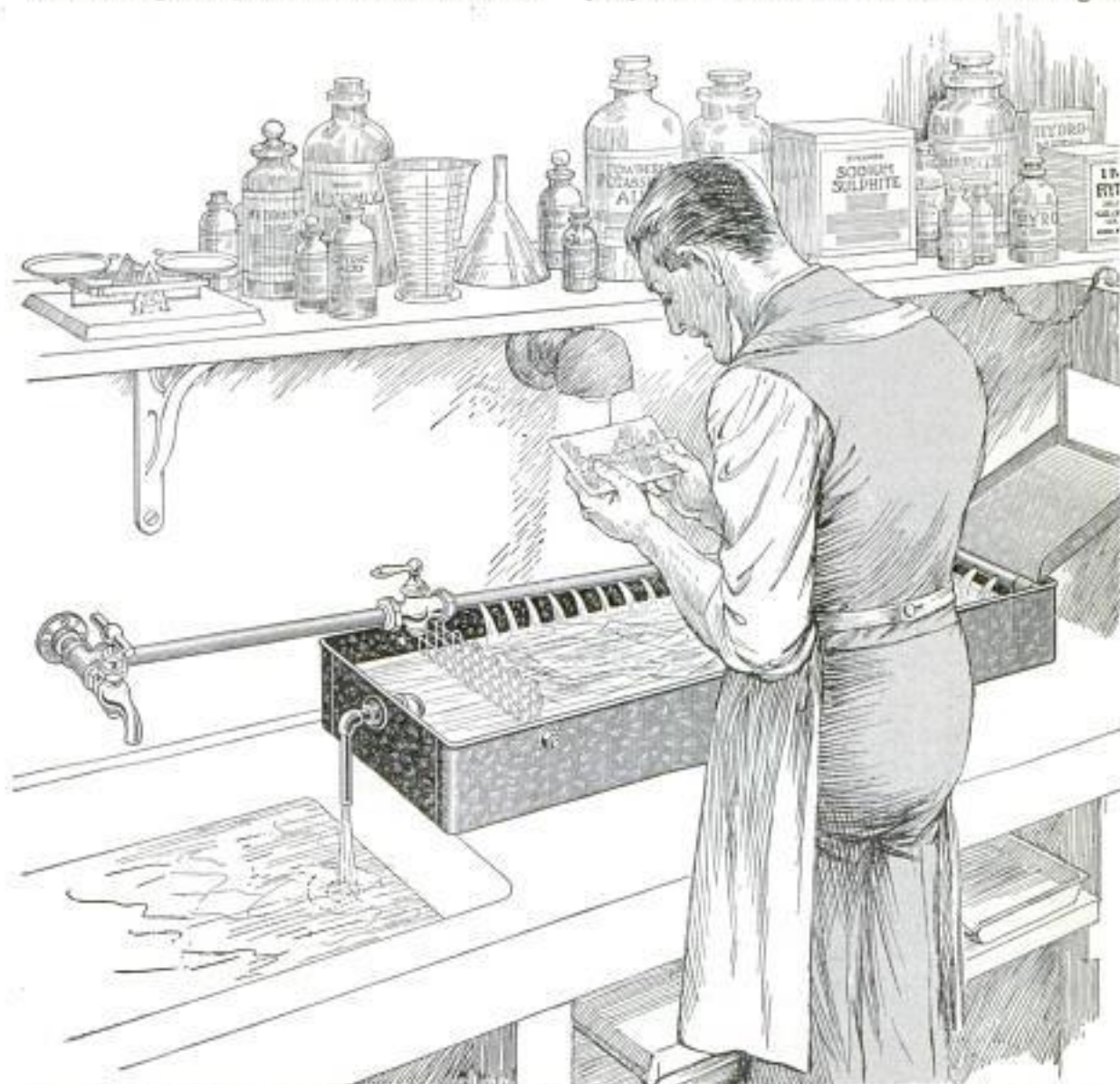

Easily Made Film and Print-Washing Tank for the Photographer; the Outlet Is Arranged So That the Tank May Be Made to Empty and Refill Itself Automatically

vanized sheet iron, measuring about 4 ft. long and 8 in. deep. The corners are soldered to insure their being water-tight. The tank is placed on a board or shelf beside the sink, then a connection is made with the cold-water pipe, preferably between the tap and the end of the pipe to which the tap is connected. This may be done by means of a reducing tee, inserted between the tap and the nipple; the tee connects with a smaller pipe, which in turn is followed by a tap, corresponding in size with the pipe used, and into this tap a pipe is screwed which runs along the entire side and one end of the tank, or it may be made to circle the tank. This pipe has small holes drilled into it a few inches apart, which permit an even spray of water to play over the tank, causing a slight but continual agitation of the water.

The outlet of the tank is arranged so as to give two methods of emptying the tank, and is in the form of a 1-in. pipe connection which drains into the sink. About 1½ in. from the top of the tank a hole is cut and a 1-in. bushing soldered into the hole. A connection, the inlet of which comes at the bottom and on the inside of the tank, is formed by a short piece of pipe leading horizontally from the bushing, then an ell pointing down, to which is connected another piece of pipe. The short

piece of pipe leading into the fixed bushing is allowed to remain a little loose so that the piece of pipe which is attached vertically to the ell (and the ell itself) may swing from the vertical to a position nearly horizontal, thereby allowing the tank to be emptied from the bottom or from the top. This sort of connection will prevent an overflow, for after the water has reached a certain height, a siphon is automatically formed and the water drains from the tank into the sink. If the inside pipe is at an angle near the horizontal the tank will contain a large quantity of water all the time, but if the pipe is turned down straight the tank will automatically empty and refill.

To prevent prints or films from adhering to the outlet connection and causing an overflow, a screen of galvanized wire is placed a few inches from the end of the pipe, and fastened in place by small bolts and nuts, or rivets may be used as effectively. A small drain shelf of galvanized sheet iron is placed at the farther end of the tank at an angle of about 30°, directly under a red light used for viewing films and prints in the process of development. While these are being examined the dripping developer falls onto this shelf and drains into the tank. The cost of material for the tank is small, and the tank solves a troublesome film-washing problem.

Buffing Short Screw Heads

It is sometimes almost impossible to hold small articles such as screws in the fingers when polishing them on a cloth buffing wheel, owing to the drag of the

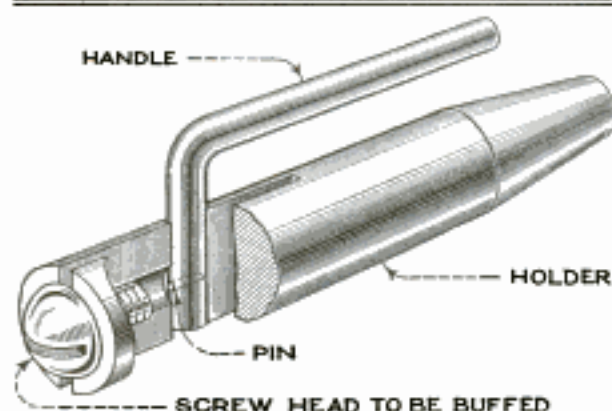

Holder for Buffing Short Screw Heads that Is Quick-Acting and Holds the Screws Securely

wheel. Unless the work is large enough to enable the operator to secure a good hold it is nearly always advisable to use a holder, especially as the work usually be-

comes very hot. There are, of course, hundreds of different kinds of holders for this work, but the one shown in the illustration is worth describing, because of its quick-operating feature. The holder itself is made of round steel, tapered at one end to fit into a file handle, and having a hole drilled at the other end a trifle smaller than the shanks of the screws to be buffed. Another hole is drilled through the side at right angles to the first for a handle, which is merely a piece of round steel rod, bent as shown. The holder is then slit open from the end to a distance beyond the handle hole. The short end of the handle is drilled for a small pin, which is rounded at both ends and projects a trifle on both sides. With the tool assembled as shown, the handle is turned at right angles to spread the end so that the screw can be inserted easily, then turned back again so that the screw will be gripped firmly. The spreading is effected by the small pin in the handle. This holder grips a screw so securely that one press into the wheel polishes it. By again turning the handle as explained, the screws are dropped into a box without coming in contact with the fingers at all.

Two Kinks for the Draftsman

Draftsmen frequently find it necessary to scribe an arc of which the center is located outside of the drawing board. This can easily be done by the method shown in the illustration. Two 4-in. boards of a thickness equal to that of the drawing board are cut to suitable lengths, and screwed together from the underside, one being about 4 in. longer than the other. The longer one is clamped to the drawing board by means of a small C-clamp, bringing the upper surface of the shorter one level with the top of the board. The pivot point of the beam compass can then be placed wherever necessary on the extension to scribe the arc. Obviously, the extension can be clamped to the board at any point most convenient for the purpose.

Often a piece of sandpaper is attached to the corner of the drawing board in a handy position for sharpening pencils, but unless the draftsman is very careful, he is likely to get some of the pencil dust on his hands or arms and then accidentally smudge the drawing with it. This can be prevented by providing a simple sheet-metal shield, as shown in the lower detail. The sheet metal is cut and bent to the shape indicated and is tacked or screwed over the sandpaper. The longitudinal flange of the shield is bent inward and in-

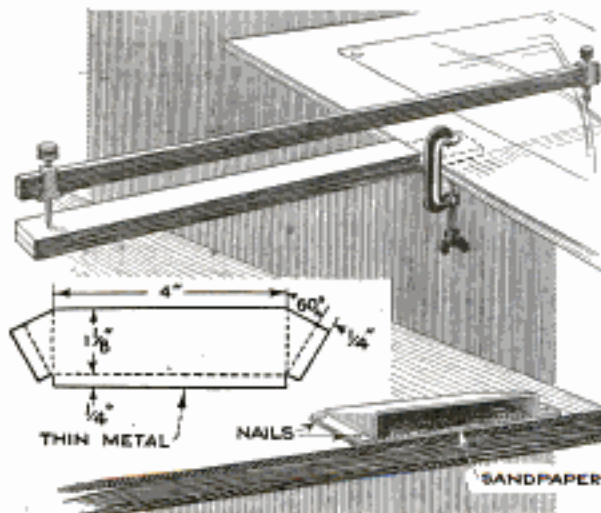

Above, Extension on Drawing Board Aids in Scribing Large Arcs; Below, Pencil-Dust Guard

serted under the sandpaper so that none of the pencil dust can work under it and onto the board.—Warren Scholl, St. Ignace, Mich.

☐ When grinding valves, hang a magnet on the radiator rod so that the valve pins can be stuck on the magnet. This will eliminate the risk of losing them.

Turning Heavy Objects

Heavy objects, such as large pulleys, oil drums and the like, can be readily rolled over the floor but it is quite a difficult task to turn them around. It will be found,

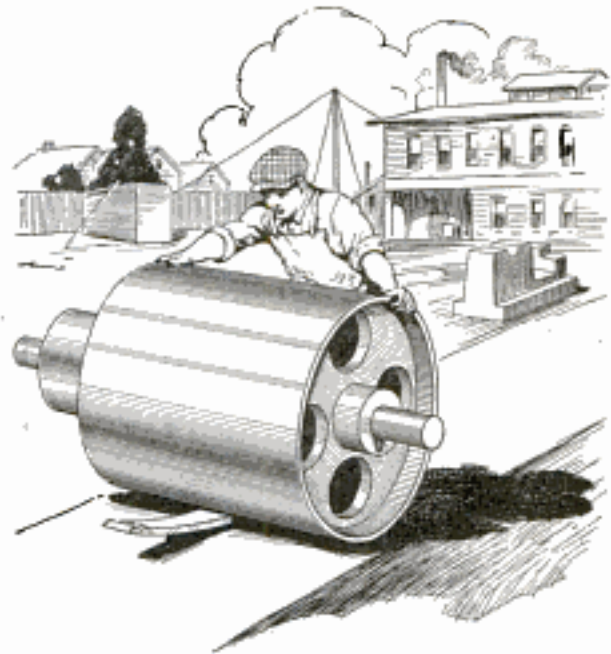

Easy Method of Turning Heavy Pulleys and Drums Around by Rolling Them onto Barrel Stave

however, that if the area of contact is reduced by rolling the object onto a barrel stave, with the concave side up as shown in the drawing, the work of turning it around becomes comparatively easy as there is then only a small part of the stave in contact with the floor and this is in the center.—A. C. Cole, Chicago, Ill.

Novel Exhaust Fan

Unusual in construction, the simple exhaust fan shown in the illustration can be made from a disk of sheet metal, with radial sections cut out on three sides and curved outward as indicated.

The disk is cut from $\frac{1}{8}$ -in. material and six blades are cut in it, the dotted lines showing where they are bent. A hole is drilled through the center so that it can be slipped on a shaft where it is held securely by means of two nuts and a lock washer. A fan of this kind can be run at high speed without any noise.

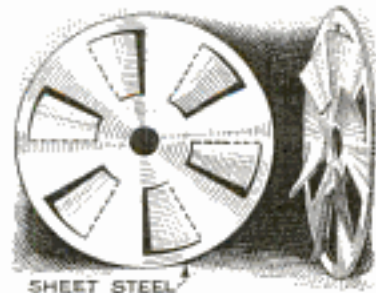

Adjustable Lumber Jack

Piling up lumber is facilitated considerably by the use of a simple jack of the kind shown in the illustration. It is made of hardwood and consists of a base and a

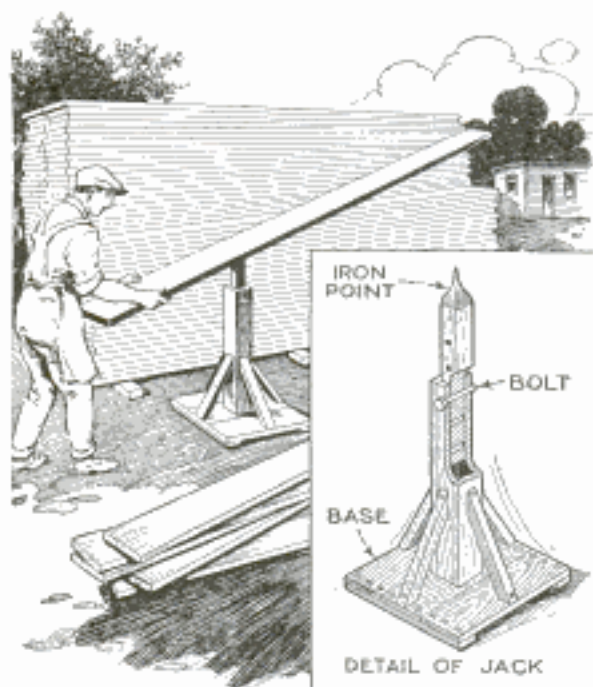

Adjustable Wooden Jack in Lumber Yard Aids Worker in Piling Up Lumber

standard to hold the lift pin. The latter is drilled at several points in a line to take a bolt which passes through the standard as indicated, and is provided with an iron point on the end to prevent the lumber from sliding. In use, the workman lifts a board at one end high enough to get its center on the jack, and he then pushes his end down so that the other end will be raised high and close enough for the man on the stack to take hold of it.—Bunyan Kennedy, McCool, Miss.

Remedy for Puddled Soils

Many soils have a tendency to run together after very heavy rain. This trouble is experienced mostly with silt and clay soils, and is caused by the soil particles being washed close together, making one solid, compact mass. Such a puddled condition forms a very hard crust when the surface dries, and it is only with great difficulty that young plants can force their way through. The circulation of air is also cut off and as a result both crop and soil suffer. The crust also causes increased loss of soil water due to evaporation, as there is a continuous movement of the water to the surface.

Puddling may be prevented to a great

extent by increasing the amount of organic matter. This improves the structure of the soil, as it holds the soil particles together in small granules, which will not break up except during the hardest rains. The effect of organic matter on soils is witnessed by examining the soil on which a straw stack or manure heap was formerly located. Careful examination will show that such spots are mellow for a long time afterward, no matter how hard the surrounding soils may be. All soils should have enough organic material in them to prevent running together. Organic matter can be added by applying manures, and by growing suitable crops and plowing them under.—E. R. Haan, Chicago, Ill.

Improvised Countersink

An improvised countersink can readily be made from a hexagon-head machine screw. Each flat on the head is ground or filed down toward the center to the angle desired for the countersink, thus forming tapered cutting edges. It is, of course, advisable to harden the screw.

Holder for Acid Pan

For diluting sulphuric acid and taking care of any spilled acid when filling storage batteries, a most practical method is

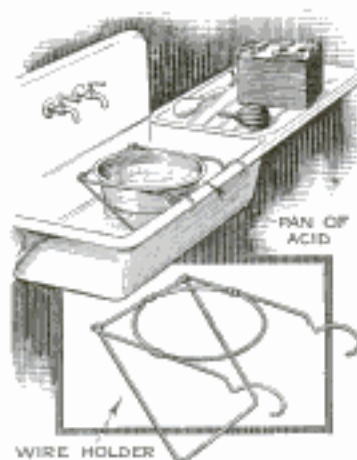

used by a service-station man. The work is done in an enameled pan which is suspended over the center of a large sink by a simple detachable wire holder. This is made of heavy galvanized wire, and may be

made collapsible, for convenient hanging when not in use, by hinging the support that rests against the bottom of the sink to the upper part. To place the pan over the sink, without being in the way of the faucets or blocking the drain, is convenient both for working height and for harmless drainage of any spilled acid, the thorough dilution of the latter being accomplished by opening the faucets. The method is applicable also to use with acid baths for cleaning and pickling small parts.

Production Work on the Drill Press

In the manufacture of a large number of parts that required to be finished on three curved surfaces, ordinary methods were found to be too slow and costly. After giving the matter considerable thought it was decided to try and do the work on a drill press, the table of which was rigged up with a series of blocks between which the pieces would make the proper fit and be held down to the table by means of a circular clamp. The blocks were so spaced that the castings just dropped into place. This arrangement insured all of the work being located centrally. For the radius nearest the center an ordinary small boring bar was used and for cutting the second concave radius the tool shown was used. This had a pilot which centered itself in a hole in the center of the table. The outside radius was machined by a vertical cutter held in a toolholder of the same type.

This arrangement proved to be very efficient, completely machining eight pieces at

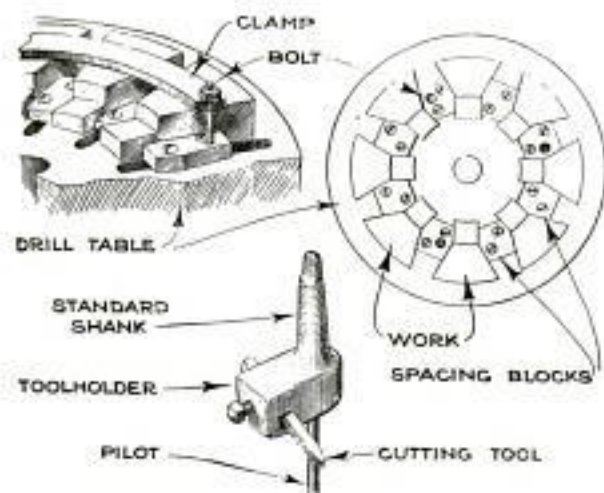

A Method for Turning Radii on a Drill Press, Adapting the Machine to Production Work

a time. The job is one that would ordinarily be done on a lathe or miller, but in the absence of either, it suggests a method for doing other types of work that are generally done on such machines.

☞ Copper is annealed by heating to a red heat and plunging into cold water.

Lockers Used in Garages

In Brooklyn, N. Y., a locker system has been put in use in a garage so that customers can leave personal belongings safely while their automobiles are left for

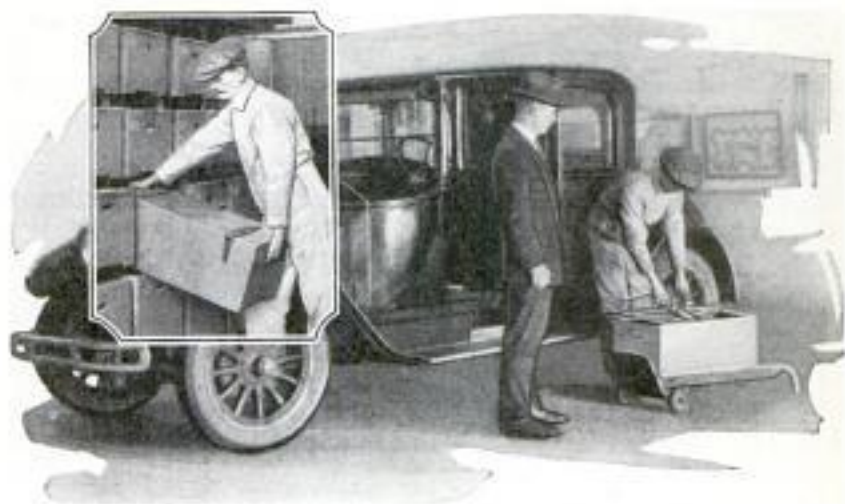

Personal Belongings Put in Lockers in Garage Storeroom While Car Is Left for Repairs or Storage, in Order to Prevent Theft

repairs or storage, without fear of loss or mix-up. The lockers consist of chests, kept in a storeroom at the rear of the garage. Each chest is locked and the key given to the owner of the contents. The cushions of the car are also removed and checked in the storeroom in order to eliminate the possibility of having them soiled while repairs are made. The locker service is free, which is a good advertisement.

Preventing Iron Stains on Buildings

Dark stains on brickwork below the supports of ornamental iron balconies or fire escapes are caused by rain washing away some of the paint on the ironwork and forming rust, which dissolves in the water and is deposited on the wall. On buildings constructed of light-colored brick or stone such stains are especially noticeable. To prevent them a tight-fitting metal collar should be fixed at the lower part of the support, as shown in the illustration. The collar should project about an inch beyond the support and be placed a few inches from the wall. The rain can then run down the support to the collar, but here it drips off away from the building.

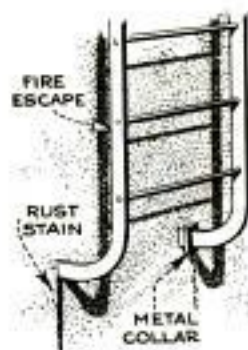

MECHANICAL POWERS

By CARL W. MITMAN

Curator

DIVISIONS OF MINERAL AND
MECHANICAL TECHNOLOGY
UNITED STATES NATIONAL
MUSEUM



Copyrighted. H. H. Windsor, Jr.

This is the sixth article of a series by Curator Mitman, explaining in simple language what every man who builds or designs a machine must know, and showing in detail just how to build a set of models of the mechanical powers that will exactly duplicate the set in the National Museum at Washington, D. C. The first articles appeared in the March, April, May, June and July issues, and the next will appear in the September number.

Part VI—The Inclined Plane and Wedge

IN addition to the forces that have been discussed thus far and which are applied to a solid body from without, there are forces acting within a body as well. Such



forces are known as stresses. The relation between these outer and inner forces is that those acting outside the body tend to deform it, but in so doing create stresses within the body which in themselves resist

deformation. The primary stresses thus created are called tension, compression and torsion, or shearing. There are in addition so-called bending stresses, but these are simply combinations of tension and compression. In structures such as buildings, bridges, and the like, individual members of the structures are quite often subject to tension stresses only or compression stresses only, but in machinery and machine parts such simple stresses are rather rare, and instead the stresses are found to be combinations of two or more simple ones of tension and compression. This is especially true of those parts of a machine that are in motion. There is probably nothing more important than to be able to determine the stresses to which each part of a machine will be subjected, so as to give it sufficient strength

to withstand the strain. Calculations can occasionally be made to solve this problem, but there are many instances where calculations cannot be made, or the results are uncertain, so that past successful designs and the results of practical experience ought to be given real consideration. In fact, in many instances one must rely wholly upon practical tests. The designer of machinery must take account of two main items; first, to develop a mechanism

that will modify the various contending external forces so that the motions required can be obtained, and second, to proportion the various parts of the machine so that they can withstand the internal stresses set up and be strong enough to do the work intended for them. The first part of this problem is a direct application of the science of mechanics, but the second part involves not only this same knowledge but in addition that generally known as the strength of materials. The two are very closely connected, and the latter is largely used in such cases where it is practically impossible to calculate the size of a machine part be-



cause of the peculiar manner in which the forces are applied to it. Then, a definite

test is made to determine the actual strength of the material.

Of the forces acting upon a machine part only the load acting upon or transmitted through the part need ordinarily be taken into account, but there are occasions when the weight of the part must also be considered. In the case of flywheels or parts moving at high velocity, or subjected to changes in velocity, forces other than direct load are encountered that set up combinations of stresses which must be taken into consideration, and, lastly, there must be considered the character of the load. There are three different kinds of load: a steady or dead load; a live load, that is, one constantly in motion, and a

makes a man able to "lift himself up by his boot straps." Its use is as "old as the hills," the most pretentious application, according to a number of authorities, probably being in the construction of the pyramids of Egypt. The average weight of the stone blocks in these pyramids is around 10 tons, and to place them in position,

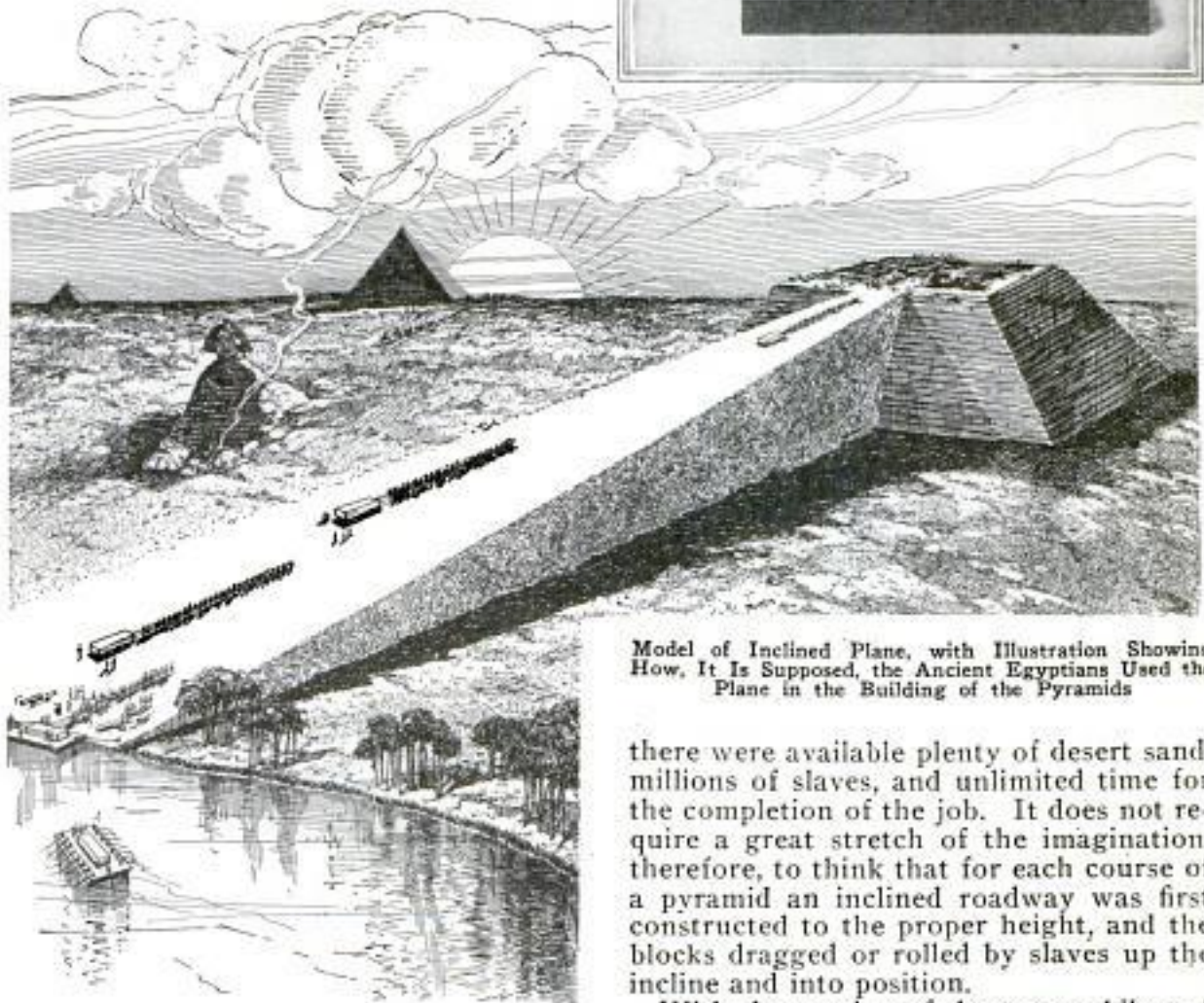
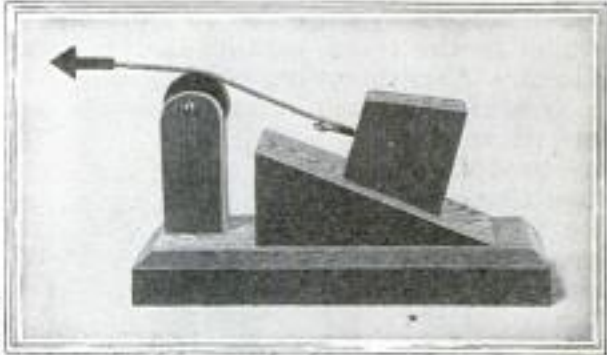

Model of Inclined Plane, with Illustration Showing How, It Is Supposed, the Ancient Egyptians Used the Plane in the Building of the Pyramids

live load alternating in direction, applied intermittently, applied gradually or applied suddenly. Of course, with manual power as the applied force (equal to about $\frac{1}{8}$ hp.), the matter of strength of materials and internal stresses needs no more than passing attention, but with greater powers this consideration is highly important.

Broadly speaking, the inclined plane

there were available plenty of desert sand, millions of slaves, and unlimited time for the completion of the job. It does not require a great stretch of the imagination, therefore, to think that for each course of a pyramid an inclined roadway was first constructed to the proper height, and the blocks dragged or rolled by slaves up the incline and into position.

With the coming of the automobile and the consequent erection of service stations and garages, the simple inclined plane has again found a practical application. At first such buildings were single-storied and covered large areas of ground; later the area was decreased and floors were added, with the installation of elevators; and lastly elevators have been eliminated and replaced by inclined planes, or ramps, between floors, thus making use of the auto-

mobile's own power to reach its storage space and saving the cost of elevator installation and operation. Man uses the inclined plane daily, for a stairway is nothing more than an inclined plane the slope of which is notched or stepped.

In mechanics the inclined plane is a hard, smooth surface set obliquely to the resistance. To move a load or weight, the applied force may act either in a direction parallel to the slope, parallel to the base or in any other direction, but in each case the conditions of equilibrium or the principle of work

may be derived from those of the simple lever. For example, in the photo of the inclined-plane model, the direction of the applied force is parallel to the slope of the plane, and equilibrium will exist when the applied force is to the resisting force as the height of the plane is to the length of the incline or slope. While the resisting force is raised through

a space equal to the vertical height of the plane, the applied force must move through a space equal to its length. In other words, if the slope is 10 ft. long and its height 2 ft., the applied force must move 10 ft. while the resisting force is raised 2 feet.

If, again, the direction of the applied force is parallel to the base of the plane, then equilibrium will exist when the applied force is to the resisting force as the height of the plane is to the base. From these two cases or conditions it follows that the effect of a given applied force is greater as the height of the inclined plane is diminished or its length increased; and that its effect is greatest when its direction is parallel to the slope, for if the applied force acts in any other direction, a part of it is expended either in increasing the pressure of the resisting force against the slope or in lifting it directly.

Instead of lifting a load by moving it along an inclined plane, the same result

may be obtained by moving the plane under the load. When so used the inclined plane is called a wedge, which is extensively used in a variety of ways; it is often used, for example, as an aid to hold objects securely, such as a swinging door. A pair of wedges made to slide along their inclined faces forms one of the essential tools of the printer to hold a form of type in position. Since the days of Benjamin Franklin this little tool has been included in the printer's kit and is still indispensable to the trade. Again, some types of the so-called expansion bolt make use of the principle of the wedge, modified, however, away from the conventional form. Furthermore, by joining two inclined planes base to base, there results the familiar wedge used in splitting wood. In the wedge shown in the photograph, force is applied to the back of the wedge and is supposed to move through a

space equal to

the length of the wedge, while the resisting force (pressure) yields to the extent of the breadth of the wedge.

As a mechanical power the wedge is used only where great force is to be exerted in a limited space. The edges of all cutting tools, as saws, knives, chisels, razors, scissors, etc., and the points of piercing instruments, as awls, nails, pins, needles, etc., are all modified wedges. In general, the softer or more yielding the material to be worked, the more acute the wedgelike tool may be made. For example, chisels intended to cut wood have the edge at an angle of about 30° ; for cutting brass from 50 to 60° , and for steel from 60 to 70° . Furthermore, tools that cut by constantly applied pressure may be sharper than those which cut by impact or blows. The theory of the wedge, however, takes no account of friction, which largely modifies the results, so that the relative effect of constant pressure and a blow cannot be defined.

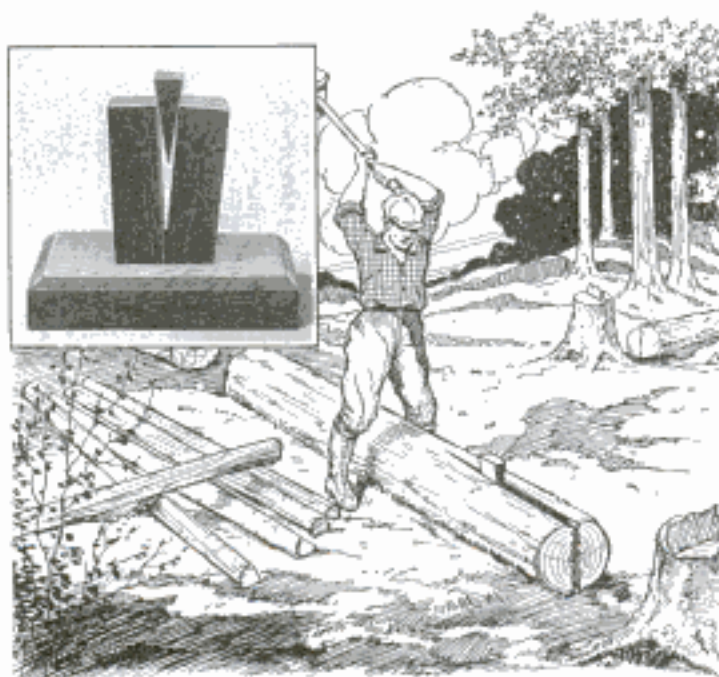

Model of Wedge; the Drawing Shows a Common Use of the Wedge, Which Consists of Two Inclined Planes, Base to Base

For the model of the inclined plane, the following materials are required:

Base, 7 by $3\frac{3}{4}$ by $\frac{3}{4}$ in.
 Pillar, $2\frac{1}{2}$ by $1\frac{1}{8}$ by $\frac{3}{8}$ in.
 Pulley, 1-in. diameter, $\frac{3}{4}$ in. thick, V-groove.
 Ramp, 4-in. base, $1\frac{1}{2}$ -in. height, 3-in. width.
 Weight (resisting force), base $1\frac{1}{4}$ in. square, top $1\frac{3}{4}$ in. square, side $1\frac{1}{2}$ in. high.
 Arrow (applied force), $1\frac{1}{2}$ in. long, $\frac{3}{4}$ in. thick, $\frac{1}{2}$ in. wide across barbs; shaft, $\frac{1}{4}$ in. square.

Square and face the base with a finish bevel on top. On the center line of the base and $\frac{3}{4}$ in. from the end, secure the ramp with glue and by screws from beneath. Saw and chisel a groove in the center of the pillar top, $\frac{7}{8}$ in. deep and $\frac{3}{8}$ in. wide, and round the ends of the lobes or ears thus fashioned. Drill a $\frac{1}{8}$ -in. hole through the center of the pulley and the ends of the lobes and mount the pulley in the groove on a suitable axle. Attach this assembly to the base on the center line, $\frac{3}{8}$ in. from the end, with glue and screws from beneath. Attach the end of a length of lead wire (representing a rope or cord) to the screw eye used as a handle for the weight, and to the other end of the wire affix the arrow by inserting the wire in a hole drilled lengthwise in the shaft. Rest the weight on the ramp and the wire in the pulley groove. Finish as desired. The wire may be enameled white to represent a cord more closely.

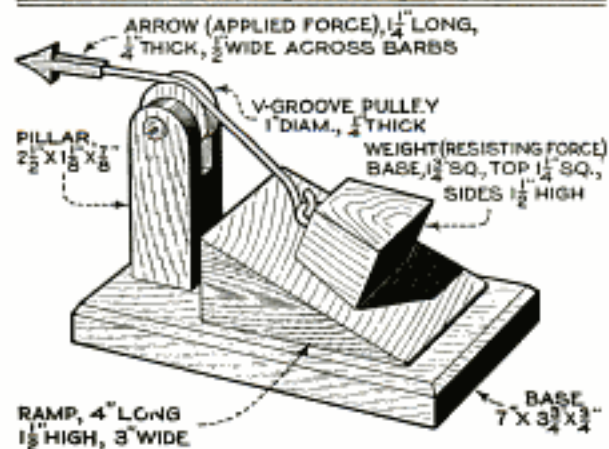

Details of Model of Inclined Plane; Above, a Modern Use of the Ramp

For the wedge model, use the following material:

Base, $4\frac{1}{2}$ in. square, $\frac{3}{4}$ in. high.
 Block, $1\frac{3}{4}$ in. square, $2\frac{3}{4}$ in. high.
 Iron wedge, base 1 by $\frac{1}{2}$ in., side $1\frac{1}{2}$ in. high.

Square and face the base with a finish

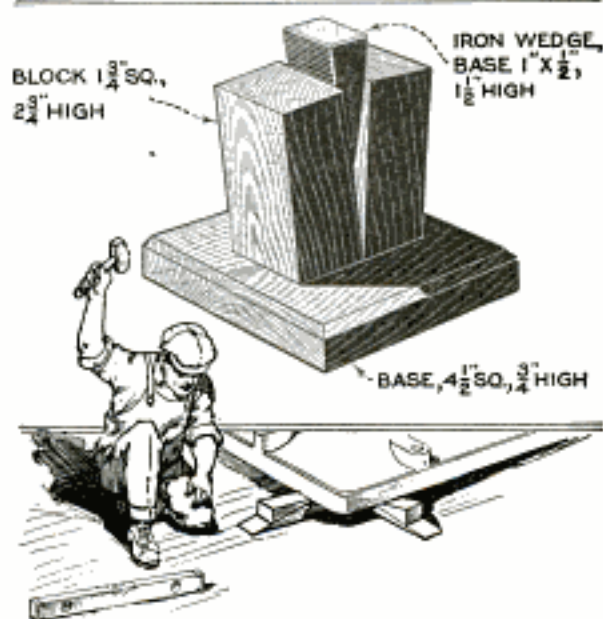

Wedge-Model Dimensions and Illustration Showing Use of Wedge in Leveling Machinery

bevel on top. Saw a cut lengthwise nearly through the block. Insert the wedge into this cut and force it in for about two-thirds of its length, separating the halves of the block, but taking care not to split it; if necessary, saw the cut in a triangular shape before forcing in the wedge. Square the bottom of the block and secure to the base with glue and screws from beneath. Finish as desired.

(Continued Next Month)

Lubricant for Auto Springs

Oil and graphite applied to the leaves of automobile springs is usually effective for a short time only, but the following mixture has been found to last for an entire season, as the wax contained in it holds the graphite between the leaves and also keeps the grease from forming an emulsion with water: japan wax, 10 parts; flake graphite, 10 parts; cup grease, 5 parts; kerosene, 1 part.

The wax can usually be had at any laundry, but if it cannot be obtained, ordinary paraffin or beeswax will do. The graphite is first mixed with the grease and the wax cut in small pieces and added, the whole being then carefully melted and thoroughly mixed. Remove the mixture from the fire before adding kerosene.

Guard Gates Used as Bridges

Guard gates are used at the Panama canal to accommodate vehicular traffic. When these were first so used it was found that, while the width permitted the

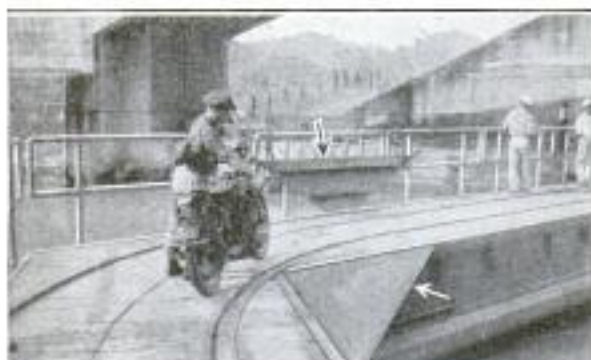

Steel Plate Used at Angle of Guard Gates at Panama Canal to Permit Vehicles to Turn Corner Safely

passage of an automobile, the gates at their meeting point formed too sharp an angle for an auto to turn safely. To overcome this difficulty, removable triangular plates were made to fit into the corner as seen in the photo. When the gates are to be opened, this plate, of course, has to be removed and is then hung on the railing of one of the gate leaves, as indicated by the black arrow.

Valuable Water-Cooling Kink

Customarily the method of cooling water by an ammonia coil is to have the latter located in the water tank as shown in Fig. 1. The objection to this method is that the water may freeze solidly if not kept in continual motion, the result being a burst tank.

Figure 2 shows a method which entirely eliminates this danger. The ammonia coil

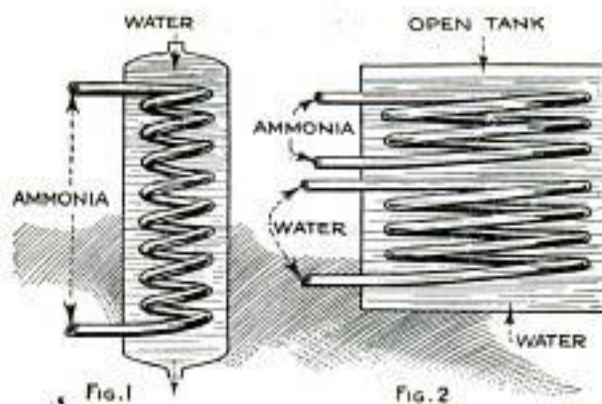

Fig. 1. Customary Method of Coil in Tank; Fig. 2. Better Method Which Prevents Freezing

is placed in a large open tank as indicated, close to the top, and the water runs

through a coil located near the bottom. The tank is filled with water. This water may freeze near the top but will not freeze solidly, and consequently there will be no rupture. As the ammonia coil is located near the top, it cools the surface water and this water then moves toward the bottom. The cold water, which is never below 32° F., surrounds the lower coil and cools the water in it. As water is drawn off intermittently from this coil, new water enters it and the water in the lower part of the tank becomes somewhat warmer than the top layer, causing it to rise again, and thus circulation in the tank is maintained.

Compact Fuse Tester

After using a weatherproof socket with an ordinary 25-watt lamp as a fuse tester, and breaking some lamps as a result, I began to consider the possibility of using a smaller lamp and so protecting it that breakage would be unlikely. The result was the compact tester detailed here-with. I obtained a telephone-switchboard lamp and inclosed it in an empty cartridge fuse of large size, as shown.

Holes were drilled in the sides so that the lighting of the lamp could readily be observed. The brass cap at one end, which in this case happened to be perforated, was made removable by pulling out the small brass rivets which held it in place. A length of common lampcord was soldered to the two base terminals of the lamp and to two darning needles, as shown. The lamp was then pushed into the cartridge and the lampcord threaded through one of the holes in the cap. When not in use, the cord and needles are disposed of inside the cartridge as indicated, permitting the tester to be carried in the pocket. The joints of the wire and the needles were covered with short pieces of small-bore rubber tubing, to provide convenient finger grips, and avoid danger from shocks.—W. W. Parker, Lead, S. Dak.

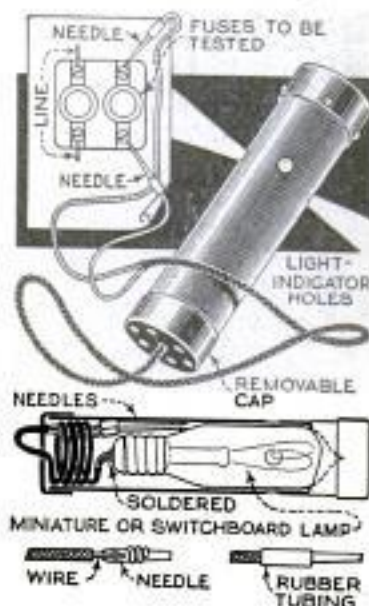

Keyless Lock for the Tool Cabinet

There are many kinds of combination locks, but few are as simple and effective as the one shown in the illustration. Since I put this on my tool cabinet a number of people have tried to open it without success, some not being able to do so even after the secret was explained to them.

There are no numbers, marks or even turns to count; simply a knob that can be manipulated as readily in the dark as in the light, because operation of the lock depends on the sense of touch. The latch is made of heavy sheet metal, and the drawing shows its construction clearly, so that no detailed description is necessary. The knob has a shank that passes through a hole drilled in the drawer front; this shank may be of any convenient size—an old valve stem, drilled at one end to take a stout wire pin, will serve very well. A coil spring is fitted between the pin and the inside of the cabinet front, to keep the shank pressed back. The shank should be long enough to allow the pin to pass the downward-projecting part of the latch, either in front or behind, without touching. A small nail is driven into the cabinet at the point indicated so that the end of the latch will rest against it.

To operate the lock, the knob is pulled outward and turned until the pin is found, by sense of touch, to rest behind and against the latch; then it is pushed in, thus

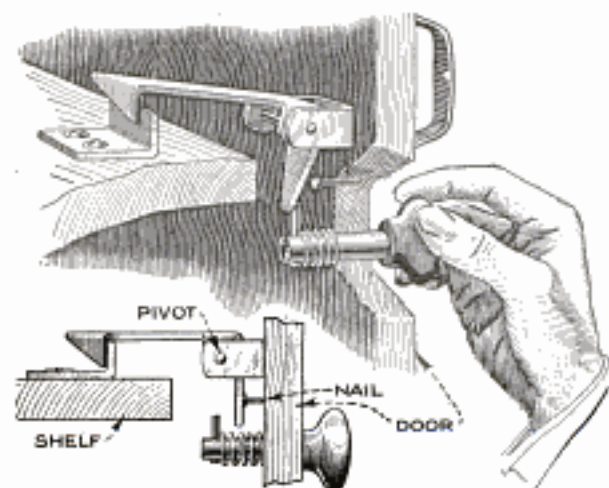

Simple and Fool-Proof Keyless Lock for the Tool Cabinet, Which Cannot Be Opened by Those Not in Secret

raising the latch.—E. Leslie MacFarlane, Nashwaaksis, N. B., Can.

☞ A draftsman's pen should not be thrown away when it is worn down and can no longer be used for ruling. It should be put in the shop's first-aid cabinet, as no better tweezers can be obtained.

Refuse Hopper for Fruit Screen

In a section of the country where cranberries are grown extensively, a boat-shaped device with a slatted bottom is used to screen the berries. Much of the chaff, twigs and dirt falls between the slats, but

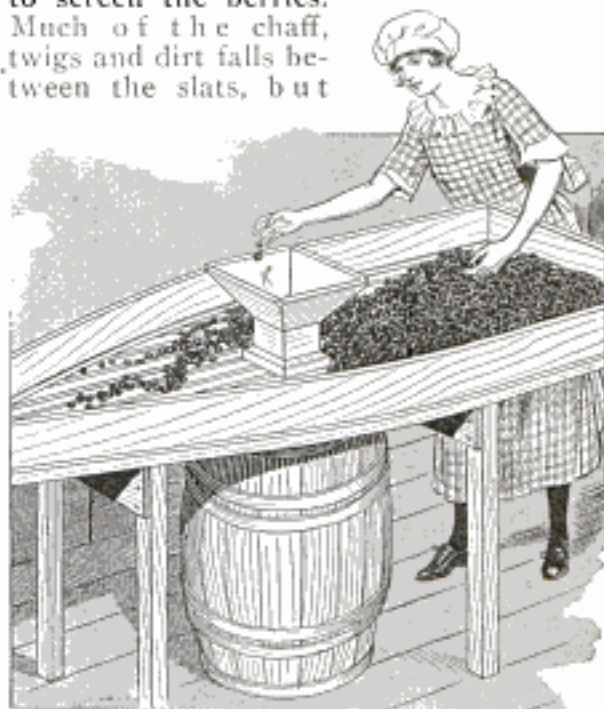

Hopper Built over Hole in Screen Bed Conveys Unsound Berries into Large Barrel

unsound berries still remain to be separated from the sound ones. It is customary to have a measure standing on the screen into which the refuse is thrown by the pickers. The repeated emptying of the measure causes much loss of time, and therefore one grower built a chute or hopper on the bottom of the screen leading into a barrel, as indicated. Cleats were nailed across the slats at a convenient point underneath; an opening, about 6 in. square, was cut out and the hopper was built up around this opening about 10 in. high. This proved quite a convenience and timesaver, and would no doubt be useful also for screening other small fruits, such as cherries, blueberries, and the like.—L. B. Robbins, Harwich, Mass.

Using Magazine Clips

The large clips used by dealers to display current issues of magazines are equally useful for the same purpose in the home in case the table room is limited. The magazines may be hung from nails driven into the wall, especially in the den or workroom, so that they are readily available. In this way, magazines can also be held open in shops where the pages might be soiled by handling.

Stamping Nameplates

In the manufacture of a number of brass plates on which the lettering had to be stamped neatly and accurately it was a problem just how to stamp the letters so

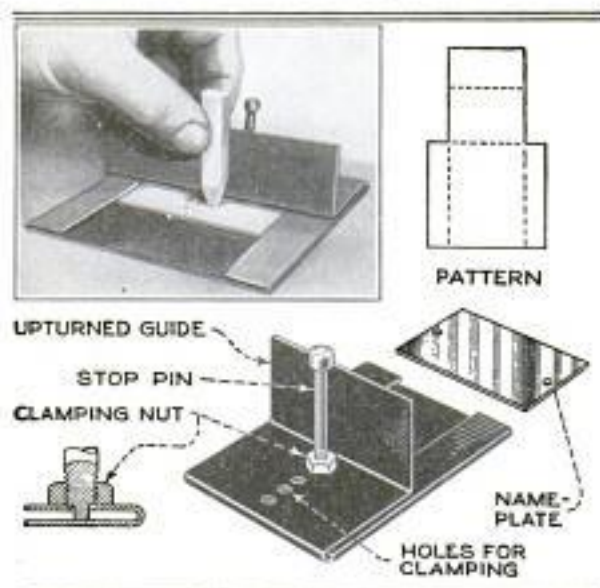

Sheet-Metal Fixture for Holding Brass Nameplates While Lettering Them

that they would be in a straight line. As only the regular steel stamps were available, it was thought best to use some kind of fixture to guide the stamps and hold them squarely in position. The fixture illustrated was the result.

It is made from a piece of sheet iron folded over on two sides as shown, one end being doubled over these folds and then bent up at right angles to form a guide against which the letters are held. A number of holes are drilled in line in the center back of the guide for a stop pin, which consists of a bolt and nut. The pin should be a snug fit in the holes, the screw thread below the nut being ground off to fit the hole and the nut resting on top. The distance between the folded sides of the holder is a sliding fit for the particular plates to be stamped and the plates are pushed against the stop pin. Thus, with the stop pin in the first hole and each stamp held close against the guide the first line is stamped. The holes should be so arranged that the lettering will be properly spaced.

Keeping Paste from Souring

There is no necessity of using sour paste for wall-paper hanging as is often done, for a few drops of formaldehyde will keep it sweet indefinitely. After experimenting with various substances, I found that for-

maldehyde was the most effective. A few drops were added to a cupful of paste, after this had been boiled, and this sample was found still sweet when examined a year later.—A. A. Kelly, Paoli, Pa.

Oiling Valve Stems

Lubricating valve stems on cars having overhead valves can be accomplished effectively by the method shown in the illustration. An asbestos rope, about $\frac{3}{16}$ in. in diameter and about 8 in. long, is wrapped a few turns around the stem after the spring has been removed. The ends are folded down along the stem and brought out at the bottom so that the pressure of the coil keeps them from working out of place when the spring is released. The application of a few drops of oil on the wick every week keeps the stem lubricated and prevents dirt from getting in contact with it.

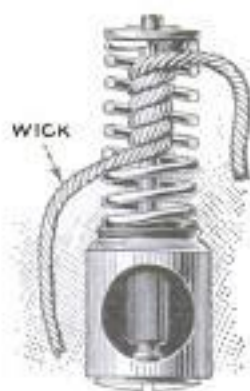

Window Frames for Small Buildings

Framing windows on small buildings, especially those that have only a few studs, is usually quite a problem. A frame put on the outside, however, as shown in the drawing, presents a good appearance and has been found very satisfactory. It is made of lengths of 2 by 4-in. stock set on edge with the sashes hinged on as indicated. The frame is made long enough for as many sashes as are to be mounted and the latter are separated by 2 by 4-in. pieces. The frame is nailed to the building from the inside. A 1 by 12-in. piece of boxing, nailed at each end, will keep the frame in place until the top and bottom pieces are nailed on. A length of quarter round is nailed along the upper edge of the frame to turn water.



Novel Circular-Glass Cutter

Two 12-in. lengths of 4-in. wood, a short brass rod and an inexpensive glass cutter form a novel tool for cutting glass of cylindrical shape. It has been found very satisfactory by an eastern concern that specializes in manufacturing wicker flower holders, the wicker work inclosing a glass container for the water. These containers are made from round bottles of various sizes and colors, the tops being cut off with the tool shown in the accompanying illustration.

The two lengths of wood are nailed together edgewise at right angles, several holes being drilled in both pieces to receive a brass rod, which serves as a stop during the cutting operation. The cutter is attached to the end of the lower piece by means of a short brass strip and two wood screws. The method of using the device is obvious; the bottle is simply turned by hand until a scratch is made around it, whereupon the top part can easily be knocked off. The sharp edge of the glass

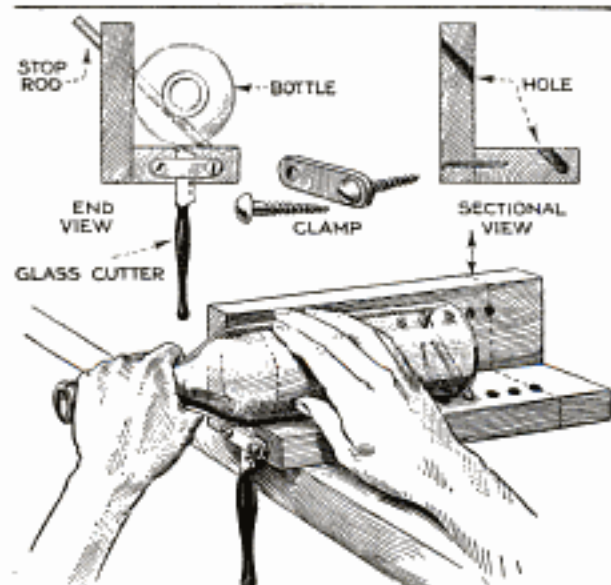

Simple Homemade Circular-Glass Cutter Cuts Bottles Quickly and Accurately

is smoothed on an emery wheel to prevent danger of cutting the hands.—G. A. Luers, Washington, D. C.

Desk and Bookcase Built in Closet

It is often desirable to have a large desk at home for correspondence work, book-keeping, etc., but on the other hand it may

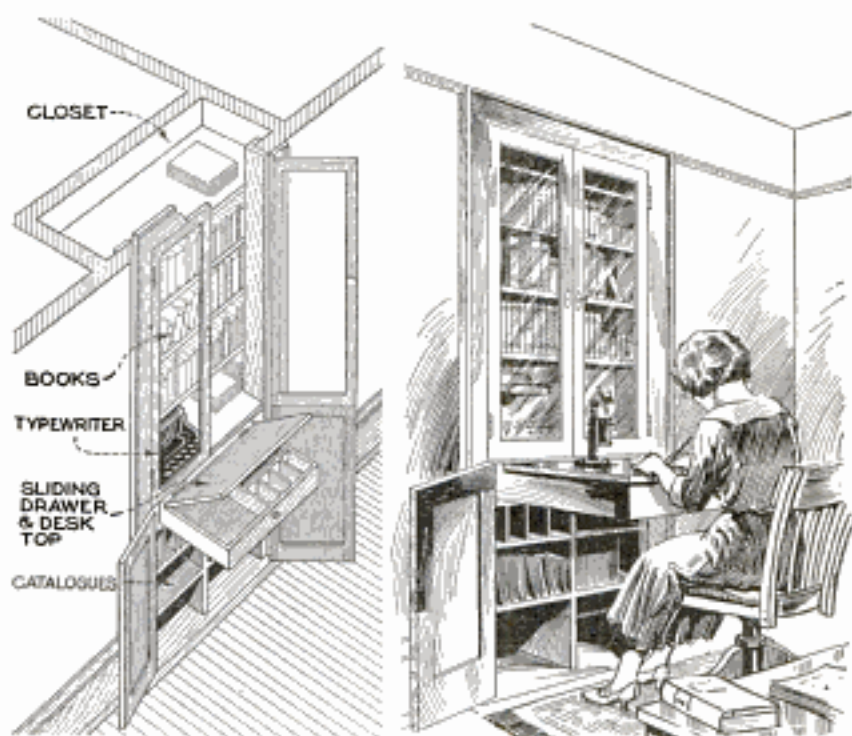

Left, Part Section, Showing How the Combination Desk and Bookcase Fits into the Closet; Right, Desk in Use

be objectionable on account of the space it occupies, and because the children will put their toys and other articles on it and can not restrain their curiosity as to the contents of the drawers. With this in mind a Washington contractor built a compact desk of large dimensions, the top of which, when not in use, could be pushed entirely out of the way into a locked closet. The closet was fitted with glass doors above and paneled doors below so that it did not detract from the appearance of the room in any way. The general plan of construction is given in the drawing, and can, with slight modifications, be adapted to most cases.

The closet consists of two compartments, separated by a horizontal shelf about 1 in. above the top of the desk, which should be about 30 in. high. Under the desk top, which is hinged, is a full-width drawer for the support of which slides are provided, and the space below is divided into shelves and pigeonholes for catalogs, stationery and the like. The drawer may also be partitioned to suit the user's particular needs. Shelves are provided in the upper compartment for books and magazines, and for the typewriter and telephone, if desired.

Making Stranded-Wire Cables

Having had considerable difficulty in obtaining good seven-stranded cable for guy wires, I hit upon the following method of making it myself: I jacked up one of the

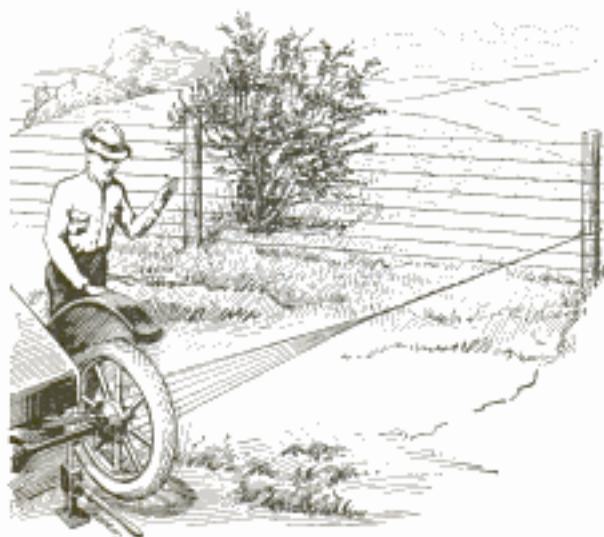

Simple Method of Making Neat Stranded Cable from a Number of Galvanized-Iron Wires

rear wheels of my car and fastened one end of a coil of galvanized-iron wire to one of the spokes, brought the wire around a fencepost, directly in line with the wheel, and attached it to the opposite spoke of the wheel, cutting it from the coil at this point. Two other lengths of wire were run in the same way and also a single length from the wheel to the post. I then started the engine and put it in gear, which caused the rear wheel to revolve and twist the wires as desired, making a strong cable. With this method I have made cables 150 ft. long.—L. Cook, Bloomingdale, Mich.

Nonreversible Drain

Water in a reservoir is usually kept below a certain level by providing a drain pipe that carries off the surplus water. Where the drain extends horizontally through the wall and discharges the water into an exterior ditch, it often happens that the water level in the ditch becomes higher than that in the reservoir, due to heavy rainstorms, and water then flows back into the reservoir through the drain. This

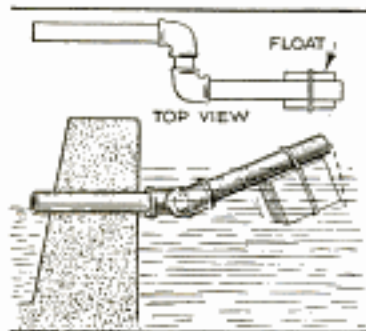

trouble can be prevented by installing a drain of the type shown in the illustration. It consists of two short lengths of pipe, two elbows and a nipple, arranged as shown in the upper detail. The couplings must be loose enough to permit the length of pipe extending into the ditch to move up and down freely. An airtight can is wired to the end of this pipe to keep it above water when the exterior level is higher than that in the reservoir, so that the water from the ditch will not flow back.—Harold E. Benson, Boulder, Colo.

Drilling Glass and Pottery

Drilling holes in glass and pottery is usually done with a highly tempered drill using camphor oil as a lubricant. Another good method—in many cases better—is to grind the holes by means of carborundum stones of proper sizes, set in the drill chuck and revolved at high speed. Holes have been ground through pieces of hard pottery in this way where the drilling method failed.

A Magazine Nut Wrench

Automobile assemblers and others who, from the character of their work, must screw down large numbers of nuts of the same size, will find in the tool illustrated a means of largely reducing the number of

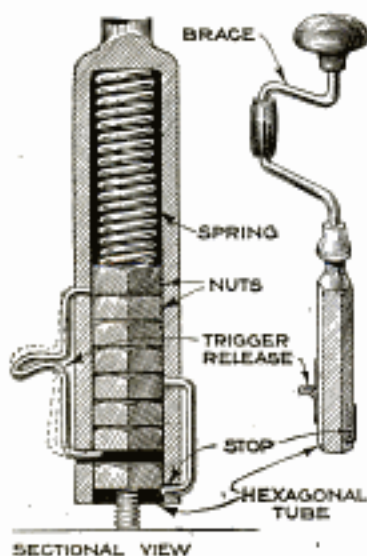

movements required. As shown in the drawing, the magazine consists of a hexagonal tube, that can easily be made by forming a piece of steel tubing over a mandrel of the same size as the nuts to be used, and welding into the upper end a suitable square shank. A compression spring inside feeds the nuts forward as fast as they are released by the trigger, which is operated manually, the nut being prevented from falling out by the stop on the opposite side. Both these parts are made from spring-steel wire with their lower points spaced apart just the thickness of one nut.

Worm-Gear Attachment for Sensitive Drill Press

By H. H. PARKER

THE type of small sensitive bench drill shown in the illustration is extensively used for light work in machine shops, factories and garages, as well as similar machines with bevel-gear drive, of slightly greater capacity. The feed is obtained by means of a rack and pinion actuated by a hand lever, and is perfectly satisfactory for small or intermittent work, but for drilling $\frac{3}{8}$ to $\frac{1}{2}$ -in. holes in hard steel, with the machine working for long peri-

ods of time, the pressure required on the hand lever is rather tiring upon the operator, and a worm gear with handwheel feed, as applied to a large drill press, would be of decided advantage. The drawings show how such a feed arrangement can be applied to the bench drill without any considerable alteration of the machine, and without detracting from its appearance or preventing use of the hand lever; the patterns required are simple and most of the

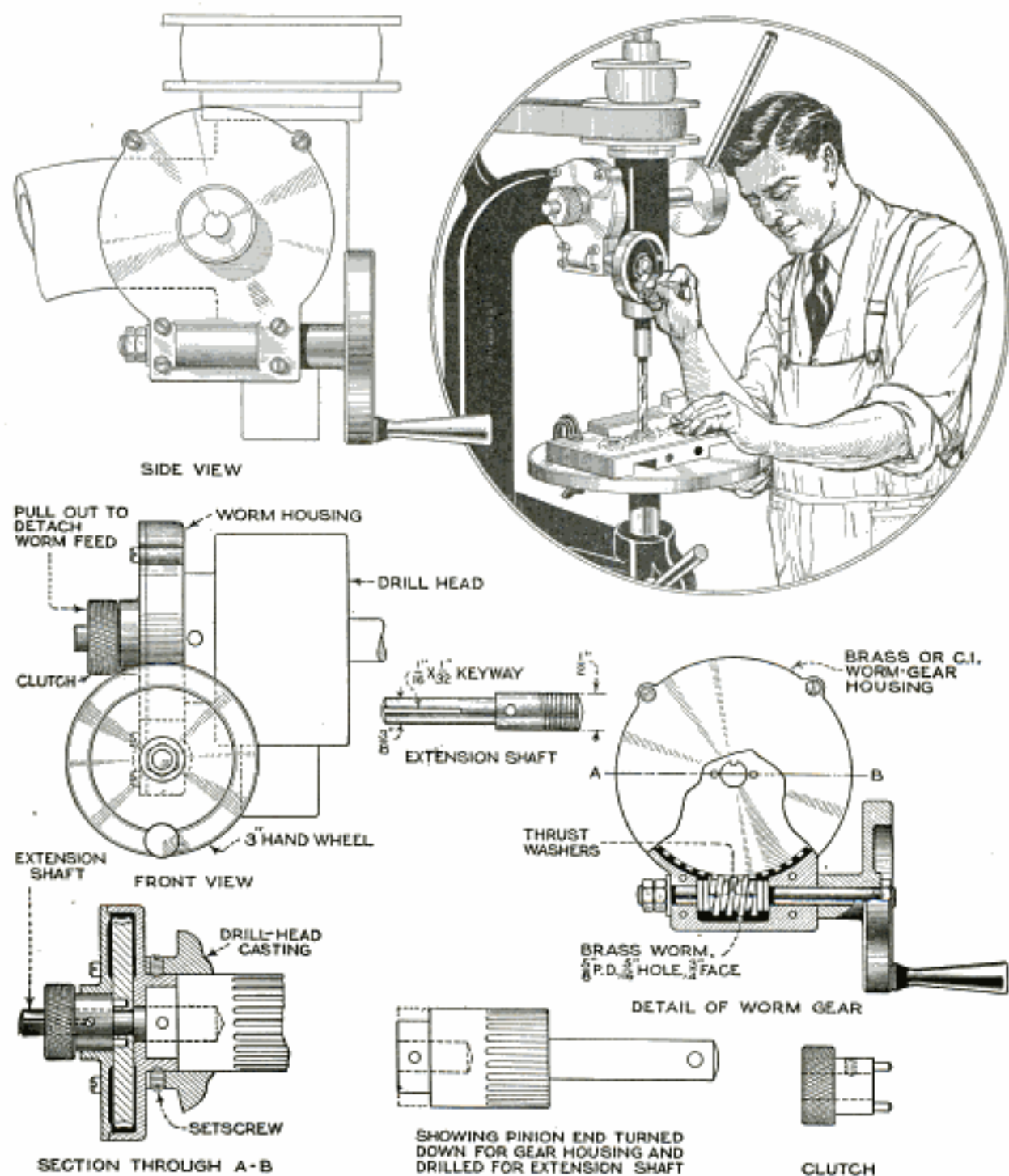

Fitting a Handwheel Feed to a Sensitive Bench Drill Press; an Attachment of This Kind Permits Heavy Work to Be Done over a Long Period without Fatigue

machine work can be performed in the lathe. While the drawings are approximately to scale, the exact dimensions will depend upon the type of drill press and the size of the worm wheel and worm. The latter may be obtained, finished, from any manufacturer of cut gearing; they are usually of brass in the small sizes. A diametral pitch of 16 is about right with a worm wheel of 3 to 4-in. diameter. Most of the bench drill presses are built with a feed pinion turned from solid stock, with a shaft at one end to take the feed-lever boss. The other end is left the full size of the gear blank and rotates in a bearing bored out of the drill-head casting. By turning this end down for about $\frac{1}{2}$ in., reducing the diameter by $\frac{3}{8}$ or $\frac{1}{2}$ in., an annular space will be formed in the pinion-bearing housing, with the pinion shaft in place, into which the boss of the worm-wheel housing can be pushed and locked in place by means of setscrews. The pinion shaft will now rotate in the worm-wheel housing as a bearing, while a stub, or extension, shaft must be screwed into the pinion shaft to take the worm wheel.

A cast-iron or brass casting is made for the worm-wheel housing; either in one piece with a cover as in the drawing, the worm shaft being put through a drilled hole, or made in halves like a blower case. In the drawing a worm wheel without a hub is shown; as this is loose on the shaft, the cover is made with a boss that bears against the web of the wheel, to steady it, a similar shallow boss being provided on the inside of the housing casting. The cover is held by three or more setscrews.

A $\frac{1}{2}$ -in. extension shaft is driven, or screwed, part way into the solid end of the pinion shaft, pinned in place and then turned down to take the worm gear, which is not fastened to it. Means must, of course, be provided for clutching and de-clutching the worm wheel when the worm feed is to be used instead of the hand lever, and vice versa. The clutch is made from a steel bar, which slides on the shaft extension and engages the worm wheel by means of two $\frac{1}{8}$ -in. steel pins that fit into holes drilled in the web of the wheel. A keyway is cut on the outer end of the shaft, and a setscrew, with its end filed to fit the keyway, set into the sliding clutch to make it rotate with the shaft. The filed end must, of course, be a sliding fit in the keyway. When the hand lever is to be used, the knurled end of the clutch is pulled out, which will disengage the worm wheel from the shaft.

Fitting the worm shaft is the only operation requiring special care; the hole for this must be accurately drilled and reamed in relation to the worm-wheel shaft. The worm (unless solid with the shaft, in which case a divided housing, or a large-diameter entrance hole is needed) is pinned, or preferably sweated, to its shaft, and thrust washers, or small ball thrusts, fitted at each end. The handwheel is 3 to 4 in. in diameter, pinned or keyed and held with an end nut; a pair of locknuts are screwed to the other end of the shaft. The arrangement of the housing and type of the clutch may, of course, be changed to suit the individual ideas of the builder, but the type shown is easy to make.

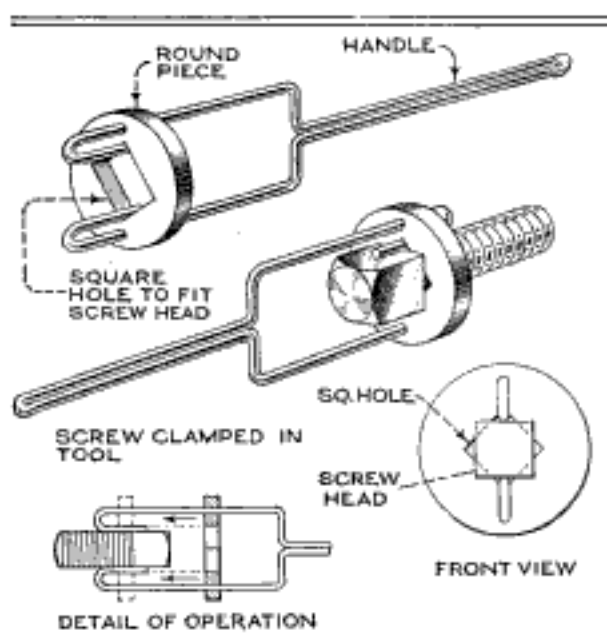

Nonslipping Holder for Square-Head Screws

Gripping Square-Head Screws

Pliers, tongs and other similar tools are often used for dipping small fixtures in cleaning solutions, but it often happens that the only part of the fixture that can be gripped conveniently is a projecting square-head screw, and holding this with the tongs or pliers often results in dropping the fixture to the bottom of the tank. An excellent holder for this purpose is shown in the illustration. A round-steel washer is squared out in the center to fit the screw head, and two holes are drilled through it on opposite sides, and in line with the corners of the square. A piece of drill rod is then bent, as shown, to fit these two holes, and with the ends bent backward to fit closely in the corners of the square. The tool is made to grip the screw by first pushing the handle forward until the ends clear the square hole so that

the latter can be passed over the screw head. When clear over, the tool is given an eighth of a turn and the handle pulled backward to lock the ends against the screw head. A little study of the drawing will soon show that the tool is nonslipping and that it is impossible for it to come off while the fixture is being swirled around in the tank. To remove the tool the operations are, of course, reversed.

Prolonging Life of Scraper

After a season of use, the edge of a scraper is usually worn out. It can readily be repaired, however, so that it will be

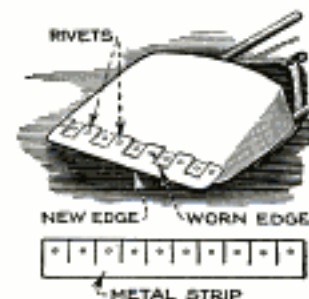

nearly as good as new by riveting a 6-in. strip of steel to the edge, as shown in the illustration. The strip should be as long as the scraper is wide and is slitted so that the resulting "tongues" can be fitted alternately

to the top and bottom of the scraper. The strip is then riveted to the scraper, as indicated, and the rivets countersunk on the underside. This will make a strong edge that will not bend easily.—Stanley McCosh, Novi, Mich.

Making Collars in One Operation

The arrangement of tools shown in the illustration has been found very handy in making collars and washers on screw machines directly from tubing without a second operation for burring or countersinking as is usually necessary.

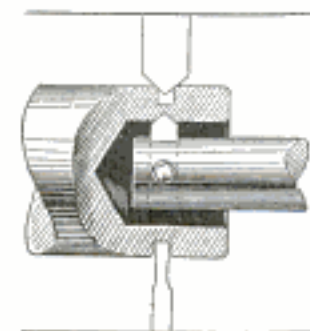

The collars are cut off with the parting tool, which is mounted on the front cross slide, and the outer edge is chamfered with a chamfering tool on the rear cross slide. The inside edges are chamfered with a tool held on a bar carried in the turret. The latter tool is fed in to the proper depth as controlled by the turret stop, and then into the work to such a depth that after the parting tool has gone through, a chamfer will be left on the inside edge.

Control for Roof Trapdoor

Trapdoors are usually rather difficult to open and for this reason the simple and easily operated control shown in the drawing should meet with instant favor. It

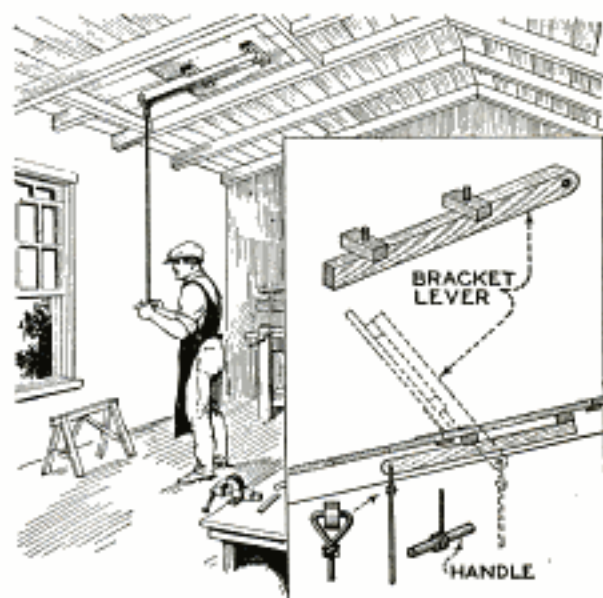

Bracket Lever and Iron Rod Used to Control Roof Trapdoor from Below

eliminates the necessity of climbing up on a ladder. A bracket lever is bolted to the underside of the door so that it extends beyond the hinged edge, as shown, and a $\frac{1}{4}$ -in. iron rod is attached to the end of the lever. A quick pull on the rod causes the trapdoor to swing to the position indicated by the dotted lines in the detail, a stop being provided to hold it there.

Wire Bracket Holds Valve Springs

Holding up valve springs is one of the difficulties met with when regrinding valves and removing carbon. Various kinds of holders are on the market, but one that is of simple construction and performs the work as well

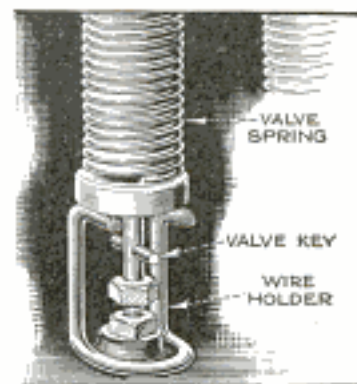

as the best, is shown here. It consists of a length of heavy wire, at least $\frac{3}{16}$ in. in diameter, bent to the shape indicated. After the valve spring has been raised, the holder is placed under it and will then hold the spring securely, without slipping.

Guide for Special Work in Braiding Machine

In making lamp cords for Christmas trees, two single wires are run together through a braiding machine, taps being

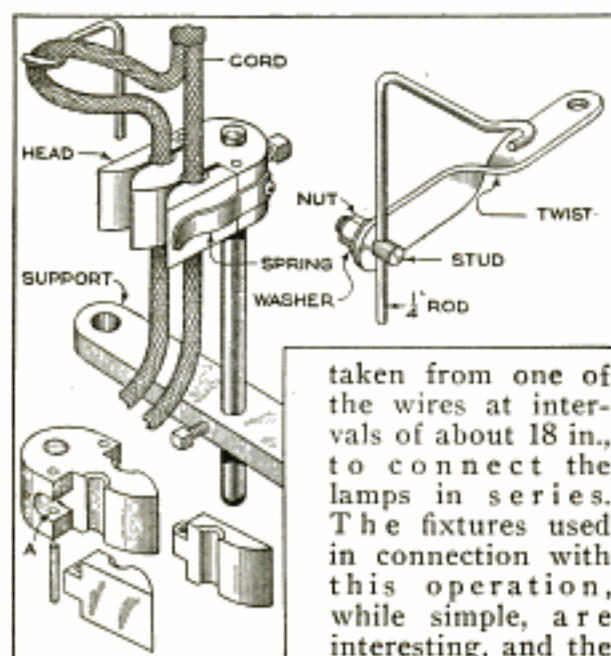

taken from one of the wires at intervals of about 18 in., to connect the lamps in series. The fixtures used in connection with this operation, while simple, are interesting, and the same principles may

be adapted to much other work.

The drawing shows the attachment that

replaces the regular guide. It is made of machine steel, casehardened. The center part of the head is milled out as shown in the lower detail, the slots at A being machined with an end mill. The two swinging pieces have lugs that fit into slots A, and are fastened to the center part by steel pins. Flat springs bearing against the sidepieces keep a tension on the wire as it is drawn through the guide. The holes for the wire are drilled and countersunk, half in the center and half in the sidepieces, and the head is held by a $\frac{3}{8}$ -in. rod, passing through a flat-steel bracket bolted to the base of the machine. To insure all the taps being of equal length the fixture shown at the right was made. This consists simply of a $\frac{1}{4}$ -in. rod, bent as shown and passing through a hole in a stud that binds the rod against a cold-rolled steel bracket. Adjustment of the distance between the rod and guide is effected by swinging the rod.

One insulated wire of each pair is drawn out to the hook, pulled tight, and the machine started, braiding on past the tap. As the braided cord travels up over the tension drum, another $\frac{1}{4}$ -in. rod, fastened to the machine frame, and bent to touch the drum, shows the operator where to stop the machine and form the next loop.

Centering Short Shafts

In the production of a large number of short shafts the work of centering them was quickly and conveniently accomplished with the use of the fixture shown in the illustration.



It consists of a cast-iron base, drilled to receive a vertical rod and having a setscrew to hold the latter in position. A similar piece, or head, of cast iron, drilled to a sliding fit on the rod, is also provided. It is held in alignment directly over the base by a key seated in the head and running in a keyway in the side of the rod. Both base and head are countersunk to receive the shafts

and a punch is provided in the head, in the center of the countersink, as shown. In use, the shaft is placed in the lower countersink and the head lowered so that the shaft is held as shown. The punch is then tapped, with

the hammer, and the process repeated for the other end of the shaft.—J. H. Rodgers, Toronto, Can.

Connecting the Universal Joint

The removal of the rear-axle assembly on the Ford car necessitates the disconnecting of the universal joint, and it is quite a difficult job to reconnect the joint by hand. However, with a lever fastened

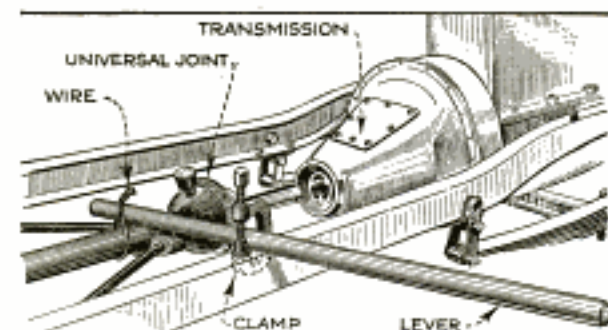

Lever Aids in Connecting Universal Joint to Engine When Rear End Is Replaced

to the joint by wire or rope and pivoted on the frame by means of a C-clamp as shown, the operation becomes quite easy. The arrangement gives a combined lift and

thrust. The universal joint is packed with heavy cup grease, which will steady the end. An open-end wrench is used to bring the shaft end in alinement with the socket.

Oiling Typewriter Bars

When overhauling typewriters the bars must be oiled a little before they are replaced. This is usually done by squirting

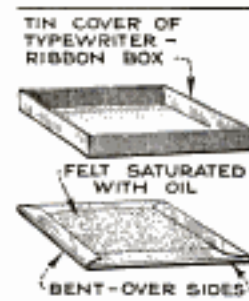

a few drops of oil on the bars or by rubbing them with an oil-soaked rag, but these methods are slow, and therefore a repairman devised the oiling pad shown in the drawing. The pad consists of a piece of thick felt, fitting inside the tin cover of a typewriter-

ribbon box, the edges of which are bent over and flattened down to hold the felt in place. Enough oil is applied to the felt so that a slight pressure will bring it to the surface. Each side of a bar is pressed against the felt with the result that it is moistened with just sufficient oil.

Neat Safety Paint Pot

The paint pot shown in the drawing is designed for inside work, to prevent spilling of the paint if accidentally tipped over, and also to provide a guard against which the brush can be wiped, in order to keep the outside of the pot clean.

For these reasons the pot should be shallow and of fairly large diameter, and the guard as wide as possible, while permitting the brush to enter freely through the center opening. The safety cover

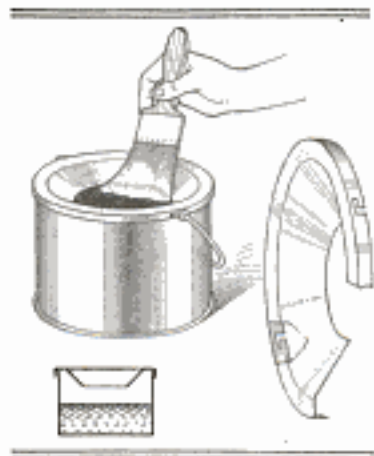

or guard is made of tin and shaped as shown in the detail. It is held on the pot by means of two bayonet slots in the turned-down edge which engage the ends of the bail. Only as much paint should be put into the pot as will be confined in the space under the cover if the pot is accidentally tipped over.

Handy Glass Carrier

Large panes of glass, which are ordinarily difficult to carry due to their bulkiness, can be carried conveniently by means of the holder shown in the illustration. It

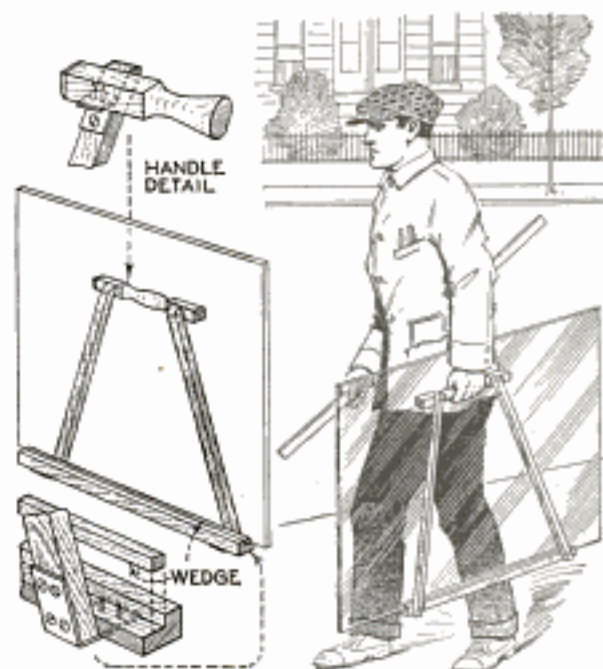

Convenient Holder for Carrying Large Panes of Glass

is made in any desired size from lengths of 1 by 2-in. wood. The lower rail on which the glass rests is screwed to two strips which are attached to the handle. A taper groove is cut lengthwise in the lower rail to receive the glass and a felt-covered wedge is provided to fit in this groove, against the glass, to hold it in place.—J. R. Minter, Chester, Pa.

Novel Arrangement of Cash Register

Cash registers in most stores are set to face the space inside of the counter, which is often inconvenient as it necessitates passing



around the counter to "ring up a sale." However, by mounting the cash register on a small turntable on the counter, clerks on either side can use it by turning it around.

☞ Brass is annealed by heating to a cherry red and then allowing it to cool slowly.

Depth Gauge for Drilled Holes

Measuring the depth of drilled holes is a somewhat uncertain operation, as the bottom is conical and dimensions are invariably given to the top of the cone. Most

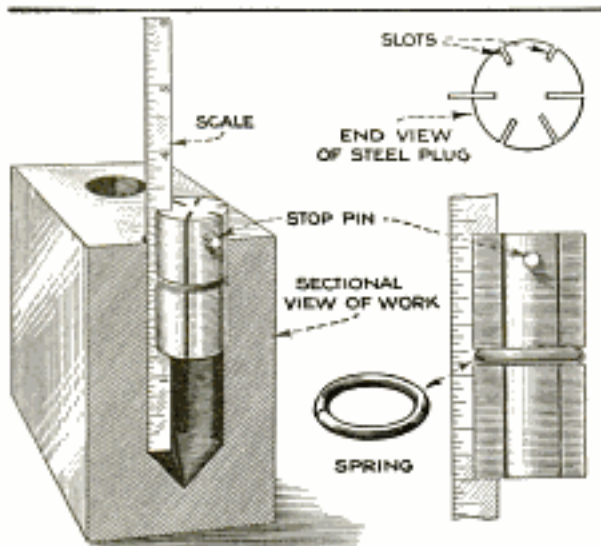

Accurate Plug Depth Gauge for Measuring Drilled Holes

measuring devices used for this work tend to slip down into the conical end, and

therefore one cannot be sure whether the holes have been correctly gauged or not. On the production of a machine part furnished with several holes of slightly different diameters, one shop uses the gauge shown in the photo.

It consists of a round-steel plug with slots sawed in it lengthwise, the depth of these slots varying to suit the different hole diameters so that when the scale is inserted in the slot the plug and scale will fit the hole exactly, as shown. A groove is cut around the plug in the center and a single coil of spring wire slipped in it to hold the scale lightly in any of the slots. At a definite distance from the top a pin is driven through the plug to prevent it from falling into the hole. In use, the scale is slipped in the slot marked to suit the hole to be measured and the plug inserted into the hole until the pin rests on the top. The scale is then pushed down until it strikes the bottom and the reading of the scale taken from the top of the plug. Thus if the face of the pin is $\frac{1}{2}$ in. below the top of the plug, the correct measurement will be $\frac{1}{2}$ in. less than the depth to the top of the plug. With slots sawed in the plug to suit the different holes it fits snugly in each case, and the measurements are accurate.

Steel Fence Posts

Good fences add to the appearance and value of a farm, and save the farmer many losses of live stock and crops. In recent years steel-post fences have gained popularity because they are rot-proof, lightning-proof, weather-resisting and durable in every way. Although they cost a little more than wooden ones their use is economical because they will outlast the latter many times. There are, in fact, records of steel posts set up 35 years ago that are still in good condition, while the average wood post lasts only six to ten years.

The durability of a steel-post fence, like any other, depends on the manner of installation. End and corner posts must be securely anchored in concrete to keep the wires tight and assure resistance to violent shocks. One method of doing this is shown in the illustration. The posts referred to are set vertically in slabs of 18 by 18 by 42-in. concrete, this being done, of course, while the concrete is soft. The steel braces bolted to the vertical posts are anchored in smaller slabs, 18 by 18 by 20 in. in dimensions,

One of the best features of steel-post fences is that there is little or no danger from lightning by which farmers annually lose millions of dollars, as, for instance, when cattle are driven against the fence by a storm and killed by a discharge of lightning conducted along the wire. This

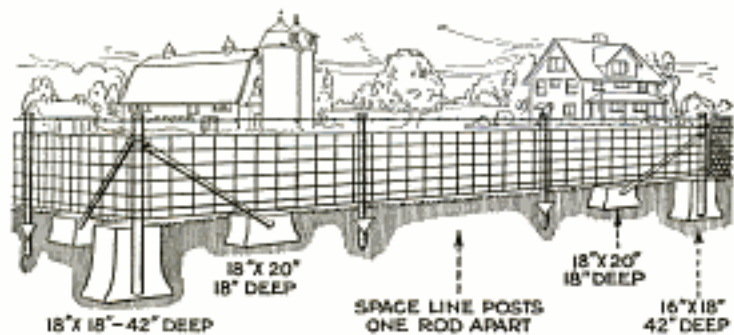

Proper Method of Setting Steel End and Corner Posts in Concrete Foundations

will not happen when steel posts are used, as they generally will ground such discharges. Another advantage of steel posts is the speed with which they can be set. One wagonload of posts is enough for a 40-acre field, and a man and boy can drive the lot into the ground in a day, while four men at least would be required to do the same work with wooden posts.



Making a Kicking Mule

By L. R. BUTCHER

THE kicking mule, as its name indicates, is an animated toy, the rear legs of which kick up as it is pulled across the floor. Apart from a pair of tin snips, the tools needed for its construction are to be found in any ordinary tool chest. Once

is made of medium-weight sheet metal, preferably blue-annealed stock, as this

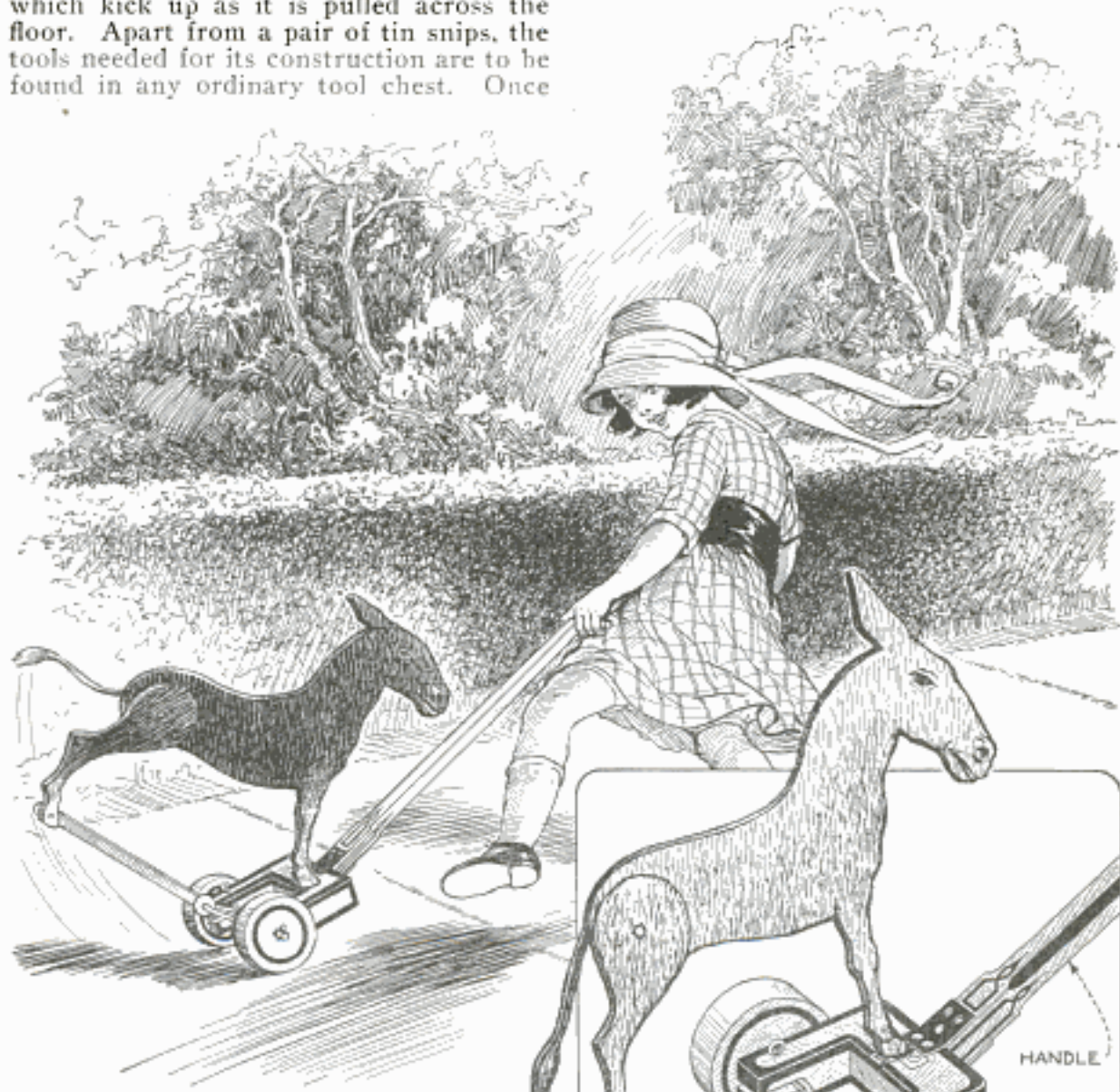

An Amusing Toy for the Youngsters, Which Can Be Made by Anyone with Ordinary Tools

the body is laid out, any tinsmith will cut it out in a few minutes, if the maker does not feel sure of his ability to do it. Scraps of wood and sheet metal furnish the materials for the toy. The body of the mule

holds paint much better than the galvanized kind. In Fig. 1, a sketch of the body is given. By laying out a square on a sheet of paper, 8 by 8 in. in size, and dividing it into 1-in. squares, the amateur artist can easily lay out the body, drawing the outline in Fig. 1 in the same relative position in each square on the pattern. After making the pattern, the outline is transferred

slots in the ends are made with a hacksaw, and are for the purpose of fastening the wheels to the axle. The wheel is slipped onto the axle and a staple inserted in the slot and driven home into the wheel. The wheel is kept from slipping off by squeezing the split end of the axle together, or by putting a drop of solder in the slot.

The connecting rod, Fig. 4, serves to connect the crank on the axle to the rear legs of the mule. One end is drilled to fit the crank, while the other is drilled to fit a small tinner's rivet. Two rear legs are needed. These are pivoted to the body, one on each side, by a tinner's rivet at their upper ends. The connecting rod is placed between them at the hoofs, and pivoted to them with a rivet near the ankles. All the pivot joints should work freely, yet without undue looseness. The handle can be applied in any manner desired, and the toy may be painted according to the maker's notion of what is fitting. Brown does well for the body, with the wheels and base of some contrasting color. A short piece of cord can be glued to the rear of the body, to serve as a tail. Pulling the mule across the floor

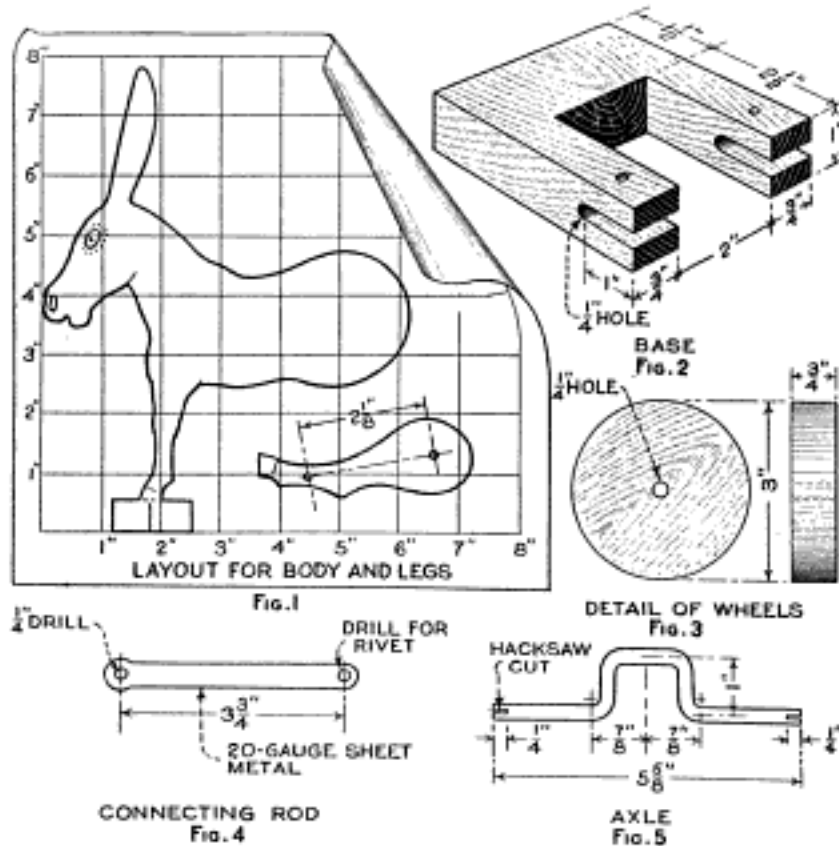

Details of Construction of the Kicking Mule, Including a Layout of the Body, to Make It Easy for the Amateur Draftsman

to the sheet metal chosen for the body. As it is almost impossible to follow the sharp curves of the body with the ordinary tin snips, the body should be trimmed to size as closely as possible with them, and the curves filed to the line with a half-round file. The rectangle of metal left on the front hoof of the mule is used to fasten the body to the base. This rectangle is slit up to the bottom of the hoof with the snips, and the two ears thus formed bent in opposite directions, at right angles to the leg. Heavy tacks are used to fasten the bracket to the base.

The base, Fig. 2, requires little explanation. It is made of 1-in. wood, sawed out as indicated. As the axle is bent before it is fitted in the base, the axle holes in the base are slotted out to the rear end, allowing the axle to be inserted from the rear. A cotter pin is used on each side to hold the axle in place. Ordinary 1/4-in. round mild steel is used for the axle, Fig. 5. The

causes the legs to kick in a lifelike manner, once for each revolution of the wheels.

Two Conveniences for the Car

A small article, such as a handkerchief, pad of paper, notebook or the like, is easily lost when it is laid on the front seat of an automobile, as it might then be blown away or drop to the floor unnoticed. To prevent this, sew a band of cloth, about 2 in. wide and hemmed on both edges, crosswise around the seat cushion in the center, or, in case a cover is used, sew the band directly to this. The ends only are stitched down, so that the articles can be slipped under the band and held there. Another convenience for the motorist is a small pocket sewed to the front of the seat cover. It is kept closed by means of a flap, fastened with two ordinary snaps. This pocket may be used for carrying an extra license plate or a notebook.

Cleaning Rust from Gun

It is usually quite difficult to keep the barrel of a gun free from rust and it is even more difficult to remove the rust after it has once formed. An easy method of doing this is to plug one end of the barrel with a cork and pour some quicksilver into it. The other end is then tightly corked also, and the barrel is tilted alternately on each end, causing the quicksilver to flow back and forth inside. The result will be an absolutely clean barrel.—Sixten N. Swenson, Harris, Minn.

An Umbrella-Rib Bow

The "stout yew bow" of Robin Hood's days is hard to find nowadays, but a bow made of umbrella ribs will give as much delight to the heart of the small boy.

Separate the ribs from the umbrella by cutting the wire that holds them, and remove the short ribs with a file or pliers. Bind five long ribs together at their centers with twine. Then bind three ribs on each end with their inner ends butting at the center of the bundle of five. Next, bind a single rib, eye outward, on each end, with the inner ends at the centers of the bundles of three. The small eyes at the ends of the outer ribs can be used for attaching the bowstring. The middle of the bow should be neatly served

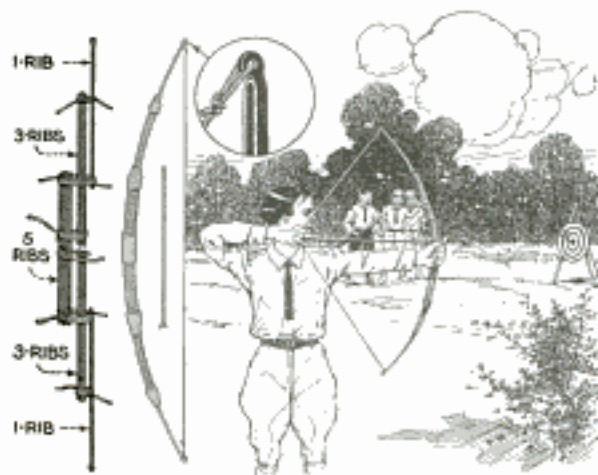

A Good Substitute for the Yew Bow of Tradition Is Made from Umbrella Ribs

or bound with twine, to prevent the ribs from scratching small hands. Any ribs left over make good arrows if nicks for the bowstring are filed in the ends.

☞ Carry a small covered can in the automobile for catching gasoline, for use when making patches and priming the engine.

Ornamental Cover Hides Curtain Top

Ornamental as well as novel in construction and design, a window-curtain covering of the kind shown in the drawing adds a pleasing touch to a Chicago parlor. The



Attractively Painted "Curtain Box" Enhances the Appearance of a Room and Hides Curtain Rods

cover, or "curtain box" as it is called, is made of thin poplar; it is long and wide enough to cover the top of the window frame, curtain and curtain rods, thus hiding this conventional but more or less ugly arrangement. After the cover is finished it is painted and decorated to match the wall paper; in this case it was given two coats of white paint, rubbed down, and then finished with a coat of white enamel. On this scrollwork and flowers were painted, giving a very attractive effect.

Repairing Cracked Aluminum Oil Pans

Cracked water jackets and aluminum oil pans can often be repaired satisfactorily with sulphur. Proceed as follows: First clean all the grease and dirt from the surface, using a solution of hot water and sal soda. Permit the surface to dry thoroughly before applying the sulphur. Warm the surfaces with a blowtorch and melt some of the sulphur in a container, taking care that it does not catch fire. Pour the melted sulphur into the crack and allow it to harden. Small cracks in aluminum are easily mended in this way. The repair will be water and oil-proof, provided fire is not allowed to come in direct contact with the sulphur.

Combining Mail Box and Gatepost



Although efforts are made by road builders to beautify the highways, not much has been done to eliminate the ugly rows of mail boxes mounted on posts. However, a progressive Indiana farmer combined his box with a concrete gatepost as shown in the photo. It is out of the way of small

children who are usually curious to know the contents; it can not be shot full of holes by a disappointed hunter or ambitious marksman, and does not detract from the appearance of the road.—A. S. Bowes, Chicago, Ill.

Safety First for the Tripod

Camera tripods are easily upset by an accidental touch of the foot against the inside of one of the legs, with the result that



an expensive camera may be badly damaged and, perhaps, the lens broken. The same tendency to slipping is experienced when setting up the tripod on surfaces where it is impossible to make the spurs hold. A simple method of preventing this trouble is shown in the illustration. Three 10-in. lengths of furnace chain, a keyring and four snaps are required. Three of the snaps are attached to the ends of the chains and the fourth to the keyring, to make the safety device adjustable. Small screweyes, for attaching the snaps, are driven into the legs of the tripod at the points indicated.—C. E. Weibezahl, Syracuse, N. Y.

Emergency Battery Clips

Galvanized-iron pipe couplings of the $\frac{1}{2}$ -in. size have been found to be excellent connectors for storage-battery posts in the absence of the regular clips used for this purpose. The couplings are screwed on the post, the tapered thread cutting into the lead and thus giving a firm electrical contact. The bared ends of the cable or wire can readily be soldered to the coupling. A little vaseline smeared on the post will prevent corrosion and facilitate the removal of the couplings. This connector will stand heavy currents, will fit almost any battery post and will not damage the posts in any way.

Heating Shoe Patches

Cement-fastened patches are often used to mend shoes. The patch is scarfed to a feather edge; it and the shoe are given two coats of

leather cement, the first being allowed to harden before the second is applied. To fasten the patch on the shoe, the cement must be softened again by heat, and to warm both the patch and shoe at the same time is usually an awkward task. By blocking up an electric lamp level with the hole in the shoe, however, and placing the patch on the block on the other side, the cement can be equally softened on both with the assurance that the patch will stick solidly to the shoe when it is applied. A small block of wood is placed inside of the shoe before applying the patch, and the latter is carefully hammered down, especially at the edges.



Preventing Draft in Touring Car

A good method of preventing the entrance of drafts at the vertical joints between motor-car side curtains is to sew a strip of curtain cloth, about 4 in. wide, to the rear edge of the front curtain, so as to overlap the rear curtain on the outside. When running at a moderate speed or when headed against the wind, this flap is pressed firmly against the rear curtain, closing the gaps effectively.—E. T. Gunderson, Humboldt, Ia.

New Sport with "Walking Stick"

Stilts and the "pogo" stick are combined in the device shown in the drawing to provide a new sport for the children. The user mounts the footboard and tips the stick toward the left and right alternately with body movements, turning the handle at the same time so that the action of the device closely resembles walking. The steps are of good length and the operation is not tiresome.

The construction of the device is shown in the insert. The legs are made from a length of $\frac{3}{4}$ -in. flat iron about $1\frac{1}{4}$ in. wide, bent to the shape indicated. A cross brace of the same material is riveted to the legs about halfway between the bottom and top. To this brace a 4-ft. length of $\frac{3}{4}$ -in. gas pipe is riveted, the end of the pipe being slit with a hacksaw and bent, the ears so formed being bent outward, flattened and drilled for the rivets. A footboard, with a hole drilled to fit on the pipe loosely, is slipped over the pipe and rests on a large metal washer placed over the top of the legs. A $\frac{3}{8}$ -in. rod is driven through a hole drilled near the top of the pipe to serve as a handle. The footboard is loose so that the user can operate the device

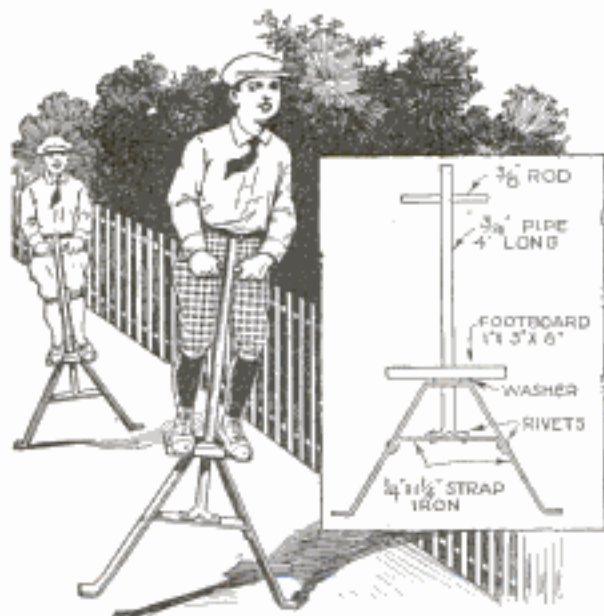

The "Walking Stick"—a Combination of Stilts and the "Pogo" Stick

without moving his feet but by giving the handle a twisting motion and swaying the body from side to side.

☛ Ebonite and hard-rubber trays can be repaired with a cement made by barely moistening chloride of zinc with water. Sprinkle immediately with oxide of zinc and press the broken parts together.

Portable Barnyard Lantern Stand

On farms not equipped with electric light the use of a lantern is a necessity. In many cases the lantern is hung on a nail



Portable Lantern Stand Proves of Considerable Convenience on the Farm

driven into the wall or a near-by post, but this is not handy because the lantern is not always in a convenient location. A portable lantern stand of the kind shown in the drawing has been found very useful as it can be set just where the light is needed. It consists of a 5-ft. length of 1-in. pipe, a piece of $\frac{1}{4}$ -in. iron rod and a discarded harrow disk. The pipe is securely fastened to the disk by means of two nuts as indicated in the detail. The iron rod is bent, as shown, to form an eye at the top for holding the lantern, a wire hook being slipped through the eye for this purpose, and the ends of the rod are then pushed into the open end of the pipe. The whole outfit is light in weight and can be carried around readily.

Storing Table Leaves

It is often a problem, especially in small houses where space is usually very limited, to dispose of extra table leaves when they are not in use. A handy closet can readily be made for them by removing the plaster between two studs so that the leaves will fit in. This opening is then embellished by providing a casing and a door, made from 1-in. material. A $\frac{3}{16}$ -in. iron rod slipped through two screweyes serves to keep the leaves in place.—T. F. Wait, Santa Ana, Calif.

Novel Use for Old Book Covers

Covers of discarded books and catalogs can be made into excellent letter-filing boxes. After removing all the leaves, a

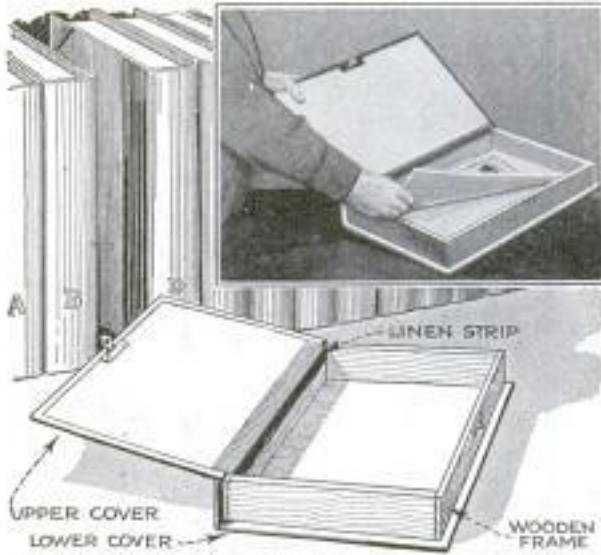

Letter-Filing Boxes Made from Covers of Discarded Books; the Frame Is of Thin Wood

frame is made of thin wood to fit inside the covers. Its dimensions should be such that the front and back covers will lie level when the frame is inserted between them, and overlap the frame $\frac{1}{2}$ in. at the top, front and bottom. The back cover is glued and tacked to the frame, and the back is also glued to the side. To strengthen the joint between the top of the frame and the back, a linen strip, about $\frac{1}{2}$ in. wide, is glued over the joint. A small catch is fastened to the front cover and a pin for this catch is fitted on the side as shown.

Preventing Loss of Gas-Tank Cap

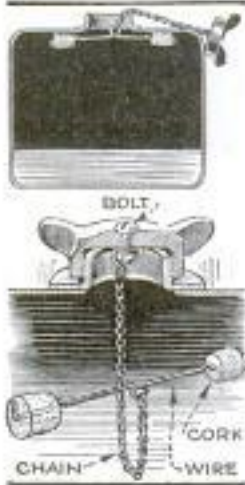

bolt, and a lug and lock washer are then slipped under the nut, as indicated. A

The caps on gasoline tanks and radiators are often lost, especially when filling is done in a hurry and the caps are screwed on quickly but not tightly. Even vibration sometimes causes them to loosen and gradually unscrew. A simple method of preventing loss of the cap is shown in the drawing. A hole is drilled through the cap for a small stove

short length of ordinary furnace chain is attached to the lug and to the center of a heavy-wire crosspiece, to which a cork is attached at each end. This crosspiece is retained inside of the tank or radiator and holds the cap if it falls off.—C. A. Champion, Detroit, Mich.

Flexible Filler Cement

An excellent filler cement or putty can be made from 1 lb. dry glue, 1 lb. powdered cement and 8 oz. glycerine. The glue is melted in $\frac{1}{2}$ pt. water and the cement added; after the ingredients are well mixed by stirring, the glycerine is poured in. The mixture should be applied hot. It will harden with a surface resembling old leather and will be very flexible. If it is to be used where water or dampness can attack it, it should be protected by one or two applications of shellac and a coating of paint or varnish.

Bracket for Wagon Lantern

Practically every state has laws which require horse-drawn vehicles to carry a lighted lantern, or some kind of light, at the left side of the vehicle, during night use. It is, of course, best to provide a permanent bracket to which the lantern can be conveniently attached whenever necessary. The construction of such a bracket is shown in the illustration.

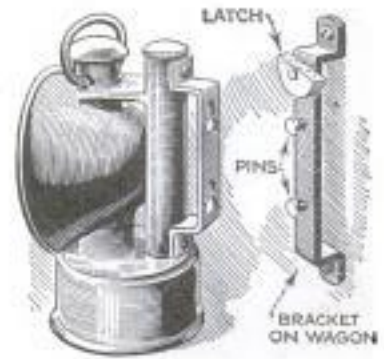

It holds the lantern securely, yet permits instantaneous removal. The part attached to the wagon consists of a piece of $\frac{3}{8}$ -in. flat iron, about $1\frac{1}{2}$ in. wide, bent and drilled at the ends as shown, so that it can be attached to the wagon with wood screws. Two pins are riveted or welded to it, and a small swing latch is provided at the top which is pivoted eccentrically so that jolting of the wagon will not cause it to lose its grip on the lantern part. The latter piece is similarly made and is attached to the lantern handle. Two holes are drilled in it to fit over the heads of the pins, and slots are cut upward from the holes to slip it down on the pin shanks.

Butterflies Mr. Sinclair, Sept. 6,
Ocean Park,
Calif.

Butterfly Art Work



By Roy B. Smith,
Butterfly Club, Inc.
36 Bromfield
Boston, Mass.
Laying the Milkweed Floss on a
Coaster in Overlapping Rows by
Means of a Pair of Tweezers; This
Is Called Shingling

THOSE who design dress goods, table linen, wall paper, magazine covers, in fact, designers in almost every branch of decorative art, have used the butterfly motive with splendid effect. It is only within the last few years, however, that an art has sprung up that utilizes the brilliant coloring of the real butterfly, assisted by the natural grasses and flowers that form its background in nature, to decorate articles for the home. This is an art at which anyone may become an adept. The technique is not at all difficult, and once acquired, progress is limited only by the natural talent of the designer.

First, of course, you must catch your butterfly. For this purpose a butterfly net, such as can be purchased at any sporting-goods store, is necessary. A killing jar is also essential; this may be made by fitting a fruit jar or can with a paper partition, under which some crystals of potassium cyanide are held in damp sand or sawdust. The partition is made by cutting a disk out of stout paper, about 1 in. larger in diameter than the jar, and marking on this another circle the diameter of the inside of the jar. The outer edge of the disk is then slitted radially as shown in the illustration, the cuts being carried to the inner circle, and the edge then folded up at right angles. After the potassium-cyanide crystals have been placed in the jar, coat the upturned edge of the disk with glue,

and slip it down into the jar. A few holes are punched in the paper for the gas to come through, and the cover of the jar made tight-fitting, and the job is done. As potassium cyanide is very poisonous, great care should be exercised in handling it. The hands should be washed thoroughly after placing the crystals in the jar—in fact, it is better to place the crystals by means of tweezers, and avoid handling them at all. Also, care should be taken not to inhale the gas given off in the jar.

When a butterfly has been enmeshed in the net, take hold of its body, from the outside of the net, and from below, holding it tightly to prevent escape or fluttering. Insert it in the jar, and close the cover as far as possible before letting the butterfly go. If the gas is strong, it will cease to flutter almost at once, but it should always be left in the jar at least 20 min-



Butterfly Art Work Not Only Is an Interesting and Remunerative Hobby, but Provides Healthy Sport in Collecting Specimens

utes, or it may revive upon being brought into pure air. When dead, remove the insect from the jar with a pair of tweezers, and at once place it in a paper, folded as shown in the drawing, with the wings up together in the natural position. In this way it can be handled many times without risk of damage, and occupies but a small space. If desired, the butterflies may be mounted on a stretcher frame, made as shown in the drawing, until ready for use, but for our particular purpose this is not essential. Those who wish to make such



Upper Left, Placing the Glass on the Floss; Above, Gluing Wings to Artificial Body; Left, Dropping Floss into Well; Below, Drawings Showing How to Make a Killing Jar and Stretcher Frame. Also How the Butterflies Should Be Packed for Safe-Keeping and Storage



CLOTH STRIP

NARROW STRIPS OF TAPE

SLOTTED BLOCK

STRETCHER FRAME

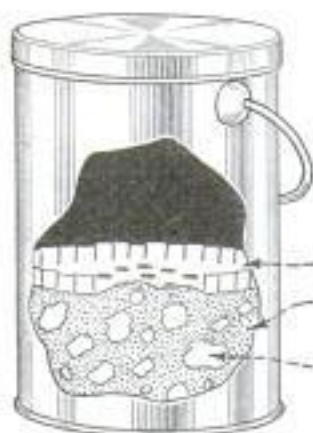
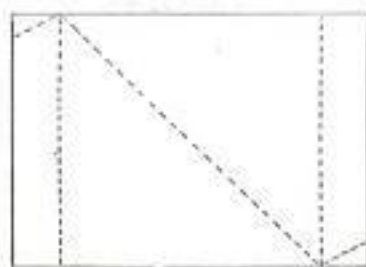

PAPER PARTITION

DAMP SAWDUST

CRYSTALS OF POTASSIUM CYANIDE

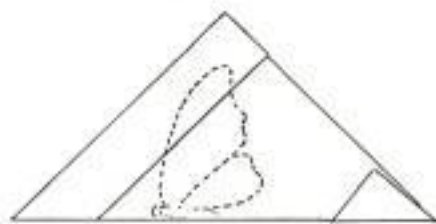

METHOD OF PACKING



Designing the Tray; the Designer Lays the Butterflies and Grasses on the Milkweed Floss by Means of a Pair of Tweezers



Trimming Off the Projecting Floss and Grass Stems; Here the Glass is Clipped to the Back



Above, Binding the Edge of the Completed Tray; Left, Cutting Off Seeds and Lower Ends of Milkweed Floss in Preparation for Laying It on the Glass by the Shingling Method



a frame, however, will find sufficient detail in the drawing.

Of course, it is not essential that you catch your own butterflies. Indeed, if you wish to use some of the most beautiful specimens it would not be possible to catch them, as they are not natives of the North American continent. For those who prefer to allow others to do their hunting for them, there are several dealers that make a specialty of buying butterflies from the four corners of the earth and preparing them for this kind of work. The insects

will keep indefinitely if stowed away with moth balls in a cigar box, but they are all ready to mount within a week or two after capture. The space allowance for butterfly art work is too small in most articles to allow the real body to be used, and it is doubtful if this is desirable practice under

any conditions. It is advised, therefore, that the wings be detached from it and an artificial body cut from celluloid, cardboard or heavy paper, to which the wings may be glued. The artificial body is fitted with antennae made of hairs taken from a black bristle brush, and if properly painted and shaded, looks so natural that one has to look twice before it can be noticed that any part of the insect is missing. So prepared, the butterfly lies flat, and may be kept in a book until ready for use. It will go splendidly under glass, in a tray, plaque or locket, and lies flat against the transparent cover, showing its greatest wing expanse and beauty unimpaired by distortion.

Butterflies may be effectively used as part of a picture made by brush, pastel or air brush, with a background of ground glass, frosted celluloid, canvas, parchment or silk, and for those skilled in these mediums many lovely effects are possible. For most of us, however, nothing will exceed the charm of the pieces made by the use

of nature's material all the way through. Backgrounds made with milkweed floss from the pods of the lowly roadside weed, pressed summer grasses carefully selected, and such dried flowers as the African everlasting, which have been found permanent in color, are the most effective. When these are combined by an artist in a picture with a perfect and lovely butterfly, the result is well worth while.

To make a tray, cut a piece of cardboard to the size of the glass to be used and cover it with a sheet of cotton wadding of the

same size. Build a "well" of cardboard or celluloid around it, then take a milkweed pod and open it by cutting the "thread" that binds it together and breaking away the bottom of the pod. Pull out a pinch of the fluff with the adhering black seeds, flick off the seeds into a waste box



Some Samples of the Completed Work, Including Candle Shades, Candy-Jar Tops, Locketts and Trays; Insert, Photo of Lamp Shade Decorated with Butterflies and Grasses

and then drop the floss into the well. Keep on in this manner until you have used a dozen or more pods, or until the fluffy pile on the wadding has reached a depth of about 8 in. Then lay on a glass disk, which has previously been cleaned, and allow it to stand overnight.

When ready to go ahead again, have the grasses laid out, with the butterfly and any flowers that you wish to use, together with a pair of tweezers for adjusting the background and handling the butterfly. Remove the glass slowly and carefully, and the floss will fluff up but an inch or two. You can now lay on the grasses as artistically as possible, then the flowers, and last of all the butterfly. The eye has a tendency to follow the direction of flight, so it is well not to place the insect so that it appears as if it were flying out of the picture. Carefully put on the glass again, and clip the underlying cardboard to it with strong paper clips. Cut off all the projecting floss, grass stems, etc., and bind the glass and cardboard all around the

edge with surgeons' $\frac{1}{2}$ -in. tape. This completes the insert, and it is now ready to be sent to the frame maker's, or you may put it in that old mahogany tray to cover up its unsightly marred frame.

In other kinds of work, such as the tops of pocket mirrors, small designs for candy boxes, lockets, calendars and Christmas cards, it is better to lay the milkweed instead of dropping it. In laying it you must cut off the bottom part of the floss fiber so that it will lie down and not fluff up. Lay across the center of the picture a line of floss, using the tweezers to handle it and arranging the fibers vertically. Do not make the line too formal. Give it a poke up here and a pull down there to take the stiffness out of it. Now lay another row overlapping or "shingling" the first, and so on, until the lower part of the background is filled with a solid iridescent coating of gleaming white floss. On this lay carefully the grass and butterfly design, and bind the glass or celluloid cover to the cardboard back with gummed-paper tape. For the top or sky part of the picture most people prefer a sort of sky-blue paper imported from Japan, but very pretty effects may be secured with satin or hand-tinted backgrounds on ordinary water-color paper. Whatever is used must be clipped to the cardboard back before the work is started, and the milkweed laid well up on it to conceal the lower edge.

When making coasters, plaques, lamp shades or candle shields, glass or frosted celluloid is used as the base, on which the floss is laid directly, in the manner just described. The butterfly may be secured to the background by a dab of glue. "Starring"—the name given to the process of picking out individual "parachutes" of floss and so spreading them on the top part of the background as to produce a raylike effect—may be used here. It is beautiful when properly done, but requires a perfectly still room and much patience.

At the holiday seasons and in wedding time, there is an active demand for artistically made trays, mirrors, lamp shades, and other articles, and those who have become proficient in the technique and have studied the principles of design, should have no difficulty in obtaining orders, at remunerative prices, for all of this work that they care to do.

☛ If a film negative is badly scratched, the marks will show in an enlargement in the form of dark lines. This can be prevented by coating the film with vaseline just before inserting it in the enlarging camera.

A Simple Camp Grate

A simple and convenient camp grate that does not take up much room and can easily be made by anyone, is shown in the drawing. It is made from a number of 18-in. lengths of $\frac{1}{8}$ -in. flat iron, about 1 in. wide. These lengths are pivoted together at the ends as shown in the upper detail,



Campers' Fire Grate, Which Can Be Folded Up Compactly When Not in Use

which arrangement permits them to be folded compactly or drawn out for use. The fire is made between two rows of rocks, as flat as can be found and of fairly equal height, as shown, and the grate placed on top of them. When not in use, the grate is folded up and put in a canvas pocket made to hold it.—Robert Page Lincoln, Hopkins, Minn.

Cranking a "Stiff" Car

After repairing a car by fitting some new bearings and taking up the old ones, it was found impossible to crank the engine, and a heavy snow prevented towing the car. However, the following scheme proved effective: Another auto was run up alongside it so that the two adjacent rear wheels of both cars were in line and could be lashed together with a rope. The axles of both cars were, of course, jacked up to keep the wheels in alinement and prevent the cars from moving. The second car was then started and both cars thrown into high gear with the result that the first one was quickly started.—Ralph Jackson, Orono, Me.

Handy Orchard Ladder

Pruning and fruit picking can be accomplished in a shorter time and with less damage to the trees with the specially devised ladder shown in the illustration, than

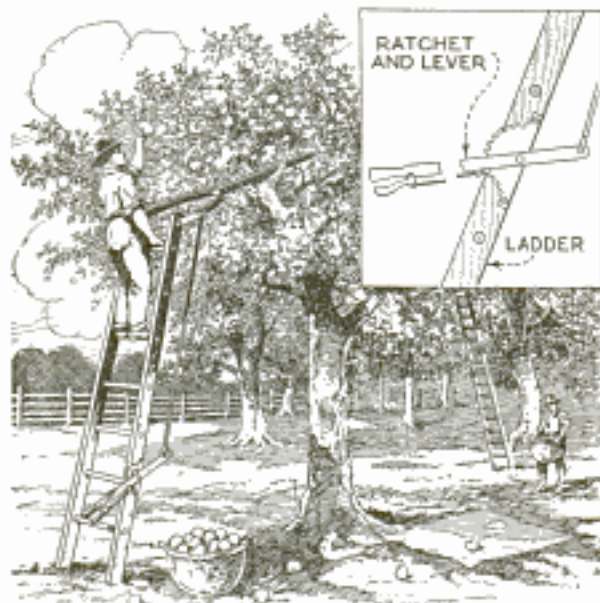

Novel Ladder with a Movable Extension Facilitates Pruning and Fruit Picking

is possible with the use of an old-style ladder. Upon the upper end of a common ladder a forked extension, made from a length of 2 by 2-in. oak and two lengths of tire iron, is hinged to swing up and down. It is controlled from below by a lever and ratchet fastened to the side of the ladder, about 4 ft. from the lower end, a discarded cultivator lever being used for the purpose. The lever is connected to the extension by means of a 1/2-in. steel rod, so that the movement of the lever causes a corresponding movement of the extension. The object of the extension is to hold the ladder at convenient distances from the trunk so that any part of the branches can be reached. The extension, being inserted in a crotch, will form a safe support and prevent such damage to the tree and fruit as might result from forcing an ordinary ladder between the branches.

Carbon-Monoxide Poisoning

Although the danger of carbon-monoxide poisoning in closed garages has been emphasized repeatedly, warnings concerning the harmful effects of this gas produced by the combustion of fuel in houses are comparatively rare, and it happens frequently that people die from poisoning by exposure to this gas in unventilated rooms during the winter season. Many house

heaters have no flues for carrying off the combustion gases and this means that they stay in the room. If all the windows and doors are closed for any length of time, as is often the case during winter months, the effect of the undesirable gas and the lack of oxygen becomes apparent by causing the occupants to become dull and sleepy, many cases being on record which have ended fatally. As a precaution the window should always be partly open when a gas heater without a flue is used. It has been determined by the U. S. bureau of mines that the atmosphere in a room should be changed at least once every hour, and this is best accomplished by keeping the window open about an inch at the bottom and also at the top. In no case should the heater be left burning with the windows closed, when retiring.

The danger also exists wherever an internal-combustion engine is used, if the exhaust pipe leaks and does not carry away all the gas. And in closed automobiles where exhaust heaters are often used, proper circulation of fresh air is imperative, as the heater may leak or the exhaust gases may get into the car from below.

Self-Adjusting Window Ventilator

Adjustable window screens of the sliding or telescoping kind are not very durable due to their light construction, and as the two screens do not always fit against each other tightly there is apt to be an

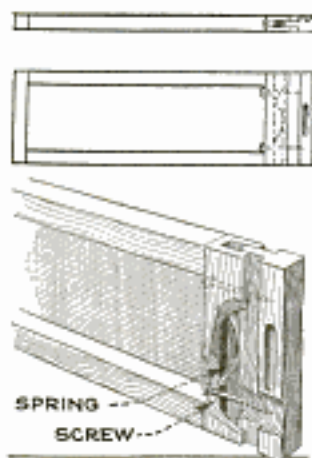

opening for flies to creep through. A much better and stronger adjustable window screen, which eliminates this undesirable feature and is much easier to put in place, is shown in the illustration. It consists of a screen tacked to a sturdy frame of 1 by 2-in. wood, and with a movable endpiece

that automatically springs against the window casing as soon as it is released. The construction of this end is as follows: The end of the frame is grooved for its entire length and about two-thirds of its depth. An equal length of 1 by 2-in. wood is rabbeted on both sides to form a tongue, to fit loosely in the groove. A length of corset steel, bent to a semi-circular shape, with the ends turned up slightly, is in-

serted in the center of the groove as shown, and two 3-in. round-head screws are used to hold the two pieces of wood together. Holes are drilled in the grooved piece for the screws to fit in loosely, but the threaded ends of the screws are driven firmly into the tongue. This arrangement allows the endpiece to be pressed inward, and the spring pushes it back again. A finger groove is provided in the endpiece to facilitate removal of the screen.—M. C. Everett, Chicago, Ill.

Drain Pipe for Washing Machine

Removing used water from a washing machine by the pailful is a slow and laborious task and the drain pipe shown in the illustration will therefore be appreciated. It consists of a 1½-in. pipe, bent and flared as shown, and fitted on the vent pipe. A check valve of the horizontal-swing type is used to prevent sewer gas from backing into the room. This is better than a goose-neck trap, which would allow the dirty and soapy water to remain in the trap between wash days and possibly give off undesirable odor. The flared end of the drain pipe may be a funnel of sheet iron soldered to its end. The washing machine is placed so that its drain cock is over the funnel, discharging the dirty water directly

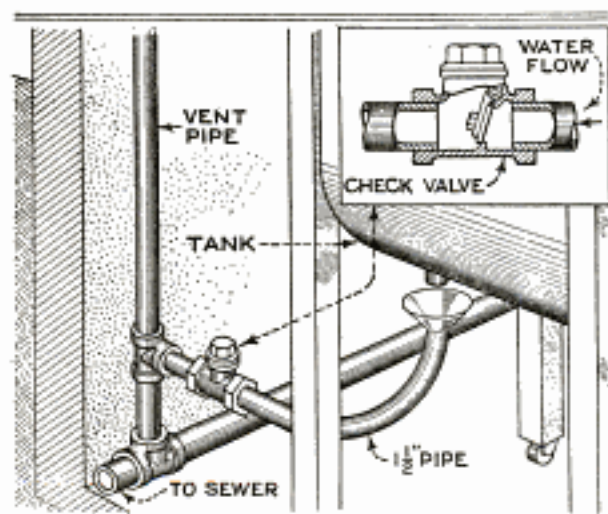

Connecting the Washing Machine to the Drain Pipe through a Check Valve

into the sewer. The connection also provides an excellent method of flushing the sewer pipe.

Electric lamps which have become loose in their bases can be used for some time by running liquid glue into the space between the bulb and the base. If the glue is too thick to run between the parts easily, it can be thinned by heating.

Half-Round Tables Conserve Space in Kitchen

There is little space to spare in the modern apartment kitchen, or rather kitchenette; the table shown in the drawing,

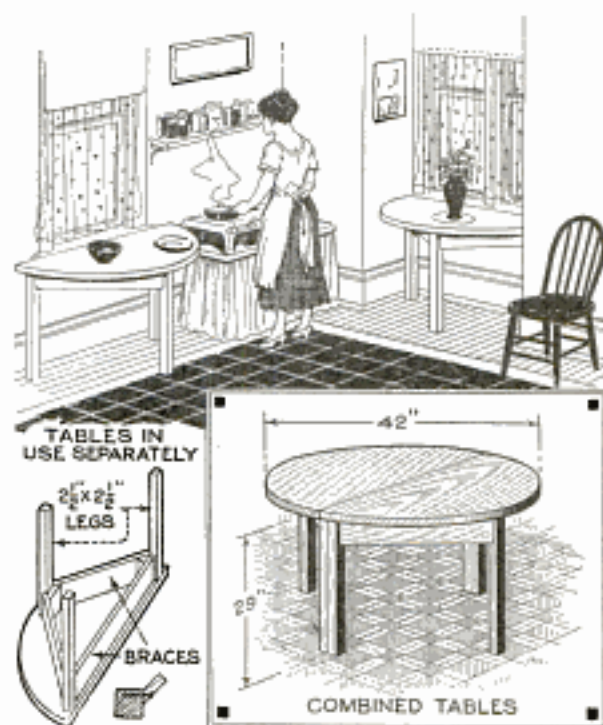

Where Space Is at a Premium This Sectional Table Will Prove of Value

therefore, will appeal to dwellers in such buildings. It is made in two half-round sections, the diameter being 42 in. and the height 29 in. As may be seen from the drawing, the construction is simple and well within the ability of the amateur cabinetmaker. Practically any wood may be used, and the table finished in enamel. When the two halves are used separately, the flat side is set against the kitchen wall, and as each is provided with three legs, they are quite steady. Placed together, they make a dining table large enough for four persons.

Waterproofing Ignition Leads

Most owners and drivers of Ford automobiles have experienced the detrimental effect of water on the high-tension ignition leads, as the water causes them to be short-circuited. It has been found that a liberal application of shellac over the wires will waterproof them effectively. After becoming wet they can readily be dried off, and there will then be no danger of short circuits. The covering of shellac also protects the rubber against oil which destroys the rubber quickly.

Reversing Switch for Toy Locomotive

A toy electric locomotive is more interesting to the boy owner if it is reversible, but engines equipped with a reversing

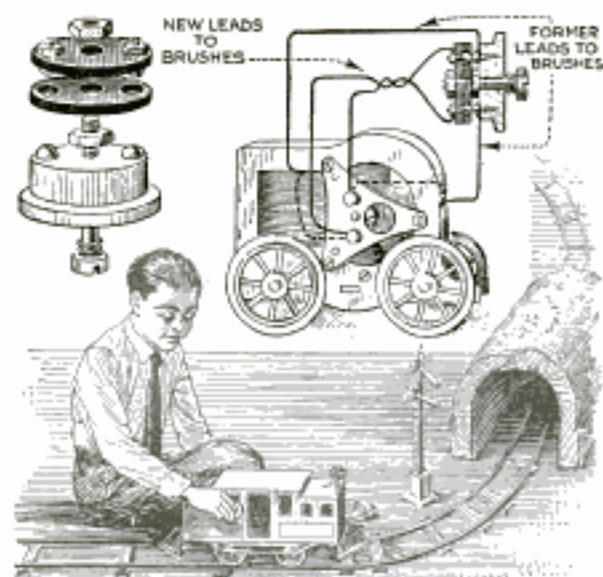

Direction of Toy Locomotive Reversed by Small Switch Which a Boy Can Make

switch cost much more than others. However, a simple reversing switch can readily be made by any boy from a small wooden spool, and two fiber disks of the same diameter. A center hole is first drilled through all three for a bolt with which the switch is attached to the engine. Two small round-head screws are driven into the spool near the edge and directly opposite each other. Two corresponding holes are drilled through each of the disks: those in the upper disk being equal to the diameter of the stem of two small bolts, which are later pushed through as shown, and the holes in the lower disk a trifle larger than the heads. The wires leading to the brushes are then detached and fastened under the heads of the small screws driven into the spool, and two other leads are run from the small bolts in the upper fiber disk back to the brushes. The heads of the bolts touch the heads of the screws and thus permit a constant current to flow. Turning the disks halfway around by means of the head of the central bolt reverses the direction of the current and consequently reverses the direction in which the locomotive is moving.

Safety Container for Cleaning Fluid

It is common practice in tailor shops and pressing establishments to have an open pan of gasoline or other cleaning fluid on

the workbench for dipping the cleaning brush; but besides being wasteful, this method is dangerous, and therefore a Wisconsin tailor devised the safety container shown in the drawing. It consists of a fruit jar with a small pan soldered to the cover. Three holes are punched or drilled through the pan and cover; one to receive a bent copper tube, one a stopper with a wire handle, and the third a valve of an old inner tube. The copper tube and valve stem are soldered in the positions shown, the lower end of the tube being about $\frac{1}{2}$ in. above the bottom of the jar. A rubber bulb is attached to the valve by means of a length of rubber tubing. In use, the jar is filled, the cover screwed on

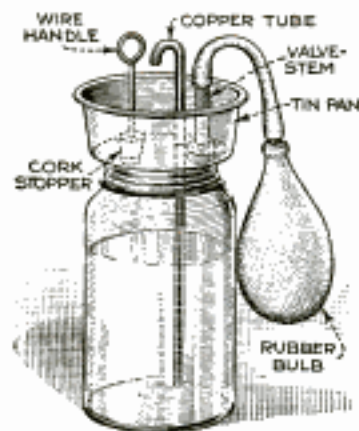

and the bulb is used to force air into the jar, causing the fluid to rise through the copper tube into the pan. When the cleaning work, or spotting, is finished, the stopper is removed, allowing the liquid remaining in the pan to flow back into the jar. The replacement of the cork prevents evaporation and accidental ignition.—G. E. Hendrickson, Argyle, Wis.

and the bulb is used to force air into the jar, causing the fluid to rise through the copper tube into the pan. When the cleaning work, or spotting, is finished, the stopper is removed, allowing the liquid remaining in the pan to flow back into the jar. The replacement of the cork prevents evaporation and accidental ignition.—G. E. Hendrickson, Argyle, Wis.

Wind-Proof Hanger for Signs

The drawing shows a pair of wind-proof hangers for a sign that has to be changed frequently, such as are used on trains and

street cars and in other similar cases. The hangers are made of round bar stock, bent to the shape indicated and screwed in position. The signs are provided with eyes large

enough to slip over the hangers. When once in position the sign will not come off unless a vertical force is applied and this can only be done manually.—A. C. Cole, Chicago, Ill.

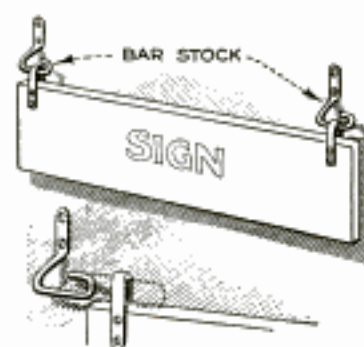

Boathouse for Small Canoe Club

By WALTER X. BRENNAN

THE boathouse described in this article was built by a small canoe club in a little Michigan town, and, in addition to storing the craft, it afforded the members a meeting place for the winter months, and kept the spirit and enthusiasm of the members alive during the periods when they could not indulge in their favorite sport. The total cost of the building was \$400, and it can be duplicated for approximately this amount in any part of the country—probably much less if any great

ters of the compartment partitions being 4 ft. apart. If the clubroom space is not desired, eight canoes can be placed on the ground level, and eight on the upper tier. The framing is made of 2 by 4-in. stock, the vertical members being 4 ft. apart. The siding is of 6-in. matched lumber, applied vertically, and the roofing boards are 12-in. second or third-grade material, covered with composition roofing.

It is the usual practice to store canoes on brackets or shelves in one large room, but this usually requires two men to put the upper ones in place. It is also necessary, with this practice, to remove all equipment when the canoe is stored, and place it in a separate locker for safe-keep-

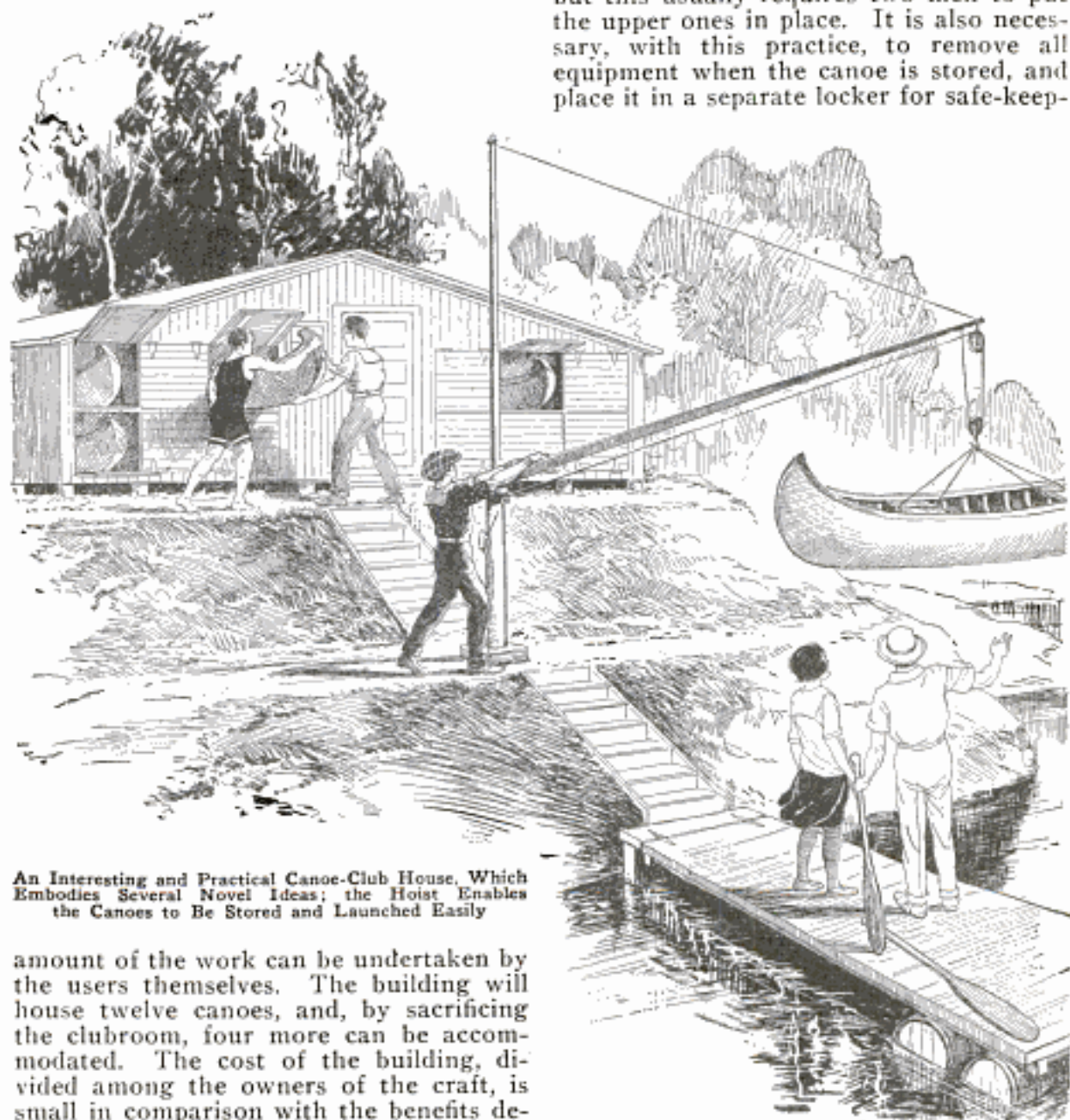

An Interesting and Practical Canoe-Club House, Which Embodies Several Novel Ideas; the Hoist Enables the Canoes to Be Stored and Launched Easily

amount of the work can be undertaken by the users themselves. The building will house twelve canoes, and, by sacrificing the clubroom, four more can be accommodated. The cost of the building, divided among the owners of the craft, is small in comparison with the benefits derived from it.

The building measures 20 ft. deep by 32 ft. wide, which allows placing six canoes on either side of the clubroom, the cen-

ing—and such lockers are invariably too small for the users' requirements. In this boathouse, however, all canoes are slid into

place from the front of the house, each having its own separate compartment with a door at the end, which may be locked by the owner of the canoe. All equipment may thus be left in the boat and be perfectly safe. In addition to this, one man can easily raise one end of the canoe to the door sill, then lift the other end and slide the craft into its compartment. The

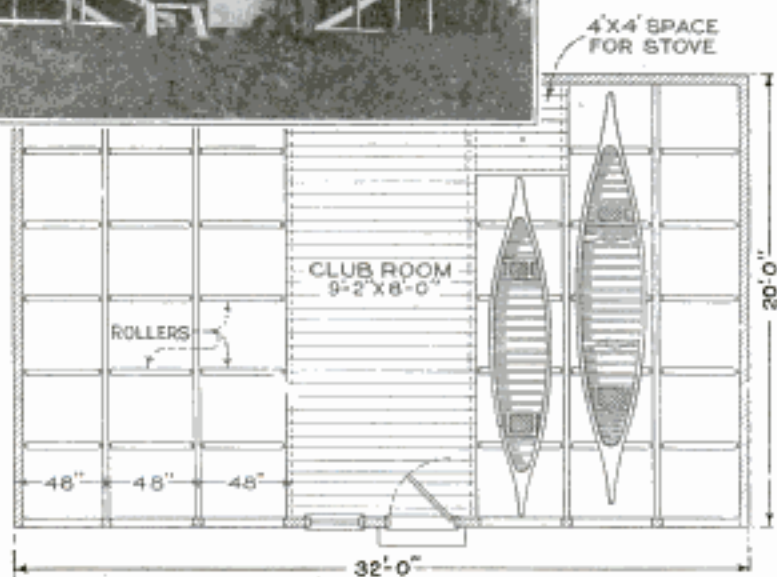

Floor Plan of Boathouse. Showing How the Canoes Are Stored; Insert, Building under Construction; Note the Compartment Framing

compartments are partitioned with chicken wire, which allows the air to circulate throughout the building, to keep the craft dry. The doors for the compartments are made of siding, the lower ones being

Laying Linoleum

When laying linoleum never butt the seams and tack to the floor along this line, so that the cutting must be done at the outside edges, but tack only the latter first, allowing approximately $1\frac{1}{2}$ or 2 in. to overlap at the seams. After all the stretch has been worked out by walking on the linoleum a few days, a straight cut is made through both layers, a very sharp knife being, of course, used to do this. The resulting joint will be a tight fit, and the edges are then tacked to the floor by means of headless tacks. Many think that it is necessary to give linoleum a coat of varnish to preserve its surface, but floor wax

hinged at the bottom so that a roller may be mounted on each door for additional ease in handling the canoes; the upper doors are hinged at the top so as not to interfere with the lower openings. The "floor" of each compartment consists of rollers, the pivots of which run in holes in the framing. These may be spaced as thought necessary.

The clubroom is partitioned from the remainder of the house with wallboard, and floored with the material used for the siding. A floored space is made at the back end of one of the canoe compartments next to the clubroom, in which a stove may be set up in winter. A full-size door, with glass upper panels, is used at one end of the room and a window at the other. As this house is on a bank 8 ft. above the water, a mast and boom are mounted half-way down the bank so as to enable the canoes to be lifted from the water and swung around in front of their berths. Two single pulleys and the necessary rope permit the average canoe to be raised easily; the end of the rope is fastened to a cleat on the mast. The butt of the mast rests in a concrete socket in the ground. The water level at this place is variable, so a semi-floating dock is used. Four barrels, lashed together, support the outer end, while the shore end is hinged to a permanent sill, so that the dock may rise and fall with the water level.

will serve the same purpose, is cheaper and can be applied with much less trouble. If well rubbed in and polished, it will produce a finish which is dirt and wear-resisting.

Non-Skid Rubbers

Those who have been annoyed by rubber heels skidding in rainy weather will appreciate the simple method of preventing this by cutting slots in them with a saw. The slots will cause the heel to grip the wet pavement firmly, no matter how slippery it is. In men's heels, three or four cuts are made each way, but in ladies' heels, two or three oblique cuts are sufficient.

Hints on Varnishing

Many amateurs fail in their attempts to do a good job in rubbed-varnish work because they do not take the important factor of temperature into consideration. The best temperature for interior varnishing is from 80 to 85° F., as the varnish will then flow evenly. All doors and windows should be closed tightly so that drafts will not vary the temperature, and also to prevent dust from being deposited on the varnish, which is another cause of poor work. The varnish should be applied sparingly, as too thick a coat will wrinkle upon drying. Vibration of the floor above must be guarded against as it loosens dust particles on the walls and ceilings which will settle on the varnished surface. After one or two coats of varnish are applied and these rubbed down with pumicestone powder and water, a thicker coat is applied and this rubbed down with rottenstone powder and crude oil. The varnish will set quickly when the room is allowed to cool gradually by opening the doors only.—L. H. Georger, Buffalo, N. Y.

Making an Ax Cut Easily



When a series of grooves is ground in the sides, as shown in the illustration, an ax will sink up to the eye in wood with very little effort. This is a simple kink, long kept secret by woodsmen and lumberjacks, who seem to make axes do most surprising things. The cause of the greater efficiency of the ax is that the surface of the blade is lessened, and consequently the friction reduced correspondingly.—J. T. Garver, Huntingdon, Tenn.

Chicken-Proof Bird Feeder

Many people feed birds by putting grain or bread crumbs on a post. However, if there are any light chickens around, such as leghorns, they can fly up on the post and devour the food. A simple and effective

method of preventing this is to provide a movable perch, pivoted on the post as shown in the drawing. As soon as a

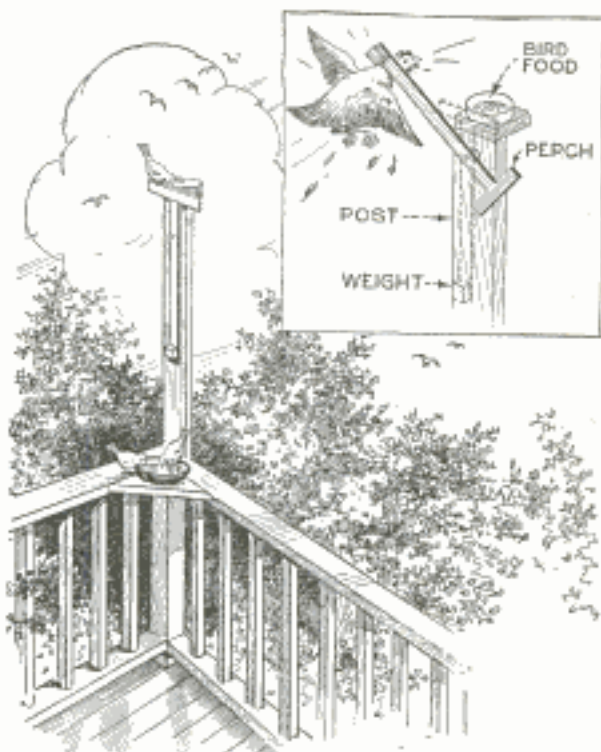

Movable Perch Used to Make Bird-Feeding Post Inaccessible to Chickens

chicken alights on the crosspiece the perch becomes topheavy and turns upside down, the other end, which is suitably weighted, swinging around and striking the chicken "in the neck," which will soon effect a cure without fatal results. On the other hand, the perch will not be upset in this way by the weight of smaller birds. The general method of making such a perch is clearly shown in the drawing, and the point to pivot it varies with the size of the perch and the weight of the wood.—J. F. Hobart, Dunedin, Fla.

Using Broken Chain-Pull Sockets

Electric chain-pull sockets are usually thrown away as soon as the mechanism is sprung or broken, which puts the switch out of order. If the sockets are otherwise in good condition, they can be used without the switch mechanism as plain keyless sockets. In pull sockets one of the lamp-cords is connected to the threaded shell into which the lamp screws and need not be changed; the other is connected to the flat spring which contacts with the center of the lamp by means of the moving parts. The latter are removed and a short insulated wire is soldered to the spring and to the center of the socket.

Detachable Running-Board Ice Box

A detachable running-board ice box of the kind shown in the illustration has been found to be of great value on camping trips. It is made of heavy galvanized iron,

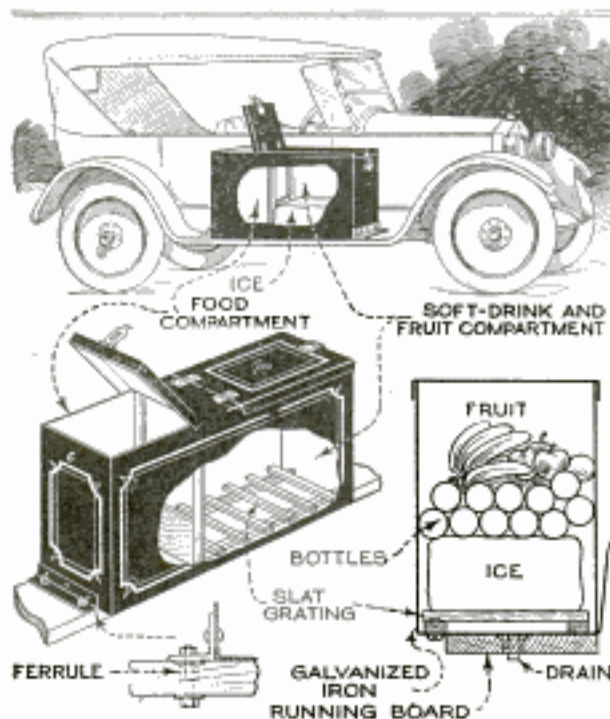

Detachable Ice Box on Running Board Is Useful on Camping Trip

has a compartment for the ice, upon which fruit and soft-drink bottles can be piled, and another compartment for bread, cakes and food that must be kept dry. Two hinged covers are fitted to the top, as indicated, and a slat grating is provided in the bottom to allow easy drainage. The whole arrangement is fastened to the running board by means of four bolts passing through two angle-iron brackets, which are riveted to the ends of the box, and through holes drilled through the running board and bushed with ferrules. The ferrules are turned up out of brass stock and are threaded with a fine-pitch thread so as to permit screwing them into the wood; these have a nicer appearance when the box is detached than plain drilled holes. A drain hole is drilled through the bottom of the ice compartment and through the running board. A $\frac{3}{8}$ -in. nut is soldered in this hole and a screw plug fitted in, a rubber washer being provided under the head.

Small Scale Made from Test Tube

A simple and accurate scale for weighing small quantities of chemicals can be made from a glass tube such as develop-

ing powders are sold in, or any ordinary test tube. The bottom is weighted down with fine shot, fixed in place with sealing wax, and a cardboard disk, cut to fit snugly, is fastened over the top with sealing wax also. By immersing the tube in water and weighting it down with small druggists' weights, the proper graduation marks can be made on the tube with the aid of a sharp file.—George Parke, Winter Park, Fla.

Preventing Columns from Rotting

Porch columns and posts cannot be painted on the underside where they rest on the floor, and as a consequence this end is the first to decay, as water running down the post seeps under it and cannot dry out quickly. This trouble can be overcome and the end protected against decay by drilling a diagonal hole at the base of the column as shown. A half-and-half mixture of linseed oil and turpentine is poured into the hole, and a wooden plug is then driven in to prevent evaporation of the mixture. The result is that the oil penetrates the wood and makes it impervious to moisture.



Catching the "Bugs"

Continually annoyed by insects flying around his electric lights at night, and finding that he could not entirely exclude



them from his shop by screens, as some were small enough to pass the mesh, a southern barber suspended a piece of sticky fly paper from the ceiling just behind each droplight. This he

found an effective means of catching the small "bugs." Three lengths of cord were used to hold the paper, one being attached at the bottom to prevent the paper from being blown against the lamp.—L. H. Unglesby, Baton Rouge, La.

"Killing" Knots

A coating of shellac applied to knots is a well-known measure which is employed universally for preventing knots from showing through painted surfaces. But some knots are so resinous that this common method is not effective, even if several coats of shellac are applied. In such cases it will be found that a small quantity of red lead mixed with the shellac will "kill" the knot and effectively prevent its appearance through the paint.

Avoiding Locking of Steering Gear

In many automobile accidents the cause has been traced to the locking of the steering gear, which may sometimes occur when turning sharp corners and is largely due to wear in the lever arm, drag link and other connecting parts. The danger of having the lever arm lock may be eliminated by either of the two attachments shown in the illustration.

For a worm-and-sector type of steering gear it is usually possible to provide two studs to project from the frame of the car, as shown, to serve as limit stops. In the case of light cars that have the straight-arm type of steering gear, which has the lever arm keyed directly to the steering-post rod, stops are made of $\frac{3}{16}$ -in. steel plate. They are cut in a triangular shape

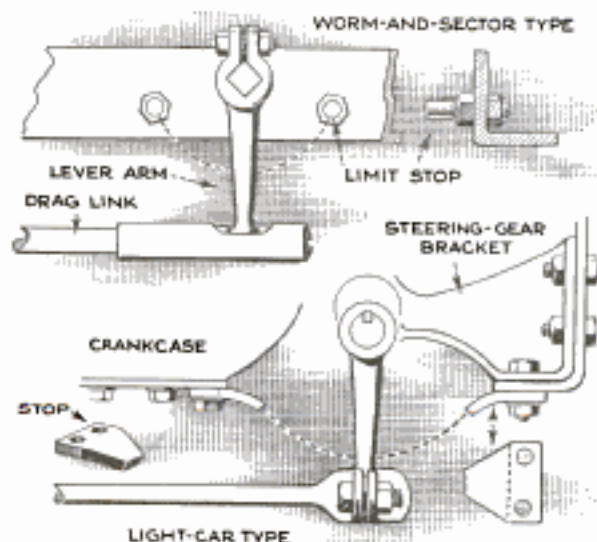

Stops Prevent Steering Gear from Locking by Limiting Its Swing

and are bolted to the underside of the crankcase and the steering-gear bracket, as shown in the lower detail, the ends being bent down a trifle as indicated. It is advisable to bolt up the brackets and measure the throw of the lever before cutting off the ends.

Ball Retriever for Lone Pitcher

The aspiring baseball pitcher is handicapped considerably if forced to practice alone. Bouncing the ball back from the

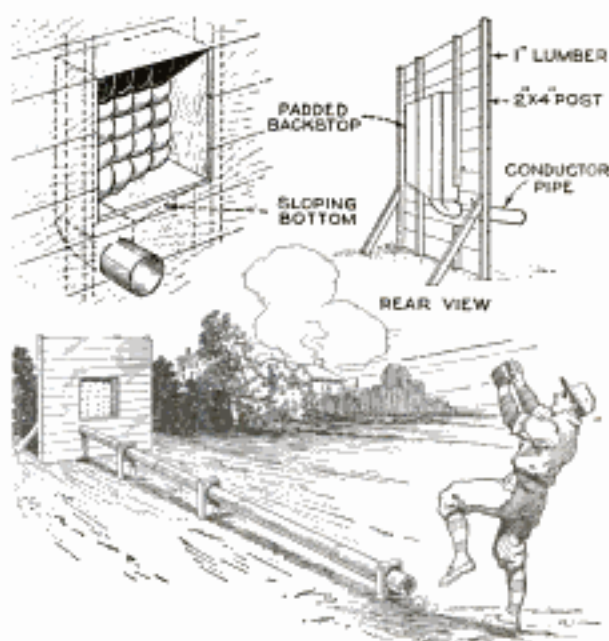

Device for Returning Baseballs to Lone Pitcher and Thus Aiding Him Considerably

side of a building is not satisfactory, and unless an area to show the range of all balls thrown is marked, little is done toward improvement.

The device shown in the drawing was made by a young chap who had no brothers, and no chums near at hand, and was compelled to devise some sort of retrieving apparatus, or walk after the balls after having thrown them. The device consists of a vertical "wall" supported on two posts, with a rectangular opening cut in it. Behind this and slightly larger than the opening is a panel, heavily padded. The panel and wall are joined just below the opening to form a trough, which slopes toward one side. Here a conductor pipe is attached, which runs through the wall and terminates about 30 ft. in front of it at the place where the pitcher stands. Balls thrown through the opening roll through the conductor pipe back to the pitcher. By using two balls he can keep himself busy continually. If the ball fails to enter the opening it will bounce back. But frequent impact against the wood shortens the life of the ball, and if one desires to avoid this, the whole surface of the larger panel may be padded and another collecting trough extended about 1 ft. in front of it, so that all balls will be returned to the point where the pitcher stands.—Dale R. Van Horn, Walton, Neb.

Easy Method of Storing Hose

Much unnecessary wear on the garden hose is avoided by having the hose connection in the basement, as indicated in the

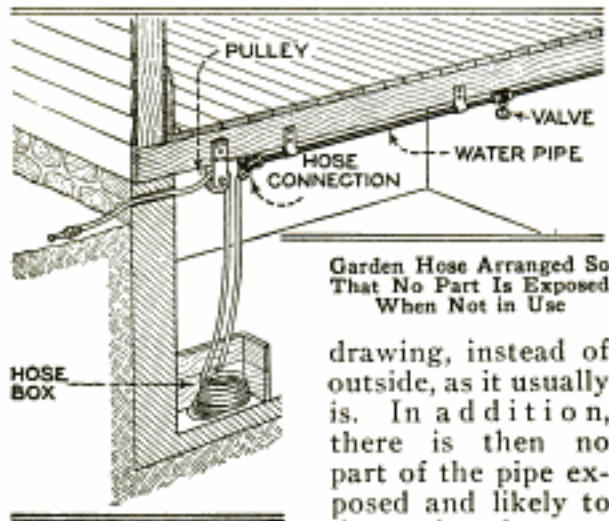

drawing, instead of outside, as it usually is. In addition, there is then no part of the pipe exposed and likely to freeze in winter.

The hose is left coupled to the faucet in the basement, and kept coiled in a box close to the wall. From the box the hose runs over a pulley fastened to a floor joist above, and passes outside through a pipe set in a hole cut through the wall. The upper edge of the pulley, of course, is in line with the pipe, and the edges of the latter are rounded off, and the inside made smooth with a file and emery, so that the hose will not be damaged in passing through it. A guard, made of heavy tin, may be clamped on the end of the hose just behind the nozzle, if it is desired to prevent it from slipping into the basement.

A Practical Drip Pan

Usually the position of an icebox has to be exact as its drain pipe must be located right above the drain in the floor. However, its position need not be so accurate if a drip pan of the kind shown in the illustration is used.

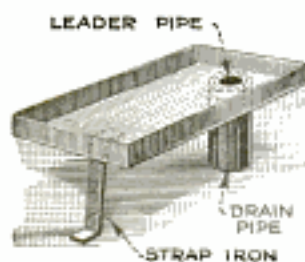

It is simply a tray with a leader pipe soldered at one end and a strap-iron leg at the other; the pan is made preferably of copper or galvanized iron so that it will not rust. It catches the water from the icebox drain pipe and allows it to run through the leader pipe into the floor drain. To insure complete drainage, it would be well to slope the bottom of the pan from all sides toward the leader pipe,

which can be done by careful hammering before the latter is soldered in. As an easier alternative, the part of the bottom surrounding the leader pipe opening might be slightly recessed to form a funnellike cup, and in either case the leg should be slightly higher than the floor-drain pipe, to give the pan a backward slant.—L. H. Georger, Buffalo, N. Y.

Loosening Corroded Battery Terminals

Loosening Corroded Battery Terminals

Corroded battery terminals are often difficult to loosen. A little heat applied with a blowtorch or alcohol lamp will do the work, but if neither of these is handy, one of the little wafers that are used for quick vulcanizing can be used. It is placed on the terminal and lighted. As it burns away it will heat up the terminal sufficiently to loosen it. Care must be taken, of course, not to melt the terminal.—Chas. Olsen, Fond du Lac, Wis.

Adjusting Auto Brakes

Of the parts on an automobile those that wear most rapidly and need most frequent adjustment are the brakes. Keeping these in good condition is essential to safety, especially in congested cities where sudden stops are often necessary to avoid collisions. Brakes are usually adjusted by two persons, one seated in the car pushing the brake pedal down and the other making the adjustments and testing the brake by turning the rear wheels, which are jacked up. This method, however, is very

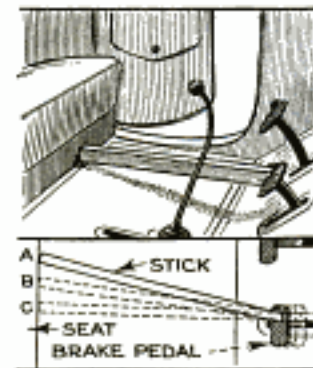

inaccurate, as the exact tension of both brakes cannot be equalized in this way, because the pressure applied to the brake by the person inside of the car is not uniform, but varies slightly from one moment to the next. A much better

method is shown in the illustration. A length of $\frac{3}{4}$ -in. wood, about 2 in. wide, a trifle longer than the distance from the edge of the seat to the brake-pedal shank when the brake pedal is pushed down as far as possible, and having a notch at one end to fit the brake pedal, is used to hold the brake down. In making the adjustment, the stick is put in position A so that there is a slight pressure on the pedal.

With the rear wheels jacked up, each one of them is turned around by hand. If both wheels turn with the same effort, no adjustment need be made so far. But if one wheel turns much more easily than the other, the brake on that wheel must be tightened until it turns just as hard. The stick on the pedal is then shifted to position B, where it will exert more pressure on the brakes. The wheels are again turned to see if the brakes are equally set. A careful adjustment of either brake may still be necessary. After this is done, the stick is moved to position C, where it presses the pedal down almost entirely. Both wheels should now be absolutely immovable, and if this is the case, they are in perfect condition. The stick should be long enough so that it will not be quite at right angles to the seat even in the last position.—J. E. Dekker, Chicago, Ill.

Convenient Garage Doorway

When driving an automobile into or out of a garage on the alley, it is difficult to make the short turn required by the limited width of the alley, especially with large cars. In building two adjoining garages this trouble was taken into consideration and eliminated by the three-door arrangement shown in the photo. The center wall is shorter than the outer walls so that the doors next to it close at an angle to the others. In this way, when all three doors

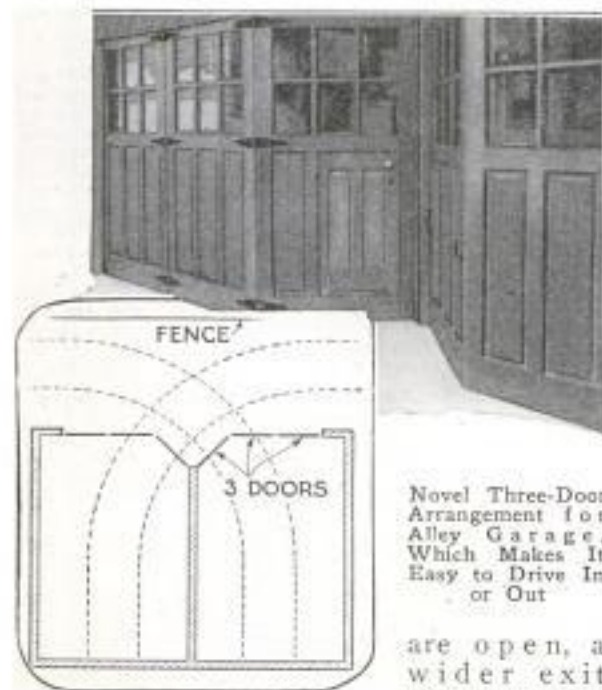

Novel Three-Door Arrangement for Alley Garage, Which Makes It Easy to Drive In or Out

are open, a wider exit than the ordinary is provided, and one can drive in or out in a larger arc, as indicated by the dotted lines in the insert.

Rigid Holder for Portable Typewriter

Many people prefer a small portable typewriter to a large one for home use, but find that the movement of the carriage, which is large and heavy in proportion to

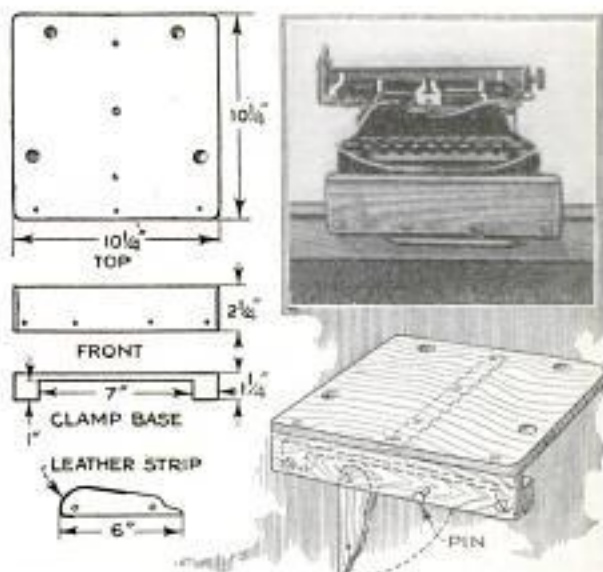

Wooden Holder for Light Portable Typewriter Is Clamped to Table Top

the rest of the machine, causes the machine to travel toward the left continually, making it necessary to move it back to its original position frequently. This trouble is readily overcome by means of a holder of the kind shown in the photograph. It consists of a board of $\frac{3}{4}$ -in. material, having holes, counterbored in the top, to receive the legs of the typewriter; a front piece of the same material, screwed to the top piece as indicated, and a clamp by which the holder is fastened securely to the table. The details of construction are given in the drawing. The size of the clamp depends on the thickness of the table top, and if different tables are to be used, the clamp should be suited to the thicker one, small wooden wedges being used to clamp the holder to the thinner. A hardwood piece, about $\frac{1}{2}$ in. wide and $\frac{1}{8}$ in. thick, as a brace for the thin wood, is mortised into the underside of the holder and held with glue and three screws. The appearance of the holder may be improved by the application of a coat of black paint.—Harold R. Harvey, Buhl, Idaho.

It often happens after stuffing and sewing up a fowl for roasting, that some of the dressing comes out between the stitches, making it rather difficult and disagreeable to handle. This trouble can be prevented by putting the end crust of a loaf of bread inside of the opening.

From the Bureau's Mail Bag

In your July, 1920, issue, I saw an illustration of an improved steam tractor. Please furnish name and address of maker. The oil or internal-combustion engine is beginning to do good work here, but old steam-engine users would like to retain them where practicable, but our old English engines are too heavy.

We are constant readers of the Popular Mechanics Magazine and the children take a great deal of interest in it and get a great deal of information from it. During the war, it was very expensive, and we stopped having it for a while. Farming here is mostly successfully done by farmers who have their own help, but the man who employs labor unless in a large way, does not seem to make much headway, unless he has more side lines.

If the tractor does what it mentions it will be just the thing for many districts around here, as it burns a low-grade oil, and there is a refinery in Melbourne where this oil can be obtained.—Thomas J. Nicholas, Barndown, Victoria, Australia.

Kindly excuse me for the trouble I put you to with my present. I am a refugee from Russia, where after twenty-five years of hard work, I was ruined and robbed by the Bolsheviks to the last handkerchief. I hardly escaped to Constantinople last summer, where I started a commission business. I had the honor to write you last August for some catalogs and particulars. Unfortunately, I could not wait for your kind reply, because on account of the unexpected and sudden catastrophe in Asia Minor, I had to run away immediately from Constantinople and come here.

In what condition are the refugees of the Turkish atrocities know well your Near East Relief here, as well as the American Red Cross Society, who generously have spent millions of dollars to help these poor and miserable creatures. Taking courage of such an example of the noblest citizens of such a philanthropic country and having not the address of friends in America, I take the liberty to address myself to you, asking for a moral assistance.

After Russia, Greece is a microscopic country. No business can be done here unless you have a big capital. It is a real struggle for life and the only *modus vivendi* is to deal with small and cheap articles, especially novelties, that can be easily sold. I have still a little capital, and I desire to deal for the present in small objects. Excuse me again for the trouble. Your kind care and advice will save me and I shall be to you forever grateful. Thanking you in anticipation.—A. Athanasides, Athens, Greece.

I would be very grateful if you would inform me as to where I could send to get all available information about the selenium cell which has from time to time been mentioned in your valuable magazine. I wish to conduct experiments in telling the color of dried fruits and as we cannot get the necessary equipment in Australia, I have taken this liberty of asking if you could help me out of this difficulty. Your magazine is well read in these parts and I myself have read it for some years past and always derived a great deal of pleasure and knowledge from so doing.—J. J. Dix, The Palms, Renmark, South Australia.

I have to thank you for your letter of the 19th December last, and for your help in regard to my questions. I believe you have put me on to one agency, at least, that promises very well—and I appreciate it.—Fred T. Tate, Dunedin, New Zealand.

Can I beg you to have some lists of small tools and machinery for metal and woodworking sent me? I am an amateur, tools are exceedingly hard to get here, in

fact they are unobtainable. Your magazine is the best of the kind that I know, and in places like this where one is 3,000 miles from tools is a great help.—John K. Cridland, Retirement Riverside, Hanover, Jamaica, British West Indies.

As I can very often read that you will answer any question concerning to mechanics, I just want you to give me the address of a house that make something we call in Spanish "Iman" and in English must be something like magneto. I am not sure but I can explain you that what I mean is a pease of steel which its chape is the same of the horseshoe but is more narrow and it atrats the iron by putting it near the magnet. So by this plain explanation I believe you must know what I mean, so if you know of any house who make them please teel it to me sending the adres to the following direction.—Alberto Veloso Serrano, Santiago de Cuba.

I have been a reader of your magazine for some considerable time and have derived very great benefits from it in my occupation as an engineer, especially in your Shop Notes, some of which I find almost indispensable. Your Bureau of Information is a great boon to readers, so, availing myself of it, I am writing to ask if you

could inform me where I could purchase some parachutes. I have made four descents from an airplane in parachutes that were used in exhibitions from balloons, but as they were not my property, I desire to purchase some for myself. I would be much obliged if you would pass on my address to some concern dealing in parachutes.—O. McGrath, Public Works Engineer, Shannon, New Zealand.

I am a constant reader of Popular Mechanics and find it very interesting for myself and most valuable in promoting my children's interest in learning the English language.—J. O. Darche, Sherbrooke, Que., Canada.

As you are aware, no doubt, this is a great sugar producing country, as a matter of fact, sugar is one of Brazil's staple products.

Some of the largest sugar mills of the country are situated in the state of Rio, not more than 8 or 12 hours from the Capital, the Federal district. If possible, I would greatly appreciate your furnishing me with more details regarding the article on "Low grade molasses yields fuel and potash." I don't mind telling you that if there is a possibility of utilizing the process to advantage in this country, it is my intention to do so.—G. Dale, Rio de Janeiro, Brazil.

Please let me have the addresses of the makers or sellers of all the things I have mentioned which you have in your magazine. You may think that I ask too much, but they are not all mine, some are of my friends, but as they do not speak or write English, they asked me to do it for them, because when I translate them they ask me to ask you about all these things. Giving you my very best thanks.—Salvador Giron Collier, Guatemala City, C. A.

I very much appreciate the information you gave me in reply to my inquiry in regard to stones coming up through the earth. This bit of information will be very much relished by the members of Hollansburg Grange 2196, as there was quite an argument on the subject. I also obtained some information from you concerning a "divining rod" that was used to locate oil, and the information you gave us caused us to feel rather pessimistic before the well was begun. We very likely saved a neat sum of money by taking your advice and investing lightly, for the well turned out dry.—Ernest J. Downing, New Madison, Ohio.

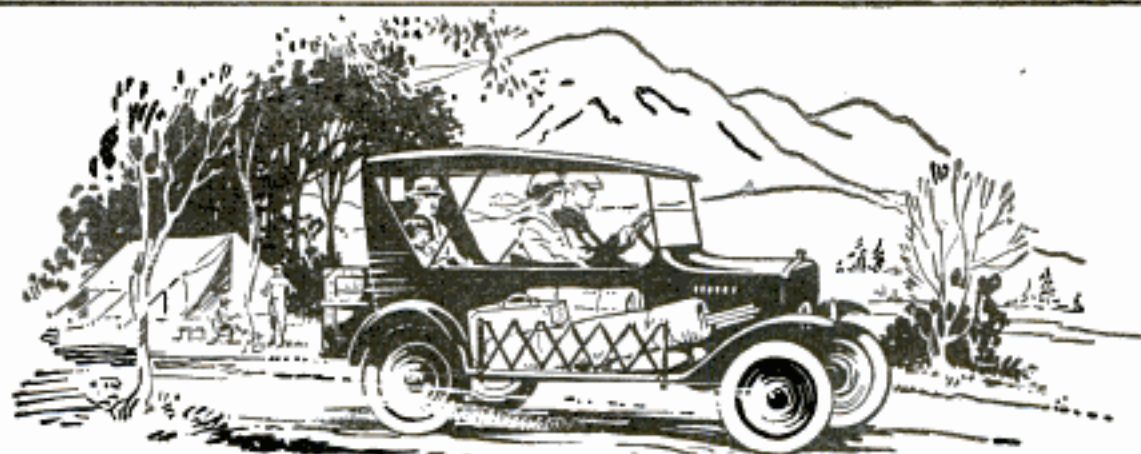

Install a RUCKSTELL AXLE and Go Anywhere

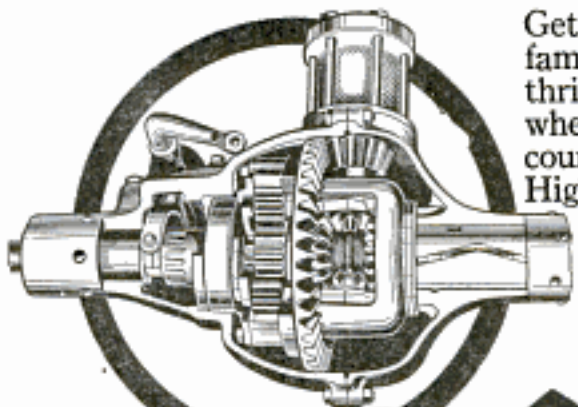

Get a light car and have the dealer install the famous Ruckstell Axle—then you'll get a new thrill out of motor car ownership. Go anywhere—to the Lakes, the Mountains—cross-country on the Dixie, Lincoln or Jefferson Highways—or through heavy, muddy roads. All look alike to the Ruckstell equipped car.

Power and Speed in ONE

You'll have 55% more power with the Ruckstell. If you want greater speed you can have 20% more. The mere shift of a handy lever transforms a light car into a "Power" or "Speed" car at the will of the driver. Never before has it been possible to combine TWO DIRECT OPPOSITES in ONE.

The Ruckstell solves the problem. Nearly 100,000 now in use. 100% satisfaction guaranteed; every owner a booster.

The Only 2-Speed Axle in the World

Installed in rear housing; becomes an integral part of the car, with the same standardized precision demanded by highest automotive engineering design and operation. Gives you TWO NOISELESS HIGH SPEEDS—four forward and two reverse. Nothing else like the RUCKSTELL AXLE. Not an auxiliary transmission; not an "accessory."

Free Demonstration See your nearest dealer in light cars. He will gladly demonstrate the wonderful TWO-PURPOSE PERFORMANCE of the Ruckstell Axle. Or, write us for Free Booklet, Prices, etc. Address our nearest office, Dept. 20A.

Ruckstell Sales & Mfg. Co.

New York City Kansas City, Mo.
San Francisco, Cal.

Montreal and Toronto, Canada

Name

Address

Make of Car

Free

This coupon good for Free Demonstration at nearest dealer, or for Free Booklet. (Dept. 20A)



55% More Power—go through any roads, muddy or sandy. No "stalling."



Climb practically all hills on "high"—pass the other fellow always.



Throttle down to 3 miles an hour in traffic. Speedy pick up; wonderful flexibility.



SHIFT THE LEVER and you have remarkable added power or speed as you prefer. Foolproof. Changes speeds no matter how fast you're driving. No clashing; no stripping.

RUCKSTELL AXLE



The Spirit of Pioneering

Impatience with present facilities, a restless searching for perfect things—these have driven men to discovery and invention. They possessed the early voyagers who turned their backs on the security of home to test opportunity in an unknown land. They explain the march westward that resulted in this settled, united country. And they have inspired the activities of the Bell System since the invention of the telephone.

The history of the Bell System records impatience with anything less than the best known way of doing a job. It records a steady and continuous search to find an even better way. In every department of telephone activity improvement has been the goal—new methods of construction and operation, refinements in

equipment, discoveries in science that might aid in advancing the telephone art. Always the road has been kept open for an unhampered and economic development of the telephone.

Increased capacity for service has been the result. Instead of rudimentary telephones connecting two rooms in 1876, to-day finds 15,000,000 telephones serving a whole people. Instead of speech through a partition, there is speech across a continent. Instead of a few subscribers who regarded the telephone as an uncertain toy, a nation recognizes it as a vital force in the business of living.

Thus has the Bell System set its own high standards of service. By to-day's striving it is still seeking to make possible the greater service of to-morrow.



**AMERICAN TELEPHONE AND TELEGRAPH COMPANY
AND ASSOCIATED COMPANIES**

BELL SYSTEM

One Policy, One System, Universal Service

Work on
your radio
with

"YANKEE" RADIO TOOLS

Now at last you can get tools specially designed for radio work. Ask your dealer to show you these "Yankee" Radio Tools.

They make radio construction easy, save time, do better work.

It's fun! You just move handle of "Yankee" Ratchet Tool Holder back and forth on ratchet movement.

The tool countersinks, reams, runs up nuts, drives screws. Attachments for these operations fit holder.

A touch on Ratchet Shifter gives you right- or left-hand ratchet; or rigid adjustment.

You will want the "Yankee" Radio Drill No. 1431. Capacity 9-32 inch. Just right for radio jobs.

Get these handy tools. You'll save money and build a set you'll be proud to show. Use these "Yankee" Tools for adding to your present set or for making adjustments; also for general use around the house.

"YANKEE" Radio Tool Set No. 105

Price \$3.25

All these attachments fit "Yankee" Ratchet Holder:

Blades—one for long reach into box, between wires, etc.

—one for small screws on dials.

—one for heavy screws—putting up aerials, etc.

Countersink—for heads of screws.

Sockets—(two) cover all small nuts.

Reamer—for enlarging holes in panel.

Wrench—one end, square or hex. Other, hex for jacks.

"YANKEE" Drill No. 1431

Price \$3.00

4 to 1 gear for speed. Special Radio Chuck to take largest drill usually supplied with radio drill sets.

Your dealer can supply you

NORTH BROS. MFG. CO., Philadelphia, U. S. A.

"YANKEE" TOOLS

Make Better mechanics



"Yankee"
Radio Set
No. 105



"Yankee"
Radio Drill
No. 1431

"Yankee" Tool Book
Free on request.

Copyrighted material

Aladdin would have liked to meet this young lady. He had a good lamp; but see this!



The biggest and the smallest

The biggest lamp made by the General Electric Company is 30,000 watts, equivalent to 100,000 candles. The smallest is called the "grain of wheat" lamp. It is used in surgical operations on the stomach.



While the cost of almost everything else has advanced since the war, the cost of MAZDA Lamps—and the current for lighting them—has been materially reduced. Use the right lamps and use them freely; no other home comfort costs so little.

Both are MAZDA Lamps, like the lamps in your home—MAZDA being the mark of the continuous research service centered in the General Electric laboratories in Schenectady.

GENERAL ELECTRIC

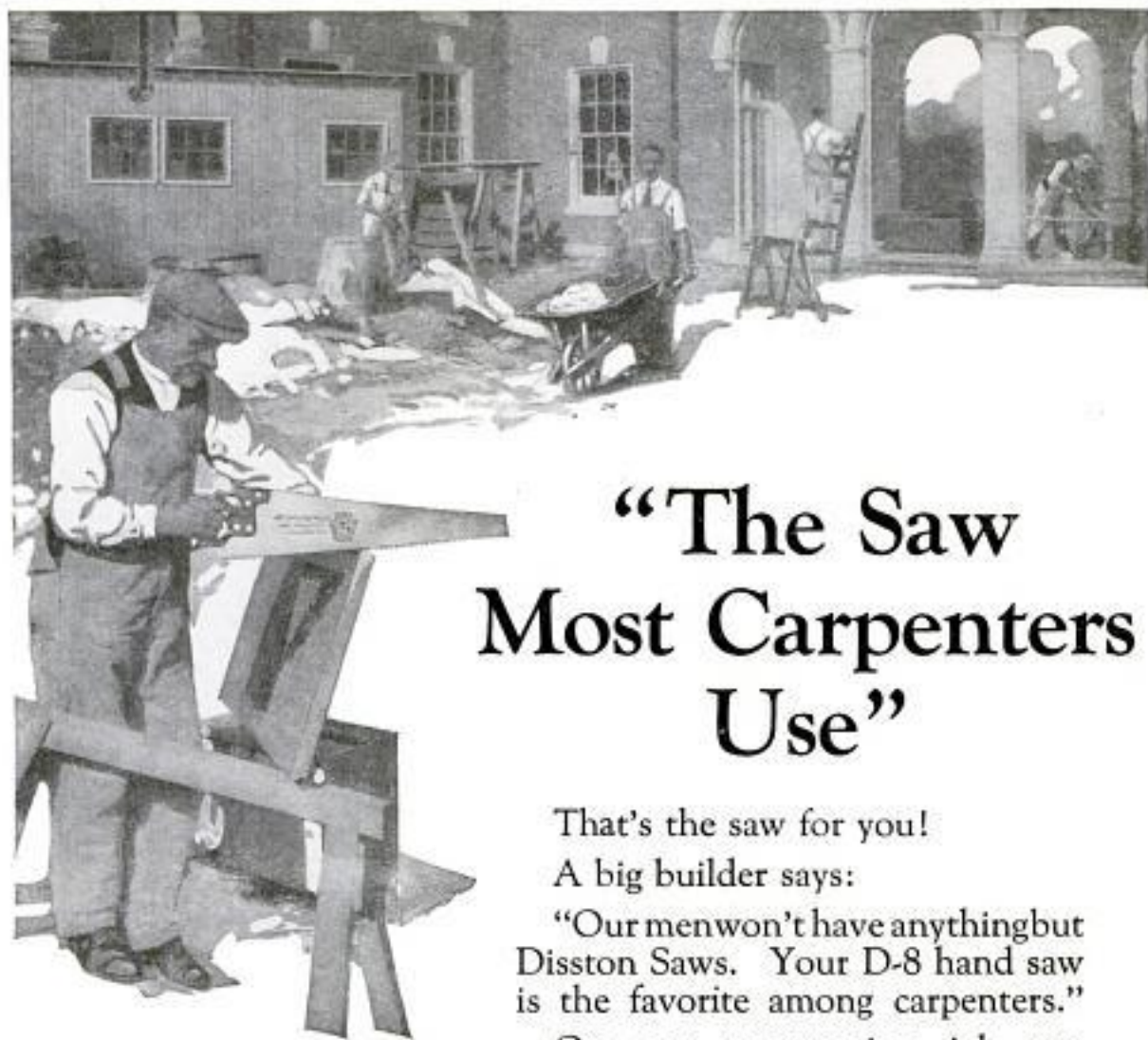

“The Saw Most Carpenters Use”

That's the saw for you!

A big builder says:

“Our men won't have anything but Disston Saws. Your D-8 hand saw is the favorite among carpenters.”

On any construction job you will see that most carpenters use Disston Saws.

Ask any user of a Disston Saw and he will tell you that only Disston can make a saw to suit him — a saw with the right hang, taper, teeth, and temper, made of Disston Steel.

The way for you to choose the best saw is to look for the name Disston.

HENRY DISSTON & SONS, Inc.
Makers of “The Saw Most Carpenters Use”
PHILADELPHIA, U. S. A.

Ask Disston

Tell us what kind of work you are doing, in either metal or wood, and we will tell you what types of saws to use to do your work better and easier. Disston issues many books to aid the user of saws and tools.

Hardware dealers
the world around
sell Disston Saws,
Tools and Files.

DISSTON

“What a whale of a difference
just a few cents make!”

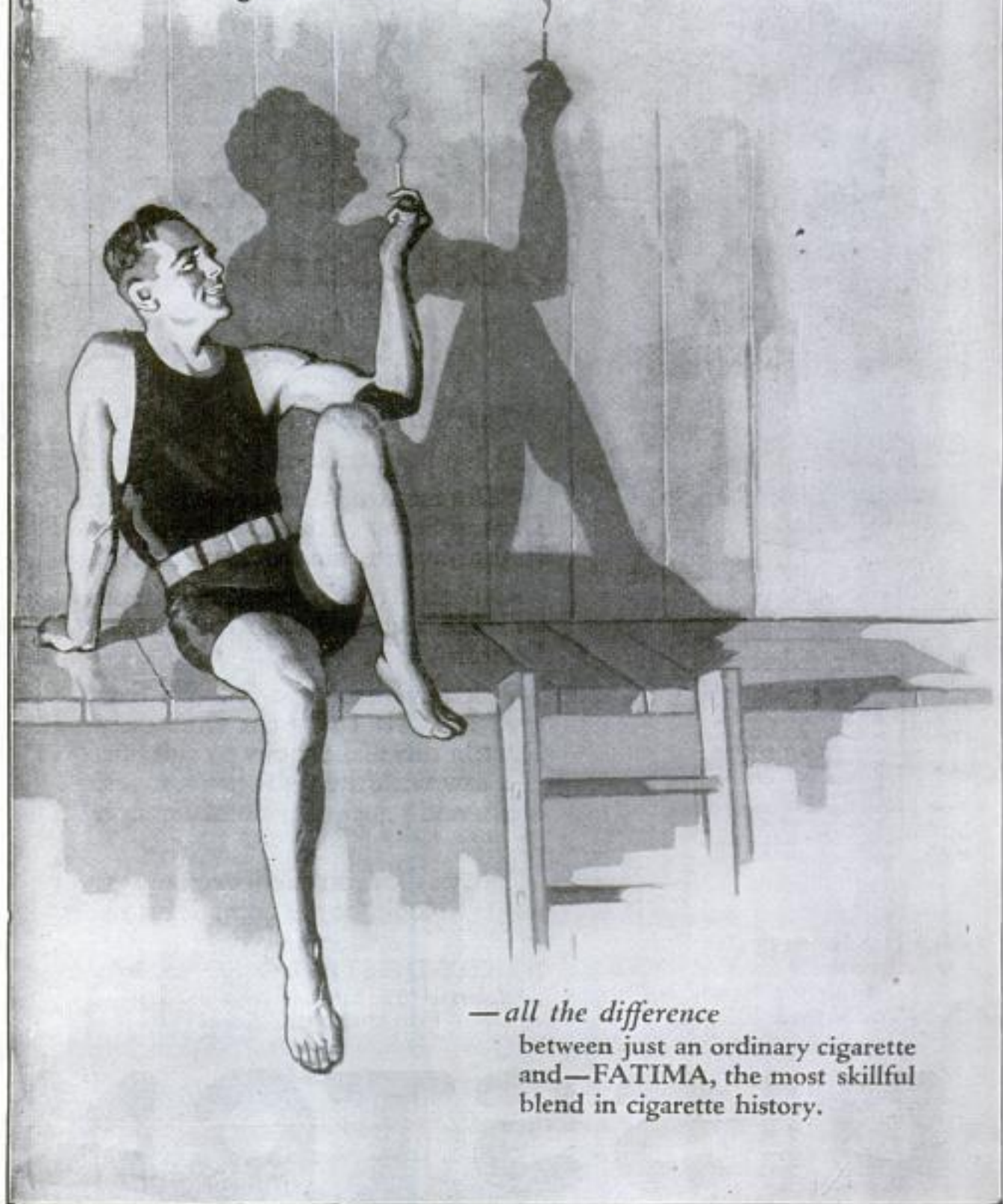

— *all the difference*
between just an ordinary cigarette
and—**FATIMA**, the most skillful
blend in cigarette history.



AN ATHLETIC-TRIM
KEDS MODEL

Keds with athletic-trim come in various styles—lace-to-toe and lace-to-instep, black, brown and grey trim.



A KEDS OXFORD

One of the many Keds styles designed for general wear as well as for sports.



A KEDS MODEL WITH
CREPE SOLE

Crepe Sole Keds are distinguished by springy lightness, ground-grip and long wear.

KEDS are a complete line of canvas rubber-soled shoes, varying in price according to grade, size and style—from \$1.25 to \$4.50.



A battle of brawn—fought to the finish!

What Army tests found out about Keds

SPORTS—games—athletics of every kind—they are a part of the regular "day's work" for the men in the army. Naturally, the army demands athletic shoes that are built *right*—and built to stand the hardest wear.

Here's the interesting report of tests made at an Army Post, with Keds:

"ONE pair was worn regularly for 12 hours every day (except Sundays and holidays) during a period of 5 weeks in all conditions of weather and service. This pair shows little wear and appears capable of withstanding at least an additional month of similar usage.

"One pair was given a general test for sport (mass games, and physical training, etc.). These shoes were turned in at the end of six weeks and showed practically no wear.

"Three pairs were in use five months for tennis, golf, walking, etc., and are still in good condition. One of these pairs was subjected to a wading test in salt water (a severe test) and no deterioration was noticed from such exposure."

Records like these help to explain why Keds are the standard shoes for sports and athletic use today. Leading players and championship teams everywhere are wearing them. They're built to give the maximum of speed, ground-grip and comfort.

Keds, of course, are a complete line of canvas rubber-soled shoes, varying in price according to grade, size and style—from \$1.25 to \$4.50.

It is important to remember that not all canvas rubber-soled shoes are Keds. Keds are made only by the United States Rubber Company. And every Keds shoe has the name *Keds* on it. It will pay you to look for the name!

The 1924 Keds Hand-book for Boys is full of things every boy will want to know about. How to make things—rules for games—woodcraft, etc. Sent free if you address Dept. 336, 1790 Broadway, New York City.

United States Rubber Company

Keds

Trademark Reg. U. S. Pat. Off

They are not Keds unless
the name Keds is on the shoe





“All Starrett’s!”

“Boy—you certainly come well recommended.”

“Yes—that’s what the foreman said when he looked over my kit this morning. And right away he wanted to know how soon I could come to work.”

Send for New Starrett Catalog

No. 23 “AP” has all the newest additions to the Starrett Line of Fine Precision Tools, Hacksaws and Steel Tapes. It will help you add wisely to your kit—contains uses, prices and complete descriptions of over 2200 Tools. Get a free copy at any good hardware store or write us.

THE L. S. STARRETT CO.

The World’s Greatest Toolmakers
Manufacturers of Hacksaws Unexcelled
 ATHOL, MASS.

Use Starrett Tools

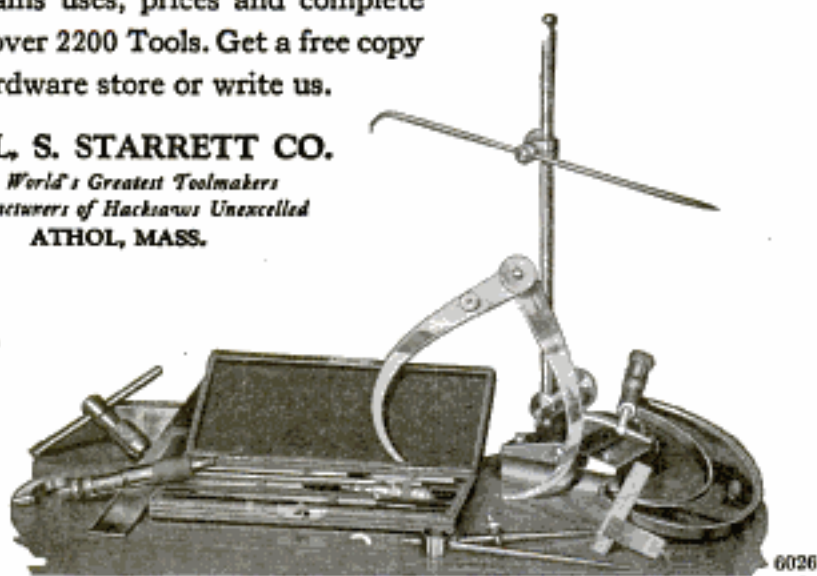

6026



A New, Better Way to Recondition Cylinders
The Do-Mo Portable Cylinder Reconditioner

The first and only machine with these radically improved features

Rebores cylinders accurately without removing the motor from the car.

Establishes a new bore of its own — absolute precision—insures perfect fit of pistons.

Enables a garage mechanic to turn out a flawless job of cylinder reconditioning in only 10 hours.

Weighs 70 pounds. Can be carried anywhere. Sets on top of motor,

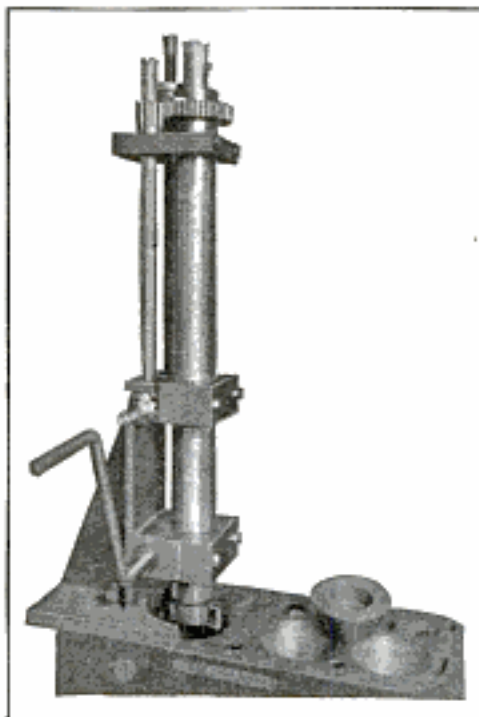

when at work. Reconditions any type or size of cylinder and can be operated by hand or motor power.

Garage men can now do cylinder reconditioning expeditiously and with super-accuracy for a little over half the cost of the old style reconditioning methods—**make a much greater net profit**, and earn the everlasting good will of the motorists.

Automotive Engineers Pronounce This the Only Practical Portable Cylinder Reconditioner Yet Invented

Will be placed only with selected garages, appointed on a franchise purchase privilege and on a per capita basis. This assures an abundance of work to each garage servicing the machine.

Purchase of a Do-Mo Portable Cylinder Reconditioner virtually entitles the purchaser to an exclusive use franchise, in conjunction with one or more other garages in the community, in accordance with our limited, per capita plan of distribution.

Live garages and auto repair shops will do well to get all information at once. Servicing garages will be appointed in the order of receipt of purchase applications.

When a community's quota of servicing garages has been filled (on a basis of one machine to every 10,000 population) no more orders will be accepted from that community. Any fair sized repair shop can easily afford the machine.

Use the coupon TODAY.

E. H. Odom Brothers Co., Inc.
Patentees and Manufacturers
 192 Courtland Street, ATLANTA, GA.

E. H. ODOM BROTHERS CO., Inc.
 192 Courtland Street, Atlanta, Ga.

Send me full particulars of your new Do-Mo Portable Cylinder Reconditioner, price, terms, etc.

Name.....

Address.....

City..... State..... P.M.



Sargent
Auto-Set
Bench Plane

Sargent
Steel Block
Plane

Sargent Planes *make a quick, clean job of it*

WHATEVER it is—if it is made of wood and needs smoothing or finishing—one or the other of these two Sargent Planes insures satisfaction.

For heavy work, or where good deep cuts are desirable, the Sargent Auto-Set Bench Plane fills the bill in every particular. At the same time it is an excellent smoothing and finishing tool—an all 'round plane for the busy workshop.

Examine the Auto-Set at your hardware dealer's. Note how quickly the cutter of

chromium steel may be removed and replaced when it does need sharpening—all without disturbing the original adjustment. Back in place, not even the toughest or knottiest wood can make it chatter.

For the smaller jobs, for cabinetmaking, for getting into real close quarters, and for the finishing touches to your workmanship, you need the Sargent Steel Block Plane. This is made with the same care and precision which characterize every tool bearing the name Sargent.

These two Sargent Planes should be on your work-bench. Write for booklets

SARGENT & COMPANY, Mfrs., 49 Water Street, New Haven, Conn.

SARGENT
Tools & Hardware

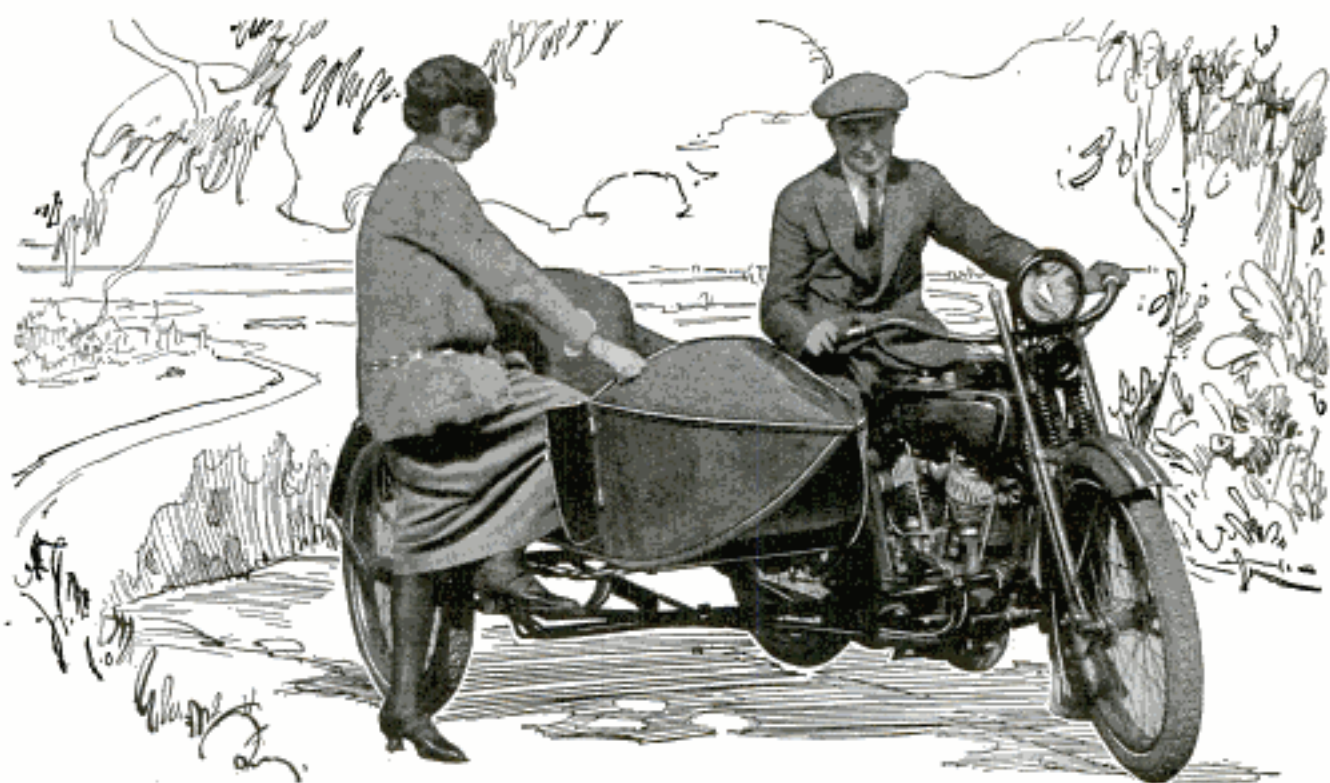

Ride Away from the Heat!

IT'S cool and breezy out at the lake!
Swimming — fishing — "loafing" — or
whatever sport you like best — they're all
inviting you to come!

Let a glistening, pulsing Harley-Davidson
speed you and your pal away from the heat—
the monotony—of the city. Pick out your
favorite beach, picnic place or fishing ground
—then GO! You'll get there long before the
automobiles, and at a fourth the expense!

*Your dealer has a Pay-as-You-Ride Plan.
And he will treat you to a Demonstration
Tour — free. Send us the coupon below.*

HARLEY-DAVIDSON MOTOR CO.

Dept. P, MILWAUKEE, WIS.

Money-making
sales opportuni-
ties in open terri-
tories. Write for
particulars.

Harley-Davidson
The Motorcycle

Harley-Davidson Motor Co., Dept. P, Milwaukee, Wis.
Send me, free, postpaid, new catalog showing 1924 models
in annual colors.

Name _____
Address _____

For mechanics—the new BROWN & SHARPE

SMALL TOOL CATALOG No. 29



This new catalog lists many new and improved tools that are invaluable to every mechanic. Over 2000 different styles and sizes of tools are listed. In addition to being illustrated it contains much information concerning tools, tables, etc., making it a handy reference book that no mechanic can afford to be without.

Ask your dealer for a copy. If he cannot supply you, write us direct.

OVER
2000
STYLES AND SIZES
OF TOOLS

BROWN & SHARPE MFG. CO.
PROVIDENCE, R. I., U. S. A.



The new size is most convenient, slips right in the pocket, easy to handle and above all it lists the best tools you can buy.

BROWN & SHARPE TOOLS
"Standard of the mechanical world"



\$3
DOWN

and it's YOURS

The Greatest Typewriter Bargain Ever Offered

Right now we are making you the greatest typewriter offer you ever dreamed of—an eye opener. This wonderful standard Shipman-Ward Rebuilt Underwood only \$3.00 down. Ten days' free trial and the easiest monthly payments, shipped direct to you from our big factory.

10 Days' Free Trial From Factory to You

Yes, only \$3.00 down puts this genuine late model Shipman-Ward Rebuilt Underwood in your home. You can try it, test it, and then decide. See for yourself how new it is, how it writes. You must be satisfied. Your \$3.00 unconditionally returned if at the end of ten days you are not satisfied. The entire transaction will not cost you one cent.

EASY Monthly Payments

Little more than rental. Balance of payments so small you will hardly notice them, while you enjoy the use of this wonderful machine. You don't have to scrimp and save to pay cash. All at a big saving to you.

5 Year Guarantee

With every typewriter we give a written guarantee. These machines are rebuilt like new by the famous SHIPMAN-WARD PROCESS. Equipped with late improvements. You can't tell them from a new machine. The world's standard typewriter, the same models as sold by the Underwood Typewriter Company today, at a big saving to you. Act now! Get this splendid offer and save money.

These machines are shipped direct from our factory—the largest typewriter rebuilding plant in the world. They are rebuilt by the famous SHIPMAN-WARD PROCESS. Developed through 30 years in the typewriter business. Through our money saving methods of rebuilding and elimination of a large expensive sales force we are able to make this wonderful money saving offer to you. ACT TODAY, take advantage of it and you will SAVE MONEY.

ACT NOW! Mail this coupon today.

Free Book of Facts

Write for this free book of facts explaining Shipman-Ward's wonderful system of rebuilding typewriters. We show you exactly how it's done. How you are able to buy them. Complete and valuable information about the typewriter industry, both instructive and educational.

FREE with Every Typewriter

A complete course in touch typewriting. You don't have to know how to operate a typewriter. You can learn to operate this machine in one day. We also give free a waterproof cover and all tools that come with a typewriter.



All Shipments made direct to you from our modern factory—the largest typewriter rebuilding plant in the world.

FREE BOOK COUPON

SHIPMAN-WARD MFG. CO.
C212 Shipman Bldg.
Montrose and Ravenswood Aves.
CHICAGO

Send by return mail your wonderful offer of Shipman-Ward Standard Rebuilt Underwood, also your book of facts. (This is not an order and does not obligate me in any way.)

NAME.....

STREET.....

POST OFFICE.....STATE.....

SHIPMAN-WARD MFG. CO.

C212 Shipman Bldg., Montrose and Ravenswood Aves., Chicago

OXO-GAS

OIL BURNERS

OXO-GAS OIL BURNERS

For

Furnaces
Cook Stoves
Large Ranges
Heating Stoves
Base Burners
Shipmates
Bake Ovens
Vulcanizers
Hot Water Heaters
Hot Plate Heaters
Water Coil Heaters
Camp Stoves

And many other
purposes



Kerosene or Distillate and Air
the FUEL.

OXO-GAS
the RESULT!

A pure blue flame of
high heating efficiency.

Burns as silently as city
gas. The cheapest,
cleanest and most
efficient fuel known to
science.

*Illustrating OXO-GAS Burner
in Cook Stove—installed in a few
minutes—lasts a lifetime—pays
dividends in money, health and
happiness.*

OVER A MILLION IN EVERY DAY USE



Hot water in any
quantity—The simplest
method of heating water
ever conceived. Just
light the heater, then no
more bother. Its price
within the reach of all.



The **BIG FOUR** Furnace
Burner will operate per-
fectly in any standard
furnace for heating homes
up to twelve rooms. Easily
and quickly installed with-
out any change in the furnace. No noisy motors
or other machinery. Will give a lifetime of
clean, cheap, efficient service. So low in price
that anyone can afford it.

**Big Four
Furnace
Burner**



Heat, plenty of it, in
base burner or heating
stove. Clean,
satisfactory, econom-
ical, convenient as
steam heat. Brings
happiness, plus.

Agents Wanted Some
territory for OXO-GAS agencies still open
to thoroughly responsible parties. Your
own locality may yet be unassigned. Just
write and ask us for our agent's proposition,
and we will discuss the matter with you
either by mail or in person.

Gloria Light Company

[Established 1906]

111-115 North May Street

CHICAGO, ILLINOIS

21 Jewel Santa Fe Special

Sent
ON

Approval

21 Perfect Jewels
Adjusted to Positions
Adjusted to Temperature
Adjusted to Isochronism
Adjusted to the Second
25 Year Gold Strata Case
Your choice of Dials (including Montgomery R. R. Dial)
New Thin Models. All sizes.

WHILE other watch dealers are raising their prices, asking you for larger monthly payments, and making payment terms harder for you to meet, we are offering you our new model Santa Fe Special, no advance in price, no money down, easier terms and smaller monthly payments. We realize the war is over and in order to double our business we **MUST** give you pre-war inducements, better prices, easier terms, and smaller payments.

Send No Money Without one penny of advance payment let us place in your hands to see, to examine, to inspect, to admire, to approve a real masterpiece in watch creation. Our determination to this year double our sales of the world famous Santa Fe Special and Bunn Special Watches prompts this matchless offer.

Ladies' Wrist Watch—New Elite

This Artistic dependable Ladies' Wrist Watch, fitted with genuine Illinois Springfield movement. A perfect timepiece. Beautiful 14 Karat white or green solid gold case. Many designs—Ask for New Watch Book showing New Elite case designs in color. Watch sent on approval and sold on payments.

Page 12 of Our Watch Book Is of Special Interest to You!

Ask for our Watch Book free—then select the watch you would like to see, either the famous Santa Fe Special or the 6 position Bunn Special, and let us explain our easy payment plan and send the watch, express prepaid, for you to examine. No money down. **REMEMBER**—No money down—easy payments buys a master timepiece—a 21 Jewel guaranteed for a lifetime at about half the price you pay for a similar watch of other makes. No money down. A wonderful offer.

SANTA FE WATCH COMPANY
86 Thomas Building TOPEKA, KANSAS
"Home of the Great Santa Fe Railway"

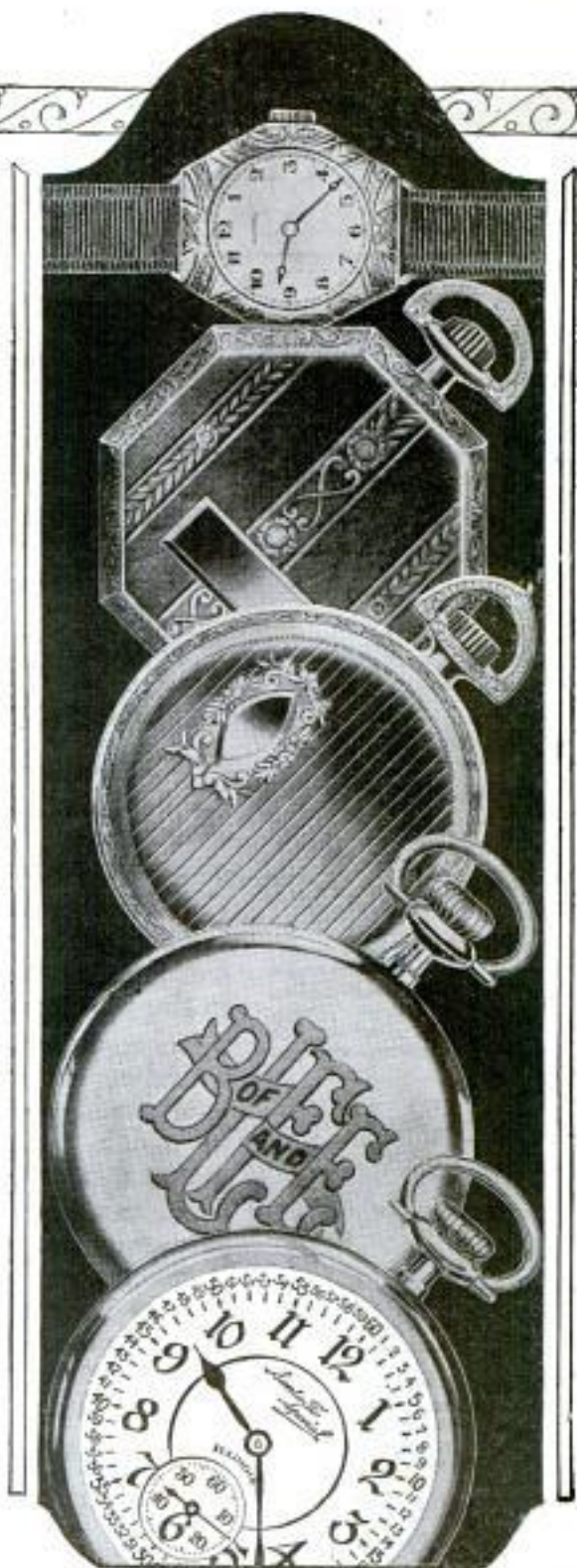

SANTA FE WATCH CO.

86 Thomas Bldg., Topeka, Kansas

Please send prepaid and without obligation your Watch Book free, explaining your "No Money Down" Offer on this Santa Fe Special Watch.

Name.....

Address.....

State.....

Superior Erla Circuits Are Now Also Easiest to Build

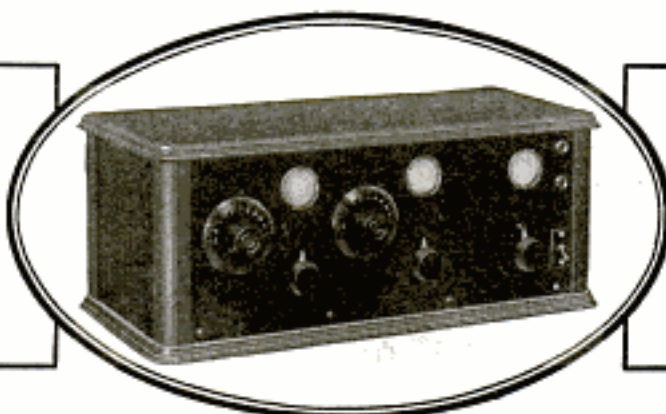
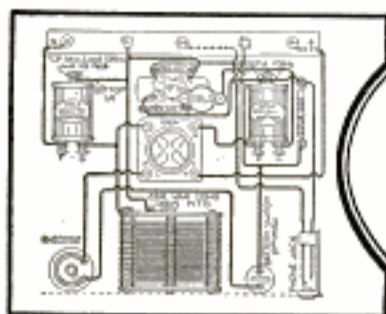

Providing greatly improved selectivity and simplified control in reflex circuits, Erla Selectoformer records material advancement. \$5 ea.



Unrivalled ability to meet the requirements of high resistance loud speakers gives first place to Erla push-pull audios. Pair \$10



Nickel shell and moulded Bakelite base of Erla sockets combine maximum beauty, electrical efficiency and strength. Two sizes, 65-75c

Factory Sealed Complete Parts Guarantee Perfect Results

TO the singular efficiency of Erla Duo-Reflex Circuits, tube for tube, the most powerful circuits ever built, now is added maximum ease of construction.

Complete parts for each circuit, down to the last screw and nut, are packed in sealed factory cartons that eliminate all difficulty and doubt in the purchase and assembly of materials.

Synchronizing reflex and audio transformers, tested capacity condensers, balanced crystals, every unit especially designed for the circuit in which it is to function—these positively assure success to the amateur builder.

And, as a final guarantee of accurate, flawless assembly, there is also included a drilled and lettered panel, stenciled baseboard showing the exact location of each piece of apparatus, and full-size blueprints that make child's play of wiring. Even soldering is eliminated, through Erla solderless connectors.

For surest enjoyment of all that radio affords, for purest tone quality, maximum selectivity and ease of control, as well as range and volume, ask your dealer about Erla knock-down receivers, in the factory-sealed carton. Or write direct, giving your dealer's name.

Electrical Research Laboratories
Dept. J 2500 Cottage Grove Ave., Chicago

ERLA



Materially improved range and volume, over the whole broadcasting waveband, follows the installation of Erla reflex transformers. List \$5



Exclusive core construction is but one of many reasons for unduplicated Erla ability to amplify three audio stages without distortion. List \$5



Panel layouts are improved 100% through patented Erla bezels, in 1" and 1 1/2" diameter, for 1/8" to 1/4" panels. Nickel, black, gold. 20-30c

KERMATH

BOAT ENGINES

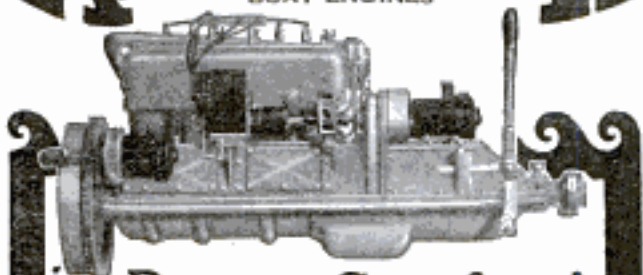

Breezy Comfort!

Watch the crowded excursion steamers from the breezy comfort of your own motor boat!

Kermath marine motored launches and boats are simple to operate and "always run." They are trouble-proof and remarkably economical.

Whatever size or type of boat you want—for ocean, river or lake—there is a dependable Kermath marine motor for it. Get the advice of our experienced Courtesy Department on boats and engines—no obligation, of course.

Kermaths have years of experience in marine engine building behind them. And because they are made in quantities are very attractive in price.

3-50 H. P. \$135 to \$1050

KERMATH MANUFACTURING COMPANY

5886 Commonwealth Ave. Detroit, Mich.
Canadian address: 11 E. Wellington St. Toronto, Ontario

A Kermath Always Runs

SEND for the INTERNATIONAL CATALOG

FOR FORD PRICES FROM \$27.95 UP.

Factory to Consumer direct—Pay only one price.



Our set price list. Full line of auto bodies and accessories for Ford at Wholesale Prices.

Save big money on bodies by buying direct from factory.

INTERNATIONAL BODY WORKS, Dept. 7, 914 W. Ohio Street, CHICAGO, ILL.

Build This Real Auto!

A sturdy, dependable motor car. Any handy man or boy can build it. Power supplied by famous

2½ H. P. SHAW Motor. Send for illustrated Circulars, 2c postpaid. Complete Illustrated Book of Building Plans 25c postpaid. Write today.

SHAW MFG. CO. Dept. P. M. 3-6, GALESBURG, ILL.



Book of PLANS 25¢

Write For Book About the Elto

3 H. P.—The Fastest "Light Twin"

Designed and built by Ole Evinrude Weighs less than 17 lbs. per H. P.

Gives half more power, much more speed, yet easy to carry. Instant starting without spinning. Safe rider steering. Trouble-proof carburetor. Push button reverse, without danger of tipping boat. The ideal family motor. Fits carrying case without taking apart. Write for catalog.

ELTO OUTBOARD MOTOR COMPANY

Manufacturers' Home Bldg., Dept. AA, Milwaukee, Wis.



½ More Power—Much More Speed



Abundant lather
Quick action



Lasting lather
A clean shave



Fine after-effects

Five New Joys

Await you in Palmolive Shaving Cream

By V. K. Cassidy, Chief Chemist

GENTLEMEN:

Let us show you five new joys we have brought to millions in Palmolive Shaving Cream.

This offers you a Ten-Shave Tube to try.

A very unique creation

Three years ago most men were wedded to some other soap or cream. Most of them were satisfied, perhaps. Then came Palmolive Shaving Cream, made by famous experts. The final result of 60 years of soap study.

A test was offered which countless men accepted. The users were amazed. In the short time since then this soap has become the Shaving Cream sensation. It has built up a new idea of what shaving cream can do.

Try it as a courtesy to us. We made up 130 formulas in seeking to perfect it. Now judge the result for yourself. Clip this coupon. Mail it at your leisure for a Ten-Shave Tube.

Five reasons why

- 1—Multiplies itself in lather 250 times.
- 2—Softens the beard in one minute.
- 3—Maintains its creamy fullness for 10 minutes on the face.
- 4—Strong bubbles hold the hairs erect for cutting.
- 5—The palm and olive oil content brings one fine after-effects.

THE PALMOLIVE COMPANY (Del. Corp.)
360 N. Michigan Ave., Chicago, Ill.

PALMOLIVE SHAVING CREAM

To add the final touch to shaving luxury, we have created Palmolive After Shaving Talc—especially for men. Doesn't show. Leaves the skin smooth and fresh, and gives that well-groomed look.

© P. Co. 1924



10 SHAVES FREE

and a can of Palmolive After Shaving Talc. Simply insert your name and address and mail to: Address for residents of Wisconsin, The Palmolive Company (Wis. Corp.), Milwaukee, Wis., Dept. B-847. Address for residents other than Wisconsin, The Palmolive Company (Del. Corp.), 360 North Michigan Avenue, Chicago, Ill., Dept. B-847.

2372A

AGENTS-FORD OWNERS

Sell this new and amazing invention for Fords. A necessity—not just another accessory. Every Ford Owner will buy. Sales remarkably easy. Sells for \$5.00.

PATENT
APPLIED
FOR

Make Big Money with little effort

The **Kirst Clutch Control** at last solves the difficulty of running Fords in low without keeping your foot on the pedal. Imagine what this means when climbing a hill or over rough going! Control keeps clutch pedal in any position you put it. Makes Ford driving 50 per cent easier. No more need of the tireless strain of bearing down on low speed pedal. Prevents "bucking" when backing up. Doubles breaking power on a hill. Saves clutch bands, brake shoes, tires, oil and gas. Saves cost every three weeks. Anybody can install in 5 minutes. A proven article of real merit! \$300.00 or more every month easy selling the **Kirst Clutch Control**.

Hurry! Territories Going Fast

This will be the fastest selling Ford device on the market. Thousands in it for you. Our plan starts you at no expense and tells you how to make from \$300.00 to \$5000.00 a month. No experience needed. But hurry—your territory may already be spoken for. Write now for proposition.

MORGAN SALES COMPANY
Dept. 1, 1001 Washington Boulevard, Chicago

KIRST CLUTCH CONTROL FOR ALL FORDS

FREE Beautiful Book About Taxidermy

Learn at home by mail to mount birds, animals, tax skins. Be a taxidermist. Delightful art easily learned by men and women. Decorate home and den. Make big profits. Wonderful new art. Intensely interesting. Investigate. Write Today For This Wonderful Free Book, and our amazing offer. Send TODAY. N. W. School of Taxidermy, 6177 Elwood Bldg., Omaha, Neb.



Private Stationery



YOUR name and address printed FREE on every sheet and envelope in dark blue ink using Engravers Copper Plate Gothic Type. 50 sheets, size 6x7, and 20 envelopes to match—3 months' supply. Pure White, Velvet Smooth, Crisp, Crinkly, heavy bond ink writing paper.

FREE Big Bargain catalog free with stationery. Send only 30c. Money back if dissatisfied. Write clearly. C. F. JOHNSON & CO., 19 W. Jackson Blvd., Dept. P-62 CHICAGO, U. S. A.

SWEATERS SAVE 20%-30%



Any Style or Design for Men, Women, Boys, Schools, Clubs, Teams

Order direct from mill. Save from 20% -30%. Pick any style, any color, size or design from our regular stock or special to order. Finest virgin wool and pure worsted only. Custom tailored workmanship of highest grade. Closely knit. Warm, soft, snug. Real beauties you will be proud to wear.

FINEST QUALITY AT BARGAIN PRICES

FREE Always holds shape. Most customers get from 3 to 5 years wear easily. Can endure severe wear and retain bright, fresh appearance. Retain values inlustrary. Workmanship guaranteed. Prices slashed. Unusual chance to save. Special offers to schools, clubs, teams. Write for free illustrated catalog.

AMERICAN KNITTING MILLS 1538 Clybourn Avenue Dept. 25 CHICAGO



AUTOMOBILE MAKES 27 MILES ON AIR

An automobile goes 27 miles on air by using an automatic device which was installed in less than 5 minutes. The automobile was only making 30 miles on a gallon of gasoline but after this remarkable invention was installed, it made better than 57. The inventor, Mr. J. A. Stransky, 1004 Eleventh St., Pukwana, So. Dakota, wants agents and is willing to send a sample at his own risk. Write him today.—Adv.

TOPS

Ford Touring Top and Back Curtain

32 oz., \$5.25; 36 oz., \$6.25; Side Curtains, \$5.95; Door-Opening type, \$6.95; Back Curtain, regular, \$2; Gypsy type, \$4. Ford One-Man Top, fits 1915 to 1922 model, all new bows and side curtains, \$25. Chevrolet, Dodge, Overland 4 tops, 34 oz., \$9.75; double texture, \$12.25. 6x18 glass Gypsy Curtain extra, \$2. Tacks, etc., furnished ready to put on. Delivered 1000 miles. Vanderpool's Top Factory, Dept. 8P, Springfield, Ohio

Ford Fan Belts Can't Come Off

This SUPERIOR Crank Shaft Pulley

Fits All Fords 1917-24

This Ad and \$1.00 Brings It
Superior Auto Supplies
1202 Chestnut St., Milwaukee, Wis.



BURN YOUR NAME ON TOOLS

WITH ARKOGRAF

Protect your tools from theft. Write any name, engrave any design on metal with electricity like writing on paper with pen or pencil. Complete outfit \$3.50, prepaid anywhere. Interesting descriptive circular free. Write today. Agents Wanted. Arkograf Pen Company 1171 East Stark St. Portland, Oregon



PILLIOD

Tool Cases Excel

Machinists, Tool Makers and Carpenters find them most satisfactory in construction, appearance, service and price. Immediate shipment.

Booklet describing 20 styles on request.
THE PILLIOD LUMBER CO.
Dept. 1 Swanton, Ohio



THE SCREWDRIVER THAT HOLDS THE SCREW

As Good as a Third Hand in Assembling anything from a Watch to an Automobile



Appeals Especially to Radio amateurs and professionals. A wonderful (patented) improvement.

Jobbers, Dealers and Agents, Favorable discounts \$1.00 Postpaid THE COBURN TOOL CO., Inc., 739 Boylston St., Boston, Mass.

Great New Invention



For Seekers of Health—Power—Beauty Generate High Frequency Violet Ray, Mechanical Vibration, Medical Electricity and Ozone—the four greatest curative agents. Combined or separate. They operate on the electric light in your home or on their own motive power at less than 50 cents per year.

WRITE Ask for the book on these inventions which has just been prepared. It will be sent to you without cost. Re-vitalize yourself. Reincubate energy. Be wholly alive. Write today! LINDSTROM & CO., 39 West Lake Street, Dept. C-135, CHICAGO

5-Room \$548

ALADDIN



We Pay the Freight

You can buy all the materials for a complete home direct from the manufacturer and save four profits on the lumber, millwork, hardware and labor.

6-Room \$695

ALADDIN

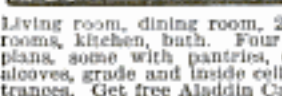

Living room, dining room, 2 bedrooms, kitchen, bath. Four other plans, some with pantries, dining alcoves, grade and inside cellar entrances. Get free Aladdin Catalog.

Price includes all lumber cut to fit; highest grade interior woodwork, siding, flooring, windows, doors, glass, paints, hardware, nails, lath, roofing, with complete instructions and drawings. Freight paid to your station. Permanent Homes—NOT PORTABLE. Many styles to choose from. Write nearest mill today for FREE Money-Saving Aladdin Catalog No. 953.

The ALADDIN Co., BAY CITY, MICHIGAN
Wilmington, North Carolina; Portland, Ore.; Toronto, Ont.

UNEXCELLED FOR BEAUTY AND EFFICIENCY

There is no truer in comparison with it at any price. The unswerving opinion of over 220 experts. Contains 2 tubes. Arranged to produce 3 wide efficiency. Solid magnesium cabinet with vacuum (no dry cell batteries and accessories). Licensed under Armstrong U. S. Patent No. 1,212,548. For Sale by Good Radio Dealers. Write for Descriptive Matter and Free Booklet, "Simplicity of Radio."

The Grosley Radio Corporation
1000 North Dearborn St., Chicago, Ill.

GROSLEY
Better—Cost Less
Radio Products

TRIRDYN 3R3 SPECIAL



MINT VENDING MACHINE

Pays \$10 to \$20 Day Profit

Pays Rent for Store Owner

Install one in your store or any public place and get this easy money. Requires no attention. Always works. Machine's profits pay the rent. Write us about rebuilt penny and nickel machines. Finished like new. In excellent running order. Pay their cost in 10 days.

Write or wire today for full particulars, \$25 down payment. Balance C. O. D. Export orders full down payment. Mints \$15 per case, 1,000 5 cent packages. Single boxes, 100 5 cent packages, \$1.50. **SILVER KING NOVELTY CO.**
400 Williams Bldg. Indianapolis, Ind.



HANDS UP!

Get one of these little beauties right now, and protect yourself against hold-up thugs, rowdies, etc. and at the same time it serves as the best novelty cigarette case ever invented.

Made exactly like the real thing! Just pull the trigger, back flies the lid showing a full package of your cigarettes.

Lots of fun scaring your friends and at the same time useful and a great protector.

Made of light weight metal, gun metal finish, 4 3/4 inches long. Sold exclusively by us. Order at once, supply limited. Special introductory price \$1.75 each. PAY POSTMAN on delivery our price plus postage. Money back if not satisfied.

PATHFINDER COMPANY

Dept. NK4B 534 Sixth Avenue New York



Pat. Pending

LOFTIS

BROS. & CO. F&S

DIAMONDS WATCHES

CASH or CREDIT

DIAMOND IMPORTERS

We import Diamonds direct from Europe and sell direct by mail—a great saving to you. Our Diamonds are "quality" gems, blue white, perfect cut, personally inspected by our expert buyers. We invite comparison.



"Muriel"
Diamond Ring
Beautiful Blue White, perfect-cut Diamond. Ring is Solid 18-k White Gold, basket mounting \$100
Also at \$75, \$125, \$150

"Norma"
Diamond Ring
Blue White, perfect-cut Diamond. Ring is Solid 18-k White Gold. \$375
Other Solid White or Green Gold rings at same price.

GENUINE DIAMONDS—GUARANTEED

SEND FOR CATALOG

Over 2000 Illustrations of Diamond-set Jewelry, Watches, Wrist Watches, Pearls, Mesh Bags, Silverware, etc. Sent prepaid for your Free Examination. Catalog explains everything.

Satisfaction Guaranteed or Money Refunded



"Sylvia"
Diamond Ring
Blue White, radiant, perfect-cut Diamond. Ring is 18-k solid White Gold \$100

Loftis Carved
"Perfection"
Diamond Ring
Blue White, perfect-cut Diamond, set in White Gold prongs. Ring is 18-k solid Green Gold \$50

"Amazon"
Diamond Ring
Brilliant Blue White, perfect-cut Diamond. Solid 18-k White Gold ring. \$150

CREDIT TERMS

All orders delivered on first payment of one-tenth of purchase price; balance in equal amounts within eight months, as suits your convenience.

WEDDING RINGS

All Platinum, \$25 up. With Diamonds: Three Diamonds, \$65; five Diamonds, \$80; seven Diamonds, \$95; nine Diamonds, \$110; surrounded by Diamonds, \$225. Solid White or Green Gold, \$5.00 up.

17 Jewel

Elgin

Guaranteed

25 Years

No. 15—Green

Gold, engraved,

assorted

patterns. 12

Size, gilt dial.

\$32



No. 16—Wrist Watch, Solid 18-k White Gold, 17 J., \$29.75; 14-k, 16 J., \$24.85

Railroad Watches—Guaranteed to Pass Inspection

HAMILTON NO. 992, 21 Jewels, Adjusted to 5 Positions, Gold filled 25-Year Case \$55

ILLINOIS "BUNN SPECIAL," 21 Jewels, Adjusted to 6 Positions, Gold filled 25-Year Case \$50

ELGIN'S LATEST RAYMOND, 21 Jewels, 8 Adj. Runs 40 hr. one winding. Gold filled 20-Yr. Case \$55

LOFTIS

BROS. & CO. F&S

THE OLD RELIABLE ORIGINAL CREDIT JEWELERS

Dept. C894 108 N. State Street, Chicago, Ill.

Stores in Leading Cities



Install a South Bend Lathe

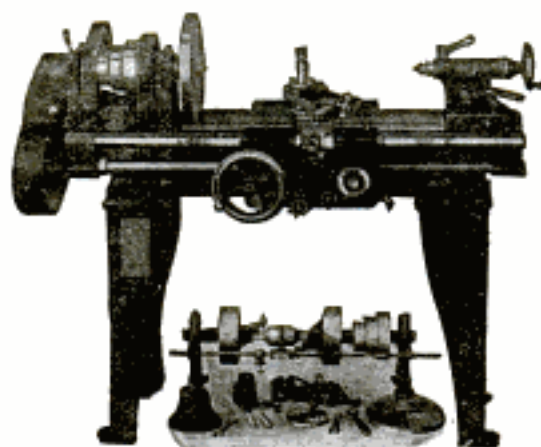

11' x 3' Standard Change Gear Lathe \$240.00

	Standard Change Gear	Quick Change Gear
9' x 3' Lathe.....	\$211.00	\$241.00
11' x 4' Lathe.....	248.00	288.00
13' x 5' Lathe.....	304.00	354.00
15' x 6' Lathe.....	376.00	431.00
16' x 8' Lathe.....	438.00	498.00

South Bend Lathe Works 559 East Madison Street
ESTABLISHED 1906 SOUTH BEND, IND., U. S. A.

Under Our Easy Payment Plan

This remarkable plan, offered for the first time by a reliable lathe manufacturer, enables you to make a South Bend Lathe pay for itself in your own shop.

A small payment puts it to work, the balance is paid a little at a time out of its earnings.

Write today for Circular No. 43 describing the EASY PAYMENT PLAN. Mention size Lathe desired.

Over 31,000 South Bend Lathes in Use

For your home shop!



PARKS
Cabinet Shop
Special

\$225.00

with all attachments
and motor

Here's an all-round woodworker for the small shop. Sturdy, fast and true. The biggest little woodworker ever built. Saw table has 8-in. rip and cross-cut saw, and 4-in. jointer and borer. You can choose from these extra attachments: band saw; shaper; sander; lathe; and motor.

Send for Bulletin C-S and complete Parks catalog.

The Parks Ball Bearing Machine Company
1500-1540 Knowlton St. Cincinnati, Ohio
Canadian Factory: 200 Notre Dame East, Montreal, Can.

PARKS
WOODWORKING MACHINES

New 1/4 H. P. 110 volt A. C. Guaranteed Motors
60 cycle, complete with cord, plug and pulley



Gen. Elec. 1725 speed \$14.75
Gen. Elec. 1/4 H. P. Rep. Ind. 39.00
Master 3/4 H. P. Rep. Ind. 52.50
Master 1 H. P. Rep. Ind. 60.00

Special values in rebuilt motors.

HYRE ELECTRIC CO.
615-T S. Dearborn St., Chicago, Ill.



It is the well known quality of CRESCENT machines that justifies you in selecting one of them each time you have need for wood working machinery. The CRESCENT line is better than ever and will always give you satisfaction in every particular. Ask today for catalog of hand saws, saw tables, jointers, shapers, planers, borers, splines and matchers, swing saws, disk grinders, cut off tables, hollow chisel mortiser, variety wood worker, Universal wood workers.

THE CRESCENT MACHINE CO., 83 Columbia Street, Leontia, Ohio

Write for free catalog illustrating and describing our complete line of 1500 Good Tools.

GOODSELL-PRATT COMPANY
Toolsmiths
Greenfield, Mass., U. S. A.

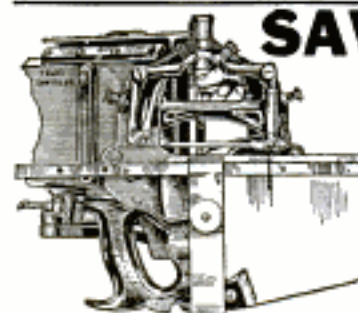

**SAW FILING
PAYS**

Buy a Foley Saw Filer and Setter and establish an independent, profitable business. Prices and catalog on request. Territory open to interested parties

FOLEY SAW TOOL CO.
3627 Portland Ave., Minneapolis, Minn.

Don't forget
your pliers*



Women too, should keep a pair of Bernards (No. 102) handy. For with Bernards, wire becomes as easy to manipulate as thread. You can cut it, bend it, straighten it, wind it and do the finest work. Bernards grip like a vise, and cut clean, close and easily. Don't forget to buy a pair today.

* BERNARD

Standard High-Power Cutting
PLIERS



No. 286 "Paragon" Revolving Belt Punches, six tube.

Catalog "P" free on request from

WM. SCHOLLHORN CO., NEW HAVEN, CONN.



Gerstner Tool Cases are unusual values. Selected materials, skilled workmanship, finest finish and the latest designs give a value that cannot be beaten.

Toolmakers and Machinists get our free catalog

Gerstner & Sons

408 Columbia St., DAYTON, OHIO

MATHEMATICS

can be easily mastered with the Midget 5 in 1 Slide Rule. With this calculator you can instantly add, subtract, multiply and divide any combination of decimals, fractions, whole and mixed numbers. Also obtain all roots, powers, Logs, and Trig. Functions.

It is used at all colleges, 200 at Harvard, 200 at Cornell, etc. The Engine-Divided Scales are on white celluloid, mounted on aluminum and are grease and waterproof. Diameter 4 inches. Price with Instruction Book \$1.50
Leather Case 50c extra. Catalogue Free. Your money back if you are not satisfied.
GILSON SLIDE RULE CO., Niles, Mich.



ONLY \$3.00

Quality Top and Die Set

5 Taps—sizes 1/4", 3/16", 1/8", 7/16", and 3/8"

5 Dies—to match

1 Die Stock

1 Tap and Reamer

Wrench

Hardness Chestnut Box

WORCESTER STEEL PRODUCTS CO.
Dept. 7, 25 Union St., Worcester, Mass.

"Interlox"

MASTER SLIDE RULE

The quick acting and durable rule. Slides out; no folding. Any length 2 to 8 feet, 20¢ per lineal foot. If not at dealers, sent postpaid. Dealers and Agents: request attractive proposition. Master Rule Mfg. Co., 941-43 East 136th St., New York

Takes inside as well as outside measurements accurately

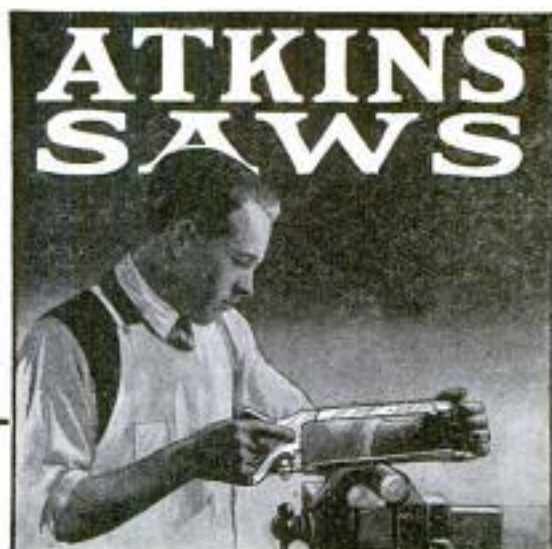

Shown above is Atkins No. 10 Hack Saw, with "Non-Breakable" Blade. Has "easy-grip" handle, nicked steel frame, adjustable for 8 to 12-inch blades

Saws for Every Use

For every man who uses saws, there's an Atkins saw to do the work easier, quicker and better. Here are a few of many popular Atkins saws. If your dealer hasn't the ones you want, write us, and we will see that you are supplied.

No. 400 HAND SAW
SHIP POINT



Finest saw made, in quality, workmanship and finish. Genuine SILVER STEEL BLADE, Ship point, 26-inch length, five gauges taper ground. Mirror Polish. Solid Rosewood Handle of Improved Perfection Pattern. Skew or Straight Back Blade.

JUNIOR MECHANIC
HAND SAW



A new saw for the Boy Scout and radio mechanic. Handy for home use, too. Blade 20 inches long, skew or straight back, nine points, taper ground, highly polished; beech handle.

No. 3 NEST
OF
SAWS



This set includes 12-inch keyhole blade, 14-inch compass blade and 18-inch special nail-cutting blade, interchangeable in adjustable handle.

Booklets FREE

"Saw Sense" shows Atkins wood-cutting saws, tells how to file saws and gives helpful facts on building. "Saws in the Shop" shows our metal-cutting saws, and contains many money-saving suggestions. Write for the booklet you want.

E. C. Atkins & Co., Inc.
Makers of "Silver Steel" Saws and Tools
Dept. P Indianapolis, Ind.

Please Mention Popular Mechanics

Copyrighted material

CEE TEE CO PLIERS

are covered by the same satisfaction guarantee that covers the genuine CRESCENT WRENCH

the year's "best buy" in pliers

—a genuine Crescent drop-forged, hardened, oil-tempered slip-joint plier with wire cutter and screwdriver, just like our higher priced pliers, except machine finish instead of hand finish reduces cost. Retail price 30c, at hardware and accessory stores.

Crescent Tool Co.
210 Harrison Street,
Jamestown, N. Y.

CRESCENT TOOLS

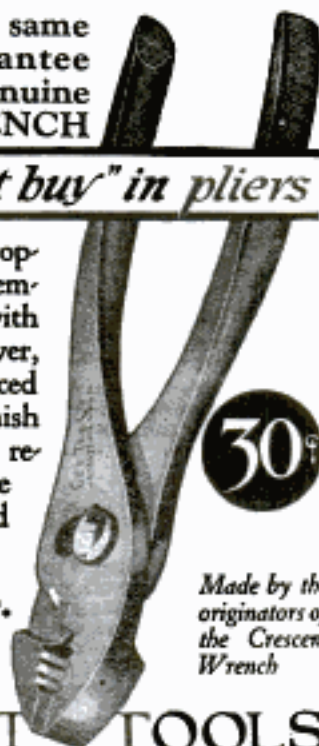

Made by the originators of the Crescent Wrench

Be Your Own Boss

Build a Profitable Business at Home

With a
**BOICE PONY
BENCH SAW**

Make screens, benches, tables, cabinets, lamps and all kinds of woodwork. You'll find a ready market in your neighborhood. The Pony Bench Saw combines six machines in one. It saws, sands, grinds, drills, dados and bevels. Saws 1 1/2" stock. Driven by 1/4 or 1/2 h. p. motor attached to any light socket.

Sold On Money-Back Guarantee

Write for descriptive folder on Bench Saws, Band Saws and Jointers.

Dept. P. M. 2
W. B. & J. E. BOICE, 1732 Norwood Ave., TOLEDO, O.



\$2 Brings This Genuine DIAMOND RING

No Red Tape
No Delay

SET IN
PLATINUM

Think of it—seven brilliant genuine diamonds massed in setting of solid platinum so closely together that only close inspection will distinguish it from a \$750 solitaire.



10 DAYS'
FREE TRIAL

Simply send \$2.00; if you can duplicate this diamond ring for less than \$65 your deposit will be refunded. Guarantee bond accompanies each ring. After trial, pay balance \$4.65 a month for ten months. Price only \$48.50.

FREE ROYAL CATALOG

Illustrates thousands of special offers in Diamonds, Watches and Jewelry from our \$2,000,000 stock. Write Dept. 1229.

ROYAL DIAMOND & WATCH CO.
170 Broadway, NEW YORK

TIGHTEN THAT LOOSE DRAWER HANDLE WITH SMOOTH-ON No. 1

Pack the Smooth-On around the bolt, washer and on the threads, and the handle can never again come loose. Try the same trick on any loose tool, knife, or umbrella handle, door knob, etc., and the result will surprise you.

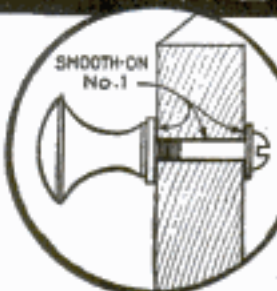

SMOOTH-ON No. 1

Get this
Booklet
Free

is also sure cure for leaks of water, steam, fire, etc., at cracks or breaks in metal. Just the thing for repairing radiators, heating boilers, furnaces, tanks, pipes, leaky pails, etc. Keep a can on hand for emergencies.

SMOOTH-ON
REPAIR
BOOK

Sold in 6-oz., 1-lb., 5-lb. and 10-lb. tins at all live supply stores.

SMOOTH-ON MFG. CO.

Dept. 37

574 Communipaw Avenue
Jersey City, N. J.

30 Days' Free Trial

Select from 44 Styles, colors and sizes, famous Ranger bicycles. Delivered free on approval, express prepaid, at Factory Prices. You can easily save \$10 to \$25 on your bicycle. Prices \$21.50 and up. \$5 a Month on any Ranger if posted. Payments often advanced first deposit. Boys and girls can easily earn small monthly payments. Pay as you ride. Best quality, at factory prices, express prepaid. Tires, lamps, wheels and equipment, low prices. Send No Money, do business direct with makers.

Mead CYCLE COMPANY
DEPT. 108 CHICAGO

Write today for free Ranger Catalog, factory prices and marvelous easy payment terms.



SEND NO MONEY Big 3 foot Telescope in 5 Sections

See people and objects miles away just like they were close, see Moon and Stars as you never did before. Brass bound, useful and entertaining. "Could tell color of aeroplane 4 miles away." "Mrs. Yarbrough." "Watch my boy arrive at school 2 miles away." "Mrs. Horn." "Read numbers on freight cars mile away, see mountains on moon." A. C. Palmer, Thousands pleased. SPECIAL OFFER: Send just your name. On arrival pay postman \$1.85 plus few cents postage. Satisfaction Guaranteed or money back. **FERRY & CO., 630 Jackson Blvd., Dept. C177, Chicago, Ill.**



"Have been watching submarine 8 miles off the coast." F. G. Hunt

Let
Hartman
Feather
Your Nest

FREE Bargain Catalog!

Absolutely Free—this great book with over 300 pages of amazing bargains in home furnishings, farm machinery, etc.—all on easy monthly terms and 30 days FREE TRIAL. Send postcard! **HARTMAN FURNITURE and CARPET CO., Dept. 6465, Chicago**

Only \$14²⁴

Down For
2 H-P. WITTE

(Throttling Governor)

Easy Terms on best engine built. Burns kerosene, distillate, gasoline or gas. Change power at will. Equipped with the famous WICO Magneto. Other sizes, 2 to 25 H-P.—all styles.

FREE—Write today for my Big Engine Book. Sent free—No obligation on your part.

WITTE ENGINE WORKS

1741 Oakland Avenue, - KANSAS CITY, MO.
1741 Empire Building, - PITTSBURGH, PA.





Magnified 225 Diameters

This is what the tip of a fly's leg is like when seen thru the

Wonderful New Ultralens Microscope

At last the high powered microscope is within the reach of all who wish to study, observe and experiment with the vast world of minute objects that are invisible to the naked eye.

Any amateur can immediately start using his Ultralens to examine the edge of a razor, the mesh of a cotton shirt, the bacteria in dirty water. No technical training required yet hundreds of scientists and teachers are using this instrument today. It is at once interesting, instructive, and scientific. Gives enormous magnification and perfect definition.



Order Today Order direct from this advertisement and get your Ultralens Microscope now. Fully guaranteed. If, however, you desire more information before purchasing, we will gladly send free descriptive catalog.

SCIENTIFIC APPARATUS CORP.
Dept. 209 MILTON, PA.

\$7.50
for
Complete
Outfit Prepaid

FREE LESSON IN DRAFTING

Send for our free lesson, which shows how easily you can master Drafting by the Chicago "Tech" Method and prepare for a high salaried job.

Increase Your Income
You get this pay-raising training by mail under the direction of our experts. The fees are moderate, the terms easy. Find out about this now. The lesson is free and we send our catalog with it. Write today.

CHICAGO TECHNICAL COLLEGE
830-A CHICAGO "TECH" BUILDING - CHICAGO, ILLINOIS

I Offer You \$8.00 a Day

and a

Buick
TOURING CAR

Write today for offer. \$8.00 a day to start and a Buick touring car if you make good. Demonstrate and take orders for Comer All-Weather Raincoats. Permanent, high-grade business. Largest company of its kind in the world. No experience required. We furnish complete outfit and instructions. Write now.

Comer Mfg. Co., Dept. 5W-597, Dayton, O.



SQUAB BOOK FREE!

Squabs are selling at highest prices ever known. Greatest market for 25 years. Make money breeding them. No mixing feed, no night labor, no young to attend. Start small, grow big. Start now. Read how our customers sell squabs for \$12 a dozen. We have been established for 25 years. Better look into this. Let us send you, at no cost to you, our big, illustrated free book telling how to make money breeding squabs. Address

Plymouth Rock Squab Co., 634 HSt., Melrose Highlands, Mass.

DEAFNESS IS MISERY

I know because I was Deaf and had **Head Noises** for over 30 years. My invisible Antiseptic Ear Drums restored my hearing and stopped Head Noises, and will do it for you. They are Tiny Megaphones. Cannot be seen when worn. Effective when Deafness is caused by Catarrh or by Perforated, Partially or Wholly Destroyed Natural Drums. Easy to put in, easy to take out. Are "Unseen comforts." Inexpensive. Write for Booklet and my sworn statement of how I recovered my hearing.

A. O. LEONARD, Suite 226, 70 5th Avenue, New York City

CAMERAS

Over a Hundred Styles and Sizes
Send for new illustrated catalog showing latest reduced prices. It's Free.

10 days' trial given

SENECA CAMERA MFG. COMPANY
300 Central Avenue Rochester, N. Y.



I PAY \$75.00 MEN a Week and up

I pay men \$75.00 a week and up by my plan which I want to send you at once. Be your own boss, work where and when you like. You can do fine even without previous experience. **Biggest values—positively sell on sight.**

Profits in Advance

My plan pays biggest profits and commissions in this line, paid in advance, we attend to delivering orders and collections.

Sell fine Tailoring



Astonishing values get orders easy when you show samples of our tailored to order, all wool, suits and o'coats, all one price \$31.50. Our advertising helps you take orders quick.

FREE

This big, fine sample outfit furnished free, contains 100 all wool big samples, all one price \$31.50, fine colored, fashions, stationery, supplies, tape, etc. All in classy fine carrying case. Also complete sales manual, we place you in Big Money class.

\$31.50
ONE PRICE
W.Z. Gibson

W. Z. GIBSON, Inc., CHICAGO, ILLINOIS
161 West Harrison Street, Dept. H-11

Please send me your plan for \$75 a week and up, also FREE outfit and sales manual.

Name _____

Address _____

City _____ State _____

70% PROFIT

Add to your profit with a

Kingery

Pop Corn Popper or Peanut Roaster

Every man, woman and child likes peanuts and popcorn. Dimes and nickels pile up fast. Small down payment. Easy terms. Write today for FREE BOOK.

KINGERY MFG. CO.

420 E. Pearl St. Dept. B Cincinnati





Turn Your Spare Hours Into Real Money

HAVEN'T you often wished for a spare-time way of making more money than comes in the regular pay envelope? Of the various ways which present themselves none is more pleasant or profitable than playing engagements in a Band or Orchestra.

Send the Coupon

For particulars of our Easy Payment Plan that tells How You Can Pay While You Play. Free Trial - We want you to try out a "King" in your own home, without obligation, and if you do not find the "King" the very best instrument you ever played--return it.

Trade-in-Proposition -- Turn in the instrument you now own as part payment on a new "King". Our latest catalogs show many new model "Kings" and tell why they are the best instruments to learn on and play on. Use the coupon to order your copy.

THE H. N. WHITE CO.
5211-54 Superior Avenue, Cleveland, Ohio

Please send me free, your latest catalog on

Instrument.

Name _____

Address _____

City _____

State _____

A \$30.00 Repair Job for \$7.50

Adjusto
THROUGH BEARING



\$7.50 Postage Paid

Doubles the Life of Any Ford Car or Truck

Takes End Play out of Crankshaft and Transmission
AND KEEPS IT OUT!

Takes Jerk out of Clutch and Chatter out of Gears. Saves the Expense of Overhauling and Rebuilding Transmission.

Easy to install, Without Removing Motor. **ORDER NOW FROM**

DURHAM ADJUSTO BEARING CO.

9325-M Grand River Avenue

DETROIT, MICH.

TRADE MARK

NATHAN

Seat Covers for Fords \$2 to 4.50

Nathan Seat Covers protect clothes from dust, dirt and grease--give exceptional service and value. Low in price, washable, strongly made--buttoned on and off in a jiffy. Ready to attach with all necessary fasteners. **Order by number.**

The Nathan trade mark assures best quality and smooth fit.

FM 1141 Roadster 1914-24.....	\$2.00 Complete Set
FM 1142 Touring 1914-24.....	4.30
FM 1144 Sedan, Old 2 door, up to 1923 inclusive.....	4.50
FM 1146 Sedan, 4 door, 1923 and 1924.....	4.50
FM 1187 Sedan, New Tudor 1924.....	4.50
FM 1184 Coupe, All up to including 1923.....	2.50
FM 1186 Coupe, 1924.....	2.50

Send for free booklet of bargains. AGENTS--write for these and other money-making specialties.

NATHAN NOVELTY MFG. CO.
Dept. P.M., 2157 Prospect Ave., New York, N.Y.



RE-MANUFACTURE FORDS

Start a **FORD Service Station**

THE MOST PROFITABLE BUSINESS ON EARTH

FORDS REMANUFACTURED BY THE FACTORY PROCESS

SQUARE DEAL GARAGE



\$14,355.00 Profit on 300 Jobs

Facts and figures from hundreds of KRW Equip Shop Records.

9,000,000 Fords Need Repairs

Are you getting your share of that business?

\$850 Completely equips your shop to RE-MANUFACTURE Fords

We can furnish entire equipment for cash or on easy payment plan. Ford Motor Co. recommend these tools. Catalog.

K.R. WILSON, 13 Lock St., Buffalo, N. Y.

RECOGNIZED HEADQUARTERS FOR

TENTS

ALL TYPES - ALL SIZES
GET OUR PRICES

Camp in Comfort

"OUTDOOR" Auto Tents embody patented features found nowhere else. Made of highest quality. Close Count specially woven drill, absolutely water-proof, mildew-proof and shadow-proof. Umbrella Tents have sewed in floor cloth; come with or without center pole; can be equipped with Cot Trussion (patented).

"Outdoor" Tourist Bungalow

Exclusive Patented outfit. Fits to fit running-board. Nothing like it. Comfortable complete, compact, includes double bed, table, benches, covered trunk, and shelves for supplies. Up easy, quick. Durable. Water-proof.

WRITE TODAY for complete catalog of Tents and Camp Equipment--sent FREE.

United States Tent & Awning Co.
Edward R. Litzinger, President
731 North Sangamon Street
CHICAGO, ILL.



I Made \$100,000

in less than five years as a real estate specialist. Started during my spare time, with no experience and less than \$5 capital. If you want to learn the secret of my success and follow my money-making method, send your name and address at once to American Business Builders, Dept. A-448-A, 1133 Broadway, New York. They send full information free, telling you how you can build up an independent, profitable business of your own by using my amazingly successful system.

Drive 100 Tacks and Save \$25

on your next Top or Seat recovering. Fords \$3.75 to \$10. Chevrolets \$7.95 to \$10. All other cars \$9.95 to \$22. Our Plate Glass Lights enhance the value of your car. Side Curtains \$5.95 up. Seat Covers \$2.50 to \$32. Quality and fit the best. Our instructions make it easy to apply. Send for samples. Our prices include delivery at your door. Eastern orders shipped from Ohio.

\$375 up delivered

Auto Equipment Co., 1117 So. Main St., Los Angeles, Calif.

MOTORCYCLE BARGAINS

Save 25% to 65%

on Slightly used and Rebuilt Motorcycles, Side Cars, Johnson Motor Wheels, Evans Power Cycles, Bicycles. Send for Free Bargain Bulletin and Money Saving Message, listing hundreds of bargains in used, rebuilt and new machines, supplies, accessories, etc.

AMERICAN MOTOR CYCLE CO.
Dept. 827, 2047 W. Chicago Avenue, CHICAGO



WRITE FOR FREE BOOKLETS describing and illustrating complete line of **IVER JOHNSON** Bicycles, Velocipedes, Revolvers and Shot Guns.

IVER JOHNSON'S ARMS & CYCLE WORKS
4 River Street
FITCHBURG, MASS.

Roofing Book FREE



World's Best Roofing at Factory Price

Don't buy Roofing of any kind until you get our big Free Roofing Book, describing full line of Edwards Famous "Tightcoats" Galvanized Roofings, Sidings and Ceilings, and our lowest factory prices. Then see for yourself how much we save you by selling direct and saving you all in-between dealers' profits.

EDWARDS "REO" Metal Shingles

Absolutely rust proof. By our patented "Tightcoats" process, edges as well as sides of metal sheets are heavily coated with zinc—not a space the size of a pin point exposed to weather. Fire and lightning proof. Outlasts three ordinary roofs. Forever wind and weather proof. Need no repairs—and all roofing expense. Patent INTERLOCKING DEVICE makes water tight seams—all nail heads covered—no chance for rust or leaks.

EDWARDS Galvanizing Test

Edwards "Tightcoats" Galvanized Roofing can be bent, twisted or struck by lightning, and the galvanizing will not crack or flake. Bend it or hammer it—you can't loosen or scale the galvanizing. No other galvanized roofing can withstand this test.

Low Priced Garages

Wide variety of styles, all sizes of Portable Fireproof Metal Garages. Lowest prices ever made. Postal Bureau Big Garage Catalog free.

Write Today for free samples and proof that we can save you a lot of money on any kind of roofing, siding or ceiling you may need. Ask for Roofing Book No. 100.

THE EDWARDS MFG. CO.,
800-850 Pike St., Cincinnati, O.

FREE
Samples &
Roofing Book

SHAW MOTOR ATTACHMENT MAKES YOUR BIKE A MOTORCYCLE!

A high grade 2½ H. P. motor attachment quickly clamped on any bike frame. Speed 4 to 40 miles an hour. 90 to 125 miles per gallon of gas.

Special Low Price Now! Write today for Complete Description and Special Low Prices on SHAW Motor Attachments and the SHAW Complete Motorbicycle. **SHAW MANUFACTURING COMPANY**
Dept. 37
Galesburg, Kansas



MOTORCYCLES



RELIABLE STANDARD MAKES that you can **DEPEND** on. Enjoy the glorious experience of going wherever you like—wherever you like. The price is within your means—25% to 50% less than others. These machines are slightly used, thoroughly overhauled or rebuilt. **Send for catalogue.**

MYEROW BROS.,
15 Berkeley St., Boston, Mass.

DOUBLE YOUR INCOME

by selling Style-Center all-wool, made-to-measure Suits and Overcoats for \$23.50. Thousands of pleased customers. Full-time salesmen make \$75 to \$150 a week—easy—right at the start. 200 attractive samples. Fall Lines Ready. Write us today.

STYLE-CENTER TAILORING CO.
Dept. 502, Sixth and Broadway
CINCINNATI, OHIO

These FORDS ran 35 to 48 Miles on Gallon of Gasoline with Air Friction Carburetor



We guarantee any Ford 34 miles to the gallon of gasoline and 30% to 60% more power and "pep" on it or any other make of car. Guarantees of mileage on other cars given below. Guy Bickford, Newman, N. Y., writes—"Put it on 1922 Ford—got about 35 miles per gal. and go up hills on high I hardly dared go up on low." Gust. Zima, Grand Haven, Mich., writes—"I have been to Chicago, distance 188 miles on 4½ gals. of gas—average better than 40 miles to the gal. on my 1922 Ford." Albert Wieske, Chamberlain, S. D., writes—"Used my Air Friction Carburetor for two years on Ford and made as much as 40 miles on a gal. of gas." W. W. Parker, Mabank, Tex., writes—"Formerly got 17 miles to gal. of gas with my 1922 Ford—now get 40 with Air Friction Carburetor on." Wm. H. Tappen, 648 Ocean Avenue, Lakewood, N. J., writes—"I have used Air Friction Carburetor 13 years and get 38 miles out of Ford truck on one gal. of gasoline." Y. H. Gregory, Box 185, Morristown, N. J., writes—"Air Friction Carburetor gets 35 miles per gal. on my Ford car. Engine not in good condition, but think soon to go more miles than any other." What these men have done any other man can do. Don't take our word for it. Try it out on your own car—30 days' trial and money refunded if not satisfied.

SENT ON 30 DAYS TRIAL

We guarantee all other makes of cars to nearly double present mileage and power, flexibility and to make hills on high formerly difficult in low. Carburetors shipped same day order is received for any make or model of car, truck, tractor, marine or stationary engine with full guarantee of performance or money back. Makes old cars better than when new.

STARTS EASY AT ZERO

or colder with out priming or heating—hundreds of letters to prove this from satisfied users. See our wonderful mileage guarantees or money back for other makes of cars:

Ford.....34mi.	Reo.....24mi.	Chevro't.....32mi.
Bulk4...30mi.	Chalm...23mi.	Max'(25)30mi.
Bulk6...24mi.	Olds6...23mi.	Nash6...23mi.
Hudson...20mi.	Paige6...20mi.	Lincoln8...17mi.
Hupp...25mi.	Oaklnd6...24mi.	StdbkrL.623mi.
Dodge...28mi.	Over'd4...32mi.	Coia8...17mi.

If your car is not mentioned here send us name and model number for particulars and our guarantee on it. Cadillacs and Lincoln report 18 to 20 miles on gal. You can drive any car in heaviest traffic without shifting gears. Starts off on high in any weather without priming or heating—no jerking or choking. No more foul spark plugs or carbon in cylinders. No leaking of gas into crank case. Try it 30 days on our guarantee of money back if not entirely satisfied. No strings to our guarantee. **YOU ARE THE JUDGE.** Anyone who can handle a wrench can attach it. No boring of new holes or changing of operating mechanism.

AGENTS WANTED We want car owners, agents and dealers in every city and town. Special agent's introductory and demonstration discount given on first purchase for your own car. Many farmers make more money in winter selling Air Friction Carburetors to neighbors than they make on their farms in summer. Write today. No trouble to use your car all winter with Air Friction Carburetor on.
THE AIR FRICTION CARBURETOR CO.
1075 Raymond Bldg., Dayton, Ohio, U. S. A.

Tire AGENTS WANTED

Use and introduce **MELLINGER CORD TIRES**
12,000 MILES GUARANTEED

Lowest Wholesale Prices in America. Shipped prepaid on approval. Make big money all or part time. No capital or experience. Sample sections furnished.

Your Tires Free! Simply send name today for valuable **FREE BOOK**, tells how thousands have gone into big business. **SPECIAL AGENTS' OFFER.** Wholesale Prices and **FREE SAMPLE KIT.**

MELLINGER TIRE & RUBBER CO.
1769 Grand, Kansas City, Mo. \$600,000 Capital



MAKE YOUR FORD INTO THIS SPORT CAR—SAVE \$50 to \$150 WITH **Red-i-Kut** Life-Size Patterns \$6.40

Famous **Red-i-Kut** life-size patterns and pleasure-fit instructions show you how you can easily convert your Ford into this Fast, Snappy Sport Car as thousands have done, with easily-obtained tools. No need to lay up the car. **LOOK AT WILFRED ENO'S PAL—3000 says, "Total material cost with steel and paint for my Pal only \$14.25. It took me just 3 Sundays to build it and I sure am proud to hear them say, 'He built that snappy sport car.' I never cut any steel or did any woodwork before but one cut of cross with my hand saw." (Overland City, Mo. Louis, Mo. The "Pal" with crossed metal streamline rear,**

life-size patterns for each part of the body so you can't go wrong, picture instructions and **CONICAL DISK WHEEL PATTERNS** Only \$2.49 delivered. Order now while we can make good delivery, and really enjoy these wonderful days in your "Pal." Keen, Glossy, Up-to-the-minute. You can build it. Over 11,000 in use. Don't hesitate. "Swing Lo" Underbody Irons, no frame cutting kind, only \$6.59. Send in soon for new manual of other distinctive sport body patterns from \$2.50 up —"RKO" Steel "Swing-Lo" Irons, "Jiffy" Top and "Gower" Windshields. **Kaempel Co.,** 51 Kaempel Bldg., Gettensberg, Iowa



WORLD'S GREATEST Bargain Book FREE

Hosiery and Underwear—Direct from Mill



Take this money-saving step today. Send for this FREE catalog and see for yourself the wonderful values offered in **World's Star Hosiery and Klean Knit Underwear**. A big, beautiful book in colors. Most complete of its kind printed. Accurately and truthfully pictures and describes more than 5,000 bargains. It offers you the easiest, best way to buy your season's needs and make certain of getting the very best, long wearing quality at the lowest possible prices.

Amazing Savings Every page of this wonder book is a bargain surprise. You can hardly believe such values are possible. Big hosiery bargains by the hundreds in silk, wool, mercerized, cotton, for men, women and children. Scores of underwear bargains in all weights, grades and kinds for every member of the family. Don't miss this opportunity. Write today. Send postcard or letter **now**.

World's Star Knitting Company 278 Lake Street
BAY CITY, MICHIGAN



AGENTS, \$90⁰⁰ A Week!

Men and Women! If you earn less than \$50.00 a week I can place you in a position with a wonderful opportunity. With new plans you can make \$2.00 to \$5.00 an hour spare time, up to

\$15.00 a Day! Pleasant, dignified work. No experience necessary. No delivering or collecting. No capital required. If interested address me by special Day—Send me Free Cash Order." L. M. Nims, General Manager.



How Bleachodent Whitens Dark Teeth In Three Minutes

Bleachodent Combination contains a mild liquid to soften stains—and a special paste which gently removes them. Dull, yellow or tobacco-stained teeth are made flashing white, sparkling clear—almost while you wait! Perfected by two prominent dentists. Just use liquid once a week—paste every day. **Keeps** teeth wonderfully white and lustrous. Don't go around with bad looking teeth. They spoil appearance, and besides cause tooth decay, and bad breath. Get Bleachodent COMBINATION (containing both liquid and paste) for small cost. Distributed by Bleachodent Dental Laboratories and sold by drug and department stores everywhere.



RAISE BELGIAN HARES

New Zealand Reds—Flemish Giants—American Blues
FOR US—BIG PROFITS—WE SUPPLY STOCK AND PAY \$2 TO \$8 EACH. Also other fur bearing animals; easily raised anywhere. Large Catalog and Contract **FREE!** Big Illustrated Rabbit book, and copy of our large small stock magazine free.

OUTDOOR ENTERPRISE CO., 1065 S. E. St., Kansas City, Mo.

Sell GOOD Tailoring

Make \$65⁰⁰ to \$100⁰⁰ a Week

You can earn a steady income by selling Bradley's fine made-to-measure suits and overcoats direct to wearer. Finest hand tailoring. Over 140 Virgin Wool, water-shrunk fabrics. \$38 values all for one price—\$32.50. Satisfaction guaranteed or money refunded. Every man a prospect.

PROFITS IN ADVANCE

Liberal commissions in advance. Repeat business sure. No deposit on \$27 outfit if you send references and facts about yourself. Write for sample today!

Robt. E. Bradley, Inc.
Dept. PM-5, Indianapolis

FREE

Actual Coat Front

Proves the quality. Sells for you. An exclusive Bradley feature.

AGENTS 500% PROFIT

GENUINE GOLD LEAF LETTERS

\$ guaranteed to never tarnish. Anyone can put them on stores and office windows. Enormous demand, large profits. Paul Clark says: Smallest day \$28.70. R. L. Reel made \$920 in two months. Write today for free sample and liberal offer to general agents.

METALLIC LETTER CO., 433-B N. Clark St., CHICAGO

21 Jewels

Nothing less than 21 Ruby and Sapphire Jewels is good enough for the Burlington masterpiece.

Quality and Style

Adjusted to the second—temperature—ionization—positions. 20 year Gold Strata Case. In 100 exquisite designs. Only \$1 down. Balance in small monthly payments. Send for free book.

Burlington Watch Company
19th Street and Marshall Boulevard
Dept. C-135 Chicago, Illinois



Summer Home in Maine

A gentleman's estate of 175 acres on the Maine coast, with frontage on a lake 9 miles long; master's house; large bungalow; caretaker's house; large garage; barns; private electric light and inexhaustible water works, and every modern improvement. Forty acres very large trees. Golf and yacht clubs only a few minutes away; good markets in the town.

The scenery of mountains, lake and ocean is pronounced one of the best five in New England. House and bungalow both completely furnished; steam heat.

Will be sold at a great bargain.

Address OWNER

206 East Ontario Street

CHICAGO, ILL.

Healthful Heat without Dust or Dirt!

Few people realize how the ordinary furnace contaminates the atmosphere they have to breathe. The wall paper and draperies in many homes heated with the common type of furnace are always covered with a fine dust and soot. Think of having to breathe that dust-and-dirt-laden air all winter!—to say nothing of the fire poisons which leak out through the seams of the average furnace.

Now read this: "The FarQuar Heating and Ventilating System installed in my home two years ago, has proven satisfactory. It has kept my house at an even temperature of 70 to 75 degrees both night and day. The air is always fresh and pure; no dirt, dust, smoke or dangerous gases, thanks to the air tight drum. It has done everything promised for it. It regulates itself and ventilates automatically, and requires attention only once every 24 hours. It is very economical; have only used 7 tons of soft coal to date." C. G. Smith (Missouri).

And here are the Exclusive FarQuar Features which make such results possible

—One piece, electrically welded, steel fire-box prevents escape of dust, dirt, gases and fire poisons.

—Large grate area with complete downdraft insures slow combustion and economy of fuel.

—Automatic control actuated by fire-box keeps fire under perfect control, maintains

an even temperature throughout the house in any weather, and makes firing necessary only once a day.

—Vent and Return System removes all stale, devitalized air, floods the rooms with pure, fresh air, gently warmed, and insures a uniform distribution of heat to all rooms.

Write today for free illustrated booklet.
Dealers and Sales Representatives wanted.

The Farquhar Furnace Company
1608 Farquhar Bldg. Wilmington, Ohio

THE
FARQUAR
HEATING AND VENTILATING
SYSTEM

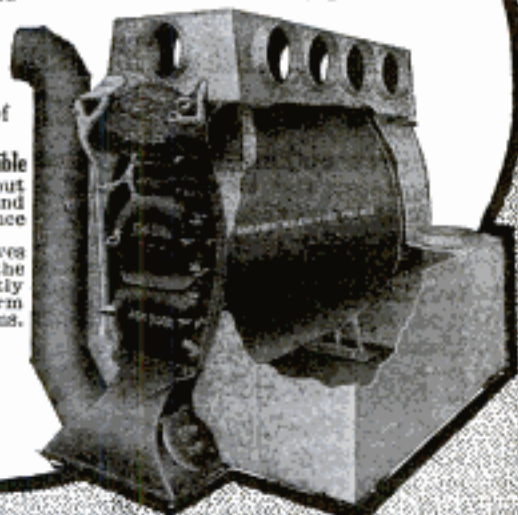

Drive This Beautiful Raceabout Instead of Your OLD FORD



Choice of Four Colors; Fiat or the Bullet Nose Radiator Shell. Send for 1924 Free Catalog of New Auto Accessories, Bodies and

Speed Equipment. Direct from Factory.

AMERICAN TOP AND BODY CO., Park Ave. DELPHI, IND.

Beautiful HOUSES \$900 and BUNGALOWS

CAN BE BUILT FOR AND UP

This and many others in my new book, Building Plans for Modern Homes, will save you hundreds of dollars. One of the most complete and comprehensive books of plans ever published by any architect. New edition just off the press. Nearly 500 floor plans and photographs of bungalows, Colonial houses, etc., costing from \$200 up; gives sizes and cost to build. Sent postpaid for \$2.00.



FREDERICK H. GOWING
ARCHITECT
101 Tremont St., BOSTON, MASS.

Prices Reduced On All Standard Make Typewriters Lowest Prices in Years



We will ship any make you choose for one week's trial, Underwood, Royal, L. C. Smith, Remington, Oliver, etc.

Easy Terms Pay less than rent each month and own a typewriter. Guaranteed good as new. Perfectly rebuilt by experts—the famous "Young Process." Send for our free trial offer and new low price list now. Write today.

Young Typewriter Co.

654 W. Randolph St., Dept. 1108, CHICAGO, ILL.



"Been on a
vacation
Bill?"

"No, Jim—I've stopped smoking. Gained six pounds in a week. You know how I used to smoke—a package of cigarettes and a cigar or two a day—it sure had some hold on me. But I'm cured—

took a scientific home tobacco treatment—fixed me up in two weeks.

"Wasn't hard on me at all—noticed improvement the first day—I feel like a new man. It didn't interfere with my work—didn't leave any druggish after-effects—the money I saved in the last two weeks has paid for the treatment alone.

"Why don't you take it? It has cured men like you and me for over forty years—it is a doctor's individual prescription that sure fixes you up. Just send the coupon for full information NOW. No obligation. All correspondence is strictly confidential."



A Doctor's
Prescription

The Keeley Institute, Dwight, Ill.

Please send me, without any obligation on my part, your free booklet which will tell me how to rid myself of the tobacco habit.

Name.....

Town.....

Street..... State..... P. M.-8



Get Behind a Hohner for Happiness!

There's nothing like good music for happiness; and there's nothing like a Hohner for good music. Any boy or girl can learn to play real music quickly with the aid of the Free Hohner Instruction Book, procurable at all good dealers. And all good dealers sell Hohner's Harmonicas—

The World's Best

"That Musical Pal of Mine" is a favorite expression among Hohner enthusiasts everywhere. Hohner enthusiasm is sweeping the country. Why don't you get in line for popularity and enjoyment?

Go to your dealer today, get a Hohner Harmonica—50¢ up—and ask for the Free Instruction Book. If your dealer is out of copies, write M. Hohner, Inc., Dept. 181, New York City.

HOHNER HARMONICAS

AGENTS—NOW IS THE TIME TO INCREASE YOUR INCOME—A SPECIALTY WITH A REAL SALES APPEAL.

Sell this improved, electrically heated, highly finished, Aluminum peanut machine. A SALE A DAY MEANS \$350 PER MONTH. New and exclusive features. Weighs only 8 pounds. Write for FREE booklet, "The Flash Gets the Cash" and learn the facts.

MABEY ELEC. & MFG. CO.
968 FT. WAYNE AVE. INDIANAPOLIS



"If I hadn't been all through it myself, I wouldn't have the assurance to say to you 'cheer up.'"

ERICKSON.

Those who wear them say:
ERICKSON LEGS are Wonderful
because they do not chafe, overheat or draw end of stump.



If you have had a recent amputation send for new booklet on TEST LEGS for beginners.
E. H. ERICKSON CO.
38-A Washington Av. N. W.
MINNEAPOLIS - MINN.

Different from all others—the NEW BENJAMIN

AIR RIFLE

Made on a different principle from all other Air-Rifles. The Benjamin is really a strong air-pump used to compress the air in the air chamber to any degree of power desired. From one to six strokes of the pump give all the force necessary. Each additional stroke gives increased power. The Benjamin works on the same principle as all air-drills and air-hammers—with this difference:

You control the shooting force as you desire. Look at this block of hardwood. It shows how Benjamin power is regulated as you wish.

You can't have accidents with a Benjamin. It's safe, always, because you control the power. The Benjamin never loses shooting force, and has no springs to get out of order or shake your aim. Write us for an interesting folder about this wonderful air-gun.

If your dealer does not handle ours, send direct to factory—
(PRICE \$5)
(POSTPAID)
BENJAMIN AIR-RIFLE & MFG. CO., 515 N. Broadway, St. Louis, Mo.

Ask your dealer for demonstration.

Pacific-Coast Representatives
THAYER & BOWEN
Los Angeles, Calif., and San Francisco, Calif.

Sell Shirts



Sell Madison "Better-Made" Shirts, Pajamas, and Nightshirts direct from our factory to wearer. Nationally advertised. Easy to sell. Exclusive patterns. Exceptional values. No experience or capital required. Large steady income assured. Entirely new proposition.
WRITE FOR FREE SAMPLES.
MADISON SHIRT CO., 803 B'way, N. Y. City

Clear-Tone FOR PIMPLES

Your skin can be quickly cleared of Pimples, Blackheads, Acne Eruptions on the face or body, Enlarged Pores, Oily or Shiny Skin. \$1,000.00 Gold Cash says I can clear your skin of the above blemishes.

FREE WRITE TODAY for my FREE Booklet—"A Clear-Tone Skin"—telling how I cured myself after being afflicted for fifteen years.

E.S. GIVENS, 129 Chemical Bldg., Kansas City, Mo.

Send No Money

Ladies' Solitaire Examination Free

This perfectly cut Diamond will be sent free of charge for your complete examination and approval. No money in advance. If satisfied, pay only \$2.00 on arrival and keep it. Price \$30.00.

10 MONTHS TO PAY

The balance you send in 10 small monthly payments—only \$2.00 a month. Take advantage of this amazing offer today.

FREE De Luxe Catalog in colors. Write for details of Great Diamond Offer and Book to Dept. 64-N
Capital \$1,000,000



THE HOUSE OF QUALITY
AUTHORIZED CAPITAL \$1,000,000.

L.W. SWEET INC.

Dept. 64-N 1660 BROADWAY, NEW YORK

Wrestling Book FREE



Learn to be an expert wrestler. Know scientific wrestling, self-defense, and jiu-jitsu. Develop a splendid physique, and have perfect health. Join this popular school and learn by mail. The famous world's champions—the marvelous

Frank Gotch and Farmer Burns

offer you a wonderful opportunity. Wrestling is easily and quickly learned at home by mail. Men and boys write now for splendid free book. Learn all the science and tricks. Be able to handle big men with ease. Accept this wonderful offer NOW. Send for free book today, stating your age.

Farmer Burns School of Wrestling, C977, Range Blvd., Omaha, Neb.

Build This Phonograph Yourself

TREMENDOUS SAVING IN COST

Easy, fascinating work with our SIMPLIFIED PLANS. We furnish blue prints, diagrams, motor, cabinet pieces, ready-built horn, etc. You don't need to be a cabinet maker. A few hours assembling and you will have a fine instrument at one-quarter the regular retail price. AGENTS MAKE MONEY making and selling these instruments. Write today for full details and our FREE OFFER. Address

LUPERL PHONOARTS CO.
2648 W. Chicago Ave., Dept. 16 CHICAGO, ILLINOIS

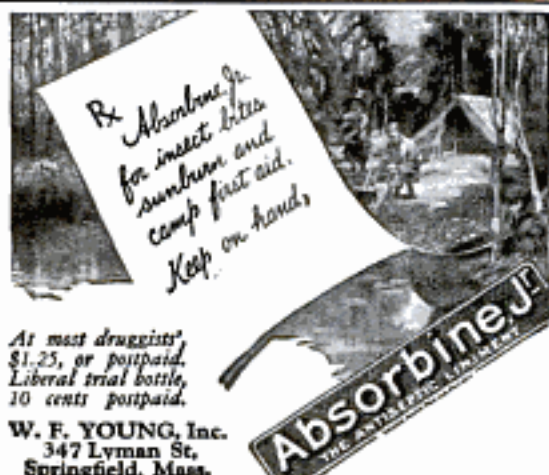

At most druggists,
\$1.25, or postpaid.
Liberal trial bottle,
10 cents postpaid.

W. F. YOUNG, Inc.
347 Lyman St.
Springfield, Mass.

WURLITZER

TRADE MARK REG
THE WORLD'S LARGEST MUSIC HOUSE



200 Years Ago in the little Saxon town of Saxe-Weissenfels lived Hans Adam Wurlitzer, Master Violin Maker. His shop was a gathering place for musicians of the time, for he was a true craftsman.

When he died his shop passed into the hands of his eldest son, and for seven generations, down to the present day, the descendants of Hans Adam Wurlitzer have carried on his work.

Today in every Wurlitzer instrument you will find a quality, a character, that could not come from mere excellence of manufacture. It is the heritage of these seven generations of music craftsmanship.

Try any Wurlitzer Instrument in your Own Home

YOU may now have any Wurlitzer instrument for a week's free trial in your own home. Examine the instrument, show it to your friends, play it as much as you wish. No obligation to buy—no expense for the trial. We make this liberal offer because we want you to try for yourself these wonderful instruments, the result of 200 years' experience in musical instrument building.

Easy payments are arranged to suit your convenience. This is your opportunity to try a famous Wurlitzer instrument in your own home.

Send for New Catalog

The greatest musical catalog ever published! Over 3,000 articles—every known instrument described and illustrated; many of them shown in full color. Gives you lowest prices and all details of Free Trial, Easy Payment plan. All sent FREE—no obligation

Send this Coupon

THE RUDOLPH WURLITZER CO., Dept. C177

120 W. 42nd St., New York 117 E. 4th St., Cincinnati

329 S. Wabash Ave., Chicago 250 Stockton St., San Francisco

Send me, absolutely free, your new illustrated catalog, with prices and description of every known musical instrument. Also tell me how I may try any instrument in my own home and pay for it in small monthly sums. No obligation.

Name _____

Address _____

City _____ State _____

Instrument _____

(State instrument in which you are interested.)

Copyright, 1924, The Rudolph Wurlitzer Co.

Guaranteed HEATING Systems

Save 25% on Your Heating System by Ordering Now!

If you're going to build, improve, or remodel, buy now while material is plentiful and low prices prevail. Avoid costly delays, material shortages and high prices. Don't wait until the snow flies to do your planning.

Expert Engineers

Practical men are waiting here to help you solve your plumbing and heating problems. They will aid you in adding comfort and health in your home at lowest possible expense.

See What You Save!

Some idea of our low prices can be had on the following guaranteed efficient heating systems for an average sized bungalow with five rooms and bath.

\$93 **\$125** **\$315**

Single register warm air heating system. **Warm air pipe heating system.** **Perfection Hot Water Heating System.**

Perfection Heating Systems are furnished complete to the last fitting with square or round boilers as wanted.

Plumbing Systems

We furnish every needed item to completely install guaranteed plumbing systems. The bathroom outfit shown includes bathtub five foot long, white porcelain enameled on the inside, low pattern white tank (elbow out) and white porcelain enameled lavatory complete with all fittings above and below floor line, special \$70.00



HARRIS BROTHERS CO.

Dept. WC-7

35th and Iron Streets
CHICAGO, ILL.

A LINE FROM YOU WILL BRING FULL DETAILS

AGENTS WE START YOU WITHOUT A DOLLAR

Famous Carnation Products—Creams, Soaps, Extracts, Perfumes, Toilet Goods, Household necessities. Widely known line; 200 items, 100% profit, repeat orders enormous. We give agents big concessions. Experience unnecessary. Write today. Carnation Co., 144 St. Louis, Mo.

TURN WASTED TIME INTO MONEY



Every purchaser finds numerous uses for

Torit Acetylene Torch No. 13

Uses nothing but acetylene. No oxygen or air pressure required. Tips suck in air. Simply connect to Presto auto tank, light gas, and outfit is put to work.

Beats anything you ever tried for soldering, heating, melting, and light brazing.

Outfit consists of 4 tips for different kinds of work, soldering copper, 5 ft. tubing, tank connection, and full instructions.

ST. PAUL WELDING & MFG. CO.
177 W. Third Street ST. PAUL, MINN.

\$750 in U. S. A.

\$10.00 in Canada



GET THIS WONDERFUL RING

IF YOU CAN TELL IT FROM A GENUINE DIAMOND SEND IT BACK These Absolutely Beautiful CORODITE Gems match the scintillating beauty of GENUINE DIAMONDS in every way. They have the same gorgeous blazing flash and dazzling play of living rainbow fire. Standing the terrific Acid Test of direct comparison. Life time experts need all their experience to see any difference. Prove this yourself.

Make this Test Wear a Genuine CORODITE and a Diamond side by side on the same finger. If you and your friends can tell the difference send it back, you won't lose out a penny. That's fair enough. If you keep the ring, price printed here is all you pay. Remember CORODITES alone have the same facet cutting as Genuine Stones.

No. 1 Ladies Solitaire 14K Gold Filled Ring \$2.84
No. 2 Ladies Pierced Filigree 4 Post Ring, Platinum effect \$2.19
No. 3 Ladies Hand Carved Basket Ring, Platinum effect \$3.96
No. 4 Ladies Bridal Blossom Engraved Solitaire \$3.94
No. 5 Men's Heavy Belcher 14K Gold Filled Ring \$3.68
No. 6 Men's Massive Hand Carved Hexagon Gypsy \$4.28

Carat Size Gems. Beautiful Hand Carved and Engraved. Mountings of most modern design, bearing an unqualified 20 year guarantee. Art Leatherside and Velvet Lined Gift Cases Free with each ring.

SEND NO MONEY Keep your money right at home. Just send name, address and number of ring wanted and size, as shown by slip of paper fitting end to end around finger joint and your ring will come by return mail. Deposit amount shown above with postman. You do not risk a penny as our binding legal guarantee to refund your money in full is attached to every ring we sell. **SEND TODAY.**

E. RICHWINE CO., Dept. 153 19 West Jackson Blvd.
CHICAGO, ILLINOIS

Sole Importers Genuine Corodite Gems

TYPEWRITERS



\$50 buys a brand new Corona, the Personal Writing Machine. Latest model with many improved features. Write for free booklet No. 8.

Corona Typewriter Co., Inc.
GROTON, N. Y.



California Bathing Beauty

transparent handled pocket knives sell on sight. You will want one when you see our illustrated price list. Finest quality. Satisfaction guaranteed. Special offer tells how to get one free. **Cash Commission** to agents. Write us today. **NATIONAL CUTLERY CO.,** 224 S. LOS ANGELES, CALIF.

Make Big Money

Tailoring Agents

Our wonderful outfit pulls orders quick, on sight. Clever, new, different from all others. Bigger profits, paid in advance, taking orders for our fine made-to-measure clothes. We deliver and collect for you.

\$65.00 a Week AND UP
Entirely NEW Plan

Just think, you get \$4.00 to \$8.00 profits on every order. Cash in big on this winning NEW WAY, no delay, no waiting. Get FREE classy samples and booklet, explains everything clear, simple.

Big Sample Outfit FREE

You can't fail to make good. You will be delighted with this wonderful outfit, cloth samples 3x2 1/2, handsome fashions and everything needed to make success certain. All in classy buckram cover with snap fastener. A knockout for Big Money. Limited supply left. **WRITE TODAY.**

Washington Tailoring Co., Dept. H-345, Chicago Send No Money



MADE TO ORDER

Radio Safeguards

SOLDERALL

SOLDERS ALL JOINTS PERMANENTLY **25¢**

STORM KING LIGHTNING ARRESTER

APPROVED BY THE NATIONAL BOARD OF FIRE UNDERWRITERS



\$1.00
AT ALL DEALERS

SOLDERALL CO., Newark, N.J.

CATALOG L-25-148
PAGES FREE!

Super - Heterodyne — Neutrodyne!

New Complete Branston Kits, Including Oscillator Coupler, Antennae Coupler, 3 Inter. R. F. Trans. and Special Transfer Coupler. **\$36.50**
Complete Kit lists.....

Acme 30 Kilocycle R. F. Trans. **\$5.00.** All American 2,000 to 10,000 Meter Trans. **\$6.00.** Hilo Antennae Coupler **\$8.00.** Oscillator Coupler. **\$7.00.** Gen. Fada Neut. Parts. 5 Tube, **\$65.00.** 4 Tube, **\$64.00.** Kit. **\$25.00.**

AMERICAN RADIO MFG. CO.
WHOLESALE DISTRIBUTORS
Dept. O 6 WEST 14TH ST. KANSAS CITY, MO.

RADIO TEXT BOOK & CATALOG
FREE



Contains—
75 Radio "Hook-Ups"
300 Illustrations
556 Articles
84 Pages

"Build Your Own with RASCO Parts"

RADIO SPECIALTY CO.
99-E Park Place, NEW YORK, N. Y.

TOWER'S

TOWERS Scientific
\$2.95
Plus a few cents postage



OUR \$200,000.00 COMPANY STANDS SQUARELY BACK OF EVERY HEADSET

WORLD'S GREATEST HEADSET VALUE

Model 51-51, with notable improvements
Larger Cord (1/2 inch), Stronger Magnets, Higher Resistance, Increase of Sensitivity, Perfect Tone Mass
EVERY SET TESTED BY LICENSED RADIO OPERATORS

Send no money - Order on a Post-Card
THE TOWER MFG. CO. Dept. P, 93 BROOKLINE AVENUE, BOSTON, MASS.

Scientific



Cunningham

RADIO TUBES

The Ideal Tube for Vacation Time

At the seashore—in one of our great national parks, or while motoring you will find the Cunningham Dry Battery Detector and Amplifier, Type C-299, the ideal tube for your portable receiving set.

The special filament of this tube having a current so low that it may receive its supply from standard No. 6 Dry batteries or even from ordinary flashlight batteries, makes possible this entertaining application of Radio in places far remote.

Your dealer can give you useful suggestions for the purchase or construction of a highly efficient and practical portable Radio Set.

Cunningham 40-page Data Book fully explaining care and operation of Radio Tubes now available by sending 10c in stamps to San Francisco office.

PRICES ON CUNNINGHAM RADIO TUBES

Now in Effect
C-300 A—5 Volta 1-4
Amperes Element - - \$5.00
C-299—3 Volta 06
amp. Dry Battery
Det. and Amp. - - - 5.00
C-300—5 Volta Gas
Coastal Detector - - 5.00
C-11—1.1 Volta 25
amp. Dry Battery
Det. and Amp. - - - 5.00
Special Base - - - 5.00
C-12—Similar to C-11
with standard base 5.00

PATENT NOTICE

Cunningham tubes are covered by patents dated 8-18-08, 8-18-18, 12-30-15, 10-23-17, 10-23-17, and others issued and pending. Licensed only for amateur, experimental and entertainment use in radio communication.

Any other use will be an infringement.

R. J. Cunningham, Inc.

Home Office: 182 Second Street
Branch: CHICAGO SAN FRANCISCO Branch: NEW YORK

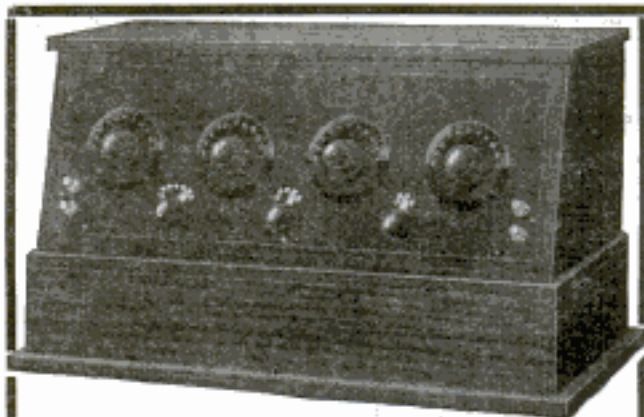

MAKE MONEY—SELL RADIO!

Radio offers the biggest money-making opportunity on earth today. And the *Ozarka Plan* opens the door to this big opportunity. Look at the picture of this beautiful Radio Receiver. This picture was made from an actual photograph. By the Ozarka Plan that Radio Instrument can be the product of your own making—easily, simply and surely. It will be yours to make, to sell and to reap a rich reward in cash profits.

No experience necessary. You need not have much cash. All you need is spare time, determination and action. If you're that kind of a chap, the Ozarka Plan will start you on a straight line toward a real money-making business of your own. It can be as big and as profitable as you are ambitious to make it. We want good men in every county. Exclusive territory is going fast. Be sure and give us the name of your county. Write today for the Ozarka Plan. A wonderfully interesting book, of facts, particulars and proofs. It is FREE. Act now.

OZARKA, INC.

851 Washington Blvd.

CHICAGO

RADIO BOOK

514 PAGES

Only

\$1

Just off the press! The greatest book on Radio ever written. Price only \$1. Filled with sound, practical, tested information for every radio fan, from beginner to hard-boiled owl. Written, compiled and edited by men of national reputation. Every page tells you something useful—and there are 514 pages. Mail \$1 to-day and get this L. C. S. Radio Handbook before you spend another cent on parts.

INTERNATIONAL CORRESPONDENCE SCHOOLS
Box 3626-D, Scranton, Penna.

A BETTER BLOW TORCH Absolutely Safe!

Burns gasoline or kerosene, 400 degrees more heat. Simple to operate. 11 patented features. Used by experts and biggest shops. Fearlessly guaranteed. Get yours today from your hardware dealer—or direct.

Send for Complete Catalog

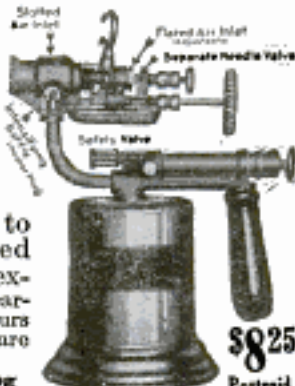

\$8.25

Postpaid

THE TURNER BRASS WORKS
Industry Ave., SYCAMORE, ILL.
The World's Largest Exclusive Manufacturers of Blow Torches, Fire Pots and Brazers

Rings Bells Without Batteries

Avoid the annoyance of having bells out of order. At a nominal cost you can install this little device which will ring electric bells, buzzers, annunciators, electric heat regulators, door-openers, etc., from the same current that lights your home.

ONLY \$2.00
Canada \$3.00

Air-Way Bell Ringer Transformer

Connects direct to lighting-current, and eliminates forever the use of troublesome dry batteries. Does not use enough current to register on meter. Buy it from any electrical dealer, or we will send it anywhere postpaid upon receipt of price. Your money back if you are not satisfied. JAGGERS, DEALERS, AGENTS—Write for selling proposition.

AIR-WAY ELECTRIC APPLIANCE CORPORATION
Toledo, Ohio

MIRACO GETS 'EM FROM COAST TO COAST

PRICE ONLY \$29.20

At rock-bottom prices you get the efficiency of sets costing three times as much. Users tell us that Miraco Radio frequency receivers pick up stations from coast to coast. Operate either on dry cells or storage battery. Solid mahogany cabinets—finest workmanship throughout. Order direct or send for bulletin.

Two tube outfit \$29.50
Four tube outfit \$4.50

DEALERS—AGENTS—Write for proposition quickly—it's a winner

THE MIDWEST RADIO COMPANY
807 Main Street, Cincinnati, Ohio

DEMONSTRATORS WANTED For 5-Tube Neutrodyne Set RADIO

Live young man in every town and neighborhood, to own, operate and take orders for the licensed, standardized, synchronized "De Luxe 5-Tube Coast-to-Coast Neutrodyne" made famous in "The Radio Digest." Complete assembly retails only \$34.49. Thousands sold. Furnished you at discount. Liberal financial arrangements. Write us at once all about yourself. Ask for plan. Also illustrated description of set. **Do First.**

The Radio Shack America's LARGEST Radio Dealers
Dept. PMS, 55 Vesey Street, New York City

The Triple Duty Charger

Charges radio 2, 4 or 6 volt "A" battery, radio "B" battery up to 120 volts and auto batteries from lamp socket. Average cost per charge about a nickel. Solidly built—will not get out of order. Foot-proof and simple. The first successful charger—introduced over ten years ago. Type A. E., price \$20; West of Rockies, \$22. Type G for 6 volt "A" or auto batteries, price \$15; West of Rockies, \$18. "B" battery charging attachment, \$2.50 extra. Write for literature and name of dealer who will supply you with the genuine FF charger.

FRANCE MFG. CO.
10424 Beros Road CLEVELAND, OHIO

Branston D. L. Honeycomb Coils and Geared Back and Front Panel Mountings BEST for SELECTIVE TUNING

Superior construction and vernier adjustment give better results in your set. Licensed under De Forest P. trms. Send 2c for new Radio Manual with 5 Honeycomb Coil "Hook-ups."

CHAS. A. BRANSTON, Inc.
319 Main St. Buffalo, N. Y.
In Canada—Chas. A. Branston, Ltd., Toronto

Save 1/2 Cost of New Tubes VACUUM TUBES REPAIRED

Guaranteed equal to new. Send in your burned out or broken tubes by P. P. All repaired tubes returned P. P., C. O. D. We try to repair and return within 48 hours.

Harvard Radio Laboratories
200-204 Old Colony Ave., So. Boston, Mass.



They'll give new life to your radio set

MURDOCK Radio Phones reproduce distant broadcastings—with clearness and volume. They'll give new life to your receiving set.

Get a pair of Murdock's today. Sold on "money back" guarantee. Send for our **FREE BOOKLET**—"The Ears of Radio."

At your nearest dealer

WM. J. MURDOCK CO.
349 Washington Ave., Chelsea, Mass.

MURDOCK RADIO PHONES

Standard since 1904

a type for every circuit

ALL-AMERICAN Amplifying Transformers

Largest Selling Transformers in the World

SPECIAL OFFER! Book of Tested Hook-ups and Power Amplification diagram-circular sent for 10 cents.

RAULAND MFG. CO. 2656 Coyne St., Chicago

Over 700,000

in service

The Traffic Cop of the Air



He arranges in orderly fashion the mass and jumble of Broadcasting Stations that are seeking entrance to your set and brings 'em in, one at a time, so you can enjoy them! Never reduces, but nearly always increases volume. Add a Ferbend Wave Trap to your set and "Police" your reception. Regulate the Traffic!

Guaranteed to tune out any interfering station. The price is \$8.50. Shipment is made parcel post C. O. D. plus a few cents postage. If you prefer, send cash in full with order and we will ship postage prepaid. Send us your order today.

**FERBEND
Wave Trap**

**FERBEND
ELECTRIC CO.**
15 E. South
Water Street
Chicago, Ill.



FREE

To Each Purchaser of a World Battery



A 24-Volt "B" Storage Battery positively given **FREE** with each purchase of a **WORLD "A" Storage Battery**. The **WORLD Battery** is famous for its guaranteed quality and service. Backed by years of Successful Manufacture and Thousands of Satisfied Users. You save 60%.

Prices That Save and Satisfy

Auto Batteries		Radio Batteries	
6-Volt, 11 Plate	\$12.25	6-Volt, 60 Amps.	\$10.00
6-Volt, 13 Plate	14.25	6-Volt, 100 Amps.	12.50
12-Volt, 7 Plate	17.00	6-Volt, 120 Amps.	14.50
		6-Volt, 140 Amps.	16.00

Shipment Express C. O. D. subject to examination. 4 per cent discount for cash on full with order.

2-Yr. Guarantee Bond in Writing With Each World Storage Battery

proves satisfactory World performance. Mail this ad with your name and address—we will ship battery day order is received; and give you your choice of "B" Storage Battery or a handsome nickel finish Auto Spotlite, **FREE**. Write **TODAY**.

WORLD BATTERY COMPANY
1219 So. Wabash Ave., Dept. 6, CHICAGO, ILL.

This **FREE "B" Storage Battery** takes the place of dry cell "B" batteries. Can be recharged and will last indefinitely. To be sold retail for \$6.00. It is the only battery of its kind equipped with solid rubber case—and insurance against acid and leak—no. Take advantage of this remarkable introductory offer **NOW**. (To those who prefer it, we will send **FREE** a handsome nickel finish Auto Spotlite, instead of the "B" Battery. Be sure to specify which is wanted.)

GIVEN FREE

To introduce this new and superior World "B" Storage Battery to the Public.



CROSLBY
Better—Cost Less
Radio Products
Trendy \$6.50



FIVE TUBE EFFICIENCY

This 5 tube receiver, licensed under Armstrong U. S. Patent No. 1,111,145, contains a combination that assures the efficiency of a 3 tube set. For accurate calibration, sensitivity and tuning range, the Tridyne is unequalled.

For Sale by Local Dealers Everywhere.

Write for Descriptive Matter and Free Booklet, "Simplicity of Radio"
The Crosby Radio Corporation, 7153 Alfred St., Cincinnati, O.

"ROLLS-ROYCE" RADIO TUBES



Like their name, significant of quality. Durable and powerful. Bring in distance with a maximum of volume and clearness.

Type 200....5 Volts, 1 Ampere Detector Tube.

Type 201A....5 Volts, .25 Ampere Amplifier and Detector.

Type 199....3-4 Volts, .06 Ampere Amplifier and Detector.

Type 199....3-4 Volts, .06 Ampere With Standard Base.

Type 12....1 1/2 Volts, .25 Ampere Platinum Filament.

Amplifier and Detector.

Type 202....5 Watt Transmitters \$3

"The Rolls Royce of Radio Tubes." **ALL TYPES \$2.50**

ALL TUBES GUARANTEED

to work in Radio Frequency. Especially adapted for Neutrodine, Reflex and Super-Heterodyne Sets.

Shipped Parcel Post C. O. D. When Ordering Mention Type

ROLLS ROYCE TUBE CO. 21 Newwood St., Dept. 7
NEWARK, N. J.



Our New York Office
Suite 1007 Woolworth Bldg.



Our Philadelphia Office
Suite 714-15 Liberty Bldg.



Our Washington Office
Victor Building

PATENTS TRADE-MARKS AND COPYRIGHTS

Have You An Idea?

Our Offer: No Charge for Examination and Instructions

Protect Your Invention

Your first step before disclosing or submitting your invention to anyone either for entry in a prize competition or for sale should be to write for our blank form



"RECORD OF INVENTION"

This should be signed and witnessed and returned to us together with model or sketch and description of the invention for examination and instruction and to establish Evidence of Conception.
No charge for the above information.

**Our Three Books Mailed
Free to Inventors**

Our Illustrated Guide BOOK

How to Obtain a Patent

Full instructions regarding U. S. Patents. Our Methods, Terms, and 100 Mechanical Movements illustrated and described.

Our Trade Mark Book

Shows value and necessity of Trade Mark Protection. Information regarding *Trade Marks and unfair competition in trade.*

Our Foreign Book

We have Direct Agencies in Foreign Countries, and secure Foreign Patents in shortest time and lowest cost.

**All Communications and Data Strictly Confidential
Interference and Infringement Suits Prosecuted**

We Regard a Satisfied Client as our best advertisement, and furnish anyone, upon request, lists of clients in any state for whom we have secured patents.

**Highest References—Prompt Attention
—Reasonable Terms**

VICTOR J. EVANS & CO.
PATENT ATTORNEYS

Main Offices: 956 9th St., N. W., Washington, D. C.

Opposite U. S. Patent Office

PATENTS TRADE-MARKS AND COPYRIGHTS

IMPORTANT

Before you can interest anyone in your invention it will be necessary to furnish proof that the invention is patentable or application has been filed. In order to have **YOUR CASE MADE SPECIAL TO AVOID DELAY** you should take the precaution of having your case made **Special** in our office to secure protection, save correspondence and secure early filing date in Patent Office. To secure special preparation of your case send \$25.00 on account with model, sketch and description.



MAIN OFFICE, VICTOR J. EVANS & CO.—VICTOR BUILDING, WASHINGTON, D. C.



Our Chicago Office
Suite 1114 Tacoma Building



Our Pittsburgh Office
Suite 514 Empire Building



Our San Francisco Office
Suite 1010 Hobart Building

Specialization — Our Staff

The field of invention is so vast that it is impossible for any one man to become an expert in all classes of invention. We employ a number of patent lawyers and draftsmen who have been selected for their special knowledge and ability in certain lines of invention.

OUR ORGANIZATION OFFERS PERSONAL SERVICE

by registered and practical attorneys and draftsmen of long and varied experience, who will give your patent business special attention, the whole being under the supervision of Victor J. Evans.

**FREE
COUPON**

**VICTOR J. EVANS & CO.
PATENT ATTORNEYS**

NEW YORK OFFICES
1907 Woolworth Bldg.

CHICAGO OFFICES
1114 Tacoma Bldg.

PHILADELPHIA OFFICES
714-715 Liberty Bldg.

PITTSBURGH OFFICES
514 Empire Bldg.

SAN FRANCISCO OFFICES
Hobart Bldg.

MAIN OFFICES: 956 9th Street, N. W., WASHINGTON, D. C.

Gentlemen: Please send me *Free of Charge* your books as described on preceding page.

Name

Address

PATENT TRADE MARKS PROTECT

ANY NEW article, machine, design or improvement thereof, or any combination of parts or improvements in any known article which increases its efficiency or usefulness, may be patented, if it involves invention.

IF YOU HAVE ANY NEW IDEAS

which you feel are useful, practical and novel, take prompt action to protect your rights. If you have invented any new machine, or new combination of parts or improvement, or any new design or process, SEND DRAWING, MODEL OR DESCRIPTION of it for information as to procedure to secure protection.



DRAFTING and SPECIFICATION ROOM of CLARENCE A. O'BRIEN, Registered Patent Attorney, Washington, D.C.

All Communications are held in strict confidence. My personal, careful and thorough attention is given to each case. I offer you efficient, reliable and prompt service—based upon practical experience. **Highest references.**

NO CHARGE FOR ABOVE INFORMATION

Clarence A. O'Brien

REGISTERED PATENT LAWYER

Member of { Court of Appeals, District of Columbia, United States Court of Claims;
Bar of { Supreme Court of United States, Supreme Court, District of Columbia

Practice Confined to Patents, Trade Marks and Copyrights

NTS

COPYRIGHTS YOUR IDEAS

WRITE TODAY FOR FREE BOOKS,

“How to Obtain a Patent” and “Invention and Industry”

These books will give you valuable information, and they may save you much time and effort. **Send for them, NOW.** My practice is devoted **exclusively** to United States and Foreign Patents and Trade Marks. Write me freely, frankly and with full confidence; it is very probable that I can help you.

WRITE TODAY FOR
BLANK FORM “RECORD OF INVENTION”

USE THE COUPON attached, and immediately upon its receipt I shall send you this form to be returned to me with drawing, description or model of your idea; promptly upon receiving your idea I shall write you as to procedure and costs.

FREE COUPON



CLARENCE A. O'BRIEN

Registered Patent Lawyer

705 Security & Savings & Commercial
Bank Building

Directly Across Street from Patent Office

WASHINGTON, D. C.

Please send me your free books, “HOW TO OBTAIN A PATENT” and “INVENTION AND INDUSTRY” and blank form, “RECORD OF INVENTION,” without any obligation on my part.

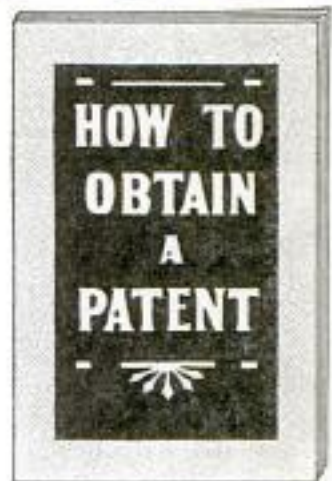

Name.....

Address.....

IMPORTANT — WRITE OR PRINT NAME CLEARLY.

PATENTS

*Seventy-eight
Years of Practice*

THE firm of Munn & Company filed its first application for a patent in 1846, and for seventy-eight years has endeavored to keep pace with the inventive genius of the United States.

An experience of many years is at your disposal. If you have an invention which you wish to patent, send your sketches or model together with a description of your device, explaining its operation, and you will receive prompt, courteous attention.

Write for our Handbook on
PATENTS

A full and complete booklet on Patents, Designs, Trade-Marks, Foreign Patents, Copyrights, Labels and Patent Office Practice with an explanation about our methods, terms, etc.

All communications strictly confidential.

Keep in touch with the inventions of the world by reading

SCIENTIFIC AMERICAN

The MONTHLY MAGAZINE with a special appeal to every man of inventive genius. Recent rulings of the Patent Office, descriptions of the latest patented inventions, legislation and court decisions affecting patents, are noted in this authoritative publication.

MUNN & COMPANY

Patent Attorneys

672 Woolworth Building, New York
Scientific American Bldg., Washington, D. C.
1301 Tower Bldg., Chicago, Ill.
Hobart Bldg., 582 Market St., San Francisco, Cal.
Van Nuys Building, Los Angeles, Calif.

U.S. PATENTS



**SEND FOR
THIS FORM**

DON'T LOSE YOUR RIGHTS TO PATENT PROTECTION

Before disclosing your invention to anyone send for blank form "EVIDENCE OF CONCEPTION" to be signed and witnessed. A sample form together with printed instructions will show you just how to work up your evidence and establish the same before filing application for patent. As registered patent attorneys we represent hundreds of inventors all over the United States and Canada in the advancement of inventions. Our schedule of fees will be found reasonable. The form "Evidence of Conception," sample, instructions relating to obtaining of patents and schedule of fees sent upon request. Ask for them—a post card will do.

PATENTS AND TRADE MARKS



480 Ouray Bldg. Washington, D. C.
Originators of forms "Evidence of Conception."

BLUE BOOK ON PATENTS

gives instructive information and candid advice.
MONROE E. MILLER, PATENT LAWYER
411-2 Ouray Building WASHINGTON, D. C.
ELECTRICAL AND MECHANICAL EXPERT

PATENTS

REGISTERED PATENT ATTORNEY SINCE 1905
CHARLES W. LOVETT SECURITY BLDG. LYNN MASS.
SEND FOR FREE BOOKLET



PATENTS

Send us sketch or model for free patentability opinion and exact cost of patent. Our book "How to Obtain a Patent" Sent Free on request. It tells how to apply for Patents, Trade Marks, Foreign Patents, Copyrights, etc.; gives information on Patent Procedure; tells what every inventor should know. Thousands of inventors, who are our clients, are our references.

CHANDLEE & CHANDLEE, 25 Years' Experience
455 7th St. Washington, D. C.

Have You An Invention?

If so the WORLD PROGRESS will show you how to **PROTECT AND PROFIT FROM YOUR IDEAS**
Sample copy free. One year's subscription \$1.00.
Send for free book,

"WHAT TO INVENT"

containing SUGGESTIONS TO INVENTORS as to Inventions Needed. We invite manufacturers to address us regarding inventions they want.

WORLD PROGRESS PUB. CO., Inc.
Room 203 Victor Bldg. WASHINGTON, D. C.

PATENTS

To the Man with an Idea

I offer a comprehensive, experienced, efficient service for his prompt, legal protection and the development of his proposition.

Send sketch, or model and description, for advice as to cost, search through prior United States patents, etc. Preliminary advice gladly furnished without charge.

My experience and familiarity with various arts frequently enable me to accurately advise clients as to probable patentability before they go to any expense.

Booklet of valuable information and form for properly disclosing your idea free on request. Write today.

Richard B. Owen, Patent Lawyer
9-303 Owen Building, Washington, D. C.
2276-E Woolworth Bldg., New York City

PATENTS Patent Litigation Trade Marks Copyrights

Handbook of instructions, "How to Protect Inventions," sent free on request.

R. H. FRAVEL, Patent Lawyer
Formerly of the U. S. Patent Office Examining Corps
Room 1503, McLauchlen Bldg., WASHINGTON, D. C.

PATENTS

Trade-Marks, Copyrights and Patent Litigation

Write for advice and instructions how to proceed, costs, etc. Hand Book with illustrations of 100 Mechanical Movements sent free on request.

ALBERT E. DIETERICH

Patent Lawyer and Solicitor

Successor to Fred G. Dieterich & Co. 621A Ouray Bldg., Washington, D. C.

INVENTORS

who derive largest profits know and heed certain simple but vital facts before applying for Patents. Our book *Patent-Sense* gives those facts; sent free. Write **LACEY & LACEY**, 646 F St., Washington, D. C. Established 1869.

SELL US A PRACTICAL IDEA

of some new and useful WAY to utilize Pressed Metal in place of other materials. The undersigned pays cash for every acceptable suggestion approved by our Engineering Advisory Board. Free book gives you the facts.

PRESSED METAL TRADE COUNCIL

EXTENSION
27 QUINCY STREET, SUITE 1705, CHICAGO

INVENTORS

18 years' extensive experience in developing and perfecting inventions; making drawings and working models for demonstration. Expert engineering advice free on all matters before or after patent. Strictly confidential. References on request.

BERNARD & HELLER, 275-B Water St., N. Y.

\$112,000 in prizes For Inventors

What chance have you to win one of the prizes—some of them amounting to thousands of dollars—which are now being offered for useful inventions? Here is a glorious opportunity to earn a handsome sum of money if you know what to do. Thousands surely will try for these prizes, but, as you know, those who have some training in *practical* invention have the best chance to win.

A Fortune for You

Big as these prizes are, they don't begin to compare with the money some inventors have earned. Even simple things—like the humped hair-pin, the metal-tipped shoelace, the pencil eraser—have brought their inventors wealth and luxury. You, also, can develop your inventive instinct so it may bring you all that you have ever dreamed of. It doesn't matter who you are, where you live, what you do—you have the ability to invent, which can be strengthened and developed so it will be worth real money to you.

You Can Learn to Invent!

If you ever had an idea for an invention, or if you would like to become a spare-time or professional inventor, see what this fascinating new course can do for you. Fifteen famous inventors now teach you at home the secrets of invention; show you how to get the information you want, how to perfect your ideas quickly, what to invent, and (just as important) what not to invent. You also learn how to avoid the mistakes which cost many inventors thousands and thousands of dollars. This complete course teaches you everything you want to know—how to get a patent, how to protect your patent rights, how to dispose of your invention to get the greatest possible profits, and hundreds of other facts about invention worth a fortune to you.



RAYMOND F. YATES

Write for This FREE BOOK

A wonderful book explaining this fascinating course will be sent to you free. It explains the course in detail, and proves that you can easily train your mind to think inventively so you may become a successful inventor. It shows how this course gives you, in a short time, a wealth of information which other inventors learned only after years of hard work and bitter experience. Get the advice of these fifteen famous inventors. Send for this book today. There is no cost or obligation. This bureau is not connected with patent attorneys or manufacturers. Our only work is to teach you how to develop your ideas so they will bring you big money.

BUREAU OF INVENTIVE SCIENCE

Dept. 38, Wisner Bldg. ROCHESTER, N. Y.

Bureau of Inventive Science

Dept. 38, Wisner Bldg., Rochester, N. Y.

Please send me, without cost or obligation, your free book, "The Science of Invention."

Name

Address

City..... State.....

PATENTS

Booklet Free Highest References Promptness Assured Best Results

Send drawing or model for preliminary examination

ALL BUSINESS GIVEN PROMPT AND PROPER ATTENTION

WATSON E. COLEMAN, Patent Lawyer, 644 G St., Washington, D. C.



Begin Right —The Easy Way!

"Well begun is half done." That is why it pays to start the new Lyon & Healy **Contourier** Way. Don't waste time learning to force and favor an old-style brass instrument! Its "wolf" tones, its imperfections are unnecessary.

Lyon & Healy **Contourier Continuous Conical Bore Band Instruments**

make learning easy. They alone follow *Nature's Law*—that "a sound wave expands diametrically as it travels." Their *Continuous Conical Bore* extends clear through the valves! As a result they are easy to blow. Tones are *true to pitch* in every key and interval. Even as a beginner you can produce tones of velvety smoothness and quality.

Write today for **Free Catalog** containing the whole wonderful story. Easy payments can be arranged. Pay as you play, from your earnings. (Mention whether you desire Band Instruments or Saxophones and if you now have an instrument.) Write **TODAY!**

LYON & HEALY 66-94
Inc. Jackson Blvd.
CHICAGO

DEALERS—Some choice territory still available

NEW HOME TREATMENT FOR GLAND TROUBLE

Medical authorities agree that 65% of all men past middle age (many much younger) are afflicted with a disorder of the prostate gland. Aches in feet, legs and back, frequent nightly risings, sciatic pains, are some of the signs—and now, a member of the American Association for the Advancement of Science has written a remarkably interesting Free Book that tells of other symptoms and just what they mean. No longer should a man approaching or past the prime of life be content to regard these pains and conditions as inevitable signs of approaching age. Already more than 10,000 men have used the amazing method described in this book to restore their youthful health and vigor—and to restore the prostate gland to its proper functioning. Send immediately for this book. If you will mail your request to the Electro Thermal Company, 2136 Main Street, Steubenville, Ohio—the concern that is distributing this book for the author—it will be sent to you absolutely free, without obligation. Simply send name and address. But don't delay, for the edition of this book is limited. Western Office, Dept. 21-A, Los Angeles, Calif.



Fish Bite like hungry wolves, any season, if you bait with **Magic Fish Lure.**

Best Fish Bait ever discovered. Keeps you busy pulling them out. **\$1 Box Free** to introduce our fish and animal traps. Write today. Agts. Wtd. **Walton Supply Co., Dept. C-1, St. Louis, Mo.**



CROSLY Better—Cost Less Radio Products

TAKE YOUR ENTERTAINMENT WITH YOU
The new Crosley Portable, licensed under Armstrong U. S. Patent No. 1,513,545 makes it easy. Stations all over the U. S. brought in. Two dry cell tubes. Completely self-contained. Use at home or wherever you go. Price quoted is without accessories. For July 30, Good Dealers. Write for Descriptive Matter and Free Booklet, "Simplicity of Radio." The Radio Sales Corporation, 4211 Alford St., Cincinnati, O.

INVENTORS PROTECT YOUR IDEAS

Send for our Guide Book, **HOW TO GET A PATENT**, and Evidence of Invention Blank, sent Free on request. Tells our terms, methods, etc. Send model or sketch and description of your invention for our Examination and Instructions without charge.

RANDOLPH & CO.
300 Victor Bldg., WASHINGTON, D. C.

NAME.....

STREET.....

CITY..... STATE.....

Reline Your Ford Transmission — in a Jiffy



The QUIKON provides an easy method for relining your FORD transmission. Made in one piece, it can be readily installed without removing the transmission cover or self-starter.

Anyone Can Install the QUIKON
No previous experience is necessary. Mechanical changes or additional accessories are not required. It is built to fit the FORD. Ask your garageman for the QUIKON—if not in stock, order from us. Price \$3.50. Send for circular.

Harrison Auto Products Corp'n
820 Hamilton Street, Harrison, N. J.

Quikon TRANSMISSION LINING for Fords
ONE PIECE

Your commission \$5.50!

A few of our men, selling Tailormode Made-to-Measure Suits and Overcoats at \$29.50 direct to the wearer, are star salesmen. Others are only sincere, earnest workers. But all of them are living well, making good money, and building up a growing and profitable business of their own. They sell the same customers over and over, because real style, fit and extra quality are tailored into every Tailormode Suit or Overcoat. If you are making less than \$75 to \$100 a week, and are willing to work for real success, write today for full details. Fall-winter sample lines now being placed.

Tailormode Clothes, 108 Anderson Bldg., Cincinnati, O.

TAILORMODE
Clothes

Rider Agents Wanted

Select from the 44 Styles, colors and sizes of Ranger Bicycles. Ride and exhibit sample Ranger and make money. Delivered free, express prepaid, on approval. Factory-to-Rider bicycles \$21.50 up, \$5 a month on any Ranger if desired. Boys and girls easily save the small monthly payments. Parents often advance first payment. Best quality, at factory prices, express prepaid. Lamps, wheels and equipment, low prices. Send No Money, do business direct with makers.



Mead CYCLE COMPANY
DEPT. 108 CHICAGO

Write today for free Ranger Catalog. Factory prices and marvelous easy payment terms.

"The Torpedo"

The Model D—popular Torpedo type body equipped with a complete Flat style Radiator. The body is sturdy and guaranteed to stand up under any kind of strain (generally used for professional racing).

Gas tank in tail end, door on right side with inside lever lock.

Champion Racing Body Co., Dept. PM, 7-9 E. 28th St., Chicago, Ill.



AGENTS

Make \$10 to \$20 daily selling Premier Knife and Scissors Sharpeners.



200% PROFIT

or more. 9 out of 10 women buy. Produces keen edge quickly. Sells for 50c.

PREMIER MFG. CO.
Dept. 29, DETROIT, MICH.

Self-Filler DE LUXE Style Pen

"INDEPENDENT"

All the best features of a Fountain. Loyal Inker, Writes smoother, Improves handwriting, Eliminates inkage. GUARANTEED.

\$2.00

By Mail

14 Kt. White Gold Point. Chased Rubber Holder. Lever Filler. Pocket Clip.

Your Name in Gold Inlay, 25c.

Write for Pen Catalog. Agents Wanted.

J. C. Ulrich & Co., 151 Washington St., New York

Known the World Over for 40 Years.

2½ Tons Heats 5 Rooms!

"There is no heater to compare with the Bulldog. I burned 2½ tons of coal last winter and heated five rooms and bath."
— Walter Geary, Gloucester, Mass.

That's what the Bulldog does with coal! Here's what it does with about the lowest grade fuel you can think of!

"I can run my Bulldog furnace steady for fourteen days in normal weather conditions on the actual cost of fifty cents." So writes F. R. Redetake, of Cleveland, North Dakota, and he adds: "Hard to believe, is it? That's what some of our neighbors thought until I showed them! We have an unlimited amount of grain screenings in this country. That's the fuel I am using."



BULLDOG PIPELESS FURNACE

If you are even thinking of a pipeless furnace, or any furnace, write for our free catalog. The Bulldog is one furnace you MUST investigate. Comes completely erected. Fits any height of basement and you install it yourself.

No Money Down

The Bulldog is sent for free inspection.

Then, if satisfied, you make only small monthly payments at our amazingly low price. Factory connections in both East and West. We ship from nearest point. Don't consider buying any furnace until you find out about the Bulldog. Write at once for our special offer and our free catalog together with the wonderful record of Bulldog success. Mail this coupon today.

Babson Bros.

19th and California Ave., Dept. C-135, Chicago

Without obligating me in any way please send me your free catalog and special offer on the Bulldog Pipeless Furnace.

Name

Address.....



FREE

140-page Book full of life-size ruled forms, each one completely filled in. The answer to problems of accounting and record keeping for any business or profession.

Send for this **FREE** Book today
John C. Moore Corporation
 (Established 1839)
 2149 Stone St., Rochester, N. Y.

MOORE'S LOOSE LEAF SYSTEMS
 In Use In More Than
 300,000 Offices



You Can Also Charge "B" Batteries at Home!

The APCO "B" Battery Charger is a worthy ally to the successful APCO Charger for "A" batteries. Renews any 24 or 48 volt wet "B" battery in ten hours—without disconnecting set. It's noiseless, clean and as easy to hook up as an electric iron. Complete with wires ready to use..... **\$10**

Write for interesting circular and nearest dealer's name.

Apco Mfg. Co. New York Avenue
 Providence, R. I.



AMERICAN BOY SCROLL SAW

**The Wonder Toy
 —for Every Boy**

Boys: This is what you need to cut your bakelite, fibre, wood, etc., for your radio set, bird houses, aeroplanes, scooter and toys of every description. Saws wood up to 1" and soft metal up to 3/4" thick. Sturdy construction.

It's a Regular Tool

PARENTS: It's a character builder also.

Send for Particulars

Delta Specialty Co. 858 Third Street
 MILWAUKEE, WIS.



\$25.00 a DAY-CLEAR

SURFACING FLOORS

Write Quick for Details

Scores of inexperienced men whom we started as American Universal Floor Surfacing Contractors are making up to \$10,000 a year in this wonderful, new, uncrowded field. Electrically driven American Universal Machines do 500% more work and 100% better work than most expert hand scraper, and earn six men's pay. Work is plentiful, fascinating, immensely profitable. Experience unnecessary. Small amount starts you. We furnish everything, teach you, help you succeed. Opportunity of lifetime to be your own boss and make big money.

AMERICAN FLOOR SURFACING MACHINE CO.
 523 So. St. Clair St. TOLEDO, OHIO



SPORT BODIES \$34.50 UP
 For Ford or Chevrolet

We can furnish you with the latest style roadster or racing body at prices that will surprise you. These bodies may be used with or without top or windshield or fenders, and may be underlating (if desired).

Write for Our Book **HOW TO BUILD A FORD RACER 25¢**

CENTRAL AUTO SUPPLY CO. Dept. 126 LOUISVILLE KENTUCKY



Saws Logs—Falls Trees—
 Buzzes Branches—
 Does Belt Work
 25-Year Guarantee—Cash or Easy Terms.

One Man Saws 15 Cords a Day!

—Easy with the OTTAWA Log Saw! Wood selling for \$3 a cord brings owner \$45 a day. Use 4 H.P. Engine for other work. Wheel mounted—easy to move. Saws faster than 10 men. Shipped from factory or nearest of 10 Branch houses. Write for **FREE** Book—"Wood Encyclopedia"—today.

OTTAWA MANUFACTURING CO.
 1741-T Wood Street, Ottawa, Kansas
 Room 1741-T Magee Bldg., Pittsburgh, Pa.



REMINGTON
 PORTABLE TYPEWRITER
 Dealers and Branches Everywhere

DIAMONDS
 Here at 60%
 of Market Price

This snappy accurately cut diamond 7/8 less 5/32 ct. at \$32.00 among bargains in recent list. Many other big values in our lists. Buy here! Prices based on loan values, not market values. This 75 year old diamond banking firm has thousands of unpaid loans and other bargains. Many from big cash deals direct with European Diamond Cutters. Must sell NOW to get back our cash.

Why Pay Full Prices
 Any diamond sent for absolutely free examination at our risk. No obligation. No cost to you.

Send for Latest List
 Describes Diamond Bargains in detail, gives guaranteed loan values. Explains unliquidated exchange privileges. Write for list today. Send NOW.

JOS. DEROY & SONS 1923 DeRoy Building
 Only Opposite Post Office Pittsburgh, Pa.

Write Today for list of Diamond Bargains



Try any Conn Instrument

Conns give you **FREE** most pleasure and quickest opportunity for profit because they are easiest to play—beautiful in tone—perfect in scale—handsome in design and finish.

Send for Free Book, "Success in Music and How to Win It" by John Philip Sousa and others—and details of Free Trial, Easy Payment plan on any Conn instrument. Mention instrument.

C. C. CONN, Ltd.
831 Conn Bldg.
Elkhart, Ind.



AGENTS BIG WINNER JUST OUT!

New Invention—Marvelous Quickedge

Knife and Shear Sharpener. Needed in every home. Sells on Sight. Sharpens any knife or shears in ten seconds. Just put knife in slot—turn crank—sharpens both sides at once. We want men and women hustlers in every county. Profits start first day.

\$90 A WEEK

No Experience Necessary—200% Profit. This means \$15 a day up to \$7500 a year to agent who gets your county. J. C. Lewis, of Kansas, says: "I have sold 100 Sharpeners in four days." Herbert Cain, of Kentucky, sold nine after supper. Wm. G. Hall, of N. J., sold six in a half hour. You can make this money. **WRITE TODAY.** Territory Free. Got busy at once.

QUICKEDGE SHARPENER CO.
108 Sharpener Bldg.
JACKSON MICHIGAN

Only \$200

Selling Price

Write for Sample Offer

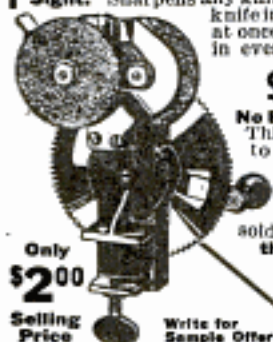

Save More Than Half On Your Hosiery!

Our new plan actually saves you MORE than 50% on your hosiery. You buy direct at less than usual prices—then get AN EXTRA BOX FREE by co-operating in our unique selling idea. Let us send you complete explanation and full details. No obligation. Write today for color chart and FREE booklet.

H. T. FLEISHER, Inc., 17-G N. 21st St., Philadelphia, Pa.



For Men—For Women—For Children

Watch for



Imported

LOUDSPEAKER

TYPE W

announcement in the September magazines. New in principle, new in shape, new in quality of reproduction.

Made by the makers of the famous N & K Head Set, Model D, 4000 ohms, price \$8.50.

TH. GOLDSCHMIDT CORP.
Dept. M-8, 15 William Street, New York

AMPLION

The World's Standard Loud Speaker

MOVIES BROADCASTING



Send without delay for our free illustrated 64 page catalogue of Moving Picture Machines—Cameras—Stereopticons—Optical Specialties—Finest Radio Sets—Complete Radio Parts.

We also sell best standard movie film and have a film exchange service for home users.

Consult us—Every Mail Box Our Branch Office
PARAMOUNT MFG. COMPANY Dept. M4
Boston, Mass.

KESTER METAL MENDER

It's a Genuine Solder

Simple to Use

Requires Only Heat



HOUSEWIVES

A simple, practical mender for metal ware in the home



SCHOOL BOYS

For mending and making toys



SPORTSMEN

Keep a can in your kit—you'll have need for it



HOMETINKERS

Need will develop from roof to cellar



MOTORISTS

For repairs on the road or at home



FARMERS

For use in dairy, garage, household and emergency repairs



If your neighborhood dealer cannot supply you send us—

25¢ for full size Can

Chicago Solder Company

4219 Wrightwood Ave., Chicago, Ill.

Gentlemen: Send me one can Kester Metal Mender for which I enclose 25c in stamps.

(Postpaid anywhere in U. S. A.)

Name.....

Address.....

City..... State.....

Dealer.....

SEND \$2 DOWN **PAY \$5.60 EACH MONTH**



A flashing, blue-white, absolutely perfect diamond, sparkling with the fiery colors of a rainbow, is mounted in forget-me-not engagement ring.

TWO BLUE SAPPHIRES are set in the shanks of this 18 kt. solid white gold engraved and pierced ring to add beauty and style.

10 DAYS TRIAL **NO RED TAPE**

Just send \$2.00 deposit to show your good faith (or pay postman \$2.00 on delivery) and we will send this handsome diamond ring. Then pay only \$5.60 a month for ten months. Total price only \$58.00. (Mention size.)

ABSOLUTELY PERFECT QUALITY

The finest and best blue white diamonds have no flaws, no imperfections, no spots, scratches or blemishes of any kind. The diamonds in these rings are guaranteed absolutely perfect and flawless. Priced at \$297.00 a carat but worth double. Will stand any test.

WARNING: Do not be fooled into thinking that diamonds advertised as "perfectly cut" are absolutely perfect in quality. Diamond experts will tell you that 95% of all diamonds advertised as "perfectly cut" actually are imperfectly cut and besides have flaws and spots and imperfections of one kind or another which cheapens them.

Write for Bargain Catalog

It brings our large jewelry store right into your home. Other diamonds, right perfect quality, listed below:

ORDER FROM THIS BARGAIN LIST			
1/2 Carat.....	\$25.00	1 1/2 Carat.....	\$147.75
3/4 ".....	\$49.25	1 ".....	\$197.00
1 ".....	\$65.65	1 1/4 ".....	\$206.25
1 1/4 ".....	\$73.75	1 3/4 ".....	\$205.50
1 3/4 ".....	\$98.50	2 ".....	\$394.00

Every diamond guaranteed genuine blue white. Money back guarantee certificate with each diamond. Pay 10% down and 10% per month. WORTH \$325 A CARAT.

STERLING DIAMOND & WATCH CO.
(Diamond Importers—\$1,000,000 Stock—Est. 1878)
63 PARK ROW, Dept. 1716, NEW YORK

Our BUREAU of INFORMATION will answer all questions regarding articles in this magazine. Address Popular Mechanics Magazine, Chicago.

SUITS SUITS YOU!

\$29.75

OVERCOATS

TAILORING SALESMEN

Sell Strictly Made-To-Measure ALL-WOOL Suits and Overcoats for \$29.75 Retail

To wide awake salesmen who recognize the possibilities of selling UNION MADE tailoring. Direct from Maker-to-Wearer, at \$15.00 less than store prices, we have an unusual proposition to offer.

The nationally known "Oliver E. Woods Line" is completely covered by an iron-clad guarantee. Liberal profits paid when sale is made. A bona fide proposition for live wires.

TODAY—write us all about your past experience; send for all the facts and the big DeLuxe selling equipment.

Oliver E. Woods & Co.
535-539 So. Franklin St. CHICAGO, U.S.A.

Make \$2.50 an Hour
YOUR PROFITS IN ADVANCE

STAY-PREST TROUSER PRESSER sells quick—everywhere. Thousands in use. Salesmen and saleswomen cleaning up. Sells on eight-minute demonstration. Reasonable price. 40% clear profit for you. You take orders. We deliver.

Wonderful New Invention

Puts perfect crease in trousers. Takes out wrinkles and baggy knees. Easy to use—takes less than a minute. Folds into small size. Finely finished. Looks rich. Saves clothes and tailor bills. Every man wants one or two.

Make Big Profits—Others Do

Jack Ames made \$24.00 in four hours. Handle sold twenty-five the first day. Mary Roberts made \$10.00 in one evening. Others making good in full or spare time. So can you.

FREE Write us quick for free sample order and full details.

The Getgey-Jung Co., Dept. 216 G. & J. Bldg. Cincinnati, O.

MID-SEASON CLEARANCE SALE!

Speed & Sport Bodies—12 Models

Underlying Fixtures, Discs, Overhead Valves, Fenders and 90 other items



PRICES SLASHED!

Telegraph, telephone or write today. Large Illustrated Catalog Free. "Bargain Counter" specials on display. Don't miss this opportunity to obtain quality goods at sacrifice prices.

S. R. FORDSPEED BODY MANUFACTURERS, 250 W. 54th St., New York

FOUNTAIN PENS
Repaired

Mail us your pen; made like new or money refunded. Prices reasonable. Only new genuine parts used.

Buffalo Jewelry Mfg. Co., Dept. 1, Buffalo, N. Y. Since 1892

Columbia Dry Batteries —they last longer

The Fansteel Balkite Battery Charger

for Radio "A" Batteries is noiseless, bulbless, and practically indestructible. It has no moving parts. Price \$19.50 (\$20.00 west of Rockies).

FANSTEEL PRODUCTS CO., Inc., North Chicago, Ill.

Ask Your Dealer to Show You
The New SIGNAL
Vernier Variable Condenser



Make Your Ford a Closed Car!

Limo weather-proof sections will change your 1923-1924 Ford Touring or Roadster, into classy limousine-style closed car. Doors open from outside. Sliding front panels for ventilation. Three-ply, double covered veneer frames. Color matches your top. Easily, quickly installed. Guaranteed. Low priced. Fine for bad weather. Write for prices.

BUOB & SCHEU, Dept. A-8, 216 Webster St., Cincinnati, O.

\$100 to \$200 Per Week

We Teach You How to Make It

Money—big money—is waiting for you to come and get it. No matter where you live nor what your experience, we teach you how to make money. **Special Proposition Open Now**

Fireite *Sells on Sight*
TRADE MARK

Fireite amazes everyone who sees it used. A single demonstration often makes a dozen sales. It has saved many thousands of dollars of property damage. Men, women and children are astounded and fascinated by the ease with which it puts out an alarming fire. It is no exaggeration to state that Fireite is one of the easiest to demonstrate and fastest sellers ever made. Why? Because it is so simple a child can use it with one hand. It always works—(wonderful secret composition). No pump nor mechanism. Beautiful and long lasting. The low price is within the means of everyone—50% less than most others. Sold to every home, school, garage, factory, office, store, hotel, etc., wherever shown.

AGENTS and MANAGERS WANTED
In All Territory Not Taken
You can make big money using all or part of your time. We supply everything for your success. This is an **unusual opportunity** for a sound, substantial, permanent income. Write for our agent's—or manager's—special proposition today before it is withdrawn.

FIREITE CO., Dept. 2, Masontown, Pa.

\$25 A DAY *Selling Suits*

Fifth Ave. New York Custom Tailors

want agents to sell advertised brand all wool tailored to measure suits and overcoats direct to wearer. **Lowest Prices in America.** Sell on sight. No capital or experience required. Big line swatch samples free. **Biggest Commissions** paid daily. Permanent positions. \$75 to \$100 weekly. Auto Free to Agents.

MONARCH TAILORING CO., 100 Fifth Ave., Dept. F-1, NEW YORK

DRESS UP
\$3.85 YOUR CAR
AND UP A seedy looking top spoils **CUSTOM MADE** its appearance. Get a Liberty Custom Made Top. It's fun putting it on; simple directions furnished. Save a big labor bill. We are manufacturers of tops, side curtains and seat covers, for any make or model car. Amazing values. Special proposition for Fords, Chevrolets, Dodges and Maxwells. Write today for big money saving catalog.

Liberty Top & Tire Co., Dept. E-7, Cincinnati, Ohio

An Outdoor Home for Every Trip

Go anywhere, stop anywhere. With a DeMoine Tour Tent you can live outdoors in privacy and comfort. Be independent. Save hotel and garage expenses. The DeMoine Tour Tent shelters both you and your car. Rain-tight, wind-tight, it protects you in every storm. Packs into a snug bundle, 12x24 inches. One man can pack it up in five minutes. Tent can be packed wet for the day's travel, without danger of mildew. Used with or without poles.

Our Book of Outing Conveniences gives full details of the DeMoine Tour Tent. Also describes all the latest outdoor equipment that saves time and trouble. Write today for free copy of this book.

Des Moines Tent & Awning Company
521 Walnut St. Des Moines, Ia.

You'll Want This Book
Send for it TODAY

DeMOINE
YOUR TENT

Book of Outing Conveniences

21 Jewel ~ Extra thin
STUDEBAKER
The *Insured* Watch

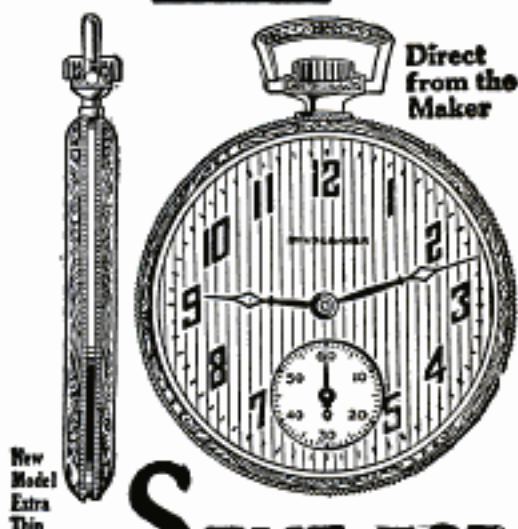

New Model
Extra Thin

Direct from the Maker

SENT FOR
\$1.00 DOWN!

Only \$1.00! The balance in easy monthly payments. You get the famous Studebaker 21 Jewel Watch—Insured for a lifetime; a choice of 54 new Art Beauty Cases; 8 adjustments, including heat, cold, isochronism and 5 positions—direct from the maker at lowest prices ever named on equal quality. Write today for **FREE BOOK** of Advance Watch Styles.

Fine Chain FREE!

For a limited time we are offering **FREE** with the Studebaker Watch a beautiful pattern Studebaker Watch Chain. Write now while offer lasts.

Mail Coupon for FREE Book

Send at once and get a copy of this book—**FREE!** See the newest, beautiful, advance styles in Studebaker Art Beauty Cases and Dials. Read how you can buy a 21 Jewel Studebaker Insured Watch direct from the maker—save big money—and pay for it on easy monthly payments.

Write! for our free book. It will post you on watch styles and watch values. Send coupon at once. Get Free chain offer today while it lasts.

Studebaker Watch Co.
Dept. 228 South Bend, Ind.

Canadian Address: Windsor, Ont.

LADIES' BRACELET WATCHES
Handsome new designs and styles in 14-K white gold—excellent time-keepers. Write for special folder No. 1-W.

STUDEBAKER WATCH CO.
Dept. 228, South Bend, Indiana

Please send me your Free Book of Advance Watch Styles and particulars of your \$1.00 down offer.

Name

Address

City State

MAKE MORE MONEY!**\$3,000
PROFIT IN
4 MONTHS!****CRISPETTES**

GEOURGE ALEXANDER of Pennsylvania made \$3000.00 in 4 months making and selling CRISPETTES with this outfit. (Nov. 7th, 1923).

Jacob Gordon, New Jersey, (November 2nd, 1923), says: "Profits over \$4000.00 in 2 months!" Mesner of Baltimore \$250.00, in one day! M. L. Cronen, Ohio, (November 3rd, 1923), writes: "Doing big business—sold over 200,000 packages Crispettes last year". Mrs. Lane, Pittsburgh, says: "Sold 8,000 packages in ONE day!"

We Start You In Business

Crispettes easy to make, easy to sell. We furnish everything—complete outfit, secret formulas, raw materials, full directions, wrappers, etc. No experience needed. Little capital starts you on road to wealth. Open a retail store of your own. Sell wholesale to groceries, drug stores, etc.

Build a Business of Your Own

Crispettes sell fast everywhere. Everybody likes them. They're a delicious confection. We'll tell you how to build a business of your own. Start now, in your town.

Profit \$1,000 a Month Easily Possible

Send for illustrated BOOK OF FACTS. Tells how many people in small towns and big cities are making big successes of Crispette Business. Shows how, when and where to start. Full of valuable information. It's FREE. Write now. Postal brings it.

LONG EAKINS COMPANY
828 HIGH STREET SPRINGFIELD, OHIO

**Turn Your Ideas
Into Money**

Develop your creative ability; make money with your genius and mechanical skill; put your ideas into practical use. It matters not whether you are interested in light manufacturing, repairing, or experimental work; whether you are a mechanic, engineer, inventor, amateur or student, this machine will help you.

The New Model "B" Baby Grand Lathe

Sturdily built of best quality materials. Produces precision work with wide speed range. Operates same as large lathes. Thousands in use. Highly recommended by skilled mechanics. Practical and dependable—not a toy. Sold only direct to user on money-back guarantee. We also make Bench Drills and Grinders.

Write for illustrated story, complete description and prices.

**WATSON
MFG. CO.**
108 Watson Bldg.
Toledo, Ohio

all free! RADIO LIBRARY

**JUST SEND A POST CARD
YOU GET** absolutely free—the A-K "Library of Latest Radio Literature," written by foremost radio authorities. Contains HUNDREDS of valuable wiring diagrams, HOOP-UPS, illustrations, articles, etc.

EXPLAINS in clear, understandable language the popular new circuits: reflex, autodyne, vibrator, "saunders," super-heterodyne, etc., and how to build sets. Covers long and short wave amplification, push-pull and audio amplifiers. Latest information on multitude of other radio subjects. **LOG BOOK INCLUDED FREE.** Also our latest Radio Catalog featuring NATIONALLY ADVERTISED items at attractive savings. Write today—offer limited. Address:

ATWOOD-KING, INC.
Dept. C 5 163 W. Washington St., Chicago

**ATWOOD KING
INC.**

**"Lighting Fixtures"
READY TO HANG**
(Direct from Manufacturer)
Completely wired, including glassware.
Send for Catalogue No. 26. Just Off the Press.
Special proposition to DEALERS.
ERIE FIXTURE SUPPLY CO.
STA. A ERIE, PA.

Como Duplex Transformers "The World's Standard Push-Pull Transformer"
Maximum Volume without Distortion
Price \$12.50 per pair At All Leading Dealers
COMO APPARATUS CORP., 445 Tremont Street, BOSTON, MASS.

SHOTGUN There's remarkable gun value in a Stevens. Write for the interesting catalog describing our line.
RIFLE
J. STEVENS ARMS COMPANY
Dept. 575 Chicopee Falls, Mass.
Owned and Operated by the Savage Arms Corporation.

LYON BODIES

Send For Our 1924
**FREE BOOK OF
BARGAINS**

Containing a full line of bodies and accessories at exceptionally low prices. Buy direct from the factory.



**\$27.50
AND UP**

**AUTO TIRE
SALES CO.**

Body Division Dept. 723
1346 S. Michigan Ave., Chicago

Print Your Own Stationery

Cards, circulars, labels, tags, book, menu, paper, Press, \$12. Larger Ed. Job Press \$150 up. Save money. Print for others. **BIG PROFITS.** All easy, rules sent. Write factory TODAY for press catalog, TYPE, cards, paper. **THE PRESS CO., D-37, MERIDEN, CONN.**

Sells for \$1.25 — Agent's Sample 65c!

ITS THE POINT. HAS EIGHT GROOVES FOR INK TO FEED

Imported from Japan. "It makes Carbon Copies." Guaranteed for One Year. Hustlers Make \$20.00 Daily! Money refunded if you don't think it the best pen you ever wrote with. Just Out! Comes in beautiful brown, trimmed in black. Send for quantity price list and distributing plans. **F. SPORS & COMPANY, 335 Main Street, LESUEUR CENTER, MINNESOTA**

**New
Self-Filling
Bamboo
Fountain Pen
with
Stylo Point**

Bulging Waistline Reduced -Easily!

New Self-Massaging Belt Makes You Look Many Pounds Lighter and Inches Thinner the Moment You Put It On—While Actual Fat Disappears as Quickly and Surely as Though Under the Hands of An Expert Masseur, No Dieting—No Drugs—No Exercise.

A WONDERFUL new invention that not only gives you an *instant* appearance of slimness—but actually reduces your bulging waistline to normal in an amazingly short time—is now being used by thousands of men who were formerly overburdened with an excess of fat.

With this remarkable discovery it is no longer necessary to resort to heart-straining exercises or weakening diets—and few men can take the time or pay the exorbitant fees charged by the professional masseur.

Gets Same Results as Expert Masseur

As every one knows, the masseur, by skillfully manipulating the loggy tissues right at the spot, sets up a vigorous circulation that seems to literally melt the surplus fat away.

The Weil Scientific Reducing Belt operates on exactly the same principle. Made of specially prepared and scientifically fitted, rubber, it not only reduces your waistline as much as 4 to 6 inches the moment you put it on, but is so constructed that every movement you make, every breath you take, imparts a constant, gentle massage to every inch of your abdomen. It massages away the abdominal fat so quickly and easily that it seems almost like magic. In a few weeks inches and inches of fat should actually disappear.

Endorsed by Physicians and Athletes

Thousands of men who were formerly burdened with bulky, disfiguring fat have not only vastly improved their appearance at **once** with the Weil Reducing Belt, but have quickly acquired a normal waistline in this easy, pleasant, inexpensive way. It is the choice of hundreds of athletes and jockeys. Physicians everywhere endorse it because it not only actually takes off fat, but corrects stomach disorders, constipation, backache, shortness of breath and puts the sagging internal organs back into place. Satisfaction **guaranteed** or your money back without question.

Mail the coupon at once for full description and special Reduced Price Offer. Address THE WEIL COMPANY, 98 Hill St., New Haven, Conn.

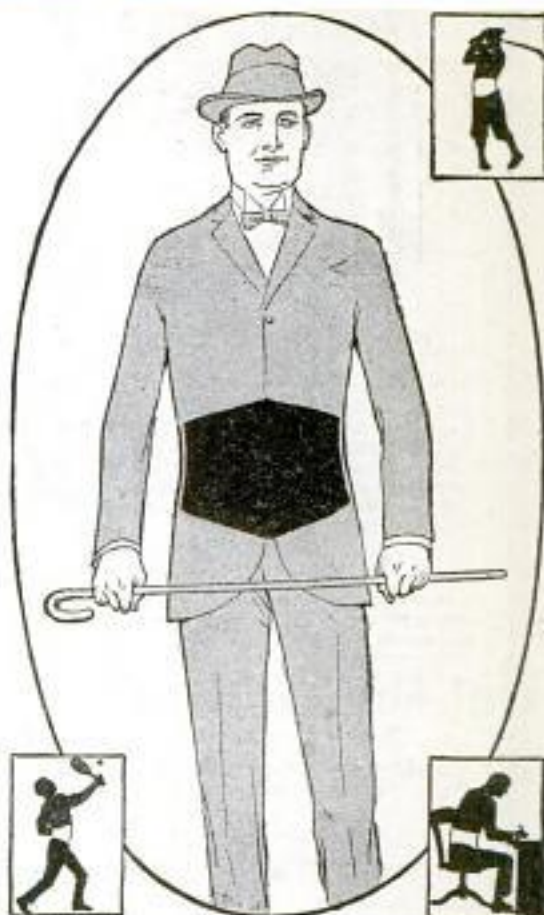

As shown above, every move of your body walking, climbing stairs—merely breathing as you sit—causes the Weil Belt to massage your abdomen. It is working every second to remove your fat.

THE WEIL COMPANY,
98 Hill Street, New Haven, Conn.

Gentlemen: Please send me, without obligation, complete description of the Weil Scientific Reducing Belt and also your Special 10-day Reduced Price Offer.

Name

Address

City.....State.....

Buchstein's Fibre Limb
is soothing to your stump—strong, cool, neat, light. Easy payments. Braces for all deformities.
D. BUCHSTEIN CO.
610 3rd Ave., St., MINNEAPOLIS, MINN.

Send for Catalog Today

Try This on Your Hair 15 Days Then let your mirror prove results.



Write Today for **FREE Trial Offer!**

Your hair need not thin out, nor need you become bald, for there is a way to destroy the microbe that destroys the hair. This different method will stop thinning out of the hair, lifeless hair, remove dandruff, itching, darken gray hair and threaten or increasing baldness, by strengthening and prolonging life of the hair for men and women. Send your name now before it is too late for the 15 days' free trial offer.

AYMES CO., 3932 N. Robey Street, M 390, CHICAGO

NO MORE BALD HEADS



WHEN our VACUUM CAP is used a few minutes daily. We accept no pay until you have tried the Cap 30 days and are satisfied. The Vacuum Cap is an appliance that draws the blood to the Hair Roots and starts a new healthy crop of hair. It stops Dandruff, stops the hair from falling out.

Bought by Doctors and men who know that it is the only reasonable HAIR GROWER known to science. No Drugs Used. Write for application blank, testimonials, and booklet on "HAIR," sent sealed in plain envelope, FREE.

THE MODERN VACUUM CAP CO.

Y 559 BARCLAY, DENVER, COLO.



Get the Thrills of Your Life on the New Indian Scout

If you love the thrills of the great outdoors—if you long to break away from the drab monotony of a hum-drum existence—if you want to feel your blood tingle with excitement—throw a leg over the new Indian Scout—open the throttle and let 'er go! You'll get the happiest sensation of your life.

The New Scout is really wonderful! Weighs 100 pounds less than the average motorcycle! Low enough for a youngster—big and sturdy enough for a motor cop—safe enough for even a girl! Goes 60 to 75 miles on a gallon; tires good for 10,000 to 15,000 miles! Has New Indian Fork which doubles the life of the machine by absorbing all the shocks of the road.

With the Scout you can go camping, hunting, fishing—anytime—anywhere—over any kind of roads! You can ride to and from work in perfect comfort. Easy to own an Indian Scout on our "pay-as-you-ride" plan.

Ask your local Indian Dealer about it—or write us for free descriptive literature and name of your nearest Indian Dealer.

Indian Motorcycle Co.

Dept. P-8, Springfield, Mass.



AGENTS WANTED! SALESMEN— DISTRIBUTORS

to use and introduce attachment that makes Fords run on 94% air. THERMOSTAT on exhaust automatically turns down needle valve as engine warms, exactly as Ford Manual says do by hand.

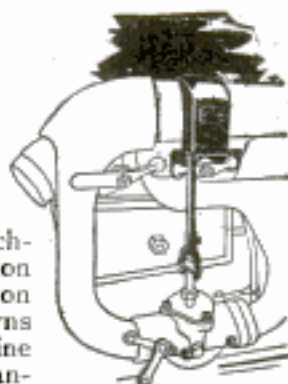

BLANCHE THERMOSTATIC AUTOMATIC CARBURETOR CONTROL FOR FORD CARS AND TRUCKS

Makes Fords start easier winter or summer—saves half gas and oil—cuts repair bills one-half—reduces carbon formation one-half. Sells on sight to every Ford owner as easily as giving him a \$100.00 bill, because it saves \$100.00 every 10,000 miles.

CADILLAC NOW USES as STANDARD EQUIP- MENT THERMOSTATIC CARBURETOR CONTROL UNDER BLANCHE LICENSE

You can make Big Money selling this wonderful proven device. Experience not necessary. Blanche plan will start you without capital in a business of your own that makes you from \$250 to \$2000 a month profit. Write for free circulars Now!

A. C. BLANCHE & CO.

Dept. 364, 602 W. Lake Street CHICAGO, ILLINOIS

PATENTS

C. L. PARKER
Formerly Member Examining
Corps, U. S. Patent Office
PATENT LAWYER
MCGILL BLDG.
WASHINGTON, D. C.

Patents, Trade Marks, Copyrights, Patent Litigation
Handbook for Inventors, "Protecting, Exploiting
and Selling Inventions," sent free upon request.



WHY APPEAR BOWLEGGED OR KNOCK-KNEED?

Put on a pair of Straight Leg Sock Supporters and be convinced

\$3.00 Per Pair

Send for Free Booklet

SUPPORTER SALES CO.

DEPT. F

ROME CITY, INDIANA



Get Your SUIT FREE

Satis-
faction
Garan-
teed



GET OUR New Plan

and Make Big Money in your spare time—something different, better, bigger, most liberal offer ever made. Lower prices, better clothes, bigger cash profits, express or postage paid on everything

DOUBLE PAY FREE CLOTHES and CASH PROFITS BESIDES

You can easily earn \$30 cash, extra every week during your spare time, taking orders for our made-to-measure clothes. We don't ask you to use your cash profits for your own clothes. That's not our way of doing business. Ours is a new and better plan. Fifty-six stylish, real cloth samples. Free colored fashion plates; inside wholesale prices, everything is Free. Just drop us a line today and we will send complete outfit Free.

SPENCER MEAD CO., Dept. H-245, Chicago, Illinois

I WANT YOU FOR MY AGENT

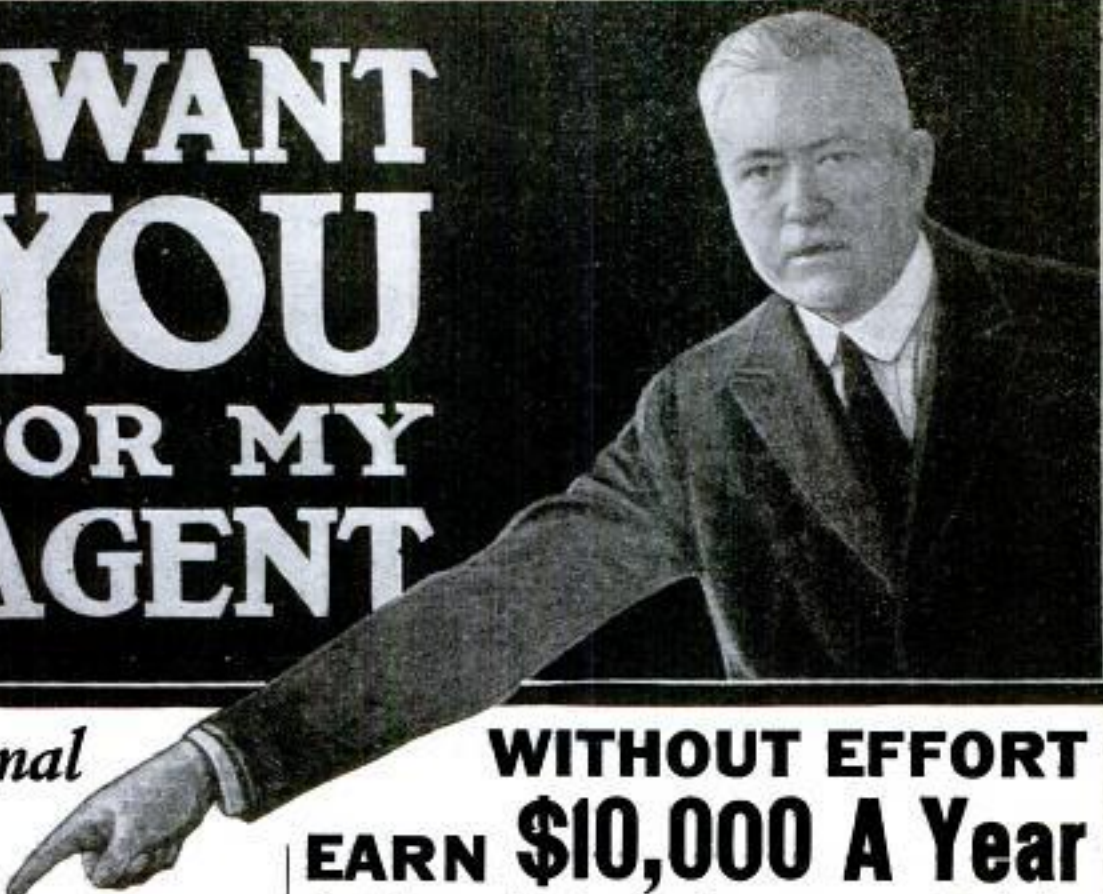

*Personal
Read
These!*

Berkeley, Calif., July 1, 1923.

Airlox Rubber Company:

I have had Airlox tubes in the tires of my automobile for one year and have not had a particle of trouble. It is highly satisfactory in every way.

I do not see why all automobile tires are not equipped with Airlox tubes, especially when cars are driven by women.

Yours truly,

Agnes A. Carpenter, 2810 Prince St.

Dubuque, Iowa, Jan. 6, 1924.

Airlox Rubber Company:

Having given your Airlox Tubes a fair trial and tubes now in use are 100 per cent so far, I have a number of car users now in the market for tubes this coming summer. As I am perfectly satisfied that it will do the work and give satisfaction, I would be pleased to have your latest prices.

Harry E. Haines, 2844 Elm St.

Wellington, Kansas, Jan. 7, 1923.

Airlox Rubber Company:

Enclosed please find check for which send me two of your 32x3½ inner tubes by parcels post. I have been using some of them for some time and find them a great saving of time and trouble.

F. M. Borders, 219 East Harvey Ave.

Decatur, Ill., Jan. 24, 1923.

Airlox Rubber Company:

Seven months ago today I equipped my car with your tubes. Aside from taking two nails out of the tires I have not touched them since. I was rather anxious to know whether there had been any decrease in pressure, so this morning I took pressure readings. I was delighted to know that I had 60 lbs. in each tire. The same pressure I put in the tires on June 24th, 1922.

My tires have been driven over 12,000 miles and they look like new.

E. L. Dickey.

WITHOUT EFFORT EARN \$10,000 A Year

Get into a business of your own. Be independent. Prospects unlimited. Sell Air-Tight Puncture-Proof Inner Tubes. Go, while the going is good. **RIGHT NOW.**

CAR OWNERS WANTED

Doubles Tire Mileage Without Loss of Air A new air-tight, puncture-proof inner tube, which in actual test ran 22,000 miles without the

loss of air although punctured many times, is the great achievement of F. C. Hughes, of the Airlox Rubber Co., Chicago. The tube is equipped with a leak-proof valve cap. Both puncture troubles and valve leaks are done away with, making it possible to keep tires up to proper air pressure and therefore doubling tire mileage. Yet Airlox Tubes cost no more than ordinary tubes. Mr. Hughes wants these wonderful tubes and valve caps introduced in every territory throughout the United States. There is a very unusual opportunity for anyone who wants to distribute these quick sellers. Write at once to Mr. F. C. Hughes, 2514 W. Monroe Street, Chicago.

WRITE FOR OUR FREE TUBE OFFER

Also our Air-Tight Valve Cap proposition



AIRLOX RUBBER COMPANY

2514 W. Monroe St., CHICAGO, ILLINOIS

Please send me, without obligation on my part, your literature telling me how I can become your agent and make big money selling Airlox Puncture-Proof Tubes. Also tell me how I can secure my set free.

Name

Address

City.....State.....

\$120 a Week!

—that's exactly what I'll pay you — that's the very figure I'll guarantee you if you take only four orders a day for my finely tailored to measure suits and overcoats at the astounding price of \$32.50 each.

It's easy — there's no trick about it. I have hundreds of men now who are doing that very thing. They haven't anything up their sleeve — just conscientious workers — that's all.

I have one price only — \$32.50. Collect \$5.00 with the order — keep it — it's yours — and I give you a big bonus on top of that.

Get busy — fill in the coupon — mail it. Write me a short letter telling me why you want to sell Mason's All Wool Tailored-to-order Suits and Overcoats. Don't put it off — write me and do it NOW!

JOHN C. MASON CO., Wholesale Custom Tailors
3300 W. 23rd Street, Dept. 805, Chicago, Ill.

JOHN C. MASON CO., Wholesale Custom Tailors
Dept. 805, 3300 West 23rd Street, CHICAGO
Dear John Mason: Your proposition interests me. I would like to have further and complete information relative to it. Kindly send facts without obligating me in the least.

Name.....
Number and Street.....
City..... State.....

DO YOU LIKE GOOD TOOLS?

You will like this one, the Simore magazine tool. Three blades in the handle, always ready, blades can be changed in two seconds, the ideal tool for the sportsman or for household use.

Model No. 12 has a keen steel knife blade as shown and two screwdriver blades. Strong, handy, practical. Handle blued to prevent rust. You'll like it. Sent postpaid for only \$2.25.

Model No. 11 same as No. 12 except has three screwdriver blades. Sent postpaid for only \$1.80. Send money order or your check. Ask your dealer or write direct.

Dealers are asked to write for information on this tool and the Simore Automotize Trysquare.



The
Tools
That are
Different

THE SIMON & SKIDMORE MFG. CO.
Dept. 2-8 SANTA ANA, CALIFORNIA

\$104 PROFIT IN 3 1/2 HOURS



G. A. Barton, Indiana, made that amount-making and selling Candy Floss. Others send in amazing reports: Small, Chicago, says— "Did \$125 business on Sunday." Wendel, Kansas, writes, "Averaged \$128 a day for 3 weeks." Gardner reports, "2,437 sacks of candy sold from 11 a.m. to 10:15 p.m. Big Money in Candy Floss! Rees says: "Cleaned up \$225 in 4 nights in Greenville, Ohio." Candy Floss is a delicious, novelty confection—fluffy, soft as cotton, white as snow, or any color or flavor. Can be made anywhere—in store window, in parks, on street corners, at picnics, summer resorts, base ball games, or wherever crowds gather. Machine easy to operate. Raw materials plentiful and cheap. Send name and address for free illustrated book of facts. Drop postal. Act now! Address

FREE
MY BOOK
"CANDY SUCCESS"

A. T. DIETZ
44 Sayre Bldg. Toledo, Ohio

How to Build ULTRADYNE *The Improved* SUPER-HETERODYNE



32 page illustrated book with detailed instructions on drilling, wiring, assembling and operating 6 and 8 tube Ultradyne Receivers. Latest authentic edition by R. E. Lacault—A. M. I. R. E. inventor of the Ultradyne, the most selective receiver known. Write for descriptive circular

PHENIX RADIO CORP.
9 Beekman St., N.Y.

50¢

Factory to Rider

Saves \$10 to \$25 on the Ranger Bicycle you select. You can have your choice of 44 Styles, colors and sizes. Delivered free on approval, express prepaid, for 30 DAYS' FREE TRIAL. Bicycles, \$21.50 up, \$5 a Month if desired. Possession and use at once. Parents often advance first payment.

Best quality, at factory prices, express prepaid. Lamps, wheels and equipment, low prices. Send No Money, on business direct with maker.

MEAD CYCLE COMPANY
DEPT. 108 CHICAGO

Write today for free Ranger Catalog, factory prices and marvelous easy payment terms



FREE 1000 Illustrations ELECTRIC FIXTURE CATALOG!



Write today for your copy. Save 50% direct from Manufacturer. No Middleman's Profit. OUR SPECIAL: 8 Room Electric Set, ready to hang, \$24.50—Other bargains.



UNITED LIGHTING FIXTURE CO.
280 Bowery Dept. P.M. New York

Be Independent!

Own a Grape Fruit and Orange grove—Truck or Poultry Farm. Increase your Income. You can start a grove today under our new plan and have a Home and Income in Sunny Florida on the easiest terms imaginable. Any size Farm. Groves developed for Non-Residents. We raise our own guaranteed Citrus Trees in our own Nurseries. We have the Right Land—in the Right Location—at the Right Price, and on the easiest terms. Write for Book "The Call of the Southland"—It's Free.

NORTH TAMPA LAND CO., 404 Zack St., Dept. S-24, Tampa, Fla.

WANT Special SCREWS or GEARS?

Send us your blue prints or samples for our quotation on your requirements. Our factory is completely equipped for all kinds of MACHINE WORK—THIRTY-EIGHT years in business. Write today. **TUERK MFG. CO., 561 W. Washington St., Chicago, Ill.**

\$985 Improved
Only **DOWN** New Model

1 1/2 H-P PULLS OVER 2 H-P
(Burns Kerosene or Gasoline)

You can get any size OTTAWA from my factory at lower prices and on easy monthly payments. Earn its cost as you use it.

No Interest to Pay 30 days Free Trial on your farm. Thousands in use today. Easy machine to start. Sizes 1 1/2 H-P, to 22 H-P. Write for new Free Book, "How to Know Better Engines." Send name on card today. **OTTAWA MFG. CO. 531-B King St. Ottawa, Kan. Desk 531-B Maple Bldg., Pittsburgh, Pa.**



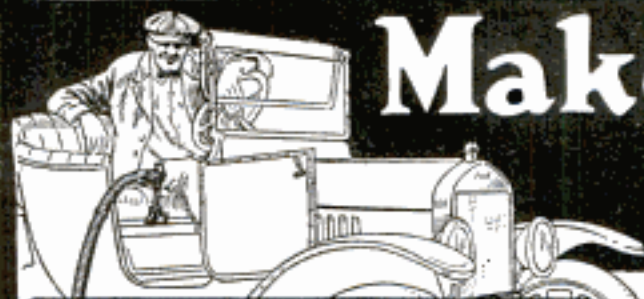

Make Big Money Fast!



"Every Ford Needs It"

OTHER salesmen and dealers are doing it—in all parts of the country. You can do it, too! You don't have to be an experienced salesman, either.

W. W. Lefan, of Texas, made sales of **\$1,583** in 10 days. W. H. Stacey, in Maine, totaled **\$489** his first month. G. R. McKenzie, B—, Alabama, sold 6 the first afternoon. A. M. Fuller, P—, Pa., writes: "Am enclosing order for 300, in addition to the 400 ordered last week." (Complete addresses of these and other salesmen supplied on request.) These and many other men are making **\$50 to \$200** a week or more.

Here's one of the biggest sellers in the entire Ford Field, something you can actually sell on

sight to almost every Ford Owner; it does away with the greatest annoyance and inconvenience of driving a Ford. A Ford owner must be some tightwad to resist the impulse to buy it at once. Think of it—5,000,000 Ford owners—five million red hot prospects waiting to be shown the



Clamps into Tank Opening

Kirstin Fil-Gage

FILLS YOUR TANK GAUGES YOUR GAS

For all models of Fords and for Chevrolets with under seat tanks

It fills the Ford gas tank without lifting the seat cushion or getting out of the car. It takes full flow of gas from any pump—at top speed.

The gas gauge is in plain sight from the driver's seat. It has a luminous indicator which can be easily seen in the dark. No need to run out of gas and walk to the next town for more.

It can be easily installed by the owner himself—in ten minutes. It clamps in regular tank opening. It is located in the middle of the seat—between the driver and passenger—down below the top of cushion and out of the way.

Guaranteed absolutely for one year against defects or against breakage from any cause. Made of pressed steel with the wonderful Duco Finish as used on 1924 Oaklands. It is very simple in operation and sturdy in construction. It will outlast the car.



Fills Tank—Gauges Gas Without Lifting Cushion

Retail Price \$6.00
25 cents extra in West

Less than the price of a good gauge alone. There is nothing else like it on the market—no competition, no price resistance.

We Set You Up in Business

We furnish complete selling and advertising outfit and instructions, help you get started and back you up to the limit. Write for our proposition and sales plan. It's a winner!

If you want to save time in getting started, send \$6.00 for 1 Fil-Gage, sample case, advertising material, etc. Your money back in 10 days if you want it.

Territories going fast—Write or wire today before someone else gets lined up for your territory.

A. J. Kirstin Company, 801 First Street, Escanaba, Mich.

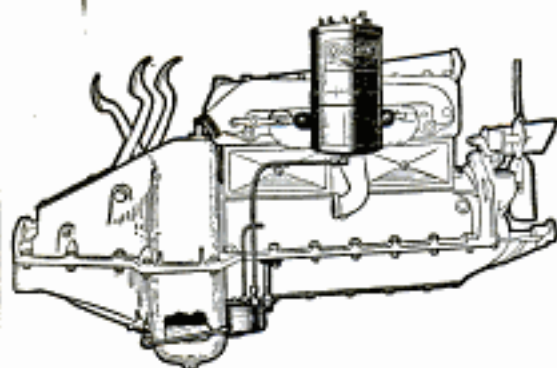

OILOMATIK What Every Ford Needs

**SALESMEN-DISTRIBUTERS WANTED
WRITE FOR A 10-DAY FREE TRIAL**

A Real Necessity Every Ford owner knows that the problem of lubrication is foremost in his mind. It necessitates work that is irksome, dirty, disagreeable and, after all, only guess work. The "OILOMATIK" is accurate and prevents 90% of all troubles. It is not the hard work that your Ford motor does, but rather the lack of lubrication which determines the frequency with which your car visits the repair shop. The "OILOMATIK" saves repair bills and cuts oil consumption twenty-five to fifty per cent. It is the most inexpensive Ford insurance and covers the biggest risk. "OILOMATIK" insurance costs nothing. Your saved repair bills pay for it over and over again. Good for a lifetime. A real necessity.

OILOMATIK SALES CO., 341 East Ohio St., CHICAGO, ILL.

RADIO'S LATEST DEVELOPMENT

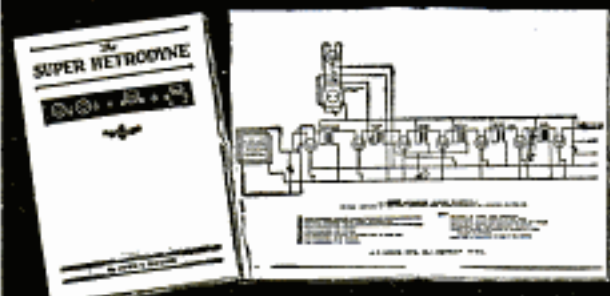

You Need This Book!

A Complete Text Book on Super-Hetrodynes

Here for the first time is a thoroughly scientific volume treating of what the super-hetrodyne system means to radio, together with a wealth of data on its development, advantages and operation. Written by a man who was a pioneer in the development of radio, this book covers the entire field of super-hetrodyne equipment. Profusely illustrated, and liberally supplied with charts and wiring diagrams, this book gives you a fund of information found nowhere else. The price is \$1.00 postpaid. Order today. Use the coupon below.

J. T. BOONE CORPORATION, Manufacturers of
BOONE SUPER HETRODYNE TRANSFORMER KITS
BOONE SUPER FOLDING LOOP AERIALS
BOONE SUPER VARIABLE CONDENSERS

From your dealer or direct from our factory.

J. T. BOONE CORP., 1469 E. Jefferson, Detroit, Mich.

- Enclosed is \$1.00 for your text book "The Super-Hetrodyne."
 Please also send me information on your Super-Hetrodyne Transformer Kits—Folding Loop Aerials—Low Loss Variable Condensers.

Name

Address

(2-1)

FROST-RADIO Shock-Absorber Gang Socket

A three gang shock absorber socket with genuine BAKELITE base. Sponge rubber cushions make it non-micro-phonous. In standard base or C-299, UV-199 types. List. \$2.75



TESTS SHOW FORD CAN RUN 60 MILES ON GALLON OF GAS

The amazing fact that a Ford can run 60 miles on 1 gallon of gasoline was recently brought to light through tests conducted by America's foremost engineers. Great strides have already been made in this direction by the recent invention of a simple attachment which can be installed in a few minutes without any alterations to motor. A. C. Winterburn made 41.4 miles on one gallon of gasoline after this device was attached. E. O. Weeks, famous aviator and inventor, wants agents and will send sample for trial. Write him today at 1304-601 Fordville Ave., Milwaukee, Wis.

SENSATIONAL SALE



GUARANTEED TYPEWRITERS
Limited quantity fully guaranteed rebuilt standard make Typewriters. **5 Days Free Trial.** Lowest prices ever offered. Some at \$45.35. Easy payments as low as \$3 monthly. Send today for **FREE booklet** of valuable Typewriter Information and Special Sale Bulletin.
SMITH TYPEWRITER SALES CO.
300-360 E. Grand Ave. Chicago, Ill.

FREE! DIAMOND, WATCH AND JEWELRY CATALOG, showing latest designs and highest quality jewelry at lowest prices and EASY CREDIT TERMS. Ten months to pay. Prices from \$10 to \$1000. Legal guarantee bond with every article. Don't buy until you send for this Free Catalog. **Baer Bros. Co., Dept. 826, 6 Maiden Lane, N. Y.**

NEW HEAT WITHOUT COAL

FOR FURNACE OR STOVE. Amazing new invention proves stupendous success. Burns ordinary distillate—96% air, 4% oil. Fits any furnace, range or stove. Burns on sight. Write for literature and Free 30-Day Trial Offer Today—Agents Wanted Everywhere.
O. K. MANUFACTURING CO., EAST ST. LOUIS, ILL.

START A BIG MONEY MAKING BUSINESS NOW WITH 8 HOUR CONSTANT POTENTIAL BATTERY CHARGING

With practically no cash investment other than the first small payment on an HB Charging Outfit, you can have your own money-making battery charging business. No experience is needed to make these big profits. Small cash payment puts an HB Constant Potential Battery Charger in your shop complete with bus bars, connecting cables, etc. Easy \$20 monthly terms; let your HB pay for itself with nice surplus besides. HB users make \$150 to \$300 monthly, beat competition, save on current and labor.

30 Days' FREE TRIAL in Your Shop on Money-back Guarantee

No obligation whatever on your part. Order your HB outfit on trial and use it 30 days. If it does not fulfill every claim we make—cut charging costs, bring new business, increase profits and give more complete satisfaction than any other equipment—you return it and we will refund every cent you have paid us. Our positive guarantee of satisfaction-or-money-back gives you complete protection.

Write for Bulletin 728.

HOBART BROS. CO., Box M8, Troy, Ohio

Successful Manufacturers Since 1893

Pays for Itself ~ Earns Big Profits



A Tool Kit without a Speednut Wrench is like a Car without a Self-Starter

Each SPEEDNUT WRENCH is a Whole Kit of Wrenches in One

SPEEDNUT WRENCHES SAVE

Bulk, weight, money, time, nuts, guessing. Can be used everywhere—

In Homes
Railroads
Shipyards
Mines

Machine Shops
Farm Implements
Motorboats
Air Mail Service
Automobiles

Power Plants
Tractors
Army and Navy
Public Utility
Companies

STRENGTH To "twist off" the $\frac{3}{4}$ -inch bolt shown here, a 20-inch bar was used on the 8-inch SPEEDNUT WRENCH to secure necessary leverage. Notice: The nut corners were not even marred. This proves the "Non-Slip-Grip" as well as the extraordinary strength of SPEEDNUT WRENCH.



Improved and Perfected Model 1924

GUARANTEED The World's Quickest Nut Wrench

SPEEDNUT is an "entirely new wrench in principle."

All its three parts are of forged high grade carbon steel.

Accurate workmanship, carefully heat treated, attractively polished, thoroughly tested and **Guaranteed Absolutely.**

FOR FARMERS—Because one 8-inch "SPEEDNUT" will fit all the nuts around any harvesting machine. Harvesting machinery nuts are usually painted and not perfectly made, but a "SPEEDNUT" will fit them perfectly because it adjusts itself to the nut. It is THE wrench to use on those "hard to get at nuts," and as it will stand more strain than any other type of wrench, it will never fail to loosen a "rusted on" nut. It is the only wrench a farmer needs on the field, and he can easily carry it in his pocket. Last, but not least, **IT CAN'T SLIP OR CAN'T ROUND OFF THE CORNERS OF A NUT.**

FOR AUTOMOBILE OWNERS—Because one 8-inch "SPEEDNUT" will fit most of the nuts around a car. It will also fit a spark plug and demountable rim. It can be used in the dark because it does not have to be ad-

justed. The 6-inch "SPEEDNUT" is also a handy wrench around a car as it will fit the very small nuts. A set of two "SPEEDNUTS" will settle any automobile owner's wrench troubles.

FOR MOTORCYCLE OWNERS—Because one 6-inch "SPEEDNUT" will fit all the nuts around a motorcycle and fit them quicker and tighter than any other type of wrench. It takes such a flat, tight grip that it will not injure the nickel plating. It is small, light and easy to carry.

FOR PLUMBERS—Because one 8-inch "SPEEDNUT" will fit all the nuts and unions around bathroom fixtures, and as it takes such a flat, tight grip, it will not injure the nickel plating.

FOR MECHANICS—Because a "SPEEDNUT" is a good, useful, handy tool and will save them time with their work. A "SPEEDNUT" is as useful to a mechanic as a hammer.

Notice That It Has No Slow Thumb Screw Adjustment But a Lightning Grip on All Nuts Within Range

The harder the pull, the tighter it Grips. "JUST LIKE A BULL DOG."

Its tight Grip prevents slipping on nut and wearing off the corners.

Ratchets on nuts, thereby permitting rapid operation.

Occupies less space in kit and is cheaper than the corresponding quota of double end and screw wrenches.

A man, to make money, must think for himself. To the man who will think of this marvelous wrench, its almost human work, its great need, its tremendous market—if he will think, he will see the opportunity.

This is the wrench that was described in the editorial section of this magazine on page 505—October, 1923, issue.

A whole kit of wrenches in one. Simple in construction.

Always in repair and ready for use, has no complicated parts to get out of order.

Get one of these wrenches—you'll use it more than all your other tools combined. No matter how large an assortment you have or how few, you're wasting time without a SPEEDNUT.

Distributors Wanted

Sample 8-inch SPEEDNUT WRENCH will be sent Parcel Post Insured upon receipt of \$4. Express or Money Order. Distributors will appreciate Wonderful Money Making Opportunity when they see and test the SPEEDNUT WRENCH. Order Now.

SPEEDNUT WRENCH CORPORATION

Sales Office: 20 E. Jackson Blvd. Dept. P. Factory: 559-561 W. Lake Street
CHICAGO, ILL., U. S. A.

No more guessing the size wrench needed.

No more skinned knuckles, never slips.

No more fretting and fussing. It always fits.

No more Rounded Nut Corners.

SPEEDNUT wrenches should be in every Tool Kit. They are a wonderful "first aid" to all wrench users. You will be proud of your SPEEDNUT. It grips them all, the large ones and the small, and it RATCHETS.

Rarely, if ever before, has a mechanical specialty appealed to the general public as does the "SPEEDNUT WRENCH." It sells itself. Engineers and Mechanics the World Over will find in the "SPEEDNUT WRENCH," a creation embodying a perfected mechanical principle which revolutionizes wrench construction.

YOUR BEST WRENCH BUY

6-inch SPEEDNUT is the FORD Size—opens from 9/32 to 15/16 in.

8-inch SPEEDNUT is for LARGE CARS—opens from 9/16 to 1 1/2 in.

If your dealer cannot supply you, mail the coupon.

Speednut Wrench Corp., Dept. "P"
20 E. Jackson Blvd., Chicago, Ill.

I enclose Express or Money Order for \$4 for which send me one 8-inch SPEEDNUT WRENCH Parcel Post Insured. I am to return this wrench Parcel Post Insured within 10 days if not satisfied and you are to return the amount paid.

Name.....

Street.....

City..... State.....

Business or Occupation.....

(PRINT NAME AND ADDRESS PLAINLY)

HEAT Without Coal!

Perfect Heating Satisfaction Guaranteed or Money Refunded—That's the Liberal Money-Back Guarantee On Which the new INTERNATIONAL Burner is Sold. An Amazing New Invention That Replaces Coal in Stoves and Furnaces—Manufactured By The Old Reliable INTERNATIONAL Heating Company.

THE FIRST INEXPENSIVE FURNACE BURNER THAT IS SATISFACTORY!

Here is a Furnace Oil Burner that is different. Thousands who had been disappointed with cheap, ineffective Furnace Oil Burners—thousands more who curse the complicated, high priced burners—and other thousands who had been slaves to wood and coal are now enthusiastic users of the new INTERNATIONAL Burner because of its amazing simplicity, efficiency, and unequalled economy.

Write for 30 Day Free Trial

The new INTERNATIONAL Burner fits any hot air, steam or hot water furnace, and is the cheapest to install and operate. Burns without waste most economical fuel known, 96% air and 4% oil. The new INTERNATIONAL has no noisy motors, no moving parts, nothing to get out of order; action purely automatic, eliminating odors and smoke. The new INTERNATIONAL is always ready and safe. Cost unbelievably low. Installation quick and easy without damage to furnace. Can be moved if you move. Try the new INTERNATIONAL, and you'll never use any other. Low introductory price and 30 day free trial offer to those who write at once. This offer is for limited time only.

FITS ANY STOVE, RANGE OR FURNACE

Recommended and endorsed by leading institutions. Given highest rating.



Thousands of testimonials from 48 states.



It's amazing what this new burner can do. Four special models of this wonderful invention are made to fit any heating stove or range. Simply sets in firebox, and transforms oil and air into Instant-Gas, giving three times the heat of coal, and cheaper. Can be turned on or off in a jiffy. Better cooking and baking. Installed in five minutes; no damage to stove. Absolutely safe; lasts a lifetime. Sold on money-back guarantee. Over 160,000 INTERNATIONAL Burners in use. Write today for 30 day free trial offer and Free Book, "Scientific Oil Burning." Specify whether for stove or furnace. Use coupon for quick action.

INTERNATIONAL HEATING CO.

Dept. 1-H, 117 So. 14th St.

ST. LOUIS, MO.

Makes Autos Go 40 Miles on Gallon of Gas

The perfection of an amazing device is announced which is enabling car owners all over the country to double their mileage from each gallon of gasoline used, and remove every particle of carbon from their motors. When the device is attached, automobiles have made over 40 miles on a gallon, increased their power and pep tremendously and eliminated all spark plug difficulties. This inexpensive little device is entirely automatic and self-regulating and can be easily attached by anyone in a few minutes without tapping or drilling.

Free Proof Offer In order to introduce this startling new invention the manufacturers are willing to send a sample at their own risk to one car owner in each town who can show it to neighbors and handle the big volume of business which will be built up wherever it is shown. Just send your name and address to the Western Specialty Co., 1200 LaCotah Bldg., Sioux Falls, S. Dak., and get their free sample offer.



The International's combination safety and indicator valve, approved by Underwriters Laboratories of National Board of Fire Underwriters.

AGENTS WANTED

Agents, distributors and salesmen wanted at once. Write or wire for exclusive free territory quick. Now is the time to get started—jump into this immediately for a big season. Hundreds of men and women are making big money with the new INTERNATIONAL Burner. Adrian of Pennsylvania made \$150 the week after he started. Fleurent of Rhode Island made \$90 the first week, so did Clark of Nebraska. Palley of Iowa made \$65 in three days. Bible of Wyoming earned \$30 in two hours. Meade of Mexico made \$126 in one day. Arnel of California runs up \$40 in two days, and hundreds of others are cashing in big with the new INTERNATIONAL Burner. High-powered salesmanship not necessary. The new INTERNATIONAL practically sells itself. Write at once for free sample offer and special agents' proposition.

INTERNATIONAL HEATING CO., Dept. 1-H, 117 So. 14th St., St. Louis, Mo. Mail me, postpaid, your Free Book, "Scientific Oil Burning" and further information about your burner for:—

.....Stove
.....Furnace
(Check style desired)

For agent's sample offer, place (x) below.

Name.....

Street or P. O. Box.....

City..... State.....



MOORE PUSH-PINS

Glass Heads—Steel Points

Moore Push-less Hangers

To hang up things

Ask your dealer to show them

Sold Everywhere 10c Per Packet

MOORE PUSH-PIN CO.

Wayne Junction Philadelphia

AUTO SUPPLIES
WHOLESALE
3000 BARGAINS

SEND FOR THIS CATALOG—

it's FREE!

Everything you need in Auto Supplies at Amazingly LOW PRICES.

NEMCO BARGAIN SUPPLY HOUSE

33 to 49 No. Peoria St. Dept. P. CHICAGO, ILL.

Be the Tom Brown of your town



You may have the talent to develop into a Saxophone wizard like Tom Brown, of the famous Tom Brown's Clown Band, and enjoy this most pleasant of vocations. Buescher Band and Orchestra Instruments have helped make famous such leaders as Paul Whiteman, Jascha Gurewicz, Clyde C. Doerr, Bennie Krueger, Ben Selvin, Joseph C. Smith, Dan Russo, Gene Rodemich, Henry Santrey, Zex Confrey and thousands of others. \$100 to \$500 weekly for a few hours a day is not uncommon for musicians of ability to earn.

BUESCHER

(4) True-Tone SAXOPHONE

The Buescher Saxophone is so perfected and simplified that it is the easiest of all musical instruments to learn. It is the one instrument that everyone can play—man or woman, boy or girl—and it wholly satisfies that craving everybody has to personally produce music. You can learn the scale in an hour's practice, play popular music in a few weeks and take your place in an Orchestra or Band within 90 days, if you so desire. Nothing can take the place of a Saxophone for home entertainment, church, lodge or school. It increases the pleasure you get out of life, increases your popularity and your opportunities.

FREE Saxophone Book Six days' free trial and easy terms of payment arranged on any Buescher Saxophone, Cornet, Trumpet or other instrument. Just fill out and mail coupon on the right for Free Saxophone Book or Complete Catalog.

BUESCHER BAND INSTRUMENT CO.
Everything in Band and Orchestra Instruments
136 Buescher Block ELKHART, IND.

Buescher Band Instrument Co.,
136 Buescher Block, Elkhart, Ind.

Gentlemen:

I am interested in the instrument checked below:

Saxophone.....Cornet.....Trombone.....Trumpet.....
(Mention any other instrument interested in)

Name.....

St. Address.....

Town.....

State.....

**Easy to Play
Easy to Pay**

HANES

For downright
Underwear value

AGENTS \$12 A DAY

New Wonder Light Invention

For every home. Sensation of age. 300 Candle Power. Brilliant, white light—soft, restful to eyes. Burns 95% air. Equal safety, cleanliness and convenience of electricity at 1/10th the cost, 20 times brighter than wick lamps. No smoke. No noise. No odor.

FREE Outfit to Workers. New plan starts you without capital. No experience needed. Profits start first day. Vivian, Minn., made \$400 in 30 days. Bartley, O., made \$500 in 47 days. Write quick for territory and **Free Outfit Offer.**

THE AKRON LAMP CO., 108 Lamp Bldg., Akron, O.



GROSLEY
Better-Cost Less
Radio Products

Two Tube Regenerative Receiver
Largest Tube Amplifier U. S. Patent No. 1,113,145. Contains regenerative detector and one stage of audio frequency amplification. Loud speaker volume is secured at all times on local stations and for distant stations under low receiving conditions. For Sale by Good Dealers Everywhere. Write for Descriptive Matter and Free Booklet, "Simplicity of Radio".
The Grosley Radio Corporation
7711 Alford St.
Cincinnati, O.



NEW TUBE SET \$18.50
MODEL 51 TWO TUBE SET
REGENERATIVE

**Tires With 500 Nail
Holes Leak No AIR**

A new puncture-proof inner tube has been invented by a Mr. M. E. Milburn of Chicago. In actual test it was punctured 500 times without the loss of air. This wonderful new tube increases mileage from 10,000 to 12,000 miles and eliminates changing tires. It costs no more than the ordinary tube. Mr. Milburn wants them introduced everywhere and is making a special offer to agents.
Write Sales Manager, E. H. Hansen,
336 West 47th St., Chicago

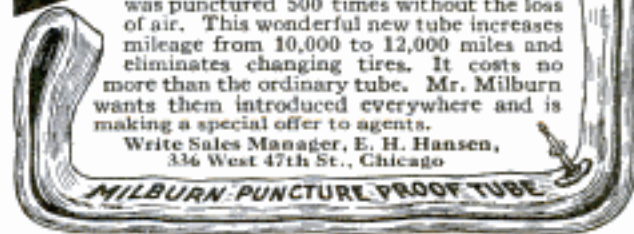

Hand
Forged
Razor Steel
Blades, No. 57



A GENUINE \$2 KNIFE
FOR
\$1.18 POSTPAID

Direct at Factory Prices

This \$2 KNIFE \$1.18 Postpaid
Hand Forged Razor Steel Blades
Handy shaped Blade makes this knife best for mechanics, sportsmen and farmers; light but strong; re-sharpened easily. Stag handle. German silver finish; blades file tested, hand forged from razor steel and warranted.

Sample \$1.18 3 for \$3.00 Postpaid.

Send for our 100-page List and "HOW TO USE A RAZOR" **FREE**
MAHER & GROSCH CO., 108 A St., Toledo, Ohio

FREE—25c Book on Wood Finishing



It Tells

How to finish soft and hardwoods.

How to stain wood artistically.

How to remove old paint and varnish.

How to secure a beautiful enamel finish.



Johnson's Wood Dye comes in all sizes from half pints to gallons. Among the seventeen popular shades are:

- No. 128 Light Mahogany
- No. 129 Dark Mahogany
- No. 127 Brown Mahogany
- No. 123 Dark Oak
- No. 126 Light Oak
- No. 124 Golden Oak
- No. 110 Bog Oak
- No. 131 Walnut



If you have a hobby for making cabinets, furniture, porch swings—radio boxes, etc.—you will find our book invaluable. Naturally, you want to give your handiwork a beautiful finish. Our Book gives complete instructions for finishing all wood—hard or soft, old or new. It is the work of experts—beautifully illustrated in color. Gives covering capacities—includes color charts, etc. Use coupon below.

JOHNSON'S WOOD DYE

(PENETRATING)

Johnson's Wood Dye is very easy to apply—it dries in four hours and will not rub off or smudge—penetrates deeply, bringing out the beauty of the grain without raising it. Made in seventeen popular shades, all of which may be easily lightened or darkened. Full directions on every label. Read and follow them.

Johnson's Wood Dye has many uses for both the artisan and amateur. *Architects* and *contractors* specify it for coloring woodwork and flooring in new buildings. *Painters* and *decorators* use it with equal satisfaction on new and old woodwork of all kinds. *Housewives* delight in it for doing over old furniture and for coloring reed and wicker baskets, etc. *Manual training teachers* and *pupils* use it for finishing their models. *Upholsterers*, *furniture repairers* and *cabinet makers* find it "just the thing" for their work—old and new.

Ask for a FREE copy of the Johnson Book on Wood Finishing at any store displaying the sign shown at right. If no store in your locality has a Johnson Service Department, mail this coupon to us.

DEALER'S NAME.....

Your Name.....

Address.....

City and State.....

Mail to
S. C. JOHNSON & SON, Dept. P. A. 8, RACINE, WIS.



S. C. JOHNSON & SON

"The Wood Finishing Authorities"

Racine,

Wisconsin, U. S. A.

SAVE HALF - INSTALL YOUR OWN PLUMBING AND HEATING BY OUR *New Easy Method*



Get
This
Big
Book

Any Handy Man can save half on Water Supply Systems, Bathroom outfits, heating plants, or plumbing materials. We show you how to install with simple diagrams and clear instructions. Do the work yourself and save high cost. Installing plans FREE. We even loan the tools if necessary. You are entitled to enjoy the modern conveniences of running water, up-to-date bathroom, and convenient kitchen plumbing.



BIG HANDY MAN BOOK

Our Handy Man Book tells the whole story. Shows the Hardin-Lavin easy way. Send coupon with 25c for your copy today. This big, instructive, well-bound "Handy Man" Book-Catalog combines our wholesale catalog with trade secrets, money saving kinks, practical plans, many diagrams, sketches, elevations, etc. Every Handy Man, every home owner, contractor, farmer, mechanic and institution needs this book.

Plumbing Outfits—Heating Plants—Water Supply Systems—At Wholesale

Hot Water Plant AT LOW COST

Send a rough sketch or better still a blue print of your building, and from this, we will give you our lowest wholesale price on a complete, high-grade, guaranteed Hot Water Heating Plant.



CUT-TO-FIT YOUR HOME

Our method is different because we furnish a Heating Plant for the exact job for which it is intended, and cut, thread, and mark all large pipes so that any handy man with the aid of our simplified plain installing plans can put the plant together by our

For 50 years, we have been economy headquarters for everything in plumbing and heating. In our money saving Encyclopedia-Catalog of plumbing and heating supplies, you will find bathroom outfits, plumbing systems, or heating plants that will give you the conveniences that are rightly yours.

Factory Fitted PLUMBING & HEATING

All connections and trimmings fitted at factory. You save waste labor, time, money and materials when you buy at wholesale from Big "Handy Man" Plumbing and Heating Encyclopedia. Shows over 10,000 fixtures and supplies. Hot air, water or steam heating plants. Bathroom outfits, kitchen sinks, plumbing goods of every description, and water supply systems. Do your plumbing and heating by our new easy method and save half.

Ask for Estimate Our Help Free—No Obligation

Send us a rough sketch of the arrangements of your rooms and we will figure the wholesale cost of your heating plant or plumbing system. We will show you many kinks and wrinkles where you can make savings that will surprise you.

50 Years and Million Dollar Plants Behind Our Guaranty.

When you buy from us you get the benefit of 50 Years' Service to Economy Buyers. Quality merchandise with exclusive features. Trained experts who help you plan. Our personal interest in your needs. A guarantee of satisfaction or your money back.

HARDIN-LAVIN Bath Outfit



HARDIN-LAVIN Steam Boiler



HARDIN-LAVIN Pipeless Furnace

New Easy Method

Send plan today for our low wholesale price on a complete modern Plant, delivered to your city.

MAIL COUPON WITH 25¢ TO-DAY!

Our combined Catalog-Encyclopedia represents many years' experience and expense in gathering the wealth of information it contains. To avoid sending so valuable a book broadcast, we request a deposit of 25c (regular price 50c) to cover wrapping and mailing. Deposit refunded on first order. Send for this money-saving book TODAY.

ACT
AT
ONCE

HARDIN-LAVIN CO., Chicago, Ill.
4547-57 Cottage Grove Ave., Chicago, Ill.

Centlemen: Enclosed find 25c (34 regular price) for which please send me your Big, Complete, "Handy Man" Book-Catalogue, with special wholesale discount sheets. Also mail me your FREE Bulletin Service. I am interested in

- | | |
|--|---|
| <input type="checkbox"/> Hot water heating plant | <input type="checkbox"/> Pipeless Furnace |
| <input type="checkbox"/> Steam heating plant | <input type="checkbox"/> Water supply systems |
| <input type="checkbox"/> Hot air furnace | <input type="checkbox"/> Plumbing systems |

Name

Address

City

THIS LABEL PROTECTS YOU



SEND COUPON WITH 25c TODAY

HARDIN-LAVIN CO.

50 Years at

4547-57 Cottage Grove Av., Chicago



HARDIN-LAVIN Water Supply System

**No Noisy Motors - No Electricity
No Moving Parts**

© 1924
O O O CO.



Now!

A PERFECTED OIL-BURNER Every Family Can Afford

DISTRIBUTORS WANTED

200,000 homes have banished forever, coal — ashes — dirt — smoke — soot — dust — building fires — cleaning furnaces — frozen pipes — exorbitant fuel prices — uneven heat — cold rooms — with Oliver Oil-Gas Burners.

Above is reproduced the perfected No. 30-A Furnace Burner—listed as standard by the Underwriters' Laboratories. It is the final triumph of the Oliver engineers. It will give you automatic heat—smokeless, sootless and even—for Winter's coldest days. And because Oliver is by far the largest manufacturer of oil-gas burners you can get this perfected unit at a fraction of the cost of other burners.

No Complicated Machinery

When you install an Oliver Burner you have no worry about expensive, delicate machinery getting out of order.

There are no noisy motors—no moving parts. You do not have to depend upon electricity or gas for operation. This simple device converts any type or size of steam, hot air or hot water furnace into any automatic heating plant. Quickly and easily installed without change to your furnace. Absolutely safe. Lasts a lifetime.

Free Book—Mail Coupon

The performances of Oliver Burners has been so thoroughly tested and proved that they are sold on an extraordinary guarantee of complete satisfaction. The Oliver line includes burners for every type of heating stove, cook stove, etc. You, too, can be free from the dirt and drudgery of coal or wood. An interesting book will be sent you free if you will simply send us your name and address. Fill in the coupon and mail it at once.



There are 16 types of Oliver Burners for every kind of heating stove, cook stove and furnace.

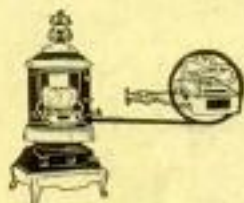

Any degree of heat desired, off and on at turn of valve. Excellent for year round heating. No odor, no wicks. Absolutely safe.

OLIVER OIL-GAS BURNER

857 Oliver Bldg. - - - St. Louis, Mo.

Oldest and largest manufacturers of oil-gas burners in the world

Canadian Distributor: 857 Oliver Bldg., Toronto, Ont.

**Oliver Oil-Gas Burner Co.,
857 Oliver Bldg., St. Louis, Mo.**

Please send me at once your free book, and full details on
 Furnace Burner Cook Stove Burner
 Heating Stove Burner

Name.....

Address.....

City..... State.....

(Check here if interested in becoming a Distributor or Sales Agent)
 Distributor Sales Agent

DISTRIBUTORS AND SALES AGENTS

Experienced business men will grasp at once the tremendous possibilities for the sale of a perfected furnace oil burner at a price within reach of the masses. We are now appointing Exclusive Distributors for counties and sections—turning over to them our established business, in many cases already organized sales forces. Write or wire at once for full details—an attractive proposition can be outlined entirely commensurate with your ability and present position. We also need Dealers, Sales Agents and Spare Time Workers. Many earn \$100 to \$250 a week. Send immediately for Sales Plan.