

JUNE

N.S.E.

25 CENTS

# POPULAR MECHANICS MAGAZINE

WRITTEN SO YOU CAN UNDERSTAND IT

REG'D. TRADE MARK, GREAT BRITAIN, No. 410425

REG. U. S. PAT. OFF.

**\$78,300**  
offered for  
**IDEAS**

SEE PAGE 813

Copyrighted material



# Be an Auto and Electrical Expert

**McSweeney Trained Men in Demand  
at \$40 to \$150 a Week**



Here's one instance of the success McSweeney Training has brought thousands of men:

George W. Smith, West Alexandria, O., has earned over \$800 a month ever since he finished his training. He now owns his own garage and auto agency. When Smith came to me he knew nothing about autos. In eight weeks my methods made a big-money man out of him. And there's no reason why any boy can't do just as well.

**I'll Pay Your Railroad Fare to Cincinnati and Board You for My Full 8 Weeks Term**



I get calls every day from garages, battery stations, auto factories and so on, for McSweeney-trained men. Albert Boyer, of Alexandria, Ky., is only 19 years old, but has been making a big success in his own business. He says my training made him win out. To fill the calls on me for trained experts, I'm making this wonderful offer for a short time. I'll pay your railroad fare to Cincinnati, and board you for the full eight weeks.

**In 50 Days You're Ready  
to Command a Big Pay Job**



13,000,000 Autos and 1,000,000 Tractors must be kept running. Spend 50 days in my great shops and no job will be too hard for you. Big wages and steady work certain. "McSweeney training made me Chief Mechanic of a big plant in three months," writes Fred Pendley, Blowing Rock, N. C.

**Electrical Course Included**

Every one of my students receives a complete course in practical electricity. He learns ignition, starting, lighting, power plant and generator wiring—all by the same work-shop job-methods which teach him all about carburetors, transmissions, vulcanizing, battery construction and repair. He learns in 50 days to tackle any machine, in any condition, and "put it on its feet"

**"Mac" Trains Men With Tools - Not Textbooks  
You Learn Under Experts in a Wonderful Shop**



"The Great McSweeney School"

I have successfully managed more auto and tractor schools than any man in the world. Now I am in complete control of the former Rahe Auto & Tractor School, of Cincinnati, Ohio. Now I can put into complete operation many ideas and plans which, I sincerely believe, will make this the greatest Auto, Tractor and Electrical training institution in existence. Write me and I'll tell you what this splendid school can mean to YOU, to your pay envelope and to your future.

**Write Today for Free Catalog & Special Reduced  
Tuition Offer for McSweeney Life Scholarship.**

**MCSWEENEY**  
**Auto, Tractor & Electrical**  
NINTH & WALNUT STS. **SCHOOL** CINCINNATI OHIO  
**Successors to Rahe Auto & Tractor School**

McSweeney Auto, Tractor & Electrical School  
Dept. 145, Ninth & Walnut, Cincinnati, Ohio

Send me your Big Free Book on auto and tractor business, and send me information on special reduced tuition offer, in effect for a short time only.

Name .....

Street or R. R. ....

City or Town ..... State .....

(No facilities for colored students)



# \$35 for a *two tube* Radiola



This symbol of  
quality is your  
protection.



**Radiola III**

At \$35

Radiola III. Two Radiotrons WD-11. Head telephones. In brief, everything except the dry batteries and the antenna.

You Can Add

Radiola Loudspeaker . . . \$36.50  
Radiola Balanced Amplifier (push-pull) to get long distances with a loudspeaker. Including two Radiotrons WD-11, \$30

Or Buy Complete

RADIOLA III-A, the amplifier combined with Radiola III in one cabinet; with four Radiotrons WD-11, head telephones and Radiola Loudspeaker, \$100

A NEW two-tube RADIOLA—designed and built by world-famed engineers in the great RCA laboratories—priced at less than you could build it for at home! A real RADIOLA—including the tubes and headphones. A new model. Improved in sensitivity and selectivity. Getting distance on the headphones, and near stations on a loudspeaker. Receiving clearly—reproducing truthfully. Its thirty-five dollar price means at last that every home everywhere can tune in on the fun with a small receiver built for big performance.

Radio Corporation of America

233 Broadway  
New York

Sales Offices:  
10 So. La Salle St.  
Chicago, Ill.

433 California St.  
San Francisco, Cal.

There are many Radiolas at many prices.  
Send for free booklet that describes them all.

# Radiola

REG. U.S. PAT. OFF.

RADIO CORPORATION OF AMERICA  
Dept. 516 (Address office nearest you).  
Please send me your free Radio Booklet.

Name \_\_\_\_\_  
Street Address \_\_\_\_\_  
City \_\_\_\_\_ R. F. D. \_\_\_\_\_  
State \_\_\_\_\_



TUHE-1A8-UF94



*In Specifying Cypress, "the Wood Eternal," say "TIDEWATER."*

**T**HE ONLY true "Wood Eternal" species of *Taxodium distichum* (known commercially as CYPRESS), is that which grows within about 200 miles of the Southern and Southeastern coastline of the U.S.

There is a kindred species, whose habitat is farther inland, on higher ground, which has not the same decay-resistant traits, and which often is substituted when the buyer fails to be insistent upon identified "TIDEWATER" CYPRESS.

For complete security, you need only require that the



be the identifying symbol of every Cypress board or bundle.

Responsible lumber dealers will gladly aid you to obtain the genuine. We invite correspondence, and will respond in a helpful way. Our first concern is to see that you get the genuine "Wood Eternal," when and where you want it.

*Respectfully submitted:*

SOUTHERN CYPRESS MANUFACTURERS ASSOCIATION  
1219 Poydras Bldg., New Orleans, La., or 1219 Graham Bldg., Jacksonville, Fla.



# Popular Mechanics Magazine

200 E. Ontario Street, Chicago, U. S. A.

H. H. WINDSOR, Editor

London: Hachette & Co.,  
16-17 King William Street, Charing Cross, W. C. 2

Paris: Hachette & Co.,  
111 Rue Reaumur

Melbourne, Australia  
The Australasian News Co.

ISSUED MONTHLY

SUBSCRIPTION:

SINGLE COPY, 25 CENTS

In United States and its possessions, also Canada, Cuba, and Mexico, per year, postpaid - \$2.50  
To all other countries in the Postal Union . . . . . 3.00

All subscriptions are discontinued at expiration. Please examine the date printed on your wrapper.

Entered as Second Class Matter Sept. 15, 1908, at the Post Office at Chicago, Illinois, under Act of March 3rd, 1879.

Entered as Second Class Matter at the Post Office Department, Canada.

Published monthly by POPULAR MECHANICS CO.

Copyright, 1924, by H. H. Windsor.

Copyright in Australia. Copyright in France

Vol. 41

Contents for June, 1924

No. 6

Abattoirs—Cattle Killed by Electricity . . . . .	886	Dishes Peeled to Clean . . . . .	889
Airplanes to Carry Mail in Alaska . . . . .	885	Dyes, Potato Tops Yield . . . . .	925
Airships—Dirigibles to Be Anchored to Ships' Masts . . . . .	842	Earthquakes—Japan Expresses Thanks for Earthquake Help . . . . .	870
Animal Mummies Lifelike by Special Fluid . . . . .	873	Earthquakes, Weak Spots in Earth's Crust Clue to . . . . .	921
Arctic Region—Figures Modeled in Wax, Sugar and Linoleum . . . . .	873	Earth's Slip Revealed by Zenith Tube Photography . . . . .	908
Australia, Size of . . . . .	823	Editor's Mail Bag . . . . .	904
Automobile Accelerator Guard . . . . .	925	El. Electric, Scientists Study Power Plant of . . . . .	830
Automobile Racing—Gambling with Death . . . . .	902	Electricity, Coal Slack to Generate, in Alaska . . . . .	893
Automobiles, Lighting—Regulator for Auto Lamp . . . . .	830	Electric Speed Motor of 10,000 r.p.m. . . . .	942
Automobiles—Mud "Boots" for Safety . . . . .	845	Elevators Carry Daily Nine Million in New York City . . . . .	912
Parking a Problem, by John Ihlder . . . . .	877	Eraser, Adjustable, Lasts as Long as Pencil . . . . .	921
Parking in Revolving Tower . . . . .	879	Excavating Machinery—Trench Pull-Shovel Backs Away from Work . . . . .	837
Signal Lights Indicate Turns . . . . .	901	Exhaust Gas Analyzer Checks Carburetors . . . . .	941
Aviation—Airmen to Cross Frozen Top-of-the-World Limit of Flying Speed Predicted . . . . .	832	Explosions from Dust Checked by Tests . . . . .	917
Stores Cached Along Route for World Flyers . . . . .	820	Fertilizers—Need of Shown by Tabulated Disk . . . . .	892
Axle Shaft, Cost Reduced by Hot Swaging . . . . .	944	Finger Prints Enlarged . . . . .	855
Bark from Trees Rivals Hides in Toughness . . . . .	909	Fire Apparatus—Electric Alarm Foretells Start of Fire . . . . .	802
Basketball—Dummy Catcher for Indoor Practice . . . . .	907	Fishing in Ocean with Horse and Wagon . . . . .	886
Martin Luther, Well Preserved . . . . .	831	Fishing—Anglers Lured to Haunts of Trout . . . . .	833
Caught with Noose . . . . .	843	Leat Bait Stuns the Fish in Madagascar . . . . .	870
Bats Fly Hundred Miles an Hour without Stop . . . . .	856	Fish, Perforated Strainer Supplies Air to . . . . .	828
Birds of Paradise Sought in Jungle . . . . .	878	Food and Seeds Preserved by Light Rays . . . . .	822
Birds, Zoo, "Surgeons" Save Lives of . . . . .	862	Forest Fires—Warning Given by Instrument . . . . .	831
Bleachers Fold Up in Wagon . . . . .	844	Fountain Pens, Double Barreled . . . . .	829
Blowtorch and Soldering Iron Combined, Pumps . . . . .	917	Fuel from Dust and Waste . . . . .	858
Boat, Gliding, Skims on Water, Ice or Snow . . . . .	920	Fundy (Bay)—Harnessing Tides Will Rival Niagara . . . . .	876
Bomb Carried on Airplane Weighs Two Tons . . . . .	867	Garage Built of Auto Tags, Rust Proof . . . . .	918
Boring Machinery—Earth Boring Machine on Truck . . . . .	941	Gas and Oil Engines, Safety Tank, Cap for . . . . .	911
Bridge Moved on Pontoons . . . . .	844	Gauge Checks Cylinders . . . . .	944
Brushes, Electric Floor . . . . .	909	Gears—Speed Reduction 90,000 to One . . . . .	928
Bull Fight Ring in Mexico . . . . .	850	Golden Call, Temple of, Unearthed near Ur . . . . .	920
Butterflies, Dormant, Revived by Light in London Zoo . . . . .	901	Gold Mined from Buffers . . . . .	832
Calves Fed by Rubber Nipple Attached to Pail . . . . .	901	Golf Charts Teach Strokes . . . . .	832
Camera, Automatic, Winds Up Its Own Film Roll . . . . .	819	Golf Club Face of Aluminum, Removable . . . . .	862
Canaries, Shipload to Meet Demand . . . . .	871	Golf—Indoor Putting Cup . . . . .	879
Cap with Double Visor . . . . .	883	Golf—Skill Improved by Science . . . . .	839
Card Table "Clock" Tells Next Dealer . . . . .	846	Gun Crew Prize, Letter "E" Painted on Ship . . . . .	905
Carnivals, Traveling, Sell Happiness . . . . .	894	Gun Fires 32 Bullets a Second . . . . .	918
Cattle, Carting in Motorcycle . . . . .	823	Handle, Screwdriver, for Combination S Wrenches . . . . .	912
Cement Designs . . . . .	884	Heart—Turtle Heart Beat Recorded by Movie Camera . . . . .	917
Centering, Punch Transfers Hole Centers . . . . .	943	Hedge Trimmer Like Mower . . . . .	927
Chair, Easy, Made of Two Steel Springs . . . . .	892	Hopper Box Sorts Nails . . . . .	878
Chairs Hidden in Table . . . . .	837	Horses Go to Army School . . . . .	824
Charcoal Gas Supplies Power for Automobile . . . . .	819	Horses, Pull of, Tests Show . . . . .	819
Churches of England, Ancient, May Be Shipped to U.S. . . . .	854	Household Devices . . . . .	880
Cigar Wrapper Run by Motor . . . . .	920	Houses Built Like Thermos Bottles . . . . .	868
Clamp Typewriter to Desk without Screws . . . . .	928	Humidifier, Electrically Connected, Has Fountain . . . . .	882
Clamps—Ring Clamp Nozzle Holder with Prong Attachments . . . . .	854	Hydroelectric—Mitchell Dam Operates in Twenty-Five Months . . . . .	858
Coins, Gold, Millions Lost by Wear . . . . .	857	Hyena Strong but Cowardly . . . . .	905
Comb, Pocket, Touch of Button Opens . . . . .	866	Ideas, \$78,800 Offered by Industries for . . . . .	813
Combustion—Fuel Tablets Burn in Water . . . . .	921	Industrial Education, Training for Labor . . . . .	847
Comment and Review, by H. H. Windsor . . . . .	859	Ink Prints on Dough before Baking . . . . .	823
Cork, Insert Clutch Disk, Repaired by Tool . . . . .	942	Insects and Worms, Floated Out of Soil for Examination . . . . .	913
Cotton Crop, Electric "Fingers" Harvest . . . . .	900	Insects Painted to Help War against Disease . . . . .	845
Cuff Links Locked by Spring . . . . .	870	Inventions, Great, How Delayed . . . . .	887
Cup, Drinking, Has Chocolate Coating . . . . .	912	Iron Found in Koolan Island in Pacific . . . . .	907
Cylinders Honed by Motor-Driven Tool . . . . .	942	Ironing Board, Adjustable . . . . .	845
Dating Stamp with Revolving Dies . . . . .	854	June Month of "New Arrivals" in Field and Forest . . . . .	918
Deerfield Valley Dammed for Power . . . . .	898	Khyber Pass, Camel Train Crossing Pontoon Near . . . . .	909
Desk of President Token of British Good Will . . . . .	889	Kitchen Utensils—Cake Shell Pan for Desserts . . . . .	866
Dictaphone—Electric Stenographer . . . . .	851		

[Continued on Page 4]

*Chruslatten 868*



## [Contents—Continued]

Lighters for Water Heater from Any Floor	911	Turbines—Stream Harnessed near Lake Pully	842
Lighting—Electric in Millions of Homes	918	Turbogenerator to Generate 83,000 Horsepower	820
Loading and Unloading—Trucks Loaded from Rear by Power	830	Valves, Noisy, Silencer for	850
Lock, Keyless, Fitted from Inside on Door	921	Vise Has All Steel Slide	941
Lock on Private Telephone	876	Washing Machine Clamps on Any Tub	842
Locomotive, Baby Switch, Gasoline Driven	889	Water Supply from Floating Plant for Refinery	916
Locomotives Gaining in Power	846	Weather Watch Forecasts Twelve Hours Ahead	907
Lost Continent, Search for	892	Whistle, Locomotive, Can Be Heard Three Miles Away	907
Luminous Paint, Keyhole Seen in Dark with	854		
Marking Machine Works Rapidly	944		
Match Box Lid, Wind Proof	901		
Milk Bottles, Lock Box for	875		
Model—Miniature Streets as Court Evidence	829		
Royal Doll House Rivals Palace	922		
Model of Town from Odds and Ends	906		
Mount Everest Ascent to Be Attempted Again	893		
Moving Pictures—Warning Indicator on Film Projector	921		
Musical Instruments—Bamboo Orchestra, Tones Via with "Jazz"	913		
Player Built in Automobile	924		
Roll Maker Wired to Piano Makes Records	871		
Saxophone So Large Player Stands on Ladder	866		
Music Used by Surgeons to Ease Operations	905		
Navigation—Sea's Perils Revealed by Wire Drag	925		
Panama Canal—Dam, Movable, at Gatun	834		
Paper, Waxed, in Box with Metal Cutting Edge	871		
Phonograph Master Records, Apparatus Duplicates	843		
Photography, Aerial, Reveals Errors in Maps	857		
Plants, Electric "Sunlight" Speeds Growth of	898		
Plants Supply Enough Light to Take Photographs	879		
Police Practice at Target from Bullet-Proof Auto	870		
Presses, Steam, Wire Guard for Safety	885		
Press Prints Several Colors at Once	876		
Printed Matter Reduced by Photographic Process	900		
Pumps—Tire Pump, Self Oiling	893		
Pumps to Raise Water a Mile in Mines	908		
Putty Gun That Fits Pocket	898		
"Question Shop" Answers Telephoned Queries	925		
Radio—Blind Spots Mystify Science	937		
Broadcast Station in Los Angeles Church	929		
Causes of Silent Tubes	939		
Cleaning Crystals with Alcohol	936		
Coupler Permits Selectivity	932		
Grid Leak Has Flexible Ribbon Element	940		
High Power Station for Australia	932		
Indoor Antenna Like Picture Frame	936		
Neurodyne Set Built in Console	933		
Phone Block Connects Six Headsets	940		
Phone Plug Has Quick Release	929		
Preventing Multi Conductor Aerial from Rolling	939		
Set Has Parts of Solid Gold	936		
Sixteen Tube Set in Restaurant	932		
Teletype Success on Planes	940		
Tester Condenser Shows Correct Finder Capacity	932		
Railways, Swiss, One-Half Operated by Electricity	898		
Reflecting Indicator Warns if Lamp Is Out	876		
Road Scraper, Fool Proof, One Man	943		
Roads Hewn from Mountain Cliff	927		
Rubber Suit for Motorist	871		
Safe, Pocket-Size, for Small Valuables	858		
Safety Devices and Measures—Traffic Post, Self-Righting	855		
Safety Movement—Street Car Sides as Signboards	924		
Sahara, Six-Wheeled Autos Conquer	912		
Saw, Carpenter's, Has Square Attachment	943		
Sharpener for Shears and Mowers with Changeable Grinder	906		
Shoes Sold by "Walking Store"	882		
Signs and Sign Posts in Desert Direct to Water	850		
Skyscraper, Black Brick and Gold Trim Used for	908		
Smoke Screen Disperses Frost and Kills Insects	906		
Soda Fountain Syrups Measured by Special Valve in Container	882		
Sound, Photos of, to Improve Music and Radio	823		
Spools Make Useful Furniture	911		
Stakes Adjustable as Plant Supports	823		
Stand for Plants, Adjusts to Any Angle	867		
Steamer "Norfolk," Crippled, Takes to Sails	846		
Steeple Jacks	890		
Street Cleaning by Bamboo Brush on Tractor	908		
Street 33 Years Old Repaired Like New	820		
Stamp Puller, One Man	885		
Submarines, Guarded against Unseen Perils	857		
Swine, Raising Scientifically and Efficiently	911		
Tank, Amphibious, Aids Warship at Manuevers	883		
Telephones, "Booster," Speed Train Dispatching	878		
Tent without Center Pole Works Like Umbrella	875		
Testing Rubber	843		
Toothbrush Bristles Open for Cleaning	831		
Trolleys, Aerial, Bolivian Peaks to Have	831		

Truck loaded from Rear 830

misty folding  
Wrenches 912

## SHOP NOTES

Automobiles—Gearbox Used in Machine Tool Driver	961
Babbitting, Shaft Holder for	959
Belt Shifter Lock	956
Box for Nails and Screws	958
Centrifuge for Farmers	964
Conveyor Device Starts Boxes that Stick	960
Cotter Pin, Closing Sides of	953
Dowels, Wood	957
Drawings, Transparent Flap Protects	963
Drill Chuck for Round Shanks	958
Drinking Fountain for Small Stock	945
Hardy, Handy	955
Irrigation Ditches Dammed by Metal Pieces	958
Lamp, Traveling, Illuminates Gauge	963
Lathe Centers, Grinding	962
Lathe Support for Long, Slender Work	947
Loading Hay Made Easy	961
Lunches of Employees Checked at Special Trucks	963
Mechanical Powers—Part IV	948
Painter's Kink	963
Polishing Wheel, Handy	962
Poppet Valve Gauge	953
Punch, Pneumatic	953
Roller, Steel, Protects Barn Corner	956
Saw, Portable, Motor-Driven	955
Soldering—Kink for Square Corners	959
Soldering—Vacuum Cleaner Furnishes Blast	947
Spindle Bushings, Removing	956
Tomatoes Washed by Boat-Propeller	959
Tongs for Lifting I-Beams	954
V-Block Capacity Increased	960
Vise, Portable, Support for	962
Wagon Bed Made to Last	955
Water Heated with Steam	947
Welding Rod Holders	954
Wheelbarrow for Gardeners' Baskets	954
Wheel Puller, Crossbar and Chain	954
Wrench Made from Connecting Rod	954

## AMATEUR MECHANICS

Adapter for Bayonet Socket Lamps	970
Alcove Usefulness Increased	983
Anchor for Small Boats	909
Automobile—Hiding Spare Ignition Key	976
Spring Overhaul	971
Boating—Outboard Motor Efficiency Increased	981
Bottle Cover	967
Bunsen Burner	976
Campfire Hob	965
Carpet Sweeper, Use for Old	983
Drawer Stop	969
Egg Beater with Extension Handle	970
Envelopes Re-Used	968
Ferris Wheel, Water Driven, for the Camp	979
Ferry, Improvised	977
Fishhooks Made Detachable	968
Ford Rear End, Connecting	969
Glue—Soaped Article Will Not Stick	975
Gun—Recoil Pad for Trigger Guard	970
Hair Drying Attachment for Fan	981
Holder for Shaving Brush	975
Incubator Leaks Stopped	966
Ladder, Portable, for Garret	968
Lens, Fitting Camera	966
Mitten, Elastic, on Paint Brush	977
Pamphlet Holder	978
Photos Enlarged and Reduced	978
Press for Lard or Fruit	967
Screen and Storm Sash Fastening	975
Screen Door Check	978
Sharpening Steel, to Clean	976
Spindle Bolt's Replaced	967
Tire Cover from Inner Tube	983
Toy Boat, Compressed Air	982
Umbrella Loss Prevented	977
Ventilator, Window	970
Weeder for Dandelions Made from Hoe	965
Wood Yard	967



# DRAKE'S PRACTICAL MECHANICAL BOOKS

## THEY WILL RAISE YOUR PAY—

### ORDER ON 5-DAY TRIAL

The books listed below will perfect you in your chosen trade—pave the way to the big positions. Written in non-technical language—easy to read and understand. *Every book covers its subject completely. An entire course of instruction condensed into one volume.* Your choice sent postpaid—you benefit 5 days—money refunded in full if not entirely satisfactory. Order direct from this page.



### Automobile Books

- Automobile Starting, Lighting and Ignition, by Manly. [Pub. Jan. 1924.] 700 pp. . . . . Leatherette **\$3.00**  
 Brookes' Automobile Handbook, 1924 Edition. . . . . Leatherette **\$2.00**  
 Ford Motor Car, Truck and Tractor, by Manly. . . . . Cloth **\$1.50**  
 Starting and Lighting Troubles, Remedies and Repairs, by Manly. . . . . Leatherette **\$3.00**  
 Automobile Battery, Care and Repair, by Manly. . . . . Leatherette **\$2.00**  
 Automobile Catechism and Repair Manual. . . . . Leatherette **\$1.50**  
 Tires and Vulcanizing, by Tufford. . . . . Cloth **\$2.00**  
 Gas and Oil Engine Handbook. . . . . Cloth **\$1.50**  
 Automobile Upkeep and Care, by Manly. . . . . Cloth **\$1.50**  
 Motorcycle Handbook, by Manly. . . . . Cloth **\$1.50**

### Shop Practice Books

- Sheet Metal Workers' Manual. . . . . Leatherette **\$2.00**  
 Oxy-Acetylene Welding and Cutting. . . . . Cloth **\$1.25**  
 Slide Rule and Logarithmic Tables. . . . . Leatherette **\$2.00**  
 Handbook for Millwrights. . . . . Cloth **\$2.00**  
 Modern Blacksmithing. . . . . Cloth **\$1.25**  
 Machine Shop Practice. . . . . Cloth **\$2.00**

## ORDER DIRECT FROM THIS PAGE—ON OUR MONEY-BACK PLAN

The books listed above are only a few of the many in our catalogue, which you will receive promptly after filling out and mailing us the attached coupon. For quick action order direct from this page—cross name of each book wanted and send in with price quoted. We prepay postage and send the books on our money-back plan.

### FREDERICK J. DRAKE & CO.

PUBLISHERS

1008 Michigan Ave., Chicago

Drake Books Are For Sale at All Book Stores

Mail Coupon For Free Catalogue  
 Your Guide to Home Study

- Mechanical Drawing and Machine Design. . . . . Cloth **\$2.00**  
 Pattern Making. . . . . Cloth **\$1.50**

### Carpentry Books

Cloth Binding

- Modern Carpentry, 2 vols. . . . . **\$3.00**  
 The Steel Square, 2 vols. . . . . **\$3.00**  
 Wooden Boat and Shipbuilding. . . . . **\$1.50**  
 Modern Estimator. . . . . **\$1.50**  
 Timber Framing. . . . . **\$2.00**  
 Builder's Architectural Drawing. . . . . **\$2.00**  
 Concrete. . . . . **\$1.50**  
 Practical Bungalows. . . . . **\$1.00**  
 Low Cost Homes. . . . . **\$1.00**  
 Roof Framing, by Van Gasbeek. . . . . **\$1.50**  
 Stair Building and Hand Railing. . . . . **\$1.50**

### Electrical Books

- Telephony, Including Automatic Switching, by Smith. [Pub. Jan. 1924.] 500 pp. . . . . Leatherette **\$2.50**  
 Practical Applied Electricity. . . . . **\$2.00**  
 Alternating Current. . . . . **\$1.50**  
 Electric Motor Control Systems. . . . . **\$1.50**  
 Wiring Diagrams and Descriptions. . . . . **\$1.50**  
 Electrical Tables and Data. . . . . **\$1.50**  
 Armature and Magnet Winding. . . . . **\$1.50**  
 Modern Electrical Construction. . . . . **\$1.50**  
 Modern Electric Illumination. . . . . **\$1.50**  
 Electricians' Operating and Testing. . . . . **\$1.50**  
 Motion Picture Operation. . . . . **\$1.50**  
 Drake's Electrical Dictionary. . . . . **\$1.50**  
 Electric Motors, D. & A. . . . . **\$1.50**  
 Electrical Measurements and Meter Testing. . . . . **\$1.50**  
 Drake's Telephone Handbook. . . . . **\$1.50**  
 Easy Experiments. . . . . Cloth **\$1.25**  
 Wireless Telegraph and Telephone Handbook. . . . . Cloth **\$1.25**  
 Telegraphy Self-Taught. . . . . Cloth **\$1.25**

### Steam Engineering

- Swingle's Handbook for Steam Engineers and Electricians. Leatherette **\$4.00**  
 Examination Questions and Answers for Marine and Stationary Engineers. . . . . Leatherette **\$2.00**  
 Steam Boilers. . . . . Leatherette **\$2.00**  
 Swingle's Catechism of Steam, Gas and Electrical Engineering. . . . . Leatherette **\$1.50**

### Painting Books

- The Mixing of Colors and Paints, By Vanderwalker. . . . . Cloth **\$2.00**  
 Scene Painting and Bulletin Art. . . . . Cloth **\$4.00**  
 A Show at Sho' Cards. . . . . Cloth **\$4.00**  
 Sign Painting. . . . . Cloth **\$4.00**  
 Strong's Book of Designs. . . . . Leatherette **\$4.00**  
 Strong's Art of Show Card Writing. . . . . Cloth **\$4.00**  
 Signist's Alphabets. . . . . Cloth **\$1.50**  
 Modern Painter's Cyclopaedia. . . . . Cloth **\$2.00**  
 Automobile Painting. . . . . Cloth **\$1.50**  
 Estimates, Costs and Profits, Painting and Decorating. . . . . Cloth **\$1.50**  
 New Hardwood Finishing. . . . . Cloth **\$1.50**  
 The Amateur Artist. . . . . Cloth **\$1.50**  
 New Stencils. . . . . Cloth **\$1.25**  
 Chalk Talk and Crayon Presentation. . . . . Cloth **\$1.25**

### Farm Books

- Farm Mechanics. . . . . Cloth **\$1.25**  
 Farm Buildings. . . . . Cloth **\$1.25**  
 Farm Engines. . . . . Cloth **\$1.25**  
 Traction Farming. . . . . Cloth **\$1.50**

### Business and Reference Books

- Better Business Letters. . . . . Cloth **\$1.00**  
 Better Business English. . . . . Cloth **\$1.00**  
 Better Advertising. . . . . Cloth **\$1.00**  
 Finger Prints Simplified. . . . . Cloth **\$1.25**  
 Practical Bricklaying. . . . . Cloth **\$1.25**  
 Practical Instruction for Detectives. . . . . Cloth **\$1.00**  
 Practical Plumbing. . . . . Cloth **\$1.50**  
 Hot Water Heating. . . . . Cloth **\$1.50**  
 Elementary Chemistry. . . . . Cloth **\$1.50**  
 Courses in Civil Service. . . . . Cloth **\$1.50**  
 Cyclopaedia of Recipes. . . . . Cloth **\$1.50**  
 American Star Speaker. . . . . Cloth **\$1.50**

### Modern Languages

- By Prof. P. S. Allen, U. of Chicago  
 French without a Teacher. . . . . Cloth **\$1.25**  
 Spanish without a Teacher. . . . . Cloth **\$1.25**  
 German without a Teacher. . . . . Cloth **\$1.25**  
 Everyday French. . . . . **\$1.25**  
 Everyday Spanish. . . . . **\$1.25**

FREDERICK J. DRAKE & CO.  
 1008 Michigan Avenue  
 Chicago, Ill.

GENTLEMEN:—Please send me free, postage paid, your illustrated catalogue which lists and describes over 100 Practical Mechanical Books for Home Study.

My name is .....

and my address .....





## High School Course in Two Years!

### You Want to Earn Big Money!

And you will not be satisfied unless you earn steady promotion. But are you prepared for the job ahead of you? Do you measure up to the standard that insures success? For a more responsible position a fairly good education is necessary. To write a sensible business letter, to prepare estimates, to figure cost and to compute interest, you must have a certain amount of preparation. All this you must be able to do before you will earn promotion. Many business houses hire no men whose general knowledge is not equal to a high school course. Why? Because big business refuses to burden itself with men who are barred from promotion by the lack of elementary education.

#### Can You Qualify for a Better Position

We have a plan whereby you can. We can give you a complete but simplified high school course in two years, giving you all the essentials that form the foundation of practical business. It will prepare you to hold your own where competition is keen and exacting. Do not doubt your ability, but make up your mind to it and you will soon have the requirements that will bring you success and big money. YOU CAN DO IT.

Let us show you how to get on the road to success. It will not cost you a single working hour. Write today. It costs you nothing but a stamp.

### American School

Dept. HA74, Drexel Ave. and 58th St., Chicago

### American School

Dept. HA74, Drexel Ave. and 58th St., Chicago

Send me full information on the subject checked and how you will help me win success.

- |                             |                           |
|-----------------------------|---------------------------|
| ....Architect               | ....Lawyer                |
| ....Building Contractor     | ....Machine Shop Practice |
| ....Automobile Engineer     | ....Photoplay Writer      |
| ....Automobile Repairman    | ....Mechanical Engineer   |
| ....Civil Engineer          | ....Shop Superintendent   |
| ....Structural Engineer     | ....Employment Manager    |
| ....Business Manager        | ....Steam Engineer        |
| ....Cert. Public Accountant | ....Foremanship           |
| ....Accountant and Auditor  | ....Sanitary Engineer     |
| ....Bookkeeper              | ....Surveyor (& Mapping)  |
| ....Draftsman and Designer  | ....Telephone Engineer    |
| ....Electrical Engineer     | ....Telegraph Engineer    |
| ....Electric Light & Power  | ....High School Graduate  |
| ....General Education       | ....Fire Insurance Expert |
| ....Vocational Guidance     | ....Wireless Radio        |
| ....Business Law            | ....Undecided             |

Name.....

Address.....



Some men and women seem to attract success, power, wealth, health and attainment with very little conscious effort; others conquer with great difficulty; still others fail altogether to reach their ambitions, desires and ideals. Why is this so?

The Master Key will tell you why. No one can read it and not be a changed person. None but will emerge from its magic pages with a firmer grasp of the future—a surer understanding of what he can do.

The Master Key is a key with which many are converting loss into gain, fear into courage, despair into joy, hope into fruition.

A copy will be sent to you without cost or obligation of any kind if you will address

CHARLES F. HAANEL, 214 Howard Bldg., St. Louis, Mo.

## LAW STUDY AT HOME

Become a lawyer. Legally trained men win high positions and big success in business and public life. Greater opportunities now than ever before. Lawyers earn \$3,000 to \$10,000 Annually. We guide you step by step. You can train at home during spare time. Let us send you records and letters from LaSalle students admitted to the bar in various states. Degree of LL.B. conferred. Thousands of successful students enrolled. Low cost, easy terms. We furnish all text material, including fourteen-volume Law Library. Get our valuable 128-page "Law Guide" and "Evidence" books FREE. Send for them—NOW. LaSalle Extension University, Dept. 664-1 Chicago, Ill.

### Rider Agents Wanted

Select from the 44 Styles, colors and sizes of Ranger Bicycles. Ride and exhibit sample Ranger and make money. Delivered free, express prepaid, on approval. Factory-to-Rider bicycles \$21.50 up.

\$5 a Month on any Ranger if desired. Boys and girls easily see the small monthly payments. Parents often advance first payment.

Tires, best quality, at factory prices, express prepaid. Lamps, wheels and equipment, low prices. Send No Money, do business direct with makers.

MEAD CYCLE COMPANY DEPT. 100 CHICAGO

Write today for free Ranger Catalog, factory prices and marvelous easy payment terms.



## LEARN Wrestling Secrets at Home by Mail

Yes, learn the secrets of World's Champions—how to wrestle expertly—how to handle big men with ease—how to win. Be athletic, be strong, be healthy. Learn how to defend yourself.

### Farmer Burns

the world's most scientific wrestler, who trained the undefeated Champion Frank

Gotch—who also trained six other World's Champions, will now train you. Investigate today his wonderful methods—the secrets of Champions. Every man and boy in the world, no matter what age, needs this information on SCIENTIFIC WRESTLING—PHYSICAL CULTURE—JIU-JITSU—SELF DEFENSE.

Free Book Send your name and age and get my splendid 32 page illustrated wrestling and athletic book—absolutely free—no obligations of any kind. Write NOW. FARMER BURNS, A 177 Ry. Exchange Bldg., Omaha, Neb.



# CARPENTERS

## GUIDES THAT SOLVE PROBLEMS

A Complete Course in Practical Carpentry and Building Work

POCKET SIZE—  
FLEXIBLE  
COVERS—  
3100 ILLUSTRATIONS  
— 1600  
PAGES

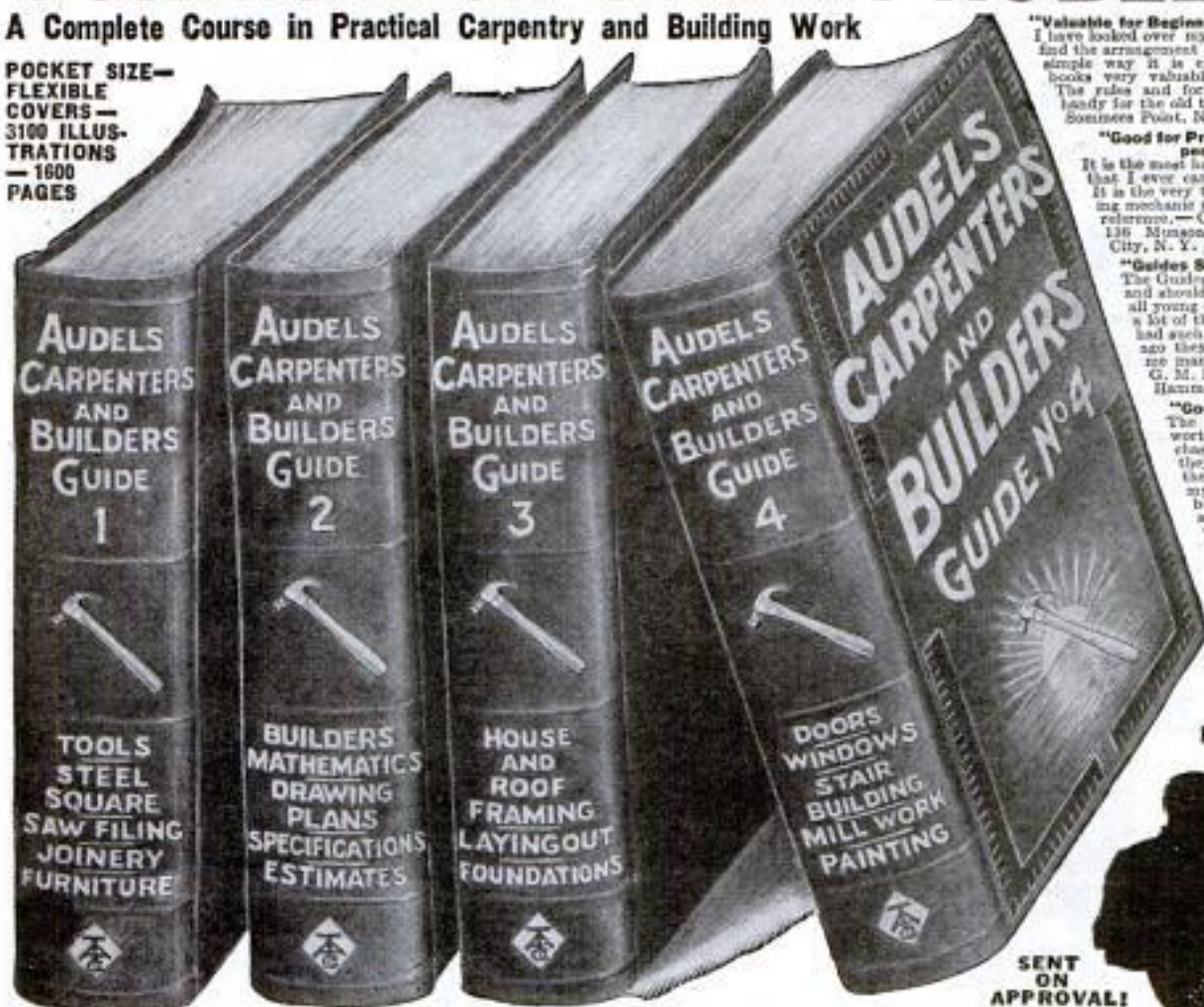

**"Valuable for Beginners or Old Timers"**  
I have looked over my Audel Guides and find the arrangement of subjects and the simple way it is explained make the books very valuable for the beginner. The rules and formulas are mighty handy for the old timers.—*Ross Smith, Southington, N. J.*

**"Good for Professional Carpenters"**  
It is the most handy reference work that I ever came in contact with. It is the very thing that the building mechanic needs every day for reference.—*George H. Watson, 136 Munson St., Long Island City, N. Y.*

**"Guides Save Hard Knocks"**  
The Guides are truly wonderful and should be in the hands of all young carpenters as well as a lot of the older ones. If I had such information 20 years ago they would have saved me many a hard knock.—*G. M. McInerney, R. R. 1, Hammond, Ind.*

**"Good for Amateurs"**  
The books are surely worth more than the purchase price, especially as they serve as a guide to the non-professional like myself who is trying to build himself a house at the least expense.—*Otto F. Schalte, P. O. Box 142, Westmont, Ill.*

\$1

PER MONTH



SENT ON APPROVAL!

### NEW IDEAS—MODERN METHODS—SHORT CUTS

This course, "Audel's Guides for Carpenters and Builders," consists of 4 handy volumes of over 1500 pages with thoroughly illustrated charts, diagrams, graphs, pictures with calculations for every job from making the excavation to constructing the entire building. You will find these new Guides most complete and comprehensive in addition to being both timely and practical. There are 3700 actual examples of efficient construction work with new methods, ideas, solutions, plans, systems, short

cuts, time and labor saving suggestions, new ways that cover the entire theory and practice of the subject illustrated by sketches and forms all specific and practical. Audel's Guides give you the short cut, professional information you want. No need to guess or take chances. Every day you have before you in this set the exact, practical, useful information that will help you with every job that comes up in your daily work.

### HOW To Handle the Job That Puzzles YOU

There are thousands of examples of modern construction and building work—new methods, new ideas, proved efficiency plans, short cuts, time saving suggestions, new ways that cover the entire theory and practice of modern carpentry. Every point is easy to read and understand and clearly illustrated with sketches and forms. Inside Trade Informa-

tion for Carpenters, Builders, Joiners, Building Mechanics and all Woodworkers on—Care and Use of Tools—How to Use the Steel Square—File Saws—Make All Kinds of Joints—Draw and Read Plans—Write Specifications—Make Estimates—How to Frame Roofs and Houses—Lay Out Work—Put in Foundations—Full Instruction on In and Outside Building Work—Stair Building—Saw Mill Work—Practical Painting—Thousands of Short-Cuts that save time and money—information usually obtained only by hard experience.

**NO MONEY!**  
MERELY SEND COUPON AND LOOK THE SET OVER AT AUDEL'S RISK

**THEO. AUDEL & CO., 72 5th Avenue, NEW YORK CITY**  
Send me for free examination Audel's Carpenters and Builders Guides. If satisfactory I will send you \$1 within 6 days and mail \$1 monthly until \$6 is paid.

# FREE

**EXAMINATION**  
Not a cent to pay until you see the books. No obligation to buy unless you are satisfied. Fill in coupon in pencil. Send now—today—get this great help library for carpenters and builders.

Name.....  
Address.....  
Occupation.....  
Employed by.....  
Reference.....  
6 T 30





Be An **AUTO EXPERT**  
 Make \$75 to \$200  
 A WEEK

Let Me  
 Train You  
 At Home  
 to **BOSS**  
 the **JOB!**



**B. W. Cooke,** Directing Engineer

**CHICAGO AUTO SHOPS**

**I** WILL make you a successful **AUTO EXPERT**, prepare you to go into business for yourself, train you for positions paying \$3,000 to \$10,000 a year. Keep your job, stay home—just loan me a part of your spare time. As Directing Engineer of the big **CHICAGO AUTO SHOPS**, I know what training you need and I give it to you. I train you the "JOB-WAY"—not with books. Go into the best-paying business on earth—get your share of the thousand million dollars spent every year to keep Autos, Trucks and Tractors running!

**I TRAIN YOU**

**AT HOME!**  
 Go Into  
 Business!  
 Make \$5,000 to  
 \$15,000 a Year

There are thousands of opportunities to go into business for yourself, with small capital. Auto Experts run big service stations, make up to \$15,000 a year! The same wonderful opportunity is waiting for you. My "Job-Way" instruction prepares you for it.

**B. W. COOKE, Directing Engineer**  
**CHICAGO AUTO SHOPS**  
 Dept. A16, 1553 W. Madison St., Chicago

Send me **FREE** Auto Book and proof that I can become an Auto Expert at home in spare time. Also send your special offers of **FREE** outfit, reduced price and easy terms.

Name .....

Address .....

City..... State.....

Occupation..... Age.....

**FREE!**  
 Big  
 Repair  
 Outfit

**FREE Jobs**

My big Employment Dept. helps my graduates get big pay jobs without one penny of cost.

**FREE Outfit**

Big repair and testing outfit free to my students! Mail coupon for my remarkable offer. Use it to do my **JOBS**, use it to make money, use it to make this training pay for itself!

**Auto Experts Wanted!**  
**\$3,000 to \$10,000 a Year!**

The "best-paying business on earth" is hungry for **EXPERTS!** Where else can you find such opportunities as in the **AUTO** business? 15 million Autos, Trucks and Tractors to keep going, 50 million tires to repair, 15 million starting, lighting and electric systems to maintain, 15 million batteries to service and replace. *Man alive!* Wake up to this rich money-making opportunity!

**Big Auto Book FREE!** I don't care how old or young you are, how much or little education you have, this training will make you a successful Auto Expert. Special inducements and many **EXTRA** features *right now*. Easy terms and low cost. Coupon brings free book and complete information.

Mail it today!

**B. W. COOKE, Directing Engineer**  
**CHICAGO AUTO SHOPS**  
 Dept. A16  
 1553 W. Madison St., Chicago, Ill.





## “What would I do if I lost my job?”

**W**HAT *would* you do? What would your wife and children do?

Suppose your employer notified you tomorrow that he didn't need you any longer? Have you any idea where you could get another position?

You wouldn't have to worry if you were a trained man. You wouldn't have to spend your mornings reading the “Want Ads” and then trudging from place to place, meeting rebuffs and discouragements, piling up bills, finally willing “to do anything” if only you could get on somebody's payroll.

Don't have this spectre of unemployment hanging over your head forever. Train yourself to do some one thing so well that your services will be in demand. Employers don't discharge such men. They *promote* them!

Decide to-day that you are going to get the specialized training you must have if you are ever going to get a real job and a real salary. It is easy if you really try.

Right at home, in the odds and ends of spare time that now go to waste, you can prepare for the position you want in the work you like best. For the International Correspondence Schools will train

you just as they are training thousands of other men—no matter where you live—no matter what your circumstances.

At least find out how, by marking and mailing the coupon printed below. There's no cost or obligation, and it takes only a moment of your time, but it may be the means of changing your whole life.

**Mail the Coupon To-day!**

**INTERNATIONAL CORRESPONDENCE SCHOOLS**  
Box 5605-D, Scranton, Penna.

Without cost or obligation, please tell me how I can qualify for the position or in the subject *before* which I have marked an X:

### BUSINESS TRAINING COURSES

- |  |   |
|--|---|
| <input type="checkbox"/> Business Management                     | <input type="checkbox"/> Salesmanship                                     |
| <input type="checkbox"/> Industrial Management                   | <input type="checkbox"/> Advertising                                      |
| <input type="checkbox"/> Personnel Organisation                  | <input type="checkbox"/> Better Letters                                   |
| <input type="checkbox"/> Traffic Management                      | <input type="checkbox"/> Show Card Lettering                              |
| <input type="checkbox"/> Business Law                            | <input type="checkbox"/> Stenography and Typing                           |
| <input type="checkbox"/> Banking and Banking Law                 | <input type="checkbox"/> Business English                                 |
| <input type="checkbox"/> Accountancy (including C.P.A.)          | <input type="checkbox"/> Civil Service                                    |
| <input type="checkbox"/> Nicholson Cost Accounting               | <input type="checkbox"/> Railway Mail Clerk                               |
| <input type="checkbox"/> Bookkeeping                             | <input type="checkbox"/> Common School Subjects                           |
| <input type="checkbox"/> Private Secretary                       | <input type="checkbox"/> High School Subjects                             |
| <input type="checkbox"/> Spanish <input type="checkbox"/> French | <input type="checkbox"/> Illustrating <input type="checkbox"/> Cartooning |

### TECHNICAL AND INDUSTRIAL COURSES

- |   |  |
|---|--|
| <input type="checkbox"/> Electrical Engineering | <input type="checkbox"/> Architect                                   |
| <input type="checkbox"/> Electric Lighting      | <input type="checkbox"/> Architects' Blue Prints                     |
| <input type="checkbox"/> Mechanical Engineer    | <input type="checkbox"/> Contractor and Builder                      |
| <input type="checkbox"/> Mechanical Draftsman   | <input type="checkbox"/> Architectural Draftsman                     |
| <input type="checkbox"/> Machine Shop Practice  | <input type="checkbox"/> Concrete Builder                            |
| <input type="checkbox"/> Railroad Positions     | <input type="checkbox"/> Structural Engineer                         |
| <input type="checkbox"/> Gas Engine Operating   | <input type="checkbox"/> Chemistry <input type="checkbox"/> Pharmacy |
| <input type="checkbox"/> Civil Engineer         | <input type="checkbox"/> Automobile Work                             |
| <input type="checkbox"/> Surveying and Mapping  | <input type="checkbox"/> Airplane Engines                            |
| <input type="checkbox"/> Metallurgy             | <input type="checkbox"/> Navigation                                  |
| <input type="checkbox"/> Steam Engineering      | <input type="checkbox"/> Agriculture and Poultry                     |
| <input type="checkbox"/> Radio                  | <input type="checkbox"/> Mathematics                                 |

Name.....  
Street.....  
Address..... 3-6-24

City..... State.....

Occupation.....

Persons residing in Canada should send this coupon to the International Correspondence Schools Canadian, Limited, Montreal, Canada.



# Drawing Table Free!



Yes, this is exactly what I am doing. I am giving this drafting table free to you when you enroll as my student. I do this because I want you to have the right kind of Draftsman's Working Outfit — because I want to help ambitious men and boys get ahead. This is the kind you will use when you have completed my course and have become a regular draftsman.

## Complete Drawing Outfit FREE

Besides the drafting table I also furnish free the set of regular working instruments shown here. You get both table and instruments free if you enroll at once. I will do everything possible to help you get ahead.

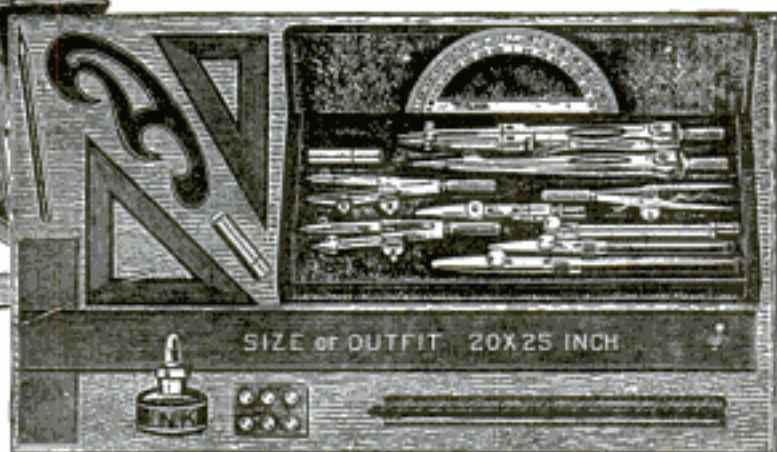

## Also FREE \$90 Drafting Course

To my students enrolling now I give an opportunity of getting a \$90 drafting course absolutely without cost to them. This means you need not pay me for my personal instructions or for the complete working outfit.

### Salaries up to \$250 and \$300 a Month

Positions paying up to \$250 and \$300 a month which ought to be filled by skilled draftsmen are vacant everywhere. There are in every part of the country ambitious men, who with practical training and personal assistance will be qualified to fill the positions. I can now take and train a limited number of students, guarantee to train them by mail UNTIL placed in a permanent position at a salary up to \$250 and \$300 a month.



### Here is the Rule you get FREE

To each young man stating his age when sending a sketch as shown in box at right, I am going to mail FREE AND PREPAID the Draftsman's Ivory Pocket Rule shown here.

## Extra !!

### Copy this Sketch and Get Ivory Pocket Rule

To each young man sending a sketch I will mail free prepaid the Draftsman's Ivory Pocket Rule shown here. With it I will send you a 6 x 9 book on "Successful Draftsmanship." Just state your age.

There are no conditions requiring you to buy anything. You are under no obligations in sending in your sketch.



### Chief Draftsman, Engineers' Equipment Co. 1951 Lawrence Ave., Div. A-135 Chicago, Ill.

Without any obligation to me please mail your book "Successful Draftsmanship" and full particulars of your liberal "Personal Direction" offer to a few students. Also full information as to how I can get a \$90 Drafting Course Free.

Name .....

Address .....

Age .....

## Mail Coupon

Mail coupon at once for full information how you can get the table and working instruments Free, also how you can get the \$90 drafting course Free. Even if you don't send in a copy of the sketch send for this information.

Chief Draftsman, Engineers' Equipment Co.  
1951 Lawrence Ave., Div. A-135 Chicago, Ill.



# We Will Make You An Electrical Expert In 3½ Months At Coyne

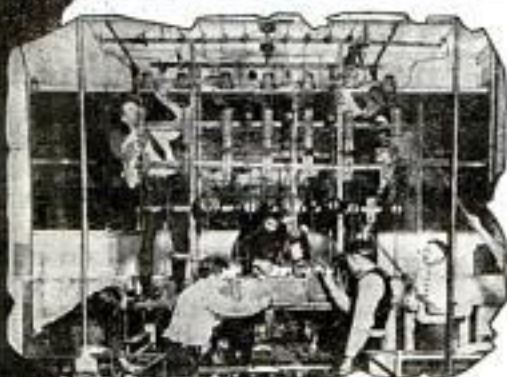

Students Doing Actual Work On  
Power Transmission Apparatus



Students Working on Massive  
A. C. Control Equipment



Students Practicing House-Wiring  
In Skeleton Houses

**Earn \$65 to \$200 a Week!  
Or Go In Business for  
Yourself and Make \$3500  
to \$15,000 a Year!**

Yes, 3½ months at the **Great School of Coyne**, located in Chicago, The Electrical Center of the World, will make you an **Electrical Expert** capable of commanding big pay. The whole world of electricity is open to the practical man—the man who has had actual experience with electrical apparatus. Coyne gives you a practical training on a stupendous outlay of electrical apparatus, everything from door bells to power plants.

## Not a Correspondence School

We don't make you a mere "paper" electrician. We train you by practice on our mammoth outlay of actual equipment. We train you in house-wiring by having you do it exactly as it is done outside—not just by reading about it. The same applies to armature winding, power plant operating, motor installations, automotive work and hundreds of other electrical jobs. That's why we can train you to become a **Master Electrical Expert**.

## No Books—No Lessons—You Do Actual Work

The Coyne practical course includes no books, printed lessons or useless theory. We train you to work with your head and hands on the same kind of electrical apparatus as you will find "out in the field." Coyne gives you Free a Life Scholarship which enables you to return at any time for instructions on new apparatus which we are continually adding to our course. We assist you to a position after graduation. We also include Free a course in radio.

## Age, Lack of Experience or Education Is No Hindrance

Our students range from 16 to 60 years of age. No previous training necessary. You don't even have to be a grammar school graduate.

**Earn While You Learn!** We help students to secure jobs to earn a good part of their living expenses while studying.

**Send For Free Book**

Send for the Big Free Book which shows the Great School of Coyne and a great part of our massive electrical equipment. You will be convinced that the only place to get a practical electrical training is in the Great School of Coyne.

**COYNE**  
Electrical School

Endorsed by Electrical Industry

1300-1310 W. Harrison St., Dept. A-135, Chicago

**Free R. R. Fare**

Coyne Electrical School, Dept. A-135  
1300-1310 W. Harrison St., Chicago

Dear Sir: Please send me free your big catalog and full particulars of your special offer of Free Railroad Fare.

Name .....

Address .....





# Famous Course in BOXING

now **\$1.67**

This Course Was \$5

**H**ERE it is—the famous Stillman Course in Boxing, Jiu-jitsu and Wrestling, now at the extraordinary price of \$1.67 instead of \$5.00—6 big books—85 lessons, 381 pages, 246 illustrations!

This course teaches you the game right in your own home from the simplest rudiments of hitting and guarding to the most scientific blows and guards such as the Benny Leonard Triple, the Jack Dempsey Triple, the Fitzsimmons Shift, etc. So quickly do pupils learn that many outbox bigger opponents after only two weeks' training.

## 10-DAY TRIAL

The Stillman Association,  
Dept. 1224-F, 50 East 42nd St., New York

You may send me on approval the complete Stillman Course. When I receive the course, I will deposit \$1.67 (plus the actual postage) with the postman, with the understanding that if, after 10 days, I wish to return the course I may do so and my deposit will be instantly refunded. If I keep the course, there is to be nothing further to pay.

Name.....

Address.....

Canadian and foreign orders must be accompanied by cash (\$1.67 U. S. funds) subject to money back guarantee if not satisfactory.

## Also Jiu-Jitsu and Wrestling

You also learn 15 Jiu-Jitsu holds—how to disarm an opponent, how to break a strangle hold, etc.—and 14 of the best mat holds—the Gotch Toe Hold, the Stecher Scissors Hold, the Head-lock, etc.

With the course, you get a Free History of 69 Famous Boxers, with their pictures and "inside" stories about them.

**Send No Money** Simply fill in and mail the coupon. When you have the course in your hands, deposit \$1.67 (plus the actual postage) with the postman. Use the course for 10 days—try it out thoroughly. If for any reason, you are not entirely satisfied return the course, and get your money back at once. Mail the coupon now to The Stillman Association, Dept. 1224-F, 50 East 42nd Street, New York.

## New Easy Way to Learn CARTOONING

You can now quickly learn to make comics, sport cartoons, animated and serious cartoons, etc. Cartooning is lots of fun—and fun that pays **big money!** Learn cartooning at home in spare time this amazingly easy way.

**SEND FOR FREE BOOK**  
Mail postcard or letter today for Free Book on Cartooning. It tells all about this easy method perfected by one of America's most successful cartoonists—also is filled with interesting facts about cartooning. Mail card TODAY! Give Age if under 16 years.

**Washington School of Cartooning**  
Room 306, 1113-15th St., N. W., WASHINGTON, D. C.



### Anyone CAN LEARN

No talent or experience necessary. Fascinating work. Pays big money. Complete instruction book tells about: Alphabets, Colors, How to Draw Prints, Show Cards, Window Board and Wall Signs, Ready made letters, Gilding, Tricks of the Trade, also gives 100 Alphabets and Designs. Book bound in flexible art. leather-poledges, and four ball bearing Show Card Pens. Sent postpaid \$3.00 (C. O. D. 10c ex.)  
Globe Pub. Co., 57 Race St., Dept. 50, N. Y. City

**EARN MONEY IMMEDIATELY—  
WE FURNISH EQUIPMENT TO START!!**

### Be Independent!

Own a Grape Fruit and Orange grove—Truck or Poultry Farm. Increase your income. You can start a grove today under our new plan and have a Home and Income in Sunny Florida on the easiest terms imaginable. Any size Farm. Groves developed for Non-Residents. We raise our own guaranteed Citrus Trees in our own Nurseries. We have the Right Land—in the Right Location—at the Right Price, and on the easiest terms. Write for Book "The Call of the Southland"—It's Free.

**NORTH TAMPA LAND CO., 404 Zack St., Dept. 6-24, Tampa, Fla.**

# POSITIONS OPEN IN HOTELS

PAYING UP TO \$400 AND \$500 PER MONTH

You can easily qualify for one of many good hotel positions open by preparing in spare time at home. Hotels looking to us for *trained* men and women—thousands wanted now. Opportunities without comparison as to salaries paid, rapid advancement, luxurious surroundings. You can prepare without previous experience in few weeks' time. Training endorsed by leading hotel executives.



## Let Us Train You

Send for full particulars as to big future for you in hotels, successful graduates, easily-mastered training. Cost moderate; pay as you learn. We help you secure a position. Send coupon today for free booklet No. H-166.

**Standard Business Training Inst.**  
Buffalo, N. Y.

Send Free Booklet No. H-166.

Name.....

Street.....

City.....



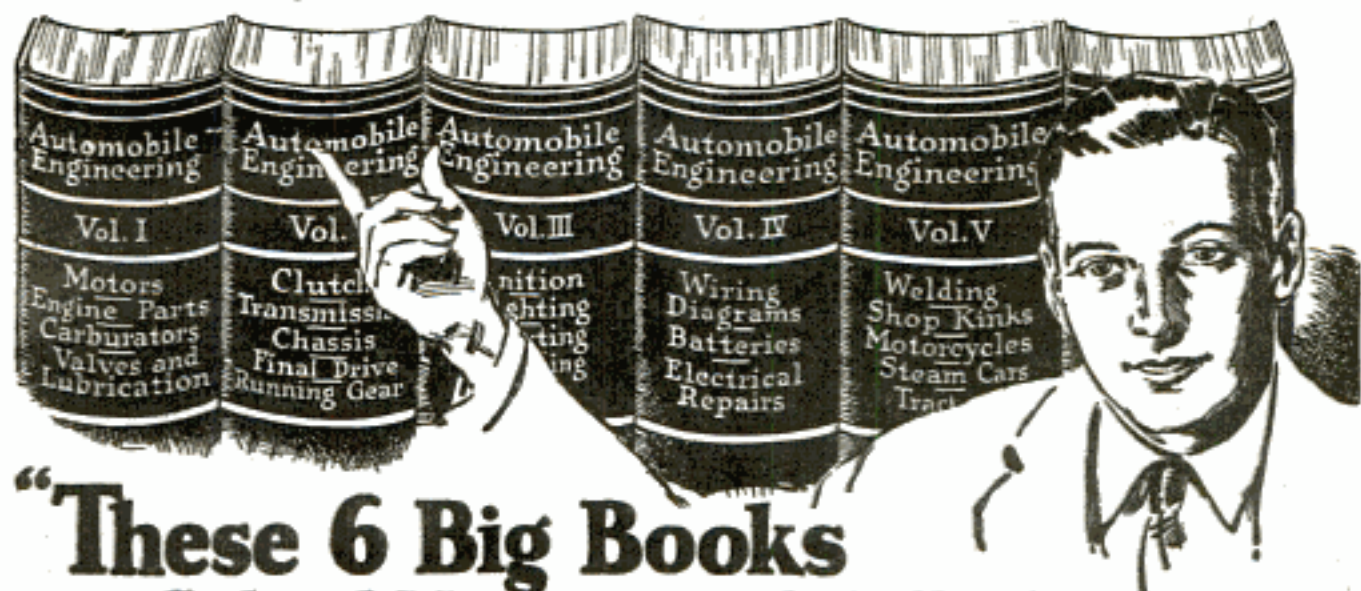

## “These 6 Big Books Solved My Automobile Problems and Increased My Pay!”

**S**IX months ago I was a mechanic's helper in an auto repair shop. I was anxious to learn the automobile business from the bottom up and I thought I could get a practical training by doing odd jobs and watching experienced men handle the complicated work. But I soon learned that I had a hard grind ahead of me, with plenty of dirty work, little encouragement and poor pay.

“Whenever there was a crank case to be drained, or grease cups to be filled, or a car to be washed—I got the job. I was willing and enthusiastic at first, for I thought I was following the only road to success. But I soon found out it wasn't how much I *did* that counted, but how much I *knew*.”

“Several months passed and I was still doing the dirty jobs—merely *taking* orders, while the trained men were *giving* them. I was pretty well discouraged and ready to quit. I went to the boss and asked his advice. ‘What we need in this business,’ he said, ‘are *trained* men—men who have studied the principles of automobile engineering, who have acquired a practical knowledge of ignition, starting and lighting systems, motors, valves, gears, carburetors, etc., and who can supervise the big jobs, tell the workmen *what* to do and, if necessary, *how* to do it.’

“He went to a shelf back of his desk and took down six big books on ‘Automobile Engineering.’ ‘I'll make you a proposition,’ he said. ‘If you really want to become an expert in this business you'll have to do some studying at home and learn what it's all about. Send to the American Technical Society, in Chicago,’ he continued, ‘and get a set of these books. You can buy them on easy monthly payments. With them you'll get a Free Consulting Membership in the Society, which will entitle you to the help and advice of twenty experts. With these books as a work and reference library at home and the daily help of these experts in solving your problems, you can quickly prepare for a big pay job in the automotive field.’

“Needless to say, I followed his advice. I sent for

the books on the easy monthly terms and received the Free Consulting Membership in the Society. Each night I devoted at least an hour to the study of automobile engineering in all its phases. When I had a difficult problem to work out, or when I wanted some special information about a job at the shop, I sent a letter or wire to the Society and back came the answer.

“It wasn't long before I was able to show the boss that I was profiting by his advice. Draining crank cases, filling grease cups and washing cars became things of the past. Gradually I was let in on the important repair jobs; and in three months I was given a special line of examination and estimating work, with a helper to carry out my instructions. With the new work and responsibility, came a real salary. And there's a bigger future ahead, with plenty of opportunities and big money.

“What I have done, any man can do. My opportunity came in the form of these six big pay-raising books and I grasped it. If you knew what I know, you'd never be content with a small pay job when it's so easy to train for a big one. The coupon below offers you a chance to *Learn* more and *Earn* more. Why not mail it today? American Technical Society, Dept. AA19, Chicago, U. S. A.”

### Five Day Examination Coupon AMERICAN TECHNICAL SOCIETY, Dept. AA19 Chicago, U. S. A.

I want to *Learn* more and *Earn* more. Please send me, postpaid, the six volumes of “Automobile Engineering.” I will deposit \$3 with the postman on arrival. If I decide to keep the books I will send you \$3 monthly for six months; otherwise I may return them in 5 days and get my money. It is understood this entitles me to a Free Consulting Membership in the Society which I may use daily if I like.

Name.....

Street.....

City.....State.....

Employed by.....



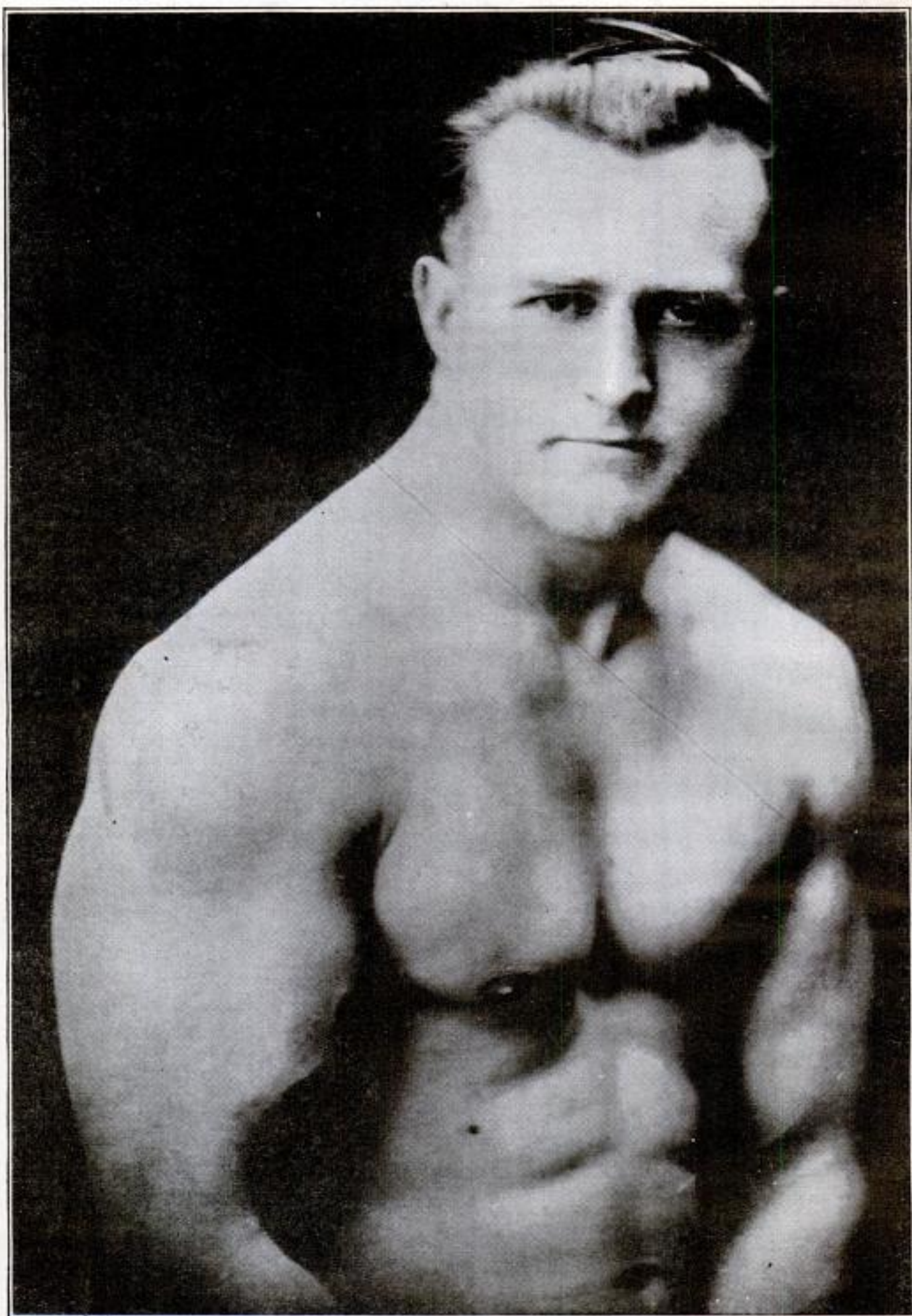

EARLE E. LIEDERMAN, *America's Leading Authority on Physical Education*



# HOW DO YOU LOOK IN A BATHING SUIT?

The good old swimming days are here. Oh boy! But it's great to rip off the old shirt, into your suit and — SPLASH!! But what a shock to some of the poor girls when they see their heroes come out with their flat chests and skinny arms instead of the big, husky frames they expected to see.

## YOU ARE OUT OF LUCK

Don't try to make excuses. You are just out of luck. It's your own fault. You can't blame anyone but yourself. What are you going to do? She is going to find you out.

## A PHYSIQUE TO BE PROUD OF

It's not too late. Snap into it and I can save you yet. It means hard work and plenty of it, but—wait till you see the results.

## THE MUSCLE BUILDER

My job is to build muscle. That is why they call me The Muscle Builder. In just 30 days I am going to add one full inch to your biceps. Yes, and two inches on your chest in the same length of time. But that's only a starter. I am going to broaden out those shoulders and shoot a quiver up your old backbone. I am going to put a man's neck on you and a pair of legs to balance the strong sturdy body they support. You will have a spring to your step and a flash to your eye, radiating the dynamic life within you. Before summer is past you will never recognize your former self. You will have a strong, sturdy, virile body to be really proud of. You will be admired for your perfect manhood—while others are given glances of pity and scorn. This is no idle prattle, fellows. I don't just promise these things. I guarantee them. Are you with me? Let's go. Time is short and we have a job to do.

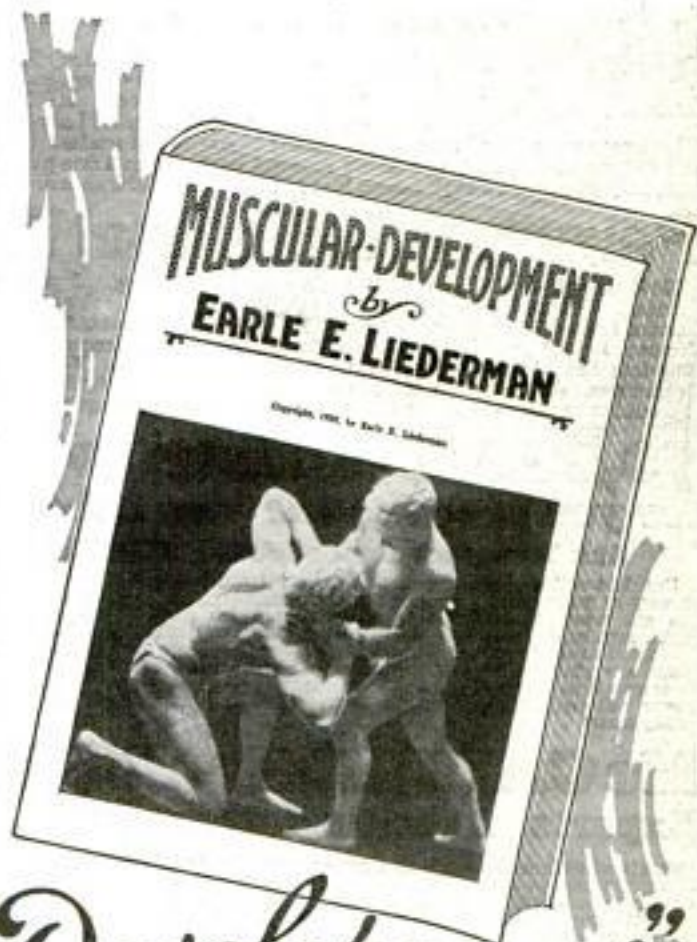

Send For My New  
64 Page Book—

*"Muscular Development"*  
IT IS FREE

It contains forty-three full-page photographs of myself and some of the many prize-winning pupils I have trained. Some of these came to me as pitiful weaklings, imploring me to help them. Look them over now and you will marvel at their present physiques. This book will prove an impetus and a real inspiration to you. It will thrill you through and through. All I ask is 10 cents to cover the cost of wrapping and mailing and it is yours to keep. This will not obligate you at all, but for the sake of your future health and happiness, do not put it off. Send today—right now, before you turn this page.

**EARLE E. LIEDERMAN**  
Dept. 2006, 305 Broadway, New York City

**EARLE E. LIEDERMAN**

Dept. 2006, 305 Broadway, New York City

Dear Sir: I enclose herewith 10c for which you are to send me, without obligation on my part whatever, a copy of your latest book "Muscular Development."

Name.....

Street.....

City..... State.....

(PLEASE WRITE OR PRINT PLAINLY)





# I will make you a Dental Laboratory EXPERT

*H. A. McCarrie*

H. A. McCarrie is recognized as one of the great authorities on Mechanical Dentistry. But his greatest reputation is as TEACHER of successful Dental Laboratory Experts.

## New BIG PAY Profession

The demand for Dental Laboratory Experts is getting bigger every day! Right this minute there are THOUSANDS of big-salaried positions open to you. HUNDREDS of wonderful opportunities for running Dental Laboratories waiting for you. Why waste your time in the old, worn-out overcrowded trades? I will make you a Dental Laboratory Expert in a few quick months, help you to a fine position or to go into business, help you make a big success, just as I have done for hundreds of McCarrie graduates.

## Personal, Individual Training!

No books here. Learn with tools and instruments. I personally supervise your training. Positively no "classes" at McCarrie School. You learn by doing actual Dental Laboratory jobs. Complete training, every branch included: Rubber plates, Crowns, Bridge work, Metal Base Dentures, fixed and removable bridge work, etc. A complete list of subjects would fill this entire page. Yet my rapid-fire, short-cut methods enable you to get it all in a few months, and get it thoroughly and perfectly! It would take years to cover the same ground as an apprentice.

## 70,000 Dentists waiting for you to open your own Laboratory!

Ask Your Own Dentist About This Big Field

Dentists will encourage you to take my training, to prepare to open a Laboratory of your own. Because they must have quicker, better service than they can get now. Comparatively few Laboratories now. They work day and night, and can't turn out the work as fast as it comes in. Dentists have awakened to the advantages of sending their mechanical work to Laboratories. They are glad to pay \$3 an hour for Dental Laboratory work, because their own time is worth \$6 to \$15 an hour working on the patient's mouth. There will be 250,000 Dentists in the U. S. in a few years—so get ready now!

## McCARRIE-Trained Experts Always Successful!

This is what I guarantee to give you as my student: 1. Free R.R. fare to Chicago or to my new school in Detroit. 2. Employment service helps day students find outside evening jobs, helps night students find day-time jobs—all the help you need to take advantage of this wonderful training. 3. Employment service helps graduates find big-pay positions, or helps you find a good location for your own Laboratory. 4. Life consultation service and many other valuable features. I don't merely promise you success—I GUARANTEE TO TRAIN YOU UNTIL YOU ARE SUCCESSFUL!



# FREE!

R.R. Fare to Chicago  
or Detroit



No other work or business is growing as rapidly as Dental Laboratory work

RUSH COUPON TODAY!

- Free Dental Laboratory Book  
 R.R. Fare to Chicago or Detroit Free

H. A. McCarrie, Director  
McCarrie School of Mechanical Dentistry,  
Dept. 901, now at 1338-1342 S. Michigan Ave., Chicago

Please send me your special offers and free book about Dental Laboratory work.

Name .....

Address .....

City.....State.....

# \$20

## a Day for Dental "Lab" Experts!

Easiest, pleasantest, most interesting work in the world. Be your own Boss, be successful, make money from the very start. Many start their own Laboratory on a "shoe-string" when they are McCarrie-trained. \$3 an hour the average Laboratory charge.

## Coupon Brings Full Information!

The enormous demand for McCarrie-trained Dental Laboratory Experts has compelled me to open a new branch school at Detroit. Special prices, easy terms and many extra features right now. Coupon brings complete information and new big catalog—all free. Mail it to me personally—today!

H. A. McCARRIE, Director

**McCarrie School of Mechanical Dentistry**  
Dept. 901, now at 1338-1342 S. Michigan Ave., CHICAGO





Ellis Sumner  
Cook,  
Chicago, Ill.

**\$3000 First Year!**  
"When I first saw your inspiring message I was a civil service employee. Now I have better than a \$9,000 position with lots of room to grow."



# What This Amazing Book Did for These 8 Men

It would be just as easy to tell the same story about 20,000 men—even more—but what this book brought these eight men is typical. If you do not get a big salary increase after reading this message you have no one but yourself to blame. This amazing book is



**\$1,000 in 30 Days**  
"After ten years in the railway mail service I decided to make a change. My earnings during the past thirty days were more than \$1,000."—W. Hartie, Chicago, Ill.

**First Month \$1000**  
"The very first month I earned \$1,000. I was formerly a farm-hand."—Charles Berry, Winterset, Iowa.



**\$523 in Two Weeks**  
"I had never earned more than \$60 a month. Last week I cleared \$500 and this week \$218."—Geo. W. Kearns, Oklahoma City.

**City Salesman**  
"I want to tell you that the N. S. T. A. helped me to a good selling position with the Shaw-Walker Company."—Wm. W. Johnstone, Jr., Minneapolis, Minn.



**\$554.37 in One Week**  
"Last week my earnings amounted to \$554.37; this week will go over \$400."—F. Wynn, Portland, Ore.

**\$100 a Week in Only 3 Months**  
H. D. Miller, of Chicago, made \$100 a month as stenographer in July. In September, three months later, he was making \$100 a week as a salesman.



**\$10,000 a Year**  
O. H. Mallroft, of Boston, Mass., stepped into a \$10,000 position as a SALES MANAGER—so thorough is this training.

# NOW FREE

IT seems such a simple thing—but the eight men on this page who did this simple thing were shown the way to quickly jump from deadly, monotonous routine work and miserable earnings to incomes running anywhere from \$5,000 to \$10,000 a year. They sent for the book, "Modern Salesmanship," that you can now get—free.

Possibly it is just as hard for you at this moment to see quick success ahead as it was for Ellis Sumner Cook, 20 East Jackson Blvd., Chicago. When he was earning only \$25.00 a week the large sum of \$9,000 a year seemed a million miles away. But read what happened after he had read the book we want you to send for. Almost overnight, as far as time is concerned, he was making real money. The first year he made \$9,000.

There is nothing unusual about Mr. Cook, or about his success. Thousands after reading this book have duplicated what he did—Mr. Cook simply was willing to investigate.

The only question is—do you want to increase your earning power? If so—this book will quickly show you how to do it in an amazingly easy way.

## SUCCESS INSIDE TWENTY WEEKS

Within twenty weeks you can be ready to forge ahead. This may sound remarkable—but after sixteen years of intensive investigation the National Demonstration Method has been perfected—and this means you can now step into a selling position in one-fourth the time it formerly took to prepare for this greatest of all money-making professions.

## SIMPLE AS A B C

There is nothing remarkable about the success that men enjoy shortly after they take up this result-securing system of Salesmanship training. For there are certain ways to approach different types of prospects, certain ways to stimulate keen interest—certain ways to overcome objections, batter down prejudice, outwit competition and make the prospect act. Learn these secrets and brilliant success awaits you in the selling field.

## MAKE THIS FREE TEST AT ONCE

Simply send the coupon for this Free Book. Ask yourself the questions it contains. The answers you make will show you definitely whether a big success awaits you in this fascinating field. Then the road is clear before you. This amazing book will be a revelation to you.

**National Salesmen's Training Association**  
Dept. 12-G, 51 W. Jackson Blvd.  
Chicago, Illinois



National Salesmen's Training Association, Dept. 12-G Chicago, Ill.

Gentlemen: I will accept a copy of "Modern Salesmanship" with the understanding that it is sent me entirely free.

Name.....

Address.....

City.....State.....

Age.....Occupation.....





## \$95 an Hour!

"Every hour I spent on my I. C. S. Course has been worth \$95 to me! My position, my \$5,000 a year income, my home, my family's happiness—I owe it all to my spare-time training with the International Correspondence Schools!"

Every mail brings letters from some of the thousands of I. C. S. students telling of promotions or increases in salary as the rewards of spare-time study.

What are you doing with the hours after supper? Can you afford to let them slip by unimproved when you can easily make them mean so much? One hour a day spent with the I. C. S. will prepare you for the position you want in the work you like best. Yes, it will! Put it up to us to prove it. Mark and mail this coupon now!

### INTERNATIONAL CORRESPONDENCE SCHOOLS Box 5610-D, Scranton, Penna.

Without cost or obligation, please tell me how I can qualify for the position or in the subject before which I have marked an X:

#### BUSINESS TRAINING COURSES

- |  |   |
|--|---|
| <input type="checkbox"/> Business Management                     | <input type="checkbox"/> Salesmanship                                     |
| <input type="checkbox"/> Industrial Management                   | <input type="checkbox"/> Advertising                                      |
| <input type="checkbox"/> Personnel Organization                  | <input type="checkbox"/> Better Letters                                   |
| <input type="checkbox"/> Traffic Management                      | <input type="checkbox"/> Show Card Lettering                              |
| <input type="checkbox"/> Business Law                            | <input type="checkbox"/> Stenography and Typing                           |
| <input type="checkbox"/> Banking and Banking Law                 | <input type="checkbox"/> Business English                                 |
| <input type="checkbox"/> Accountancy (Including C.P.A.)          | <input type="checkbox"/> Civil Service                                    |
| <input type="checkbox"/> Nicholson Cost Accounting               | <input type="checkbox"/> Railway Mail Clerk                               |
| <input type="checkbox"/> Bookkeeping                             | <input type="checkbox"/> Common School Subjects                           |
| <input type="checkbox"/> Private Secretary                       | <input type="checkbox"/> High School Subjects                             |
| <input type="checkbox"/> Spanish <input type="checkbox"/> French | <input type="checkbox"/> Illustrating <input type="checkbox"/> Cartooning |

#### TECHNICAL AND INDUSTRIAL COURSES

- |   |  |
|---|--|
| <input type="checkbox"/> Electrical Engineering | <input type="checkbox"/> Architect                                   |
| <input type="checkbox"/> Electric Lighting      | <input type="checkbox"/> Architects' Blue Prints                     |
| <input type="checkbox"/> Mechanical Engineer    | <input type="checkbox"/> Contractor and Builder                      |
| <input type="checkbox"/> Mechanical Draftsman   | <input type="checkbox"/> Architectural Draftsman                     |
| <input type="checkbox"/> Machine Shop Practice  | <input type="checkbox"/> Concrete Builder                            |
| <input type="checkbox"/> Railroad Positions     | <input type="checkbox"/> Structural Engineer                         |
| <input type="checkbox"/> Gas Engine Operating   | <input type="checkbox"/> Chemistry <input type="checkbox"/> Pharmacy |
| <input type="checkbox"/> Civil Engineer         | <input type="checkbox"/> Automobile Work                             |
| <input type="checkbox"/> Surveying and Mapping  | <input type="checkbox"/> Airplane Engines                            |
| <input type="checkbox"/> Metallurgy             | <input type="checkbox"/> Navigation                                  |
| <input type="checkbox"/> Steam Engineering      | <input type="checkbox"/> Agriculture and Poultry                     |
| <input type="checkbox"/> Radio                  | <input type="checkbox"/> Mathematics                                 |

Name.....  
Street Address..... 3-6-24

City..... State.....

Occupation.....

Persons residing in Canada should send this coupon to the International Correspondence Schools Canadian, Limited, Montreal, Canada.



## Why Miss Half the Fun in Life?

BE POPULAR—Learn to dance well! Arthur Murray, World's greatest dancing teacher, has invented a remarkable new easy method which enables anyone to learn all the newest dances at home—in a few hours—at very little cost! No music or partner needed. Success positively guaranteed! "120,000 learned dancing by mail."

**FREE 5 DANCING LESSONS—** To prove you can learn easily and quickly, Arthur Murray will send you Five FREE lessons, including Fox Trot, Secret of Leading, and How to Gain Confidence. To pay cost of mailing, printing, etc., enclose 10c. Act NOW and be a good dancer soon.

Arthur Murray, Studio 209  
801 Madison Ave. New York

## Become an Expert in DRAFTING

### in Spare Time at Home

Master Drafting and a big job will be waiting for you. Not enough really able men are available to fill the high-salaried positions offered by railroads, manufacturers, architects, contractors, electrical works, etc. Chicago Tech. will train you by mail—make you an expert—through practical instruction by experienced men. Moderate fees. Easy terms.

**FREE Trial Lesson** Find out before you enroll or pay a penny how well qualified you are to follow Drafting. Chicago Tech. does not require enrollment and payment of fees in advance but sends this lesson first. Write today.

Chicago Technical College, 630 Chicago Tech. Bldg., Chicago

## HOW TO BECOME A PROFESSIONAL PHOTOGRAPHER

### EARNING \$35 TO \$125 A WEEK

Three to six months' course. Motion Picture, Commercial, Portraiture, Practical Instruction. Day or Evening Classes. Ask for Catalog No. 49.



N. Y. INSTITUTE OF PHOTOGRAPHY  
NEW YORK CHICAGO BROOKLYN  
141 W. 36th St. 630 So. Wabash Ave. 505 State St.

## LEARN WATCHMAKING

and become independent. Good-paying positions secured. Easy to learn. Send for FREE CATALOG.

ST. LOUIS WATCHMAKING SCHOOL, Dept. 5, ST. LOUIS, MO.

## 30 Days' Free Trial

Select from 44 Styles, colors and sizes, famous Ranger bicycles. Delivered free on approval, express prepaid, at Factory Prices. You can easily save \$10 to \$25 on your bicycle. Prices \$21.50 and up. \$5 a Month on any Ranger if desired. Parents often advance first deposit. Boys and girls can easily earn small monthly payments. Pay as you ride. Best quality, at factory prices, express prepaid. Lamps, wheels and equipment, low prices. Send no money, do business direct with traders.



Mead CYCLE COMPANY  
DEPT. 108 CHICAGO

Write today for free Ranger Catalog, factory prices and marvelous easy payment terms.



## I WANT YOU!

MEN—WOMEN, 18 UP

\$1140 to \$3000 a Year

Hundreds U. S. Government Jobs now obtainable. Steady work. Experience not necessary. Common Education sufficient.

Mail Coupon Immediately  
DO NOT DELAY

COUPON  
FRANKLIN INSTITUTE  
Dept. K179, Rochester, N. Y.

Send me, at once, free of any charge, a list and description of Government Jobs now obtainable.

Name.....

Address.....



# ELECTRICITY



*I'll Send You  
This Book FREE!*



Thousands of men have found this free book the starting point to big money jobs and success. You should have it.

## To Prove You Can Qualify for The Biggest Jobs in **20** Weeks!

You know there is no field in the world that offers such money making possibilities as ELECTRICITY. And now, thousands are qualifying a new quick way in spare time in their own homes. I will train you in 20 weeks, to step right into jobs paying from \$50 to \$150 a week. To prove my statement I will send you Absolutely Free a big illustrated booklet which I have just written.

Don't stand back now on account of education, experience, age, or location. No matter where you live, or what you are now doing, through my course you have the chance to become in a very short time a big pay "Electrical Expert."

### Actual Shop Methods in Your Own Home

For I have devised the wonderful new copyright Shop Type System that gives you the benefit of Actual Shop Experience in your own home. Never before has this been possible. But now, after finishing my training you will be at home in the biggest electrical plant, in a sub-station, in a battery station, or with expert maintenance men, or in automobile and tractor starting, lighting and ignition work because you will have had actual experience, which no other correspondence school can give you, but which means everything.

### Backed by Lincoln Institute of Technology

This new system of teaching electricity has proved so successful that it has been highly recommended and endorsed by the Lincoln Institute of Technology. When you enroll you know that you are backed by this institution. You receive free, Employment Service and Expert Advisory Service as long as you live.

### FREE OUTFIT

There is such a call for men that we are giving free, an Electrical outfit for experimental and practical home use if

you enroll now. Think what it will mean to leave forever the low pay rut, to become a trained, efficient Electrical technician, capable of managing and supervising ten or five hundred men on the biggest jobs; to travel, to be a man of influence—to have a salary of \$5,000 to \$10,000 per year. Find out now how you can do this. You cannot afford to delay a day. Send right now for this wonderful free book that is pointing the way for thousands to big money in electricity. The coupon brings you this book entirely free, without obligation. Fill it out.

#### S & H ENGINEERING CO.

*Affiliated with the Lincoln Institute of Technology*

Dept. F-1 1422 West Monroe Street, Chicago, Illinois

#### FREE—FREE OUTFIT COUPON

S & H ENGINEERING CO.,  
Chief Engineer Smith,  
Division of Lincoln Institute of Technology,  
Dept. F-1, 1422 W. Monroe St., Chicago, Illinois.

Please send me at once your big book, "How to Get the Better Jobs in Electricity," and full particulars of your course in practical electricity, your free outfit and your free employment service offer. I am not obligated in any way.

Name.....

Address.....

City.....State.....

Give age if under 18.....



## Are You the Boss? —or Are You Riley?

**T**HE BOSS gives the orders—Riley takes them and does what he is told. Both started the same, had equal ability to begin with. Riley works harder than the BOSS and gets less money. What is the answer?

Training did it. Your brain is an engine that needs fuel. Study and training supply the fuel that makes it go. And when you mix brains with your work you **SIMPLY CANNOT HELP BUT GET AHEAD.**

### Be a Contractor or Builder

Fit yourself for a big job in the Contracting or Building business. Train for it right at home. The Course is easy to learn, is simple but thorough, is taught by experts who have made it their life study. We teach you Estimating, Blue Print Reading, Building Regulation, Use of Steel Square, Water Supply and Drainage, Heating and Ventilating, etc.

The cost is low, terms easy, results quick and sure. Our money-back guarantee insures satisfaction. Thousands are earning **BIG MONEY** in this business today. Get ready to get yours. Fill out the coupon now. Check the Course you are interested in. It costs you nothing but a 2c stamp for full information. It will mean much for your future.

### American School

Dept.  
G-A74

Drexel Ave.  
& 58th St.  
CHICAGO

© A. S.  
1923



"Riley—Take up These Bricks"

"All Right Boss"

**AMERICAN SCHOOL,**  
Dept. G-A74, Drexel Ave. & 58th St., Chicago  
Send me full information on the subject checked.

- |                                     |                          |
|-------------------------------------|--------------------------|
| .. Architect                        | .. Business Law          |
| .. Building Contractor or Carpenter | .. Lawyer                |
| .. Automobile Engineer              | .. Machine Shop Practice |
| .. Automobile Repairman             | .. Photoplay Writer      |
| .. Civil Engineer                   | .. Mechanical Engineer   |
| .. Advertising Manager              | .. Shop Superintendent   |
| .. Business Manager                 | .. Employment Manager    |
| .. Financial Manager                | .. Steam Engineer        |
| .. Sales Manager                    | .. Foremanship           |
| .. Cert. Pub. Accountant            | .. Sanitary Engineer     |
| .. Accountant & Auditor             | .. Surveyor (& Mapping)  |
| .. Bookkeeper                       | .. Telephone Engineer    |
| .. Draftsman & Designer             | .. Telegraph Engineer    |
| .. Electrical Engineer              | .. High School           |
| .. General Education                | .. Fire Insurance Expert |
| .. Personal Analysis                | .. Wireless-Radio        |
|                                     | .. Undecided             |

Name .....

Address .....

Occupation .....



## Learn to Draw at Home

**New Method Makes It Amazingly Easy**

Trained artists earn from \$50 to over \$250 a week. Tremendous demand right now for good art work. Magazines, newspapers, advertisers, printing houses, etc.

Become an artist through wonderful new easy method—right at home in spare time. Learn Illustrating, Designing and Cartooning. Actual fun learning this way. Individual attention by mail from one of America's most famous artists. Learn to draw and earn big money.

### Send for FREE BOOK

Just printed—a new book which describes the latest developments and wonderful opportunities in Commercial Art, and gives full details on this new easy method of learning to draw. Tells all about students—their successes—what they say—actual reproductions of their work—and how many earned big money even while learning. Write for this Free Book and details of special free offer. Mail postcard or letter now.

**WASHINGTON SCHOOL OF ART**  
Room 306, 1115-15th St. N. W. WASHINGTON, D. C.

**Music Lessons**  
**At Home**

**With Celebrated**  
**TEACHERS**

Lessons specially prepared for home study. Endorsed by Paderewski. Not a new method. Long established school now celebrating its 20th Anniversary.

**Any Instrument** Write naming course you are interested in—Piano, Harmony, Voice, Public School Music, Violin, Cornet, Mandolin, Guitar, Banjo or Reed Organ—and we will send **FREE CATALOG**. **SEND for it NOW!**

**UNIVERSITY EXTENSION CONSERVATORY**  
948 Siegel-Myers Building Chicago, Illinois

**STAMMER NO MORE**  
Kill the fear of stammering. Re-education the key. The widely famed Hatfield Method fully outlined in an accurate, dependable, worthwhile book—"HOW TO STOP STAMMERING." It has inspired thousands. Free copy today.

**THE HATFIELD INSTITUTE, 109 N. Dearborn, Chicago, Ill.**

**Be a Taxidermy Artist**  
**Marvelous Book Sent FREE**

You can now learn **Taxidermy**, the wonderful art of mounting birds, animals, tanning skins, etc. **Learn at home, by mail.** The free book tells how. *Mount your own trophies. Decorate home and den. Hunters, trappers, nature lovers, you need taxidermy. Interesting, fascinating, big profits. Join our school. 55,000 students. Success guaranteed. Get our free book without delay. Send right now—today.*

N. W. School of Taxidermy, 4977 Elwood Bldg., Omaha, Neb.

## LEARN WATCH REPAIRING

Be a watchmaker—you can learn this profitable trade by correspondence in a few weeks in your own home by the DeSelms Chart System. After you complete the course you will know a watch from A to Z. You will know just what the matter is and how to repair one. When you graduate you will be a practical watchmaker and repairer and competent to fill any position. Positions for our graduates. Ask for our Free Book. It explains our system and terms.

**THE DeSELMS WATCH SCHOOL**  
23 Perry Street ATTICA, INDIANA





# ELECTRICITY

## THE BIG PAY TRADE

In Electricity there is a wide range of opportunity for the **trained** man—the man that knows the business **thoroughly**. In Hawkins Electrical Guides you find complete information and instruction, from the Basic Principles to Modern Methods and Short Cuts.

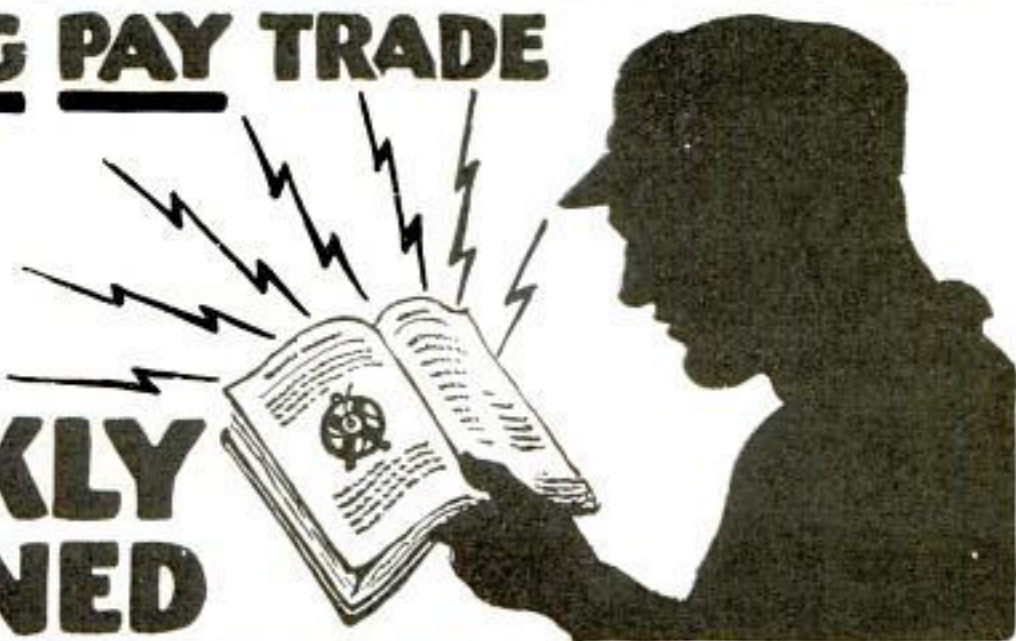

## QUICKLY LEARNED BY EASY SPARE-TIME READING

Free Examination Coupon Below!

No need to worry about getting a job or holding a job if you have a practical working knowledge of electricity. **Electricity** is the most important Factor today. This is the Age of Electricity. Electrical Workers that really know electricity

are in demand! The way to keep in close touch with the progress made in electrical work is to consult these Guides daily for study, reference and review. **Hawkins Guides** will protect you from mistakes, check leaks, waste and increase your earning power.

## HAWKINS ELECTRICAL GUIDES

3500 PAGES—4700 PICTURES—\$1 A VOLUME—\$1 A MONTH—10 VOLUMES



OVER 5000 READERS HAVE OK'D THIS SET

Know the facts in Electricity. They mean more money and better position for you. Hawkins Guides tell you all you need to know about Electricity. Every important electrical subject covered so you can understand it. Easy to study and apply. A complete, practical working course, in 10 volumes. Books are pocket size; flexible covers. Order a set today to look over.

### LEARN ALL ABOUT THESE IMPORTANT POINTS

Magnetism—Induction—Experiments—Dynamometers—Electric Machinery—Motors—Armatures—Armature Windings—Installing of Dynamometers—Electrical Instrument Testing—Practical Management of Dynamometers and Motors—Distribution Systems—Wiring—Wiring Diagrams—Sign Flashers—Storage Batteries—Principles of Alternating Currents and Alter-

nators—Alternating Current Motors—Transformers—Converters—Rectifiers—Alternating Current Systems—Circuit Breakers—Measuring Instruments—Switchboards—Wiring—Power Stations—Installing—Telephone—Telegraph—Wireless—Bells—Lighting—Railways. Also many Modern Practical Applications of Electricity and Ready Reference Index of the ten numbers.

**FREE** Not a cent to pay until you see the books. No obligation to buy unless you are satisfied. Send Coupon now—today—and get this great help library and see if it is not worth \$100 to you—you pay \$1 a month for ten months or return it.



THEO. AUDEL & CO., 72 Fifth Ave., New York City

Please submit me for free examination, HAWKINS ELECTRICAL GUIDE, (Price \$1 a number). Ship at once prepaid, the 10 numbers. If satisfactory, I agree to send you \$1 within seven days and to further mail you \$1.00 each month until paid.

Name.....

Occupation.....

Employed by.....

Home Address.....

Reference.....

6 T 30





## This Man Earns \$3500 to \$5000 a Year

—WORKING WITH A DENTIST—  
THREE MONTHS' TRAINING  
QUALIFIED HIM TO DO IT

There are thousands of these positions awaiting trained men in this profitable profession. After just a few months of specialized training hundreds of men will have become full-fledged members of the dignified profession of

### MECHANICAL DENTISTRY

They will have the technical knowledge and skill to enable them to earn several thousand per year. You can be among them. 2500 more Dental Mechanics are needed right now and the Dental Profession is constantly calling for graduates of the four great schools of this institution; salaries from \$35 to \$45 a week to start, with advancement up to \$125 a week.

### FREE PARTIAL SCHOLARSHIPS

In order to meet this urgent demand for the men we train, we are offering for a limited time Free Partial Scholarships. You will want to get in on this exceptional offer—so don't delay. NOW is the time!

### JUST COMPARE

Compare the unusual opportunities this profitable professional trade offers with what you are now doing—the earnings, the pleasant, dignified occupation. Compare also our ability to train you and put you in touch with the right opportunity—our four large, well-equipped schools, over 30 years of experience in this one line, our wide acquaintance with the Dental Profession throughout the nation!

### SEND FOR CATALOG AND SCHOLARSHIP OFFER

Describes the field and why the demand. Shows how students "Learn by Doing" actual work through practical, individual instruction, day or evening sessions. Shows how you can "Earn while Learning."

## BODEE DENTAL INSTITUTE

136 West 52d Street, NEW YORK

PHILADELPHIA      BUFFALO      BROOKLYN  
1305 No. Broad St.      1226 Main St.      15 Flatbush Ave.

BODEE DENTAL INSTITUTE: Without obligation to me send me a Free Copy of your catalog and complete details of the Free Partial Scholarship Plan No. 2.

Name .....

Address .....

# We Teach COMMERCIAL ART

**Meyer Both Company, the largest Commercial Art Organization in the World** offers you an unusual opportunity for practical training, based upon twenty-three years of success. This nationally known organization each year produces and sells to advertisers over 15,000 commercial drawings. Meyer Both instruction is the difference between successful fact and experimental theory. This well paid profession equally open to men and women. Home study instruction.

**Get Facts Before You Enroll in Any School**

Ask the Advertising Manager of the leading newspapers in your city, anywhere in the United States, Canada, England or Australia about the Meyer Both Company—let them tell you about us. Write for our illustrated book telling about the success of our students—for one-half the cost of mailing—four cents in stamps.

**MEYER BOTH COMPANY**  
Department of Art Instruction  
Michigan Ave. at 20th St., Dept. 16 CHICAGO, ILL.  
Note—To Art and Engraving Firms: Secure practical artists among our graduates. Write us.

## SPEAK AND WRITE MASTERLY ENGLISH

Wonderful new way to learn English. No rules to learn. No hard study. Grammar, spelling, punctuation and expression, taught in 15 minutes a day—at home. Self-Correcting feature makes it fascinating as a game. Write today for Free Book "How to Speak and Write Masterly English" and 15 minute test which you can take in your own home. The answers are given so that you can tell at once just where you stand. Address

**SHERWIN CODY SCHOOL OF ENGLISH**  
56 Searle Building      ROCHESTER, N. Y.

## PLAY THE PIANO BY EAR

Play popular song hits perfectly. Hum the tune, play it by ear. Self instruction—no teacher required. No tedious ding-dong daily practice—just twenty brief, entertaining lessons which you master at home in your spare time.

BE A JAZZ MUSIC MASTER IN 60 DAYS  
Send for FREE BOOK. Learn many styles of bass and syncopation—trick endings, fill-ins, etc.

Niagara School of Music, Dept. 651, Niagara Falls, N. Y.

## STAMMER

If you stammer attend no Institute till you get my large FREE book entitled "STAMMERING, its Origin and The Advanced Natural Method of Treatment." Ask for special tuition rate and a FREE copy of "The Natural Speech Magazine," published monthly in the interest of those afflicted with stammering, stuttering and other speech impediments. Largest, best equipped and most successful school in the world for the cure of stammering. Established 20 years. No sing-song or time-beat. Write today. Millard Institute of Normal Speech, 2317 Millard Bldg., Milwaukee, Wis.

## Let the World's Most Perfect Man Show You the Way to Radiant Health and Energy

Be physically perfect—develop your power of will—overcome disease—Prof. Atlas will show you how. Send for new amazing 64-page book full of extraordinary living pictures of specimens of perfect manhood. Enclose 10 cents to cover wrapping and mailing charges. Grasp this opportunity of learning these rare secrets of becoming physically perfect. Do it now. Address

**Prof. Charles Atlas**  
Twice pronounced the World's MOST PERFECT Man, receiving two \$1000.00 FIRST PRIZES. No other man can claim this title.

**CHARLES ATLAS**  
96 Fifth Ave., Suite 427, N. Y. City



# Let This Gift Tenor Banjo

## Bring You Summer Popularity

Worth  
**\$18**  
Given  
Free

Learn In  
**30 Minutes**  
Be a Master  
before  
Vacation  
Time

This handsome, full size professional tenor banjo is yours. It will bring you unexpected joy and popularity on your vacation. I want to enroll one thousand new students this month. I want to present one of these wonderful, delightful instruments as a gift to each of one thousand readers of this magazine—and here's why. Before becoming a professor and as a lover of music, particularly the tenor banjo, I yearned and yearned for the possession of a genuine professional instrument, the same kind used by the big successful professionals of the world. Now that I have succeeded, I want to help every music lover that I can attain success and this gift offer is made to pave the way for you, and no previous musical knowledge is necessary.

Not only do I start you on the way to popularity, success and fame by supplying you with an instrument that compares with any used or displayed in your town, but under my personal supervision you will be given by mail the benefit of my twenty-two years as Director of Glee and Instrumental Clubs of New York University (my name is Harry S. Six). In my course, I don't just send you a lot of printed words and instructions and trust to luck that you will catch on. Put me to the test. You pay only a few cents a day while you learn to play.

## Learn in 30 Minutes With My Picture Method

Arthur Brisbane, the highest paid journalist in the world, once said that "a single picture is worth a thousand words." He was right, for it stands to reason, when you take your instrument in hand along with the actual photographs

of myself in action as your guide, it is easy to imitate and do the right thing. But that's not all.

### Make Big Money

Hundreds have started orchestras in their towns and are making money. They have completed their lessons and have received their diplomas and are now finished tenor banjoists. You can do the same. My lessons are interesting and you quickly catch on.



### Phonograph Records Free

I also furnish, as an additional guide, phonographic records of my own playing of the piece you are learning, along with my thorough, printed and illustrated easy-to-read course. Doesn't that sound easy? It is easy. If you could sit at my desk and see the letters and telegrams from my pupils, you would be convinced that I have perfected the simplest, yet most highly efficient course to insure your mastering the tenor banjo.

### Don't Send a Single Cent

Investigate my offer today. Don't put off until tomorrow because you might forget and miss this wonderful opportunity. It might be the turning point in your career. Don't send me a single cent. Just drop me a line—use coupon or postal card will do—telling me you are interested in receiving full particulars about my course and to reserve one of my regular eighteen dollar, full size, professional tenor banjos for you, which I have offered as a gift. Act quickly.

## Earn Big Money-Rush Coupon

PROF. HARRY S. SIX, New York Academy of Music,  
Studio 16, 212 Fifth Ave., New York, N. Y.

Please rush all information relative to your Tenor Banjo Course and reserve a gift Tenor Banjo for me. This obligates me in no way whatever.

Name .....

Address .....

City ..... State .....

### Proof

Plays Latest Pieces  
Nov. 8, 1923.

Dear Mr. Six:  
Your course of tenor banjo lessons you gave me was the hit of my life. I was very glad to take lessons from you and now I can play all the latest pieces.

Very truly yours,  
(Signed) Donald Dunn,  
63 St. Johns Pl.

Plain As Could Be

Dear Mr. Six:  
I am sending you two payments. I like to pay in advance. The lessons are very interesting and I sure practice every time I get a chance. I know the lessons are as plain as they could be written. I hope to become a good banjoist. Your faithful student,  
(Signed)  
Chas. De Moss,  
Metairie Falls, Wash.

### The Joy of Popularity will follow you

Don't be a wall flower or porch squatter this summer. Send to me for particulars about my wonderfully delightful, simple course and let the tenor banjo pave the way for a real vacation this summer—a vacation that you, yourself, never thought it possible to enjoy. Music has made thousands popular and it can do the same for you.







# BE A RAILWAY TRAFFIC INSPECTOR

**Earn Up to \$250 Per Month Expenses Paid**

**Position Guaranteed or Money Refunded**



Ralph E. Becker writes: "I finished my course five months ago, and ten days after receiving my diploma I was given a position with a large railway company in the east, and at present I am working for one of the largest and best equipped electric systems in the country. Traffic inspection offers steady employment and the opportunity to travel all over the country and at the same time be employed in a position where the hours of work are very agreeable."

H. M. Long states: "I want to say for the Standard Business Training Institute that its promises are carried out to the letter and even more. Furthermore, they are always willing to help a man after he has begun working; and for those who do not know, let me say that this means more than they can imagine."

## POSITION GUARANTEED Starting at \$110 per Month or More

Prepare in three months' spare-time study at home for this fascinating profession. Many opportunities for advancement; many men are needed. Steady, pleasant outdoor work; travel or remain near home.

### YOU TAKE NO RISK

After completing course if we do not get you a position paying at least \$110.00 a month and expenses, we refund your entire enrollment fee. Cost is moderate.

Send coupon today for full details

Standard Business Training Institute  
BUFFALO, N. Y.



Standard Business Training Institute  
BUFFALO, N. Y.

Send me, entirely free, Booklet No. D-63, giving full particulars about course in Railway Traffic Inspection.

Name.....

Street.....

City.....

# BLISS Electrical SCHOOL

A special technical school, with concise but comprehensive course



**Electrical** men with training are in demand. For more than 30 years this school has been training men of ambition and limited time, for the electrical industries. Condensed course in Electrical

## Engineering

enables graduates to secure good positions and promotions. Theoretical and Practical Electricity, Mathematics and Mechanical Drawing. Students construct motors, install wiring and test electrical machinery. Course with diploma complete



## In One Year

Over 4000 men trained. Thoroughly equipped fire-proof dormitories, dining hall, laboratories, shops. Prepare for your profession in the most interesting city in the world. Free catalog. 32nd year begins Sept. 24, 1924.

BLISS ELECTRICAL SCHOOL, 104 Takoma Ave., Washington, D. C.

# Learn Photography at HOME

Make \$75.00 a Week on the Side

Establish yourself as a Photographic Expert quickly—during your spare time—under a leading photographer. I'll show you how to start your own business—or command a large salary. Good for your general offer—it's really temporary. Act at once. A postal will do. H. R. VANT. INTERNATIONAL STUDIOS, Inc. Dept. 119A, 3601 Michigan Ave., Chicago, U.S.A.



# "STAMMERING

Its Cause and Cure"

You can be quickly cured if you stammer. Send 10 cents, coin or stamps, for 288 page cloth bound book on Stammering and Stuttering. It tells how I cured myself after Stammering and Stuttering for 20 years. BENJAMIN N. BOGUE 6910 Bogue Building, 1147 N. III. St. Indianapolis

**"BECOME A LIGHTNING TRICK CARTOONIST"**  
MAKE MONEY CHALK TALKING. SEND \$1.00 FOR SNAPPY PROGRAM OF TRICK DRAWINGS WITH INSTRUCTIONS BY A PROFESSIONAL CARTOONIST. SATISFACTION GUARANTEED. CIRCULAR FREE. BALDA ART SERVICE, Q1, OSHKOSH, WIS.

## Earnest Men Wanted

to show our samples of All-Wool Suits, regular \$55.00 values for only \$31.75. Splendid pay. Ask for details. Address Dept. 925

**GOODWEAR Chicago, Inc.**  
West Adams Street at Peoria, CHICAGO

## RAISE POULTRY FOR PROFIT

We teach you how. Easily learned at home. Our guaranteed methods make success certain—indorsed by leading Agricultural Colleges. Send TODAY for FREE BOOK—"How To Raise Poultry For Profit."



National Poultry Institute  
Dept. 312 Washington, D. C.



# What Do You Call an Opportunity?

**I**N MY LIFETIME I have heard many men speak of opportunity. I have read some very fine definitions of this wonder-word. It has been the subject of many splendid speeches; authors have written abundantly about it in prose and poetry.

You have said, "I wish I had an opportunity."

But I am wondering what you call an opportunity.

Do you—as so many do—mistakenly associate it with "good fortune" or "good luck"?

Suppose tomorrow you heard of a \$10,000 position seeking a man. Could you fill it? If so, it would be an opportunity. If not, it would be no opportunity at all so far as you are concerned. It would be merely a bit of information from which you could not benefit.

Opportunity, I believe, is usually a recognition of worth.

The biggest opportunity that can ever come to you will never be any bigger than your preparation—your worth-whileness.

If you are not worth considering, Opportunity won't give you a thought.

The biggest job of all the big jobs open and filled in the last twenty-four hours would have been an opportunity for you—

—if you had been prepared.

And I am not one who believes that Opportunity knocks but once.

The hundreds of opportunities which are here to-day will come again tomorrow—

—if you are prepared.

But you can be sure they will never be found on the door-steps of worthless prospects—men who are not ready.

Opportunity seeks and finds only those who have paid the price of preparation. She does not pick men as you pick a number from a lottery; neither does she cover up what she has to offer. Her gifts are an open book—yours from which to choose.

Pick the thing you want, and get ready for it. Opportunities do not come except as you



attract them. LaSalle training offers a sure way to increase your powers of attraction.

Just bear in mind that the biggest opportunity that can ever come to you will never be greater than your preparation.

*J. Hopkins*  
President  
LaSalle Extension University

## — INQUIRY COUPON —

### LaSalle Extension University

The Largest Business Training Institution in the World

Dept. 664-R Chicago, Illinois

Gentlemen: Send without obligation to me information regarding course indicated below, also copy of your interesting book, "Ten Years' Promotion in One."



- |   |  |
|---|--|
| <input type="checkbox"/> Business Management        | <input type="checkbox"/> Modern Business Correspondence and Practice |
| <input type="checkbox"/> Modern Salesmanship        | <input type="checkbox"/> Modern Foremanship and Production Methods   |
| <input type="checkbox"/> Higher Accountancy         | <input type="checkbox"/> Personnel and Employment Management         |
| <input type="checkbox"/> Law—Degree of LL.B.        | <input type="checkbox"/> Expert Bookkeeping                          |
| <input type="checkbox"/> Traffic Management         | <input type="checkbox"/> Business English                            |
| <input type="checkbox"/> Railway Station Management | <input type="checkbox"/> Commercial Spanish                          |
| <input type="checkbox"/> Commercial Law             | <input type="checkbox"/> Effective Speaking                          |
| <input type="checkbox"/> Industrial Management      | <input type="checkbox"/> C. P. A. Coaching                           |
| <input type="checkbox"/> Efficiency                 |  |
| <input type="checkbox"/> Banking and Finance        |  |

Name.....

Present Position.....

Address.....



# LEARN CARTOONING

Successful cartoonists earn big salaries. Many of the most popular cartoonists of today learned to draw in their spare time, at home, through the Landon Course of Cartooning and now earn \$75 to \$200 a week.



The Landon Picture Chart Method of teaching ORIGINAL drawing makes cartooning easy to learn. Hundreds of sketches like the above explain every step in creating ORIGINAL heads, figures, animals, etc.

Write today for Sample Landon Picture Chart, long list of successful Landon students and full information showing possibilities for you. Please state your age.

The LONDON SCHOOL, 738 National Building, CLEVELAND, OHIO

## Four Successful Landon Students From One Village

Here is the record of four boys—all from Nappanee, Ind. (2200 population)—who, after taking the Landon Course, won national reputations:

Merrill Blosser is now nationally famous as creator of "Freckles and His Friends."

Henry Maust's work appears in Saturday Evening Post, Cosmopolitan, etc.

Francis Parks, following their advice, is now a cartoonist for the Omaha News.

Fred Neher is comic artist with the Universal Feature Co.

Whatever Your Question;—be it the pronunciation of Fascista, the spelling of a puzzling word, the location of Esthonia the meaning of soviet, realtor, vitamin, etc., this Supreme Authority—

## WEBSTER'S NEW INTERNATIONAL DICTIONARY

contains an accurate, final answer. 407,000 Words, 2700 Pages, 6000 Illustrations. Regular and India-Paper Editions. G. & C. MERRIAM CO., Springfield, Mass.

Write for specimen pages, prices, etc. and FREE Pocket Maps per POPULAR MECHANICS

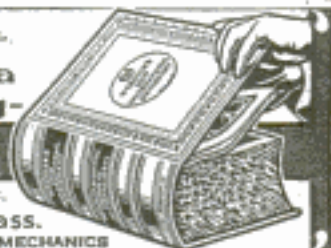

"THERE'S MONEY IN IT"

AT HOME

## LEARN TELEGRAPHY

AT HOME

MORSE AND WIRELESS

### TEACH YOURSELF

in half usual time, at trifling cost, with the wonderful Automatic Transmitter, THE OMNIGRAPH. Sends unlimited Morse or Continental messages, at any speed, just as an expert operator would. Adopted by U. S. Government, and leading Universities, Colleges and Telegraph Schools. 3 Styles. Catalog free. OMNIGRAPH MFG. CO., 16-22 Hudson St., NEW YORK

If you own a Radio Phone Set—and don't know the code—you are missing most of the fun.

## Learn Watchwork, Jewelrywork and Engraving.

Dent. P. Bradley Institute, PEORIA, ILL., for our latest catalog.

OUR BUREAU OF INFORMATION will answer all questions regarding articles appearing in this magazine. Address Bureau of Information, Popular Mechanics Magazine, Chicago.

## Dhassi Will Tell You FREE

Do You Know? Under which Zodiac Sign you were born? What significance it has in shaping your life?

Are You Lucky? IN LOVE MARRIAGE FRIENDS INHERITANCE SUCCESS

Send Birth Date

I have made Astrology my life's work and offer the most interesting astrological interpretations of the Zodiac sign under which you were born. Send exact name, address and

exact date of birth in own handwriting and receive your astrological interpretation in plain sealed envelope, post paid. A great surprise awaits you. Enclose 12c to cover cost of this notice and mailing. Address me personally—DHASSI.

TARA STUDIO, 1133 Broadway, Desk 44-C, NEW YORK



# WANTED

## RAILWAY POSTAL CLERKS

### \$1600 to \$2300 Year

MEN — BOYS 18 UP. MAIL COUPON IMMEDIATELY

Steady work. No layoffs. Paid Vacations

Common education sufficient:

TRAVEL—SEE YOUR COUNTRY



FRANKLIN INSTITUTE, Dept. K178, Rochester, N. Y.

Bitte: Send me without charge, (1) Sample Railway Postal Clerk Examination questions; (2) Send List of U. S. government jobs now obtainable; (3) Send free illustrated book, "How to Get Government Jobs."

Name.....

Address.....



# YOU CAN PLAY THE HAWAIIAN GUITAR

## Just Like the Hawaiians!

### Because Our Native Hawaiian Instructors Will Show You How!

Be the Most Popular Member of Your Set, Play "Once In a Blue Moon", "Raggedy Ann", "Linger A While", "Shanghai Lullaby". All the Late Song and Dance Hits—You Can play First Selection in Half an Hour and Harmonious Chords AT ONCE.

Here is your chance to get in the swim—to learn to play the most fascinating of all instruments, the Hawaiian Guitar, **just as the Hawaiians do**, and in an amazingly short time. Our method is so simple, plain and easy that you begin a piece your first lesson. In half an hour you can play it! Thousands of successful students prove this to be true. It is quite astonishing to find the ease with which you can master the Hawaiian Guitar—no matter how little your knowledge of music may be you can positively learn to play by our plain and easy method.

### Expert Hawaiians Teach You to Quickly Master Their Secrets of This Fascinating Music

The instructions you receive from such world famous experts as Lawrence Kalaniki, Walter Kolomoku, Frank Ferrer, Carl Seville and others are invaluable. **No other Conservatory can even begin** to give you the expert teaching and knowledge you gain through us. And remember, while it is conceded that the Hawaiian Guitar produces the sweetest music, yet its mastery by you will be simple and quick, since there are

## ONLY 4 EASY MOTIONS

to learn to be able to play **any** music—popular, dance, classical, native Hawaiian airs, or old time melodies and hymns. Just think of it! **You need never have read a musical note** in your life! For that matter, even though you haven't the slightest knowledge of **any** musical instrument we guarantee to teach you how to play just like the Hawaiians!

### A Complete Conservatory Course!

Never before has such a complete and easily understood Conservatory Course in Hawaiian Guitar been offered. We are able to grant you this opportunity of quickly learning how to play the Hawaiian Guitar through acquiring the services of real Hawaiians to teach you.

How well this has been accomplished is proved by the fact that this is the **only Conservatory teaching Hawaiian Guitar** exactly as played by the Hawaiians. It is your good fortune as well as ours, that these Native Masters of Hawaiian Guitar came to this Conservatory to teach—and best of all

### We Furnish Everything

When you enroll as a student in this Conservatory you receive **FREE** a handsome, sweet toned Genuine Hawaiian Guitar—valued at \$15.00—52 especially arranged lessons and 52 carefully selected pieces of music, as well as all necessary picks, Steel Playing Bar, etc. There is **nothing** extra to buy, everything is furnished.

## SEND FOR DETAILS TODAY

of this remarkable course—simply fill in the coupon, mail to us and we'll gladly send you full details of our complete Conservatory Course and **FREE Hawaiian Guitar Offer!** We know you will not let another day go by without enrolling as a student in this Conservatory, once you learn how quickly and easily you can master this most popular of all instruments—the Hawaiian Guitar—**So mail the Coupon NOW.**

**First Hawaiian Conservatory of Music, Inc.**  
Dept. 48, 233 Broadway (Woolworth Bldg.) N. Y.

Special Courses Under Famous Teachers: TENOR-BANJO  
VIOLIN, BANJO-UKULELE and UKULELE



# FREE

This Genuine  
**HAWAIIAN**  
Guitar—

A Real  
**\$15.00**  
Value



## MAIL THIS COUPON NOW!

First Hawaiian Conservatory of Music, Inc.,  
Dept. 48, 233 Broadway, (Woolworth Bldg.), New York  
Please mail at once full details of your 52 easy lessons and  
**FREE Hawaiian Guitar offer.** This, of course, does not oblige  
me in the least.

Name \_\_\_\_\_  
Address \_\_\_\_\_  
City \_\_\_\_\_ State \_\_\_\_\_

(Please PRINT name and address clearly)



MANAGER  
PRIVATE



## "I Made Myself HEAD

"I used to be one of the hands.

Luck? Pull? There's no such thing in business! Training is everything. Only three years ago I had your very job! A. T. S. books put me where I am today!

"Take a tip from one who knows. Buy a set of A. T. S. books and let them fit you for a big job, as I did. They're crowded with paying facts written by noted experts. They are easy to read, too—charts, diagrams and illustrations make them as simple as A. B. C.

"But don't take my word for it. Investigate for yourself—it won't cost a cent!" Pick the set you want, mail the coupon and the books will be shipped to you for 7 days' free inspection.

### PAY RAISING BOOKS at Greatly Reduced Prices

Automobile Engineering, 6 volumes, 2600 pages, 2000 pictures. Was \$45.00.....	Now \$21.00
Carpentry and Contracting, 5 volumes, 2133 pages, 1000 pictures. Was \$37.50.....	Now 19.80
Civil Engineering, 2 volumes, 2900 pages, 8000 pictures. Was \$67.50.....	Now 34.80
Business Management, 8 volumes, 2500 pages, well illustrated. Was \$52.50.....	Now 29.80
Fire Prevention and Insurance, 4 volumes, 1500 pages, 600 pictures. Was \$30.00.....	Now 14.80
Electrical Engineering, 8 volumes, 3800 pages, 3000 pictures. Was \$50.00.....	Now 29.80
Machine Shop Practice, 6 volumes, 2300 pages, 2500 pictures. Was \$45.00.....	Now 21.80
Steam and Gas Engineering, 7 volumes, 3300 pages, 2500 pictures. Was \$52.50.....	Now 24.80
Law and Practice (with reading course), 13 volumes, 6000 pages, illustrated. Was \$97.50.....	Now 49.80
Telephony and Telegraphy, 4 volumes, 1728 pages, 2000 pictures. Was \$30.00.....	Now 14.80
Sanitation, Heating and Ventilating, 4 volumes, 1454 pages, 1400 pictures. Was \$30.00.....	Now 14.80
Drawing, 4 volumes, 1675 pages, 1000 pictures, blue-prints, etc. Was \$30.00.....	Now 14.80
Employment Management and Safety Engineering, 7 volumes, 1500 pages, 540 illustrations, charts and diagrams. Was \$62.50.....	Now 24.80

### SEND NO MONEY Shipped for 7 Days' Trial

You be the judge of these books. Don't send us a penny, but mail the coupon and we'll ship you any set you want for 7 days' free examination. Use them a whole week. If you don't want them, return the books at our expense. If you decide to keep them, remit only \$2.50 at the end of the week and \$3.00 a month until the balance is paid. Take the step toward bigger pay today. Mail the coupon—NOW!

American Technical Society, Dept. XA-19 Chicago, U. S. A.

American Technical Society,  
Dept. XA-19 Chicago, U. S. A.

Please send me set of.....

for 7 DAYS' examination, shipping charges collect. I will examine the books thoroughly and, if satisfied, will send \$2.50 within 7 days and \$3.00 each month until I have paid the special price of..... If I decide not to keep the books I will return them at your expense at the end of one week. Title not to pass to me until the set is fully paid for.

Name.....

Address.....

Employed by.....

(Please fill out all three lines)

# Learn to Write

## I Teach by Mail

I can make a good penman of you at your home during spare time, no matter where you live or how poorly you now write. My simplified system has shown thousands the way to good penmanship during the past twenty-five years — it CAN and WILL do the same for YOU.

My beautifully illustrated 32-page Book

### "How to Become a Good Penman" FREE!!

It contains many beautiful specimens of penmanship showing what others have accomplished by the Tamblin System, with testimonials and general information about our courses. (Your name elegantly written on a card, 27 sets, outside stamp for postage.) Ladies taught as successfully as men. Write Today. Address

**F. W. TAMBLIN**  
418 Ridge Bldg. Kansas City, Mo., U. S. A.

# F. W. Tamblin

## MUSIC LESSONS FREE



IN YOUR  
OWN  
HOME

**Piano, Organ, Violin, Mandolin, Guitar, Banjo, etc.**  
Beginners or advanced players. One lesson weekly. Illustrations make everything plain. Only expense about 2c per day to cover cost of postage and music used. Write for FREE booklet which explains everything in full.

**AMERICAN SCHOOL OF MUSIC, 51 Lakeside Building, CHICAGO**

A FILE

## Stop Forgetting

Make Your Mind an index from which you select facts, figures, names, faces. Develop concentration, self-control; overcome bashfulness, forgetfulness.

Write today for FREE memory and concentration test and illustrated booklet, "How to Remember."

**PROF. HENRY DICKSON**  
Dept. 7056 Evanston, Ill.

NOT A FILE

## BE AN ARTIST

Comics, Cartoons, Commercial, Newspaper and Magazine Illustrating, Pastel Crayon Portraits and Fashions. Our simple method quickly develops your talent in spare time. By Mail or Local Classes. Write for terms and list of successful students.

**ASSOCIATED ART STUDIOS 87-B Flatiron Building, NEW YORK**

## Learn Expert Auto Painting



There is Big Money in auto painting and refinishing. Our Home Study Course in Practical Auto Painting will enable you to do the finest work and earn big wages. Wonderful opportunity for new money-making business of your own.

**FREE** circular tells all about this big new business. Be first. Write quick.  
**CHICAGO COLLEGE OF AUTO PAINTING**  
Dept. 64, 140 S. Dearborn St., CHICAGO, U. S. A.

## Learn to PAINT SIGNS and SHOW CARDS

Big field—unlimited possibilities—increasing demand for men with creative ideas. Our course develops ability and originality. Work intensely interesting.

**EARN \$25 TO \$75 WEEKLY**

You can do it if ambitious. Successful graduates everywhere. Our course thoroughly covers every phase of work. Our graduates command big salaries. Write for catalog, samples, guarantee and Free Outfit Offer.

**Detroit School of Lettering, 828 D. S. L. Bldg., Detroit, Mich.**





# ENGINEERING

## Self taught

Here in these handy pocket size books is a modern, progressive, illustrated course covering the entire field of Modern Engineering and Mechanical Practice. The field is broad and big. **To earn more—learn more.**



## AUDEL'S ENGINEERS & MECHANICS GUIDES

In Audel's Master Set for Engineers and Mechanics is found a practical course for study and reference work. Valuable to all Engineers, Electricians, Mechanics and students. Eight

progressive numbers; 8754 trade illustrations; 4750 pages. Flexible binding, gilt edge, pocket size. Free examination. No obligation to buy unless satisfied.

### AUDEL'S GUIDES INCREASE PAY

**Practical Sets for Practical Men**  
Audel's Engineers and Mechanics Guides contain a resume of all the more important subjects together with the later modern additions. They are presented in a way most practical for a practical man. L. M. Cowan, Sandwich, Ill.

#### Helps to Higher Position

I started in as a locomotive fireman but with the help of Audel's Engineers and Mechanics Guides I soon expect to be able to fill a higher position and intend to apply for a higher class license. T. A. Pelissier, Marsus, Wash.

#### Combines Theory with Practice

I have several volumes on power plant practice, but I am more pleased with Audel's than with any other treatise on this subject. This set is just what I have been looking for, because it thoroughly combines theory and practice. Neil N. News, Chicago, Ill.

#### Four Weeks Study Did It

I studied your Engineers and Mechanics Guides only four weeks and passed an examination with a high percentage. Any man, no matter how little mechanical knowledge he may have, can be successful after studying your course. James Scott, Bellair, O.

#### Worth \$50 a Vol.

I know that in order to know the value of your books one must own them. I would not sell my books for \$50 apiece, if I could not buy another. S. C. Pinnell, Tennant, Cal.

#### TURN SPARE TIME INTO CASH!!

Fifteen minutes study a day will increase your pay. Spare time reading brings cash returns.

Use Coupon

### QUESTION AND ANSWER METHOD EASY TO LEARN

#### Study This Brief Table of Contents:

Theory, Practice and Operation of ALL Steam Engines, Valve Motions—VALVE SETTING: complete information on All engines and pumps—CORLISS ENGINES and the Theory, Construction and Operation of all Steam Engines, including UNIFLOW and POPPET VALVE ENGINES, and LOCOMOBILES—Locomotive-Marine Engines; Turbines; Rotary Engines—the Indicator—Lubrications—PRACTICAL MANAGEMENT. How to use Indicator—GAS, GASOLINE, OIL, SEMI- and FULL DIESEL ENGINES—Aeroplanes and Aviation—HOW TO SELECT AN ENGINE, working instructions, drawings on STEAM ENGINE DESIGN, including rules and formulae. Theory and Construction of ALL Steam Boilers; Heat-Combustion; Fuel and Flue Gas Analysis—

CO<sub>2</sub> recorders—Characteristics of Boilers—Materials—Construction of all types of Boilers. (THE LATEST PRACTICE.)—Boiler Construction—Mechanical Stokers—Oil Burners—Setting—Chimneys—Mechanical Draught—HOW TO SELECT A BOILER—Complete instructions and drawings on BOILER DESIGN based on A. S. M. E. BOILER CODE—OPERATION, including installation, FIRING; care and repair of Steam Boilers—Pipes, Fittings and Pipe Fitting—Heating and Ventilation—Refrigeration—Cooling Towers—Condensers—Distilling Apparatus—Elevators—Cranes and Hoisting Machinery—Ropes and Cables—Splicing—electric wiring in ALL branches; compendium of practical electrical engineering as an aid for engineers and electricians in obtaining a license—57 chapters—ready reference index, covering entire field of Modern Electricity.

# FREE

## EXAMINATION

Not a cent to pay until you see the books. No obligation to pay unless you are satisfied. Send coupon now—today and get this new master set for engineers.

**PAY ONLY \$1 A MONTH**

**THEO. AUDEL & CO., 72 Fifth Ave., New York City**

Please submit me for free examination, AUDEL'S MASTER SET FOR ENGINEERS AND MECHANICS. Ship at once prepaid, the 8 numbers, total cost \$12.00. If satisfactory, I agree to send you \$1 within seven days and to further mail you \$1 each month until paid.

Name.....  
Occupation.....  
Employed by.....  
Home Address.....  
Reference.....





## An Easy Way to Learn PHARMACY AT HOME

Graduate pharmacists are always in demand. The work is interesting and pleasant and salaries are good. Many young men open drug stores of their own and become independent.

There's an easy way to learn pharmacy right in your own home in spare time, without losing a day or a dollar from your present work.

The International Correspondence Schools course in Pharmacy supplies the knowledge which it will be necessary for you to have in order that you may pass your State Board Examination.

Just mark and mail the coupon printed below to the International Correspondence Schools, Box 5608-D, Scranton, Pa., and full particulars about the Pharmacy Course or any other work of your choice will come speeding to you by return mail.

### INTERNATIONAL CORRESPONDENCE SCHOOLS Box 5608-D, Scranton, Penna.

Without cost or obligation, please send me full information about the subject before which I have marked an X in the list below:

#### TECHNICAL AND INDUSTRIAL COURSES

- |  |   |
|--|---|
| <input type="checkbox"/> PHARMACY                | <input type="checkbox"/> Civil Engineer                                     |
| <input type="checkbox"/> Chemistry               | <input type="checkbox"/> Surveying and Mapping                              |
| <input type="checkbox"/> Automobile Work         | <input type="checkbox"/> Mine Foreman or Engineer                           |
| <input type="checkbox"/> Navigation              | <input type="checkbox"/> Steam Engineer                                     |
| <input type="checkbox"/> Agriculture and Poultry | <input type="checkbox"/> Gas Engine Operating                               |
| <input type="checkbox"/> Mathematics             | <input type="checkbox"/> Wireless <input type="checkbox"/> Airplane Engines |
| <input type="checkbox"/> Electrical Engineering  | <input type="checkbox"/> Architect  |
| <input type="checkbox"/> Electrician             | <input type="checkbox"/> Contractor and Builder                             |
| <input type="checkbox"/> Mechanical Engineer     | <input type="checkbox"/> Architectural Draftsman                            |
| <input type="checkbox"/> Mechanical Draftsman    | <input type="checkbox"/> Concrete Builder                                   |
| <input type="checkbox"/> Machine Shop Practice   | <input type="checkbox"/> Structural Engineer                                |
| <input type="checkbox"/> Railroad Positions      | <input type="checkbox"/> Plumbing and Heating                               |

#### BUSINESS TRAINING COURSES

- |   |   |
|---|---|
| <input type="checkbox"/> Business Management                              | <input type="checkbox"/> Salesmanship                                     |
| <input type="checkbox"/> Industrial Management                            | <input type="checkbox"/> Advertising                                      |
| <input type="checkbox"/> Personnel Organization                           | <input type="checkbox"/> Better Letters                                   |
| <input type="checkbox"/> Traffic Management                               | <input type="checkbox"/> Foreign Trade                                    |
| <input type="checkbox"/> Business Law                                     | <input type="checkbox"/> Stenography and Typing                           |
| <input type="checkbox"/> Banking and Banking Law                          | <input type="checkbox"/> Business English                                 |
| <input type="checkbox"/> Accountancy (including C.P.A.)                   | <input type="checkbox"/> Civil Service                                    |
| <input type="checkbox"/> Nicholson Cost Accounting                        | <input type="checkbox"/> Railway Mail Clerk                               |
| <input type="checkbox"/> Bookkeeping                                      | <input type="checkbox"/> Common School Subjects                           |
| <input type="checkbox"/> Private Secretary                                | <input type="checkbox"/> High School Subjects                             |
| <input type="checkbox"/> Business Spanish <input type="checkbox"/> French | <input type="checkbox"/> Illustrating <input type="checkbox"/> Cartooning |

Name.....

Street.....

Address.....

City..... State.....

Occupation.....

Persons residing in Canada should send this coupon to the International Correspondence Schools Canadian, Limited, Montreal, Canada

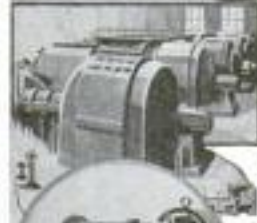

## LEARN BY DOING

Every phase of all branches of

## ELECTRICITY

taught by

**Actual Practice**

In America's foremost  
and oldest institution  
for trade training

**No Books Used**

Individual Instruction  
Start Any Day

Write for FREE 64-page catalog

**THE NEW YORK  
ELECTRICAL SCHOOL**

44 West 17th St., New York City

## BE AN ARTIST

WE CAN TEACH  
YOU DRAWING in  
your own home during your  
spare time. Twenty-five years of  
successful teaching proves our ability.  
Artists receive large salaries.

Write Today for Art Year Book

**SCHOOL OF APPLIED ART**  
ROOM NO. 2 BATTLE CREEK MICH.



### FREE BOOK



## Learn Piano!

This Interesting Free Book

shows how you can become a skilled player of piano or organ at quarter usual cost. It shows why one lesson with an expert is worth a dozen other lessons. Dr. Quinn's famous Written Method includes all of the many important modern improvements in teaching music. Brings right to your home the great advantage of conservatory study. For the beginner or experienced player. Highly endorsed. Successful graduates everywhere. Scientific yet easy to understand. Fully illustrated. All music free. Diploma granted. Write today for free book.

Quinn Conservatory, Studio P.M.86, 598 Columbia Road, Boston, 25, Mass.



Wonderful, new device, guides your hand; corrects your writing in few days. Big improvement in three hours. No failures. Complete outline FREE. Write C. J. Osment, D-34, St. Louis, Mo.

## LEARN WATCH REPAIRING



You can learn by our modern and original system of instruction every part of the **Watch Repairing Trade** at home as good or better than at a shop. You can earn money while learning and secure a well paying position or start in business after completing our course of instruction. Good watch repairers are always in demand and earn from \$30 to \$70 per week. For particulars apply to the **Wisconsin School of Watch Repairing**  
106 Mason St., MILWAUKEE, WIS.



# "The Drafting EXPERT Plans Everything"



MACHINERY



AUTOMOBILES

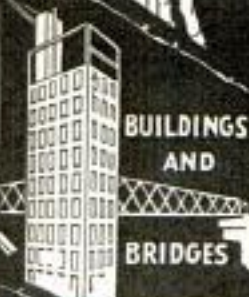

RAIL-ROADS

SHIP  
YARDSBUILDINGS  
AND  
BRIDGES

INVENTIONS

Be a **COYNE TRAINED**

# DRAFTING EXPERT!

**With My Training You  
Can Earn \$200 to \$400 a Month!**

Don't sell your time for a penny less than \$50 to \$100 a week. You don't need to **if you take my training**. You don't need to put up with hard work, long hours and small pay **ONE MINUTE LONGER**. I will prove to you under bond, **guarantee** that after only a few months' easy spare time practice, you too, can win success as a Drafting Expert!

## I Train You AT HOME!

You'll enjoy life as a Drafting Expert. Short hours, **big pay**, fascinating, original, easy work really like play. Close contact with the **BOSS**, with **BIG MEN**. Always in line for executive positions, for promotion.

## FREE! DRAFTING OUTFIT

The same "professional instruments" and outfit I use myself. You'll use them later when employed as a high-priced Drafting Expert. I train you with **actual Drafting room jobs** so you can earn top-salaries in any Drafting office.

## Big Demand for Coyne-Trained Experts

Business is booming. Factories, U. S. Government, states, counties, cities, railroads, ship yards, ALL need Drafting Experts. My spare time **home-training** prepares you quick for your choice of a thousand wonderful opportunities.

## Coupon Brings Drafting Book FREE!

As Chief Draftsman of this big school I know what training you need to succeed and **I give it to you**. I guarantee you will succeed or to refund your money, no matter what your age, no matter what your education. Free instruments and special offer right now. Mail coupon for my big Drafting Book—it's free.

Chief Draftsman,  
Coyne School of Drafting  
Dept. A 19, 1 to 9 S. Ashland Ave., Chicago

Please reserve Free Drafting Outfit for me, and send me your big Drafting book **Free**. Tell me about the opportunities for the Coyne trained Drafting Experts.

Name .....

Address .....

City .....

State .....

**Chief Draftsman, Coyne School of Drafting  
Dept. A 19, 1 to 9 S. Ashland Ave., CHICAGO, ILLINOIS**



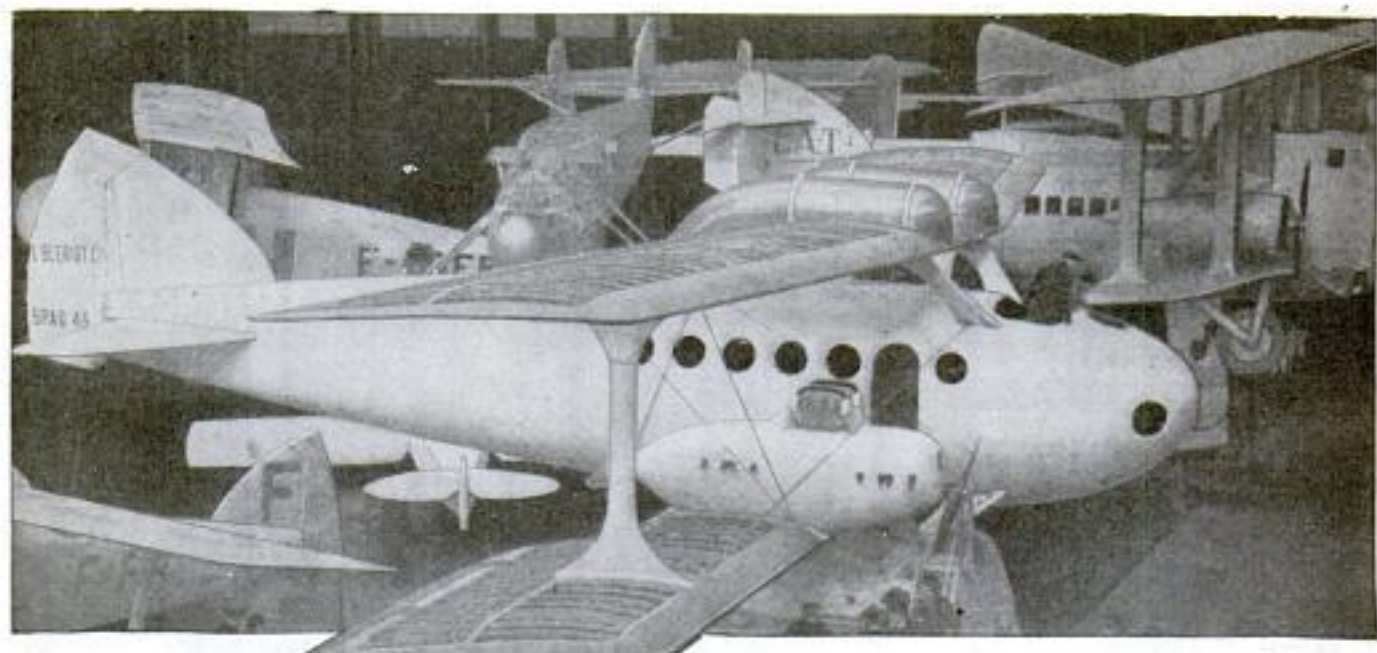

# Quick Success in Aviation Fascinating—Daring—Big Paying

To young men of daring, no other field of work will offer such a fascination, such high pay, nor such opportunities for quick success as the field of Aviation. As yet, aviation is practically in its infancy. NOW is the time to get in.

## Amazing Opportunities in Airplane Industries

In the automobile industry and in the moving picture business hundreds of men got rich by getting in at the start. They made their success before others woke up. Today, these lines offer no greater opportunities than a hundred and one others. BUT AVIATION IS NEW. Get in while the opportunity is big. All over the country there will be a clamor for trained men. It will not be a question of pay, but of getting capable men.

**HERE ARE REAL  
POSITIONS, \$50 TO  
\$150 PER WEEK**



View in an Airplane Factory

*Aeronautical Instructor, Aeronautical Engineer, Aeronautical Contractor, Airplane Repairman, Airplane Mechanician, Airplane Inspector, Airplane Salesman, Airplane Assembler, Airplane Builder.*

**AMERICAN SCHOOL OF AVIATION**  
3601 Michigan Ave., Dept. 119A, Chicago, Ill.

Without any obligation, send me your Free Book, "Opportunities in the Airplane Industry," also information about your Course in Practical Aeronautics.

Name.....

Street.....

City..... State.....

## A Sure and Easy Way to Learn Aviation—at Home



A New Job—The Aerial Postman

The study of aviation is almost as fascinating as the actual work. Every lesson is full of interest. That is why it is easy to learn aviation. You do not have to make yourself study—it is like reading an interesting book that tells you things you have always wanted to know. Only one hour each evening will give you the basic training in a surprisingly short time. You need only a common school education.

One of my students, James Powers, Pa., says, "I am indeed surprised that such a valuable Course can be had from such practical men for so little cost."



A New Seven-Passenger Airplane

## Personal Instruction by Experienced Men

Men who have had actual experience give you personal attention. They select the lessons, lectures, blueprints and bulletins. They tell you things that are essential in everyday practice. Each lesson is easy to read and understand.

## Big Book of Opportunities FREE

Send coupon at left for New Book, just out, "Opportunities in the Airplane Industry." It is interesting and instructive. It will show you many things you never knew before about aviation. Due to shortage of paper we could get only a limited supply of these books—send the coupon before they are all gone.

**AMERICAN SCHOOL OF AVIATION**  
3601 Michigan Ave., Dept. 119A Chicago, Ill.



# Classified Advertisements

## WORLD'S BEST WANT AD MEDIUM

Advertisements in this section, 25 cents per word, each insertion, minimum 10 words, payable in advance. To be inserted under proper classification in July issue, copy should be in our office May 18th.

### ADVERTISING AGENCIES

To secure agents or salesmen or for selling farms and reaching investors, use classified (want) ads in largest newspapers and magazines. Price list No. 30 sent free. Ankrum Advertising Agency, 20 W. Jackson Blvd., Chicago, Ill. The largest classified advertising agency in the U. S.

25 WORDS—355 Rural Weeklies \$14.20. Ad-Meyer Agency, 4112-M Hartford, St. Louis.

### FOR ADVERTISERS

ADVERTISE Personally! Mail-order buyers, \$2.00 thousand. National List, Springfield, Ohio.

MAILING Lists of every nature. Dynamic, order-getting sales letters written. Multigraphing, addressing, folding. Tell us your wants. Gordon Company, 682 Pickering Bldg., Cincinnati.

INCH Display 100 Magazines, Thrice, \$8. Beck, 5408 Alaska, St. Louis.

I WRITE letters, folders, booklets, complete follow-up for manufacturers, mail-order dealers. Long experience. Write for details. L. Taylor, Box C44, Freeport, Ill.

INTERNATIONALIZE Your Business! Sell!—Trade!—Buy! Everything!—Everywhere! Advertisements: \$1.00 inch; 1c word. Circulation throughout the World! Subscriptions: Six Months \$5; Copy 10c. Special Cut-Rate Advertising Offer! (Positively good only till June 10th, 1924!) One-Fourth, 5" x 9" Page Ad.—Only \$2.00! 3,000 to 5,000 circulation guaranteed. International-Opportunity. Brookings, S. Dak.

ADVERTISE in 24 Big Sunday Newspapers, 24 words \$15.00. Catalog listing 1,000 leading Dailies, Weeklies, Magazines, 4c stamps. Union Advertising, Baltimore Bldg., Chicago.

ADVERTISE, hundred magazines, three issues, 10c word. Pennell-Company, Covington, Ky.

### SALES PROMOTION

I HAVE been writing dynamic, order-getting sales letters, twenty years. Satisfaction guaranteed. Gordon, 682 Pickering Bldg., Cincinnati.

\$150,000 SIX Weeks Sales, Equaling best previous year's sales, followed my plans within two months. Within four years a million annual sales largely the result of my direct-mail plans, \$50 to \$50,000 daily sales developed for clients. Submit sales problems for free preliminary diagnosis. Ten years Sales Promotion Manager Larkin Co. James C. Johnson, 118A Woodbridge Ave., Buffalo.

400 FORCEFUL, Effective, Business-getting Letters, prepared in typewritten form. Covers practically every kind of business; \$5.00 prepaid. Particulars free. J. Rodgers Hoggard, Windsor, N. C.

### AUTOMOBILE SUPPLIES

NEW Electric Light Oil Gauge for Ford, Chevrolet and Nash cars. Price \$3.50 postpaid. Electric Light Oil Gauge Company, Galva, Iowa.

WORLD War Souvenirs. New Airplane Propellers for Ceiling Fans, Only \$3. Cost \$100. Smith Machinery Co., Box 153, Houston, Texas.

AUTO Tire Vulcanizing Equipment. If you have idle equipment we turn it into cash for you. If you want to buy we save you 25 to 50%. Write, Equipment Exchange, 1117 Main, Los Angeles.

NEW 4 Cyl. Auto Engine, 20 H. P. with Starter, Generator and Magneto. A bargain at \$109.00. Fox Auto Parts Co., 57 E. 20th Street, Chicago, Ill.

GARAGES and Service Stations—Give real air service to your customers. Put a Phoenix Automatic Tire Inflator on your air line—saves time—saves gauges—saves pliers and draws trade. Send for prices and circular. Phoenix Products Company, Box 1268, Phoenix, Ariz.

BUY at wholesale. Bearings, Pistons, Piston pins and rings, Ignition parts, Valves, Axles. Give make, model and year of car. Economy Car Parts Co., 331-333 Main St., Bowling Green, Ky.

AIR Compressors, Automatic. Twin Cylinder, Guaranteed. Easy payments. Free Air service increases business and profits. Particulars free. Hobartco, Troy, Ohio.

AUTOMOBILE parts for all cars. Lowest prices. Save money; get our wholesale catalogue. State make of car, model and parts wanted. Parts shipped immediately from stock. We refund your money if not satisfied. Mechanics Gear Co., 3706 No. Halsted St., Chicago.

REPAIRING Ford Cars, Trucks and Tractors in the most proper and efficient way is explained in a new 229-page book by the former director of the Ford Motor Co. Service School. This information is otherwise unavailable outside the Ford plant. Written more especially for the mechanic and repairman. Price \$2 postpaid. Popular Mechanics Book Dept., 206 E. Ontario St., Chicago.

PATENTED Instrument Removes Carbon from Running Motor—Increases Mileage 15-50%. Tremendously Profitable. Exclusive Territory. "Workers' Communicate, "Wizard," Rochester, N. Y.

PRONTO Series Gap Spark plugs. Guaranteed Life of Motor and to shoot through oil. 100% Government test. Particulars gladly furnished. Pronto Mfg. Co., Council Bluffs, Iowa.

FORD Touring Top and Back Curtain \$4.95 Delivered. Vanderpool's, Springfield, Ohio.

PUT "Reddy" to work. 32-page illustrated book—how to make or repair 101 articles of rubber for automobile, home or camp—using old automobile inner tubes. Complete with large Reddy rubber repair kit for \$1.00. Reddy Rubber Co., 149b Marvin, Akron, Ohio.

RAYFIELD Carburetor Sales and Service, 3941 Washington Blvd., Chicago, Ill. Have your carburetor built like new and get more mileage, better pick-up. Material and workmanship guaranteed one year.

60% OFF on used parts for Buick 4 and 6, Chevrolet, Studebaker 4 and 6, Hup, Dodge, Nash, Mitchell, Reo '15, etc. Guaranteed good condition. Economy Car Parts Co., 321-323 Main St., Bowling Green, Ky.

BARGAINS—Guaranteed Radiators—Dodge \$19.95, Maxwell, \$21.50, Chevrolet 4-90 \$16.95, and many others. State make and model required. Sport Bodies built to order; send sketch. Independent Radiator Co., 1119 Wabash Ave., Chicago, Ill.

WE'VE Got Everything in New and Used Auto Parts, Accessories and Supplies, for all makes and models of cars. Engines, Transmissions, Clutches, Axles, Wheels, Rims, Tires, Radiators, Gears, Axle Shafts, Bearings, Magnets, Starters, Generators, Collis, Batteries, Etc., Etc. Ours is the largest stock of its kind in the world. Our Motto is "Service, Quality, and Low Price." Write for catalog and bargain lists. Warshawsky & Company, Inc., World's Largest Car Wheelers and Replacement Parts House, Phone Calumet 7315, 1915-35 S. State St., Chicago, Ill. No Branches.

AUTO and Truck Parts. Save 25-80%. New and used motors, gears, axles, bearings, springs, generators, \$10 up. New Zenith, Johnson, Rayfield, Stromberg carburetors, \$7.50 up; new waterproof Simms and Bering magnets, \$15; Ford retopping, \$4-80; other cars, \$12 up. Brightman Auto Exchange, 321 Windsor Ave., Hartford, Conn.

AUTOMOBILE Parts—Used parts for most any car at half factory list prices. Allen, Buick, Buick, Cadillac, Chalmers, Chevrolet, Dodge, Dort, Grant, Hudson, Hupmobile, Oakland, Overland, Oldsmobile, Reo, Studebaker and many others. Send list of parts wanted. Maxwell Bros., 4100 Olive St., St. Louis, Mo.

BATTERY recharging pays \$100 to \$400 monthly with new Eight Hour Charging System. Easy monthly terms let outfit pay for itself. Thirty day's trial, money back guarantee. Particulars free. Hobarts, Troy, Ohio.

### AUTOMOBILES

WHAT do you need? We have it. Gray's Auto Parts Company, 3212 Brighton Road, Pittsburgh, Pa.

PATENTS—M. P. Laughlin—Engineer-Attorney, 47 West 42d St., New York.

AUTOMOBILE Owner's Handbook containing 286 ideas for making your car longer lived and more comfortable. Also tells how to make emergency repairs on the road. 221 illustrations. 50 cents. You should also have Automobile Tourist's Handbook which has dozens of ideas on auto camping and touring. 50 cents. Both books for \$1. Popular Mechanics Press, Room 806, Popular Mechanics Building, Chicago, Ill.

PATENTS Procured. Send sketch or model today for examination, prompt report and advice. No charge for preliminary advice. Write for free Booklet and blank form on which to disclose your idea. Highest references. Promptness assured. Clarence A. O'Brien, Registered Patent Lawyer, 583 Security Bank Building. Directly across the street from Patent Office, Washington, D. C. See pages 150 and 151.

RACING Bodies for Fords and Cherolets 490. Send for free particulars. Our book "How to Build a Ford Racer" sent on receipt of 25c. Central Auto Supply Company, Dept. 120-C, Louisville, Ky.

PATENTS—Write for our Guide Books and "Record of Invention Blank" before disclosing inventions. Send model, or sketch and description of your invention for our free Examination and Instructions. Highest references. Reasonable terms. See advertisement on pages 152 and 153. Victor J. Evans & Co., 185 Ninth, Washington, D. C.

DYKE'S Automobile Encyclopedia. 13th edition, new, greater than ever, entirely rewritten and rearranged. Contains greatest array of automobile facts ever published in one volume. Separate books containing same information cost \$21. Over 1200 pages and 4100 illus. Cloth \$5. Flex. Amer. Morocco \$7.50 postpaid. Popular Mechanics Book Dept., 206 E. Ontario St., Chicago.

### FOR FORD OWNERS

TWO-DOOR Ford Sedan beds \$6.50. Particulars. Milligan & Chrey, Bremerton, Wash.

FORD Repair Book Free: A very complete and well illustrated book explaining how to make repairs on most every part of your Ford. We offer this book free with a nine months' subscription to Ford Owner and Dealer Magazine—at only \$1.00. Everyone interested in the Ford car should read this big magazine of about 200 pages monthly. It clearly explains the things you want to know about cutting down the cost of operation, the engine, ignition, transmission, carburetor, etc. Send Today and get the valuable Repair Book Free. Ford Owner and Dealer Magazine, 542 Montgomery Bldg., Milwaukee, Wis.

LINCOLNETTES—"Four Miles More Per Gallon." Valuable Information "Free." "Wizard," Rochester, N. Y.

SPORT and Speedster Bodies for Fords built to order. \$36.00 and up. Write for particulars. Keller Auto Body Co., Inc., Dept. 42, 317 W. Winkler Ave., Louisville, Ky.

FORD Propelled boats always go. Illustrated Ford Boat Booklet sent free. Harry Rider, 206B Commercial Bldg., Norwalk, Conn.

AVOID "turning turtle," leaving the road, backing over center. You can steer safely and easily out of ruts, through mud, sand, snow and on center-crowned roads, with a Sprague Worm Steering Gear on your Ford. Same type as used on all larger cars. Prevents bumps in road from turning front wheels aside; gives you control of steering. Also absorbs shock, vibration and strain on arms and shoulders. Makes a far better and safer car. Easily, quickly installed; no holes to bore; outlasts car. Guaranteed to satisfy you. Write for particulars. Sprague Tire Co., Dept. 2, Omaha, Neb.

GASOLINE Economy for Fords made certain by installing the famous Auxiliary Gasoline System. Better than a Vacuum at a mere fraction of the cost. Warm gasoline improves ignition and saves fuel. Uniform gasoline pressure to carburetor at all times—no grades too steep. Carries additional gasoline for an emergency. Easily installed. Send \$3.50 for outfit complete prepaid. Absolute and positive guarantee. A Products Company, Mfrs., Department A, Denver, Colo.



**UNDERSLING** with "RKO" Swing Lo Irons. See "Red-1-Kut" ad page 161.

**BUILD** your own two door sport Coupe or Roadster (speedster type). Send dime for blue printed specifications and particulars, M. Meyler, R 10, Kalamazoo, Mich.

**WIPE** Timer Brush—Replaces roller in any standard Ford Timer. Smooths out roller worn timer shells. Positive contact—strong steady spark—uses no oil or grease. The high grade carbon steel lip, or wearing surface, is harder than glass—develops 2½ more volts than any ordinary Ford Timer. Helps keep spark plugs clean. Eliminates much carbon and coil trouble. More power, more pep, better pick-up, and instant starting. Sent Prepaid for \$7.75. Fully guaranteed. Order one today, 4 A Products Co., Mrs., Department A, Denver, Colo.

**12c. BRINGS** Catalogue—3,000 Bargains Tires, Accessories, Radio Supplies. Will refund money on first order. Jones Motor Company, Dept. P, Bowling Green, Ky.

#### MOTORCYCLES, BICYCLES & SUPPLIES

**OVERSTOCKED**—200 Used Motorcycles. Must be sold at once. We have Harley-Davidsons, Indians, Hendersons, Excelsiors, Cleverlands. Write for our Bargain List, Myerow Brothers, Dept. B, 15 Berkeley St., Boston, Mass.

**SEND** for our Bargain Bulletin and Money Saving Message. It will save you money on Motorcycles, Side Cars, Motor Wheels, Repair Parts and Accessories. Some used parts at less than half. Cleveland and Ace Motorcycles our specialty. See our ad on page 142, American Motor Cycle Co., 2943-5-7 W. Chicago Ave., Chicago.

**MOTORCYCLE** Riders make big money Demonstrating and Selling Internationally Famous Fixible Sidecars and other products in open territories. Special Discount on Demonstrating car and liberal Commissions on Sales. Fixible Co., 328 Water Street, Loudonville, Ohio.

**NEW** and used parts for Motorcycles and Bicycles. Get our prices on parts needed. Kingshighway Motor Co., 1166 N. Kingshighway, St. Louis, Mo.

**1922 HARLEY-DAVIDSONS**, \$135; 1921, \$115; 1920, \$85; 1919, \$65; 1917, \$50; 1916, \$45; 1915, \$40; 1914, \$35. Guaranteed. Money refunded if not satisfied. Circular free. Wisconsin Cycle Sales Co., 726 National Ave., Milwaukee, Wis.

**MOTORCYCLE** Sidecars—Bargain Prices on Experimental and Discontinued Models. Write Fixible Co., 328 Water Street, Loudonville, Ohio.

**USED** parts for all motorcycles, cheap. State wants. Schuck Cycle Co., 1922 Westlake, Seattle, Wash.

**DON'T** buy a Bicycle Motor Attachment until you get our new catalogue and prices. Also runs washers, pumps, and shop machinery. Shaw Mfg. Co., Dept. 27, Galenburg, Kans.

**SEND** for big list of slightly used motorcycles on the easy payment plan. Howard Cycle Co., Trenton, N. J.

#### AVIATION

**SEND** 10c for our latest aeronautical catalog listing a complete line of airplane goods at reduced prices; Propeller catalog 4c. Ford Airplane, or Motorcycle Airplane circulars 4c each. Resistal goggles \$2.99. Heath Airplane Co., Chicago, Ill.

**BARGAINS**—propellers, motors, hubs, compasses, carburetors, sparkplugs, Thompson, 265 Fairview St., New Britain, Conn.

**CLERGET** 135 Horse-Power motors complete, \$90.00. OX5 90 Horse-Power, slightly used, \$85.00. Stacy Shelton, 3821 Miller Way, Sacramento, Calif.

**AIRPLANES** \$350 up. Motors 28 to 200 HP. Aviators' Leather Coats, \$12.50. Smith Machinery Co., Box 153, Houston, Texas.

**"LEARN TO Fly."** Ten Twenty-Minute Lessons, \$100. Army Training Plane. Shop Course Included. Sportplanes, New, Used, and Parts. Lowest Prices. Blueprints and Instructions: Biplane, \$2.50. Monoplane, \$1. Aviation Engineering Co., Lawrence, Kansas.

**LEARN** To Fly with Varney Aircraft Co., Peoria, Ill. Lowest tuition compatible with Safety, Thoroughness, and Efficiency.

**PATENTS** Procured. Send sketch or model today for examination, prompt report and advice. No charge for preliminary advice. Write for free Booklet and blank form on which to disclose your idea. Highest references. Promptness assured. Clarence A. O'Brien, Registered Patent Lawyer, 583 Security Bank Building. Directly across the street from Patent Office, Washington, D. C. See pages 150 and 151.

**TEN** lessons in the air, of twenty minutes each, will make you a pilot, by our advanced method of training. This, together with our five-week shop course at \$100.00, makes America's oldest aircraft factory the most popular flying school. Work after class hours guaranteed. Heath Airplane Co., Chicago, Ill.

**THE** American School of Aviation announces a new correspondence course in Mechanics of Aviation. A thorough training in Practical Aeronautics. American School of Aviation, Dept. 1865, 3601 Michigan Ave., Chicago, Ill.

#### BOOKS AND PERIODICALS

**L. C. S. HANDBOOKS**, \$1 each, 24 titles; Home Study Handbooks, 90 titles; description free. "Cartoons Magazine" and "American Art Student"—sample either 30c; both 50c. Used Educational Publications—list free. Dunbar, Dorchester Center, Mass.

**HYPNOTISM** Astounds, Controls. Insures wealth and fame. 25 easy lessons \$1.00. "Mindreading?" (Any distance.) Simply Wonderful. Anyone can succeed. 30c. Popular Institute, K1914 Belmont, Chicago.

**SUGGESTION** and Autosuggestion (Email Coue) 35c—Dr. Braid's Wonderful Method of Hypnotizing, \$1.10; "The Way to Win" 10c. Baker Specialty Co., P4213 Carroll Ave., Chicago.

**ELECTRICIANS**—aid to examination for license; illustrations, diagrams, tables, etc.; price \$1.25. Marine and Stationary Engineers—latest answers to questions asked at examinations; profusely illustrated. Price \$2.50. Steam Boilers—construction, care and operation; 170 illustrations; complete and valuable information; price \$2.50. Catechism of Steam, Gas and Electric Engineering, over 1,400 questions and answers; price \$2. All books written in simple, concise English by expert authorities. Reade Pub. Co., 296 Broadway, New York.

**PERSONAL** Advancement—The new Magazine published by Popular Mechanics Press for all who want to get ahead. Inspiration, Education, Entertainment, Advice. Will help you to decide upon a vocation, to get help in preparing yourself for that vocation, to get the best books on travel, mechanics, and on related subjects. One year free. Send your name and address on a postal to Popular Mechanics Press, Room 805, Popular Mechanics Building, Chicago, Ill.

**WRITERS**: Study at home; 30 text books; criticism and advice regarding markets for manuscripts. Catalogue free. Correspondence invited. James Knapp Reeve (former editor The Editor), 50 Alexander Bldg., Franklin, Ohio.

**POPULAR MECHANICS** Handbook for Women has 294 ideas for those who keep house. 50 cents. Home Mechanics contains 329 ideas for making things at home. 50 cents. Popular Mechanics Concrete Handbook No. 1 has 173 articles on the use of concrete about the home, in the shop, and on the farm. 50 cents. The three books for \$1.35. Popular Mechanics Press, Room 806, Popular Mechanics Building, Chicago, Ill.

**"PERSONAL** Success." Illustrated Catalogue 4c. Phipps Library, 1014 Belmont, Chicago.

**"SECRETS** and Mysteries of Applied Psychology." One dollar. Dr. Grumbine, Hotel Winton, Cleveland, Ohio.

**PRACTICAL** Psychology Teaches Hypnotism, Personal Magnetism, Magnetic Healing, Auto-Suggestion, Cure Habits and Disease. Easy Lessons. Send for Booklet, 4 cents stamps. Fernando, Dept. M, Springfield, Mass.

**FREE**—Send for my Newthought, Self-culture, Occult, Mystic and Scientific book literature. Martens Publisher, Burlington, Iowa.

**INDUSTRIAL** Alcohol. Wright's book. Full directions for making drawings. \$2.50. Sporn & Chamberlain, 120 P. M. Liberty Street, New York, N. Y.

**"LIGHTS,** Colors, Tones and Nature's Finer Forces" covering Vibrations; Odic-Auras; Cold-lights; Radio; Inventions; 270 pages. Satisfaction guaranteed; \$2.00. Circulars Free. M. Stevens, Publisher, 242 Powell, San Francisco.

**HINDU** Psychology, Secret Sciences. Illustrated Catalogue, lesson 25c. Adarso, 116 South Michigan, Chicago.

**HYPNOTISM** easily learned. Lessons guaranteed. Postpaid \$1.10. Smith Pub. Co., Dent, 3, Springfield, Mass.

**176 PRACTICAL** Subjects, how to master any of them. A new booklet giving reliable advice on how to study 176 subjects at home is free. Write your name and address on a postal and say, Send me "An Easy Way to Master 176 Practical Subjects" and mail to Popular Mechanics Press, Room 805, Popular Mechanics Building, Chicago, Ill.

#### PICTURES AND POSTCARDS

**JOIN** Live Postcard Club. Membership lists, including catalog, 10c. Harvey Teeple, Decatur, Ind.

**JOIN** International Postcard Club. Big Membership Hobby Magazine, prospectus, 10c. "Universal," 1034P Eighteenth St., Chicago.

**ART** Cover your Postcards, Photo-prints, Clippings into albums with Engel Art Corners—permanently or removably. No paste needed. Neater and more convenient than the old-fashioned methods. Let's show you. Send a dime for package of 100 and samples. Engel Art Corners Co., 4709 North Clark, Chicago.

**JOIN** the Old Reliable Card Club. Membership, 10c. Riverside Club, Frederick, Md.

#### NOVELTIES, CURIOS, ETC.

**MEXICAN** Novelties, Purses, Hammocks, Canes, Leather Goods, Novelties, Box 814, New Orleans.

**LEARN** Polychrome Painting, etc. Write Art Novelty Co., 599 Ohio St., Lima, O.

**CHINESE** Embroidered Shawls, Ivory Articles, Mahjong Sets are obtainable from us at Manufacturers' Prices. Purchases of every description undertaken. Address The Equitable Supply Company, Post Box 502, Hongkong, China.

**SOUVENIR** Moonshine Still \$1.25 Postpaid. Money Refunded if Dissatisfied. Payne Sales Co., Box 831, Asheville, N. C.

**BOOKS,** Antiques, Curios, etc. Particulars Free. O. W. Miller, 278X Warren St., New York.

#### GAMES, ENTERTAINMENTS AND PLAYS

**LEARN** the art of Ventriloquism. Send 25c for instructions. Write Ventriloquist, 696 Henri Julien Ave., Montreal, Que., Can.

**VENTRILLOQUISM** taught almost anyone at home. Small cost. Send 2c stamp today for particulars and proof. George W. Smith, Room M-865, 125 N. Jefferson Ave., Peoria, Ill.

**POPULAR MECHANICS** new illustrated Book Catalog lists books of entertainments and games. A copy is free. Address Popular Mechanics Press, Room 806, Popular Mechanics Building, Chicago, Ill.

**LEARN** To Swim—Complete Instructions 50c. Meratus, Box 1422, Indianapolis.

**"ROMAN'S** Three New Games" 10c postpaid. Roman Arndt, 3689 Townsend, Detroit, Mich.

**200 KINDS** Iron, wood and wire puzzles. Leader and illustrated list 10c. Western Puzzle Works, St. Paul, Minn.

**PLAYS,** musical comedies and revues, minstrel music, blackface skits, vaudeville acts, monologs, dialog, recitations, entertainments, musical readings, stage handbooks make-up goods. Big catalog free. T. S. Denison & Co., 623 So. Wabash, Dept. 11, Chicago.

#### MAGIC TRICKS, BOOKS, AND JOKERS' NOVELTIES

**MAGIC** goods, cards, books, novelties, illusions, Catalog free. O. Fenner, 2491 Jefferson, Louisville, Ky.

**MAGIC.** Latest thrillers, largest assortment, free trick, lists, catalog, 25c. Thayer's, 334 S. San Pedro, Los Angeles, Calif.

**LATEST** and Best in Magic Books—Personal Advancement, Popular Mechanics new magazine, keeps you posted on the best books of magic. Helpful suggestions for making money with magic performances. Free for one year. No strings to this offer. Send your name and address to Popular Mechanics Press, Room 805, Popular Mechanics Building, Chicago, Ill.

**FREE,** puzzles, tricks, jokes. Sun Bureau, Box 496, Corington, Ind.

**FREE**—our puzzle, trick, game, joke Novelty Catalog. Wright & Son, 601-G Ind. Ave., Peoria, Ill.

**LARGE** Illustrated catalog free. Magic, Sensational escapes, crystal gazing, Mind-reading effects, card tricks, prestidigitator's books, great Illusions, funny jokes, and carnival goods. Write us. Heaney Magic Co., Berlin, Wisconsin. Special Stage Illusion catalog, finely illustrated, 25 cents.

**250 MAGIC** Tricks 10c. Lowe, Box 387, Spokane, Wash.

**MAGIC**—Tricks, Books and Supplies. For Amateurs as well as the great professionals. Anyone can learn through our instructions. Feature Acts in Mind Reading, Spiritualism, Rope Ties, etc. Large illustrated Professional Catalog, 20c. Chicago Magic Co., 140 S. Dearborn St., Dept. B, Chicago, Ill.

**MAGICIAN'S** Nicheled Pistol \$1.00. Seven tricks and four catalogs 25c. Gilmaglio, Morgan Park, Chicago.



**TRICKS**, puzzles, jokes, magical apparatus, plays, stage supplies, mind-reading, sensational escapes, large illustrated professional catalog, 16c. Oaks Magical Co., Dept. 548, Oshkosh, Wis.

### STAMP COLLECTING

**A DOVER Bargain Stamp Outfit!** 250 Perforable Hinges, 50 all diff. stamps, Plume (triangle), Nyassa, French Colo. (Pictorial), Malay (Tiger), etc.; 29 Vars. War and New Europe, 5 Blank Approval sheets, 36-page list and Bargain list, all for only 10c to those asking to see my choice 50% approval. L. B. Dover (Dept. C), Clayton, Mo.

**25 DIFFERENT** Czech-Slovakia free to approval applicants. King Stamp Co., 4559 N. St. Louis Ave., Chicago, Ill.

**U. S. PRICE List** Free. Midwest Stamp Co., Kemper Bldg., Kansas City, Mo.

**HARDING** Unperforated—\$1.00 U. S.—100 Diff. Foreign, 16c. Mountain City Stamp Co., Box 535, Mannington, W. Va.

**FAMOUS Fenway Outfit**—2 triangle stamps, small album, 5 blank approval sheets, 250 hinges, perforation gauge, 5 large French Colonials, 2 special delicacies, animal set, red cross set, pocket 35 different, including Abyssinia, Azores, Cape of Good Hope, Bosnia, Crete, Congo, etc. 16-page price list, all for 12c to new approval applicants. Fenway Stamp Co., Fenway Station, Boston, Mass.

**\$3.00 FOR 12c!** 100 different Newroupe. Catalogued \$2.00 Red Cross set, Airplane set, Perforation gauge, Millimetre scale, Fine wallet, 5 approval sheets, 250 hinges, scarce packet from Nyassa, Abyssinia, etc., price list and approvals—all for 12c to approval applicants. Atlanta Stamp Co., Box 532, Atlanta, Ga.

**50 DIFFERENT** South American 25c; 90, 50c; 125, \$1; 200, \$2. Fred Onken, 630 79th Street, Brooklyn.

**FREE**, 20 Luxembourg Stamps given to applicants requesting my approval selections at 65% discount. Reference Required. J. de Jong, 516 West 162d St., New York, N. Y.

**FRENCH Colonies:** 100 different, postpaid 50c. Lee Fuller, Centerville, Iowa.

**FINEST** one-cent approvals. Boehm, 401 W. 149th St., New York.

**RARE Bargain!** 24 different scarce German Provisionals 10c; catalog over \$2. Penna. Stamp Co., Manor, Pa.

**SET** Greece Stamps, Packet Hinges, Perforation Gauge, 10c. Quaker City Stamp Co., Box 181, Rachel, W. Va.

**START** a Stamp Collection—70 different stamps from 70 different foreign countries, including Africa, Asia, Australia, Europe, West Indies, etc. Our pamphlet which tells "How to make a collection properly," and price list of albums, packets and sets all for only 16 cents. Queen City Stamp Co., Room 36, 604 Race St., Cincinnati, O.

**1,000 MIXED** Stamps from Europe, Asia, Africa, etc., only 20 cents. Nielsen, 3244 Whipple St., Chicago.

**BEST** one-cent approvals in America. F. P. Hand, 1117 So. 60th St., Philadelphia, Pa.

**FINE** Packet 100 different (mostly unused), including Congo, Nyassaland, San Marino, and small album. All for 6c to Approval Applicants. World Wide Stamp Co., Phoenix, Ariz.

**START** Right! Wonderful variegated collection 20c. National Institute, Springfield, Ohio.

**PACKET** of 23 stamps, no two countries alike. Packet hinges. Set of \$1 and \$2 U. S. Rev., all for 5c. P. M. Miami Stamp Co., Toledo, Ohio.

**20 UNUSED** stamps free. All different. Postage, 2c. P. M. Fisk Stamp Co., Toledo, Ohio.

**FOUR** unused sets, including "Prisoners of War," 55 different, hinges, premium, 15c. Deering, Newton St., Marlborough, Mass.

**FREE!** World's smallest stamp. Approvals, Postage 2c. Cannon Co., Davenport, 6, Iowa.

**950 FOREIGN** stamps, catalogued \$10, for \$1. Lowe, Box 387, Spokane, Wash.

**TWO** Dollar Cat. Value for 6 Cents. 100 diff. stamps, incl. Plume (triangle), set German Air Mail, French Colo., pictorials (Tiger, etc.) for 6 cents to approval applicants. Perf. gauge and price list Free. Pathe Stamp Co., 521 Woodward Ave., Atlanta, Ga.

**STAMPS** sent on approval at 70% discount. Reference required. Emory Renoll, Hanover, Pa.

**UNIVERSAL** Packet, 100 varieties, all over the world, 10 cents. Covert Stamp, 39 State, Rochester, N. Y.

**FREE**, \$1 Canada to approval Applicants. References. B. A. Turner, Greensburg, Ind.

**ANCHER'S \$\$\$ Outfit**—Only 12c! Fine triangle stamp; set German stamps with (pre-war) value forty million dollars (interesting!); perforation gauge, name, scale; small album; 2 approval sheets; airmail set; scarce stamp from smallest republic on earth; newspaper set; packet good stamps from Travancore, Johore, Dutch Indies, etc. Entire outfit for 12c to approval applicants! (Nice pocket stock book, value 25c, with every order!) Ancher Stamp Co., 934 Monticello Ave., Jersey City, N. J.

**SAVAGES** and wild animals, 10 different French Colonial stamps, 2c. Nickles, Room 116, 122 Florida, Washington, D. C.

**100 DIFFERENT** New Europe Free to approval applicants sending return postage. Anvelink, 2410 Prairie, Milwaukee, Wis.

**25 STAMPS** catalogued over \$1.00—10c coin, 400 mixed, catalogued over \$16.00—\$1.00. W. Benno, Glen Ellyn, Ill.

**STAMPS** on approval—4c up. Free Premium. Herbert Kelgwin, Middletown, N. Y.

**MYSTIC'S "Mysterious" Packet!** Contains stamps from the lands of cannibals, heathens, sun worshippers, and wild savages. Included are Travancore, Malay, Dutch Indies, Liberia, Siam, Africa, Abyssinia, North Borneo, Nyassa, Congo, etc. This wonderful packet containing 110 all different (mostly unused) for only 8 cents to approval applicants. Mystic Stamp Co., Dept. 8, Camden, New York.

**NYASSA** Giraffe and packet of 52 different scarce stamps. Plume Triangle, large \$1.00 U. S. Rev., millimetre scale, perforation gauge and ruler for only 9c. To introduce our Sudden Service approvals, Pennell Stamp Company, Dept. P, Fullerton Bldg., St. Louis, Mo.

**FREE!** Loose Leaf Postage Stamp Album at rate of 8 pages each month given with subscription to monthly Journal. Send 2c stamp for prospectus. United Stamp Co., Marquette Bldg., Chicago, Ill.

**100 DIFFERENT** stamps free to applicants for our Popular Approvals. Postage 2 cents. Christensen, Sycamore Bldg., Milwaukee, Wis.

**158 GENUINE** Foreign Stamps, Mexico War Issues, Venezuela, Salvador and India Service, Guatemala, China, etc., only 10c. Finest approval sheets 5c to 60%. Agents Wanted. Big 72-p. Lists Free. We Buy Stamps. Estab. 29 years. Hussman Stamp Co., Dept. 54, St. Louis, Mo.

**FREE**—Two sets Nyassa, 20 Diff. British Colonies Barbados and Jamaica pictorials and a packet of hinges—all for a request for my 1, 2 and 3c net approvals, none better. Chas. T. Egner, 4821 Frankford Ave., Frankford, Phila., Pa.

**24 VARIETIES** Cuban stamps, 10 cents. List of 6,000 low-priced stamps free. Address Chambers Stamp Co., 111P, Nassau St., New York City, N. Y.

**STAMPS**, 50 varieties, Africa, Brazil, Peru, Cuba, Mexico, etc., 10c. 50 different U. S., 25c; 1,000 mixed, 40c; 1,000 hinges, 10c. List free. C. Stegman, 5948 Cote Brillante, St. Louis, Mo.

**105 CHINA**, etc., stamp dictionary. List, 2c. Album (500 illustrations), 3c. Ballard, Stn. A, Boston.

**100 RARE** Stamps, all different; Bargain lists, Stamp Magazine, everything 7c. Stanton, Niantic, Conn.

**2,000 DIFFERENT** stamps \$5.55; 1,000, \$1.45; 500, 45c; 300, 25c. Mitchell, 5353 Cabernet, Chicago.

**STAMPS**, 100 all different. Postage 2c. Lists free. P. M. Quaker Stamp Co., Toledo, O.

**FREE**—25 different U. S. Stamps with 60% approvals to reliable parties, 75 different U. S. Stamps 25c. C. Seidenberg, Merton, Wis.

**FREE**—50 varieties to approval applicants sending 2c. Richard P. Lamprecht, Valparaiso, Ind.

**DANZIG** Free—Nice Set Danzig Stamps with Biggest Lists issued, 2c. postage. Midland Stamp Co., Station E2, Toronto, Canada.

**FRENCH** Colonies Free—Pretty Picture Set, Native Chiefs, Tigers, 2c Postage. Empire Stamp Company, 342 Lipponcott, Toronto, Canada.

**BIG Variety** Packet Foreign Stamps Free for 2c postage. Gray Stamp Company, Station E10, Toronto, Canada.

**50 DIFFERENT** Newroupe, German Air Mail Set. Free to applicants for my 1, 2, and 3c net approvals; also my high-priced stamps at 50% discount. Chas. W. Schmidt, 3227 Benner St., Wissinaming, Philadelphia, Pa.

**FRENCH** Colonies 150 different \$1.00, with nice Morocco set free. Georges Stamp 4153 Second, Detroit, Mich.

**FREE**—200 different stamps to approval applicants sending 4 cents postage. H. W. Myers & Co., 1018 Florida St., Richmond, Calif.

### RARE COINS

**OLD** U. S. Silver Coins Cheap. Old bust type dimes dated before 1838, 25c. Old half dollars with lettered edge, dated before 1836, 75c; Columbian Half Dollars with bust of Columbus (sold at \$1 in 1893), price 75c. Five foreign coins, 1 over 100 years old, and my large 50 page Illustrated Coin Catalog for only 20c. Our catalog free with any order for above coins. All kinds of Coins and Bills for sale. B. Max Mehl, Numismatist, Mehl Bldg., Dept. P, Fort Worth, Texas. Largest Rare Coin Establishment in the United States.

**TEN** Billion German Marks fifty cents. Craig Dare, Patchogue, N. Y.

**100 MIXED** foreign copper coins from Holland, France, Russia, Finland, German East Africa, Norway, Denmark, Sweden, Switzerland; all bright new condition; post-paid, 50 cents. Nagy, 33P South 18th Street, Philadelphia.

**FOR** Sale—old coins. Large Cent—Price List—15 cents. Elery Fleming, Gainesville, Ga.

**40** OLD coins, all different, \$1.00. 20 Large U. S. Cents, all different dates, \$1.25. 200 all different German City Bills \$1.00. 25 different German High Value Bank Notes, 50c. Claud Denney, Box 315, Dallas, Tex.

**1** BILLION German Marks 25c. Nagy, 33 South 18th St., Philadelphia.

**100,000** GERMAN Marks—10c; \$20 Mexican Revolutionary Note—10c; 10 New Foreign Copper Coins and German Bill—25c; Nickel, 3c and 2c—15c; Price Lists and Wild Cat Bill—6c. Al E. Bonsall, Richmond, Ind.

**OLD** Money Wanted. We paid \$2,500.00 for one silver dollar to Mr. Manning of Albany, N. Y. We buy all rare coins and pay highest cash premiums. Send 4c for large Coin Circular. May mean much profit to you. Numismatic Bank, Dept. H, Fort Worth, Texas.

**CALIFORNIA** gold, 3/4 size, 27c; 3/8 size, 53c; three-cent-piece and catalogue, 10c. Norman S'witz, Colorado Springs, Colo.

**OLD** Coins. Large Spring selling catalogue of coins for sale, free. Catalogue quoting prices paid for coins, 10c. William Hesslein, 101 A Tremont St., Boston, Mass.

**RARE** Coins, Medals, Paper Money, United States, Foreign and Ancient, Villa Coin and New Catalog 10c. Alexis Mengelle, Box 387, Colorado Springs, Colo.

### FOR BOYS

**MOUTH-ORGAN** Instructor, 25c. Learn in one hour. Boxing Instructor, 25c. 150 Song Parodies, 10c. 250 Magic Tricks, 10c. Ford Joke Book, 10c. "Ventriloquist," 10c. Boy Electrician, 10c. ToyMaker Book, 10c. All for \$1.00. G. Elsen, Bowling Green, Ohio.

**BUILD** Horizontal Engine; Blueprint for Quarter. Coin preferred. South Buffalo Engine Co., 326 McKinley Pkwy, Buffalo, N. Y.

**FREE**—Big Fun Magazine and selling proposition. Pin-Ko, 944-M Clark, Toledo, Ohio.

### CAMERAS AND PHOTO SUPPLIES

**PHOTOGRAPHIC** equipments and accessories of every description are listed and illustrated in our 178-page catalogue. It will pay you to secure a copy which is issued free, as our prices are low. We also deal in used goods which are sold under the same guarantee as new goods. Ask for our Bargain Book. Central Camera Co., Dept. E-82, 124 S. Wabash Ave., Chicago, Ill.

**8x10 ENLARGEMENT** from your film colored and framed for 98c plus 2c for insurance. Cash with order. Send for circular. Altes Photo Service, Braintree, Mass.

**KODAK** Vergains—All sizes and styles. Stillier's, Kodak Specialists, Green Bay, Wis.

**GENUINE** 6 or 8 Power Schutz High Grade Prism Binoculars in leather case, \$24.50. A limited lot at this astonishing price. Shipped for examination upon receipt of \$5.00 deposit. Send your order quick. Bass Camera Company, 109 N. Dearborn St., Chicago, Ill.

**DOUBLE** print Kodak Photo, new art style, entirely different, never seen before. Roll developed, 6 prints for 2 dimes. Malden Art Co., 19, Cincinnati, Ohio.

**M. & F. QUALITY** Prints are backed by 35 years' photographic experience. Judge us by a trial order. Marks & Fuller, Inc., Dept. B, 45 East Avenue, Rochester, N. Y.



**FILMS** Developed. Printed. Never fade glass prints. Lightning service. Something new. Write for prices. F. R. B. Photographers, 1303 Lincoln Ave., Cincinnati, Ohio.

**FILMS** developed. Prints made. Write for Price List today. Z. Koscielniak, Box 1361, Detroit, Mich.

**YOUR** small films enlarged to Postcard-Size, 10c each. Kodafin, 387 Bellevue Place, Milwaukee, Wis.

**CAMERAS**, telescope, binocular, cheap; list free. Duro, 25 Mulberry, N. Y. City.

**ANY** Size Oil Painted Picture made from your photo, film or kodak picture. Write for prices. Otto E. Hueser, 4336 North Lincoln St., Chicago, Ill.

**KODAK** Films—Special trial offer; your next kodak film developed, 5c—prints, 2c each. Moser & Son, 1917 St. James Ave., Cincinnati.

**FILMS** Developed. Special Trial Offer. Any Size Kodak film developed 5c, prints 3c each. Trial 6x10 Enlargement in handsome folder 40c. Overnight Service. Roanoke Photo Finishing Co., 209 Bell Ave., Roanoke, Va.

**FILMS** Developed 5c—Prints 3c each. The new Davo finish. Davis Photo Shop, Dept. A, Cincinnati, Ohio.

**ART** Corner your Photo-Prints, Postcards, Clippings into albums with Engel Art Corners—permanently or removably. No Paste needed. Neater and more convenient than the old-fashioned methods. Let's show you. Send a dime for package of 100 and samples. Engel Art Corners Co., 4707 North Clark, Chicago.

**PHOTOGRAPHS** taken easily without films. New discovery. Save money. Nothing to sell. Photo and complete instructions thirty cents. W. Wilkinson, Clarkson, N. Y.

**HAVE** You a Camera? Write for Free sample of our big magazine, showing how to make better pictures and earn money. American Photography, 116 Camera House, Boston, 17, Mass.

**SUPERIOR** quality finishing and enlarging. Trial offer: Any size 6 exposure roll developed and printed, 25 cents. 8x10 enlargement unmounted, 30 cents. Carkhuff Photo Finishing Co., 2129 W. Van Buren St., Chicago, Ill.

**BIG** Money Saved on Photographic Lenses and Apparatus—goods exchanged; repairing done. Ralph J. Golsen, 1128 Arzyle St., Chicago, Dept. P.

**MODERN** Photography in all its branches now taught by mail. New Successful Method. Students earning \$300.00 while learning. Big Opportunity. Write for particulars and unusual offer open for short time. Dept. 3431, International Studios, Inc., 3601 Michigan Ave., Chicago.

#### MOTION PICTURES

**REMARKABLE** New Home Motion Picture Projector, light weight, good illumination, smooth running. Can also be used as a slide machine. Complete with reel of film, \$32.00. No better value possible. Send your order quick. DeFranne Importers, 109 N. Dearborn, Chicago, Ill.

**400** REELS Features, Comedy and Educational. Bargain lists free. National Equipment Co., Duluth, Minn.

**BARGAIN**. 6 Two Reel Slapstick Comedy Movies \$4 per Reel, while they last. M. Gordon, 1002 Malters Bldg., Chicago.

**MOVING** Picture Machines and Films for Sale. Send Stamp for List. National Film Brokers, 3907 Summit, Kansas City, Mo.

**ELECTRICITY** 10c per hour. Motson Auto Generator operates on any automobile or truck. Produces electricity for moving picture machines, theatres, tents, schools, churches, etc. Mazda equipment and globes for all professional and suitcase machines. Details free. Monarch Theatre Supply Co., Dept. S. T., 724 So. Wabash Avenue, Chicago.

**\$35.00 PROFIT** nightly. Small capital starts you. No experience needed. Our machines are used and endorsed by government institutions. Catalog free. Atlas Moving Picture Company, 482 Morton Bldg., Chicago.

**HOME** Projector, 1,000-foot, \$25. Motor Driven Projector, \$50. \$250 New Sult Case, motor driven, \$75. Road Show Projectors, \$30. Sacrificing all Movie Cameras, \$50 up. Films, \$3. War Reels and Comedies, \$5. New \$28.50 Kodak \$15. New \$60 Radio Receiver \$27.50. Ray, 324 5th Ave., New York.

**WONDERFUL** Opportunities for Making Fortunes in this Business. No Experience needed. Complete Theatre Outfits sold on Easy Terms. Free Catalog. Monarch Theatre Supply Co., Dept. P, Memphis, Tenn. **CALL**.

**O BOY!** The Bass "Bargaingram" for this month will astonish you. Think of a complete Professional Motion Picture Camera, Tripod, Film, ready to start in a news weekly studio or commercial motion-picture film for only \$74.50. Dozens of other items just as good. Write for your copy at once. Hundreds of Bass' customers have become financially independent making motion pictures. The 575-page "Cinema Handbook" for only \$3.00 postpaid. The 52-page "Bass Catalogue" is free! Write or wire at once! Bass Camera Company, 105 North Dearborn St., Chicago, Ill.

**BIG** Money Nightly—Good assortment. Complete Outfits, installment plan. Splendid Home Outfit, \$25.00. Ralph J. Golsen, Dept. M, 1128 Arzyle St., Chicago.

**AMERICA'S** Greatest Fortunes made in the Motion Picture business. We furnish complete theatre equipment on easy payments. Openings everywhere. Catalog free. Monarch Theatre Supply Co., Dept. A, 724 So. Wabash Av., Chicago, Ill.

**\$\$\$ FOR** Ideas. Photoplay plots accepted any form; revised, criticized, copyrighted, marketed. Advice free. Universal Scenario Corporation, 206 Security Bldg., Santa Monica and Western, Hollywood, Calif.

**START** a Theatre. Picture Machines Complete \$50.00 up. Fire Proof Booths, Carbons, Mazda Equipment. Send for Literature. Western Motion Picture Company, Danville, Ill.

**MOVIE** Films for home and theatrical use; largest stock, lowest prices; comedies, complete subjects, \$3.50 reel up; features \$20 up. Write for list. Independent Film Exchange, Dept. B, 303 West Commerce St., San Antonio, Texas.

**UNLOADING** all our high-grade film, comedies, westerns, dramas, one, two and five reel features \$5.00 a reel. Send \$5.00 or a 1,000-foot reel. Complete stories. Order now. Mutt and Jeff cartoons per reel \$8.00. Illinois Film Sales Co., Dept. 83, 724 So. Wabash Ave., Chicago.

**MOVIE** Films for Home, School, Church and Theatres. Comedy, Drama, Cartoon, Cowboy, Indian, Jungle, Religious, Historical, Patriy, Travel, Vodevil and Educational subjects. \$5.00 per reel up. Complete List. Monarch Theatre Supply Co., Dept. G, Memphis, Tenn.

**MAKE** money writing photoplays; details free to beginners. No correspondence course. Producers League, 230 Wainwright, St. Louis.

#### SCENERY TO RENT

**SETTINGS** for Opera, Plays, Minstrels. Plush drops. Address Amelia Grain, Philadelphia.

#### EDUCATIONAL AND INSTRUCTION

**USED** educational matter bought, sold, exchanged. Bulletin free. Instruction Correspondence Exchange, 1968 Broadway, New York.

**SHOWCARD** writing made easy. Instruction book and complete outfit \$1.00. D. Gale, Box 315, White Plains, N. Y.

**WORLD-ROMIC** System, Masterkey to All Languages. Primers, \$1.94 each language: Bohemian, Chinese, Danish, Dutch, English, French, German, Italian, Japanese, Latin, Pasjabi, Polish, Portuguese, Rumanian, Russian, Sechuans, Singalese, Spanish, Swedish, Tamil. Pronunciation-Tables, 30c each language. Dictionaries, grammars, 4,000 languages, of 1,700,000,000 people: Afro-Asiatic, Amerindic, Eurindic, Indopacific, Siberic, Sinidic. Languages Publishing Company, 8 West 40th Street, New York.

**CARTOONISTS**—Improve your style by following the work of the greatest cartoonists found in the bound volumes of Cartoons Magazine. Three volumes, each covering six months, Jan.-June 1919 to Jan.-June 1920, inclusive. 1200 cartoons, 900 pages to a volume, 7 by 9 1/2 in., 3 in. thick. New books, durable and attractive binding. Sold separately at \$2 per vol. postpaid. Summy Limited. Send at once. Popular Mechanics Book Dept., 206 E. Ontario St., Chicago.

**LEARN** Patent Drafting. Complete Instructions 50c. Patent Drafting Syndicate, Box 858, Schenectady, N. Y.

**CARPENTERS**—Handy-men, make combination stool, step-ladder, bench, stand, writing table, service tray, drafting easel, all in one. Drawings 50 cents. Home Equipment Co., Drawer 923, Butler, Penna.

**FEAR**, timidity and bashfulness banished. Self-confidence achieved in ten nights of subconscious reconstruction; in ten days of directed activity or your money promptly refunded. Complete course \$1.00. Address, H. Lawrence Jahnke, Box 854, Sacramento,

**PERSONAL** Advancement tells how to decide upon a vocation, how to plan a course of home study, how to avoid duplication in the books you buy, how to secure the best book on any subject. And it's free for a year. Send your name and address on a postal today to Popular Mechanics Press, Room 895, Popular Mechanics Building, Chicago, Ill.

**CIVIL** Engineering. Six months' course, Begin in May. Technical Institute, Greenville, Ohio.

**BE** a Laboratory Expert. Earn \$300.00 to \$500.00 a month. Study Microbiology, Bacteriology, Laboratory Technology, Sanitation. Interesting Extension and Residential Courses. Diplomas and Degrees granted. 71-piece Urinalysis Outfit Free to students. Write for Free 48-page Prospectus Today. Int'l Physicians and Surgeons College of Microbiology, Room 955, 550 Garfield Ave., Chicago, Ill.

**WRITE** articles, stories, news, in spare time for newspapers and magazines. Big pay. Copyright book free. Press Syndicate, 981, St. Louis, Mo.

**SQUARE** Dance Self-instructor. Illustrated, 25c. Quick results. G. Elsea, Bowling Green, Ohio.

**USED** educational matter, books, etc., sold, rented and exchanged. Big list free. Lee Mountain, Pisgah, Ala.

**"WHAT** to Invent for Profit" free. Patent News-N, Washington, D. C.

**YOU** can have a business profession of your own and earn big income in service fees. A new system of foot correction; readily learned by anyone at home in a few weeks. Easy terms for training; openings everywhere with all the trade you can attend to. No capital required or goods to buy, no agency or soliciting. Address Stephenson Laboratory, 1 Back Bay, Boston, Mass.

**DOUBLE** Entry Bookkeeping mastered in 60 hours with 8 keys; guaranteed; diplomas. Our graduates lead in bookkeeping, auditing, accountancy, balance sheets, and financial statements. International Bookkeeping Institute, Dept. 8, Springfield, Mo.

**USED** books and educational matter bought, sold, exchanged. List 1,000 items free. Students' Exchange, 47-A West Forty-second Street, New York, N. Y.

**ARTIFICIAL** Marble, sanitary flooring instructions, ornamental casting, concrete plaster, papier-mache decorations, garden furniture, statuary, Rubber-moulds, Electrometallurgy, particulars and 200 illustrations free. Chris Mahler, Box 123, Huntington, N. Y.

**BOOKKEEPING** in a Week, \$1 Postpaid. Dukes, 1857 Walton Ave., New York.

**ROPI'S** Calculator and Short-Cut Arithmetic shows the answer as quickly as a watch shows the time to all problems likely to occur in office, store, shop, bank, farm or factory. Price, pocket size, paper 35 cents; cloth 50 cents; leatherette \$1. Desk size, cloth \$1.50 postpaid. Popular Mechanics Book Dept., 206 E. Ontario St., Chicago.

#### RADIO OUTFITS AND SUPPLIES

**FOR** Sale—10 watt set for key or broadcasting. For particulars write A. E. Schilling, 108 Elm St., Kalamazoo, Mich. Station WLAQ. Will mail photo on request.

**RADIO**—Build your own and save money! 12 standard, practical working diagrams, one to five tube, good size blueprints, \$1.00. Cash, money order, check. Act quick. L. F. Walters & Co., 131 West 23rd Street, New York City.

**HARKNESS** circuit two tubes take place of four or five. Detector 2 R. F., 2 A. F. Complete genuine parts including set of Pflexo-formers-Reinhold detector and 201A type tubes \$23.50. Range 1,000 to 1,500 miles on loud speaker. New catalogue 6c on request. Royal Mfg. Co., Dept. 501, 206 Broadway, New York.

**KNOW** Radio. Send \$3.00 for Cameron's "Text Book on Radio," endorsed by authorities. No amateur or radio fan should be without it. It tells everything—better than a lifetime subscription to a radio magazine. Postpaid on receipt of \$3.00 anywhere in U. S. A. and Canada. Department-Radio, Bass Camera Company, 109 N. Dearborn, Chicago.

**LONG** distance single tube set. Complete with tube, \$13.75. Specialty Sales Co., 234 Greeley St., Milwaukee.

**LAMBERT'S** Beach-Out Crystals. The kind I use on my famous DX crystal sets that reach out and bring in concerts 400 to 1,000 miles away. Mounted, 60c each, two for \$1.00. Unmounted, 40c each, three for \$1.00. Fixed detector, \$1.50. Mailed postpaid the day I get your order. Leon Lambert, 539A South Volusia, Wichita, Kans.



**RADIO Fans!** Get this latest book. Radio Circuit Designs. Entirely new and thoroughly practical work containing immense amount of authoritative information which will meet the needs of every radio enthusiast whether novice or expert, amateur or professional. Full of clear and correct instructions from which anyone can build and successfully operate any of the circuits given. Contains largest collection of hook-ups ever published, including all standard types and latest developments. Gives complete electrical designs of circuits showing every detail on diagrams. Surpasses all other books of its kind in its simplicity and in thoroughness of detail. 275 pages, 284 illustrations. No radio enthusiast can afford to be without it. Price only \$1.00 postpaid to any address. Write for free catalogue of other good practical and scientific books. A. Burley, 63 West 51st Street, New York City.

**CRYSTAL Radio Receiving Set.** Guaranteed to work. 50c postpaid. Tru-Blu Supply Co., 164 Lake, Rochester, N. Y.

**B. M. PANEL** Tool for cutting peep or meter holes in radio panels. Cuts smooth hole, one to five inches in diameter. Only \$2.50 postpaid. Homer Malcomb, White-water, Wis.

**2,650 MILES** Distance with one tube. Any Novice understands our Simplified Instructions, including Panel Layout and Photo 25c. Vesco Radio Co., Box PM-117, Oakland, Calif.

**STORAGE Batteries**, 6 volt, 60 ampere, brand new, \$5.75; Transparent cells. J. Zied, 530 Callowhill, Philadelphia, Pa.

**DICTIONARY** of Radio words and terms, electrical symbols, wiring diagrams, radio diagrams and complete electrical dictionary, new, up-to-the-minute, just published. 188 pages, cloth cover, test-pocket size. 35c postpaid. Popular Mechanics Book Dept., 206 E. Ontario St., Chicago.

**RADIO Generators**—500V, 100 watt \$28.50. Battery Charging Generators \$8.50. High Speed Motors—Motor Generator Sets, all sizes. Motor Specialties Co., Crafton, Penna.

**RADIO Sets**—\$39 to \$390. Super Heterodynes, Neutrodyne and other types. All makes, at 50% off list. Why pay more? Send for Bulletin 244. Radio Exchange, 925 Broadway, New York.

**IVORY Radio Panel**; White "Ivorylite" makes most beautiful set. Guaranteed satisfactory. Any size 3-14" thick. Three cents per square inch. Sample sent, E. P. Halton, 614 Main, Dept. P, Fort Worth, Texas.

**ONE-FOURTH** ampere detector or amplifier tubes \$3.49, variometer parts 49c, 180° variocouplers \$1.49, sockets 34c, dials 23c, rheostats 38c. Write for list. Martin Hardware Company, Hamilton, Mo.

**LOUD Speaking Crystal Set.** Broadcastings heard throughout house. Easily constructed. Instructions complete 25c. Catalog free. Steinmetz Wireless Mfg. Co., Eastend, Pittsburgh, Pa.

**RADIO Map** of the U. S.—Government Radio Stations, Broadcasting Stations, Commercial Stations, Call Letters, Wave Lengths, etc., 35c postpaid. Popular Mechanics Book Dept., 206 E. Ontario St., Chicago.

#### TELEGRAPHY

**TELEGRAPHY**—Both Morse and Wireless—taught thoroughly and quickly. Tremendous demand. Big salaries. Wonderful opportunities. Expenses low; chance to earn part. School established fifty years. Catalog free. Dodge's Institute, H St., Valparaiso, Ind.

#### TRADE SCHOOLS

**YOU** can't do better for Your Future Than Learn a Big Paying Trade. Write for our Free Catalogue of Sign Painting, Show Card Writing, Pictorial Painting, Decorating, Paperhanging, Graining and Marbling, Auto Painting, Chicago Painting School, 147 West Austin Ave., Chicago, Ill.

**NO Matter** What Trade you are interested in, you can get help from Personal Advancement magazine, published by Popular Mechanics and sent free to all who request it. Will help you decide upon a vocation. Send your name and address on a postal to Popular Mechanics Press, Room 805, Popular Mechanics Building, Chicago, Ill.

#### BUSINESS OPPORTUNITIES

**25 MAILORDER** Magazine and Papers 50c. Hansen Company, Brookings, S. Dak.

**GOLD Window Sign Letters.** Manufacture them at home. Unlimited profits and business opportunities. Complete instructions and patterns. No experience required. Particulars, Wilberding, 1144 Pleasant Street, Oak Park, Ill.

**BIG Profits.** Refinish, Regloss, Retrim, Clean Cars. Make auto specialties. Demand unlimited. We teach you these modern trades by Mail. Small outlay starts your own shop. Autorenuco, Sheboygan, Wis.

**\$2.00 WORTH** of Potatoes makes \$27.00 worth of "Tater-Flakes." Newly patented Potato Chip Machine turning out the best product ever known is rapidly being placed on market with great success. Machines in Chicago, Des Moines, Los Angeles, Kansas City, Jacksonville, Peoria, Sumbury, Pa. and other towns are making \$100-\$150 weekly net profit to owners. Only one machine sold to a community. Remarkable retail and wholesale business. Investment of about \$1,250 puts you in business of your own. Good man needed in your town who is ambitious and has some business experience; such man as our representative will make \$5,000 to \$8,000 yearly. If you are the man write us immediately or better, come to Chicago and convince yourself as to the merits of the proposition. Tater-Flakes Co., Room 709, 20 East Jackson Blvd., Chicago.

**SIGNS, Banners, Cards** Easily Painted with the aid of Letter Patterns. Samples of 10 different styles 10c. John F. Rahn, A2433 Greenview Ave., Chicago.

**MANUFACTURE** new, fast selling articles. Free list of plans, patterns, molds. Morton Barter, 3937 Tracy, Kansas City, Mo.

**PATENTS**—Write for our Guide Books and "Record of Invention Blank" before disclosing inventions. Send model or sketch and description of invention for examination and instructions. No charge for the above information. See advertisement on pages 152 and 153. Victor J. Evans & Co., 192 Ninth, Washington, D. C.

**PATENTS** Procured. Send sketch or model today for examination, prompt report and advice. No charge for preliminary advice. Write for free Booklet and blank form on which to disclose your idea. Highest references. Promptness assured. Clarence A. O'Brien, Registered Patent Lawyer, 583 Security Bank Building, Directly across the street from Patent Office, Washington, D. C. See pages 159 and 151.

**500% PROFIT.** Copyright Novelty Chart. Wonderful Mail and Agent Proposition. Sample and Selling Instructions 25c Silver. Reynolds Company, Dept. H, Box 1241, Trenton, Pa.

**MONEY!** Silvering Autolights, Radiators, Mirrors, tableware, stoves, Outfits, Methods free. Clarence Sprinkle, Dept. 28, Marion, Ind.

**LEARN Candy Making.** Make big profits at home or in shop. Big demand for good candy. Easily, quickly learned through our correspondence course. Write today for booklet 1-6. The Candy Institute, Sixty West Fifth Street, New York.

**INK Powder**, guaranteed formulas for making any color, \$1.00 each. Frank Shilling, 1017 Duesler, Canton, Ohio.

**AGENTS** Wanted—Something New—Fire fighter sells easily. Makes a spectacular demonstration; car owners, homes, factories, stores, practically buy on sight. Our men make \$10.00 to \$50.00 a day; exclusive territory. If you wish to establish a business of your own with unlimited possibilities for making big money, write us today. Fry-Flyer Co., 14 Fry-Flyer Bldg., Dayton, Ohio.

**A TEA ROOM** or Cafeteria will make you a fortune—you can operate one of your own or manage one for others. We teach you in a few weeks and put you in touch with positions and money-making opportunities—earn \$5,000 a year—be independent. Write today for book "Pouring Tea for Profit." Lewis Tea Room Institute, Bureau G-31, Washington, D. C.

**COMMON** Sense and \$100 or more will establish cash business. Dept. M, Paul Kaye, 149 Broadway, New York.

**MEN** Wanted everywhere to start a business of their own. Pays \$75 to \$100 monthly. Brains and energy the only capital required. Full particulars and working plan, by mail, 50c. Claude Hurley, Box 383, Calver City, Calif.

**MONEY** Getter—Attractive refreshment, patented. Get busy, machines ready. Small capital required. Write Inventor, 1323 West 101 St., Los Angeles, Calif.

**COUNTY Distributors** Wanted—Sell New Thermostatic Automatic Carburetor Control Attachment for Fords. Big Profits, full or part time. Burns 95% air. Doubles Mileage. Attached in 2 minutes. No drilling. Does automatically exactly what Ford Manual says do by hand. Cadillac now using Thermostatic Carburetor Control under Blanche license. Write today. A. C. Blanche & Co., Dept. 161-B, 602 W. Lake St., Chicago.

**START** small publishing and mail order business. Magazines free if you send some advertising. Sample, plan, 10c. Harvey Teeple, Decatur, Ind.

**\$5 TO \$15 Daily**—Sworn Proof. Introducing New Guaranteed Hose. Must wear or replaced free. No capital or experience required. You simply write orders—We deliver and collect. Your Pay Daily, monthly bonus besides. Spare time satisfactory. Mac-O-Chee Hosiery Company, Room 2586, Cincinnati, Ohio.

**A BUSINESS** of your own for \$3.00. Think of it! \$3.00 starts you on the road to success. A daily Necessity to every housewife. Easy to sell. Cleans, polishes metal, glass, enamel, grease from the hands. Case of 24, exclusive territory. Free samples \$3.00. Mail application today. Lumite Products, 409 Walnut N. E. Canton, Ohio.

**120 MONEY-MAKING** Plans Free! Webster Bureau, G3, Muskegon, Mich.

**START** Mail Order Business—Practical information concerning its wonderful opportunities obtainable through The Mail Order News, America's leading mail trade publication. Yearly subscription \$3.00. Sample 25c. Booklet free. Mail Order News, 1633 Bristol Bldg., New York.

**CEMENT** Masons, Plasterers, Contractors. Build successful business, succeeding old and new buildings with Everlastone Indestructible Stucco; also installing Corkstone Floors over worn-out flooring. Write immediately for agency proposition. Everlastone Corporation, 828 W. Pratt St., Baltimore, Md.

**BE** Ready for your golden opportunity by preparing yourself. Personal Advancement, a new magazine, tells how to do this. Will be sent you free. No strings to this offer. Popular Mechanics Press, Popular Mechanics Building, Room 805, Chicago, Ill.

**STRAW** Hat cleaning compound in bulk or package; sample package and particulars 10c. Big profits. Byron, 27 Station Eye, New York.

**MAKE** Money at Home. Quickly. Easily. Steadily. Spare Time. New, Simple. Mail-order Plan. Details Free. Geo. P. Bucknam, 63 Court St., Room 1, Boston, Mass.

**PATENTS** Procured; Trade Marks Registered—A comprehensive, experienced, prompt service for the protection and development of your ideas. Preliminary advice gladly furnished without charge. Booklet of information and form for disclosing idea free on request. Richard W. Owen, 30 Owen Bldg., Washington, D. C., or 2276-B Woolworth Bldg., New York.

**NICKEL** plate automobile accessories, hardware, electrical parts. Big profits. Requires no capital. Simple battery process. Write today. Webster Engineering Co., Webster Groves, Mo.

**FORMULAS, Processes, Trade-Secrets.** Different, dependable, profitable. Catalog free. B. Thaxly Co., Washington, D. C.

**FREE** Book. Operate little Mail Order business anywhere. Home employment evenings. We furnish Working Outfit, 500 Circulars and instruction. Also tell you how to get agents to sell your specialties for you. Instructive Booklet free. Pier, 670 Cortland St., New York.

**GOOD** Money easily earned at home spare time Silvering Mirrors, Glass Embossing, Chipping, Frosting, Gold Leafing, etc. G. L. Patterson & Co., Brooksville, Ky.

**"GET** into the Specialty Manufacturing Business" or "Why Work for Others?" may sound good to you, but you won't succeed in that business unless you possess Formulas that are absolutely reliable, the same required by leading manufacturers supplying the Best. Don't be Bunked into buying a Collection of cheap "Formulas" and expect to succeed. Send today for my valuable literature and Formula Lists and Real Money-Makers in the Specialty Manufacturing Business. 26 years supplying the Best. Miller, Chemist, 895 De Leon St., Tampa, Fla.

**"HOW** to Sell Patents" free. Patent News-H, Washington, D. C.

**UNPATENTED** Ideas Can Be Sold. I tell you how and help you make the sale. Free particulars (Copyrighted 1923). Write W. T. Greene, 819 Jeniffer Building, Washington, D. C.

**MAKE** toys and novelties at home. Big profits. Instructions and 200 illustrations, 25c. Astrolite Company, Sharpsburg, Pa.

**ATTENTION!** You can have a business of your own. Establish and operate New System Real Estate Business, brokerage and insurance agency in your community. Office at home. Earn \$5,000 year. Representatives wanted everywhere. Send stamp for free booklet. Hayes Realty Association, Cincinnati, Ohio.

**FOR** Sale—A small mail-order business that has been very profitable for last two years. Will sell stock, dies, electrocs, good will, etc. Splendid opening for hustler with small capital; big future if properly developed. Now furnishing one of the largest mail-order houses in this country. Recommended by Good Housekeeping Institute. Must sell because of sickness. For particulars write G. A. %Room 304, 290 East Ontario St., Chicago, Ill.



**SILVERING Mirrors!** My exclusive French Tartaric method opens enormously profitable business. Booklet free. H. Barstow, 514 25d Street, Oakland, Calif.

**INVENTORS**—Write for our Guide Book, "How to Get Your Patent" and Evidence of Invention Blank. Send model or sketch of your invention for our free Examination and Instructions. Randolph & Co., Dept. 435, Washington, D. C.

**\$3,000 TO \$6,000 Yearly.** Want it? Others are making it. Send check or money order today for our invaluable books "How to Sell Real Estate," \$3.00—and "How to Conduct Real Estate and Insurance Business," \$1.50. Absolute satisfaction guaranteed. Free catalogs. Realty Book Co., Dept. 52, Cleveland, Ohio.

**CHEMICAL** Expert furnishes manufacturing formulas with complete working directions, resulting products possessing distinct individuality and merit. Processes perfected. All lines. No lists of worthless stock formulas but reliable individual service. Charges reasonable, correspondence invited. Dr. Arthur VanHeeden, 508 South Oakley Boulevard, Chicago.

**MAIL Order Business** is your opportunity. Brenner's Famous Handbooks teach how to start small, grow big. Sell merchandise, service, ideas; enormous profits. Spare time to begin. Get complete set, 11 books, \$3.00, and be posted. Brenner, 335 Walnut, Philadelphia. Descriptive Catalog and big batch interesting mail order information, 25c. None free.

**BIG** money writing photoplays, stories, poems, songs. Send for free copy America's greatest magazine for writers. Tells you how to write and sell. Writer's Digest, 603 Butler Bldg., Cincinnati, Ohio.

**EXCEPTIONAL** Opportunity for Sales Manager capable of handling state distribution. Marvelous new Adding Machine. Retail \$15. Work equals \$350 machine. Tremendous possibilities. Unlimited profits. Write quick for details. Lightning Calculator Co., Dept. B., Grand Rapids, Mich.

**WE Start You in Business**, furnishing everything; men and women, \$30.00 to \$100.00 weekly operating our "New System Specialty Candy Factories" anywhere. Opportunity lifetime; booklet free. W. Hillier Ragsdale, Drawer 4, East Orange, N. J.

**ENTER** a new business. Earn \$3,000 to \$6,000 yearly in professional fees making and fitting a foot specialty, openings everywhere; easily learned by anyone at home in a few weeks, at small expense; no further capital required, no goods to buy, job hunting, soliciting or agency. Address Stephen Laboratory, (1) Back Bay, Boston, Mass.

**START** and Operate Your Own Business. Our System proprietary specialty manufacturing offers wonderful opportunity to make \$100 to \$500 weekly. Openings everywhere. Either men or women. We furnish everything and show you how. Big explanatory book, "The Open Door to Fortune" free. Write for it now. National Scientific Laboratories, 208 Monroe, Richmond, Va.

**ICELESS** Refrigerators. How to make. How to sell them and how to finance your business. Mailed complete for \$2.00. Sensible System, 2875 California St., San Francisco.

**CHEMICAL** Expert will furnish Formulas and Trade Secrets. All lines. Lists Free. W. L. Cummings, Ph. D., 228 Gordon Ave., Syracuse, N. Y.

**COST \$5.00.** Your profits \$104.75, transferring monograms on autos, trunks, bags, etc. No skill required. Samples and information free. World Monogram Co., Dept. 16, Newark, N. J.

**MEN**—Look into our proposition of Wallpaper Cleaning. Take big cleaning contracts. Unlimited field. C. Swanson & Sons, Mankato, Minn.

**START** a Real Estate Office of your own. Earn from \$3,500 upwards. Our course of 21 lessons tells you how. Booklet M, on application. Frederick Jenkins, Corlaer Helcht, Schenectady, N. Y.

**PATENTBOOK**, 139 mechanical movements and illustrations, sent free. Labinere, 3 Parkrow, New York.

**I MADE \$30 a Week Home.** French Breadmaking. 15 years' experience; Free Booklet tells. Ashbrook 67, Marengo, O.

**MAKE \$3.00 hourly.** Electric Lawn Mower Sharpening. 415 South Lardale Ave., Kansas City, Mo.

**FIFTY "Moneymakers"** for Mail Dealers, 50% profit. K. Home, 1937 Warren, Chicago.

**MAKE** Money at Home—making toys. We show you how. Send \$1 for complete working drawings and instructions. DeKalb Designing Co., Decatur, Ga.

**GREATEST** Fortunes in Motion Picture Business. Small Capital Starts you with Complete Outfit. Details Free. Memarch Theatre Supply Co., Dept. F, Memphis, Tenn.

**GO** into the Crispette business. Everybody likes Crispettes. You can make a lot of money. We start you. Write for facts. Long Eakins, 1959 High St., Springfield, Ohio.

**INCH** Display Advertisement 166 Magazines Thrice \$15. Year \$50. Page \$100. Wood's Popular Services, Atlantic City, N. J.

**"WHAT** to Invent for Profit" free. Patent News-C, Washington, D. C.

**RAISE** guinea pigs. Pay better than poultry or rabbits; easy to raise; little space required. We guarantee market. Particulars and booklet how to raise free. Cavies Distributing Co., 3102 Grand Ave., Kansas City, Mo.

**DOLLARS** Yearly in your Backyard No mushroom dope. Particulars free. Metz, 313 East 89th, New York.

**"SCHEMER** Magazine," Alliance, Ohio, prints big profit schemes; one subscriber making \$25,000 from three; another \$10,000 from one. Try your luck. Year, only \$1.00; three months, 25c.

**MARBLE** mixing instructions, covering wood or cement flooring 1/2 inch thick, fire-proof, waterproof, low cost, sanitary, all colors. Particulars, 200 illustrations free. Chris Mahler, Box 122, Huntington, N. Y.

**EARN \$10** daily silvering mirrors, plating and refinishing metalware, autos, chandeliers, bedsteads, headlights. Outfits furnished. E. Decie Laboratories, 1133 Broadway, New York.

**LEARN** the collection business. Good income, quick results. Interesting booklet, "Skillful Collecting" free. National Collectors Assn., Long St., Newark, O.

#### CHEMISTRY

**CHEMICAL** Processes, Analysis, Research. Technical Information. Consulting Chemist, Madison, Maine.

**PRODUCTS** formulated, duplicated, improved, cheapened. Universal alcohol substitute, \$50; Waterless Hot Water Bag, \$25.00. Circular. Hurry-Harding, L. B. 1029, Chicago.

**YOUR** chemical problem solved and working process furnished Five Dollars. Write me. W. Stedman Richards, Consulting Chemist, address, Box 2402, Boston, Mass.

**EXPERIMENTERS**—complete supplies for the chemical laboratory. Catalogue 5c. National Scientific Supply Co., 241 Pa. Ave., Washington, D. C.

**TECHNICAL** Information, analyses, formulas, trade secrets. Consultation \$1. Jacob Sloyter, Chemist, 2525 East St., Davenport, Iowa.

**ABSOLUTELY** guaranteed chemical analysis of any product so that it may be duplicated, our charge \$3.00. Manufacturing products formulated. Correspondence invited. Doris Chemical Laboratories, East Cleveland, Box 59, Cleveland, Ohio.

#### FORMULAS AND TRADE SECRETS

**500 VALUABLE** Formulas 25c. Literature free. Harvey Teeple, Decatur, Ind.

**10,000** SELECTED chemical, technological and practical recipes and processes, including hundreds of so-called trade secrets for every business, alphabetically arranged in one large volume of 800 pages. Price \$4 postpaid. Popular Mechanics Book Dept., 206 E. Ontario St., Chicago.

**BECOME** Successful—Three new Formulas 10c. Radio Chemical Co., Chelsea, Mass.

**PRACTICAL** Formulas, 500 in book form 50 cts. postpaid. Pentland Specialty Service, Two Thames Avenue, Norwalk, Conn.

**200** FORMULAS, many Suitable for own business, and Digest monthly, full of ideas, one year, \$1.00. Digest, Grand Rapids, Mich.

**250** GUARANTEED Money-Making formulas \$1.00. Singleton, Phenix, R. I.

**FORMULAS**—Best that Chemical Science can devise. Not "Better Sort" Formulas, but Guaranteed Reliable processes in all lines. Stamp brings Valuable Literature and Latest Summer Sellers from an Analytical Chemist. Miller, Chemist, 807 De Leon, Tampa, Fla.

**BIG**, Interesting formula catalog free. National Scientific Laboratories, 208 Monroe Street, Richmond, Va.

**5,000 RECIPES**, \$1.25. Best formulas and processes for every business, trade or occupation are in "Youman's Guide." Many never before published. Worth \$1.25 each. 530 pages. Paper cover \$1.25. Cloth \$2.00, postpaid. Book catalog free. Wells and Edwards, Department X, 352 George, Chicago.

#### AGENTS WANTED

**PORTRAITS**, photo pillow tops, frames, sheet pictures, medallions, merchant's signs, water-proof and tea aprons, guaranteed hose, toilet requisites, luminous crucifixes. Catalog 50 specialties free, 30 days' credit. Jas. C. Bailey Co., Desk A-6, Chicago.

**AMERICAN** Woolen Mills Co., Dept. 2075, Chicago, are making a free suit for one agent in each community to introduce their fine tailored to order suits at \$18 and up. Write them today for their offer.

**WONDERFUL** Invention eliminates all needles for photographs. New, different, lasts for years. Preserves records, 12,000,000 prospects. \$15 to \$30 daily easy. Carry day's supply in pocket. Everplay, Desk 7-F, McClurg Bldg., Chicago.

**MEN** and Women Make Money Easy selling Perfection Steam Pressure Cookers. Wonderful new invention. Cooks in one-third the time—makes toughest meat tender. Saves time—Saves money. Write Jubilee Mfg. Co., 53 Sta. C., Omaha, Nebr.

**AGENTS**, Salesmen, Demonstrators, you will have the devil's own time trying to find a better seller than "Zippo." If there was such a thing we'd have it. Splendid profit on 50c "Go Getter" repeat article that sells on ten second demonstration. Works While You Watch It. Demonstrates value, while others waste time making claims. New Discovery! Greatest Scientific Triumph of the age. It's the berries. Haven't room to tell our story here. Write immediately. Karam-Smith Co., 606 Bevan St., Ft. Wayne, Ind.

**AGENTS**—\$15 a day—Easy, quick sales—Free Auto—Big Weekly Bonus—\$1.50 premium Free to every customer. Simply show our Beautiful 7-piece Solid Aluminum Handle Cutlery Set. Appeals Instantly. We deliver and collect. Pay daily. New Era Mfg. Co., 803 Madison St., Dept. 21-BA, Chicago.

**AGENTS**, make over \$100 every week selling Nu-Way Mending Fluid. 150% profit—a sale every two minutes. Mends hosiery and all fabrics quicker and better. Every housewife buys. Write for outfit quick. Nu-Way Laboratories, Inc., Dept. T-4, Mt. Healthy, Cincinnati, Ohio.

**AGENTS**—\$50 a week taking orders for guaranteed hosiery for men, women and children. Must wear 12 months or replaced free. All styles and finest line of silk hose. Write for sample outfit. Thomas Mfg. Co., Class 262, Dayton, Ohio.

**AGENTS**—\$72 a week. New Serenola. Wonderful invention. Does more than machines costing ten times its price. Plays any record. Built in just like a suitcase. Carry it with you anywhere. Pay you every day. Write or wire for territory. Perry Ludlow Co., Class 1862, Dayton, Ohio.

**A BUSINESS** of Your Own. Make Sparking Glass Name and Number Plates, Medallions, Checkboards, Signs. Big Illustrated Book Free. E. Palmer, 512, Weoster, O.

**AGENTS** Wanted to Advertise our goods and distribute free samples to consumers; 90c an hour; write for full particulars. American Products Co., 1796 American Bldg., Cincinnati, Ohio.

**AGENTS**, \$42 a week. Sell guaranteed hosiery for men, women, children. Must give satisfaction or new hose free. Finest line of silk hose. Latest styles and shades. Big orders everywhere. Pay you every day. Write for samples. Parker Mfg. Co., Sample 978, Dayton, Ohio.

**AGENTS**: \$25.00 daily taking orders for Walton-Duplex Reversible Doublewear Shirts, factory to wearer. Pay advanced. We deliver. Walton-Duplex Company, 221 Brooks Bldg., Chicago.

**AGENTS**: \$100.00 weekly. Pay daily. We deliver. High grade Hosiery, direct to wearer. 21 styles for men, women and children. Doode Hosiery Co., 563 Lees Bldg., Chicago.

**CREW** Managers—Distributors—Magie Washing Compound. Your name on package. Sells Fast. Great Repeater. 300% profit. Samples with your name on furnished free. Besco, 1913-W Irving Park, Chicago.

**WHY** Work for others? Start and operate your own business. Our system proprietary specialty business offers wonderful opportunities to make \$100 to \$500 weekly. Openings everywhere. We furnish everything and show you how. Booklet free. National Scientific Laboratories, 208 Monroe, Richmond, Va.



**FREE Sample.** "Rain Shield Wiper." Retail \$1.00—Costs (25c). Sold, Clear and Rainy Days. No Cloth—No Paste—No Attachment. (1) Rub keeps Windshield Clear (48) Hours. Experience unnecessary. NuLife Corporation, Hartford, Conn.

**AGENTS—**Send for free sample "Fretnot"—washday wonder. You can clear at least \$20 to \$100 weekly, according to spare or whole time. You don't have to talk; if she doesn't buy at sight, leave sample; she will be looking for you long before you are able to make the rounds again. Samples furnished free. Premiums for your customers. Exclusive territory. Credit given. Empire Specialties Co., 1549 N. Wells, Dept. 191, Chicago.

**MOST Wonderful Seller.** 96¢ profit every dollar. No stock to carry. License unnecessary. Sample free. Mission Factory PM. 519 N. Halsted, Chicago, Ill.

**GENUINE Gold Leaf Letters** anyone can put on store windows. Guaranteed to never tarnish. Large profits. Enormous demand. Free samples. Write today. Metallic Letter Co., 438-A North Clark, Chicago.

**MEN to Introduce the Finest Combination Kitchen Cutlery Set—Housewife's Friend—Sells on sight—Every house and office a prospect. Wonderful seller—New Plan—\$1.25 premium with each set. Can sell separate pieces also. Samples Free. Massachusetts Cutlery Company, Stand 1106, Cincinnati, Ohio.**

**AMAZING Im. Diamonds, defy experts; massive solid silver platinum finish mountings; agents can harvest 100% easy; wholesale only. \$2. brings ladies' and men's sample. Start your business now. Pauer (Importer), 152 Dewitt, Buffalo, N. Y.**

**STAMPING** names on emblem key checks. Sample 20c. Key check outfits, steel dies, key cases, etc. Service Sales Corporation, Shelby, Ohio.

**EVERYBODY Buys Our New Household Knife-Sharpener, a real grinder that any woman can use. Automatically puts correct bevel and keen edge on any knife in ten seconds. Half-minute demonstration makes the sale. J. M. Pitkin & Co., 657 Commercial Bldg., Newark, N. Y.**

**BIG Money—Selling Fiber House Brooms. Sure-Fire Seller and Repeater. Biggest Season Here. Write Today. Bartlett, Van Tine & Jones, Hillside, Mich.**

**HERE They Are; Fifty Fast Sellers; everybody needs and buys. Fifty Dollars Weekly easily made. B. & G. Rubber Co., Dept. 571, Pittsburgh, Pa.**

**ORANGEADE.** In powder—just add cold water—most delicious drink you ever tasted. Fine for home, parties, picnics, dances, etc. Start in this business—big money easily made. Send dime for ten glass package, postpaid, 7 kinds, Cherry, Grape, Lemon, Strawberry, etc., for 70 glasses only 50c, postpaid. Morrissey Company, 4417-25 Madison St., Chicago.

**AGENTS: 500% profit.** "Happy Home Maker Shampoo" builds your own big business. Martin of Indiana made \$75.00 in one day. Missouri man made \$750.00 one month. Exclusive territory. Geo. A. Schmidt & Co., 236 W. North Ave., Chicago.

**AGENTS Make Big Money** selling new auto invention. Hoffenberg's sold 900 in 2 months. Profit \$2,700. For full particulars write Stransky Co., Dept. Z-10, Pukwana, S. Dak.

**SILK Fish Lines.** We sell direct to you; that means half price. Send stamp for samples. Silkline Co., Department L, Pekin, Ill.

**FAST Selling Profitable Rubber Goods.** Fancy Aprons, Sanitary Belts, Napkin Supporters, Bed Sheets, Bibs, Bloomers, Bathing Caps, Gloves, etc. Details Free. American Rubber Products Co., Dept. 508, Pittsburgh, Pa.

**AGENTS: Big Profits, Gold Sign Letters, Easily Applied, Samples Free. Liberal Offer to General Agents.** Dept. C, Interstate Sign, 2620 N. Halsted St., Chicago.

**AGENTS: Get our big sample assortment free offer.** Teas, coffee, extracts, spices, food products, things people eat. 240 fast sellers. Harley Co., 390 Harley Bldg., Dayton, Ohio.

**AGENTS, District Managers, 4 pairs Ladies' Guaranteed Silk Hosiery \$5.00—over 50% commission; 17 other numbers; 18 neckwear patterns; we deliver. Managers 10% bonus. Write for Free Samples. The Lexington Co., Dept. 1242, Lexington, Ky.**

**AGENTS: Write for our 1924 catalog of fast sellers. 100% profit. Capital unnecessary. The Universal Leather Goods Co., 442 N. Wells, Chicago.**

**AGENTS—Brockton Shoe Factory** Distributor wants agents to sell men's shoes direct to wearer. Every pair guaranteed. Unrequired capital. Your commission \$1.00 pair. Write Carter Shoe Co., 189 Crescent St., Brockton, Mass.

**THESE Advertisements of mine** have appeared in Popular Mechanics for sixteen years. Hundreds of Successful Manufacturers today owe their success to my formulas and valuable information. Majority started with practically nothing. You can do the same—write today for my valuable literature relative to my Guaranteed Manufacturer's Formulas for making Non-Thermic Ice-Saving Cloths, Delicious Beverages for Home, Bottlers and Fountain sale. Pure Food Products, Non-Alcoholic Flavors, Launderite Washing Marvel, Zest, greatest stain remover, Sta-Combed, Marcel Hair Curler, and latest Toilet specialties. Mexican Yucca Soap, Laundry Soaps, Flynox, Sensol, and all latest disinfectants. Amazon Tire Repair, Toy Rubber Balloons and all latest selling goods in all lines. Don't compare these with "junk" commonly offered. Analytical work carefully done. Highest references. Miller, Chemist, Tampa, Fla.

**HOUSE Dresses, \$12 doz.** Sell dozen daily, \$2 each. Sample sent C. O. D. \$1.10. Write for free catalog. Economy Sales Co., Dept. 48, Boston, Mass.

**I NEED 100 more men and women** to act as my agents and take orders for Cozier raincoats, raincoats and water-proof aprons. I paid T. D. Wick \$13.00 profit on orders taken during two hours of his spare time. Prentiss made \$945 in one month. Wonderful values. Four average orders a day gives you \$96 a week cash profit. No delivering or collecting. I will give you a complete outfit and instructions for getting orders. Drop a post card today for my liberal offer. C. E. Comer, Dept. W-595, Dayton, Ohio.

**AGENTS—Mosco Corn and Callous Remover** will build you a steady repeat business. Send today for pocket size trial outfit. The Moss Company, 192 Searle Bldg., Rochester, N. Y.

**MONEY! Silvering Autolights, Radiators, Mirrors, tableware, stoves. Outfits, Methods free.** Clarence Sprinkle, Dept. 28, Marion, Ind.

**BIG Money for mechanics, machinists and train men** selling "Great Stuff," wonderful hand cleaner, to fellow workmen. Removes all trace of grime, grease, dirt, paint and stain in a jiffy. No harmful effects. Get sole agency for your shop. Sells like hot cakes. Send 25c for package and proposition. G. S. Products Co., Minneapolis, Minn.

**BIG Profits. New \$3.50 Automatic Adding Machine. Quick Sales. No competition.** Ten daily easy. Absolutely accurate. Fully guaranteed. Pocket size. Business people everywhere positive customers. Exclusive territory to workers. Act quick. Bassett Company, 1458-J Hollywood Ave., Chicago.

**DIAMOND Sensation at Last! Amazing discovery of Rajah Gem** startles Jewelry World. \$100 weekly introducing these magnificent gems. Sample case free. Write quick! Rajah Company, Dept. FT, Salisbury, N. C.

**AGENTS' experience unnecessary; as high as 120% commission; 10% bonus to managers.** 18 Latest Hosiery Styles and colors. 18 Neckwear patterns. We deliver. Write for Free Samples. S. Q. S. Co., Dept. 1216, Lexington, Ky.

**GERHART made \$21.00 the first hour** selling our new auto necessity. Our money back guarantee makes sales easy and does the trick. Agents, distributors, write for proposition. Manager, Box 105H, Brockton, Mass.

**SELLS Like Hot Cakes; Big Profits; New Ironing Wax Pad and Asbestos Rest; Clamps Board; Perfumes Clothes; Outfit 10c.** Yankee Mfg's, 380 Atlantic Ave., Brooklyn, N. Y.

**\$10-\$25 DAILY Selling Men's and Women's shoes** direct to wearer; exclusive territory; sales come easy. Lyman B. Musser Shoe Co., 207 Palace Bldg., Kansas City, Mo.

**\$10 DAILY easy. Experience unnecessary.** Complete line fancy aprons and house dresses. Something new. Nothing like them. American Braiding Co., Dept. P, 329 Monroe, Chicago.

**\$30.00 DAILY, \$22.00 Eastman Kodak free.** Lucky Six line combination topcoats, raincoats, \$3.98 up, \$1.00 gift makes sales easy. We deliver, collect. Eagle Raincoat Co., 640 Mid City Bank Bldg., Chicago.

**AGENTS—Sell Make-Em-White Laundry Tablet—best for washing clothes. No rubbing.** Big seller this season. Free Sample. Ridgely Co., 224D Sheldon, Chicago.

**PROTECTS Your Home and Property, the Junior Electric Burglar Alarm, attached to your Doors and Windows, complete with directions for installing, Only \$7.50.** Send \$1.00 with order; balance C. O. D. Agents Wanted. Watro Alarm, Box 664, Chicago.

**HAIR-NETS 30c dozen. 4 dozen \$1.00.** Sobeco Sales Co., Sound Beach, Conn.

**WHY Work for others? Start and operate your own business.** Our system proprietary specialty business offers wonderful opportunities to make \$100 to \$500 weekly. Openings everywhere. We furnish everything and show you how. Booklet free. National Scientific Laboratories, 208 Monroe, Richmond, Va.

**BIG Paying Business—Earn \$50 to \$100 Weekly** handling See-Well; every auto owner buys on sight; quick cash sales; steady repeat orders; small capital starts your own business. Write for free booklet. S. & W. Mfg. Co., Desk P, 403 Diamond Ave., S. W., Grand Rapids, Mich.

**AGENTS, Distributors; Radio Pack—the** waterless hot bag, sells on sight; no experience or capital required; demonstration sells it; steady repeat demand "reel.rge"; collect your commission as deposit; v.c. deliver and collect balance C. O. D. Write today for selling plans. Radio Pack Co., Dept. M, 59 Pearl St., New York.

**AGENTS—\$10 to \$35 a week spare time—\$30 to \$100 a week full time.** Sell 21 Jewel new style, thin-model, Studebaker Insured Watches direct from factory to consumer at great savings, on new easy payment plan. No collections. Experience unnecessary. Commission paid on first payment. Catalog and Plan Free. Write to Studebaker Watch Co., Dept. 111, South Bend, Ind.

**AGENTS Wanted—Something New—Fire** Fighter sells easily. Makes a spectacular demonstration; car owners, homes, factories, stores, practically buy on sight. Our men make \$10.00 to \$50.00 a day; exclusive territory. If you wish to establish a business of your own with unlimited possibilities for making big money, write us today. Fyr-Fyter Co., 12 Fyr-Fyter Bldg., Dayton, Ohio.

**AGENTS—Big Profits Genuine Gold Leaf** window letters and scripts; anyone can put up. Consolidated Sign Letter Co., 632 S. Dearborn, Chicago.

**YOU hustlers—drop everything—write for** our cleanup proposition on pearl necklaces. It's wonderful, not maybe but sure enough. Empire Trading Co., 21 East Van Buren St., Chicago, Ill.

**MAKE \$31.00 Profit—Cost you \$1.50.** Complete Gold Monogramming Outfit. Transferred Instantly on Automobiles, Trunks, Bags, Windows. Experience Unnecessary. Free Samples. NuLife Monogram, Hartford, Conn.

**ANY man handy with paint brush or** light tools can start new mechanical business on nearly nothing; needed everywhere; nearly all profit; experience not required. John Braceland, 1457 So. Ninth, Philadelphia, Pa.

**EVERYBODY uses extracts. Sell Duo** Double Strength Extracts. Complete line household necessities. Big repeaters. Write today. Duo Co., Dept. E1, Attica, N. Y.

**AGENTS—Sell Orangeola and make big** money. Makes the most delicious drink you ever tasted. Send 15 cents for package which makes a gallon. Money-back guarantee. Orangeola Co., 6558 N. Maplewood Avenue, Chicago, Ill.

**AGENTS, Send one dollar for sample and** proposition. Nationally Advertised Specialty for all Automobiles; sells for \$2.00, 50,000 users. "I in 5" Mfg. Co., 2965 Grd River Ave., Detroit, Mich.

**MENDING Tissue, Indorsed by Tailors,** Milliners, Housewives. Sample package 10c, 3 for 25c. Agents wanted. Byron, 27, Station I, New York.

**SELL Komik Display Cards, Price tickets,** card holders, display stands, etc. Big Demand. Komik Advertising Co., Cambridge, Ohio.

**RADIO Gas Lighters sell on a Moment's** demonstration. Big Profits. Write for particulars and Self-Selling plans. W. Masterlite Co., 110 East 23d St., New York.

**MEMORANDUM Register—Desk Memo-**randum Machine! Every store, office, doctor, etc., needs one. Two models, writing, both single and duplicate; both have permanent reversible features. Patented. No competition. Sells at \$5.00 and \$6.00 F. O. B. Indianapolis. Big Commission. Want Representatives in every city. Just organizing sales force. Hanna Register Co., 229 North Pennsylvania St., Indianapolis, Ind.

**\$75.00 PER Week Selling Our New Un-**breakable Combs. Kind You Can Hit With a Hammer. Sell Like Hot Cakes. Write Today. G. Buchanan, 63 Court St., Room 1, Boston, Mass.

**MAN Wanted by largest concern of its** kind. Part or full time. Experience unnecessary. Our men getting up to \$200.00 weekly. Lowest prices. Red Seal Coal Company, 353 Coal Exchange Building, Chicago.



**GOODYEAR Mfg. Co.**, 1745 Goodyear Bldg., Kansas City, Mo., is making an offer to send a handsome railroad free to one person in each locality who will recommend it to friends. Write today.

**HEMSTITCHING** and Plecting Attachment fits any machine, for home work. \$2.50 sent collect. Agents' prices reduced. Colorado Attachment Co., Denver, Col., Box 2210.

**GET** into the tailoring game—one of the most profitable of all lines in the selling field. Experience isn't necessary, and spare time will do. We teach you how to sell our line, and supply you with everything necessary to go out and make from \$10 to \$20 a day from the very first day. Our selling outfit is the finest ever gotten together and shows more than 100 large samples of finest quality woolsens. You do no delivering with our line. You just write the orders. We do the rest. Your profits run big and you get them cash with order. If you want to get into this most profitable business, write us quick. Address Goodwear Chicago, Inc., Dept. 923, Chicago.

**MOTORDOM'S** Greatest Decarbonizer Economizer—Unbelievable Efficiency "All" Engines. Enormously Profitable. "Hustlers" Communicate. "Wizard," Rochester, N. Y.

**FABRIC Patch-It Paste**—Agents make enormous profits with Mrs. Efner's original and the only crystal white mending paste. It mends without stiffening or discoloring all colors and kinds of fabrics, hosiery, rubber, and leather. Will wash, boil and iron. Sells on two-minute demonstration. Needed in every home. Send 35c for trial tube and sheer white patch. Recommended by the Good Housekeeping Magazine Agents, Crew Managers, and Distributors, write for territory and low quantity prices. E-F Manufacturing Company, 2726 East Lake Street, Minneapolis, Minn.

**FORMULAS**, Processes, Trade-Secrets, Different, dependable, profitable. Catalog free. B. Thaxly Co., Washington, D. C.

**AGENTS**—Both sexes. We manufacture and control new household article, fast seller, big profits, exclusive territory; write now. Connolly, 123 Liberty St., New York.

**TABLECLOTH** manufacturer needs fifty additional representatives. Tremendous demand. Splendid earnings. Commissions daily. Julian Pam, 26½ East 21st Street, New York City.

**AGENTS**—\$15 daily easy—Your Pay In Advance—Introducing New Insured Hosiery. Must wear or replaced free. No capital or experience required. Just show samples—write orders. Elegant outfit furnished. All colors, grades including silks. Macohee Hosiery Company, Room 5806, Cincinnati, Ohio.

**BUILD** permanent business. Men's Women's Children's guaranteed shoes direct to wearer. A. P. Condon, Sales Manager Allen Shoe Co., 110 Summer, Boston.

**\$1.00 FOR FIVE Minutes' Work**. Latest automobile necessity. Prize lucky number makes sales never fail. Newest idea. Specialties, 1443 New York Ave., Washington, D. C.

**AGENTS**—Steady Income. Exceptionally useful household article. Handicap Co., Newark, N. J.

**REPRESENTATIVE** in every town. No selling. Money maker. M. Barter, 3937 Tracy, Kansas City, Mo.

**EARN \$200.00 weekly** selling musical novelties. Latest American tunes. No competition. Write immediately Mignonette Co., 13 Park Row, New York.

**\$100.00 WEEKLY** in your spare time. Get the "Marvel" proposition from Union Import Co., 15 Park Row, New York.

**PORTRAIT** and Medalion Agents—Our Goods Will Make You Big Profits; delivery guaranteed; prompt shipments; low prices; send for latest catalog. Adam J. Kroll & Co., 602 Blue Island Ave., Chicago.

**AGENTS**, 200% profit selling Gem Kettle Bottoms. A household article with a dozen uses. Fastest seller of the day. Every housekeeper buys on demonstration. Get Agents' "Quick" Sales Plan. Columbia Specialty Co., Box 73-D, East Liverpool, Ohio.

**MAKE \$8 daily**. Whirlwind seller. Imported Bamboo Fountain Pen. Free sample. Mehler, Dept. 5, 416 S. Dearborn, Chicago.

**ADD \$50.00 Weekly** to Your Bank Account Selling Needle Companions. Retail 25c. Sample 10c. Mail Order House, Dept. A-1, Wilmerding, Penna.

**AGENTS**, Salesmen—Sell New Thermostatic Automatic Carburetor Control Attachment for Fords. Big Profits, full or part time. Burns 95% air. Doubles Mileage. Attached in 2 minutes. No drilling. Does automatically exactly what Ford Manual says do by hand. Cadillac now using Thermostatic Carburetor Control under Blanche license. Write today. A. C. Blanche & Co., Dept. 150-C, 602 Lake St., Chicago.

**WHY Work for others?** Start and operate your own business. Our system proprietary specialty business offers wonderful opportunities to make \$100 to \$500 weekly. Openings everywhere. We furnish everything and show you how. Booklet free. National Scientific Laboratories, 208 Monroe, Richmond, Va.

**NOVELTIES** from Japan, Germany and France, \$20 a day easy. Write for selling plans. Spors Co., Lesueur Center, Minn.

**125% CLEAR** profit selling neckties; 3 samples \$1.00; satisfactory or money refunded. Raymond Mfg. Co., 132nd St. and Madison Avenue, New York.

**NEW 1924 Specialty**, 200% Profit when sold at 50c. Real \$1.00 value. Sells in every home. No Competition \$1.00 to \$3.00 an hour, full or spare time. Thirty other big sellers. Free sample case offer. Send post card today for particulars. General Products Company, Dept. 7, Newark, N. J.

**PORTRAIT** Agents: Big profits working for yourself, pay for Prints, Portraits, Frames after delivery. Samples Free. Picture Man Friedman, Dent. 8, 541 Lake St., Chicago.

**YOU Can Easily Make \$60 Weekly** selling new, popular Perflex Fibre Broom. Outlasts four ordinary brooms. 100% profit. Get agent's Special Introductory Offer. Brooklyn Perflex Corp., 145-C New Jersey Ave., Brooklyn, N. Y.

**PORTRAIT** Agents!—Live Wires!—Get This! Biggest hit house to house men have ever known. Artful Portrait Paintings—look exactly like oil paintings. Big seller. Big repeater. Big profits on every sale. With Famous P. & G. Medallions makes a "clean-up" line. Write for details. Pudlin & Goldstein, 259C Bowers, New York.

**SALESMAN V. W. Crawley** writes: "For six months, April to October, 1923, my net earnings have been \$1688.03." You can do as good or better with our line, 60% profit, best brushes made and other striking advantages. Write for best brush story ever told. Queen City Brush & Specialty Co., Dept. G, Cincinnati, Ohio.

**AGENTS**, Sell Anti-Rain Compound. Keeps rain, snow and steam off windshields and eyeglasses for 36 hours. Send 50c for sample and particulars. Anti-Rain Co., 3932 N. Robey St., Chicago, Ill.

**BIG Money** quick and easy selling Horsey-Bassett Rubber Aprons. Finest on market. Fast sellers. You show samples and mail us orders. We deliver and collect. Your profits in advance. Send 75c in stamps for Samples and Selling Outfit. Sales guaranteed. Address The Horsey-Bassett Co., Inc., Dept. PM-6, Crisfield, Md.

**BIG Clean Profits**. Intertwining Gold Leaf Monogram, any designs; for automobiles, trunks, bags. Easily applied. Samples free. National Monogram, 1018 Coronation Building, Montreal, Canada.

**\$10.00 A DAY** Easily Earned taking orders for our big line, quality soaps, perfumes, toilet goods, extracts, summer fruit drinks, spices, foods, towels, jewelry, remedies, novelty needle books, rubber goods, etc. Men and women write for big offer. Catalogue outfit free. Western Products Co., Dent. X3, 406 No. Oakley Blvd., Chicago.

**YOU don't need** mother to wash your back! Our red rubber vacuum cup (bath tub) massage brush will do it for you. Holds to tub by vacuum. Size 6½ x 3 inches. Be your own osteopath. A household necessity so novel that it makes its own approach. Sells on sight at \$1.50. Big profits. Write for territory and agency prices. Hutchison Manufacturing Company, 7721-23 Susquehanna Street, Pittsburgh, Pa.

**AGENTS** Wanted. Entirely New Professional Line, Small Articles. Korn Co., 299 Hinson St., Brooklyn.

**AGENTS**—Three neckties boxed singly for \$1.00. Retail \$2.00, cash with order. Address 401 Searle Bldg., Rochester, N. Y.

**AGENTS**. Household necessity. Sells rapidly. Large Profit. Square deal. Premier Mfg. Co., Dept. 813, Detroit, Mich.

**\$14.00 DAY** easily made selling new product. Get this one; it's a money maker. Write quick. Specialty Mfg. Co., 645 Lincoln Bldg., Detroit, Mich.

**\$81.50 WEEKLY**. Introducing and selling a new gas light burner for kerosene lamps. Beautiful light. No chimneys. No mantle. Samples free. Experience not necessary. Write today. Luther Mfg. Co., Dept. 510, Cincinnati, Ohio.

**AGENTS**: \$5 to \$10 daily selling imported headed bags. Every woman buys on sight. Sample \$1.00, sells for \$1.50 to \$2.00. Hales Sales Co., 1018 Wabash, Chicago.

**SHOES**—Men's Moccasin Work Shoes. Your commission \$1.00 pair. We carry stock. Direct to wearer. Exclusive territory open in various counties. Big repeat business. Write now. Charles Kellert Co., 116 Bedford St., (Dept. 501), Boston, Mass.

**NEW Patented Auto Match Lighter** sells to every auto owner who smokes. Big money for agents selling to garages, gasoline stations, cigar and news stands, barber shops, etc. Send 25c for sample and full particulars. John N. Spies Manfg. Co., Watertown, N. Y.

**\$5 TO \$15 daily easy**—Introducing New Style Guaranteed Hosiery. Must wear or replaced free. No capital or experience required. Just show samples, write orders. Your Pay In Advance. We deliver and collect. Elegant outfit furnished—all colors—grades including silks, lises, chiffons. Mac-O-Chee Hosiery Company, Room 2566, Cincinnati, Ohio.

**EVERY-DAY** necessities for every-one. Unlimited demand. Every article guaranteed. Sales Dept., Elms College, Newark, New York.

**AT last!** Fill those orders. Peppermint, Jamaica Ginger, Nitre, Camphorated Oil, Tasteless Castor Oil, Arnica, Peroxide, Iodine, Breakfast Cocoa, Baking Powder, Castile Soap. Profit Big. Jet Pharmaceutical Company, Allentown, Pa.

**AGENTS**, Storekeepers, Hustlers, Give European Money Free with Every Purchase. Triple Your Sales. Early-Boys Cleaning Up. Cheapest Prices on Earth. Buy Where Dealers Buy. Circular Free. Hirschex, 79 Wall St., New York.

**SELL** Startling new necessities that every one must use continuously; unique, unrivaled, irresistible, all purpose solvent makes life easy. 20 products in one with thousand uses; scientific marvel, in package or bulk for merchants, mechanics, motorists, garages, factories, banks, homes; liberal free samples and exquisite imported jewel premiums. Easy \$5,000 yearly earner for workers. Erote Process Co., Lakewood, Ohio.

**EXCLUSIVE** territory Evershine stove and metal polishes in tubes. 150 per cent profit. Evershine Company, Inc., Atlanta, Ga.

**300% PROFIT**: Whirlwind Seller. Tremendous repeater. "Kleanrite." Marvelous Discovery. Washes clothes without rubbing. Premiums for customers. Sells 25c. You make 18c. Free samples make easy sales. Write quick. Bestever Products Co., 1911-K6 Irving Park, Chicago.

**BIG Money** Applying Gold Initials and Monograms to Automobiles; Easy Transfer Process; Cost 5c. Get \$1.50. Sample Free. "Halo," 323 Harrison Ave., Boston, Mass.

**AGENTS**, Big money-making opportunity, selling Pure Silk guaranteed hosiery. Permanent business proposition. Mayville Mills, Mayville, N. Y.

**MAKE** your own goods; 1,000% profit; guaranteed proposition. Electro Co., Quincy, Ill.

**AGENTS**. Be Independent. Sell a 25c article on the street. Costs only 2c to make. Particulars free. Fisher, Rockport, Wash.

**BIG Money** and Fast Sales—Everybody—Everywhere—Everyday finds hundreds of uses for Darn E-Z Universal Fabric Cement—Good exclusive territory still open. Darn E-Z Laboratories, Dayton, Ohio, Dept. P. 8.

**AGENTS** wanted to sell a combination light weight Overcoat and Raincoat to ladies, men and boys. Samples furnished free—price to consumer \$8.50. Commissions paid daily—agents easily sell 200 monthly. Chas. E. Morris & Co., 637 Arch Street, Philadelphia, Pa.

**IMPORTED** liquid light pocket lamp. No matches; sensational, beautiful. Enormous demand. Particulars and sample 25c. Box 1181, Washington, D. C.

**SELL** "Simond's Safety Scale Clip" to mechanics for 25c. Trial dozen \$1.00; gross \$10.80. Roman Arndt, 2839 Townsend, Detroit, Mich.

**EARN \$10 to \$50 a day** in your spare time selling Jiffy Blow Torches and Soldering Outfits. Easy to sell. Big Profits. Write for particulars to Apex Stamping Co., Dept. 2, Riverdale, Ill.

**PORTRAIT** and picture men when in need of bromide prints for portrait work, write us. We specialize in unmounted prints for proof passing. United Print Co., Sta. D., Chicago, Ill.

**AGENTS** and District Managers Wanted by manufacturer; sell men's underwear to wearer, wholesale prices. Big commissions. Ace Underwear Mills, 309 Fifth Ave., New York.

**AGENTS**—Voltage Electric Insides; fast sellers, pay handsome profit; sample pair 50c. Get complete price list of money-makers. The Electric Appliance Co., Burlington, Kans.

**GET** posted—Good prices paid for butterflies, insects. See Sinclair display advertisement, page 59.

**COLLAPSIBLE** Garment Hanger, also towel rack. (See ad. page 161.) Quick sellers. Agents make big profits. Gause Mfg. Co., Elkhart, Ind.



**PATENTS** Procured. Send sketch or model today for examination, prompt report and advice. No charge for preliminary advice. Write for free Booklet and blank form on which to disclose your idea. Highest references. Promptness assured. Clarence A. O'Brien, Registered Patent Lawyer, 583 Security Bank Building. Directly across the street from Patent Office, Washington, D. C. See pages 150 and 151.

**NEW** Invention beats vacuum sweeper and all its attachments. No electricity required. All complete only \$2.85. Over 100% profit to agents. Write O. P. Morgan, Mgr., 226 Grimes St., Fairfield, Iowa.

**ABSOLUTELY** free box Bassett's Native Herbs sent to introduce. For constipation, indigestion, rheumatism, headache. Big money selling all or part time. Established 1879. Bassett, Dept. 1, Columbus, Ohio.

**WILLIAMS** No Water Hand Soap. In tubes, has taken Auto owners by storm; washes dirtiest hands perfectly clean without water. Easy demonstration makes quick sales; 150% profit. Williams Co., Box 265, Montclair, N. J.

**INDIAN** Artcrafts, Wagonmound, New Mexico, requires refined agents. Photographs, particulars free.

**\$8.00 TO \$20.00** per day. A wonderful seller. Any man, woman, boy or girl can make big wages Selling Crimp Grip Clothes Line Fasteners. It is a perfect rope holder and can be used for many purposes. Crimp Grips are a simple, time-saving device. They last a life time and will not rust; it holds the line tight, and saves time on wash days. Every buyer is a booster. Send 50c for Mounted Sample and one pair of Crimp Grip Clothes Line Fasteners. Write for particulars. Crimp Grip Company, Belvidere, Ill.

**ASTOUNDING** invention. Fords use kerosene, start instantly. Mileage doubled. Big profit. Super, 1306 Fondulac, Milwaukee, Wis.

**AGENTS:** You can coin money selling our new Fabric Table Covers, require no laundering. Size 56 x 58, prepaid \$1.50, 13-piece Luncheon set included Free. Write for sample and special offer. P. Condon, 77 Bedford St., Boston, Mass.

**MAKE** Big Money Easy in your spare time. Double profits. New Self-Wringing Mop. Eastway Company, 405 St. Paul, Baltimore, Md.

**\$100 WEEKLY** easy selling Oriental Perfumes and Cosmetics. Highest profit. Sample Case and Illustrated catalogue absolutely free. Romola Parfumerie, Inc., 6546 Cottage Grove Ave., Chicago.

**AGENTS—**Here is that unusual selling combination, a household necessity which is the simplest, best and cheapest. Write for "How to make money." Selfseal Pressure Cooker Co., Dept. E, Jamaica, N. Y.

**AGENTS,** \$10 to \$25 a day. No investment. Free outfit. Best values. Largest commissions. World Raincoat Co., 639-B Morris Park Ave., New York.

**JUST** out: we manufacture the finest high grade tool steel household necessity on the face of the earth. Millions will be sold. Retail \$1.00; sample 25c, returnable. Box 71, York, Pa.

**SELL** Pearl Necklaces. Everybody wants one. Write for rock-bottom prices on opalescent, indestructible pearl necklaces. Star Import Company, 63 Second Avenue, New York.

**AGENTS—**Insta cleans hands instantly; economical, harmless. Free sample; trial package, 10c. Spare time agents wanted in every shop and factory. W. A. Marsh, Westfield, N. Y.

**AGENTS—**Specializing on toilet preparations; 150 fast sellers. Beauty Clay, Hair Gloss, Toilet Soaps. Colonial Chemical Co., 631 Penn Ave., Pittsburgh, Pa.

**AGGRESSIVE** salesmen wanted to sell our complete line of Hosiery, Underwear and Silk Knitted Neckties. Full or Part Time. Liberal Commission. Pennsylvania Hosiery Mills, 1705 Ludlow St., Philadelphia, Pa.

**BIG** Profits with Exclusive Territory—\$50 to \$100 weekly easy. More has often been made in one day's work. A hot or cold running water bath equipment for any home at only \$7.50. No plumbing or water works required. Investigate. Send no money. Write today. Sanitary Supply Co., 709 Allen Building, Toledo, Ohio.

**WANTED** Men and Women to demonstrate and take orders for Presto Pad self-warming hot bag, carry in pocket or use in home; \$15 to \$20 a day profit for you; your commission \$1 on each order, paid in advance; we deliver and collect. Presto Pad Co., A303 W. Chicago Ave., Chicago, Ill.

**TAILORING** Agents. Make \$50 to \$100 a week selling all wool 2 piece suits at \$21.50 Also our famous virgin wool suits at \$31.50—none higher. Commissions daily. Beautiful assortment of 6x9 swatches free. No experience needed. Can use spare time workers—if hustlers. Write J. B. Simpson, Inc., Dept. 750, 843 West Adams St., Chicago.

**MORE** Money. Anybody can get it. Free booklet shows how. Pitts, 561 W. Washington St., Chicago.

**TO** secure agents or salesmen or for selling farms and reaching investors, use classified (want) ads in largest newspapers and magazines. Price list No. 30 sent free. Ankrum Advertising Agency, 20 W. Jackson Blvd., Chicago, Ill. The largest classified advertising agency in the U. S.

**MAKE** \$17 daily—Finest Extracts, Food Products, Toilet Preparations, Household Necessities. Credit: Sample Case Free. Write for amazing offer. Perkins Products, B-6, Hastings, Nebr.

**GET** Our Free Sample Case—Toilet articles, perfumes and specialties. Wonderfully profitable. La Derma Co., Dept. A, St. Louis, Mo.

**AGENTS—**Clever Invention! Inkspoon makes every pen a fountain pen. Fast office seller; big profit, demand increasing everywhere. Exclusive territory offered. Sample free. H. Marul Company, Tribune Bldg., New York, N. Y.

**AGENTS:** Big returns, fast office sellers; particulars and samples free. One Dip Pen Co., 2 Daily Record, Baltimore, Md.

**WHY** Work for others? Start and operate your own business. Our system proprietary specialty business offers wonderful opportunities to make \$100 to \$500 weekly. Openings everywhere. We furnish everything and show you how. Booklet free. National Scientific Laboratories, 208 Monroe, Richmond, Va.

**DUSTLESS** Sponge Cloth. New Invention. Retail (50c)—costs (10c). (1) Rub Cleans, Polishes Automobiles. Pianos. Furniture. NoLife Sponge, Hartford, Conn.

**CALIFORNIA** Rosebuds selling like hot cakes. Agents coining money; new stuff. Big profits. Catalog free. Mission Factory PM, 519 No. Halsted, Chicago, Ill.

**START** your own business as our sole agent. Selling 100 famous home products. All or spare time. Dr. Blair Laboratories, Dept. 524, Lomburg, Va.

**BIG** money and fast sales—every owner buys gold initials for his auto. You charge \$1.50, make \$1.44. 10 orders daily easy. Samples and information free. World Monogram Co., Dept. 73, Newark, N. J.

**BRING** Home the Bacon—selling Stuart's Stain Remover. Removes ink, iron rust, grass and fruit stains. Write for free samples and terms today. C. H. Stuart & Co., 5967 Broadway, Newark, N. York.

**AGENTS** Coining Money applying Monograms on automobiles; you charge \$1.50, profit \$1.40; \$15 daily easy; experience unnecessary; free samples. Worcester Monogram Co., Worcester, Mass.

**CLARKE** made \$18 an hour selling vest-pocket windshield cleaner needed by every autoist, motorman, engineer; one rub keeps glass clear 24 hours; 90,000 sold; amazing proposition free. Security Mfg. Co., Dept. 735, Toledo, Ohio.

**\$200 WEEKLY.** Agents, State distributors. Wonderful new patented Ford accessory. Mossedale, 25 North Dearborn, Chicago.

**GET** into the Big Money Class. Make \$15 to \$25 daily selling the famous guaranteed Hamilton Hosiery from Mill to Wearer. Selling outfit free. G. M. Hamilton Corporation, 11 Barrow St., New York.

**EARN** \$50 to \$75 weekly selling our beautiful umbrellas. Splendid value makes rapid sales. Every sale nets \$1 commission. Write for particulars. A. E. Erasmus Specialty Co., 305 Broadway, New York.

**\$60-\$200 A WEEK.** Genuine Gold Letters for store windows. Easily applied. Free samples. Liberal offer to general agents. Metallic Letter Co., 438-D, North Clark, Chicago.

**AGENTS** sell Wolverine Laundry Soap. Wonderful repeater and good profit maker. Free auto to hustlers. Wolverine Soap Co., Dept. B37, Grand Rapids, Mich.

**AGENTS** make 500% profit handling Auto Monograms, New Pictures, Window Letters, Transfer Flags; Novelty Signs. Catalog Free. Write Hinton Co., 1153 No. Wells, Chicago.

**HANDY** Men!—Permanent, non-toxic business; needed everywhere. Calhan, 52 Levant, San Francisco, Calif.

**WE** deliver the goods. Agents to take orders for a patented household necessity. Tested and approved by Good Housekeeping, Modern Priscilla, New York Tribune Institute. Dundee Mfg. Co., Inc., 17 Edinboro St., Boston, Mass.

**MARVELOUS** Ink, Rust, Stain, Spot remover, 25c tubes, 150% profit. Livest house in America for agents. Jet Chemical Co., Allentown, Pa.

**AGENTS—**Men and Women. Establish a permanent business. 34c money order or check brings sample of a wonderful Gravy and Stew improver. Try it yourself and be convinced. Every home a prospect. Every sale will bring repeat orders. A new article with a big future. Exclusive territory to live agents. Smith & Gray, Guinda, Calif.

**AGENTS** sell made to measure gabardines, whipcords. \$14.50; reversible raincoats; \$75-100 weekly. Outfit free. Standard Raincoat, Dept. 5, 129 W. 17 St., New York.

**AGENTS—**Best seller: Jem Rubber Repair for tires and tubes; supersedes vulcanization at saving of over 800 per cent; put it on cold, vulcanizes itself in two minutes, and is guaranteed to last the life of the tire or tube. Sells to every auto owner and accessory dealer. For particulars how to make big money and free sample, address Amazon Rubber Co., Amazon Bldg., Philadelphia, Pa., Dept. 565.

**AGENTS** clear \$50.00 weekly selling Opaline Portraits. Expense money advanced. Credit given. Big line now ready. Samples and Catalog free. Consolidated Portrait Co., Desk 2, Chicago.

**PATENTED** Cigar Lighters with Glass Advertising Front. Also Electric Cigar Moisteners. Wonderful Sellers. No Competition. Big Steady Profits. Proof, Cuts, Sales Plan Free. Drake Mfg. Co., Dept. M, Milwaukee, Wis.

**WE** have the finest needle case. \$50.00 to \$200.00 weekly. Send 10c for sample; sells 25c. Empire Specialties Co., 1549 N. Wells, Dept. 301, Chicago.

**AGENTS** get Klossnik the newly invented door spring. Whirlwind seller. Retail for 50c. You make 100% or more. Sell 50 to 80 a day easy. Write for 45c sample and easy starting offer. Klossnik Mfg. Co., Dept. A, 17 West 42nd St., New York.

**AGENTS:** Big money Monogramming by Transfer Method. Catalog Showing Over 50 Styles and Particulars Free. Motorists' Accessories Co., Mansfield, Ohio.

**SELF-THREADING** Needles. Needle Hooks, Machine needles, find sales in every home. Fine side lines, easily carried, big profits, sample and catalogues free. Prentice Lee, 145 East 23rd St., New York.

**YOU** can sell every merchant in town our changeable signs. Large profits; easy sales. Write for territory now. Changeable Sign Co., 581 East 102nd, Cleveland.

**AUTO** owner tire agent wanted each locality to use and take orders for handmade Mellinger fabric and cord tires; guarantee bond 8,000 and 12,000 miles (no seconds); shipped prepaid on approval; get your tires free; no capital or experience required; make \$100 to \$300 weekly. Write for wholesale prices and sample kit. Address, Mellinger Tire Co., Dept. 290, Kansas City, Mo.

**WONDERFUL!** Startling! Amazing! Our Ex-Cel Luminous Crucifix and Magical (Luminous) Necklaces shine brilliantly in the dark. Sell on first demonstration. Big profits to you. Write for further particulars, or better still, send for sample and territory protection immediately. Crucifix \$1.50, Necklace \$1.00, postpaid. W. G. Hannan Co., Dept. B, 57 E. 18th St., Chicago.

**\$75 WEEKLY** Selling Nustile Guaranteed Hosiery. Your pay daily. All styles and colors; also Pure Silk, 4 pairs, \$7.50. Special monthly bonus. Sample outfit furnished. Nustile Hosiery Mills, Dept. 175, Philadelphia, Pa.

**GOLD** Mine for Salesmen. New Invention. A complete outfit. Washes and dries windows, sweeps, scrubs, mops, etc. Costs less than brooms. Over 100% profit. Greatest year 'round seller. Write Harper Brush Works, 132 2nd St., Fairfield, Iowa.

**IF** you want good live agents—fellows who can get the business—ask me how others are doing it. I'll gladly render the necessary assistance. Gen. F. Baker, Mgr. Classified Advertising, Popular Mechanics Magazine, Chicago.

**AGENTS:** A sale in every home for our beautiful dress goods, silks and general yard goods. Quick sales! Big profits. Large book of nearly 1,000 handsome fabric samples furnished to agents. Write today. National Importing & Mfg. Co., Dept. 6X, 573 Broadway, New York, N. Y.



YOU can be your own boss with our Key-Check outfit. Good for \$5 a day stamping names on pocket key checks, fobs, etc. Sample check with your name and address, 20 cents. Pease Die Works, Dept. M, Winchester, N. H.

SELL Madison "Better Made" Shirts direct from our factory to wearer. No capital or experience required. Easily sold. Big profits. Write for free samples. Madison Mills, 563 Broadway, New York.

AGENTS—Sell "Instant Shine" Metal Polishing Cloths, 25c; costs 7½c. Sample free. Instant Shine Polish Company, Utica, N. Y.

FORMULAS—Dependable manufacturing formulas with complete working directions. Charges reasonable. Write me, S. Virginia, Chemist, 135 Meadow St., Pittsburgh, Pa.

CASH In on this quick seller. Wingo cleared \$1,000 with Never Fail Razor Sharpener in six weeks; Purdy, \$40.50 first day. Applewhite, also inexperienced, six orders in thirty minutes. No end to ready buyers. Exclusive territory for quick workers. Be first. Address Never Fail Company, 159 Allen Bldg., Toledo, Ohio.

YOU can make \$75.00 to \$100.00 a week selling our big line of 150 articles, used constantly in every home. Write us, we will send you our handsome \$15.00 Sample Case Outfit on trust. Federal Pure Food Co., Dept. PP, Chicago.

BIG Money and Fast Sales. Every owner buys Gold Initials for his auto. You charge \$1.50; make \$1.35. Ten orders a day easy. Write for particulars and free samples. American Monogram Co., Dept. 40, East Orange, N. J.

EXCLUSIVE agents \$225 weekly. Genuine gold letters for store windows. Free samples; selling instructions. Chicago Window Sign System, 6225-A Kimbark Avenue, Chicago.

LIVE Agents make \$10 day selling Eureka Strainer and Splash Preventer for every water faucet. Takes on sight. Widely advertised and known. Get details today. A. H. Seed Filter Company, 73 Franklin, New York.

AT Last—World's Greatest Adding Machine. Almost human. Retail \$15; work equals \$300 machine. \$500 monthly easily made, demonstrating to stores, offices, garages, factories. Simple, easy; adds, subtracts, multiplies, divides automatically. Speedy, accurate, durable, handsome. Five year guarantee. Tremendous demand, amazing profits. Liberal trial offer. Protected territory. Write quick. Lightning Calculator Corp., Dept. F, Grand Rapids, Mich.

AGENTS—Stamping names on Pocket Key Protectors; sample Check with your name and address, 25c. Stamping Outfits, Emblem Checks, Check Fobs, Name Plates. Hart Mfg. Co., Desk 2, 303 Degraw St., Brooklyn, N. Y.

MAKE money silvering mirrors, all kinds plating, knives, spoons, auto headlights. Outfits furnished. Free booklet. International Laboratories, Dept. 25, 311 Fifth Ave., New York.

INSTANT Weld. Repairs largest punctures without cement or heat. Lenn's profit one day, \$56. Write quick. Free sample; territory going fast. Tourists' Pride Mfg. Co., Desk T, Minneapolis, Minn.

POLMET—The Wonderful Polishing Cloth that cleans all metals without liquid, paste or powder. Approved by "Good Housekeeping" and "Modern Priscilla"—sells fast at 25c. Sample free. Gale & Co., Inc., 15 Edinboro St., Boston.

WE start You Without a Dollar. Soaps, Extracts, Perfumes, Toilet Goods. Experience unnecessary. Carnation Co., Dept. 201, St. Louis.

"HOW to Sell Patents" free. Patent News-O, Washington, D. C.

MAIL-ORDER houses and distributors; we pack big profit beauty creams, face powders, perfumes, toilet preparations with your label. Chemist, 944A No. Clark, Chicago.

AGENTS: Big profits. Best and cheapest window letters made. Easily applied. Dime brings five samples. Particulars free. Stalbritte Co., 1115 Second Ave., New York.

EARN big money fast applying gold initials to autos. Every owner buys—\$1.35 profit on \$1.50 sale—particulars and samples free. Write quick. Lithogram Co., Dept. 17, East Orange, N. J.

EASY, pleasant work for Mechanics, Shop Men, Clerks, during spare hours; will add many dollars to their salaries. Also want persons who can give full time. Big wages assured. Novelty Cutlery Co., 67 Bar St., Canton, Ohio.

EARN \$10 daily silvering mirrors, plating and refinishing metalware, autos, chandeliers, bedsteads, headlights. Outfits furnished. E. Decie Laboratories, 1133 Broadway, New York.

WANT Distributing Agents everywhere for Hanslick, the new original powdered handsoap. Removes grease, grime, ink, paint, and most anything from the hands without injury to the skin. Every mechanic and auto-owner, everybody who gets his hands dirty will be a customer. A great opportunity for a hustler to get in business for himself. Full information free. Send 10 cents, coin or stamps, for liberal sample can. Solar Products Company, 122 West Lake Street, Chicago.

MAKE \$25 to \$50 Week, representing Clow's Famous Philadelphia Hosiery, direct from mill—for men, women, children. Every pair guaranteed. Prices that win. Free book "How to Start" tells the story. George Clow Company, Desk 31, Philadelphia, Pa.

SELL Necessities. Everybody needs and buys the "Business Guide." Bryant cleared \$300.00 in July. Send for sample. It's free. Nichols Co., Box 4-B, Naperville, Ill.

#### HIGH-GRADE SALESMEN WANTED

BEATS Owning a Store. "This new way of selling beats owning a store. Any earnest worker can easily make \$1,000 to \$3,000 a year net without investment or financial risk," says William Garden, former merchant who started with us two years ago. Other former merchants now happy and prosperous with us are De Lanza, Pack, Carter, Bogen, Lee, and Peck. They earn as much or more than ever; have no investment or financial worries and are building a constantly growing business. We are now making the best suit that we ever produced retailing at \$31.50. Our values are remarkable. Our fit and style so good that you can sell the best trade. Every fabric is virgin wool. Every garment tailored to order. Our all wool summer suits retail for \$21.50. Both the \$31.50 and \$21.50 lines are red-hot sellers. We have openings for men who are looking for a permanent connection and have the courage to depend solely on their own industry for success. Such men will find a wonderful opportunity with us. Write for full information, Dept. 800, J. B. Simpson, Inc., 831 Adams St., Chicago.

A DIGNIFIED Side Line with Splendid Possibilities. We desire high-grade salesmen who are selling both large and small business establishments, and who would like to increase their income through the sale of a most distinctive line of greeting folders, cards, gift certificates and announcements, prepared exclusively for business establishments. Beautiful sample book of 45 subjects can be carried easily in your portfolio. Sales possibilities are exceptionally good and an aggressive salesman should earn several thousand dollars annually through selling this artistic and distinctive product. In order to qualify give information as to your present work, sales ability and character. Write J. J. Sher, Federal Art Guild, 508 So. 4th St., Minneapolis, Minn.

MAKE \$75.00 to \$125.00 a week selling our strictly All-Wool Made-to-Measure Suits at one amazing low price. You collect profits in advance and keep them. We supply finest selling outfit in America, showing powerful assortment of over 100 Virgin Wool Fabrics, more than 75% of which are fine long-staple Worsted and Serges. Also big assortment of summer-weight fabrics, raincoats, and other exclusive money-making features. Tailoring, raincoat, and side-line men, part or full time, get in touch with us immediately. Goodwear Chicago, Inc., Dept. 924, Chicago.

AGENTS Wanted—Something New—Fire Fighter sells easily. Makes a spectacular demonstration; car owners, homes, factories, stores, practically buy on sight. Our men make \$10.00 to \$30.00 a day; exclusive territory. If you wish to establish a business of your own with unlimited possibilities for making big money, write us today. Fyr-Fyter Co., 13 Fyr-Fyter Bldg., Dayton, Ohio.

WANTED Salesman—in each locality with Ford car to show and sell Grey Goose Shock Absorbers. Easiest riding Absorber of all time. Quietly attached. They double spring length—lessen spring breakage, and look like a part of the car. Agents making big money on our liberal commission offer. A ride makes a sale. Priced within easy reach of every Ford owner. Write for agency proposition. Jenkins Vulcan Spring Co., Dept. 19, Richmond, Ind.

SELL Coal in Carload Lots. Side or main line. Experience unnecessary. Earn week's pay in an hour. Liberal drawing account arrangement. Washington Coal Company, 827 Coal Exchange Building, Chicago. If You Desire Further Information, See Our Big Ad Page 161.

REPRESENTATIVES Make Philadelphia Mint Jealous. Automobists Flabbergasted. Exclusive Territory. "Free" Pocket Sample. Investigate. "Wizard," Rochester, N. Y.

SALESMEN—Make big money selling Nationally known Armstrong Caps. Write at once for information. Armstrong Cap Co., Marion Bldg., Cleveland, Ohio, Dept. B.

DO you believe in yourself?—believe in the philosophy of success?—believe in hard work? If so, here is your chance to join a company which is made to your order. You can develop your earning power and build your savings account at the same time. Alexander Film Company, 3389 So. Broadway, Denver, Colo.

WANTED—First Class Specialty Salesmen to sell patented Automatic Tire Inflator to garages and service stations. Write for proposition. Phoenix Products Company, Box 1269, Phoenix, Ariz.

STOP Right Here. Make real money this summer. Week's salary often made on one sale. Look at our salesmen's monthly averages: N. Y. man, \$600.00; N. Dakota man, \$500.00; Ind. man, \$750.00, and so on. You call on business men only. Introduce entirely new proposition. No competition. Rich territory open. No collections. No deliveries. You take orders—we do the rest. Write—get complete dope. National Advertising Service, Inc., P. O. Box 73, La Grange, Ind.

SELL Advertising Pencils. Big Profits. Peerless Novelty Works, 740 Hodapp, Dayton, Ohio.

SALESMEN Pocket Sample free. Empey, 9 Oak St., Charlestown, Mass.

\$100 WEEKLY selling One-Minute Tire Changer to car owners, garages, tire stores, bus lines, etc. Simple—sure—speedy—sells on sight. Big sales records. Make wonderful demonstration. Exclusive. We help you start. Write Dept. E, R-M Mfg. Co., 14 Rice St., Dayton, Ohio.

THE Telalok, a time saver made of hand-somely polished metal; has paper roll conveying information; dial and hands indicating time of return; receiver for messages; all under lock and key. Place on desk or attach to door. \$5.00 delivered. Big commission to high-grade salesmen. Perkins Indicator Co., Guyton, Okla.

SALESMAN: If You Think in Terms of \$6,000 This Year, Write Me. Strong retail store line. Advertised nationally. Established Company. Liberal weekly advance to producer. The Continental Co., 1920 Euclid Ave., Cleveland, Ohio, Dept. 200.

GIVE customers \$100 value for \$10.00. Your profit \$6.50. Ukollet System, New Orleans, La.

RETIRE in five years selling 1-2-3 ball gum machines, six balls, 3c. Just out. 100% profit. Color circulars. Purity Gum Co., 273 20th St., Milwaukee, Wis.

SELL \$1.00 Radio Guaranteed Crystal Sets; Sample Set \$1.00; Dozen \$6.50 Prepaid. Southern Co., Box 217, Washington, D. C.

PAGE 560, April Number, describes our product. Salesmen coinng money. Acid-proof Ink Co., Nictown, Philadelphia, Pa.

SIDELINE Salesmen and Distributors Wanted, to sell Wollo Spark Plugs. Saves gasoline, keeps down carbon, fires in that oil soaker. Liberal commission proposition. Write Wollo, 3328 Olive St., St. Louis, Mo.

SALESMEN Wanted—To interview furniture and department stores in their locality on a splendid proposition for reliable manufacturer. You can earn \$100.00 a week or more, in full or spare time, on commission. Interesting, steady work. Write today for full particulars. The Marvel Co., Hammond, Ind.

WORLD'S Fastest Selling Auto Accessory! County distributors wanted; write today. G. L. W. Spring Oiler Co., San Diego, Calif.

MAKE \$100 Weekly in Spare Time. Sell what the public wants—long distance radio receiving sets. Two sales weekly pays \$100 profit. No big investment, no canvassing. Sharpe of Colorado made \$955 in one month. Representatives wanted at once. This plan is sweeping the country—write today before your county is gone. Ozarka, 802 Washington Blvd., Chicago.

SALESMEN Can make \$5.00 a day selling our Calendars, Pencils, Signs, Advertising Novelties, Yardsticks, Whistles, etc. Liberal terms. Sells entire year. Fine side line. Local and traveling agents. Model Calendar Co., Dept. 226, South Bend, Ind.



**SALESMEN**—Make \$50.00 weekly taking orders for notebands, envelopes, key tags and hotel supplies as sideline. Gallop & Sons, 3654 Fullerton Ave., Chicago.

**A WONDERFUL Seller!** Any man, woman, boy or girl can make big wages. Some agents make from \$8.00 to \$20.00 per day. Crimp Grip Clothes Line Fasteners are a simple, time-saving device for holding a rope—also used for many other purposes. It pays for itself quickly in time saved on wash days. No knots—it fastens and releases quickly. Every home a prospect. Every housewife who uses Crimp Grips—and there are thousands of them—is a booster. There is but one Crimp Grip. Write for particulars, or send 50c for one pair and a mounted sample, with full particulars to agents. Crimp Grip Company, Heildersheim, Ill.

**CALIFORNIA** Rosebuds selling like hot cakes. Agents coinng money. Absolutely new. Big profits. Catalog free. Mission Factory 8P, 519 No. Halsted, Chicago, Ill.

**OVER 250% Profit.** Salesmen—Crew Managers—Agents; Large Profits, Easy Sales, Satisfied Customers, are prime factors in selling. Midwest Household Necessities embrace these factors. Particulars free. Midwest Drug Co., 185 E. Naghten St., Columbus, Ohio.

**SALESMEN**—Sell "Amens" Radloux Shirts, guaranteed to wear a year. Very liberal commissions. Get our proposition first. Mensin Shirt Co., 481M East Tremont Avenue, New York.

**SALESMEN**—You can make \$150 per month in your spare time selling only one policy a day! Five policies a day pays you \$750 monthly! Policy pays \$5,000 death and \$25 weekly benefit for sickness or injury. Total cost \$10 yearly. You get amazing results using our Direct-by-Mail Selling Plan. Address Underwriters, Dept. RL, Bonnell Bldg., Newark, N. J.

**WANTED**—Tailoring Salesmen, make \$60 to \$125 per week. Biggest merchants in many towns have started with our line. We are the largest made-to-measure tailoring house in the country, furnishing elaborate sample equipments, including 500 all-wool fabrics. You make your own profits from \$8.00 to \$15.00 on each order. Guaranteed absolute satisfaction, perfect fit, best workmanship, or no sale. Write for line and all accessories to be sent free. Tell us all about yourself. Address N. O. Perry, Sales Manager, Box 483, Chicago, Ill.

**SELL** Advertising Specialties. They move fast. Good men easily make \$100 weekly. Write today for full particulars. S. G. Silver Chamberlin Company, Clayton, N. J.

**EVERYONE** Buys Every Day some part of our line. You can take orders for complete line of groceries, paints, roofing, motor oils, tires and radio sets, from institutions, boarding houses and private families. We deliver and collect. Our goods are nationally known and guaranteed quality; just show samples and secure large orders. No capital or selling experience necessary. Heavy orders make a steady profitable business. Address Hitchcock-Hill Company, Dept. 226, Chicago. Reference: any bank or express company.

**SALESMEN** sell sales and order books, auto, reg. rolls and bill ledgers. Large demand. Liberal commission. Wirth Sales Book Co., Chicago.

**TRAVELING** Salesmen calling on retail stores wanted by large manufacturer to sell unique line of business-boosting articles. Year round, fast selling, main or side line. If not earning \$150 weekly, address Elmsler Works, 222 Charles St., Booneville, N. Y.

**SALESMEN**—Sideline pays five to ten dollars a day taking orders for Specialty printed gummed advertising and Match Box Stickers. Write for proposition, samples, etc., today. Beardsley's Printery, Rock Island, Ill.

**WHY** Work for others? Start and operate your own business. Our system proprietary specialty business offers wonderful opportunities to make \$100 to \$500 weekly. Openings everywhere. We furnish everything and show you how. Booklet free. National Scientific Laboratories, 208 Monroe, Richmond, Va.

**BEST** Seller: Jem Rubber Repairs for tires and tubes; supercedes vulcanization at saving of over 80%; put it on cold, vulcanizes itself in two minutes, guaranteed to last life of tire or tube; sells to every auto owner and accessory dealer. Get particulars how to make big money and free sample. Amazon Rubber Co., Philadelphia, Pa., Dept. 510.

**\$4.00 PROFIT** on Every \$5.00 sale. "Free Sample"—New Specialty. (Money Getter.) Every Storekeeper, Doctor, buys quickly. Experience unnecessary. Territories open. Box 596, Hartford, Conn.

**\$60-\$200 A WEEK.** Genuine Gold Letters for store windows. Easily applied. Free samples. Liberal offer to general agents. Metallic Letter Co., 438-B North Clark, Chicago.

#### HELP WANTED

**MONEY!** Silvering Autolights, Radiators, Mirrors, tableware, stoves. Outfits. Methods free. Clarence Sprinkle, Dept. 28, Marion, Ind.

**75 MEN**—boys, 18 up, wanted immediately to prepare for U. S. Government Positions, Railway Mail Clerks, City Mail Carriers, Post Office Clerks, Income Tax Examiners, \$117 to \$250 month. Steady work. Short hours. Paid vacation. Influence unnecessary. Write immediately—for schedule of examinations. Franklin Institute, Dept. K-3, Rochester, N. Y.

**SALESMEN.** We pay larger commissions than any other Brush House in the Country to men selling our line of Sanitary twisted-in wire brushes. Sanitary Wire Grip Brush Co., 15 Mercer St., New York.

**BE a Finger Print Expert.** Write, American Finger Print System, 1966 Broadway, New York.

**FIREMEN,** Brakemen, Baggage-men, Sleeping car, train porters (colored). \$140-\$200. Experience unnecessary. \$10 Railway Bureau, East St. Louis, Ill.

**BOYS**—men. Become Automobile Experts. \$25 week. Earn while learning. Write Franklin Institute, Dept. K-401, Rochester, N. Y.

**RAILWAY** Mail Clerks, \$1,600-\$2,500 yearly. Postoffice Clerks and Carriers, \$1,400-\$2,000. Customs, Internal Revenue, and many other positions open. Vacations and sick leave with full pay. Common education sufficient. Experience unnecessary. Write immediately. Chicago Civil Service College, A-41 Keener Building, Chicago.

**\$5 TO \$15** daily in advance—No lay-offs—Monthly bonus besides. Muir made \$415.20 in 24 days. Send for sworn proof. No experience or capital required. Introducing Latest Style Hosiery. 7 pairs guaranteed 7 months. 53 styles, 29 colors. Spare time satisfactory—Just show samples we furnish. All colors—grades for Men, Women, Children. Write orders. We deliver and collect. Transportation charges paid. Your Pay Daily. Macochee Hosiery Company, Room 4726, Cincinnati, Ohio.

**GET** posted—Good prices paid for butterflies, insects. See Sinclair display advertisement, page 50.

**MONEY** Polychroming, also Silvering Mirrors. Particulars free. Polychrome Works, 2604 East 40th, Kansas City, Mo.

**INVENTORS** desiring to secure patents should write for our book "How to Get Your Patent," tells our terms and methods. Send sketch for our examination and instructions without charge. Randolph & Co., Dept. 418, Washington, D. C.

**WRITE** articles, stories, news, in spare time for newspapers and magazines. Big pay. Copyrighted book free. Press Syndicate, 982, St. Louis, Mo.

**HUNDREDS** men, 18 up, wanted as Railway Mail Clerks, \$133-\$192 month. Common education sufficient. List positions free. Write immediately. Franklin Institute, Dept. K-20, Rochester, N. Y.

**STORIES,** poems, plays, etc., are wanted for publication. Good ideas bring big money. Submit manuscripts or write Literary Bureau, 522, Hannibal, Mo.

**\$60-\$200 A WEEK.** Genuine Gold Letters for store windows. Easily applied. Free samples. Liberal offer to general agents. Metallic Letter Co., 438-C, North Clark, Chicago.

**FINGER** Print Experts—Excellent paying positions; particulars free. Finger Print Headquarters, 188 East 79th, New York.

**SILVERING** Mirrors, French plate. Easily learned; immense profits. Plans free. Address, Wear Mirror Works, Excelsior Springs, Mo.

**MEN** Wanted—Molding finishers, decorators, sign painters. Discovered a wonderful bright burnish bronze finish; it's inexpensive. Write W. J. Crake, Ft. William, Ont., Canada.

**GOVERNMENT** Jobs, \$1,140-\$3,000 year. Men—Women, 18 up wanted. List positions free. Write immediately. Franklin Institute, Dept. K-20, Rochester, N. Y.

**SELL** your spare time—\$2.50 per hour—Your Pay Daily. Pleasant, profitable, easy work near home, writing orders for Mac-O-Chee New Style Guaranteed Hosiery. No capital required—No experience necessary—We teach you how to succeed. Special premiums to purchaser makes sales easy. Hammond made \$18.20 first day. Mrs. M. Brewer, \$12.50. You should do as well. Send for new sales plan and Proof of Profits—Free. Mac-O-Chee Hosiery Company, Room 2606, Cincinnati, Ohio.

**LOCOMOTIVE** Firemen for railroads nearest their homes—everywhere; beginners \$200, later as Locomotive Engineers; \$300-\$400 monthly. Best paying positions in Railroad Service. Railway Association, Desk M1, Brooklyn, N. Y.

**\$150 MONTH** average. Railway Mail Clerks. Hundreds wanted. List positions free. Write immediately. Franklin Institute, Dept. K-20, Rochester, N. Y.

**MEN** Wanting Forest Ranger and railway mail clerk positions, write for particulars. McKane, B-12, Denver, Colo.

**SALESMEN**—Become independent. Own your business; experience unnecessary; selling our \$7,500 Accidental Death, \$50 Accident, \$25 Sick Weekly Benefits; \$12.50 yearly; other amounts proportionate. Guaranteed steady income from renewals. \$250,000 deposited Insurance Department. Registration Dept. A, Newark, N. J.

**CLERKS;** Railway Mail. Other good Government Postal positions. \$1,400-\$2,300 yearly. Experience unnecessary. Full particulars free by writing G. W. Robbins, Civil Service Expert, 411 Burchell Bldg., Washington, D. C.

**MAKE** money writing Photo-plays; details free to beginners. No correspondence course. Producers' League, 230 Wainwright, St. Louis.

**WHY** work for others? Start and operate your own business. Our system proprietary specialty business offers wonderful opportunities to make \$100 to \$500 weekly. Openings everywhere. We furnish everything and show you how. Booklet free. National Scientific Laboratories, 208 Monroe, Richmond, Va.

**EARN** \$10 daily silvering mirrors, plating and refinishing metalware, autos, chandeliers, bedsteads, headlights. Outfits furnished. E. Deele Laboratories, 1133 Broadway New York.

**MEN**—Boys. Become Railway Mail Clerks, \$135 month. Write immediately. Franklin Institute, Dept. K-20, Rochester, N. Y.

**MEN**—Age 18-40, wanting Railway Station-Office positions, \$115-\$250 month, free transportation, experience unnecessary. Write Baker, Supt., 74 Wainwright, St. Louis.

**ALL** men, women, boys, girls, 17 to 65, willing to accept Government Positions, \$117-\$250 traveling or stationary. Write Mr. Orment, 101 St. Louis, Mo., immediately.

**WANTED:** Railway Mail Clerks—\$1,600 to \$2,300. Exams everywhere. Write today for full information. Patterson, Civil Service Expert, Box 4025, Rochester, N. Y.

**OUR** genuine gold window sign letters are an excellent money-making proposition for handy men. Slann Sign System, Bethune Ave. E., Detroit, Mich.

#### INFORMATION

**ACCURATE,** detailed information. Literary, scientific, subjects, \$1.00. National Institute, Springfield, Ohio.

**COMPLETE** information on any book published. Or will supply lists of books that are the best on any subject. Information is free. Room 805, Popular Mechanics Building, Chicago, Ill.

**COMPLETE,** accurate, information on any subject. \$1. National Information Bureau, 1429N Milton St., Grand Rapids, Mich.

**GUARANTEED** information, any subject, strictly confidential, \$1.00. Doris Chemical Laboratories, East Cleveland, Box 59, Cleveland, Ohio.

#### BUSINESS SERVICE

**DELAWARE** Incorporator, Charters; Fees Small; forms. Chas. G. Guyer, 801 Orange St., Wilmington, Del.

#### TYPEWRITERS AND SUPPLIES

**TYPEWRITERS** All Makes. Save one-half. Thoroughly rebuilt in our factory by the famous "Young Process." Fully guaranteed. Free trial. We handle all standard makes. Cash or sold on easy terms. Write for Catalog. Young Typewriter Co., Dept. 5028, Chicago, Ill.

**TYPEWRITER** for Sale. Cost \$100—will sell for \$35. Machine guaranteed—will ship on trial. Address Galbreath Company, Rogers, Ohio.



**UNDERWOOD** Typewriters—only \$3.00 down. Easy monthly payments. Low prices at less than manufacturers. 10 days' free trial. Rebuilt, all worn parts replaced. Just like a new machine, 5-year guarantee. Write for big free catalogue A-151. Shipman-Ward Mfg. Co., 1514 Shipman Bldg., Chicago, Ill.

**TYPEWRITERS**, all standard makes, \$10 up. Fully guaranteed. Free trial. Write for complete illustrated lists. Northwestern Typewriter Exchange, 121 N. Francisco Ave., Chicago.

#### TYPEWRITING

**EXPERT** Typing: 50c per 1,000. Perkins, 711 Brady, Davenport, Iowa.

#### MAILING LISTS

We have the list you want. Accuracy guaranteed. Gordon Company, 682 Pickering Bldg., Cincinnati.

\$35.00 **BUYS** 5,000 addresses of Ministers and business men. Now being sold first time. 100% correct. H. J. Payne, Box 193, Jackson, Tenn.

#### ADDING MACHINES

**NEW** \$3.50 Automatic Adding Machine. Adds, Subtracts, Multiplies. Absolutely accurate. Capacity \$999,999.99. Fully guaranteed. 75,000 pleased users. Makes adding easy, positive, quick. Eliminates Mistakes. Saves Time. Postpaid \$3.50. Bassett Co., 1158-K Hollywood Ave., Chicago.

**FREE** Trial. Marvelous new Adding Machine. Adds, Subtracts, Multiplies, Divides, automatically. Work equals \$350.00 machine. Price only \$15.00. Speedy, durable, handsome. Five-year guarantee. Used by largest corporations. Write today for catalogue and free trial offer. Lightning Calculator Co., Dept. E, Grand Rapids, Mich.

#### DUPLICATORS AND DEVICES

**STENCIL** Duplicating Outfit—\$2.00, \$3.00, \$4.00. Prints Typewriting, Handwriting, etc. On Approval. Primos Specialty Co., 3-M, Primos, Pa.

YOU can make 50 to 100 copies of a letter, notice, etc., at a cost of three cents on a Hever Quality Duplicator. Write for free trial offer. The Hever Duplicator Co., 14 S. Wells St., Chicago, Ill.

**"MODERN"** Duplicators save Time, Labor, and Money. Gets business. Reproduces Typewritten or Penned Letters, Drawings, Lessons, Music, Menus, Bids, Notices, Specifications, Maps or anything in one or more colors. Prints Two per minute. Special Sale On 30 Days' Free Trial. \$2.25 up. Booklet Free. J. E. Durkin-Reeves Co., Pittsburgh, Pa.

#### PRINTING, ENGRAVING AND MULTIGRAPHING

**MONOGRAM** Personal Stationery Two-fold Linen stock, 100 in a set \$1.00. Samples Free. Blackhawk, 5057-9 Addison, Chicago.

20 LB. Hammermill Bond Letterheads, 500 \$2.30—1,000 \$3.00—3,000 \$8.50—5,000 \$13.75. Postage prepaid. Envelopes 10 per cent less. We print anything. Work guaranteed. Samples furnished. National Printing Company, Goshen, Ind.

**MULTIGRAPHING**, addressing, folding, Rates reasonable. Gordon Company, 682 Pickering Bldg., Cincinnati.

5,000 6 x 9 **CIRCULARS** \$8.50, postpaid; 5,000 3 x 6 circulars \$4.00. Circulars, folders our specialty. Write, Saxon Press, Columbia, Missouri.

**AUTOMATIC** Press just installed—Special low prices on Circulars and Folders—all sizes—1,000 to 100,000 up. Good's Printery, Harrisonburg, Va.

**PRINT** Celluloid advertising novelties in your shop. Easy, simple process. Directions and illustrative pieces, \$1.00 postfree. Guy Milner, Fairfax, Calif.

**"NEARGRAVURE"**—It's Different—1,000 Letterheads \$3.50 prepaid. Sollday's, Knox, Ind.

**PRINTING**—500 Letterheads \$1.50. Send stamp for samples. Place, Harding, Mass.

10,000 **MILK** bottle stoppers printed to your order \$5.00. Samples on request. Muncie Bottle Cap Co., Muncie, Ind.

1,000 **HAMMERMILL** Letterheads or Envelopes, \$4.00. Full Line Samples Free. Quality Printshop, Marietta, Ohio.

500 **EACH** Letterheads, Envelopes, \$5.00. C. O. D. Jacobus Service, Irvington, N. J.

**AUTOMATIC** Cardpresses—prints 100 cards minute. Information free. Hahben, 3127 Locust, St. Louis.

1000 **20-LB.** Bond Letter Heads, name and address. \$2.75 postpaid. E. Foster, 365 State Street, New Haven, Conn.

**STICKERS**—We label everything on earth. Before buying Gummed Labels, consult our catalogue. Clarence Howe, Vineland, N. J.

**BARGAINS** in Quality Printing—1,000 Letterheads \$4.00; 1,000 Envelopes \$3.50; 500 Cards \$2.75; 1,000 4-page folders \$8.50. Postpaid. Cash with order. Quick Service, Samples free. Padberg, the Printer, Dept. "A," Freeport, Ill.

500 **EACH**, letterheads, envelopes, \$4.75 prepaid, 3rd zone. Samples, Mathews, Printer, Watertown, S. D.

**OUR** Specialty is Letterheads, Envelopes, Circulars, Pamphlets and Catalogues. Write for Prices. The Shenandoah Press, Dayton, Va.

We print Stationery, Booklets, Catalogs, Circulars, Campaign printing. Samples, Commercial Press, Batavia, Ohio.

100 8 1/2 x 11 **BOND** letterheads and 100 envelopes, \$1.10. Drexton, Box 1051, Fargo, N. D.

**CATALOGUE** and Job Printing. Get our estimate on your printing needs. Smith-Roberts, Watseka, Ill.

500 **TWO-COLOR** Letterheads \$2.75. Sample free. "Superior", 1825 Roosevelt, Indianapolis.

225 **BOND** letterheads, envelopes, billheads, cards, \$1.25 each. Combination, \$4.00. Economic Press, Leonia, N. J.

**QUALITY** Printing! Reasonable Prices! Tell us your wants and let us quote our Money-Saving prices. Best Work. We print anything. Ernest Fantus, 525 South Dearborn Street, Chicago.

**PRINTING** Outfits—Presses, type supplies, type novelties. Send stamp for catalogue. Model Press, York, Penna.

**PRE-USED** Printing Presses. Type and supplies. List for stamp. Popular Bargains, Richland, Pa.

250 **LETTERHEADS**, 250 white envelopes, printed and mailed, \$3.00. Samples printing free. Sunco, Mohawk, N. Y.

1,000 **LETTERHEADS** or Envelopes, \$3.00. Sent Prepaid. Samples Free. Monitor Press, Morrisville, Pa.

#### FOR SMOKERS

**TWENTY** Wonderful Havana Smokes for \$1.00. Factory-to-Smoker System saves you half. Enjoy genuine cigar-comfort in guaranteed ten-cent value. \$2.50 for 50. Postpaid, \$1.00 for trial box of 20. Send name and address, pay Postman and be convinced. Montrose Cigar Factory, 4004 Montrose Avenue, Chicago, Ill.

**GENUINE** "Hewlett" London Hand Made Pipes at import prices. Write for circular. Specialty Sales Co., Greeley St., Milwaukee.

**PURE** red leaf tobacco, quality guaranteed. Best chewing, 3 lbs., \$1.00; 10 lbs., \$3.25. Mild smoking, 4 lbs., \$1.00; 10 lbs., \$3.25, postpaid. O. D. Collier, Agent, Martin, Tenn. Collier is reliable. Martin Bank, Raymer, Cashier.

#### FOR MEN

**ARE** you old at forty? See our advertisement on page 146 of this issue. The Electro Thermal Company, 2134 Main St., Steubenville, Ohio.

#### BOATS AND LAUNCHES

**MAKE** rowboats sail, \$5.00. Graham Centerboard Mfg., Harbor Springs, Mich.

16-**FOOT** Rowboat—easily made. Construction blueprint 50c. Weesho-Uco., West Market, Detroit, Mich.

**NEW** Boat Book telling how to make 21 kinds of boats. Also many other helpful ideas for those who like boats. Profusely illustrated, 50 cents. Popular Mechanics Press, Room 805, Popular Mechanics Building, Chicago, Ill.

**BOATS** that always go are propelled by Ford Engines. Ford Boat Booklet sent free. Harry Rider, 206B Commercial Bldg., Norwalk, Conn.

**MAKE** your own Row-boat from Easy to Build Construction Prints. Box 160, Escanaba, Mich.

**SPEED** Boat for small engine. Plans and directions 25 cents. Free catalog of boat plans and books. The Rudder, 9 Murray Street, New York City.

**"HOW** to make your boat leakproof." Send for booklet. L. W. Ferdinand & Co., 152 Kneeland St., Boston, Mass.

#### RAZORS AND BLADES

**BLADES**, resharpened, one edge 2c; double 3c. New York Edge Co., Glen Cove, N. Y.

**BLADES** resharpened, 3c any make; guaranteed service. Standard Safety Razor Corp., Pittsburgh.

#### OPTICAL GOODS

**ARMY** compasses \$1.50, cost Government \$22.50. G. Walker, Box 633, Cincinnati, Ohio.

**POWERFUL** binocular \$18, worth \$63. G. Walker, Box 633, Cincinnati, Ohio.

#### DIAMONDS, WATCHES AND JEWELRY

**WONDERFUL** Scientific Discovery; Blue White Sapphires rival finest Diamonds, \$3 per carat; Canary Yellow and Fire Sapphire \$2. Imported exclusively, loose stones or mounted, wholesale only. Write Pauer (Importer), 152 Dewitt, Buffalo, N. Y.

#### FOR THE HOME

**MAKE** a Kiddy Cabinet; interesting, useful, ornamental. Pattern, instructions 25c. Coin. Bogrons Kiddy Cabinet, 2651 8th Ave., New York City.

**HOME** Mechanics—A new Popular Mechanics Handbook containing 329 discoveries that will be of value to anyone who has a home. 96 pages—203 illustrations. 50 cents. Popular Mechanics Press, Popular Mechanics Building, Room 805, Chicago, Ill.

**LOOMS**—Only \$9.90—Big money in weaving rugs, carpets, portieres, etc., at home, from rags and waste material. Weavers are rushed with orders. Send for free loom book, it tells all about the weaving business and our wonderful \$9.90 and other looms. Union Loom Works, 480 Factory St., Boonville, N. Y.

**CONCRETE** Handbook, for the Amateur. We have just published a book describing 173 ways of using concrete in the home, shop and on the farm, with full directions for doing these things yourself with ordinary tools. 138 illustrations. It is "written so you can understand it." Price 50 cents, postpaid. Popular Mechanics Book Dept., 206 E. Ontario St., Chicago.

#### PHONOGRAPHS AND RECORDS

**A PREPARATION** for treating Phonograph Records. Put the old favorites back into service. Where there's a Phonograph, there's a sale. 50 cts. postpaid, sufficient for (100) records. Parties wanting Agency ask for particulars when ordering. Reconditioner Mfg. Co., Box 217, Salina, Kans.

50,000 **STANDARD** 75c, 10-in. Double Phonograph Records. Plays any machine. While they last, 500—15c; 100—10c. Sample order 25 Records—all different, \$1.75. Order today. Andrew Beck, Nashville, Tenn.

**BUILD** your own Phonograph. We furnish everything. Write for catalog and free Blueprint offer. American Phonograph Co., 3515 North Crawford, Chicago.

**BUILD** your own phonograph. We can supply you with motors, tone arms and all accessories at wholesale prices. Write for catalogue AX. Plesing Sound Phonograph Co., 204 East 113th St., New York, N. Y.

**BUILD** Your Phonograph. Quality phonographs. Quality Serenades motor and motor of other types. Electric Motors, tonearms, reproducers, amplifiers, case materials, accessories. Free blueprints and building instructions. Big saving. Wonderful results. Prompt delivery. Catalog mailed for ten cents. Hoosier Manufacturing & Supply Co., 313 Baldwin Block, Indianapolis, Ind.

#### MUSIC AND MUSICAL INSTRUMENTS

**"BELLE ISLE"** (Little Queen of All Islands) Beautiful fox-trot. Vocal, piano copies or dance orchestrations 25c postpaid. Special quantity prices. Roman Arndt Music Publishing Co., 3637-9 Townsend, Detroit, Mich.

**NEGRO** Harmony; Piano Chimes. Player Piano Effects, Kar Piano Playing, Jazz Chords, Snappy Bass Styles, Easily learned at home. Write for Free Booklet, "Piano Bill," 211 Ossington Ave., Toronto, Canada.

**WRITE** Songs. Big money and reputation. Write for information. J. Gordon Pub. Co., 201 N. Hoyne Ave., Chicago.

"**MUSIC** Composed" to words. Bauer Bros., (formerly of Sousa's Band), Oshkosh, Wis.

**VIOLINS**, Deep, Mellow, Soulful—on credit. Easy terms for wonderful instrument. Get details today. Gustav F. Henning, 2424 Gaylord St., Denver, Colo.

**I PAY** Cash for Saxophones, band and orchestra instruments. Ship for estimate or state your price. I prepare return charges if my offer not acceptable. River Forest, Ill. State Bank my references. Chicago Band Instrument Exchange, Dept. 305, 333 S. Dearborn St., Chicago.

**I WANT** Song Poems. Casper Nathan, 1252 Bryn Mawr, Chicago.



## PATENT ATTORNEYS

**PATENT** Procured. Prompt Service. Personal, careful and efficient service. Highest references. Moderate fees. Send sketch or model for actual search and advice. George P. Kimmel, Master of Patent Law, 54-F Loan and Trust Bldg., Washington, D. C.

**LOWEST** Charges. Patents, Trade-Marks; Send ideas, free patentability opinion. Guide Co., Fendall Building, Washington, D. C.

**PATENTS** Procured; Trade Marks Registered—A comprehensive, experienced, prompt service for the protection and development of your ideas. Preliminary advice gladly furnished without charge. Booklet of information and form for disclosing idea free on request. Richard B. Owen, 30 Owen Bldg., Washington, D. C., or 2276-R Woolworth Bldg., New York.

**MILLIONS** spent annually for ideas! Hundreds now wanted! Patent yours and profit! Write today for free books—tell how to protect yourself, how to invent, ideas wanted, how we help you sell, etc. American Industries, Inc., 500 Kresge Bldg., Washington, D. C.

**PATENTS:** Personal attention and investigation given to patent matters for reasonable charge. Albert Robinson, McLachlen Bldg., Washington, D. C. Formerly an Assistant Examiner of Patents.

**PATENTS,** patent litigation, trademarks, copyrights. Handbook of instructions "How to protect inventions" free on request. R. H. Fravel, Patent Attorney, formerly of the U. S. Patent Office Examining Corps, Room 503 McLachlen Bldg., Washington, D. C.

**ESTABLISHED** 1864. Milo B. Stevens & Company, Registered Attorneys (No. 830), Patents—Trade Marks—Copyrights. Full information upon request. Moderate fees. Offices: Barrister Building, Washington; Leader Building, Cleveland; Monasnock Block, Chicago.

**MONROE MILLER,** Ouray Bldg., Washington, D. C., Patent Attorney; Mechanical, Electrical Expert, Free Blue Book gives candid advice.

**PATENTS** and Trade-marks obtained. Prompt service. Write for our new book on patents. Established in 1889. D. Swift & Co., 399 7th St., Washington, D. C.

**INVENTORS**—Send for form "Evidence of Conception" to be signed and witnessed. Form, fee schedule, information free. Lancaster and Alwine, 221 Ouray Bldg., Washington, D. C.

**THE PATENTOME** is free. A liberal education in patents. Anderson & Son, Attorneys, estab. 1865. 635 F St., N. W., Washington, D. C.

**PATENTS**—Let me assist you in obtaining your valid Patent rights. Personal service. Promptness assured. George Van Den Berg, Barrister Bldg., Washington, D. C.

**PATENTS,** Trade-Marks, Copyrights and Patent Litigation. Write for advice and instructions how to proceed, costs, etc. Hand Book with illustrations of 160 Mechanical Movements sent free on request. Albert E. Dieterich, Patent Lawyer and Solicitor, 621-B Ouray Bldg., Washington, D. C.

**INVENTORS**—Patent your idea. Send sketch or model for opinion on patentability. Information how to proceed free. Reasonable charges. Frank B. Hoffman, Patent Lawyer, Union Bank Building, Washington, D. C.

**PATENTS**—M. P. Laughlin—Engineer-Attorney. 47 West 42d St., New York.

**CASHING** In—If you have a practical useful invention to sell, write us today, stating whether patented. American Patents Corporation, Barrister Building, Washington, D. C.

**UNPATENTED** Ideas Can Be Sold. I tell you how and help you make the sale. Free particulars (Copyrighted 1923). Write W. T. Greene, 806 Jenifer Building, Washington, D. C.

**CO-OPERATIVE** Plan for handling patent applications. Write for free book telling how to safeguard inventions and sell under "Patent Pending." Ralph Burch, Patent Lawyer, 500 Jenifer Building, Washington, D. C.

**INVENTORS**—Write for our Guide Book, "How to Get Your Patent" and Evidence of Invention Blank. Send model or sketch of your invention for our prompt examination and instructions free. Randolph & Co., Dept. 430, Washington, D. C.

**HORACE L. WOODWARD**—Efficient, conscientious service. Send sketch for preliminary advice. Established 1906. 704 Ninth, Washington, D. C.

**HERBERT JENNER,** patent attorney and mechanical expert, 695 F Street, Washington, D. C. I report if patent obtainable and exact cost. Send for circular.

**INVENTORS** should write us for our book, "How to Obtain a Patent," which clearly sets forth what may be patented and the necessary steps to protect an invention; it describes the procedure in patent office and tells about assignments, license and trade marks, and gives many useful facts about patents which every inventor should know; many persons well versed in patent matters have pronounced the book the best of its kind they have ever read; it is written so you can understand it; copy free upon request. Talbert & Talbert, Patent Lawyers, 481 McGill Bldg., Washington, D. C.

**PATENT SENSE**—"The book the inventor keeps." Free. See Lacey ad, page 154.

**PATENTS**—Write for our Guide Books and "Record of Invention Blank" before disclosing inventions. Send model or sketch of your invention for Examination and Instructions. No charge for the above information. See advertisement on pages 152 and 153. Victor J. Evans & Co., 934 Ninth, Washington, D. C.

**PATENTS** Procured. Send sketch or model today for examination, prompt report and advice. No charge for preliminary advice. Write for free Booklet and blank form on which to disclose your idea. Highest references. Promptness assured. Clarence A. O'Brien, Registered Patent Lawyer, 583 Security Bank Building, Directly across the street from Patent Office, Washington, D. C. See pages 150 and 151.

**TRADEMARKS** \$35; Design patents \$35; Copyrights \$5; Booklet Free; 20 years experience. Sanders, Registered Patent Attorney, 7 Rand-McNally Building, Chicago.

**PATENTS.** My fees in installments. Advice book free. Frank Fuller, Washington, D. C.

**"INVENTOR'S** Advisor," the valuable Patent book with 139 mechanical movements and illustrations, sent free upon request. M.M. Labiner, Patent Attorney, 3 Parkrow, New York.

**PERCY S. WEBSTER,** Savings and Loan Building, Stockton, California. Long established organization. Send for free book on Patents.

**INVENTORS:** Send sketch or model of invention for opinion concerning patentable nature and exact cost of patent. Book "How to Obtain a Patent," sent free. Tell what every inventor should know. Established twenty-eight years. Highest references. Prompt service. Reasonable charges. Address Chandler & Chandler, 456 Seventh, Washington, D. C.

**"INVENTORS' Guide"** free on request; gives valuable information and advice for all who have original ideas or improvements. Frank Ledermann, Registered Attorney and Engineer, 15-F Park Row, New York.

**H. F. LOWENSTEIN,** Registered Patent Attorney, Technical expert. McLachlen Building, Washington, D. C.

**PATENTS,** Trade marks, copyrights. Prompt, personal, reliable service. Over 35 years' active practice. Write for terms. Book free. Address E. G. Siggers, N. U. Bldg., 913 F St., Washington, D. C.

**PATENTS,** Booklet free. Highest references. Best results. Promptness assured. Send model or drawing for preliminary examination. Watson E. Coleman, Patent Lawyer, 644 G Street, Washington, D. C.

## FOR INVENTORS

**PATENTS.** If you have an invention which you wish to patent you can write fully and freely to Munn & Co. for advice in regard to the best way of obtaining protection. Please send sketches, or a model of your invention and a description of the device, explaining its operation. All communications are strictly confidential. Our vast practice, extending over a period of seventy-eight years, enables us in many cases to advise in regard to patentability without expense to the client. Our Hand-Book on Patents is sent free on request. This explains our methods, terms, etc., in regard to Patents, Trade Marks, Foreign Patents, etc. "Scientific American" contains Patent Office Notes, Decisions of interest to inventors and particulars of recently patented inventions. Munn & Company, Solicitors of Patents, 618 Woolworth Building, New York; Scientific American Bldg., Washington, D. C.; Tower Bldg., Chicago, Ill.; Hobart Bldg., 582 Market St., San Francisco, Calif.; Van Nuys Building, Los Angeles, Calif.

**PATENT** applications filed with drawing \$20; deferred \$15; strongest claims; priority rights guarded. Inventors' Service, 11 Broadway, New York.

**MONROE MILLER,** Ouray Bldg., Washington, D. C., Patent Attorney; Mechanical, Electrical Expert. Before proceeding, read free Blue Book.

**INVENTORS** of improvements to Steam Engines, Boilers, Valve Gears, etc. We build working models and do experimental work. Estimates promptly. Model engineering catalogue, 20c. Bathe Manufacturing Co., Dept. D, 3214 Woodland Ave., Philadelphia.

**INVENTORS:** Our experience covers eighteen years designing and development service; expert drawings; confidential patent counsel. C. J. Williams, Patent Engineer, 520 Pacific Building, San Francisco.

**FREE** Information on Technical Books—Personal Advancement is a new magazine published by Popular Mechanics to help those who want information on books. Will supply you with list of books on various subjects, and information as to price and where they may be secured. Free. Popular Mechanics Press, Popular Mechanics Building, Room 805, Chicago, Ill.

**INVENTORS' Educator:** 900 Mechanical Movements. 50 Perpetual Motions. How to procure and sell patents. Mechanical Movements greatly assist inventors, suggest new ideas. Explains how to select an attorney and avoid Patent Sharks. Price \$1.50. Postage Free. Albert E. Dieterich, 621 Ouray Building, Washington, D. C.

**INVENTORS,** before applying for Patent, send for our free circular "Advance Confidential Service for Inventors," designed to save you money and increase your opportunities for success. Caston-Guay Engineers, 30 Sixteenth Street, Southeast, Washington, D. C.

**PATENT** application on simple non-technical invention prepared for \$15. Personal service. A. M. Benner, Olympia, Wash.

**COMMERCIALIZE** your ideas according to My Cooperative Plan before patenting. Booklet Free. Ralph Burch, Patent Lawyer, Jenifer Building, Washington, D. C.

**PATENTS**—Send for Booklet. Contains valuable information for inventors. Our charge for search of Patent Office records \$3.00. Prompt service, twenty years' experience. Talbert & Talbert, 500 McGill Building, Washington, D. C.

**CASHING** In—If you have a practical, useful invention to sell, write us today, stating whether patented. American Patents Corporation, Barrister Building, Washington, D. C.

**LACEY** Patent Sense. See page 154.

**INVENTORS**—Write for our Guide Books and "Record of Invention Blank" before disclosing inventions. Send model or sketch of your invention for our free examination and instructions. See advertisement on pages 152 and 153. Victor J. Evans & Co., 157 Ninth, Washington, D. C.

**PATENTS** Procured. Send sketch or model today for examination, prompt report and advice. No charge for preliminary advice. Write for free Booklet and blank form on which to disclose your idea. Highest references. Promptness assured. Clarence A. O'Brien, Registered Patent Lawyer, 583 Security Bank Building, Directly across the street from Patent Office, Washington, D. C. See pages 150 and 151.

**INVENTORS:** We develop your invention to practical use; make necessary drawings, models; expert engineering counsel; before or after Patent; also help market your invention. Investigate. (No attorneys or brokers.) Caston-Guay Engineers, Washington, D. C.

**PATENTS** Procured; Trade Marks Registered—A comprehensive, experienced, prompt service for the protection and development of your ideas. Preliminary advice gladly furnished without charge. Booklet of information and form for disclosing idea free on request. Richard B. Owen, 30 Owen Bldg., Washington, D. C., or 2276-R Woolworth Bldg., New York.

**HAVE** You an Invention? If so, write for our free book, "How to Get Your Patent," tells our terms and methods. Send model or sketch for our free examination and instructions. Randolph & Co., Dept. 144, Washington, D. C.

**UNPATENTED** Ideas Can Be Sold. I tell you how and help you make the sale. Free particulars (Copyrighted 1923). Write W. T. Greene, 807 Jenifer Building, Washington, D. C.

**I SELL** Patents. Established in 1900. My Service is employed by inventors who are also Bankers, Lawyers, Patent Attorneys, Mechanics. Men in all walks of life—and Corporations with patents to sell. Why not you? Charles A. Scott, 773PM Garson Avenue, Rochester, N. Y.



**MODEL** Making and experimental work. Modern shop; expert workmen. Manufacturing. Lamson Electrical & Mfg. Co., 625 W. Jackson, Chicago.

To sell your Patent. Write me; experienced handling, immediate action. Address Arthur S. Billings, Suite 401 Dekum Bldg., Portland, Ore.

Get your own patents. Application blanks, complete instructions \$1. Cutting Sons, Campbell, Cal.

PATENT Application Blanks free to inventors. Patent News-D, Washington, D. C.

WE Develop your ideas into commercial shape for presentation to purchasers, making working models, drawings, experiments or tests. Courtesy, efficiency, secrecy and ample equipment; 30 years' experience. Ducommun-Rich Engineering Co., 504 Pacific Mutual Bldg., Los Angeles, Calif.

#### PATENTS FOR SALE

FOR Sale—Patent—Improvement on one of the most popular selling articles. Market for twenty millions. Very cheaply manufactured. Luther P. Creasy, Catawissa, Pa.

FOR Sale or Royalty—Invention—Improved Brown. Patents pending. Write B. Molsberger, % Mr. M. Watson, Jr., Safe Deposit & Trust Co., Greensburg, Westmoreland County, Pa.

PATENT for Sale on improved Lock Nut. Will not loosen, but readily removed when desired. Withstood load of over 22,000 lbs. In Stevens Institute test. Bolt fractured without starting nut. Outright or Royalty. H. H. Goodwin, 26 Church St., New York.

PATENT on novel Laundry Bag. Manufacturing cost low. Unlimited demand. Sell outright. Alex Waldich, 3753 Wilton, Chicago.

FOR SALE—Patent on fountain automobile washing device, including mop or swab. J. Kumagawa, 1644 N. Hoover St., Hollywood, Calif.

FOR Sale—U. S. Patent No. 1,399,876, on a Best Harvester. Digs, tops and loads. Will sell for cash or on royalty. This is a very valuable invention. For further particulars, address W. Z. Pulliam, 903 W. 65th St., Los Angeles, Calif.

AUTOMATIC Window Ventilator. U. S. Patent No. 1,018,585; Great Britain Patent No. 27,805; Canada No. 132, 002. Also Root Potter, U. S. Patent No. 1,364,807. D. L. Reitz, Box 362, Calmbrook, Pa.

FAST Catcher Fly Trap, No. 1,487,691. Fred Day, Alcester, So. Dak.

FOR Sale—Outright—Spark-Plug patents, U. S. 1,384,914; Can. 228,825. 9 claims. Experiments completed. Investigate. Then make me offer. Wm. P. Ossinger, 2037 Birchwood Ave., Chicago, Ill.

FOR Sale—My Foreign Patents on pocket sewing device. Great money maker. C. A. Myers, 6224 Woodlawn Ave., Chicago, Ill., U. S. A.

PARTNER wanted to help in manufacture of new kind of brass. Process patented. Will sell outright at proper price. Otto Najacht, 1002 N. Wells St., Chicago.

PATENT for Sale—Sanitary Cuspidors and Smoking Cabinet, Outright or Royalty. Wm. Smith, 405 W. State, Olean, N. Y.

FOR Sale—Patent on a Wall Paper Hanging Machine. Something new; fits any roll of paper. Can easily be operated by anyone. Made very simple. Weighs three pounds. Will sell for cash or royalty. P. B., P. O. Box 221, Jackson, Mich.

FOR Sale—Double action hand-saw setting device, patent No. 1,457,289. Stanley Borostewski, Patentee, 1009 Polk Street, Portland, Ore.

U. S. PATENT for improved pipe wrench, reasonable; for patent copy, and further information, address, William H. Wiegert, 93 Emerick St., Kingston, N. Y.

FOR Sale, a few hardware inventions of door and window. Fred Battemiller, 315 Brazil Ave., San Francisco, Calif.

WANTED—Royalty on revolving banana hanger, attachable to floor or counter; bunch lifted from crate by windlass and hangs over counter. Fred Minder, Pawnee, Ill.

A METAL collapsible combination double bed, table and benches for sale; can be folded so as to fit on running board of automobile. Will also sell patent rights on a combination davenport, couch, swing and crib. V. Hrachovina, 436 Superior St., St. Paul, Minn.

PATENT Pending. Improved tapping machine for light manufacturing. Write for particulars. Baum's Metal Specialties, Kansas City, Mo.

FOUNTAIN Tooth Brush. No competition. Partnership or royalty. G. Bjorkholtz, 6417 Greenview Ave., Chicago, Ill.

KITCHEN Memoranda. Proven success by sales of over a year. Tested and approved by Good Housekeeping. Cheaply manufactured. Wonderful advertising possibilities. W. W. Bonnell, 102 S. Harrison St., Bellevue, Pa.

PATENT on Rotary Snow Plows for all Cars. Robert Earl Haynes, 1917 Ave. C, Kearney, Neb.

SEVERAL Good Money Making Patents for Sale. Investigate. G. M. Beard, Auburn, Ind.

FOR Sale—Patent on Hard Grease Cup recently issued. This is the most practical hard grease cup yet produced. An unlimited market. Will sell outright or on royalty. For full particulars address Fred C. Grant, Bangerville, Maine.

DEVICE of wood and cork prevents spoiling of top ensilage in silos. Investigate. F. Bright, 208 W. 139th St., New York City.

NON-Spill Diner Coffee Cup, U. S. Patent; Sale or royalty. The closed cup eliminates soiled linen. Bertha E. Hodgkin, Russellville, Ind.

FOLDABLE screened rocking chair, against mosquitoes and flies. Stransky, 200 Greenway Ave., Darby, Pa.

YOU have a worth-while patent, haven't you. Why don't you tell our two million readers about it? Most of them are specially interested in patents and new inventions. Ask me to tell you how other inventors successfully sold their patents. Geo. F. Baker, Manager, Classified Advertising, Popular Mechanics Magazine, Chicago, Ill.

PATENTS For Sale: To sell, buy or obtain patents, write Patent News-P, Washington, D. C.

#### SURVEYING INSTRUMENTS

NEW and used surveying instruments direct from factory. Satisfaction guaranteed or money refunded. Wissler, 619 Broadway, St. Louis.

#### MODELS AND MODEL SUPPLIES

SPECIAL machine builders, tool and die makers, inventors' models, production work of all kinds. Dept. L, Quality Hardware & Machine Co., E. Ravenswood and Thorndale Avenues, Chicago, Ill.

MODEL steam engine  $\frac{1}{2}$ " x  $\frac{3}{8}$ " \$8.50. Finished parts for same, \$7.25. Other engines, boilers, blowlamps. \* Catalog for 10c stamp. Model Machine Shop Co., 417 East 71 St., New York City.

PATENTS Procured. Send sketch or model today for examination, prompt report and advice. No charge for preliminary advice. Write for free booklet and blank form on which to disclose your idea. Highest references. Promptness assured. Clarence A. O'Brien, Registered Patent Lawyer, 533 Security Bank Building. Directly across the street from Patent Office, Washington, D. C. See pages 159 and 151.

INVENTORS—Write for our Guide Book and "Record of Invention Blank." Send model or sketch of invention for our free examination and instructions. See advertisement on pages 152 and 153. Victor J. Evans & Co., 165 Ninth, Washington, D. C.

MODELS and Patterns made. Light manufacturing. Address H. W. Hathorn, Mason City, Iowa.

THE Modelmaker. For those interested in making working models. Send 10 cents. Address P. M. 120 Liberty Street, New York.

DIES, Tools and General Manufacturing. Models and Manufacturing of new inventions our specialty. Logan Machine Co., 222 S. Clinton St., Chicago, Ill.

MODEL Making and experimental work; Modern Shop, expert workmen. Manufacturing. Lamson Electrical and Mfg. Co., 625 W. Jackson, Chicago.

#### MANUFACTURING

LONG established manufacturer of auto accessories which are daily sold by practically all wholesale and retail accessory houses will consider manufacturing and distributing new automobile products, capable of equally wide sale through same channels. Patented articles preferred. Address Auto Accessory Manufacturer, Room 2104, 310 S. Michigan Ave., Chicago, Ill.

METAL-CRAFT!—Eventually Metal-Craft. Competent Engineers, Designers, and Producing Organization await your commands on dies, stamping, die-casting, deep pressing, screw-machine and wire products. Plating, Enameling, Burnishing, Wrapping and Packing to your specifications. Very reasonable. Large, completely equipped plant. "Your problem is our challenge to solve." Metal-Craft Manufacturing Company, Box 259-W, Chicago.

ELECTRIC pumps for circulating water in fountains, aquariums, advertising novelties, etc. Walter L. Haanel & Co., 4521 Ravenswood Ave., Chicago.

PATENTED Articles, Models, Brass Work, Machine Construction; Dies Made. Baum's Metal Specialties, Kansas City, Mo.

LET us manufacture it for you. Can quote low prices and can furnish a product you would be proud of. Ideas worked out and simplified. Models made. Metal parts made to drawings or sample. Simplex Tool Co., Woonsocket, R. I.

BOLTS, nuts, rivets. O. L. Dickey, 48 Trask, Bayonne, N. J.

OUR factory will make your models, manufacture your articles as well as build your tools, dies and fixtures. Standard Die & Specialty Co., 817 W. Washington Blvd., Chicago, Ill.

WIRE goods made to order. Cooley Mfg. Co., 524 N. Western Ave., Chicago.

EXPERIMENTS developed, dies, models and manufacturing machine designing. Estimates and information promptly given. Address Schroer Bros. Machine Works, 513 East 25th Street, Kansas City, Mo.

PATTERNS, wood and metal. Models, tools and dies. Brass, bronze, aluminum and iron castings. Screw machine work, production work of all kinds. Write Moore's Machine & Pattern Co., Terre Haute, Ind.

SCREWS, nuts, screw machine products, all metals. Autoscrew Works, 355 West Broadway, New York City.

IRON, Brass, Aluminum Castings, Models, Patterns, Light Manufacturing. Weich Brothers Co., North Chicago, Ill.

#### MACHINERY, TOOLS AND SUPPLIES

ONE Kempsmith Universal Milling machine, complete with dividing heads, \$275. 16" x 36" Pratt and Whitney Planer \$175. 16" x 19" Lodge Engine lathe, a bargain, \$190. Power hack saw, \$23.50. Write for particulars. Cincinnati Machinery Supply Co., 218 Pearl Street, Cincinnati, O.

FOR Sale. Rebuilt No. 60 Head Cylinder Grinder. Lucas & Son, Bridgeport, Conn.

SPECIAL Drills. Drills and taps out broken faucet screws. \$1.50 Postpaid. E. S. Specialty Co., 3415 Monroe St., Brooklyn, N. Y.

GANDY Thresher and Tractor Belts. Best endless canvas thresher belts made. Nationally known. Unusually low prices. Cast Iron Pulleys, Belting, etc. Folder Free. George Weitschurack, Lafayette, Ind.

CONCRETE Building Block Machines and Molds. Catalogue free. Concrete Machine Co., 303 South Third St., St. Louis, Mo.

STEPTOE'S medium priced line of Shavers, Milling Machines, Lathes and Die Slotters will reduce your manufacturing costs. Established since 1845. Catalog upon request. The John Steptoe Company, Stock Yards Station, Cincinnati, Ohio.

SPECIAL labor saving machinery designed and built. Punches and Dies and other special tools furnished for manufacturing work. Simplex Tool Company, Woonsocket, R. I.

#### ENGINES, MOTORS AND DYNAMOS

AUTO Engines for Power. Let us show you how to fix yours up to sell or use. Candee-Smith Governor Co., Springville, N. Y.

MOTORS—Manufacturers' Surplus Sale;  $\frac{1}{2}$  hp. \$8.50.  $\frac{3}{4}$  hp. \$32.50. 1 hp. \$54.50. 8-volt Charging Generators \$8.50. Complete Lighting Plants, Generators, Light Machinery. Write for Catalog. Motor Specialties Co., Crafton, Penna.

GENERATOR 32 Volt, 300 Watt \$16.00 500 Watt \$22.50, 1,000 Watt \$35.00.  $\frac{1}{2}$  Horse Alternating Motor connected to 25 Volt 5 ampere Generator \$30.00. Also bargains in other Motors, Generators and Motor Generators. Queen City Electric Company, 1736 West Grand Avenue, Chicago, Ill.

MOTORS— $\frac{1}{2}$  H. P. on stand, \$9.94 C. O. D. Miller, 302 Miller Bldg., Scranton, Pa.

BJUR Generators, brand new, 6 volts, maximum output 22 amperes at 2000 r. p. m. Government paid \$45.00 each, our price \$10.00. General Sales Company, 1919 S. Michigan Avenue, Chicago, Ill.

#### FOR MECHANICS

1,000,000 INDUSTRIAL Facts, Calculations, Receipts, Processes and Trade Secrets for every business are contained in the 1016-page book "Moore's Universal Assistant and Complete Mechanic," 500 Engravings, Cloth. Price \$2 postpaid. Popular Mechanics Book Dept., 205 E. Ontario St., Chicago.



**PATENTS**—Write for our Guide Books and "Record of Invention Blank" before disclosing inventions. Send model or sketch of your invention for examination and instructions. No charge for the above information. See advertisement on pages 152 and 153. Victor J. Evans & Co., 184 Ninth, Washington, D. C.

**LATHES** Handbook—The experiences of 106 lath operators in handling special jobs. A brand new book that is selling like hot cakes. Only 50 cents. Popular Mechanics Press, Room 805, Popular Mechanics Building, Chicago, Ill.

#### FOR THE SHOP

**MARK** Tools—Saws, Knives, Razors, Etc., with a rubber stamp, by Kent's Simple Etching Process. Particulars. Ed. Kent, 151 McCoppin St., San Francisco, Calif.

**MECHANICS!** You will seldom if ever get stuck on a job if you keep on hand for quick reference a 15-volume set of Popular Mechanics Shop Notes. At the price of 50 cents a volume, any one of the several thousand time and labor-saving hints may save you the cost many times over. Any one of the volumes may be purchased separately at the same price. Popular Mechanics Book Dept., 206 E. Ontario St., Chicago.

**JUST** Out! Shop Notes Book for 1924, comprising the 550 articles that have appeared in the Shop Notes section of Popular Mechanics during the past year. Bigger and better than ever. 242 pp., 455 illus., 50 cents postpaid. Popular Mechanics Book Dept., 206 E. Ontario St., Chicago.

#### ELECTRICAL

**WRITE** us about your small armature and field coil winding and commutators. Electric Fan Motor Service Corporation, 200 W. Monroe St., Chicago, Ill.

#### BLACKSMITHS

**SENSATION** of the season; the new Hossfeld Wrenchless Universal Bender; bends Eye bolts, U's, Angles, etc. Bends 1 1/4 in. standard Pipe cold. Also rolls perfect Automobile Spring Eyes. Machine can be instantly set for any kind or size of work without the use of a wrench. Simple, Powerful, Inexpensive. Send for circular. Universal Iron Bender Co., Inc., Winona, Minn. Representatives Wanted.

**BLACKSMITHS.** Listen! Make more money doing hard jobs easy with Toy's Modern Methods of Master Machine Blacksmithing, Forging and Solid Welding, Tool Dressing and Tempering to a standard with colored tempering charts. All for One Dollar. Samples Free. W. M. Toy, Sidney, Ohio.

#### FOR SALE—MISCELLANEOUS

**PAPERSHELL** Pecans, hand graded, pound \$1.40. Music rubber stamps, numbering machines, burning brands, stencil letters, sign alphabets, egg daters, seals, rubber type catalogue 25c. W. Karstaedt, Dayton, Ohio.

**FOR** Sale—Rebuilt fifteen-dollar France Chargers—eight dollars while available. These machines were taken in trade on larger apparatus. Factory guaranteed. Send for bulletin. France Mfg. Co., 10312 Berea Rd., Cleveland, Ohio.

**FREE!** Large Tube Dental Cream with every order for Shampoo Pearls 50c postpaid. National, 1252 Seventh Street, Milwaukee, Wis.

**ADDRESSOGRAPH.** Letter Folders, Multigraphs, Envelope Sealers, Duplicators, less than half price. Guaranteed. Pruitt Co., 170 N. Wells, Chicago.

**LET'S** Swap! Buy! Sell! What's ya got? What's ya want? Four Months dime. International Opportunity, Brookings, S. Dak.

**BUY—Exchange—Sell!** Many of our readers have for sale or exchange the article you are looking for—and lots of them are looking for the very items you want to turn into cash. Get together! Let our two million readers know your wishes—they'll help you! Send your ad today to Geo. F. Baker, Manager Classified Advertising, Popular Mechanics Magazine, Chicago.

#### WANTED—MISCELLANEOUS

**CASH** for old jewelry, teeth, gold, silver. Highest prices. Prompt payment. Mail to Baltic Mercantile Co., 10117 Baltic Rd., Cleveland, Ohio.

**MAIL** us your discarded Jewelry, Gold, Crowns and Bridges, Watches, Diamonds, Silver, Platinum, and old False Teeth. Money promptly mailed. Goods returned if offer refused. United States Smelting Works, (The Old Reliable), Dept. 71, Chicago.

**WANTED:** Light Machinery—Lathes—Drill Presses—Model High-Speed Gasoline and Steam Motors. Best Cash Prices Paid. Motor Specialties Co., Crafton, Penna.

#### REAL ESTATE, FARM AND ORCHARD LANDS

**FLORIDA** Orange Grove for \$1650. An association of orange growers and nurserymen, not land men, but residents wishing to rapidly develop this beautiful section, will sell you ten acres of fine, young orange or grapefruit grove for only \$1650, or \$165 per acre, about one-fourth cost elsewhere. Terms, \$750 cash and \$10 a month. Fine trees and fine land in Florida's great highland lake region. No swamps, palmetto or malaria. Save all agent's or middlemen's profits; buy from owners. No time for curiosity seekers or tourists, but if you want a grove, write for free book of actual facts and photos. Lake County Land Owners' Association, 93 Nursery Avenue, Fruitland Park, Fla.

**\$500** CASH Secures 110 Acres with Cow, Crops, Horse, poultry, furniture, implements, tools, etc.; near lake and village; good 7-room house, barn, etc. \$900 takes all, only \$500 needed. Details page 39 Bargain Catalog, best sections United States. Copy free. Strout Farm Agency, 150P Nassau St., New York City.

**320-ACRE** Black Hills Ranch, dairy, sheep, stock, cattle, Alfalfa bottoms; room for 100 tons Hay under roof. Running springs, fine body saw timber, game, Chas. Lehner, Sundance, Wyo.

**ATTENTION**—"Get acquainted." Cash for your property, Farm, Hotel or Retail Store, no matter where located; confidential service. Hayes' Business Agency, Cincinnati, Ohio.

**FOR** Sale—Three full sections in McKenzie County and two sections in Billings County, North Dakota. Each section contains land suitable for crops, balance for cattle. Each section has valuable deposits of lignite which some day will alone be worth many times the present value of the land. This part of the state is developing very rapidly with good schools within easy access. As owner cannot use this land himself, will sell one or more sections at a price which almost anyone can afford to pay. Address W., care Popular Mechanics, 200 East Ontario St., Chicago.

**20 ACRES** or more of our best land in Michigan; \$20 to \$50 per acre; near town 3,000 pop. \$10 down, bal. long time. 52 page book free. Swigart Land Co., P-1259 First Nat'l Bank Bldg., Chicago.

**SELL** your property quickly for cash, no matter where located. Don't pay big commission. Particulars free. Real Estate Salesmen Co., Desk B., Lincoln, Neb.

**\$5.00** DOWN, \$5.00 monthly; 10 acres unimproved property, fruit, stock, woodland; \$100; Ozark. Fishing, hunting, trapping. Alfred Zimmerman, 1800 N. Fifth, Kansas City, Kan.

#### DOGS AND PETS

**BEAUTIFUL** White Collie Puppies. Pedigreed stock; satisfaction guaranteed. Prices from \$20 to \$40. Banners Best Collie Kennel, Flora, Ill.

**BEAUTIFUL** registered bull pups cheap. Bulldogs, 501 Rockwood, Dallas, Texas.

**SILVERBLACK** Foxes \$350.00. Time payments. Booklet dime. Arthur Schamacher, Lockland, O.

#### POULTRY

**PROFITABLE** Poultry. 32 hens paid for \$3,000 home in 26 months. Booklet for stamp. Spencer, R. 1, Santa Cruz, Calif.

**CHICKS:** Leading varieties. Our big illustrated chick book free. Comfort Hatchery, Windsor, Mo.

**YOU** should turn lazy, profitless hens into hustlers and get the eggs. For free explanation, address Pentland Specialty Service, Two Thames Avenue, Norwalk, Conn.

#### PERSONAL

**UNUSUAL** Horoscope—Six pages, 2,500 words, consisting of extensive four-page Special Horoscope, Astro-Analysis, and two-page valuable guide giving daily and monthly advice covering entire year. Send 50c and birthdate. Money returned if dissatisfied. Prof. Bolles, Box 125, Cranford, N. J.

**KNOW** THYSELF! Wonderful Three Page Horoscope—your talents, character, friends, enemies, business. Send birth date, year, specimen of handwriting, and 10c. Gargilli Studio, Box 2771-D, Boston, Mass.

**LUCKY** Charms, Lockettes, Secrets, Occult Books, Catalogue 5 cents, Box 55-P, Station I, New York.

**ARE** You Old at Forty? See our advertisement on page 146 of this issue. The Electro Thermal Company, 2134 Main Street, Steubenville, Ohio.

**LUCKY** Days—Two years scientifically forecast. Birthdate. 50c. Satisfaction. Box 1646, Denver.

**YOUR** Horoscope — Business, Character Changes, Friends, Enemies. Send birth date and ten cents (stamps) for remarkable test reading. Zanya, 290-C. W., 70th St., New York City.

**TOBACCO** Kills manly Vigor. Quit easily. Cigarettes, chewing, smoking, snuff conquered or no charge. Small sum if satisfactory. Stops craving; harmless. Full treatment on trial. Perkins Co., 31-A, Hastings, Neb.

**TOBACCO** or Snuff Habit cured or no pay. \$1.00 if cured. Remedy sent on trial. Superba Co., TP, Baltimore, Md.

**FREE**—Information of a scientific nature that has brought happiness through perfect health to thousands. No charge; no obligation. Enclose stamp for reply. C. O. Wood & Co., Colorado Springs, Colo.

**FREE**—Stop using tobacco. We will give free information how to conquer habit easily and permanently. Results guaranteed. Anti-Tobacco League, Box K, Omaha, Neb.

#### MISCELLANEOUS

**FORMS** to cast Tin Soldiers, Indians, Marines, Trappers, Animals. 142 kinds. Send for Catalogue. Henry Schiercke, 1034 72nd St., Brooklyn, N. Y.

**LOCKSMITHS:** Send \$1.00 for valuable chart for cutting tumbler padlock keys. Globe System, 278 Washington St., Newark, N. J.

**UNIQUE** Catalog of dime bargains free. Clarence Edwards Co., Orland, Ohio.

**MAKE** Money Making Cuts By Simplified Photo-Engraving Process. Particulars 2 cents. Horton and Fisher, Box 42, Princeton, Ill.

**GET** posted—Good prices paid for butterflies, insects. See Sinclair display advertisement, page 59.

**TATTOOS** Removed in one week. Safe, sure and convenient. Mail dollar for complete instructions. W. E. Peck, 57 So. Bannock, Denver, Colo.

**REDDY**—"The Wonder"—Rubber repair kit, complete with illustrated book—how to make or repair 101 useful, attractive articles—pouches, tool cases, folding water buckets, etc., from old automobile inner tubes. \$1.00 prepaid. Put "Reddy" to work. Reddy Rubber Co., 149c Marvin, Akron, Ohio.

**ARE** You Old at Forty? See our advertisement on page 146 of this issue. The Electro Thermal Company, 2134 Main Street, Steubenville, Ohio.

**MONEY** in Minerals. Many common minerals have market value. List free. Minerals tested. Mineralogist, Zenlin, Mo.

**COIN** Operated Machines bought, sold, exchanged, repaired. Barr Novelty Company, Shamokin, Pa.

**ARTIFICIAL** Eyes, \$3. Booklet free. Denver Optic, 559 Barclay, Denver, Colo.

**HOMOEOPATHIC** and Biochemic preparations sent postpaid to all parts of the world. Manual and booklets free. Halsey Bros. Co., 111 N. Wabash Ave., Chicago, Ill. Established 1855.

**CUTS** anybody can make. Simple, cheap process. \$1. Specimens, particulars, 2c stamp. M. Day, Windfall, Ind.

**ROCKS** and Minerals for sale—hundreds of varieties—price List Free. Peter Zoda, 157 Wells St., Peekskill, N. Y.





## BECOME A RAILWAY MAIL CLERK

No strikes. No lockouts. When everybody else is worrying about his job or looking for work, the U. S. Civil Service Employee is earning good, steady pay in a pleasant occupation of his own selection. **EARN \$1600 to \$2300.** Let me train you to pass the U. S. Civil Service Examination with high rating so you can get a position quickest at \$1600 to \$2300 a year as a Railway Mail Clerk or in Customs, Internal Revenue, Departmental, Immigration, Postmaster, Post Office and Rural Branches. I have trained thousands to successfully pass the examination. Money refunded if unsuccessful in securing a position. Examinations Coming. Write today. Mail coupon for catalog.

Patterson  
Civil Service School  
Dept. 86, Rochester, N.Y.

Sir, Send me without charge your  
catalog describing this and other U. S.  
Government Positions.

**PATTERSON CIVIL SERVICE SCHOOL**  
Dept. 86  
ROCHESTER, N. Y.

Name.....

Address.....

## Trained Men Make Big Money in the Auto Business

Six weeks at the Cleveland Auto School will give you a training that is second to none. More than 7,000 of our graduates are now earning big wages in all branches of the business. Many own their own garages and are prosperous and respected members of their communities. You can do the same. Classes starting now. Write now for full information.



**THE CLEVELAND AUTO SCHOOL, 1814 East 24th Street, CLEVELAND, OHIO**

## Make Money Drawing Cartoons

*It's Easy To Learn When Shown In The Right Way*

Some of the cleverest cartoonists and comic artists in America today learned to draw during their spare time by following **CARTOONIST EVANS' SIMPLE AND EASY METHOD.** This school is recommended by foremost cartoonists because they know the students are handled right. If you like to draw, send a sample of your work, either an original or a copy, and we will send you a **portfolio of cartoons and full details.** The course is **NOT EXPENSIVE.**

**The W. L. Evans School of Cartooning** 821 Leader Building  
CLEVELAND, OHIO



**LEARN TO GET DOLLARS OUT OF WATCHES.**  
WATCH-REPAIRING. ENGRAVING. JEWELRY REPAIRING.  
**WRITE NOW.**  
ENICAR TRADE SCHOOL  
530 W MONUMENT SQUARE, RACINE, WIS.

**Perfect Health Absolutely FREE** through a Natural Law  
Address **ALOIS P. SWOBODA**  
1252 Berkeley Bldg. NEW YORK

## Are You Reaching for the Truth?

**I will tell you FREE**

Under which Zodiac Sign were you born? What are your opportunities in life, your future prospects, happiness in marriage, friends, enemies, success in all undertakings and many other vital questions as indicated by **ASTROLOGY**, the most ancient and interesting science of history?

Were you born under a lucky star? I will tell you free, the most interesting astrological interpretation of the Zodiac Sign you were born under.

Simply send me the exact date of your birth in your own handwriting. To cover cost of this notice and postage, **enclose twelve cents** in any form and your exact name and address. Your astrological interpretation will be written in plain language and sent to you securely sealed and postpaid. A great surprise awaits you!

**Do not fail to send Birthdate and to enclose 12c.**  
**Print name and address to avoid delay in mailing.**

Write now — **TODAY** — to the

**ASTA STUDIO, 309 Fifth Ave., Dept. 138, New York**





**\$400 to \$600 a Month for Auto Experts!**

# Big Pay for men trained by RAHE SHOP METHOD

## Auto Mechanics Earn Big Money!

Men trained by the Rahe Shop Method make big pay in steady jobs. William Sharp, of Albion, Pa., says "Since learning a trade in the Rahe Auto School, I am making \$3,000 a year and getting along fine". Mr. Sharp's experience is like that of thousands of other men who have received the thorough, practical Rahe training. Men who knew nothing about automobiles are *quickly* trained in our school.

## Rahe Trained Men Are Always In Demand

Every day there are calls from garages, automobile factories, etc., for men trained in Rahe shops. This demand means that we must train more men than ever before--the automobile industry must have skilled mechanics. We teach you in a few weeks to operate, adjust and repair all makes of motors, and to repair and build batteries. You learn quickly and thoroughly under personal supervision of expert instructors.

## The Rahe Course Is Complete

Under the "Rahe Shop Method" you are trained in every detail of automobile and electrical mechanics. After you complete our course you will be out of the small pay class--you can then do automobile work that pays big money.

## We Pay Your Railroad Fare

We pay your railroad fare to either our Pittsburgh or Kansas City School and provide room and board. Mail the coupon today, and we will send you our Special Offer for this month only.

## The Automobile Industry Needs Trained Men

# RAHE Auto and ELECTRICAL SCHOOL

916 Forbes Street 11th & Locust Sts.,  
Pittsburgh, Pa. Kansas City, Mo.

*"You must learn so that you can earn"*

*Henry Rahe*



*You learn by actual work with  
tools and motors*

**MAIL THIS COUPON NOW**

HENRY J. RAHE, President,  
Rahe Auto & Electrical School,  
916 Forbes Street, Pittsburgh, Pa.

P. M. Ju

Without any obligation on my part, please send me your booklet and full particulars, explaining your course in automobile and electrical mechanics, and your special offer.

Name \_\_\_\_\_

Address \_\_\_\_\_



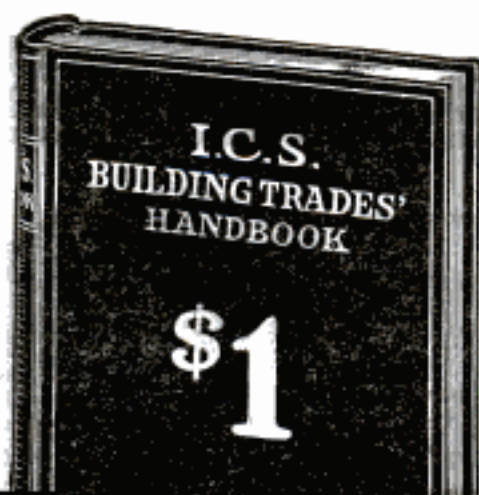

## BUILDING TRADES' HANDBOOK

409 pages  
263 illustrations

Only

A reference book for every man connected with the building trades. Contents:—

Blue Prints, Weights and Measures, Formulas, Mensuration, Geometric Drawing, Structural Design, Materials of Masonry Construction (stone, brick, terra cotta, lime, cements, sand, mortar, concrete), Carpentry and Joinery, Roofing, Steel Square, Plumbing, Heating, Estimating, Architectural Design, etc.

Thousands sold. Complete—practical—thorough. Easy to understand. Pocket size.

Just fill out the coupon below—slip it into an envelope with a dollar bill and mail, and this 409-page I. C. S. Building Trades' Handbook will come speeding to you by return mail.

**You run no risk  
Money back if desired**

### INTERNATIONAL CORRESPONDENCE SCHOOLS

Box 5607-D, Scranton, Penna.

I enclose One Dollar. Please send me—post-paid—the 409-page I. C. S. Building Trades' Handbook. It is understood that if I am not entirely satisfied I may return this book within five days and you will refund my money.

Name.....

Address.....



## Make more money Playing Tenor-Banjo

McNeil of Isham Jones Orchestra  
Will Show You How

The demand for competent players at salaries from \$75.00 to \$225.00 a week is still far from filled because leaders demand banjoists who can play *right*. Faking, ear-playing, ukulele tuning and various other make-shift methods do not fit in with the really good jobs.

Charles McNeil of the famous  
**ISHAM JONES ORCHESTRA**

has created a chord system that will teach you all you need to know in order to hold a top-notch position.

Formerly sold as a correspondence course for \$25.00. Price now, in 96-page book form, \$3.00. Send money order (P. O. or Express). The 400 chord inversions, all explained, are worth more than the price of the book. Write today!

**McNEIL CHORD SYSTEM, Dept. 6, 1644 Apple St. CHICAGO, ILLINOIS**

## LEARN Jewelry Making



### Easy To Learn

a delightful accomplishment, a money-making profession. \$10 for 30 lesson course. You complete two pieces of jewelry in first lesson. Tools for every article in course included FREE.

Send for illustrated booklet.  
N. Y. School of Jewelry Making,  
110 E. 23rd St., New York

**WHY NOT** spend Spring, Summer and Fall gathering butterflies, insects? I buy hundreds of kinds for collections. Some worth \$1 to \$7 each. Simple outdoor work with my instructions, pictures, price-list. Send 10c (not stamp) for my illustrated Prospectus before sending butterflies.

**MR. SINCLAIR, Dealer in Insects, Dept. 6, OCEAN PARK, CALIF.**



## Fibre-Lite Limbs

Easy Payments—Do Nature's Work.  
**AGENTS WANTED** who use Artificial Leg. **GOOD PAY.**  
FREE Fibre Sample.  
DESCRIBE STUMP TO **WORMAN CO. 252-P HENNEPIN AVE. MINNEAPOLIS, MINN.**

WRITE TODAY for

Our 168-PAGE

FREE BOOK on

## Deafness

and learn how Perfect Hearing is now being restored in every condition of deafness or defective hearing. Our "Little Wireless Phones for the Ears" require no medicine, but effectively replace what is lacking or defective in the natural ear drums. They are simple devices, which the wearer easily fits into the ears, where they are invisible. Soft, safe and comfortable.

**WILSON EAR DRUM CO., Incorporated**  
1110 Inter-Southern Bldg. LOUISVILLE, KY.

## DON'T WEAR A TRUSS

### BE COMFORTABLE—

Wear the Brooks Appliance, the modern scientific invention which gives rupture sufferers immediate relief. It has no obnoxious springs or pads. Automatic Air Cushions bind and draw together the broken parts. No salves or plasters. Durable. Cheap. Sent on trial to prove its worth. Beware of imitations. Look for trade-mark bearing portrait and signature of C. E. Brooks which appears on every Appliance. None other genuine. Full information and booklet sent free in plain, sealed envelope.



MR. C. E. BROOKS

**BROOKS APPLIANCE CO., 215 State St., Marshall, Mich.**





## SHOP WORK with a

# CARNES ARTIFICIAL ARM

FOR nearly ten years a Carnes Artificial Arm has kept Mr. Pahbe Yazze of Lawrence, Kan., on the payroll as a draftsman and machinist at a good salary. Thousands of other mechanics, artisans, office workers, farmers and laborers owe their independence to this improved arm.

**Life-Like in Action and Appearance**

The Carnes Arm cannot be detected from the natural except by close inspection. Its user can dress himself, use knife, fork, pen, pencil and keys; pick up large or small objects, carry grips—in fact, do virtually everything that was possible before. He can bend the elbow of the Carnes Arm, bend and turn the wrist and open and close the fingers at will, even if the amputation is at the shoulder.

**192-Page Book FREE.** A book of 192 pages, profusely illustrated with photographs showing what can be done with this remarkable invention, will be sent free to any person interested. Send for it now.

**CARNES ARTIFICIAL LIMB CO.,**  
208 Carnes Bldg., Kansas City, Mo.

Imported Japanese Bamboo Self-filling  **FOUNTAIN PEN.** Stylus point improves with use—longer used, the smoother it writes. Capillary attraction controls the ink, no blotter necessary. Written guarantee—satisfaction guaranteed for one year. Retail \$1.25. Sample 60c. 100,000 German marks free. Dozen pens, \$5.00.

**TOKYO IMPORTERS, 608 1/2 Vine Street, CINCINNATI, OHIO**

## QUIT TOBACCO OR SNUFF RUINING YOUR HEALTH WASTING YOUR MONEY

Harmless treatment quickly overcomes craving for cigars, cigarettes, pipe, chewing or snuff. Sent on trial. Costs \$1.00 if it cures, nothing if it fails. Used by over 400,000 people. Superba Co. H-2 Baltimore, Md.

## Try This on Your Hair 15 Days



Then let your mirror prove results. Write Today for FREE Trial Offer. Your hair need not thin out, nor need you become bald, for there is a way

to destroy the microbe that destroys the hair. This different method will stop thinning out of the hair, lifeless hair, remove dandruff, itching, darken gray hair and threatened or increasing baldness, by strengthening and prolonging life of the hair for men and women. Send your name now before it is too late for the 15 days' free trial offer.

**AYMES CO., 3932 N. Robey St., M. 390, Chicago**



## GARTER FOR CROOKED LEGS

(PATENTED)

**Makes Trousers Hang Straight**  
If Legs Bend In or Out  
Self-adjustable It holds  
**Socks Up—Shirt Down**  
Not a "Form" or "Harness"  
No Metal Springs Free Circular

**THE T. GARTER CO.,**  
Dept. 29 SOUTH BEND, INDIANA

# Free

latest BOOK on  
**HEALTH and BEAUTY**

Enjoy  
**NEW**  
SCIENTIFIC  
**Discovery**  
**FREE**  
**Trial**  
in Your Home

for Men  
and  
**Women**  
Sent  
Prepaid



## "Wonder Mist" VIOLET RAY

### New Scientific Discovery

Our FREE book describes this marvelous strange force, tells how "Wonder Mist," improved Violet Ray, revitalizes every cell and works miracles overcoming pain and sickness. Physicians and plain folks explain how "Wonder Mist" has made them well, strong and happy. 64 pages, illustrated, actual photographs, scientific charts and diagrams. It's FREE.

### QUICK RESULTS—No Medicine

"Wonder Mist" works quickly; it's scientific, goes after the cause. That's why results are quick, permanent. Dr. Duncan, Kewanee, Ill., writes, "Wonder Mist" is the finest thing I ever used . . . to relieve pain, treatments are so pleasant all my patients like it." Use it at home. Save Doctors' bills. Brings natural magnetic beauty of health, no dieting, exercise or drugs.

Partial list of ailments successfully treated with "Wonder Mist"

Catarrh	Headache	Rheumatism
Colds	Goitre	Skin Diseases
Constipation	Insomnia	Sore Throat
Earaches	Lumbago	Whooping Cough
Eye Diseases	Nervousness	Asthma
Falling Hair	Neuritis	
Hay Fever	Piles	

### EARN CASH

Men, women, without experience earn liberal profits in spare time show "Wonder Mist" to neighbors. Proves results and sells on sight. Get offer, wholesale prices.

### SEND FOR FREE BOOK

Explains how Nikola Tesla discovered "Wonder Mist", how it works, why it heals. Tells how to conquer pain, disease and nervous trouble.

Reveals Marvelous Scientific Discovery. Shows charts of human body, explains where pains start, how to banish them. Offered Free for a limited time only, to introduce "Wonder Mist." Send for Free copy.

**VI-REX CO., 211 S. Peoria St., Dept. 25, Chicago, Ill.**

### MAIL COUPON — SEND NO MONEY

**VI-REX CO., 211 S. Peoria St., Dept. 25, Chicago, Ill.**  
Please send me, without cost or obligation your free 64-p. book describing your VI-REX "Wonder Mist" outfit, and details of your FREE Trial Offer.

Name \_\_\_\_\_

Address \_\_\_\_\_

City \_\_\_\_\_

State \_\_\_\_\_



## I Can Train You For A \$3500 Hotel Job in 20 weeks



The Hotel Business offers wonderful opportunities to the trained man or woman! Now fourth largest industry in America. Hundreds of high-salaried executive positions now standing open—waiting for the trained worker. You can easily qualify for one of these big-paying jobs—in your spare time at home. No previous experience necessary.

### I Guarantee to Teach You

in my 50-lesson home-study course on hotel work, all that the leading hotel experts know about the business—men making from \$5,000 to \$50,000 a year! My students are eagerly sought by the biggest and best hotels in the country. You won't have to look for a job. Big pay, fine living, free meals and apartment, fascinating work—these are only a few of the many advantages of hotel work.

### Send for FREE Book

20 Years' Experience in 20 Weeks is what this wonderfully complete course gives you. Course prepared by Clifford Lewis, a hotel expert of national reputation. Endorsed by managers of such hotels as Biltmore, Waldorf-Astoria, Copley-Plaza, Commodore, etc. Interesting free book explains all. Send for it today.

### LEWIS HOTEL TRAINING SCHOOLS

Founded 1915. The Original Hotel Training School

CLIFFORD LEWIS, President

Room G-330 Washington, D. C.  
The National Institute for Hotel, Restaurant and Tea Room Training

# AGENTS

## Make \$25 a Day in Summer



"Made \$742.50 in one month."  
—R. W. Carter, Mass.

Many make more than that. Bentley of Philadelphia writes, "Ye Gods! Some Summer Seller. Made \$215 today."

### Sells Itself

It only takes 15 minutes to demonstrate the wonderful Oliver Oil-Gas Burner. No wonder agents are cleaning up fortunes.

### Big Summer Seller

It offers relief from sweltering Summer kitchens—from the dirt and drudgery of coal and wood. Every housewife wants one the minute she sees it. Over 200,000 already installed.

Cheap, clean, safe, odorless, wickless—any heat at turn of valve. Perfect baking and cooking.

### Exclusive Territory

Write quick to get details of our Exclusive Territory and Free Sample Case Offers. Many agents clean up from \$1000 to \$3000 every Summer. You might as well be one of these. But you must act quickly to be sure of getting a territory. Get a letter in the first mail to

### OLIVER OIL-GAS BURNER CO.

Oldest and Largest Manufacturers of Oil-Gas Burners in the World.  
657 Oliver Bldg., St. Louis, Mo.

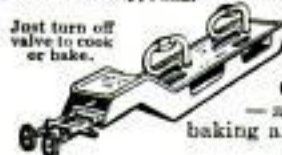

Just turn off valve to cook or bake.



## COMMERCIAL LETTERING PAYS

More artists make a start in art through knowledge of lettering than in any other way. Send 25c stamps for lettering book and pens. Make the start now. Price list of drawing material and equipment on request.  
**BART SUPPLIES, MINNEAPOLIS**

## AGENTS WANTED

# Security

CHECK-PROTECTOR  
FOUNTAIN PEN

SECURITY PEN CORPORATION  
Dept. O 910 W. Jackson Blvd., CHICAGO

# ELECTRICITY

## AND THE ONE BEST WAY TO LEARN IT

This great profession will make your successful future a certainty.

The School of Engineering of Milwaukee has specialized for 19 years in training young men for

### Electrical Engineering

With a B. S. Degree in 3 Years.

Institute of Electrotechnics

(Academic and Electrical Training)

—12 to 30 months, depending upon previous education.

Electrotechnicians are in great demand and draw Big Pay.

**Commercial Electrical Engineering**—1 year for high school graduates.

**Automotive Electricity**—a 3 to 6 months' course will make you a highly paid specialist on all types of starting, lighting and ignition systems.

**Armature Winding**—and Motor Generator Repair—through 3 months' course.

**Practical Electricity**—6 to 12 months' course to become a Master Electrician. We will **AID YOU EARN YOUR WAY**

**THROUGH COLLEGE**, through our practical plan of co-operative industrial employment. Board and room at cost. Student activities, orchestra, daily broadcasting WIAO.

**SPRING TERM NOW OPEN.** Write TODAY for latest catalog and full details. Mention age, education, and course of interest.

**SCHOOL OF ENGINEERING**

of Milwaukee

E808 415 Marshall Street, Milwaukee, Wisconsin



## STANDARD Trade School Graduates Earn \$75 to \$200 a Week

You, too, can become a trained expert. Cash in on the big pay jobs. We guarantee to teach in a few short weeks. You learn by our "on-the-job" methods, without books or rules, but with your head and tools. You will be under the personal supervision of experts.

**Standard Training** includes these auto and building trades—Auto Repairing, Auto Painting and Trimming, Metal Finishing, Auto Electrician, Battery Expert, Vulcanizing and Retreading, Bricklaying, Plastering, Plumbing, Construction Electrician.

If you really have ambition, if you have the grit and determination to get into your proper place, grasp this opportunity NOW to earn more money and to occupy a worthwhile position in the world. Mr. L. A. Mandral, a STANDARD TRADE GRADUATE, earned \$89.50 his first week and he expects to double it.

Hundreds of OUR GRADUATES are MAKING GOOD—so can YOU

Write today for our big free catalogue.

**CLIP THE COUPON—NOW!**

**STANDARD TRADE SCHOOL**  
416 Woodward Avenue, Detroit

- |   |   |
|---|---|
| Auto Repairing <input type="checkbox"/> | Auto Metal Finishing <input type="checkbox"/>     |
| Auto Painting <input type="checkbox"/>  | Auto Battery Building <input type="checkbox"/>    |
| Auto Trimming <input type="checkbox"/>  | Auto Electrician <input type="checkbox"/>         |
| Bricklaying <input type="checkbox"/>    | Plastering <input type="checkbox"/>               |
| Plumbing <input type="checkbox"/>       | Construction Electrician <input type="checkbox"/> |

Name .....

Street.....City.....



# Thirty Lessons In Swimming by the Greatest Coach in America for less than 10c a lesson

**T**HINK of it, a complete thirty lesson course in swimming by the man who has developed more world and national swimming champions than any other coach in the history of swimming. Among his pupils are Miss Ethelda Bleibtrey, double Olympic champion, Miss Helen Wainwright, Miss Aileen Riffin, all record holders, and, greatest of all women swimmers, Miss Gertrude Ederle. Mr. Handley is also swimming coach of the New York Athletic Club and captained and coached its water polo sextet which held the national championship for more than ten years.

## Everybody Ought to Swim and NOW Anybody Can

Everybody wants to swim and everybody ought to swim. Swimming is a glorious sport and greater still as a health and body building exercise. Only when you race through the water every muscle and nerve tingling with the joy of real health can you realize how wonderfully beneficial it is. For men and boys swimming is an ideal sport for developing vitality and endurance; for girls and women a sure way to slender hips and a shapeliness of limb that is the envy of all non-swimmers. Swimming avoids the sharp encounters of other women's sports and gives an all-around development that is remarkable. And think of the fun you can have this summer on your vacation if you learn now, at the beginning of the season.

## The Self-Teaching System of a Master Coach

Never before was it made so easy to learn to swim. Mr. Handley's remarkable self-teaching system is so clearly explained, so lucidly written that you don't need any one to explain the instructions or any one to help you in the water. The illustrations show every feature of each stroke. The directions are concise and easily remembered. And you are taught the complete stroke at one time so that you can go immediately into shallow water and with the utmost confidence begin to swim. No need to learn separate arm and leg movements, no need for tedious and tiresome land drills, no

need for rubber wings or for someone to hold you up, you begin to swim at once. Then Mr. Handley takes you back and shows you how to improve each separate movement, how to get drive into your leg action, how to handle your arms to the utmost advantage and how to time each movement into a perfectly harmonious action that takes you through the water at lightning speed.

The system developed by Mr. Handley is absolutely unique in the shortness of time it takes to teach you to swim. Think of learning to swim in one or two half hour periods. That is all the time it takes to learn the whole of the famous crawl stroke by this new method. Think of it, in half an hour or an hour you are really swimming. Don't let the fact that you have never attempted to swim before deter you. This course will quickly convince you that you can become an expert in an amazingly short time. Nor does the course stop with merely teaching you how to swim, it teaches you all the more popular strokes such as the crawl, back stroke, breast stroke and trudgeon, and how to perfect yourself in each. Also how to float, how to tread water, how to save and resuscitate a drowning person and a great deal more than space permits telling here.

## Send for this Course on 10 Days' Trial

We want you to see this course — to study this method by which thousands of others have learned to swim — to try it out and satisfy yourself that you too can quickly learn to swim — not just paddle around — but really swim. Then, if you like, keep the thirty lessons and go on developing into an expert, or you can return the course to us and your money will be immediately refunded.



**L. de B. HANDLEY**  
Swimming Coach  
New York A. C.,  
New York Women's  
Swimming Assn.  
and Coach American  
Women's Olympic  
Swimming Team

You have always wanted to swim — always said that some day you would learn. Here is a wonderful opportunity to learn for only a fraction of what personal instruction would cost. Thirty lessons for less than ten cents a lesson and six big 25c issues of the fastest growing health and body building magazine in America in the bargain.

But to make sure of the course you must make your reservation at once as this offer may be discontinued without notice. So mail the coupon today.

## THE MILO PUBLISHING CO. 2739 Palethorpe St., Philadelphia, Pa. Publishers of *STRENGTH* Magazine

The Milo Publishing Company, P.M. 6-24  
2739 N. Palethorpe St., Philadelphia, Pa.

You may send me L. de B. Handley's complete course "Thirty Lessons in Swimming" and enter my subscription to *STRENGTH* Magazine for six months. Upon receipt of the course I will deposit \$2.85 (plus actual postage) with the postman in full payment for both the course and the magazine, with the understanding that if at the end of 10 days I am not entirely satisfied I may return the course and have my money immediately refunded.  
(Please write plainly)

Name.....

Address.....

City.....

Canadian (\$3.10) and foreign (\$3.35). Orders must be accompanied by cash (U. S. funds) subject to money back guarantee if not entirely satisfied.

**B**elieving *STRENGTH* Magazine will appeal most strongly to readers interested in Mr. Handley's splendid swimming course we have included a six months subscription to *STRENGTH* Magazine in our offer. *STRENGTH* is preeminently the magazine for the physical culturist and health seeker. Every issue contains dozens of articles on exercise, sports, and the great outdoors for both men and women. Money cannot buy health but *STRENGTH* can and will show any man or woman how they can get health and keep it after they have it. If you are not reading *STRENGTH*, you are missing something. Get acquainted NOW: there are some very pleasant surprises in store for you. Take advantage of this offer. When you have looked over the magazine and the course make your decision. If you are not delighted your money will be immediately refunded. But act without delay, there is no time to lose.



# I make Champs

I can do for you what I have done for thousands in every branch of athletics—whether it be for pleasure or as a profession, I can guide you. Ask Charles Daniels, champion swimmer, Tim Jordan, home run hitter, Oswald Kirby, former golf champion, Harry Babcock, World's champion pole vaulter, and a long list of others. They will tell you that my system always starts a man right and keeps him right. My system never fails. Over 25 years as a trainer in all branches of sports is my record—and I can still make the present day record holders step some to keep up with me.

**28 Champs  
to my  
Credit**



## "Pep Up"—Let Me Help You

I hold the all-around world's championship. Picture No. 1 is a photo of myself. It shows my perfect body development. I don't just develop you so that you can show off. I pep you up, so that you are better able to do your daily work. I don't try to make you do something you don't like. I let you pick the exercise or sport you like best—whether it be body development, boxing, golf, running, swimming, baseball or any of the fifty other sports. I tell you how to become perfect in the sport of your own choice. When you get fun out of something, you surely get all of the real exercise, body development and limbering up anyone needs. I actually guarantee to make you expert in the sport you select. You will find several sports pictured here, but these are only a few of the many I can help you in.

### Booklet FREE

Write me telling what sport you are interested in and I will advise you personally, and send you a booklet describing your needs and my system. Do it now. My system never fails.

**DR. P. M. SEIXAS**

**SEIXAS ATHLETIC SYSTEMS, Inc.**

Suite 503T, 280 Broadway, New York.

Please send me Free Booklet by return mail. I am interested in..... This obligates me in no way whatever.

Name.....

Address.....

City..... State.....

## EAR TROUBLE ADVICE FREE

You can easily get rid of deafness, ear aches, head noises and all other ear troubles. Mr. Folds suffered 15 years and was relieved almost at once. Read his book, "How to Take Care of the Ears." FREE. Send for it today. Dept. N., Aurine Remedy Co., 1801 S. Racine Ave., Chicago, Ill.

## STOP USING A TRUSS

Do Away With Steel And Rubber Bands

# FREE TRIAL



Inner surface is made adhesive to secure the PLAPAO-PAD firmly to the body, keeping the PLAPAO continually applied and the pad from slipping. No straps, buckles or springs attached. Soft as velvet—easy to apply.

It's the Non-Slipping, yet Non-Rigid Pad and What is Within It That Counts

## FREE to 5,000 Truss Sufferers

To the extent of 5,000 sufferers who may apply I will send, ABSOLUTELY FREE, a sufficient quantity of the Plapao to positively convince them that this is the only logical, commonsense way of treating rupture. Plapao is a highly astringent medication placed within the Plapao-Pad and being absorbed through the skin, creates a wonderful feeling of relief and at the same time tends to strengthen the weakened muscles and thus permanently close the rupture opening. The process of recovery is natural, so you'll have no use for a truss—you can throw it away forever! Old and young have testified under oath that the Plapao-Pads cured their rupture—many of them long-standing, aggravated cases—without delay from work. Patent allowed in U. S. and foreign countries. Awarded Gold Medal at Rome and Grand Prix at Paris.

Send No Money—for a sufficient quantity of the Plapao is sent without charge to enable you to give it a thorough test; you pay nothing for this trial now or ever. Write for it and full information today. Address: Plapao Laboratories, Block 1427 St. Louis, Mo.

## BECOME A Commercial Electrical Engineer In One Year

Fascinating new branch of the Electrical Profession. He knows business as well as the technique of electricity. He is a Consulting Efficiency Engineer, the man who knows how to solve commercial engineering problems. Master it here—in America's Greatest Institution for Electrical Education. Other courses: Automotive Electrical Engineer, 1 year; Armature Winding, 3 months; Practical Electricity, 6 months; Electro-technics, 18 months; Automotive Electricity, 3 months; Electrical Engineering, B. S. Degree, 3 years.

### EARN WHILE YOU LEARN— FREE BOOK TELLS HOW

19th year now opening. Write quick for big FREE Book, giving you full details of this great school. State age, education and course interested in.

**SCHOOL OF ENGINEERING**  
of Milwaukee  
Dept. C588 415 Marshall Street, Milwaukee, Wisconsin



The  
BOOK  
OF  
FATE

Send  
birth  
date

## What is Going to Happen to You?

Do you fear what the future has in store for you? Are you constantly worried that something dreadful is going to happen? Stop worrying. Learn what the stars predict. The ancient science of astrology reveals all. Simply send in your name and address and I will interpret the Zodiac sign you were born under. Be sure to state the exact day, month and year of your birth in your own hand writing. Enclose 12c to cover cost of mailing and postage. Your astrological reading will be sent you written in plain language, mailed sealed, postpaid. You will be overjoyed with the good news. Don't wait, send birth date and 12c NOW.

**VIRGO WILL FREE  
TELL YOU**

VIRGO STUDIO, 38 Howard St., New York, Dept. 655



# Don't Envy Successful Salesmen—BE One!

Those fellows who are making anywhere from ten to thirty thousand dollars a year—who travel first class, stop at the best hotels, are in daily contact with prosperous business men—did you ever figure out what it is that enables them to **SELL** with such success?

It can't be size—or good looks!—

Otherwise keen sales executives would specialize in furniture heavers and chorus men—whereas some of the best salesmen you ever knew measure less than five feet five and are so homely that you actually feel sorry for them.

It can't be schooling—

Otherwise only college graduates would hold the records—and men like Schwab wouldn't have a chance in the world.

It can't be any special GIFT which they inherit—

For there's many a salesman straight from the land where the tall corn grows—his father a farmer and his father's father before him—who fairly astonishes the "boss" at the way he brings in the business.

If it isn't any of THESE things—then it is surely possible for ANY man of average intelligence—provided he has the courage to TRY and the willingness to LEARN—to become a successful salesman.

—For the REASON for success in selling is nothing more nor less than the knowledge and application of SALES-MANSHIP.

GET that knowledge and APPLY it—whether you are now in the selling field or not—and we predict that your income will mount and will NEVER CEASE TO MOUNT—so long as your health is good and you stay in business!

## How You Can Get the Training That Will Bring Success

A bold statement, you may think—but it is based on bed-rock facts.

When LaSalle Extension University was preparing its training in Modern Salesmanship, it made a careful study, over a period of years, of the selling processes of more than a thousand outstanding salesmen engaged in selling a wide variety of products and many different types of service. These men were already rated as exceptional. Their records proved it.

Under the direction of a nationally known sales executive—himself a \$50,000 man—the particular methods which were found to yield the highest percentage of results were sifted out—and for two years, and at a time when selling was anything but "easy," more than four hundred salesmen—comprising a number of separate sales crews—were instructed to specialize in these particular selling methods.

Out of this test came unusual and often surprising results. The best men on various forces—in lines ranging from boots and shoes and electrical apparatus to motor cars and life insurance policies—thru the basics furnished them MATERIALLY INCREASED THEIR SALES.

One salesman stated that what was furnished him was responsible for the establishing of more than 100 new accounts in his territory and a large increase with his old trade.

Increases of 100% and in some cases 500% were reported.

On the strength of these findings, the identical principles and methods used by these men and proven sound and practical by the severest kind of tests, were organized and incorporated into the present training offered by LaSalle in Modern Salesmanship.

And AGAIN they are proving out—as witnessed by the following statements, typical of hundreds that have been received by LaSalle within the last few months:

"The first two texts have given me so much that I am firmly convinced that if I never learn anything more from the course, I would have a full return for the entire investment. I tell you frankly that I would not take \$25,000 for my scholarship if another could not be had."—C. J. JONES, Canada.

"From a salesman in the ranks, in two short months



my sales have shot up nearly 150 per cent, and I have received a promotion from a company I had been with only six months. I am now a district manager with eleven men working under me. Not only have my immediate sales shown an increase—and right in the middle of the summer months—but I have had a keener grasp of the principles of selling. I know the meaning of 'fundamentals' now; I know that by the application of certain definite truths, certain definite results can be attained. My effort, formerly more or less of an uncertainty, is now a certainty. Getting down to brass tacks, I know what I am doing now."

—C. RUTHERFORD, Ontario.

## Send for "Modern Salesmanship"

To explain within the brief limits of a page how LaSalle training in Modern Salesmanship is conducted, or to give more than the barest hint of its value to the man ambitious to develop as a salesman, is impossible. We have therefore prepared a 66-page book entitled "Modern Salesmanship"—an interesting and compelling presentation of the present-day opportunities in salesmanship and a clear outline of the way they may be quickly realized.

No man engaged in selling—or looking forward to salesmanship as a career—should be without a copy of "Modern Salesmanship." The University will be glad to mail a copy to any man who marks and signs and mails the coupon just below this text. There is, of course, no obligation.

—INQUIRY COUPON—

## LASALLE EXTENSION UNIVERSITY

The Largest Business Training Institution in the World

Dept. 664-SR Chicago, Illinois

Please send me catalog and full information regarding the course and service I have marked with an X below. Also a copy of your book, "Ten Years' Promotion in One," all without obligation to me.

### Modern Salesmanship

Training for position as Sales Executive, Salesman, Sales Coach or Trainer, Sales Promotion Manager, Manufacturer's Agent, Solicitor, and all positions in retail, wholesale, or specialty selling.



**Other LaSalle Training Courses** LaSalle is the largest business training institution in the world. It offers training for every important business need. If more interested in any of these courses, check here:

- |   |  |
|---|--|
| <input type="checkbox"/> Business Management        | <input type="checkbox"/> Modern Business Correspondence and Practice |
| <input type="checkbox"/> Traffic Management         | <input type="checkbox"/> Modern Foremanship and Production Methods   |
| <input type="checkbox"/> Higher Accountancy         | <input type="checkbox"/> Personnel and Employment Management         |
| <input type="checkbox"/> Railway Station Management | <input type="checkbox"/> Expert Bookkeeping                          |
| <input type="checkbox"/> Law—Degree of LL. B.       | <input type="checkbox"/> Business English                            |
| <input type="checkbox"/> Commercial Law             | <input type="checkbox"/> Commercial Spanish                          |
| <input type="checkbox"/> Industrial Management      | <input type="checkbox"/> Effective Speaking                          |
| <input type="checkbox"/> Efficiency                 | <input type="checkbox"/> C. P. A. Coaching                           |
| <input type="checkbox"/> Banking and Finance        |  |

Name .....

Present Position .....

Address .....





GARAGE



MOTOR REPAIRING



ELECTRIC SERVICE



BATTERY



# These Jobs Pay A Better

Get into the automobile business to make big money. More trained men are needed now. Over 15 million cars now in use. All need repairing, overhauling. Motorists want to economize—make their cars last twice as long. Trained men must keep them in repair. 70 million tires to be re-treaded, put into longer use. Millions of batteries must be repaired. Right now this spells the greatest money-making opportunity in the world for ambitious, red-blooded, "go-getting" men.

## More Money Spent for Repairs Than for New Cars

I wonder if you realize what an enormous business the repairing of cars really is. Last year the selling price of all the new automobiles sold was \$2,500,000,000, on which the dealers made a net profit of 3%, or \$75,000,000. But look at this: the selling price of parts used on repair jobs was \$2,900,000,000 or \$400,000,000 more than the price of the new cars, and the profit on these repair parts was 15%, or \$435,000,000. Nearly six times as much profit on service as on new cars.

But look again: this is only on the parts used in repair jobs; it doesn't include the charges for the work, which run as high or higher than the parts and materials. When you add that, you see that the money spent for repairs is many times greater than the money spent for new cars. **The repair business is the business to get into.** And now is the time to get into it.

## NO EXPERIENCE NECESSARY

In a few short weeks, under "Michigan State" guaranteed training, you can become a first-class, all-around, practical auto and tractor mechanic, capable of filling a garage job at bigger pay. Or, you can quickly become an Auto Electrician, and double your earnings. You can go into business for yourself—start a garage—electric service station—tire repair shop—battery station—or welding shop. You can sell cars, trucks, tractors, farm-lighting systems or engines. It's a great business—a certain money-making future. Special course in Business Management and Salesmanship is included at no extra cost.

### Endorsed by Big Factories Read These Letters

**DODGE BROTHERS**  
INCORPORATED  
DETROIT, U. S. A.

"We believe the Michigan State Automobile School of this city to be an exceptionally high class school, and no doubt a diploma from this school would assist materially in obtaining employment with high class automobile dealers."



**BUICK MOTOR COMPANY**

"We believe the MICHIGAN STATE AUTO SCHOOL, Detroit, would best meet your requirements, as its course of technical training is most thorough and complete in every detail."

**THE STUDEBAKER CORPORATION**  
OF AMERICA

"We do not know of a better automobile school than the MICHIGAN STATE."

## YOU, TOO, CAN SUCCEED!

You have the ambition—you want success. Success is certain if you are willing to work for it. You can have independence—be your own boss—stop the plodding, get into work you like. Earn big money, be prosperous, happy and independent. You can do it just as well, or better, perhaps, than Ed. Wambhof, who writes: "I now have charge of a garage and average \$350 to \$375 a month." Thousands of similar successes among "Michigan State" graduates. Records seem amazing, but they are only ordinary. It is all done through head and hand training at the "Michigan State." Decide now to give yourself the training that will pay you big, and establish you in a successful life work.

## COME TO DETROIT—THE AUTO CENTER

*To the School in the Heart of the Automobile Business*

Come to Detroit, to the MICHIGAN STATE AUTOMOBILE SCHOOL. This is the way to get started right, up the ladder of success. Detroit, the automobile center, in the heart of the industry, is the logical place to learn the auto trade. Here a car fare will take you to the great FORD plants, or the PACKARD, the CADILLAC, the HUDSON, ESSEX, HUPMOBILE, RICKENBACKER, PAIGE, STUDEBAKER, MAXWELL, LINCOLN, DODGE, or to more than two hundred and fifty accessory factories—right in the very headquarters of the business at the fountain head of this great industry. 79% of all cars are made right here. No other place can give you the same opportunity for first-hand knowledge.

# MICHIGAN STATE

306 Auto Building

Detroit, Mich.





WELDING



MACHINE SHOP



TIRE REPAIRING



SELLING

# \$200 to \$500 a Month

## Job Now!

### Train Head and Hand! By Factory Endorsed Methods

Who knows better how to teach autos, trucks and tractors than the men who build them? These men know how training should be given to make the most valuable men. The courses of the "Michigan State" (Detroit's Auto School) are outlined with the assistance of the leaders of the Auto industry and are endorsed by them. Here you have up-to-date equipment, latest model cars, trucks, engines, transmissions, axles, electric equipment, etc.—everything complete to give thorough training.

### Spend Your Summer at Detroit "The Summer Resort" City

Where business is always good. Where weather is always fine. Detroit's location in center of the Great Lakes gives it ideal climate, not too cold in winter, not too hot in summer. Get away from the burning sun into the cool breezes of Michigan. After school hours, enjoy boat trips, swimming, fishing, sailing, canoeing on the lakes and river. See Major League baseball games—see Ty Cobb, Babe Ruth, Eddie Collins, Tris Speaker, Walter Johnson, George Sisler—all the stars. Spend a pleasant summer and **improve yourself at the same time.** We work hard up here but we believe in some good times too.

### DAY OR EVENING CLASSES— EARN YOUR WAY

The quickest way to learn is in day classes. But you can work your way through if you have to. Our Free Employment Department will get you a job in Detroit and you can take the evening classes. Exactly same training, under same instructors, on same equipment.

### DETROIT-TRAINED MEN GET BEST JOBS

The MICHIGAN STATE AUTOMOBILE SCHOOL is known the world over. Wherever autos are used—Detroit-trained men get the best jobs, highest pay. Auto, truck, and tractor factories employ "Michigan State" graduates. Leading factories, dealers, garages, and farms want men who have trained their heads as well as their hands—the "Michigan State" Detroit-kind.

### This ILLUSTRATED CATALOG

Decide NOW that you will make more money. Decide NOW that you will forever discard the old, plodding, low-pay life. Make a success! You can do it! Work is a pleasure when you like it. Learn all the interesting facts. We will send you FREE, without obligation, this big illustrated book that tells all about it, and what the "Michigan State" can do for you; also book "Who Are the Best Judges of An Automobile School?" Positive proof. Don't fail to get it. Send coupon or post card today.

## AUTOMOBILE SCHOOL

3729 Woodward Avenue, Detroit, Mich.



A.G. Zeller  
Pres.

### Money Back Guarantee

I personally guarantee that a course of training in this school, the Michigan State Automobile School, will qualify you for a position as repair man, demonstrator, auto electrician, garage man, automobile dealer, tractor mechanic and operator, chauffeur or farm lighting expert; or refund your money. A similar guarantee is made with all courses. Each course includes Life Membership with privilege of our service without charge at any time.

A. G. ZELLER,  
President and General Manager  
MICHIGAN STATE  
AUTOMOBILE SCHOOL

### Learn in a Few Weeks

Stay as long as you like. A thorough training is the thing that fills the pay envelope. You can take a full Automotive Course, or specialize in any one of its money-making branches. You can be an Auto Electrician; a Tire Expert; a Battery Service Man; a Chauffeur; a Repair Man, a Welder; a Machinist; or specialize in motorized farming, with special truck, tractor, or farm electric-lighting and farm engine training. Life Membership included with all courses.



### Mail Coupon To Day

Michigan State Automobile School 306 Auto Building, DETROIT, MICHIGAN

Send me FREE and without obligation your illustrated catalog and complete information about Detroit-training to make the most money.

Name.....

Street or R. F. D.....

City..... State.....

Do you prefer to start your training at home or at our School in Detroit?.....





## Tobacco Is Hurting You

Look at the facts square in the face, Mr. Tobacco User. You may think tobacco is not hurting you.

That is because you haven't as yet, perhaps, felt the effects of the nicotine poison in YOUR system. For you know that nicotine, as absorbed into the system through smoking and chewing tobacco, is a slow working poison. Slow, yes—but sure.

Tobacco is lowering your efficiency. It slows a man down. Makes it harder for you to concentrate your mind on your work. You haven't near the amount of "pep" and energy you would have if you stopped using it. There's many a man twice as old as you in years who's twice as young in energy, simply because he lets tobacco alone.

Some day you will realize to what an alarming extent tobacco has undermined your system.

When your hands begin to tremble—  
and your appetite begins to fail—  
and your heart seems to "skip a beat" now and then—  
and slight exertion makes you short of breath—  
then you have a right to suspect that  
**TOBACCO** is getting the upper hand.

Any well-informed doctor will tell you that these are only a few of many symptoms of tobacco poisoning.

And YOU know that the use of tobacco in any form is an expensive, utterly useless habit. You know you ought to quit.

## Tobacco Habit Banished Let Us Help You

It doesn't make a particle of difference whether you've been a user of tobacco for a single month or 50 years, or how much you use, or in what form you use it—whether you smoke cigars, cigarettes, pipe, chew plug or fine cut or use snuff—**Tobacco Redeemer** will positively remove all craving for tobacco in any form in a very few days. Not the slightest shock to the nervous system. Your tobacco craving will usually begin to decrease after the very first dose—there's no long waiting for results.

**Tobacco Redeemer** contains no habit-forming drugs of any kind and is marvelously quick, scientific and thoroughly reliable.

It is in no sense a substitute for tobacco. After finishing the treatment you have absolutely no desire to use tobacco again or to continue the use of the remedy. It helps to quiet the nerves and make you feel better in every way.

**Results Guaranteed** A single trial will convince you. Our legal-binding, money-back guarantee goes with each full treatment. We will refund every cent you pay for the treatment if after taking it according to the easy-to-follow directions, it should fail to banish the tobacco habit completely.

**SEND Coupon for Free Proof** Let us send you our free booklet on the deadly effects of tobacco, together with testimonial letters from men all over the country telling how they have been absolutely freed from the tobacco habit by this simple home treatment. You could not ask for stronger proof that **Tobacco Redeemer** will free you from the habit than the evidence we will gladly send on request. Just mail the coupon—or a postal will do.

**NEWELL PHARMACAL CO.**

Dept. 300

St. Louis, Mo.



## Free Book Coupon

**NEWELL PHARMACAL CO.**

Dept. 300

St. Louis, Mo.

Please send, without obligating me in any way, your free booklet regarding the tobacco habit and proof that **Tobacco Redeemer** will positively free me from the tobacco habit or my money will be refunded.

Name .....

Street and No. ....

Town..... State.....



# Is THIS Why the Boss Laughed When You Demanded Bigger Pay?



**LIONEL STRONGFORT**

DR. SARGENT, of Harvard, declares that "Strongfort is unquestionably the finest specimen of physical development ever seen."

## A Book That Chills and Thrills

In a good natured mood I have decided to make you a present of my world-famous book of the body, "Promotion and Conservation of Health, Strength and Mental Energy." Beautifully illustrated, it contains the man-building experiences of a crowded quarter-century devoted to the succor of sick, disabled, hopeless, helpless men. It is an absolutely necessary work to any man who is afraid of his job or dissatisfied with it. The book is yours (free, postpaid and without obligation) if you'll send the coupon now.

# Lionel Strongfort

Physical and Health Specialist for 25 Years  
Dept. 1423, Newark, N. J., U. S. A.

Did you notice how The Chief gave you the "once-over"—the "up-and-down"—taking you in from top to toe? He was getting your number—taking your measure—deciding in his own mind just how far he dared to go with you.

THEN HE TURNED YOU DOWN FLAT! He knew he had you licked before you started. And there was scorn in his eyes, a sneer in his voice, a sting in his words of refusal. You were in the right and he was wrong—but he bluffed and bullied you out of what belonged to you. And why? Simply because he knew that—

**HE WAS A STRONGER MAN THAN YOU!** Not just because he was your superior in position but because he was your master in the stern, rugged qualities of dominating manhood. He had stronger nerves, a clearer head, greater daring and more fighting force than you ever dreamed of owning. **AND THAT'S WHY HE'S THE BOSS AND YOU'RE THE MAN THAT'S WORKING FOR HIM.**

**ONE THING HE NEVER COULD LAUGH OFF.** Listen, my friend. What do you think would have happened if you had shouldered your way into that bird's office with your proper fighting weight of clean, hard muscle—with a cold glitter in your clear eye—with the fine upstanding posture of a man to whom fear is only a word in the dictionary? Would he have laughed that off do you suppose? Not on your tintype, my friend—not on your life. He'd have given you the raise you asked and apologized for not making it a bigger one.

## YOU ARE A VEGETABLE!

Yes, you can crawl out of bed in the morning and totter off to work without the help of crutches. You can last out the day and stagger home again without falling down. You can draw a pay envelope every so often and support yourself without charity. **BUT THAT ISN'T LIVING—THAT ISN'T MANHOOD. THAT'S JUST EXISTING—JUST VEGETATING LIKE A CABBAGE IN A PATCH. I'D FIGHT LIKE A FIEND** before I would submit to such a servile life as yours. **I'D MUSCULARIZE INSIDE AND OUT.** I'd energize and I'd **STRONGFORTIZE** until every muscle on my body was rippling with joy and every organ inside of me was hitting on all six cylinders. I'd win a digestion like an ostrich's and a vitality like a tiger's. I'd gain white nerves and clean limbs and strong lungs. Then I'd step on the gas, blow my horn and tell the world to look out because I was on my way.

## Health—Strength—Vitality STRONGFORTISM with Scientific Muscularity

For 25 Years I have taught the science of Mastery through Health, Strength and Vitality. I have "muscled" more successful professional stage "strong men" than any physical instructor who ever lived. I have brought lasting happiness and success to thousands of pupils who came to me much worse off than you are and who have risen infinitely higher in the world than that tough boss of yours can ever hope to climb.

**ARE YOU LISTENING TO ME?** Are you with me or against yourself? To oblige me will you **CONSENT** to become a successful man—a big man in every sense of the word—a real moneymaker commanding universal respect through sheer power of body, strength of will and force of personality and mentality?

**YES? Then SEND THE COUPON NOW!**

### CONSULTATION COUPON

*Absolutely Confidential*

**LIONEL STRONGFORT, Department 1423, Newark, N. J.**

Send me your big 54 Page Illustrated Book of the Body, postpaid and without cost or obligation to me. It may teach me something startling about ME. Send me special information on subjects marked (X) below, without obligation.

..... Colds	..... Skin Disorders
..... Catarrh	..... Debility
..... Too Fat	..... Torpid Liver
..... Too Thin	..... Vitality Restored
..... Stomach Trouble	..... Muscular Development
..... Flat Chest	..... Great Strength
..... Bad Blood	..... Rupture
..... Nervousness	..... Lumbago
..... Constipation	..... Neuralgia
..... Dependency	

Name.....

Age..... Occupation.....

Address.....



# MECHANICS' HANDBOOK



**330 PAGES**

**More than 300,000 sold**

**H**ANDIEST book of its kind ever written. Prepared by experts under the direction of the International Correspondence Schools. Written in language that you can understand. Note this partial list of subjects:

**Only**  
**\$1**

Weights and Measures; Easily Understood Mathematics; Formulae; Mensuration; Belting; Hydro-mechanics; Strength of Materials; Boiler Design; Care and Inspection of Boilers; Horsepower of Boilers; Chimneys; Exhaust Heating; Machine Design; Horsepower of Engines; Boilers and Pumps; The Slide Valve; Belt Pulleys; Rope Belting; Cylinders and Steam Chests; Electricity; Currents; Wiring; Dynamos and Meters; Batteries; Cable Testing; Compass Surveying; Curves; Leveling; Etc.

Just mail this advertisement with a dollar bill and your name and address, and this 330-page I. C. S. Mechanics' Handbook or any of the other I. C. S. Handbooks that you want will come to you by return mail.

INTERNATIONAL CORRESPONDENCE SCHOOLS  
Box 5606-D, Scranton, Penna.

I enclose \$..... for which send me, post-paid, the Handbooks marked X, at \$1.00 each. It is understood that if I am not entirely satisfied I may return any or all of them within five days and get my money back.

MECHANICS' HANDBOOK

- |   |  |
|---|--|
| <input type="checkbox"/> Automobile Handbook      | <input type="checkbox"/> Radio Handbook        |
| <input type="checkbox"/> Electrical Handbook      | <input type="checkbox"/> Salesman's Handbook   |
| <input type="checkbox"/> Chemistry Handbook       | <input type="checkbox"/> Advertising Handbook  |
| <input type="checkbox"/> Building Trades Handbook | <input type="checkbox"/> Bookkeeper's Handbook |

Name.....

Address.....

## Travel The D & C Waterway On the Great Lakes

**Restful-Economical-Healthful-Safe Traveling**

You'll enjoy a trip on the palatial, homelike D. & C. Steamers that make daily trips between Detroit and Buffalo, and Detroit and Cleveland. Direct rail connections at these three cities for all sections of the country.

<p><b>Detroit &amp; Buffalo</b> Lv. Detroit 5:30 p.m. Lv. Buffalo 6:00 p.m. Fare, \$6.00 one way, \$11.50 round trip.</p>	<p><b>Detroit &amp; Cleveland</b> Lv. each city 11 p.m. *Daylight trips during July and Aug. Lv. each city 8:30 a.m. Fare, \$3.60 one way, \$6.50 round trip.</p>
---	---

\*Operations subject to necessity for service. Schedule subject to change without notice. Berths, \$1.50 up; state-rooms, \$1.20 up; parlor \$1.20 up. Rail tickets are accepted. Automobiles transported. Dogs must be removed. Wireless aboard. For reservations and further information, address agent at port of departure. The D. & C. will operate an Express Service between Detroit and Chicago via Mackinac Island in 1925.

**DETROIT & CLEVELAND NAVIGATION CO.**  
General Offices, Detroit, Mich.  
A. A. Schantz, Pres. & Gen. Mgr.  
J. T. McMillan, Vice Pres. R. G. Stoddard, Gen. Pass. & Ticket Agt.

## The Only Right Way to Get a Practical Electrical Education

Learn by the thorough approved scientific methods which our seventeen years of specializing enable us to give you. **A. C. and D. C. Armature Winding, Wiring and Testing, Practical Electricity, Drafting, Electrotechnics, Commercial Engineering, Electrical Engineering with B. S. Degree.** "Earn While You Learn." Radio Broadcasting WIAO Every Day. Next term opens soon.



**Book Free** Write for 72-Page Illustrated Catalog. It's Free. Mention Age, Education, and Course interested in. Do this now. Obey that impulse that burns within you. Many men who have taken this simple step are now prosperous, successful experts. Write quick.

**SCHOOL of ENGINEERING of MILWAUKEE**  
Dept. P608, 415 Marshall Street, Milwaukee, Wis.

**AUTOMOTIVE ELECTRICITY**  
**WILL PAY YOU**  
**\$200 TO \$500 A MONTH**  
**50 DAYS FROM NOW**  
**THIS BOOK TELLS YOU HOW**

Winning  
**\$100.00**  
a week in  
Automotive  
Electricity

Ambu training qualifies you in 50 days for positions paying \$200 to \$500 a month. No previous experience necessary. 10 years manufacturing experience behind Ambu training guarantees our fitness—our high percentage of successful graduates guarantees our method. A successful Ambu graduate lives near you. Ask him—or ask us for his name. Write for FREE Book, "Winning \$100 a Week in Automotive Electricity" that explains how we make this big money yours in 50 days. Send for it today.

**AMBU ENGINEERING INSTITUTE**  
Dept. 16 2632 Prairie Ave. CHICAGO



# WINDOW SIGNS



## AGENTS 500% PROFIT

### Genuine Gold Leaf Letters

**GUARANTEED TO NEVER TARNISH**



For store fronts, office windows, Bank windows, Office Doors, Panels, Board Signs, Trucks, Automobiles and Glass Signs of all kinds. Anyone can put them on and make money right from the start without previous experience. All you have to do is to show your samples; the letters are very attractive and easy to sell. Letters costing 4c sell for 25c. One agent says: "Your Letters are the best thing I have seen in years: I have made \$125.00 the first week and still going strong." Paul Clark says: "Smallest day \$28.70." H. Gilder made \$835.00 in six weeks.

## \$60 TO \$200 A WEEK

**GENERAL AGENTS**—It is easy to appoint sub-agents for this line. We pay you 20% cash commission on all orders we receive from local agents appointed by you anywhere. We allow you 50% discount on your own orders. You can sell to nearby trade or travel all over the country, as you please. Large demand for window lettering everywhere. Write today for free sample, full particulars and liberal offer to general agents.

**Metallic Letter Co., 433-C N. Clark St., Chicago**

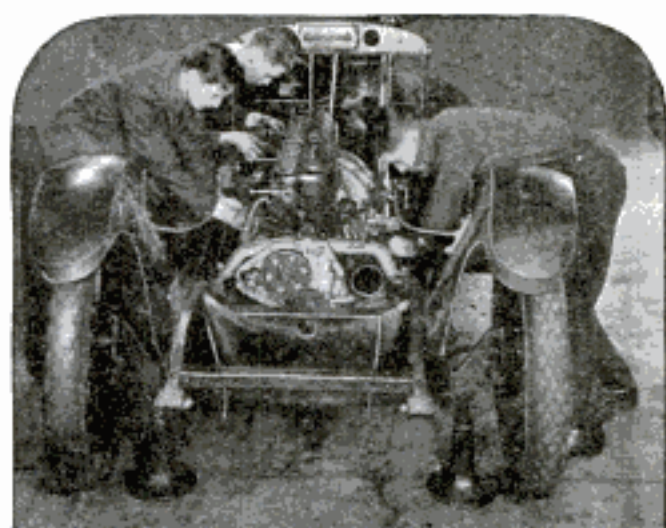

## How You Can Make \$3,000 to \$5,000 a Year

IT is now possible for any man, regardless of education or experience, to be trained for a big pay job at the Stewart Automobile School in New York.

Thousands of successful graduates since 1909 testify to the excellence of the Stewart system of individual instruction with tools.

We find a job for you if needed that enables you to support yourself while learning. After you graduate we can place you in a good pay position. *You cannot lose.*

Special Business Management Course *Free*—for a limited time only. Tuition for this course is regularly \$50, but you will get it *free* if you enroll now.

**Free Book** Our new big **FREE** catalogue describes in detail the Stewart School and its exclusive advantages; how you can be independent and successful after only a few months' training. Send for it today. Simply fill in the coupon below and mail it now. It will open the door to your Success.



NO. 1 \$2.63 NO. 2 \$3.25  
NO. 3 \$5.90 NO. 4 \$4.98

**WEAR SEVEN FREE DAYS**

### OUR MARVELOUS MEXICAN DIAMONDS

have delighted thousands of customers for 18 years. They positively match genuine diamonds. Same perfect cut, same dazzling play of rainbow fire. Stand intense acid test of side by side comparison with genuine. *Noted experts positively need their experience to detect any difference whatsoever.* Perhaps the gems you admire on your closest friends are **MEXICAN DIAMONDS** and you never knew it. **Test a MEXICAN DIAMOND FREE; you risk nothing.** Wear it seven days side by side with a genuine diamond. If you see any difference, send it back; it won't cost you a cent.

### HALF PRICE TO INTRODUCE

To introduce to new customers, we quote these prices which are all you pay and just half our catalog prices.  
No. 1—Ladies 1 ct. Solitaire, fine 14k gold f. \$2.63  
No. 2—Gents Heavy Tooth Belcher, 1 ct. gem, 14k gold f. \$3.25  
No. 3—Ladies 3 stone Duchess ring, fine platinum finish, two 5/8 ct. first water Mex. diamonds, one blue sapphire. \$5.90  
No. 4—Gents Ex. Heavy Cypri ring, platinum finish, black inlay on sides; 1 7/8 ct. first water Mex. Diamond. \$4.98

**SEND NO MONEY** Just send name, address and slip of paper that meets around ring finger to show size. Say which ring you want. We ship promptly. On arrival, deposit price with postman. If you decide not to keep it, return in 7 days and we'll refund your money. **Write TO DAY. Agents wanted.**

**MEXICAN DIAMOND IMPORTING CO.**  
Dept. ET LAS CRUCES, N. MEX.

Exclusive Controllers of Mexican Diamonds for 18 years.

### STEWART AUTOMOBILE SCHOOL (Founded 1909)

225 W. 57th St., Dept. A 175, New York, N. Y.

Please send me your free book that describes your school and the opportunities in the Automobile Business. I am under no obligation.

Name.....

Address.....

City.....

State.....





TAKE a box of lunch and your fishin' rod—and let's break away from the hot, dusty city! Let's pick out a nice cool quiet trail which no automobiles can find; let's take a 50-mile spin and fill our lungs with the cool crisp air—and then for the ol' trout stream. That's real fun!

### The Joy of Owning An Indian Scout

It takes you anywhere—anytime—quickly, cheaply—comfortably. The Scout is light, powerful and perfectly balanced. Equipped with the new Indian Fork which absorbs all shocks of the road. Goes 60 miles to a gallon. Tires good for 10,000 to 15,000 miles! 100 pounds lighter than average motorcycles. Ask your local Indian Dealer about the new Scout—or write us for free descriptive literature and name of your nearest Indian Dealer.

## Indian Motorcycle Co.

Dept. P-6

SPRINGFIELD, MASS.

## Make More Money PAINT AUTOS

Get into this newest, brightest, big-paying business. The field is there—the business is to be had—the profits are large—the demand is everywhere—and the future is unlimited. This is your chance now to step right into

### A Business of Your Own

with opportunity all around you. Somebody will operate these auto paint shops that the country must have—why not you? All you have to do is know how to do the work, and this we teach you.

No previous experience required and no large capital needed. Start in with just your own knowledge and soon have a business paying you

### \$3,000 to \$15,000 Year

We teach you so you know exactly how cars of all makes are painted at the factory and can do strictly high grade job, which makes you satisfied customers and brings you more business. Our method teaches you so you can go right into auto factory and get job painting autos—work for auto dealers everywhere.

Just give us a few weeks of your time—that's all, and you are ready for job or go in business for yourself.

You should certainly get the facts—write us and learn the way to better yourself.

ADDRESS  
Detroit Auto Painting School  
36 D. A. P. S. Bldg., Detroit, Mich.

**FREE** Book of Newest Styles just out. Women's, men's, children's clothing on credit and at bargain prices, less than cash prices everywhere. Very latest fashions; best materials. Open a charge account with us. Buy on credit and save money! Dress in newest styles. Send for Style Book absolutely FREE today! Elmer Richards Co., Dept. A177, W. 35th Street, Chicago

### PAUL REVERE BICYCLE

A sturdy dependable Bicycle—all workmanship and parts absolutely guaranteed for five years. 7 models to choose from. 12 months to pay. Express charges prepaid. Beautiful catalogue free. Agents wanted.

**MYEROW BROS.**  
15 Berkeley St., BOSTON, MASS.

## Get this Wonderful Book without cost



PROF. TITUS  
as he is today

It is written by the man who has trained many of the world's greatest strong men. It tells you how to develop

**Vitality, Energy, Endurance,  
Nerve Strength, Muscular  
Strength, Perfect Physique.**

My new 64 page book, "Building Better Bodies" is just off the press. It contains the kind of clearly written information you want, including 30 halftone illustrations of my pupils now among the professional ranks. It tells you, if you are weak and underdeveloped, how to grow strong; if strong, how to grow stronger. It explains how to develop the lungs and muscles—a strong heart and vigorous digestion—in short, how to improve health and strength internally as well as externally.

If you will send me 10c in coin or stamps to help pay postage and wrapping, I will mail you a copy at once. Send TODAY—NOW.

**PROF. H. W. TITUS** 105 E. 13th St., Dept. 59  
NEW YORK CITY



# New Kind of Hat

## Worn 10 Minutes a Day

# Grows Hair

# in 30 Days

# —or No Cost

No matter how thin your hair may be, this remarkable new scientific invention is absolutely guaranteed to give you a brand new growth of hair in 30 days—or it costs you nothing. Don't send a cent. Just mail coupon below.

By ALOIS MERKE

Founder of Famous Merke Institute, Fifth Ave., N. Y.

I HAVE perfected a new invention that I absolutely guarantee will give you a new head of hair in only 30 days—or the trial costs you nothing.

This new invention—the result of an experience gained in treating thousands of cases of baldness—is in the form of a new kind of hat. It is worn on the head just 10 minutes a day. No unnecessary fuss of any kind. Just put the hat on your head. Wear it 10 minutes. And that's all there is to it.

Sounds impossible, doesn't it? All right. Then let me emphasize this fact. I don't care how thin your hair is. I don't care how many treatments you have taken without results. Unless my discovery actually produces a new growth of hair on your head in 30 days, then all you need do is tell me so. And without asking one question, I will instantly—and gladly—mail you a check refunding you every penny you have paid me.

### How It Works

My invention proves that in a big percentage of hair troubles the hair roots are NOT dead, but merely dormant!

The reason ordinary measures failed to restore hair is because they merely treated the surface skin.

My new invention gets right to the cause of most of hair troubles—the starving dormant roots.

Your hair grows just as a tree grows—from the roots. To make a tree grow you wouldn't rub "growing fluid" on the bark. Instead you would nourish the roots. And my invention provides, at last, not only an efficient way of stimulating these dormant roots, but of giving them the nourishment they need to grow hair again.

### What Users Say

"I have been bothered with dandruff for twenty years and had lost nearly all of my hair. I have used your treatment 30 days now and have a good growth of hair coming in. I cannot say too much in praise of the Merke Treatment."  
C. H. B.

"Treatment positively shows quick results. After five weeks' treatment a new growth of hair has shown on each side of the temple, where I have been bald for years."  
C. B.

### No Risk of Any Kind

At the Merke Institute, Fifth Avenue, N. Y., which I founded, stage and social celebrities have paid as high as \$500 for the results secured through personal treatments. Yet now, through my new invention, these results may be secured in any home where there is electricity—for just a few cents a day!

Remember—I don't ask you to risk a cent. I realize that my treatment will not grow hair for EVERYBODY. There are some extreme cases of baldness that nothing in the world can help. But my new invention has already grown new hair for so many hundreds of others who had long ago given up hope that I am willing to let you try it entirely at my risk, and if it fails then I lose—not you.

### Free Booklet Explains Invention

If you will merely fill in and mail the coupon below I will gladly send you—without cost or obligation—an interesting 32-page booklet, "The New Way to Make Hair Grow," describing my new invention in detail.

This booklet contains much helpful information on the care of hair—and, in addition, shows what my treatment is doing for thousands of others.

No matter how nearly bald you are—no matter how many treatments you have tried without results—this booklet will prove of deepest interest to you. So mail the coupon now—and it will be sent you by return mail. ALLIED MERKE INSTITUTES, Inc., 512 Fifth Avenue, Dept. 166, New York City.

ALLIED MERKE INSTITUTES, Inc.

Dept. 166, 512 Fifth Ave., New York City.

Please send me, without cost or obligation on my part, a copy of the new booklet, "The New Way to Make Hair Grow," describing in full detail the Merke Institute Home Treatment.

Name.....  
(State whether Mr., Miss or Mrs.)

Address.....

City..... State.....







## The First Iver Johnson Bicycle

**THIRTY-EIGHT** years ago in a small New England workshop, Iver Johnson, mechanic-inventor, built his first bicycle.

In looks, it was a crude affair compared to the present-day models, but it had those sturdy, superior qualities that in a few years made the name Iver Johnson famous wherever bicycles are known.

### Famous Features

The Iver-Johnson Truss-Bridge construction assures absolute rigidity, preventing give and sway of the frame during fast pedaling, pushing up hills, or through sand. Also made in Drop-Bar models.

The high carbon seamless steel tubing used in Iver Johnson frames and forks has a tensile strength of 90,000 pounds to the square inch! Fork crowns, cranks, fork-ends, handle-bar stems, seat posts, and other parts are of genuine drop-forgings made in our own plant.

The two-piece crank set and two-point ball bearings will outlast any other type, and make pedaling easy as walking.

Iver Johnson Bicycles are made to fit all sizes of men and women, boys and girls. Colors: Ivory Black, Copper Bronze, Poitu Blue, Iver Johnson Blue and Maroon. Best guaranteed equipment.

### Write for Free Booklets

Catalog "B" illustrates and describes the complete line of Iver Johnson Bicycles, as well as Iver Johnson Velocipedes.

Catalog "A" illustrates and describes the complete line of Iver Johnson "Hammer the Hammer" Safety Revolvers, as well as Iver Johnson Champion Single Barrel Shot Guns and Hammerless Double Barrel Shot Guns.



**IVER JOHNSON'S ARMS & CYCLE WORKS**  
4 River Street FITCHBURG, MASS.  
New York Chicago San Francisco  
151 Chambers St. 108 W. Lake St. 717 Market St.

# IVER JOHNSON BICYCLES

## TOP WAGES IN A GOOD TRADE



A very small investment in one or more of our painting courses will enable you to make more money. Highly skilled instructors teach you sign and pictorial painting—decorating—graining—marbling—show card writing—paperhanging—auto painting. This is the world's leading School of Painting, as I can prove to you if you will come and see what we are doing.

**HARRY GLICK**  
Principal

## THE CHICAGO PAINTING SCHOOL WILL EQUIP YOU TO MAKE MORE MONEY

If you are now a painter, I can show you how to increase your earning power. If you have not chosen a trade, or are dissatisfied with your present one, we can start you toward making from \$10 to \$20 a day.

Come to Chicago and talk it over with me. If you enroll, I will refund your railroad fare. I know you will want to stay, because you will be impressed by our work, by what we have done and are doing for others, by the type of men who are directing this splendid work of making better all-round painters, decorators, sign writers, etc.

Send for  
**FREE**  
Catalogue

**I Will** Write me today and tell me when to expect you. I will send you a copy of our handsomely illustrated catalogue by return mail. Address Harry Glick, Principal.  
**Pay Your R. R. Fare to Chicago** Chicago Painting School  
148 W. Austin Av., Chicago, Ill.

### HOME MOVIE-MACHINE

\$7.50 Postpaid

Uses same films as in big theatres. 100 feet film only 75c with best stars. Not a toy. Guaranteed to satisfy. A wonderful entertainer.

Send to-day for free catalogue of Home Movie outfits, Cameras, Radio Sets and Radio parts. We sell them all.

**PARAMOUNT MFG. CO., Dept. M3, BOSTON, MASS., U. S. A.**

### "FLIVVER" RADIO SET

\$2.95 Postpaid

This whirlwind complete set guaranteed equal in reception qualities to any \$50 crystal set. Not a toy. No up-keep—no batteries—no tubes. Headphones \$2.95 a pair.

Send to-day for free catalogue of Home Movie outfits, Cameras, Radio Sets and Radio parts. We sell them all.

**PARAMOUNT MFG. CO., Dept. M3, BOSTON, MASS., U. S. A.**

**1/8 H. P. Gasoline Engine \$25.00 COMPLETE**

Castings \$7.50. 40 other styles and sizes. Gen. Cat. No. 22, 20c. Eng. Cat. No. 24, 20c. Both postpaid for 40c stamps (4 dimes preferred). Refunded first order.

**MODERN ENGINE & SUPPLY CO.**  
334 Monadnock Bldg. CHICAGO, ILL.

**The Triple Duty Charger**

Charges radio 2, 4 or 6 volt "A" battery, radio "B" battery up to 120 volts and auto batteries from lamp socket. Average cost per charge about a nickel. Solidly built—will not get out of order. Fool-proof and simple. The first successful charger—introduced over ten years ago. Type A, B, price \$20; West of Rockies, \$22. Type C for 6 volt "A" or auto batteries, price \$15; West of Rockies, \$16. "B" battery charging attachment, \$2.50 extra. Write for literature and name of dealer who will supply you with the genuine FF charger.

**FRANCE MFG. CO.**  
10424 Berea Road CLEVELAND, OHIO

**MELODIES arranged for Piano Band and Orchestra**

**HARRY L. ALFORD**  
618 State-Lake Bldg. CHICAGO

**20 YEARS SERVICE**



# YOU TOO CAN MAKE BIG MONEY

*Begin Now!*



## Learn RADIO DRAFTING

**Free Course**

THE popularity of the Radio and its increasing field of usefulness have created a keen demand for men who can design and draw plans for Radio equipment and layout. Get in on the ground floor of this profitable occupation. Here is your opportunity to learn

### RADIO DRAFTING FREE

As soon as our regular course in Mechanical Drafting has been completed the graduate is entitled to take our Radio Drafting Course Free of Charge.

### THIS OFFER IS MADE FOR A LIMITED TIME ONLY

— therefore do not delay and miss the chance of this unusual offer. Write us today for full particulars.

### OTHER POST GRADUATE COURSES

— which may be selected in place of Radio Drafting — and also taught free — are as follows:

Electrical Drafting  
Aeroplane Drafting  
Machine Design

Automobile Drafting  
Sheet Metal Drafting  
Shop Mathematics

Special and complete instruction in lettering with all courses.

### GET YOU A JOB

We help you secure a satisfactory position as soon as you are qualified as a Draftsman, which is frequently

before our course is half completed. Your ability to make good from the start is assured by our thorough and practical training.

ROY C. CLAFLIN, President  
**Columbia School of Drafting**

Dept. F-14, 14th at T St., N. W.  
WASHINGTON, D. C.



N. L. SCHNEE,  
Los Angeles, Cal.  
Got a Drafting Position long before finishing the course. He writes: "I was with Columbia School Co. 6 weeks at \$25 per week and raised to \$40."



C. GREENE  
Des Moines, Ia.  
got work as a Topographic Draftsman with the telephone Co., after only his 11th lesson. raise soon after.



A. K. MAHABLE  
Jacksonville, Fla.  
"... only a few months with your school has won me a position as a signing machine-ry." This graduate averages about \$20 monthly now.



ROY C. CLAFLIN  
President

As a student of the Columbia School of Drafting you will be under the personal instruction of Roy C. Clafin, owner and president of this school. He gives you his most earnest cooperation and the tens of thousands of men who have been benefited by his highly efficient method of training are a living proof of the value of his guidance. Mr. Clafin's long years of experience as a professional Draftsman, as well as a teacher, especially qualify him for this great work.



This Drafting Set is a part of the course.

**COLUMBIA SCHOOL OF DRAFTING,**  
Dept. F-14, Washington, D. C.

Without obligation, please send me your interesting catalog, showing opportunities in drafting, a free copy of your student paper, THE COMPASS, and an enrollment blank

Name.....

Address..... My Address.....

City..... State.....





# Get this Message

## Tune in on The Auto

Station W. H. B. is right here in my million dollar auto and tractor school—Kansas City, U. S. A. Cost me \$50,000 to erect, and reaches any point in the country. That's one reason why the Sweeney School is known the world over—I never have grudged expense or any amount of hard work to provide my students with every single thing they need to step into the big pay jobs and their own business.

### THE FAMOUS SWEENEY SYSTEM

No need for me to tell you about the wonderful opportunities for you in this fast growing field, with thousands of jobs open right now at pay ranging from \$150 to \$600 a month, and up. You know all that. And I reckon there's just one thing you want to know right now. That's this: Can Sweeney do for me what he says he can do? Can he train me in 47 days to have a garage, vulcanizing shop, tire repair, battery station, etc., or one of the big pay jobs like the other 60,000 men he's trained successfully? And my answer is YES! I don't know you, of course, but I don't have to know you. For 15 years here in Kansas City I've trained men with little education, no experience, no capital to speak of. And every one of these men is living proof that the famous Sweeney system is exactly what you need to step into success quick.

### Tools—Not Books

It's known all over the world that E. J. Sweeney was one of the first men to take ambitious men and make automobile experts out of them. And if the Sweeney system had not been the one certain, right system, I couldn't have stayed here in Kansas City so long, and built the finest auto school in the world, out of the measly little garage I started in. Here in my school you have \$250,000 worth of equipment. You have all kinds of cars and tractors to work on and experiment with. You learn every phase of the game—A to Izzard, step by step, under capable instructors. No makeshift equipment. No skimping, no cheap, counterfeit instruction. NO! But the very best of everything money can buy.

And special instruction that is Sweeney's own. And I'll just leave it to your own good judgment whether or not the world-wide success of the Sweeney system, and the completeness of the Sweeney school, and the low cost of the Sweeney course, are things you can overlook if you really want to be the kind of an expert that can always demand the cream of this fast growing business. And I just want to get this one message over to you—you spend 2 cents, and send for my big book, and I'll show you that the Sweeney system is your one best bet.

**LEARN A**  
**Sweeney**  
**SCHOOL OF AUTO**  
**37-G SWEENEY BLDG.**



# from Station WHB

## the Big Money in and Tractor Business

I guarantee to refund your railroad fare to and from your home to the Sweeney school if you do not find everything in my school exactly as represented in my book and letters. In putting this message straight across to YOU I want you to know that Sweeney means just what he says and the proof is a deal sight better than mere words any time. In my 15 years' successful work I've never yet asked a man to take my school sight unseen and I never will.

### YOUR OWN BOSS? YES!

Now, then, what about being your own boss, and your own good paying business? I say you can, after you've been trained by the famous Sweeney system. Twenty thousand of my students have done it. I'll show you proof from all over this country and other countries that Sweeney trained men do step right into shops of their own. If it hadn't been for the Sweeney system they'd still be punching a time clock at \$2.50 a day or less, or one of the white collar boys that are scratching like chickens in a barnyard for enough to pay their laundry bill. A part of the Sweeney System is the wonderful training you get so you'll know how to get started and run your own business.

#### Let Experts Train You Right

No matter what you want to learn, if it's important to your future, you naturally want to choose the very best men possible to teach you. That's just common sense. And when I built up the Sweeney system I paid particular attention to this one feature. Cost me a lot more, of course, but the Sweeney school houses the best automobile tractor, aviation and radio instructors to be found anywhere. They answer to me for every step of your training. They know that their job isn't finished until every student is ready to do credit to the LIFE SCHOLARSHIP that 60,000 Sweeney trained men are so proud of.

*I'll pay Your! Railroad Fare!*

To help you get started right in the Sweeney school I'll pay your railroad fare to Kansas City from any point in the United States. Come to my school and look it over thoroughly. And then if you don't find it just what I represent in my book and letters, I'll pay your fare home again. Is that fair enough? Doesn't it give you an idea that the Sweeney system must be the best anywhere if I can afford to make such an offer?

### FREE BOOK! AND SPECIAL OFFER!

I've told you all I can in this small space. Now, you take the first step. That is to send right now for my 64-page, beautifully illustrated book that tells you everything. Then you decide. I'll tell you of my FREE RADIO COURSE, and a special tuition offer I'm making for a short time. I'll show you how men come to my school from all over the world, and step out into the big pay jobs and their own business, just like you can do. Send in the coupon right now.



#### What Job Do You Want?

Demonstrator and Salesman	\$150 to \$600
Garage Manager	\$150 to \$400
Tractor Engineer	\$10 a day
Auto Electrician	\$225
Auto Mechanic	\$6 to \$10 a day
Chauffeurs	\$90 to \$150
Truck Drivers	\$125
Tire Vulcanizers	\$100 to \$200
Welders	\$140 to \$200
Battery Men	\$150 to \$200

tor, aviation and radio instructors to be found anywhere. They answer to me for every step of your training. They know that their job isn't finished until every student is ready to do credit to the LIFE SCHOLARSHIP that 60,000 Sweeney trained men are so proud of.

**TRADE**  
*new*  
TRACTOR-AVIATION  
KANSAS CITY, MO

Mail  
This  
Now

**FOR BIG OFFER AND FREE BOOK**  
EMORY J. SWEENEY, President, Dept. 27-G, Sweeney Building, Kansas City, Mo.  
Please send me without cost or obligation your 64-page book, and tell me of the many opportunities for me in the auto and tractor business.

Name .....

Address .....

City .....

State .....





**Get Bigger Pay—Travel—See The Country  
—No Lay-Offs—Life Job—Pension—  
Free Railroad Fare**

Fit yourself for a life of travel and excitement. Just think of riding in your own private car. Imagine going on a vacation with full pay, with free railroad fare. Think of it. A permanent job with big pay, fascinating work, free transportation, expenses while traveling, and a comfortable pension in your old age. Get into this, the greatest industry on earth, something new all the time. Get into railroading.

**EARN \$3,000 TO \$6,000 OR MORE A YEAR**

Blame yourself. It's your own fault if you don't earn more. I guide you, step by step, to fit you for one of thousands of jobs on our big railroads paying from \$2,000 to \$6,000 per year. There are not enough able men to supply the demand. Our great American railroads need men who have the training to handle the important problems which must be worked out practically and accurately.

It is possible to make \$60,000 per year. The greatest men in railroading were self trained. C. H. Markham, President of the Illinois Central Railroad, Daniel Willard, President of the Baltimore & Ohio Railroad, and scores of other presidents and big executives began with no more knowledge of railroading than you have today. And there are many others. What others have done, you can do.

**START TO LEARN AT HOME IN YOUR SPARE TIME**

Don't let any doubt about your being able to qualify stand in your way. Can you read and write? Are you ambitious? Those are the requirements. Learn at home in spare time, by new method, positively fascinating. Experts who have spent their lives on our great railroads helped me create this easy, self training course. I coach you personally, and then I help you get a job.

**POSITIONS GUARANTEED—  
Or Money Refunded**

I don't stop with simply training you. I give the most binding guarantee of an actual job ever offered. You prepare for this fascinating work in your spare time at home. I will guarantee to give you all your money back if you do not have an opportunity presented to you to enter railroad service during or after finishing my course.

**GET OUR SPECIAL OFFER**

Get the vital facts. Let me tell you more about the big demand for trained railroad men.

**ACT NOW**

I have room for just a few more students under our present plan. Full details of this special offer, which will be withdrawn as soon as classes are full, will be given by return mail.

**Investigate—Mail the Coupon**

**RAILWAY EDUCATIONAL DIRECTOR**

9 South Clinton Street, CHICAGO, ILLINOIS



**COUPON**

Please send full details of reduced price offer on self training course for the greatest industry on earth.

Name.....

Address.....

## Be a Plumber!

**Earn \$60.50 a Week**

Good Plumbers at Big Pay are in demand! There are not enough apprentices being trained annually to fill the needs of the trade. No need of serving 4 years apprenticeship—

**Learn In 8 Weeks!** Come to the

Kansas City School of Plumbing! Learn all branches of the trade quickly—under real plumbers. Learn it right! Step into a big pay job or start a plumbing shop of your own.

Get Ahead! Write at once for full information, low tuition fees, opportunities offered, etc. Send a postcard now!

**KANSAS CITY SCHOOL  
OF PLUMBING**

1716 Baltimore Ave., Kansas City, Mo.



## LEARN ENGINEERING

Great Demand for Practical-Technical Men. Big Salaries. Wonderful Opportunities. Beautiful New Building. Extensive Laboratory and Shop Equipment. Not a trade school but a Practical-Technical College. Faculty of Trained Experts. 3 mo. courses in Practical Electricity and Steam. 1, 2 and 3 year courses in Mechanical and Electrical Engineering. Architectural, Structural, Mechanical Drafting. Day and night. Degrees awarded. 22nd year. Write for catalog D.

**FINLAY ENGINEERING COLLEGE, Kansas City, Mo.**

## nerve



Intensive feeding, no water. Substitute freely all food juices. SOLVENT BLOOD dissolves tumors, blood clots, lime in joints (enabling use of limbs again) also eliminates catarrhal matter from nose, ears, tonsils, bronchials, etc. Eating nerve or muscle food TO SUIT OCCUPATION prevents formation of WASTE in blood (the basis of every disease). Demineralized, denatured, disproportioned foods cause disease, from which wild animals are free. Educational booklet 10 cents. Sworn results. Over 6,000 pupils. BRINKLER SCHOOL OF EATING Dept. 42-G 131 W. 72d Street, New York.

## Can you afford to STAMMER? or STUTTER?

It ruins many chances for promotion. Send postage for large free book "The Correction of Stammering and Stuttering." Methods successful for over a quarter-century. THE LEWIS INSTITUTE, 33 Lewis Bldg., 77 Adelaide St., Detroit, Mich., U.S.A.



## LEARN TO PITCH

Lessons by "MATTY" WALSH, WHITE, JOHNSON, RUCKER, WOOD — KITCH, THE FADE-A-WAY, SPITTER, KNUCKLER, SMOKE BALL, etc., clearly described and illustrated by 56 Pictures. Entire COURSE OF LESSONS sent p.p. for 25c. J.C. DORN, 721 S. Dearborn St., Dept. 45, Chicago, Ill.

## PIMPLY SKIN made WELL

When a few applications of this wonder-working lotion has cleared faces of pimples, blackheads, acne eruptions on the face or body, barbers itch, eczema, enlarged pores, oily or shiny skin, you can realize why CLEAR-TONE has been tested and approved in over 100,000 Test Cases. The simplicity of the treatment, and The Story of How I Cured Myself are all explained in my free booklet, "A Clear-Tone Skin." Write for your copy today and learn of the results gotten by thousands of men and women.

E. S. GIVENS, 128 Chemical Bldg., Kansas City, Mo.



**MEN WANTED**

Never before have there been such opportunities in **ELECTRICITY**

**Earn \$3,000 to \$10,000 A Year!**



AEE-Trained Men Run Power Plants.



AEE-Trained Men Cash in on Radio.



AEE Trained Men Make Good in Business For Themselves.



AEE Trained Men Are Real Automotive Electric Experts

## HERE'S PROOF for YOU

Hundreds of millions are being spent for electrical development. You see it all around you. New power plants! New electrical equipment for the home! New electric machinery and railways! More Radios! More automobiles! No other industry is growing so fast. That's why the electrical field opens such good opportunities—and pays so well for electrical experts. Electricity needs you.

## You Can't Down These Facts

The bare facts show a startling shortage of trained electrical experts that can't be overcome for five years at least. **Get this, men—there is a real chance for you in the big pay electrical field.** Don't let anyone tell you different. Don't say it can't be done. Get the facts. Send for our big FREE Book; then judge for yourself.

## Now you can become an ELECTRICAL EXPERT

At last you have a chance to get the kind of electrical training that makes real experts. The Associated Electrical Engineers of America have thrown open their doors to you, and will train you at home—quickly and practically.

## The Greatest Electrical Home Training Method Ever Developed

The A. E. E. method is an exclusive copyrighted method of home training that surpasses anything of the kind ever offered; developed by a group of men who have trained thousands for electrical success, it teaches you the big important things you need on the job.

## \$3,000 to \$10,000 a Year

**On the Job** Electricity is paying \$75, \$100, \$200, a week right now to an army of trained electrical experts. Thousands of others are starting Electrical Contracting, Supply, Radio, or Automotive Electrical Business "on a shoestring" and becoming wealthy. **You can do it too!** Working for someone else, or in business for yourself, this is your opportunity.

## Don't Let Lack of Experience or Education Stop YOU

The A. E. E. training method is so clear and sensible that all you need is education enough to read plain English.

## A. E. E. Training is COMPLETE

You get practical, clear, understandable information on every branch of electricity—General, Automotive, Radio; and Complete Electrical Business Training Free! **LABORATORY Outfit FREE** You learn by doing; we supply you with a wonderful FREE working outfit of tools and electrical appliances, so that you can break into the money-getting class quickly.

**Legal Guarantee of Satisfaction** You don't risk a cent with the A. E. E. A legally binding guarantee of satisfaction protects you. Back comes your money if you are not satisfied.

**Now—Mail the Coupon** and get your copy of our big FREE book on Electrical Opportunities, with the facts that prove every word we say.

## THIS GREAT BOOK

# FREE

Where Shall We Mail It?



**Associated Electrical Engineers**  
Dept 164, 537 S. Dearborn St., Chicago, Ill.

Send my book, facts and information about Electrical opportunities without obligation to

Name .....

Address .....

**ASSOCIATED ELECTRICAL ENGINEERS**  
OF AMERICA - 537 South Dearborn St. Chicago - Ill.





## "Don't tell me you never had a chance!"

"Four years ago you and I worked at the same bench. I realized that to get ahead I needed special training, and decided to let the International Correspondence Schools help me. I wanted you to do the same, but you said, 'Aw, forget it!' You had the same chance I had, but you turned it down. No, Jim, you can't expect more money until you've trained yourself to handle bigger work."

There are lots of "Jims" in the world—in stores, factories, offices, everywhere. Are you one of them? Wake up! Every time you see an I. C. S. coupon your chance is staring you in the face. Don't turn it down.

Right now more than 180,000 men and women are preparing themselves for bigger jobs and better pay through I. C. S. courses.

You can join them and get in line for promotion. Mark and mail this coupon, and find out how.

### INTERNATIONAL CORRESPONDENCE SCHOOLS Box 5609-D, Scranton, Penna.

Without cost or obligation, please tell me how I can qualify for the position or in the subject before which I have marked an X:

#### BUSINESS TRAINING COURSES

- |  |   |
|--|---|
| <input type="checkbox"/> Business Management                     | <input type="checkbox"/> Salesmanship                                     |
| <input type="checkbox"/> Industrial Management                   | <input type="checkbox"/> Advertising                                      |
| <input type="checkbox"/> Personnel Organization                  | <input type="checkbox"/> Better Letters                                   |
| <input type="checkbox"/> Traffic Management                      | <input type="checkbox"/> Show Card Lettering                              |
| <input type="checkbox"/> Business Law                            | <input type="checkbox"/> Stenography and Typing                           |
| <input type="checkbox"/> Banking and Banking Law                 | <input type="checkbox"/> Business English                                 |
| <input type="checkbox"/> Accountancy (Including C.P.A.)          | <input type="checkbox"/> Civil Service                                    |
| <input type="checkbox"/> Nicholson Cost Accounting               | <input type="checkbox"/> Railway Mail Clerk                               |
| <input type="checkbox"/> Bookkeeping                             | <input type="checkbox"/> Common School Subjects                           |
| <input type="checkbox"/> Private Secretary                       | <input type="checkbox"/> High School Subjects                             |
| <input type="checkbox"/> Spanish <input type="checkbox"/> French | <input type="checkbox"/> Illustrating <input type="checkbox"/> Cartooning |

#### TECHNICAL AND INDUSTRIAL COURSES

- |   |  |
|---|--|
| <input type="checkbox"/> Electrical Engineering | <input type="checkbox"/> Architect                                   |
| <input type="checkbox"/> Electric Lighting      | <input type="checkbox"/> Architects' Blue Prints                     |
| <input type="checkbox"/> Mechanical Engineer    | <input type="checkbox"/> Contractor and Builder                      |
| <input type="checkbox"/> Mechanical Draftsman   | <input type="checkbox"/> Architectural Draftsman                     |
| <input type="checkbox"/> Machine Shop Practice  | <input type="checkbox"/> Concrete Builder                            |
| <input type="checkbox"/> Railroad Positions     | <input type="checkbox"/> Structural Engineer                         |
| <input type="checkbox"/> Gas Engine Operating   | <input type="checkbox"/> Chemistry <input type="checkbox"/> Pharmacy |
| <input type="checkbox"/> Civil Engineer         | <input type="checkbox"/> Automobile Work                             |
| <input type="checkbox"/> Surveying and Mapping  | <input type="checkbox"/> Airplane Engines                            |
| <input type="checkbox"/> Metallurgy             | <input type="checkbox"/> Navigation                                  |
| <input type="checkbox"/> Steam Engineering      | <input type="checkbox"/> Agriculture and Poultry                     |
| <input type="checkbox"/> Radio                  | <input type="checkbox"/> Mathematics                                 |

Name.....  
Street.....  
Address..... 3-6-24  
City..... State.....

Occupation.....  
Persons residing in Canada should send this coupon to the International Correspondence Schools Canadian, Limited, Montreal, Canada.

PLAY **TEN-TEN-TENNESSEE!** ON HA HA

**THE TENOR BANJO JAZZ**

No Previous Musical Knowledge Necessary--Quick--Easy--Positive Prof. Barker's method is so simple and easy that you quickly play any and all of the popular dance hits just as you have heard them played in dance or orchestra, on the stage--everywhere. **JAZZ NEW ORCHESTRA STYLE NEW EASY WAY--FUN GALORE**

Just Mail a Post Card for Details of our remarkable FREE Tenor Banjo Offer--simply write: "I am interested"--BUT DO IT TODAY.

**First Hawaiian Conservatory of Music, Inc.**  
Desk 60  
233 Broadway  
(Woolworth Bldg.)  
New York City

Special courses under famous teachers: Hawaiian Guitar, Violin, Ukulele, Instrument Free

**FREE A Beautiful Tenor Banjo**



## Send for This Booklet

Jimmy De Forest, trainer and conditioner of Jack Dempsey, Longboat, Firpo, Roosevelt, Eibert Hubbard and others, has written a booklet, "Physical Fitness and the Pay Envelope." Every man who believes in keeping physically fit should have a copy. Send 10c to cover cost of postage and mailing. The man who commands the big salary is physically fit.

Jimmy De Forest Physical Training System  
347 Madison Ave. Dept. 17, New York



## Cheapest Way to Go

to work or school and recreation is on a Ranger bicycle. You can have your choice of 44 styles, colors and sizes, 30 DAYS FREE TRIAL. Express prepaid, Factory-to-Rider bicycles from \$21.50 up. \$5 a Month if desired. Saved time and carfare easily meets the small monthly payments. Parents often advance first payment.

Best quality, at factory prices, express prepaid, CS Lamps, wheels and equipment, low prices. Send No Money to business direct with makers.

**Mead CYCLE COMPANY**  
DEPT. 108 CHICAGO

Write today for free Ranger Catalog, factory prices and marvelous easy payment terms



## GOV'T. HELP NEEDED

All men, women, boys, girls, 17 to 65, willing to accept Government Positions, \$117-\$250, stationary, at or near home, or traveling, write Mr. Ozment, 111 St. Louis, Mo., immediately.

**LEARN WATCHMAKING AND ENGRAVING**

ENGRAVING, JEWELRY REPAIRING BY OUR PROFIT-SHARING PLAN

**OUR GRADUATES SUCCEED**

One of our Iowa students started in a very small way--now doing over \$30,000 a year. Another in Wisconsin, over \$10,000 the first year. Day or night classes. Call or write for FREE BOOK.

CHICAGO SCHOOL OF WATCHMAKING Dept. 20 4844 Lincoln Avenue, CHICAGO



I will teach you Penmanship by mail

Small Cost, Spare Time, Easy Lessons. Write for my Free Book, "How to Become an Expert Penman." It contains specimens and tells how others became expert writers by the Tevis Method. Your name will be written on a card if you enclose stamp. Write Today.  
T. M. TEVIS, Box 25K, Chillicothe, Mo.



For Car Owners and Men Who Want  
to Become Automobile Experts

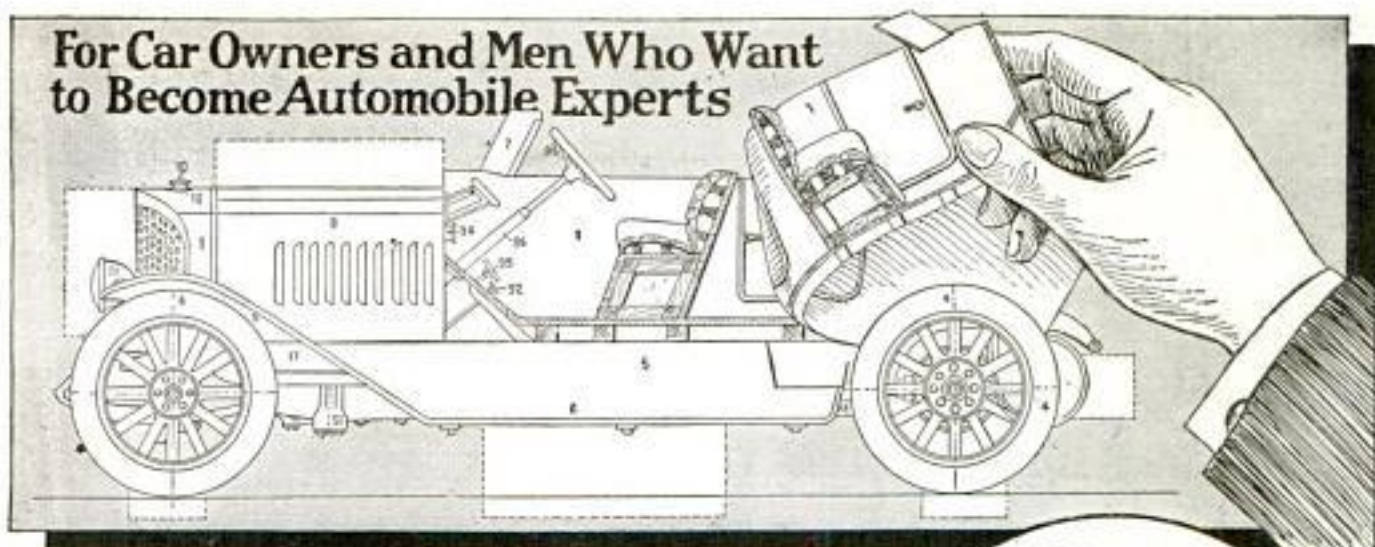

## This Automobile Manikin **FREE!**

You can't buy this manikin. It is not for sale at any price. But you get it free with **Dyke's Automobile and Gas Engine Encyclopedia**. This Manikin and Encyclopedia give you a practical and complete course of instruction on the automobile, just like having a real car and an expert at your elbow to explain everything. The Manikin, which is worth \$5.00 to any man who owns a car or who wants to become an automobile expert, will be furnished for a limited time exclusively to buyers of the Encyclopedia without a penny of extra charge. Read special offer below and mail the coupon.

### Shows Every Part of a 6-Cylinder Car

Here is a complete model of a modern high-powered touring car. You take it apart piece by piece. Every part is there—every part named, numbered and indexed. Even the inside of the wheel bearings, every part of the motor and every other part shown in exact and minute detail. So simple, yet so complete that operation and construction are understood instantly. Developed by years of practical experience in automobile design and construction. Nothing else like it. Send while the offer lasts. Put it into the mail today.

# Dyke's Automobile and Gas Engine Encyclopedia Will Make You an Automobile Expert!

## 16,000 Topics

1236 pages of useful information and instruction. 4143 illustrations and diagrams. Seventy-three pages for the index alone. Every type and style of car completely analyzed and demonstrated. Pleasure cars, commercial cars, trucks, tractors, motorcycles—steam cars, gas cars,—you are shown all about them. Every feature covered clearly, completely. Every possible car trouble explained and the way to correct it given. You can't ask any question about the automobile that is not clearly, completely answered.

### Used by U. S. Government and Auto Schools

So valuable is Dyke's Encyclopedia that during the war the government furnished it to every man in the transport service. It is used as a reference book in 45,000 garages and repair shops and is a text book in practically all automobile schools. 13 big editions already required to supply the demand.

## Earn \$100 a Week or More

Expert repair men, expert assemblers and garage executives are in big demand. There are more good jobs than men to fill them—and they pay big money. Don't stay in a job without a future when this opportunity to get an expert training in spare time is offered. If you are a car owner, you also need this great Encyclopedia for the saving in time and money you can make by cutting out repair bills. One adjustment, one repair job done yourself saves more than the cost of the book. In your leisure hours you can gather from this encyclopedia the latest, most authoritative knowledge of the automobile—you can become an expert.

Even if you paid \$500, you could not get more complete information.

## Don't Send a Penny

Send for this Encyclopedia now and get with it FREE the wonderful Automobile Manikin. Pay postman on arrival \$6.00 for cloth binding, \$7.50 for American Morocco binding. Examine it thoroughly. Then if not convinced that it is worth far more than the purchase price, send it back within 10 days and your money will be returned. Mail coupon now.

**Goodheart-Willcox Company**  
209 South Michigan Avenue  
Chicago, Ill.

Send Dyke's Encyclopedia in binding and at price marked X below, and with it the Free Manikin.

- Cloth, \$6.00.  
 Limp American Morocco, \$7.50.

I will pay postman the price, plus few cents postage, upon delivery, it being understood that if not satisfied I may return the book and manikin within 10 days and you will refund my money.

Name .....

Address .....

Town..... State.....

**GOODHEART-WILCOX COMPANY**  
209 South Michigan Avenue, Chicago, Illinois





# Follow this Man

*Secret Service Operator 38 is on the job*

**F**OLLOW him through all the excitement of his chase of the counterfeit gang. See how a crafty operator works. Telltale finger prints on the lamp stand in the murdered girl's room! The operator's cigarette case is handled by the unsuspecting gangster, and a great mystery is solved. Better than fiction. It's true, every word of it. No obligation. Just send the coupon and get—

## FREE!

**The Confidential Reports  
No. 38 Made to His Chief**

And the best part of it all is this. It may open your eyes to the great future for YOU as a highly paid Finger Print Expert. More men are needed right now. This school has taken men just like you and trained them for high official positions. This is the kind of work you would like. Days full of excitement. Big salaries. Rewards.

### Can you meet this test?

Can you read and write? Are you ambitious? Would you give 30 minutes a day of your spare time preparing yourself for this profession? Would you like a life of excitement, thrilling adventures and high pay? Answer "yes" and I'll show you how to attain all this.

Send the coupon and I'll send the Free Reports—also a wonderful illustrated book telling of the future awaiting you as a Finger Print Expert.

T. G. COOKE, Pres.

**UNIVERSITY OF APPLIED SCIENCE**  
1920 Sunnyside Ave., Dept. A-135 Chicago, Ill.

**University of Applied Science**  
1920 Sunnyside A. e., Dept. A-135. Chicago, Ill.

Gentlemen:—Without any obligation whatever, send me the Reports of Operator No. 38, also your illustrated Free Book on Finger Prints and your offer of a FREE course in Secret Service Intelligence and the Free Professional Finger Print Outfit.

Name .....

Address .....

Age .....

## Who Else Wants to Play JAZZ



LEARN TO PLAY ANY INSTRUMENT

Piano	Mandolin
Organ	Drums and
Violin	Traps
Banjo	Harmony and
Clarinet	Composition
Flute	Sight Singing
Harp	Ukulele
Cornet	Flora
Cello	Trombone
Guitar	Saxophone
Voice and Speech Culture	Automatic Finger Control

**In Few Months** You can learn by playing actual selections instead of tiresome exercises and eliminate endless hours of practice. A new simplified method of teaching reduces all music to its simplest possible form. We teach you in your own home by note. No numbers or "trick stuff." So simple that young and old find it easy to play with amazing skill. All intricate "mysteries" of music eliminated. Thousands have learned this splendid quick way. Surprise everyone and become popular, practically overnight, with your new accomplishment.

### FREE BOOK and Illustrated Folder

offers this wonderful musical opportunity. Send for them today. You'll be astounded, thrilled, fascinated, at this easy, rapid way to become a veritable master of your favorite instrument. Name the instrument you are particularly interested in. Special reduced price if you write at once.

U. S. SCHOOL OF MUSIC, 76 Brunswick Bldg., New York City

## NO MORE BALD HEADS



**W**HEN our VACUUM CAP is used a few minutes daily. We accept no pay until you have tried the Cap 60 days and are satisfied. The Vacuum Cap is an appliance that draws the blood to the Hair Roots and starts a new healthy crop of hair. It stops Dandruff, stops the hair from falling out.

Bought by Doctors and men who know that it is the only reasonable HAIR GROWER known to science. No Drugs Used. Write for application blank, testimonials, and booklet on "HAIR," sent sealed in plain envelope, FREE.

**THE MODERN VACUUM CAP CO.**

W 559 BARCLAY, DENVER, COLO.

## Great New Invention



**For Seekers of Health—Power—Beauty**  
Generate High Frequency Violet Ray, Mechanical Vibration, Medical Electricity and Ozone—the four greatest curative agents. Combined or separate. They operate on the electric light in your home or on their own motive power at less than 60 cents per year.

**WRITE** Ask for the book on these inventions which has just been prepared. It will be sent to you without cost. Re-vitalize yourself. Bring back energy. Be wholly alive. Write today!

LINDSTROM & CO., 442-448 N. Wells St., Dept. A-135, Chicago

## No Joke To Be Deaf



—Every Deaf Person Knows That

I make myself hear, after being deaf for 25 years, with my Artificial Ear Drums. I wear them day and night. They are perfectly comfortable. No one sees them. They stop head-noises. Write me and I will tell you a true story, how I became deaf and how I make you hear. Address

**GEO. P. WAY, Artificial Ear Drum Co. (Inc.)**  
80 Hoffman Bldg., 2509 Woodward Ave., Detroit, Mich.



# Learn Auto Business THIS SUMMER

## Special Opportunity Offered You HERE

This Summer and Fall there will be hundreds of Automobile Jobs—paying \$35 to \$100 per week—*still open* for properly trained men. Sixteen Million Autos now in the U. S. to work on.

If you want one of these jobs write us—**RIGHT NOW**—for Special **SUMMER TRAINING OFFER** that you can afford—but *cannot afford to overlook!*

**We pay Railroad Fare to Chicago—and GUARANTEE Jobs While Learning and After You Graduate.**

Only a limited number of men can be accommodated on this offer. Mail the Coupon **NOW** for full information and first consideration.

### Eight Weeks Will Put You On Your Feet

It takes only 8 weeks to complete training in our day class. Special Summer Course includes Machine Shop Practice—Shop Management—Selling—Truck, Tractor and Auto Repairing—Lighting—Starting—Vulcanizing—Storage Batteries—Driving—everything in automobile mechanics.

**Learn all about it—MAIL THE COUPON**  
**No obligation on your part**



# GREER COLLEGE

*of Automotive Engineering*

2024 So. Wabash Avenue

Dept. 6J

CHICAGO, ILL.

## Earn Big Money The Rest of Your Life

*Hundreds of Our  
Graduates Own  
Their Own Business*



Mail Coupon for this

**FREE  
BOOK**  
Now

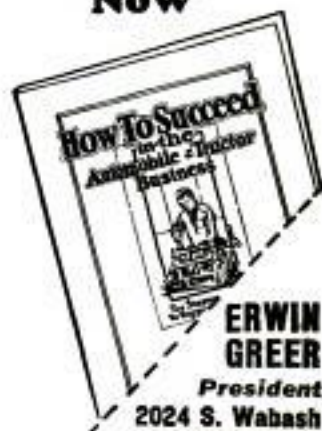

**ERWIN  
GREER**

President

2024 S. Wabash

Avenue

Dept. 6J

CHICAGO, ILL.

Please send me **FREE BOOK**, "How To Succeed in the Automobile Business," and full information on Special Summer Training Course.

Name.....

Address.....



# Earn \$100 a Week in RADIO!

## Easy to Learn at Home

\$50 to \$300 a week for fascinating easy work—wonderful future. Hundreds of big paying positions in this huge new industry!



## More Money for YOU in Radio

THOUSANDS of Radio Experts are needed to design, repair, maintain, sell radio apparatus, to operate broadcasting stations, as ship and land operators, to go into business; to instruct, demonstrate, superintend and for scores of other big paying radio jobs.

And now, you can easily become a Radio Expert. Studying at home in spare time, you can quickly qualify for a splendid Radio position. Astonishingly small cost. Famous radio instructors give you individual help by mail. Training GUARANTEED.

## We Help You to Big-Pay Positions

Hardly a week goes by without our receiving urgent calls for our graduates. "We need a competent Radio Engineer"—"We want men with executive ability in addition to radio knowledge to become our local managers"—"We require the services of several resident demonstrators"—these are just a few small indications of the great variety of opportunities open to our graduates.

## FREE—Receiving Set and Special Parts

Our course of practical instruction includes not only several of our own special patented instruments, but in addition we furnish material and diagrams for building receiving sets, and finally this complete receiving set—all without additional cost.

## Free Employment Service

Scores of young men who have taken our course are already earning from \$75 to over \$200 a week. Merle Wetzel of Chicago Heights, Ill., advanced from lineman to Radio Engineer, increasing his salary 100% even while taking our course! Emmett Welsh, right after finishing his training started earning \$300 a month and expenses. Another graduate is now an operator of a broadcasting station PWX of Havana, Cuba, and earns \$250 a month. Still another graduate only 16 years old is averaging \$70 a week in a radio store, and we help our graduates to positions like these.

## Send for FREE BOOK

There's more money for YOU in Radio. Find out what this field has meant to hundreds of our graduates—and how you too can profit in it. "Rich Rewards in Radio" has just been printed. It is filled with the latest Radio facts, figures and illustrations of tremendous interest to you. Right now—if you are at all ambitious—send for this valuable free book. Fill out the coupon—and mail it now!

## NATIONAL RADIO INSTITUTE Dept. 15FA WASHINGTON, D. C.

National Radio Institute, Dept. 15FA  
Washington, D. C.

Without obligation send me your book "Rich Rewards in Radio," which tells all about the opportunities in Radio, how spare time study at home will qualify me quickly as a Certified Radiotriician so I can get one of these splendid positions, and how your Employment Service helps me to secure a big pay job.

Name.....Age.....  
Street.....Occupation.....  
City.....State.....

# LEARN

In a few short weeks!  
WE TRAIN  
You to be an  
**Expert Barber**  
New,  
Easy Way

NO matter what you are now doing, no matter how much you earn, our amazing new system of training for the barbering profession enables you to step into this clean, pleasant, profitable business in a few short weeks. Start right in earning \$60 to \$150 a week.

J. F. McGregor, of New Orleans, writes: "I have never been out of a job since you sent me in the one from the Post Graduate department a year ago. I have saved up a nice bank account. I am glad I learned Modern Barbering with you."

F. Erbat, of Chicago, writes: "I own my own home! I have my own automobile! I am independent! I have made it all since graduating from your school five years ago."

**EARN \$50 TO \$150 EACH WEEK**  
**Easy Work** A trade that enables you to travel and see the world—one that pays in tips and commissions in addition to salaries.  
**Always Busy** Moier System graduates are in great demand and have no trouble in securing good jobs.  
**BIG PAY**

### WRITE FOR FREE BOOKLET

Our catalog that we mail free tells how we enable you to earn while learning, how we put you into the best city jobs, how we equip your shop on easy payments. In fact, how we take you just as you are, make your life's work easier, better paying and more independent. We have 83 branch schools in leading cities. We have one near you.

### THE MOIER SYSTEM OF COLLEGES

157 Third Ave., New York, N.Y.  
105 S. Wells St., Chicago, Ill.  
510 N. 6th St., St. Louis, Mo.  
544 Main St., Kansas City, Mo.  
206 E. 4th St., Cincinnati, Ohio  
215 Huron Rd., Cleveland, Ohio  
1045 Cass Ave., Detroit, Mich.  
1229 17th St., Denver, Colo.  
727 W. Commerce St., San Antonio, Texas  
110 S. 14th St., Omaha, Nebr.  
512 E. Water St., Milwaukee, Wis.  
1065 Canal St., New Orleans, La.  
25 N. Forsyth St., Atlanta, Ga.  
80 N. 2nd St., Memphis, Tenn.  
910 Main St., Dallas, Texas  
712 Franklin Ave., Houston, Tex.



**FREE** Fine Tone Musical Instruments  
**\$20**  
We have a wonderful new copyrighted system of teaching note music by mail! To first pupils in each locality we will give free a \$20 superb Violin, Tenor Banjo, Ukulele, Hawaiian-Guitar, Banjo, Mandolin, Banjo-Ukulele, Banjo-Mandolin, Cornet or Banjo-Cornet, Flute, free. Also teach Piano and Organ. Very small charge for lessons only. Four lessons will teach you several pieces. Over 100,000 successful players. We guarantee success or no charge. Complete outfit free. Write today, Dept. 167. No obligation.  
SLINGERLAND SCHOOL OF MUSIC, 1815 Orchard Street, CHICAGO, ILLINOIS



## Buchstein's Fibre Limb

is soothing to your stump—strong, cool, neat, light. Easy payments. Braces for all deformities.  
D. BUCHSTEIN CO.  
610 3rd Ave., So., MINNEAPOLIS, MINN.

STATEMENT OF THE OWNERSHIP, MANAGEMENT, CIRCULATION, ETC., REQUIRED BY THE ACT OF CONGRESS OF AUGUST 24, 1912, of Popular Mechanics Magazine, published monthly at Chicago, Ill., for April 1st, 1924.

State of Illinois, County of Cook, ss Before me, a notary public in and for the state and county aforesaid, personally appeared H. H. Windsor, who having been duly sworn, according to law, depose and say that he is the editor and business manager of the Popular Mechanics Magazine and that the following is, to the best of his knowledge and belief, a true statement of the ownership, management, etc., of the aforesaid publication for the date shown in the above caption, required by the Act of August 24, 1912, embodied in section 443, Postal Laws and Regulations, printed on the reverse of this form, to wit: First. That the names and addresses of the publisher, editor, managing editor, and business manager are: Publisher, Popular Mechanics Co., 200 East Ontario St., Chicago, Ill., Editor, H. H. Windsor, 200 East Ontario St., Chicago, Ill., Managing Editor, L. K. Weber, 200 East Ontario St., Chicago, Ill., Business Manager, H. H. Windsor, 200 East Ontario St., Chicago, Ill. Second. That the owners are: Give names and addresses of individual owners, or, if a corporation, give its name and the names and addresses of stockholders owning or holding 1 per cent or more of the total amount of stock: H. H. Windsor, 200 East Ontario St., Chicago, Ill.; L. H. Windsor, 200 East Ontario St., Chicago, Ill.; H. H. Windsor, Jr., 200 East Ontario St., Chicago, Ill.; First Trust and Savings Bank, Trustee for H. H. Windsor, Jr., Chicago, Ill. Third. That the known bondholders, mortgagees, and other security holders owning or holding 1 per cent or more of total amount of bonds, mortgages or other securities are: If there are none so state: None. Fourth. That the two paragraphs next above, giving the names of the owners, stockholders and security holders, if any, contain not only the list of stockholders and security holders as they appear upon the books of the company but also, in cases where the stockholder or security holder appears upon the books of the company as trustee or in any other fiduciary relation, the name of the person or corporation for whom such trustee is acting, is given; also that the said two paragraphs contain statements embracing affiant's full knowledge and belief as to the circumstances and conditions under which stockholders and security holders who do not appear upon the books of the company as trustees, held stock and securities in a capacity other than that of a bona fide owner; and this affiant has no reason to believe that any other person, association, or corporation has any interest direct or indirect in the said stock, bonds or other securities than as so stated by him. H. H. WINDSOR, Editor, Sworn to and subscribed before me, this 28th day of March, 1924. J. GRAHAM, Notary Public. (My commission expires June 17, 1924.)



# Become an Expert Accountant

## The profession that pays big incomes



There will always be a demand for well trained accountants—men whose training combines a knowledge of Auditing, Cost Accounting, Business Law, Organization, Management and Finance. Few professions offer better opportunities to men of ambition and intelligence. The tremendous business growth of this country has created a rich field for the expert.

## Train at Home

### Under the LaSalle Problem Method

The LaSalle Problem Method will train you by mail under the direct supervision of William B. Castenholz, A. M., C. P. A., former Comptroller and instructor, University of Illinois, member of American Institute of Accountants, and a director of the National Association of Cost Accountants. He is assisted by a staff of 75 instructors—legal staff, organization and management specialists; business efficiency engineers, including 31 C. P. A.'s. You will be given whatever training, instruction or review on the subject of bookkeeping you may personally need—and without any extra expense to you. Our big free book on the accountancy profession fully explains how we train you from the ground up, according to your individual needs, from the simplest bookkeeping principles to the most advanced accounting problems. All text material supplied in the course has been especially prepared in clear, easy-to-understand language, so that you can readily master the principles by home study.

Get our free book, which fully describes our expert training course and tells all about our C. P. A. examinations, state regulations, salaries and incomes, and how you can qualify for a high-grade accounting position without inter-

ference with your present position. Send the coupon—NOW.

INQUIRY COUPON

### LASALLE EXTENSION UNIVERSITY

The Largest Business Training Institution in the World

Dept. 664-HR Chicago, Ill.

Please send me your book, "Accountancy, the Profession That Pays," and full information regarding the course and service. Also a copy of your book, "Ten Years' Promotion in One," all without obligation to me.

#### Higher Accountancy

Training for position as Auditor, Comptroller, Certified Public Accountant, Cost Accountant, etc.

#### Other LaSalle Training Courses

LaSalle is the largest business training institution in the world. It offers training for every important business need. If more interested in any of these courses, check here:

- |  |  |
|--|--|
| <input type="checkbox"/> Business Management                         | <input type="checkbox"/> Banking and Finance                 |
| <input type="checkbox"/> Modern Salesmanship                         | <input type="checkbox"/> Modern Foremanship                  |
| <input type="checkbox"/> Railway Station Management                  | <input type="checkbox"/> and Production Methods              |
| <input type="checkbox"/> Law—Degree of LL. B.                        | <input type="checkbox"/> Personnel and Employment Management |
| <input type="checkbox"/> Commercial Law                              | <input type="checkbox"/> Expert Bookkeeping                  |
| <input type="checkbox"/> Traffic Management                          | <input type="checkbox"/> Business English                    |
| <input type="checkbox"/> Industrial Management Efficiency            | <input type="checkbox"/> Commercial Spanish                  |
| <input type="checkbox"/> Modern Business Correspondence and Practice | <input type="checkbox"/> Effective Speaking                  |
|  | <input type="checkbox"/> C. P. A. Coaching                   |

Name.....

Present Position.....

Address.....



# ELECTRICITY

**Earn \$3500 to \$10000 a year  
as an Electrical Expert**

## What's Your Future?

Now you earn \$20 or \$30 or \$40 a week. In the same six days as an Electrical Expert you can make \$70 to \$200 and make it easier—not work half so hard. Why, then, remain in the small-pay game, in a line of work that offers no chance, no

big promotion, no big income?

Fit yourself for a "bossing" job—

**Be An  
"Electrical  
Expert!"**

### Some Features of Cooke Training That Make SUCCESS Certain

1. Practical Money-Making Instruction—no useless, high-sounding theory.
2. Free Electrical Outfit—Finest outfit ever sent out for home experiment and practical use.
3. Free Employment Service. (Helps you get a good job.)
4. Free Consulting Service. (No chance to get stuck on anything, while studying or afterward.)
5. Free Subscription to monthly Engineering Magazine.
6. Free use of my Big Electrical Laboratory.
7. EXTRA Courses Free—Radio—Electrical Drafting—Business—Automobile Electricity—Mine Electricity and Special Lessons on Health and Thrift.
8. Spare Time Work—Special earn-while-you-learn lessons.
9. Reduced prices on all Electrical Supplies.
10. Cash Refund Guarantee Bond.

These features are all explained in my big Free Book—the "Vital Facts"

Today even ordinary Electricians—the "screw driver" kind—are making money—big money. But it's the trained man—the man who knows the whys and wherefores of Electricity—the "Electrical Expert,"—who is picked to "boss" the ordinary Electricians—to boss the Big Jobs—the jobs that pay \$3500 to \$10,000 a year.

### Auto Electricity and Radio Courses FREE

If you want to specialize in Automobile or Radio work I will give you a special course on either or both subjects **Free** when you enroll for my regular Electrical Course. These are not makeshift lessons but regular \$40 and \$50 Complete Courses. This part of my offer may be withdrawn without notice.

**The "COOKE" Trained Man is the**



# NEEDS YOU!

*I will train you at home  
to fill a Big Pay Job*

**\$3,500 to \$10,000 a Year**

Get in line for one of these "Big-Pay Jobs" by enrolling now for my easily learned, quickly-grasped right-up-to-the-minute, Spare-Time Home-Study Course in Practical Electricity.

**Age or Lack of Experience No Draw-Back**

You don't have to be a High School graduate—it isn't even necessary that you should have finished the grades. As Chief Engineer of the Chicago Engineering Works, I know exactly the kind of training you need, and I will give you that training. My course in Electricity is the most simple, thorough, successful and practical in existence, and offers every man, regardless of age, education, or previous experience, the chance to become in a few short months, an "Electrical Expert," able to make from \$70 to \$200 a week.

**Earn While You Learn**

With me you do practical work—at once. In my first few lessons I show you how to make money doing Electrical work in your spare time. (Over half of my students are paying for their course in this way.) I show you also, how to get started in business for yourself, and then help you to get started.

**FREE—Electrical Working Outfit—FREE**

To do spare time work you'll need tools, etc. These I give you—Free—a whole kit including measuring instruments, a real electric motor (no toy), and other things—the greatest value ever given by any School.

**Your Satisfaction Guaranteed by a Million Dollar Institution**

I absolutely guarantee to return every penny paid me in tuition if, when you have finished my Course, you are not satisfied in every way with my instruction. And back of me, in my guarantee, stands the Chicago Engineering Works, a million dollar institution.

**Nothing Like "Cooke" Training Anywhere**

"Cooke" training is different because it's the most practical and most successful. It's best because it's backed up by the greatest Service to students ever known. It's this Service, plus "Cooke" training, that makes the "Cooke" trained man the "Big Pay" man everywhere. Become a "Cooke" Trained Man yourself, and earn \$12 to \$30 a day—\$70 to \$200 a week—\$3500 to \$10,000 a year.

**Investigate! Mail Coupon**

Get the Vital Facts. Let me send you free my big new book on The Future of Electricity. Let me tell you more about the big demand for "Cooke" trained Electrical Experts. Sign and send me Coupon below.

**L. L. COOKE, Chief Engineer**  
Chicago Engineering Works, Inc.  
2150 Lawrence Avenue  
Dept. 1-A CHICAGO, ILL.

Send for  
this **FREE**  
book

*The  
Vital  
Facts*

**mail this coupon NOW**

L. L. COOKE, Chief Engineer  
Chicago Engineering Works, Dept. 1-A  
2150 Lawrence Ave., Chicago, Ill.

Dear Sir:—Send at once the "Vital Facts" containing Sample Lessons, your Big Book, and full particulars of your Free Outfit and Home Study Course—all fully prepaid, without obligation on my part.

Name.....

Address.....

City and State.....

Occupation..... Age.....

**"Big Pay" Man!**





## “There’s One Man We’re Going to Keep”

“Ed Wilson, there, is one of the most ambitious men in the plant. I notice that he never fools away his spare time. He studies his International Correspondence Schools Course every chance he gets.

“It’s been the making of him, too. He hasn’t been here nearly so long as Tom Downey, who was laid off yesterday, but he knows ten times as much about this business.

“I’m going to give him Tom’s job at a raise in salary. He’s the kind of man we want around here.”

**H**OW do you stand in your shop or office? Are you an Ed Wilson or a Tom Downey? Are you going up? Or down?

No matter where you live, the International Correspondence Schools will come to you. No matter what your handicaps or how small your means, we have a plan to meet your circumstances. No matter how limited your previous education, the simply-written, wonderfully-illustrated I. C. S. textbooks make it easy to learn.

This is all we ask: Without cost, without obligating yourself in any way, put it up to us to prove how we can help you. Just mark and mail this coupon.

### INTERNATIONAL CORRESPONDENCE SCHOOLS Box 5611-D, Scranton, Penna.

Without cost or obligation, please tell me how I can qualify for the position or in the subject before which I have marked an X:

#### BUSINESS TRAINING COURSES

- |  |   |
|--|---|
| <input type="checkbox"/> Business Management                     | <input type="checkbox"/> Salesmanship                                     |
| <input type="checkbox"/> Industrial Management                   | <input type="checkbox"/> Advertising                                      |
| <input type="checkbox"/> Personnel Organization                  | <input type="checkbox"/> Better Letters                                   |
| <input type="checkbox"/> Traffic Management                      | <input type="checkbox"/> Show Card Lettering                              |
| <input type="checkbox"/> Business Law                            | <input type="checkbox"/> Stenography and Typing                           |
| <input type="checkbox"/> Banking and Banking Law                 | <input type="checkbox"/> Business English                                 |
| <input type="checkbox"/> Accountancy (including C.P.A.)          | <input type="checkbox"/> Civil Service                                    |
| <input type="checkbox"/> Nicholson Cost Accounting               | <input type="checkbox"/> Railway Mail Clerk                               |
| <input type="checkbox"/> Bookkeeping                             | <input type="checkbox"/> Common School Subjects                           |
| <input type="checkbox"/> Private Secretary                       | <input type="checkbox"/> High School Subjects                             |
| <input type="checkbox"/> Spanish <input type="checkbox"/> French | <input type="checkbox"/> Illustrating <input type="checkbox"/> Cartooning |

#### TECHNICAL AND INDUSTRIAL COURSES

- |   |  |
|---|--|
| <input type="checkbox"/> Electrical Engineering | <input type="checkbox"/> Architect                                   |
| <input type="checkbox"/> Electric Lighting      | <input type="checkbox"/> Architects' Blue Prints                     |
| <input type="checkbox"/> Mechanical Engineer    | <input type="checkbox"/> Contractor and Builder                      |
| <input type="checkbox"/> Mechanical Draftsman   | <input type="checkbox"/> Architectural Draftsman                     |
| <input type="checkbox"/> Machine Shop Practice  | <input type="checkbox"/> Concrete Builder                            |
| <input type="checkbox"/> Railroad Positions     | <input type="checkbox"/> Structural Engineer                         |
| <input type="checkbox"/> Gas Engine Operating   | <input type="checkbox"/> Chemistry <input type="checkbox"/> Pharmacy |
| <input type="checkbox"/> Civil Engineer         | <input type="checkbox"/> Automobile Work                             |
| <input type="checkbox"/> Surveying and Mapping  | <input type="checkbox"/> Airplane Engines                            |
| <input type="checkbox"/> Metallurgy             | <input type="checkbox"/> Navigation                                  |
| <input type="checkbox"/> Steam Engineering      | <input type="checkbox"/> Agriculture and Poultry                     |
| <input type="checkbox"/> Radio                  | <input type="checkbox"/> Mathematics                                 |

Name.....  
Street..... 3-6-24  
Address.....

City..... State.....

Occupation.....  
Persons residing in Canada should send this coupon to the International Correspondence Schools Canadian, Limited, Montreal, Canada.

## Make \$5000 a Year As an AUTO EXPERT



Why work for slave wages?  
Here's the quick way to Big Pay

Just loan me an hour a day of your spare time for a few weeks. I'll guarantee to put you in the \$100 a week class as an Auto Expert, quicker than you can learn any other big pay work. Don't quit your job—stay home! Thousands of men, no better than you, are making big money. Norman Robinson jumped from \$20 to \$100 a week in 6 months. P. A. Sheets is now foreman of Big Auto Shops. You, too, can boss the job. I'll show you how.

Learn the “Job-Way”  
Learn Auto Repairing—  
Auto Electricity—Battery—  
Welding—Valcanizing.

Automotive Expert  
\$3,000 to \$8,000

## LEARN AT HOME!

Learn in your spare time. My copyrighted “Job-Way” system teaches you in an hour what ordinarily takes a month to learn. Fascinating and interesting work. Intensely practical. “Job-Way” system makes you a specialist in every branch of automotive work. 15,000,000 autos, 1,000,000 trucks need repairing and overhauling. Opportunities everywhere.

## FREE Write Today for Free Book and Free Lessons

Get this big illustrated free book. Shows the quick way to Big Pay. Explains practical “Job-Way” method. Gives details of money back guarantee. See free tools offer and other free features. Special low price and easy terms. Don't pass up this opportunity. Write today. Book is Free. No obligation. A postal will do.

J.R. BAYSTON, Chicago Automotive Inst. 536 So. Clark Street  
President Dept. A177, Chicago

## PIANO JAZZ

By Note or Ear. With or without music. Short Course. Adult beginners taught by mail. No teacher required. Self-instruction Course for Advanced Pianists. Learn 67 styles of Bass, 180 Syncopated Effects, Blue Harmony, Oriental, Chime, Movie and Cafe Jazz, Trick Endings, Clever Breaks, Space Fillers, Sax Slurs, Triple Bass, Wicked Harmony, Blue Obligato, and 247 other Subjects, including Ear Playing and Musical Invention. 110 pages of REAL Jazz, 25,000 words. A Postal brings our FREE Special Offer.

Waterman Piano School, 259 Superia Thesis Bldg., Los Angeles, Cal.

## Tri-State College of Engineering

Makes you a Civil, Mechanical, Electrical or Chemical Engineer in two years, 48 weeks each. No entrance examinations. High school Diploma not required. Compact courses made up of essentials only. Expenses low. For catalog address, Box M-6, Angola, Ind.



I won the World's First Prize in Penmanship. By my new system many are becoming expert penmen. Am placing my students as instructors in commercial colleges. If you wish to become a better penman, write me. I will send you FREE one of my Favorite Pens and a copy of the Transamerican Journal. C. W. Bassen, 3512 C. LeBlond, Kansas City, Mo.



MAIL CLERKS  
**WANTED!**  
\$1600 TO \$2300  
A YEAR  
Travel—See Your Country  
MEN—BOYS  
18 UP

Franklin Institute  
Dept. K181, Rochester, N. Y.

Send me, without charge,  
(1) Specimen Railway Mail Clerk Examination questions; (2) schedule showing places of U. S. Government examinations; (3) list of Government jobs now obtainable. (Men—women.)

Name.....  
Address.....



"THE AIR IS FULL OF THINGS YOU SHOULDN'T MISS"



## More Power for Summer Radio

WHEN you take radio away with you—take Eveready Radio "A" and "B" Batteries, the batteries whose great power lasts longer. Remember, summer's the time when radio signals are weaker.

Batteries do get used up in time. The ones you've been using, though partly exhausted, may be satisfactory for the strong winter signals, but are probably inadequate for the weaker summer signals.

For a "B" Battery use the familiar standard 22 1/2-volt Eveready "B" Battery No. 766. It has variable taps for "soft" detector tubes. Put two, three or four in series to provide sufficient power for amplifying tubes.

To light the filaments of your dry cell vacuum tubes for the longest time, use Eveready Dry Cell Radio "A" Battery No. 7111. The Eveready "A" will astonish you by its long-sustained vigor. It is advisable to use two Eveready "A's"

connected in multiple for each WD-11 or WD-12 tube—this gives the "economical eighth" ampere drain per cell which insures maximum economy and longer life. For sets employing one to three UV-100 tubes use three Eveready Dry Cell Radio "A" Batteries No. 7111 connected in series.

The greatest electro-chemical laboratory known created these famous dry cell batteries on which radio largely depends. The experience of thirty years in battery making stands back of them.

Buy Eveready Radio "A," "B" and "C" Batteries—lively, peppy, long-lived producers of power.

For your light-weight sets to take camping or on hikes, Eveready has suitable small batteries.

Manufactured and guaranteed by  
NATIONAL CARBON COMPANY, Inc., New York, San Francisco  
Headquarters for Radio Battery Information  
Canadian National Carbon Co., Limited, Toronto, Ontario

Informative and money-saving booklets on radio batteries sent free on request. If you have any questions regarding radio batteries, write to G. C. Furness, Manager, Radio Division, National Carbon Company, Inc., 207 Manley Street, Long Island City, N. Y.



# EVEREADY Radio Batteries

*-they last longer*



# And the World Once Jeered Their Efforts



**THE NATURE OF  
ELECTRICITY  
FRANKLIN**



**THE FIRST  
COTTON-GIN  
WHITNEY**



**THE EMBRYO OF THE  
REAPER  
McCORMICK**

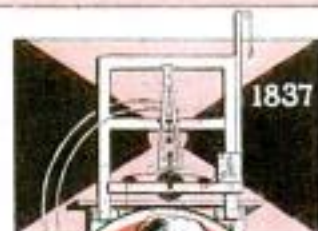

**THE FIRST SUCCESSFUL  
TELEGRAPH  
MORSE**



**THE FIRST LOCK-STITCH  
SEWING-MACHINE  
HOWE**



**THE FIRST SUCCESSFUL  
TELEPHONE  
BELL**



**THE FIRST  
PHONOGRAPH  
EDISON**



**THE FIRST SUCCESSFUL  
FLYING-MACHINE  
WRIGHTS**



**THE FIRST SUCCESSFUL  
WIRELESS  
MARCONI**



# Popular Mechanics Magazine

REGISTERED IN U. S. PATENT OFFICE

WRITTEN SO YOU CAN UNDERSTAND IT

Vol. 41

JUNE, 1924

No. 6

## \$78,800 Offered by Industries for Ideas

506

### Nationally Known Industries Co-operate to Awaken Inventive Genius of Country

Copyright, 1924, by H. H. Windsor

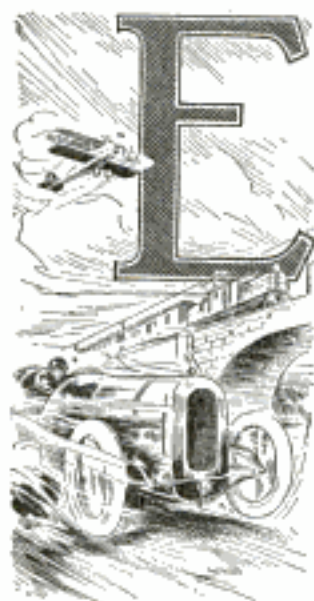

EVERYONE has inventive ability because every man, woman and child at some time or other has ideas which they put to practical use to save time, abolish drudgery or to add to their own happiness. But, because of lack of appreciation of their value, many such ideas lie unused and forgotten to the loss both of the inventor and humanity

to whom they might have proved of inestimable value.

More than a year ago Popular Mechanics Magazine conceived the idea of the Industrial Award Plan to awaken and concentrate the enormous undeveloped inventive forces of the country to aid in the solution of unsolved problems of industry. This idea has been carefully worked out and the details in the following pages are the result.

Every branch of modern industry constantly is facing new problems that cry for solution and every advance made only opens up further fields of research, as Gerard Swope, president of the General Electric company, declared recently. Although scarcely fifty years ago there was nothing electrical in industry, he says, no generators, motors, transmission lines, lights, communication, or traction, today electricity is doing the work of 170,000,000 men and every step forward has opened more highways for achievement and success. To meet these conditions, to bring

together the manufacturer and the inventor, to promote a better understanding between the two and to arouse and direct the undeveloped inventive genius of the world along the most profitable lines, Popular Mechanics Magazine has obtained the co-operation of several of the nation's leading industries who have outlined some of their problems and offered tangible cash rewards for satisfactory solutions. While it is true that a few of these problems have defied the efforts of expert engineers, history records that many of the greatest inventions have been the work of men with little or no technical training who therefore were unhampered by tradition or prejudice. Pasteur, who discovered anti-toxin, was not a doctor. Bell, who invented the telephone, was not an electrician. Morse, father of the telegraph, was a portrait painter.

Charles M. Schwab, the steel master who started life carrying a water pail, declares that hardly anything that the human mind can conceive is impossible of accomplishment. Edison was a train "butcher"; Whitney was only visiting in the south when he conceived the idea of the cotton gin; Goodyear, after years of toil, found the way to vulcanize rubber by accidentally dropping a piece of gum on a hot stove lid. In fact, chance has played a leading role in epoch-making discoveries that touch the life of everyone.

Who, for instance, conceived the notion of dropping aniline dye in water and selling it as violet ink? Somebody dyed cloth a wrong color, and washed it with alum in a vain effort to correct the error. After it was dry someone else tried to wash the material but could not even wet it. So waterproofing was invented. The glazing of pottery also was discovered by chance. A servant girl fell asleep while watching a pot of boiling brine. When she woke up





Paul Curie Demonstrating the Discovery of Radium before the French Academy of Science in 1898

she found the pot was glazed. The man who put the hump in the hairpin made thousands of dollars just by the flash of thought. The inventor who thought of pointing the ordinary wood screw got more for that idea than many a man has earned by working hard all his life. Soft glue used for making printers' rollers was discovered by accident. Lithography also was the result of chance. Repeatedly, **THE MAN WHO DID NOT KNOW IT COULDN'T BE DONE** has won out after experts have failed.

With all these things in mind, Popular Mechanics Magazine has found business men ready to co-operate with the Industrial Award Plan. They have offered \$78,800 for your ideas, outlined their problems and now stand ready to pay the awards to the persons who send them satisfactory

solutions. None of the offers are limited to subscribers or to those who buy the magazine from newsdealers. Anyone can take advantage of the opportunity. Do not hesitate to send in your ideas concerning any particular problem simply because you know nothing of the technicalities involved. You may have the right idea—the manufacturer can hire men capable of working out the details.

As the object of the Industrial Award Plan is to bring together the manufacturer and the inventor, Popular Mechanics Magazine obviously cannot act as a judge, all negotiations being left directly to those offering the awards and those submitting ideas. Our part ends when we have told you what the industries desire. A few of the problems follow, others will be printed in subsequent issues:

**Yellow Cab Manufacturing Co.**

**No. 1—\$50,000—Traffic Safety**

The Yellow Cab Manufacturing Company, supplying vehicles to 815 yellow cab operating companies in the United States, offers an award of \$50,000 for a perfected plan, including regulations, mechanical devices, etc., for the promotion of greater street safety in the cities of this country. This offer expires May 1, 1925.

The plan of traffic and pedestrian correction and regulation must be of such caliber as to recommend its adoption by at least two of the six largest cities of the United States and must have basic qualities suitable for improvement of traffic management in cities of any size.

The successful solution must materially supplement any suggestions grouped in such comprehensive traffic plans as have been made public before the first publication of the present offer. Address Yellow Cab Manufacturing Company, 5801 West Dickens Avenue, Chicago, Illinois.

**Lyon and Healy, Inc.**

**No 2—\$10,000—Musical Instrument**

Lyon and Healy will undertake the manufacture of an entirely new and original design of musical instrument that can be made in their piano factory, banjo and guitar factory or their band instrument factory. The design may be very simple or it may be an elaborate one. It must be a genuine musical instrument to be





James Watt, Inventor of the Steam Engine, with His First Model



Beginning of the Lathe Built about 1862 by Blanchard to Make Rifle Barrels



About 120 B.C. this Ancient Turbine Was Invented by Hero, a Scholar of Greece

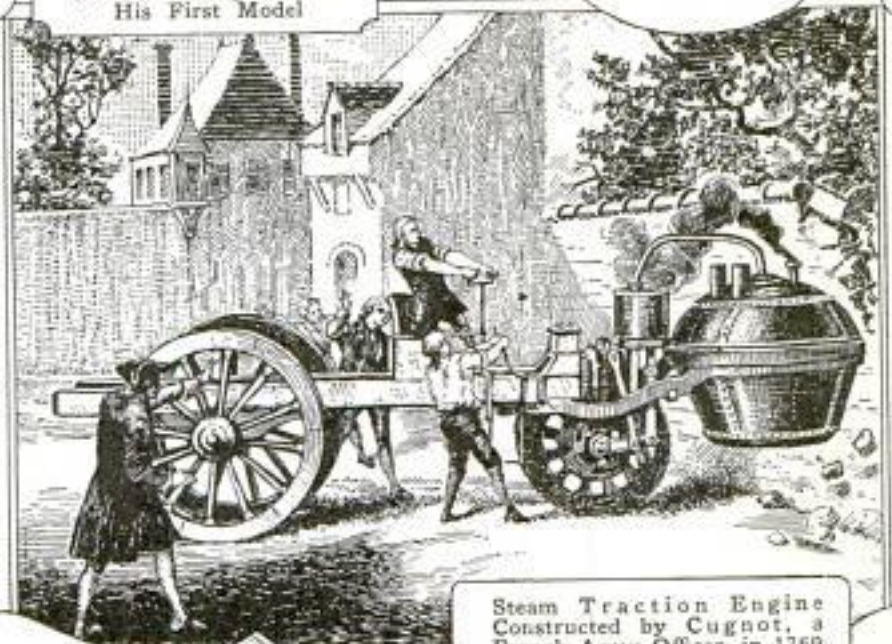

Steam Traction Engine Constructed by Cugnot, a French Army Officer, in 1769



"Mogul" of Early 18th Century Drawing Ancestor of De Luxe Passenger Trains

Hand-Operated Printing Press of the Type Used by Newspapers of Long Ago



considered and must be such that it will be welcomed into the ranks of orchestra or brass band players. To the inventor of an instrument which gains the indorsement of this organization, the donor offers the following terms: They will enter into a contract to make and sell the instrument and will award the inventor royalties from the sales until such time as the royalties aggregate the sum of \$10,000, when they shall cease and the instrument and all patents covering same shall become the sole property of Lyon and Healy, incorporated.

No entrants connected in any way with Lyon and Healy will receive any consideration in this offer. The instrument must be submitted as a working model, so the committee can judge of its value as an addition to the present family of musical instruments. No ideas, plans, sketches or blueprints will receive consideration. There must have a playable model. This offer ends May 1, 1925. Examining committee will consist of W. F. Kirk and H. H. Windsor, editor of Popular Mechanics Magazine. Address W. F. Kirk, 4110 Fullerton Avenue, Chicago, Illinois.

### Everhot Manufacturing Co.

#### No. 3—\$500—Mechanical Improvement

The Everhot Manufacturing Company, making a gasoline-heated blowtorch and soldering and branding iron combined, will pay \$500 for the best suggested improvement on its product that meets the requirements and is adopted by this concern.

#### No. 3A—\$200—Best New Use

This firm will also pay \$200 for the best suggested new use received before May 1, 1925, the date these offers expire. In addition to the above, cash payments in proportion to their value to us, will be given for all suggestions having reference to the production, distribution, and use of our products, not already known to us, and which we will adopt. Address Everhot Manufacturing Company, Maywood, Illinois.

### Problem Number AM-1

#### No. 4—\$500—Preventing Waste of Zinc

In operating a brass foundry there is a considerable loss of zinc at the furnaces. Zinc oxidizes freely and while being melted, oxidizes and passes off in the form of a white cloud in the air. It is obnoxious to workmen and frequently causes illness. The loss of zinc that escapes thus is variously estimated at from three to ten per cent. If any way could be devised whereby this zinc oxide could be saved and reduced to the metallic state again, it would mean a great gain. This donor will pay \$500 for a practical solution of the problem, and one which they would adopt. This offer will end May 1, 1925. Address Problem Number AM-1, Popular Mechanics Magazine, Chicago, Illinois.

### John J. Harris and Company

#### No. 5—\$1,000—Waterproofing and Sales

This concern makes paste known as "Bull Grip" having practically universal application as an adhesive. It can be used as a library paste, a glue, a cement and a mucilage. The adhesive and cohesive properties of the compound are exceedingly strong. It will cause a thin strip of metal to adhere so strongly to a piece of wood that it will sustain the weight of several hundred pounds, and will cause like substances to cohere powerfully. We desire the best way to market the product in wholesale quantities among manufacturers who can make use of it. We also wish an economical method of making the paste waterproof.

John J. Harris and Company will pay \$500 for a solution for each of these problems accepted by them, and which is received prior to May 1, 1925, when the offer will end. Address John J. Harris and Company, 4035 West Kinzie Street, Chicago, Illinois.

### Benjamin Electric Mfg. Co.

#### No. 6—\$250—Making Electric Stand Lamps

For the most practical and workable method, as determined by our engineering department, by which Benjamin stand lamp clusters can be anchored to standard forms of vases, urns, etc., including covering and finishing of openings, thus converting them to electric stand lamps, we shall pay \$250.

#### No. 6A—\$150—Lamps from Old Vases

For the most practical and workable method, as determined by us, of attaching Benjamin stand lamp clusters to vases, urns, etc., with the aid of ordinary materials usually found among stocks of electrical contractors and lamp dealers, \$150 will be paid.

#### No. 6B—\$100—Advertising Plan

For the best scheme or method by which electric lamp dealers can stimulate the business of converting vases, urns, old lamps, etc., to modern electric lamps, using the Benjamin stand lamp clusters, we shall pay \$100. This calls for a workable, concrete sales promotion idea which will attract customers desiring old vases, etc., made into electric lamps. These three offers close May 1, 1925. Address, Advertising Dept., Benjamin Elec. Mfg. Co., 847 W. Jackson Blvd., Chicago, Illinois.

### Problem Number LR-2

#### No. 7—\$5,000—What Shall We Manufacture?

A splendidly equipped factory manufactures bent wood rims similar to those on wheels of bicycles. Facilities and special machinery permit of a large increase over our present production. We can manufacture in sizes from 14 inches to 25 inches out-to-out diameter, and in cross section, any shape that can be made from 1½ inches wide and ¼ inch thick. Possibly someone could invent a product in which these rims could be incorporated or an existing product could be improved to use these rims. For a bona fide plan or proposition that will solve our problem and one that we would adopt, we shall pay \$5,000 when the idea has proved successful and satisfactory within a reasonable time. Offer expires May 1, 1925. Address Problem Number LR-2, Popular Mechanics Magazine, Chicago, Illinois.

### Ilg Electric Ventilating Co.

#### No. 8—\$5,000—Uses for Ventilating Fans

We will pay a total of \$5,000 for ideas suggesting novel and practical uses of Ilg motor propeller fans with automatic shutters, Ilg blowers and Ilg unit heaters.

In paying for suggestions their value will be determined by novelty, and usefulness; the more widely the suggestion can be used, the more we shall pay for it. The amounts to be paid for suggestions will probably range from \$100 to \$1,000. All suggestions will be looked over carefully and those that cannot merit payment will be returned; those adopted will be paid for promptly. We will be sole judges in determining the suggestions that are useful and their value to us. Offer ends May 1, 1925. Address Ilg Electric Ventilating Company, 2850 North Crawford Avenue, Chicago, Ill.

### Jahn & Ollier Engraving Co.

#### No. 9—\$500—What Is "Relief" or "Dry Effect"?

Frequently on plates developed in pyro-soda, photographers find shadows raised in relief. This occurs more with wet plates, than when making a Velox print. A





Whitney, Inventor of the Cotton Gin, Studying a Crude Model of the Machine that Revolutionized a Great Industry; Right, Morse, Father of the Telegraph in His Laboratory where the First "Set" Was Born

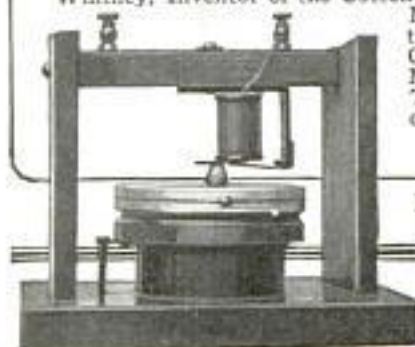

Early Form of Bell's Telephone



piece of glass is coated with albumen so the film will not wash off the plate, and left to dry. Then it is covered with collodion, which "sets," and is put into a silver nitrate bath to sensitize. Exposure is made while the plate is wet, and after washing, it is "fixed" in a cyanide of potassium bath to clear away undeveloped silver.

After fixing, it is intensified by immersion in a solution of sulphite of copper, washed and placed in a nitrate of silver solution. (Some claim this operation is the cause of dry effect.) Following intensification, the negative is bleached with a solution of iodine made soluble with iodine of potassium and water. It is then cleared in a weak bath of cyanide of potassium to bring out the tones. Washing, and bleaching with sodium sulphide follows. Some such negatives are treated with a solution of mercury and blackened with ammonia sulphide, washed, and a weak mixture of nitrate acid used to clear any stains left by ammonia sulphide. A solution of rubber dissolved in either benzol or gasoline is applied after the plate dries. Over this a coating of collodion is placed, which consists of alcohol, ether, gun cotton and castor oil. The film is separated from the glass by immersing in water for a few minutes. It is then stripped to a glass plate and printed on sensitized copper. It is here that the dry effect shows. For a process that will eliminate "dry effect" successfully, we will pay \$500.

**No. 9A—\$500—Color Separation**

A cover of this magazine is reproduced in four-color process from an original water-color drawing. The inks used in printing are yellow, red, blue and black, requiring four different plates. When photographing the original drawing, filters are used in front of lenses to separate colors. For the yellow plate, a purple filter is used to eliminate blues, purples and magenta reds and to emphasize yellows, orange and yellow green. An orange filter is used for the blue plate to strain out all red, orange and yellow and to strengthen blue, green and cold colors. Greenish yellow filters are employed to make black plates, eliminating a little of all colors and emphasizing blacks or near blacks. Last, for the red plate, a green filter is used, eliminating green and near green and giving strength to red, pink, deep orange and violet. Dry plates and emulsions have not proved entirely satisfactory, especially for the plates and filters for the red. We will pay \$500 for a perfect improvement on these processes.

**No. 9B—\$500—Etching Process**

In making a halftone plate our greatest problem is to get a true and absolute photographic reproduction of the copy. By staging and fine etching, you could turn out a more or less mechanical reproduction and lose photographic values. A high negative could be made and staging done away with, but you would lose in the middle tones and light middle tones, and again lose copy value. If we could turn out a finished plate and a true reproduction of copy, in a one-depth "bite" (of the etching acid), it would result in a great saving in present cost. Offers 9, 9A and 9B expire May 1, 1925. For such a process, we will pay \$500. Address Jahn & Ollier Engraving Company, 554 West Adams Street, Chicago, Illinois.

**The Imperial Brass Mfg. Co.**

**No. 10—\$500—Electric Iron Attachment**

Design—An electric heating element that will operate successfully and interchange with the base and cover of the Imperial self-heating gasoline iron. For an accepted design we shall pay the designer \$500. The Imperial Brass Manufacturing Company will arrange to send entrants irons at factory cost and refund such deposit, if and when the iron is returned in perfect condition, within a reasonable time. The closing date of this offer is May 1, 1925. Address Imperial Brass Manufacturing Company, 1200 West Harrison Street, Chicago, Illinois.

**Bassick Manufacturing Co.**

**No. 11—\$100—Chamois Skin Waste**

In cutting out chamois skin pieces for use in our gasoline strainer, scraps are left after trimming the center from sheets averaging about 6 by 12 inches square. We will pay \$100 for a plan, process or method of profitably disposing of these scraps, adopted by us. Offer ends May 1, 1925. Address Bassick Manufacturing Company, 2650 North Crawford Avenue, Chicago, Ill.



**Liquid Carbonic Company**

**No. 12—\$1,000—Additional Uses of Product**

The Liquid Carbonic Company will pay \$1,000 for the discovery of a new use for carbon dioxide gas or for improvements to present uses that will produce for the company additional gas sales of at least 200,000 pounds a year.

**No. 12A—\$1,000—Freeze-Proof Soda Cooler**

This concern will pay \$1,000 for an automatic freeze-proof soda or water cooler for soda fountains, this cooler to have sufficient capacity to care for average two-hour peak load of fifteen gallons of water and soda per hour and to be proof against freezing during normal overnight no-load periods. This cooler must be adaptable to either the so called "iceless" type or mechanically refrigerated

soda fountains where the cooling will be derived from liquid medium at average temperature of ten degrees above zero. All designs subject to sole judgment of this company. Both our offers will end May 1, 1925. Address Liquid Carbonic Company, 3100 South Kedzie Avenue, Chicago, Illinois.

**National Lumber Mfrs.' Assn.**

**No. 13—\$2,000—Salvaging Waste**

The united lumber industry through its agency, the National Lumber Manufacturers' Association, offers an annual award of \$2,000 in a series of payments for the best, most constructive and most practical suggestions for salvaging the lumber which, for one reason or another, drops out of sight and is lost somewhere between the time the tree is cut and the time the lumber reaches the consumer. Address National Lumber Manufacturers' Association, Washington, D. C.

**HERE IS THE PLAN**

1. All offers of awards made, and all solutions of problems submitted, are subject to these terms and conditions, except where they are in conflict with or modified by the terms of the offer. In that case the offer controls.
2. The one offering the award is hereinafter called the "Donor," and the one submitting a solution the "Entrant."
3. All proposed solutions shall be mailed or delivered as directed in the offer.
4. The donor shall pay the award to the entrant who submits a solution of donor's problem which is complete, practical and economically sound and satisfactory, to, and not already known to, the donor.
5. The donor shall have the period of one year from the receipt of any proposed solution to pass upon it, and, in case it be regarded as a partial solution, to agree with the entrant as to the amount of the award. During that one-year period the entrant shall not offer or submit said solution, or any part thereof, to any one else.
6. If the donor shall not have paid the whole or any part of the offered award mutually satisfactory to any entrant within said one-year period, unless entrant agrees to an extension of time, the donor shall return to such entrant by mail the solution submitted by him. If the entrant had the right to sub-

- mit such solution, donor shall make no use of such or the information given, provided, however, that nothing herein contained shall prevent the donor from using any solution, idea, device or information which donor knew about and had the right to use before the receipt by the donor of such entrant's solution.
7. Any patent on, or any patentable feature of any entrant's solution accepted and paid for as herein provided, shall belong to the donor, and entrant shall assign to the donor any such patent already issued and any invention for such a patent on which applications shall have been made. And entrant, at donor's request shall execute all such applications, assignments and other documents as may, in donor's judgment, be necessary or expedient for the purpose of obtaining a patent on entrant's solution, or any feature thereof, such patent to be issued in the name of, and to be the sole property of the donor.
8. Popular Mechanics Magazine shall receive no fees or commissions, directly or indirectly, for publishing any offer made through this department, nor for anything it may do in connection therewith. And the publisher is not and shall not be held responsible for the performance of any obligation either of a donor or an entrant. The publisher's responsibility ceases with the publication of the offer.

Entrants may sign and accompany their solution with the following:

To.....  
(Here write name of firm to whom your solution is offered.)

CITY....., STATE.....

Dear Sirs:  
Enclosed find my solution of your problem, published in Popular Mechanics Magazine. I hereby submit my solution to you for examination, subject to the terms and conditions published in said magazine, in connection with your offer.

NAME .....

ADDRESS .....



WHAT HORSE CAN PULL SHOWN BY TESTS IN ENGLAND

Tests made recently in England proved that a pair of horses, each weighing 1,600 pounds, could haul a load 550 pounds greater than themselves. On a metal track, one of these animals, it has been shown, can draw one and two-thirds times as much as on a good asphalt surface, five times as much as on cobblestone paving and twenty times the load it can pull on an ordinary mud road. For the usual type of farm horse, a cart carrying a weight of 1,500 pounds is considered to be a fair task. While pulling light vehicles and under saddle, records indicate that horses are equal to great feats of strength and endurance. A twenty-year-old beast hitched to a light cart is known to have traveled a hundred miles in less than thirteen and a half hours and was in excellent condition at the end of its journey.

AUTOMATIC CAMERA WINDS UP ITS OWN FILM ROLL

Double exposures and "blanks" are prevented and a rapid "fire" of six "snaps" in as many seconds can be taken by an automatic camera now on the market. By means of a spring motor, concealed in the case, the film is automatically wound after each picture is taken, thus preparing it for the next exposure. The operator does not have to worry about turning a key. It is especially valuable in outdoor photography, in catching glimpses of parades, gatherings and other scenes where quick action is necessary. The motor does not interfere with taking slow or time exposures, is easily wound, strong and reliable.

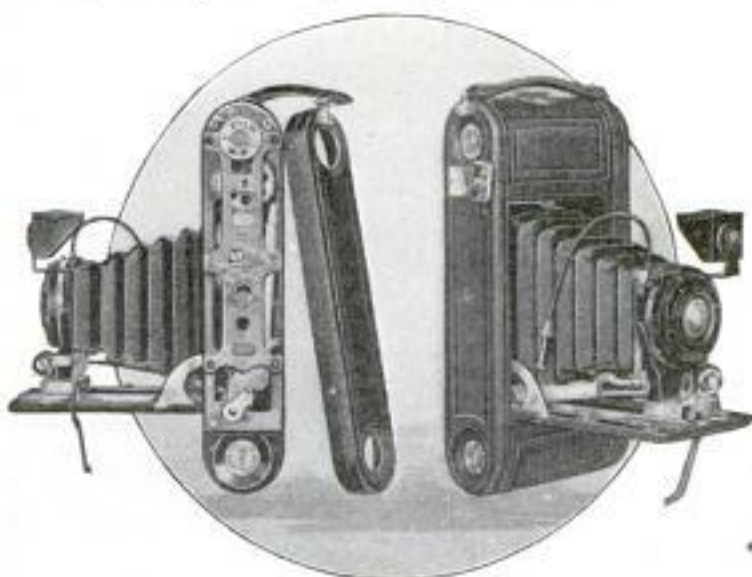

Front and Side View of Automatic Camera Showing Motor Concealed in Regulation Case

Dr. Carl Bornmann, Supt. Ansco Camera Works

Ansco Photo Products, Inc., Binghamton, N.Y.

CHARCOAL GAS RUNS CAR SIXTY MILES AT SMALL COST

Propelled by gas generated from the combustion of charcoal, an automobile in France was driven sixty miles at a cost of



Charcoal Gas Generator that Supplies Power, Is Placed Where Driver Can Tend It

twenty-five cents. Thirty-three pounds of the material were required for the trip. The gas was produced in a compartment built into the body of the car. The experiment was pronounced a success.

No other information

SPEED OF GREAT CITY TOLD BY STARTLING FIGURES

Statistics for the city of New York show that an immigrant arrives at that port every thirty seconds and an average of one arrest is made each two minutes. A child is born every five minutes and a funeral occurs every seven. Every twelve minutes a marriage is performed and a divorce is granted for each six hours of the day. New businesses are started at the rate of one every forty minutes and a failure takes place every five hours. A ship leaves the harbor every forty-five minutes and someone is killed by accident every fifty-five minutes. The crime records of the metropolis are startling in that they show that every seven hours there is an attempt to take some person's life, a suicide is committed each ten hours, and a murder occurs every twelve hours.

Kansas City Journal Mar. 5, 1924

Underwood news Photo Service Chicago Herald. To answer Jan. 23 1924



### ELECTRIC GENERATOR WEIGHS QUARTER MILLION POUNDS

335

With an estimated output of 83,000 horsepower, a giant turbogenerator has been built for a Brooklyn, N. Y., power

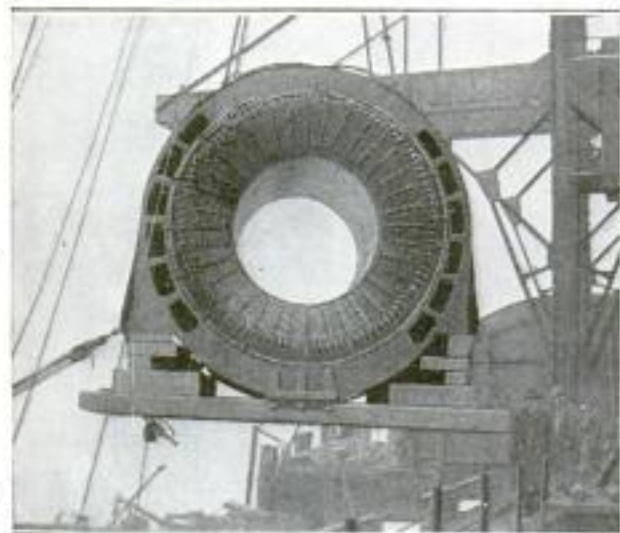

Part of Giant Electric Generator which Will Produce Eighty-Three Thousand Horsepower

house. When completed, it will weigh 260,000 pounds and the cost is estimated at nearly \$1,000,000. The shipment of the heavy parts required much ingenuity.

### WORLD FLYERS' STORES CACHED ALONG ISOLATED ROUTES

758

To enable the around-the-world flyers of the United States air service to repair and re-fuel their planes, stores of provisions and parts have been cached along the most isolated stretches of the route. The flight was scheduled so as to pass over the waters about Greenland during mid-summer when the seas will be sufficiently clear of ice floes to permit landings. For ocean flights, pontoons are attached to the ships at the start of overseas laps, and exchanged for landing gear of wheels when cross-continent journeys are taken up. The airway around the earth is divided into six sections. Each division has a main base and one or more sub-depots containing principal items of supply, while fuel and oil can be had at practically all stops. Scattered at various points along the way are enough engine replacement parts to equal fifteen complete motors and sufficient airplane sections to build four entire craft. Extra pontoons are stored at bases on the laps where flying will be confined to water-covered areas. The longest "leg" of the route is 878 miles, between two islands of the Japan group, and the shortest stretch is 127 miles in California.

### 26 SECONDHAND PAVEMENTS FOUND GOOD AS NEW

Emb. A van & Hook, % U. S. Reclamation Bureau Denver, Colo.

Saving in paving costs has been effected in one city by re-cutting and shaping thirty-year-old cobble stones that had been roughened by constant wear. The edges were trimmed off and the large blocks, little damaged underneath the surface by their long service, were shaped into smaller pieces of convenient size at a cost of two

cents each, including hauling. It was estimated that the old stones utilized in this way saved the taxpayers approximately \$3.10 a square yard in the paving contract. When they were pressed into place and the cracks filled with asphalt, they formed a pavement which engineers pronounced practically as "good as new."

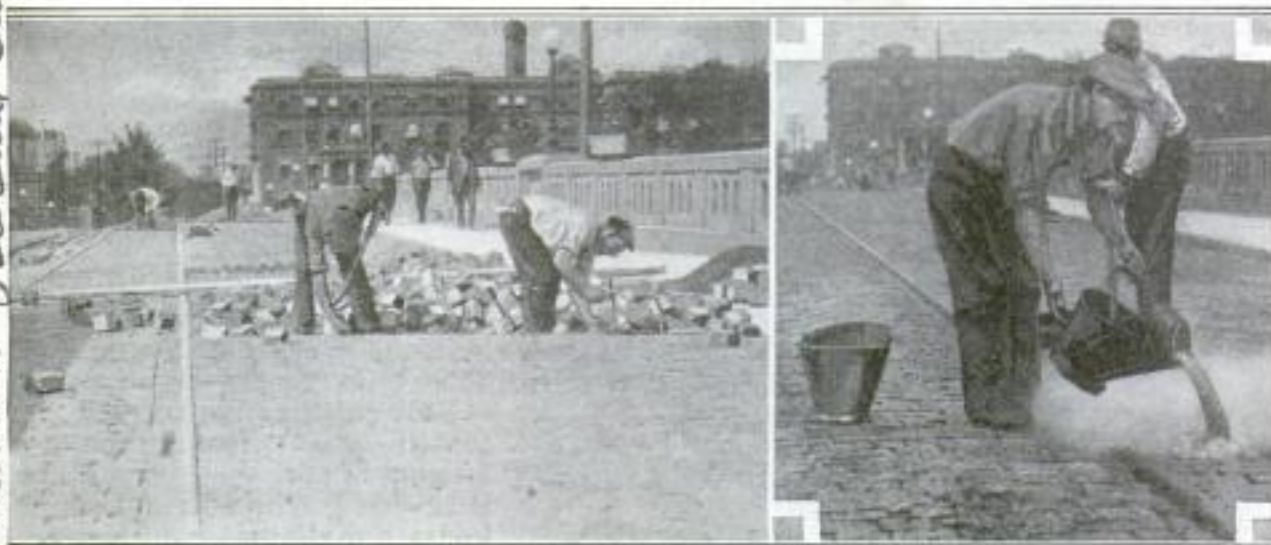

Laying Stones and Filling the Cracks in New Pavement of Secondhand Blocks



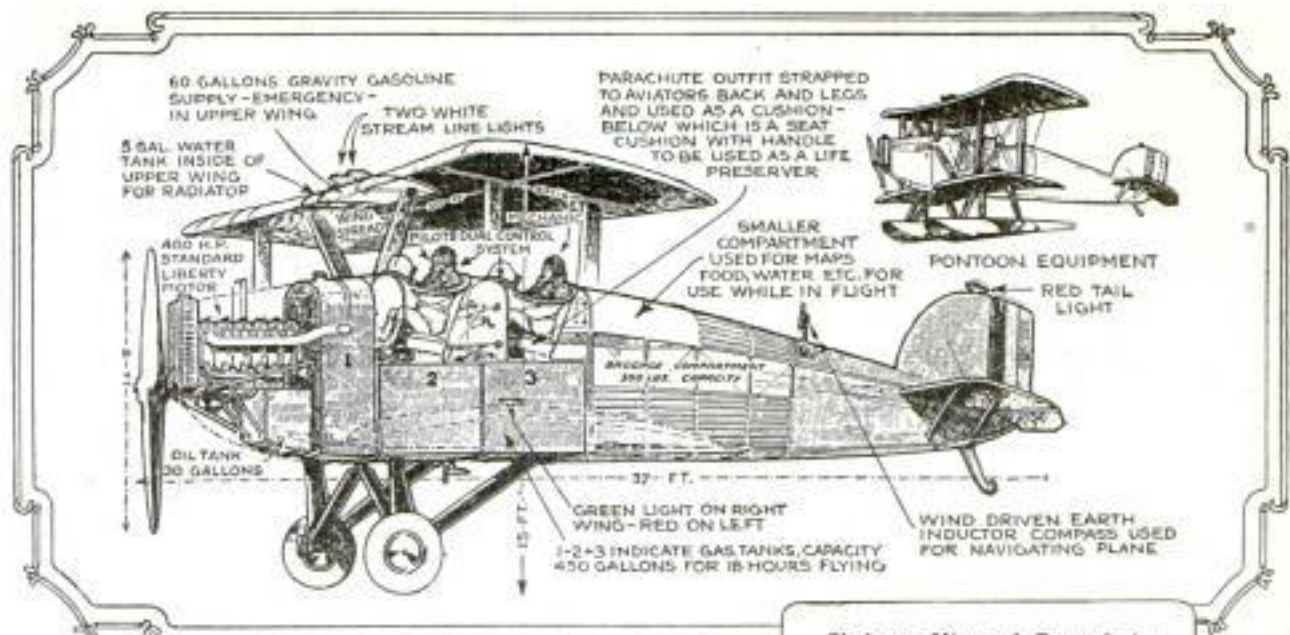

Skeleton View of One of the Four Douglas World Cruisers Showing Special Equipment of Planes

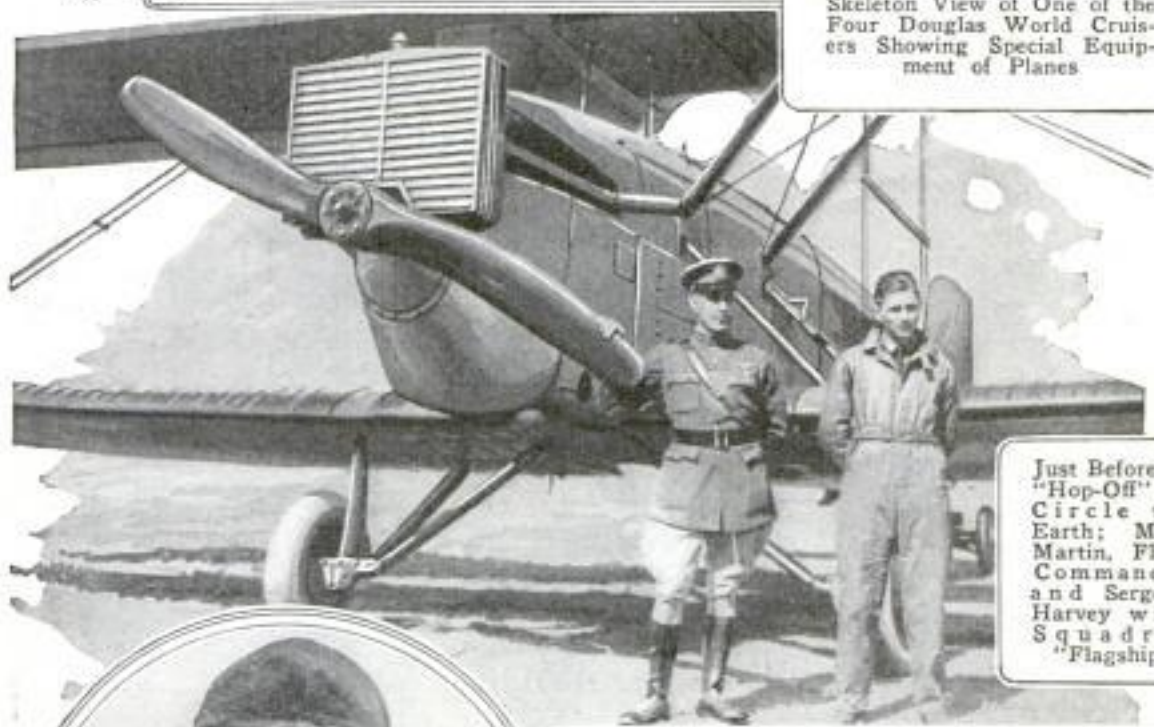

Just Before the "Hop-Off" to Circle the Earth; Major Martin, Flight Commander, and Sergeant Harvey with Squadron "Flagship"



Fur-Clad Headgear Worn by Aviators as Protection against Cold of High Altitudes

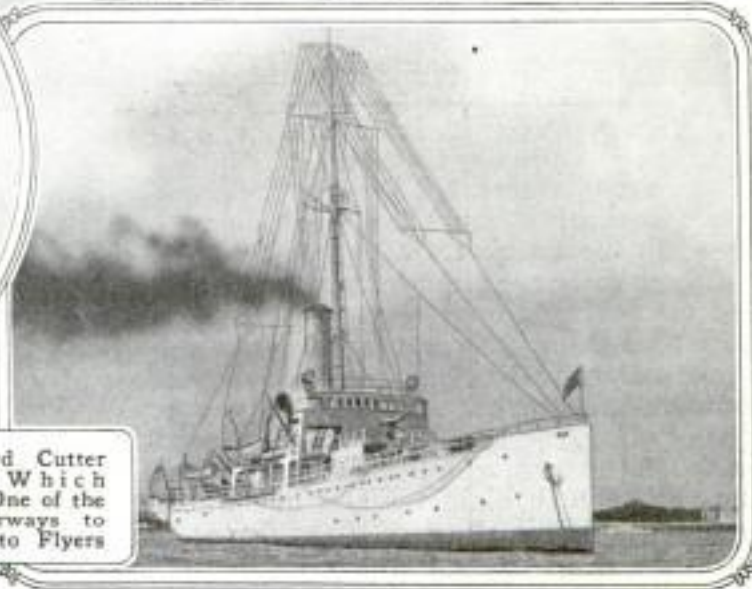

Coast-Guard Cutter "Haida," Which Patrolled One of the Ocean Airways to Give Aid to Flyers



## LIGHT RAYS PRESERVE FOOD AND VITALIZE SEED

68 |  
10/18 of 1910 from  
Blvd.

A method of preserving foods and fruit juices which many believe will do away with most cooking, pasteurizing, refrigeration and the use of chemicals for this purpose has been invented by Dr. N. H. Hazeldine, of Los Angeles. "Solar vitalizing," the name given to the process, is accomplished simply by leaving any perishable article a certain length of time beneath a sheet of specially constructed glass

also must be placed in a certain position with reference to the points of the compass. It is claimed that the process preserves food products and juices perfectly as to odor, color and flavor. The inventor also asserts that it renders all substances immune to insect attacks, so that dried fruits, beans, peas and cornmeal, for instance, after an hour in the vitalizer, could be kept indefinitely without being infested with worms or weevils. A piece of beef hanging in a shed buzzing with flies would be untouched

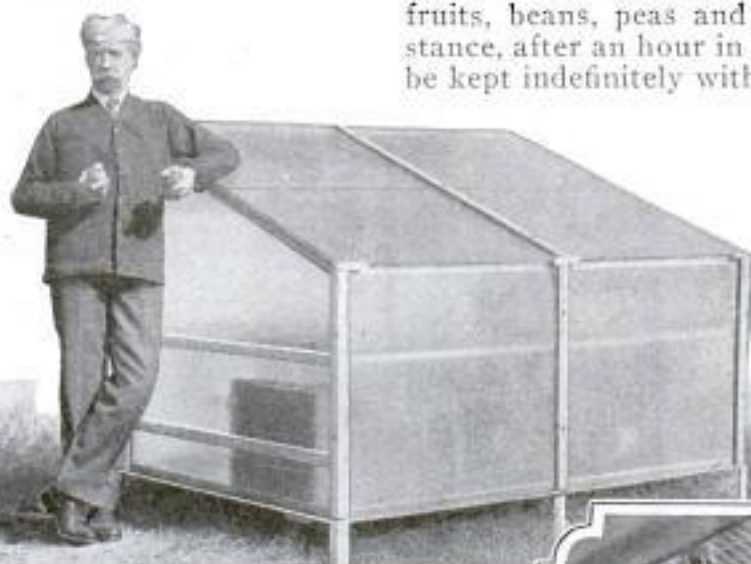

Inventor with "Vitalizing" Cabinet and Foods Being Treated; Note Lenses in Roof over Piece of Meat at Right

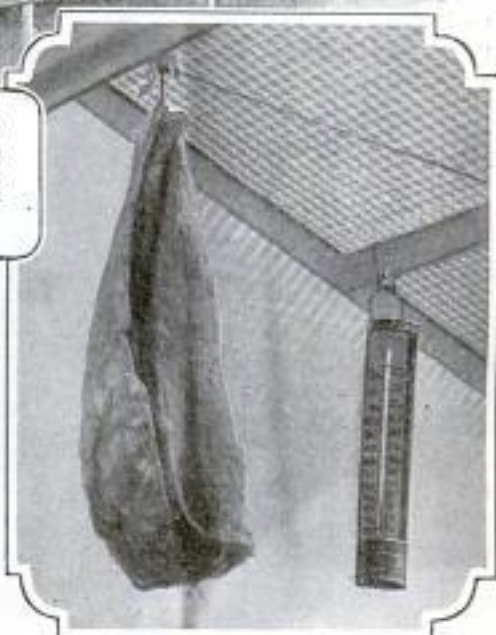

and then putting it into airtight containers. Oils and dry materials may be left in open containers. The time required varies from a few hours to a week, depending upon the article treated, result desired and the weather. The process can be carried on during cloudy days, but requires more time than on bright days. The vitalizer consists of a box or room with sides of common translucent glass and a top or roof of glass, the underside of which is indented in the form of bulbs or lenses, about one-half inch in diameter and one-eighth inch thick. This sheet of glass slopes to the south at a certain angle, a few degrees of variation rendering it ineffective. It

by a single insect. A California law provides that pasteurized milk may contain 20,000 bacteria per cubic centimeter, but vitalized milk is said to contain none at all. Vitalizing also is said to cause seeds to sprout quickly, grow vigorously and produce plants less subject to pests and disease than those grown from untreated seed.

736  
Shoes of braided leather are being manufactured in Berlin. They are said to give a better appearance, greater ease in walking and more ventilation to the foot. Made of narrow leather strips carefully interwoven and shaped, they can be tightly laced to furnish a strong support.

*newspaper clipping*



Carl George A. Holden,  
Hill Crest Lodge,  
Tipton View Road, Chesterfield  
POPULAR MECHANICS

SECRET INK PRINTS ON BREAD  
TO REDUCE ITS COST

England 834

Edible advertisements have appeared in Italy in the form of bread bearing printed matter impressed upon the dough before baking to explain the merits of a wide variety of products. Money the baker receives from the "ads" is expected to result in a cheaper loaf for the purchaser, and the large distribution of the bread is counted a point in favor of the advertiser who buys "space" on the loaves. The process is said to have been approved by the food inspectors. A secret coloring material is used for ink. Baking the bread is said to darken the printing, making the letters more distinct.

MOTOR CYCLE IS CATTLE CART  
FOR TRIPS TO MARKET 556

To haul live stock to market, a farmer in England built a roomy crate on the frame of a motor-cycle sidecar. The pen which is of strong wood, accommodates a large animal and has a compartment for egg



How English Farmer Transports Cattle to Market with a Pen on Motor-Cycle Sidecar

boxes and other produce. A gate at the rear serves as an entrance and a halter tied to the slats holds the animal steady while the machine is in motion.

WAR GAS SEEN IN LONDON FOG 700

"Fog poisoning" is the term applied to an affliction that attacked a great number of children in London last winter. A scientist, investigating the cause, is said to have discovered, in the fogs so often enveloping that city, varieties of mustard gas and other poisonous mixtures similar to those used in the great war. These affect delicate parts of the nose and throat.

Chicago Daily News  
March 8, 1924

PHOTOS OF SOUND TO IMPROVE  
MUSIC AND RADIO 587

Photographs of the vibrations produced by musical instruments are taken with a camera by the use of a special transmitting



Inventor and His Camera with Transmitting Apparatus which Registers Waves Produced by Sound

apparatus and are recorded in regular curved lines on the photographic plate. Pictures thus obtained are an aid to the study of the quality of the tones produced by instruments of various grades, and have also been used in research work in radio to determine the character of the waves set up by different kinds of music.

STAKES FOR HOLDING PLANTS  
HAVE ADJUSTABLE LOOPS 521

Growing flowers, shrubs and vegetable plants are kept from being blown over by adjustable supports with wire loops. They can be placed in position in a fraction of the time required to tie tape about the branches, and consist of hardwood stakes of various lengths with the loops attached in such a way that they can be slipped up or down as the plant grows. These supports do not bruise the plants, but keep them in the best position for getting light and air.



THE WAY TO ADJUST IT

If Australia could be placed in the Atlantic ocean it would fill up all the space between America and the British isles.

Rayton C. Miller,  
Los Angeles, Calif.  
Horred Seed Co., Cortland, N.Y.



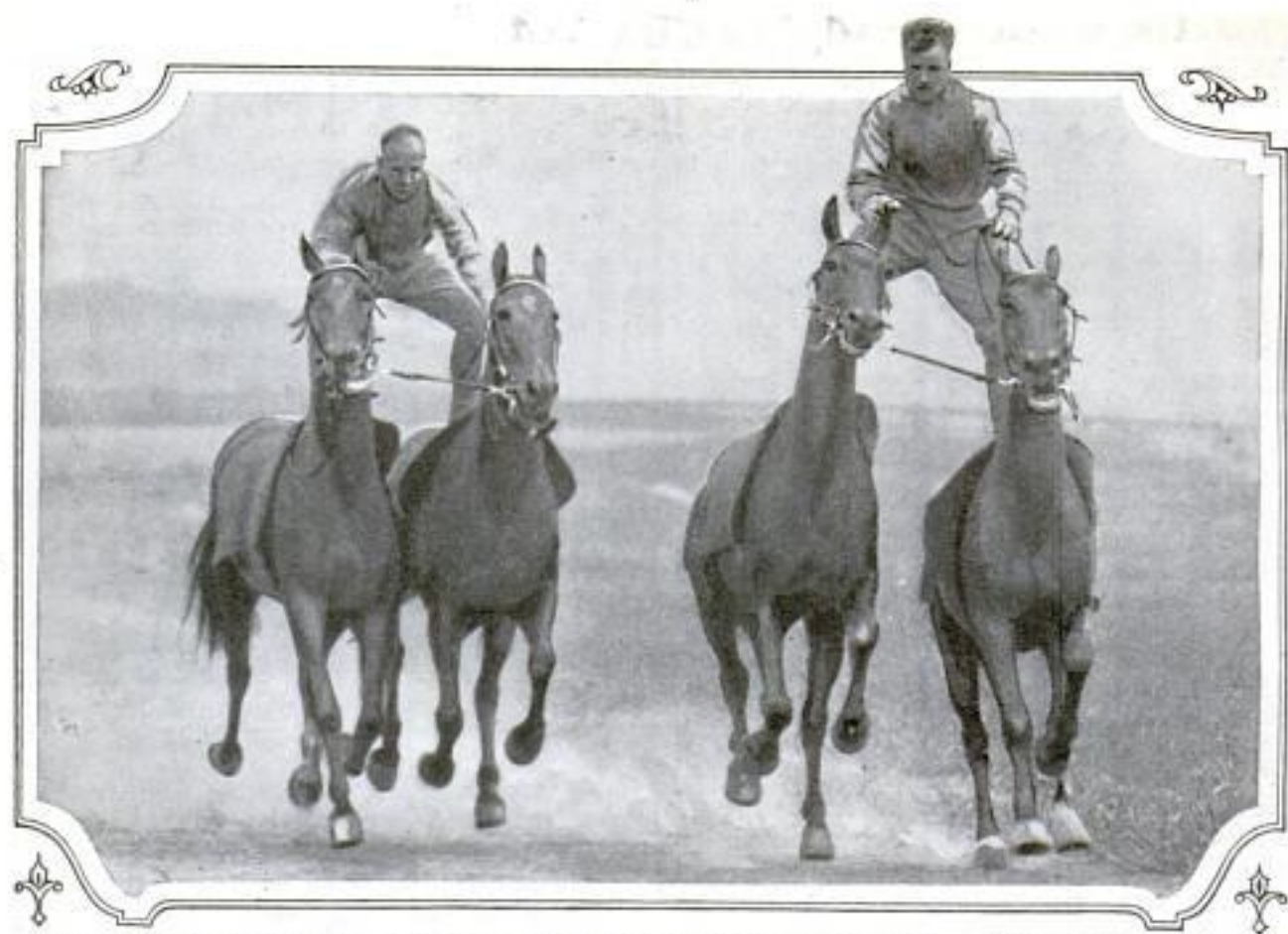

"Roman" Riding, a Thrilling Performance that Requires Expert Horsemanship and Well-Matched Mounts Trained by Long Practice to Travel at Even Speeds and with Equally Measured Steps

*Army*

## Horses that Go to School

How Training Classes for Animals in Mounted Services Make "Scholars" and "Athletes" of Army's Equine Soldiers

**A**LTHOUGH the Great War did much to reduce the size of cavalry services maintained by military organizations, the mounted soldier is still a highly necessary unit in the armies of the world. To furnish trained horses to these branches, schools are maintained wherein the equine "soldier" gets his education for the ranks.

Young horses are selected with respect to uniform height and weight. Most of them are unaccustomed to the voice of man and entirely unused to his presence and activities near them. "Barefooted," and soft muscled, they are awkward beginners compared to the iron-shod, agile beasts they become. Under the tutelage of experienced and gentle trainers, the colt, in his first days of "drill," is put on the longe, a circular track of small diameter, and held in leash by a long rope in the hand of the teacher, who stands in the center of the ring. Quiet commands, accompanied by slight jerks on the line, gradually teach the "recruit" to associate his actions with the

signals of his patient master. If he does his preliminary work well, the young horse is rewarded by affectionate caresses and early release to the picket line or stables, but if he is slow or 'rebellious, he is sent back to his stall to rest and quiet in preparation for another day's grill on the longe.

Even under the most trying circumstances harsh words or rough treatment is never accorded the beginner. Only by winning the confidence of the young mount can he be taught the wisdom of the veteran troop horse. Saddles and bridles are put upon him with gentle care, and nothing is done that might strike fear in his shy heart. The presence of older horses serve to give him courage and set examples that are great aids to the instructor, whose purpose is to school the animal to his trade, and not to "break" him.

Only a couple of weeks are necessary to bring the colt to a realization of the spirit of the work. Then he seems to enter into the daily task of training with an appear-



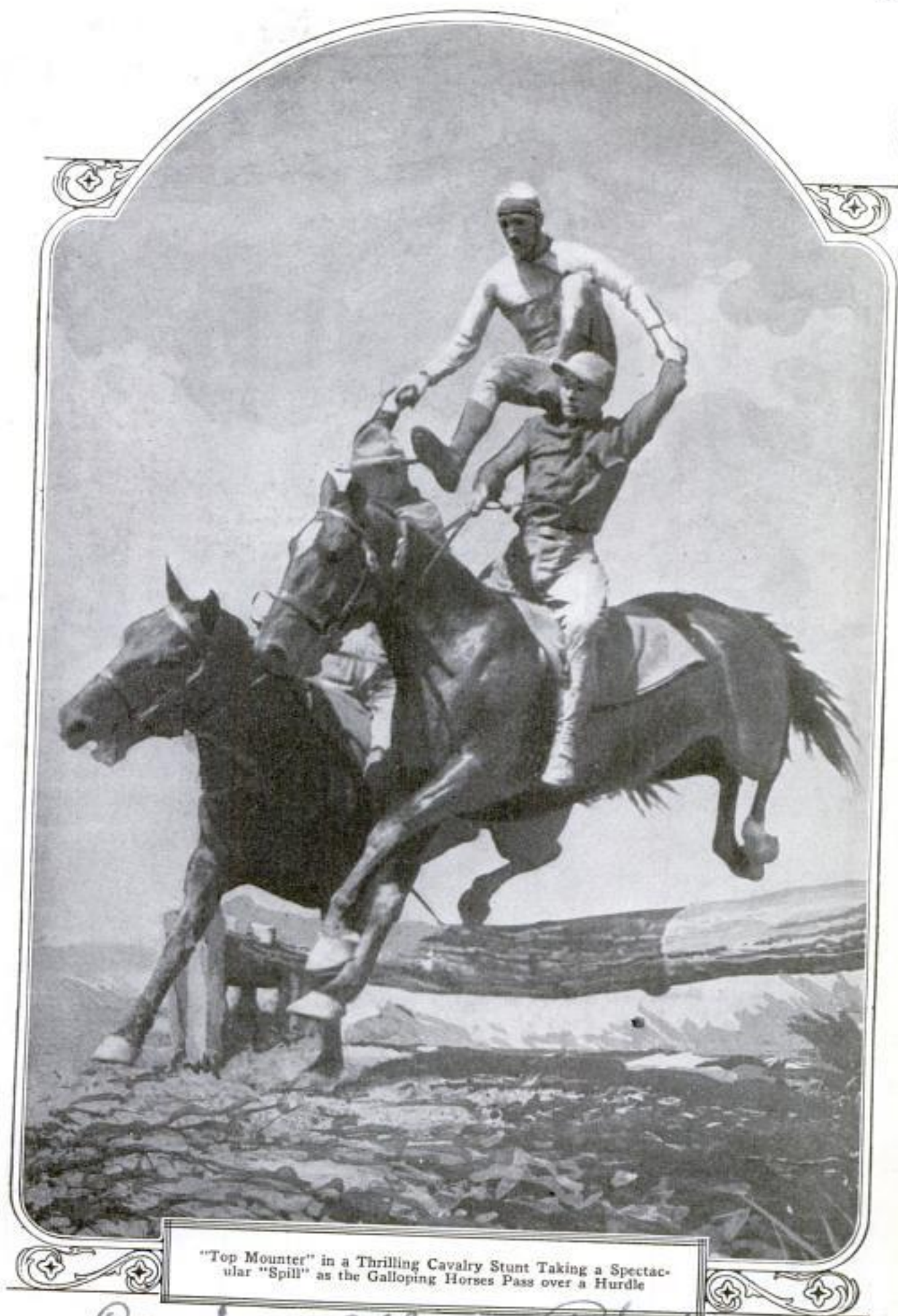

"Top Mounter" in a Thrilling Cavalry Stunt Taking a Spectacular "Spill" as the Galloping Horses Pass over a Hurdle

Pacific & Atlantic Photos

25 Park

Place  
New York City





©Underwood & Underwood  
 Defying Laws of Gravity,  
 and on Insecure  
 Footing, Rough Riders  
 Thunder through Their  
 Perilous Drills Amid  
 Clouds of Dust



Educated Cavalry Horse  
 Jumping Human Barrier, a  
 Trick that Tests Troopers'  
 Nerves and Teaches Ani-  
 mals to Avoid Injury to  
 Fallen Men





Start of Pushball Contest Where Horses and Riders Display Fearlessness and Expertness in Rough Tactics of Game



"Six Up on Three"; a Pyramid of Horsemen Testing Their Skill and Daring during "Monkey Drills" with Animals Trained to Be Cautious



At a Fast Trot Standing on a Pair of Perfectly Matched Mounts Patiently Taught to Step Together to Give a Level Footing for the Rider

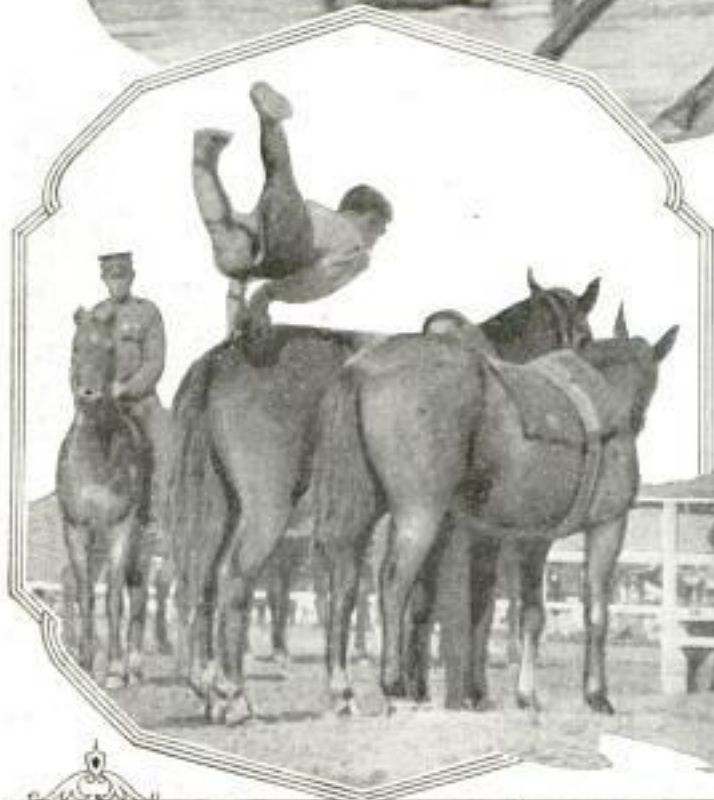

Performing Dangerous Gymnastics during "Horse-Hurdling" Exhibitions: Part of Program Calling for Perilous Risks from Entrants to Contests





583  
828

ance of understanding that gratifies the instructor and gains for the "pupil" admiration as well as affection from his rider. He learns marching and drilling order, the meaning of the various touches of knee and spur and soon seems to feel that he is an important figure among the hundreds of others linked by a common bond to ever attentive men who surround them.

Romance and adventure go with the cavalry horse's lot. The ring of the bugle apparently stirs his blood and thrilled by the voice of his rider, he dashes into an ordered charge with all the vim and action of his highly trained body.

While it is generally held that at least two years of service in the ranks are necessary to perfect the education of the average horse, many of them become adept in the performance of difficult tasks in much less time. With shining coat, alert eye and ear and muscles of steel, they participate in the gymnastic "monkey drills," aiding the acrobatic performances of the riders with intelligence rivaling that of the most expert veterans of the circus ring.

Paired off and teamed in fours, they take their places, frequently at an early age, in practice for Roman riding and the spectacular tactics that make up the thrill and excitement of "rough riding," hurdle racing, and the like.

One of the most admired movements of a well-trained cavalry mount is that of two-tracking, a graceful performance that consists of running sideways, cross-stepping both front and hind feet, while traveling in a double path. This is seldom found in horses other than those used by officers, and the movement is employed when the

rider inspects the troopers in line formation, when, facing them, he passes down the entire length of the unit without turning his mount to the right or left.

Not unlike the army training, is that of the mounted police services in large cities, where the animals must be even more accustomed to the activities of crowded streets and noise of traffic. The horse of the traffic squad undergoes an education amid an almost constant din of sounds that are designed to accustom him to trolley bells, railway trains, automobile sirens and the roar that will greet him when he takes his place in line of duty. In addition to becoming a good rider, he is taught quaint little tricks to assist his master in keeping order at times of emergency.

The police horse is trained to combat the rush of mobs by swinging his body to force back the front line of such crowds. At a touch of the spur he may even raise his hind foot in position for a kick that never lands, for that is but part of his tactics to intimidate persons in combat with his rider, or threaten those who get too near for his safety. In the school hall he has also learned that little danger to him lurks in ponderous busses and trucks that pass noisily. Under the care and attention of his mentors, he is trained to ignore the sudden rush of men toward whom he is driven, in imitation of a charge on a mob. Boxes and barrels are rolled from platforms, papers are torn and thrown into the air about the horse's face and he is even punched with clubs and struck by small pebbles cast from a distance to harden him to the things he will meet in his career.

592

### FISH ARE SUPPLIED WITH AIR BY PERFORATED STRAINER

While transporting the young fish hatched each year in the government fisheries to stock the streams of the country, water in the shipping cans must be aerated to prevent the young fry being suffocated. This is done quickly with a perforated strainer with a hooked handle of one-quarter-inch pipe that serves as an air vent. The attendant places his thumb over the pipe after the strainer is inserted in the can, then elevates the dipper over the bucket. Water is carried up with it and is released through the holes when the thumb is taken away. Falling into the fish pail, it aerates the contents, and assists in the removal of sediment. One or two repetitions of the movement are sufficient to give the fish a supply of fresh air.



Government Hatchery Attendant Aerating Water in Fish Shipping Can with Perforated Strainer

10000  
National Press Club,  
Washington, D.C.



*Inv. Walter C. Menyhart,  
130 E. 15th St.,  
New York City*

**DOUBLE-BARREL FOUNTAIN PEN  
WRITES IN TWO COLORS** *56*

For writing in two different colors, a fountain pen with a double barrel has been invented. Two shades of fluid can be stored in the stem and either one released without danger of mixing. A button at the top closes and opens the channels through which the liquid supplies pass, while an indicator shows the side of the device that is ready for use. The pen is said to be a time saver for draftsmen, bookkeepers and others whose occupations require frequent changing of writing fluids for work where more than one color of ink must appear.

**ARMY OF CLEANERS KEPT BUSY  
IN RAILWAY TERMINAL** *262*

In one of the largest railway terminals in New York City, where traces of millions of feet must be erased and hundreds of windows and miles of walls washed every night, 150 men are employed for this service. Upon the heels of twenty-five men who have been engaged during the day in dusting and sweeping and picking up rubbish, the "scrubbing squad" start work at seven o'clock in the evening. They are helped by many labor-saving devices, such as electric mops and cleaners. The workers themselves find ways to lighten their toil.

The member of the crew shown in the illustration designed a frame to hold his buckets and tools. The whole outfit may



Member of Railway-Terminal Cleaning Brigade with Kit of His Own Design

be slipped on his back and easily carried to any part of the station.

**MINIATURE STREETS USED IN COURT EVIDENCE** *263*

For use in courts to speed up the taking of evidence presented in accident or traffic violation cases, an adjustable model has been invented to illustrate street conditions. It is about three feet in length and

shows street intersection with trolley lines running in both directions. Miniature electric lights, telephone poles, fire hydrants, vehicles and pedestrians are represented and may be moved about.

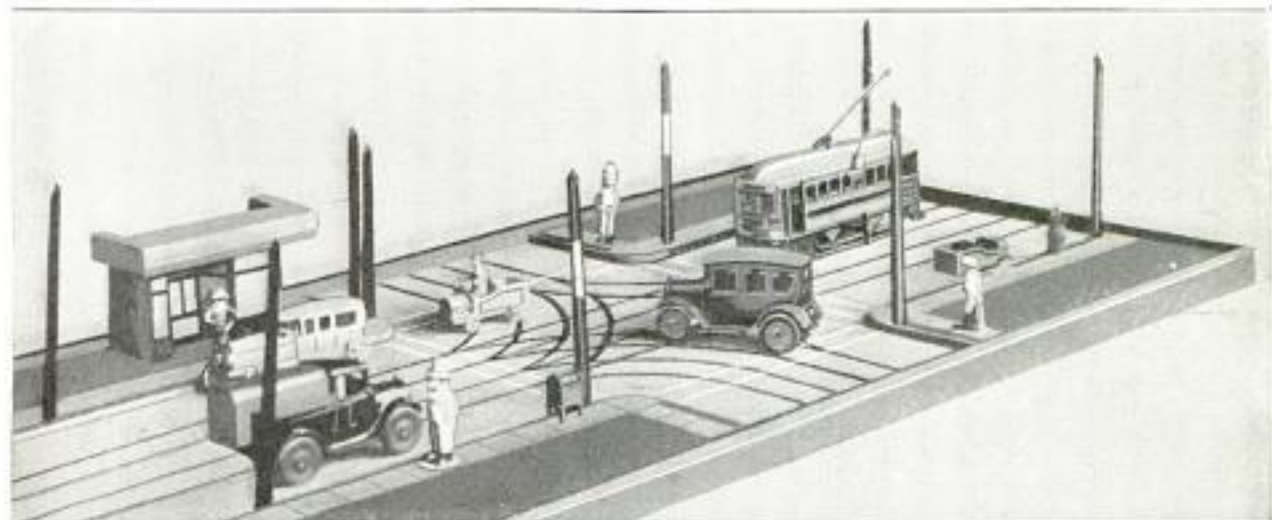

Model of Street Corner Designed to Facilitate the Presentation of Evidence in Court Regarding Accident or Traffic Violation Cases; the Figures Are Adjustable

*Inventor Elsworth C. Meyers,  
Master Mechanic Springfield, Mass.  
Police Dept.*



TRUCKS QUICKLY LOADED FROM REAR BY POWER

Considerable saving in time and labor is claimed for a power-loading apparatus invented in Europe. Loading platforms are placed on the ground and then raised to the truck. On reaching a destination, the

process is reversed. The essential part of the equipment is a winch mounted on the chassis just behind the driver and capable of being driven by the motor. A wire cable pulls the loaded platform into position.



Reprinted from Motor Transport June 11, 1923



Loading Log Truck by Pulling Filled Platform over Rear; Diagrams Below Illustrate Working Principle of Winch Run by Motor and Winding Cable Attached to Sliding Body

REGULATOR FOR AUTO LAMPS PREVENTS SUDDEN GLARE

Even transition from faint to bright light to prevent the blinding effect when the automobile headlights suddenly are switched fully on, has been obtained in a patented regulating apparatus which may

be placed on the steering rod or instrument board. Graphite has been used to take up the resistance so that the regulator is not injured by the shaking of the car. Shading the light in this way is said to give longer life to both batteries and lamps.

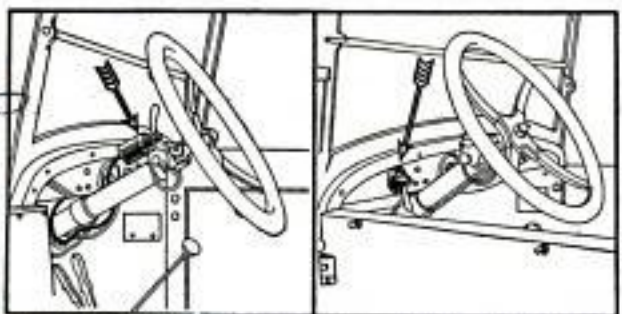

Diagrams of Headlight Regulator Attached to Steering Wheel and to Instrument Board

SALT IS TOUGHER THAN STEEL

Strands of wire made from ordinary rock salt by a Russian chemist are reported to be tougher than those of steel. The inventor expects the process to aid in hardening and strengthening common metals, and believes that the treatment, if applied to other minerals, may result in materials that would permit moving machinery to travel at much greater speeds. The scientist is said to put raw rock salt under high heat pressures, thus changing its form and increasing its flexibility and strength.

Conk F. Christie  
356 Union Station  
Winnipeg, Man.

291  
English agent. Swiss Berna, Ltd.  
Short St. New Cut London  
d. e. l. England  
to Vetro co.,  
Dehenschlagerogade 8,  
Copenhagen Denmark

no further information



New York Times

8/27/24

POPULAR MECHANICS

Pacific Atlantic Photos, Inc.

\$31

25 Park Place, New York

### SIX MILES OF AERIAL TROLLEY TO SPAN BOLIVIAN PEAKS

Rising about 3,700 feet, and at its highest point 1,600 feet above sea level, what is said to be the highest aerial trolley line of its kind in the world is being constructed by a tin-mining company to cross the mountains at Caracoles, Bolivia. It will be six miles long, and is expected to take six months to complete. Steel will be worked on the ground, and the trolley line itself will carry material for its construction up the mountain.

### MARTIN LUTHER BIBLE DEFIES THE RAVAGES OF TIME

Almost as legible as the day when it was printed in 1729, and with binding and paper



Bible Printed Centuries Ago that Is Still Well Preserved and with Printing Little Faded

well preserved, a Martin Luther bible has been found in a California city. Contrasted with the pocket-size volumes which modern invention has made possible, the book is cumbersome, but the materials and workmanship were so fine that time has done little damage to it.

San Diego

### FOREST-FIRE WARNING GIVEN BY MEASURING MOISTURE

Warning of fire danger in forests is given by an instrument designed by M. E. Dunlap, of the Forest Products Laboratory, Madison, Wis., and H. T. Osborne, of the Priest River Forest Experiment Station, Missoula, Mont. The device measures the moisture in the forest floor and its usefulness lies in the fact that during spells of dry weather, the fire peril can be estimated according to the degree of dryness of the very inflammable material at the base of the trees. The instrument consists of a dial and a tube that contains a

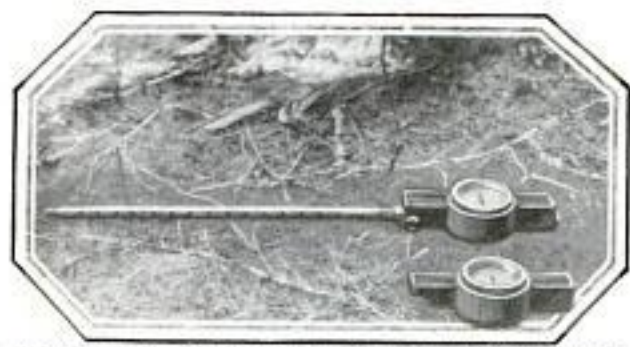

Instrument for Measuring the Amount of Moisture in Forest Floors to Foretell Fire Hazards

strip of rattan which expands and contracts with changes in the moisture content of the material with which it is in contact. The changes are registered by a needle on the dial.

### STAINLESS STEEL IN JEWELRY OUSTING GOLD IN EUROPE

Cut-steel jewelry is said to be gaining in popularity in Europe, replacing gold for finger and earrings, hatpins and clasps. The metal does not stain or tarnish readily and is being worn much with black evening gowns. The ornaments cost less than the precious metals and are easily replaced.

Cont. George H. Holden  
Crest Lodge, Tapton View  
Road, Chesterfield, Eng.

### TOOTHBRUSH IS EASY TO CLEAN AS BRISTLE ROWS OPEN

Made so that each row of bristles can be separated for cleaning, an improved toothbrush has been placed on the market. There are three lines of bristles, but when the parts are opened, every fiber is revealed, so that food particles may be easily removed. When folded, it may be conveniently carried in the pocket.



Folding Toothbrush So Constructed that Rows of Bristles Can Be Opened for Cleaning

S. Sprague, Plaza  
Box 95, Brooklyn, N.Y.



## GOLD "MINED" FROM BUFFERS — SAVES THOUSANDS YEARLY

Salvaging the "dust," thrown off as pieces of jewelry are polished on rapidly rotating buffers, yields a harvest of thou-



Copyright, Underwood & Underwood  
Operating One of the Gold-Polishing Buffers in a Large Jewelry Store

sands each year for many firms. One mid-western company saves more than \$6,000 each year in this way. The covering of the buffing wheels is made of cotton-felt, layers of linen, small bristles, or other materials, to give the various finishes desired. From time to time, the cloths are washed and treated in acid and the dust surrounding the machines is gathered up and subjected to an acid bath to save the valuable particles.

## LIMIT OF FLYING SPEED NEAR PREDICTION OF SCIENCE

How fast can a man fly, and live? With the increased perfection of design, particularly as regards streamlining and other methods of cutting down wind resistance, and the invention of new and more powerful motors, the question becomes of vital importance. If it were merely a matter of mechanical skill and engineering knowledge, aviators say that a speed of 1,000 miles an hour would be possible in the near future. But the human factor enters the field, and, according to authorities, a man traveling at such a pace would be in grave danger of losing his life. It would not be the straightaway flying that would imperil the aviator, says Maj. L. H. Bauer, commandant of the school of aviation medicine at Mitchel Field, L. I. The real danger would occur in making turns, par-

ticularly sharply banked deviations from the original line of flight. When a moving body is deflected from a straight line, centrifugal force is developed. It is the tendency of the body to follow its original path. The greater the speed and the sharper the deflection, the more powerful is this force. The result is that when an aviator makes a sharp turn, the blood supply to the brain is drawn away, causing unconsciousness. If the force were sufficient, death would result.

## GOLF CHARTS TEACH STROKES AND STANDING POSITIONS

To check the game of experienced golfers or to teach beginners, a set of six charts, printed with directions and illustrations showing correct standing positions, grips and strokes, and other fine points, has been devised. With them, one may read a lesson in golf technique and follow it at the same time. Printed on heavy paper, the charts are to be placed on the floor. Standing over them with club in hand, the player is able to get the proper grip and position and execute the stroke in correct form. The diagrams afford a



Reading Printed Directions on Chart and Executing Golf Stroke at the Same Time

constant check and means of comparison for accuracy in every detail. The charts can be used at odd moments at home.

Maynor Co. Bldg.  
Merchants Philadelphia, Pa.

Kansas City Star  
2/10/24

421

225





## Anglers Lured by Spring to Haunts of Trout

Wary Game Fish of Lake and Stream Sought by Boot-Clad Sportsmen Armed with Rod and Reel

**F**IRST signs of spring bring to the trout fisherman an ardent glow of anticipation swept in upon a warm and mounting tide of fascinating and luring memories of

foam-flecked pools in whose depths the big gold-and-olive velvet beauties watch and wait; of churning, swirling rapids which test the mettle of this prince of game fish.

When the willows fling their silvery welcome to the returning sun, it's time for the trout fisherman to overhaul his tackle, his rods, lines, leaders and flies, for the coming campaign.

The opening of the season brings a new zest to life for every follower of old Izaak Walton. There is a great and binding fraternity among all fishermen, whether their quarry be the crimson-slashed cutthroat, the dazzling rainbow, the fighting golden beauty of California, the Dolly Varden or the pearl of them all—the brook trout of the east. Roughly speaking, there are some forty kinds of trout in American waters, a number of them brought here from Europe.

American trout are divided into two great classes, salmon trout and charr trout, to which latter class belongs the brook or speckled trout. The differences are to be noted in arrangement and location of teeth and color of body. As a general rule, according to one expert, if a fisherman is







Copyright, Underwood &amp; Underwood

Seining in One of Lincoln Park Lakes; Some of the Fish Will Be Kept for Permanent Exhibits and Others Used to Re-Stock Streams or for Hatcheries

in doubt as to whether the fish he has caught is a salmon trout or a charr trout, he has only to put his finger in the mouth of the fish and if a single or a double row of

teeth is found on the front and the rear part of the roof bone of the mouth, he holds in his hand a salmon trout, but if only a single patch is found in the rear of this bone, called the vomer, the fish is a charr. Another and even surer way of telling them apart is by the size of the scales. Other differences are found in the number of vertebrae, the form of the gill cover, the width of the jaw, the development of the pectoral and caudal fins, and the number of gill rakers, a series of bony appendages along the inner edge of the gill arch.

The salmon trout are divided into several series, mostly found in the west. To the cutthroat series belong the Columbia river trout, the Yellowstone trout and eleven others. There are four forms in the steelhead series, including the popularly so-called "salmon trout" of the Pacific coast. The rainbow series, among seven varieties, includes the well-known rainbow trout of the coast range, and the famous golden trout of Mt. Whitney, the latter of great beauty. To these twenty-four forms of the salmon trout may be added the brown or German trout, now more or less common in eastern waters, the Loch Laven trout, introduced from Scotland, and the European sea trout.

There are thirteen species and subspecies of native charr trout in American waters and two imported varieties from Europe, the Swiss lake trout and the European charr or saibling. The native species include the well-known brook or



Copyright, Underwood &amp; Underwood

Aquarium Group of Catfish Showing Their Spiny "Feelers" Used for Digging Up Food



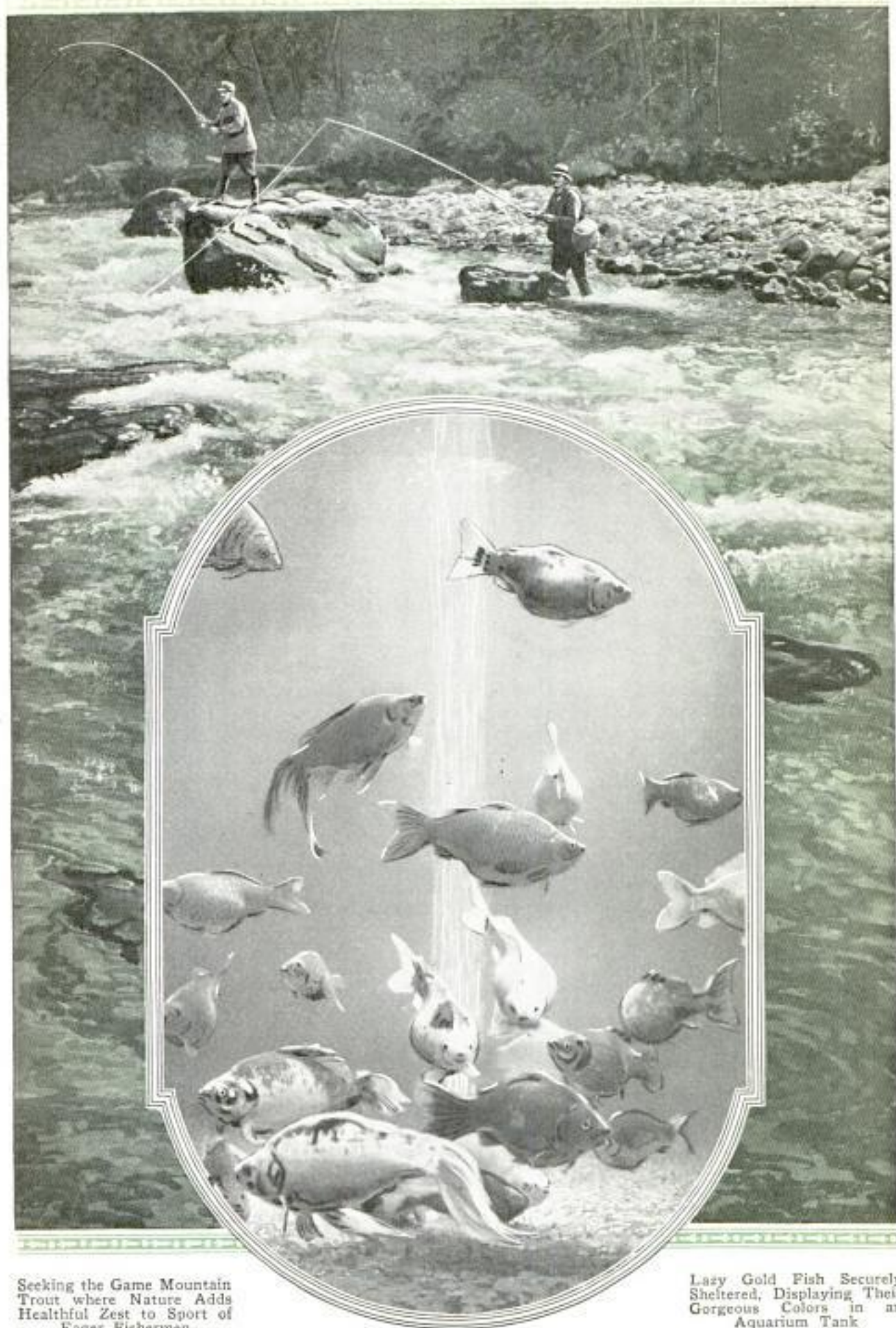

Seeking the Game Mountain Trout where Nature Adds Healthful Zest to Sport of Eager Fishermen

Lazy Gold Fish Securely Sheltered, Displaying Their Gorgeous Colors in an Aquarium Tank





Copyright, Underwood & Underwood

Placing Lincoln Park Catch in Storage Tanks before Shipping Them to Lakes and Streams; on Long Journeys It Is Necessary to Keep Water Fresh by Aeration

speckled trout, the Great Lake, the Dolly Varden, the Sunapee, the blueback and several others not so well known.

The charr live and thrive in lively waters, and in whatever stream they may be, they seek the higher reaches of it to spawn. If the mouth of their home waters connects with a salt estuary, just as soon as the ice forms in the stream the trout go down into deeper haunts and subsequently migrate and adapt themselves to a life in salt water. Here they lose their brilliant coloring and become more robust in form. The brook trout is not only the most beautiful and active of the American charr, but it also is the most widely distributed. In the middle west, inadequate game laws, devastating sewage and the impossibility of policing large areas have threatened to make the trout and the pike almost as rare as the buffalo. But the situation is being relieved by a number of aquariums, and in one season tanks of the Lincoln Park aquarium in Chicago con-

tributed 18,000,000 whitefish, 30,000,000 wall-eyed pike, 500,000 lake trout, 40,000 salmon, 60,000 rainbow trout and many other varieties to the waters of Lake Michigan and neighboring streams.

Fresh eggs for the hatcheries are taken from the lakes or obtained from agents. They are shipped in wooden boxes fitted with two trays that hold a total of 200,000. A muslin bottom in each tray prevents injury, and wet moss and ice keep the eggs cool and moist. Unfertilized eggs have to be removed from the fertile ones and constant care is taken to assure fresh water in the tanks to prevent smothering the hosts of wriggling fry that soon appear. In addition to the hatchery, the aquarium houses



Sorting Out Different Kinds of Fish from One of the Hatchery Tanks with Small Scoop Nets

two display rooms, one devoted to fresh-water fish and the other to fish of the tropics. The tanks, thirty or forty in number on the first floor, are built into the walls of the building. Their interiors are lined with colored stones and form an ideal background for the occupants.



**TRENCH PULL-SHOVEL BACKS AWAY FROM WORK**

To eliminate the use of mats as the machine advances and thus give it greater mobility, a pull-shovel has been made for digging trenches and sewers. It is driven by a gasoline motor and is mounted on crawler treads. As it backs away from work, it is always on firm ground, needs no mats and never has to straddle the

trench. It is steered and operated by one man without swinging the cab. Under its own power, it will load itself on the standard flat car and can be shipped without dismantling.



Trench Pull-Shovel Which Backs Away from Work, Needs No Mats and Never Has to Straddle the Trench; It Is Mounted on Crawler Treads and Driven by Gasoline Motor

**VULTURE THAT BARKS LIKE DOG IS FOUND IN BRAZIL** 609

Vultures that bark like dogs, fish equipped with a poison spike and vampire bats galore were among the curiosities of nature reported by Capt. S. C. Bullock in a paper read before the Royal Geographic Society in London, as having been encountered in his expedition to northern Brazil. The vultures were described as being black, except for the breast and underside of the wings. In one instance, water hogs shot by the explorers fell into the stream and were torn and eaten by the fish, which jumped onto their backs.

*New York Times 2/28/24*

**CHAIRS ARE HIDDEN IN TABLE WHEN NOT IN USE** 480

Compactly fitted into one useful article of household furniture, two chairs and thirteen drawers are included in a patented table with two large extension leaves. When not in use, the chairs can be folded up and slid out of sight under the table. The leaves, when detached, can be used as wall shelves for storing dishes and, in place, provide sufficient space so that ten persons can be seated comfortably. The

drawers are of different sizes to hold table linen, silver, and kitchen implements. Combining the functions of a workbench, a cabinet, a breakfast table and chairs, the article saves apartment space and reduces the number of steps required in doing the housework. It is attractively finished, is strong and durable, and is moved easily.



Cabinet Table with Folding Chairs Extended and Leaves Attached; Drawers on Each Side

*Mrs. William Reid  
 413 S. Greene St.  
 Spokane, Wash*



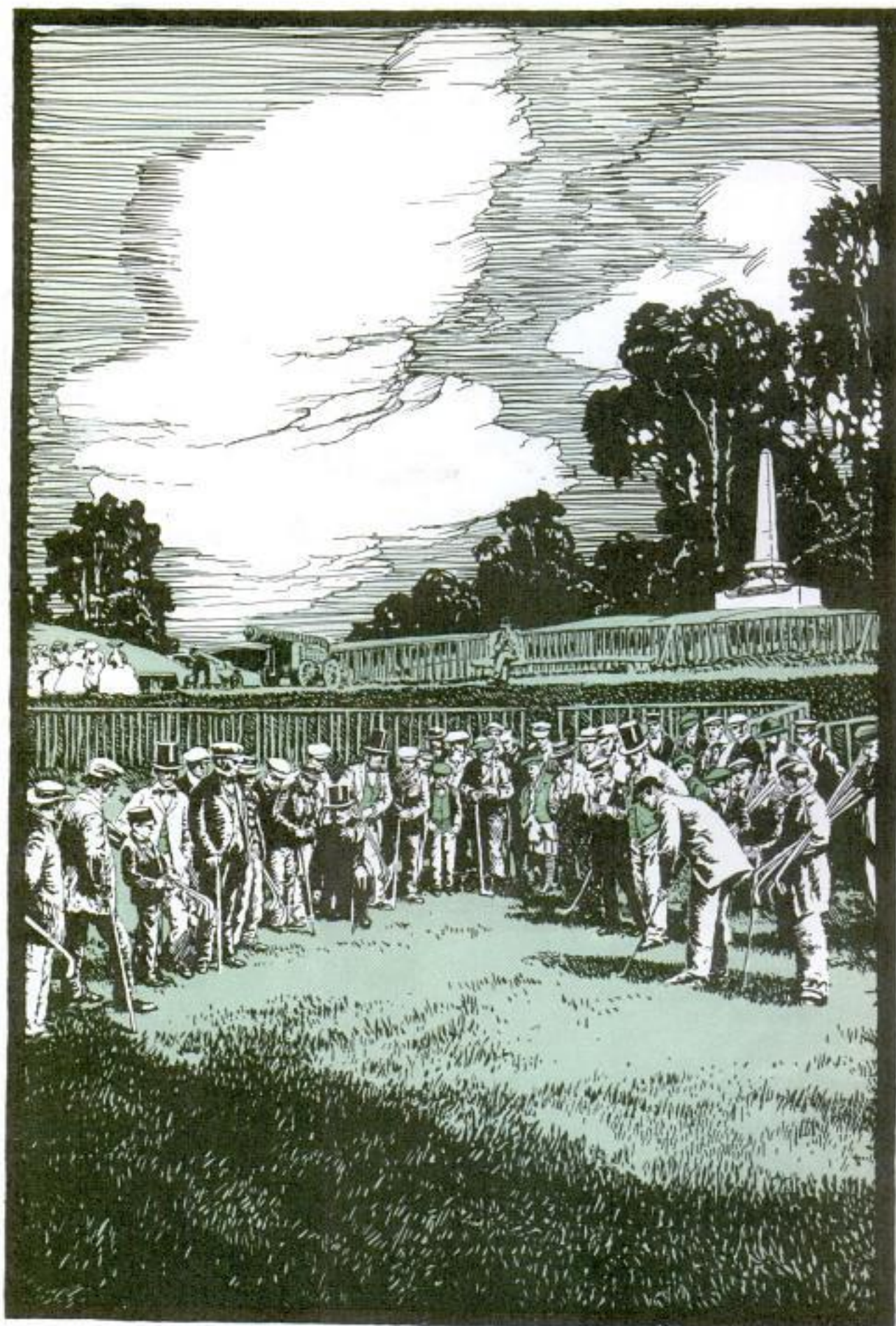

Golf Championship Match of a Century Ago when Links Were Unkempt and Rough, before Flexible Balls and Balanced Steel-Tipped Clubs Gave Golfers Present Skill





Gallery of Modern Golf Enthusiasts Watching Championship Tournament over Scientifically Constructed Course Where "Shots" Are Lengthened and Putting Aided by Skillfully Designed Clubs and Well-Kept Greens

## Golfers' Skill Improved by Science

### Steel Clubs, Balanced Balls and Level Greens Replace Pebbles and Crooks of Scotch Shepherds Who Invented Game

**I**N spite of the fact that golf is hundreds of years old, it has only been in the past seventy-five that science and craftsmanship succeeded in improving players' records 100 per cent over those of several centuries ago. Although the sport was ancient when Columbus discovered America, the best score ever made for eighteen holes up to 1853 was ninety-four. Today, thousands of ordinary golfers, aided by mechanical invention and improvement, can beat that record. Experts can shoot eighteen holes in seventy right along and on rare instances have scored in the sixties. A century ago, 110 was a wonderful score.

The figures seem to indicate that the average golfer of today is as expert a shooter as the star of 1850 and better than the best of 1800. That is a fallacy. There has been some improvement, of course, in the natural ability of players, but the real change has come in the mechanical end, which has been mainly along three lines: improvements in the clubs and balls, in the course, and mechanical contrivances that

train beginners at home and give steady practice regardless of weather conditions.

Hundreds of years ago, Scotch shepherds invented golf. To amuse themselves, they knocked round pebbles along the ground with their shepherds' crooks, inverting them so that the curved handle would serve as a club head. This quickly developed into a game to see how few strokes could be taken in knocking a stone from a given point into a hole some distance away.

Later, balls were made from wood because the surface could be easily smoothed, and then came the "featheries"—leather covers stuffed with feathers. The shepherds' crooks gave way to specially made clubs—huge cumbersome affairs like a modern hockey stick. Following these came the first hint of the modern club. Iron strips were tied to sticks, and the old clubs were gone forever.

This was the situation at the time William St. Clair, in winning the Silver Club tournament at Edinburgh in 1777, made the astounding score of 121. James





Above, Where Art and Nature Combined to Create Ideal Golf Greens; and Below, Old-Time Scotch Golfer Using Early Models of Assembled Clubs

Durham scored ninety-four in 1787 and this record stood unbroken until 1853 when science and mechanical invention decided to pay some attention to the game. It was not until later than 1865, however, that Durham's ninety-four was beaten with any regularity.

The first big change came in clubs. The old ones were five feet long. The heads, set at right angles to the shafts, were ten and twelve inches long. Full swings were almost impossible. The player stood back and jabbed at the ball. One club was about the same as another. Science began by designing a weighted head so that the greatest possible power would get into the swing. The shafts were shortened, making their length and the weight of the head a matter of careful figuring, so that the club would be nicely balanced. Special clubs were designed for every shot. The driver and brassie,

wooden-headed, were used for long shots. The ball was teed up for the drive, so the club's face was straight up and down. No tee was used for the brassie; the face was, therefore, slanted a bit to "loft" the ball. Iron heads were given various weights and loft so that even if a ball was in a hole there was a club to dig it out with. Gradually,

more and more types of clubs were designed, until now there are about a score where formerly there was but one. A very recent development is the steel shaft. It is indestructible and the rigidity helps the player keep the shot straight.

The greatest contribution to golf by invention came with the discovery of a process to vulcanize rubber. The feather-and-leather balls gave way to "guttys" (gutta percha), which brought much greater distance—shots of 200 yards. With such a ball, in 1853, Capt. James Stewart shot





eighteen holes in ninety, beating the record of ninety-four which had stood for sixty-five years. As the gutty ball was improved, scores became lower

and lower. The invention, about 1901, by Haskell, an American, of a machine to wind golf balls from rubber string finally produced the extremely hard, yet resilient ball now in use.

The value of these mechanical improvements is shown by George Sargent's score of 290 for seventy-two holes when he won the national open championship in 1909. Then "Chick" Evans, in 1916, won the championship with a score of 286, a record that still stands. Seventy-two hole matches were not played seventy-five years ago, but the scores for eighteen holes at that time were at the rate of 376 for seventy-two holes, or nearly 100 strokes poorer than Evans' mark. The next advance came in the golf course itself. Today it is scientifically laid out by engineers with all the modern surveying instruments. Even the grass is of a special kind, developed through careful experiment. Water reservoirs are built to supply moisture so that the turf may always be of the proper softness. Steam pumps carry the water, special

lawnmowers trim the grass, brooms have been designed to sweep the greens—for even a worm cast is an object of criticism by the modern player. The present course is as different in surface from the ancient one as a billiard table from a plowed field.

Now scores of home practicing devices are available to help create a class of golfers naturally a bit better than those of olden days. Several machines have been invented for indoor use, which register exactly the distance the ball would have traveled if hit in the open. One has a captive ball tied to a meter. When the ball is struck, it jerks the register up to mark the

yardage such a stroke would produce. The popularity of golf, brought about through mechanical changes in the game, is shown by the fact that last year 24,000,000 golf balls were sold for \$18,000,000. Millions of dollars are invested in golf courses.

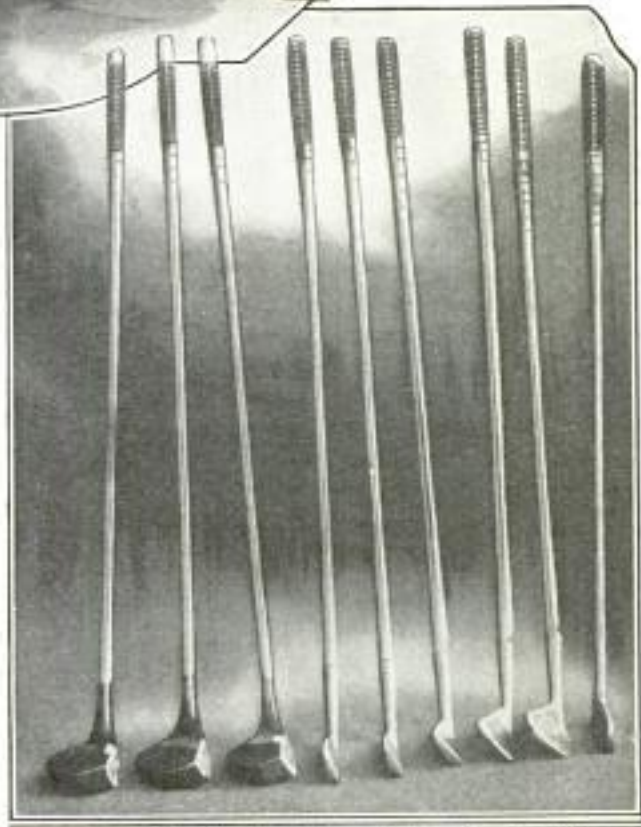

Above, Swinging for Long Drive; Center, Indoor Practice Meter; Below, Golf Clubs



Navigation, Mary Leitch, Washington, D.C.  
**DIRIGIBLES TO BE ANCHORED TO SHIPS' MASTS**

To meet demands arising from developments in aviation, mother ships carrying tanks of helium, fuel, and repair parts for the "Shenandoah" and other dirigibles that the United States expects to acquire,

are being constructed from the tankers "Patoka" and "Ramapo." They also will be equipped with mooring masts, 115 feet high and corresponding in many details to the one at Lakehurst, N. J., from which the "Shenandoah" broke loose a few months ago, which will have a "gooseneck" swivel to hold the huge aircraft securely in place and a landing platform by which the crew can pass into the cabin.

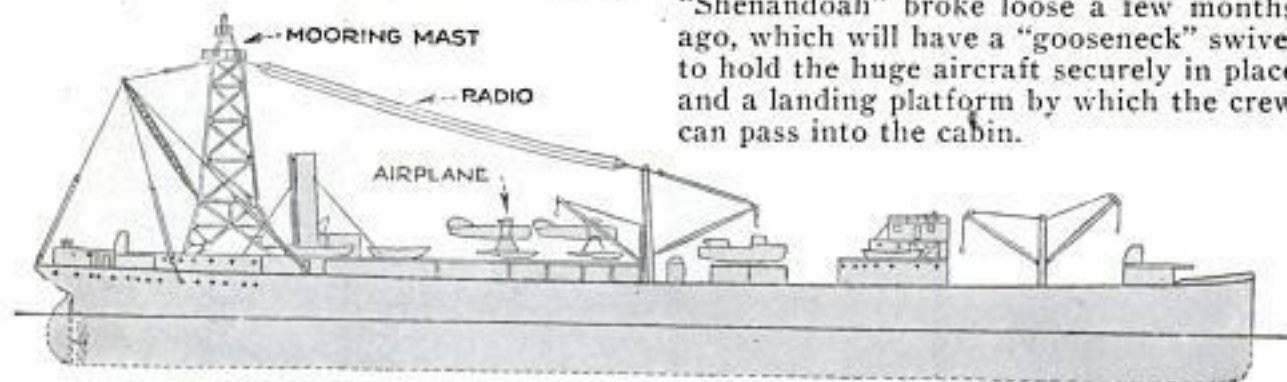

Mother Ship for Aircraft with Mooring Mast for Dirigibles and Platforms for Airplanes; Fuel Tanks, Radio and Repair Equipment Also Are Carried

**WASHER CLAMPS ON ANY TUB AND WORKS BY HAND**

Operated by a hand lever, a simple attachment has been made that will turn any tub into a washing machine. Always ready for instant service, it may be stored away in a small corner when not in use. It does

away with the washboard and will easily do the work for an entire family. As there are only two moving parts, there is nothing to get out of order.

**WEATHER SUPERSTITIONS ARE DISPROVED BY SCIENCE**

Several common superstitions concerning the weather have been dispelled by the weather bureau at Washington. In both Europe and America there is an old belief that a severe storm—the so-called "equinoctial gale"—is due about the date of either equinox, that is, March 21 or Sept. 22. According to scientists there is no maximum of storm frequency either in this country or abroad close to the date of either equinox. Of course, in the long run, storms do occur about these dates, just as they occur at all other times in the year, but there is no reason why they should be especially frequent at the equinoxes. Commenting on the moon's influence on the weather, the bureau says: "Modern science is unable to find any evidence that the moon affects the weather to an appreciable extent, and is unable to conceive of any reason why it should." The belief in "dry" and "wet" moons, indicated by the position of the lunar crescent in the evening sky, and a host of other notions are denounced as merely idle superstitions.

*New York Times 1/24/24*

Advertising on postage stamps has been permitted by the Italian government. The advertisers agree to turn over sixty per cent of their receipts for the privilege.



Simple Attachment that Will Quickly Turn Any Tub into an Efficient Washing Machine

*The Patent Office, Ford Wayne, d. n. d.*



### FISHING FOR BIRDS WITH POLE TO SUPPLY ZOO AVIARIES <sup>629</sup>

Supplying the collection of live birds in an eastern zoological garden with specimens of winter migrants from the far north is accomplished with the aid of an eight or ten-foot bamboo fishing pole to which is attached a loop of oiled silk line. Seed-eating birds, such as the pine and evening grosbeaks, purple finches and tree sparrows, driven south by cold weather, are found in large numbers in weed patches and about thorn shrubs to which still adhere a few of last fall's berries. Coming from locations where men and boys with guns and slingshot are unknown, the birds have no fear of man's approach. The fish-pole is quietly and slowly extended until the noose is slipped over the head of the bird. A gentle pull tightens the noose, and the victim is captured. Speed and care must be taken to remove the noose at once, lest the bird strangle, and to get it into the specimen box before its fluttering and cries alarm its mates.

### MOLDER OF PHONOGRAPH DISKS DUPLICATES MASTER RECORD <sup>494</sup>

More than 150,000,000 talking-machine records are manufactured each year in the United States to supply the demands of music lovers throughout the country. Carefully designed duplicating apparatus has been devised to prepare thousands of imprints from master records made di-



Artist Taking a Completed Imprint Record from the Duplicating Apparatus

rectly from the singer's voice. This helps to reduce the cost of the records and supply the markets in desired quantities.

*Brunswick Laboratory  
Los Angeles, Calif.*

### STRETCHING TESTS FOR RUBBER IMPROVE AUTO TIRES <sup>344</sup>

Strength and stretch of rubber for inner tubes of various makes are tested and measured accurately by experts in the

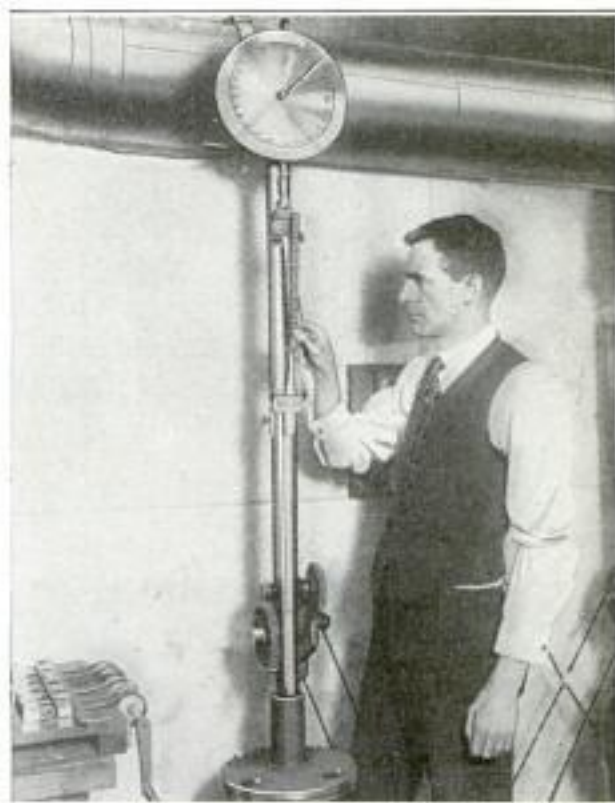

Measuring Strength and Stretch of Length of Inner-Tube Rubber in Government Laboratory

United States bureau of standards to protect motorists. Attached to clamps in a machine device designed for the purpose, a length of the rubber is stretched while a dial registers the amount of the pull and a ruler shows the length of the stretch. An exhibition test performed not long ago by one company proved that a tube of tested rubber could lift 2,980 pounds dead weight. It was attached to an automobile and the machine was lifted several inches above the ground by the rubber "rope" hung from a derrick.

*622*

### CAN THE SKIN SEE, IS QUERY

That human skin has powers of vision which to a great extent have been lost through years of neglect, is the theory of a French scientist. A series of experiments conducted by him are said to support this belief. The sensitivity of the skin and underlying tissue with its intricate net of nerves is well known, but no one heretofore has supposed them to be capable of picking up light waves in a manner comparable with the process of seeing.

*Radio World  
March 1, 1924*



## BLEACHERS FOLD UP IN WAGONS LIKE JACKKNIFE

Circus seats that fold up as compactly as a jackknife within the wagons used to transport them have been invented to save time, labor and money in handling the equipment of the "big top." With these

and the higher ones on the other, leaving the huge truck in about the center of the section where it gives the grandstand

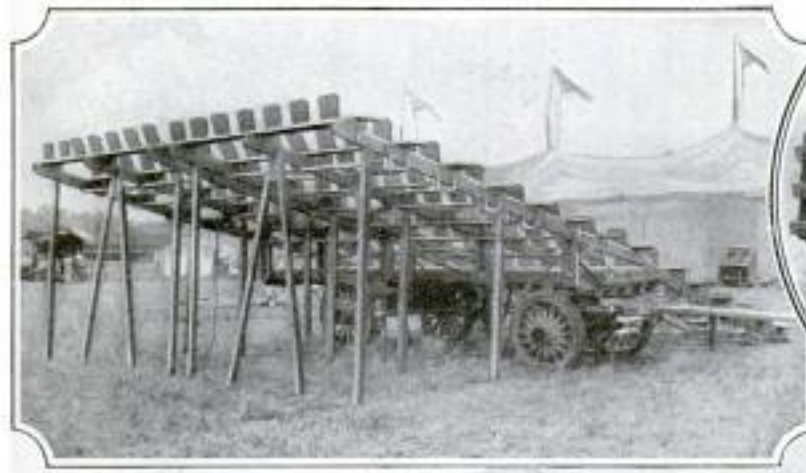

bleachers, four men are able to place the seats of the average traveling circus in about twenty minutes. All that is required is to haul the wagons where they are wanted and unfold the seats. When the circus has to move, the tiers are pushed back into the wagons and in a few moments are ready to be loaded on the trains. The lower rows of seats are placed on one side of the wagon



Unloading the Bleachers Takes Crew but a Few Moments and Wagon Remains as Additional Support; Upper Pictures Show Section Extended and Packed

added rigidity and eliminates using as many props as with the old-style bleachers.

## ART OF SOAP MAKING TRACED TO THE ANCIENT GAULS

Made from goat's tallow and beechwood ashes, the earliest forms of soap were used by the ancient inhabitants of Germany to give a reddish color to the hair, according to the records of the historian, Pliny the elder. Although mixed into hard and liquid material, it was not known as a cleansing substance, but was often employed in the treatment of skin troubles. The Gauls, it is said, introduced it into the other parts of the world. Today the yearly production in this country is estimated to be 2,500,000,000 pounds. Not until about the second century of the Christian era was the product used as a cleansing article, it is claimed, and an ancient factory for manufacturing the material unearthed in the ruins of Pompeii still contained a quantity

of it in a good state of preservation. Northern Spain and Marseilles later became the chief centers of the industry and produced large amounts of the Castile variety from olive oil and lye. Earlier accounts of the existence of soap among Asiatic peoples are believed to refer to some kinds of mixtures which were devoted to purposes entirely apart from those of dyes or cleaning substances.

## TIDE HELPS TO MOVE BRIDGE

Resting on five pontoons, a 300-ton railway bridge that spanned the waterway between Oakland and Alameda, Calif., was lifted from its position with the help of a rising tide and by pumping the water from the floats upon which it rested. Trains were operated over the span up to seven hours before it was moved.

New York Times  
March 13, 1924

55  
New York Times  
3/13/24



New York Times  
3/8/24

Water power

**SIX-MILES-A-MINUTE STREAM HARNESSSED BY TURBINES**

What is considered an important engineering triumph has been accomplished in the Swiss Alps in harnessing with specially constructed turbines, a stream of water flowing at the rate of 540 feet a second or more than six miles a minute. The column of water has the strength and rigidity of a steel bar and such force that each of the four 3,000-horsepower units in the plant is driven with a stream only one and three-eighths inches in diameter. To withstand the terrific pressure, special apparatus had to be built. The water is taken from the Lake of Fully and flows through three miles of steel pipe with a fall of approximately one mile to reach the turbines.

441

**IRONING BOARD IS ADJUSTABLE, SAVING SPACE AND LABOR**

Attachable in a few seconds to any shape of table, window sill or any other edge, an adjustable ironing board has been patented. The support can be changed to various heights and is locked securely in place by means of a spring-hinged strap and cleats. The ironing board is fifty-seven inches long and fourteen inches wide and is made of bay wood. It has two holders, underlaid with asbestos cloth to prevent burning or scorching when the irons are

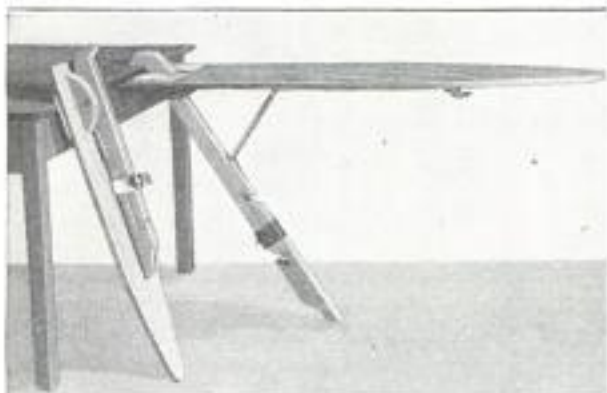

"Jackknife" Ironing Board in Place and Folded Up with Adjustable Leg Braced

not in use. In position, there is ample space under it for a clothes basket. When the ironing is done the board folds up like a jackknife.

In the last twenty-three years, only seventy-three persons have been killed in railway accidents in England. The years 1901 and 1908 were without a single fatal accident to passengers and in 1923, only one railway accident involved loss of life.

Wm. H. K. Sheffield,  
Valdosta, Ga.

**PAINTINGS OF PESTS TO HELP WAR AGAINST DISEASE**

Greatly enlarged pictures of insects that serve as germ carriers are painted by Prof. L. H. Wilder to aid the campaign against



Painting a "Portrait" of the Fly that Is Believed to Carry Infantile Paralysis

disease by the United States public health service. In making a portrait, in heroic size, of the common stable fly, he has been forced to use as many as fifty of the pests to get a single perfect picture, as each part of the anatomy must be exactly portrayed.

**MUD "BOOTS" FOR AUTOS GIVE GRIP TO SLIPPING WHEELS**

To provide a grip for automobile wheels when slipping in mud holes or on ice, mud chains that cover only part of the tire are being manufactured by a Mississippi concern.



Easily packed in the car, the attachments can be placed quickly on the back wheels. Because they leave most of the tread bare when in position, it is said that the motor can get momentum before the grips strike the ground and they will not "dig in." No raising or rolling of the machine is necessary to fix the mud "boots" to the rims. Strongly made, the devices will withstand wear and tear.

The Emergency Mud  
Boat Co., Crystal Springs  
Miss



ARROW IN CARD-TABLE "CLOCK" POINTS TO NEXT DEALER

516

To avoid disputes regarding whose deal comes next in four-handed card games, an arrow pointer "clock" has been made. The indicator is pushed automatically one-fourth of the way around the dial whenever the pencil used to keep the score is inserted in the round holder at the side.



Card "Clock" in Use; Position of Pencil Holder Shows if Dial Is Misplaced

Thus, when the score has been written and the pencil placed back in its socket, if the clock has been set in the correct position at the beginning of the game, the dealer question is solved by the arrow which has swung to point toward the next dealer.

OLD-FASHIONED SEAMANSHIP SAVES CRIPPLED STEAMER

Sail

510

Old-fashioned seamanship is still being practiced, although modern sailors know more about machinery than about masts and rigging. When engines break down sails often come to the rescue. Such an instance took place when the Federal liner, "Norfolk," was disabled in the Indian ocean on a voyage from Port Natal to Albany. Captain Corner ordered the fires drawn, called all hands on deck and set them to work with needles fashioning sails from awnings, tarpaulins, and spare bits of canvas found on board. By using cargo derricks, he erected bowsprit and yards and finally bent on two headsails, four square-sails and five trysails. Under this improvised rig and by dint of persistence and skill, the captain brought his craft into Fremantle, 6,000 miles away.

Marine Journal: 1/2/24

316 LOCOMOTIVES GAINING STEADILY IN POWER

With the great increase in weight of locomotives in the United States, the question has been raised as to what will be the limit in size, speed and weight. Important factors considered are size and overhead clearance. With the gauge of the standard track fixed at four feet eight and one-half inches, and with tunnels, viaducts and buildings constructed on a scale to fit the average locomotive of today, there are immediate limits preventing

weight as the engines have increased in size, but this is due largely, builders say, to improved mechanism, auxiliary power units and to improvements in design. Engineers are now seeking to increase the efficiency of the engine, not by adding to its size, but by changes in the power plant. Regarding speed, it is pointed out that there has been no attempt for the last few years to maintain generally faster schedules and, in some instances, passenger

The Washington locomotive works Philadelphia, Pa.



Contrasting a Modern Passenger Locomotive with One Built in 1861 to Show How Engines Have "Grown"; The Larger Is Equal to About Five of the Smaller

much greater height or width in engines. For many years, there has been a steady increase in horsepower per pound of

trains have been reduced in running time for the sake of greater safety and because of excessive costs.





Where Youthful Students Are Taught Processes of Woodworking by Highly Trained Instructors in Large Trades School that Prepares Its Pupils for Profitable Careers of Labor

## Training Recruits for Ranks of Labor

Skilled Craftsmen and Sound Citizens Result from Vocational Instruction of Students Preparing for Careers in Industry

COMBINING the best features of old-time apprenticeship systems with the most modern methods of vocational education, trades schools are attempting to meet the wide demand of industries by developing enthusiastic students into full-fledged artisans possessing both practical and mental training. As many as 4,600 pupils attend a single trades school in a mid-western city, where they prepare for careers of productive labor, equipped with full knowledge and practical experience in such callings as carpentry, cabinetmaking, pattern work, founding and forging, electricity, automobile mechanics,

machine-shop practice, baking, and printing. Beginning the courses at an average age of fourteen, the youngsters enter upon the work with an enthusiasm which is reflected in the perfection of some of the products of their learning made in class periods. As in other trades schools, each department manufactures materials and furnishings needed by the other sections, so far as equipment permits, as part of the course. In this, the practical end of the training and the thoroughness with which the students perform the various tasks are tested in actual operation and fitness of the products. Only highly skilled and compe-

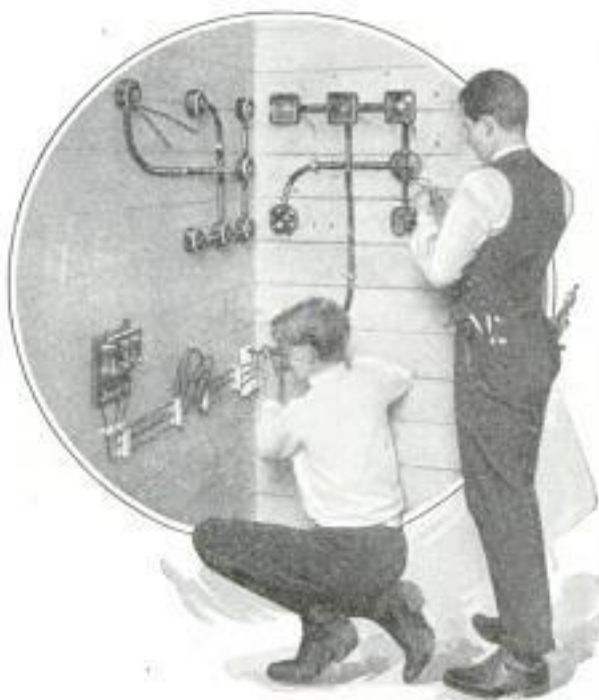

How Scholar-Apprentices in Vocational Schools Get Benefit of Practical Training in Electrical Wiring

Lane Technical School, Des Moines and Sedgwick, Iowa



tent instructors, themselves schooled in academic as well as practical methods of crafts, are permitted to teach, thus insuring the pupil the benefits of the most modern and scientific practices. Unlike apprenticeships where only the mere mechanical training is accorded for a trade, without proper education of mind to direct the efforts of the worker, trades schools include the molding of good character and a sound knowledge of the citizenship in the education of the craftsmen. This insures to the industry a workman versed in not only the mechanical performances of his trade, but trained in proper conduct in association with others of his kind.

While much has already been done in furthering the development of the industrial training institutions, skill and energy of the teaching forces are constantly adding greater advantages demanded by the pace set by industry. The pupil studying

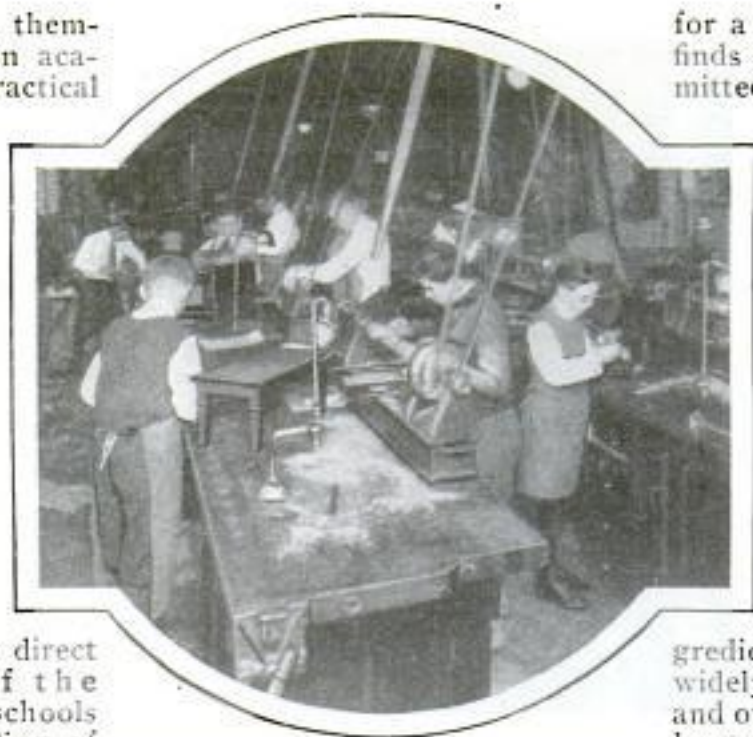

Amid the Hum of Whirling Lathes, this Class of Trades Students Gets Practical Experience in Wood Turning

for a mechanical career finds that he is permitted to learn all about blue prints, mechanical designing, and construction of various metals and the action of different chemicals brought in contact with them. The young baker sees before him, in a laboratory which forms part of his schoolroom, ingredients prepared from widely differing grains and other food materials he works with. Brick-laying students are told the values of clays, and binding elements, such

as mixtures of cements and sands, are analyzed for their information. In the end they enter upon their life's work with full knowledge of the origin and purpose of the calling.

Everything possible is done in the schools to insure the greatest amount of interest from the scholar. While they are being taught the work of the hand, considerable time is given to study of other subjects such as mathematics, history, Eng-

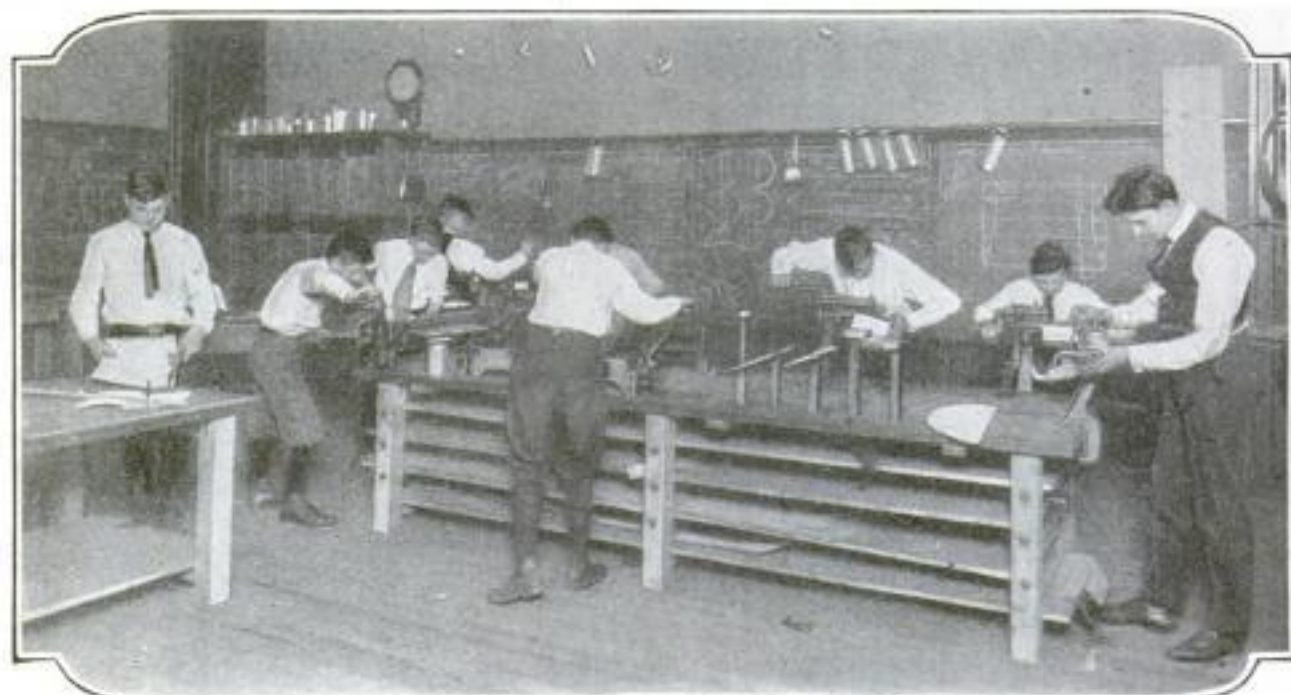

Where Recruits for the Industrial Army Receive First Hand Knowledge of Sheet Metal Working; Designs Are Drawn on Blackboards before Being Worked Up into Finished Articles





Student Bakers Are Called Upon to Perform Actual Tasks of Mixing and Preparing Dough for Bread and Pastries in Classroom Bake Shops of Vocational Schools

lish, geography, recreation, and hygiene. While these subjects are practical in their application to the things met after graduation, they are taught so that they fit in with the work in the shops.

Modern methods of operation coupled with more or less cultural training are designed to fit the youth for rapid advancement when he enters upon the practice of his trade. In connection with these the processes of good citizenship are emphasized in a manner to insure the growth of sound character during later life. Where trades schools have departments for the vocational education of girls, millinery, sewing, dress designing and cutting, household sciences and courses that fit them for business and light factory supervision are accorded the students. As with the other industrial studies the practical training is closely allied

with the general education of the pupil, and in all cases only the most up-to-date examples of modern industry and commerce are permitted to form the pattern for the molding of the student-apprentice into a valuable recruit to the ranks of labor.

Most of the courses run over a period of four years, but many may be completed in two and are so organized that the graduate will be sufficiently equipped to take up his or her calling at a point almost equal to the

rating of a veteran. To aid them in absorption of the latest developments in highly organized trade and factory methods, tours are made by the classes, under direction of instructors, through typical industrial plants and over structures in the course of erection, where first hand information can be gleaned from watching actual processes of trade practice.

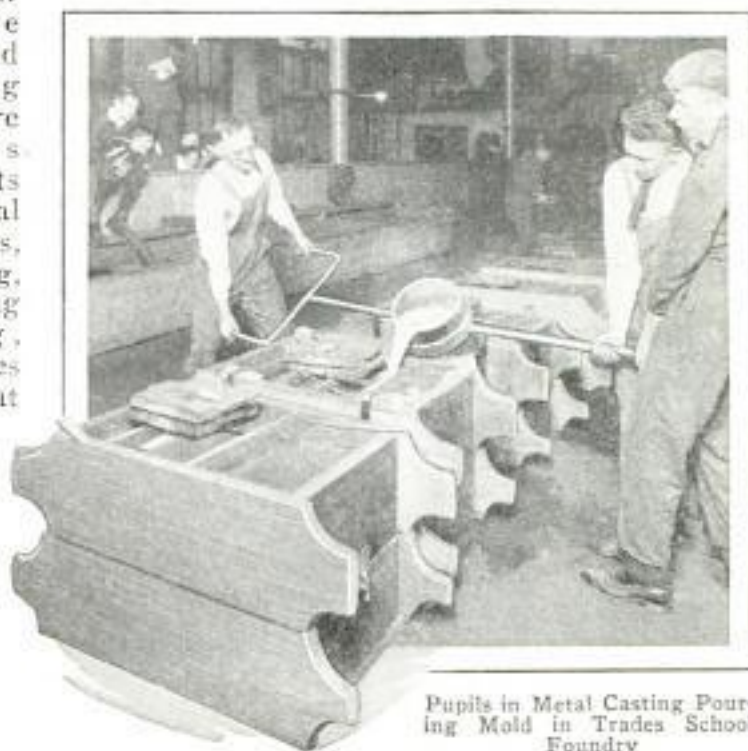

Pupils in Metal Casting Pouring Mold in Trades School Foundry



Emb. Allen P. Child  
Box 4673,  
850

Kansas City, Mo.

483

**FINDING OF WATER IN DESERT  
MADE EASY BY SIGNS**

Welcome signposts, directing the traveler to the nearest watering place, are being erected on the barren wastes of west-



Desert Signpost Erected by United States Geological Survey for Aid of Travelers

ern deserts, by the United States geological survey, as aid to automobile tourists and others venturing through this roadless territory. The posts are galvanized iron, about twelve feet long, and are anchored to two red-wood blocks set deep in the ground. Metal sheets with enameled letters and direction arrows are bolted to

them. The survey has mapped and posted already large areas of the 500,000 square miles of desert country and, as the work progresses, the water-famine peril is lessened alike to motorists and to those who still travel with horses.

**ELECTRIC EEL'S POWER PLANT  
IS STUDIED BY SCIENTISTS**

716

Attendants at the New York zoo having been stunned by current from the electric eel, an investigation has been begun of the creature's power plant. Previous attempts at measuring the current have failed because the apparatus used was not sufficiently sensitive to register the sudden and intense shocks delivered. These are said to be powerful enough to stun a horse and are described by keepers who suffered them as "sledge-hammer" blows that caused black and blue marks on the skin. A German professor, according to R. L. Ditmars, curator, has obtained light of dazzling intensity by connecting the current to bulbs, but the flash was over in an instant, defying attempts to measure it.

*Popular Weekly News*

**NOISY VALVES ARE SILENCED  
BY THIN METAL DISKS**

670

Smaller than a thin dime, an automobile valve adjuster and silencer consists only of a small disk of metal that fits over the push rods and is held in place by flanges. No tool or special skill is required for its installation. Less noise and better mileage are some of the advantages claimed for the device which also eliminates the need for adjusting nuts on the rods.

*Wrecking Co. Price, 50¢.  
Albee, Wash. D.C.*

564



Resembling a Large Athletic Bowl, "El Toreo," or Bull-Fight Ring, Is One of Mexico City's Modern Architectural Achievements, Covering an Area of 200,000 Square Feet



**VOICES RECORDED BY ELECTRIC STENOGRAPHER**

Combining the telephone, radio, and the dictaphone, and intended to eliminate court and trial stenographers and shorthand reporters, a device has been developed by Prof. L. E. Watkins, of the University of California, to such a degree that it is in daily use in the classes in public speaking and dramatics in that university. In fact, the idea back of the "mechanical stenographer" is an outgrowth of a desire to obtain an absolute and permanent check on voice inflection, grammar, sentence structure, and vowel and consonant pronunciation. More than a year has been devoted to the making of the instrument, which is made up of parts of other sound-transmitting and preserving apparatus now in common use. It consists of two sections, the first, which stands on a table or desk, anywhere within twenty feet of the speaker or speakers; and the second, which may be located anywhere within telephoning distance from the first. The transmitting apparatus consists simply of a telephone mouthpiece or microphone. In trials, debates, or at conferences, several such instruments may be installed in the same room, so as to obtain with the greatest clearness the voice of each speaker. In the receiving room, the wires are connected to a specially constructed amplifier, equipped with three auxiliary adjustments to enable the operator to regulate the sound volume. Out of the amplifier, the wires pass to a loud speaker. This is connected by means of a flexible tube to the transmitter of an ordinary dictaphone. The voice of the speaker or speakers passes into

the telephone transmitter, through the amplifier and the loud speaker, and is delivered, exactly as spoken, into the recording

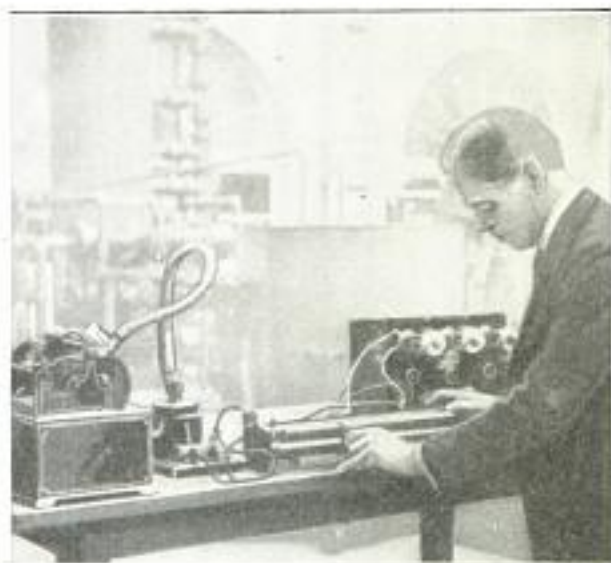

Combination Radio, Telephone and Dictaphone Designed to Do Work of Court Stenographer

instrument, the dictaphone. The records may be taken out and run slowly through a phonograph for copying; they may be sealed and filed, or they may be run for the benefit of the student-speaker, to enable him to correct his errors of speech, grammar, or subject matter. The advantage over stenographic records is that here is preserved for all time exactly what the speaker said, with no chance for the human element of error to creep in.

■ Pulp left after extracting oil from olives is used as fuel in Spain.

*Patent number not given*

*564*



With an Arena 450 Feet in Diameter and Seating Stands of Concrete and Steel, Mexico's Most Prominent Outdoor Amusement Structure Affords Room for 20,000 Spectators

*Cont. Mr. James McIntyre Apartado 370,*  
*Mexico City, Mexico*





One of Aerial Limousines which Will Carry Amundsen Party to Polar Lands in Search of Short Routes for Air Highways between World's Cities

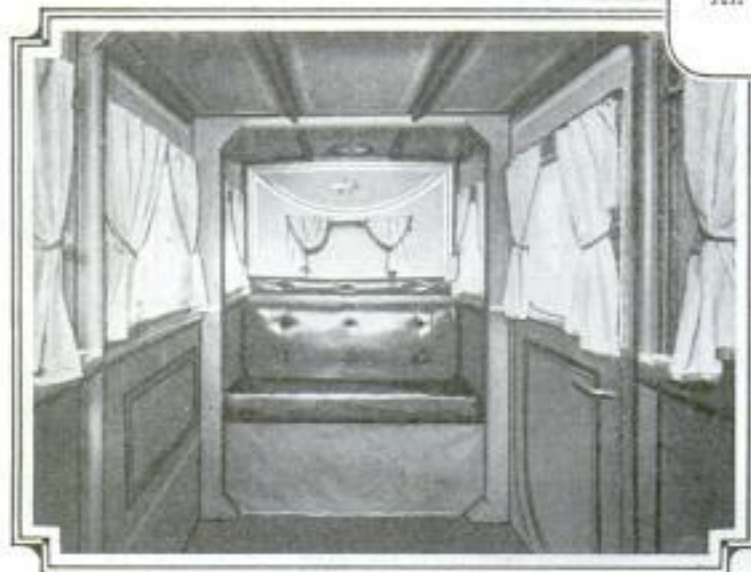

Cabin of Airplane, which Will House Amundsen Crew on Polar Trip



Explorer Amundsen, Right, and Lieutenant, Ready for Flight

## Airmen to Cross Frozen Top-o'-the-World

**I**N search of air highways across the frozen wastes spreading about the north pole, intrepid aviators and explorers will attempt to "pioneer" an unknown ice-bound area of 1,000,000 square miles. Belief that not only great expanses of uncharted land, but that wide currents of warm air in the upper regions exist within the boundaries of this "no man's land," serves to promise the scientific success of the ventures. Besides affording shorter routes for air travel to Europe and Japan, by flying over the polar territory, it is thought that more accurate forecasts of weather can be made through the information it is hoped the expeditions will gather. Both dirigibles and airplanes are to be employed to transport the explorers in their searches. In England, an expedition composed of one giant airship is proposed to seek out the secrets of aerial possibilities over the Arctic. For the purpose, the

dirigible airship "R-36," a massive craft, has been designated as the proper one for the trip. Its powerful engines and sturdy construction are believed equal to almost any weather conditions that might be met, while its comfortable accommodations for the crew can relieve them of many of the hardships experienced in the extreme cold of the frozen north.

Under direction and command of Roald Amundsen, discoverer of the south pole, the expedition of two airplanes, planned to invade the north, will explore hitherto uncharted territory and collect data for the use of future aviators and commercial aerial travel.

Each plane has a cruising radius of 1,300 miles and it is thought that by establishing a point of supply in the neighborhood of the pole, preparations can quickly be made for a final dash across the barren wastes at the top of the earth.



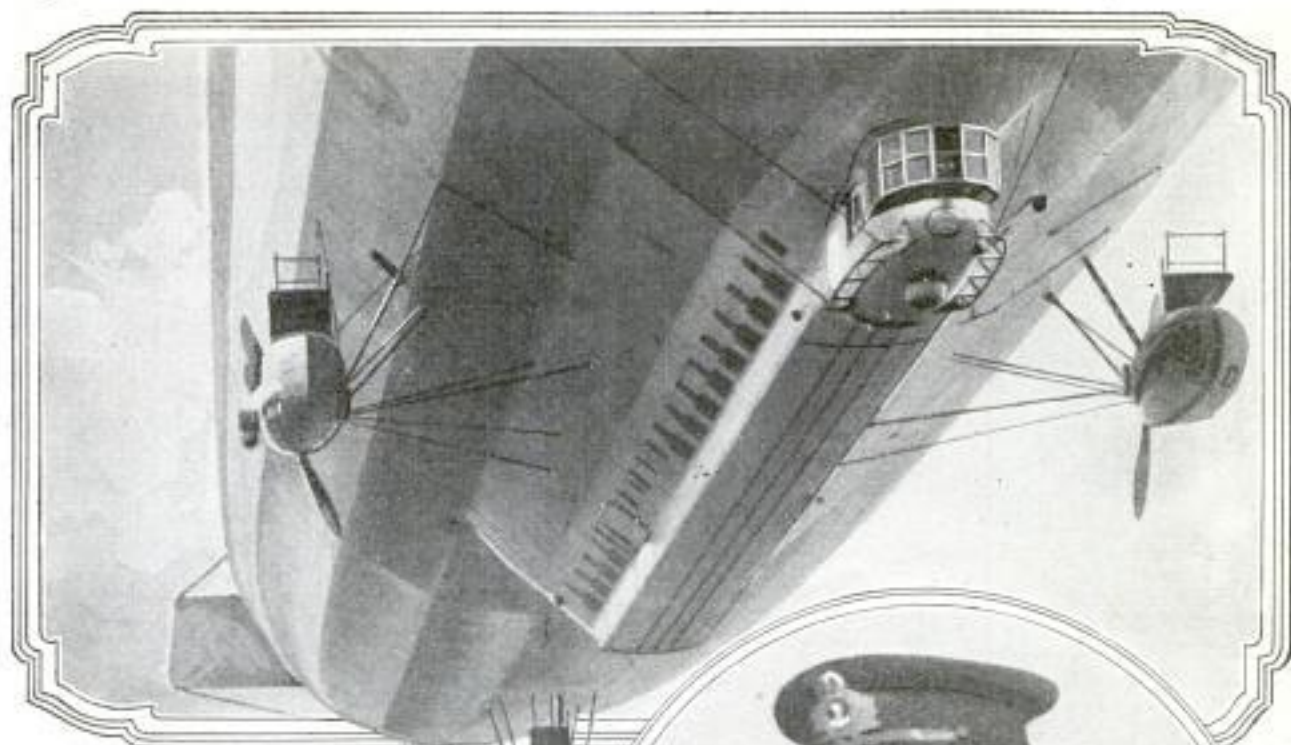

Looking Upward at the Giant Air Liner, Showing Three of the Powerful Motor-Driven Propellers, and the Luxurious Cabin Cozily Nesting Close beneath the Big Gas Bag.



Commander F. M. Boothby, of the British Dirigible "R-36," Who Will Direct the Venture over Wastes of Frozen North

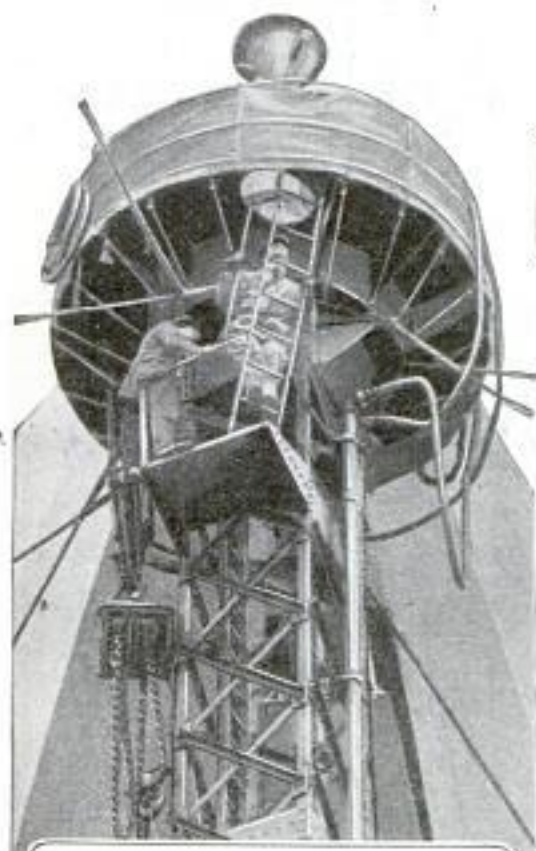

Tied Up to Its Aerial Anchorage, the Huge Nose of the British Dirigible, "R-36," Hugs the Steel Mooring Mast while Workmen Inspect Machinery and "Skin" of the Massive Airship



Snug Sleeping Quarters of the "R-36," with Berths Made Up for the Night, and Part of the Dining Room Ready for Breakfast



Wide World Photos  
 229 W. 43rd St.  
 854 POPULAR MECHANICS  
 New York City

**MOVABLE DAM BLOCKS CANAL WITH METAL PLATES**

537

Resembling a large drawbridge, the movable emergency dam at Gatun, on the Panama Canal, can be swung across the chan-



Movable Dam on Panama Canal that Bars Off Channel in Cases of Emergencies

nel whenever needed. Supported by heavy steel trusswork, the mechanism with which it is equipped may be made to lower metal plates into the bed of the canal as a barrier to cut off a section of the stream. Despite its great weight, the huge structure is easily controlled from a tower, and when idle rests on sturdy foundations to relieve the strain on the girders. The apparatus, it is said, enables repairs and inspections to be accomplished in much less time than would be required where the ordinary method of damming off the water is employed.

**RUBBER DATE-STAMP WHEELS ARE EASILY ADJUSTED**

Clearer impressions and greater ease in operation are claimed for a rubber stamp

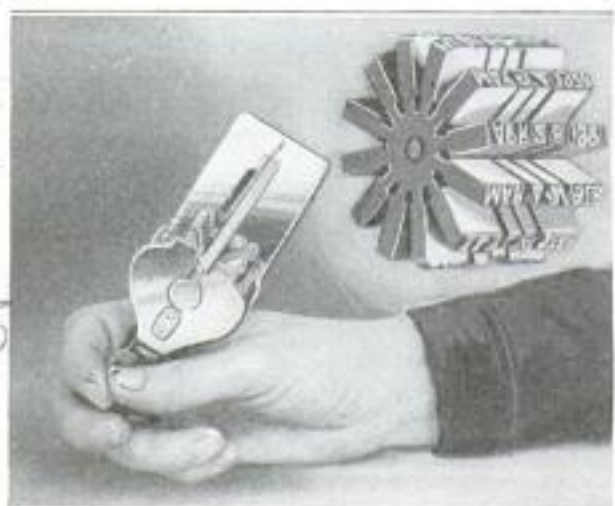

Easily Adjusted Rubber Stamp with Revolving Date Dies Molded from One Piece

dmw. Walter C. Menyhart  
 R. 722 - 130 E. 15th St. New York

which has dates and names of the months on one-piece revolving dies. They turn freely on a brass pin, are easily locked and lined by a hinged bar and are inclosed in a heavy metal yoke. Less time is required to assemble the date with this style of stamp and all letters and numbers are shown in exact alinement on the paper.

**KEYHOLE EASILY SEEN IN DARK WITH LUMINOUS CASING**

Finding a keyhole in the dark is made easy by a patented celluloid casing that fits around the inside of the lock and is filled with phosphorus or luminous paint. It also is made in the form of a cap to slip over electric push buttons.

**HOSE NOZZLE IS HELD STEADY BY PRONGED HOLDER**

As an aid in sprinkling the lawn or garden, a single-piece, heavy galvanized-wire support for the hose has been invented. It has a double ring clamp and two sharp prongs to be pushed into the ground, so that the holder will not turn or fall backward when the hose is inserted in the clamp. The support may be painted or enameled a bright color to make it more attractive. It is especially designed for use with full-stream nozzles.

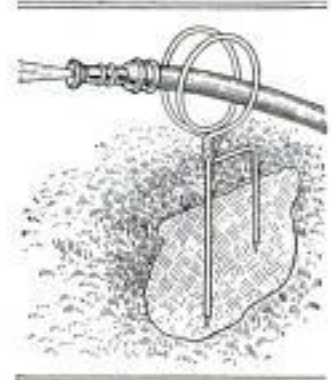

dmw. Edward Coleman  
 2918 Oak St. Oakland, Calif.  
**ANCIENT CHURCHES OF ENGLAND**  
 743 MAY BE SHIPPED TO U. S.

Americans, without leaving their native shores, may be able soon to attend services in churches built years ago in the city of London. Several of these old structures have been condemned and it is now proposed that they be dismantled and re-erected in various cities throughout the world. Included in the number are several which were designed by Sir Christopher Wren, and all are said to be connected with some phase of national or international history. The plan to remove some of them to the United States is being furthered by Edward Page Gaston, lecturer and journalist, who is seeking the co-operation of church organizations in this country.

New York Times  
 3/10/24

W. A. Smith Mfg. Co.  
 Springfield, Mass.

signed material



*Minneapolis, Minn.*

**ACCIDENT-PROOF TRAFFIC POST TILTS WHEN HIT**

To prevent automobile accidents caused by running into stationary traffic signs in the streets, an inventor has patented a signal post anchored to steel springs which allow it to tilt over when struck and pull it back into an erect position when released. Parts are in-

closed in a steel drum below the surface of the pavement. The post rests on a metal ball which permits ample play in every direction. Non-illuminated danger posts and electric "Stop" and "Go" traffic regulators have been fitted with the flexible anchor and have been successful.

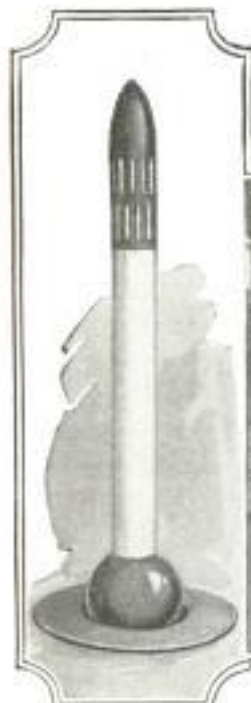

Two Styles of Tilting Traffic Sign Post Resting on Ball Support and One in Position in Street; Dotted Lines Indicate How It Would Swing if Struck

**CAMERA SEES TRACE OF CRIME AND CONVICTS OFFENDER**

By enlarging an ordinary photograph of a criminal's finger print many times, a French criminologist discovered evidence of the offender's deed lodged in the pores of the skin. Repeated washings had failed to remove the traces, it is said, and the aid thus given the police resulted in a conviction. Usually prints of the finger tips are

used to identify criminals with their misdeeds, and as a means of record the pictures are kept on file. The enlargement not only showed the pattern of curved lines of the cuticle, but increased the size of the pores, disclosing the telltale evidence.



Enlarged Finger Print of Criminal which Revealed Traces of Crime Lodged in Pores of Skin

**DUCKS AND LOONS USE WINGS TO SWIM UNDER WATER**

Do ducks use their wings while swimming under water? The question is discussed frequently among sportsmen and nature students, and opinions sometimes differ. Testimony of reliable authorities, however, supports the belief that various species of ducks and grebes, loons and other diving birds do use their wings when swimming beneath the surface for food or in trying to escape capture. A ruddy duck was observed in Lake Michigan not long ago, feeding in fifteen or twenty feet of clear water. As it got well started on its downward plunge, the wings, about two-thirds extended, were used in quick, short strokes at the rate of about one a second to assist in propelling it and in rising to the top as well.

*Handwritten:* Cmt. George H. Morse, Jr. 547 County Bldg. Chicago



Muller



Conning Tower and Deck of Submarine Ready for Dip under Sea; Showing Vessel's Narrow Beam that Reduces Resistance to Water as It Slips Silently through the Depths

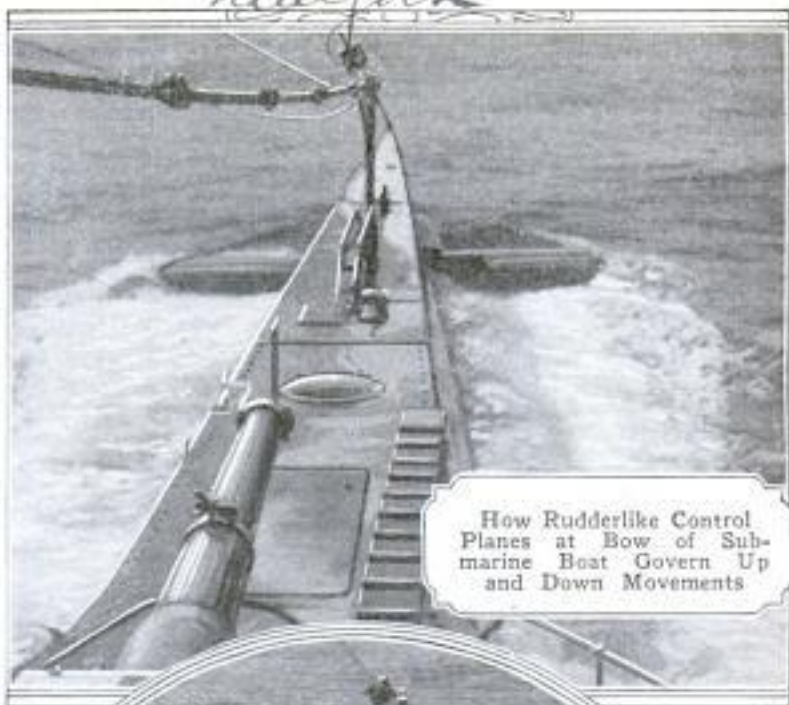

How Rudderlike Control Planes at Bow of Submarine Boat Govern Up and Down Movements

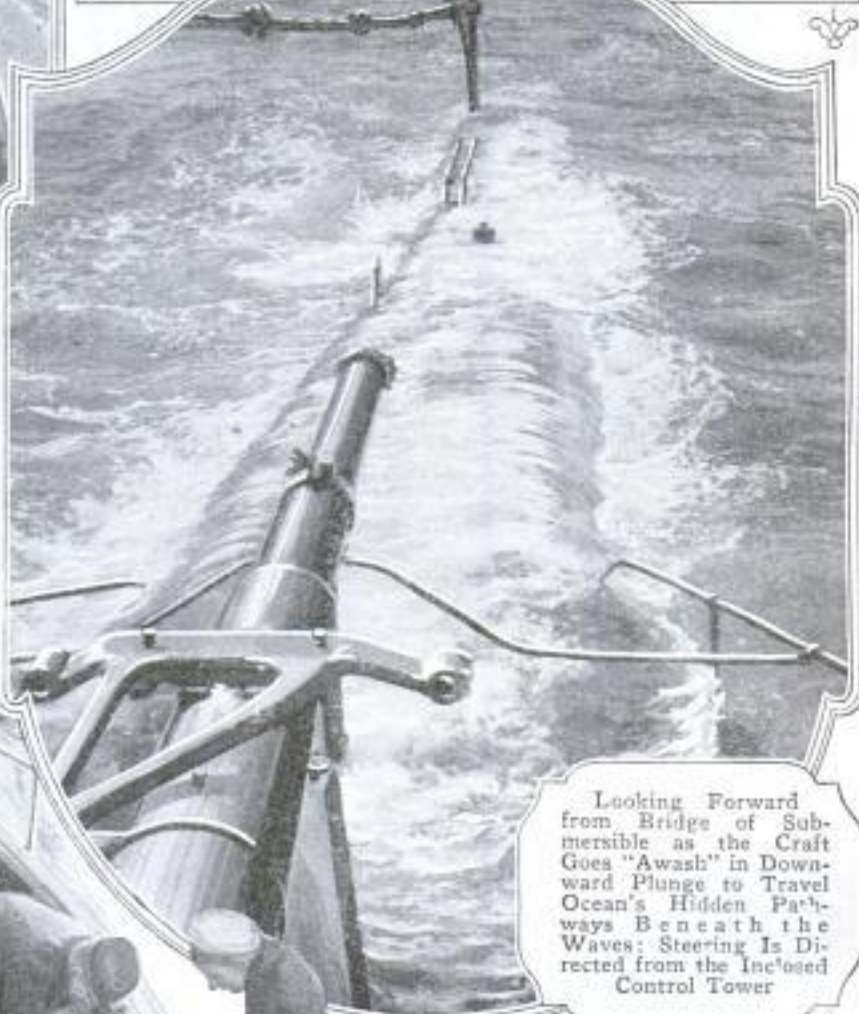

Looking Forward from Bridge of Submersible as the Craft Goes "Awash" in Downward Plunge to Travel Ocean's Hidden Pathways Beneath the Waves; Steering Is Directed from the Inclosed Control Tower

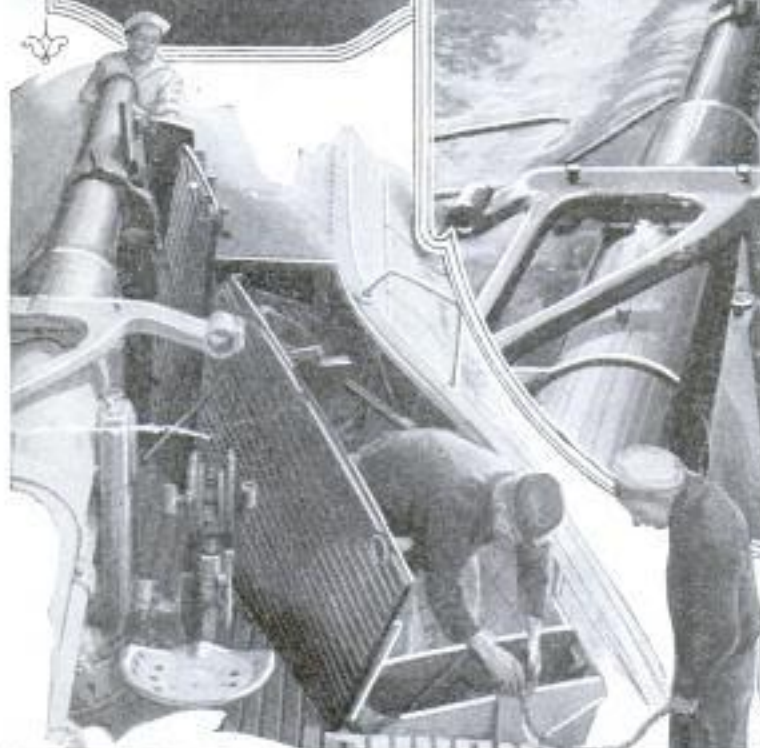

Stowing Life Boats Away below Main Deck of Undersea Vessel, from where They Can Be Raised and Lowered in a Few Minutes Should Accidents Occur while Craft Is Riding the Surface



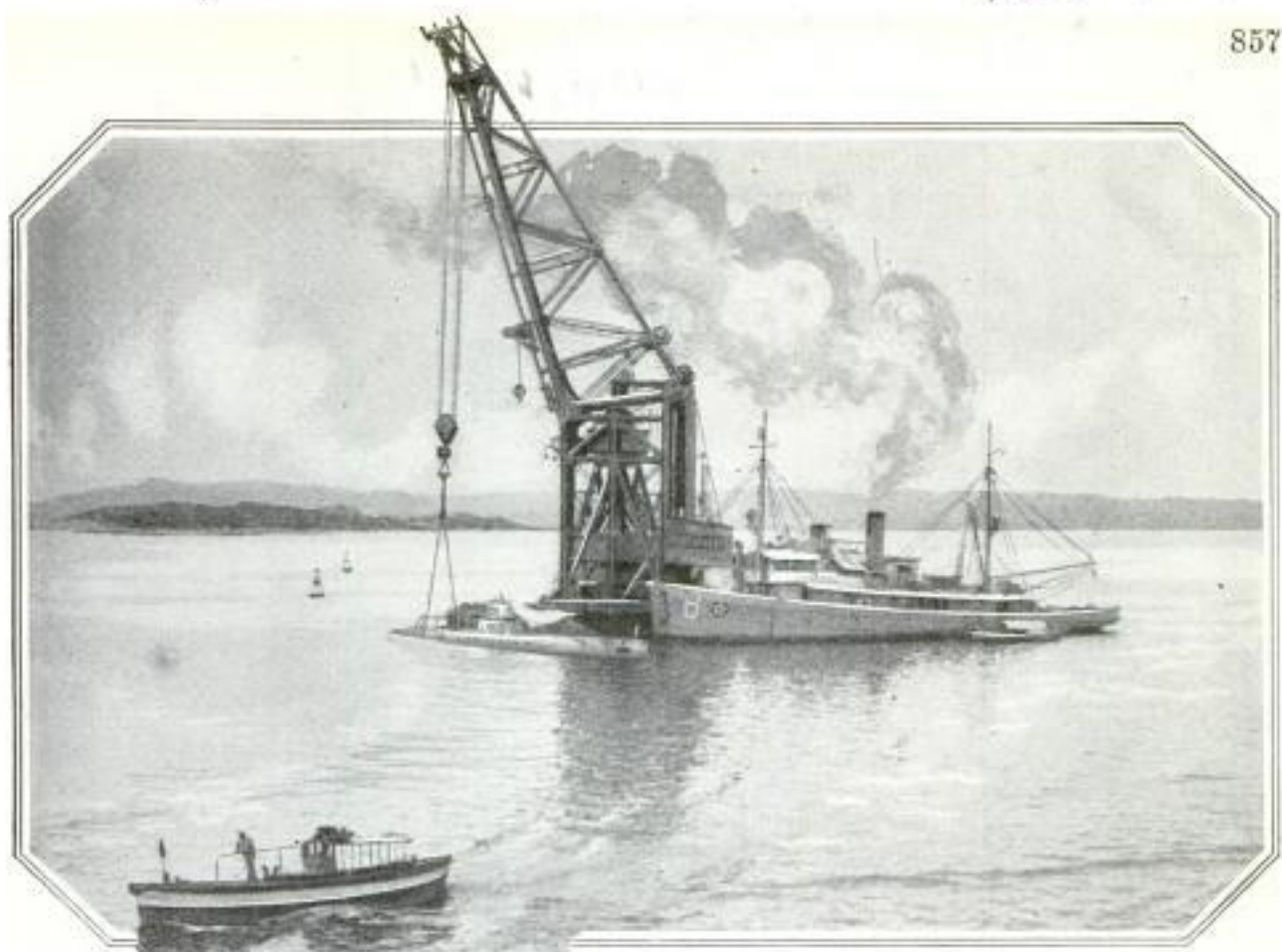

Giant Floating Crane Raising a Crippled Submarine

### SEA'S HIDDEN HIGHWAYS IMPERIL SUBMARINES

42 32

### WEAR ON GOLD COINS RESULTS IN LOSS OF MILLIONS

732

What becomes of gold? It has many channels of disappearance, according to experts. Figures show that more than half of the annual output is employed in the fine arts and jewelry trade. Thousands of pounds also are used by dentists, one estimate being that over a ton is needed every year for the filling of teeth. Then money is worn away in handling, this loss being placed at \$1,250,000 annually. Bank of England sovereigns are often tested and found to have lost much of the original weight. Of the immense quantities of the precious metal that have been buried away in the earth, it is believed comparatively little has ever been recovered. The priests of Peru are said to have buried approximately \$10,000,000 worth of treasure to preserve it from the clutches of their persecutors. None of this has been found. The tombs of the old kings of Egypt were treasure houses, immense quantities of gold and jewels being interred with them. It has been estimated by historians that Alexander the Great became the master of great hoards of gold, all of which, so far as is known, has vanished.

Because of many dangers surrounding the lives of crews aboard submarine boats, extra precautions are taken to school the sailors against accidents. Many grave disasters have been averted through training the men in operation of the craft during emergencies when mishaps to machinery often result in the failure of the vessel to rise after submerging. Careful watch is kept on the submersibles by surface craft and constant check on their positions when maneuvering insures instant aid should signs of their distress be noted. Although tanks of air are provided crews of submersibles in case of accident beneath the waves, hours of imprisonment and consumption of oxygen from the atmosphere inside the craft, often result in disaster. When mishaps occur in shallow waters, rescue can be accomplished by powerful floating cranes which raise the boat from its position and support it securely on the surface.

### COW BONES SHIPPED TO CHINA

738

Three carloads of shinbones from cows slaughtered at a Chicago packing plant have been shipped from Galveston to China where they will be used in the manufacture of Maj Jang sets.

*Kansas City Journal*  
3/8/24

*Chas. W. Ellis, Mrs. Harvey*  
Copyrighted material



Emb. Wm. Benjamin West

858

200

Broadway  
POPULAR MECHANICS

New York City

# RIVER IS HARNESSSED IN TWENTY-FIVE MONTHS

562

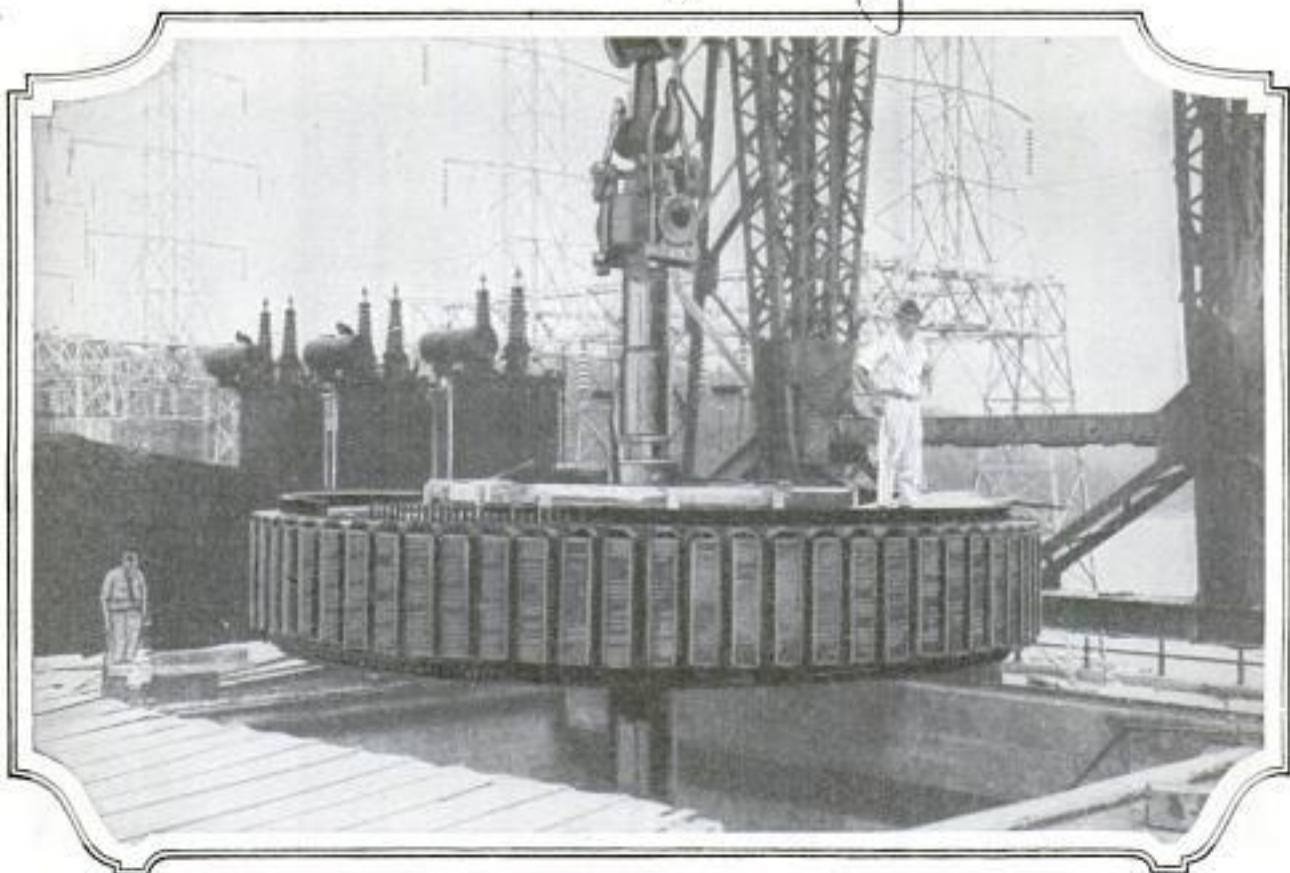

Rotating Part of an Electric Generator for the Mitchell Dam Power Plant in Alabama which Began Operation Twenty-Five Months after Its Construction Was Started

Designed as part of a hydroelectric plant which is to harness the Coosa river in Alabama, the Mitchell dam, recently completed, consists of five units with a combined production of 120,000 horsepower. The turbines which drive the big generators are of the vertical-shaft type and will operate at 100 revolutions per minute. The shafts are twenty-five inches in diameter and eighty feet long. One of

the remarkable features about the installation is the short time required in its construction, twenty-five months being consumed from the date the work started to the beginning of the plant's operation. The dam is 1,264 feet long and almost seventy-five feet wide at its base. The structure was planned to take care of a flow of 300,000 cubic feet a second, so that even great flood stages would not impair its action.

## POCKET "SAFE" FOR KEY RING HOLDS VALUED PAPERS

For carrying identification papers, an automobile license or other small documents, an attractive cylinder case with a



Pocket Case for Papers that Takes Up No More Space than a Fair-Sized Key

screw top has been devised. It is fire and waterproof, and has a ring on one end through which a chain may be inserted so

it can be suspended from the neck or attached to a key ring. The threads in the top are so finely cut that the cover fits tightly enough to exclude moisture.

## FUEL FROM DUST AND WASTE 714 AT TWO DOLLARS A TON

Great savings in the cost of heating and power are claimed for a fuel manufactured in Japan from charcoal dust, chaff and chopped straw. The mixture is ground and moistened with water to the consistency of thick paste. This is then rolled out, cut and formed into blocks or balls of various sizes, which after drying are ready to be burned. This fuel can be sold at two dollars a ton, it is said.

Emb. George N. Holden  
Hill Crest Lodge  
Lakewood, Colorado  
Sakon View Road

constitute N.Y. Co.  
111 Main St.  
New York, N.Y.

water held



## COMMENT AND REVIEW

### Delay in Patents

**WHEN** an idea has progressed to the point where its owner is ready to apply for a patent, he naturally becomes very anxious to have his application passed upon by the patent office, and is impatient and even suspicious at long delays. He wants his patent right away or to know that it is unpatentable. Following the war it was usually impossible to get final action on an application for a patent under a year and a half. The patent attorneys have often been held responsible by inventors for this delay when they were doing everything humanly possible to secure action and results. One fundamental rule in the patent office—and a just one—is that applications shall be examined and started on their course in the order in which they are received.

The war robbed the patent office of a large number of its trained men, few of whom returned after it was over, as they easily found other occupations much more remunerative. This threw a heavy load on those who were left and the applications came in so much faster than the decisions could be made that six months ago the waiting applications amounted to 75,000 cases.

Recently an appropriation was made to enable the office to put on eighty-five additional men, forty-five of whom were examiners and this, with a reorganization in the manner of handling applications, and the introduction by the present commissioner of modern methods generally, has already resulted in a gain of 1,000 cases per month so that at the present time there are less than 64,000 applications awaiting action. The new men will naturally become more efficient and expert as they gain experience in this special work, but even under most favorable conditions, with the present office force, it will require at least five years to reach the point where the desks are cleared and an application can secure attention promptly on receipt. At present the very best that can be done in some classes of inventions is to date and number an application and file it away for nine months. This catching-up process scheduled to be worked out in five years depends, moreover, on no increase in the number of patents applied for.

So, Mr. Inventor, do not blame the commissioner of patents, nor his able assistants, nor your own patent attorney; they are all working like beavers to dig out and get your case through at the earliest possible moment. Nor should the present delayed action discourage inventors to let up on their activities. In a way, it is to the inventor's advantage, as his patent when finally issued bears date, not of application, but date of issue. In the meantime he can go ahead, manufacture and sell with "Patent Applied For" on each article, providing, of course, his patent attorney, who works promptly after making the "search" for infringements, assures him he has something not already covered by a patent. In that event, of course, he would not get the right to manufacture anyway, soon or late, although an experienced patent attorney can often tell the inventor how to change or improve his invention so as to avoid prior patents. The public never dreams of the number of patents made possible by the help of the patent attorney handling an application. I, myself, have known of scores of such cases, and there are thousands.

In order to shorten the five years to prompt action, the commissioner of patents has requested congress to provide for 100 additional examiners. This has been approved by the house of representatives and it is expected to pass the senate, but here another difficulty present itself. At the present time, the patent office is much overcrowded and this hampers the work of the officials. Even the hallways have been converted into rooms in order to relieve the situation, and when the additional examiners are provided, conditions will be worse. To accomplish the best results more space is required, and this can easily be arranged with the permission of congress. Not only is more space required by the per-



848

sonnel of the patent office, but more storage space is needed, in which to preserve the records which have increased into the millions and which are constantly increasing at a rapid rate. If you are interested in getting prompt and efficient service on the part of the patent office, get after your senators and congressmen for an appropriation to provide for enlarging the quarters of the patent office.

The progress and prosperity of our country owes such a vast debt to its inventors, that the comparatively small amount required to provide for additional patent office space is a very modest request for an investment sure to return a thousand-fold and in which the public is the chief gainer.

The present quarters occupied by the patent office are, for the most part, as much out of date as an old East Side tenement in New York compared to a modern apartment building. Not only out of date but utterly inadequate, and actually a disgrace in a nation so largely indebted to inventors; a nation with more inventive ideas than all the rest of the world put together. It is to be hoped that congress will promptly afford this desperately needed relief.

\* \* \* \* \*

**A**N English mining engineer now visiting the United States expressed to me great surprise at the frequency and mortality of coal mine explosions in this country. He ascribes these disasters chiefly to carelessness on the part of the

Explosions  
in  
Coal Mines

miners themselves in striking matches to light cigarettes or pipes. In England every man is carefully searched before being allowed to enter the mine, and if so much as a single match is found about his clothes he is subject to a possible short term in jail. So rigidly is this examination enforced that explosions are confined chiefly to the ignition of gas from powder blasts, and even these are comparatively few. The average American

is apt to be careless and to take chances even where his life may be the penalty; he resents anything which savors of rigid personal inspection. Aside from all question of moral responsibility for the lives of employes, it would seem that the risk of great financial loss alone should insure the same care which has made English coal mines apparently so much safer than ours.

\* \* \* \* \*

**A**UTO accidents, which would otherwise be trivial, are increasing all the time, caused by broken windshields. In a collision the passenger seated next to the driver, often both, are hurled through the heavy plate glass, causing wounds from which the victim bleeds to death, or dies, or is permanently crippled from infection.

The  
Windshield  
Danger

Riding on a train through the mountains of West Virginia recently a man was helped aboard whose head was covered with bandages. He was on his way to a noted specialist in a big city hospital. I asked him, "Did your car turn turtle?" He replied, "No. I was climbing a steep mountain road at a speed

not to exceed 15 miles an hour, when a chicken flew directly across the road over my car. It struck the windshield with the result you see. I still hope to save one of my eyes." Similar instances of windshields broken by flying birds or fowls are becoming so numerous they no longer cause much surprise.

However, inventors have already come to the relief of this danger, for it can be easily prevented by the use of a new plain clear glass, containing no wire screen, which to all appearances is ordinary plate glass, only a trifle thicker. Even this difference escapes notice except on close examination. It will not only stop birds and fowl, but likewise a brick thrown at short range and even a bullet fired from a revolver. Under the impact of brick or bullet the glass on the side from which the missile came shows a slight fracture in its surface, but neither can find its way through the glass; and a blow from a hammer is equally harmless.

One more tribute to the ingenuity of the inventor, who seldom fails for long to meet new conditions, no matter how difficult.

Safety Glass Co., Wood) Philadelphia Pa.  
Broad + Wood

Mr. Bullet proof and non-shatterable  
Glass Corp., 25 W. 43rd St.  
New York - (Armed Glass)



OF all the works of man, radio is the most cosmopolitan and far-reaching. The lights of his greatest projectors fade out and are unseen at 200 miles. The thunders of his mightiest cannon are unheard at seventy-five miles. The human voice, with its utmost physical effort, only reaches one mile. But radio, still in its infancy, already takes the word spoken almost in a whisper and hurls it thousands of miles, not in one direction only but in all directions.

**Radio  
the  
Inexhaustible**

Man has never climbed a mountain so high or plowed the record heights of space in his airplane beyond the point where its voice would not reach. It follows him into the chasms of the earth hundreds of feet below sea level, and has found its way into the hidden recesses of its deepest mines several thousand feet below its surface. You cannot hide from it nor shut the door against its entrance, for it penetrates walls and prisons and there, when wanted, declares its message. It almost rivals that still, small voice of conscience in its universal presence, with only this difference: It does not impose itself on your consciousness. You must bid it speak or it remains silent. But you cannot evade its presence; it is there, although no one has ever seen it and you refuse to listen.

Who can longer doubt that some day—sooner perhaps than we dream—the signals or voice of radio will be heard and answered from other vast worlds which now to us are little more than pin points of diamond light in the limitless space of the firmament. Today millions of people can remember well the time when the present commonplace service of telephone, electric light and airplane was no less unbelievable and apparently much less likely. In all the ages of civilization no other scientific mechanism has ever plunged so quickly from its first crude efforts to its present useful efficiency on so huge a scale of adoption and use as radio.

Another wonder of the radio is its undiminished supply. The most powerful locomotive can pull only a certain number of cars; the smallest church or the largest auditorium has only a limited capacity. But radio is a magic spring that cannot be exhausted. The effort of the singer or speaker, or the power required of the broadcasting apparatus itself, is not increased by so much as the strength of the tiniest form of life when the solitary listener is increased to a thousand. And when that thousand grows to tens and hundreds of thousands, yes even millions, the effort required is exactly the same. They all fill their cups from the same spring at the same instant, but the flow is unchanged however few or many. There are few physical things in this world which are not diminished by use. In time crops exhaust the land; all the fish can be taken from a lake; mines refuse to longer yield their treasures; oil wells cease to flow; but when once the radio impulse is sent forth from even a single station all the receiving sets in the world cannot use it up or diminish it. There would still be the same supply for as many more at the same instant.

\* \* \* \* \*

LAST year fresh-water game fishes alone were taken by anglers from our rivers and lakes having a market food value of \$48,000,000. But each year the supply decreases, and with good roads and automobiles there will soon be more fishers than fish unless something is done. A bill recently introduced in congress—and which I hope is passed before these words are read—is known as the Izaak Walton league bill, and provides for a national refuge for game birds and fish in the marsh lands of the upper Mississippi. These bottom lands, which are unfit for cultivation, are the greatest breeding places in the world for black bass and other fresh-water fish.

**Saving  
the  
Outdoors**

Each year more and more streams are made so poisonous by pollution that all fish and feathered game desert them. One of the objects of the stop further stream pollution and in time restore streams now ruined. The Izaak Walton league is working to preserve enough of the Great Outdoors—forests, streams and lakes—that coming generations will have more enjoyment and use than we have today.

H. H. WINDSOR



*dr. W. E. Harnese*

*Cml. George J. Morse Jr. 547 County Bldg. Chicago*

862

**POPULAR MECHANICS**

*Lexington Ill.*  
**ALUMINUM GOLF CLUB'S HEAD HAS REMOVABLE FACE**

*431*

With a head made of aluminum, a golf club has been patented which, it is claimed,

will last a lifetime. The metal is cast in a hollow shell into which is fitted a fiber block held in place by four screws through the bottom of the base. The fiber top and face of the club are exposed.



Aluminum-Headed Golf Club, the Fiber Face of Which May Be Changed to Suit the User

**INJURED BIRDS' LIVES SAVED BY ZOO "SURGEONS"**

*705*

Injured birds that have been struck by automobiles, stunned as a result of having flown against windows or captured by cats and other natural enemies are frequently taken to zoos and aviaries where their hurts are doctored and they live to become parts of the exhibits. Broken wings and legs are carefully set in splints and the "patients" are kept in dark and quiet cages so the injury will mend quickly. Precautions are taken to keep them from being frightened or becoming excited while undergoing treatment, and the most tempting feeds are offered them, owing to their refusal to eat during the first days of captivity. Fish-eating birds have to be coaxed to consume freshly caught dead fish by putting live minnows into their drinking fountains. Newly captured adult birds must also be permitted more exercise and food than others.

**ELECTRIC ALARM SOUNDS BEFORE FIRE STARTS**

*215*

Protection against overheated furnaces, burning out of bearings, and spontaneous combustion is secured with the aid of an adjustable electrical instrument designed to sound an alarm bell and locate the danger spot before damage results. It consists of a small case in which a carefully adjusted loop of wire is inclosed. Should the temperature rise above a certain degree, the loop is expanded, forming a con-

tact with an adjusting pin and closing an electric circuit which registers an alarm by ringing a bell. In case several of these instruments are installed in one plant or home, a register board is provided to show the number of the one giving the alarm. It may be installed in mines, airplanes, ovens, stores and factories, on board ships, and in practically any place where there is fire hazard from overheating.

*Mr. A. J. Brohm, John & Sons, Chicago*

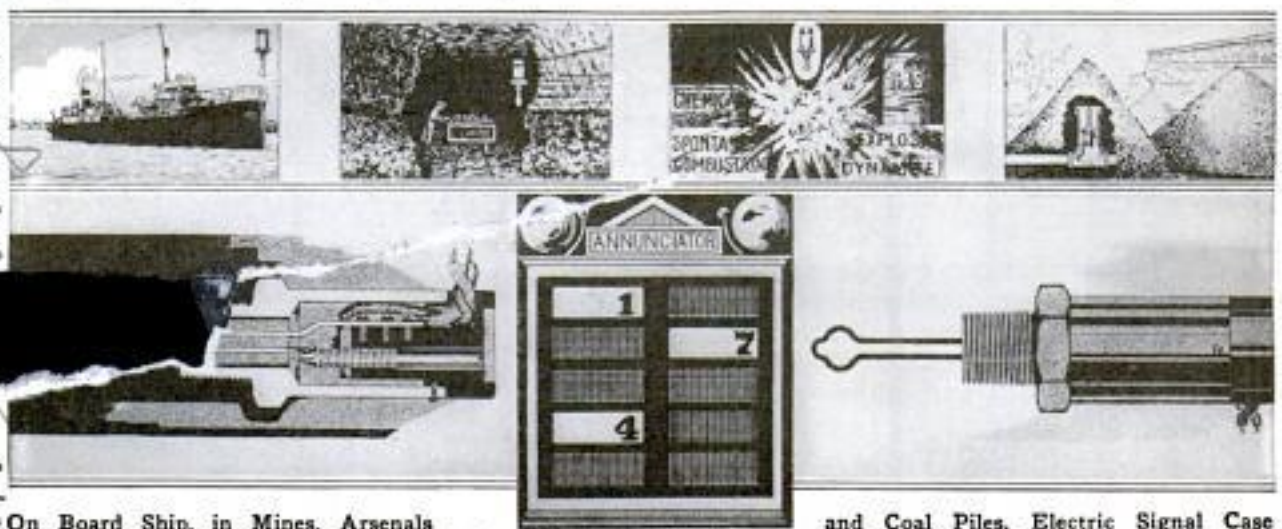

On Board Ship, in Mines, Arsenals and Coal Piles, Electric Signal Case Here Diagrammed with Annunciator Signal Board, Instantly Sounds Alarm of Fire Danger

*dr. c/o H.O. 6248*



*Bismarckian*

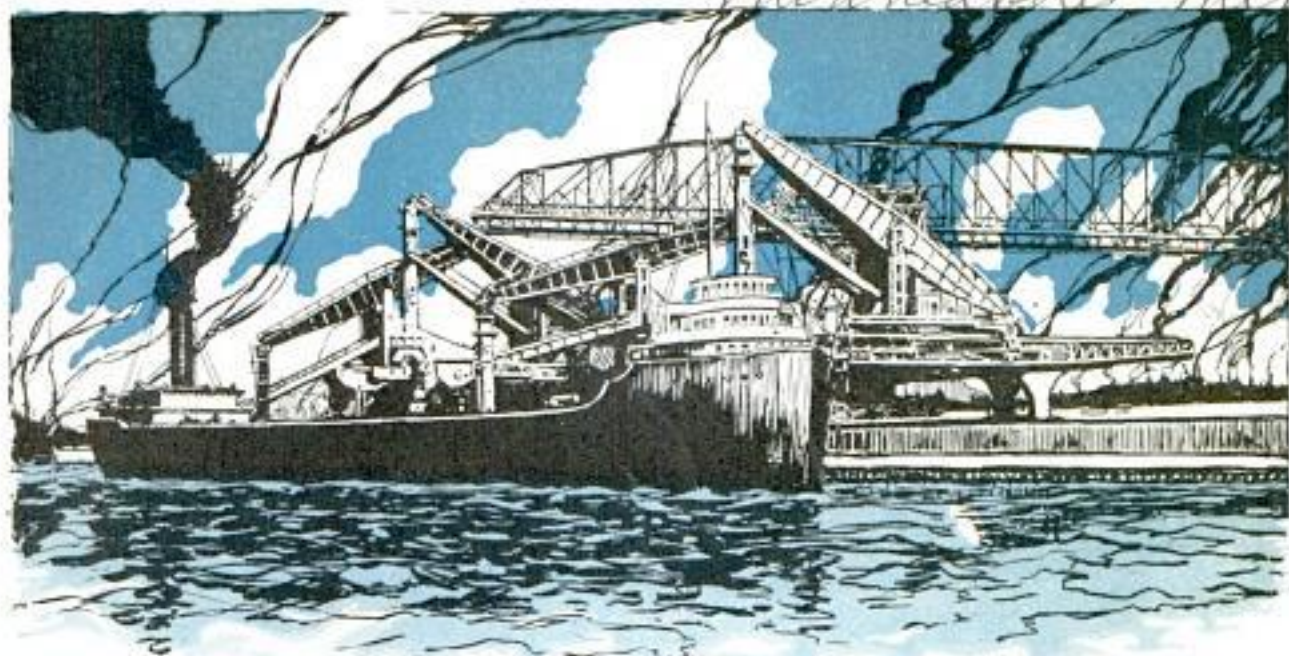

How Four Seventeen-Ton Unloaders at a Modern Great Lakes Dock Relieve a Gigantic Ore Carrier of Its Cargo in a Few Hours

## Motor Ships Link Inland Seas to Oceans 539

### Electrically Driven Freighters of Light Draft to Seek Maritime Highways through Narrow Channels of Great Lakes

RECALLING the days when "fir-built" sailing vessels plowed the fresh-water lanes of the Great Lakes, electrically driven boats of light draft, with collapsible stacks and bridges to enable passage through the narrow channels that join the inland seas with other waters, have appeared to take their places in the growing commerce of the lakes. With a yearly volume of more than 90,000,000 tons of freight, valued at more than \$1,250,000,000, the need for sturdy light craft has brought the motor ship because of its ability to make speed and short stops, despite schedules of many calls. Bulky propelling machinery has been replaced by powerful Diesel engines

that mark a decided contrast to the sailing vessels that made up the lake fleets less than a century ago. Narrow canals and shallow channels that prevent wide range to massive grain and ore boats afford easy passage to the slim hull of the motor ship. Rough seas have no more effect upon it than on the heavier types, permitting such craft to enter into overseas and coastwise trade under smaller crews and lower operating costs than their larger relatives.

Coupled with the ease with which the electric ship can be manipulated through the lake harbors, loading machinery found now on almost every dock, shortens the periods required to transfer



Rare Old Type of Lumber Boat, Relic of Romantic "Pioneering" Days on Inland Seas



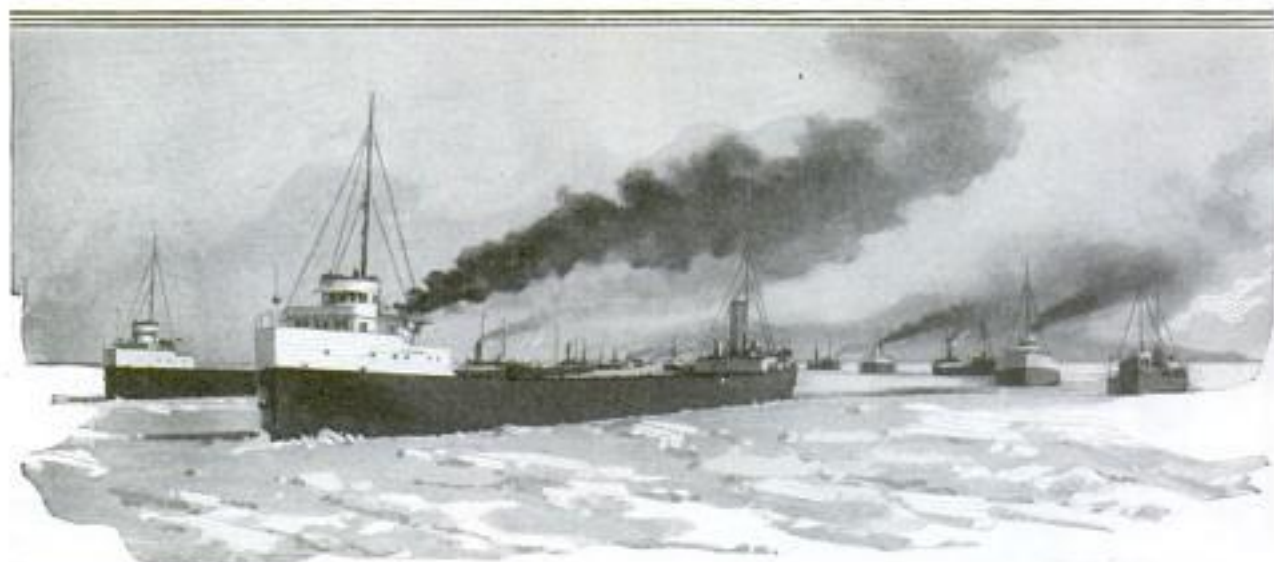

Freight Boats Ice-Bound on the Great Lakes in Mid-Winter Awaiting the "Break-Up" to Resume Their Tireless Journeys between Ore Mines and Steel Mills

cargoes, reducing waiting time and freeing the freighter to take up its journey in much less time than was necessary under methods of a few years ago. Easing up to the docks, the hatches are thrown open and the powerful arms of giant cranes and tentaclelike hoists snatch out the burden from the dark holds, quickly transferring it to storage heaps or into waiting railroad cars that carry it to mill and factory. To salt-water sailors who breast the breezes

of the fresh-water seas on ships that steam in from the "outside," as the wide ocean lanes are known, this waiting mass of steel cables and girders that reach out to seize their cargoes means short "shore leave." The huge piles of bulky material that lie close by on the dock, and which they are to take aboard in exchange for the freight they bring, pass into the holds with a silent quickness that amazes the seasoned "sea-dog" accustomed to the slow, creaking machinery and scrambling stevedores that mark such movements in salt-water ports.

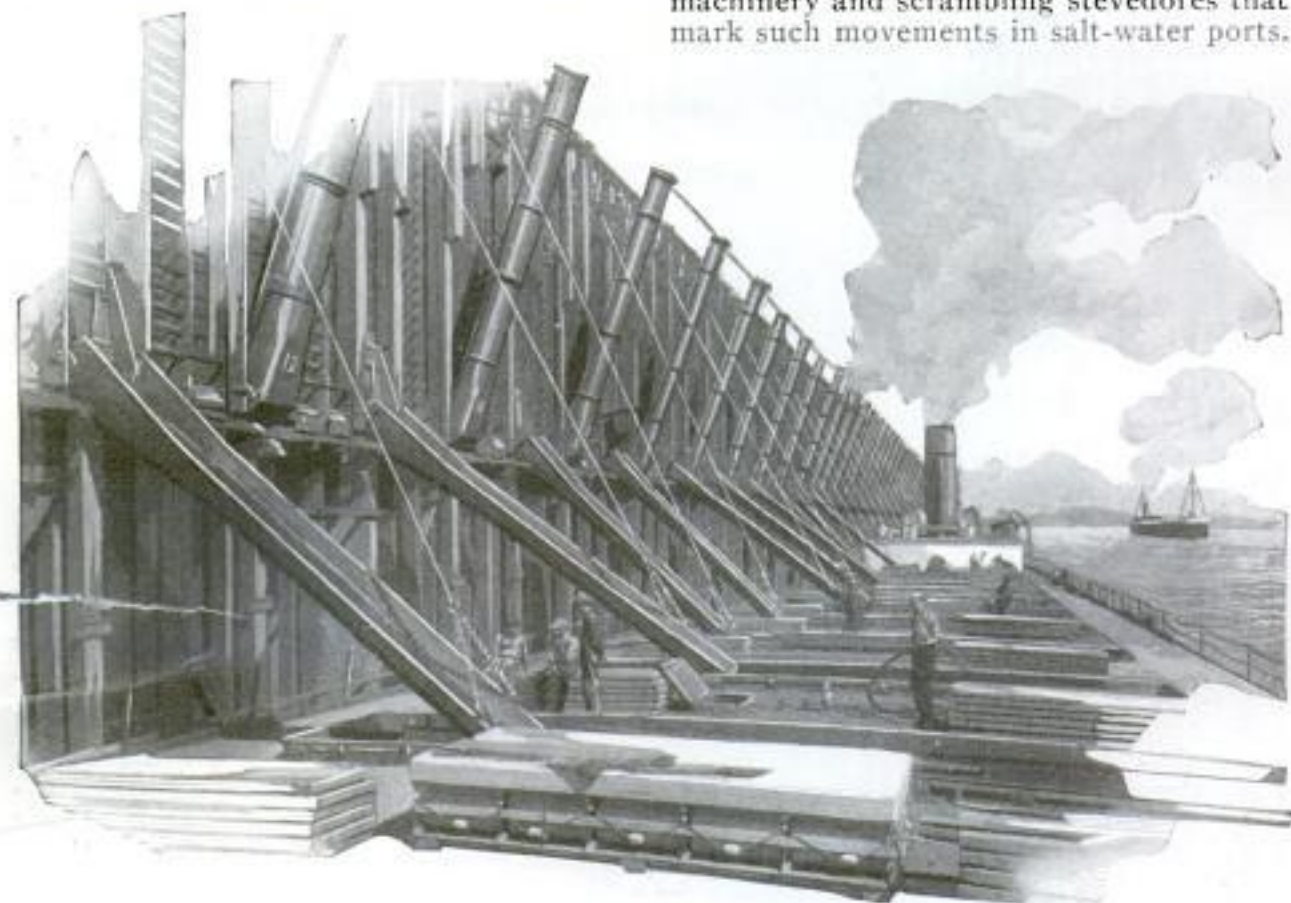

Loading Ore into a Boat as It Lies in the Slip of a Storage Dock Where Sufficient Chutes Are Provided to Serve Several Vessels at the Same Time



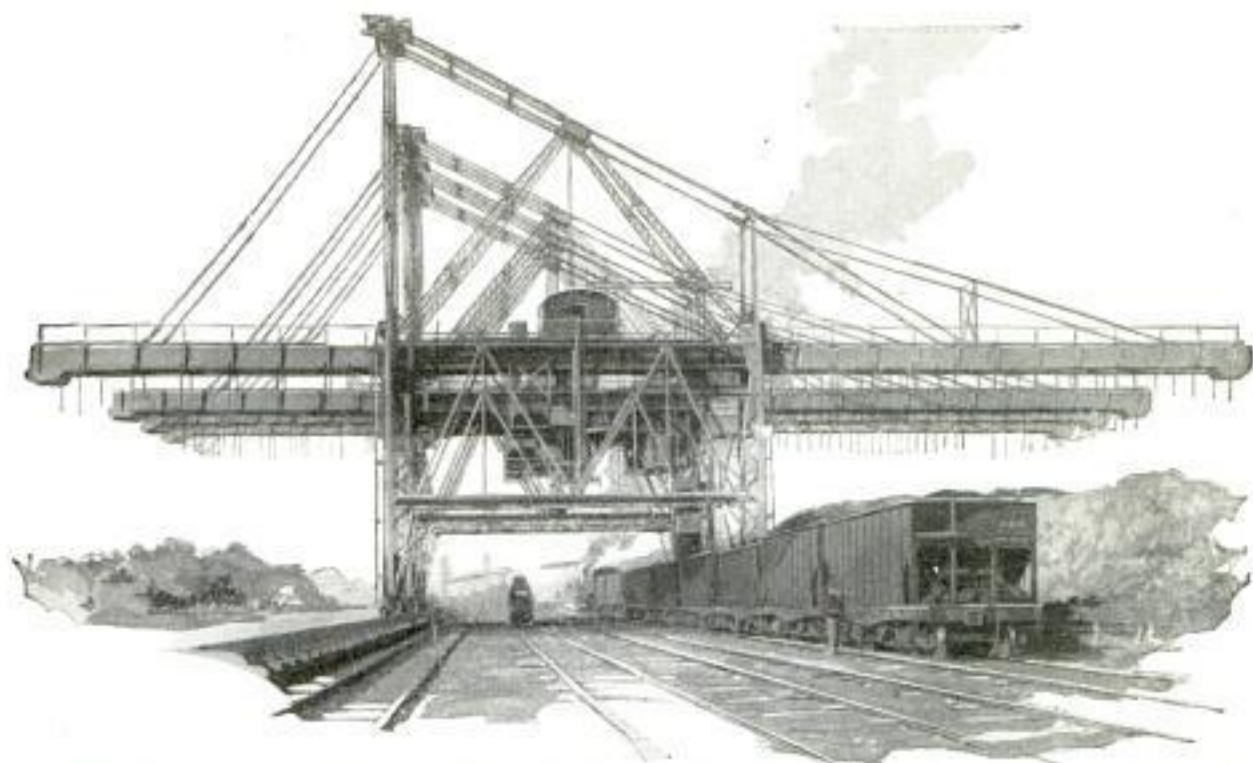

Monster Movable Conveyor Crane that Transfers Iron Ore from the Holds of Boats Lying in the Canal to Waiting Railroad Cars for Direct Transportation to Mills

For a number of years many ocean steamers have been propelled with electric engines, as some authorities believe such types are capable of greater speeds and endurance than the ordinary coal fuel vessel. With fleets of these and contemplated enlargements of the existing channels and locks in the Great Lakes area, it is expected that eighty per cent of the ships in the world's commercial service could make use of the inland waters to trade directly with centers supplying grain, iron ore, coal, steel, lumber and similar products, by extending their sailing range to lake ports.

In spite of severe winters the lakes are seldom closed to freight traffic, ore boats and lumber steamers plying their busy

ways practically the whole year around. Some of these monsters carry burdens of 12,000 tons and are manned by crews of less than twenty men. Systematic handling of freight at the docks, being accomplished with the aid of modern machinery, has superseded the old process of hand labor and the wheelbarrow corps. Boats with bulk cargoes of 10,000 tons have been emptied by one crane alone in less than two hours. The entire battery of unloading machinery is such that it can be controlled and operated by one man.

Grain elevators holding millions of bushels of wheat can pour their treasures directly into the interior of these gigantic hulls at such speed that as many as half a dozen can be filled in a day.



Fleet of Big Lake Freighters Passing through One of the Many Narrow Channels that Connect the "Inland Seas" into an Immense Fresh-Water Highway



*Ind - Bits  
2/9/24*

**GIANT SAXOPHONE IS SO LARGE  
PLAYER STANDS ON LADDER**

Weighing 500 pounds and modeled accurately after smaller instruments, a huge saxophone was displayed not long ago in

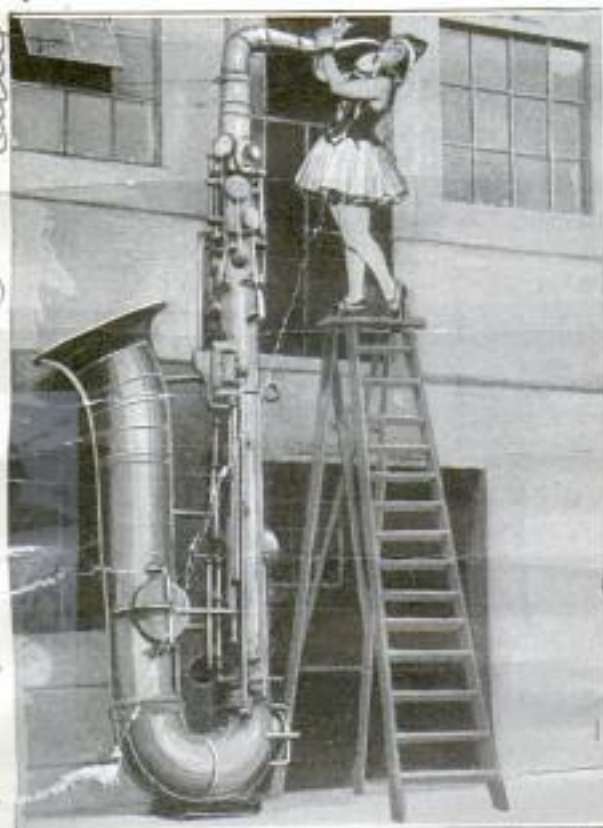

Trying to Blow a Few Notes on Saxophone Weighing Five Hundred Pounds

California. Securely bracketed to the outside of the manufacturer's shop, the giant instrument formed an impressive advertising display, and to emphasize its tremendous proportions, a young woman who attempted to play it was compelled to mount a ladder to reach the mouthpiece.

**NOVEL DESSERTS EASILY MADE  
WITH CAKE-SHELL PAN**



Many novel desserts are possible with a patented aluminum cake-shell pan. It may be used to bake forms for fresh or canned fruits, gelatin and custards with their topping of whipped cream or meringue.

Made of one-piece, highly finished metal, it may be cleaned easily and cannot burn out with reasonable use.

**HUNDRED MILES AN HOUR BIRDS  
FLY DAY WITHOUT STOP**

Flying at a rate of a hundred miles an hour, some birds can continue on the wing for a day without stopping. The vulture, it is said, can travel great distances at this speed and often stays in the air for a full day of flight. Many wild ducks and similar fowl attain almost as great speeds when migrating, while, among smaller birds, the swallow has been known to reach ninety miles an hour and to keep up that record for long stretches. The eagle, despite its strength and big wings, seldom flies as fast as a mile a minute. The crow, though seeming to be a slow mover in flight, makes about twenty-five miles an hour, and the carrier pigeon does an average of sixty miles in the same time. The tiny sparrow can travel at twenty miles an hour but only for very short distances. The wild goose does one hundred for hours without appearing to slacken its pace during the entire time it is flying.

**COMB HIDDEN IN POCKET CASE  
IS WORKED BY BUTTON**

Combining cleanliness, neatness and convenience, a collapsible pocket comb, attached to a metal case that incloses the teeth to protect them from dust and dirt, has been placed on the market. On the top of a case is a small button switch, which, when pulled to one side, lifts the comb into position. A reverse movement causes it to slide back again into its case. The article is manufactured in handy sizes, corners are



Collapsible Pocket Comb Folded Up or Ready for Use at Touch of Lever

rounded so they will not tear the clothing, and the sides of the case are suitable for engraving or other decoration.

☐ We want all our readers to write us freely and often whenever they wish additional information on articles published in this magazine. Address Bureau of Information, Popular Mechanics, Chicago.

*370  
Dan  
Francis  
71  
La Haye  
516  
n  
m  
a  
c  
a  
s  
t  
e  
r  
P  
a.*

*Clemington Co.  
Swanson  
Carton*

*Burr-Patterson & Co.,  
Detroit, Mich.*



515  
*Aero*

### BOMB CARRIED ON AIRPLANE WEIGHS TWO TONS

Weighing 4,000 pounds and nearly fourteen feet long, a bomb has been completed by the United States army ordnance corps. It was designed to be carried on a bombing plane and the two together are said to form one of the most powerful demolition units ever devised. Explosive sufficient to blow a crater 150 feet wide in

the surface of the earth can be carried in the huge "death shell." The bomb was exhibited in a New York hotel during a banquet of war department officials and engineers who met to discuss industrial preparedness as a war preventive.



*International*

Special Tackle and Squad of Soldiers Were Required to Slide Heavy Airplane Bomb into New York Hotel Dining Room where It Was Exhibited at Banquet

*Aero*

### PHOTOGRAPHS TAKEN FROM SKY REVEAL ERRORS IN MAPS 610

Mapping of changes in coast line, which under ordinary conditions would take anywhere from six months to a year, is being accurately completed in a few weeks through the use of the airship in surveying. Swamp lands in Florida, forests in Canada, and other uninhabited areas considered possible for settlement, are being mapped from the sky; wood mills are using airships to inventory standing timber, and railroads are determining favorable routes with the aid of bird's-eye photographs. The advantage of airships over the old ground-surveying methods was shown when recent air mapping by the Ontario government brought to light many errors and omissions in former maps.

*New York Times 2/27/24*

### METAL SHIELD GUARDS POLICE WHILE DIRECTING TRAFFIC 28

Traffic policemen in Washington, D. C., are protected from the weather and the possibility of being struck by automobiles by a metal shield, somewhat like a bottomless barrel, in which they stand. One side is left open to permit entrance and exit. It is large enough to allow freedom of movement and acts as an efficient "snubbing-post" when cars approach too near.

*Cmk H. A. Windsor  
etc.*

### FOLDING STAND HOLDS PLANTS IN ANY POSITION DESIRED 323

Especially suited to decorative displays in stores, windows and in homes, a telescopic stand has been made that will hold plants in any position desired. The larger and heavier the pot, the more securely it is held at any angle, height or position de-



Telescopic Plant Stand that Will Hold Pot at Any Angle, Height or Position Desired

sired. It will not tip and eliminates the danger of the plant being upset. When not in use, it folds into small space.

*The McCullum Co.  
137 - Seventh St.  
Pittsburgh, Pa.*



Illinois Asbestos Products Co  
 140 S Dearborn Chicago  
 POPULAR MECHANICS

868  
 589  
 C.77



Women Students at Teachers' College, Columbia University, Building Workingman's Home; and, at Right, a Miniature Guide for House Buyers



Attractive, but Inexpensive, Home with Double Walls of Concrete Blocks Which Serve to Keep It Cool in Summer and Warm in Winter

Refer to Universal Gypsum Co., 105 H.W. Washington  
 Homes Are Turned into Thermos Bottles  
 Chicago

**Insulating Material Poured between Walls Saves Fuel in Winter and Protects against Heat in Summer Months**

TO cut fuel costs in the winter months and, at the same time, to add greatly to the comfort of the home during the hot summer, a Chicago inventor has perfected a material to insulate walls, floors, ceilings and roofs and make them fire, vermin and noise-proof. This is done by taking gypsum wall plaster and mixing with it some dry chemicals which have the property of forming, when mixed with water, the same gas that yeast forms in bread. In practice, the material, consisting of the chemicals mixed with the gypsum plaster, is brought in paper bags to the building which is to be insulated. To all outward appearances the material looks just like ordinary plaster. When water is added, however, a great change takes place. The gas generated in the mixture expands the mass just as the yeast expands the dough used for bread. By the time the "mix" is thoroughly stirred it has increased in bulk five times. As soon as the mixing is complete the mixture is poured into place. In thirty minutes it has set hard, producing a mass honeycombed

with millions of fine air cells, visible to the eye. One of the most important points to consider in any house is the insulation of the ceilings immediately under the attic. Reports made by Armour Institute of Technology declare that two inches of this puffed gypsum placed above the lath and plaster will save sixty-nine per cent of the heat loss that would pass through the ordinary ceiling. Its use also means the elimination of the intense heat radiated through the roof during the summer. In a home where the ceilings under the attic were properly insulated the upstairs rooms would be as cool as those downstairs.

When insulating a ceiling in an old house, waterproof paper is placed over the lath and plaster to prevent any possibility of water stains. An ordinary tub, a couple of buckets, and a paddle are the only tools required. The mixture is poured into place and smoothed out to the required thickness. It can be applied by anyone without previous experience. In insulating the side walls of a building the puffed gypsum is cast on the



Cross Section of a Puffed Gypsum Block Showing the Large Number of Confined Air Cells

Central 8255  
 see May 1926 - 745





Portal of Modern Home that Shows Some of the Artistic Possibilities to Be Obtained with Concrete.

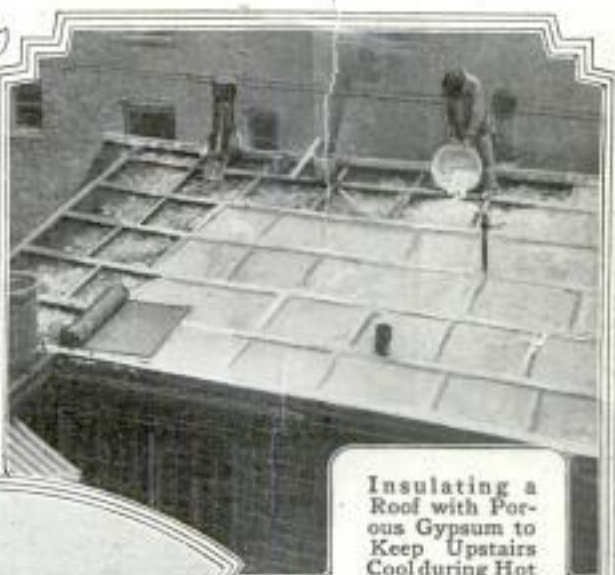

Insulating a Roof with Porous Gypsum to Keep Upstairs Cool during Hot Months; and, Below, How Material Is Poured.



Slabs of Gypsum Used to Insulate Walls Being Cut and Placed between Studs after Material Has Been Poured on the Job and Has Partially Hardened.



Another Example of the Artistic Possibilities of Concrete in the Construction of Homes for Which It Is Constantly Growing in Popularity Due to Its Low Cost.



United Newspictures  
461-8th Ave  
New York

floor in large slabs on top of sheathing paper. In thirty minutes it has set hard enough to cut up with a putty knife into sizes to fill between the studs.

In a test to determine fuel saving, an insulated house used only three tons of coal during the winter, while a similar house without any protection required seven.

Tests also were made with a number of storage tanks used in heating water for household use both with gas and coal. In every instance where the insulation was applied, the cost of the fuel was reported to have been cut in half.

By installing sufficient insulation in floors, side walls and ceilings, it is said to have been proved possible to make a thermos bottle out of any building.

300 **JAPAN EXPRESSES ITS THANKS FOR EARTHQUAKE HELP**

Containing the names of approximately 50,000 Japanese citizens, a letter of thanks for the help given by the United States



Book Containing Fifty Thousand Names of Japanese Who Express Thanks for Earthquake Relief

after the earthquake has been received by the state department in Washington. The signatures have attracted much attention.

**TREE LEAVES AS BAIT FOR FISH STUNS ITS VICTIMS 7/2**

In Madagascar, where primitive methods of procuring food are still practiced by the natives, fishermen gather their catch by first paralyzing their prey with a bait made from leaves of a peculiar tree. These are laid out to wither for a few days and are then crushed and chopped into a sticky mass. Thrown upon the water, it floats, attracting the fish which appear stunned when they seize it and are powerless to escape the nets used to trap them.

**POLICE IN BULLET-PROOF CARS PRACTICE SHOOTING TARGET**

332 To perfect their marksmanship, the Philadelphia patrolmen assigned to duty with a fleet of fast, bullet-proof automobiles,



Patrolman Shooting at Target from Bullet-Proof Car Used to Chase Criminals in Philadelphia

have been practicing shooting at a target while the cars are in motion. The machines have been assigned to patrol duty as a precaution against criminals who also employ high-powered machines.

**KEY TO CHARACTER IN PENCILS ACCORDING TO EXPERT 639**

Can character be read from the type of pencil used? According to one expert the answer is yes. Men are usually attracted by the lead and women by the outside coloring, he says. Persons of strong character know just what they want and will not be satisfied with anything else in buying, while weak characters adjust themselves to the first pencil offered them. Conservative people, who are used to certain pencils, demand what they have always had. Cautious folk wish to try out a pencil extensively before purchasing it. Freak pencils are said to be much in demand.

*New York Times 3/2/29*  
**CUFF LINKS LOCKED BY SPRING 523**

**CANNOT PULL APART**

Cuff buttons that can be unfastened only when a spring release in the lower half is pressed have been patented. Each link consists of two sections.

The top half has a bar projection which is inserted into a spring catch in the lower part. When this snaps shut, it can be released only by pressing



a knob on the outside. The links are attractively finished, rounded so they will not tear fabrics, and are quickly inserted.

*McRae + Keeler, Inc., Attleboro, Mass*

*Drue-Japanoria  
Vogelli  
Pacific + Atlantic  
25 Park Plaza  
New York*

*no price*



*Ind-Bits  
2/9/24*

*440*

**CANARIES BY THE SHIPLOAD  
NEEDED TO MEET DEMAND**

*554*

When the Cunard liner "Andania" docked at New York on one of its trips from Southampton, the songs of 8,000 canaries and the chatter of 2,000 cockatoos greeted dock hands who descended to unload the steamer. Each songster had been placed in a separate wicker cage and they were piled high in the steamer's store-rooms. The birds consumed 4,000 pounds of seed on the voyage and required the care of four attendants. Most of the canaries sold in the United States are bred in Germany. During the war, domestic breeders supplied many markets, but importations are now regaining their normal volume. Dealers assert that the pet canary is increasingly popular and sales are growing each year.

**RUBBER SUIT KEEPS MOTORIST  
DRY AND COMFORTABLE**

For the protection of motorists and others in case of storm, a waterproof, over-all suit has been manufactured that can be



Rubber Suit with Hood Protector and Diagrams of Cape Ventilator and Collar

slipped on or off in a few seconds, has no bothersome buttons, allows freedom in movement, and covers the entire figure. It is composed of two plies of strong fabric between which is a layer of rubber. Patented fasteners at the front, wrists and ankles are quickly adjusted. The collar can be drawn over the head for additional protection and, when folded up, the suit occupies but little space. The garment is so well ventilated that it can be worn in hot weather and yet provides warmth in storm and cold.

*Watson Mfg. Co.,  
Acad Bldg.,  
Chicago*

**ROLL MAKER WIRED TO PIANO  
RECORDS NOTES AND WORDS**

Connected directly to the piano keys, an electric instrument that perforates a paper record of the selection as it is played, has



Inventor Playing Directly upon the Roll through the Record Punch Connected with Piano

been patented. It consists of a series of plungers actuated by electro-magnets. As various keys on the piano are depressed, corresponding circuits cause the plungers to punch holes in the paper beneath them. Words of the song can also be printed on the roll as it passes through the recording apparatus. The inventor says that it gives a faithful reproduction of the exact phrasing and expression of the artist's playing and that rolls can be made more cheaply in this manner than by any other means of reproducing.

**BOX WITH WAXED-PAPER ROLLS  
HAS METAL CUTTING EDGE**

Waxed paper in rolls is being supplied in a special box with a metal cutting edge for quickly separating the required length. This paper has many uses in the kitchen and also is of service in wrapping around flowers and sandwiches. The holder keeps the paper from being wrinkled or lost.

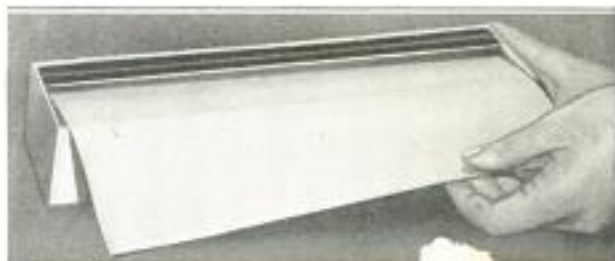

Waxed Paper in Special Box with Metal Cutting Edge for Separating the Required Amount

*Staines Kitchen Equipment  
Co., 94 Victoria St.  
London, S.W. England.*

*Blavilla, Sh. new Orleans  
1930 Art.*

*J. J. J. J. J.*

*copy of Watson's  
add  
201  
24*





Wax, Sugar, Paint and Prosaic Lino'leum, Transformed by the Modeler's Skill into a Drama of the Far North; Shadows Are Produced by Clever Use of Tints and Overhead Lights; in Reality, this Scene, from One of the Groups, Is Less than Six Feet Wide





## Frozen North Lives in Wax and Sugar

Skilled Museum Artists Create Realistic Imitations of Eskimo-land on Miniature Stages of Oilcloth and Wood

AS though lifted from their natural settings, shrunk to convenient size and carried away in magic cabinets, vivid scenes of the life of the Eskimo tribes of the far north have been placed in the Public Museum of Milwaukee, Wis., in an exhibit of miniature groups. They are part of a series which will number 468, large and small, when complete.

Using clay, sugar and wax, strips of linoleum and pieces of wood, scientists and artists have reproduced expanses of polar landscape and groups of natives at their daily hunting and domestic scenes. Practically every side of stern life in the frozen north is disclosed to the ob-

server in the museum, who can gaze across "miles" of the frozen north or into the intimate circle of an imitation Eskimo family about its igloo "fireside." The figures, modeled to the scale of about an inch to the foot, stand in lighted booths or stages about three feet deep, six feet wide and six feet high. So realistic are the impressions when looking at the lighted scenes, that one may easily imagine he is peering through a large window in northern climes. The "pictures" are the designs and creation of C. R. Porteus, modeler in the mu-



Modeling a Polar Bear "Actor" for One of the Scenes; Note Size of Finished Group in Background





Tinting Wax and Sugar "Snow" to Produce Realistic Arctic Shadows before an Igloo

seum. Six groups already completed represent a year's labor. Each group has been posed from the most reliable data of explorers and scientists. The linoleum background is painted first and the colors are applied to the smooth side of the material. By carefully mixing wax and sugar and painting on realistic shadows, various snow effects are secured. The ice may snap with an appearance of extreme cold or tracks depicted in the ground may give the appearance of melting or softer snow. Repeated experiments are made with the lights and the shadows before the desired results

are obtained. The scene is then ready for the "characters." These have been modeled first in clay, plaster molds formed and the finished figures produced by pouring molten wax into the molds. Bears, dogs, Eskimo men, women and children, and various animals are made in this way. They are given realistic colors and are staged to show to the best advantage the part that each one is to "act." All furniture for interior views, the arrangement of the igloo and the poses and actions of the wax people are studied out and based on authentic sources, then executed with greater care and deliberation than are used in plotting a scene for the theater. In gathering material for other groups for the museum, the directors and chief artist and assistants go to various parts of the country and after careful explorations in the region that is to be used, construct a small model on the spot which is shipped back for reproduction in larger form.

Frequently, in Indian or other groups, natives who are familiar with the life that is to be portrayed are asked to criticize the work of the scientists and their suggestions are often valuable in securing an accurate finished display. Scenes showing bird, fish and mammal life and the important geological formations from all parts of the world are being included in the museum's series of these realistic groups. Similar to ordinary practices in use on

theatrical stages, backgrounds for some of the landscapes are produced on a series of rigid frames that blend with one another to convey appearance of distance when the set is erected.



Behind the Scenes: "Making Up" Small Figures. Modeling Animals in Wax and Painting the Back Drops for Realistic Arctic Stages in the Museum's Specially Equipped Studio



*Dr. Walter C. Muehler*  
130 E. 15th St. P. O. Box 432  
New York City

POPULAR MECHANICS

*Copyrighted material*  
875  
- 48

**DOUBLE EXPOSURES ARE EASY WITH SHUTTER OVER LENS**

For taking two pictures on the same piece of film, a double-exposure shutter for cameras has been invented which masks half of the lens as each photograph is snapped. It is easily attached and quickly removed when the entire lens is required. Made to fit either a box camera or the folding types, it has no parts to get out of order.

**LIFELIKE ANIMAL MUMMIES ARE MADE WITH FLUID**

Lifelike mummies of various kinds of animals for museums and laboratories are



Copyright, Henry Miller

Preserving Carcass of Rabbit with Mummifying Fluid to Restore Original Colors and Tissues

said to have been prepared successfully by the use of a patented fluid. The substance is declared to be similar in composition to the drugs used by the Egyptians in preserving their dead. It is said to restore the original colors, size and softness to the tissues and to keep them indefinitely.

**LOCK BOX FOR MILK BOTTLES GUARDS AGAINST THEFT**

For safeguarding milk bottles, packages of groceries or other articles delivered at the home from theft, a cabinet with door that cannot be reopened from the outside unless an interior lock release is set, has been devised. It is designed to be placed in an opening in the wall of the house so that packages may be removed directly into the kitchen or storeroom. The door locks each time it is closed and can be opened again from the outside only by

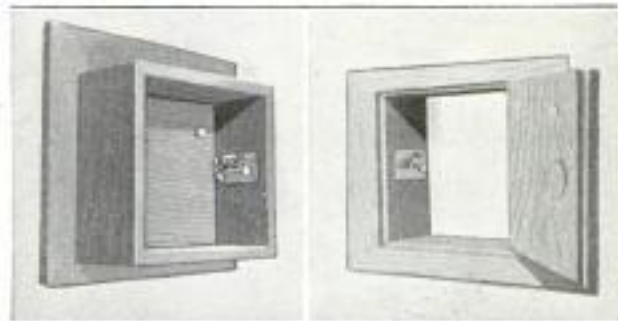

Cabinet with Front Door Open and Shut; Set-Lock Mechanism on Side Wall

releasing a catch which automatically sets the lock again when the door closes.

*Inv. Leo S. Miller*  
934 1/2 *Copyrighted material*  
Detroit Mich

**TENT WITHOUT CENTER POLE EASILY CARRIED ON AUTO**

By eliminating the center pole, increased space for the camper and greater ease in handling are provided in a folding canvas tent designed especially for automobile tourists. Lengths of light steel tubing form the corner supports. The top rests on an adjustable screw shaft that automatically locks in any position and is attached to four cross ribs, one from each corner of the tent. It can be raised or



Adjusting the Umbrella Top of Roomy Tourist's Tent by Turning the Shaft Handle

lowered somewhat like an umbrella. In this way, the canvas is loosened to prevent stretching in wet weather or can be tightened in heavy winds. The tent is large enough for a double or two single beds and has ample dressing space besides. It has sewed-in canvas floors and a storm door. The entire outfit folds up into a carrying bag that fits on the running board.

Not much larger than a blue-bottle fly, a humming-bird found in Central America is said to be the smallest known bird.

*The Slickety*  
*Co. St. Toledo Ohio*  
*329-70th St.*

*8th - Monroe St. Brookland Wash D.C.*

*Designed by - Francis*



*Ermond Multicolor Printing Press*  
 21 E. 40 St. *New York*  
 POPULAR MECHANICS  
 PRESS PRINTS MANY COLORS  
 AT ONE IMPRESSION

509 To print any number of colors at one impression, a press has been invented that is said to work equally well on paper, glass,

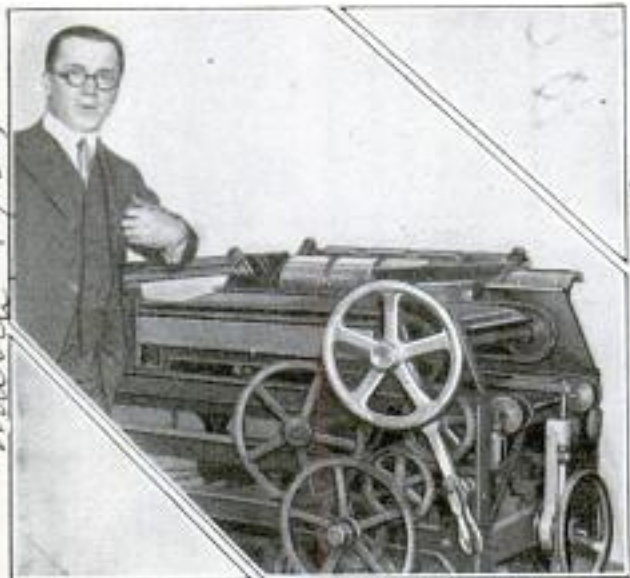

Inventor with Press that Prints Several Colors at One Time on Paper, Metal, or Wood

in wood, and other substances. It is so constructed that the surfaces of bottles, jars, and similarly shaped articles can be put through the process in a single operation. Built for newspaper work, the machine, it is claimed, can reproduce illustrations in several shades in much less time than is required for other methods. By reducing the number of presses necessary to print such matter, it is believed the apparatus will greatly reduce labor costs.

**INDICATOR ON AUTO HEADLIGHT WARNS IF LAMP IS OUT**

Attached to the upper rim of automobile headlights, reflecting indicators have been devised to warn the driver of any failure

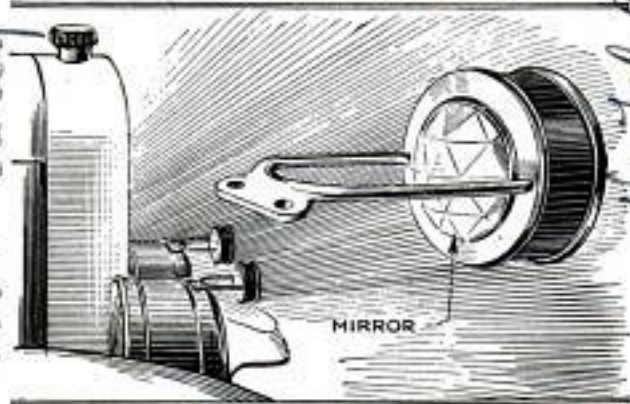

Red-Backed Auto Headlight Indicators which Are Plainly Visible from Driver's Seat

of the lamps. The back side of the glass is red and serves as a warning signal to other motorists. The indicators have no parts to get out of order, are attached easily, keep the autoist aware of the condition of the lights, and are ornamental. They project just far enough to catch the rays, but do not interfere with the efficiency of the headlights.

**SEA TIDE HARNESSSED BY DAMS TO RIVAL NIAGARA'S POWER**

By harnessing the tides in the Bay of Fundy between Nova Scotia and New Brunswick, approximately 500,000 horsepower will be developed, it is estimated by engineers who have made preliminary surveys of the project. It is planned to construct a series of dams, five miles long, which will hold the water in an upper and lower reservoir at the change of the tides. The power plant is to be located between the levels, and gates in the dams will allow the water to flow through the power-developing station at a volume estimated greater than that of Niagara.

**LOCK ON TELEPHONE PREVENTS ITS USE BY STRANGERS**

Locking a telephone so that it cannot be used except by persons having a key is

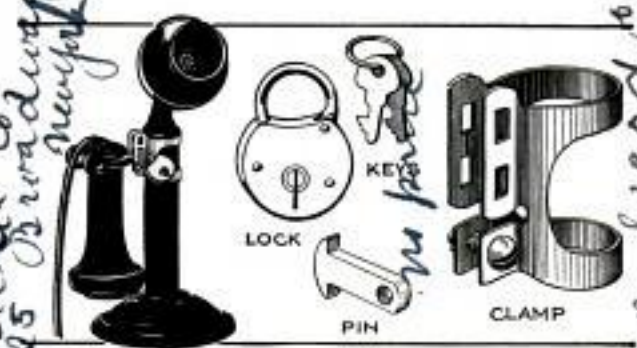

Telephone Secured with Padlock and Pin that Holds Receiver Hook Down

possible with a simple device having only four parts. The receiver-hook bar is held down by a pin through a bracket that carries a padlock. The attachment is put on quickly. It is attractive in appearance and its use is said to result in a considerable reduction in phone bills.

Just when the demand was at its lowest ebb for months, 2,000,000 brick and 2,000 bags of foreign-made cement arrived in New York. This constitutes one of the largest shipments of European building material since the war.

*Similar device March 1925*

*Similar device March 1925*  
*Chicago Herald Examiner 2/14/24*  
*The Sel-O-Lard Co. 2025 Broadway New York*  
*The Sel-O-Lard Co. 2025 Broadway New York*

*New York*  
*New York*



5-28

Wide World Photos  
New York City

# AUTO PARKING GREATER PROBLEM THAN SPEED

By JOHN IHLDER, *High. Civic Development*  
Chamber of Commerce of the United States

**T**HE saturation point for automobiles is coming to be the incapacity of streets not only in cities, but even in towns and villages, to hold more cars.

The interesting game of regulating traffic, while the more dramatic, is not the more important part of the problem after all. The present need is to find out what to do with automobiles, not when they are moving, but when they are standing still. Until some inventive genius invents a collapsible car that can be folded up and put into the hall closet or a corner of the office, this question is going to cause more and more concern to manufacturers and would-be owners

the answer is to limit more strictly the use of automobiles in downtown areas, perhaps confining it to taxicabs which serve a greater number of passengers and call for only a fraction of the parking space.

Such a solution as this is no solution, but is rather a method of intensifying conditions that make for further overcrowding of our already overcrowded areas. The

means immediately available for dealing with the standing automobile



Traffic Inspector Davis, of New York, Explaining to Hon. K. R. Wang, Chief Inspector of the Shanghai, China, Police Department, Signals Used in Regulation of the Traffic in Manhattan

than ever has been caused by justices of the peace with a keen eye for local revenue.

Of course, there have been tentative and superficial efforts to answer this question, but with results so unsatisfactory that in the largest cities car owners have given up the attempt to drive to their offices near the center, and even in moderate-sized towns the merchants, the police and the car-owning public are most dissatisfied with these results and with each other.

So recent is our realization of this problem that there are regulatory authorities who still approach it from the point of view that the automobile owner is more or less of a nuisance who should be thankful for whatever facilities are grudgingly granted him, and some traffic experts who maintain that inasmuch as two or three riders in an automobile take up more space in a city street than do several times that number in trolley cars or subway trains, therefore

are limited and are largely in the nature of more or less unsatisfactory expedients. The degree in which they may be used will vary according to local conditions. There are, however, some generalizations which may be used as guides:

First, the streets are designed primarily for transit. Consequently they must be kept free from standing vehicles to the extent necessary for an even flow of traffic.

Second, the entrances to hotels, office buildings, large stores and other buildings in which there is a great amount of coming and going must be kept accessible.

Third, so far as is consistent with the foregoing, car owners should be permitted to park their cars on the public streets or other public space in front of or close to their destination and leave the cars there all day if they so desire.

But with all the time-limit expedients more parking space must be provided.



*Mountain Pacific*

36 **3 "BOOSTER" PHONES SPEED TRAIN DISPATCHING**

Dispatching trains by telephone, a method that is supplanting rapidly the use of the telegraph on many lines, has been further improved by means of a "selective" telephone system in use on a western rail-

It is claimed that one dispatcher with this arrangement can handle a third more business. The switchboard, with the names of each station written under a lever for calling each operator, also has a master key



"Selective" Telephone Switchboard with Which Operator Calls One or More Stations Simultaneously

road. Instruments are so connected that any station may be called without disturbing the others and several operators may listen in at once without impairing the efficiency of the circuit. The receiving apparatus is provided with a "booster" mechanism that amplifies the transmission.

by which all the telephones on the circuit can be connected for a simultaneous message all along the line. A return impulse indicates that the telephone at the outlying station is ringing, thus preventing an operator giving the excuse that his signal did not sound.

**HOPPER BOX THAT SORTS NAILS SAVES CARPENTERS' TIME**

For the convenience of box-makers, carpenters on rush jobs and others, a hopper that sorts the nails and places them points down, in sloping slots where they are within easy reach, has been manufactured. With the thumb and forefinger, any desired number of nails may be grasped at

one time and held in position for nailing. As the slots are emptied, more nails slide down from above and automatically slip into the grooves. The cabinet, when not in use, can be folded up like a small suitcase. It weighs only ten pounds.

**JUNGLE PERILS FACED IN HUNT FOR BIRDS OF PARADISE**

Because hunters threaten the extinction of the gorgeous birds of paradise, the Dutch government of New Guinea is considering a law to protect them. Although the greater part of the country where the birds are found is made up of high mountains and vast, foul-smelling swamps and jungle, hundreds of gunners, lured by the rich returns the gayly colored plumes bring in the market, brave these perils every year. Sometimes a party is compelled to live for months amid the perils of poisonous everglades surrounded by deadly reptiles, hostile savages and prowling animals. The most sought-for variety of the plumes are those of the blue bird of paradise. As much as \$500 has been paid for a single specimen, while red, brown and yellow ones command prices from \$25 to \$300. Five months are allowed the hunters to bag a supply of the feathers, beginning with

*runner machinery Co.,  
Tampa, Fla.*



Hopper Sorter Open and Tipped to Working Position; Nails Falling into Wire Slots

*517  
563  
Strathfield, N.S.W., Australia*

*Chas. H. White Esq.  
Norma, Mount Street*







973

100

Walter

# Time and Money-Saving Tools



When Garments Become Shiny, a Little Roller Set with Many Needles, Run over the Cloth, Gives It a New Nap



Handles on Each Side Keep the Nursing Bottle from Rolling Away and Enable the Child to Hold It; Tape or Ribbon May Be Run through Them and Tied to the Crib; Below Is a Strong Wire Tong Lifter for Taking Fruit Jars Out of Hot Water without Burning the Fingers

Electric Toaster Pictured Below, Is Shaped so that Crumbs Are Brushed Away Easily and Large Heating Coils Crisp Bread Quickly

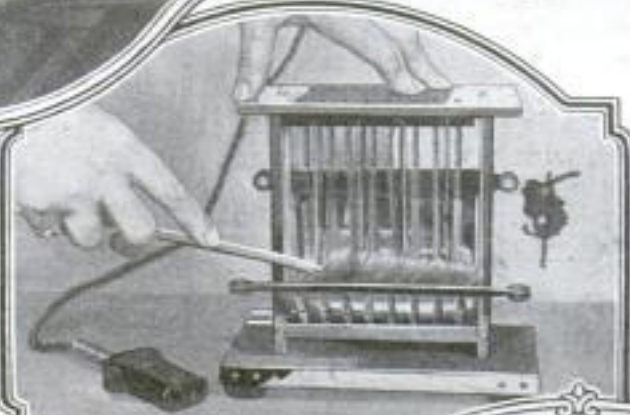

Below: Tray and Rack for Silver Protect Tablecloth and Provide Receptacle for Ashes

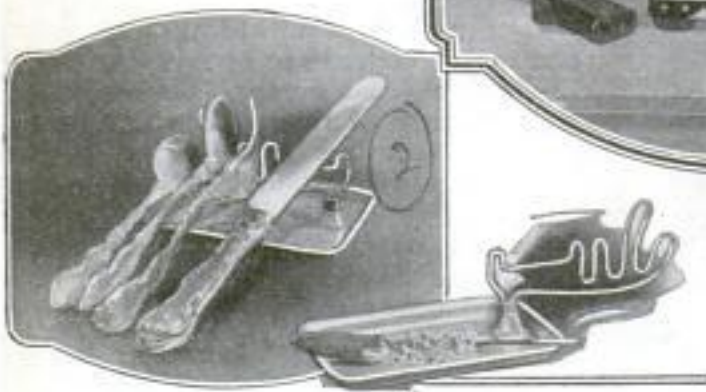

Without Marring the Woodwork or Drilling Holes, a Strong Steel Rubber-Tipped Clamp that Holds a Trapeze, Gymnasium Rings or Swing for the Children Can Be Set Up in a Few Moments in any Doorway; Below Is a Novel Duck-Shaped Bag for Carrying the Bathing Suit

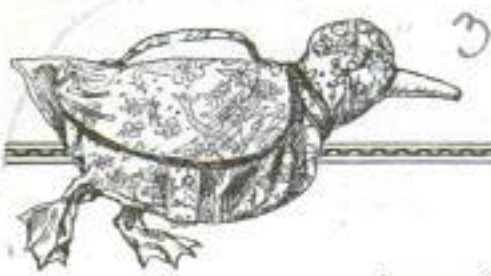

Anyone wishing further information on devices described in the editorial pages can



# for Woman's Workshop in Home

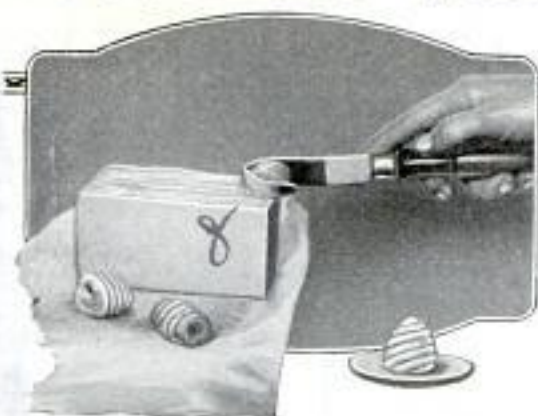

First Dipped into Boiling Water, then Drawn lightly over the Roll, this Saw-Tooth Curler quickly Prepares Butter into Rose-Shaped Patties for Serving without Waste or Trouble



Magnetized Tips of Serviceable Spring Shears that Cut to the Ends of the Blades Are Useful in Picking Up Needles

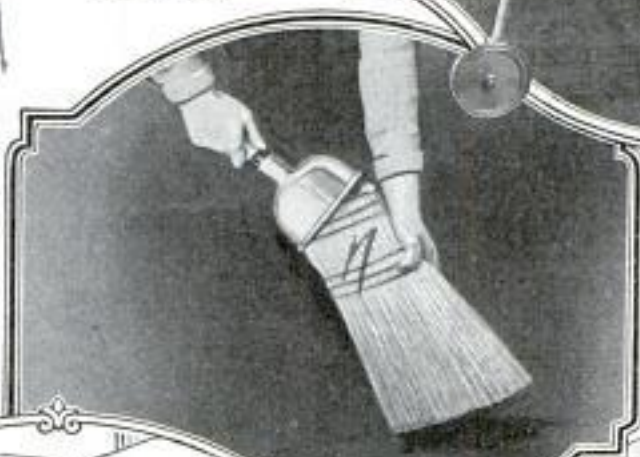

Clearing Table and Washing Dishes Are Combined in One Easy Operation with Practical Machine on Roller Frame that Fits over Sink



When Broom Wears Out, New Filler Is Inserted Easily in this Aluminum Holder at Considerably Less Cost than a New Broom

Many Garments May Be Hung Neatly in Small Closet Space on Folding Steel Clothes Rack with Overlapping Hooks; Below: Picture Hook that Leaves No Holes; Point Is Broken Off and Left in Wall



Portable Washtub on Detachable Roller Legs with a Center Drain Pipe

obtain it by addressing Bureau of Information, Popular Mechanics Magazine, Chicago



*newspaper  
Clipping*

### SHOES ARE SOLD AT THE CURB BY WALKING "STORE"

343 Without waiting for customers to come to him, a Mexican shoe peddler in Los Angeles, Calif., ties his stock about his



Proprietor of Curb Shoe Market with Daily Stock in Trade Looking for Business

*Pacific Alliance*  
shoulders and goes out after business. Prospective buyers are given fittings on the street curbing and sales are usually followed by "spot" cash. With no rent or overhead expense to pay, this convenient "store" is said to do a profitable business in the foreign quarter of the city.

### HOME OR OFFICE HUMIDIFIER REDUCES FUEL BILLS 518

Air in heated rooms is kept moist to prevent throat irritations, coughs and colds, and to save fuel, by means of a small patented humidifier which generates vapor with heat supplied from an electric light or wall socket. Water is supplied automatically by a fountain. The device is attractive



in appearance and occupies little space on either a desk or table.

### MINT-FLAVOR COST IS RAISED 73% BY GUM CHEWING

As a result of the great increase in the number of gum chewers, the price of mint used in flavoring has steadily mounted. In two Michigan counties 4,000 acres are devoted to the production of the plant. Oil of peppermint is also employed now to test steam boilers. If the odor escapes, it indicates the presence of leaks. A boiler that will hold the smell of the oil is said to be capable of retaining any pressure to which it is ordinarily subjected. The mint is raised on marshland formerly given over entirely to the production of hay.

### DRINKS FROM SIRUP FOUNTAIN 544 MEASURED BY VALVE

For serving evenly measured supplies of flavored liquids at soda fountains, a sirup tank has been patented with a valve and cup that allow an

exact quantity to pass out when the handle is pulled. The reservoir that feeds the measure can be kept filled automatically from a storage drum, or barrel. The appliance is said to adjust itself to any wear on the working parts. A similar model is claimed to be of great advantage for apportioning



oils and gasoline at automobile filling stations where the amounts of such materials are to be accurately measured while passing into the containers of cars. A meter for indicating the volumes drawn from the magazine can be attached if desired. No motors, pistons, cranks, or similar apparatus, are used in the fountain, which is strongly made and does not easily get out of order.

### PULLER LIFTS WEEDS WITHOUT LEAVING HOLE IN TURF

Weeds in the lawn or garden are pulled out by the roots with a puller which has a crossbar and a handle long enough to eliminate stooping. It is designed so it does not cut the top of the weed from the roots but lifts it out in its entirety without leaving a large hole.

*Dr. Roy Berry,  
Elizabethtown, Ill.*  
*Autcome Mfg. Co.  
north Chicago, Ill.*

*Standard Engineering Works  
Pawtucket, R.I.*



584

Pacific + Atlantic Photos, Inc.  
25 Park Place

POPULAR MECHANICS

883

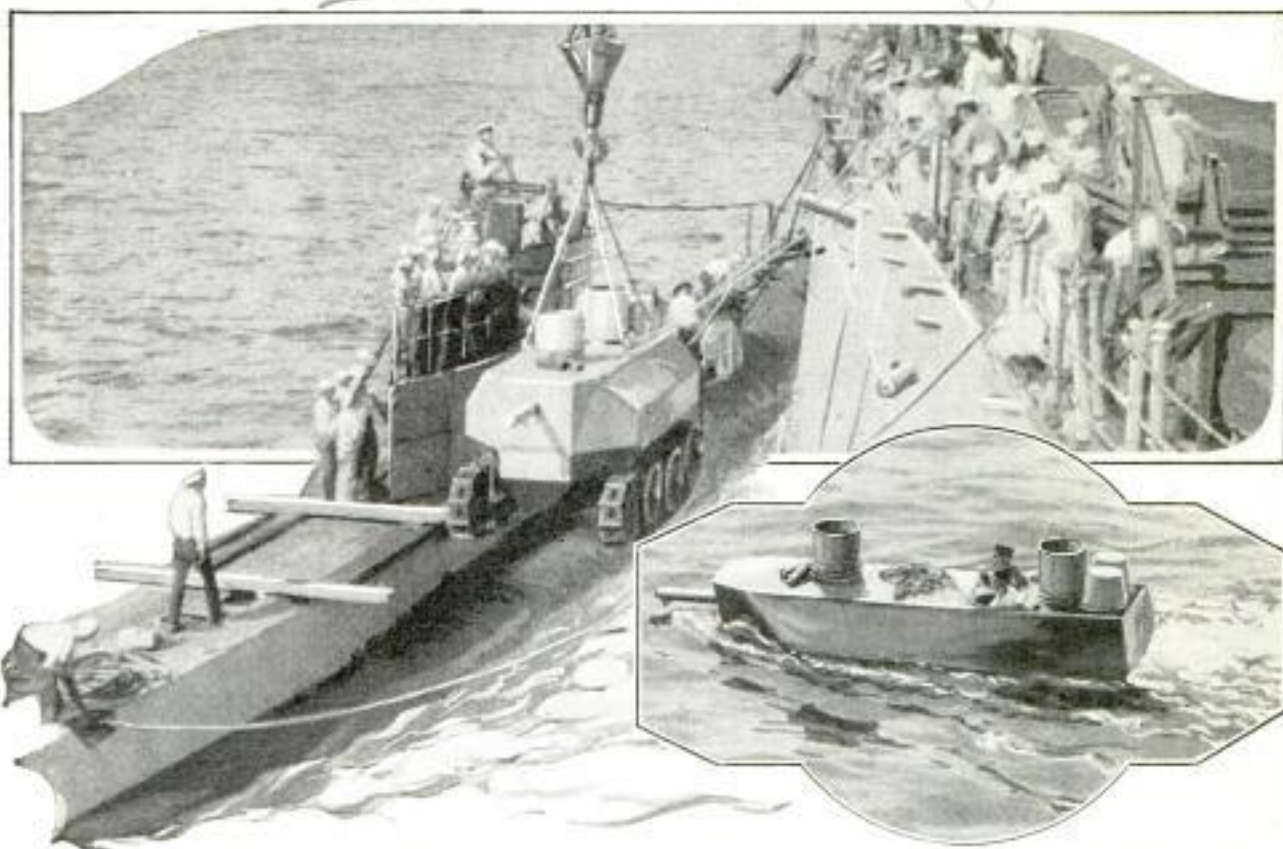
ARMORED "TANK" AIDS WARSHIP AT MANEUVERS  
*New York City*

Swinging Sea-Going Tank from U.S.S. "Wyoming" upon Back of Submarine and Sturdy Fighting Unit as It Appeared "Going into Action" with Crew and French Field Gun at Bow

With a French field gun at its bow and plowing through the water at the rate of sixteen miles an hour, an amphibious, armored "tank," part of the equipment of the U. S. S. "Wyoming," was given a thorough test at the maneuvers at Panama and aided in the movements of the cruisers and submarines. It was one of the first

demonstrations of the possibilities of this fighting unit as a rapid-fire scout ship to aid the larger craft. These tanks have been developed for the use of the army and navy where difficult and broken territory must be traversed. They have endless-tread traction for land and propellers, both run by the same gasoline motor.

455  
**DOUBLE VISOR ON MOTOR CAP  
SHIELDS EYES FROM GLARE**

Motorists and others exposed to glaring headlights or the intense rays of the sun are afforded a convenient shield for the

eyes in a cap with an amber-colored celluloid visor that can be released from the peak and lowered sufficiently to protect the vision. It is held in place by a press button and, when not needed, is quickly raised out of the way.



Double-Visored Cap with Amber-Colored Celluloid Lower Part Dropped to Shield Eyes

**SEED TREATED BY ELECTRICITY  
DOES NOT HELP YIELD** 678

Claims that treating the seed of small grains with electricity increases the yield have not been substantiated by the tests of government scientists. The process consists in subjecting the seed to an electric current passing through a solution in which it is immersed. "Grain yields from such treated seed were less than from plots sown with untreated seed," it was reported by the department of agriculture after the experiments.

Messrs. Cole, E. C.,  
152 Fleet St. E. C.,  
London, W. Eng.

*New York Times*  
Copyrighted material  
3/6/24



Cont. A. J. R. Curtis,

884

POPULAR MECHANICS

111 W Washington St Chicago

444



Above, Some Unusual Designs of Artistic Garden Ornaments Molded from Cement, Including Flower Boxes, Benches, Trellises and Pedestals; Left, Attractive Arrangement of Urns, Stepping Stones, and an Arbor with Rails Inserted in Chain of Cement Links which are Reinforced and Hand Tooled; Below, Unique Form of Old-time Sun Clock, Cast from Concrete; Rough Surfaces are Smoothed Down after Drying to Produce Neat Finish



Large Concrete Sun Dial that Marks Time on Figured Circular Base Imbedded in Ground

The White Sundial Mfg. Co.  
Memphis, Tenn.

The White Sundial Mfg. Co.  
Memphis, Tenn.

Copyrighted material



Hercules Mfg. Co., Centerville, Iowa.  
 \$36.00 for one or two horses.  
 POPULAR MECHANICS

885  
 525

ONE-MAN STUMP PULLER HELPS IN CLEARING LAND

*Triple Power - \$108.64*

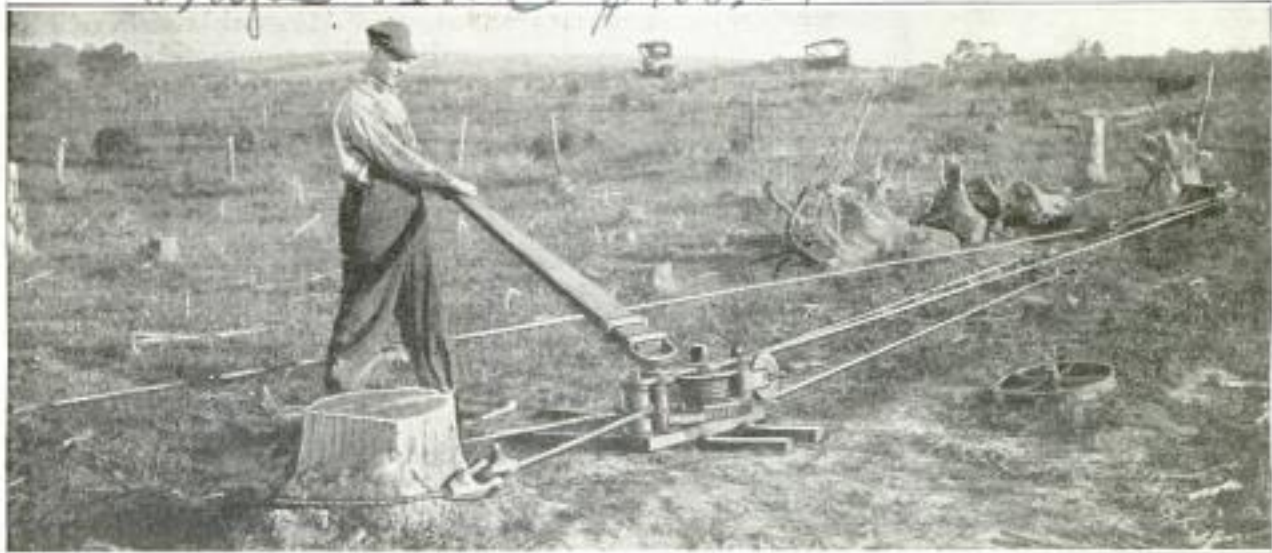

Clearing Land with Windlass Stump Puller; Anchors Are in Foreground, One about Stump

Consisting of a ratchet windlass and cable wound up by means of a wrench bar attached to the windlass gear, a stump puller that can be operated by one man has

been placed on the market. Anchored to two posts, the cable is placed about a third and, as slack is taken up, the "top stump" is uprooted.

WIRE GUARD PROTECTS GIRLS WORKING STEAM PRESSER

To prevent girl workers from getting their hands caught in a steam-pressing machine, a wire guard has been made that

fits over the top of the device. If, in closing, the wire is touched by the hand or arm, it instantly stops the machine, thus eliminating all possibility of accident.



Wire Guard on Pressing Machine that Stops It if Accidentally Touched by the Hand

*Shown at Exhibition of American Museum of Natural History at 24th St.*

SMELLING TWO MILES AWAY

While elephants are known to have a wonderful sense of smell, the keenest-scented animal is said to be the rhinoceros. One big game hunter has stated that in favorable weather this animal can "wind" a man for two miles. Most animals give off scent through their feet. The bloodhound can "scent" the object of its search many hours after it has passed. The length of time depends upon atmospheric conditions. On a sharp, dry day, it does not "lay." On a damp day, however, the odor sticks to surrounding objects.

*The English Observer*  
 PLANE TO ASSIST DOG TEAMS WITH MAIL IN ALASKA 199

To speed the delivery of United States mails over Alaskan snows, an airplane for the postoffice service was shipped to that territory recently. It will be used to supplant the dog team and pedestrian delivery service in part of the country. A contract calling for two flights each month for five months has been made with the aviator. Valuable flying information may be gathered, it is said.

*Copyrighted Material  
 Deriv. of Paris Lickie  
 Canada.*



## FISHING IN THE OCEAN WITH HORSE AND WAGON

One of the most unusual methods of catching ocean fish is said to have been developed in New England. While the use of huge nets a few miles from shore is common, this particular trap is different because of the fact that all the conveying of workmen and catch is done by horse and wagon—and the trap is more than two

miles out at sea. Along this strip of Cape Cod shore the tides completely cover the ocean bottom but, on receding, the water is not more than a few feet deep for several miles out. As a result, the fishermen can start out with horse and wagon after the tide starts to ebb, gather in the fish and return to shore before the water is deep.



Nets More than Two Miles Out at Sea Which Fishermen Reach with Horse and Wagon to Collect Catch and Make Repairs while the Tide Is Out

## MAN-MADE ROCKS TO RIVAL THE WORK OF NATURE 642

Man-made rocks may be one of the results of experiments now under way. During these tests the essential ingredients are placed in little steel bombs and subjected to terrific heat and pressure, and in this manner fragments of rocks and minerals already have been produced. Thus science has duplicated nature's processes, but on a small scale, of course. The problem now is to duplicate the natural product at reasonable cost. A synthetic tombstone,

for instance, probably could be artificially made but it would cost an enormous sum of money.

## ELECTRICITY REPLACES CLUBS IN KILLING CATTLE 669

Killing cattle by electricity has been started by an Omaha packing company after several years of experimenting. Replacing the old method of clubbing the animals over the head, electrocution is expected to save a great amount of money and is said to be more humane.

New York Times  
March 3, 1924

today.  
secret process



369 Cont. Henry S. White  
1877 Kinkoraphan  
Chicago, Ill.

## How Great Inventions Were Delayed

Years of Effort Wasted in Search for Things Which Are Now  
Everyday, Household Necessities

**M**OST persons have heard the story of how a swineherd in China discovered the savoriness of roast pork by licking his burnt fingers after digging out a roasted pig from the ruins of his hut that had been accidentally demolished by fire.

For centuries thereafter the conventional method of roasting a pig was to put the beast in a hut which was then burnt down. Finally some brilliant genius had an inspiration—the result was the first crude form of the gridiron. Thenceforth, pigs were roasted without the necessity of burning down the owner's dwelling.

Very similar in development have been all mechanical discoveries. For countless ages the sewing needle had been made with the eye at the end opposite the sewing



point. When more modern men began to try to make sewing machines they retained the needle in its ancient form. One after the other failed until, in

1846, Elias Howe turned the needle upside down, putting the eye at the sewing point. The result was the first successful sewing machine, and it is calculated that Howe, by the time of his death, in 1867, had received \$2,000,000 in the form of royalties on his patents. In those days that was a lot of money, and even today it would not be sneezed at. But the main benefit is that as a result of this bit of topsy-turvydom the sewing machine is now in such universal use that a thimble has become almost a curiosity.

The lobes of every boll of cotton contain seeds which have to be separated from the fiber by a process called "ginning."



In the southern states, as elsewhere, this was done by hand, requiring the labor of many slaves who had to be fed and clothed even

though not paid much in wages. This method was so expensive and slow that the culture of cotton remained insignificant until Eli Whitney, in 1794, patented his saw gin, which did the work of a thousand slaves, and made cotton growing the lead-

ing industry of the south. In spinning and weaving the cotton all kinds of primitive devices had failed to supersede the human fingers and thumb until, about 1767, Hargreaves, a carpenter in the north of England, produced the spinning jenny which would produce twenty or thirty threads at a time as easily as up till that time it had been possible to spin a single thread. But his machine had its defects, for the threads spun by it could only be used as weft, not possessing sufficient firmness or hardness for warp, or the longitudinal threads. The industry struggled

along as best it could until presently came Richard Arkwright, who originated modern methods with his spinning frame, which makes a vast number of threads of any degree of firmness and hardness. Weaving also had been done by hand until, in 1785, Edmund Cartwright, at Doncaster, first invented the power loom, and later on perfected it.

In the early days of the railway and for a long time the handling of trains was made difficult because there was no continuity of action possible in the brakes, so that all the brake blocks on the train could be applied simultaneously by one operator. The earliest mechanical means tried for doing this consisted of a continuous rod under the cars. Other equally ineffective means were tried, and the first practical solution of the problem was the Westinghouse automatic air brake, worked by compressed air. In a short time this became the universal



method. All kinds of hot air and gas engines were tried with little success until, in a patent of January 7, 1862, and later in a pamphlet, Beau de Rochas, of Paris, France, pointed out the necessity of compressing the charge before ignition. This was the origin of what is known as the



"Otto" cycle, and from it has developed every form of modern internal-combustion engine.

In the early days of electricity many attempts were made to reproduce sounds at a distance from their source. These were all based on the principle of transmitting vibrations electrically from one disk, or membrane, to another by connecting them with a wire attached at each end to the centers of the membranes. Early experimenters caused a membrane to open and close an electric circuit at each vibration. Thus there was transmitted through the circuit an electric impulse for every vibration in the sound. At the receiving end these electric impulses acted upon an electromagnet. In 1874 came Alexander Graham Bell, then resident in Boston. After some unsuccessful experiments he solved the problem by using a thin iron disk, supported around its edge, and which acted as both membrane and armature.

Many kinds of wire were used in incandescent lamps unsuccessfully until finally Thomas Alva Edison used a filament made of carbon inclosed in a vacuous space, and, presto! the incandescent lamp was a success and went into world-wide use.

The first writing machines were operated by processes analogous to lithography, or by apparatus worked on the stencil method. Numerous attempts to produce typewriting machines had been made both in England and America, all of which led to no practical results. After many experiments and failures in this direction, finally in 1873 Messrs. E. Remington & Sons brought out the type-bar machine of which all subse-

quent machines are modifications. It was the idea of the type bar that did it.

In typesetting machines the first plan was to use ordinary loose type and design machines to set it in the way it is set by hand. For a long time it was found that the nimble fingers of a good compositor favorably compared on the ground of economy with any of these mechanical arrangements. Finally, Mergenthaler conceived the idea of casting type slugs in a machine with a keyboard operated like a typewriter. The nimblest-fingered compositor could not compete with that.

The idea of heavier-than-air flying machines was ridiculed for years—nay, for centuries—on account of the many senseless attempts that were made to imitate the bird. It remained for the Wright brothers in a small American town to put into practice theories propounded by a profound scientist, Octave Chanute, and construct wings in the form of planes that could be warped. These immediately made heavier-than-air flying machines practicable.

In the early days of the motor car, automotive engineers wasted much time in following the precedent of the steam locomotive. Their carriages and motor trucks were separate like the cars and locomotive of a railway train, until in 1895, Geo. B. Selden, of Rochester, N. Y., took out a patent on a machine that combined everything on one frame or chassis. In combination with the motor was a clutch which drove the propelling shaft, in connection with which were reducing and reversing gears. That was the prototype of the modern automobile.

### LAMP HELD IN ANY POSITION BY STRONG SPRING GRIP

With a spring grip that is easily attached to almost anything, an electric lamp has been made that will cast a sun-bright light exactly where wanted. It can be fixed to a book, the side of a wire basket, the edge of a shelf, or to a tool. A ball-and-socket joint permits the rays to be focused wherever desired. Rubber covering on the clamps prevents them from scratching a polished surface. The reflector is finished inside with a bright enamel and is attached so firmly to the holder that it will not easily jar loose.

☐ We want all our readers to write us freely and often whenever they wish additional information on articles published in this magazine. Address Bureau of Information, Popular Mechanics, Chicago.

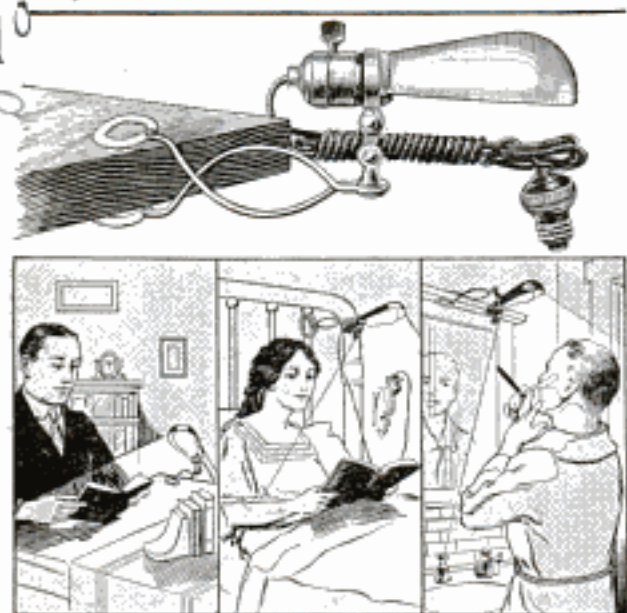

Just a Few of the Handy Lamp's Many Uses and Drawing of Lamp with Its Holding Clamp

A. B. Stewart & Co., Chicago  
225 W. Harrison



419 The Fleet Agency  
 152 Fleet St. & Co.

POPULAR MECHANICS

889

BABY SWITCH ENGINE IS DRIVEN BY "GAS"

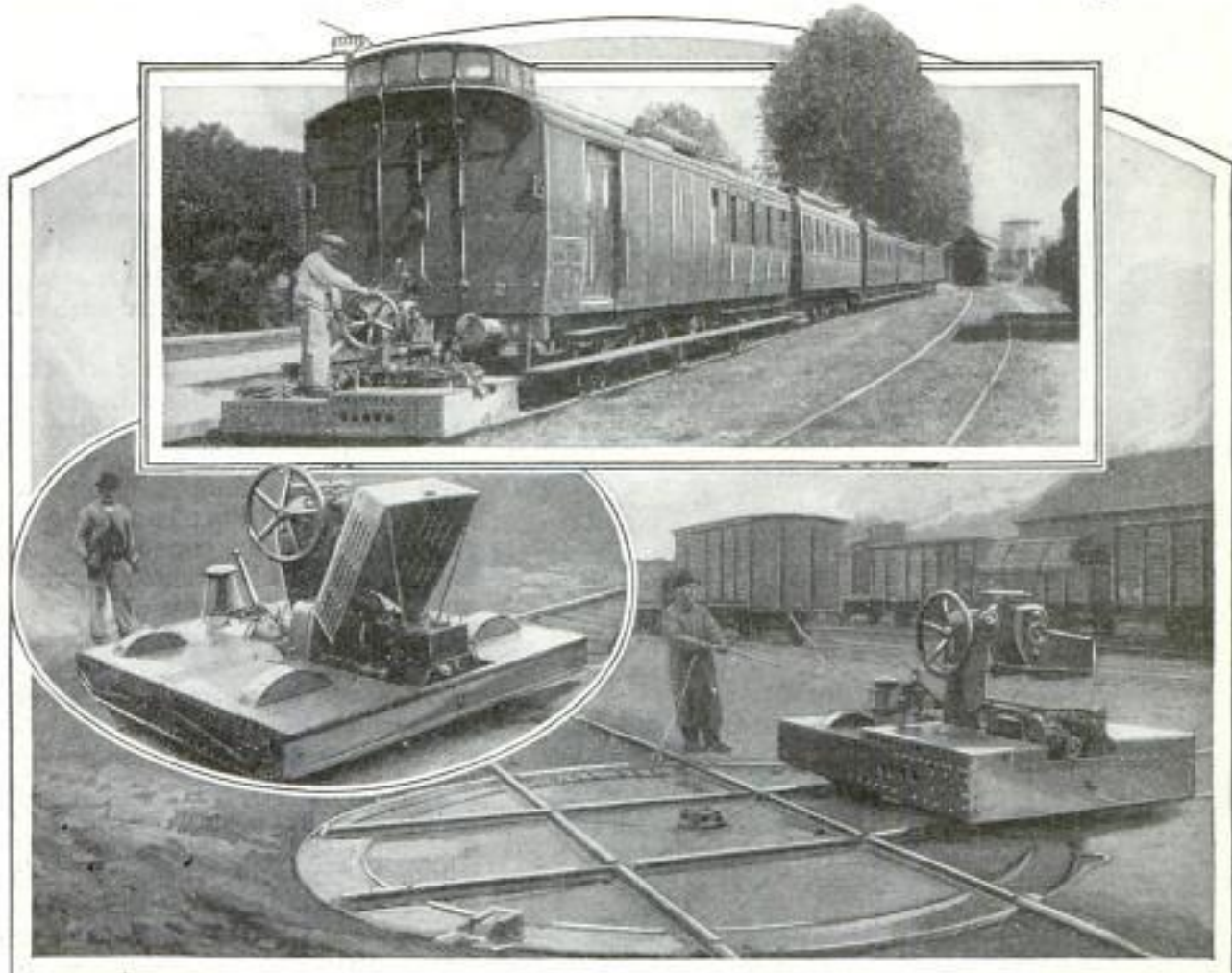

Compact Gas-Driven Switch Engine Pulling Train of Cars; Being Run upon Turntable with Freight Car in Tow and with Hood Raised to Show Engine

Capable of pulling a load of 150 tons, a small locomotive, driven by a gasoline or kerosene engine, is being used on a French railway for switching cars in the freight yards. Weighing only four tons, it is more quickly moved about, costs less to oper-

ate, and can be run by one man. By attaching cables from the locomotive to cars on other tracks, they can be moved without coupling to the engine. A small turntable in the yards quickly places the small locomotive on cross tracks.

DISHES CLEANED BY PEELING INSTEAD OF WASHING 626

Peeling takes the place of washing in a dish which will shortly be placed on the



Peeling Off the Top Layer Leaves Surface of Dish Clean and Ready for Next Meal

*d. w. a. d. Parf. Walker, Minn*

market. The device consists of a stiff base, on which is mounted a number of thin layers closely compressed. When the dish is soiled, the top layer is peeled off, leaving a clean dry dish for the next meal.

DESK OF PRESIDENT IS TAKEN OF NATION'S GOOD WILL 53

Made from the timbers of the "Resolute," the rescue ship caught in an ice floe and abandoned in an expedition in search of Sir John Franklin in 1852, the desk used at the White House by the president was constructed in England. It was a present from Queen Victoria as evidence of the good will existing between the two nations.

*The Target Cincinnati*

*4/2/10*

Copyrighted material



## Hazards of Dizzy by Aerial

**UNDAUNTED** by dizzy heights and brisk winds that sway their "bos'n's chairs" far above busy streets or humming industries, steeple jacks ply their precarious callings dangling atop tower and chimney stack with apparent ease.

Notwithstanding the fact that safety appliances have been designed to assist these aerial "engineers" to accomplish perilous climbs aloft to their daily labors, most of them resort to the board seat swung from a rope and pulley for support, while hanging in mid-air over the edge of a skyscraper or swinging from the pinnacle of a tall chimney stack.

Although considered extremely dangerous by the "man in the street," steeple jacks who have followed the trade for years attach no great risks to their tasks. Few disasters are recorded among their ranks because of the skill with which hazardous undertakings are carried out. Daily association with the problems to be surmounted in working at lofty heights, they say, eliminates the fear of falling which

the average person almost invariably experiences in high places. It is pointed out that it is just as easy to walk a plank bridg-



Where the "Bos'n's Chair" Affords Comfortable Support for Dauntless Worker Hung in Midair High over Busy City Streets

ging a deep gorge as it is to tread the same beam when lying on the ground, if the person can keep his mind from the perils below and his eyes to the front. Only long training, however, can fit a worker to go about his duties aloft with the freedom of those toiling nearer the ground or inside of buildings. The steeple jack must have a wide knowledge of various trades to be successful. Bricklaying, carpentry, stonework, painting and ironwork all demand attention from him at some time during his career. High metal chimneys and brick stacks of large factories frequently become damaged by lightning or wind, or wear out at the top from the ravages of the weather. Armed with tools and material, then, the climber must enter his frail-looking rigging and ascend to mountainous heights, sometimes making the round trip several times in one day. Often, tasks are confronted which require utmost care from the climbers. Where the brick summits of high chimneys have begun to crumble extreme caution is exercised to secure a safe support for ropes and grappling irons. In many instances, narrow scaffolding has to be built around the defective parts of the masonry to provide footing for work involving any great length of time. It is then that the skill of the climber

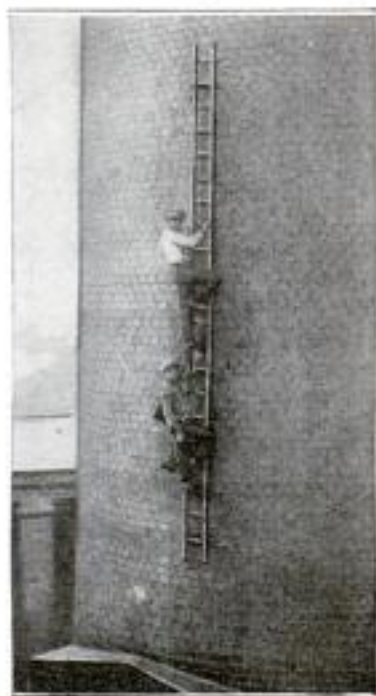

Cmt. E. Ellsworth Clapsby, Lewistown, Pa.



## Heights Scorned Engineers

is called into play, for it is no easy matter to anchor the flimsy balcony to insure absolute safety.

Means are invariably provided by the builders of high stacks and towers, for raising workmen and materials for future repairs. Cables are left fastened to the top. To these the ropes of the steeple jacks may be attached. But often even these precautions have been overlooked or the lines have worn out. Under such conditions the climber must become a "human fly," finding footing wherever he can until within proper distance of a support around which he can cast a line to carry the ropes for his chair.

With skyscrapers being built to greater heights each year, wider fields of employment are steadily added to those already afforded aerial workers. Structural iron must not only be carried to distances of hundreds of feet in the air, but the means to support it while awaiting lodgment in the framework are necessary. Derricks have to be dismantled and transferred from one floor to another as the structure develops. Riggers, whose duty it is to accomplish this work, perform their tasks with barely any other aid than their trained muscles and skill in winding about the booms and masts of the hoists. Perched on the tip of a beam held upright by guy ropes and swinging with every slight breeze, they are called upon to assume the most trying positions while attach-



Dangling from the Ledge of a Lofty Skyscraper in a Self-Hoisting Chair that Climbs the Cable as a Crank Is Turned



ing the regular sustaining cables to fastenings. When care and guidance are required to hoist some certain material from the ground level up the side of the structure to the erecting crew above, the dauntless iron worker rides the load with the freedom of one safely aboard an elevator in a modern office building, even using the weight of his body to balance the burden as it twists or turns under stress of the cable. While many hair-breadth escapes are known to occur among the aerial engineers, skillful handling of supporting apparatus and agility insure them against many serious mishaps. Instances have been reported where missteps resulted in falls, but due to the quick thinking and rapid handwork the climbers have saved themselves by entangling legs and arms securely in the ropes to await rescue by others of their kind.

During the early days of the skyscraper age it was said that the price of man power paid to erect them was "a life for every floor." But with improved safety devices, intelligent handling of working implements and constant education of the workers, serious accidents rarely occur in the construction of modern office buildings that now rise to heights undreamed of a few years ago. And many of the once familiar cranes on their roofs have given place to elevators for the raising of materials.



**DISK SHOWS FERTILIZER NEEDS OF DIFFERENT CROPS**

For determining the correct amount and proportions of fertilizers needed for various crops in different kinds of soil in the



Card Indicator to Tell at a Glance Proper Amounts of Fertilizers for Crops

south, a tabulated disk arrangement has been prepared. On a small rotating slotted card are listed the different products with a key letter opposite each. The top card is revolved upon the lower one which shows the soil divisions for the territory. When the upper disk is placed opposite the proper key letter below, proportions of phosphoric acid, nitrogen and potash necessary for that particular crop in any section of the south can be read in figures through the slots in the top card.

**SEARCH FOR LOST CONTINENT TO TAKE TWO YEARS**

Somewhere in the vastness of the Atlantic ocean a tiny steamer today is plying its way on one of the most romantic quests of history, a search for evidence of the existence 10,000 years ago of the lost continent of Atlantis. If the statements of Pliny, ancient historian, and the theories held by many modern scientists are founded on fact, the answer to many riddles of history is to be found thousands of feet beneath the surface of the sea. Something like 10,000 years ago, according to legends, there existed an immense expanse of land just beyond the straits of Gibraltar, which was inhabited by a mighty race of peoples who had developed mechanics, science and arts to a higher point than any-

where else in that day. While an attack against Greece was being prepared, an earthquake, accompanied by volcanic eruptions, took place, and the continent of Atlantis disappeared beneath the raging sea carrying with it every vestige of this once great nation. In addition to this evidence from books, it has been determined that the sea bottom in the neighborhood is volcanic and that eruptions are even now taking place. George F. Simmons, of Houston, Tex., formerly state game warden and professor of ornithology in the State and Rice universities, heads the present expedition, which is expected to be two years in completing its work. Forty-five islands, all far out of the paths of ocean traffic and only half a dozen of them inhabited, will be visited. The party consists of sixteen men, including Simmons, and their home for the next two years will be the "Blossom," a three-masted schooner, 109 feet long with a twenty-four foot beam.

**TWO-PIECE EASY CHAIR BUILT OF SPRING STEEL BARS**

Designed by a disabled soldier whose hospital experiences had taught him the value of a comfortable resting place, a light, durable easy chair, simply constructed of two lengths of spring steel covered by a canvas bag, has been made. The bars on each side afford ample resilience and the bottom supports are sufficiently long to keep the chair from tipping over when it

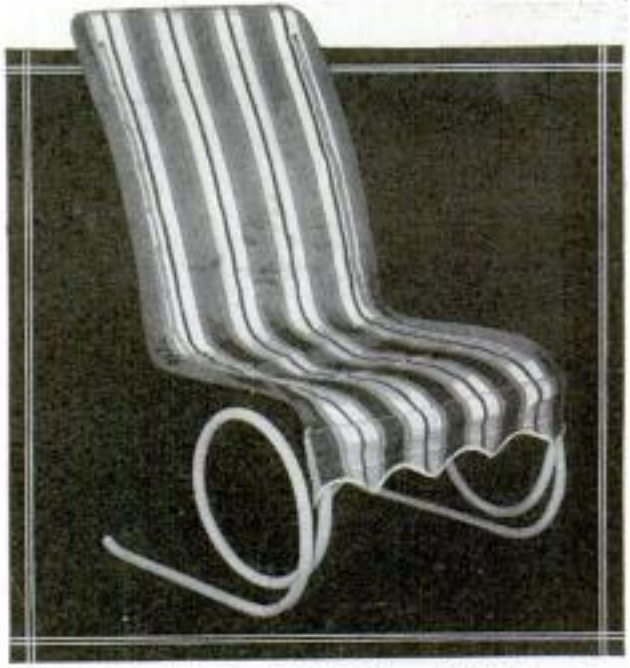

Easy Chair with Two Steel Springs Which Are Part of Its Collapsible Frame

rocks. The canvas cover is slipped on over the front like a pillow slip, and can be removed for laundering.

Soil Improvement Committee, Southern Fertilizer Association, Atlanta, Ga.  
 261 DuPont Ave.  
 Atl. Ga.

inc. H. E. Holroyd  
 743-19th St. Des Moines Iowa



## MOUNT EVEREST ASCENT TO BE ATTEMPTED AGAIN

Like aviators who ascend extreme altitudes, mountain climbers often wear special clothing, protectors for the face and eyes, and carry supplies of oxygen to breathe in the rare atmosphere. The height to which they can go frequently depends upon the efficiency of their equip-

shield their eyes from the intense rays of the reflected sun, carried tanks of oxygen and had costumes especially designed to meet the rigors of the biting winds. They reported that often as early as 8 o'clock in the morning, the heat of the sun's rays beating down on their backs caused ex-



Members of the British Geographic Expedition in Their Weird Regalia Resting on Mount Everest

ment. Members of the British geographic expedition, who failed by only 1,700 feet in 1922 to reach the top of Mt. Everest, 29,002 feet above sea level, wore goggles to

shield their eyes from the intense rays of the reflected sun, carried tanks of oxygen and had costumes especially designed to meet the rigors of the biting winds. They reported that often as early as 8 o'clock in the morning, the heat of the sun's rays beating down on their backs caused ex-

### ELECTRICITY FROM COAL SLACK TO DIG ALASKAN GOLD *551*

Alaska gold production may be increased greatly in the near future if plans to use electricity in mining operations there prove successful. Some \$20,000,000 in placer gold is still lying in the gravels of the Tanana valley, it is estimated, but the excessive cost of digging through the frozen ground and pumping water from the shafts has prevented extensive development. It is now proposed to use coal slack from the sub-bituminous mines that abound in the Healy fields, 100 miles from Fairbanks, for fuel to generate electricity for the pumps and drills. The supply of coal is said to be inexhaustible and by utilizing the abundant water power available in the open months, electricity sufficient to

operate mines over a large territory can be obtained at a practical cost, it is believed. The project is being investigated by Prof. Charles E. Bunnell, president of the Fairbanks agricultural college and school of mines.

### *Auto (1.5.21)* TIRE PUMP IS SELF OILING TO PREVENT LEAKS *590.*

To prevent leaks caused by drying out of the washer on its plunger, a tire pump has a felt disk soaked with oil to lubricate the leather. By stopping shrinkage, a full supply of air is discharged with each thrust of the piston, even after it has been in use for some time. With the upward movement of the valve when in operation, a small amount of oil is pressed out of the pad and is absorbed by the leather.

*Chicago Evening Post*  
*2/21/24*

*Monroe Auto Equipment Co.*  
*Copyrighted material*  
*Monroe, Mich.*



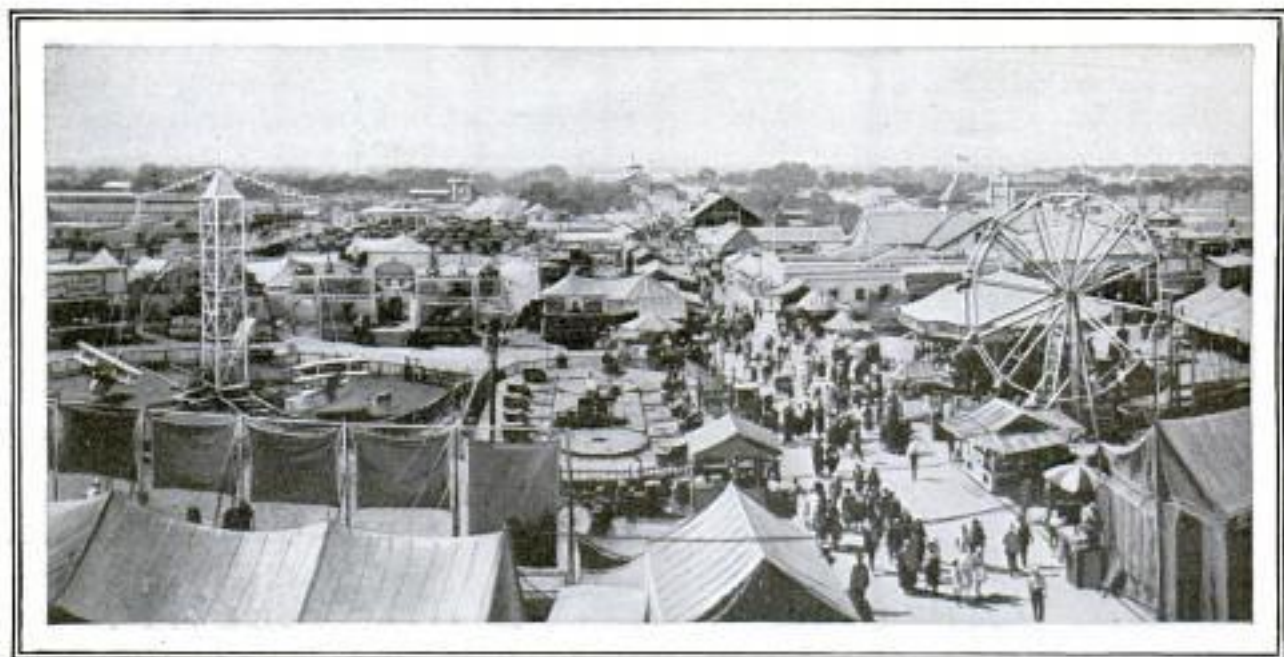

## Selling Happiness by the Pound

Modern Carnivals Carry Mechanical, Joy-Making Devices to Hundreds of Towns Every Week in Steel Trains

**J**OY is sold by the pound throughout the summer and fall by carnivals and traveling amusement expositions in every village, town and city, the length and breadth of the United States and Canada.

Happiness is dispensed by them with a consistency akin to that shown by any great business enterprise. Scores of mechanical entertaining devices, thrill-giving rides, glittering midways of "wonders, curiosities and strange people from the four corners of the earth," and miles of bunting are by no means a matter of chance even if they do appear as though summoned by a magician's wand. All of these things are

the result of organized effort and are available at fixed prices which vary literally according to the weight of the shipment required by any community. A few years ago forty-one carnivals were touring the country. There are over two hundred to-

day. Each one owns its own steel train of double-length cars, and represents an investment of from \$20,000 to \$300,000. It is now a business in which millions of dollars are invested. Looked at in perspective, the carnival world presents almost as great an undertaking as the motion-picture industry. Like the movies and baseball, it has a censor. Tom Johnson, a Chicago lawyer, is the dictator of







Transforming Drab Streets into Thoroughfares Filled with Laughing Humanity, the Modern Carnival Brings Happiness to Over Two Hundred Communities Every Week





this form of amusement. He is the Will Hays of the movies and the Landis of baseball to some 200,000 employees of carnivaldom. In addition, each state has its own local deputy who reports on his territory. Should anything untoward be discovered, the offender is forever barred from exhibiting in the United States and Canada.

When a carnival comes for a week's engagement, the town puts on gala attire and attends. Although the exhibits appear spontaneously, not a single detail has been left to chance. Ad-

vance agents, who travel during the winter months, have perfected all arrangements. Thus it happens that from fifteen to forty cars of amusement steam into a railroad siding, unload their glittering wonders and set up for a week's stay. The carnival, unlike the circus, is absolutely forced to remain six or seven days at each exhibition point. It is unlike the circus in that it cannot move its





many complicated riding devices and make money when it stays a shorter period.

Usually these amusements are conducted upon the community plan. The various rides, shows and concessions are all owned by separate individuals, who in turn are responsible to the general manager. Each owner pays his own help, own electric-light bills and boards himself as well as those employed by him. Every night the profits of the day are turned over to the treasurer, who at the end of the week, after deducting various expenses such as ground rent, pays each individual his share.

Just a few years ago, the carnival loaded its paraphernalia onto freight and box cars. Then it was the duty of the advance agent to have wagons and horses ready to transfer the properties to the grounds. This was known as "gilling." Today, the carnival carries its own baggage horses, wagons and, generally,

two or three tractors. The wagons roll up on the flat cars, circus-fashion, and are unloaded the same way.

Such thrills as riding a ferris wheel, an aeroplane swing, or a caterpillar could never be experienced in the average city and town, were it not for the carnivals. They bring, direct to the doorstep of everyone, that first wonderful sensation that comes from mounting high in the air and being whirled about at record speed. A trip along the midway takes one through a

replica of "King Tut's Tomb;" lets you shake hands with midgets; peer up at tremendous live giants; have your fortune told; take a "trip to Mars"; see yourself in innumerable odd-shaped mirrors; enjoy the wonders of "the crazy house," consisting of falling stairs and undulating floors, or go whirling about on "the whip," and a multitude of other mechanical aids to happy laughter.

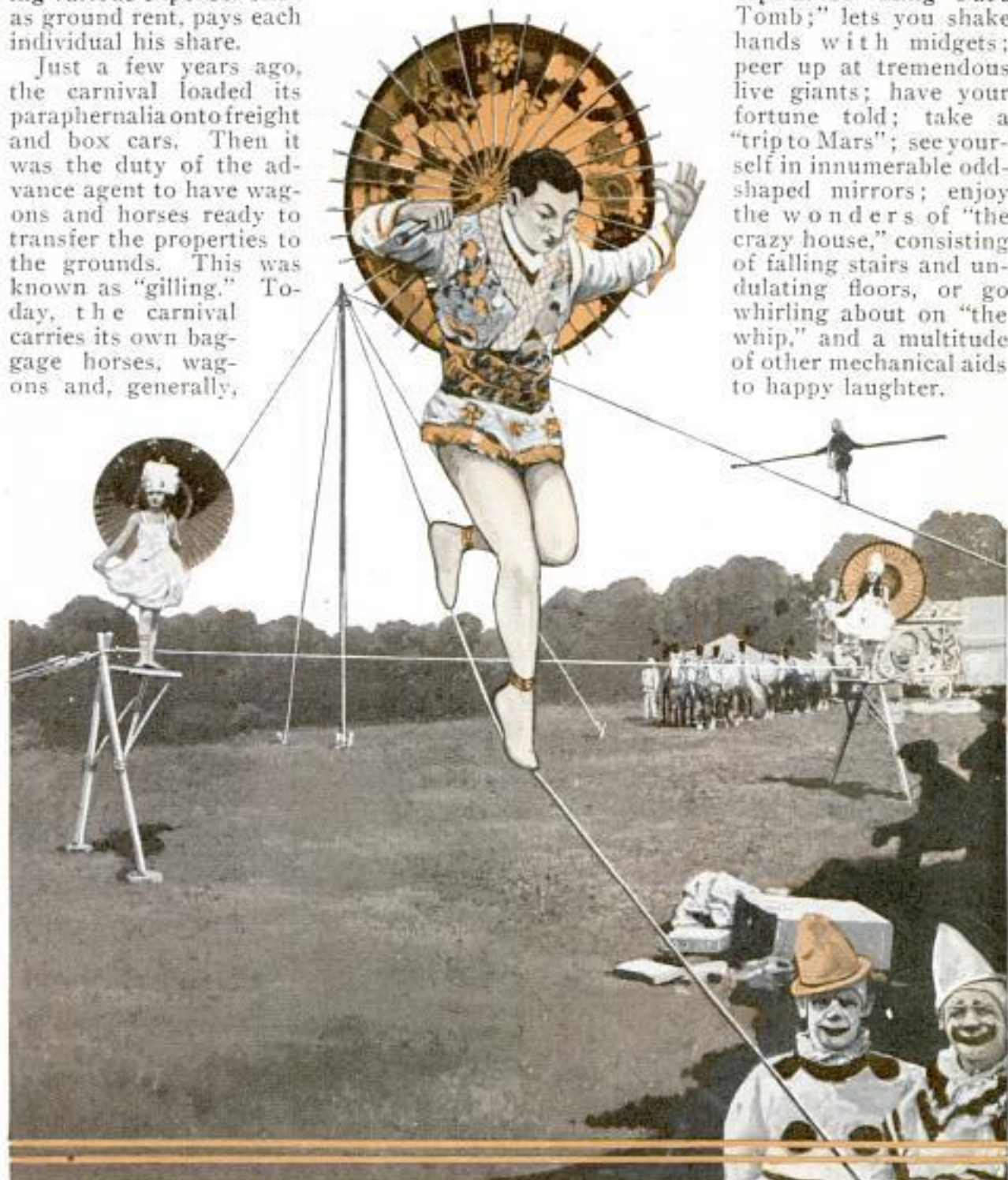

Unlike the Circus, the Carnival, with Its Glittering Wonders and Skilled Performers, Is Forced to Stay Several Days at Each Exhibition Point



## ELECTRIC "SUNLIGHT" SPEEDS GROWTH OF PLANTS

For speeding the growth of young plants and to give them a richer, greener and more vigorous appearance than ordinary

specimens, electric lights are being directed on them for several hours each night. Many thus exposed are reported to have grown to almost twice the size of those subjected to daylight alone. Experiments showed that nearly all plants having large leaves, or thick clusters of small ones, were greatly stimulated by the artificial "sun." It is believed that with proper temperatures and moisture regulation, the process can be

made to produce crops of vegetables at much earlier periods of the year than is now possible. With expensive types of

flowers the electric light may be used to quicken the development of the blooms which are generally in seasonal demand, such as Easter blossoms and Christmas plants. In some cases, as in beans, celery, lettuce, snapdragons, and mignonette, beginning of growth was hastened from four

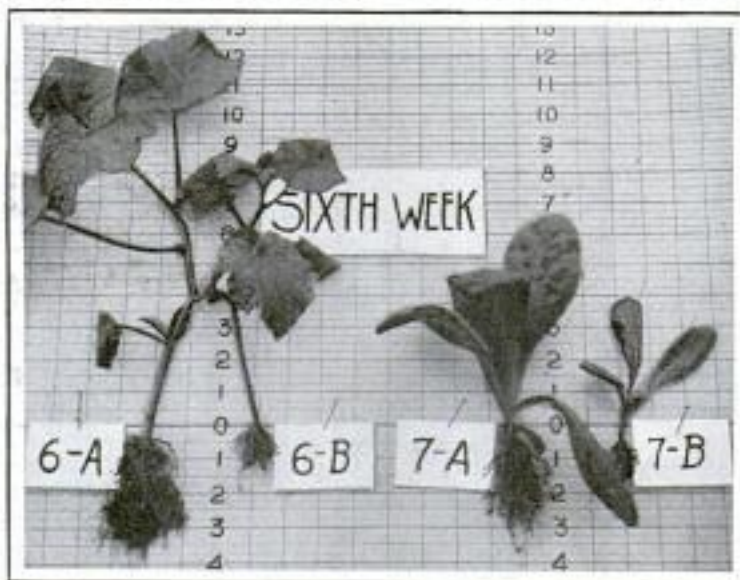

Plant at Left of Each Pair Received Extra Aid of Artificial Light; the Others Grew under Daylight Only

to twelve days, while other flowers bloomed longer and were stronger than those that received only the benefit of daylight.

### PUTTY GUN THAT FITS POCKET TAKES PLACE OF KNIFE

For glazing windows, an angular-shaped "gun" that applies the putty evenly and firmly from a plunger barrel and can also be used for driving the points, has been

invented. The end of the tool is shaped to fit the space between the glass and the frame, and putty held in the barrel is kept from drying out and ready for instant application. The gun can be carried in the pocket by painters or repair men and with it a novice can apply the putty with little difficulty.

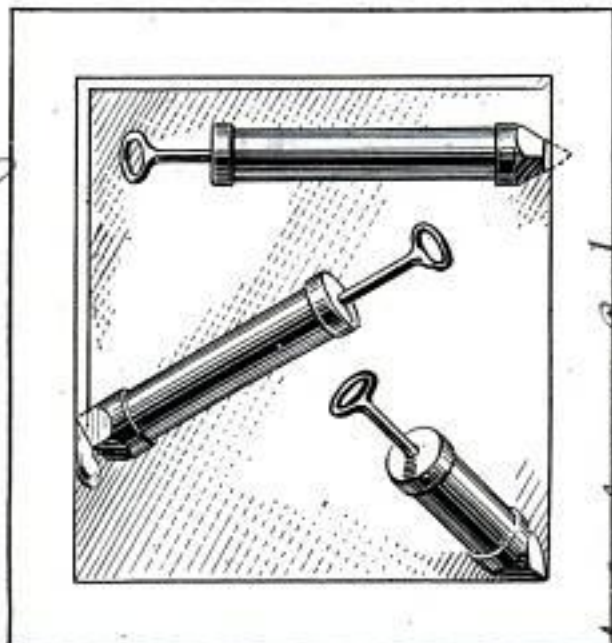

Applying Putty and Driving Points with Handy Pocket Gun that Simplifies Repair Work

### LAKE BUILT IN RIVER VALLEY TO RUN POWER PLANTS

By harnessing the small river that plunges through the Deerfield valley in Vermont, power for the operation of a number of industrial plants is to be provided. Far below the 200-foot earth dam that impounds the water at the foot of the valley, lies the hydroelectric station from which 110,000 volts of electricity will be sent over a transmission line seventy-six miles long to Millbury, Mass. The huge reservoir holds 38,000,000,000 gallons of water and to complete it, it was necessary to move many buildings, several cemeteries and railroad tracks and to clear hundreds of acres of woods and underbrush.

Approximately 300 miles, or about half, of the Swiss national railways are now operated by electricity.

Emb. W. D. Thackwell  
 319 Monroe Bldg. Chicago  
 4 4 9  
 548  
 Walch Bros. Co.  
 north Chicago, Ill.

no price





Rare and Expensive Blooms Strengthened and Advanced by "Electric Sunlight" Directed on Them at Night to Shorten Developing Periods and Produce Richer and More Vigorous Specimens



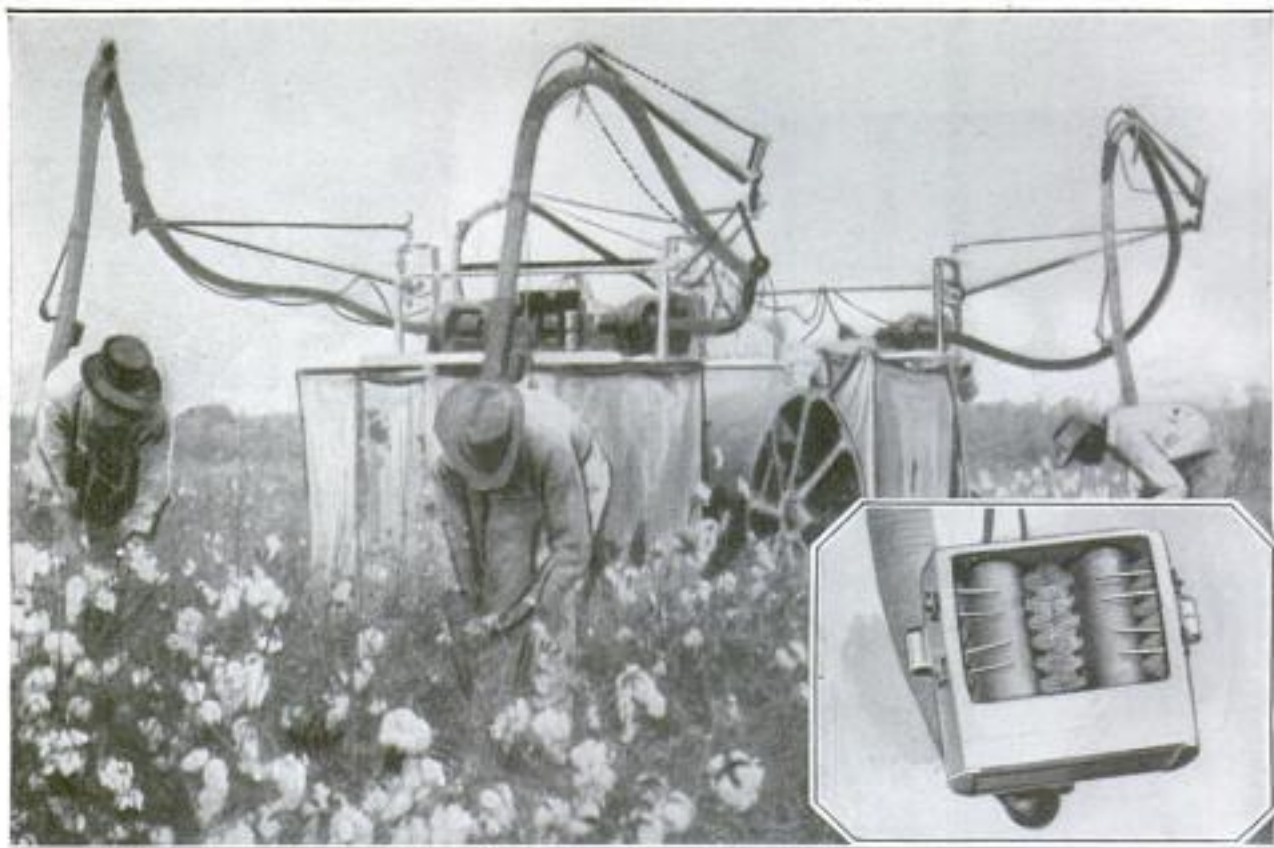

Guided by Workers, "Tentacles" of the Cotton-Picking Machine Quickly Cover a Wide Radius and Suck the Bolls into Bags; Inset Shows One of the "Fingers"

*Underwood*

Operated by electricity, a cotton-picking machine has been used successfully in southern fields. Radiating from a central power unit are flexible tubes, at the ends of which are small revolving brushes. These whirling "fingers" pull the cotton from the bolls at the rate of one per second and the

suction carries the fiber down the tube to large storage bags at the other end. One of these outfits is said to do the work of five hand pickers and with it, one man can gather from 500 to 800 pounds of cotton each day. The fiber is said to be fluffier when pulled in this manner.

402

#### WHOLE LIBRARY PUT IN POCKET BY PHOTOGRAPHIC PROCESS

Reducing a whole library to such size that it may be carried easily in the pocket is the feat of a German scientist. This was accomplished with the aid of photography; printed matter and drawings being cut down to a scale of more than one in thirty while still retaining even the faintest details, so that they could be read as well as ordinary print under the microscope. By this process the Encyclopædia Britannica could be reduced to thirty pages, each of them no larger than those of the ordinary magazine.

☛Tones of the human voice are echoed sixteen times in what is known as the Joseph gallery, a cavern in one of the salt mines in Roumania.

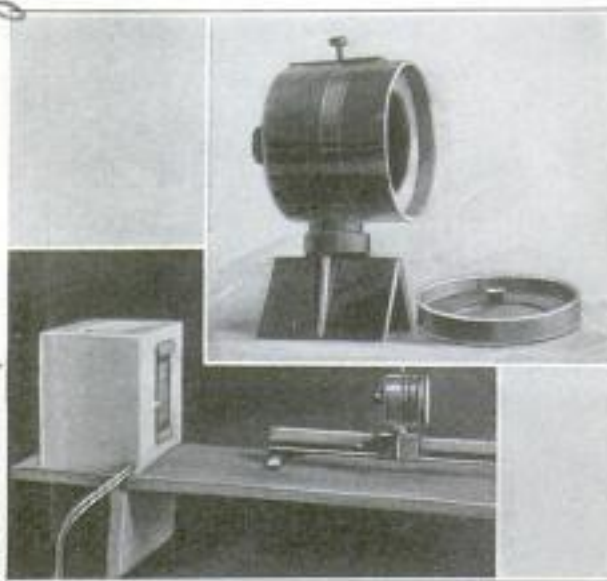

Metal Camera and Method of Reducing Printed Matter and Drawings in Photographic Form

*Discovered by Dr. Goldberg  
Breslau, Germany*



<sup>1924</sup>  
**BUTTERFLIES IN COLD STORAGE  
ARE REVIVED BY LIGHT** 498

To prevent their hibernating at times when the public may want to see them, butterflies in a large and beautiful collection in the London Zoological Garden are kept in cold-storage cases where they remain dormant. When they are wanted for display, they are placed among flowers sprayed with honey and a strong light directed upon them. Under this stimulus, they soon regain their normal activity and fly about to the delight of the spectators.

425  
**LIGHTS SIGNAL AS AUTO TURNS  
TO GUARD NIGHT DRIVING**

To insure greater safety in driving an automobile at night, a system of rear signal lights to indicate right or left turns, and lamps that show the path in front, has been invented. The arrangement is controlled by levers on the steering wheel. In making a right turn, for instance, a touch of a lever throws on a rear light which shows which direction the automobile is to take. When the car regains a straight course, the light automatically goes out. At the same time, a

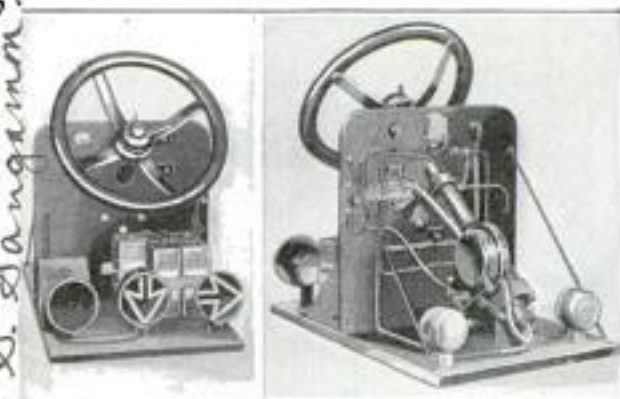

Left: Signal Lights Mounted to Show Position; Right: Small Front Lights Aiding on Turns

lamp in front, as the car swerves, throws a strong beam into the path of the curve, thus preventing accidents.

571  
**PLUG TELLS IF FUSE IS BLOWN**

To quickly indicate damaged fuses, a plug has been designed which shows the word "Off" through the aperture in the center of its face by the action of a spring release when the plug is blown. The word "On" is seen as long as the plug is in good condition. Overloaded current, resulting in a blown fuse, moves this signal aside and exposes the "Off" sign.

*no information available*

**CALVES FED BY RUBBER NIPPLE  
ATTACHED TO TIN PAIL** 391

Time and labor are saved in the usually unpleasant farm task of feeding calves that are being weaned, by placing a pail with a



Copyright, Ewing & Gallows, 118 E. 28th Street, New York  
Calf Getting a Square Meal at Nipple Bucket Securely Held in Frame

rubber nipple in the bottom in a wooden frame at a convenient height for the calf to reach, so that it can feed itself when the milk is poured in. This arrangement prevents spilling the milk and breaking the pails, and requires little time.

38  
**STORMPROOF MATCH-BOX-LID  
DEFIES WIND AND RAIN**

So that a match can be lighted in the wind or rain, a stormproof box holder has been made that fits into the pocket. It carries a small package of matches. When the holder is slipped half way up the box, a compartment is formed into which the lighted match is slipped through a V-shaped slot where the wind does not easily reach the flame.



It is designed especially for the out-of-door season for the use of sportsmen.

Patent Novelty Co, Inc.  
711 Columbia St. N.Y.C.

*Benjamin Electric Mfg. Chicago  
120 S. Sangamon St.*



Ralph De Palma 812 W. 10th St.  
Los Angeles Calif.

POPULAR MECHANICS

302 902 1/2 new Ascot Motor Speedway



## Gambling with Death on the Speedway

Auto Racing Kings Risk Lives through Love of Game and  
with Scant Hopes of Fame or Financial Reward

**S**TORMING down the long straightaway on a sun-baked oval, skidding into steeply banked curves and flashing past cheering crowds in a throbbing, roaring creation of steel and rubber, may seem like sport to the casual spectator at an automobile race, but it is the hardest kind of work to the drivers. Also, it serves a practical purpose to the



Ralph De Palma

ordinary motor-car owner—the man in the street—for the speedway has ever been the laboratory in which the latest designs of the engineers are submitted to a fiery ordeal before being submitted to the critical public. Between the starting gun and the checkered flag at the finish, every part of the machine is subjected to a greater stress and strain than it would be called upon to bear in years of ordinary service. Tracks of board and concrete that look as level as a billiard table to the spectator, contain undulations and irregu-

larities in the surfacing, despite the utmost care in building, that are magnified a thousand times when the speed over them is reckoned at from ninety to 120 miles an hour. At the opening of a speedway in



Copyright, Gravelle Pictorial News  
Pit Attendant Signaling Driver His Position in Race  
and Number of Laps Covered



the northwest, one of the drivers had to be lifted from his car at the end of 200 miles, his body being covered with bruises. "Automobile racing is the hardest way I know to make a

self, among them being "Tommy" Milton, Joe Boyer and Eddie Hearne.

Racing is an expensive business as the cars cost from \$5,000 to \$50,000. One big factory recently estimated that it would cost \$750,000 to build three racing cars and campaign them for a year. Strangely enough, however, it is not millionaires who play this game. It usually is an inventor or engineer who wants to gain a reputation for his product or to

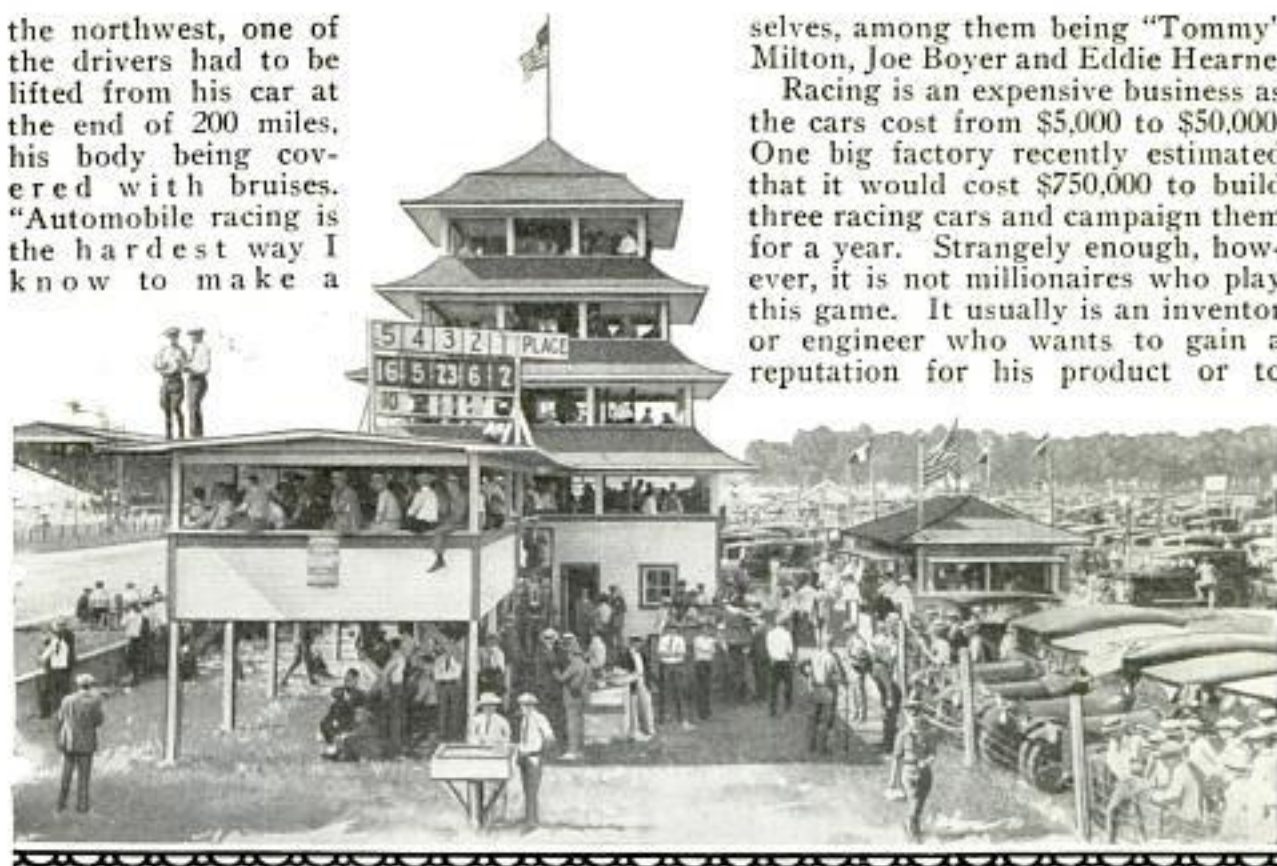

Photos Copyright, Gravelle Pictorial News

The Famous Pagoda at the Indianapolis Motor Speedway from Which the News of the Big Race Is Telegraphed to All Parts of the Country, and the Scoreboard

living," declares Ralph De Palma. "Coal mining is mere child's play compared with it." Racing requires the strength to weather the rigors of the working day and night without adequate sleep or properly prepared meals for days at a time. It requires nerves of steel and the ability to take grueling punishment. Few drivers have ever jumped into a pilot's seat and remained there. Most of them are graduates of the mechanics school like "Jimmy" Murphy, Harry Hartz, "Art" Klein and De Palma. A few have been able to outfit them-

quickly prove its merit. One Kansas City enthusiast spent \$30,000 in equipping two stock cars with a special motor head for the Indianapolis race. Neither of them

won a place. On the other hand, Sig Haugdahl, after years spent in barnstorming on the dirt tracks, picked up a discarded airplane motor which had been built for the government. Fitting it into a chassis, he took the car to Daytona, and negotiated a mile at a speed of better than 180 miles an hour. Somewhat similar was the experience of a garage mechanic in a northern state.



Just before the Start of the Race—an Anxious Driver Giving His Motor and Ignition a Final Inspection





He rebuilt a small car himself, drove it overland to Denver and entered the Pikes Peak climb. Before the race, he did not even have money enough to equip his car with new tires, but finally succeeded in obtaining the much needed casings from a friendly dealer. In the contest, he defeated several specially built racing machines and some of the highest-priced cars in the country. Professionals who specialize in the dirt-track contests in all parts of the country are paid from \$100 to \$250 a week, while their mechanics receive \$75 to \$100. This is in addition to their railway fare, and they pay their own living expenses. These cars travel in groups, or "stables," and enter contests at county fairs, often contending against local drivers.

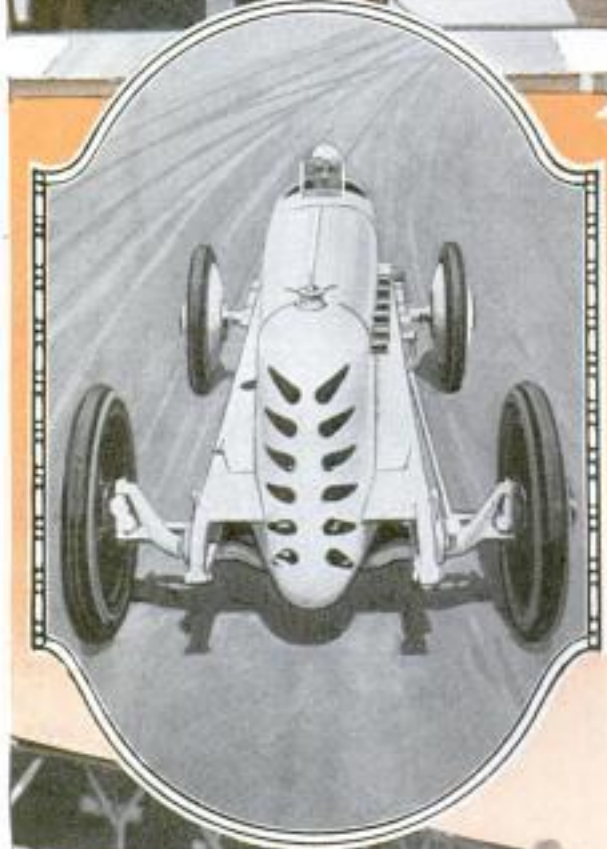

Some of the professionals, however, have their own cars and travel from one town to another in them, stripping off the fenders and headlights just before entering a race. One of the most successful of these is a former locomotive engineer. After winning his first race in a stripped stock car, he abandoned his railway job and devoted his entire time in the summer months to racing. Another is a former garage mechanic who has gained fame throughout Kansas and the central states.

Besides brute strength, racing requires quick thinking, as the wink of an eye often means the difference between life or death and success or failure. One instance of this took place during a climb to the "top-o-the-world" at Denver. Several factory

In the Judges' Stand (Top): Sig Haugdahl in His "White Speck," and (Bottom) a Stop at the Pits for Tires and Gas



Photos Copyright, Gravelle Pictorial News





teams were entered. Practice over the twisting course up the Peak was permitted only in the morning hours. From the bottom, the finish could not be seen, so it was impossible for team managers to check the time of the rival drivers.

One of them, however, located a vantage point from which he could view both ends of the course through a pair of binoculars. He found that his car was several seconds slower than several of the other entrants. He also noticed that all of the cars slowed up slightly in taking the worst curve on

the climb. In doing this, the clutch was withdrawn and the throttle slightly closed to prevent racing of the engine.

After going over the course carefully himself, he ordered his driver to slip his clutch, but not to touch the throttle. This allowed the engine to race, but when the clutch was thrown back again, the car picked up speed more quickly, although the spinning of the rear wheels wore out a pair of tires every time the car made the ascent. The result was that the slower car won the race.

546

#### LETTER ON WARSHIP'S TOWER MARKS PRIZE GUN CREW

For designating the battleship whose gun crews make the highest firing scores of a fleet in the United States navy, a large white "E" is painted on each side of the fire-control tower and displayed for one year. It is from this station that combat is directed during battle or rifle practice. Fully protected by steel armor, 20 inches thick, the observers watch the action through slits in the wall.

#### HYENA STRONG BUT COWARDLY, RUNS FROM SMALL DOG 402

Although it is one of the strongest mammals, the hyena is a notorious coward and will often flee when pursued by a small dog. Only when cornered will it offer fight but then it defends itself desperately. Because of its skulking nature and its habit of living from refuse on village dumps and carrion left by other beasts, the hyena is held in contempt among the natives of Asia and Africa, where it is most commonly found. The strength of its jaws is sufficient to crush the shinbone of a horse.



"E" Mark of Merit on Warship's Tower Announcing Its Gun Crews as Fleet Champions

Com. George F. Morse  
Jr. 547 County Bldg.  
Chicago

Com. R. P. Lumber  
% U. S. Navy Yard  
Washington, D. C.



Mr. Armour of Peckham Eng

Tid - Ozty 2/9/24

WORKING MINIATURE OF TOWN BUILT OF ODDS AND ENDS

With odds and ends picked up about his home, an Englishman has constructed



Realistic Model of a Village and Figures that Move When a Wheel Is Turned

a working miniature of a town with bridges, churches and public buildings portrayed in realistic fashion. At the turn of a wheel back of the model, figures of persons, trains and motor vehicles, connected by gears, are moved about the streets in lifelike manner and lights appear in the windows. Spare time for several years was devoted to the construction of the ingenious display.

SHARPEN SHEARS AND MOWERS WITH CHANGEABLE GRINDER

So its cutting surface may be changed when worn down, a sharpener for scissors and lawn mowers has four grinding sides.

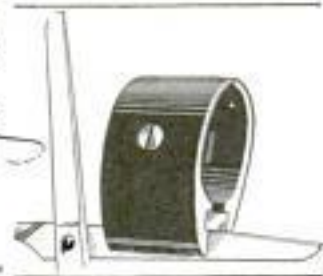

When renewal is necessary, a screw in the side of the bracket can be easily loosened, permitting another face of the rasp to be put in position for use. The tool is said to do its work quickly and

to require little exertion on the part of the operator. Simply pulling it along a dull blade a few times is claimed to be sufficient to produce a keen cutting edge.

When you want anything and do not know where to get it, write Bureau of Information, Popular Mechanics, Chicago.

WIRELESS AS CAREER OFFERS OPPORTUNITY TO MANY

What kind of a job does radio offer to the young man? The question is answered by Arthur R. Burrows, director of programs for the British broadcasting company, who declares that there is a constantly increasing demand for trained engineers, research workers, telegraphists, men versed in commercial trade routes and with a knowledge of geography, who can be intrusted with the installation and maintenance of high-power stations in remote regions. Knowledge of electricity, ability to speak several languages, and familiarity with music, so that the operator may be better able to control the electrical equivalents of the musical sounds to be broadcast, are desirable to those who expect to occupy important positions.

MUSIC IS USED BY SURGEONS TO EASE OPERATIONS

Music has been found of value in surgical operations to ease patients during



Phonograph Supplying Music During a Surgical Operation at a Brooklyn, New York, Hospital

and after the administration of ether. Melodies are supplied by a phonograph, or instrumental selections are rendered by an artist. Several demonstrations have been made at a Brooklyn, N. Y., hospital.

SMOKE SCREEN DISPELS FROST AND KILLS INSECT PESTS

"Smoke screens" and gas clouds, similar to those used in the war, are said to have been used successfully by Vidar Jernberg, a Swedish engineer, to keep frost from fruit trees and to kill grasshoppers and other insects. A smoke projector which this inventor designed to aid in protecting battleships from the enemy, occupies but two cubic-feet of space, but can produce a

Chicago Post  
New York Times 2/25/24

varanua knife sharpener Co, York Pa, Box 71

334  
490  
National Hospital

No other material



*Universal Pitching  
Target Co., 2001  
Morris Ave New York.*

dense cloud of vaporous smoke at the rate of more than 1,500,000 cubic yards per minute. This fog, released over a budding orchard, shields the trees in a protecting blanket and prevents radiation from the ground, thus dispelling frosts. The inventor also believes that he has solved the problem of producing a gas which will be fatal to grasshoppers and other pests, but will not injure human beings or plants.

**IRON ISLAND FOUND IN PACIFIC**

Containing nearly 80,000,000 tons of rich iron ore, Koolan island, off the north-west coast of Australia, is described by a prospector who visited the place as a "veritable lump of solid iron resting on the sea." The island is uninhabited, is seven miles long and three miles wide, has an excellent harbor and thousands of tons of metal are believed to lie in beds extending under the sea. Tests have shown that the ore contains little sulphur, phosphorus or other impurities. *New York Times*

**FORECAST OF WEATHER WATCH IS TWELVE HOURS AHEAD**

For the convenience of sportsmen and travelers, a weather watch is being made in England which, it is said, will give accurate forecasts for twelve hours. It can be carried in the waistcoat pocket, and the reading is obtained by noting the wind direction. Another type of foreteller is used in conjunction with a barometer, consisting of brass plates, five inches in diameter, en-

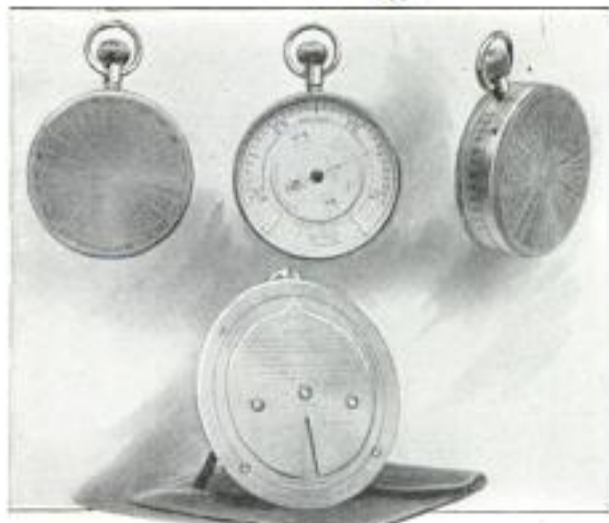

Pocket Weather Watch and Forecast Scale Below, Give Travelers Warning of Approaching Storms

graved with a scale of forecasts. A third style of instrument has been combined with a barometer.

*Negretti + Zambra,  
122, Regent St. England.  
London.*

**DUMMY OF BASEBALL CATCHER AIDS INDOOR PRACTICE**

With the aid of a small indoor cage, containing a target placed back of lines to represent the home plate and the

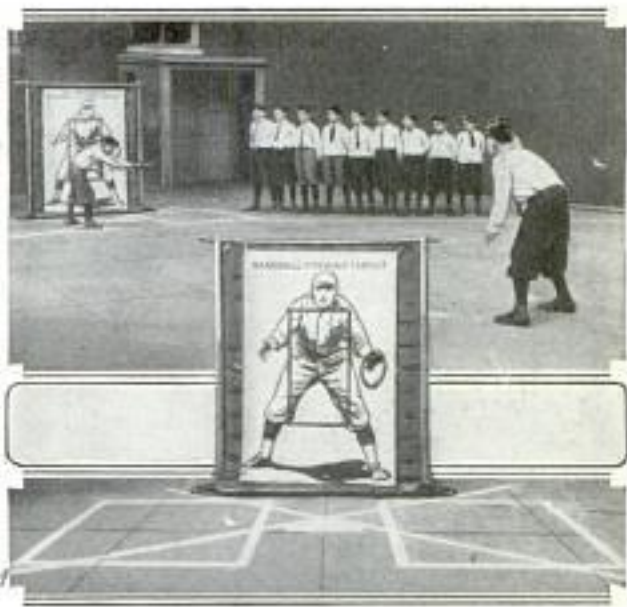

"Canvas Catcher" as Baseball Target for Pitching Practice Indoors or Out of Season

batter's position, baseball pitching practice may be obtained regardless of the weather. The target is made of heavy canvas and is attached by metal eyelets to a portable frame, six feet high and four feet wide. The life-size figure of a catcher is painted on the canvas and a scoring chart below gives rating for balls and strikes in training. The "strike area" is plainly indicated on the figure of the catcher in heavy red lines. As the ball hits the canvas it rebounds and on a smooth surface will roll back to the pitcher for another delivery. The target is also an aid in batting practice and for coaching individual pitchers or squads. It is made in two sizes, one for girls or boys in elementary schools and the other for students in colleges.

**LOCOMOTIVE WHISTLE IS HEARD THREE MILES AWAY**

So that the warning blasts of locomotive whistles may be heard a greater distance, a whistle has been patented that projects the sound waves upward and outward above the muffling blanket of smoke and steam that pour from the stack and frequently smother the alarm signal. Tests are said to have shown that this whistle can be heard distinctly three miles away. The sound waves are directed by an inverted, cone-shaped sleeve on the exterior of the bell part of the whistle.

*drawn by C  
Rockwell  
Hort Wayne, Ind.*

ae  
ea  
ul  
E  
ca  
r  
dl  
ne  
cic



**"SLIP" OF EARTH IS REVEALED  
IN PHOTOS OF STARS**

By photographing the stars from time to time, a machine, known as a "Zenith tube," is said to indicate the distance land slips each year. The earth wobbling

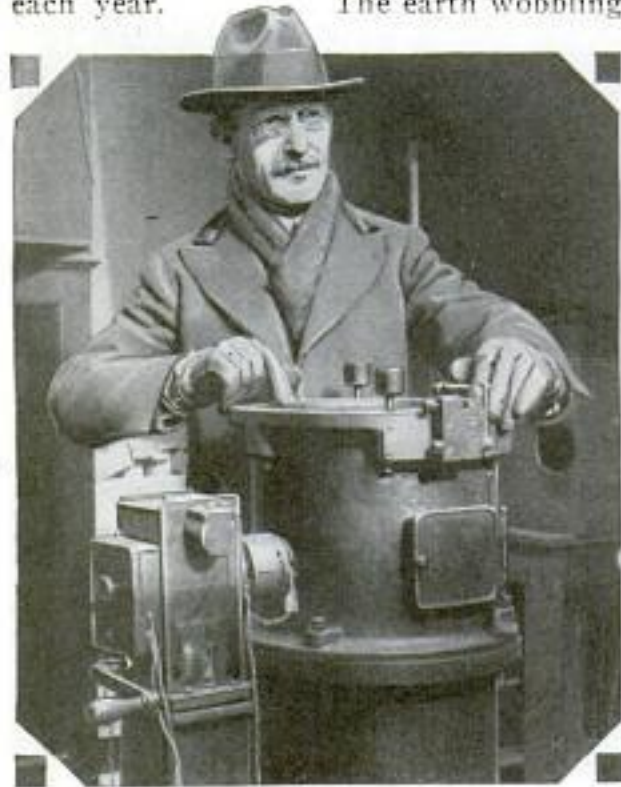

Copyright, Keystone View Co.  
"Zenith Tube" Which Shows, by Photographing Stars, the Distance the Earth Slips Each Year

on its axis is believed to cause the continents to move. Prof. F. B. Littel, designer of the tube, asserts that the United States is slipping from twenty-six to fifty-four feet annually. Pictures of the stars taken by the apparatus are compared with those previously made to estimate the amount of change occurring at certain ground positions. The stars are said to show the extent of the movement by the distance they seem to travel away from designated points.

**BLACK BRICK AND GOLD TRIM  
USED FOR SKYSCRAPER**

Black-face brick and gold-colored stone have been selected for an office building to be constructed in New York City. Believing that the style of decoration would relieve much of the somberness of ordinary stone work, the architects assert that such a color scheme was used by builders in ancient Pompeii and in France during the time of the empire. They also state that it may be seen in some of the public buildings of Brussels. The walls are to be of rich black brick trimmed with stone of a

golden hue. The shade of the structure, it is claimed, will offset the effect of the windows which appear to be square black holes in most modern office buildings. An additional feature will be the fact that over ninety per cent of the floor space will be within twenty-five feet of windows.

**WATER RAISED MILE IN MINE  
BY UNDERGROUND PUMPS**

Energy sufficient to raise water from the depth of a mile underground, which means the driving of pumps against tremendous pressure, will be provided by an installation of electric motors in the Michigan copper mining district. The actual depth at which the pump will work is 5,256 feet, which is so great that a relay pump will be installed at a middle level of 2,450 feet below the surface. The pressure of the great head of water with which these pumps will have to deal will be 1,200 pounds to the square inch at the bottom level. Chambers will be hewn out of the solid rock to accommodate the motor installations, which will be designed to work eighteen hours a day in the high temperatures encountered.

**STREETS CLEANED BY BAMBOO  
BRUSH ON A TRACTOR**

Driven direct from the tractor motor, a street sweeper has been made with bamboo bristles which are said to be superior to hickory, as they are more pliable. As the brush operates in sight of the driver, it is easy to maneuver and is able to handle

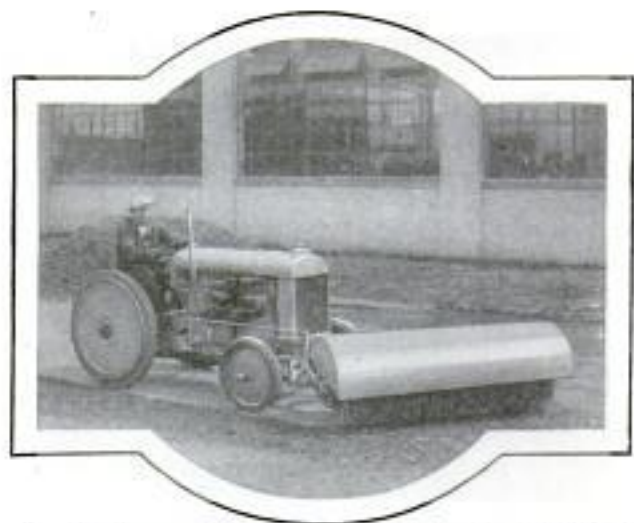

Street Sweeper Run by Tractor Motor, the Bristles of Which Are Made of Pliable Bamboo

snow ten to twelve inches in depth. Several speeds are available, and the brush is so built that it can be refilled at any time.

*Whitehead & Sales Co  
Beecher & McRae  
Detroit, Mich*

*293  
naval armory, Washington D.C.  
American Builder  
February 1924*

*235*

*235*

*423*

*Chicagoapolis news  
Jan 25, 1924*

*1489*

*Copyrighted Material*



### CAMEL TRAINS OF ARMY SPAN HISTORIC PASS



Camel Supply Train of British Army Wending Its Way across Pontoon Bridge Constructed by Engineers to Speed Movements of Forces through Treacherous and Historic Khyber Pass

*International*

Modern military operations in the rugged mountain fastnesses of Afghanistan are battles against the forces of nature as well as clashes between men. In recent uprisings there, supplies for the British troops were conveyed to the historic Khyber Pass on long camel trains across pontoon bridges. At one point over a

steep cliff, the way is only fifteen feet wide and is cut into the side of a limestone ledge. Through this gateway to the plains of India in the last 2,000 years, have echoed the footsteps of the hosts of Alexander and of Persian, Greek and Mongolian conquerors who have gone down to defeat in the lofty mountain summits of the region.

*Emp. Sec. H. Holden, Chesterfield Eng.*

### LEATHER FROM TREES RIVALS HIDES IN TOUGHNESS 7/13

Bark of the red beechwood tree is said to have been treated successfully by an Australian chemist in such a way that it may be used as an efficient substitute for genuine sole leather. Trees from fifty to sixty years old have been found best for the purpose and are cut in the spring. The bark is peeled, steamed and treated by a special chemical process under different pressures. It is stated, also, that the material can be sewed as easily as leather.

### ELECTRIC FLOOR BRUSH SAVES TIME AND LABOR 258

To reduce the time and labor required to clean and polish floors, an electric scrubber is being made that takes power from an ordinary light socket. Old varnish can be removed by a special attachment that rotates a pad of steel wool over the surface after "remover" has been applied. Wax and other finishes may be spread by the machine in but a fraction of the time consumed in doing the work by hand, the regular movement of the device producing a smooth and even gloss. Disks for sandpapering and brushes for dusting and cleaning floors are furnished with the ap-

paratus. An appliance also is made that takes up dirty water by suction, thus preventing it from settling in cracks and corners. The implement can also be used for dressing and renovating linoleum. It is



Cleaning Floor with Electric Scrubber; Above, "Close-Up" of Apparatus and Brush Attachment

said that less effort is needed to operate the machine than is necessary to run a vacuum cleaner.

*No price*

*International  
Poncell 220 W. 19th St. New York City  
The Hoover Machine Co.  
Copyrighted material*



Diamond Bar Hog Ranch  
near Los Angeles,  
Calif.

POPULAR MECHANICS

27 910

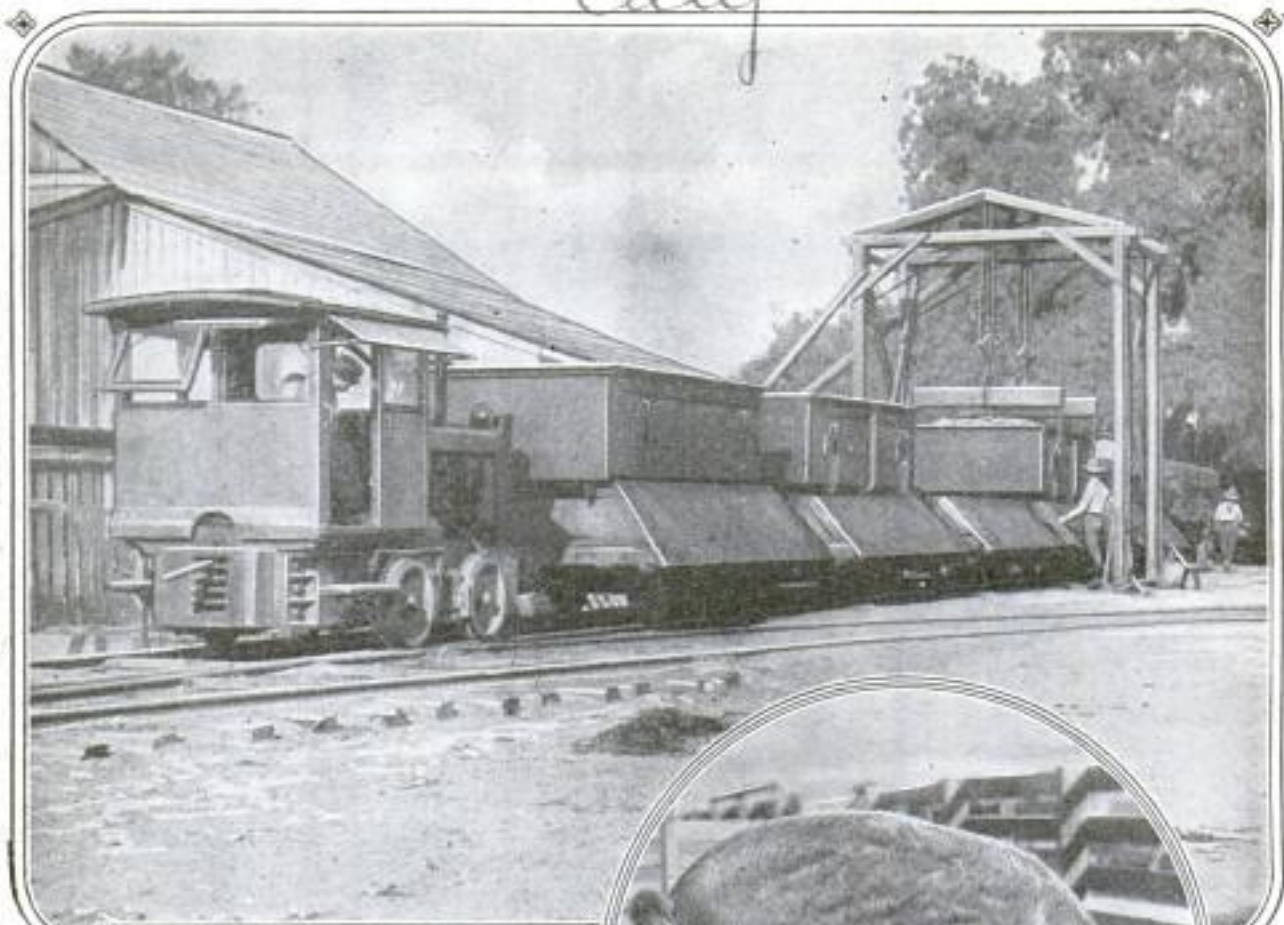

Placing Hoppers of Feed on the Fodder Train Which Provisions 5,000 Pigs in Half an Hour; Right, Prize Hog Worth Several Thousand Dollars

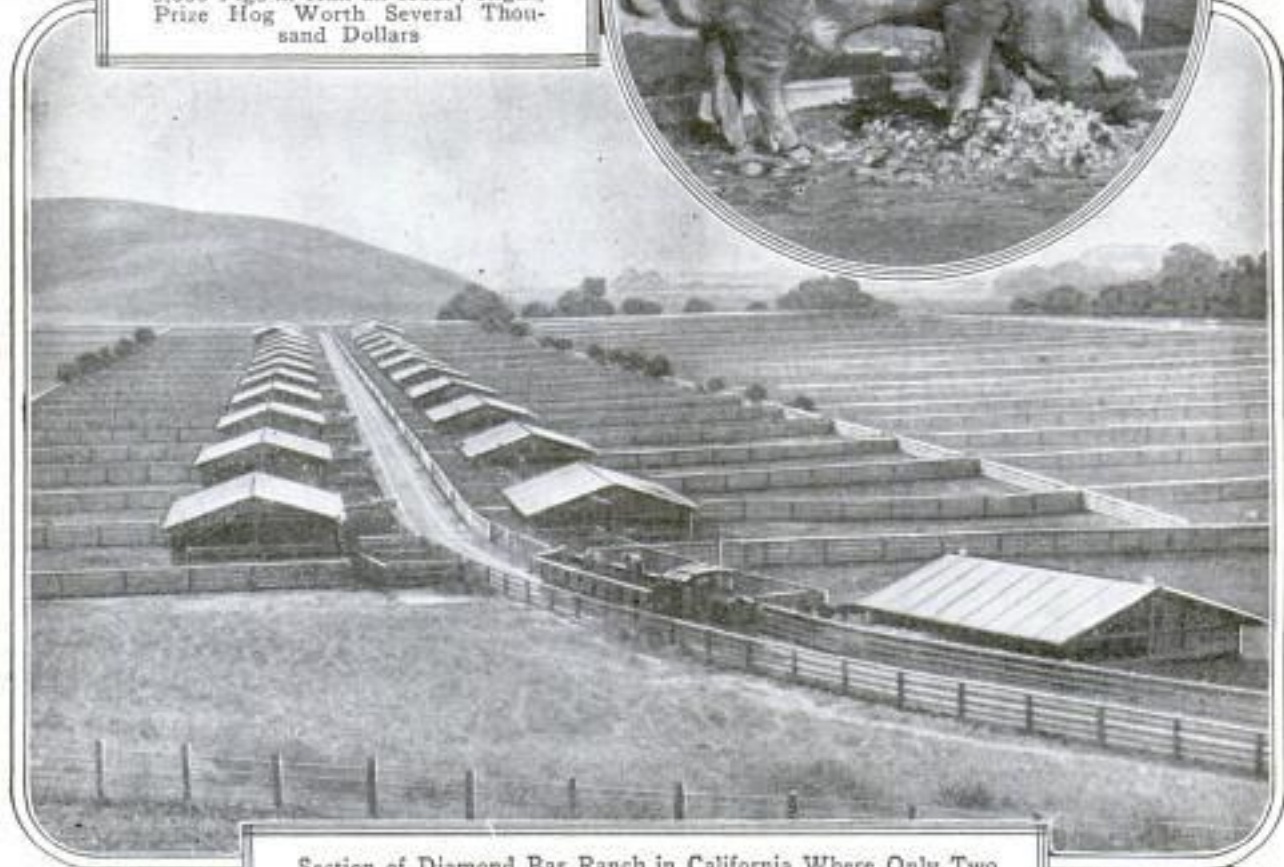

Section of Diamond Bar Ranch in California Where Only Two Men, Aided by Scientific Methods and Motorized Implements, Care for Hundreds of Pens of Hogs, Raised under Ideal Conditions



**FIVE THOUSAND PIGS ON RANCH  
 GIVEN MODERN "LUXURIES" 3**

Raising pigs under highly scientific methods is accomplished on a large scale at a hog ranch near Los Angeles, Calif., where more than 5,000 prize porkers receive the exclusive attention of two experts in the business and are surrounded by practically every "luxury" known to modern swine breeding. Houses of the latest type of construction are arranged somewhat after the manner of military barracks, with ample pens and pastures, and with a track between the rows on which a motor-driven engine hauls small carloads of refuse from the city tables for feed. More than thirty-six tons of garbage are distributed daily, and the arrangement of the troughs and of the feeding machinery is so well adjusted that the entire herd can be fed in half an hour. From the day the pigs are born until they are killed or sold, they are tended with exacting care, and the burden of the task has been reduced to a minimum with the aid of modern inventions. Pure-bred stock is cultivated, a single boar exhibited recently being valued at \$5,000.

**MAKING FURNITURE OF SPOOLS  
 IS HOBBY OF WOMAN 255**

Seven hundred empty spools were used by a Washington woman in building a cabinet in her first attempt at carpentry.



Copyright, Underwood & Underwood  
 Odd Cabinet Built by Woman of Seven Hundred Empty Spools Held together by Nails

**LIGHTER FOR WATER HEATER  
 ACTS FROM ANY FLOOR 275**

Attachable to any coil water heater, an automatic lighter has been designed which may be operated from any floor of the home. A patented device is installed in the gas pipe which regulates the flow of gas to the burner and provides a pilot light. A chain is connected with this and conduct-



ed to any floor desired, where it is fixed to a wall plate. By lifting the chain to a hook on the plate the gas is turned on and the pilot lights a flame. Dropping the chain from the hook turns off the heater. Not only does the lighter save trips to the basement but is claimed to save waste.

Fastened together by some 800 nails, the pieces formed a serviceable article of furniture which has attracted much attention because of its odd appearance. The success of her initial effort has encouraged her to attempt the construction of several other household appliances.

**SAFETY AUTO "GAS"-TANK CAP  
 IS ALWAYS IN PLACE 637**

Removal of the auto "gas"-tank cap often results in breaking of the thread and letting in of dust and dirt. A new safety cap entirely removes this risk, it is claimed. In appearance like an ordinary cap, it differs in construction in that the top and side are separate. The top is held against a flange on the side by a spring underneath it, and thus acts as a self-closing valve. The hole left by the flange is large enough to let in the hose nozzle when the tank is being filled. Thus the cap need never be removed.

*Johnson-Murphy Co,*  
*Detroit, Mich*

*Inv. Walter C.*  
*Copyrighted material*  
*15 W. 26. New York*



### MOTOR CARS ON SIX WHEELS CONQUER SAHARA SANDS

Scouting lightly over the shifting sands of the Sahara desert, a caravan of automobiles not long ago traversed a 500-mile



Modern Six-Wheeled "Ship of the Desert" Mounting Crest of a Sahara Dune

stretch of the country, proving that the modern motor can conquer obstacles heretofore considered unsurmountable without the aid of camels. Six double wheels afforded traction in the loose sands and distributed the weight of the vehicles so evenly that they did not sink down. The French government has sponsored the expeditions for the purpose of survey and discovery and to open up secrets of the inner desert, parts of which are believed never to have been seen by human eyes.

4651

### "NEST" OF FOLDING WRENCHES HAS SCREWDRIVER HANDLE

So they can be folded to occupy no more space than a single tool, a "nest" of S-wrenches, built on a pivot, has been de-

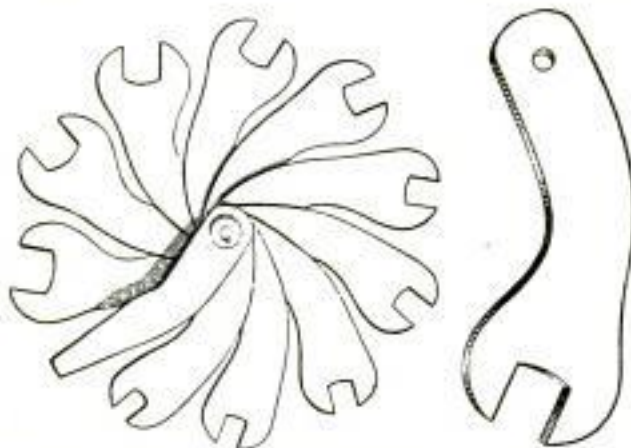

"Nest" of Ten Different Size S-Wrenches and a Screw-  
driver that Forms Handle for Tools

signed. Eleven different sized utensils are in the bunch and a screwdriver is so arranged that it becomes the handle for any one of the set. Because of its compactness, the device is said to be a convenient instrument for automobile owners, as a wrench for almost any nut on a car is included in it. Any of the tools can be easily selected and quickly extended for use. Of strong, light metal, the implement is claimed to be able to accomplish heavy tasks without damage.

### DRINKING CUP THAT IS EATEN HAS CHOCOLATE COATING

In connection with the daily serving of lunches to pupils in many schools, a cup has been introduced which the child eats after drinking the milk it holds. It is made of graham and other cereals, with a coating of chocolate on the inside and takes the



Drinking Cup Used in Schools that Is Eaten after the  
Pupil Has Swallowed the Milk It Holds

place of the crackers supplied to the smaller children. The quantity of liquid held is about equal to that in a teacup.

641

### NINE MILLION PERSONS DAILY RIDE IN CITY'S ELEVATORS

More than 9,000,000 passengers daily, it is estimated, are carried by the elevators in New York City. This number exceeds the number of riders on the street railways, subways, and electric lines, it is said. In many large buildings traffic rules and schedules are observed almost as scrupulously as those of large railroads, in order that adequate service may be rendered.

New York Times

3/2/29 Copyrighted material

336  
 Kennell  
 Dr. M. D. Smith  
 Box 55, Cottonwood, Ill.



**BUGS FLOATED OUT OF SOIL TO PROTECT CROPS**

With the aid of a machine which floats worms and bugs from soil, scientists of the agricultural department are studying the kinds and numbers of various parasites that destroy crops. Because many destructive pests make their homes in the ground, it has been difficult to tell which ones are ravaging vegetation. Samples of earth placed in the floating device are treated to drive the hidden insects to the surface, where they can be seen and counted. It is believed the instrument will result in preventing much of the yearly losses in agricultural products, by making it possible to prescribe remedies to fight the particular pest responsible.



Testing Soil with Machine that "Floats" Bugs and Worms for Study and Numbering

**WRIST WATCH WINDS ITSELF BY SWINGING PENDULUM 689**

Made by a farmer during his leisure hours, a wrist watch that winds itself has attracted attention in Tennessee. It is said to have a pendulum that swings back and forth as the owner walks, and this movement winds the springs.

*of Mr. Samuel Bird a farmer living near Chattanooga, Tenn.*

**BAMBOO ORCHESTRA TONES VIE WITH "JAZZ" 503**

Tones said to rival the notes produced by the modern metal saxophone are blown by members of a Manila orchestra on their bamboo instruments. Variations in the length and diameter of the pipes of the

saxophones cause different tones and some of the players have devised crude stops to increase the range. The abundance of the wood places the orchestral equipment within the reach of those of moderate means.



Queer Instruments of Bamboo Whose Tones Rival Those of Metal Saxophones  
*Com. Miss H. Ault, 2500 Van Ness Ave San Francisco, Calif*



809 Carl. A. Es Shackwell.  
319 Monroe Bldg. Chicago  
Distinctive Costumes for Outdoor Play



Straight Skirt and Slip-over Jacket Give Stylish Lines to This Knitted Sport Suit Effectively Worn with Light Straw Hat with Scarf Trimming



Comfort, Style and Utility Combine in This Pretty Blue Chambray Apron. Simply Made, to Be Slipped over the Most Delicate Frock, It Is Becoming and Easily Laundered



© Marshall Field  
Just the Frock for a Summer Day Is This Dainty Dress of Embroidered Net with Rows of Tiny Lace Ruffles. An Orchid Shade Hat Adds Charm



Soft Felt Hat of Tan with Brown and Gold Side Ornament Completes the Sport Costume



Cinderella-Like and Fascinating Are Evening Slippers Made of a Variety of Gold and Black Metal Combinations



A Rose Taffeta Parasol in "Mushroom" Shape Affords a Flattering Protection from the Hot Summer Sun

Arnold contable  
5th av. + 40th St.  
New York

66. 39th St.  
New York

J. Miller 5th  
av. 416th St  
New York



and the Season's Odd Fads and Fancies



© Marshall Field

Strictly Tailored Is This Suit of Blue Twill with Its Mannish Lines. A Close-Fitting Black Hat and White Gloves with Cuffs Give Contrast



Attractive with Its Bright Green Silk Folds, Buttons, and Bands Woven in the Fabric, Is This Cool-Looking Sport Suit of White Silk and Wool Crepe



"Black and White," Fashion's Favorite, Is Emphasized in This Black Satin Mandarin Style Coat Embroidered in White and Gold

*Arden, 104 W. 27th St. New York City*



Hat of Fine Straw, Rim-Bound with Contrasting Silk Is Popular Shape. Back Flower Trimming Is "New"



For Dressy Wear Is This Hat of Shirred Silk, with Large Roses of Contrasting Color on the Rim



Sandals with Cut-Out Design or Plain, with Slender Strap over the Instep, Come in Patent Leather and Blue Ca'f



49 FLOATING PLANT SUPPLIES WATER FOR REFINERY

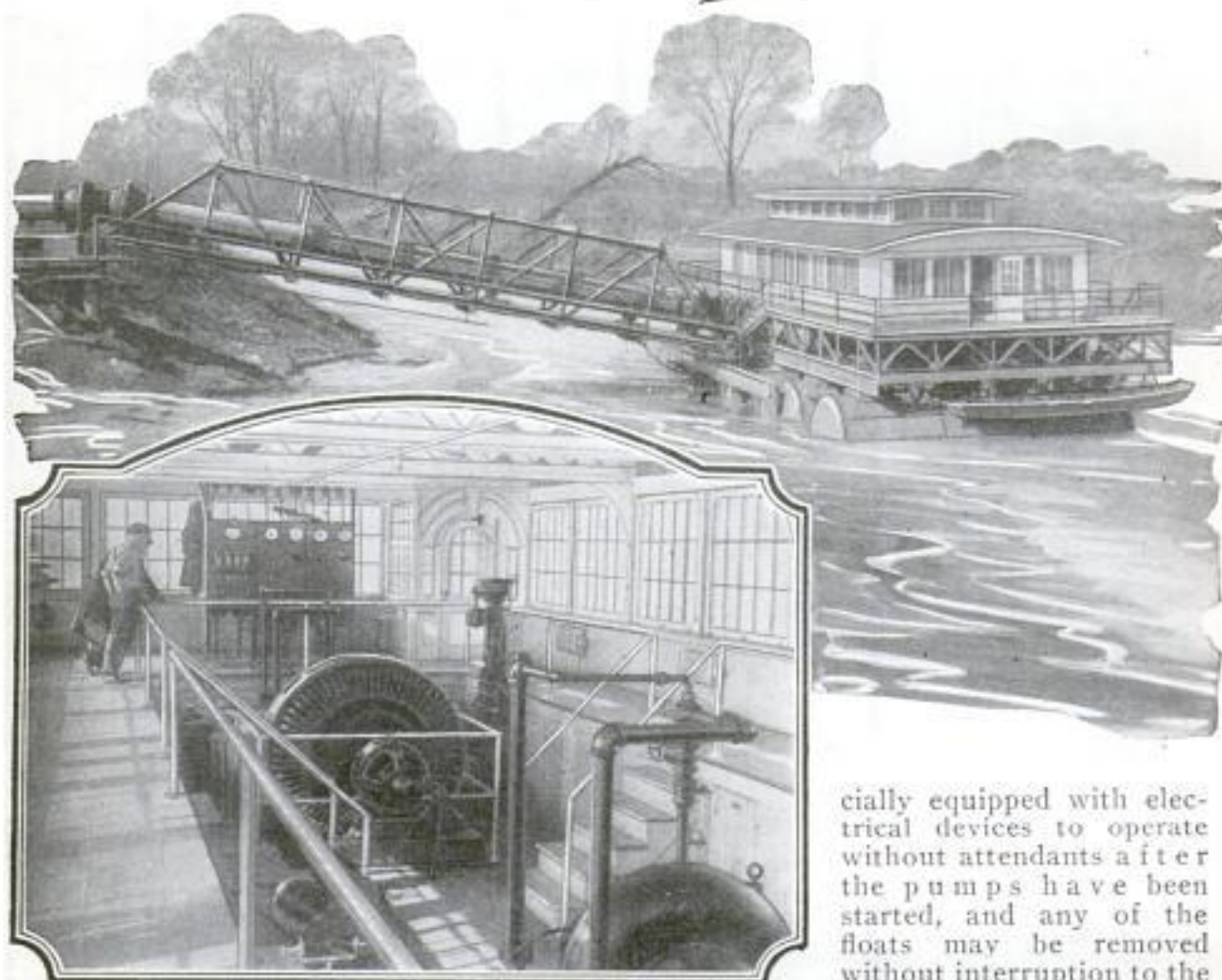

Above, Floating Pumping Station and "Flexible" Pipeline that Carries Discharge; Below, Interior of Plant Showing Balcony and Motors in Pit

Owing to a change in the course of the river, an Illinois oil refinery installed a floating plant containing two pumps in the stream. Resting on six pontoons made from former pressure tanks, the building, which with its contents weighs several tons, adjusts itself to the rise and fall of the water, while a flexible joint in the supply pipe allows a section of the line to move up or down. The station is espe-

cially equipped with electrical devices to operate without attendants after the pumps have been started, and any of the floats may be removed without interruption to the machinery. The motors are located in a pit several feet below the floor and are surrounded by a balcony from which inspection of the equipment can be made. A bridge carries the discharge pipe from the plant to the shore and serves as a means for workers to reach the station. The spot over which the pumps are placed has been dredged to a depth of fifteen feet to insure a constant source of water supply. Each of the pumps works a week at a time and can handle 12,000 gallons of water a minute.

69 PLANT WRITES OWN HISTORY WHILE SEALED IN BOTTLE

Instruments for measuring the sensibilities of plants are now in use in the Bose institute at Calcutta. There is one which enables a shrub to write its own digestive history. A section of a plant is placed in a bottle of liquid containing carbonic acid gas. From this runs a glass tube, at the end of which is a valve connected electrically with an automatic recording machine.

As food is assimilated, oxygen is given off, and this closes an electric circuit which rings a bell, as well as operates a pen on a moving scroll of paper. Another device magnifies the rate of growth so that it can be observed easily.

☐ The Popular Mechanics' Bureau of Information offers its free service to all readers of our magazine. Names and addresses of manufacturers and dealers will be furnished by addressing the Bureau.

Cont. George M. Schreiber  
91 Church Road  
Richmond, Surrey, Eng.



New York Times  
3/3/24

**TURTLE HEART BEAT RECORDED  
BY MOVIE CAMERA 645**

Heart beats of a turtle have been successfully photographed by the motion-picture camera, which also has recorded the effects on sheep and goats of removing the thyroid gland. The heart was photographed at a five-inch range and the picture clearly showed the rhythmic expansion and contraction of the muscles. The effect of removing the thyroid gland was demonstrated by putting the animals through a maze. The normal sheep almost invariably chose the right turn, while those without the gland acted in an indecisive manner and usually took the wrong path.

**BLOWTORCH WITHOUT PUMP  
ALSO A SOLDERING IRON 568**

So it can be used as a blowtorch and for soldering, a heating device that burns gasoline has a removable iron which may be taken off in a few seconds. No pumps or wicks are necessary to carry the flame to the nozzle, and it is claimed the heater can be placed over a gas fire, in case it is needed quickly, and made ready for work in 35 seconds. Low-grade fuel may be supplied the appliance, which, it is said, operates evenly and does not require frequent adjustment. Because of an almost perfect mixture of air and gasoline, no carbon is formed in the tube. As it produces a long, pointed flame, the torch is convenient for tasks in small openings and other places



Blowtorch without Pump or Wick that Has a Removable Iron for Soldering

hard to reach with ordinary soldering tools. Light in weight and equipped with a hand grip, it is easily manipulated.

There are approximately 3,000 vessels in the Japanese merchant marine, according to recent estimates.

W. C. Slowney & Co.  
Springfield, Ohio

**DUST EXPLOSIONS ARE CHECKED  
BY GOVERNMENT TESTS**

Dust from grain elevators and mines is being tested constantly by government experts in an effort to prevent disastrous ex-

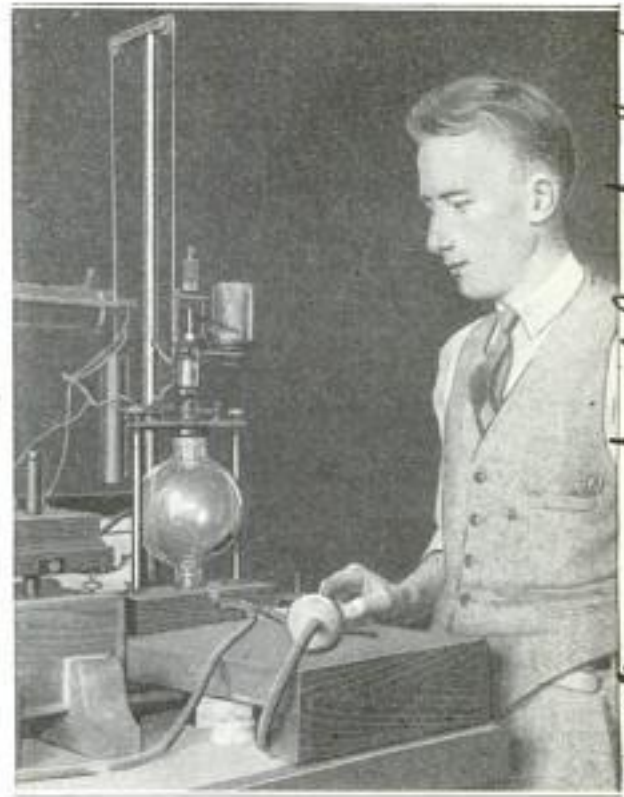

Globe in which Dust Is Ignited So that the Force of Its Explosion May Be Measured

plosions. A globe has been devised by a scientist in the department of agriculture in which the dust is ignited so that its force may be accurately measured and preventive measures devised.

**SEA GULL'S HABIT IS CHANGED  
BY LIFE NEAR CITIES 703**

Sea gulls inhabiting the waters of the Great Lakes no longer move south for the winter as others of the species do, but gather a scant living along the waterfronts and from refuse heaps of near-by towns during the cold weather. At the southern end of Lake Michigan thousands of the birds congregate when steamer traffic stops and forage far inland for food, because ice prevents them from catching fish in the rivers and lakes. Thus they often may be seen at farmyards four or five miles from shore picking up scattered grain and other morsels. In the autumn when the fish have grown too large to inhabit the surface waters, certain gulls are not infrequently found chasing moths and other insects above neighboring cities.

Com. George F. Morse  
gr. 547  
Chicago

W. F. prevent. dust to platoon  
of acrimony



no information

### GUN THAT FIRES TWO BULLETS A SECOND GUARDS BANK

493

Easily handled by one man, a speed rifle adopted by a Chicago bank as protective equipment, fires thirty-two shots in sixteen

cannot locate maker



Bank Guard Demonstrating One-Man Speed Gun that Fires Two Shots a Second

The weapon, which was brought from Germany, has a round magazine at the side from which the bullets are fed to the chamber. Of light construction, the gun is said to be readily operated and can be conveniently placed for emergencies. The weapon is surrounded by a perforated metal jacket to protect the hands in case the barrel becomes hot, while air is permitted to circulate through the holes for cooling the piece.

### OVER HUNDRED MILLION LIVING IN ELECTRIC-LIGHTED HOMES

792

Electric lights are now used in the homes of approximately 111,000,000 persons, nearly six and one-half per cent of the world's population, according to a recent survey. In the United States, 39,000,000 persons enjoy the benefits of electric service in their homes, this country leading all others in the amount of electric power used each year. Japan is second, with 23,000,000 living in electrically lighted homes and Germany is third with 8,810,000. Seventy-five per cent of all people in New York have electric lights.

New York 3/10/24

### "NEW ARRIVALS" THROUGH FIELD AND FOREST

3803

June and the months of early summer are important ones to hosts of living creatures in forests and fields, the "new arrivals" testing limbs and wings and being educated for the life ahead of them. Young foxes, born in April, are being taught the rudiments of their craftiness, wolves have had their eyes open but a few weeks and are learning to eat meat. They quit their parents in November and December, being "graduated" from the family circle with full independence in less than a year. The woodchuck or common groundhog, whose legendary powers of weather prophecy attract considerable attention in February, is born in the late spring and early summer. The young are left to shift for themselves when they are a few months old.

Myriads of insects also make their first appearance and the warfare between various species and for food is beginning its annual cycle.

### GARAGE BUILT OF AUTO TAGS IS PROOF AGAINST RUST

693

Tightly sheathed on roof and sides with unused automobile license tags, a serviceable garage, seventeen feet square and ten feet high, with space for two cars has been built in Denver, Colo. The tags were obtained from a surplus of 22,000 left over in the office of the secretary of state. More than 10,000 of the plates, which are rust-proof, were required to cover the

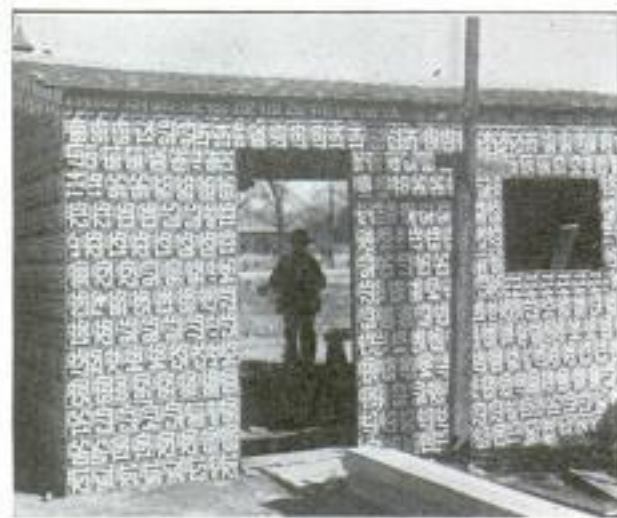

Automobile License-Tag Garage as It Looked before Covering Numbers with Coat of Paint

structure. They were laid overlapping like shingles upon a rough board siding and a layer of tar paper. A coat of paint was applied to obliterate the numbers.

Made by James A. Fite  
4606 Josephine St. Denver, Colo.



*Amesville Wash*

3803 Cont. Francis Leckie  
Heriot Bay. B. C., Canada



Roused from a Delicious Sun Bath, a Young Red Fox Was Snapped just before He Scurried into the Underbrush



By Autumn These Ten-Day-Old Barn Owls Will Have Learned Their Weird Cries



Young Bitterns, Solemn and Inquisitive after Fifteen Days of Life



Famed for His Weather Prophecies, Young Mr. Groundhog Detects a Ray of Sunshine



Sleepy Young Barn Swallows Will Soon Be Off in Graceful Flight



Made by Col. Marcelle Despassy,  
 Naval and Aeronautical Architect  
 POPULAR MECHANICS

278  
 920

**GLIDER BOAT SKIMS ON WATER, ICE OR SNOW**

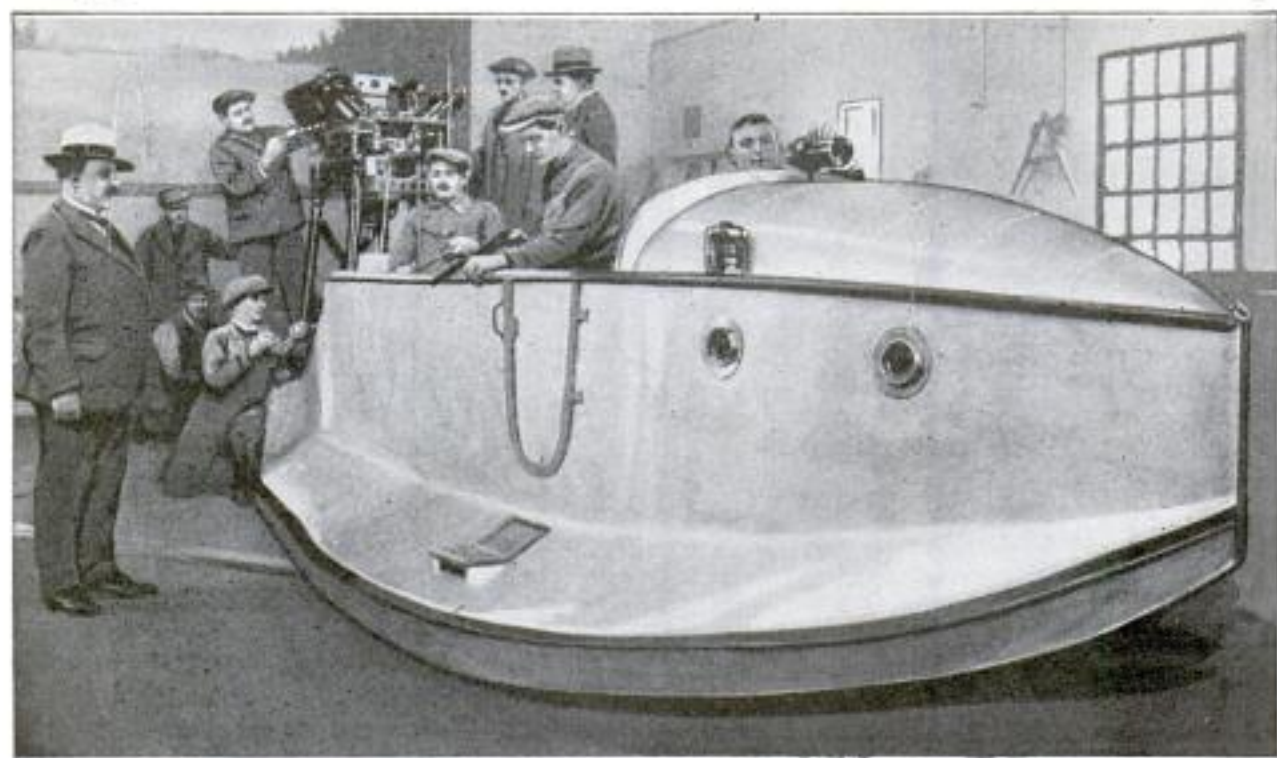

Finishing Flat-Bottomed Glider that May Aid Battleships and Coast Police

Designed to skim over the surface of the water or across ice or snow, a seagoing "glider," equipped with an airplane engine and propeller, is being tested. The inventor has planned the craft as an aid to police and government officials in chasing

lawbreakers and as a torpedo carrier for battleships. Six of the boats, he declares, each with space for four torpedo tubes, can be kept on one warship. The boat is thirty-two feet long, has a seven-foot beam and runs in shallow water.

**CIGAR WRAPPER RUN BY MOTOR EXCEEDS HAND OUTPUT**

386

Cleverly adjusted parts of a machine run by an electric motor took the place of the nimble fingers of cigar makers at a tobacco exposition recently and turned out shapely "smokes," neatly and accurately wrapped,

by the thousands. A fast hand worker can complete, on the average, about 300 cigars a day. The skill of these workers is such that they are able to produce a much more satisfactory cigar than many power devices which have been tried. Experiments are being conducted constantly, however, to get apparatus that will have as great skill as the human hand.



Operator at Electric Wrapper: Cigars Ready for Their Covers on Rack at Left

**TEMPLE OF THE GOLDEN CALF UNearthED BY EXPLORERS**

602

Excavations near Ur of the Chaldees have uncovered Nebuchadnezzar's temple, which is believed to be identical with the Temple of the Golden Calf mentioned in the Old Testament. The Bible story of the temple relates how three Israelite brothers, refusing to worship the golden image of a calf, were thrown into a fiery furnace, but emerged unharmed. Among the ruins are drain pipes which are believed by authorities to have been used to carry off blood of living sacrifices before the golden image.

Rader & Herbert, 1538 Toledo  
 42nd St. New York

Chicago Evening Post  
 2/27/24  
 Copyrighted material



3/6/24

**WEAK SPOTS IN EARTH'S CRUST  
CLUE TO FUTURE QUAKE** 677

Weak spots in the crust of the earth are the places where earthquakes are most likely to occur, according to Prof. Warren D. Smith, of the University of Oregon. The straits of Messina between Sicily and Italy, the region of Java and the Philippines, the Chilean coast, the San Andreas rift in California and a section of the northwest part of the Pacific near the great Tuscara deep, he asserts, are typical earthquake "fields" where shocks may be expected. Unstable strata in these regions are affected by changes in the earth's crust and by terrific ocean pressures. East of the Philippines, he says, a submerged mountain range is slowly rising out of the sea and some day will form a new festoon of islands parallel to Japan.

**KEYLESS LOCK FITTED ON DOOR  
FOILS BURGLAR'S "JIMMY"** 512

To prevent doors being unlocked from the outside by inserting a "jimmy" knife or other instrument, a safety shield has been invented. It is attached on the inside of the door by means of a bracket resting on the jamb. By turning a screw, the shield, slipped between the lock and the catch, is fitted securely about the keeper and the bracket is bound fast to the wood. The guard can be attached in a moment's time, and, carried in the pocket when a person is traveling, it can be used to afford extra protection in rooms not securely guarded by locks.



**FUEL TABLETS BURN IN WATER  
GIVING INTENSE HEAT** 715

Small bricks of a chemical substance that will burn even under water have been put on the market in Germany. Although only about the size of a watch, they are said to be capable of giving heat energy equivalent to over 5,000° Fahrenheit in six seconds. The bricks are especially adapted to heating flatirons, foot warmers, soldering irons and to boiling water. They can be lighted only by a special kind of match and are safe from ignition or explosion if kept dry.

*Max Briketts*

**INDICATOR ON FILM PROJECTOR  
SAVES MOVIE DELAYS** 446

To warn motion-picture machine operators when the film is near the end so that a new reel may be prepared without delay,

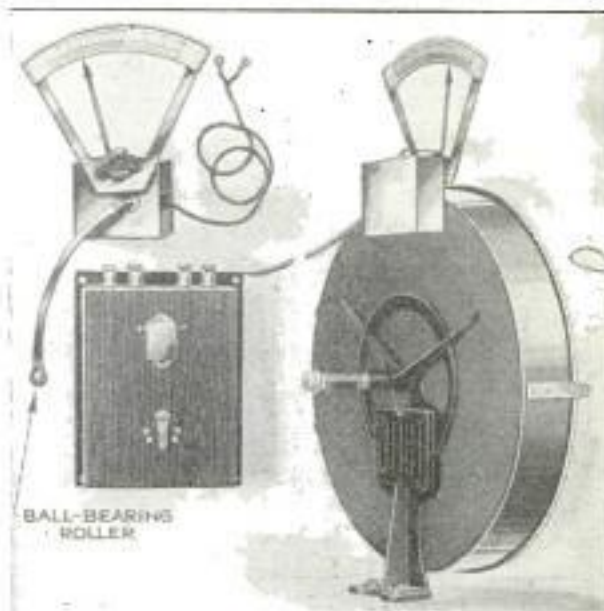

Film Indicator Connected to Buzzer; at Right, Mounted on Projector Magazine

and to show how many feet of the film have been run, an indicator has been invented that is attached to the magazine of the projector. An arrow on a dial gives warning, and an electrical contact is made to sound a buzzer.

**ADJUSTABLE ERASER IN CLAMP  
LASTS AS LONG AS PENCIL** 445

Fitted within an adjustable clamp in a socket at the end of the pencil, an eraser that can be pulled out as it becomes worn down and will thus last as long as the lead,



Eraser and Adjustable Clamp Holder Fitted into Socket at End of Pencil

has been designed. The clamp is removed easily and, after taking another "bite" on the rubber, is slipped back in place.

*Richard, Haber  
200 Fifth Av. New York*

*Mr. Sebastian Ulrich, Akron, Ohio  
858 Persimmon St.*

*Eraser especially useful for drawing heavy lines.*



# Royal Doll House

## 535 Rivals Palace of King

CONTAINING all the luxurious conveniences and decorations found in the most modern palace of royalty, a doll house to be presented to the queen of England has been designed and ornamented by the most prominent architects and artists of that country. Intended as a monument to show future generations what the present type of elaborate home is like, the miniature palace stands five feet high and is only eight and a half feet long. So that the entire interior can be revealed, the outside walls are made to be lifted off like a box cover, permitting inspection of the tiny rooms and their ornate furnishings.

The front of the little building is formed to resemble that of Buckingham Palace, the residence of the royal family, and a toy garden which can be slid into the base of the structure forms the "grounds" at the rear. A garage in which may be seen the most expensive types of automobiles, also folds up and may be pushed into the basement. Small walks that resemble strips of ribbon, but made of costly material, cross the garden and are bordered by imitations of many kinds of flowers and trees. Even a ring of tiny toadstools, an eighth of an inch high, seem to grow from the artificial earth. Within are gorgeous dining rooms, library, bedrooms and bathrooms. Sleeping quarters are furnished with delicate silk draperies, costly little rugs and finely



Provided with Miniature Toilet Articles This Tiny Bathroom Even Has Running Water

wrought walnut furniture. Every article that can be found in the most elaborate homes has been put in its proper place in these rooms. Toothbrushes not more than three-quarters of an inch long may be seen hanging in their accustomed positions in the bathrooms, which are equipped with replicas of those in the large mansions. The nursery, painted by a leading artist, has every toy a child could need, including tin soldiers as small as mosquitoes, toy trains and scooters. Storerooms and wine cellars occupy parts of the basement and have minute bottles of real liquors and boxes and cans of provisions. The strong room contains tiny crowns and scepters, set with small genuine jewels. Portraits created by prominent masters of the brush hang on the walls and the ceilings are studded with brilliant electric fixtures that glow like the original articles. In the bookcases may be seen a selection of miniature volumes, patterned after larger sets written by popular authors. Elegant tables and chairs less than three inches high, made by expert craftsmen, and finely paneled walls grace the entire inside of the house. A carved table, laid with a perfect service of silver and china, seems to await a feast from the kitchen.



Pygmy Imitations of Luxurious Decorations and Paintings Ornamenting the "King's Bedroom" in the Royal Doll House



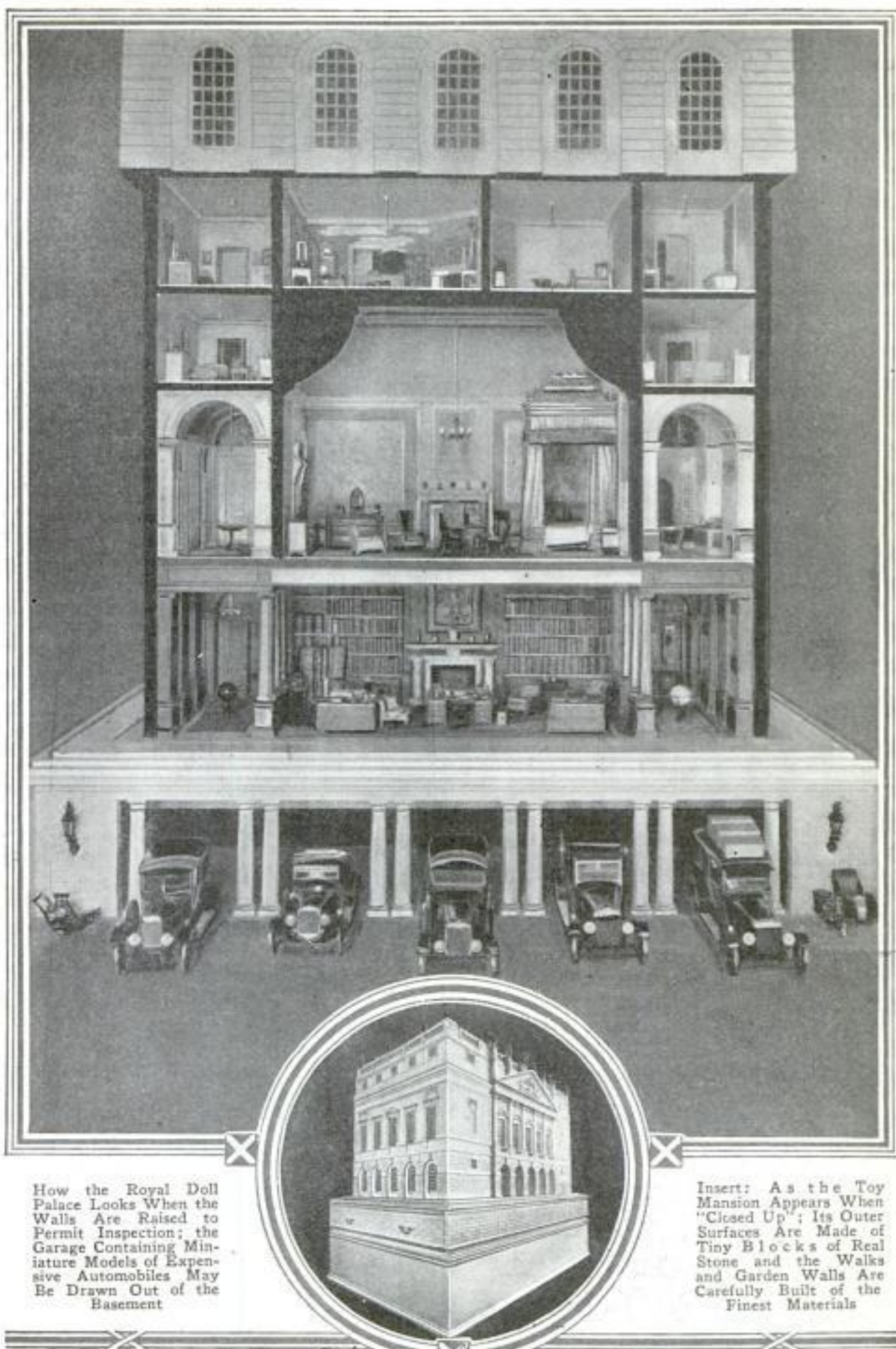

How the Royal Doll Palace Looks When the Walls Are Raised to Permit Inspection; the Garage Containing Miniature Models of Expensive Automobiles May Be Drawn Out of the Basement

Insert: As the Toy Mansion Appears When "Closed Up"; Its Outer Surfaces Are Made of Tiny Blocks of Real Stone and the Walks and Garden Walls Are Carefully Built of the Finest Materials

Wide World Photos

229 W. 43 rd

Copyrighted material  
New York



**STREET-CAR SIGNBOARD AIDS SAFETY-FIRST CAMPAIGN**

*466*  
 In a recent drive for safety on the streets of Jacksonville, Fla., citizens were impressed with the importance of taking pre-



Jacksonville Traction Company's Street-Car Crusader Covered with Signs for Safety-First Campaign

cautions in driving their automobiles and in getting on and off street cars by a "sign car" run daily throughout the city by the

Jacksonville Traction company. Sides of the car were covered with huge warning signs printed with legends appealing directly to the citizen to do his part in protecting life and limb. Guided through the busiest sections of the city and in the midst of crowded traffic, the car was a silent but eloquent argument in behalf of the cause of safety first.

**MOOSE CAPTURED WITH LASSO**

*630*  
 When the heavy snows cover the north woods the moose, like many others of the deer family, choose some sheltered location where there is plenty of browse, and as the snows deepen they make a maze of well-beaten paths in order to reach their food. Since they are easily exhausted by plunging through the drifts, the animals seldom leave the paths unless compelled by failure of the food supply or attack by an enemy. At this time the hunter carefully approaches the "yard," as the shelter with its connecting paths is called, and often is able to come close enough to lasso one of them. Once the noose tightens around his neck, the moose makes a break for freedom, often dragging his captor miles in a desperate attempt to get away but in the end always giving up from exhaustion.

**AUTO DISPENSES MUSIC FROM AUTOMATIC PLAYER**

*415*  
 Fitted into a specially designed automobile, a self-playing musical instrument with a tone somewhat like an air calliope, has attracted attention in the west. Played with a keyboard, by hand or with an ordinary piano-player roll, it furnished music that could be heard nearly a mile. The device occupies floor space of only twenty-

four by thirty-one inches in the automobile, which has sleeping quarters built in it.

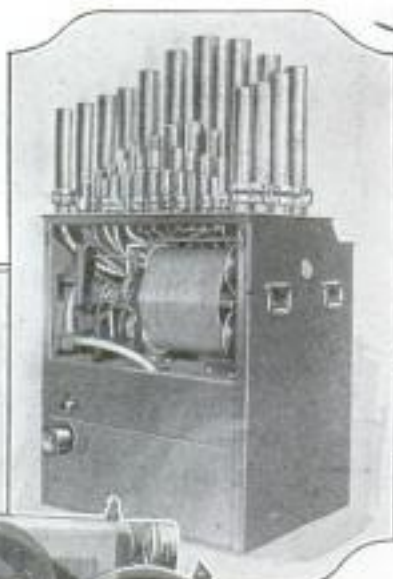

Luxurious Touring Car Fitted with Musical Instrument that Can Be Heard Nearly a Mile

*Musical instrument in auto - J.C. Seagan, Chicago*  
*1960 Bertean*  
*Seagan Una - Jan - J.C. Seagan, Chicago*

*Constructed by Mr. Dave Rickle*  
*7543 Santa Monica Blvd.*  
*Los Angeles, Calif.*



*Cont. George H. Holden,  
Hick Crest Lodge  
Japan via POPULAR MECHANICS*

**ONCE WASTEFUL POTATO TOPS  
YIELD VALUABLE DYE** 6/6

Once considered a nuisance, the problem of what to do with the tens of thousands of tons of potato tops is believed to have been solved by a Danish chemist's discovery that the waste may be utilized as dye. In harvesting the dye, the tops are cut when the plant is in flower. After withering for a day or two, the vegetable is bruised and pressed between huge rollers so as to extract the juice. In using "potato yellow," the articles to be dyed are steeped in the juice for several hours, after which time a fine, solid and permanent yellow color is given to them. If desired, the yellow may be changed to a beautiful green merely by plunging the garments in a bath of blue dye after they are thoroughly impregnated with the yellow.

**"QUESTION SHOP" GIVES ANSWER  
TO ANY TELEPHONED QUERY** 2/5

Offering to answer any reasonable question telephoned to its office, a firm deal-



Copyright, Underwood & Underwood  
Operator of "Question Shop" Replying by Telephone to Puzzling Query from Distant Subscriber

ing in general information is said to have set up business in New York City. Subscribers to the service are permitted to put as many queries to the "question shop" as they desire. Each patron is given a code name and, it is reported, can receive aid from the station at any hour of the day or night. It is also claimed that eighty per cent of the queries do not require more than two minutes for an answer.

Gas generated by the submerged grain cargo of the steamer "Hivos," sunk by a submarine in 1916, off the coast of Algeria, raised the vessel to the surface. When the water pressure was removed, the vessel blew up.

*Phone - 43 chgo,  
25 W. 43 rd St.  
New York City*

**SEA'S HIDDEN PERILS REVEALED  
— BY WIRE-CABLE DRAG** 2/4

Hidden reefs, bowlders, and "needle" rocks that jut up from the floor of the sea



Model of Sea Drag Used to Locate Hidden Obstructions that Imperil Ships

and threaten the safety of vessels, are being located with a wire cable dragged above the ocean bottom by specially built ships of the United States coast and geodetic survey. Lowered from twenty to sixty feet below the surface, the line is supported between two craft by floats. When it strikes an obstacle, an alarm signal above water notifies the attendants. The position of the obstruction is ascertained and recorded for transfer to charts.

**GUARD FOR AUTO ACCELERATOR  
TO PREVENT ACCIDENTS** 5/4

For preventing an automobile driver from stepping on the accelerator when applying the brakes, a guard, for which a patent has been asked, has an arm that extends over the "gas" pedal. The extension is free to move upward to allow the motorist to remove his foot from the accelerator, but a spring forces it back into

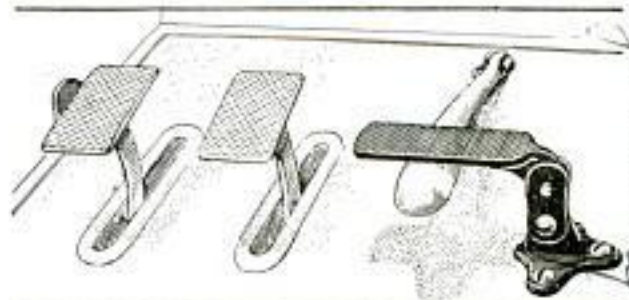

Guard for Automobile Accelerator that Prevents the Driver from Accidentally "Stepping on the Gas"

safety position again. It is claimed the device is of aid to nervous drivers and to those operating cars in crowded streets.

*Auto Accelerator Guard and Co.  
Indicet. Boone County  
Melford Ky*

*Letter  
retd*



Road blasted by the Southern  
California Edison Co.  
POPULAR MECHANICS

926

132

Emb. U. S. S. Shackwell, 319 Monroe Bldg., Chicago

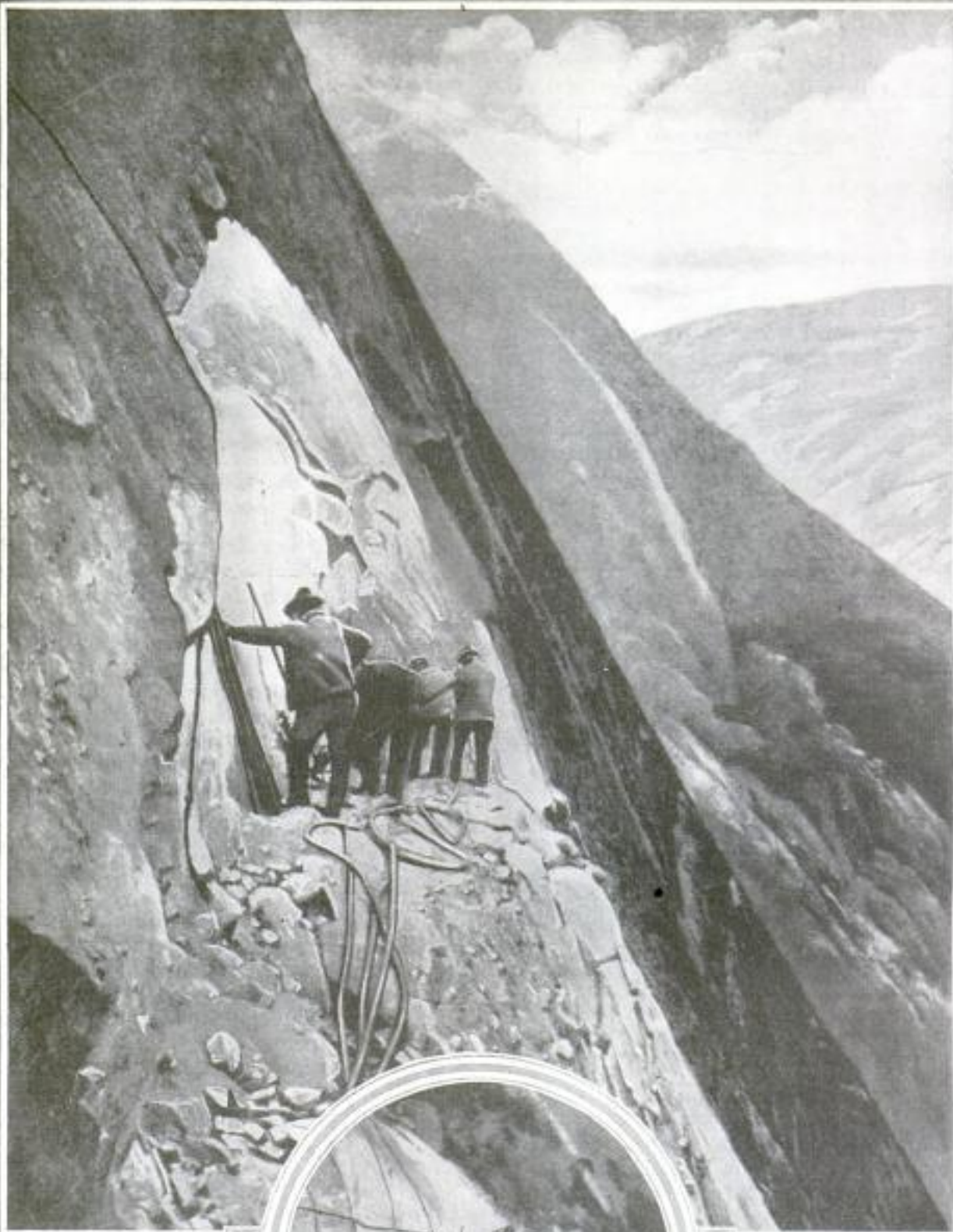

Digging a Road into the Face of a Steep and Slippery Cliff, where Steel and Powder First Gnawed a Narrow Niche in the Stone Wall to Make a Platform for the Crews to Work Unsupported by Ropes

Left: Having Carved a Wide Shelf from the Rock, Pneumatic Hand Tools Gave Way to the Steam Shovel Whose Power Was Conveyed to It by Pipelines Hung against the Side of the Budding Highway

Courtesy The Explosive Engineer

Copyrighted material



*Pruner - \$5.00, West of Mississippi \$5.50.  
Trimmer - 7.50, West - \$8.00*

**HIGHWAY IS HEWN FROM CLIFF WITH POWDER AND STEEL** *132*

In building a highway along the steep and slippery slope of a California cliff, workmen first had to be lowered with ropes to drill holes for explosives. Powder and steel then gnawed out a narrow niche on which the crew could work. This was widened for a steam shovel that completed the grading of what now forms a wonderful scenic boulevard for motorists.

**EXPLORERS SEEK PIRATE GOLD IN DEPTHS OF RIVER** *625*

In the hope of retrieving a chest of gold said to have been hidden in the Sheepscot river by Captain Kidd, notorious buccaneer of the seventeenth century, an expedition is about to be launched by Lewistown men. A grappling device invented by a member of the party will be used in locating the treasure. According to the leader, he while a boy was present when the anchor of a sloop riding in the river was hauled in with an old chest attached to one of the flukes. Before it could be brought aboard, however, it fell off and was lost in the river bottom. The explorers firmly believe that the chest was Captain Kidd's, and it is on that assumption they are taking up the quest over 200 years after the pirate sailed the seas.

**KNIFE TO CUT MAIL WRAPPERS WILL NOT INJURE CONTENTS** *463*

To open tough, paper mailing wrappers without damaging the contents, a knife with a curved point has been invented. The turned tip of the tool is flattened for

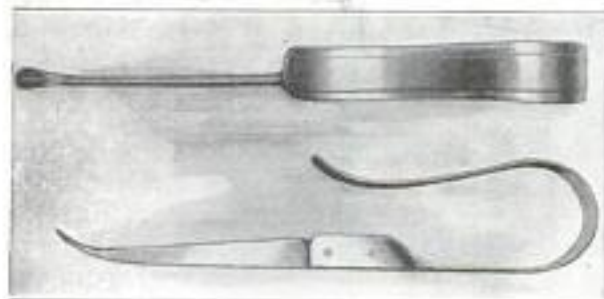

Knife with Flat, Curved Point that Opens Tough Mailing Wrappers of Magazines and Newspapers

easy insertion under the paper. A forward movement of the instrument is said to result in a clean slitting of the cover. The utensil, it is claimed, is also being used to cut twine and cord with which packages of mail are fastened.

*Chas. Arthur H. Hoffman,  
Rural Mail Carrier,  
Harvard, Neb.*

**HEDGE TRIMMER LIKE MOWER CUTS AWAY GROWTHS** *504*

For cutting fresh hedge growths quickly and evenly, a trimmer is being manufactured which works like the blades of a mowing machine. With each complete



Using Hand Hedge Trimmer that Works Like Toothed Blades of a Mowing Machine

movement of opening and closing the handles, two rows of sharp steel teeth perform a clipping motion as they rapidly pass each other. The device is said to do many times the work of ordinary tools in one operation and to balance perfectly while being used. For pruning and lopping old growth, a similar utensil is made with notched teeth, which also may be employed as a trimmer. Adjusting screws are provided to tighten or loosen the parts.

**BLOOD POISONING IS TREATED BY INJECTIONS OF DRUGS** *640*

Injections of a combination of drugs prepared by staff physicians attached to a department of the Johns Hopkins hospital, are said to have proved successful in the treatment of blood poisoning. The remedy was prepared after five years of experimentation and consists of two drugs comparatively new to medical science. It has a deadly effect, it is said, on the organisms that cause the poisoning when injected into the veins of the sufferer.

*Chicago Daily  
Copyrighted 1924*

*Stenton Patent Mfg. Co., 112 Broadway St.*



*Dr. W. George Smith Morrison*  
 609 Chamber of Commerce Bldg  
 928 Pittsburgh Pa  
 POPULAR MECHANICS

**SPEED-REDUCTION GEAR RATIO  
 NINETY THOUSAND TO ONE**

32 Using toothless gears for ordinary speed ratios, a unique power-transmission unit has been designed for tasks where speed re-

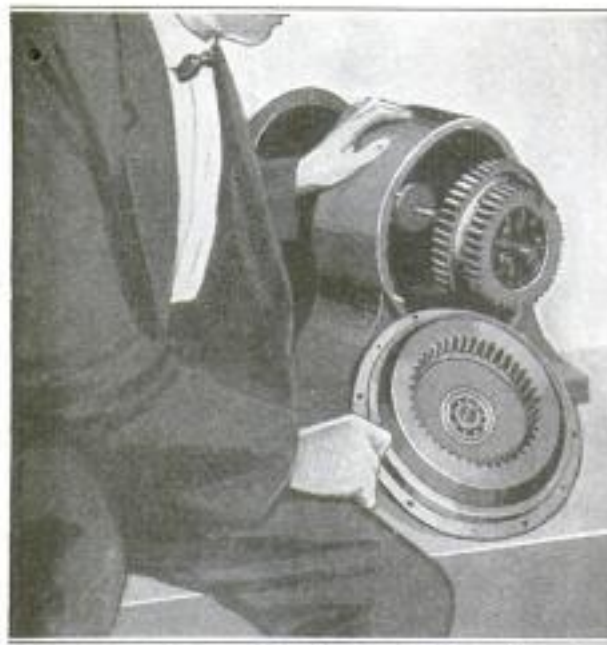

Power Transmission Unit for Speed Reductions from 90,000 Revolutions a Minute Down to One

duction of a ratio less than ten to one is required. To attain these low ratios, three rollers, one of them larger than the other two, are fixed within a stationary ring, the inner surface of which forms a track, as they are revolved by a rotating shaft inserted between them. A frame binding the small pair of wheels together

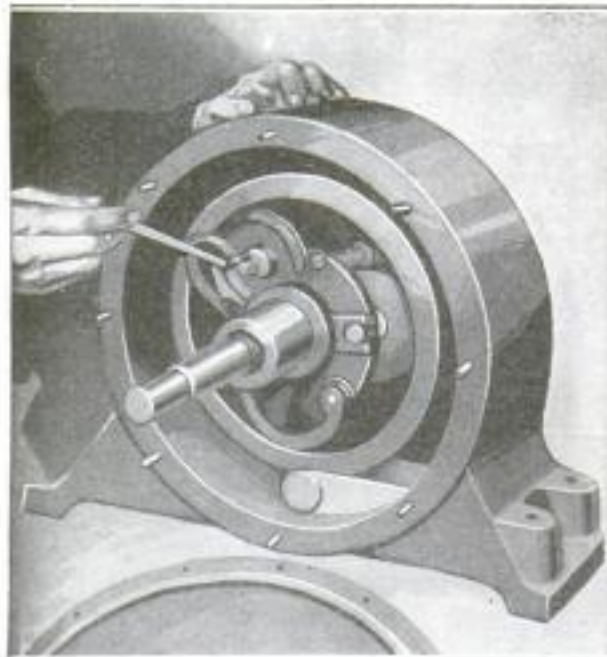

Toothless Gear for Ordinary Velocities where Tasks Require Reductions of Less than Ten to One

serves as a means to turn the slower driven shaft. Reduction as great as 90,000 revolutions a minute down to one has been accomplished by allowing the ring to revolve, and cutting teeth on it to mesh with an outer ring which, in turn, is geared to the driven shaft. The gearing is being fitted to hoisting machines, conveyors for glass factories and packing plants, and for elevating mechanism used as part of equipment for electric steel furnaces.

614 **TOOTHBRUSH HANDLES CARVED INTO ATTRACTIVE TRINKETS**

Carved from disused toothbrush handles, many attractive trinkets have been prepared for sale by an English inventor, who has devised a way to cut the objects at a profit. The design is traced in the material and the article nearly completed before it is severed from the handle. Small knives and files are the principal tools used. A watch fob can be made in about four hours, but several days are required for pieces of more intricate design.

*Cmt. George H. Hadden, Chesterfield Eng*  
**DESK CLAMP FOR TYPEWRITER  
 REQUIRES NO SCREWS**

To anchor portable typewriters tightly to the edge of a desk in a convenient writing position, a clamp has been invented. No screws are needed to attach it, and it does not mar either the furniture or the typewriter.



*Corona Typewriter Co. Eng*  
**SILVER HIDDEN IN SEA WAVES**

623 **COATS HULLS OF WRECKS**

Millions of tons of silver are held in solution in the waters of the sea. One estimate places the amount at one grain for every 1,450 gallons, which means not far from 50,000 times as much as has been taken from the mines of the earth from the discovery of America to 1902. The metal is found in comparatively large proportions in seaweeds and the hulls of ships become impregnated with it. Examination of the sheathing of a vessel that had been trading for some time off the Pacific coast of South America showed that it contained more than a pound of silver for every ton of the sheathing.

*Cmt. H. Journeay, Eng  
 Thundersley,  
 Southend Eng*

*Morrison near Co., 576 Swanton St. Melbourne, Australia.*





### New Theory of Radio Is Advanced <sup>123 OK</sup>

In the opinion of Carl Pfanstiehl, a Chicago radio engineer, the wave theory of radio will soon be exploded completely, and the radiant-energy theory take its place in explaining radio phenomena. Mr. Pfanstiehl is of the opinion that there is no such thing as "ether" as commonly referred to. He says that what are usually spoken of as radio waves are undoubtedly particles smaller than an electron that are sent flying by an electric current. These particles, it is assumed, bump into each other, thus transmitting energy which is picked up as sound in the receiver. When a stream of radiant energy or particles strikes the antenna, it sets up a very weak current, which is transformed into sound or air waves in the receiving set.

The development of this theory, says Mr. Pfanstiehl, has been very rapid and startling, and further investigation of the nature of these particles may explain the mechanism of direct communication and telepathy between minds. Also, through the new principle, wireless transmission of vision may become an accomplished fact.

### Compact Phone Plug Has <sup>3/6/24</sup>

#### 65-Quick Release

Neat and compact in appearance, a new phone plug has the further advantage that the cord tips may be attached or detached



instantly. The body of the plug is circular and has two small projecting metal tongues which lock the cord tips. To insert the tip it is only necessary to push them into the holes in the body; to detach, the metal tongues are pressed toward each other and the tips pulled out. The sleeve and one of the tongues are marked with a + sign, to show that they are electrically connected. In using certain headsets it is important to know this, as the B-battery positive should be connected to the proper phone lead.

Weston Tech. Club in  
10 Weston Ave.  
Newark, N.J.

### Broadcast Station Built in Church <sup>20-R</sup>

Aimee Semple McPherson, the famous woman evangelist, has recently completed the installation of a powerful broadcasting station in Angelus Temple, Los Angeles,



Famous Woman Evangelist Broadcasting Her First Sermon from Church Station

and will broadcast her sermons as well as the music from the church.

Radio antenna masts towering above the church structure afford a rather novel sight now, but in a few years this will be common, so rapid is the march of radio.

### Eliminating Jacks in Receiving Sets <sup>75-0</sup>

When tuning in stations most people use the amplifiers from the start, turning the filaments down low while using the phones and turning them up while using the loud speaker. Therefore, the use of a separate jack for the detector and first-stage amplifier is often unnecessary and a useless expense. Besides this, the use of two or more jacks adds to the complication of the construction and requires much more soldering than if only one jack were used.

—A. C. Cole, Chicago, Ill. <sup>302749</sup>



Photograms all this material.

118-R. Latest Fads, Fancies and Novelties



The Dentist's Chair Has Lost Its Terrors for This Little Chap, Who Forgets the Ache of His Tooth When He Clamps on the Head Phones



Parisiennes May Now Enjoy Radio Programs While Strolling along the Boulevards, by Using the Umbrella Set Devised by a Paris Inventor



A Real Radio Fan: the Set Is Tuned by Opening and Closing the Leaf Coils

© Keystone View Co.



Photograms

It Is Not Necessary for the Dyed-in-the-Wool Radio Fan to Pass Up a Favorite Program to Indulge in a Canter. This Young Lady Must Have Her Ride Every Morning, but She Carries Her Radio Set with Her and Combines Sport with Entertainment.



Fighters Now Skip Rope, Shadow Box and Punch the Bag to Music Carried on Radio Waves, in the Arcade Gymnasium, Chicago, Where Many Champions Have Been Trained. Our Photo Shows, from Left to Right, Stanley Zbyszko, Jack Malone, Eddie Welsh, Howard Carr and Conn Currie, as They Appeared During One of the Radio Workouts

Keystone  
115-R  
W. H. H. Co.  
91-10 Broadway  
New York

Panji + Atlantic Photos  
25 Park Place N.Y.C.

121-R  
Photograms, 129 E. 27th  
New York



Filed under 99-R  
to Be Found in the World of Radio

Radio  
Novelty Photo

113-R



Keystone

117-R

Hologram



119-R



© Keystone View Co.  
Fair Fishers Entertain Themselves  
When Bites Are  
Few; Right, Radio  
Set Built in Lobster  
Claw

114-R

Keystone

With His Own Little  
Radio Set, the Stage-  
Door Man Can Fol-  
low the Performance  
for the First Time

Hologram

Radiophone Transmitting Appa-  
ratus that Will Minimize the  
Dangers of Underground Work.  
It Requires neither Aerial nor  
Ground and Uses Only Small Dry  
Batteries; Men Working in Mines  
Can Carry It with Them and  
Communicate with the Surface



The Latest Novelty, a Radio Set,  
Reading Lamp and Phonograph Com-  
bined. The Phonograph is Cleverly  
Concealed in the Base of the Lamp,  
and When the Doors Are Closed,  
There is Nothing to Indicate the  
Unusual Character of the Lamp; the  
Radio Set is Mounted in the Same  
Compartment

120-R

Hologram

Mr. P. W. Hochstetler  
Dayton, Ohio

Advertiser of Advertising  
485 Broad St. Newark, N.J.



### Sixteen-Tube Set Serves Restaurant Patrons

Warren H. Keates, of Philadelphia, is the proud possessor of a real radio set, which he perfected and built himself.

The set has 16 tubes, and has a receiving range of 7,000 miles. Getting such stations

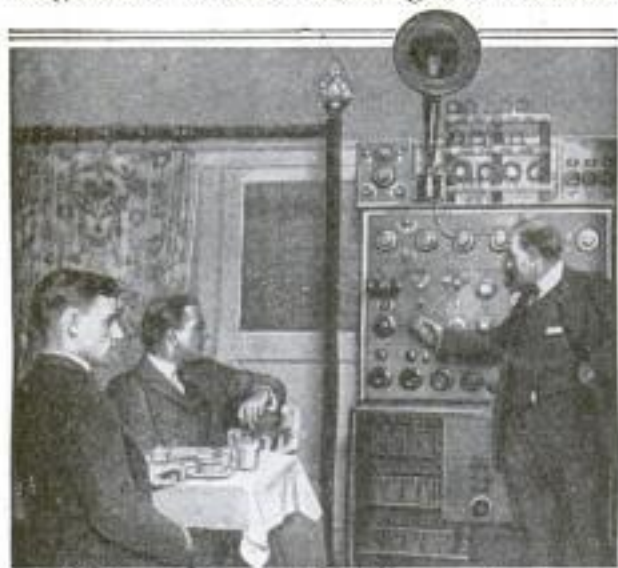

*Radio Atlantic*  
Diners at This Restaurant Are Entertained by a 16-Tube Radio Set

as 2LO, London; 2ZY, Manchester; the Eiffel Tower, Paris; Brussels, or even Rio de Janeiro, Brazil, is a common occurrence with this set.

It is used to entertain diners at the Radio Tearoom in Philadelphia.

### Coupler Permits Greater Selectivity

Requiring no adjustment, and permitting the coupling of the antenna to the receiver without causing broadening of signals, an instrument is now available which, it is said, largely does away with the need of switches, taps, etc., while permitting greater selectivity in tuning practically any unit using a variocoupler, except one-tube reflex sets. The antenna circuit is never tuned to resonance with any particular incoming signal, and the coupling of the signal to the receiver is only sufficient to excite the receiver at the wave length to which it is tuned, without adding the resistance of the antenna circuit to the secondary circuit, which always causes a broadening and loss of signals. The in-



strument also makes an excellent wave trap when used with a 23-plate variable condenser, and, when so used, it is said, adds to the strength of the incoming signals. Used in an absorbing circuit, it prevents re-radiation from sets that oscillate.

12-02.

### High-Power Station for Australia

Direct radio communication between Australia and America or Great Britain will be established with the completion of a station to be erected shortly, at a cost of approximately \$2,000,000. The transmitting equipment will have a power of at least 1,000 kw., and will be installed in duplicate. The aerial system will be supported by twenty lattice masts 80 ft. high. The receiving apparatus is to consist of five sets of high-speed commercial instruments, capable of receiving messages from five different countries simultaneously, if necessary, while the transmitter is sending messages to any of them. The main station, which will be either at Melbourne or Sydney, will transmit messages to interior cities by means of smaller transmitters.

*Engineer 11/16/23*

### Tester Shows Correct Capacity

It is often found necessary to change grid condensers after a set is built because the one originally used is not of the correct capacity. With a new "finder" the proper capacity can be found very easily. It consists of five condensers, ranging in capacity from .00005 to .0008 mf. connected to a permanent base fitted with binding posts. The five condensers give a total variation of 31 different capacity values, and by trying various combinations, it may readily be determined just what value is best for any particular hookup. The instrument will prove of value to any radio experimenter.

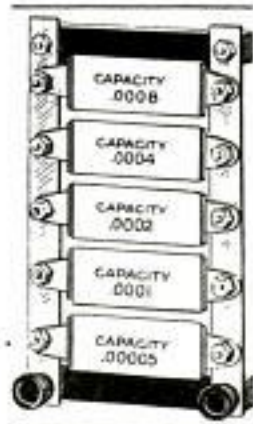

Amateur builders should carefully check up the wiring after it has been completed by marking off each wire with red ink on the plan, while tracing it from terminal to terminal in the set. This eliminates the danger of burning out tubes accidentally.

*Chas. Freshman Co.  
Inc., 106 - Seventh Ave.  
New York*

*04-0  
Electrical Research Lab.  
Michigan Ave.  
Chicago  
2515 E.*



73-R

# Neutrodyne Set Built in a Console

By F. L. BRITTIN

*1409 Rosewood Ave  
Chicago*

MANY radio amateurs would like to assemble the five-tube neutrodyne receiver in a console, but hesitate on account of the length of the panel in the usual instrument of this type. The compartment or drawer space in the average console is about 18 in. wide, and the neutrodyne panel, as given in our February issue, 1924, is 26 in. wide. This difficulty can be overcome by condensing the arrangement of the instruments, but the new layout must be very carefully considered, so as not to lessen the efficiency of the instrument. There is no doubt that the console cabinet adds to the convenience and appearance of the receiver, and, besides, it allows the storage and B-batteries to be placed out of sight in the body of the console, where they can do no harm to rugs or fine floors.

The console receiver shown in the illus-



Completed Instrument in Use, with Door of Receiver Compartment Open

trations is the one built for the editor of this magazine, and has proved very efficient in operation. It will be noted that the upper half of one compartment contains the instrument itself; in the space below this the B-batteries are placed, while the left-hand compartment holds the charger and 6-volt storage battery. A double-pole, double-throw switch is screwed to the side of the storage-battery compartment, and is used to throw the storage battery either to the receiver or to the charger. Another switch, which can either be of the knife type shown in the drawing or of the snap and plug-and-socket type, is mounted beside the first, for connecting the charger to the a.c. supply. The author has found the tungar type of battery charger to be best for this purpose, as it is practically noiseless—an item of importance in a receiver of this type. It is a good idea to place the storage battery in a glass or hard-rubber tray, so that any leakage that may take place may be detected before the cabinet is injured. Also, the charger should be placed on a thick felt pad, to absorb all vibrations, and thus lengthen the life of the tungar bulb. The B-batteries are connected as shown in the circuit diagram, and the lead wires run up through holes drilled in the bottom of the instrument drawer to the proper binding posts. These posts are mounted on a strip of bakelite at the rear of the instrument drawer, as shown in the top view

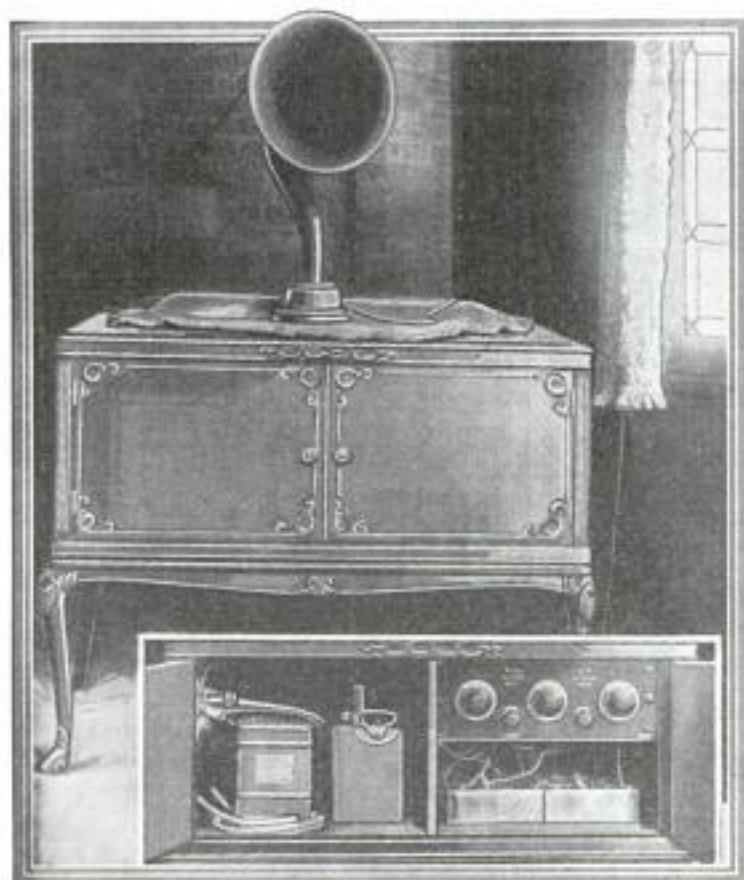

Instrument Closed, Showing Neat and Finished Appearance; Inset, Close-Up of Both Compartments



73-Q

ALL HOLES NOT OTHERWISE MARKED—NO. 26 DRILL  
COUNTERSUNK HOLES MARKED WITH DOUBLE CIRCLE.

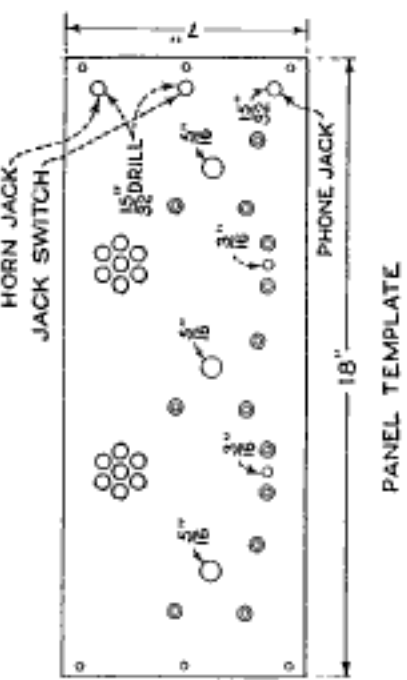

PANEL TEMPLATE

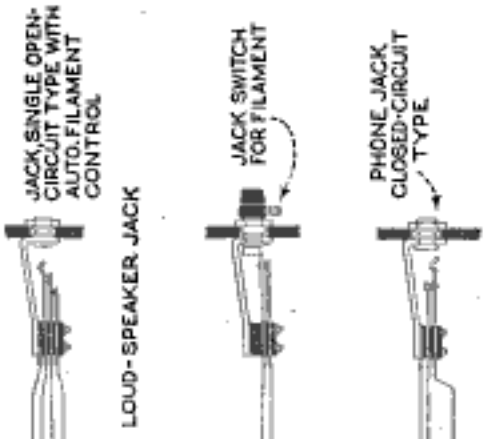
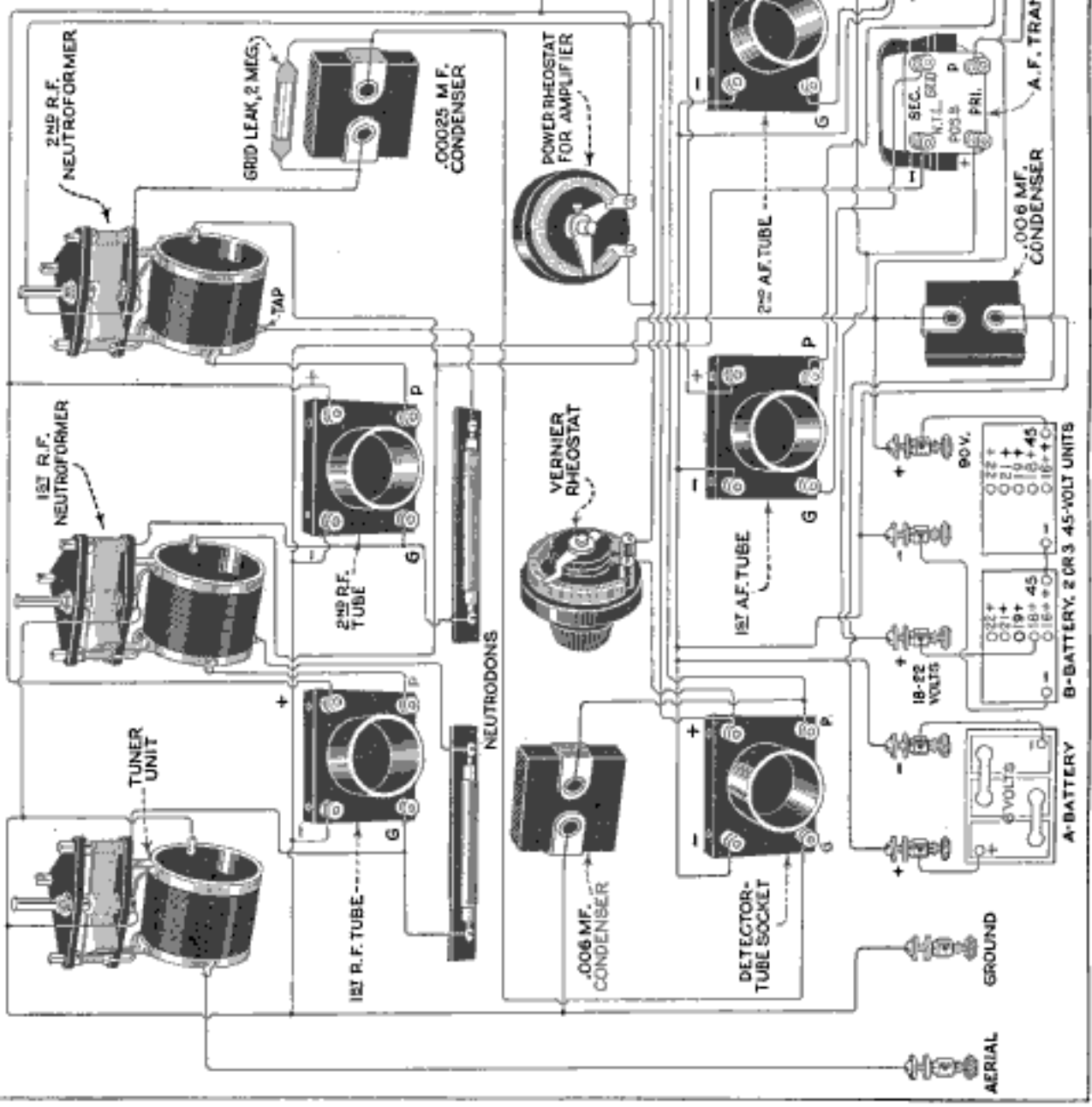

Circuit Diagram, with Instruments  
Spread Apart to Simplify the Reading  
and Following of the Wires;  
Upper Right, Outline Template of  
Panel, Showing Position of  
Control Knobs



of the receiver assembly. All outside wires, such as the aerial, ground, etc., are brought in through the back of the console and concealed from view. The panel template is shown to the right of the circuit diagram; this panel is 18 by 7 by  $\frac{3}{16}$  in. thick, but, as all consoles are not alike, only the general arrangement of the instruments is shown on the template. The builder will have no trouble in laying out his panel, however, as templates giving the correct angles are furnished with the neutroformers. The panel is set far enough back in the cabinet so that when the compartment door is closed it will clear the control knobs. The lower part of the compartment may be finished with a grill, or with a panel to match the woodwork of the console, as access to this compartment is necessary only at long intervals. The circuit diagram is a rearrangement of that given in the February number, and is shown with the instruments spread apart to make the wiring clear. All wires, however, must be kept as short as possible, for good results, while following the diagram faithfully. Tinned-copper "bus-bar" wire should be used, covered with varnished-cambric tubing where necessary, and the wiring run in straight lines, with square, sharp turns, made with a pair of pliers. The general directions given in the February article should be followed, but instead of mounting the binding posts at the front of the panel, they are fastened to the  $\frac{3}{16}$  by 1 by 7-in. strip before mentioned, which

is mounted on two small fiber blocks at the back of the drawer. Small holes are bored

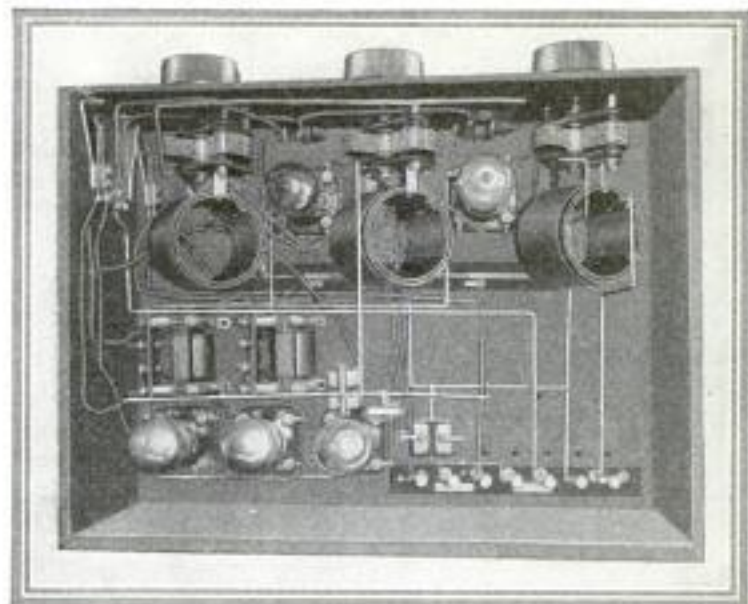

Top View of Instrument Drawer, Illustrating the Arrangement of the Tubes, Neutroformers and Transformers

below the posts for the leads from the aerial, ground and batteries.

If no drawers are provided in the console, the panel may be mounted on a baseboard of the proper size, and supporting strips glued and screwed to the sides of the cabinet so that the instrument may be removed at will. The loud speaker was placed on top of the console, as shown in the illustrations; this was thought better than trying to incorporate it into the cabinet and thus crowding out the storage battery and charger, neither of which would look as well exposed as the loud speaker.

Details for neutralizing the instrument were given in the March, 1924, issue, and, as the circuit is unchanged in its essentials, these directions may be followed throughout. The materials required for the instrument are exactly the same as for the receiver described in the February and March numbers.

### Finishing Radio Panels

Panels on radio cabinets usually have a highly polished surface but it is sometimes desirable to have a dull satin finish instead. Such a surface may be obtained by sanding the panel down with a piece of No. 0000 sandpaper, attached to a block padded with a piece of felt or similar material. The block should be about 3 or 4 in. long and the felt about  $\frac{1}{4}$  in. thick. The panel should be rubbed in one direction only. After the glossy surface is removed the panel should be wiped with an oily rag, and it will then have a beautiful satin finish.

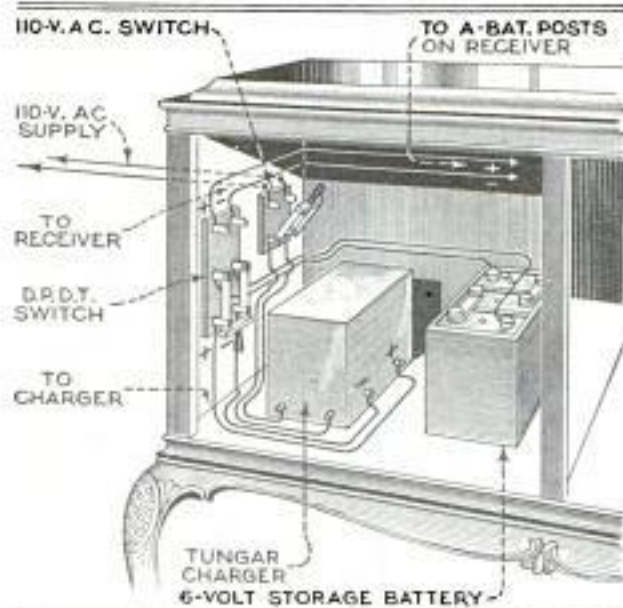

Arrangement of Battery and Charger in Left-Hand Compartment, with Wiring and Switches



101- *R*  
Set Has Parts of Solid Gold

Not many radio fans can boast of such an elaborate set as A. E. Hearland V. S. Vaughan of Chicago. The front panel, back, sides and top are made of heavy plate



*Pacific & Atlantic*  
All the Working Parts in This Set Are Made of Solid Gold

glass; this, in itself, is not entirely novel, but the really interesting part about the set is the fact that the sockets, switches, shafts, plates—in fact, all the working parts—are made of solid gold.

It is claimed that the gold parts improve the operation of the set considerably, eliminating a lot of the internal resistance, as well as reducing interference effects, and that there is no danger of corrosion. This may all be very true, but most radio fans will still have to be content with solid-brass nickelplated parts in their sets.

*64 R*  
Novel Indoor Antenna

Constructed to resemble a picture, a novel indoor antenna has the combined features of attractiveness and portability, and is unlike the loop aerial in that it is

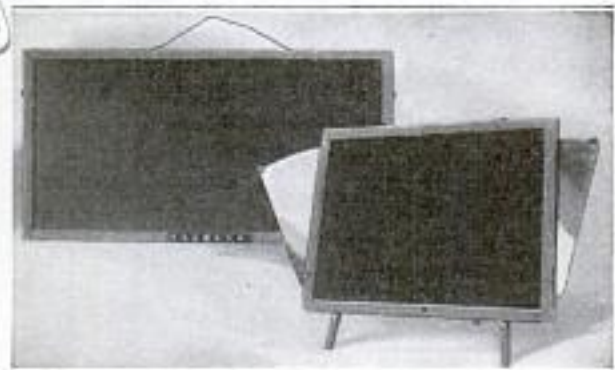

Two Types of a New Indoor Antenna that Resembles a Picture

non-directional. The larger one, shown at the left in the photograph, is about 16 by 30 in. and is designed to be hung on the

wall, while that at the right is mounted on a stand to be set on a table or desk. This antenna is designed especially for the Ingersoll circuit. Both types have two sliding plates, one for wave-length control and the other to hold the grid just below the point of oscillation. A picture may be placed inside the frame, thus adding to the attractiveness of a room, instead of detracting from it as the ordinary indoor antenna does.

*88-R*  
Opera Singer Puzzles Radio Fans

With close to five thousand radio listeners eagerly straining their ears to discover her identity, a star from the Chicago Civic Opera company recently sang at WJAZ, the Edgewater Beach Hotel station in Chicago, announced only as "Madame X."

"Who is Madame X? Guess and send us a telegram," requested the announcer, after the star had sung "Annie Laurie," "The Last Rose of Summer," and finally "Caro Nome." Did the fans respond? They did! From north, south, east and west—as far away as Portland, Oregon—came the telegrams, until the telegraph operators got cramps in their fingers, and the station officials lost count; 4,700 had been received when the official teller finally quit.

One Tennessee woman wired, "Never heard Galli-Curci in finer voice."

And 46 per cent of the guessers all over the country guessed correctly. The singer was Florence Macbeth.

*news paper*  
*66-R*  
Cleaning Crystals with Alcohol

The sensitiveness of a crystal determines to a great extent the receiving range of a set. Some crystals are much better than others in this respect, but even good ones are soon spoiled by improper care. Air causes the surface of the crystal to oxidize gradually, which of course decreases its efficiency. Dust particles in the air also lodge on the surface and adhere to it. The most trouble is, however, caused by handling the crystal, as the oil on the hands and fingers, which is imperceptible to the naked eye, insulates the surface of the crystal, and for this reason crystals should never be touched. An excellent method of cleaning crystals, which will in many cases restore the original sensitiveness, is to give them a bath in alcohol, using an old toothbrush to scrub them. It is much better to use a crystal inclosed in glass as it is better protected and will remain sensitive much longer than one exposed.

*E. R. Haan - Office*

*national appearance to N. State St. Chicago 1917*



## Blind Spots in Radio Mystify Science

WHAT is the mysterious force that makes certain spots on the earth's surface apparently impervious to radio messages? Although about fifty of these "dead" gaps have been charted in North America, and its coastwise waters, no one has found the cause for the "blind" pockets.

One of the largest dead gaps is just south of Hudson bay in Canada; another is over the ocean off Atlantic City, while a third is supposed to be in the vicinity of Camden, N. J. Neither does Mexico offer an entirely uninterrupted path to the wireless waves, for somewhere south of that country's capital a blind spot has been found in the air, and further north, on the border of Texas, there is a gap that defies passage of the wireless.

Over on the Pacific coast, three more of the trouble stretches are known to lie; one off Oregon, another near the entrance to San Francisco bay, and one in the neigh-



Mine in Mohave Desert to which Radio Is Denied by "Dead" Spot

borhood of the Santa Barbara islands. Six charted areas in which radio signals cannot be received exist in the state of California, and it is even difficult at times to get anything through to the bottom of Yosemite valley. Although radio messages can be received all around these spots and beyond them, the waves appear to collapse as soon as they enter the limits of the blind sections. In spite of the fact that other territories with exactly the same climate and land formations can be easily reached by ordinary roads, the dead areas cannot be penetrated even with sending sets placed close to their boundaries.

These blind spots have been found almost entirely by accident. Some of them have been located by parties of hikers and campers who, having small receiving sets with them for their entertainment, suddenly found that they could get nothing from any station and could raise no sound of any kind from the air. However, by moving over the ground, testing out their sets from time to time, they were able to learn the extent of the dead areas, several of which are approximately fifty square miles in extent.

Believing that the peculiar condition might affect only receiving



Hikers in Western Mountains Located Radio "Blind" Spots When Their Receiving Sets Failed to Work

Bureau of Standards have data





Yosemite Valley Where Unknown Forces Make Difficult the Sending and Receiving of Wireless

apparatus, experimenters tested the sections for sending as well, only to learn that even where almost ideal conditions existed, their signals could get through only with great difficulty.

Fortunately for ocean traffic these gaps do not occur as frequently at sea as they do on land, where the waves seem to strike some impassable force and fade out much as a ripple of water vanishes when it strikes a rock or other solid obstacle. Experts have found that radio signals which may be heard for hundreds of miles on all sides of these spots fail to cause the most powerful receivers to record a murmur when they are set within the limits of the "blind."

Investigations being carried on by radio organizations, government officials and scientists are resulting in the charting and mapping of the dead spots and, it is believed, the near future will disclose the mysterious causes responsible for the trouble. Two of the most dangerous dead areas at sea, under study by scientists, are believed to lie in mid-ocean, one on each side of the equator. Into these "holes" experts of both the United States and the British governments are systematically pouring a steady stream of radio waves from all directions. It is thought that some of the unsolved disappearances of ships equipped with radio apparatus may be due to their presence in these "hidden" waters



Map Showing Approximate Positions of California's "Dead" Gaps through which Radio Will Not Pass

when disaster overtook them. Of scores of theories advanced to explain the strange conditions almost all have been tested and found groundless. One not yet thoroughly tried is said to be that some form of energy in the air, not known to science, exists in these places, and when vibrating at the same rate as the radio waves it meets, causes the annihilation of both forces. If this proves true, some form of treatment for these areas will be necessary to make them free for the passage of the wireless.

In view of the fact that radio signals sent at night can be made to travel two to



five times as far as those sent during the day, it is thought by some that excessive heat may be the cause of the dead spots, and tests are to be held over the territories just before dawn when temperatures are at the lowest. Mineral deposits will be sounded in mountainous districts to determine if they have any effect on the passage of the wave, for it has been pointed out that the flow of wireless passes most rapidly over plains and wide valleys. One of the most troublesome spots, however, is on the comparatively smooth floor of the desert in southeastern California, and another is over the low hills on the eastern shore of San Francisco bay.

No sooner do certain conditions appear to be true of all these dead spots, than another one is found which does not offer the same conditions of difficulty and conforms to none of those previously discovered. The radio-restricted areas all seem to have little in common, except that they will not carry the waves across the trouble gaps. Two spots in northern California are in heavily forested territory, and it has been said that such growths offer an obstacle to radio because the leaves and trunks of the large trees absorb the energy from the ether. Many radio experts do not accept this as a fact, however. For a long time it was held that failure of radio waves to "arrive" was due to slow absorption of the energy, but this has been proved untrue, hence it cannot assist the searchers in their hunt for the mysterious power that stops messages in certain districts that, to the ordinary observer, look exactly like miles of other territory that permits rapid travel to the fleeting flow of the radio.

**Tube Socket Has Spring Clip**

Hard rubber is the material employed in the construction of a tube socket that is claimed to have several advantages in its favor. One of its features is a spring clip mounted on the side, which holds the tube firmly in position without having to twist it against the push of strong base springs. Such action, it is said, frequently has a tendency to weaken the base, permitting air seepage and the early ruin of the tube. The tube is quickly released by springing out the clip with the thumb or forefinger. Another good feature is a side mounting ridge which enables the builder to mount the tube on the panel if he desires.



the tube on the panel if he desires.

*Goodrich Rubber Co.  
Akron, Ohio*

**Radio in Milady's Vanity Case**

A number of designers have built receiving sets in cigar boxes, safety-razor cases, matchboxes and what not, but now we have a really practical set built in a vanity case.

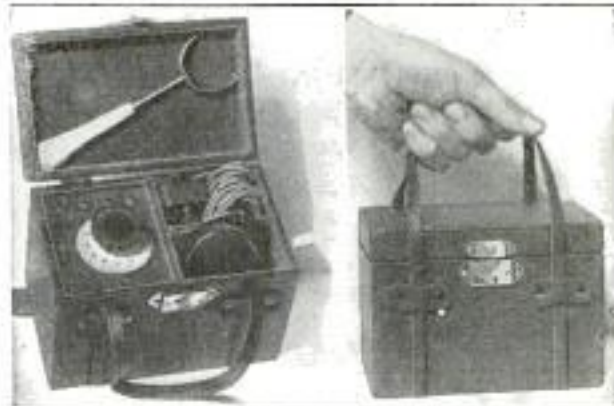

Left, Vanity-Case Set Open, Showing Single Control; Right, Case Closed

The complete set, including phone, aerial and ground, is contained in the case, which measures 7 by 4 by 4 inches, and is covered with leather. The parts are arranged with a view not only to compactness, but also to efficiency, and the instrument is well made and finished, the case being velvet-lined. This set may be used at home, in the office, in a hotel, in an auto, in fact anywhere, as no outside wires of any kind are used.

**Preventing Aerial from Rolling**

One of the most common troubles experienced with multi-conductor aerials is that the spreader turns around in a windstorm and the wires cross, making it necessary to climb up on the roof to disentangle them again. A simple and effective method of preventing this trouble is to suspend a weight, which may be a heavy pipe elbow, from each spreader as shown in the illustration. The weight is tied to the center of a rope and the ends of the rope fastened to the ends of the spreaders as shown.—M. E. Duggan, Kenosha, Wis.

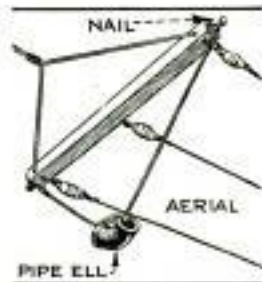

In many cases silent tubes are due to imperfect contact between the prongs of the tube and the spring terminals of the socket. This trouble can readily be eliminated by bending the latter up a trifle to insure a good connection.

*95- R  
Dr. J. W. Davis B. Hagerman, Peck, Ill.  
Chicago Engineering School, Ill.*

*107- OR*

*1714 Prairie Ave*



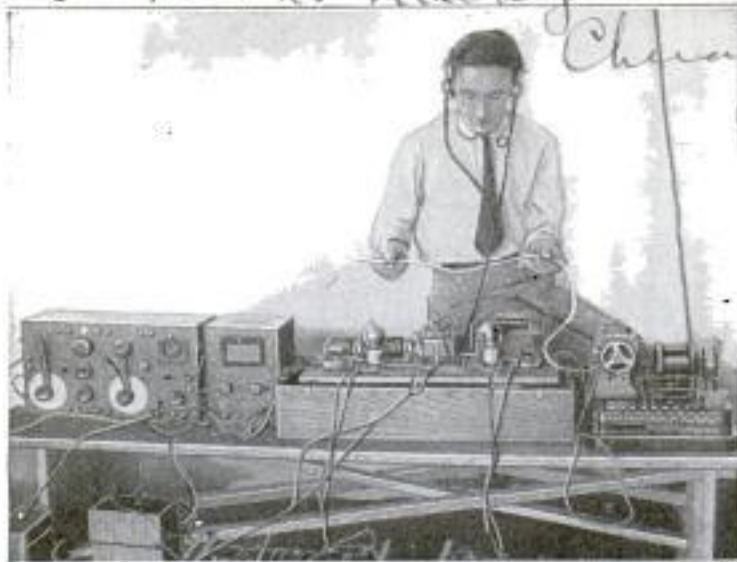

Reading a Typewritten Message Sent by an Aeroplane Many Miles Away in the Clouds

**Radio Typewriter Success on Planes**

Typewriting in a plane flying among the clouds, with a radio-controlled machine duplicating the message in a ground station miles away, is a new development announced by the Navy Department. The new system gives aircraft a means of communication considerably in advance of radio telegraph and telephones now in use, and has been named the "teletype."

130-6  
 [The Danish Folkething has agreed to advance the money necessary for the erection of four radio stations in Greenland.]

*The Renew (London)*

29- R **Drilling Two-Color Panels**

The two-color panel stock that is now on the market owes its resemblance to polished mahogany to a thin layer of veneer about 1/2 in. thick, which is pressed into the material when it is made. Certain precautions are required in drilling these panels, as the veneer is brittle, and therefore cracks very easily, and cracks that would otherwise be almost invisible are made very conspicuous because the veneer is light in color. A simple method of reducing the danger of splitting the veneer is to drill the holes from the front and not from the back, using a sharp bit to do the work, and laying the panel down so that it is solidly supported.

69- R **Phone Block Connects Six Headsets**

A particularly neat and efficient connector is now available for hooking up a number of headsets at once. The "phone block" is mounted on a hard-rubber panel,

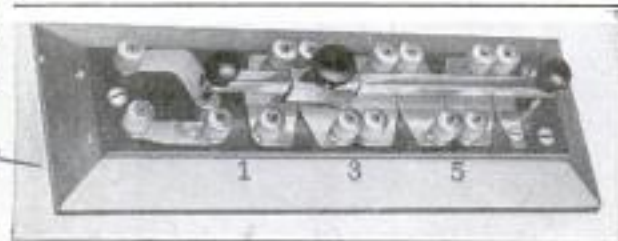

A Neat and Efficient Phone Connector that Takes Up to Six Headsets

set on a mahogany-finish base. It is equipped with combination jack binding posts, thus making connection easy. A sliding bar, passing over special contact

plates, throws any number of phones up to six into the active circuit. There is no wiring in the block, and no danger of short circuits occurring between cord tips.

63- R **Grid Leak Has Flexible Ribbon Element**

A rather novel variable grid leak, which has some distinct advantages over the common type, has made its appearance. The varying element is a flexible ribbon, which is fed between two metal rollers by turning the knob in the usual way. The resisting material is spread on the ribbon in a pennant shape, the strip being narrow at the free end of the ribbon, and constantly becoming wider toward the other end. The ribbon is of fiber, impervious to moisture, and the resistance material, it is said, will not rub off, thereby varying the conductivity. The action is smooth throughout its range and affords positive leak control at all points.

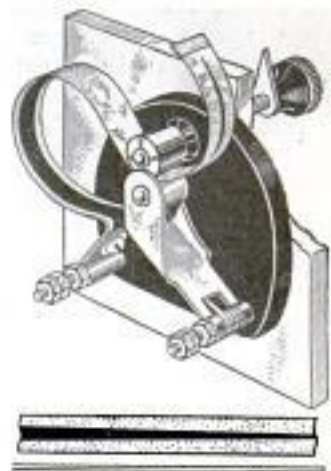

[When a tube turns bluish it is a warning to the user of too much plate voltage from the B-battery. The remedy is to reduce the plate voltage immediately.]

Monroe Mfg. Co.,  
 30 S. Franklin  
 Chicago

A.C. Cole, Box 44  
 Chicago  
 Monroe Mfg. Co.,  
 Reading Mass.



## EARTH-BORING MACHINE CUTS LABOR COSTS

143-2

Engineers, contractors and telegraph and telephone line chiefs have been able to "mechanicalize" most of their work except the digging of holes and setting of poles. This has been one of the most expensive parts of installation and repair work, because it has been necessary to do it by hand labor, with inefficient tools, at best. Now, however, comes a machine that not only digs the holes but sets the poles as well. The machine is mounted on a four-wheel drive truck, which is of special advantage in negotiating the bad roads, ditches and fields where telephone and telegraph lines must be installed. In addition to this, the short turning radius of the truck (25 ft. 3 in.) enables the machine to go easily into and out of

the confined spaces met in city work. It is claimed that the machine will dig holes in any ground except solid rock, and that two or three men with it can dig more holes and set more poles in a day than 60 men can do by hand. The boring machine is driven from the truck transmission through special gearing, which is under the complete control of the truck driver. Three speeds and reverse are obtainable through the regular transmission, and the speed is controlled by the accelerator just as the speed of the truck is governed. The

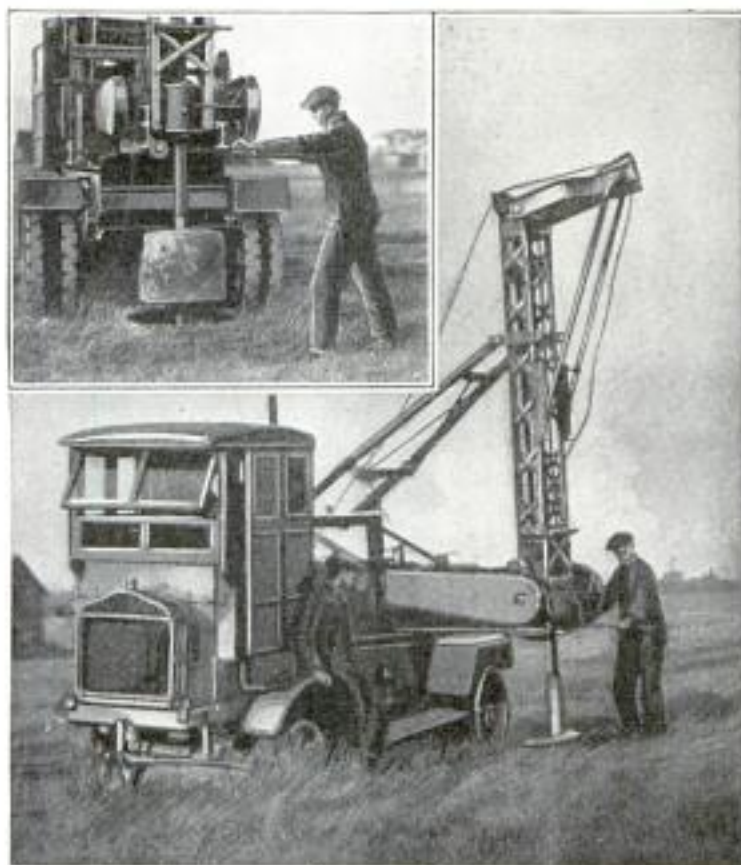

Upper Left, Digging at Rear of Truck; Below, Digging a Hole with Tower Swung over Side of Truck

winch for hoisting and setting the poles is also power-driven, and the whole tower may be swung in a wide arc around the truck. The machine can also be used for pulling poles.

## EXHAUST-GAS ANALYZER CHECKS CARBURETORS

155-72

A rather simple device, evolved by the U. S. bureau of mines, is now available for analyzing the exhaust gases from internal-combustion engines. It provides a ready method of setting or adjusting a carburetor on a really scientific basis; only a few minutes are required to make a test and the apparatus can be used by anyone.

The more completely the mixture in an internal-combustion engine is burned, the greater the efficiency. The exhaust gas is made up of a mixture of various gases, including carbon dioxide. When the mixture is well burned, the carbon-dioxide content is relatively high and it is lower as the combustion is less complete and efficiency drops.

By measuring the carbon-dioxide con-

tent in the exhaust gas, it is readily determined just how well the mixture is being burned. This is what the analyzer does. After the test is made, the mixture may be enriched or made leaner until the proportion of carbon dioxide is correct.

## WISE HAS ALL-STEEL SLIDE

149-2

It is said that broken slides account for the scrapping of 90 per cent of all vises thrown out of service. A vise with an all-steel slide, which is now available, should appeal to all vise purchasers, therefore. Several other refinements are incorporated in the design of the vise. For instance, the square-thread screw is retained by a cap in front of the sliding jaw, thus eliminating the necessity of coring the inside of the vise for a collar. The nut, which is of ample length, is replaceable.

Burritt Tech. Safety Co.  
Pittsburgh, Pa

Copyrighted material  
Woodbury, N.Y.



Storm Mfg Co.  
 Milwaukee  
 POPULAR MECHANICS

no. Char L Boissel  
 Box 1505,  
 New Orleans, La.

942

**MOTOR-DRIVEN TOOL HONES**

123 *m* **AUTO CYLINDERS**

The "honing" of automobile cylinders to correct the uneven wear caused by the friction of the rings and the angular thrust

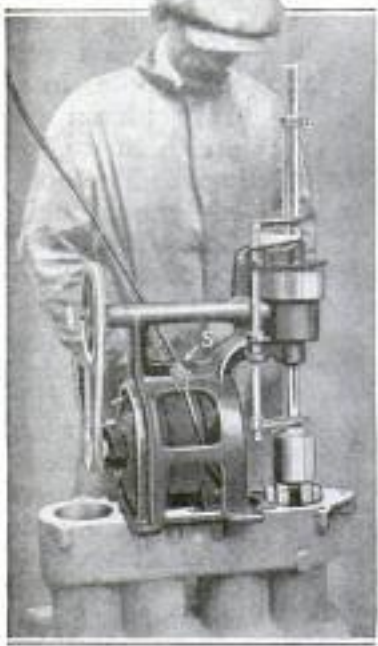

of the connecting rods is now a well-known process, although of comparatively recent origin. In small shops, however, the tools available for the work have usually been driven by a hand electric drill, and the feeding of the hone up and down in the cylinders has been accom-

plished by hand—a tiresome process. Now, a motor-driven tool has been developed that may be clamped on the cylinder head, and, when once set, need not be touched until the cylinder is finished. The hone is simply set in the cylinder, a pair of collars set to reverse the travel of the hone at the points desired, and the motor started. The hone centers the machine above the bore, and is automatically fed back and forth at the proper speed without further attention.

This is a very useful machine for re-sizing cylinders, and for fitting oversize pistons. It may also be used for producing the final polish after boring, reaming, or grinding the cylinders.

**SAFETY BLOW-OFF VALVE**

In many power plants two or more boilers may be connected to one common line



Safety Double-Flap Blow-Off Valve: the Cone-Shaped Section Is Designed to Fit Directly in a Sewer Manhole

for blow-off purposes, and where this is practiced extensively carelessness on the

part of operators may result in the severe scalding of a man working in an empty boiler. The blow-off usually takes some little time, and there is an inclination on the part of the boiler attendant to open a valve and then to plan to go back to close it when the blow-off is completed. If the valve is left open inadvertently, there is the danger of injury to a worker if the blow-off valve be opened on the other boiler.

To prevent this, a Chicago man has recently brought out a double-seated flap valve. A vertical pin hinges the V-shaped flap valve between two 4-in. pipes receiving the blow-down from adjacent boilers. The valve is seated so that it blocks the entrance to one boiler of the pair, and the outcoming steam or any back pressure building up serves to hold it fast in place. When one wing is open to allow the blow-down to pass, the other wing automatically closes the entrance to the other boiler, and there is no chance for the steam to get into the boiler and injure a man who may be repairing or cleaning it.

**TOOLS REPAIR CORK-INSERT**

139-*m* **CLUTCH DISKS**

Worn-out cork-insert clutch disks may be repaired in a minimum of time with a pair of tools lately developed, thus not

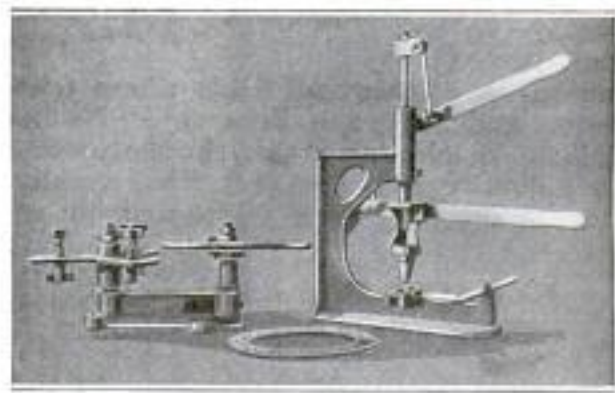

Tools for Re-Corking and Trimming Worn-Out Cork-Insert Clutch Disks

only saving the customer money, but saving a great deal of time in the service station and reducing the amount of stock it is necessary to carry.

With the new tools, a man can re-cork and trim a set of eight disks in less than an hour, leaving the disks just as good as new.

162-*m*  
 An electric motor has recently been built that runs at the very high speed of 10,000 r.p.m. The output is 25 hp., and the unit is designed for a 300-volt d.c. circuit. Operation is reported to have been very satisfactory.

Mawdsley's Ltd.  
 Hursley, Gloucestershire,  
 England

J. W. Pearl, 30 N. La Salle St Chicago



### SCRAPER WORKS SURFACE BACK AND FORTH

A road scraper that is claimed to be fool-proof, that will not destroy the road crown even when driven by an inexperienced man, will surface 30 miles in a day and can be operated by one man, is the invention of an Iowa engineer.

The frame carries three scraping blades, mounted at a wide angle to each other so that the dirt or gravel is worked back and forth for a distance of 42 feet, and the material thus thoroughly pulverized. This permits the road surface to pack down hard.

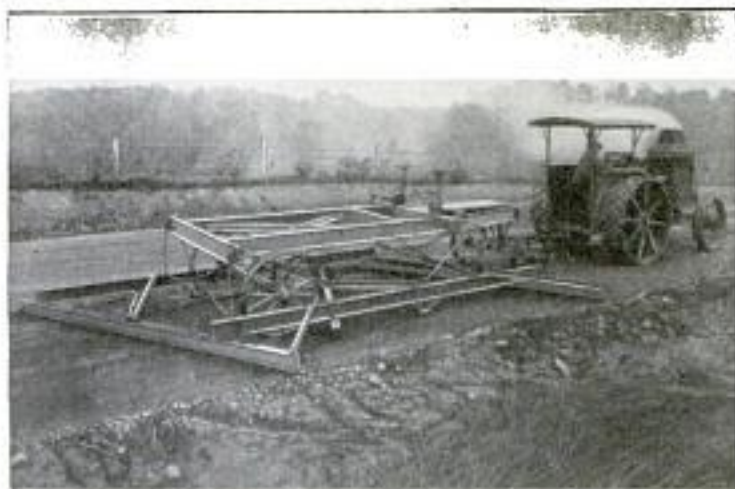

Road Scraper that Works Material Back and Forth Across Roadway for a Length of 42 Feet

### CARPENTERS' HANDSAW HAS SQUARE ATTACHMENT

An improvement on the carpenters' saw that greatly increases its usefulness has been made by an eastern inventor. It consists of an attachment

that converts the saw into a square. A U-shaped metal strap is fitted to the blade close to the handle, and has upturned flanges that form the short

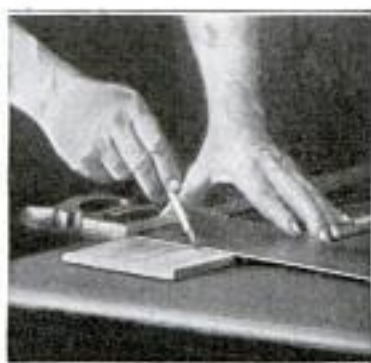

arm of the square, the device being set accurately at right angles to the back of the saw blade. The back may thus be used as the long arm of the carpenters' square is used, to mark across boards, etc. The device makes it possible for the workman to eliminate one tool from his kit, which in itself is a great convenience.

### PROTECTING ALUMINUM IN CLEANING BATH

The practice employed in railroad and other maintenance shops, of cleaning dirty parts in a boiling soda or potash solution involves difficulties in the automobile industry, because the solutions dissolve aluminum and its alloys. The use of sodium silicate (water glass) to prevent this has been the subject of experiments made in Germany. It was found that the addition of 1/2 per cent of water glass to the soda solution either reduced greatly or entirely eliminated the solvent action.

A protective coating obtained by dipping the article in a boiling soda solution containing water glass was also found effective in a cold soda solution. It is recommended, therefore, that the aluminum parts of an automobile be protected from the action of solvents by filling the cooling system, for the first time, with a weak soda solution containing a small percentage of water glass instead of with pure water.

### HOLE CENTERS TRANSFERRED BY PUNCH

Intended for sheet-steel and plate work, a new punch greatly facilitates the work of transferring hole centers from a template or from one sheet to another. The body of the tool has a wide conical center drilled lengthwise to take a prick punch. The body is supported by three legs to keep it vertical on the template or plate. In use, the conical nose is simply set in the hole in the template, thus automatically centering the tool, and the upper end of the prick punch is tapped with a hammer; this makes the center mark on the lower plate or sheet. The prick punch is kept up by means of a spring contained in the body, so that it returns in readiness for the next hole after every hammer tap.



*Arden Industrial*  
*2/14/24*  
*Arden Industrial Co. White Lake, Michigan*  
*Copyrighted material*  
*Warland, N.C.*



**GAUGE CHECKS CYLINDERS**

An instrument that indicates conveniently and accurately the size and concentricity of a cylinder throughout its entire length has recently been placed on the

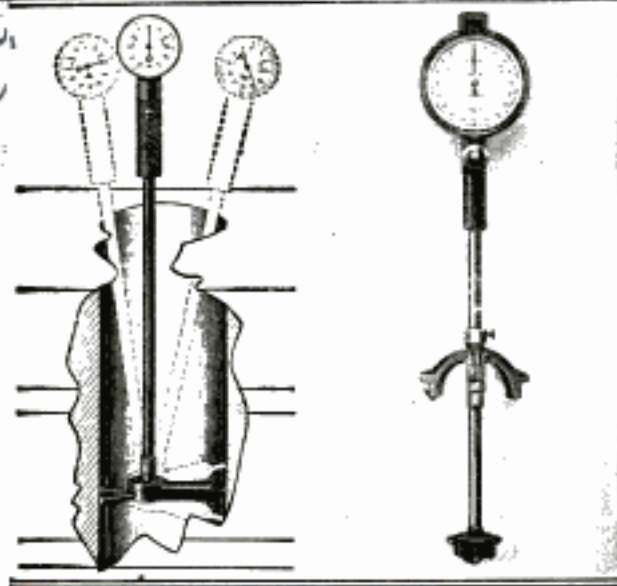

Left, Gauge in Place in Cylinder, Showing Method of Use; Right, Gauge with Centering Attachment

market. It is made in two models, one for those who have a variety of models to test and one for those having occasion to measure only cylinders of a standard size.

The gauge fingers project from a casing mounted on the bottom of a tube, through which runs the rod that actuates the dial hand. By pushing down a button on the dial sleeve, the fingers are drawn in sufficiently to enable them to be placed within the cylinder. Releasing the pressure on the button permits the fingers to press against the cylinder wall.

The fingers, before insertion in the cylinder, are set to a master gauge, while the dial is turned until the hand registers zero. The gauge is then used in somewhat the same manner as an inside micrometer. One model is fitted with an attachment that holds it central in the cylinder, to facilitate inspection for variation in diameter.

**GROUND TAPS EFFECT ECONOMY**

All distorting effects, such as warped teeth, bent taps, etc., caused by the hardening, are overcome in a new line of taps by grinding the shanks and thread forms after hardening.

The taps are made of high-speed steel only, and as they can be carried to full high-speed hardening heat without troubling about fused points or edges, since

these are corrected in grinding, they are said to give better results in service than unground taps. Ground taps run true in a true holder, cut to accurate size, and make threads of accurate lead, thus making fitting of properly made screws unnecessary in assembly.

**HOT SWAGING REDUCES COST OF AXLE SHAFTS**

Stronger live rear-axle shafts, at a reduced cost, are produced by means of hot swaging, according to R. A. DeVlieg, in a paper read before a recent meeting of the Society of Automotive Engineers. His conclusion was that, of the four existing methods of roughing live-axle shafts, hot swaging is much cheaper than rolling, forging under steam hammers, or turning.

Practically no stock is wasted, as the original bar is 8 in. shorter and  $\frac{1}{8}$  in. larger in diameter than the finished axle, and only about  $\frac{3}{4}$  in. is sheared off the small end. The physical properties of the steel are improved about 15 per cent.

**MACHINE MARKS PARTS**

**146 RAPIDLY**

A new type of marking machine for stamping sizes, trade-marks or other designs upon bushings or other similar cylindrical work has recently been brought out. It is simple and positive in action, has no



reversing or reciprocating parts and the work travels continuously in one direction from the feed chute to the marking die; thence it is thrown out automatically to a receptacle placed to receive it. The stamp may be adjusted to make the impressions light or heavy or to set it for various sizes of

work. With the dial feed supplied, work up to  $1\frac{1}{4}$ -in. diameter may be marked, but by substituting another dial the capacity may be increased. Pieces may be marked at the rate of 6,000 to 7,500 per hour.

Noble + Westbrook  
Mfg. Co. Hartford, Conn.

A-60.00  
 B-50.00  
 F. A. B. Providence  
 Jones + Lamson Machine Co. Springfield, Vt.

Maxwell Mfg. Corp.  
 146  
 Noble + Westbrook Mfg. Co. Conn.



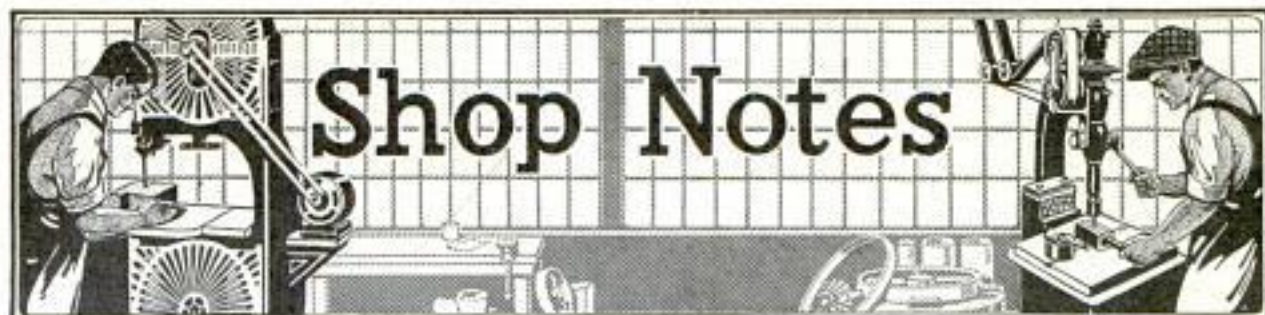

All Shop Notes published in 1923, in book form—Fifty Cents—from our Book Department

## A Drinking Fountain for Small Stock

By L. R. BUTCHER

IT is a well-known fact that swine make faster gains and are much healthier if fresh water is available at all times. However, some farmers dislike to buy the number of watering devices necessary to install one in each feed lot. This should keep no farmer from using them, for, in odd moments or on rainy days, he can make watering devices that serve every need just as well as the manufactured ones. They can be made in the farm shop at little cost.

The completed fountain, as shown in the illustrations, is connected directly to the farm watering system. The lever and float arrangement allows the device to be used on any system of ordinary pressure. Once

installed, the fountain requires no attention save an occasional cleaning. If desired, it is as readily attached to a stock tank or a supply barrel.

The box for the fountain consists of two parts: a drinking compartment and a float

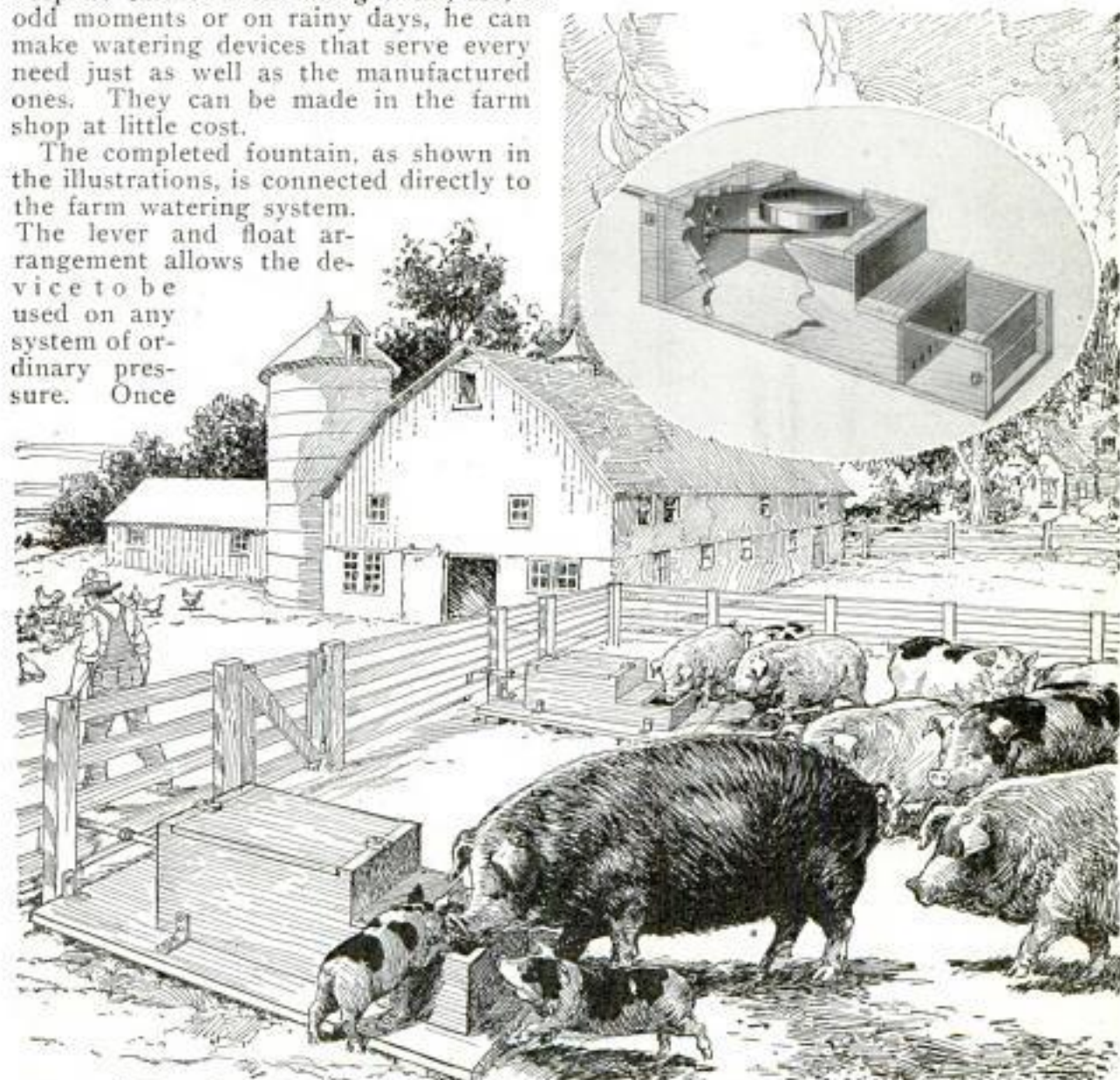

Automatic Fountains for Small Stock May Easily Be Made by the Farmer at Home, and Will Quickly Repay Him for the Time Spent; Insert, Arrangement of Float



chamber. Water flows from the float chamber to the drinking compartment through small holes drilled through the partition. These holes should be about 2 in. above the bottom of the box. Located in this manner, little dirt or trash will find its way from the drinking compartment into the float chamber. The detail drawing gives all general dimensions necessary to make the box; the sides are of 2-in. material, and all other parts of 1-in. stock. The cover is held in place by two buttons—one at each end—such as are used to fasten window screens in place.

The float and lever arrangement is shown in the insert. A bracket is fastened to the inside of the float compartment and forms a pivot point for the lever. One end of the lever carries the float, while the bent end presses against the leather valve

placed over the end of the supply pipe. As the float rises, the leather is pressed against the end of the pipe, cutting off the water supply until the water level is lowered. The supply pipe should project through the end of the box about  $\frac{1}{16}$  in., providing a firm seat for the valve. One-eighth-inch pipe has a large enough opening for the supply, and if the hole for the pipe is bored slightly smaller than the outside diameter of the pipe, the threaded end of the pipe

can be screwed into the wood. A liberal coat of white lead will keep the joint from leaking. The float shown in the photograph is attached almost directly to the lever, but a better arrangement would be to connect the two with a short chain. The water level of the fountain may then be changed by changing the float level, and adjustment may be made for any desired level. The detail drawings require but little explanation. Galvanized metal should, of course, be used for the float; scraps of sheet metal may be used, if large enough. The bracket is cut from a sheet of  $\frac{1}{8}$ -in. metal and bent to shape before drilling. Bending can be done cold, although the work will be easier if the metal is heated. The float lever is made from  $\frac{1}{8}$  by  $\frac{1}{2}$ -in. strap iron. Heat will be necessary to make the bend

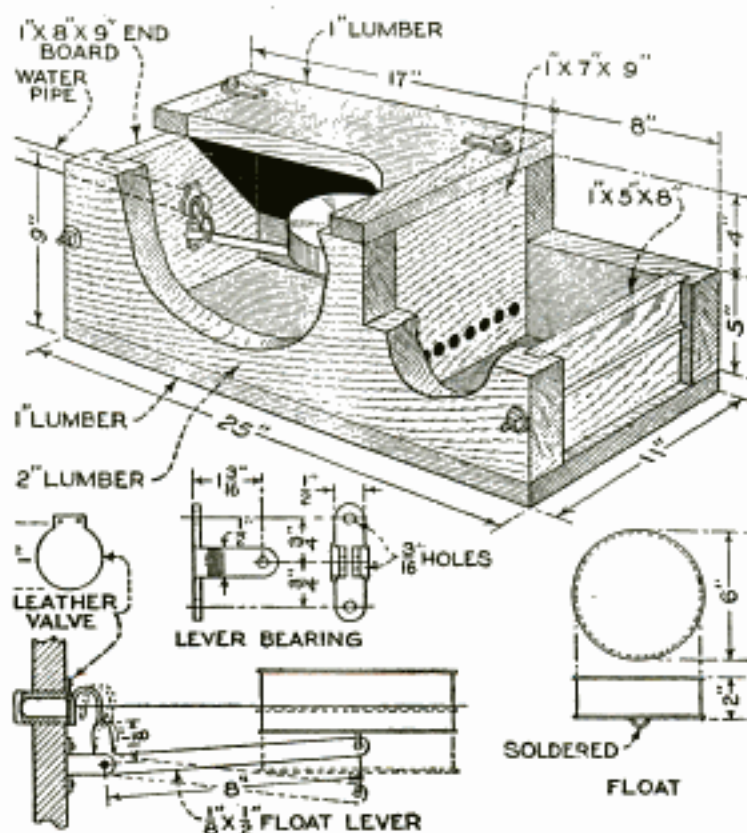

Details and Dimensions of the Automatic Fountain, Showing the Inlet Valve and Float Mechanism

at the pivot point. The quarter-turn is made by clamping the piece in the vise and bending with a heavy pair of tongs. A heavy cotter pin or a stove bolt serves as a pivot. One caution should be observed in installing the fountain—it must be fastened firmly in place. If this is not done, the swine will shove and lift the fountain until leaky joints develop. If very small pigs are to drink from the device, it is well to cover part of the compartment as shown.

### Mirrors Useful in Garage

Small mirrors have been found very useful in an automobile repair shop when repairing cars. They are used for reflecting light into such places as the differential. The mirrors can also be used for reflecting light upward when working behind the instrument board. Handles should be provided on the mirrors so that they can be inserted in narrow places.

### Melting Metal for Alloys

In making alloys first melt the metal of the highest fusing point, and when this is melted, drop in the other metal, broken into chunks. Cover the surface of the molten metal with salt or other flux, or with charcoal, in order to prevent oxidation. The metals should be stirred well with an iron or graphite rod before pouring from the crucible.



### Supporting Long, Slender Work in Lathe

A very efficient method of supporting slender work required to be turned down in a lathe is shown in the drawing. When turning work of this description, if the diameter is small, a center in the end is not of much value unless a number of very light cuts are taken, as the work will spring away from the tool when near the center.

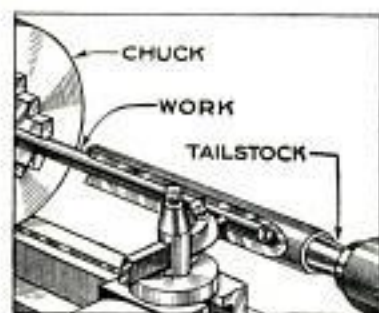

When a number of such pieces require to be turned, get a piece of stock large enough to give it strength. Turn one end

to fit the tailstock spindle and bore out to the diameter of the stock to be turned. A V-slot is next cut the length of the bore. This slot should be just wide enough to clear the tool at the bottom and allow for the escape of chips at the top. In this manner the work is well supported throughout its length and can be finished in one cut.

### Heating Water with Steam

In many shops no provision is made for hot water for toilet purposes, although the buildings are heated with steam. In



such cases, a steam line is often run to a point near the sink, and a hose run from the end of the pipe into the water. This heats the water quickly enough when the steam is turned on, but

it is accompanied by an annoying noise, and the steam is apt to burn a careless user. A much neater arrangement is shown in the photo. Here the steam line is connected to the water pipe before the latter enters the sink, and is fitted with a globe valve to control the steam pressure. When the valve is opened full the steam heats the water to the boiling point. It is advisable in an arrangement of this kind, of course, to have the water turned on before opening the steam valve, especially when the steam pressure is low.

### Vacuum Cleaner Furnishes Torch Blast

For soldering jobs that require higher temperatures than usual and for light



Hot Brazing Flame Produced by Using Ordinary Gas and Compressed Air from Vacuum Cleaner

brazing work, a mixture of forced air and ordinary cooking gas may be used to produce the desired heat. A compressor was thought to be too expensive in one case, and therefore the method of providing air by means of an old vacuum cleaner, as shown in the drawing, was resorted to and found satisfactory. A small hole was cut in the dust bag and a  $\frac{1}{4}$ -in. pipe nipple inserted, with washers and nuts on both sides to hold it in place. A length of gas tubing connected the nipple and the brazing nozzle, which was also connected to the gas outlet on the wall. The heat of the flame was varied by properly regulating the air and gas supplies. With some cleaners, an attachment can be had that locks on the outlet of the fan in place of the bag. If an attachment of this kind can be obtained, and the air hose attached to it instead of to the bag, a much neater and better job will result.

### Patching Auto Tops

When patching auto tops it is a good plan to place a board across the top bows under the covering to provide a firm surface on which to work. After the patch is applied a weight should be placed on it and left until the cement is dry, so that the patch will not curl up at the edges.



# MECHANICAL POWERS

By **CARL W. MITMAN**

*Curator*

DIVISIONS OF MINERAL AND  
MECHANICAL TECHNOLOGY  
UNITED STATES NATIONAL  
MUSEUM



Copyrighted, H. H. Windsor

This is the fourth article of a series by Curator Mitman, explaining in simple language what every man who builds or designs a machine must know, and showing in detail just how to build a set of models of the mechanical powers that will exactly duplicate the set in the National Museum at Washington, D. C. The first articles of the series appeared in the March, April, and May issues, and the next will appear in the July number.

## Part IV—Gravity: Revolving Levers

**N**O consideration of mechanics would be complete were it to avoid a discussion of that prevalent natural force, gravity. This unseen attractive force exists between the earth and all other bodies and is endeavoring constantly to pull them downward to the earth. The measure of this pull is called weight. For instance, it is commonly stated that a man weighs 150



pounds, which simply means that he is being drawn to the earth by a force equal to that which pulls downward 150 standard 1-lb. weights. This pull is greatest at or near the earth's surface, but decreases with increasing depth beneath the surface, and also with increasing altitude above the surface. Furthermore, it varies for different localities upon the earth's surface, depending upon the distance of each place above or below the equator. This is due to the fact that the diameter of the earth through the north and south poles is 26 miles shorter than the diameter through the equator, in other words, the earth is not a perfect sphere.

Gravity pulls all bodies toward the earth's center, but as each body is made up of many particles, each of which has weight, the gravity of that body acts in the direction of lines (as many as there are particles composing the body) converging and meeting at the earth's center. The

length of these lines, however, in proportion to the dimensions of the body, is so great that they are always assumed to be parallel. Furthermore, by one of the fundamental laws of mechanics, these parallel-acting forces can be compounded into a single force equal to the sum of the weights of the particles composing that body, and whatever may be its position, there is always one point in the body through which this single force will pass; this point is called the center of gravity. It is the point at which the weight of a body is concentrated and thus may be defined as that point about which a body will balance in any position.

The importance of taking into consideration the center of gravity in the design and construction of every machine or other structure has resulted in making available many formulas and directions for finding the center of gravity of lines, areas and solids, and the reader is referred to this literature for the solution of specific problems.

The term revolving lever is not one of common usage to describe any particular type of machine but is the selection of the writer as a name for a class of mechanical powers which operate on the principle of the wheel and





axle, but which are quite distinct in appearance from the commonly accepted form. The distinctive feature of the so-called revolving lever is the axle, which, instead of being elongated as in the several types of windlasses, is short and, in fact, is more like the hub of the wheel than anything else. As an aid to raising heavy loads, a rope is usually attached to the load and to the hub or axle and power is applied to the wheel through another rope which fits into a groove in the wheel. By applying the power to the wheel through a rope rather than directly to the wheel a wider range of positions for the applied force is obtained. For instance, if manual power is used, applied through a rope or chain attached to the wheel, the pull may be directed downward, upward or horizontally, and at any convenient distance from the machine. The principle involved is, of course, one of the lever arms, and as in straight levers, three classes or orders of revolving levers are recognized, depending upon the relative positions of the fulcrum, a



plied force and resisting force. As in the case of the wheel and axle, the center of the revolving lever corresponds to the fulcrum, the wheel to the long arm and the hub or axle to the short arm of the simple lever. A revolving lever of the first order is shown in Fig. 1, reproduced from a model. The applied force acts downward, as does the resisting force, but the two forces are on opposite sides of the fulcrum. The mechanical advantage gained in this machine is the same as in a straight lever of the same order with the added advantage that the action is continuous. By reversing the direction of winding of the rope on the wheel, the applied force will be in an upward direction, as shown in Fig. 2. By this arrangement, however, the action becomes that of a second-order lever, having both applied and resisting forces on the same side of the fulcrum but with the same mechanical advantage. Still another arrangement that can be made is that shown in Fig. 3, illustrating a revolving lever of the third order,

More power is required to raise a given load than with the first or second-order forms, but if speed of raising the load is of first importance, this arrangement will bring about the desired result. In all the various types of lever actions discussed so



Model of Revolving-Lever Train

far in this series, the principle of moments has been considered, and it is undoubtedly realized that the relative lengths of the two arms of each lever influence the work which can be done. So, in the case of revolving levers, their efficiency can be augmented by diminishing the diameter of the hub or by increasing the diameter of the wheel. But the amount of increase in efficiency of a single machine is limited, for, if a very great power is required, either the hub would become too small to support the weight or the wheel would have to be made inconveniently large. For a case such as this a combination of revolving levers may be used, resulting in a system of machines which corresponds to the compound lever and which is governed by the same law.

A system such as this is illustrated in Fig. 4. The pull exerted on the first wheel transmits its effect to the axle or hub of that wheel, this acts by friction on the second wheel, which transfers the effect to the second hub, and so on, until the original applied force transmitted through the series in this order arrives at the last hub where the resisting force is encountered.

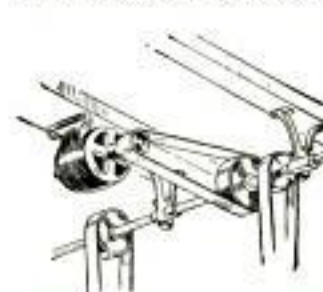

According to the principle of moments, the applied force in this machine multiplied by the continued product of the radii of all the wheels, is equal to the resisting force multiplied by the continued product of the radii of the hubs. In actual practice compound revolving levers are extensively used



but not exactly with the transmission form described above. Instead, for some purposes, both the wheels and hubs are toothed, and for others they are connected by belts. When so arranged, the series is called a train; a wheel which imparts motion is called a driver and one which receives motion, a driven wheel. Where the toothed-wheel arrangement is met with, calculations as to size of wheels, necessary applied force, etc., are figured by using the number of teeth in the wheels, since these are proportional to the circumference and also the radii of the wheels, and the principle of moments is stated thus: The applied force multiplied by the product of the number of teeth of all the wheels, is equal to the resisting force multiplied by the product of the number of teeth in all the hubs or pinions.

In the discussion of the single revolving levers, the fact was brought out that with one order of lever speed could be obtained by sacrificing power and with another order great loads could be moved with a small force. Similarly wheel trains are employed either to do heavy work with

Fig. 4. In the second case, this arrangement is reversed; the available force is applied or exerts itself on the hub or pinion of the first wheel and thus produces the rapid revolution of the last wheel. Cranes of all kinds for hoisting materials do their work by a wheel train of the first kind, and the wheel train of a watch is an example of the second arrangement.

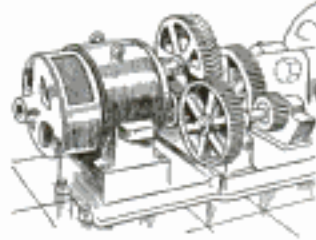

For a model of a revolving lever of the first order, the following materials are required:

- Base, 10-in. x 4½-in. x ¾-in.
- Pillar, 8½-in. x ¾-in., 4½-in. at widest end.
- Round blank, 6-in. diameter, ¼-in. thick.
- Weight (resisting force), base 1½-in. square, top 1¼-in. square, side 1½-in. high.
- Arrow (applied force), 1¼-in. long, ¼-in. thick, ½-in. wide across barbs, ¼-in. square shaft.

Square and face the base with a finish bevel on top. Construct the pillar with concave shoulders 1½ in. from the bottom. Narrow the upright shaft to ¼ in. wide. Turn from the blank (using a faceplate) concentric double pulleys, with V-grooves, of ¾-in. thickness and 6 and 3-in. diameters, drilling in the center for a pivot screw. Attach by the pivot screw to the

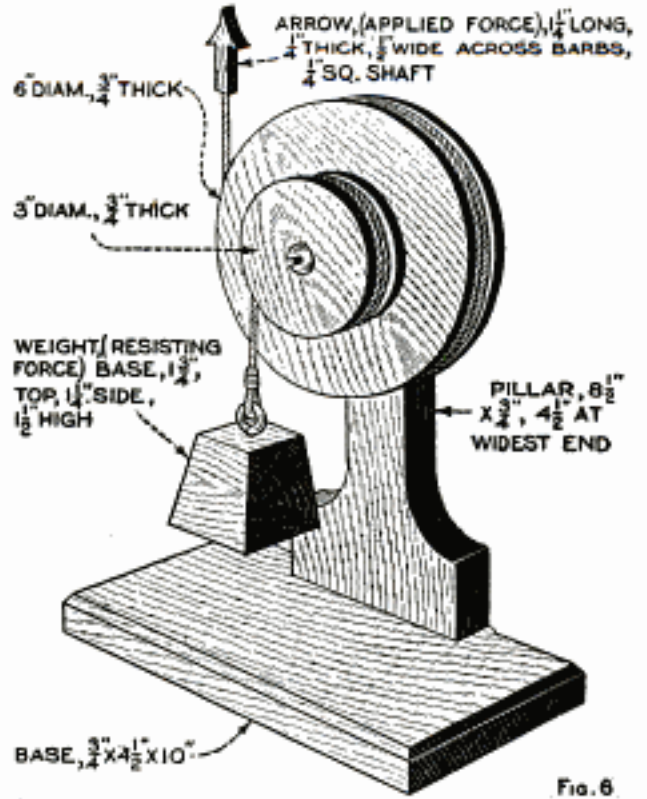
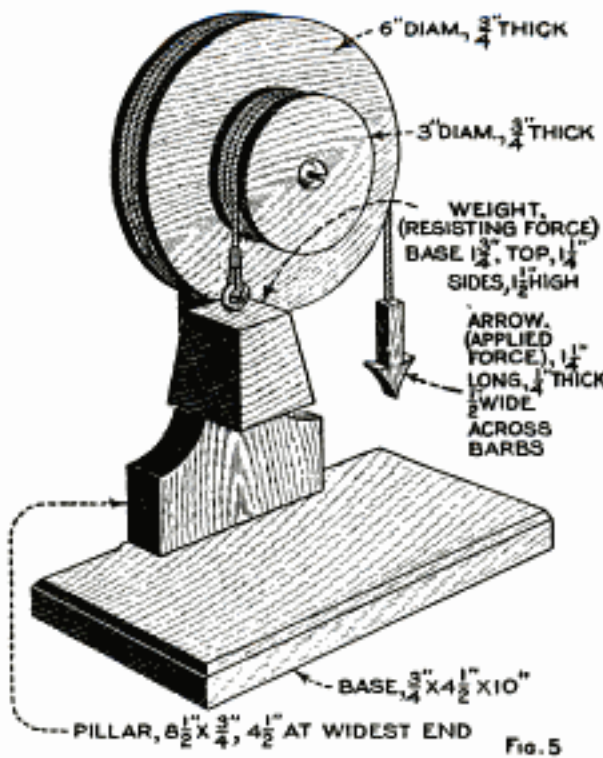

Left, Details of the Construction of a Model of a Revolving Lever of the First Order, with all Dimensions; Right, Working Drawing of Model of Second-Order Lever

little force or to produce great speed with considerable force. In the first case, the available force is applied to the first wheel of the series and is transmitted in the manner described earlier in connection with

top of the pillar. Secure one end of a piece of cord, about 6 ft. long, to the groove of the 6-in. pulley, winding the cord clockwise about the rim and permitting the free end to swing from the right side;



then attach the arrow by inserting the cord in a hole drilled in it. Attach the end of a piece of cord, about 3 ft. long, to the groove of the smaller pulley, and wind in a counterclockwise direction about the rim; then fasten the free end to the screw-eye used as a handle for the weight. Attach this assembly to the base by fastening the bottom of the pillar to the center of one side of the base by screws from beneath. Finish as desired.

For the revolving-lever model, second order, use the following materials:

Base, 10-in. x 4½-in. x ¾-in.  
 Pillar, 8½-in. x ¾-in., 4½-in. at widest end.  
 Round blank, 6-in. diameter, 1½-in. thick.  
 Weight (resisting force), base 1¾-in. square, top 1¼-in. square, side 1½-in. high.  
 Arrow (applied force), 1¼-in. long, ¼-in. thick, ½-in. wide across barbs, ¼-in. square shaft.

Square and face the base with a finish bevel on top. Fashion the pillar with concave shoulders 1½ in. from the bottom, narrowing the upright shaft to 1½ in. wide. Turn from the blank (using faceplate) concentric double pulleys of 6 and 3-in. diameters, with ⅜-in. rims and V-grooves, drilling in the center for a pivot screw. Attach by pivot screw to top of pillar. Secure one end of a cord, about 6 ft. long, to the groove of the large pulley, winding in a clockwise direction, and allowing the end to extend upward from left side and securing to the end the arrow, by means of a hole bored in the shaft. Attach to the groove of the 3-in. pulley one end of a cord, about 3 ft. long, winding in a counterclockwise direction, and fasten the screw-eye used as a handle for the weight to the free end. Attach this assembly to the base and fasten the pillar to the center of one side of the base with screws from beneath. Finish as desired.

For the model of the revolving lever of the third order, the following material is required:

Base, 10-in. x 4½-in. x ¾-in.  
 Pillar, 8½-in. x ¾-in., 4½-in. at widest end.  
 Round blank, 6-in. diameter, 1½-in. thick.  
 Weight (resisting force), base 1¾-in. square, top 1¼-in. square, side 1½-in. high.  
 Arrow (applied force), 1¼-in. long, ¼-in. thick, ½-in. wide across barbs, ¼-in. square shaft.

Square and face the base with a finish bevel on top. Shape the pillar with concave shoulders 1½ in. from bottom, narrowing the upright shaft to 1½ in. wide. Turn from the blank concentric double pulleys of 6 and 3-in. diameters, with ⅜-in. rims, V-grooves, and pivot hole in center. Attach by the pivot screw to the top of the upright shaft. Attach one end of cord, about 6 ft. long, to the groove of the large pulley, winding the cord in a clockwise direction, and attach the weight by the screw-eye used as a handle to free end.

Secure one end of a cord, about 3 ft. long, to the groove of the small pulley, winding in a counterclockwise direction, and permitting the end to extend upward; then fasten the arrow by a hole drilled in the shaft. Attach this assembly to the base by screwing the pillar to the center and one side of the base. Finish as desired.

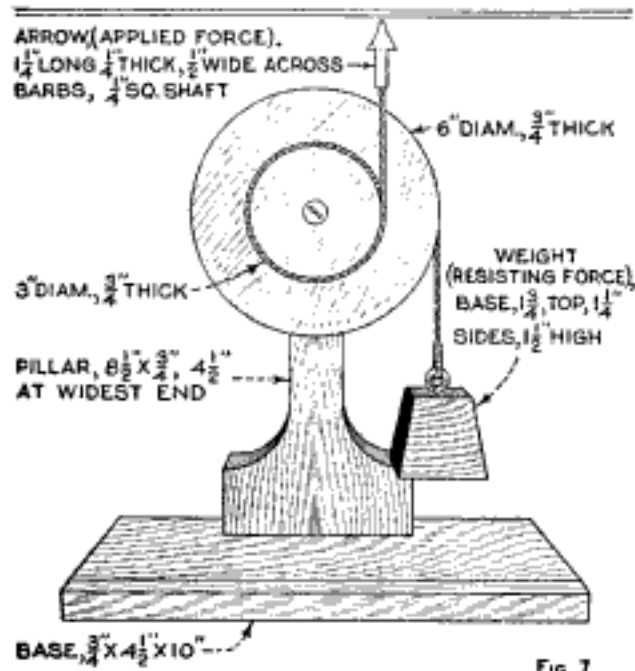

Model of Third-Order Lever: Note Positions of Force and Weight as Compared with Figs. 5 and 6

For the compound revolving-lever model, the following material is used:

Base, 12¼-in. x 5-in. x ¾-in.  
 Six uprights, 6-in. long, tapering from 1½-in. at one end to 1-in. at the other, ½-in. thick.  
 Blank, 6-in. diameter, 1¼-in. thick.  
 Blank, 4-in. diameter, 1¼-in. thick.  
 Blank, 3½-in. diameter, ⅝-in. thick.  
 Blank, 1¼-in. diameter, ¼-in. thick.  
 Two ½-in. dowels, 2½-in. long.  
 ½-in. dowel, 3½-in. long.  
 Six ½-in. washers.  
 Cordage, 3 ft.  
 Old automobile inner tube.  
 Weight (resisting force), base 1¾-in. square, top 1¼-in. square, side 1½-in. high.  
 Arrow (applied force), length 1¼-in., ¼-in. thick, ½-in. wide across barbs, shaft ¼-in. square.

Square and face the base with a finish bevel on top. Round the small ends of the uprights and drill a ½-in. hole, with its center ½ in. from the top and sides. Turn from the 6-in. blank two concentric double pulleys, with diameters 6 and 3 in., and rims ⅝ in. Turn in the larger pulley rim a square-shouldered groove, ⅛ in. deep and ½ in. wide. Drill a ½-in. hole in the center of the pulleys. Turn from the 4-in. blank two concentric pulleys with diameters 4 and 2½ in., and rims ⅝ in. wide, with square grooves ⅜ in. deep. Drill a ½-in. hole in the center of the pulleys. Turn from the 3½-in. blank a pulley 3½ in. in diameter, with a square-shouldered



groove  $\frac{3}{32}$  in. deep and  $\frac{1}{2}$  in. wide. Drill a  $\frac{1}{2}$ -in. hole in the center of the pulley. Turn from the  $1\frac{1}{4}$ -in. blank a pulley  $1\frac{1}{4}$  in. in diameter with a square-shouldered groove  $\frac{1}{4}$  in. deep and  $\frac{1}{2}$  in. wide. Drill a  $\frac{1}{2}$ -in. hole in the center of the pulley.

Cut the inner tube into several strips  $\frac{1}{2}$  in. wide, using a wet, sharp knife and a straight-edge. Glue strips of sufficient length in all the grooves of the pulleys. Construct an assembly of the 4 and  $2\frac{1}{2}$ -in. diameter pulleys upon a  $2\frac{1}{2}$ -in. dowel, the ends of the dowel being fastened in two of the uprights. Center this assembly cross-wise of the center line of the base, at a point  $6\frac{1}{4}$  in. from the end of the base, securing it with glue and screws from beneath. Construct another assembly of the 6 and 3-in. diameter pulleys, placing this on the remaining  $2\frac{1}{2}$ -in. dowel and supporting the ends upon two of the uprights. Fasten this assembly across the width of the base in a position that will permit contact between the 4 and 3-in. pulleys, with the smaller pulleys on one side, and secure to the base with glue and screws from beneath. Construct an assembly of the  $3\frac{1}{2}$ -in. pulley upon the

$3\frac{5}{8}$ -in. dowel with the protruding ends running freely through the remaining two uprights, the pulley being glued to the dowel, and glue the  $1\frac{1}{4}$ -in. pulley to the projecting end of the dowel in such a position that there will be 1 in. of dowel between

the inner pulley face and outer face of the nearest upright. Secure this assembly to the base across the width in such a position that the  $3\frac{1}{2}$ -in. pulley will make contact with the  $2\frac{1}{2}$ -in. pulley and the small pulley will be on the same side as the other small pulleys. Fasten with glue and screws from beneath. Attach an end of a piece of cord, about 1 ft. long, to the smallest pulley. Wind

the cord clockwise, and fasten the end to the screw-eye used as a handle for the weight. Fasten an end of cord, about 2 ft. long, to the largest pulley, winding it on the drum in counterclockwise direction, and gluing the end in a hole drilled lengthwise in the shaft of the arrow. The  $\frac{1}{2}$ -in. washers are used as bearings between the pulleys and uprights. Finish as desired.

Part V of this series of articles will be published next month.

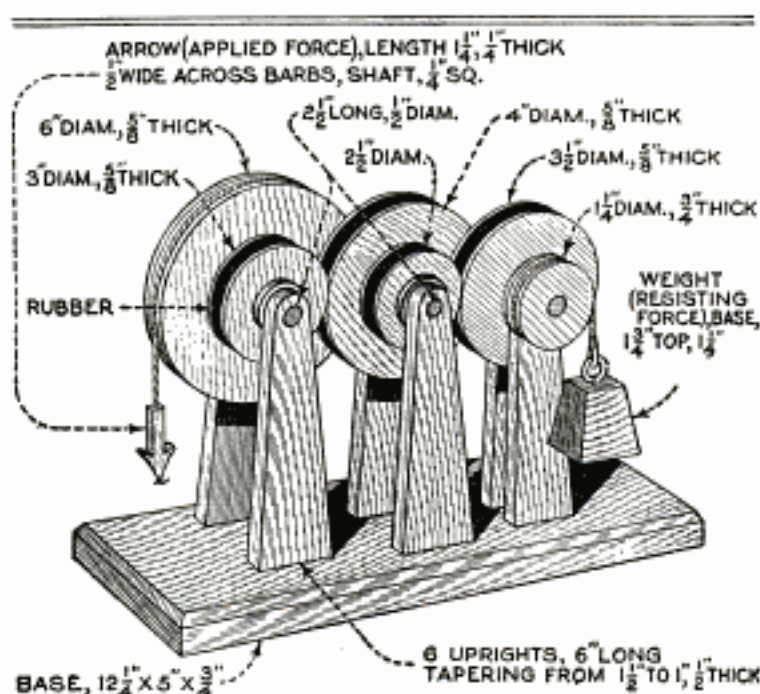

Fig. 8

Model of Compound Revolving Lever: Force Applied to the Left-Hand Pulley Raises the Weight at the Right

### Figuring Water Required on a Farm

A certain quantity of water is required as the daily output of every water-supply system, whether it is pumped by wind or other power and a storage tank must be provided for holding the water until it is used, and for caring for the surplus. If a windmill is used to pump the water a tank large enough to hold a three-day supply of water should be provided in order to furnish water over a period when there is little or no wind. If engine-driven pumps are used the tanks need only be large enough to hold a single day's supply, as the engine can be operated at any

time regardless of weather conditions. The amount of water required for all purposes from isolated water-supply plants, is, on the average, as follows: For all household and toilet purposes allow 25 gal. for each member of the family; allow 10 gal. for each horse, 10 gal. for each cow, 2 gal. for each hog, and 1 gal. for each sheep. Applying the rule, the minimum allowance for a family of five persons for household purposes only will be 125 gallons. In order that ample pressure will be obtained at all cocks the storage tank should be elevated at least 10 ft. higher than the highest tap and the higher the tank the greater will be the pressure.



### Meat Grinder Fills Bottles

An ordinary motor-driven meat grinder of large size from which the cutting disks have been removed, is used in a plant manufacturing preserved-fruit products, for filling bottles with relish and similar products. No other change has been made in the grinder, save the provision of a tapered spout at the outlet to fit the mouth of the bottle snugly. The relish is fed into the top of the grinder and the screw at the bottom forces the product out through the spout and into the bottles about as fast as the latter can be placed in position and removed by the operators. Formerly this work was done by hand, each worker filling bottles over a little wooden bowl. Twelve workers were then required to accomplish the work now done by four using the machines.—Orin Crooker, Elgin, Ill.

### A Poppet-Valve Gauge

A valve tester similar to the one shown in the drawing provides a set standard that should form a part of the garage tool equipment for setting the machine in grinding up a set of valves or a valve-re-

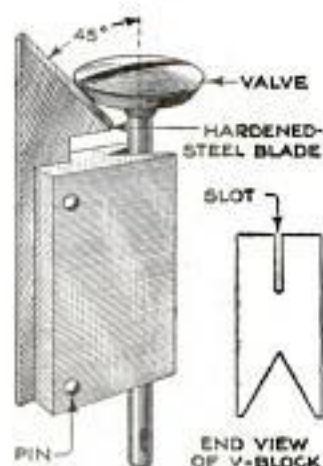

seating tool. Whenever both the valve face and the valve seat are machined to the same angle, only a small amount of grinding in will be required to obtain a perfect seating. The tester should be accurately made from two pieces of machine steel pinned together. The blade should be hardened and accurately ground so that a line parallel with the V-block forms a 45° angle with the blade line. Most valves are ground to an angle of 45°, but a 60° tester can be made along the same lines. To test a valve place the stem in the V-groove and slide it down until the face touches the blade; light showing between the valve face and edge of the blade will show the variations, if any. The valve-reseating tool is tested in the same manner.—Geo. Alexander, Pittsburgh, Pa.

☛ To close the sides of a used cotter pin, hold one of its legs on the edge of a vise and tap the head with a hammer.

### Homemade Pneumatic Punch

The illustration shows how a very useful pneumatic punch for the shop where compressed air is available can be made at little expense. The size or strength of the material used in its construction will, of

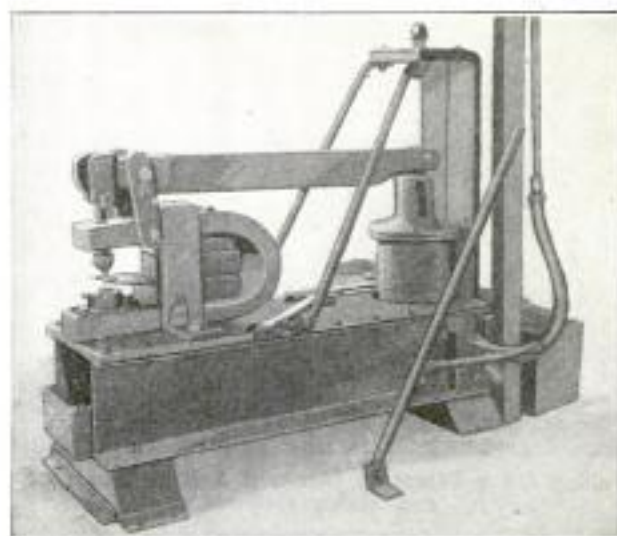

Pneumatic Punch Made in a Railroad Shop for Piercing Quarter-Inch Plate

course, vary with the thickness of the material to be punched. Plate steel up to ¼-in. thick can be punched very effectively with the one in the photo; the cylinder is 10 by 12 in., and is operated at a pressure of 50 lb. per sq. in. This machine was built only as an experiment, and therefore looks rather rough, but it is perfectly satisfactory in operation.—A. H. Keys, Baltimore, Md.

### Increasing Capacity of Lumber Wagon

When a wagon box is removed so that a load of lumber can be carried the lumber is usually piled to a width equal to that of the wagon box. However, it is possible to increase the size of the load considerably by laying cross-pieces over it when it reaches the height of the wheels, so that the wheels will have plenty of clearance, and then continuing to pile the load on top of the cross-



pieces, as shown in the illustration. Cross-pieces up to 8 ft. in length can be used, as this is the maximum width of a vehicle allowed on public roads. The size of the load can be more than doubled in this way.



### Emergency Wheel Puller

Pulling the wheel from a semi-floating axle is sometimes a very difficult task, especially after some strong-armed mechanic

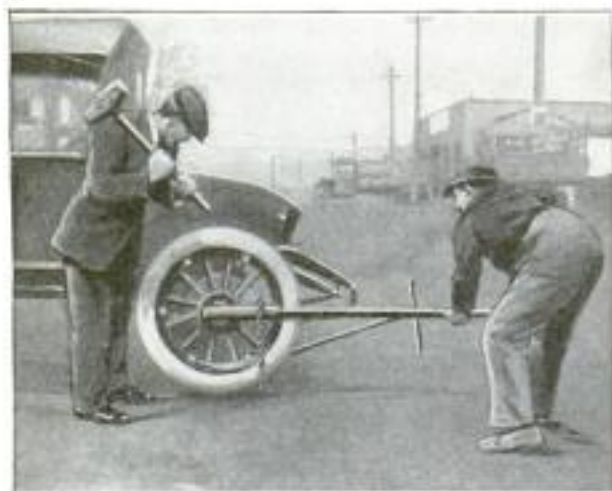

Pulling Off a Wheel by Means of a Steel Bar, Chain and Sledge Hammer

has sent the retaining nut home with a 24-in. wrench. However, the work can easily be done by two men with a crowbar, a short length of chain and a sledge hammer.

The bar is placed with the flat end resting on the axle, and the handle held toward the rear, close to the tire. The chain is strapped tightly around the bar and two or three spokes, these, of course, being protected by wrapping a piece of burlap around them. The bar is then pulled outward at the end by one man, while the other strikes the bar with the sledge hammer squarely over the axle; this will usually start the wheel immediately. In stubborn cases it may be necessary to lengthen the bar with a piece of pipe on the end.

### Welding-Rod Holders

Every acetylene welder who does heavy work on large preheated jobs knows how disagreeable the work is when ordinary short welding rods are used. As a makeshift, lengths of short rod are often welded together, but this is not entirely satisfactory because the workman cannot then hold the end of the rod on the weld so steadily. In order to overcome this trouble welding-rod holders of the kind

shown in the illustration have been made in one shop and found entirely satisfactory.

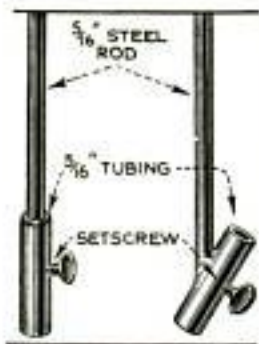

They are made from lengths of  $\frac{3}{16}$ -in. round steel rod and short lengths of  $\frac{3}{16}$ -in. tubing having a  $\frac{1}{16}$ -in. wall, the tubing being welded to the end of the rod, either in line with it or at an angle to it as indicated; one type of holder will be found suitable for one class of work, the other for work of another kind.—Edwin Kilburn, Spring Valley, Minn.

### Pouring Lead into Holes in Concrete

Occasionally it is necessary to pour melted lead or babbitt into holes drilled into damp concrete floors for the purpose of holding lag screws or leveling a machine. When the hot metal is poured into the holes it usually "flies" and numerous particles spatter up against the worker. This trouble is due to the dampness of the concrete; when the hot metal touches it steam is formed and the pressure of the steam blows the metal away. An excellent remedy is to pour a little kerosene on the floor and into the hole. The kerosene turns to a gas when the hot metal touches it, and escapes gradually.—A. S. Jamieson, Springfield, Mass.

### Lifting Tongs for I-Beams

In shops where many I-beams are handled on hoists or cranes it is customary to hold the beams by means of chain slings, but it takes considerable time and labor to attach these slings so that they will not slip. In one shop the work was greatly facilitated by the use of the tongs shown in the drawing. These could be attached and detached in a fraction of the time consumed in adjusting the sling, and they were just as safe as the latter, as they were self-locking. They consist of two forged lifting hooks having holes drilled at one end to slip on the pin of a heavy clevis, which is attached to the hoist, and having the other end bent over at right angles to grip the I-beam. A drop link holds both hooks on the beam.

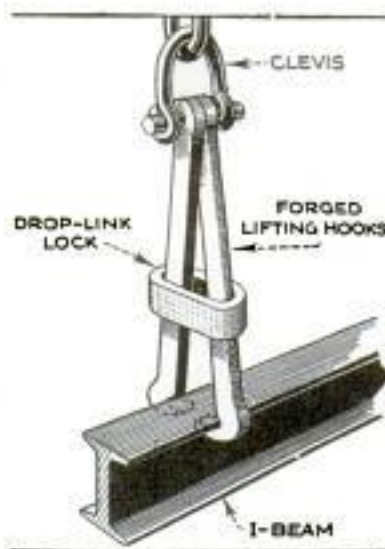



### Making Wagon Beds Last

The bottom of a wagon bed is the first part to wear out and usually has to be renewed two or three times before the sideboards and endgate are discarded. A good method of preserving it is to cover it with a piece of No. 20 sheet iron, 3 ft. wide and about 3 in. longer than the bottom. This piece is screwed down with heavy round-head screws so that about 3 in. project at the rear. The projecting portion is bent down and screwed to the underside. Such a sheet-iron cover costs only a few dollars and is well worth the investment.

### Portable Motor-Driven Saw

Operations such as sawing interior wood trimmings, cutting out floor boards when installing steam or water pipes and electric conduit, as well as other work in awkward places, are greatly facilitated by the use of

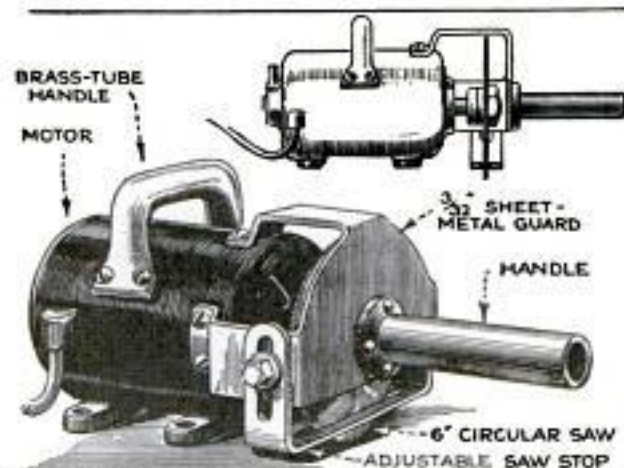

Portable Motor-Driven Saw which Can Be Made in the Home Workshop and Has Many Uses

a portable motor-driven saw that can be made in the shop.

It consists of a  $\frac{1}{8}$ -hp. electric motor of the kind generally used for driving washing machines, fitted with an extension shaft on which a 6-in. circular saw is securely mounted. For the sake of safety, a guard is cut out of a piece of sheet metal, bent to shape and fastened as shown. A stop is attached to the guard. It is slotted in the bottom for the saw and at the ends to allow depth adjustments by means of the fastening bolts. A 6-in. length of brass tubing, with the end flared to permit its attachment to the guard with small stove bolts or rivets, is provided for use as a handle and another similar handle is fitted on the top so that the saw can be handled with ease. Feet are provided on the motor, so that it can be bolted down solidly to the workbench whenever desired.

### A Gardener's Basket

Carrying baskets of garden truck from one end of the row to the other by hand is needless work when it can be made much easier by the use of a simple wheelbarrow



Large Homemade Wheelbarrow Which Is of Considerable Convenience to Truck Farmers

of the type shown in the photo. The body resembles a ladder and is built of 2 by 4-in. wood. The crosspieces are cut from 1-in. material, and the length of the body is determined by the space required by four bushel baskets set in a row, plus the additional length for the handles. The width of the body is also made to conform to the space required by the baskets. The crosspieces are spaced to provide openings for dirt to fall through, and also to reduce the weight. The wheel is mounted about 18 in. from the front end. The axle is held by means of four iron braces, which can easily be made of heavy tire iron. Wooden legs, braced securely, are provided near the handle to keep the top level.

### A Handy Hardy

As a substitute for the usual blacksmith's hardy held in the hole provided for it in the anvil, the hardy shown in the illustration has been found very useful. It is welded to a length of  $\frac{5}{8}$ -in. round or square iron rod, which is bent to fit over the top of the anvil and is hinged to the anvil block so that it can be swung down and out of the way when not in use. When wanted for use, the blacksmith reaches down with his hammer and pulls it up.

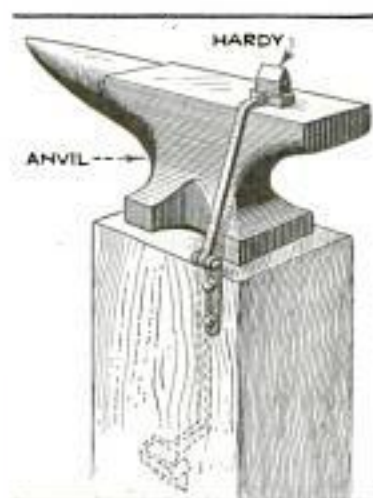



### Roller Protects Barn Corner

Farm buildings sometimes are so arranged that when hay is hoisted into the barn the team must be driven around a corner of one building in order to avoid



Iron Pipe Arranged Vertically Along Corner of Building Protects It from Hoisting Rope

another. This causes the rope to rub hard against the corner, not only wearing it out quickly but also bruising the corner.

In one case injury to both corner and rope was prevented by arranging a steel roller vertically along the edge of the building as shown. The roller consisted of a 4-ft. length of 2-in. iron pipe, turning on bolts fitted into the ends. The bolts were in turn held by short pieces of 2 by 4-in. wood, nailed securely to the barn. The roller has been in use for two or three years and has never failed in its purpose.

### Removing Auto-Spindle Bushings

After a few months of continual service there is always more or less play in the steering-spindle bushings of automobiles, which can readily be detected by shaking the front wheels. When these bushings are worn badly it is, of course, necessary to replace them, but it is sometimes a difficult task to remove the old bushings. In one case the spindle bolt was used as a punch in an attempt to drive out the bushing, but the latter could not be budged.

Heating and thereby expanding the spindle boss in which the bushing is located is the first solution a mechanic would naturally think of. This can be done by means of a blowtorch, but if a

blowtorch is not handy an improvised alcohol torch, which consists of a strip of asbestos cloth rolled up and set in the cover of a large tin can, and saturated with alcohol, will serve the purpose just as well. The asbestos acts as a wick and the burning alcohol generates considerable heat.

Often the new bushings are too small for the spindle boss, and fall out of themselves. An excellent method of fitting them in snugly is to apply strips of solder to the outside, lengthwise, and then tap the bushing into place. The excess solder will readily scrape off while the bushing is being driven in.—J. E. Dekker, Chicago, Ill.

### A Belt-Shifter Lock

A common trouble on standard counter-shafts is that the belt shifter will not stay in position on either the tight or the loose pulley. There are several methods of overcoming this trouble, such as the setting of the shifter lever and the use of spring-clamp bolts, but the writer has not found any of these as simple and practical as the lock shown in the illustration. It consists of a link, attached to the end of the shipper rod and to a ceiling joist as shown, and a coil spring to hold the link in the positions indicated. That end of the link which is connected to the shipper rod is slotted so that it will not bind when being moved

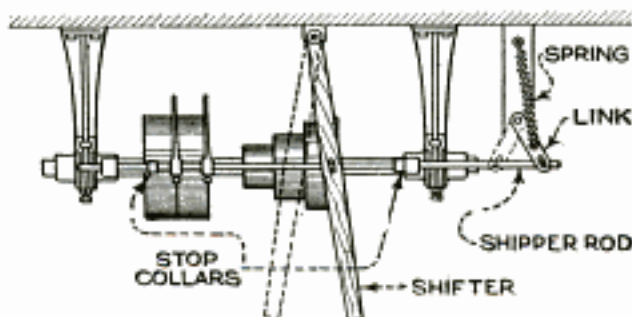

Simple Lock that Keeps the Belt Shifter in Position

from one position to the other. One end of the coil spring is attached directly above the point where the link pivots on the joist and the other end is fastened to the link just below its center. Two stop collars are fastened on the shipper rod at the points indicated, to limit its travel in either direction.—W. Burr Bennett, Honesdale, Pa.

By soldering the holes in the corners of the top of the coil box of a Ford car, a water-tight dipper is formed that will serve for filling the gasoline tank when no other receptacle is available.



## Making Wood Dowels

By H. H. PARKER

**H**ARD and soft-wood dowels are used to a large extent both in pattern-making and general woodworking, and while they may be purchased ready to cut up, there are times when none is available and they must be made by hand. A fairly good job may be done by planing and sand-papering from a square rod, but the best way is to prepare a dowel plate of the type shown in the illustration.

The stick is planed to an octagonal shape and driven through the plate, the result being an accurate round rod, true to size, and made in a fraction of the time required to shape the pin entirely by hand. The plate is drilled with a series of holes of the diameters mostly used for dowels; a thin plate will do, but one made of 1-in. square stock will produce smoother and straighter work. For continuous work,

hardened and tempered tool steel is best, or casehardened cold-rolled steel, but for occasional use, a cold-rolled steel bar, drilled and left soft, will answer the purpose very well. If a good assortment of twist drills is at hand, a good plan is to make up three plates, one with standard-size holes, the others having corresponding holes  $\frac{1}{8}$  in. larger and smaller than standard. This will allow the production of dowels for drive and push fits in holes bored with fractional-size wood bits.

At times it is of advantage to use a dowel having a groove along one side, to allow the escape of air and glue from the hole as the dowel is driven down. Such a groove is readily made by drilling and tapping a hole through the side of the plate for a small pointed setscrew; the point projects

into the dowel hole, and as the wood is driven down through the plate, a groove will be formed.

To make a dowel, first plane a wood strip square, each side being a trifle wider than the required diameter, then plane off the corners, making the stick octagonal. After pointing one end slightly, drive the stick through the plate with a mallet, while holding

the plate firmly in a vise or clamped over a hole in the bench.

A special bench fixture will be found of service when planing the strip octagonal. The simplest form is a wood block with a 90° groove planed along its top surface, in which the stick rests while the corners are being planed. Some form of end stop will, of course, be necessary. A better form of fixture consists of a strip screwed to a base block, and with another

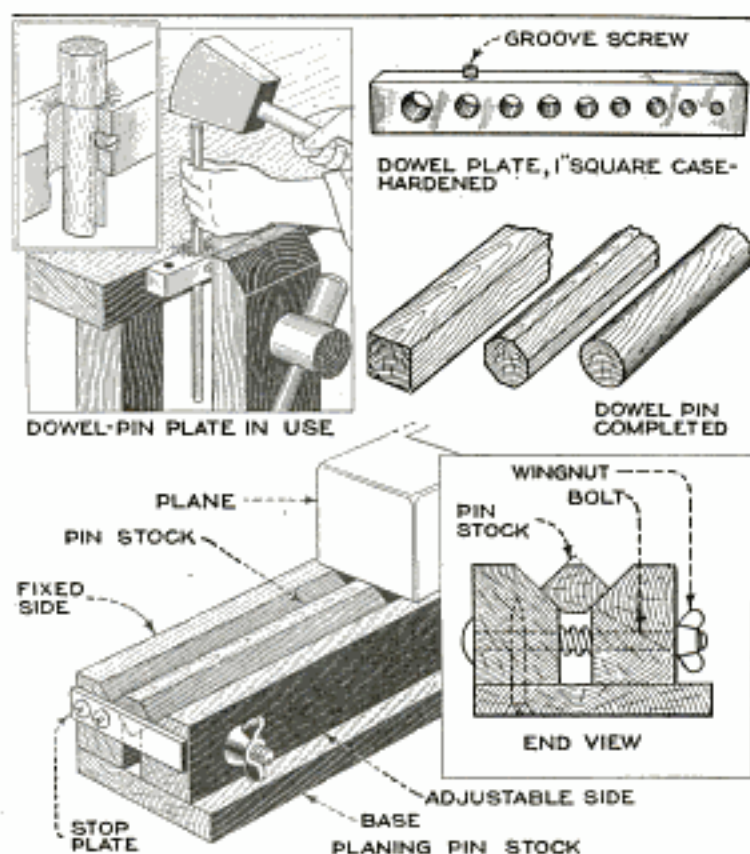

Above, Dowel Plate, Rough and Finished Dowels, and Method of Grooving; Below, Fixture for Planing Pin Stock

parallel to it, and adjustable in or out by means of two or more bolts provided with thumbnuts, as shown in the illustration. The inner upper corner of each strip is beveled at an angle of 45° to form a channel for the dowel stick to rest in; the movable strip is let out so that when the upper corner of the stick is planed down far enough, the plane will just touch the top surfaces of the fixture strip, thus making the fixture serve also as a gauge. A steel plate is screwed to one end to serve as a stop for the sticks.

Ⓢ Do not use paint containing compounds of lead about stables or outbuildings where the fumes of decaying organic matter arise, as these gases are likely to darken the color of lead paints.



### Convenient Box for Nails and Screws

The handy box illustrated is made up into as many compartments as desired, all but one being provided with an individual cover, when in use. This makes it possible to expose only the contents in the compartment in use. Also, the contents of one compartment can be dumped out without emptying the whole box. The covers are pyramidal in shape, with a depression in the top for moving them conveniently with the finger. In case it is desired to carry the box in a tool chest, where it might be upset, covers are provided for all the compartments; the extra one is slipped on just before the box is packed, and all the covers are locked in place by dropping a nail into a hole drilled through one cover and the end of the box, as in the side view.

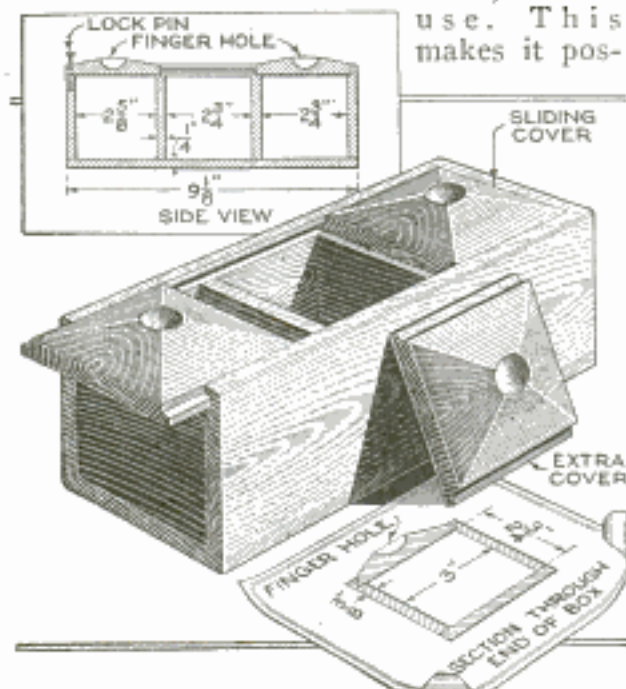

A Box of This Type Will Prove a Special Convenience to Patternmakers and Other Woodworkers

sible to expose only the contents in the compartment in use. Also, the contents of one compartment can be dumped out without emptying the whole box. The covers are pyramidal in shape, with a depression in the top for moving them conveniently with the finger. In case it is desired to carry the box in a tool chest, where it might be upset, covers are provided for all the compartments; the extra one is slipped on just before the box is packed, and all the covers are locked in place by dropping a nail into a hole drilled through one cover and the end of the box, as in the side view.

### Damming Irrigation Ditches

It is often necessary in irrigating fields to dam a ditch temporarily in order to divert water into other ditches. This can be done by means of an improvised sheet-iron dam. The sheet iron is cut about 1 ft. longer than the width of the ditch and about 1 ft. wider than its depth, and then cut to a semicircular shape. A stout piece of 2 by 4-in. wood is securely bolted along the straight edge of the sheet iron. This piece of wood should be a couple of feet longer than the sheet iron so that the projecting end can be used as a handle. A length of iron rod is bent to a U-shape and

fastened at the center of the 2 by 4-in. piece to facilitate pulling the sheet iron out of the ditch. In use, the device is forced down into the bed and sides of the ditch so that it dams the water effectively. It can be put in place or removed in a few moments whenever necessary.

### Wrench Made from Connecting Rod

A useful socket wrench can readily be made from an old drop-forged connecting rod. The rod is cut off at the point indicated and the end ground smooth. The bushing is removed from the other end and the eye heated until it is red-hot. A bolt head of the size for which the wrench is to be used is driven into one side of the eye while it is hot and the metal hammered down to fit against the flats. If desired, the other side can be similarly treated to fit bolts of larger or smaller size. — Sebastian Vierengel, West Palm Beach, Fla.



### Round-Shank Drill Chuck for Brace

The ordinary carpenter's brace will take only square-shank drills, and it is occasionally desirable to use round-shank twist drills in it. This can be done if an adapter of the type shown in the drawing is made; the tool does not take up much room in the tool kit, and will be found very handy. It is made of round steel, turned down at one end to form a shank, and drilled at the other end to suit the shank of the drill, then a slot is milled or filed across the body as shown, and the lower part drilled for a setscrew. The shank is squared and tapered to fit the brace chuck. The drill to be used in the adapter has a flat filed across the shank, as indicated, so that it will bear against the flat at the bottom of the slot in the adapter.

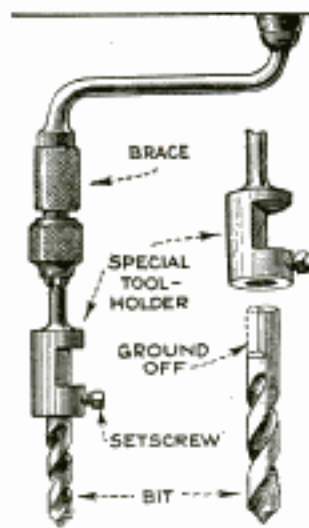



### Repairing Leaky Gasoline Tanks

When repairing leaky seams on gasoline tanks, the gasoline is, of course, always drained out of the tank first in order to prevent accidents. However, the film of gasoline left on the sides and bottom evaporates rapidly, and forms gas fumes which may explode and cause considerable damage. As a precaution against such accidents it is advisable to fill the tank with water after the gasoline has been removed, and allow the water to overflow, thus removing the residual gasoline. Another method of preventing explosions that are due to fume-filled tanks is to squirt a little liquid from a fire extinguisher inside the tank.

### Shaft Holder for Light Babbitting

A couple of shaft holders made like the one shown in the drawing are handy to use on light babbitted bearing work. Most repair shops have to do this kind of work at times and the process

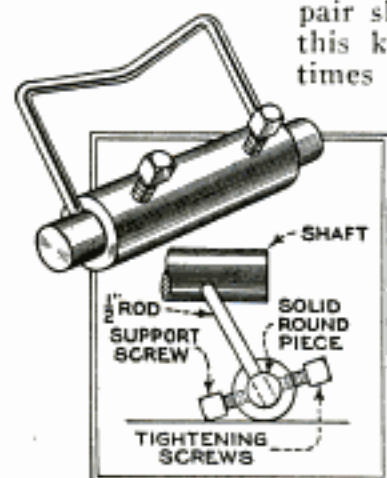

of lining up, which is generally the longest part of the job, can be shortened to a great extent by means of the shaft holders. In making the holders no particular accuracy is required and the only materials necessary are a couple of short pieces of round solid stock, two sleeves to go over these, some  $\frac{1}{2}$ -in. round rod, and half a dozen setscrews. The sleeves are drilled and tapped in three places, two screws being tightened up in line on each sleeve and a third screw in the center between them on the opposite side. The pieces of round stock are then drilled close to each end of the sleeve to take the  $\frac{1}{2}$ -in. rod, which is driven in tightly after bending to the V-shape shown. When using, the blocks or caps to be babbitted are laid on the bench and, if necessary, wooden blocks are placed at each end to rest the holders on. The shaft is then laid in the vees and adjusted for height at both ends by moving the latter around, which raises or lowers the shaft. When properly set both tightening screws are tightened and the two screws in each sleeve support the work.—Harry Moore, Montreal, Can.

### Boat Propeller Washes Tomatoes

Canners of tomatoes wash the fruit in large tanks to remove dirt and mold. A fairly rapid circulation is necessary in these tanks, but it is rather difficult to at-

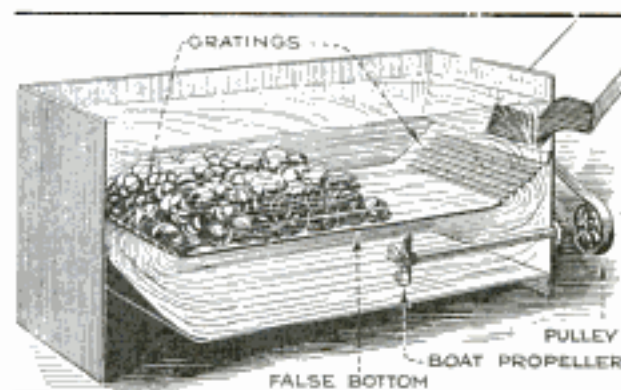

Motorboat Propeller Used to Wash Tomatoes. A False Bottom Protects the Fruit

tain without bruising the tomatoes unnecessarily. In one plant in Indiana, an ordinary motorboat propeller has been pressed into service for this purpose, with very satisfactory results.

To prevent the fruit from coming into contact with the propeller, the latter is placed at the bottom of the tank and covered with a false bottom. The propeller drives the water toward one end of the tank, where it strikes an inclined section, which deflects it upward through a grating into the upper part of the tank, where the tomatoes are dumped. A similar grating at the opposite end allows it to flow back into the bottom of the tank to be circulated over again.

### A Soldering Kink

When resoldering the square brass base of an electric table lamp, it was found difficult to hold the loose corners together. After several unsuccessful attempts, a stout cord was looped over two opposite corners as shown, and twisted by means of a small pair of pliers until the corners were sufficiently tight to permit soldering. After twisting the cord, the pliers were drawn out until the nose rested against the inside of the lamp base so that the cord could not untwist. The job was thus easily done without help.

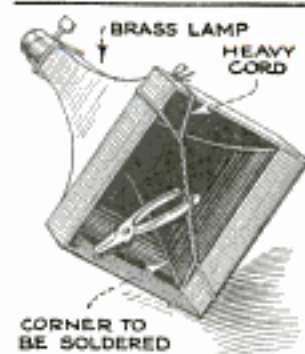



### Device Starts Boxes Along Roller Conveyor

Wire-bound shipping boxes often get stuck on roller conveyors unless the drop of the conveyor is sufficient to overcome

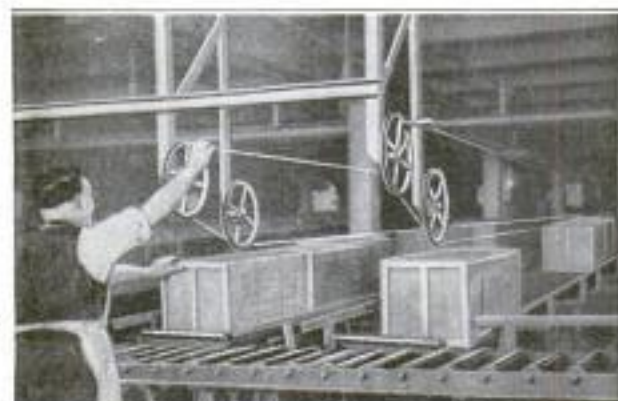

Endless Wire with Hook Located over Roller Track Gives Obstinate Boxes a New Start

this tendency. To eliminate this trouble a large gum-manufacturing concern has equipped the conveyors in its shipping department with a device which gives the obstinate boxes a new start. The device consists of an endless wire suspended over grooved pulleys over the center of the roller tracks, with an iron hook attached to the wire at the point where the two ends are joined. A handle on one of the pulleys allows the operator to bring the hook to any point over the track; the back of the hook does not catch the box but readily passes over it. Then by reversing the direction of movement the hook catches behind the box and pulls it along.

### A Planer Kink

When called upon to plane a flat spot on a number of castings that were not provided with a raised finishing pad, as is usual in such cases, I knew that the stroke of a belt-driven planer varied considerably,

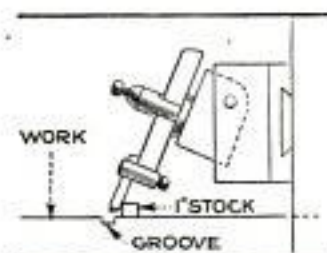

due to belt slippage, and that the usual result is a series of ragged, uneven cuts. To do a first-class job, therefore, I proceeded as follows: I marked off the spot to be finished, and chipped a groove,  $\frac{1}{8}$  in. deep and  $\frac{3}{8}$  in. wide, the width of the spot to be planed. I then clamped a piece of 1-in. square stock back of the groove, and bolted the job on the planer in the usual way. I set the table

stroke with plenty of length, so that the

stroke would go as far as the 1-in. square piece each time. In case the stroke was long the tool simply lifted, as shown, and, on the forward stroke, settled into the groove.—A. F. Loeffler, Sheboygan, Wis.

### Making Announcement Slides

After trying several different methods of making announcement slides for screen projection, I found the following method neat, simple and economical: A piece of unused black typewriter carbon paper, placed over a sheet of ordinary white paper, is fed into the typewriter and the ribbon key set to the position for stenciling. This allows the type to hit the uncoated side of the carbon paper directly, and transfers some of the carbon on the white paper. When finished, the effect can be seen clearly by holding the carbon paper closely in front of an electric lamp; there will be a contrast of nearly white and black that will be still more distinct when projected on the screen. The carbon paper is trimmed to fit the slides and is bound between them in the usual way.—Charles N. Shaw, Chattanooga, Tenn.

### Increasing Capacity of Small V-Blocks

To eliminate the necessity of carrying around heavy V-blocks, a mechanic devised the auxiliary pieces shown in the photo so that a small pair of V-blocks could be used on light work of a diameter

much larger than the blocks were intended for. The auxiliary V-blocks are made of flat-finished stock and they are held to the regular blocks by means of two pieces of round steel, drilled in the center to clear round-head screws, which

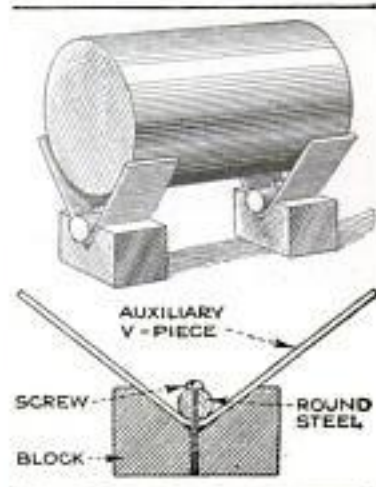

thread into tapped holes in the center of the blocks. The auxiliary pieces can be attached or removed in a moment; for light work they are just as handy as heavy blocks, and, of course, the difference in bulk and weight makes them most desirable when they have to be carried around in a tool kit from one job to another.



## Making Hay Loading Easier

By J. M. COLLINS

ANY device that reduces the work in harvest time is a boon to the farmer, even if it takes a little time to make. The wagon attachment shown in the illustration, which is used on the farm of Mr. J. E. Myers, Pataskala, Ohio, has been found very convenient when loading hay, and does away with a great deal of hard work.

The device consists of an extra half-section frame, mounted upon lengths of iron pipe, fastened lengthwise on the bed of the regular hayrack. In front of the rack

attached to the windlass by means of ropes. When loading, the frame is first set at the rear of the rack, as shown at the lower left; when it has been loaded, it is drawn to the front by means of the windlass, as shown at the lower right, and the rear half of the rack loaded. This does away with the hard work of forking the hay to the forward part of the rack by hand, which, as anyone who has tried it knows, is hard labor. The hay on the rack being thus separated into two bunches, is also



Lower Left, Frame Drawn to Rear Ready for Loading; Lower Right, Drawing the Frame Forward; Insert, Loading Rear Half of Rack

is fitted a simple windlass, also made of pipe and fittings. The extra frame is

much easier to load into the hay fork, when drawing it up into the barn.

### Auto Gearbox Used in Machine-Tool Drive

The transmission and speed-changing gear of an automobile can be successfully used for giving different speeds, including reverse, to the lineshaft in a small shop. In one instance, the transmission device was set upside down over a lathe, in such a manner that the handle was within convenient reach of the operator. With work on the machine, the operator could change speeds and reverse without taking his hand from the handle, or shifting belts. For a small shop, the gearbox could be so arranged that the speed and direction of rotation of the entire shaft could be changed. The stub shaft, which is ordinarily connected to the crankshaft in the automobile, was connected to the main shaft, which was driven by an electric motor, and the

machine to be driven was belted up to the jack shaft from the opposite end of the transmission. The gears were oiled frequently with heavy gearbox oil and a special drip pan was made to catch the waste.—James B. Hays, Boise, Idaho.

### Cleaning Files

A good method of cleaning files that have been used on wood or soft metal such as lead, is to rub the end of a brass or copper strip over the file in line with the grooves. This cuts notches into the brass corresponding to the grooves on the file and will clean the file of foreign substances more effectively and quickly than a steel brush or any other method. A thin piece of stock, about  $\frac{1}{4}$  or  $\frac{1}{2}$  in. in width, will do the work best.—H. Olsen, Park Ridge, Illinois.



### Portable Support for Vise

On jobs where it is necessary to make use of a vise it is quite often a problem, especially in the absence of a workbench

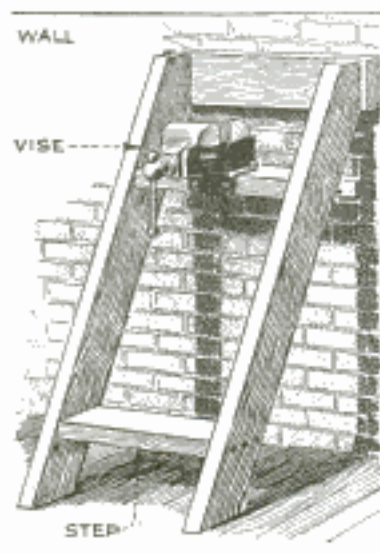

or table, to find a convenient and stable place to attach it. But if some 2-in. lumber and a few heavy nails can be found near by, a simple and sturdy support can readily and quickly be knocked together. A support of this kind, which has the further advantage of

being portable, is shown in the drawing. It consists of two 4-ft. lengths of 2 by 6-in. material with both ends sawed off at suitable angles so that the support can be set up steadily against the wall. Three cross-pieces are nailed on, the lower one serving as a step for the worker, whose weight gives additional stability, and the upper one as a backrest, permitting the support to be set against studdings, while the center piece holds the vise.—G. A. Luers, Washington, D. C.

### Grinding Hardened Lathe Centers

The usual way of truing hardened lathe centers when they become worn is to anneal them, turn them down to the proper angle and re-harden, all of which takes considerable time, particularly when there is a rush job waiting. Unless there is a toolpost grinder handy, as there generally

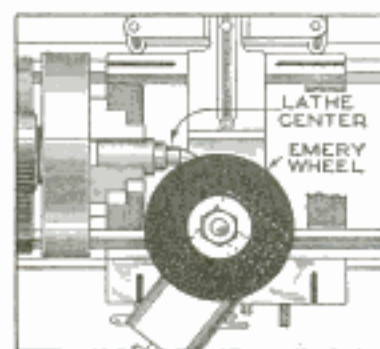

is, there is nothing else to do but take the time and anneal the centers. However, the drawing shows how the centers of a lathe were ground with an old emery

on its side and bolted in position on top of the compound rest, which had been turned around to the 60° angle. The belt was next placed on the high-speed cone and the wheel fed back and forth along the center, the cross-feed screw being used to force the wheel against the center. This method proved rapid and successful. The tailstock center was next ground in the same manner. If no old emery wheel is at hand a clamp can be made to hold a coarse-grained emery or carborundum stone.—W. S. Standiford, Youngstown, Ohio.

### A Handy Polishing Wheel

The method of securing strip emery cloth to a wheel shown in the drawing is both novel and safe and will probably be interesting to anyone who uses this type of wheel for polishing or smoothing down articles of wood or leather. The wheel is made of clear hardwood, drilled in the center to fit the machine spindle and about 1 in. from the edge to take a wooden plug;

a slit is also cut from the latter hole to the outside of the wheel. The plug, which is 1½ in. in diameter for an 8-in. wheel, has a flat on one side into which four headless nails are driven; two of these are driven straight and the others are bent slightly. The

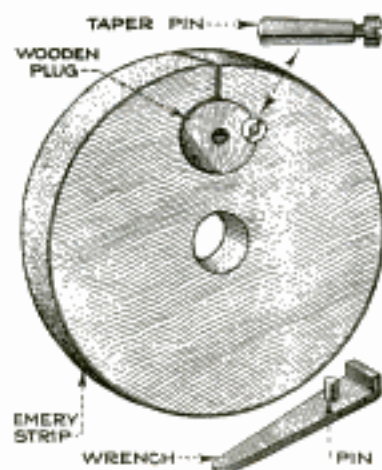

plug in all cases is smaller than the hole by the double thickness of emery cloth or paper used on the wheel. The wrench used to tighten the plug is made from a piece of flat steel or iron bent over at one end and having a pin that engages in a hole drilled in the center of the plug. To determine the length of the strip of emery cloth to use, place it around the wheel, bring the two ends through the slit and tear off, leaving enough to press over the nails in the plug when in place. Next, pull the plug around with the wrench until the emery is drawn tight on the wheel; clamp in this position and drill a taper hole, half the diameter of which is in the plug and the other in the wheel. The job is completed by fitting a taper pin, threaded on the end for a fillister-head screw, and counterboring for the screw



Harry Moore  
544 9 Third Ave.  
Rosemount, Missouri

head. When fitting new strips of emery on the wheel, tear off the correct length, using the old piece as a guide, and press both ends over the nails in the plug, then insert the latter in the hole and press the two ends above the plug through the slit at the same time, tighten with the wrench until the two halves of the taper hole come together, then slip in the taper pin. The wrench is then removed and the screw on the pin tightened, thus binding the plug firmly against the emery.

### A Kink for Paperhangers

When hanging wall paper on a side wall it is necessary to see the edge of the paper from top to bottom in order to get the correct lap. This is very difficult to do when wearing spectacles, for it is impossible to see through them as well as with the naked eye. I have found that this difficulty can be eliminated to a great extent by driving a small lath nail slightly into the wall on the edge of the paper as far from the edge as is necessary to get the correct lap, and at a point about one-third of the length from the top. The nail can readily be seen and the paper hung against it. Only the slightest fraction of an inch lap is needed in lapping, and this lap can be rolled down so as to present the appearance of a perfect butt joint.—A. A. Kelly, Paoli, Pa.

### Traveling Lamp Illuminates Gauge

When large tanks are located in dark places or their gauges have to be read at night, the latter should be well illuminated.

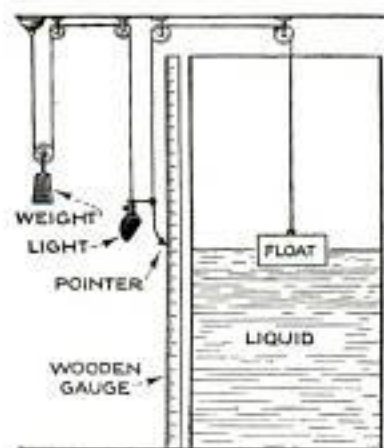

extra long lampcord is used so that a suitable counterweight can be arranged as shown, causing the lamp and gauge pointer to move smoothly together. A distant switch may control the lamp.—Kenneth Coggeshall, Webster Groves, Mo.

### Lunches Checked at Special Trucks

A Chicago factory permits its employes to bring lunches but does not allow them to be kept in lockers or carried into the operating department because left-over food thrown into wastebaskets, corners or on the floor, attracts rats, mice and other



Checking Lunches at Special Lunch Truck in Chicago Factory

pests. To take care of the packages several trucks with numerous pigeonholes were provided. In the morning the employes leave their lunches in the truck, receiving numbered checks from the attendant. Shortly before noon, the truck is moved to the company's restaurant, where the worker checks out his lunch and is permitted to eat it. Screen doors with padlocks are provided for the trucks to prevent pilfering and mix-ups.—Orin Crooker, Elgin, Illinois.

### Transparent Flap Protects Drawings

From several standpoints it is highly desirable to present finished drawings to a client or prospect protected by a sheet of transparent paper, so that the completed work presents a clean, crisp, and dressy appearance. Glassine paper, which can generally be obtained from art and stationery stores, is preferred for the purpose. One edge of the transparent paper is pasted on the back of the drawing at the upper edge and folded over the face of the work. Where the flap is to be used for a long time the bottom edge can be reinforced by pasting it between a folded strip of tough paper. Where additional protection is desirable or necessary, an additional flap of craft paper can be used.—C. Nye, New York City.



## Homemade Centrifuge for Farmers

By L. B. ROBBINS

EVERY farmer knows that the fat content of milk can be determined accurately and quickly by means of a "whirler" or centrifuge of the kind shown in the drawing. However, the cost of a manufactured machine often keeps the dairyman from using one, and this has led one farmer to design and construct a simple centrifuge at home. The device is made from old machine parts that were picked up around the farm workshop. It consists of a rectangular wooden frame, holding a horizontal and a vertical shaft, each with a bevel gear mounted on it as shown, a whirling arm, hand crank and two test tubes. The frame is built about 12 in. high and 3 in. wide, of 1-in. hardwood stock about 1 or 2 in. wide. The long pieces are screwed to the ends of the short ones, and may be braced with angle irons, if desired. Two bearing holes are drilled through the sides, to take the horizontal shaft on which the large bevel gear is mounted, and bushed with short lengths of brass tubing. A hand crank is attached to one end, and two washers and a collar are used to keep the gear in close mesh with the smaller one on the vertical shaft; this shaft is similarly mounted in two holes, drilled through the crosspieces and bushed. The shafts and

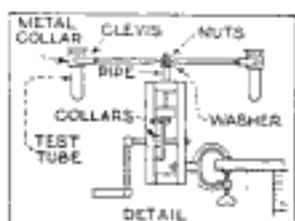

Inexpensive Homemade Centrifuge Made by a Farmer to Determine the Fat Content of Milk

bevel gears of an old ice-cream freezer were found satisfactory for this purpose. The whirling arm can be made from a 12-in. length of  $\frac{3}{8}$ -in. round steel rod, flattened and drilled in the center to fit the vertical shaft. A pipe nipple, washer and nut are fitted on the upper end of the shaft to hold it in place, and after the whirling arm is slipped over the end, the nut is

screwed on tightly. On the threaded ends of the whirling arm two Ford brake-rod clevises are attached, and a short piece of thin metal tubing is mounted loosely inside of each clevis, by means of pins soldered to the sides, to permit it to swing freely without binding. The tubing should just be large enough to receive a glass test tube as indicated. An old washing-machine or wringer clamp can

be fastened to the frame so that it can be attached to a bench or table. In use, the test tubes are filled about three-fourths full of milk, set in the tube holders on the whirling arm and the hand crank is then operated at a high rate of speed; this will cause the bottom end of the test tubes to swing outward due to centrifugal force. All solids in the milk go to the bottom, and this makes it comparatively easy to determine the fat content accurately; the device also allows the test to be made much more quickly than by any other method.

### Repairing the Faucet

It often happens when repairing a compression faucet that the screw holding the washer on the stem is stripped, making it necessary to purchase a whole new faucet, as the parts are not usually sold separately. A repair can readily be made by the handy man, however. The old screw is clipped off and the end of the stem filed down smooth. A hole, large enough to receive the end of a dry-cell binding post, is then drilled in this end, and the binding post sweated in place, screw end out. The

thumbnut of the post is cut in half so that it will not interfere with the seating of the washer, then used like the regular nut; the projecting end of the screw is also sawed or filed off.

### Blueprint Signs without Tracing

Instead of printing signs and notices on tracing cloth and then making a blueprint from the tracing cloth, much time can be saved by stenciling the sign out of drawing paper, which costs much less. After printing, the letters will stand out in blue.





## A Convenient Campfire Hob

By ROLAND B. CUTLER

**C**RUDE methods of holding pots and kettles over the campfire usually cause more or less inconvenience in preparing food, but such trouble can be avoided by providing a campfire hob of the kind shown in the illustration.

The hob is made of pipe and fittings and can easily be carried along in the automobile, as it is small and weighs only about 7 lb. It consists of a post which is driven

a heavy spike can be pushed through to serve as a rest for the crane, which is set into the end, and also as a handle to pull the post out of the ground when breaking camp. The crane is made of lengths of  $\frac{3}{8}$ -in. pipe and fittings; it consists of one 13-in. length of pipe having tees screwed on both ends and shorter extending lengths to support a revolving hob to which the cooking arms are attached. A 4-in. nipple

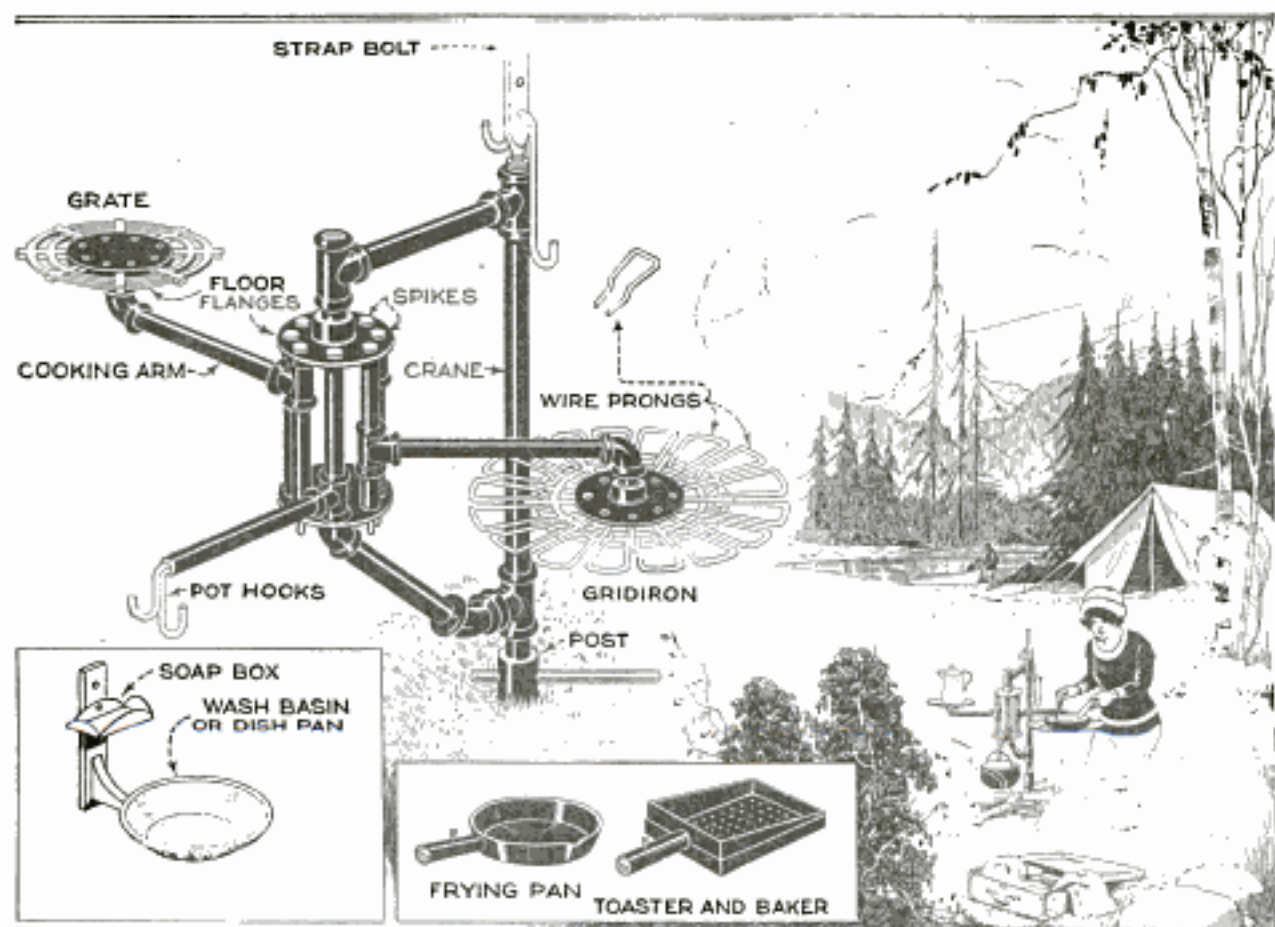

Handy Campfire Hob, Made of Pipe and Fittings. Weighs About Seven Pounds and Can Easily Be Carried in the Auto; the Lower Details Suggest a Few Handy Cooking Utensils

into the ground almost its entire length and a revolving crane fitted with cooking arms to hold such units as grid, grate and pot hooks. The post is a 24-in. length of  $\frac{3}{4}$ -in. pipe having a hole drilled through it about 3 in. from the upper end so that

is screwed into the bottom tee on the crane to fit into the top of the post.

The hob is mounted between the two arms as shown. It consists of two large floor flanges with holes drilled near the edges to accommodate large spikes, which



are slipped through  $\frac{1}{4}$ -in. pipe nipples of various lengths. These fit loosely between the flanges and are fitted with tees that hold cooking arms extending at right angles. To one of the cooking arms is attached a grate, which is simply an ordinary gas-stove grate or similar contrivance bolted to a floor flange. A gridiron is attached to another cooking arm; it consists of another gas-stove grate, also attached to a flange and fitted with a number of wire prongs, bent to the shape shown. The pot hooks are made of No. 10 galvanized-iron wire, pushed into the end of an arm. A strap bolt fitted with a wire hanger is provided on top of the crane for the purpose of hanging up cooking utensils, wash basin and the like. Both grate and grid-

iron elbows are fastened to the arms with pins so that they can be used either side up.

Although every camper has his own idea as to which cooking utensils are handiest, the lower details in the drawing suggest some useful ones. A dustpan from which the paint and varnish have been burned and with the bottom perforated, makes an excellent toaster and baker. It is fitted with an extra perforated bottom of sheet metal, bent over and riveted to the sides. A common frying pan is also used, with an extension made from a piece of sheet metal riveted to the handle. The arm tees for these units must be pinned so that they cannot turn over accidentally. The detail at the left shows a wash basin mounted on a bracket that can be hung on the strap bolt.

### Fitting Camera Lens

Portrait and copying lenses can be attached to small cameras for which they were not intended by means of a clip made of lengths of wire, bent to the shape shown in the drawing. The wire used for this

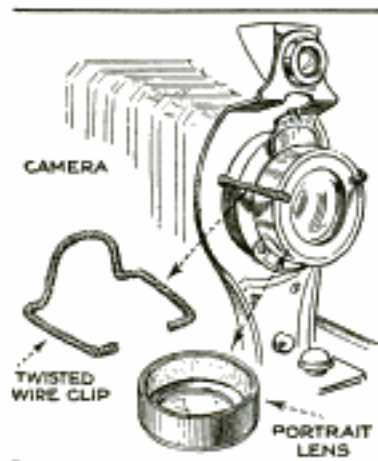

purpose is cotton-covered wire intended for artificial flower work, three lengths being twisted together. A little experimenting will show the correct length for the hooks. Place the clip in position and the portrait lens about  $\frac{1}{4}$

in. above the center of the camera lens. Then draw the lens down to center and the clip will hold it in position firmly. If there is no space behind the lens mount for the center part of the clip, two separate hooks may be employed.

### Stopping Leaks in Incubators

Most incubators from the 100-egg size to the large ones that hold several thousand eggs are heated by means of hot water, circulating in copper or iron pipes. These pipes often begin to leak after a few years of use and this causes much trouble, as it keeps the interior too moist for good hatching results, and also involves considerable labor and trouble in repairing the leaks, resoldering the joints, tightening

them up, or replacing sections of piping. A simple and effective method of stopping such leaks temporarily is to use automobile radiator cement, added to the water after the latter has been thoroughly heated. This compound will in no way affect the piping or give off injurious fumes.

The cement should be left in the hot-water system during the entire hatching season, then, when the season is over, a permanent repair can be made. However, if desired, cement can be left in the piping for several years without doing any harm; the writer left the original solution in a small incubator, which leaked badly before the cement was added, for four years, and not one leak has appeared since.—J. H. Ferris, Elberta, Mich.

### Serviceable Dandelion Hook

Occasionally the breaking off of a lobe of a hoe renders it unfit for further use and it is then usually thrown away. However, a serviceable tool for the purpose of removing dandelions can easily be made from it. The shank of the broken hoe is straightened in line with the handle, and the blade is cut and filed to the shape shown, a V-shaped notch being cut in the end and filed to a sharp cutting edge. One of the points is cut to form a pulling hook, the throat of which is, of course, dull. A tool of this kind is very handy, as it can be used to cut the dandelions at their stems or pull them out entirely.





### Replacing Auto Spindle Bolts

When replacing automobile steering-spindle bolts, it is sometimes difficult to keep the openings in the axle jaws and the one in the spindle lined up. This difficulty can often be remedied by placing the lower end of the spindle in the right position between the axle jaws and turning up another spindle bolt from below far enough to hold the spindle in position. Then bring the upper end of the spindle in place and push down the new spindle bolt from above until it meets the lower bolt. The lower bolt is turned out a half turn at a time, tapping the upper bolt gently each time this is done, until it starts in the threads of the lower jaw.

### Improved Lard or Fruit Press

An efficient lard or fruit press can be improvised in a short time from two lengths of 1-in. oak, 4 ft. long and 7 in. wide at one end and tapered down to form handles at the other. A number of grooves



are sawed across the wide ends as shown, about  $\frac{3}{8}$  in. apart, and two  $\frac{1}{2}$ -in. holes are drilled at these ends for bolts to make a loose, adjustable hinge. A cheesecloth sack of fruit or lard is inserted between the grooved ends and after the handles are squeezed together tightly, a loop of

wire is placed over the ends to hold them. The lard or fruit juice is pressed out and runs in the grooves, dripping off into a receptacle below.—J. T. Garver, Huntingdon, Tenn.

### A Novel Wood Yard

In order to avoid the unkempt appearance that firewood thrown carelessly into a pile always presents the wood "yard" illustrated herewith was devised. In effect this yard is a good deal like a small corral, a familiar sight on every western ranch. Built of peeled logs of fairly uniform diameter, the construction is similar to that of a log cabin with the "chinking" omitted. The ends of each log rest in a shallow notch in the bearing ends of the logs

underneath. The uprights for the gate are held in place with lag screws, driven into the logs next to them. As a further means of strengthening the gate posts they are mortised into the bottom log, on which they stand. The cross arm on top, consisting of a split log with its flat side rest-



Presenting a Neat Appearance, This "Yard" Keeps Firewood Stored in a Convenient Manner

ing on top of the posts and held in place by lag screws, adds somewhat to the strength and not a little to the appearance of the yard.

Such a wood yard will do not a little toward tidying up the picnic grounds or camp sites where firewood is a necessary factor in the activities of the place, nor would it be out of place on many a well-regulated farm. Where timber grows in any quantity at all the material out of which to make it is always at hand.—C. L. Meller, Fargo, N. D.

### Milk-Bottle Cover

A common cup or tumbler is often used as a cap on a milk bottle to keep the dirt out. This practice, although convenient,

is not very economical, as the cups and tumblers are often broken. It is much better to make a lid from a small tin baking-powder can as shown in the illustration. The can is cut down so that only about  $1\frac{1}{2}$  in. of the side remains and four V-shaped slots are cut into the side to



permit it to be bent inward as shown. A cap made in this way will fit closely over the mouth of any milk bottle, and can easily be removed.



### Portable Garret Step

In bungalows where limited space does not permit built-in garret steps, a "folding" stepladder of the kind shown in the drawing has been found very convenient. It is made of 1 by 5-in. lumber, the risers being

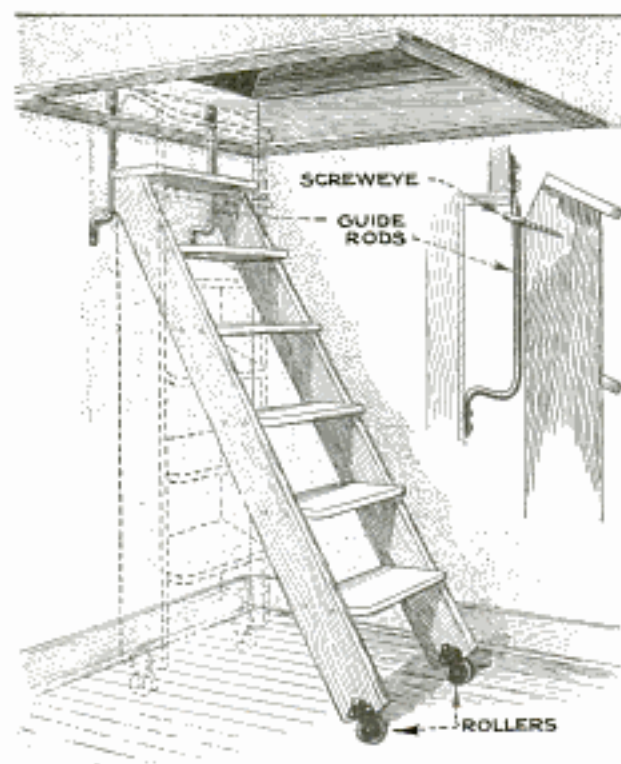

Portable Stepladder for Use in Bungalows Where Limited Space Prohibits Permanent Stairs

set between the sides at such an angle that they are perfectly horizontal when the ladder is pulled away from the wall. Two large screweyes fastened to the top of the ladder are used to hold it on the two vertical guide rods, which are permanently attached to the wall; this arrangement allows the ladder to be raised and lowered to the positions indicated. A couple of casters provided on the feet of the ladder facilitate the work of pulling it out from the wall and pushing it back again.

### Re-Using Envelopes

Ordinary envelopes can be used a second time by turning them inside out. To do this the adhesive that holds the flaps together must first be softened, after which they can be turned over and stuck together again. A good method of loosening the flaps is to first moisten a towel, wringing it out until rather dry, and spreading it out between a folded newspaper. The letter is then put on the towel so that the back of the envelope is in contact with it, the newspaper folded over all, and a moderately heavy weight put on to keep it flat. After

half an hour or so the flaps can readily be loosened with the aid of a knife. The same gum can be used to stick the flaps together on the opposite side and it only remains to gum the top flap after inserting the new letter. This method may seem "penny-pinching," but in this country anything that effects economy in the office or household is well worth while, and the kink is a good one to know for an emergency.—John L. Allen, Cortazar, Mex.

### Making Fishhooks Easily Detachable

When one desires to remove a fishhook quickly from a line in order to substitute one of another style it often occurs that the knot is too stiff to untie. An excellent and simple attachment that allows hooks to be removed and replaced easily is a common dress hook of large size, preferably one with a "hump," which locks the eye in place. The fish line is run through the eyes and tied, and the hook is slipped on as shown in the illustration. Dipping the hooks in black enamel or paint before using will render them less liable to be seen by the fish.—L. B. Robbins, Harwich, Mass.



### Reserve Gasoline Tank

A gallon gasoline can, kept in reserve, is a time and trouble-saver for the stranded motorist. The usual practice is to carry a separate can, but this has the disadvantage of being hard to stow without spilling the contents. It is much better to have the can connected to the main line with a T or Y fitting, and provided with a valve so that the contents can be supplied to

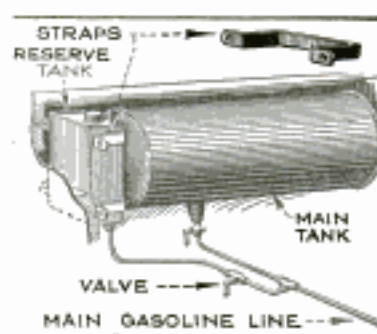

the carburetor by merely turning the cock. A good place to store the reserve tank is under the front seat, brackets being used to hold the tank securely in position. The connection should be made as close to the carburetor as possible, so that if the main feed pipe becomes clogged, the auxiliary pipe can still be used.—G. A. Luers, Washington, D. C.



### Removing Stuck Bullets

A lead bullet stuck in a rifle barrel can be easily removed in the following way: Get a piece of wire of the kind and size used for barrel hoops and long enough to reach the bullet from the chamber end of the barrel. Flatten one end of the wire by hammering it out cold, forming it to a blunt point like a flat drill, and file the edges sharp, rounding off the corners to fit the bore. If a breast drill is handy the wire is tightened in the chuck and the bullet drilled out. If a carpenter's brace is used it is necessary first to flatten the end of the wire to fit the chuck snugly. As lead is very soft it is a matter of only a few moments to drill out the bullet. The rifle should be thoroughly cleaned and oiled before firing a loaded cartridge.—Clifford Cornwall, Toronto, Can.

### A Simple Drawer Stop

It often occurs when one is in haste, that a drawer is pulled out so far that it falls out entirely. This can easily be prevented by means of the drawer stop shown in the drawing. It consists of a small block

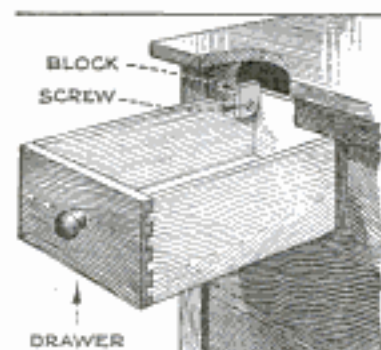

of hardwood, screwed to the side of the drawer and against the back as shown, the screw being driven through the corner of the block as indicated so that it can be turned down when it is desired to remove the drawer. The block should be raised just high enough to strike against the front crosspiece above the drawer, and the screw should be tightened enough to prevent the block from falling down accidentally.—L. Schneider, Clinton, Mo.

### Nondragging Anchor for Small Boats

Prices for anchors used to hold small mooring buoys seemed so exorbitant that I decided to make an anchor myself, and did so at a fraction of the cost of a purchased one. I got several 2-ft. lengths of  $\frac{1}{2}$ -in. iron rod from a neighboring dumping ground, and bent the ends over as shown. Then I forced these rods through a sack of ordinary cement and turned the ends toward the mouth of the sack. An-

other rod of the same length was threaded at one end, a large washer slipped on, and a nut then screwed on to keep the washer in place, while the other end was bent to form an eye through which the anchor line was slipped and tied. This rod was pushed

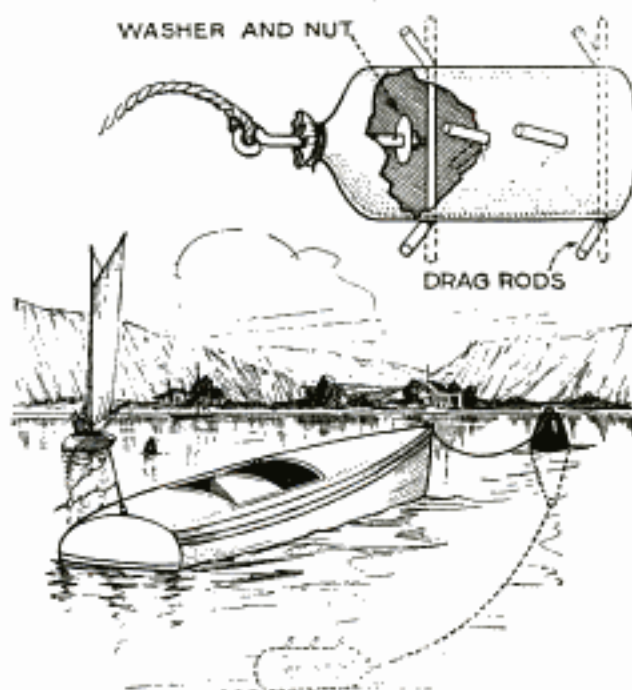

Nondragging Anchor for Small Motorboat Made from Sack of Cement and Iron Rods

into the bag of cement with the eye extending outside of the mouth as shown. The cement was saturated with water by means of the garden hose and left to harden overnight. The result was as good an anchor as could be purchased, and it cost only 75 cents—the price of the cement.—J. E. Hoag, Los Angeles, Calif.

### Connecting Ford Rear End

A simple method of connecting the Ford rear end is shown in the illustration. Place the rear end as far forward as it will go. Jack up one wheel with the jack tipped forward as shown. From under the car guide the joint with a screwdriver, and, by turning the wheel to align the male joint member with the hole, the jack will force it into place. One man can do this alone very easily and quickly.—C. W. Knight, So. Windham, Me.

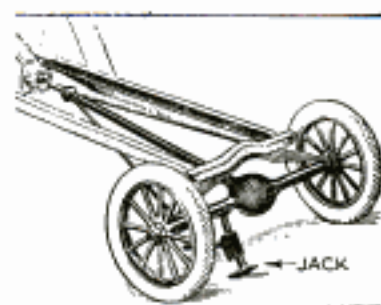



### Simple Screen-Door Check

Considerable annoyance is occasioned by slamming screen doors. To overcome this a simple and inexpensive door check can

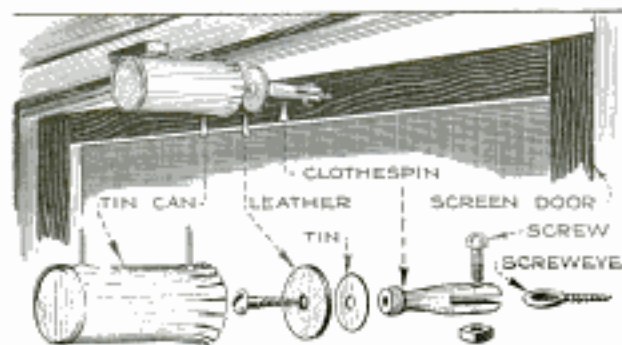

Inexpensive Screen-Door Check Made from a Tin Can and a Clothespin

be made from the materials available everywhere.

The check consists of a tin can with the edges cut and flared out as shown, and attached to the top of the door casing. The remainder of the check consists of a clothespin attached to the top of the screen door by means of a screw-eye and a stove-bolt, and a heavy leather "piston" or disk, reinforced with a disk of tin, both of which are screwed to the end of the clothespin. Upon closing the door, the piston enters the cylinder and this checks the momentum of the door and prevents it from slamming. It may be found necessary to drill a very small hole in the end of the can, so that the air may escape slowly, and allow the door to close tight.—George M. Beerbower, Tarrytown, N. Y.

### Holder for Small Pamphlets

Small leaflets and booklets, such as government bulletins and advertising cook books, can be neatly kept in compact and convenient form by means of the simple



A Handy Holder for Bulletins, Cook Books, and Similar Pamphlets

holder shown in the photograph. It is made of 1 by 9-in. lumber; the base is 12 in.

long and the vertical piece which is nailed to the base in the center, as shown, is about 6 in. high. The edges and corners of both are rounded and the whole rubbed smooth with sandpaper. A length of stiff galvanized-iron wire bent to a U-shape is fastened over the vertical piece by forcing the ends into holes drilled into the base. The booklets may then be shifted at will to either side, in the same way as a loose-leaf book. A pamphlet may also be rested, for reading, on the upright, as shown in the left-hand photo. A hole drilled in the base makes it possible to hang the holder and pamphlet up out of the way.—Harold R. Harvey, Buhl, Idaho.

### Enlarging and Reducing Photos

The width of enlarged and reduced photos, the height of which is known, and the height, when the width is known, can quickly be found by means of the simple device shown in the illustration. It consists of 3 strips of thin, strong cardboard, two of which are graduated in inches and fractions. The plain strip is laid across the original photograph diagonally from corner to corner as shown, and one of the graduated pieces is then laid parallel to the sides so that it intersects

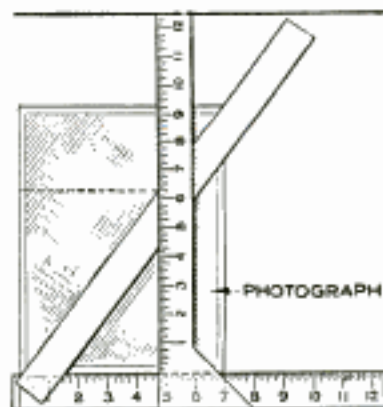

the upper edge of the diagonal strip at a point which is the correct height of the enlarged or reduced photo, as shown by the dotted lines in the drawing. The second graduated piece, or a ruler, which may be used just as well, is laid along the bottom of the photo with the beginning of the scale at the left-hand corner as indicated. The distance from this corner to the point where this scale intersects the perpendicular scale is the width of the desired enlargement or reduction.

A stronger and more elaborate instrument can be made of wood or metal, using a pivot for the plain strip and grooved guides for the graduated ones, but the simple form shown in the illustration and described above is just as convenient. The projection at the foot of the vertical strip aids in getting it exactly perpendicular to the other one.—Harold E. Benson, Boulder, Colo.





## Part II

**I**F the main bearings are slightly loose they can be tightened by removing one shim from each side of each bearing cap. Remember that not more than one shim should be removed, because if the looseness is so great that taking out one shim will not remedy it, the bearing should be rescraped, and this is no job for the inexperienced. The shim removed must be the thinnest, and when the adjustment has been made on all the main bearings, the shaft should be sufficiently free to be turned with one hand. Assuming that the main and camshaft bearings are fitted, you can proceed to install the piston and connecting-rod assemblies. Before doing this, however, you should try the connecting rods for fit on the shaft. This second test is made to make sure that the shims have not been mixed. Be sure to smear plenty of oil on the pistons and cylinder walls, and then proceed to fasten the rods to the pistons. Above all things make sure that the piston-pin screw or other fastening for the pin is securely tightened, and then locked with wire or a cotter pin. In replacing the piston and rod assembly some way must be devised to compress the rings. It is advisable to buy one of the universal ring com-

pressors that sell for about 75 cents retail. The slots in the ends of the rings will, of course, be turned as outlined in Part I, so that no adjacent ring slots are in line.

When the piston is in place, the connecting rod can be pulled over and fitted on the crankshaft. A generous supply of oil is applied to both rod and bearing and the cap is then put on. Be sure that the nuts are drawn tight and that there is a cotter in each bolt; also, before cottering, see that the bearing is adjusted properly. With all pistons and rods in place and everything tightened and adjusted it should be possible to crank the engine by hand. There should be resistance to turning, but the bearings must not be so tight that the crankshaft cannot be turned with the hand crank.

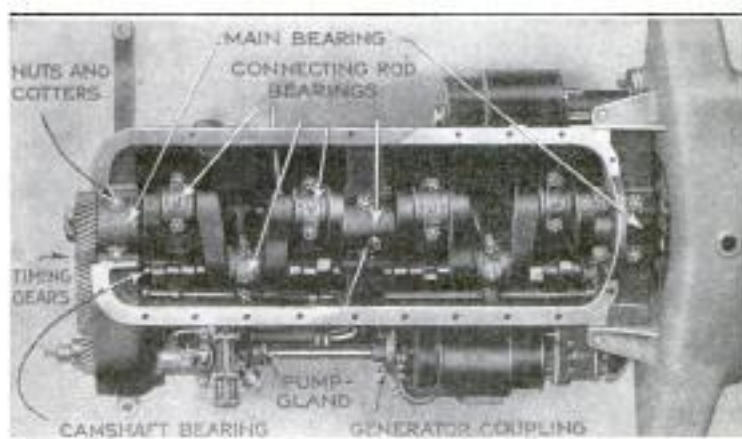

Photo Showing Parts of the Engine to Be Overhauled and Inspected when the Lower Half of the Crankcase Is Removed

pressors that sell for about 75 cents retail. The slots in the ends of the rings will, of course, be turned as outlined in Part I, so that no adjacent ring slots are in line. When the piston is in place, the connecting rod can be pulled over and fitted on the crankshaft. A generous supply of oil is applied to both rod and bearing and the cap is then put on. Be sure that the nuts are drawn tight and that there is a cotter in each bolt; also, before cottering, see that the bearing is adjusted properly. With all pistons and rods in place and everything tightened and adjusted it should be possible to crank the engine by hand. There should be resistance to turning, but the bearings must not be so tight that the crankshaft cannot be turned with the hand crank.

Too much clearance between pushrods and their guides or bushings will produce noise. There is only one method to eliminate this clearance and that is by replacing pushrods or guides, or both. A maximum of .008 in. diametral clearance is allowable between pushrod and guide and on some engines a decided noise is apparent when the clearance is half this amount. Like the camshaft bearings, the pushrods and guides do not wear rapidly and should the replacement of these parts be necessary it is better to get a complete new assembly, or have an experienced mechanic do the necessary fitting. We may now assume that the cylinder

Too much clearance between pushrods and their guides or bushings will produce noise. There is only one method to eliminate this clearance and that is by replacing pushrods or guides, or both. A maximum of .008 in. diametral clearance is allowable between pushrod and guide and on some engines a decided noise is apparent when the clearance is half this amount. Like the camshaft bearings, the pushrods and guides do not wear rapidly and should the replacement of these parts be necessary it is better to get a complete new assembly, or have an experienced mechanic do the necessary fitting. We may now assume that the cylinder



we may now assume that the cylinder



head and crankcase have been replaced and that these parts are all tightened and locked where locks are provided. No old gaskets should be used; in every case a new one should be installed. Also, when tightening the cylinder head go at it systematically, striving to tighten evenly. If there are three rows of bolts or nuts holding the head, start with the center row and then tighten one nut on the right row, following with a tightening of the one opposite in the other outside row. Give the nuts



a final tightening when the engine is warm.

Before you leave the engine for other parts go over it carefully to see that all lock washers, cotters, nuts, etc., are tight and in place. The ex-

haust pipe and muffler should be cleaned, with special emphasis on the muffler itself. Before bolting any parts of the exhaust system, spread a little fine graphite on threads and bolts. This prevents accumulation of rust and makes future removal easier. The chief thing to do with the gasoline system is to give it a good cleaning. This operation includes cleaning the gas lines with compressed air, removing the sediment bulb from the gas tank and cleaning the carburetor float chamber and screen. If the vacuum tank has not been cleaned recently the screen in the top should be unscrewed and cleaned. Take out the screws holding the top and lift out the inner tank. Be careful of the cork gasket under the head. Clean out all foreign matter from the inside of both inner and outer tanks. Do not touch the float-operating mechanism, as there is little chance of anything going wrong with it. Occasionally the float becomes punctured, which can be detected by shaking the float. It will also be heavier than usual on account of gasoline entering. Do not attempt to make a permanent repair to a punctured float but get a new one as soon as possible.

When you have covered all these points drain all the gas from the main supply tank and if possible remove it for cleaning. Some gas tanks are difficult to remove, in which case all the fittings at the bottom of the tank should be removed and a jet of air passed through the tank. If air is not available you can open the filler cap and note whether the bottom



of the tank is clean or not. If there is considerable dirt in the bottom use a garden hose for cleaning, then drain the tank thoroughly and allow it to stand until all remaining water has evaporated. Replace the bottom fittings and connect the gas line to the tank. The overhaul of the fuel system is then complete.

If the lubricating system has been functioning properly let it alone. If the oil leads are accessible, you might go over the connections and make sure that all are tight and not leaking. The oil strainer is the most common cause of trouble, and it is advisable to remove it about every 2,000 miles for cleaning. In practically every installation this strainer is located in the crankcase and can be reached by removal of a plate or plug in the bottom of the case.

To put the cooling system in shape fill the radiator with a hot solution of washing soda. The strength of the solution should be about the same as used by a housewife for cleaning floors. With the solution in the radiator operate the engine for five or six hours and then empty it, washing the inside with



clear water. If there is a pump in the cooling system remove the pump stuffing-box glands. Then examine the pump shaft for wear or corrosion. A shaft with corrosion marks deeper than  $\frac{1}{16}$  in., or a shaft with grooves worn into it to the same depth, should be replaced. Start on the ignition system by examining all wire for chafing and by cleaning the interrupter housing. The distributor itself should be thoroughly cleaned and the interrupter points should be filed to remove metal deposits caused from arcking. Remove all of the spark plugs and lay them on the bench. Place the porcelain end of the spark-plug metal shell in the vise, and separate the porcelain from the shell with a wrench. By holding the nut in the vise as suggested all chance of breaking the porcelain due to the wrench slipping is eliminated.

Complete each plug before you disassemble the next one. After the porcelain is removed from the shell clean it and the shell proper, and examine the porcelain for cracks. If any cracks are visible new porcelain must be provided. Assemble the plug and then set the gap between the electrodes with the feeler or thickness gauge. In doing this remember that the electrode that is fastened to the shell is the only one that should be bent



to get the correct gap distance. Never bend the center electrode. Some care must be exercised in the assembly of the plugs to see that the copper gasket is properly located. When the plugs are finally installed it is well to bear in mind that for high-compression engines the plugs should be screwed in more tightly than usual. Another thing to remember is that a perfect gasket is required between plug and cylinder head in order that the heat-conducting properties of the plug be retained. Do not attempt to install a new set of interrupter points, as this is a job for an experienced mechanic. The same may be said of all other parts of the ignition, starting and lighting systems.

Never add acid to the battery solution; if this seems to be necessary, have the battery station attend to it. The care that an owner can give the battery ends with supplying distilled water at regular intervals and maintaining tight connections at the battery and through the electrical system.

With the exception of the Chevrolet and Rolls Royce, all American passenger cars are equipped with the disk type of clutch. Maintenance of the cone clutch consists in regular applications of neat's-foot oil and regular lubrication of the throw-out bearing. Beyond this, a grabbing or slipping clutch can be cured only by roughing the leather facing or by installing a complete new facing. The non-adjustable type of multiple-disk clutch requires but little attention. As wear occurs on the fabric-lined plates compensation is provided by changing the adjustment on the pedal. The latter must be free so that it does not strike the floor boards.

The dry-plate Borg and Beck clutch has a simple adjustment for wear. Adjustment is made by two setscrews which swing in a circular slot in the rear face of the clutch-housing plate. To adjust, the screws are loosened and moved in a clockwise direction for increasing and counterclockwise for decreasing the tension. The adjustment is best made when the clutch pedal is down, that is, when the clutch is disengaged.

Cleaning and lubrication is the only work that can be undertaken by the car owner as far as the transmission is concerned. Do not attempt the installation of gears, bearings or other parts of this unit. The gear-box cover should be

removed and the case filled with kerosene. The kerosene should be "sloshed" around and then drawn off through the opening in the bottom of the case, which is provided with a plug. Follow this operation with replacement of the drain plug and then fill with kerosene. Use a paintbrush or stick to get into the corners of the case and when you have dislodged all old grease, drain the case again and replace the plug. When you have the case thus thoroughly cleaned, fill it to the level of the countershaft with fresh lubricant. The rear axle and universals will come in for some attention if the car has been operated for a year or more. Regarding the rear axle the extent of the owner's care is confined to lubrication and cleaning and unless there is something wrong do not attempt to improve it. If the axle is unduly noisy call in a mechanic but do not fail to drain the old lubricant, clean the axle housing and refill with fresh lubricant every 5,000 miles.

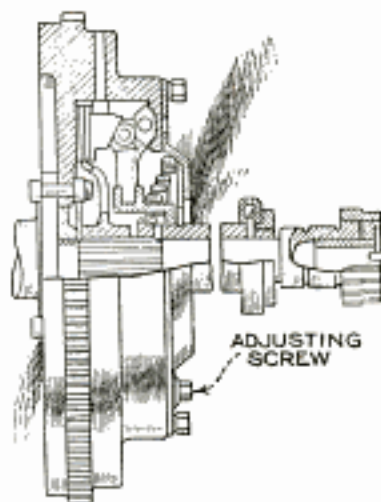

The universal joints, if of the metal type, should be inspected for looseness and lubrication. There is only one cure for a loose metal universal joint and that is replacement of the worn parts. Never fill these joints to more than two-thirds their capacity, as anything above this will be thrown out and soil the body. The fabric type of universal is very easy to maintain and should be given an inspection about every 5,000 miles. Put a wrench on the bolts that hold the disk assembly together and bring the nuts up as tightly as possible. If the disk-assembly bolts are allowed to remain loose for any length of time the holes in the fabric will be elongated and it will be necessary to install a new disk.

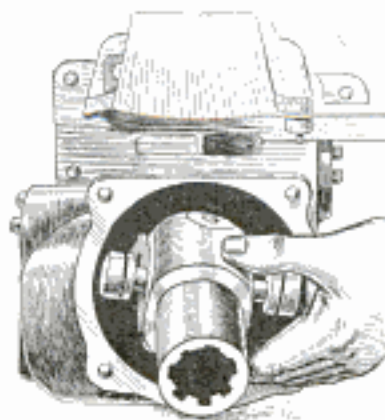

Generally speaking, the brake system of the modern car is such that only lubrication and adjustment can be applied by the average owner. A job that will be required about



every 30,000 miles is relining the brakes, which generally requires the removal of the rear wheels and sometimes the front wheels. With the exception of the actual fastening of the brake lining to the shoes and bands there are no operations on the brakes that require any great skill. It is recommended that where a lining is worn to  $\frac{1}{16}$ -in. thickness or less, the brake be relined. For best results remove the bands or brake shoes and have the local garage-

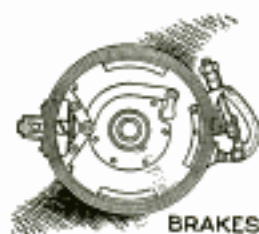

BRAKES

man apply the lining to them. Your job then will consist in reinstalling the newly lined parts, freeing the mechanism and adjusting.

In extreme cases you will find brake-

operating shafts that are so badly rusted that they will require sawing loose with a hacksaw and installing of new shafts. For other cases of brake-shaft seizure apply quantities of kerosene or penetrating oil; then, when the shaft is free, apply plenty of good grease or lubricating oil. When new lining has been applied and all brake-operating shafts are free and lubricated you may go ahead on the adjustment of the brakes, which is usually described in detail in the car manual.

The up-and-down play of the steering wheels is remedied by loosening the clamp or lock screw on top of the steering-gear bracket and turning the adjustment nut down. This action forces the shoulders of the column closer to the thrust bearing. Some gears have an eccentric bushing mounted in the side of the bracket or housing. There are generally holes or slots in the end and face of these bushings which allow them to turn after the locking devices have been removed. Some gears have a thrust adjustment for side play on the pitman shaft. This adjustment is either a thrust screw with locknut or consists of washers of varying thickness interposed between the steering bracket housing end plate and the face of the pitman shaft. Repack the steering-gear housing with non-fluid oil or heavy steam engine oil every three or four months. The drag link, which forms part of the steering system, should be removed, cleaned, inspected and lubricated each 10,000 miles. Adjustment and removal are made possible by screwing a slotted nut in or out. The steering spindles and bolts should receive regular lubrication and should this point be neglected, it will be found that the cause of hard steering will be traceable to frozen or non-lubricated spindle bolts, or king-bolts as they are sometimes called. These

are among the most neglected parts of the modern car and should have considerably more care than usually given them.

At intervals of 10,000 miles the wheels should be removed, the old grease cleaned out and the bearings inspected and replaced if any are worn or pitted. If ball bearings are used they should be tested by spinning in the hand. If they have a tendency to stop suddenly or have a slight grinding sound when thoroughly clean it indicates that the balls or raceways are worn and a new bearing should be installed. Roller bearings are inspected visually after cleaning and in every case, regardless of the type of bearing used, they should be filled with a full supply of fresh lubricant before replacing. Never make a front wheel bearing so tight that the wheel binds, as this will soon ruin the bearing. The ideal tension is reached when there is practically no end play and where the valve stem of the tire will tend to fall to the bottom, indicating that its weight is sufficient to rotate the wheel. As a general rule roller bearings are allowed just a slight amount of end play while ball bearings in the front wheels are fitted somewhat more closely. The nuts on the spring clips often work loose and it is very important to see that they are tight. If the spring-shackle bushings are worn so that they are sloppy over the shackle bolts replace them with new bushings. If the springs are excessively rusted it is advisable to remove the spring assembly entirely, supporting the car by suitable means such as wooden horses, jacks, or blocking. The spring is taken apart and the leaves are thoroughly cleaned with emery cloth, after which the individual leaves are lubricated with graphite grease and re-assembled. Remember to clamp the spring in a vise when removing the center bolt, as otherwise you may strip the bolt and nut.



If there are any leaks or tears in the top fabric have them mended. If the top material is discolored and brittle go over it with a good grade of top dressing and let the latter soak in. The same applies to side curtains and the upholstery. Often an old car can be made to look quite up to date simply by putting new binding material along the doors and where the upholstery is tacked to the body. New linoleum on the floor boards also greatly improves the appearance and if the running boards are covered they may be fitted with new



metal binding or a new covering, as required. The last step is to go over the car and see that no part has been neglected. Auxiliary devices, like shock absorbers, speedometers, horns, etc., should be gone over and any adjustments made that may be necessary. When all this has been done and the car has been taken out on the road for a tryout, the mechanical work can be called finished. The final operation after the road test is to go over the body with a

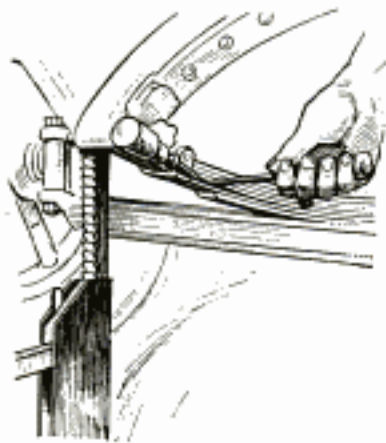

good polish and the lamps and nickel work with a good nickel polish. With this done the owner is ready for another season of driving. In closing, it should be borne in mind by every owner that there are cer-

tain limits beyond which it is not advisable to go. These include such operations as scraping bearings, repairing the ignition system, etc., which are not within the scope of the average owner's ability as a mechanic. In fact, the owner who is not a mechanic will profit most if he confines his efforts to a regular schedule of lubrication of the engine and chassis and an inspection of the entire car at regular intervals. Keep your eyes open for loose and rusted bolts and nuts, and do not allow mud or grease to accumulate and remain on the body parts longer than one day. If these simple rules are followed the maximum service of which the car is capable will be delivered.

### Fastening Screens and Storm Sash

I have had considerable trouble finding a suitable and simple means of fastening screens and storm sash, but after trying different commercial kinds I hit upon the idea of using screweyes and wood screws as shown in the illustration. This fastening is especially good for second-floor windows as many home owners have no ladder long enough to reach them from the ground. The idea is to get some fairly

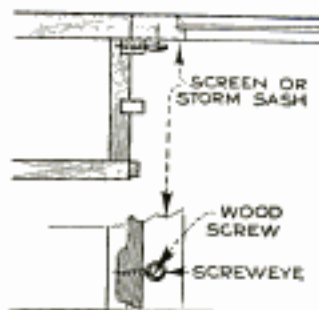

large screweyes long enough to screw through the sliding strip on the window casing, which prevents the strips from being pulled out of place. After driving in the screweyes the sash or screen is put in place and marked for the wood screws which pass through the eyes as shown.—Geo. A. Mohl, Buffalo, N. Y.

### Neat Shaving-Brush Holder

When not in use a shaving brush should be hung up so that it can dry thoroughly and quickly. A convenient holder that permits this is shown in the drawing; it will add considerably to the life of the shaving brush, besides serving as an ornament in the bathroom. The holder consists of a glass or wood panel, which is hung on the wall, and a brass clip to hold the handle of the shaving brush. If plate glass is used it should be



about  $\frac{3}{16}$  in. thick. A hole is first drilled through the glass near the top to accommodate a heavy binding-post screw. This can be done by means of an ordinary twist drill, made very hard and lubricated with a mixture of camphor and turpentine. The clip for holding the brush is made from a length of  $\frac{1}{4}$ -in. heavy brass strip, bent to the shape shown, and soldered to the top of the binding post. A short brass link, having a hole at each end, is used as a hanger, one end being held under the head of the binding-post screw. The appearance of the holder can be improved considerably by having the metal parts nickel-plated. If a wood panel is used instead of a glass one it should receive several coats of water-resisting varnish.

### Binding Glued Pieces

When gluing a broken rung of a chair or similar small piece of wood it is usually necessary to bind the parts together until the glue is dry. Rubbing the cord well with soap before it is tied around the wood will prevent it from sticking to the glue and it will be much easier to remove. \*

*make one like this. Delta Specialty Co. 858 Third St. Milwaukee, Wis.*



### Small Homemade Bunsen Burner

Amateur mechanics and jewelers will find a small bunsen burner of the kind shown in the illustration of considerable

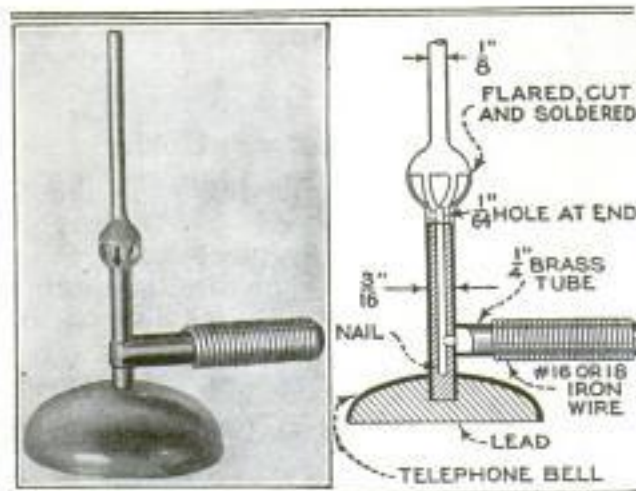

Left, Photo of Homemade Bunsen Burner; Right, Details of Construction

usefulness. It can readily be made in a short time from material always available.

The base consists of an old alarm-clock or telephone bell filled with lead. A short length of  $\frac{3}{8}$ -in. brass tubing has a  $\frac{1}{4}$ -in. nipple soldered at right angles to it as shown, and a nail, drilled lengthwise and driven snugly into the tube, is inserted through the screw hole of the bell and into the lead, when the latter is still molten. A good way to fill the bell with lead is to set it on a flat surface and pour the lead in through the screw hole. A length of iron wire is wrapped around the  $\frac{1}{4}$ -in. nipple and is sweated on with solder; this provides an excellent grip for the rubber tubing, and prevents it from slipping off. The hole drilled through the nail must be very small and exactly in the center so that a very small jet of gas is passed through the center of the upper part of the burner. A small hole, breaking into the vertical one, is drilled through the side of the tube, in the center of the nipple. The size of the hole in the end of the nail is decreased by tapping on it until it is about  $\frac{1}{8}$  in. in diameter; if made too small, it may be enlarged by reaming. The upper end of the brass tube is flared out and slots are cut in it as indicated, by means of a small jeweler's saw. A 2-in. length of  $\frac{1}{8}$ -in. brass tubing is also flared out at one end and this end is soldered to the top of the other piece, which completes the burner.

☞ To clean a greasy sharpening steel, first soak it in turpentine and then in a solution of strong soda and water.

### Sack for Picking Fruit

After using various kinds of sacks for picking fruit, all of which were more or less inconvenient, I found that an ordinary 2-bushel grain sack having a strap at the top and a belt at the bottom so that it could easily be carried, was the most satisfactory. The strap, which can be made from a piece of heavy canvas, doubled over and sewed, is formed into a loop that can be slipped over the head of the worker, and is securely sewed to the top of the sack. Three loops are sewed on near the bottom of the sack for a belt to pass through; the belt should be long enough to encircle both the bag and the waist of the worker, and should have a buckle to make it convenient. With this arrangement both hands are free and a bushel or more of fruit can easily be carried around, and, by releasing the top loop, the fruit can be dumped on the ground at once.—Arthur L. Gillis, Mt. Pleasant, Iowa.

### Hiding the Spare Ignition Key

Most autoists have two keys for the ignition lock, one carried on a key ring for constant use and the other kept at home or in the office. But an emergency unprovided against is the loss of one's key ring while far from home, and therefore it is a good idea to have a third key hidden somewhere on the car in a place known only to the owner or operator.

Two methods of keeping this extra key are shown in the drawing. A block of wood, split and hollowed out inside to fit the key, has been used by the writer for several years. The two pieces of the block are held together by means of a single wood screw driven through it as indicated. Being an apparently useless block of wood, no one is likely to take particular notice of it, and it may be safely put in the toolbox without great risk of the key being discovered. The key might also be bolted to the inside of a channel-iron bumper as shown.—J. V. Romig, Allentown, Pa.

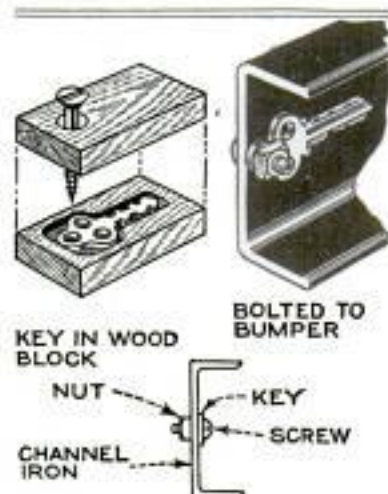



### Cleaning the Coffee Percolator

Coffee percolators occasionally become clogged and all efforts to open up the fine holes by scrubbing and washing are usually futile. A good method of doing the work is to hold the percolator in a gas flame for a few minutes and then tap it lightly; this will open all the holes at once. Obviously, this is much better than attempting to prick the holes open with a needle.—H. E. Benedict, Chicago, Ill.

### Elastic Mitten on Brush Prevents Sore Hands

Dairymen, creamery workers, and other tradesmen whose duties include the washing and scouring of cans, pails, vats, and

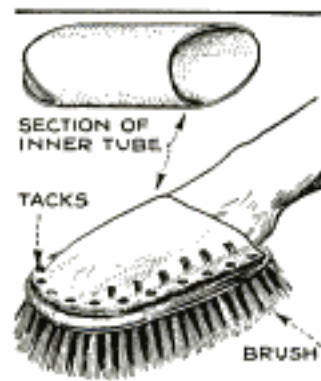

tanks often suffer from cramped and bruised hands, due to the constant use of scrub brushes. A Wisconsin dairyman, however, uses a simple protector, which he claims lessens the trouble to a considerable degree. It consists of

a section of discarded inner tube, cut and tacked to the back of the scrub brush as shown. The hand fits comfortably within the elastic mitten thus formed, and enables the worker to hold the brush in a working position without straining the muscles of the fingers; the mitten also protects the back of the hand from accidental scratches and bruises caused by contact with the can.

### Preventing Loss of Umbrella

It is a common occurrence to lose umbrellas in trains and street cars. A simple method of preventing this loss is to tie a length of stout cord, fitted with a spring clip at the end, to the umbrella handle as shown in the illustration. The clip is attached to the sleeve or coat of the owner so that when leaving the car the weight of the umbrella will remind him of it.—F. W. Erickson, New York City.

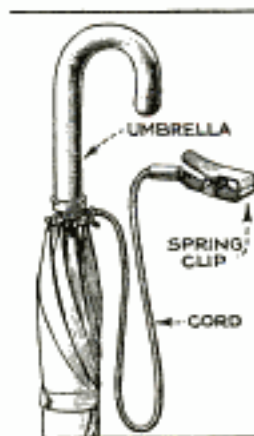

### An Improvised Ferry

A camping party selected a camp site near the bank of a narrow but deep stream. On the other side of the stream a farmhouse was located and this was the nearest place where the camping party could



A Novel Method of Using a Rowboat to Ferry Across a Stream

obtain fresh food supplies such as butter, milk and eggs.

To avoid the necessity of going around to the nearest bridge, and also to avoid the tiresome task of rowing over the stream, which was not pleasant for the women, a simple ferry was improvised in the following way: A small boat was hired and a rudder about three times the usual size was fitted to it. A heavy wire was rigidly stretched between two strong posts on opposite sides of the stream and a sheathed pulley was run on this wire. The boat was attached to the pulley by means of a rope about 30 ft. long, the bow pointing upstream. The boat could then easily be moved from side to side by manipulating the rudder, which, when set to the left, caused the boat to move toward the right and vice versa. Although the velocity of the stream was not very great it only took about three minutes to cross it, a distance of approximately 120 feet.—Dale R. Van Horn, Walton, Neb.

Scratches can be removed from furniture by rubbing well with a solution consisting of equal parts of salad oil and vinegar, using a soft rag. After the scratches have disappeared polish can be applied.



### Adapter for Bayonet-Socket Lamps

In fitting up a boat, summer camp or garage it is sometimes desired to install standard-sized wire and fittings but to use the low-voltage bulbs. The drawing shows a simple adapter made from an ordinary screw-type attachment plug. The hard-rubber screw cap is removed and discarded;

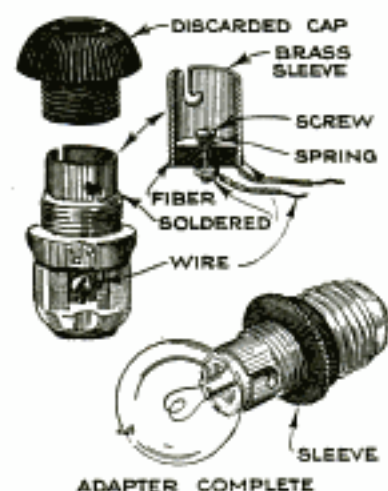

it will then be found that the inner screw sleeve of the plug will just about allow a bayonet-type socket to fit into it. A regular socket may be used or one made up from the right size of thin brass tubing that is slit

and drilled out to take the lamp base. A fiber or hard-rubber plug is driven into the lower end of the tube and drilled centrally for a small brass machine screw having a flattened head and a small brass nut. A light spring is placed between the head of the screw and the fiber plug to form a spring contact—a double-contact lamp base would require two such contacts. After soldering two short flexible-wire terminals to the sleeve and bringing them through to connect to the attachment-plug screw-contacts, the sleeve is driven into the attachment-plug sleeve or is soldered in place. The outer swiveling screw sleeve of the attachment plug is then set in place and the adapter is ready.

### Extension Handle for Egg-Beater

The writer has long wondered that suffering humanity will put up with the absurd and dinky little handles on egg-beaters. One can just about grasp the average handle and after two or three minutes



of beating the hand is tired out holding the beater in position in the bowl. The improved "pistol-grip" handle shown in the drawing was therefore fashioned from

stiff metal and tried out, much to the satisfaction of the better half of the household.

A piece of sheet steel, 6 in. long and 1½ in. wide, was cut to the shape indicated. Three holes were drilled in the small cross arm and the wide section was beaten into a semicircular shape over a piece of pipe. This latter made the handle. Then the top of the beater handle was drilled with three holes to match those in the new handle, the two were riveted together, and the handle was complete. This handle can be grasped firmly, and, owing to its size and position, offers a firm means of holding the beater steady without tiring the hand and arm of the operator.—L. B. Robbins, Harwich, Massachusetts.

### Neat Recoil Pad for Trigger Guard

The trigger guard of a "kicking" shotgun quite often bruises the user's middle finger more or less painfully. One sportsman who experienced this trouble remedied it by wiring together side by side four ½-in. pieces of small rubber tubing, fastening them to the trigger guard



as shown in the illustration. This miniature recoil pad was not only efficient but, being practically unnoticeable, detracted in no way from the appearance of the gun.

### Easily Made Window Ventilator

Ventilation without annoying draft can be obtained by using a block arranged as shown. This block is permanently hinged on the outside sill and can be instantly pushed over from its position under the window so that the window can be closed. It is made from a length of 2 by 2-in. material, preferably hard-

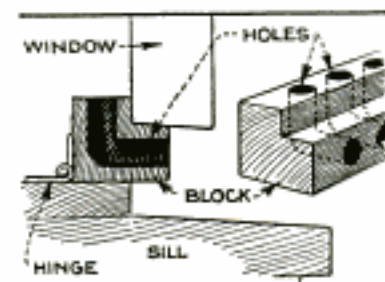

wood, cut to fit between the sides of the casing snugly and rabbeted on one edge for the window to fit in tightly. A

number of holes are drilled in two adjacent sides at right angles to each other as shown, care being taken that they do not go clear through in one direction. When the block is pulled over toward the inside it will occupy the position shown in the drawing, permitting fresh air to enter the room.—Paul R. Frohring, Cleveland, Ohio.



## A Water-Driven Ferris Wheel for the Camp

By D. R. VAN HORN

THE chief merit of the amusement device shown in the drawing is the fact that it will give the users alternate sun and water baths as long as they wish and without effort on their part. Because of this wholesome fun and the simplicity of design the wheel is a desirable addition to any summer camp situated on a stream with sufficient current to operate it. If the wheel is properly balanced and the persons seated opposite each other are very nearly equal in weight, a current with a

velocity of one mile an hour will turn the wheel. A current of three, four or five miles per hour will keep it going even though there is a difference of 25 or 30 lb.

between the riders' weights, but the weights should nevertheless be balanced whenever possible. Two 4 by 6-in. uprights are set in the stream with an inside clearance of 3 ft. The posts are sunk several feet into the bottom and further braced by one or more guy wires running from each to rocks sunk in the bottom. Though most of the strain

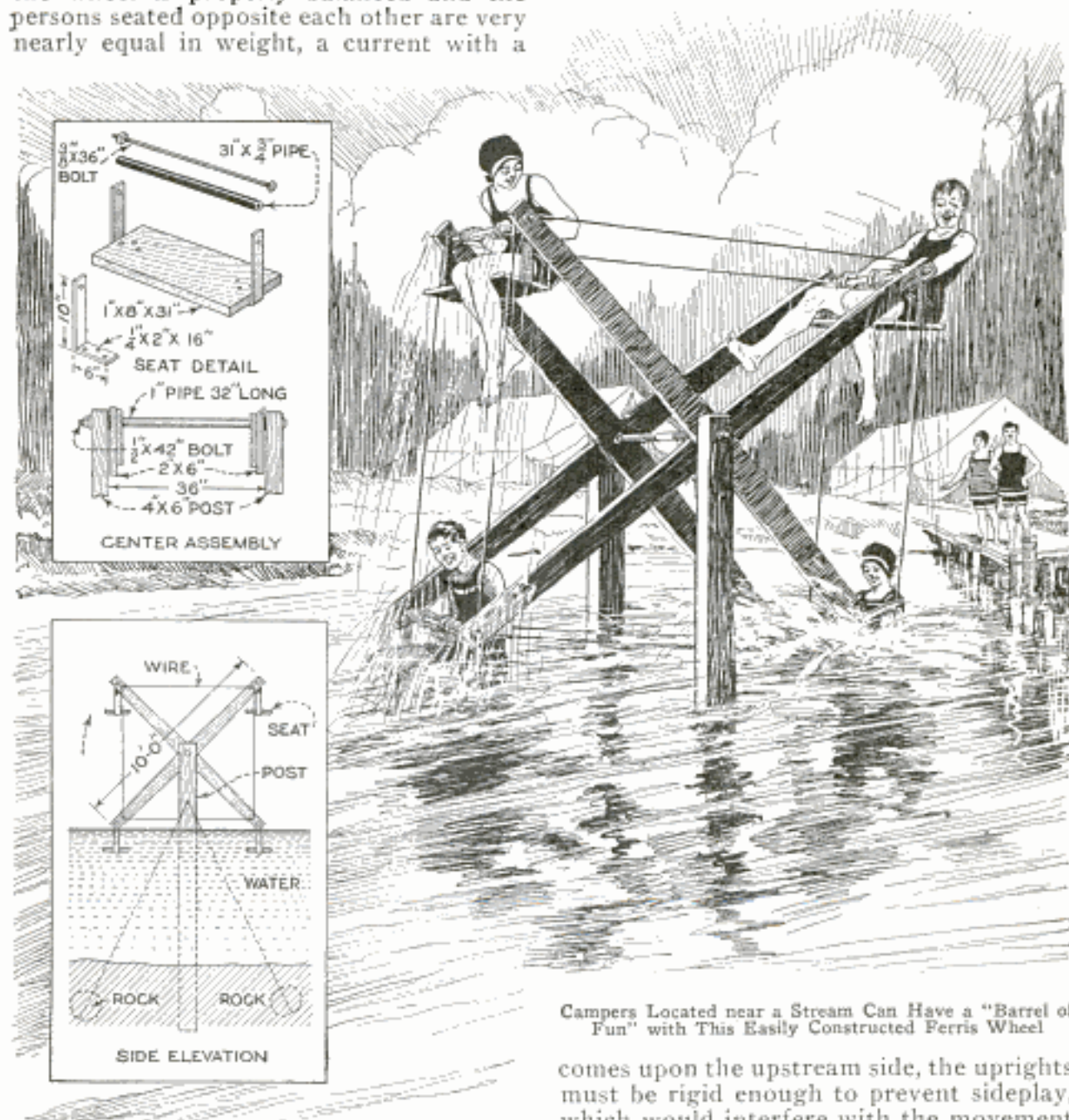

Campers Located near a Stream Can Have a "Barrel of Fun" with This Easily Constructed Ferris Wheel

comes upon the upstream side, the uprights must be rigid enough to prevent sideplay, which would interfere with the movement of the arms.

Four 2 by 6-in. pieces, each 10 ft. long, are used for the arms. Strips of wood are cut from each edge, beginning at the center, so that the width of the pieces will be

velocity of one mile an hour will turn the wheel. A current of three, four or five miles per hour will keep it going even though there is a difference of 25 or 30 lb.



reduced to 4 in. at the ends. These are mounted upon a  $\frac{1}{2}$ -in. rod, passing through the tops of the upright posts and are held properly spaced by a length of 1-in. pipe, 2 ft. 8 in. long, slipped over the rod. The ends of the rod are threaded, and nuts screwed on to tie the parts.

The outer ends are connected in much the same way by  $\frac{3}{4}$ -in. pipe and  $\frac{3}{8}$ -in. bolts. These smaller outer bolts also carry the four seats, which are suspended from them by strap irons, bent as shown in the detail and fastened with screws to the underside of the wide boards. The upper ends are drilled for the rods, and the pipes, which are placed over the rods between the strap-iron supports, not only keep the arms spaced but form good handgrips, as well. The clearance between pipe and seat should be 8 or 9 in. for the greatest comfort. Small holes are bored through the arms as indicated and by means of stiff galvanized wire, the four arms are spaced equally. This bracing withstands any ordinary strain and avoids the need of more complicated bracing at the crossing of the arms. Ordinarily the seats should submerge not more than 20 in., though the greater the depth to which they go, the greater will be the power provided by the current. Assuming that one person takes each seat, the wheel is kept in motion by

the push of the water against that person's back which is in the water. As he emerges and begins to ascend, the next person is just entering the water, so that even though the momentum created would carry the wheel over at least one revolution, there is always at least one person in the water and at least one "power impulse" every quarter turn; it will be found that the wheel will turn when empty, by the slight pressure of water against the vacant seats. To prevent excessive wear of the wooden bearings, it is advisable to get four large washers to fit the  $\frac{1}{2}$ -in. rod, and attach one by means of long wood screws to each side of the arms where they cross at the center. This will also reduce friction. If desired, this plan can be carried out also at the points where the arm-end bolts pass through. If the fit is tight, however, the rods will turn with the wheel and the friction will occur where these rods pass through the strap irons.

Care should be taken in selecting the wood. A wood that will warp badly when wet, should be avoided absolutely. Straight-grained fir or pine will do very well. To save a little in cost, the posts may be cut on the spot from small straight trees. Plans should be made to remove the wheel when camp is broken and store it away for use again next year.

#### MATERIAL LIST

2 4" by 6" posts, 15'-0" long	4 $\frac{3}{4}$ " pipes, 31" long
4 2" by 6" pieces, 10'-0" long	1 1" pipe, 32" long
4 straight-grained boards, 1" by 8", 2'-7" long	4 $\frac{3}{4}$ " bolts, 36" long
4 pieces flat iron, $\frac{3}{4}$ " by 2", 16" long	1 $\frac{1}{2}$ " bolt or rod, 42" long
100 ft. No. 9 galv.-iron wire	

#### Destroying Ants

It sometimes happens that the house becomes overrun with ants and some method is necessary to exterminate them. Sprin-

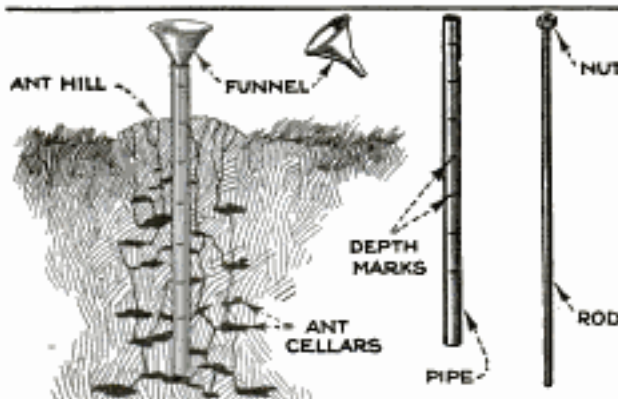

Method of Destroying Ant Colonies by Means of Formaldehyde

gling powdered mercury bichloride (poison) around where the ants travel will cause them to leave quickly and stay until

every trace of the deadly chemical has disappeared. An alcoholic solution of the bichloride painted on the floor where the ants cross is also very effective.

The ants' nest can also be destroyed by means of formaldehyde. Obtain a length of 1-in. pipe 5 or 6 ft. long, and a steel rod to slide easily inside of the pipe. Screw a nut on one end of the rod, place the rod inside the pipe, with the nut on top and drive the pipe down into the ant hill about 16 or 18 in. The pipe should be marked with a file at intervals 8 or 9 in. apart. Withdraw the rod, moving it up and down to dislodge any dirt inside of the pipe, then pour in some formaldehyde and replace the rod, which is worked up and down to force the chemical into the soil, the rod being a few inches longer than the pipe for this purpose. After the liquid has soaked into the ground drive the pipe down to another mark and repeat the operation. Some lively side stepping may be necessary to dodge the ants.



### Increasing Efficiency of Outboard Motor

Nearly every user of an outboard motor is aware of the fact that the motor loses power and the boat consequently loses speed owing to the frequent tendency of the water to "cavitate" about the propeller, which is especially noticeable when the boat is bouncing through a heavy sea; when the stern of the boat comes near the surface it often "sucks" air instead of water with the result that the motor races and may be injured.

This trouble can be prevented by the addition of a shield, as shown in the drawing. The shield is a piece of  $\frac{3}{16}$ -in. sheet brass cut to the shape indicated and large enough to project over the propeller. A hole is drilled through one end of the plate so that it can be slid onto the drive shaft. The propeller is removed by loosening the two main boss nuts and giving it a direct pull. A brass ring to serve as a collar is then driven onto the stationary portion of the shaft. This ring should be about  $\frac{1}{4}$  in. wide and can be made by hacksawing off a piece of brass tubing about  $\frac{3}{16}$  in. in thickness and of slightly larger diameter than the shaft, or better still, of such a diameter that it is a driving fit over the shaft. After the ring is driven down over the shaft the brass plate is set in place and a second ring driven on to hold the plate securely, and the whole assembly is then sweated to the shaft.

The plate's resistance against the water is practically none, for its edge cuts

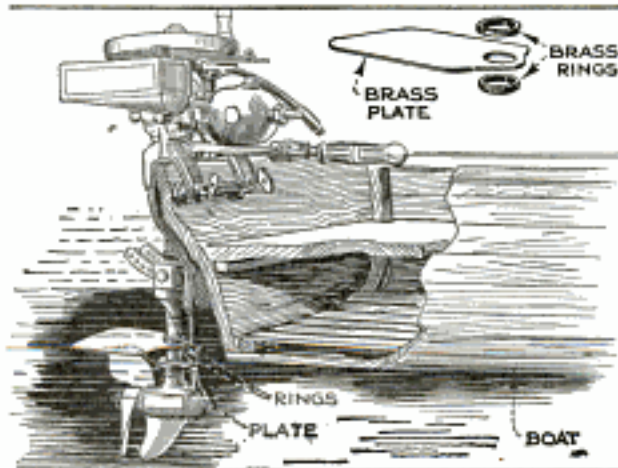

Brass Plate Installed on Shaft over Propeller Increases Efficiency of Outboard Motor

through the water like a knife. Besides eliminating the tendency of the propeller to suck air, it prevents considerable splashing about the stern of the boat, when the boat is running with the wind, and spray is blown into the back of the boat to the discomfort of the occupants.

### Hair-Drying Attachment for Fan

Drying the hair with an electric drier is a quick and convenient method, but not every one cares to buy one for such occasional use. Where some other electrical

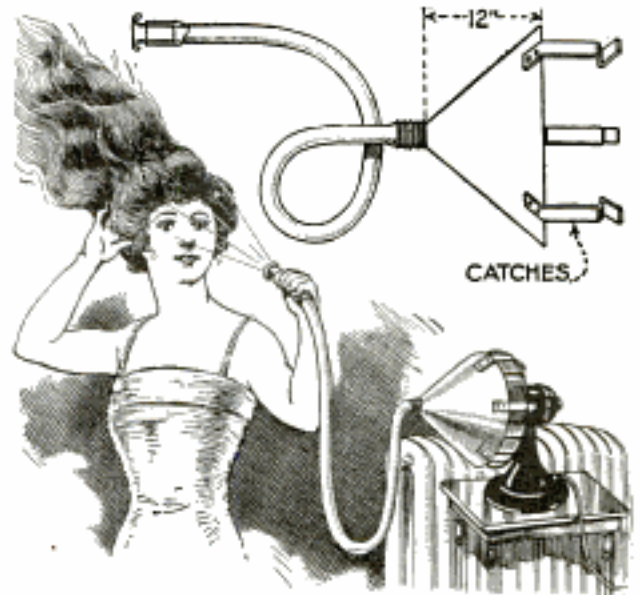

Handy Blower for Drying Hair, Which Is Attached to Electric Fan and Provides Warm Air

appliances such as a fan is at hand, an attachment can easily be made for it, that will serve the purpose.

The attachment consists essentially of a cone-shaped piece of sheet metal such as brass, to which a rubber tube with a nozzle is attached, as shown. The cone is made by cutting a circular piece about one-third larger in diameter than the fan guard, making a radial cut from the center to the edge, putting the edges thus formed over each other and riveting them together. Three catches made of brass are riveted to the cone so that it can be securely fastened to the guard. The tip of the cone is cut open and flared out so that a brass sleeve, about  $1\frac{1}{4}$  in. in diameter, can be soldered to it. A 6-ft. length of rubber tubing of the same size is attached to this sleeve, and a 4-in. length of brass tubing, with the end rounded as shown, is pushed into the end of the hose to serve as a nozzle. In one case a  $1\frac{1}{4}$ -in. motorcycle inner tube was used for the hose, but it may be still handier to use the rubber tubing usually provided with a fully equipped vacuum cleaner. The drier should be placed on or near the top of a radiator so that it delivers hot air.

☞ After cleaning all mud from the auto running boards with soap and water, wipe them with kerosene to remove the grease and oil spots. Kerosene is also excellent for cleaning floor boards.



## Toy Compressed-Air Boat

Among the many kinds of toy boats that can be built by any boy who is mechanically inclined, is the one shown in the drawing. It is propelled by means of compressed air released under the water at the stern.

The hull is a 1-in. board, 2 ft. long and 5 or 6 in. wide. One end is sawed to form a bow and rounded on the underside as shown, while the stern is left square. A hole is drilled for a rudder post in the center and about 1 in. from the stern. The hull is then given one or two applications of paint, the first coat being allowed to dry thoroughly before the second is applied. The power plant is to be installed next. It consists of an 18-in. section of automobile inner tube and an equal length of 3-in. galvanized-iron conductor pipe. The ends of the section of inner tube are vulcanized shut so that it will be airtight. An air valve is provided in the center and also at one end. The former is complete with the inside core, but from the latter the core is removed. A hole is cut in the pipe through which the center valve will project vertically when the air tube is fitted inside. The open ends of the pipe are closed by means of two disks, riveted or soldered on. A hole is cut in one of the disks to allow the end valve to project outside and the conductor pipe is then fastened to the hull by means of two tin straps in such a manner that this valve points toward the stern. A rubber tube connects the valve to a short length of  $\frac{1}{16}$ -in. copper tubing, which is fastened to the stern and bent to project about 1 in. under the water as shown.

A small rudder is whittled out of wood and fitted into the rudder hole; it should be tapered so that it will fit snugly. A spring clothespin is used to pinch the rubber tubing shut in order to prevent the escape of air from the air tube when it is inflated. Air is pumped into the tube through the center valve by means of an ordinary bicycle or automobile tire pump, to a pressure of about 40 pounds. As soon as the clothespin is removed the jet of air issuing from the underwater copper tubing propels the boat at a surprising speed.

ject vertically when the air tube is fitted inside. The open ends of the pipe are closed by means of two

disks, riveted or soldered on. A hole is cut in one of the disks to allow the end valve to project outside and the conductor pipe is then fastened to the hull by means of two tin straps in such a manner that this valve points toward the stern. A rubber tube connects the valve to a short length of  $\frac{1}{16}$ -in. copper tubing, which is fastened to the stern and bent to project about 1 in. under the water as shown.

A small rudder is whittled out of wood and fitted into the rudder hole; it should

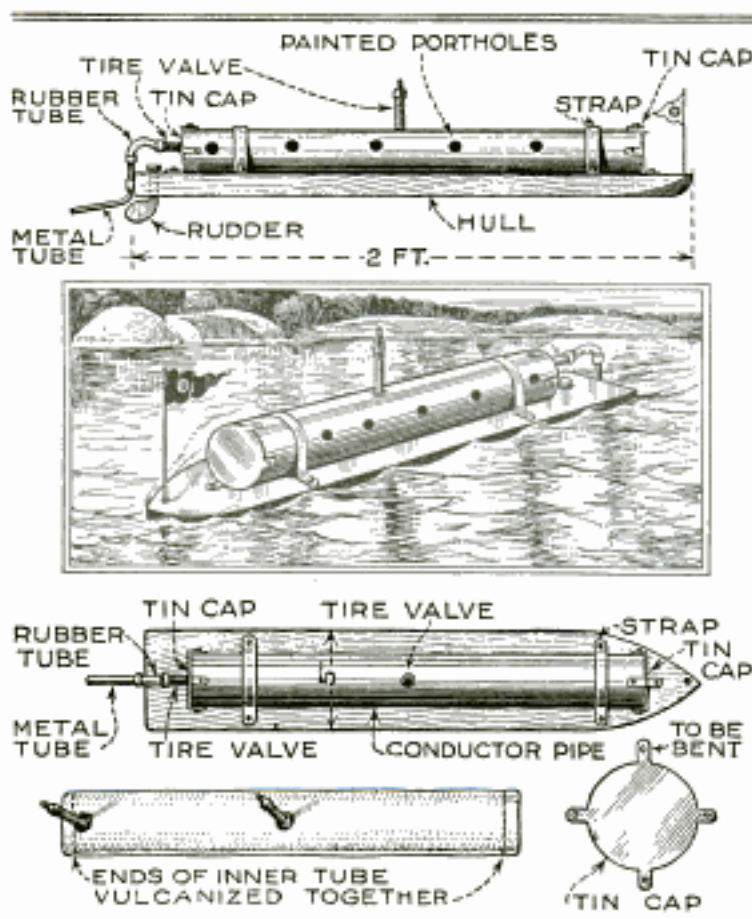

Simple Toy Boat Made from a 1-Inch Board and Propelled by Means of Compressed Air Released under Water

## Ornamental Handles for Auto Doors

A number of the lower-priced automobiles have the inside handles of door catches made in a very rough style. The crude appearance of these handles can be improved considerably by dressing them down on an emery wheel or grindstone so that the dust caps used on automobile-valve stems will fit over them snugly.—L. H. Unglesby, Baton Rouge, La.

## Cleaning and Peeling Potatoes

In some parts of the southern states, a novel and interesting method of cleaning and removing potato skins is used. The potatoes are placed in a pail half full of water and a number of rough stones are added. By stirring the potatoes and stones around in the water, the skins soon wear off due to the abrasive action of the stones, and the potatoes are washed clean.



### Typewriting Mathematical Symbols

In keeping a notebook with a typewriter it is usually necessary to make such signs as the equality sign, exponent, etc., by hand. However, many symbols can be made with the typewriter; for the equality sign, type a dash in the ordinary manner, then backspace and press the shiftkey very slightly. To make an angle use the underline dash, then backspace and place the oblique line before the dash. Exponents are made by depressing the shiftkey slightly.—Ruth Henderson, Lake Mills, Iowa.

### Good Use for Old Carpet Sweeper

When a carpet sweeper no longer sweeps it is usually thrown away. Upon examination, it will be found, however, that quite some bristle is still left on the roller, which may be used a few more years as a push brush of the kind shown in the drawing.



The brush and the wooden handle are removed from the sweeper box and also the metal brace that holds the handle. The shaft of the brush has a bearing hole at each end which usually fits the two pivots on the brace. It may be necessary to bend the brace together a little in order to hold the brush securely. At the ends of the brace are two small holes that were previously used to hold spring wires. Small wire nails are driven through these holes into the wooden part of the brush so that it cannot turn when in use. After one side of the brush has been worn down, the nails are simply removed, the brush turned around and again fastened as before.—Mrs. Caroline Michel, Jersey City, New Jersey.

After one side of the brush has been worn down, the nails are simply removed, the brush turned around and again fastened as before.—Mrs. Caroline Michel, Jersey City, New Jersey.

### Muffling the Alarm Clock

It is sometimes desirable to muffle the alarm clock so that it awakens the sleeper without disturbing those in adjacent rooms. A stout rubber band will be found very useful for this purpose. It is snapped around the clock and over the bell as shown, whether the bell is located on top or on the back, and muffles the sound most effectively.



### Increasing the Usefulness of the Alcove

A breakfast alcove constructed along the lines shown in the illustration has been found to be a very useful addition to the

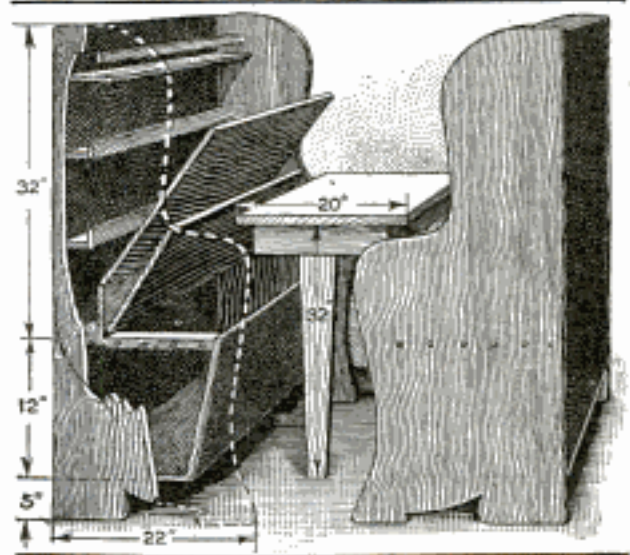

Useful Alcove for the Kitchen with Shelves in the Double Back and Capacious Boxes under the Seats

kitchen, especially where storage space is at a premium. Besides being very attractive, this alcove has special features of usefulness such as the shelves for china or silverware, and capacious boxes under the seats for linen.

Anyone who is able to handle the few simple tools that are usually found in the home workshop can build this alcove without any trouble. The general dimensions are subject to variation in accordance with the shape and size of the kitchen, as well as the maker's fancy. The entrance should not be less than 10 in. wide to allow one to enter easily. The table can be made to fold against the wall by means of hinges.

The shelves and back proper, together with the seat and the table, are made of 1/2-in. wood; the hinged false back is made of good strong wallboard. Small door catches hold the false back in place, and hinges of attractive design should be used for both back and seat.

When completed, the alcove may be enameled if desired, white lead being first used to fill all cracks and nail holes. Two coats of flat white paint are applied, the surface being sandpapered lightly after each coat, then the enamel coats are flowed on.—Ludvig Olson, Gainesville, Fla.

☛ A cheap tire cover can be made by slitting an old inner tube on the inside and cutting off a 2 1/2-in. strip all around. The tube is then turned inside out and stretched over the spare tire.



## FROM THE EDITOR'S MAIL BAG

Tokyo Metropolitan Police Station some time ago employed a new system that they will let police men carry a pistol instead of the saber which Japanese Police men carried for fifty years. But this was suddenly prohibited by the Central Government Home Department on account that pistol is more dangerous than the saber at present. Then about 500 pistols which arrived from American maker is forced to be auctioned in near time. I some time ago read Mr. H. H. Windsor's article concerning this and have the same as himself. Indeed it is fact that the pistol is more easy to handle than the saber and it is apt to harm another more easily than the latter. I wonder why Mr. Windsor does not urge more severely upon this subject and let people know the resultant danger. I expect much of his effort in this subject. Please forward my opinion to him.—N. Sakata, Tokyo, Japan.

I have been a reader of Popular Mechanics about fifteen years, and I have found it the most interesting and the most useful magazine published. I have not missed a copy since I started to read it, and I would still continue to take it if it were double the price, and consider it cheap at that. The reason in writing this letter is to let you know that I am saving about 25 per cent on the cost of coal in my steam boiler in my home this winter to what I did last winter, and I am only using soft coal instead of hard coal. If you care to publish these few hints I think some of your readers will benefit by them.

Keep all sections of boiler free from soot, once a week using the regular brush besides using a scraper that comes with the common kitchen range. This you can use to scrape the sides of the fire pot, and it is far easier to use than the brush. Don't shake the fire, but turn the grates once so that every third day they make one complete revolution, which helps to keep the grates in good condition as well as saving coal. Every other day fill a couple of old cans with coal and place in the fire pot and that will eliminate a lot of the soot. Also take a pail of water once a week out of the boiler so there will be free circulation, and place a pan of water on each radiator. By following these few hints you will find at least a 25-per-cent saving in your coal bill, as well as keeping your heating plant in good condition.—John H. Smith, Worcester, Mass.

You and your readers will do me a great favor if you will help me in trying to find my son, John W. Harrington, 17 years old, who disappeared from home in July, 1923, and has not been heard from since. He was about six feet tall and weighed 150 pounds. He was scientifically inclined and I know that if he is alive he will buy your magazine if he possesses a cent. I am sending this picture to help in the search and will be very grateful to anyone who can send me word of his whereabouts.—Mrs. Retta Harrington, 106 Joliet Ave., San Antonio, Tex.

The little article on "Color Change in Hydrangea" (December issue, p. 921) interests me and I think I can add to the further solution of the mystery. In Adelaide, South Australia, I know a man who specialized in blue-tinted

hydrangeas. His dodge was to simply surround the plant with an old rusty iron hoop off a barrel. The iron going into the soil did the trick. He found out the trick after having noted that pink hydrangeas planted in soil that was naturally rich in iron always produced blue blooms—hence his simple iron barrel-hoop stunt.—A. H. Dentry, Taiping, Federated Malay States.

I have been getting your magazine monthly for about twenty years, and I cannot tell you how much it has helped me. I have made hundreds of things from ideas furnished by you. Here are a few things that I can recall right now: The large barn that I have on my farm is a wing-joint frame building made from your plans; windlass for raising wagon boxes; kitchen arrangement, cabinets, and closets; hose reel to fit under house; grate in fireplace connected to radiator to furnish extra heat; many different farm gates; five radio sets from plans by Mr. Brittin; underslung wheelbarrow for carrying milk cans; refrigerating machine now under construction; tea wagon; breakfast-room table and seats; watering trough made of old boilers; watering trough of concrete; steam engine made of pipe fittings. I could go on and on and name a lot more; I make something every month from your articles, and I would not be without your magazine for anything in the world.—Otto Manecke, Box 341, Brooksville, Fla.

TO OUR WOMEN READERS  
ESPECIALLY

We are constantly reminded that this magazine includes among its readers thousands of women, and this appeal is especially to them.

For several years we have had in mind the publishing of a "Popular Mechanics Cook Book," and nowhere can we hope to look for better recipes than to our own women readers.

We ask you, therefore, to send us at least one recipe for bread, biscuits, pies, cakes, soups, jellies, candy, soap, etc., which you consider your very best. Don't overlook ways of preparing vegetables, meats, fowl, and fish, and suggestions for camp cooking, as well as favorite dishes of your men folks and household hints on things to make the home more comfortable and attractive.

When the recipes have all been received and compiled, the book will immediately go to press. In return for your help, each contributor will receive a copy, free. Unless otherwise requested, we shall print the name and town address of the contributor.

The recipe need not be original with you, but simply one you are fond of using. In case of absolute duplications, the first one received will be printed, but every woman who sends a recipe will receive a copy of the book. Address the Cook Book Editor, 200 East Ontario Street, Chicago, Illinois.

Clamp, p. 959. The same or similar happens with almost every number, which I always wait for with great anxiety.—F. W. Friese, M. E., Petropolis, Brazil, S. A.



Is there any young man in America who wishes to correspond with me, and exchange newspapers, postcards, stamps, journals, etc? My address is L. Zegilewicz, Krak Przedm, 89m. 4, Warsaw, Poland.

Years ago, from a suggestion found in your magazine, I made several small model-work pulleys out of sheet-metal disks, by incising the rim at regular small intervals, and bending the intervening parts to right and left, thus forming a V-groove that firmly gripped the pulley cord. On the same plan of an interrupted V-groove I later had cord pulleys cast, which, being done in plain double molding cases, proved a very economical way of making cord pulleys for transmitting light power. Am now preparing to make some "Walking Wampuses" which look like a good thing for the kids.—H. C. Magnus, Bonn, Germany.





**More Than  
50,000  
Now in Use**

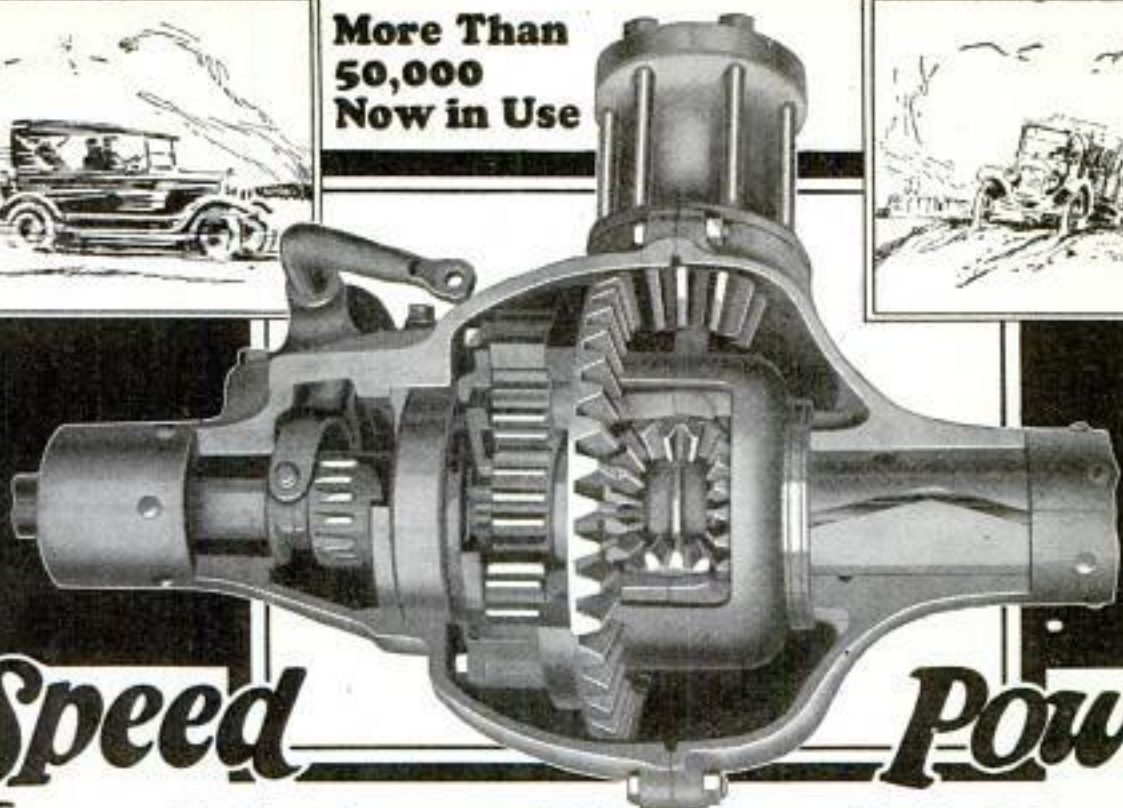

**Speed** **Power**

**Makes Your CAR or TRUCK Two-In-One**

**Speed—**

Move the lever again and you have a speedy car or truck for city driving or delivery or level country highway driving.

Thousands of farmers and business concerns everywhere say the Ruckstell Axle saves half time in getting to town and back home. Noiseless in operation. No cutting, no brazing, no welding—doesn't change principle of car or truck construction.

**Clip The Coupon—**Take it to your nearest dealer for **FREE DEMONSTRATION**, or mail direct to our Kansas City office for Free Booklet, Prices, etc. Ruckstell performance will surprise you.

**Ruckstell Sales & Mfg. Co.**  
**Desk 20A Kansas City, Mo.**

Berkeley, Calif.; Los Angeles, Denver, Buffalo.  
In Canada: Ruckstell Axle Co., Ltd.,  
Toronto and Montreal.

**Power—**The Ruckstell Axle is revolutionizing the performance of light cars and trucks. It has solved the great automotive engineering problem—combining **Two Direct Opposites In One—POWER and SPEED.**

Simply move the lever and you go through the muddiest roads; climb stubborn hills on high gear; negotiate congested traffic. For

trucks it insures "getting there" and back quicker, with practically double load

capacity.  
Increases  
power  
55%.

**FREE  
BOOK**

This coupon is good for Free Demonstration of the Ruckstell Axle at nearest Dealer or for Free Booklet giving full particulars. (20A)

Name .....

Address.....

Make of car or truck.....





## The Road to Home

Though written faithfully, his letters from home seemed to have had a way of arriving at his hotel in one city just after he had left for the next—and of never catching up.

Three weeks passed—business conferences, long night journeyings on sleepers, more conferences—with all too little news from home.

Then he turned eastward. In his hotel room in Chicago he still seemed a long way from that fireside in a New York suburb. He reached for the telephone—asked for his home number.

The bell tinkled cheerfully. His

wife's voice greeted him. Its tone and inflection told him all was right with the world. She hardly needed to say, "Yes, they are well—dancing right here by the telephone. . . . Father and mother came yesterday. . . . Oh, we'll be glad to see you!"

\* \* \* \*

Across the breadth of a continent the telephone is ready to carry your greetings with all the conviction of the human voice. Used for social or business purposes, "long distance" does more than communicate. It projects you—thought, mood, personality—to the person to whom you talk.



AMERICAN TELEPHONE AND TELEGRAPH COMPANY  
AND ASSOCIATED COMPANIES

**BELL SYSTEM**

*One Policy, One System, Universal Service*



# Columbia Dry Batteries

—they last longer

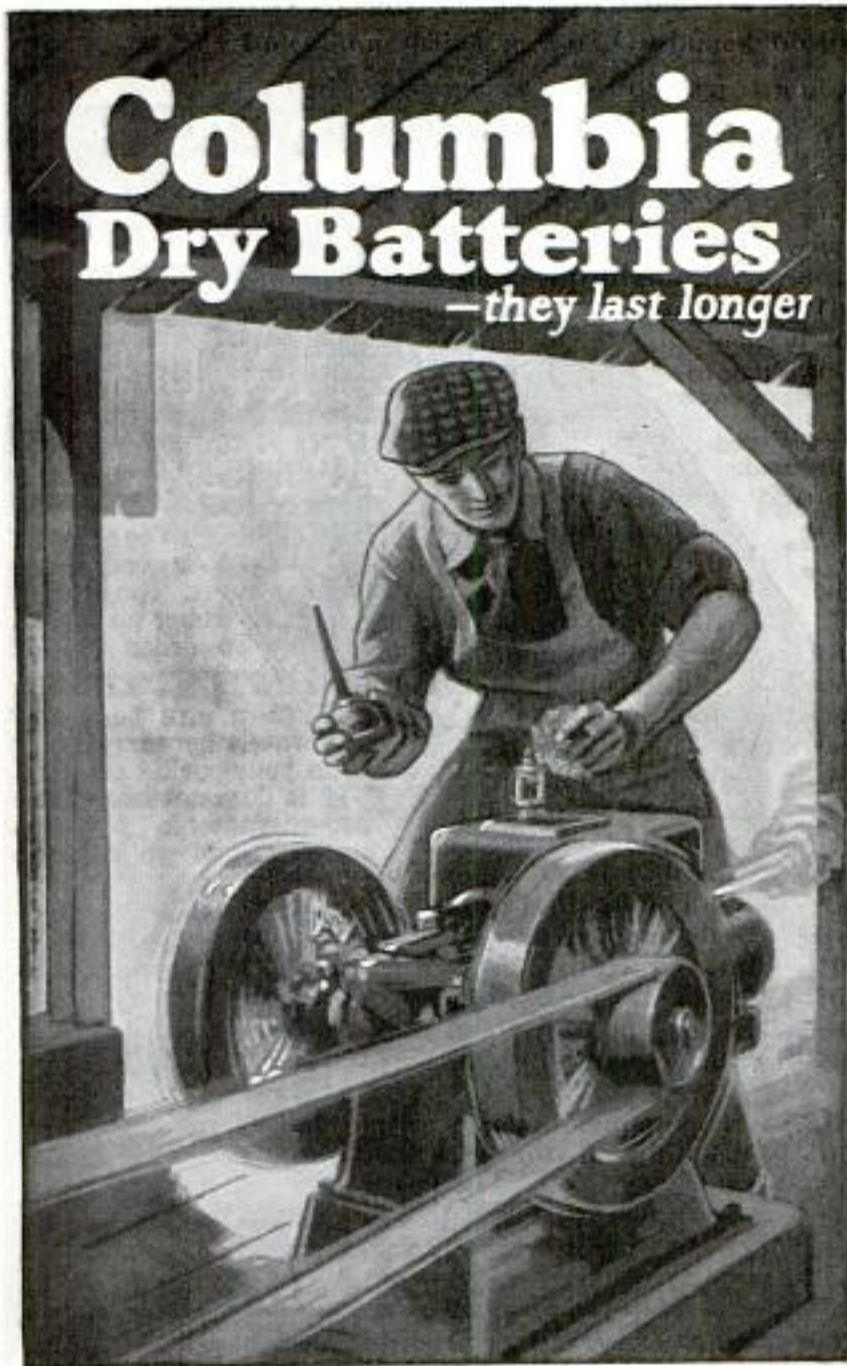

for—

Gas engine ignition  
Tractor ignition  
Starting Fords  
Doorbells  
Buzzers  
Ringing burglar alarms  
Protecting bank vaults  
Calling Pullman porters  
Running toys  
Motor boat ignition  
Telephone and telegraph  
Lighting tents and out-  
buildings  
Firing blasts  
Heat regulators  
Electric clocks  
Radio "A"

Fahnestock Spring Clip  
Binding Posts on Columbia  
Ignitor at no extra cost to you



## Two-fisted, hard hitting ignition

**R**EAL mechanics won't fool with come-and-go ignition. Surest way to keep her hitting hard and steady is with Columbia Ignitors. Fiery sparks by the millions. As sturdy and sure as the ruggedest engine. For weather exposure, the water-proof steel cased Columbia Hot Shots. Four, five or six Co-

lumbias, they recover strength while resting. Last so long you forget how long they've been in service.

Columbia Dry Batteries are sold by electrical, hardware, radio and auto accessory shops, marine supply dealers, implement dealers, garages, general stores. Insist on Columbias.

**NATIONAL CARBON COMPANY, INC.**, New York, San Francisco  
Canadian National Carbon Co., Limited      *Factory and Offices: Toronto, Ontario*



# ONLY \$2 DOWN AND YOU GET THIS FAMOUS 21 JEWELLED ILLINOIS RAILROAD WATCH BUNN SPECIAL

You can ask any railroad man in the U. S. about the **Bunn Special** watch, and even if he does not carry one himself, he will be able to tell you all about it, because it is nationally famous for extreme accuracy. This fame and reputation was earned by years of faithful performance under arduous service conditions. That's what counts.

Take your choice of plain Arabic dial or Montgomery dial, but insist on a watch with six adjustments.

## WILL PASS INSPECTION ON EVERY R. R. IN THE U. S.

There are some watches called railroad watches that will pass inspection on a few railroads but this famous timepiece is guaranteed to pass the most severe inspection requirements on any or all railroads in the United States. Not only that—it will pass inspection with colors flying, at the head of the list.

GRAND CENTRAL TERMINAL



## DESCRIPTION

These watches are 16 size, in accordance with railroad requirements. They have 21 ruby and sapphire jewels, double roller escapement,  $\frac{3}{4}$  plate model and are adjusted to 6 positions. They are built for sturdy, reliable service, and have made good on every railroad in the United States.

Pay \$5.50 A Month



PENNSYLVANIA STATION



Railroad requirements for timekeeping accuracy are the most severe we know of and a watch good enough to pass railroad inspection is good enough for any man requiring absolute accuracy. These watches stand up under the hardest kind of use, because they are cased in heavy gold filled cases, guaranteed to wear like solid gold for at least 25 years. The movement is guaranteed against any defect in material or workmanship. You can send an order for one with all confidence that you are receiving the last word in watch timekeeping SERVICE and SATISFACTION.

10 Months To Pay

PAY \$2.00 DOWN \$5.50 A MONTH!

Your credit is good, so use it. The price is going up to \$60, so order NOW!

## FREE TRIAL

You can test the watch by carrying it in your pocket on trial. If it does not keep time as guaranteed, you can return it, and we will return your money.

**YOU CAN WEAR IT 30 DAYS FREE**  
**TEAR OFF AND MAIL ~ JUST SEND YOUR NAME**

STERLING DIAMOND & WATCH CO.  
63 Park Row, Dept. 1665 New York.

Gentlemen: Please send the famous BUNN SPECIAL, 21 jeweled Illinois Watch, as described above, to me on 30 days free trial. I enclose \$2.00 deposit to show my good faith. If I am not satisfied and return the watch within 30 days, you will return my money. **If I keep the watch, I will pay you \$5.50 every month for ten months until the total price of \$57.50 is paid.** Title to this watch remains with you until I have paid you in full. It is understood that you fully guarantee this watch to be as described. Please send your big catalog.

YOUR NAME

LOCAL ADDRESS

CITY & STATE

## FOR THIS SIX POSITION R. R. WATCH

That's all—there's no red tape or delay. Your credit is good, so use it. Sign the coupon and mail it to us with only \$2.00 to show your good faith. We'll send the watch to you promptly. After trying it 30 days, just pay \$5.50 monthly for ten months until \$57.50 is paid. Montgomery Dial same price. If you are not satisfied after 30 days trial, just return the watch and we will return your money—every cent of it. You get our strong guarantee as to service, accuracy and satisfaction. You take no risk. Order right away. Specify which dial you prefer—Arabic or Montgomery. Be sure to give your complete address and references if you wish.

## WRITE FOR BIG CATALOG No. 1665

This catalog brings a big jewelry store right into your home. It shows thousands of wonderful bargains in perfect cut, blue white, genuine diamonds, men's and ladies' watches, and jewelry of all kinds. You save 40% by ordering from this bargain book. Write for it at once.

**STERLING DIAMOND & WATCH CO.**

63 PARK ROW ~ DEPT. 1665, NEW YORK

New York's Most Popular Watch House Since 1879

TEAR OUT COUPON AND MAIL ~



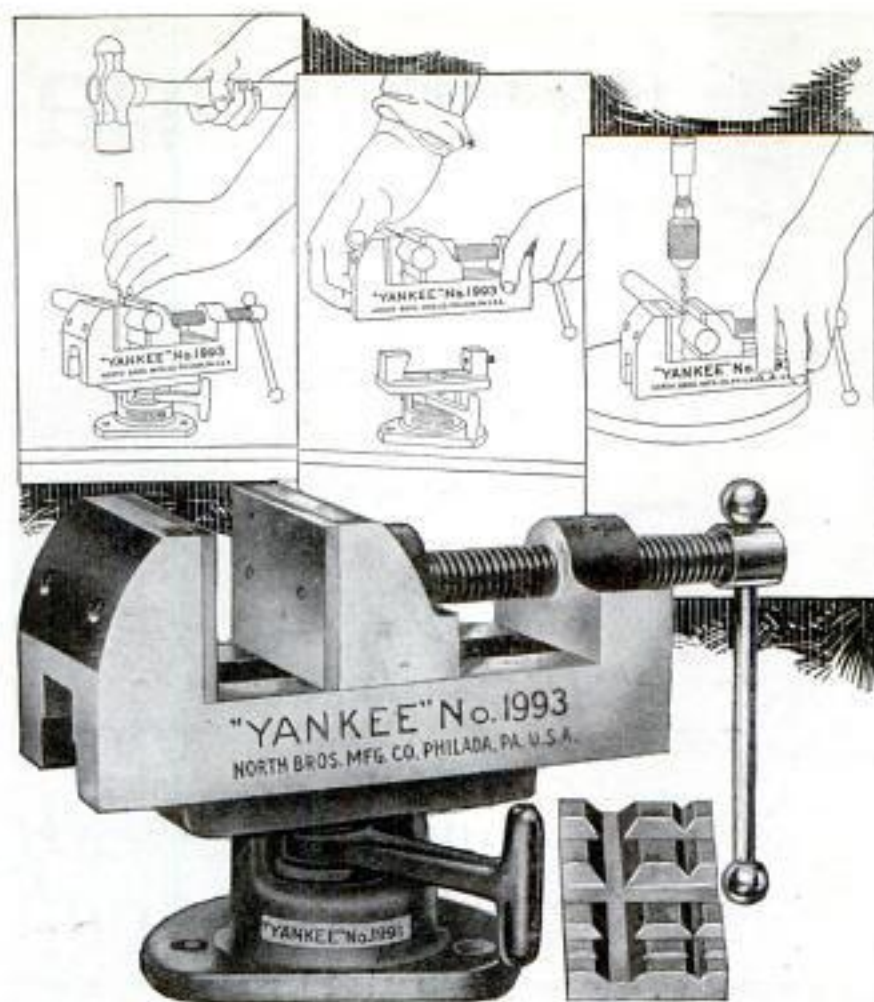

## Holds work till job is finished

### Some other "YANKEE" TOOLS

Ratchet Breast Drills  
Ratchet Hand Drills  
Ratchet Chain Drills  
Automatic Push Drills  
Ratchet Tap Wrenches  
Ratchet Bench Drills  
Spiral Screw-drivers  
Quick Return Spiral Screw-  
drivers  
Plain Screw-drivers, 1½ to  
30 in. blades

Dealers  
everywhere sell  
"YANKEE"  
TOOLS

The "Yankee" Vise lifts off its base; goes with the work from one machine to another; and back to bench with the work in the original alignment.

You can be sure of accurate work by using the "Yankee"—the only vise that is detachable from its base. Sides, tops, ends and bottom of vise are machined true.

Swivel base can be locked in any position. The removable, hardened steel block with V-shaped grooves holds round or irregular work.

**TOOL BOOK FREE.** Illustrates and describes all the ingenious "Yankee" Tools for saving time and labor. Write today for it.

### "Yankee" Vises with Swivel Base

**No. 1991**—Body 3¾ in. long, 1½ in. wide, Jaws open 1½ in.; depth ¾ in.  
**No. 1992**—Body 4¾ in. long, 2 in. wide, Jaws open 1 ¼ in.; depth 1 ¼ in.  
**No. 1993**—Body 7¾ in. long, 2¾ in. wide, Jaws open 3 ½ in.; depth 1 ¼ in.  
**No. 1994**—Body 10¾ in. long, 4 in. wide, Jaws open 4 in.; depth 2 ¼ in.

**Without Base**—  
As above: Nos.  
991, 992, 993, 994.



NORTH BROS. MFG. CO., PHILADELPHIA

# "YANKEE" TOOLS

*Make Better mechanics*



# Remington Portable



*An  
ideal gift  
for  
graduates*



**I**N college, in business, and in professional work a knowledge of typewriting is a great advantage. And the possession of a Remington Portable is a decided advantage. It has every feature common to the big machines. It has the *one and only* standard keyboard—no shifting for figures—just like the standard office typewriters. It is the easiest to learn—the simplest to operate.

It is a Remington and that insures its durability and reliability.

The Remington Portable is so light it can be carried anywhere, and so convenient it can be used anywhere. And it fits in a case only four inches high.

Price complete, \$60.00. Easy payment terms, if desired. Sold by all Remington branches everywhere and over 3500 dealers.

## REMINGTON TYPEWRITER COMPANY

Department 12, 374 Broadway, New York

### THE DE LUXE PORTABLE

A distinctive model in Ivory Tone finish, with handsome brown leather carrying case. A limited number are available at \$75.00 each.

*The best aid to self-expression*



© 1924 by  
L. E. W. Co.

*Because  
it  
Breathes*

**Waterman's  
Spoon Feed**  
(Patented)

Follows the principle of human breathing—inhalas air and exhales ink in exact proportion to the speed and pressure of the writer—never too much, never too little.

Waterman's Spoon Feed is the only soundly scientific fountain pen feed made—the only one that holds in perfect control the flow of ink from the barrel to the point of the pen without skipping or blotting.

Size for size, Waterman's Ideal Fountain Pen is the most beautifully proportioned and finely balanced of all writing implements.

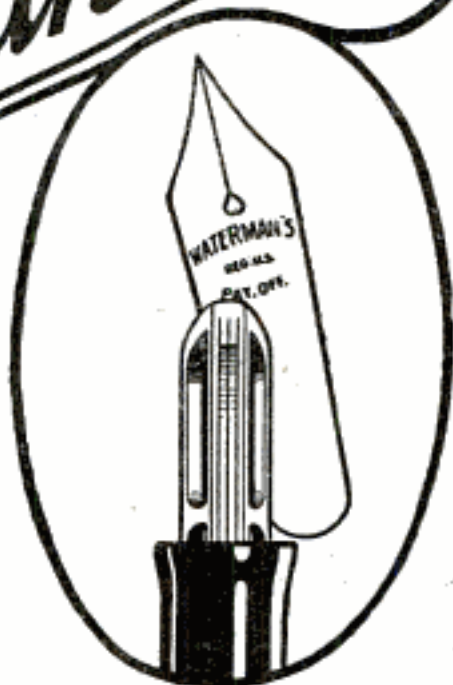

*The exact length, depth and position of channel ways and pockets was scientifically determined in the Waterman Research Laboratory.*

**Waterman's  
Ideal  
Fountain Pen**

*"The Daddy of Them All"*

The most Popular of all Vacation Companions  
and Commencement Gifts

**\$2.50 to \$50.00**

Sold at Resorts, on Ocean Liners  
and by Best Dealers the World Over

L. E. Waterman Company, 191 Broadway, New York

Chicago

Boston

San Francisco

Montreal

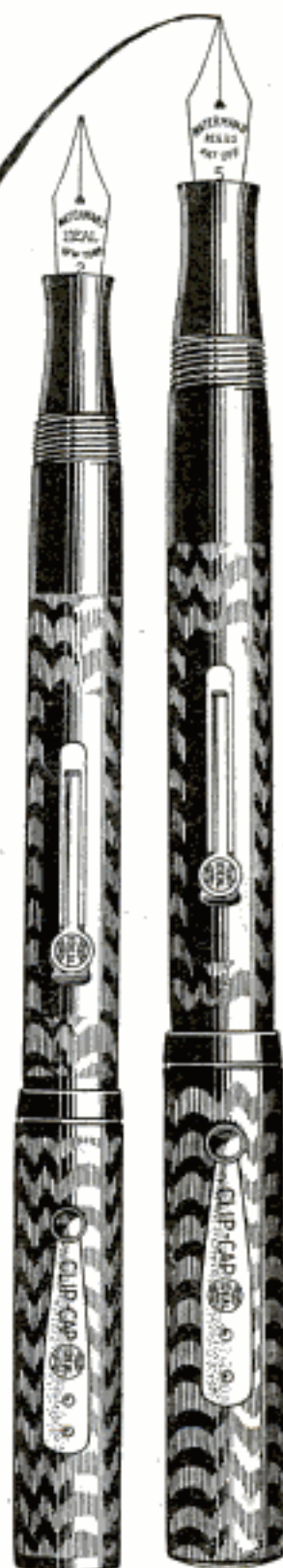

No. 52  
with  
Clip Cap  
\$2.75

No. 55  
with  
Clip Cap  
\$5.25



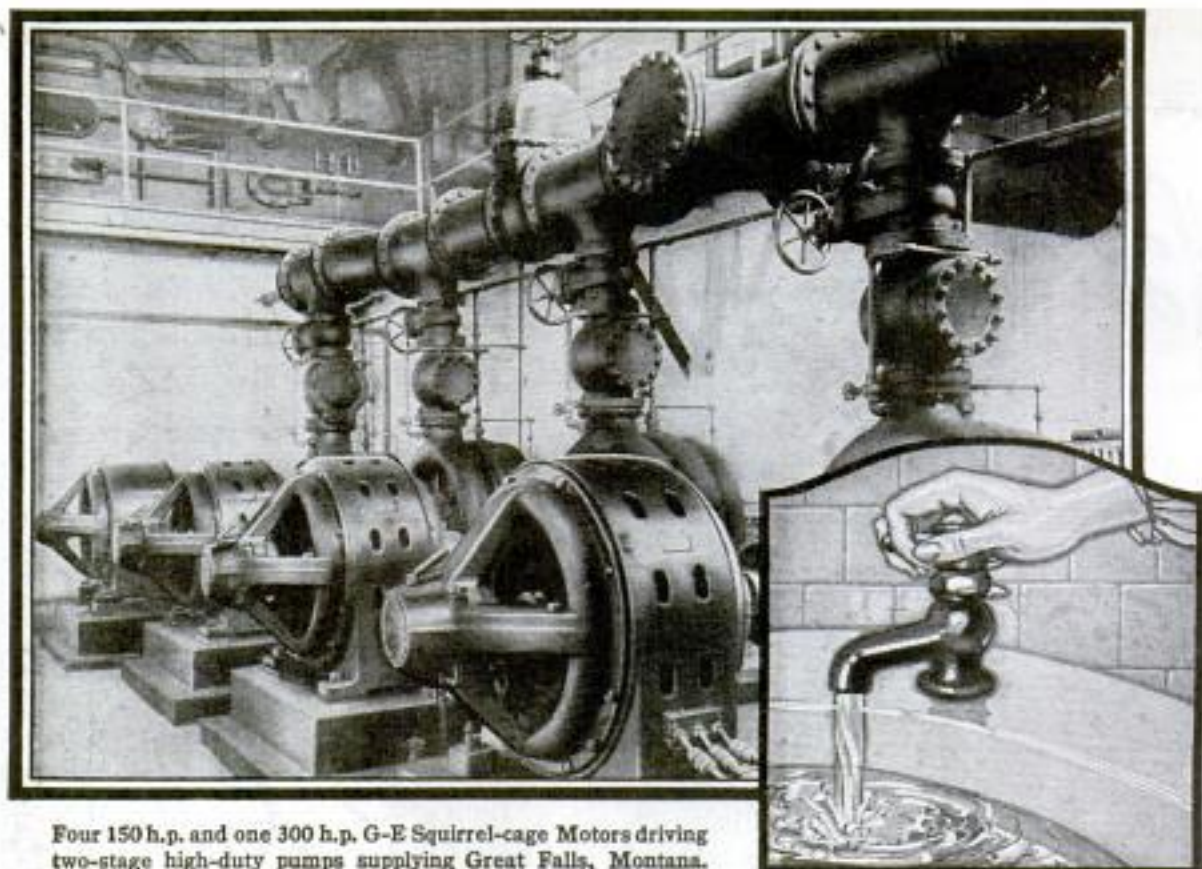

Four 150 h.p. and one 300 h.p. G-E Squirrel-cage Motors driving two-stage high-duty pumps supplying Great Falls, Montana.

## The *new* oaken bucket

"I wish to do something both great and useful for Paris," said Napoleon to an advisor. "Give it water," was the reply.



This monogram, which you see upon electric motors, generators, fans and lamps, is the symbol of a nationwide organization for the service of every community which wants to make electricity do more and better work—the General Electric Company

No longer do city homes depend on wells or nearby rivers. The old oaken bucket is replaced by electrically driven pumps. In Minneapolis, for instance, a General Electric motor of 1800 horse power drives pumps which supply 30,000,000 gallons a day.

# GENERAL ELECTRIC



# One Dollar

—for underwear satisfaction

**T**O GET the most for your money in athletic underwear, follow these rules:

Pay One Dollar—no more.  
Look for the Topkis label.

Comfort? You'll hardly know you have Topkis on! Roomy all over; especially legs and arm-holes. Topkis fits! Good fabrics. Sound tailoring. Topkis wears and wears.

Men's Shirts and Drawers, 75c a garment.  
Boys' Union Suits, Girls' Bloomer Union Suits, and Children's Waist Union Suits, 75c. In Canada, Men's Union Suits, \$1.50.

Free Booklet tells the whole story. Write for it.

TOPKIS BROTHERS COMPANY, Wilmington, Del.  
General Sales Offices: 350 Broadway, New York City

Ask for TOPKIS Underwear.

Look for the TOPKIS label.

Buy Topkis by the Box  
—Six union suits for \$6. Some men pay as much for three suits—but they don't know Topkis.



**TOPKIS**

Athletic Underwear



# Why Use Five Tubes To Do the Work of Three?

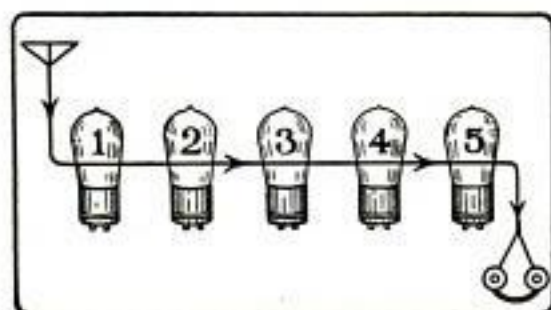

Three tubes, duo-reflexed as shown at the right, are fully equal to five tubes in conventional sequence.

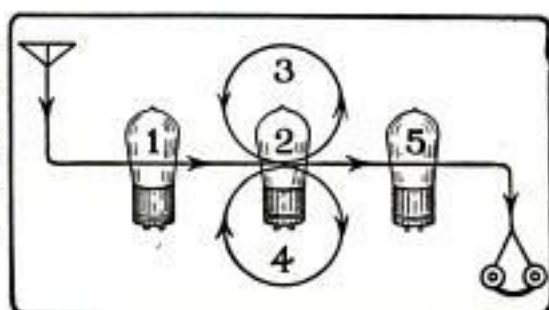

The most important advance in coupling methods of late years is Erla Selectoformer, materially improving range, selectivity and volume. \$5

**F**IVE stages of amplification with only three tubes—this is the secret of the amazing coast-to-coast loud speaker range of the Erla three-tube Duo-Reflex circuit, surpassing all but the most elaborate hook-ups in volume.

Erla Duo-Reflex action (patent applied for) enables vacuum tubes to do triple duty, as simultaneous amplifiers of received radio, reflexed radio and reflexed audio currents, multiplying efficiency while reducing cost.

Indispensable to the practical application of this principle, and the foundation of its success, are Erla synchronizing transformers.

Accurately superimposing (1) received and reflexed radio, and (2) rectified radio and reflexed audio currents, in their coincident passage through amplifying tubes, they eliminate all trace of distortion. Only those who have actually heard Erla performance can realize the vast improvement in tone quality resulting.

Other Duo-Reflex advantages, for example, the fool-proof tuning control, giving an accurate log of stations together with freedom from radiation, have equally scientific origin.

Erla Selectoformer, tested capacity condensers, and fixed crystal rectifier spell outstanding advancement in their respective fields.

For complete Erla circuits, ask your dealer for Bulletin No. 20; or write, giving his name.

**Electrical Research Laboratories**

Dept. J 2500 Cottage Grove Ave., Chicago



Unduplicated sensitiveness, range and volume, from 200 to 700 meters. Be assured through employment of Erla reflex transformers. List \$5



Erla Push-Pull transformers handle output of five-watt power tubes, using as high as 350 volts on the plate, without distortion. Pair \$10



Even three stages fail to impair the distortionless performance of Erla audio transformers, an achievement unduplicated. List \$5



Exclusive, double, tilting springs of Erla Sockets give clean, wiping contact essential to low amperage tubes. List 65c and 75c

# ERLA



Any panel is improved 100% by Erla bezels, finished in bright nickel or dull enamel, with telescoping rim to fit 3/8" to 1/4" thick material. 20c



# \$15,903 in 9 Years!

## That's What My Violano Paid Me

One of the eight greatest inventions of the decade.

Gentlemen:

It is the most perfect instrument in the way of reproducing the human skill of an orchestra. The financial receipts through my Violano Virtuoso have averaged \$33.98 a week, or \$147.25 a month.

Yours very truly,  
Rud. B. Michalek,  
Cliff House,  
North Arlington, N.J.

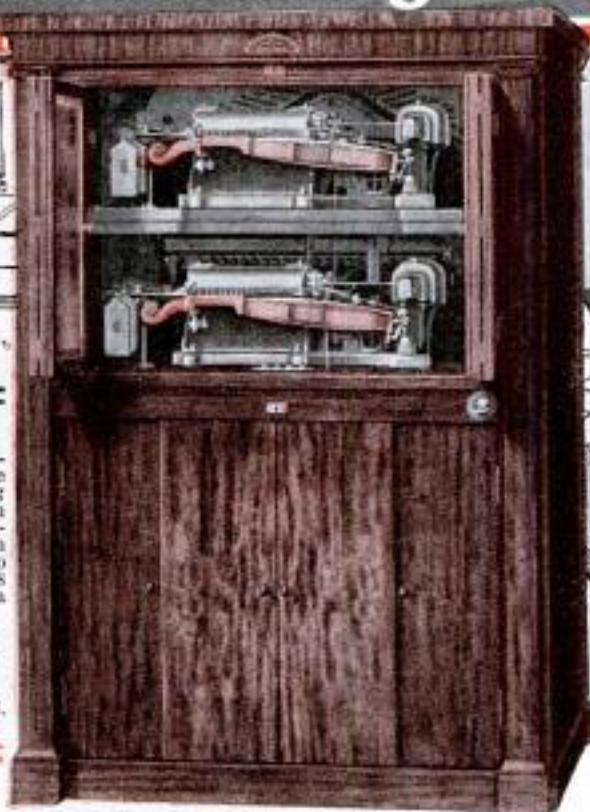

### Violano Investment Chart

Profits Figured on the Basis of \$75-\$125 a Month—  
A Typical Average of \$1,000 a Year

If You Invest \$200 Each Year	And Your Profits Are \$33.33 a Month	Your Annual Profits Are	Percentage of Return on Investment Each Year
1st year	\$33.33 per mo.	\$1,000 net	500%
2nd year	\$33.33 per mo.	1,000 net	500%
3rd year	\$33.33 per mo.	1,000 net	500%
4th year	\$33.33 per mo.	1,000 net	500%
5th year	\$33.33 per mo.	1,000 net	500%
6th year	\$33.33 per mo.	1,000 net	500%
7th year	\$33.33 per mo.	1,000 net	500%
8th year	\$33.33 per mo.	1,000 net	500%
9th year	\$33.33 per mo.	1,000 net	500%
10th year	\$33.33 per mo.	1,000 net	500%

#### Your Profits on Increased Trade

If Your Gross Weekly Sales Are Now	And the Violano Increases Your Sales 33 1-3% Weekly Increase Will Be	Yearly Increase Will Be	Your Net Profit From Increase at 20%
\$1,000	\$334	\$17,268	\$4,442
500	167	8,634	2,171
400	134	6,908	1,742
300	100	5,200	1,300
200	67	3,484	871
100	34	1,758	442

#### Thousands of Violanos Net Profits of \$75-\$125 a Month

Through good times and dull times our month by month and year by year earning tabulations show the money-making ability of the Violano. The figures show average profits of \$75-\$125 a month.

### BIG BOOK FREE!

Send for "Music Profits"—a valuable book containing money-making news, suggestions, trade data and pictures. Sent absolutely free to business men.

### Mail This Coupon!

MILLS NOVELTY COMP. N.Y.,  
823 W. Jackson Blvd., Chicago, Illinois.

Gentlemen: Please send me without obligation on my part, your big book "Music Profits," which contains money-making news, suggestions, pictures, and trade data.

Name.....

Business.....

Address.....

City.....State.....

## \$95 PROFIT ON EVERY \$100

The highest and most liberal profit on any article sold in your store is shown by the Violano. It turns profits over on an average 19 times a month. Profits on the music sold by the Violano are 19 times as great as the expense! When the Violano plays 20 times it takes in \$1.00 in cold cash. 95 cents of this dollar is CLEAR PROFIT. The remaining 5 cents goes for music, electricity and incidentals.

### World's Only Self-Playing Violin

See the real violin inside the console—remember it is the only self-playing violin in the world. There is no music like violin music and when the harmonizing piano accompaniment is added a remarkable, rich volume of music is produced.

### One of the Eight Greatest Inventions

This is the only musical instrument that ever won the distinction of being designated one of the eight greatest inventions of the decade, by the Patent Office of the Government.

1900% Profit. Turnover 19 times Every Month. Yearly Profits of \$1,140. Profits over a ten year period \$11,400—Increase in Trade 20%-50%. It is easy to get.

## IT IS A BUSINESS IN ITSELF!

**It Renders the Best Music:** The finest type of orchestral music is available in the Violano. Customers willingly pay 5 cents for a rendition.

**It Sells Other Merchandise:** It attracts crowds to your store by its superior music. They buy other merchandise while there.

**It Furnishes Entertainment:** Merchants say a store without music is dead—customers want entertainment and will go where they can get it.

**It Creates Satisfaction:** Success in any business depends upon satisfied customers. The Violano brings 100% customer satisfaction. The "Violano habit" brings patrons in daily.

**It Does Its Own Work:** The Violano is its own clerk—its own cashier. It takes up none of your time. It occupies only 11 square feet of floor space—its music fills your whole store.

## MILLS NOVELTY COMPANY

World's Largest Manufacturer Coin Operated Machines

823 W. Jackson Blvd.

CHICAGO

FACTORY BRANCHES: New York Boston Pittsburgh Detroit  
San Francisco Kansas City Indianapolis Atlanta Dallas



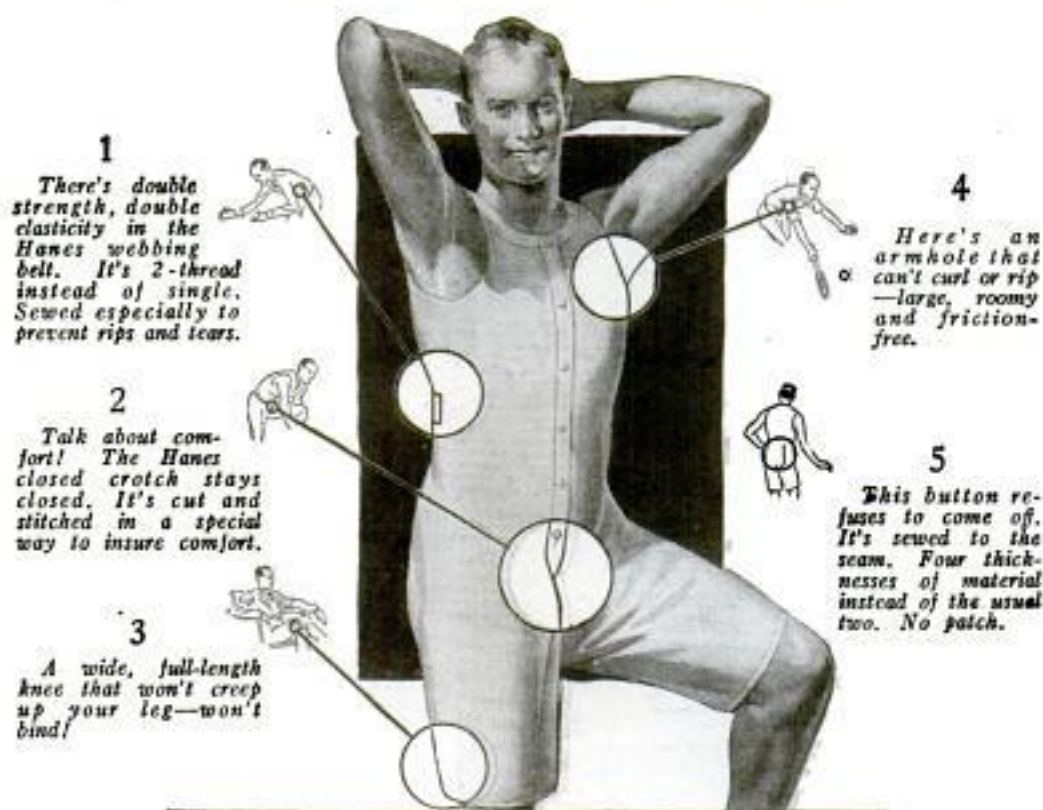

## Money can't buy greater summer comfort

**Y**OUR money never went further than when you put it into Hanes Athletics. Such comfort, freedom and coolness—a fit that feels just right.

Look over the Hanes points shown above. Here are five reasons why men everywhere, to say nothing of their wives, have come to the conclusion that it "pays to say Hanes" and have stuck to it.

The end of the summer will tell the story of Hanes value. Wash-day after wash-day, rough and ready summer wear—Hanes still looks, still feels, still fits the same. Then you will know how



safe we are in guaranteeing absolutely every stitch, thread and button.

Go in to your dealer's to-day and say "Hanes." Feel the fabric, look over the workmanship. You'll know that the price—a dollar—can't be matched.

Youngsters can be outfitted in Hanes too. And how they wear! Boys from 2 to 16 years—sizes 20 to 34.

*Read this guarantee:* We guarantee Hanes Underwear absolutely—every thread, stitch and button. We guarantee to return your money or give you a new garment if any seam breaks.

P. H. HANES KNITTING CO.  
Winston-Salem, N. C.  
New York Office, 366 Broadway

*Next Winter Wear Hanes Winter Underwear*





**\$3**  
**DOWN**

## and it's YOURS

### The Greatest Typewriter Bargain Ever Offered

Right now we are making you the greatest typewriter offer you ever dreamed of—an eye opener. This wonderful standard Shipman-Ward Rebuilt Underwood only \$3.00 down. Ten days' free trial and the easiest monthly payments, shipped direct to you from our big factory.

### 10 Days' Free Trial From Factory to You

Yes, only \$3.00 down puts this genuine late model Shipman-Ward Rebuilt Underwood in your home. You can try it, test it, and then decide. See for yourself how new it is, how it writes. You must be satisfied. Your \$3.00 unconditionally returned if at the end of ten days you are not satisfied. The entire transaction will not cost you one cent.

### EASY Monthly Payments

Little more than rental. Balance of payments so small you will hardly notice them, while you enjoy the use of this wonderful machine. You don't have to scrimp and save to pay cash. All at a big saving to you.

### 5 Year Guarantee

With every typewriter we give a written guarantee. These machines are rebuilt like new by the famous SHIPMAN-WARD PROCESS. Equipped with late improvements. You can't tell them from a new machine. The world's standard typewriter, the same models as sold by the Underwood Typewriter Company today, at a big saving to you. Act now! Get this splendid offer and save money.

These machines are shipped direct from our factory—the largest typewriter rebuilding plant in the world. They are rebuilt by the famous SHIPMAN-WARD PROCESS. Developed through 30 years in the typewriter business. Through our money saving methods of rebuilding and elimination of a large expensive sales force we are able to make this wonderful money saving offer to you. ACT TODAY, take advantage of it and you will SAVE MONEY. ACT NOW! Mail this coupon today.

### Free Book of Facts

Write for this free book of facts explaining Shipman-Ward's wonderful system of rebuilding typewriters. We show you exactly how it's done. How you are able to buy them. Complete and valuable information about the typewriter industry, both instructive and educational.

### FREE with Every Typewriter

A complete course in touch typewriting. You don't have to know how to operate a typewriter. You can learn to operate this machine in one day. We also give free a waterproof cover and all tools that come with a typewriter.



All Shipments made direct to you from our modern factory—the largest typewriter rebuilding plant in the world.

### FREE BOOK COUPON

**SHIPMAN-WARD MFG. CO.**  
A212 Shipman Bldg.  
Montrose and Ravenswood Aves.  
CHICAGO

Send by return mail your wonderful offer of Shipman-Ward Standard Rebuilt Underwood, also your book of facts. (This is not an order and does not obligate me in any way.)

NAME.....

STREET.....

POST OFFICE.....STATE.....

**SHIPMAN-WARD MFG. CO.**

A212 Shipman Bldg., Montrose and Ravenswood Aves., Chicago





## “What’s Eddie looking so black about?”

“OH, he’s sore because I won’t lend him my Starrett Combination Square—the one tool I can’t get along without.”

“Well, he’ll get over it. One of these days he’ll buy one and see for himself why it’s such a hard tool to borrow.”

JUST as it stands the Starrett Combination Square gives you seven tool uses combined in a single handy, accurate tool. Rule, Try Square, Level and Plumb, Depth Gage, Height Gage, Scribe and Miter. But add a Starrett Protractor Head, Center Head and other Attachments and at a small cost you have doubled the usefulness of this splendid tool. For more rapid work and more accurate work from fewer tools get a Starrett Combination Set at any good hardware store.

The new Starrett Catalog No. 22“AP” shows the various Attachments that can be added and illustrates the many different uses. Write for it.

THE L. S. STARRETT CO.  
The World’s Greatest Toolmakers  
Manufacturers of Hacksaaws Unexcelled  
ATHOL, MASS.



STARRETT  
Combination Square  
No. 11



# Use Starrett Tools

6025





**An athletic-trim Keds model**  
Keds athletic-trim styles are built for the hardest sports and vacation wear. This model has the popular lace-to-toe feature.



**A Keds model with Crepe Sole**  
Crepe Sole Keds are distinguished by springy lightness, ground grip and long wear. Keds Crepe Soles are vulcanized which makes them tough, and gives the greatest possible adhesion between sole and upper. Insist on Keds.



**Another athletic-trim Keds**  
This is a lace-to-instep model. You can get Keds with black, brown or grey trim—smooth, corrugated or suction soles.

Keds are a complete line of canvas rubber-soled shoes, varying in price according to grade, size and style—from \$1.25 to \$4.50.

Keds with athletic-trim are not only standard for sports and athletics but are ideal shoes for all vacation wear. Keds with Crepe Soles are the choice of thousands of tennis players—including the ten leading players in the country. There are many other Keds models—high shoes and low, with tan or white uppers.



Photo by Levick

## The hardest grilling sport shoes ever got

—a whole season on the feet of one of the greatest tennis players of all times—and still good for more

Grilling practice games—famous championship matches. Bearing the brunt of every last ounce of energy from a human dynamo!

These Keds not only were still good for more wear after this terrific test—but they had already lasted over a period when this famous champion would normally have outworn three pairs of shoes!

Records like this help to explain why Keds are the standard shoes for sports and athletic use today. Leading players and championship teams everywhere are wearing them. They're built to give the maximum of speed, ground-grip, comfort and wear.

Keds are a complete line of canvas rubber-soled shoes, varying in

price according to grade, size and style—from \$1.25 to \$4.50.

It is important to remember that all canvas rubber-soled shoes are not Keds. Keds are made only by the United States Rubber Company. They come in a wide range of styles and prices. But every pair of Keds is built to give longer wear and better service.

*And every Keds shoe has the name Keds on it.*

*The 1924 Keds Hand-Book for Boys is full of things every boy will want to know about. How to make things—rules for games—woodcraft, etc. Sent free if you address Dept. 136 1790 Broadway, New York City.*

**United States Rubber Company**

# Keds

Trademark Reg. U. S. Pat. Off.

They are not Keds unless the name Keds is on the shoe





Hand and  
Breast Drill

No. **1616**

Price \$4.50

**Light in weight  
low in price**

HERE IS A HAND DRILL that has the advantage of being light weight and easily handled—and it is also low priced.

Aluminum frame. Steel pinion gear. The guard of hardened steel holds the gears from slipping under extreme pressure. The steel spindle runs on ball bearings, and keeps end-thrust friction out of the tool and puts it into the job. All-steel chuck with three hardened jaws that grip all round-shank drills up to  $\frac{3}{8}$ -inch diameter.

Write for the Goodell-Pratt Catalog No. 15, which shows the entire line of 1500 Good Tools. It's free.

GOODELL-PRATT CO., GREENFIELD, MASS., U.S.A.

*Toolsmiths*

Makers of Mr. Punch

**GOODELL-PRATT**  
**1500 GOOD TOOLS**



# 21 Jewel Santa Fe Special

Sent  
on

# Approval

21 Perfect Jewels  
Adjusted to Positions  
Adjusted to Temperature  
Adjusted to Isochronism  
Adjusted to the Second  
25 Year Gold Strata Case  
Your choice of Dials (including  
Montgomery R. R. Dial)  
New Thin Models. All sizes.

**W**HILE other watch dealers are raising their prices, asking you for larger monthly payments, and making payment terms harder for you to meet, we are offering you our new model Santa Fe Special, no advance in price, no money down, easier terms and smaller monthly payments. We realize the war is over and in order to double our business we **MUST** give you pre-war inducements, better prices, easier terms, and smaller payments.

**Send No Money** Without one penny of advance payment let us place in your hands to see, to examine, to inspect, to admire, to approve a real masterpiece in watch creation. Our determination to this year double our sales of the world famous Santa Fe Special and Bunn Special Watches prompts this matchless offer.

## Ladies' Wrist Watch—New Elite

This Artistic dependable Ladies' Wrist Watch, fitted with genuine Illinois Springfield movement. A perfect timepiece. Beautiful 14 Karat white or green solid gold case. Many designs—Ask for New Watch Book showing New Elite case designs in color. Watch sent on approval and sold on payments.

## Page 12 of Our Watch Book Is of Special Interest to You!

Ask for our Watch Book free—then select the watch you would like to see, either the famous Santa Fe Special or the 6 position Bunn Special, and let us explain our easy payment plan and send the watch, express prepaid, for you to examine. No money down. **REMEMBER**—No money down—easy payments buys a master timepiece—a 21 Jewel guaranteed for a lifetime at about half the price you pay for a similar watch of other makes. No money down. A wonderful offer.

**SANTA FE WATCH COMPANY**  
66 Thomas Building TOPEKA, KANSAS  
"Home of the Great Santa Fe Railway"

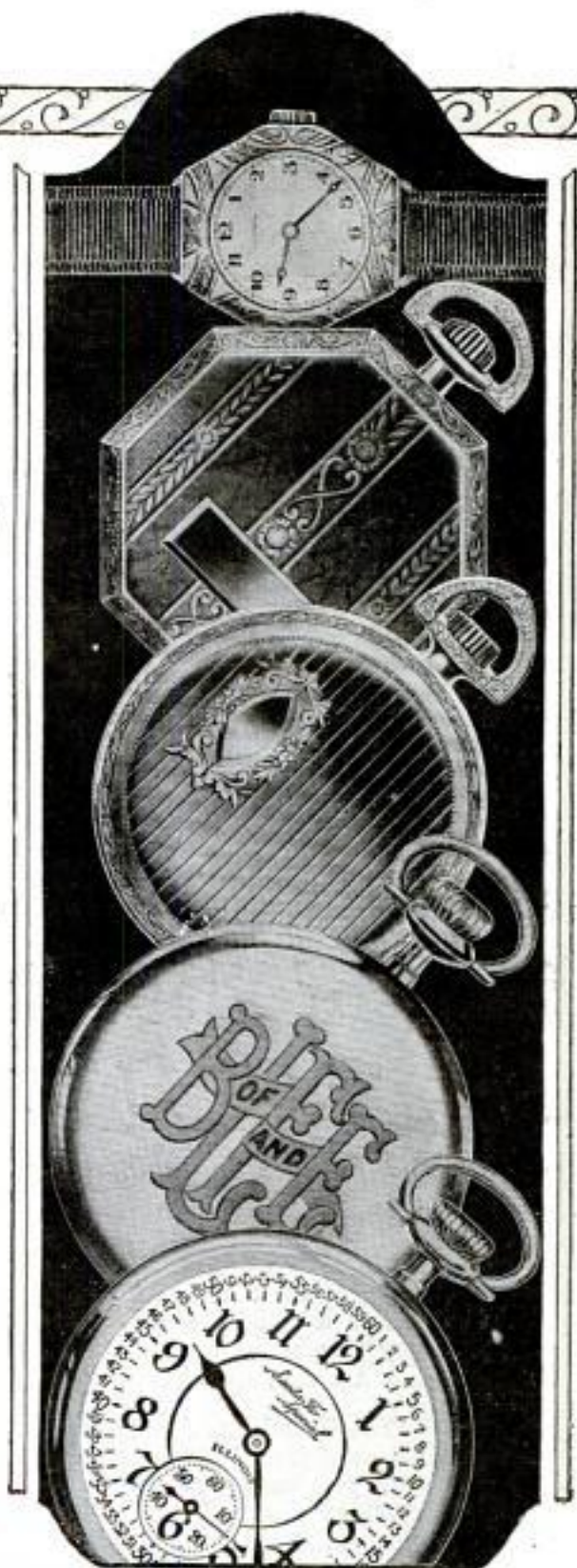

**SANTA FE WATCH CO.**  
66 Thomas Bldg., Topeka, Kansas

Please send prepaid and without obligation your Watch Book free, explaining your "No Money Down" Offer on this Santa Fe Special Watch.

Name.....

Address.....

State.....





Sargent  
Auto-Set  
Bench Plane

Sargent  
Steel Block  
Plane

## Sargent Planes are *simple* *in adjustment, keen and lasting!*

The Sargent Auto-Set Bench Plane is the handiest all-round plane you could have in your workshop. It is true, keen cutting, time-saving. It can be used on the rougher jobs where a good deep cut is a necessity as well as on finer work requiring a clean, quick finish.

You'll find its adjustments remarkably simple. With the auto-set feature you can remove the chromium steel cutter, whet and replace it without changing the original adjustment.

Then there's the Sargent Steel Block Plane. This is small in size and a right convenient tool for any work-bench. The special low angle arrangement of cutter makes it particularly good for cross-grain cutting and rough or knotty surfaces. And you can't beat it for the finishing touches or work in close quarters.

See these planes at your hardware dealer's and write for the Sargent Book of Planes which is full of detailed information.

SARGENT & COMPANY

49 Water Street

Hardware Manufacturers

New Haven, Conn.

**SARGENT**  
*Tools & Hardware*



# SENSATIONAL SALE

## GUARANTEED TYPEWRITERS



**\$1 DOWN**  
Balance on  
*Easy Terms*

This is the famous L. C. Smith typewriter which has set the world's standard for quality and service for over twenty years. Perfect machines, Standard size, Keyboard of Standard Universal arrangement, 42 Keys, writing 84 characters—universally used in teaching the touch system. The entire line of writing completely visible at all times; has the tabulator, the two color ribbon, with automatic reverse, the back spacer, ball bearing type bars, ball bearing carriage action, ball bearing shift action. This ball bearing construction makes it much easier to learn operating on the L. C. Smith than any other typewriter. Also it gives unlimited speed—beyond the limits of human possibilities. Every late style feature and modern operating convenience. Comes to you with everything complete: tools, cover, operating book and instructions—nothing extra to buy. You cannot imagine the perfection of this beautiful typewriter until you have seen it. We do the most perfect and highest class job of rebuilding known to the typewriter industry. We have sold thousands of these perfect late style machines at this bargain price and every one of these satisfied customers had this splendid, strictly up-to-date machine on five days' free trial before deciding to buy it. We will send it to you F. O. B. Chicago for five days' free trial. It will sell itself, but if you are not satisfied that this is the greatest typewriter you ever saw, you can return it at our expense. You won't want to return it after you try it, for you cannot equal this wonderful value anywhere.

**FREE COURSE OF INSTRUCTION** in the Touch System of typewriting given with every order. The best and quickest method of learning. Specially adapted to the L. C. Smith.

**FREE BOOKLET** giving description of this machine and other models, also Valuable Typewriter Information, sent on request.

Only \$1.00 down, then a few dollars a month and the machine is yours. This is absolutely the most generous typewriter offer we ever made. Why rent a machine when your rent money will buy one? Think of it—buying a perfect, late model highest grade \$102.50 Typewriter at a bargain price.

### The Famous L.C. Smith Ball Bearing

Just send \$1.00 with the coupon and the machine will be shipped at once. Then after 5 days if you are convinced that it is the best typewriter you ever saw, keep it, send us \$4.15 and then send us \$4.00 a month until our bargain price of \$57.15 is paid. All cash, \$53.06, just a little more than half its original price.

**FREE TRIAL**

If you don't want it, return it and receive your \$1.00 back. We will pay the return express charges. This machine is guaranteed just as if you paid \$102.50 for it. It is standard. Over a half-million people own and use these typewriters and think them the best ever manufactured. The supply at this price is limited; the price will probably be raised when the next advertisement appears, so don't delay. Fill in the coupon today—the typewriter will be shipped promptly. There is no red tape. We employ no solicitors—no collectors—no chattel mortgage. It is simply understood that we retain title to the machine until full \$57.15 is paid. You cannot lose. It is the greatest typewriter opportunity we have ever offered. Get the coupon in the mails today—SURE.

**SEND NOW—BEFORE THEY'RE GONE**  
**SMITH TYPEWRITER SALES CO.**  
300-360 E. Grand Ave., Chicago, Ill.

**Send This Free Trial Coupon NOW**

SMITH TYPEWRITER SALES CO.,  
300-360 E. Grand Ave., Chicago, Ill.

I enclose \$1.00 as evidence of my good faith. Ship me the L. C. Smith Model No. 5, F. O. B. Chicago. After five days' trial I will send you \$4.15 and then \$4.00 per month thereafter as rent until the \$52.00 balance of the Special \$57.15 sale price is paid. The title to remain in you until fully paid for. It is understood that I have five days in which to examine and try the typewriter. If I choose not to keep it, I will carefully repack it and ship it back to you and you will return my \$1.00 deposit. It is understood that you give the standard guarantee.

Name..... Street.....  
City..... State..... Business or  
Two Employer.....  
References.....



**Red Devil Tools**  **Better Made**

## "Red Devil" Tools for Long Life

The value of "Red Devil" Tools lies in the fact that they combine design, material and workmanship in just the way that will best fit the tool for its job, and give it unusually long life. Over a quarter century's drop forging experience behind them. Buy them for economy's sake.



### "Red Devil" Pliers

For repairing radio sets, gas engines, automobiles, trucks, tractors, vacuum cleaners, sewing machines, guns, typewriters, for amateur plumbing jobs, etc. No. 1024 — 6½ inch shown here. \$1.10 pair.

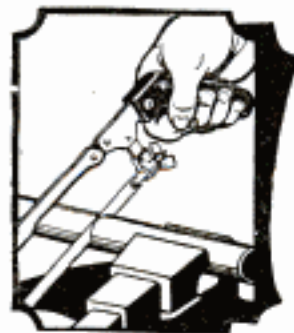

### "Red Devil" Hack Saw Frames

For cutting sheet metal, pipe, tubing, cables, steel rods and bolts, structural steel, etc. No. 1048 shown here, for 8 to 12 inch blades. \$1.00.



### "Red Devil" Glass Cutters

It's economical to do the little jobs yourself. For repairing window panes, glass sashes, green houses, for making passepartouts, table tops, glass trays, aquariums, etc. No. 024, 20c each.

Your dealer has "Red Devil" Tools in stock; if not, send his name, and order from us. FREE—Mechanic's handy tool booklet.

**SMITH & HEMENWAY CO., Inc.**  
Manufacturers of "Red Devil" Tools  
260 Broadway New York, N. Y.

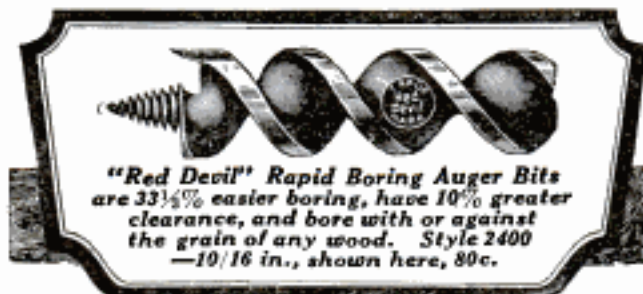

## Send for New Catalog



### Just Off the Press!

A new Series of "KING" Band Instrument Catalogs on Saxophones, Trombones, Trumpets, etc.

These new catalogs, the finest and most complete ever published, tell you in detail about the fine workmanship, accurate designing, scientific proportions and superior mechanical features found only in "KING" instruments.

**FREE TRIAL OFFER and Easy Payment Plan** fully explained.

Write today for catalog of the instrument you play, or are interested in.

**THE H. N. WHITE COMPANY**  
5211-52 Superior Avenue  
Cleveland, Ohio

Manufacturers of  
**"KING" BAND INSTRUMENTS**

## SEND for the INTERNATIONAL CATALOG

FOR FORD—  
PRICES  
FROM  
\$27.05  
UP.

Factory to  
Consumer  
direct—  
Pay only one price!



Our set price list. Full line of auto bodies and accessories for Fords at Wholesale Prices. Save big money on bodies by buying direct from factory.

**INTERNATIONAL BODY WORKS, Dept. 7, 914 W. Ohio Street, CHICAGO, ILL.**

## CAMERAS

**Over a Hundred Styles and Sizes**  
Send for new illustrated catalog showing latest reduced prices. It's Free.  
**10 days' trial given**

**SENECA CAMERA MFG. COMPANY**  
300 Central Avenue Rochester, N. Y.



## NEW VEST POCKET ADDING MACHINE

Adds as rapidly and accurately as a \$300 machine, yet fits the vest pocket. Mechanically perfect. Easy to operate. Everyone who uses figures should own one.  
**COUNTS UP TO 999,999,999** **\$2.95**



Total visible at all times. A pull of the finger clears it. Don't carry a pocket full of pencil stubs and scrap paper to do your figuring. Carry a Ve-Po-Ad. **10 DAYS TRIAL SEND NO MONEY.** Just name and address and we will send machine postpaid. Pay postman on delivery \$2.95. Use it for 10 days to prove it does all we claim. If not perfectly satisfied we will refund your money. Limited supply. Order today.

**RELIABLE ADDING MACHINE CORP.**  
170 C West Washington Street CHICAGO, ILL.

**AGENTS** Here's a money maker for you. Everybody wants one. Splendid profit. Write for special offer. **DO IT NOW.**



**I want to Pay You \$85 a week**



**Man or Woman**  
Send for my proposition, I pay men and women \$85.00 weekly to as high as \$36.00 per day for either all or spare time help. No experience necessary.

**Sell PRINCESS RADIUM LINGERIE**

Charming ladies lingerie and hosiery, pretty, low priced, sells on sight, actually. Miss Grace James averaged \$36 a day, spare time; R. G. Thompson earned \$33 in one day. You can do as well, we tell you how.

**Profits in Advance**  
Your profits in advance, we ship and collect. You show goods and mail us the orders. Nothing in any store compares in beauty and value to "Princess Radium" lingerie and hosiery.

**High Grade-Steady**  
Unusual opportunity for big cash quick, write for plan and exclusive territory, build a steady income for life. District managers wanted. Territorial rights going fast, don't delay, write now.

**Free**  
Handsome photos from actual models and samples of genuine "Princess Radium" silk, free.

**ROBERTS-FRANK & CO**  
1733 Irving Park Blvd  
DEPT E-12 CHICAGO

**How To Make More Money**



Unusually attractive profits easily and quickly made at home in spare time, raising guinea pigs, squabs, etc. Thousands being used. Highest price paid to raisers. Market guaranteed. No experience necessary. Write today for illustrated booklet—free.

**MUTUAL FOOD PRODUCTS CO., 1400-B Broadway, New York**

**Try before you Buy**

Your choice of 44 styles, colors and sizes in the famous **Ranger** line. Write for our marvelous prices and terms. Shipped on approval and **30 DAYS FREE TRIAL, express prepaid.**

**\$5 a Month** You can get immediate possession and use of your choice from Ranger or Falinder bicycles on our liberal easy Monthly Payment plan. Best quality at factory prices, express paid.

**Tires** range, wheels, horns, equipment and repairs at unusually low prices.

**Mead CYCLE COMPANY**  
DEPT. 108 CHICAGO

Write today for free Ranger Catalog, factory prices and marvelous easy payment terms



**"We sold over \$25,000 in 2 Years"**



Approved by Underwriters

**Any MAN can sell them**

W. E. Findlay ran up his commissions in a few months from \$100 to over \$500 per month. Every Home, Auto Owner, Store and Factory a Live Prospect. Keeton, Howard, and others, never sold Fire Extinguishers before. Our special training course starts you on road to success first day. If now employed, we can show you how to make big money during spare time. No Experience Necessary. Get our new Sales Plan—find out how to make real money. Territory going fast—write today! Fyr-Fyter Co., 11 Fyr-Fyter Bldg., Dayton, O.

Kemper Sidell

**LOFTIS BROS. & CO. F&S**

**DIAMONDS WATCHES**

**CASH or CREDIT**

**DIAMOND IMPORTERS**

We import Diamonds direct from Europe and sell direct by mail—a great saving to you. Our Diamonds are "quality" gems, blue white, perfect cut, personally inspected by our expert buyers. We invite comparison.

**"Muriel"**  
Diamond Ring  
Beautiful Blue White, perfect-cut Diamond. Ring is Solid 18-k White Gold, basket mounting. Also at \$75, \$125, \$150

**"Norma"**  
Diamond Ring  
Blue White, perfect-cut Diamond. Ring is Solid 18-k White Gold. Other Solid White or Green Gold rings at same price.

**GENUINE DIAMONDS—GUARANTEED**  
**SEND FOR CATALOG** Over 2000 illustrations of Diamond-set Jewelry, Watches, Wrist Watches, Pearls, Mesh Bags, Silverware, etc. Sent prepaid for your Free Examination. Catalog explains everything. Satisfaction Guaranteed or Money Refunded

**"Sylvia"**  
Diamond Ring  
Blue White, radiant, perfect-cut Diamond. Ring is 18-k solid White Gold \$100

**Loftis Carved "Perfection"**  
Diamond Ring  
Blue White, perfect-cut Diamond, set in White Gold prong. Ring is 14-k solid Green Gold \$50

**"Amazon"**  
Diamond Ring  
Brilliant Blue White, perfect-cut Diamond. Solid 18-k White Gold ring. \$150

**WEDDING RINGS**  
All Platinum, \$25 up. With Diamonds: Three Diamonds, \$65; five Diamonds, \$80; seven Diamonds, \$95; nine Diamonds, \$110; surrounded by Diamonds, \$225. Solid White or Green Gold, \$5.00 up.

**17 Jewel Elgin**  
Guaranteed 25 Years  
No. 15—Green Gold, engraved, assorted patterns. 12 Size, gilt dial. \$32

No. 16—Wrist Watch, Solid 18-k White Gold. 17 J., \$29.75; 14-k, 16 J., \$24.95

**Railroad Watches—Guaranteed to Pass Inspection**  
HAMILTON NO. 992, 21 Jewels, Adjusted to 5 Positions, Gold filled 25-Year Case \$55  
ILLINOIS "SUNN SPECIAL," 21 Jewels, Adjusted to 6 Positions, Gold filled 25-Year Case \$50  
ELGIN'S LATEST RAYMOND, 21 Jewels, 8 Adj. Runs 40 hr. one winding, Gold filled 20-Yr. Case \$55

**LOFTIS BROS. & CO. F&S**  
THE OLD RELIABLE ORIGINAL CREDIT JEWELERS  
Dept. A894 108 N. State Street, Chicago, Ill.  
Stores in Leading Cities



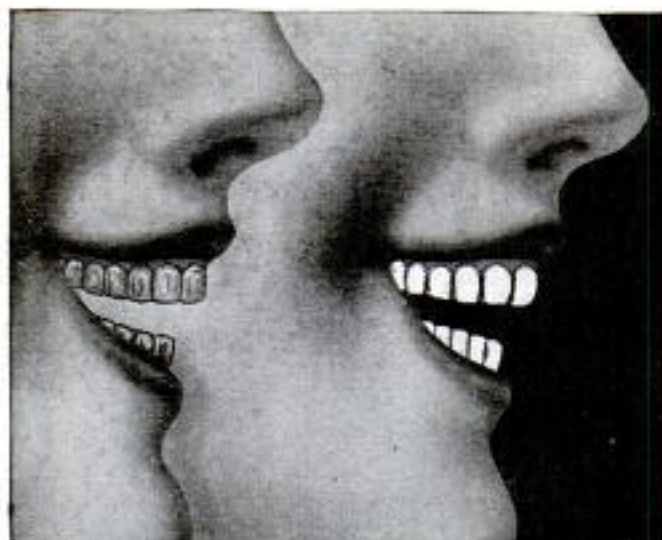

## Tobacco Stained Teeth Instantly Whitened New Safe Way

No need now for yellow, discolored, spotted, tobacco-stained teeth. Bleachodent Combination costs just a few cents and removes unsightly stains in three minutes at home. Leaves teeth white, lustrous, clean and flashing. Recommended everywhere as quicker, surer, safer than old-fashioned scouring methods which injured the enamel. Bleachodent Combination contains a marvelous mild liquid to loosen stain coats and a special paste which not only removes them, but used daily prevents formation of new stains. Only a safe, mild preparation like Bleachodent Combination should be used on soft, sensitive teeth which stain and decay easily. Acts only on stains—not on enamel. Be sure to ask for Bleachodent Combination by its full name. Distributed by Bleachodent Dental Laboratories and sold by drug and department stores everywhere.

## \$14.95 Suit

Made to Order **Now**

**SEND NO MONEY**

To introduce unbentable values, classy style, perfect fit of **PROGRESS** tailoring we offer, for \$14.95 tailored to measure

any style suit of your choice, delivered post-paid. We Guarantee Satisfaction or Money Back. Other wonderful values up to \$39.50.

**AGENTS WANTED** Earn \$9 to \$18 Daily spare time showing our samples to friends and neighbors, we explain how, no experience needed. Big Outfit, agent's wholesale prices, real wool pieces, fashion styles, tape measure, etc. Complete outfit and simple directions **FREE**. **SAMPLES**

**The PROGRESS TAILORING CO.** Dept. F-149 CHICAGO



"If I hadn't been all through it myself, I wouldn't have the assurance to say to you 'cheer up.'"

ERICKSON.

Those who wear them say:  
**ERICKSON LEGS** are Wonderful because they do not chafe, overheat or draw end of stump.



If you have had a recent amputation send for new booklet on **TEST LEGS** for beginners.  
**E. H. ERICKSON CO.**  
38-A Washington Av. N.  
MINNEAPOLIS - MINN.

# Send No Money

## Ladies' Solitaire Examination Free

This perfectly cut Diamond will be sent free of charge for your complete examination and approval. No money in advance. If satisfied, pay only \$2.00 on arrival and keep it. Price \$30.00.

**10 MONTHS TO PAY**

The balance you send in 10 small monthly payments—only \$2.89 a month. Take advantage of this amazing offer today.

**FREE** De Luxe Catalog in colors. Write for details of Great Diamond Offer and Book to Dept. 64-L. Capital \$1,000,000



**\$2.89**  
a month



THE HOUSE OF QUALITY  
AUTHORIZED CAPITAL \$1,000,000

## L.W. SWEET INC.

Dept. 64-L 1660 BROADWAY, NEW YORK

**FREE**

American Sheik and Sheba in a Crystal Glass Dome with EVERY ORDER



**Sheik-Lure** New Imported Perfume Sensation

**Solid — No Liquid — No Bottle**

Just a touch on the skin and the haunting romantic fragrance thrills and lingers days. Everybody adores it. An aroma De Luxe, Beautiful Ruby Transparent Case for lavatory or vest pocket. Outlasts a liquid \$10.00 value. **Send No Money.** Pay postman only \$1.00 when perfume arrives or, if you wish, enclose dollar bill with order. **Sheik del FREE** with first order. Money back if not **Delighted**, send post card or letter **Now**.



Lure Both Sexes

Lure Importers, West 803, Evanston, Ill.

## WHY NOT IMPROVE YOUR PERSONAL APPEARANCE?

Send for booklet showing photos of Men with and without the **PERFECT LEG FORMS** for **BOW LEGS** and **KNOCK-KNEES**. Also **BRACES** for children for **PERMANENT CURE**.

**Perfect Sales Co.** 140 N. Mayfield Ave. Dept. 5, Chicago, Ill.

## TYPEWRITERS



**\$50**

buys a brand new Corona, the Personal Writing Machine. Latest model with many improved features.

Write for free booklet No. 8.

**Corona Typewriter Co., Inc.**  
GROTON, N. Y.



## Different from all others—the NEW BENJAMIN

### AIR RIFLE

Made on a different principle from all other Air-Rifles. The Benjamin is really a strong air-pump used to compress the air in the air chamber to any degree of power desired. From one to six strokes of the pump give all the force necessary. Each additional stroke gives increased power. The Benjamin works on the same principle as all air-drills and air-hammers—with this difference:

*You control the shooting force as you desire. Look at this block of hardwood. It shows how Benjamin power is regulated as you wish.*

You can't have accidents with a Benjamin. It's safe, always, because you control the power. The Benjamin never loses shooting force, and has no springs to get out of order or shake your aim. Write us for an interesting folder about this wonderful air-gun.

If your dealer does not handle arms, send direct to factory.

**(PRICE \$5)**  
POSTPAID  
BENJAMIN AIR-RIFLE & MFG.  
CO., 615 N. Broadway, St. Louis, Mo.

Ask your dealer for demonstration.

Pacific-Coast  
Representatives  
THAYER &  
BOWER  
Los Angeles  
Calif. and  
San Francisco  
Calif.



## AGENTS Every woman wants this handy kitchen convenience

If a profit of 79¢ each on 10 to 30 sales a day appeals to you—line up with us. Tyler's Ideal Fibre Cutter is "the handiest tool in the kitchen" and our new Sales Manual gives you a selling plan that really works. *You are sure to succeed.*

House-to-House Salesmen  
make from \$40 to \$100 Weekly

Write to

M. H. TYLER MFG. CO.  
Dept. M-2 Muncie, Ind.



## FREE Beautiful Book About Taxidermy

Learn at home by mail to mount birds, animals, tax skins. Be a taxidermist. Delightful art easily learned by men and women. Decorate home and den. Make big profits. Wonderful new art. Intensely interesting. Investigate. Write Today For This Wonderful Free Book, and our amazing offer. Send TODAY. N. W. School of Taxidermy, 4177 Elwood Bldg., Omaha, Neb.



## Men's Shirts



From factory to wearer. Easy to sell. Big demand everywhere. Make \$15 daily. Under-sell stores complete line. Exclusive patterns. No experience necessary. Free samples.

Chicago Shirt Manufacturers,  
241 W. Van Buren St., Chicago, Factory 228

## Build This Phonograph Yourself

### TREMENDOUS SAVING IN COST

Easy, fascinating work with our SIMPLIFIED PLANS. We furnish blue prints, diagrams, motor, cabinet pieces, ready-built horn, etc. You don't need to be a cabinet maker. A few hours assembling and you will have a fine instrument at one-quarter the regular retail price. AGENTS MAKE MONEY making and selling these instruments. Write today for full details and our FREE OFFER. Address

LUPERL PHONOPARTS CO.  
2648 W. Chicago Ave. Dept. 14 CHICAGO, ILLINOIS



## Anna Q. Nilsson finds a York Sax



## Easy to Play!

Everyone finds the York Saxophone richly melodious, fine in quality, superb in tone and easy to play. Miss Nilsson, the renowned motion picture star, is high in her praise of the excellent workmanship apparent. You can satisfy your desire to examine a York Saxophone by having it sent to your home on

## 6 DAYS' FREE TRIAL

Play on it in your own way, compare the tone quality, the voice, the remarkable ease of blowing. Note how quickly you can master the scales and learn simple tunes. If after 6 full days, you aren't delighted simply send the instrument back and it won't cost you a penny. If you decide to buy all you have to do is to make small monthly payments on the balance. In fact you can have any York Band Instrument on our free trial and easy payment plan. State instrument you want sent on the coupon below.

## Brilliant New Trumpet

This is the latest creation of the House of York. Snappiest, smallest bore trumpet made in America. Gives the player all those effects necessary in jazz orchestrations. Very brilliant. Workmanship positively the best—beautiful model. Playing does not tire you. Let us send you particulars. Also send for free trial and sold on the easy payment plan. Use Coupon today.

## J. W. YORK & SONS (Since 1882)

Dept. 221-F

GRAND RAPIDS, MICH.

COUPON

J. W. YORK & SONS,  
Dept. 221-F, Grand Rapids, Mich.

Gentlemen: Kindly mail, without cost to me, your beautifully illustrated literature and details of your Free Trial and Easy Payment Offer.

Name.....

Address.....

Instrument.....  
(Mention instrument interested in)



## IT'S A WONDER! Does Everything in Woodworking

**ONLY \$225**  
complete  
with motor



8 inch circular rip saw  
8 inch circular cross cut saw  
11 inch band saw  
4 inch jointer  
shaper  
10 inch sander  
lathe — 14 inch swing

### Parks Cabinet Shop Special

is the last word in portable, small shop equipment.

It is a band saw, shaper, lathe—all in one. You can do sawing, rabbetting, planing, moulding, matching, panel raising. Just the thing for your home shop! You can order it complete or with just the attachments you want.

Write for circular

**The Parks Ball Bearing Machine Co.**  
1500-1540 Knowlton St., Cincinnati, Ohio  
Canadian Factory: 200 Notre Dame East, Montreal, Can.

# PARKS

WOODWORKING MACHINES

# I MAKE

**\$25.**  
a day  
with this  
Machine

That is what J. W. Fleming, Ind., wrote six months after we started him as an "American Universal" Floor Surfacing contractor. R. E. Waynick, Texas, says, "I have made \$30 in 8 hours." Don Arnold, Ind., says, "I have made as high as \$40 a day." Scores of others are doing as well or better. You, too, can make big money

### SURFACING FLOORS

The electrically driven "American Universal" Floor Surfacing Machine does the work of six hand scrapers, earns you six men's pay. Field is unlimited, demand tremendous. Every newly laid floor must be surfaced, every old floor represents a resurfacing job. No experience necessary. Work is pleasant, interesting. Small amount starts you. Here's

### Your Big Opportunity

to be your own boss, to build a paying business, and make real money from the start. We help you, show you how and where to get work, furnish advertising, stationery, office forms, everything you need.

Write now for free details of this rare opportunity.

**The American  
Floor Surfacing  
Machine  
Company**  
523 S. Saint  
Clair Street  
TOLEDO,  
OHIO



## Biggest value Tap & Die Set on the market

Buy it at low factory price **\$3**

5 taps (sizes  $\frac{1}{4}$ " 5/16"  $\frac{3}{8}$ " 7/16" and  $\frac{1}{2}$ " )

5 dies to match

A die stock

A tap and reamer wrench.

All of high grade tool steel, accurately cut.

Indispensable for threading nuts and bolts about the farm, experiment shop and automobile. In factory use, a stock set of these taps ran over 10,000 clean cuttings!

*SPECIFY WHETHER YOU WANT U.S.S. (GOVERNMENT STANDARD) OR S. A. E. (AUTOMOTIVE) THREAD.*



Hundreds of Satisfied Users

**ORDER TODAY!**

Descriptive circular on request.

**Worcester  
Steel Products  
Company**

Dept. 2, 25 Union Street  
Worcester, Mass.

**\$3.00**

### New $\frac{1}{4}$ H. P. 110 volt A. C. Guaranteed Motors 60 cycle, complete with cord, plug and pulley



Gen. Elec. 1725 speed ..... \$14.75  
Gen. Elec.  $\frac{1}{4}$  H. P. Rep. Ind. .... 39.00  
Master  $\frac{1}{4}$  H. P. Rep. Ind. .... 52.50  
Master 1 H. P. Rep. Ind. .... 60.00

Special values in rebuilt motors.

**HYRE ELECTRIC CO.**  
615-T S. Dearborn St., Chicago, Ill.

### THE SCREWDRIVER THAT HOLDS THE SCREW

As Good as a Third Hand in Assembling anything from a Watch to an Automobile



Appeals

Especially to Radio

amateurs and professionals. A wonderful (patented) improvement.

Jobbers, Dealers and Agents. Favorable discounts

\$1.00 Postpaid **THE COBURN TOOL CO., Inc., 739 Boylston St., Boston, Mass.**



10"-25" Gap Bridge base  
change gear engine lathe.

**High in Quality  
— Low in Price!**

This big capacity, low priced lathe is just the tool for the progressive garage. It will take care of your requirements satisfactorily and in time pay for its cost in savings.

WRITE FOR DETAILS.

**The Sebastian Lathe Co., 107 Culvert Street  
CINCINNATI, OHIO**



Don't forget  
your pliers\*



Even on a fishing trip you will find Bernard Pliers (No. 128) unexcelled for rigging tackle. Bernards with the outside blades cut smoothly, cleanly and closely. The parallel jaws give an all over grip that can't slip. You will find them useful in a hundred ways. Insist upon

## BERNARD

Standard High-Power Cutting  
PLIERS



No. 15 — Bernard "Parrot Head" Spring Pruning Shears

Catalog "P" free on request from

WM. SCHOLLHORN CO., New Haven, Conn.



## PILLIOD

Tool Cases Excel

Machinists, Tool Makers and Carpenters find them most satisfactory in construction, appearance, service and price. Immediate shipment.

Booklet describing 20 styles on request.  
THE PILLIOD LUMBER CO.  
Dept. 1 Swanton, Ohio

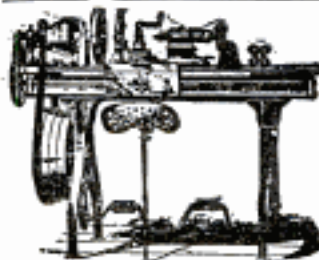

## LATHES

9 to 18-inch Swing

List price \$165 and up according to size. When ready to buy send for Lathe Catalog and prices.

W. F. & John Barnes Co.  
100 Ruby Street, ROCKFORD, ILL.

## MAKE MORE MONEY TORIT ACETYLENE TORCH NO. 13

For soldering, heating, melting, tempering, auto radiator repairing, battery repair work, and for all kinds of small jobs requiring a hot flame instantly. Usually pays for itself in a single day.



USES ACETYLENE GAS ONLY

Torch with 4 tips for different kinds of work, soldering copper, 5 ft. tubing and connection for auto-acetylene tank . . . . \$7.50  
St. Paul Welding & Mfg. Co., 177 W. 3rd St., St. Paul, Minn.

## ATKINS

SILVER STEEL  
SAWS

## A Perfect Saw for Every Purpose

For every man who uses saws there's an Atkins saw to do the work easier, quicker and better. Here are just a few of many popular Atkins Saws.

### No. 400 HAND SAW SHIP POINT



Finest saw made; Genuine SILVER STEEL BLADE, Ship point, 26-inch length, taper ground, MIRROR POLISH. ROSEWOOD HANDLE, Improved Perfection Pattern. Skew or Straight Back.

### JUNIOR MECHANIC HAND SAW



A new saw for the Boy Scout and junior or radio mechanic. Made 20 in long, skew back, taper ground, highly polished; cherry handle.

### No. 10 HACK SAW



Hard rubber handle, "easy grip" pattern; hung low, steel frame is nicked and highly polished; adjustable to 8, 9, 10, 11 and 12-in. blades.

### No. 3 NEST OF SAWS



Includes 12-inch keyhole blade, 14-inch compass blade and 18-inch special nail-cutting blade, interchangeable in adjustable handle.



## Booklets FREE

"Saw Sense" shows Atkins wood-cutting saws and tells how to file saws. "Saws in the Shop" shows our metal-cutting saws, and contains many helpful suggestions. To get booklet you want, write your name and address and dealer's name on this page and mail to us.

E. C. ATKINS & CO., Inc.

Makers of "Silver Steel" Saws and Tools

Dept. P

Indianapolis, Ind.

Please Mention Popular Mechanics



## REPAIR THAT CRACKED BOILER SECTION YOURSELF!

—do it with a few cents worth of Smooth-On No. 1 and you'll get a perfect permanent repair without putting anything harmful inside the boiler and without having a big plumber's bill.



### Smooth-On No. 1

144 pages  
This Book  
FREE

affords the simple, quick, sure means for stopping leaks in boilers, radiators, furnaces, water pipes and tanks, stove pipes, kitchen pails, etc., and can be used for hundreds of other house and automobile repairs.

The book we send free tells you how to use it, and you can get your supply in 6-oz., 1-lb., 5-lb. or 10-lb. tins from any live dealer.

**SMOOTH-ON MFG. CO.**  
574 Communipaw Ave., Dept. 37  
JERSEY CITY, N. J.

**SMOOTH-ON  
REPAIR  
BOOK**

## SEAMLESS, LONG-LASTING FLOORS

The most serviceable floor you can lay in offices, stores, apartments, kitchens, bathrooms, factories, schools, theatres. No joints to collect dirt—smooth—comfortable—permanent—inexpensive.

### Everlastestos Flooring

Superior ingredients and accurate directions for laying insure satisfactory job over old floor or in new building. Three colors—red, buff and gray.

Write for catalog and sample

**EVERLASTESTOS  
FLOORING CO.**  
Dept. P, 95 North St.  
Rochester, N. Y.



## The MONARCH Jr. Lathe

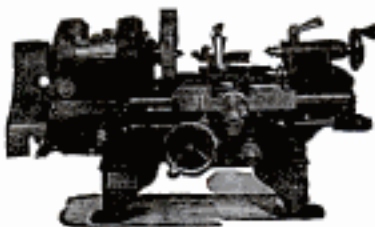

Monarch Jr. Engine Lathe  
9-in. swing, 2½ ft. bed **\$270**

Write at once for your FREE copy of the MONARCH Lathe Catalog. MONARCH Lathes are built up to 30 inches swing.

**THE MONARCH MACHINE TOOL CO.**  
400 Oak Street SIDNEY, OHIO

Inventors, experimenters, Mechanics, and Auto Repairmen—here is an ideal, compact trouble-proof lathe—Instantly ready to help you turn out the small parts you require. It works to an accuracy of 1/1000 of an inch. Can be installed on your work-bench. Has semi-quick change gear and automatic safety device. Built with bed lengths to 5 feet, also with 11 inches swing at slightly higher price.

**\$500<sup>00</sup>** A Month for  
Your Services

Miller Made \$30.00 in one evening

At last a vacuum cleaner for use in any home. No electricity, no wires, no troubles, no running costs. Child can run it. 80 per cent homes have no electricity. Everyone buys quick. No competition. Women are looking for this cleaner. Want it. You are WELCOME. Sells itself. Big profits quickly made—easily made.

Goes Anywhere  
Weight only 7½ pounds.



Proved Proposition 40,000 already in use. Every one sold sells several more. If you want to make \$5,000 to \$10,000 this year, every year, write us NOW. The secret of big money is to see a winner and grab it. But they go quick. Write TODAY!

**THE MARVEL CO., Dept. 211**  
Hammond, Ind.

Only \$14<sup>24</sup>

Down For  
2 H-P. WITTE

(Throttling Governor)

Easy Terms on best engine built. Burns kerosene, distillate, gasoline or gas. Change power at will. Equipped with the famous WICO Magneto. Other sizes, 2 to 25 H-P.—all styles.

FREE—Write today for my Big Engine Book. Sent free—No obligation on your part.

**WITTE ENGINE WORKS**

1741 Oakland Avenue, - KANSAS CITY, MO.  
1741 Empire Building, - PITTSBURGH, PA.



If you want to be free from worry about your tools, keep them safely in a

**GERSTNER Tool Chest**

There's one you can use and one you will want. Write for free catalog.

*Gerstner & Sons*

406 Columbia St., DAYTON, OHIO

## SHOTGUN or RIFLE

There's remarkable gun value in a Stevens. Write for the interesting catalog describing our line.

**J. STEVENS ARMS COMPANY**  
Dept. 575 Chicopee Falls, Mass.

Owned and Operated by the Savage Arms Corporation



It is the well known quality of CRESCENT machines that justifies you in selecting one of them each time you have need for wood working machinery. The CRESCENT line is better than ever and will always give you satisfaction in every particular. Ask today for catalog of band saws, saw tables, jointers, shapers, planers, borers, planers and matchers, cutting saws, disk grinder, cut off table, hollow chisel mortiser, variety wood worker, Universal wood workers.

**THE CRESCENT MACHINE CO., 83 Columbia Street, Leetonia, Ohio**

## MATHEMATICS

can be easily mastered with the Midget 5 in 1 Slide Rule. With this calculator you can instantly add, subtract, multiply and divide any combination of decimals, fractions, whole and mixed numbers. Also obtain all roots, powers, Logs, and Trig. Functions.

It is used at all colleges, 200 at Harvard, 200 at Cornell, etc. The Engine-Divided Scales are on white celluloid, mounted on aluminum and are grease and waterproof. Diameter 4 inches. Price with Instruction Book . . . . . \$1.50  
Leather Case 50c extra. Catalogue Free. Your money back if you are not satisfied.  
**GILSON SLIDE RULE CO., Niles, Mich.**





# DIAMONDS

## \$2<sup>00</sup> DOWN

**No. 1. The "Butterfly"** Fiery blue white perfect cut diamond. 18k. white gold hand engraved and pierced ring. \$82.50—\$2 Down—only **\$1.50 a week.**

**No. 2. "Vassar"**. Artistically pierced lace work design. 18k. white gold. Perfect cut blue white diamond. \$37.50—\$2 Down—only **\$1.00 a week.**

**No. 3. "Cluster"**. 7 fine white diamonds set in platinum. Resembles \$750 solitaire. 14k green gold. Rare beauty. \$32.50—\$2 Down—only **\$1.50 a week.**

**FREE**  
Write for Catalog.  
Diamonds  
Watches Jewelry  
\$10 to \$1000  
on easy terms.  
Wonderful values

**No. 4. "Luxor"**. Man's 14k. green gold massive ring. 18k. white gold top. Fiery blue white diamond. \$57.50—\$2 Down—only **\$1.50 a week.**

**TEN DAYS' FREE TRIAL**  
Easy for you to own or give as a gift any of these handsome rings. **Simply send \$2.** We will send ring you select on 10 days' trial. **Only if satisfied, make weekly payments until balance is paid.** If you do not agree it is an **amazing bargain**, return ring within 10 days and we will refund your \$2. **You take no risk.**

## BAER BROS. Co.

6 MAIDEN LANE, NEW YORK. Established 1890

Address  
Dept. 626

**Guarantee  
Bond with  
Every Ring.**

### PORTABLE WOOD WORKING BENCH VISE

SIMPLE—EASY TO ADJUST—EFFECTIVE

**F** CARPENTERS  
**O** THE "HANDY MAN"  
**R** MANUAL TRAINING DEPTS

Positive in action. Will do more and better work than stationary vise. Carry it in the tool kit—weighs only half pound. Won't rust. Saves time and labor. Sent postpaid for only \$1.25.

Agents Wanted  
**TEXO SALES CO.**  
501 Union Central Bldg.  
CINCINNATI



## Change Blades Instantly

In this Simore Combination knife and screwdriver, there are three blades in the handle. Each blade snaps back into the handle after it has done its duty just as is shown here. And you select and produce the blade you want by gravity just as easily and quickly. You actually change blades instantly with this tool.

**Model No. 12** with knife blade and two screwdriver blades. Only **\$2.25**

**Model No. 11** with three screwdriver blades. Only **\$1.80**

Sent postpaid on receipt of money order or your check. Satisfaction guaranteed. Ask your dealer or write direct.

Dealers are invited to write for information on Simore tools.

**THE SIMON & SKIDMORE MFG. CO.**  
Dept. 4-6, SANTA ANA, CALIF.



### BURN YOUR NAME ON TOOLS WITH ARKOGRAF

Protect your tools from theft. Write any name, engrave any design on metal with electricity like writing on paper with pen or pencil. Complete outfit \$1.50, prepaid anywhere. Interesting descriptive circular free. Write today. Agents Wanted. Arkograf Pen Company 1171 East Starr St. Portland, Oregon



### "Interlox" MASTER SLIDE RULE

Works fast. Slides in and out quickly. Durable made of brass trimmed boxwood. Any length 2 to 8 feet. 20 cents per lineal foot. If not at dealer's, sent postpaid.

Dealers and Agents: request attractive proposition

MASTER RULE MFG. CO., 841-43 E. 136th St., New York



### This Wonderful Invention!

Converts any stove into a gas stove. OXO-GAS is made from kerosene and air (mostly air). Cheaper, cleaner and more efficient than coal. Eighteen different models for all purposes.

**Responsible distributors wanted**

**GLORIA LIGHT COMPANY** 137 N. May Street CHICAGO, ILL.



## \$2<sup>08</sup> GUARANTEED per gal.

**EVER-WEAR**  
FREIGHT PREPAID

### FINEST QUALITY HOUSE PAINT

**A Real Bargain!**

Crosby Ever-Wear Paint at our rock-bottom factory-to-you price. Not a cent paid out to middlemen. A flat saving to you of better than a dollar a gallon. On paint that has been the standby of thousands of customers for more than 20 years.

**GENUINE HIGH QUALITY**

has not been sacrificed for the sake of price. Our paints are ready-mixed for immediate use; all fresh made; no staling on dealers' shelves. And our iron-clad

**MONEY BACK GUARANTEE** goes with every gallon sold. This means your complete satisfaction or your money back—promptly and without argument. Test the quality yourself through our

**FREE TRIAL OFFER**

Send your order. Try the paint. If you don't like it, return the balance at our expense and we'll refund your money.

**Hand-Book FREE** Send today for beautifully illustrated "Painter's Hand-Book," showing colors and prices of every kind of indoor and outdoor paint, varnish, stain, enamel, etc. And practical lessons in home painting. Absolutely free on request. Without obligation. Write for it today.

**Crosby-Frank Co., 314 Peoria St., Chicago, Ill.**





**SAVE MONEY**  
Get This Book

**HANDY MAN BOOK**

**Install Your Own**  
**PLUMBING & HEATING**  
NEW EASY WAY - SAVE HALF

25c  
Reg. Price 50c

Brings you this big Plumbing and Heating Encyclopedia-Catalog. Write for your copy today without fail.

### Guaranteed Heating Plants

Our Handy-Man Book shows how. Big 256-page well-bound encyclopedia of Plumbing and Heating Outfits, Systems, Supplies, Fixtures and Accessories—10,000 items—illustrated. Hundreds of floor plans, elevations, diagrams, trade secrets, money and trouble-saving kinks, etc., "How to save coal in heating," "Easy repair methods." Every householder, contractor, farmer, mechanic, institution needs this book. Shows how to save wages, work and materials.

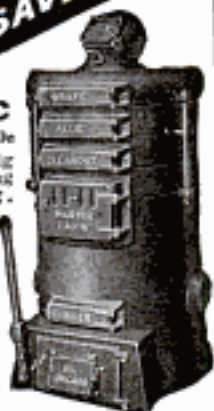

Hot Water Boiler

### Big Handy Man Book



Water Supply System

Tells how we help you plan and install. From rough sketch or description we supply working plans and clear instructions. We loan the tools needed. Any handy man can install. This is the place to buy on money-back guaranty. Plumbing Outfits and Supplies; Water Systems; Hot-Air, Water or Steam Heating Plants; Radiators, Pipes, Boilers or Septic Disposal Tanks.

### Send 25c for Yours Today

We have spared no effort or expense to complete this remarkable and instructive book. To keep from sending it broadcast to disinterested persons, we request a deposit of 25c, which will be refunded on your first order—or send for our FREE Bulletin. Write today and save half.



Bathroom Outfit

### HARDIN-LAVIN CO.

50 Years at 4547-57  
Cottage Grove Ave.,  
CHICAGO

See our advertisement on outside Back Cover April 1924 issue of this Magazine



### MONEY IN FUR ANIMALS

Chinchilla Rabbit Skins Bring \$3.00 Each  
Each doe raises 20 young yearly. PROFITS LARGE.  
Also Coivies, Fox, Mink, Skunk, Etc., are easily raised anywhere.  
Catalog, Price List and Particulars FREE  
25 page book and copy of Fur Farming Magazine 10c. Expeditious every thing. Magazine 1 year 35c.  
AMERICAN FUR FARMS, Box 56, HOLMES PARK, MISSOURI

### SWEATERS SAVE 20%-30%



Any Style or Design for Men, Women, Boys, Schools, Clubs, Teams

Order direct from mill. Save from 20% -30%. Pick any style, any color, size or design from our regular stock or special to order. Finest virgin wool and pure worsted only. Custom tailored workmanship of highest grade. Closely knit. Warm, soft, snug. Real beauties you will be proud to wear.

**FINEST QUALITY AT BARGAIN PRICES**

**FREE** Always holds shape. Most customers get from 3 to 5 years wear easily. Can endure severe wear and retain bright, fresh appearance. Biggest values in history. Workmanship guaranteed. Prices slashed. Unusual chance to save. Special offers to schools, clubs, teams. Write for free illustrated catalog.

**AMERICAN KNITTING MILLS** 1538 Clybourn Avenue Dept. 23 CHICAGO



### \$104 PROFIT IN 3 1/2 HOURS



**FREE MY BOOK "CANDY SUCCESS"**

G. A. Barton, Indiana, made that amount—making and selling **Candy Floss**. Others send in amazing reports: Small, Chicago, says—“**Did \$125 business on Sunday.**” Wendel, Kansas, writes, “**Averaged \$128 a day for 3 weeks.**” Gardner reports, “**2,437 sacks of candy sold from 11 a.m. to 10:15 p.m.**” **Big Money in Candy Floss!** Rees says: “**Cleaned up \$225 in 4 nights in Greenville, Ohio.**” **Candy Floss** is a delicious, novelty confection—fluffy, soft as cotton, white as snow, or any color or flavor. Can be made anywhere—in store window, in parks, on street corners, at picnics, summer resorts, base ball games, or wherever crowds gather. Machine easy to operate. Raw materials plentiful and cheap. Send name and address for free illustrated book of facts. Drop post. Act now! Address

**A. T. DIETZ**

44 Sayso Bldg.

Toledo, Ohio

### Prices Reduced



On All Standard Make Typewriters  
Lowest Prices in Years

We will ship any make you choose for one week's trial, Underwood, Royal, L. C. Smith, Remington, Oliver, etc.

**Easy Terms** Pay less than rent each month and own a typewriter. Guaranteed good as new. Perfectly rebuilt by experts—the famous “Young Process.”

Send for our free trial offer and new low price list now. Write today.

### Young Typewriter Co.

654 W. Randolph St., Dept. 1106, CHICAGO, ILL.

### Beautiful HOUSES \$900 and BUNGALOWS

CAN BE BUILT FOR AND UP  
This and many others in my new book, Building Plans for Modern Homes, will save you hundreds of dollars. One of the most complete and comprehensive books of plans ever published by any architect. New edition just off the press. Nearly 500 floor plans and photographs of bungalows, Colonial houses, etc., costing from \$200 up; gives sizes and cost to build.



**FREDERICK H. GOWING**  
ARCHITECT

Sent postpaid for \$2.00

101 Tremont St., BOSTON, MASS.

### A BOY'S WORKSHOP

Charts, plans, diagrams and pictures look better if hung with

### MOORE PUSH-PINS

Glass Heads—Steel Points

For heavy things, use

**Moore Push-less Hangers**

“The Hanger with the Twist”

10c pkts. Sold everywhere.

In Canada 16c

MOORE PUSH-PIN CO., Philadelphia, Pa.

### SQUAB BOOK FREE!



Squabs are selling at highest prices ever known. Greatest market for 20 years. Make money breeding them. No mixing feed, no night labor, no young to attend. Start small, grow big. Start now. Read how our customers sell squabs for \$12 a dozen. We have been established for 22 years. Better look into this. Let us send you, at no cost to you, our big, illustrated free book telling how to make money breeding squabs. Address

Plymouth Rock Squab Co., 634 HSt., Melrose Highlands, Mass.

### 21 Jewels

Nothing less than 21 Ruby and Sapphire Jewels is good enough for the Burlington masterpiece.

### Quality and Style

Adjusted to the second—temperature—isochronism—positions. 25 year Gold Strata Case, in 100 exquisite designs. Only \$1 down. Balance in small monthly payments. Send for free book.

### Burlington Watch Company

19th Street and Marshall Boulevard  
Dept. A-135 Chicago, Illinois







### GET THIS WONDERFUL RING

IF YOU CAN TELL IT FROM A GENUINE DIAMOND SEND IT BACK. These Amazingly Beautiful CORODITE Gems match the scintillating beauty of GENUINE DIAMONDS in every way. They have the same gorgeous blazing flash and dazzling play of living rainbow fire. Standing the terrific Acid Test of direct comparison. Life time experts need all their experience to see any difference. Prove this yourself.

Make this Test Wear a Genuine CORODITE and a Diamond side by side on the same finger. If you and your friends can tell the difference send it back, you won't be out a penny. That's fair enough. If you keep the ring, price printed here is all you pay. Remember CORODITE alone have the same facet cutting as Genuine Stones.

No. 1 Ladies Solitaire 14K Gold Filled Ring - \$2.84  
 No. 2 Ladies Pierced Filigree 4 Post Ring, Platinum effect - \$4.19  
 No. 3 Ladies Hand Carved Basket Ring, Platinum effect - \$3.96  
 No. 4 Ladies Bridal Blossom Engraved Solitaire - \$4.28  
 No. 5 Mens Heavy Belcher 14K Gold Filled Ring - \$3.54  
 No. 7 Mens Massive Hand Carved Hexagon Gyper - \$3.68

Carat Size Gems, Beautiful Hand Carved and Engraved, Mountings of most modern design bearing an unqualified 20 year guarantee. Art Leather, Silk and Velvet Lined Gift Case Free with each ring.

**SEND NO MONEY** Keep your money right at home. Just send name, address and number of ring wanted and size as shown by slip of paper fitting end to end around finger joint and your ring will come by return mail. Deposit amount shown above with postman. You do not risk a penny as our binding legal guarantee to refund your money in full is attached to every ring we sell. **SEND TODAY.**

**E. RICHWINE CO., Dept. 88** 19 West Jackson Blvd. CHICAGO, ILLINOIS  
 Sole Importers Genuine Corodite Gems



## Sell Shirts

Sell Madison "Better-Made" Shirts, Pajamas, and Nightshirts direct from our factory to wearer. Nationally advertised. Easy to sell. Exclusive patterns. Exceptional values. No experience or capital required. Large steady income assured. Entirely new proposition. **WRITE FOR FREE SAMPLES.**

MADISON SHIRT CO., 803 B'way, N. Y. City

## Send for FREE BOOK "FISHING-WHAT BAITS AND WHEN"

Every fisherman should have it. Interesting angling hints. Tells what baits to use for every kind of fishing. Postal gets it!

SOUTH BEND BAIT CO.  
 3560 High St., South Bend, Ind.



## Big Money for Spare Time Workers

This notice is written to interest the man who wants to earn some money and in return for very liberal pay would be willing to introduce to friends and neighbors the finest C. T. A. clothes selling for \$19.00, \$24.00, \$31.50, \$35.50 per suit. One man in each community can earn one of our best suits and in addition \$3 to \$12 for each order, besides extra cash bonuses, and many beautiful presents, including \$1000 in cash, Ford Sedan, Elgin Watch, Diamond Ring, etc. If you would like a fine suit and will be willing to show samples to at least a few men each week, send me your name and address and I will be glad to send you full details. C. A. Milligan, Manager.

Chicago Tailors Association, Dept. 588, S. C. Chicago

## WURLITZER

TRADE MARK REG. SUPREMACY IN MUSICAL INSTRUMENTS



## Try It In Your Own Home

You may now have any known musical instrument for a week's free trial in your own home. Play it as much as you wish. See how easy it is to learn. There is no obligation to buy—no expense for the trial. You may return the instrument at the end of a week if you decide not to keep it.

Wurlitzer instruments are known the world over for unusual tone quality and excellence of workmanship. They are used by the greatest musicians, bands, and orchestras.

### Easy Payments

If you decide to buy, the Wurlitzer plan makes it easy for you to own the instrument you want. Payments are conveniently arranged in small monthly sums—a few cents a day will pay.

Special combination offers on complete outfits—velvet lined case, all accessories, self-instructor, etc.—everything you need at practically the cost of the instrument alone.

### Send For Free Catalog

The greatest musical catalog ever published—over 5000 articles—every known instrument described and illustrated—many of them shown in full colors. Gives you lowest prices and all details of the Wurlitzer plan.

### Send This Coupon

The Rudolph Wurlitzer Co., Dept. A177  
 117 E. 4th St., Cincinnati 329 So. Wabash Ave., Chicago  
 120 W. 42nd St., New York 250 Stockton St., San Francisco

Send me, absolutely free, your new illustrated catalog of musical instruments. Also tell me how I may try any instrument in my own home at your expense, and how the Wurlitzer plan makes it easy for me to buy. No obligation.

Name .....

Address .....

City.....State.....

Instrument .....

(State instrument in which you are interested.)





# DELTA ELECTRIC BICYCLE LAMP

## The Eagle Eye That Spots Danger

Equip your Bicycle with a Delta Electric Bicycle Lamp and you can ride the roads at night picking the bad spots with daylight clearness. There's always radiant brightness on the road ahead — and red spot in the rear as warning to approaching motorists.

There's nothing to rattle, work loose or wear out. It does stand the gaff; outlives the bike, over a million users will substantiate this claim. And it's legal everywhere. Uses ordinary dry battery. Fits any bicycle instantly—under axle nut front left side.

Put America's Best Known and Most Popular Light on your Bike. Ask your dealer or sent prepaid, complete for \$2.25 (less battery).

### DELTA ELECTRIC COMPANY

Factory and General Offices: 100 Delta Block, Marion, Ind.

*Standard Makers of Bicycle Lamps, Auto Spotlights, Motorcycle Spotlights, Electric Lanterns, Radio Head-Phones, Flashlights and Flashlight Batteries.*

<b>NEW YORK</b> Export Dept. 30 Water St.	<b>SAN FRANCISCO</b> Sanford Bros. 311 Minna St.	<b>WINNIPEG</b> Bissett & Webb, Ltd. 126 Lombard St.
---	--	--



## Free from Punctures

No danger of getting a puncture just when you need your wheel the most. Make your tires leak-proof and avoid all trouble and delay from porous condition of the tires.

Simply inject Neverleak Tire Fluid into each tire and you can say good-bye to punctures. Ride all season without any trouble.

Look for the yellow, green and white tube.  
Price 25c. at all bicycle and repair shops.

Buffalo Specialty Company, Buffalo, N. Y.

# NEVERLEAK TIRE FLUID

"HEALS PUNCTURES ON THE RUN."

## Factory to Rider

Saves \$10 to \$25 on the Ranger Bicycle you select. You can have your choice of 44 Styles, colors and sizes. Delivered free on approval, express prepaid, for 30 DAYS' FREE TRIAL. Bicycles, \$21.50 up. \$5 a Month if desired. Possession and use at once. Parents often advance first payment.

Tires, lamps, wheels and equipment, low prices. Send No Money, do business direct with makers.

### MEAD CYCLE COMPANY

DEPT. P. CHICAGO 108

Write today for free Ranger Catalogue, factory prices and marvellous easy payment terms.



## MOTORCYCLES



RELIABLE STANDARD MAKES that you can DEPEND on. Enjoy the glorious experience of going wherever you like—when ever you like. The price is within your means—35% less than others. These machines are slightly used, thoroughly overhauled or rebuilt. Send for catalogue.

MYEROW BROS.,  
15 Berkeley St. Boston, Mass.

## MOTORCYCLE BARGAINS

Save 25% to 65%

on Slightly used and Rebuilt Motorcycles, Side Cars, Johnson Motor Wheels, Evans Power Cycles, Bicycles. Send for Free Bargain Bulletin and Money Saving Message, listing hundreds of bargains in used, rebuilt and new machines, supplies, accessories, etc.

AMERICAN MOTOR CYCLE CO.  
Dept. 627, 2047 W. Chicago Avenue, CHICAGO



## ENINGER WILL TRUST YOU

SEND 10c INSTAMPS FOR CATALOGUES  
BIG MONEY SAVING FOR YOU

Used and rebuilt motorcycles \$25 to \$100.  
used bicycles \$9.50, tricycles \$20.  
All machines fully guaranteed.  
New bicycles and motorcycles  
at factory prices, save dealers' profits. Motorcycle and automobile tires \$3. Complete line frames, engines, supplies.

ENINGER PRICE CUTTER, ROCHESTER, N. Y.

### PAY AS YOU RIDE





# FORDS-34 Miles

on Gallon of Gasoline  
with Air Friction Carburetor



We guarantee all other cars nearly double present mileage, power and flexibility, make hills on high formerly difficult on low. Models for any car, marine or stationary engine. Makes old cars better than new. See wonderful mileage guarantees for other cars.

Ford.....34 ml.	Reo.....24 ml.	Chevrolet.....32 ml.
Buick 4.....30 ml.	Chalmers.....23 ml.	Maxwell(25).....30 ml.
Buick 6.....24 ml.	Olds 6.....23 ml.	Nash 6.....23 ml.
Hudson.....20 ml.	Paige 6.....20 ml.	Lincoln 8.....17 ml.
Hupp.....25 ml.	Oakland 6.....24 ml.	Stdbkr Lt. 6.....23 ml.
Dodge.....28 ml.	Overland 4.....32 ml.	Cole 8.....17 ml.

If your car is not mentioned here send name and model for particulars and our guarantee on it. AGENTS WANTED.

**SENT ON 30 DAY'S FREE TRIAL**

You can drive any car in heaviest traffic without shifting gears. Starts off on high in any weather without priming or heating—no jerking or choking. No more foul spark plugs or carbon in cylinders. No leaking of gas into crank case. Try it 30 days on our guarantee of money back if not entirely satisfied. No strings to our guarantee. YOU ARE THE JUDGE. Anyone who can handle a wrench can attach it. No boring of new holes or changing of operating mechanism. Write today.

AIR-FRICTION CARBURETOR CO.

950 Raymond Bldg.

Dayton, Ohio, U. S. A.

## WHOLESALE PRICES

SEND FOR OUR BIG FREE BARGAIN BOOK of the best Auto Supplies made! You'd be surprised if you knew our sources and names of manufacturers.

**EVERYTHING**

Special made Bodies—Tires—Tubes—Batteries—Spotlights—Bumpers—Tools, etc. This book exactly illustrates in colors thousands of bargains—whatever you need or want in Equipment.

Every article backed by our Legal Binding Guarantee of absolute satisfaction. Thousands of pleased customers everywhere. Get on the inside of this Price-Saving business. Postal card or letter brings this book—FREE! Be sure to ask for Book Special P.

NEW YORK AUTO & RADIO SUPPLY CO.

Washington at Peoria Street

Chicago, Illinois



**BODIES**  
\$20.95 AND UP

## AUTO SUPPLIES

Drive This Beautiful Raceabout  
Instead of Your OLD FORD



Choice of Four Colors; Fiat or the Bullet Nose Radiator Shell. Send for 1924 Free Catalog of New Auto Accessories, Bodies and

Speed Equipment. Direct from Factory.

AMERICAN TOP AND BODY CO., Park Ave. DELPHI, IND.

Drive 100 Tacks and Save \$25

on your next Top or Seat re-covering. Fords \$5.20 to \$10. Chevrolets \$7.00 to \$15. All other cars \$9.50 to \$22. Our Plate Glass Lights enhance the value of your car. Side Curtains \$6.25 up. Seat Covers \$2.50 to \$32. Quality and fit the best. Our instructions make it easy to apply. Send for samples. Our prices include delivery at your door. Eastern orders shipped from Ohio.

Auto Equipment Co., 1117 So. Main St., Los Angeles, Cal'f.

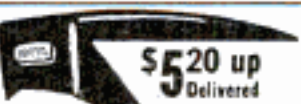

## SHAW MOTOR ATTACHMENT MAKES YOUR BIKE A MOTORCYCLE!

A high grade 2 1/2 H. P. motor attachment quickly clamped on any bike frame. Speed 4 to 40 miles an hour. 90 to 125 miles per gallon of gas.

Special Low Price Now! Write today for Complete Description and Special Low Prices on SHAW Motor Attachments and the SHAW Complete Motorcycle. SHAW MANUFACTURING COMPANY Dept. 37



**10¢** brings you an  
up-to-date  
**Auto Map**

HERE'S an unusual opportunity! By special arrangement with Rand McNally, we can send you, for a limited period only, any one, or all, of their series of Official Auto Trail Maps, covering every state in the country for only 10c apiece. Absolutely up-to-the-minute maps—give trail signs, hotels, garages, service stations and much other valuable touring information. In ordering, please be sure to tell the section of country you want to cover and give us address of shop or dealer where you go to have your brakes relined. Order now as this offer is limited.

## MULTIBESTOS THE BRAKE LINING with the Interlocking Weave



THIS is the famous brake lining that lasts so long. The lining that is specified as factory equipment by a majority of American car manufacturers. And the lining that will give you the feeling of absolute security that your brakes will work whenever you need them.

MULTIBESTOS COMPANY  
Dept. P 6, Walpole, Mass., U. S. A.





## Makes Camp Cooking a Pleasure

Have good "eats" of all kinds, anytime, anywhere you go! The COLEMAN Camp Stove bakes, boils, roasts; fries, broils, toasts. Gives quick action! The only camp stove with all these exclusive COLEMAN features: Built-in Oven; Built-in Wind Baffle; Swinging Fuel Tank always connected; Built-in Pressure Tank and Funnel; Quick Hot-Blast Starter that gives full cooking heat in 2 minutes; Warming Cabinet that keeps food hot and heats your tent on chilly days. Fuel is common motor gasoline. Stove folds up like a suit-case.

The COLEMAN Camp Stove is sold by Hardware, Auto Accessory and Sporting Goods Dealers. Write for Descriptive Literature and name of dealer near you who sells the COLEMAN. Address Camping Dept. PM-14.

THE COLEMAN LAMP COMPANY, Wichita, Kansas  
Philadelphia Chicago Los Angeles Toronto, Canada

# (14) Coleman Camp Stove

## You and This New Machine Can Earn \$500 a Month



Operate a Tire Repair Shop  
70,000,000 Tires in use. America's greatest opportunity for men with small capital. We furnish everything—\$100 and up. Easy payments. We train you FREE right at home. Start making money at once. Write today for Free Book of Opportunity.

Haywood Tire Equipment Co. 1314 S. Oakley, Chicago

## Do Your PRINTING



Cards, circulars, labels, tags, book, menus, paper, Press, \$12. Larger \$35. Job Press \$150 up. Save money. Print for others. BIG PROFITS. All easy, rules sent. Write factory TODAY for press catalog, TYPE, cards, paper. THE PRESS CO. D-37, MERIDEN, CONN.

**RE-MANUFACTURE FORDS**  
Start a FORD Service Station  
The MOST PROFITABLE BUSINESS ON EARTH

FORDS REMANUFACTURED BY THE FACTORY PROCESS

SQUARE DEAL GARAGE



**\$14,355.00 Profit on 300 Jobs**

Facts and figures from hundreds of KRW Equipt Shop Records.

**9,000,000 Fords Need Repairs**

Are you getting your share of that business?

**\$850 Completely equips your shop to RE-MANUFACTURE Fords**

We can furnish entire equipment for cash or on easy payment plan. Ford Motor Co. recommend these tools. Catalog. K.R. WILSON, 12 Lock St., Buffalo, N. Y.

# Roofing Book FREE



World's

## Best Roofing at Factory Price

Don't buy Roofing of any kind until you get our big Free Roofing Book, describing full line of Edwards Famous "Tightcote" Galvanized Roofings, Sidings and Ceilings, and our lowest factory prices. Then see for yourself how much we save you by selling direct and saving you all in-between Dealers' profits.

## EDWARDS "REO" Metal Shingles

Absolutely rust proof. By our patented "Tightcote" process, edges as well as sides of metal sheets are heavily coated with zinc—not a space the size of a pin point exposed to weather. Fire and lightning proof. Outlasts three ordinary roofs. Forever wind and weather proof. Need no repairs—end all roofing expense. Patent INTERLOCKING DEVICE makes water tight seams—all nail heads covered—no chance for rust or leaks.

### EDWARDS Galvanizing Test

Edwards "Tightcote" Galvanized Roofing can be bent, twisted or struck by lightning, and the galvanizing will not crack or flake. Bend it or hammer it—you can't loosen or scale the galvanizing. No other galvanized roofing can withstand this test.

### Low Priced Garages



Wide variety of styles, all sizes of Portable Fireproof Metal Garages. Lowest prices ever made. Postal brings Big Garage Catalog free.

Write Today for free samples and proof that we can save you a lot of money on any kind of roofing siding or ceiling you may need. Ask for Roofing Book No. 150.

THE EDWARDS MFG. CO.,  
600-650 Pike St., Cincinnati, O.

**FREE**  
Samples &  
Roofing Book

## Steady Work

in a fast growing business with Vanderpool Latest Improved Vulcanizer. Made in America.

Ask for Catalog

Vanderpool Co., Dept. 6P, Springfield, Ohio

F. H. DIBB, Agent for British Isles  
26 Fairfield Rd. Winchester, England



## Catch Fish

Eels, Mink, Muskrats and other animals in large numbers SURE — with our new folding, galvanized Steel Wire Traps. They catch them like a fly trap catches flies. Write

for our FREE TRAP offer, bargain catalog of Fishermen's Supplies and booklet on best lure known for catching all kinds of fish. Agents Wanted. WALTON SUPPLY CO., Dept. 61, ST. LOUIS, MO.

# Reline Your Ford Transmission in a Jiffy



The QUIKON provides an easy method for relining your FORD transmission. Made in one piece, it can be readily installed without removing the transmission cover or self-starter.

### Anyone Can Install the QUIKON

No previous experience is necessary. Mechanical changes or additional accessories are not required. It is built to fit the FORD. Ask your garageman for the QUIKON—if not in stock, order from us. Price \$3.50. Send for circular.

Harrison Auto Products Corp'n  
820 Hamilton Street, Harrison, N. J.

**Quikon TRANSMISSION LINING for Fords**  
ONE PIECE



# "Old Town Canoes"



Lazin'  
down a lazy stream

A SUMMER afternoon—the fresh clean smell of the woods—and a stream shining like a polished mirror. It's a perfect "Old Town" day.

"Old Town Canoes" are so light and easy to handle. They are low in price too. \$64 up. From dealer or factory.

The new 1924 catalog is beautifully illustrated. It shows all models in full colors. Write for your free copy to-day.

OLD TOWN CANOE CO.  
1466 Middle Street, Old Town, Maine, U. S. A.

## DRESS UP \$3.85 YOUR CAR AND UP

A seedy looking top spoils CUSTOM MADE its appearance. Get a Liberty Custom Made Top. It's fun putting it on; simple directions furnished. Save a big labor bill. We are manufacturers of tops, side curtains and seat covers, for any make or model car. Amazing values. Special proposition for Fords, Chevrollets, Dodges and Maxwells. Write today for big money saving catalog.

Liberty Top & Tire Co., Dept. E-7, Cincinnati, Ohio

## "THE BROADWAY"

The K-37 is the classiest sport body for Fords in America. Built of 20 Gauge Lead-Coated Steel, upholstered in very high grade black or Spanish brown material. Spring Cushions.



Stylish one-man top with side curtains. Door on right side of body with inside nickel lever. 12-gallon gas tank. Adjustable plate glass windshield. Send for Descriptive Circular and Price List.

Champion Racingbody Co., Dept. P.M., 7-9 E. 28th St., Chicago, Ill.

## Write For Book About the Elto

3 H.P.—The Fastest "Light Twin"

Designed and built by Ole Evinrude  
Weighs less than 17 lbs. per H. P.

Gives half more power, much more speed, yet easy to carry. Instant starting without spinning. Safe rudder steering. Trouble-proof carburetor. Push button reverse, without danger of tipping boat. The ideal family motor. Fits carrying case without taking apart. Write for catalog.

ELTO OUTBOARD MOTOR COMPANY  
Manufacturers' Home Bldg.,  
Dept. AA, Milwaukee, Wis.



1/2  
More  
Power—  
Much  
More  
Speed



## AGENTS AND SPECIALTY SALESMEN

9 CALLS—7 SALES  
MY AVERAGE

Profit  
\$15.00

80,000,000  
SPARK PLUGS  
WILL BE SOLD  
THIS YEAR.



Marvelous new Spark Plug invention. By the "Visible Flash" you see which cylinders are firing.

## BEACON-LITE SPARK PLUGS

You see them fire  
Each explosion is reflected  
in the Beacon-Lite

## THEY SELL FAST

J. Huebner, Pa.—"Rush 30 dozen Beacon-Lite Plugs. My average, seven sales out of nine calls."

R. W. Phillips, Ont.—"I sold 2 dozen today, 3 dozen yesterday. Rush 10 dozen."

Write Today—Department P

CENTRAL PETROLEUM CO.  
CLEVELAND, OHIO

## A LIFE-SAVER FOR AUTOMOBILISTS

Small-Compact  
Post-  
paid \$2.50

No more stalling on the road miles from the nearest garage. If your gasoline gives out on the road, simply hail the first car passing and with this wonderful Gas Siphon Gun secure enough gasoline to proceed. Also indispensable for hauling out water in boats. Nothing like it ever known before. Big money for agents.

AGENTS!  
Write TODAY  
For Territory

THE HANDY SPECIALTY CO.  
79 Walnut Street  
Somerville, Mass.

## 5-Room \$548 ALADDIN

We Pay the Freight



You can buy all the materials for a complete home direct from the manufacturer and save four profits on the lumber, millwork, hardware and labor.

## 4-Room \$414 ALADDIN



Here's your opportunity to avoid high apartment rentals. Build this home yourself. Two men can build it in a week. Our instructions explain every step. Five plans shown in Aladdin catalog.

Price includes all lumber cut to fit; highest grade interior wood-work, siding, flooring, windows, doors, glass, paints, hardware, nails, lath, roofing, with complete instructions and drawings. Freight paid to your station. Permanent Homes—NOT PORTABLE. Many styles to choose from. Write nearest mill today for FREE Money-Saving Aladdin Catalog No. 951.

The ALADDIN Co., BAY CITY, MICHIGAN  
Wilmington, North Carolina; Portland, Ore.; Toronto, Ont.



# Guaranteed HEATING Systems



**Save 25% on Your Heating System by Ordering Now!**

If you're going to build, improve, or remodel, buy now while material is plentiful and low prices prevail. Avoid costly delays, material shortages and high prices. Don't wait until the snow flies to do your planning.



**Expert Engineers**

Practical men are waiting here to help you solve your plumbing and heating problems. They will aid you in adding comfort and health in your home at lowest possible expense.



**See What You Save!**

Some idea of our low prices can be had on the following guaranteed efficient heating systems for an average sized bungalow with five rooms and bath.

**\$93      \$125      \$315**

Single register warm air heating system. Warm air pipe heating system. Perfection Hot Water Heating System.

Perfectus Heating Systems are furnished complete to the last fitting with square or round boilers as wanted.

**Plumbing Systems**

We furnish every needed item to completely install guaranteed plumbing systems. The bathroom outfit shown includes bathtub five feet long, white porcelain enameled on the inside, low pattern white tank closet outfit and white porcelain enameled lavatory complete with all fittings shown. \$70.00. Foot line, special at...



**A LINE FROM YOU WILL BRING FULL DETAILS**

**HARRIS BROTHERS CO.**  
Dept. WC-7  
35th and Iron Streets  
CHICAGO, ILL.



**ROLL YOUR OWN CIGARETTES**

Put tobacco in this nickel plated case—curved to fit pocket—close lid—out comes tailor made cigarette. Biggest hit in years. \$1.25. Watch, Knife, Chain, American seven jewel movement—this model nickel case—guaranteed time keeper. 3 pieces only \$2.75. Booklet free. Pitts Novelty Sales Co., 561 N. Washington St., Chicago



**STUDEBAKER The Insured Watch**

The balance in easy monthly payments. The famous Studenbaker 21 Jewel Watch—Insured for a lifetime; 8 adjustments, including heat, cold, isochronism and 6 positions—choice of 64 new Art Beauty Cases. Direct from the maker at lowest prices.

**Fine Chain FREE!**

**BIG SPECIAL OFFER.** Beautiful Watch Chain FREE with every watch. Limited! Write at once—while offer lasts.

Studenbaker Watch Co., Dept. 226 South Bend, Indiana

**WRITE**

Send today for wonderful Studenbaker Book of Advance Watch Styles and our \$1.00 Down Offer—FREE!

## DEAFNESS IS MISERY



I know because I was Deaf and had Head Noises for over 30 years. My invisible Antiseptic Ear Drums restored my hearing and stopped Head Noises, and will do it for you. They are Tiny Megaphones. Cannot be seen when worn. Effective when Deafness is caused by Catarrh or by Perforated, Partially or Wholly Destroyed Natural Drums. Easy to put in, easy to take out. Are "Unseen comforts." Inexpensive. Write for Booklet and my sworn statement of how I recovered my hearing.

A. O. LEONARD, Suite 226, 70 5th Avenue, New York City

## Are You Old at 40?



A very common cause of early old age is the disturbed condition of an important gland. Even big, strong men are not exempt from this serious irregularity. Our plainly written, interesting, educational

**FREE BOOK**

"Why Many Men Are Old at 40"

may bring a priceless message to you. It tells of a sensible way

by which thousands have relieved this prostate gland condition. It tells how sciatica, backaches, foot pains, interrupted sleep, mental depression, etc., are so often due to this gland. Sold for over five years upon a money-back-if-not-satisfied plan. Do not confuse it with massage, medication, violet rays, etc. No obligation. Write today.

**The Electro Thermal Co.**



2134 Main St.  
Steubenville  
Ohio



## Summer Home in Maine

A gentleman's estate of 175 acres on the Maine coast, with frontage on a lake 9 miles long; master's house; large bungalow; caretaker's house; large garage; barns; private electric light and inexhaustible water works, and every modern improvement. Forty acres very large trees. Golf and yacht clubs only a few minutes away; good markets in the town.

The scenery of mountains, lake and ocean is pronounced one of the best five in New England. House and bungalow both completely furnished; steam heat.

*Place will be sold at a great bargain as owner can no longer use it.*

**Address OWNER**  
206 East Ontario Street CHICAGO, ILL.



# 1¢ Sale

## Famous Radiex Phonograph Records

Only 69c for  
1st Record, Next  
Record Only 1c

**SEND NO MONEY**

Choose any six or more records from list below. Average cost only 35c each. Have you ever heard of brand-new, double face, 10-inch records, all the very latest hits, being sold at this amazing low price? Radiex Records play beautifully on any phonograph. Send postcard or letter giving catalog numbers of any six or more records you want. Send no money. Simply pay the postman 25 cents per record and postage, when he delivers the records. Try the records 10 days and if you find them in any way inferior to 75c or \$1.00 records return them and get your money back. But act quickly before this great advertising offer is withdrawn.

RADIEX CLUB Office PM 86 596 Columbia Road Boston, Mass.  
ORDER FROM THIS LIST—10 DAYS' TRIAL

STANDARD	POPULAR SONGS	POPULAR DANCES
Humoresque Souvenir (Violin Solo) 4015	Dream Daddy 2137 Sunshine of Virginia Smile Will Go Long	Linger Awhile Mamma 1198 Dream Daddy
When You & I Were Young Maggie 4011	Long Way 2138	Bit by Bit 1195
My Old Kentucky Home (Song)	It's A Man Every Time Mr. Radio Man	I Love You Somebody's Wrong
Kathleen Mavournees Come Back to Erin 4012	The One I Love 2142 California Here I Come	Rittin' in a Corner Fun Kist Rose 1186
Madley of Old Time Songs, No. 1 4010	So I Took the \$50,000 2141	Last Night on the Back Porch 1185
Madley of Old Time Songs, No. 2 (Vocal Quartette)	Linger Awhile 2135	Sittin' Pretty in a Pretty City
Annie Laurie Bally in Our Alley 4017	If the Best of the World Don't Want You Eatin' In A Corner	Irish Jigs and Reels, No. 1 4016
Washington Post Our Director 4022	You Didn't Want Me Last Night on the Back Porch 2126	Irish Jigs and Reels, No. 2 Scottish Sharpie Selections 7001
	Every Night I Cry	Scottish Sharpie Selections Scottish Regimental Marches

## A fine watch FREE!

or Beautiful Pearl Necklace or  
First-class Radio Set

Anyone—boy or girl, man or woman—can have any of these guaranteed articles. Only a few hours of your spare time required. Anyone can do it. Write immediately for full information and illustrated catalog. No money required.

THE CHARLES E. HIRES CO.  
222 S. 24th Street, Philadelphia, Pa.



## On with the Dance— Here's Real Music!

Why run out to a cabaret every time you want to dance? There's many an evening's fun right at home—provided there's good music. And there's always good music where there's a Hohner Harmonica—

## The World's Best

If you want to be a popular host, be ready with your Hohner at impromptu parties, after dinner dances and social gatherings. Produce your pocket orchestra, announce a good fox trot or one step, and surprise your guests with some real snappy harmony.

Get a Hohner Harmonica today and play it tonight. 50c up at all dealers. Ask for the Free Instruction Book. If your dealer is out of copies, write M. Hohner, Inc., Dept. 181, New York City.

# HOHNER HARMONICAS

## AGENTS WE START YOU WITHOUT A DOLLAR

Famous Carnation Products—Creams, Soaps, Extracts, Perfumes, Toilet Goods, Household necessities. Widely known line; 200 items, 100% profit, repeat orders enormous. We give agents big concessions. Experience unnecessary. Write today. Carnation Co., 144 St. Louis, Mo.

## Walk Away from "Em" All in a Kennebec Outboard

ONLY a speed boat can catch you!  
Exclusive Kennebec design gives  
the utmost speed consistent with safety.

Equipped with Sponsons is absolutely non-sinkable, even with motor attached, and perfectly safe in very rough water. Ideal for trolling, perfectly balanced. Light, steady, rugged and low priced. The only canoe guaranteed 5 years.

Send for Free Catalog

with 15 latest 1924 models of canoes and row-boats at special prices. Ask for dealer's name.

Kennebec Boat & Canoe Co.  
Dept. M53, Waterville, Me.



Without Sponsons  
\$86.00 and up.  
With Sponsons  
\$108.00 and up.

# \$86<sup>00</sup> and up

# KENNEBEC CANOES



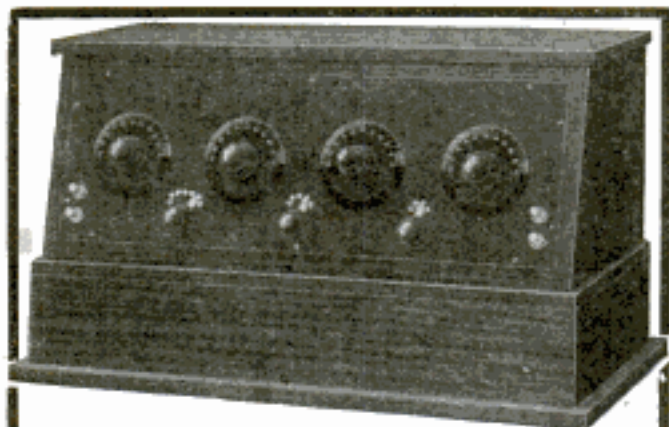

## MAKE MONEY—SELL RADIO!

Radio offers the biggest money-making opportunity on earth today. And the *Ozarka Plan* opens the door to this big opportunity. Look at the picture of this beautiful Radio Receiver. This picture was made from an actual photograph. By the *Ozarka Plan* that Radio Instrument can be the product of your own making—easily, simply and surely. It will be yours to make, to sell and to reap a rich reward in cash profits.

No experience necessary. You need not have much cash. All you need is spare time, determination and action. If you're that kind of a chap, the *Ozarka Plan* will start you on a straight line toward a real money-making business of your own. It can be as big and as profitable as you are ambitious to make it. We want good men in every county. Exclusive territory is going fast. Be sure and give us the name of your county. Write today for the *Ozarka Plan*. A wonderfully interesting book, of facts, particulars and proofs. It is FREE. Act now.

**OZARKA, INC.**

851 Washington Blvd.

CHICAGO



"Been on a vacation Bill?"

"No, Jim — I've stopped smoking.

Gained six pounds in a week. You know how I used to smoke—a package of cigarettes and a cigar or two a day—it sure had some hold on me. But I'm cured—

took a scientific home tobacco treatment—fixed me up in two weeks.

"Wasn't hard on me at all—noticed improvement the first day—I feel like a new man. It didn't interfere with my work—didn't leave any druggish after-effects—the money I saved in the last two weeks has paid for the treatment alone.

"Why don't you take it! It has cured men like you and me for over forty years—it is a doctor's individual prescription that sure fixes you up. Just send the coupon for full information NOW. No obligation. All correspondence is strictly confidential."



A Doctor's Prescription

The Keeley Institute, Dwight, Ill.

Please send me, without any obligation on my part, your free booklet which will tell me how to rid myself of the tobacco habit.

Name.....

Town.....

Street..... State..... P.M.-6

## Make \$2.50 an Hour

YOUR PROFITS IN ADVANCE

STAY-PREST TROUSER PRESSER sells quick—everywhere. Thousands in use. Salesmen and saleswomen cleaning up. Sells on eight-minute demonstration. Reasonable price. 40% clear profit for you. You take orders. We deliver.



### Wonderful New Invention

Puts perfect crease in trousers. Takes out wrinkles and baggy knees. Easy to use—takes less than a minute. Folds into small size. Finely finished. Looks rich. Saves clothes and tailor bills. Every man wants one or two.

### Make Big Profits—Others Do

Jack Ames made \$24.00 in four hours. Randle sold twenty-five the first day. Mary Roberts made \$10.00 in one evening. Others making good in full or spare time. So can you.

Four Patents

FREE

Write us quick for free sample offer and full details.

The Getgey-Jung Co., Dept. 216 G. & J. Bldg. Cincinnati, O.

## AGENTS WANTED!

Salesmen — Distributors

to use and introduce attachment that makes Fords run on 94% air. THERMOSTAT on exhaust automatically turns down needle valve as engine warms, exactly as Ford Manual says do by hand.



### BLANCHE AUTO THERMO

An Automatic Carburetor Control

Makes Fords start easier winter or summer—saves half gas and oil—cuts repair bills one-half—reduces carbon formation one-half. Sells on sight to every Ford owner as easily as giving him a \$100.00 bill, because it saves \$100.00 every 10,000 miles. CADILLAC NOW USES AS STANDARD EQUIPMENT THERMOSTATIC CARBURETOR CONTROL UNDER BLANCHE LICENSE. You can make Big Money selling this wonderful proven device. Experience not necessary. Blanche plan will start you without capital in a business of your own that makes you from \$250 to \$2500 a month profit. Write for free circulars Now!

A. C. BLANCHE & CO. Dept. 164, 602 W. Lake Street CHICAGO, ILLINOIS

## LYON BODIES

Send For Our 1924 BOOK OF BARGAINS



Containing a full line of bodies and accessories at exceptionally low prices. Buy direct from the factory.

\$27.50 AND UP

AUTO TIRE SALES CO.

Body Division Dept. P21

1346 S. Michigan Ave., Chicago

## SEND NO MONEY

For this beautiful, self-filling Fountain

Pen, with 14 Karat gold pen point

—including your name engraved free on barrel in gold letters.

Formerly sold for \$3, now offered at the introductory price of \$1.75

including engraving of your name. Pay postman \$1.75 and postage on arrival, or send payment now with order and get pen postage prepaid. Money back if not satisfied.

B. I. BRITMOR CO., 286-5th Avenue, NEW YORK

## \$3 Cash Buys Typewriter



Balance Only \$5 Monthly

Save 35 to 60% on all standard makes—Underwood, Royal, Remington, etc. Every machine thoroughly rebuilt and GUARANTEED. Try five days at our expense before you buy.

WRITE at once for Free Descriptive Circular and Special Low Prices.

WYNN TYPEWRITER EXCHANGE 13 Reliance Bldg. Kansas City, Mo.

5 DAYS FREE TRIAL



## Amazing New Invention! Cook, Bake without Coal or Wood

Place a Simplex kerosene burner in your coal or wood stove and solve your heating or cooking problems. Just turn a valve and get even, steady heat instantly. No ashes, no dirt, no smoke, no wood or coal to carry, no fires to start and feed, no waste of fuel. Cooks and bakes better than the old way.

Don't sweater over a red hot stove this summer. Installed without damage to stove; a child can do it; simply set in fire box; no wicks, no smoke, no odor.

### THE CHEAPEST and CLEANEST FUEL

Kerosene (coal oil) is cheapest in the long run because it can be turned on and off instantly, without waste, and is much more satisfactory than coal or wood. A hot, quick heat in the winter, a small amount of heat easily shut off in summer.

We guarantee this wonderful new invention in every way and prove all that we say with a **TEN DAY TRIAL**.

Full particulars will be given immediately. Address



### We Want User Agent

To one person in each neighborhood, we will sell the Simplex Burner at the lowest wholesale price, and will pay liberally for part time or steady work. \$1.00 to \$3.00 per hour can easily be made in evenings and spare time.

**SIMPLEX UTILITIES MFG. CO.,** 610 Simplex Bldg., Chicago  
1428 N. Wells St., Chicago



LIST  
PRICE  
\$200

BIG  
Commissions  
to  
YOU

### Combine Business With Pleasure!

Buy a CLEVELAND Motorcycle. Enjoy yourself during your leisure hours. Use it to land from work. Become a Rider Agent for us, if your territory is open. Earn big commissions on sales to others. Write for folder and Rider Agent Plan.

**CLEVELAND MOTORCYCLE MFG. CO.**  
7213 Platt Ave. Cleveland, U. S. A.



**Catch Fish,** Eels, Mink, Muskrats and many other fur-bearing animals, in large numbers, with my New, Folding, Galvanized Wire Mesh Traps. They catch them like a fly-trap catches flies. Made in all sizes. Strong and durable. Write today for Price List, and my Special **FREE** Offer on best baits known for attracting fish and animals.  
**J. F. GREGORY, Dept. 102, Lebanon, Mo., U.S.A.**



### RAISE BELGIAN HARES

New Zealand Reds - Flemish Giants - American Blues  
**FOR US - BIG PROFITS - WE SUPPLY STOCK AND PAY \$2 TO \$8 EACH.** Also other fur bearing animals easily raised anywhere. Large Catalog and Contract **FREE!** Big Illustrated Rabbit Book and copy of our large small stock magazine 10c.  
**OUTDOOR ENTERPRISE CO., 1005 O. E. Bldg., Kansas City, Mo.**

**Good Cash Commissions** for selling the novel Expo WATCH CAMERA among your friends. Sells on sight. Takes sharp, clear photos yet is so small you can hide it in the palm of your hand. Low price. Local and state agent territory available. Write at once.  
**Expo Camera Co., 25 E. 13 St., N. Y. City.**

## How Did Your Garters Look This Morning?

To wait until you must have a pair of "Bostons" is to court danger. To feel well dressed always your garters must be fresh.



**GEORGE FROST COMPANY, BOSTON**  
MAKERS OF VELVET GRIP HOSE SUPPORTERS  
FOR ALL THE FAMILY.

## Sell Caps!!

You'll make more money selling



### TAYLOR MADE-TO-MEASURE CAPS

Call at offices, factories, golf links and garages. Every man a live prospect. "9 out of 10 men will order."

Your customer selects style and fabric—the cap is tailored to his individual measurements. Moderate price to him—good commission paid to you in advance. Write for Sample Outfit and **FREE** Cap offer today. Act quick!

**TAYLOR CAP MANUFACTURERS**  
Dept. PM CINCINNATI, OHIO



**RACING BODIES for FORDS at \$34.50**

Send today for free particulars. Our book **"HOW TO BUILD A FORD RACER"** sent anywhere on receipt of 25 cents—cash or stamp.

**CENTRAL AUTO SUPPLY CO., Dept. 120A, LOUISVILLE, KY.**

## Sells for \$1.25 — Agent's Sample 65c!

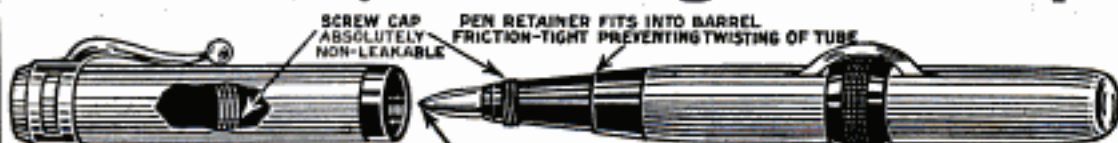

**ITS THE POINT. HAS EIGHT GROOVES FOR INK TO FEED**

Imported from Japan. "It makes Carbon Copies." Guaranteed for One Year. Hustlers make \$20.00 Daily! Money refunded if you don't think it the best pen you ever wrote with. Just Out! Comes in beautiful brown, trimmed in black. Send for quantity price list and distributing plans.  
**F. SPORS & COMPANY, 335 Main Street, LESUEUR CENTER, MINNESOTA**

**New Self-Filling Bamboo Fountain Pen with Stylo Point**



# PATENT TRADE MARKS PROTECT

ANY NEW article, machine, design or improvement thereof, or any combination of parts or improvements in any known article which increases its efficiency or usefulness, **may be patented**, if it involves invention.

## IF YOU HAVE ANY NEW IDEAS

which you feel are useful, practical and novel, **take prompt action to protect your rights**. If you have invented any new machine, or new combination of parts or improvement, or any new design or process, **SEND DRAWING, MODEL OR DESCRIPTION** of it for information as to procedure to secure protection.



DRAFTING and SPECIFICATION ROOM of CLARENCE A. O'BRIEN, Registered Patent Attorney, Washington, D.C.

**All Communications** are held in strict confidence. My personal, careful and thorough attention is given to each case. I offer you efficient, reliable and prompt service—based upon practical experience. **Highest references.**

**NO CHARGE FOR ABOVE INFORMATION**

# Clarence A. O'Brien

REGISTERED PATENT ATTORNEY

Member of } Court of Appeals, District of Columbia, United States Court of Claims;  
Bar of } Supreme Court of United States, Supreme Court, District of Columbia

**Practice Confined to Patents, Trade Marks and Copyrights**



# NTS

## COPYRIGHTS YOUR IDEAS

WRITE TODAY FOR FREE BOOK,

### "How to Obtain a Patent"

This book will give you valuable information, and it may save you much time and effort. Send for it, NOW. My practice is devoted exclusively to United States and Foreign Patents and Trade Marks. Write me freely, frankly and with full confidence; it is very probable that I can help you.



United States Patent Office as Viewed from My Office, Directly ACROSS THE STREET

### WRITE TODAY FOR BLANK FORM "RECORD OF INVENTION"

USE THE COUPON attached, and immediately upon its receipt I shall send you this form to be returned to me with drawing, description or model of your idea; promptly upon receiving your idea I shall write you as to procedure and costs.

CLARENCE A. O'BRIEN, Patent Attorney, 703 Security Savings & Com'l Bank Bldg.  
Directly Across Street from Patent Office WASHINGTON, D. C.

Please send me your free booklet, "How to Obtain a Patent," and blank form, "Record of Invention," without any obligation on my part.

**FREE  
COUPON**

Name .....

Address .....

IMPORTANT: Write or print name clearly.





# PATENTS



## OUR OFFER:

No Charge for Examination and Instructions  
**HAVE YOU AN IDEA?**  
*Your First Step* before disclosing an invention, the inventor should write for our blank form,

### "RECORD OF INVENTION"

This should be signed and witnessed and returned to us together with model or sketch and description of the invention for examination and instruction and to establish Evidence of Conception. *No charge for the above information.*

## Our Three Books Mailed Free to Inventors

Our Illustrated Guide **BOOK**

### HOW TO OBTAIN A PATENT

Contains full instructions regarding U. S. Patents. Our Methods, Terms, and 100 Mechanical Movements illustrated and described. Articles on Assignment or SALE OF PATENTS, Patent Practice and Procedure, and Law Points for inventors.

### OUR TRADE MARK BOOK

Shows the value and necessity of Trade-Mark Protection and gives information regarding *Trade-Marks and unfair competition in trade.*

### OUR FOREIGN BOOK

We have Direct Agencies in all Foreign Countries. We secure Foreign Patents in shortest time and lowest cost.

*We Regard a Satisfied Client* as our best advertisement, and will furnish to anyone, upon request, lists of clients in any state for whom we have secured patents.

*Highest References—Prompt Attention—Reasonable Terms*

## VICTOR J. EVANS & CO. PATENT ATTORNEYS

Main Offices: 956 9th Street, N. W., WASHINGTON, D. C.  
*Opposite U. S. Patent Office*



# TRADE MARKS AND COPYRIGHTS

HAVE YOUR CASE MADE SPECIAL to Avoid DELAY. Take the precaution of having your case made SPECIAL in our office to save correspondence and secure early filing date in Patent Office. To secure SPECIAL preparation of your case send us \$25.00 with model or sketch and description.



MAIN OFFICE, VICTOR J. EVANS & CO.—VICTOR BUILDING, WASHINGTON, D. C.

## Specialization—Our Staff

The field of invention is so vast that it is impossible for any one man to become an expert in all classes of invention. Only those skilled in the class to which the invention relates are capable of rendering efficient service. For this reason we employ a number of patent lawyers and draftsmen, who have been selected for their special knowledge and ability in certain lines of invention. Each case is placed in charge of an expert in the class to which the invention relates. Latest addition to our staff being a Radio Specialist.

## OUR ORGANIZATION OFFERS PERSONAL SERVICE

by registered and practical attorneys and draftsmen of long and varied experience, who will give your patent business special attention, the whole being under the supervision of Victor J. Evans.

### INFRINGEMENT AND INTERFERENCE SUITS PROSECUTED

*All communications and data strictly confidential*

**FREE  
COUPON**

## VICTOR J. EVANS & CO. PATENT ATTORNEYS

NEW YORK OFFICES  
1007 Woolworth Bldg.

CHICAGO OFFICES  
1114 Tacoma Bldg.

PHILADELPHIA OFFICES  
714-715 Liberty Bldg.

PITTSBURGH OFFICES  
514 Empire Bldg.

SAN FRANCISCO OFFICES  
Hobart Bldg.

**MAIN OFFICES: 956 9th Street, N. W., WASHINGTON, D. C.**

Gentlemen: Please send me *Free of Charge* your books as described on preceding page.

Name.....

Address.....



# PATENTS

*Seventy-eight  
Years of Practice*

**T**HE firm of Munn & Company filed its first application for a patent in 1846, and for seventy-eight years has endeavored to keep pace with the inventive genius of the United States.

An experience of many years is at your disposal. If you have an invention which you wish to patent, send your sketches or model together with a description of your device, explaining its operation, and you will receive prompt, courteous attention.

*Write for our Handbook on*  
**PATENTS**

A full and complete booklet on Patents, Designs, Trade-Marks, Foreign Patents, Copyrights, Labels and Patent Office Practice with an explanation about our methods, terms, etc.

*All communications strictly confidential.*

Keep in touch with the inventions of the world by reading

## SCIENTIFIC AMERICAN

The MONTHLY MAGAZINE with a special appeal to every man of inventive genius. Recent rulings of the Patent Office, descriptions of the latest patented inventions, legislation and court decisions affecting patents, are noted in this authoritative publication.

## MUNN & COMPANY

*Patent Attorneys*

618 Woolworth Building, New York

Scientific American Bldg., Washington, D. C.  
Tower Bldg., Chicago, Ill.

Hobart Bldg., 582 Market St., San Francisco, Cal.  
Van Nuys Building, Los Angeles, Calif.

# U.S. PATENTS



**SEND FOR  
THIS FORM**

## DON'T LOSE YOUR RIGHTS TO PATENT PROTECTION

Before disclosing your invention to anyone send for blank form "EVIDENCE OF CONCEPTION" to be signed and witnessed. A sample form together with printed instructions will show you just how to work up your evidence and establish the same before filing application for patent. As registered patent attorneys we represent hundreds of inventors all over the United States and Canada in the advancement of inventions. Our schedule of fees will be found reasonable. The form "Evidence of Conception," sample, instructions relating to obtaining of patents and schedule of fees sent upon request. Ask for them—a post card will do.

PATENTS AND TRADE MARKS

**LANCASTER & ALLWINE**

480 Ouray Bldg. Washington, D. C.  
Originators of forms "Evidence of Conception."

## BLUE BOOK ON PATENTS

gives instructive information and candid advice.  
**MONROE E. MILLER, PATENT LAWYER**  
411-2 Ouray Building WASHINGTON, D. C.  
ELECTRICAL AND MECHANICAL EXPERT

## TRADEMARKS \$35

Design Patents \$35; Copyrights \$5;  
Booklet Free; 20 years' experience.

**SANDERS, Registered Patent Attorney, CHICAGO**  
70 Reed-McKally Building.

## PATENTS

As one of the oldest patent firms in America we give inventors at lowest consistent charge, a service noted for results, evidenced by many well known Patents of extraordinary value. Book, Patent-Sense, free. Lacey & Lacey, 646 F St., Wash., D.C. Estab. 1869.

## PATENTS

REGISTERED PATENT ATTORNEY SINCE 1905  
**CHARLES W. LOVETT** SECURITY BLDG. LYNN MASS.

SEND FOR FREE BOOKLET

## Have You An Invention?

If so the WORLD PROGRESS will show you how to  
**PROTECT AND PROFIT FROM YOUR IDEAS**  
Sample copy free. One year's subscription \$1.00.  
Send for free book,

### "WHAT TO INVENT"

containing SUGGESTIONS TO INVENTORS as to Inventions Needed. We invite manufacturers to address us regarding inventions they want.

**WORLD PROGRESS PUB. CO., Inc.**  
Room 203 Victor Bldg. WASHINGTON, D. C.



# PATENTS

## To the Man with an Idea

I offer a comprehensive, experienced, efficient service for his prompt, legal protection and the development of his proposition.

Send sketch, or model and description, for advice as to cost, search through prior United States patents, etc. Preliminary advice gladly furnished without charge.

My experience and familiarity with various arts frequently enable me to accurately advise clients as to probable patentability before they go to any expense.

*Booklet of valuable information and form for properly disclosing your idea free on request. Write today.*

**Richard B. Owen, Patent Lawyer**  
9-303 Owen Building, Washington, D. C.  
2276-E Woolworth Bldg., New York City

# PATENTS

Patent Litigation  
Trade Marks  
Copyrights

Handbook of instructions, "How to Protect Inventions," sent free on request.

**R. H. FRAVEL, Patent Lawyer**  
Formerly of the U. S. Patent Office Examining Corps  
Room 1503, McLachlen Bldg., WASHINGTON, D. C.

# PATENTS

**C. L. PARKER**  
Formerly Member Examining  
Corps, U. S. Patent Office  
**PATENT LAWYER**  
MCGILL BLDG.  
WASHINGTON, D. C.

Patents, Trade Marks, Copyrights, Patent Litigation  
Handbook for Inventors, "Protecting, Exploiting  
and Selling Inventions," sent free upon request.

# PATENTS

**PROTECT  
IMPORTANT  
INVENTIONS**

**MASON, FENWICK & LAWRENCE**  
Patent and Trade Mark Lawyers  
WASHINGTON, D. C., NEW YORK AND CHICAGO  
Established over sixty years Highest references

# PATENTS

Send us sketch or model for patentability opinion and exact cost of patent. Our book "How to Obtain a Patent," Sent Free on request. It tells how to apply for Patents, Trade Marks, Foreign Patents, Copyrights, etc.; gives information on Patent Procedure; tells what every inventor should know. Thousands of Inventors, who are our clients, are our references.

**Chandlee & Chandlee, 25 Years' Experience.**  
455 7th St. Washington, D. C.

# Learn to Make BIG MONEY As an Inventor



*Raymond F. Yates, who with fourteen other famous inventors, now makes it easy for you to learn how to invent in your spare time at home.*

Amazing new home - study course now teaches you inventive science in your spare time; shows how to develop, patent, sell your ideas; how to make big money from inventions.

## Famous Inventors Now Teach You!

Invention is not a matter of luck. Edison says, "Invention is a science, and should be taught as a profession." Suppose you went home tonight and found a window rattling. Almost instinctively you would stop the rattle with a wedge. That instinct is the germ of your inventive ability, and you can develop it so strongly that in a remarkably short time you will think and act inventively. Every invention is based on exactly the same principles that you use to "fix" the rattling window—first to see a problem, and then to find some fact which solves that problem. And now, for the first time, 15 famous inventors teach you how to acquire these simple, easily learned principles of invention.

## A Fortune for One Little Idea

Even so small an idea as a new kitchen knife can bring you thousands of dollars. Waterman, the inventor of the fountain pen, became a millionaire. The inventors of the metal-tip shoelace, the "humped" hairpin, the metal tape measure, the paper-match holder, have all received thousands of dollars for just one idea. It doesn't matter who you are, where you live, what you do—every day you meet problems which suggest ideas for money-making inventions.

## Learn How to Invent at Home

If you have ever had an idea for an invention, or if you would like to become a spare-time or professional inventor, see what this fascinating new course can do for you. Fifteen famous inventors now teach you at home the secrets of invention; show you how to get the information you want, how to perfect your ideas quickly, what to invent, and (just as important) what not to invent. You also learn how to avoid the mistakes which cost many inventors thousands and thousands of dollars. This complete course teaches you everything you want to know—how to get a patent, how to protect your patent rights, how to dispose of your invention to get the greatest possible profits, and hundreds of other facts about invention worth a fortune to you.

## FREE BOOK On Inventive Science

A wonderful book explaining this fascinating course will be sent to you free. It explains the course in detail, and proves that you can easily train your mind to think inventively so you may become a successful inventor. It shows how this course gives you, in a short time, a wealth of information which other inventors learned only after years of hard work and bitter experience. Get the advice of these fifteen famous inventors. Send for this book today. There is no cost or obligation. This bureau is not connected with patent attorneys or manufacturers. Our only work is to teach you how to develop your ideas so they will bring you big money.

## BUREAU OF INVENTIVE SCIENCE

Dept. 36, Wisner Bldg. ROCHESTER, N. Y.

BUREAU OF INVENTIVE SCIENCE,  
Dept. 36, Wisner Building, Rochester, N. Y.

Please send me without cost or obligation your free book "The Science of Invention."

Name.....Age.....

Address.....

City.....State.....



# PATENTS

**Booklet Free      Highest References      Promptness Assured      Best Results**  
Send drawing or model for preliminary examination

**ALL BUSINESS GIVEN PROMPT AND PROPER ATTENTION**

**WATSON E. COLEMAN, Patent Lawyer, 644 G St., Washington, D. C.**

## Ingersoll



Reliable Watches at Low Prices

Models '2 to '10

### SELL US A PRACTICAL IDEA

of some new and useful WAY to utilize Pressed Metal in place of other materials. The undersigned pays cash for every acceptable suggestion approved by our Engineering Advisory Board. Free book gives you the facts.

**PRESSED METAL TRADE COUNCIL**  
EXTENSION  
27 QUINCY STREET, SUITE 1705, CHICAGO

**SPORT BODIES for FORD and CHEV. 490 at \$34.50**

Life-size paper patterns—You can build your own body at small cost. We are manufacturers and our quantity production enables us to quote exceptional low prices. Our unique shipping methods save you 73% in FREIGHT CHARGES. Send at once for free particulars on Central Bodies. Our Book: "HOW TO BUILD A FORD RACER" sent anywhere on receipt of 25c in cash or stamps. **WRITE TODAY!**

**Central Auto Supply Co. Dept. 120 Louisville, Ky.**



### PATENTS

**Trade-Marks, Copyrights and Patent Litigation**  
Write for advice and instructions how to proceed, costs, etc. Hand Book with illustrations of 100 Mechanical Movements sent free on request.

**ALBERT E. DIETERICH**

Patent Lawyer and Solicitor  
Successor to Fred G. Dieterich & Co. 621A Ouray Bldg., Washington, D. C.



### INVENTORS

18 years' extensive experience in developing and perfecting inventions; making drawings and working models for demonstration. Expert engineering advice free on all matters before or after patent. Strictly confidential. References on request.

**BERNARD & HELLER, 275-B Water St., N. Y.**

**Clear-Tone**  
FOR  
**PIMPLES**  
Your skin can be quickly cleared of Pimples, Blackheads, Acne Eruptions on the face or body, Enlarged Pores, Oily or Shiny Skin. \$1,000.00 Cold Cash says I can clear your skin of the above blemishes. **WRITE TODAY** for my FREE Booklet—"A Clear-Tone Skin"—telling how I cured myself after being afflicted for fifteen years.

**FREE**  
**E.S. GIVENS, 129 Chemical Bldg., Kansas City, Mo.**

## INVENTORS      PROTECT YOUR IDEAS

Send for our Guide Book, **HOW TO GET A PATENT**, and Evidence of Invention Blank, sent Free on request. Tells our terms, methods, etc. Send model or sketch and description of your invention for our Examination and Instructions without charge.

**RANDOLPH & CO.**  
300 Victor Bldg., WASHINGTON, D. C.

NAME .....

STREET .....

CITY ..... STATE .....



# New Self-Massaging Belt Reduces Waist—Easily!

Produces same results as an expert masseur, but far quicker, easier and less expensive. Substitutes good, solid, normal tissue for that bulky, useless, disfiguring fat, yet does it so gently that you hardly know it is there.

Science has found a delightfully easy way to quickly remove fat and obtain a normal waistline—without straining your heart with violent gymnastics or weakening your system by starving.

Formerly those who wished to reduce without dieting or strenuous exercise had to go to a professional masseur. His method effectively dislodged the fat and brought about the desired reduction. But it was expensive and time-consuming, and so few could take advantage of it.

## Remarkable New Invention

But now a wonderful new invention brings this same effective method within the reach of all. The Weil Scientific Reducing Belt uses this same massage principle, acting by means of its specially prepared and scientifically fitted rubber. It is so constructed that as you wear it, every breath you take and every movement you make imparts a constant gentle massage to every inch of the abdomen. Working for you this way every second, day and night, it reduces much more rapidly than ordinary massage, saving both time and money.

## Actually Removes Fat

It does not merely draw in your waist and make you appear thinner. It actually takes off the fat. Within a few weeks you find 4 to 6 inches gone from your waistline. At the same time all your stomach disorders, constipation, backaches and shortness of breath disappear as the sagging internal organs are put back in normal place. Man or woman, you are filled with a wonderful new energy, and both look and feel 10 to 15 years younger.

The Weil Belt is used by hundreds of professional athletes and jockeys because it not only reduces quickly but at the same time preserves their strength. Highly endorsed for its healthful principles by physicians everywhere. Satisfaction guaranteed or your money back without question.

Write today for full description. If you write at once you can also get in on a Special Reduced Price Offer being made for a limited time. Mail coupon today to **THE WEIL COMPANY, 96 Hill Street, New Haven, Conn.**

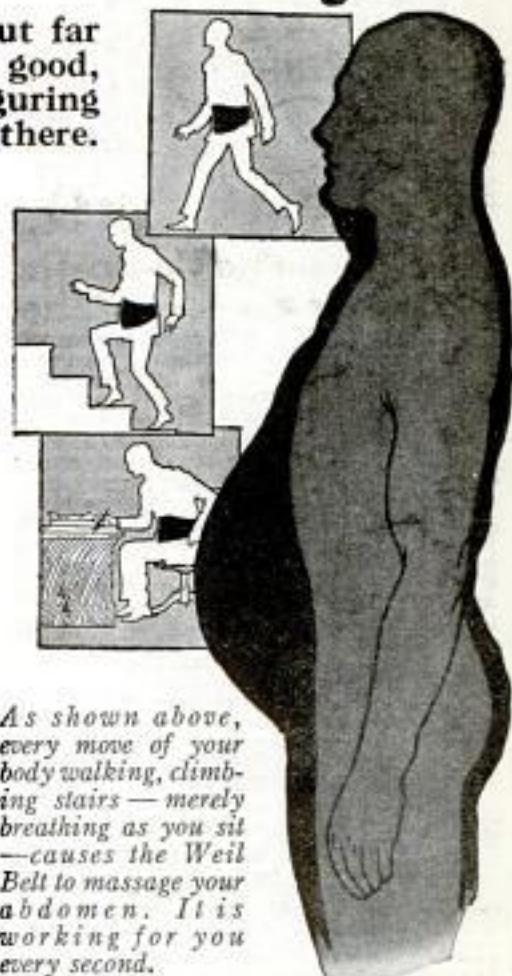

*As shown above, every move of your body walking, climbing stairs—merely breathing as you sit—causes the Weil Belt to massage your abdomen. It is working for you every second.*

The Weil Company,  
96 Hill Street, New Haven, Conn.

Gentlemen: Please send me, without obligation, complete description of the Weil Scientific Reducing Belt and also your Special 10-day Reduced Price Offer.

Name.....

Address.....

City.....State.....



## California Bathing Beauty

transparent handled pocket knives sell on sight. You will want one when you see our illustrated price list. Finest quality. Satisfaction guaranteed. Special offer tells how to get one free. **Cash Commission** to agents. Write us today. **NATIONAL CUTLERY CO., Sta. A, LOS ANGELES, CALIF.**

## Agents \$12.00 a day

### NEW Self-Heating IRON

New invention now makes ironing easy in every home. Ends hot stove drudgery. Cuts ironing time in half. Saves steps. Costs one cent for 3 hours use. No attachments. No cords. No tubes. Gives quick regulated heat. Guaranteed. Sells fast. Mrs. Wagner, Ohio, sold 24 in few hours spare time. Moyer, Pennsylvania, made \$164 in one week. You can do as well. Work all or spare time. No experience needed. No capital. New plan. Simply take orders. We deliver and collect. Commissions paid same day you take orders. Send for exclusive territory and **FREE OUTFIT OFFER**. Write today. **THE AKRON LAMP CO., 36 Iron St., AKRON, OHIO**



## Try any Conn Instrument

Conns give you **FREE** most pleasure and quickest opportunity for profit because they are easiest to play—beautiful in tone—perfect in scale—handsome in design and finish.

Send for Free Book, "Success in Music and How to Win It" by John Philip Sousa and others—and details of Free Trial, Easy Payment plan on any Conn instrument. Mention instrument.

**C. C. CONN, Ltd.**  
631 Conn Bldg.  
Elkhart, Ind.





# A NEW WAY to Wear Your PANTS

**GOOD BYE**  
to Suspenders  
& Belts



## The Up-to-Date Way To Keep Them Up!

The day of the suspender and belt has passed. Men who use to swear at wrinkly, buckling trousers and "hunched-up" shirts, are now swearing by INVISO. INVISO not only keeps trousers and underwear up, but also keeps your shirt down—and does it easily, comfortably, and with perfect surety of an always neat and stylish appearance. No more floundering about on a hot summer's day constantly "pulling-in" belt or readjusting suspenders. Here is

### SURE RELIEF!

Physicians recommend INVISO as a health belt. By clever arrangement of elastic in sides and back, it conforms to every body movement without pressure or binding. Easy to put on. Cool, sanitary, durable.

**INVISO**  
**HIP-FIT TROUSER SUPPORTER**

Take advantage of our Trial Offer. Send no money. Simply forward your measurement (measure just above hips and under the trousers) and deposit \$1.50 plus mailing cost, with postman upon receipt of your INVISO. Wear it for ten days. If unsatisfactory return at our expense and we will refund your money.

**HIP-FIT COMPANY**  
12 East 44th St. New York City

**AGENTS WANTED** Write for interesting particulars and money-making proposition for your territory.

**\$1.50**  
**TRIAL**  
**FREE**

## ALL MAKES BAND INSTRUMENTS AT 1/3 to 1/2 PRICE!

All famous American and imported instruments for band, orchestra or solo offered at astonishingly low prices. Hundreds of bargains in new list. **New Guarantee. 5 Days' Free Trial and money back guaranteed.**

### CONN

Buescher and all other famous makes in rebuilt new condition SAKO-FIXED, offered with case, reeds, straps, pearl keys. Completely rebuilt and replated—get our bargain list for descriptions and prices as low as

**\$89.75**

### CONN

Buescher, Boston Silver plated gold bell Cornet, in case, pearl keys, slightly used, completely rebuilt, guaranteed new condition, perfect. \$90 list. Our price....

**\$17.95**



### SPECIAL!

Brand new Brass Cornet made by most famous factory in U. S. Low pitch, pearl keys. List \$30.

**\$12.25**

**DEAGAN XYLOPHONE**  
\$15 list, 2 1/2 octaves, slightly used, rebuilt guaranteed like new. Our price.....

**\$8.55**

**WRITE TODAY!** Don't waste time and money. Dixie known for 21 years as bargain headquarters. Send for latest bargain list TODAY! Dixie Music House, Dept. 501, 320 S. Wabash Ave., Chicago

## RIDE 30-Days FREE



On the dandy new wheel all the boys are talking about! A bike that will make you the envy of all the other fellows. It's a knockout, boys, with racy lines, auto-type headlight, finger-fitting grips, motorbike handlebars. Just everything you could look for. Of course it's a

# BLACK-BEAUTY BICYCLE

The easiest riding, most substantial and finest looking wheel made. Shipped express prepaid, direct from the factory—at wholesale price. **Guaranteed 5 years. 6 months' insurance against accident. 30 days' trial.** Large selection of models and colors.

**Supplies** Tires, Lamps, Horns, etc. Everything for the bike at wholesale prices.

**Send for** 1924 Black Beauty Catalog. It's FREE

**HAVERFORD CYCLE CO. of PA.**

Established 88 years  
Dept. 376 PHILADELPHIA, PA.

Be a Black Beauty Rider Agent



## FREE LESSON IN DRAFTING

Send for our free lesson, which shows how easily you can master Drafting by the Chicago "Tech" Method and prepare for a high salaried job.

### Increase Your Income

You get this pay-raising training by mail under the direction of our experts. The fees are moderate, the terms easy. Find out about this now. The lesson is free and we send our catalog with it. Write today.

**CHICAGO TECHNICAL COLLEGE**

630-A CHICAGO "TECH" BUILDING, CHICAGO, ILLINOIS

## CLEANS WINDOWS IN A JIFFY

### The Lightning Cleaner



Cleans thoroughly with less effort. The chemicalized pad loosens the dirt, the rubber wiper dries and polishes. Saves hours of labor and does not muss or splash water. Ideal for homes, stores, shops, hotels, autos, etc. Sent postpaid for \$2. Satisfaction or money back. Agents, Dealers, write for prices.

International Specialties Co., Palm Bldg., Seattle, Wash.

## "Lighting Fixtures"

### READY TO HANG

(Direct from Manufacturer)

Completely wired, including glassware. Send for Catalogue No. 25. Just Off the Press.

Special proposition to DEALERS.

**ERIE FIXTURE SUPPLY CO.**  
STA. A ERIE, PA.

## Earn \$50 a day

Selling our well known

## Goodyear Raincoats

\$1.75 each, in dozen or gross lots. Sample sent upon receipt of \$2.00. Agents wanted. (Write for our Money Making Catalogue.)

**GOODYEAR RUBBER M'FG CO.**  
Dept. A. 34 East 9th Street, New York City



# Makes the Deaf Hear



Here is good news for the Deaf or people who are hard of hearing. Science has at last triumphed over deafness. Unless your Auditory Nerve is entirely destroyed, the Acousticon will enable you to hear as perfectly as anyone whose hearing is normal. Thousands who have been Deaf for years report most gratifying results—many say they can hear the slightest whisper and that their natural hearing has been greatly improved. We have testimonials from Governors, Bankers, Ministers, Lawyers and thousands of others. So great is our confidence that we invite every sufferer to

## Try It 10 Days FREE

You are not asked to purchase this remarkable invention until you have tried it 10 days FREE, until you have proved to your entire satisfaction that it is what you need and want—until you are absolutely certain that it will enable you to hear all sounds clearly. Then, if you wish, you may keep and pay for it, otherwise return it and there will be no charge.

## Send No Money

We ask for no deposit. We do not ship C. O. D. We send you this latest scientific invention entirely at our own risk and expense for 10 days FREE TRIAL. We don't ask you to pay first and then refund your money if you are not satisfied. We send you the Acousticon without cost or obligation. It must prove its own merits to your entire satisfaction. Unless you are amazed and delighted with it, you are not asked to purchase. When we say FREE TRIAL, we mean FREE TRIAL, so send name and address at once for descriptive literature, testimonials and FREE TRIAL request blank.

Dictograph Products Corporation  
1307 Candler Bldg. 220 W. 42nd St. New York

## TESTS SHOW FORD CAN RUN 60 MILES ON GALLON OF GAS

The amazing fact that a Ford can run 60 miles on 1 gallon of gasoline was recently brought to light through tests conducted by America's foremost engineers. Great strides have already been made in this direction by the recent invention of a simple attachment which can be installed in a few minutes without any alterations to motor. A. C. Winterburn made 41.4 miles on one gallon of gasoline after this device was attached. B. O. Weeks, famous aviator and inventor, wants agents and will send sample for trial. Write him today at 1304-601 Fordway Avenue, Milwaukee, Wis.

## Ride A Ranger

The finest bicycle ever built. 44 Styles, colors sizes; made in our new factory. SAVE \$10 to \$25 by direct from the factory purchase. Delivered free on approval, express prepaid, for 30 Days' Free Trial. Easy Payments, if desired.

Tires best quality, at factory prices, express paid. Lamps, wheels, horns, equipment and repairs at unusually low prices. Send No Money, do business direct with makers.

MEAD CYCLE COMPANY  
DEPT. P. CHICAGO

Write today for free Ranger Catalog, factory prices and marvelous easy payment terms.



## Are Your Headlights Out?

The Cleverest Little Device Ever Conceived  
**IS-IT-LIT REFLECTORS**

Handsome, ornamental—easily attached; tells instantly from the driver's seat if one or both headlights are out. Avoid danger of being run into on side without lights, stopping by police, etc.

Handy Specialty Co., 79 Walnut St., Somerville, Mass.

**BIG MONEY FOR AGENTS**  
**\$1.25**  
THE PAIR POSTPAID

## Build This Real Auto!

A sturdy, dependable motor car. Any handy man or boy can build it. Power supplied by famous 2½ H. P. SHAW Motor. Send for Illustrated Circulars, 2c postpaid. Complete Illustrated Book of Building Plans 25c postpaid. Write today.



SHAW MFG. CO.  
Dept. P. M. 3-6, SALESBURG, KAN.

Book of PLANS 25c



"Every Ford Needs It"

## Fills Tank —Gauges Gas Without Lifting Cushion

Every Ford owner is tired of lifting cushions. This combined gasoline gauge and filler makes an instant hit because it fills Ford tanks without lifting cushion. The gauge is always in driver's sight to keep him from running out of gas. Makes Ford tanks handier than a tank at rear. C. L. Porter, Colorado, Texas, sold 3½ dozen in 4½ hours.

# Kirstin

# Fil-Gage

FILLS YOUR TANK GAUGES YOUR GAS

Weights two pounds, simple, strong and durable. Protected by basic patents. Absolutely no competition—nothing even pretends to serve the same purpose. Fil-Gage, a combined Filler and Gauge, sells for less than a good visible gauge alone.

## SALESMEN! DEALERS! Read These 8 Big Points



Clamps into Tank Opening



Fills Tank—Gauges Gas with Cushion in Place

1. A gasoline filler and gauge combined, for less than usual price of good gauge alone.
2. No competition. Protected by broad, basic patents.
3. Every Ford owner a live prospect.
4. Clamps into regular gas tank opening.
5. Absolutely guaranteed—Nothing to break or get out of order.
6. Circular matter, window and counter displays, free co-operative local newspaper advertising furnished.
7. Profitable—Quick Sales—No Service—No Grief.
8. No price resistance. Fair established retail price. Liberal profits to salesmen and dealers.

**Retail Price \$5.00**  
For closed cars \$6.50c extra in West

## Wire or Write Today

Send for sales plan, prices, advertising helps, etc., today before territory you want is closed. If you wish, send \$1.00 for sample; C. O. D. for balance of distributors' price.

**A. J. KIRSTIN CO., Mfgs.**  
552 First Street ESCANABA, MICH.

Please Mention Popular Mechanics



**SEND \$2 DOWN** **PAY \$6.00 PER MONTH**



**FREE TRIAL** **NO RED TAPE**

A flashing, blue-white, absolutely perfect diamond, sparkling with the fiery colors of the rainbow, is mounted in latest style engagement ring. Guarantee Certificate Free.

**TWO BLUE SAPPHIRES** are attractively set in the shanks of this 18 kt. solid white gold engraved and pierced ring to add beauty and style. Send for this perfect diamond.

Just send \$2.00 deposit to show your good faith (or pay postman \$2.00 on delivery) and we will send this handsome diamond ring. Then pay only \$6.00 a month for ten months. Total price only \$62.00. Guaranteed value of \$85.00. (Mention size.)

#### ABSOLUTELY PERFECT QUALITY

The finest and best blue white diamonds have no flaws, no imperfections, no spots, scratches or blemishes of any kind. The diamonds in these rings are guaranteed absolutely perfect and flawless. Priced at \$297.00 a carat, but worth double. Will stand any test or comparison.

**WARNING:** Do not be fooled into thinking that diamonds advertised as "perfectly cut" are absolutely perfect in quality. Diamond experts will tell you that 95% of all diamonds advertised as "perfectly cut" actually are imperfectly cut and besides have flaws and spots and imperfections of one kind or another which cheapens them. Our big catalog gives valuable facts.

#### Write for Big Bargain Catalog

It brings our large jewelry store right into your home. Other sparkling diamonds, slight perfect quality, listed below:

ORDER FROM THIS BARGAIN LIST			
1/4 Carat.....	\$25.00	3/4 Carat.....	\$147.75
1/2 ".....	\$49.25	1 ".....	\$197.00
3/4 ".....	\$65.65	1 1/4 ".....	\$246.25
1 ".....	\$73.75	1 3/4 ".....	\$295.50
1 1/4 ".....	\$98.50	2 ".....	\$394.00

Every diamond guaranteed genuine blue white. Money back guarantee certificate with each diamond. Pay 10% down and 10% per month. **WORTH \$325 A CARAT.**

**STERLING DIAMOND & WATCH CO.**  
(Diamond Importers—\$1,000,000 Stock—Established 1879)  
63 PARK ROW Dept. 1691 NEW YORK, N. Y.

## EARN BIG PROFITS Selling Electrical Appliances

WE START YOU OUT

The electrical industry is yet merely in its infancy. Get in on the ground floor of a dignified, interesting and profitable business. Steady income, pleasant, easy, demonstrating Violet Rays and electrical appliances which sell on sight. Experience not required. MEN and WOMEN earn big money, spare or all time. Salary to producers. Commissions liberal, in advance. We deliver and collect. Write for exclusive territory.

**VI-REX CO., Dept. A-74, 211 S. Peoria St., Chicago**

Let  
**Hartman**  
Feather  
Your Nest

#### FREE Bargain Catalog!

Absolutely Free—this great book with over 300 pages of amazing bargains in home furnishings, farm machinery, etc.—all on easy monthly terms and 30 days FREE TRIAL. Send postcard!

**HARTMAN FURNITURE and CARPET CO., Dept. 6465, Chicago**

**AGENTS** *Some Seller*  
At \$2.00  
Looks Like \$5.00 Worth  
Gives You \$1.10 Profit!



## \$12 AN HOUR!

W. H. Marion, a beginner made 36 sales in three hours, first day, \$36 profit! How? Our representatives introduce our products with a first sale of beautiful combination sets of Toilet Articles, Soap, etc. You sell at half store prices—no fancy talk—sell on sight. Make 20 to 30 sales a day with \$1.10 profit on each. Easy to average \$100 a week. Could you ask more while introducing line, establishing a permanent business for yourself? Another plan calls for no deliveries, no investment, no delays. You bank immediate profits. Also a plan with winning premium to each sale. Write quick for full details.

**FORD FREE!** No contest. Every producer gets a Ford Car absolutely free. Most amazing offer ever made. Don't waste a minute. Write TODAY for illustrated circulars explaining our Unique Plans including 30 other packages. **ACT NOW.**

**E. M. DAVIS CO. Dept. 5618 Chicago**

## TIRES WITH 500 NAIL HOLES LEAK NO AIR

A new puncture-proof inner tube has been invented by a Mr. M. J. Milburn of Chicago. In actual test it was punctured 500 times without the loss of air. This wonderful new tube increases mileage from 10,000 to 12,000 miles, eliminates changing tires, and makes riding a real pleasure. It costs no more than the ordinary tube. Mr. M. J. Milburn, 331 West 47th St., Chicago, wants them introduced everywhere and is making a special offer to agents. Write him today. See our advertisement on page 187 February issue.

**\$33 UP** **SHOP ENGINES**

Saved \$21 ordering direct from your factory, says W. Price, Ind. You will save on our reliable engines. Built to do hard, heavy work, Kerosene, Gasoline. Easy to start—no cranking. Sizes 1 1/2 to 22 H. P., 3 Months' Trial. Cash. Easy Terms. 10-Year Guarantee. Thousands of Ottawa engines in use in 70 countries. —Export correspondence solicited.

**FREE BOOK** "How to Know Better Engines." Write today.

**OTTAWA MFG. CO.**  
531-A King Street, Deck 531-A Magee Bldg., OTTAWA, KANSAS  
PITTSBURGH, PA.

Hand Forged  
Razor Steel  
Blades, No. 57



#### Direct at Factory Prices

This \$2 KNIFE \$1.18 Postpaid  
Hand Forged Razor Steel Blades  
Handy shaped Blade makes this knife best for mechanics, sportsmen and farmers; light but strong; re-sharpened easily. Stag handle. German silver finish; blades file tested, hand forged from razor steel and warranted.

Sample \$1.18 3 for \$3.00 Postpaid.

Send for our 100-page List and **FREE** "HOW TO USE A RAZOR"

**MAHER & GROSH CO., 106 A St., Toledo, Ohio**



# SELL COAL!

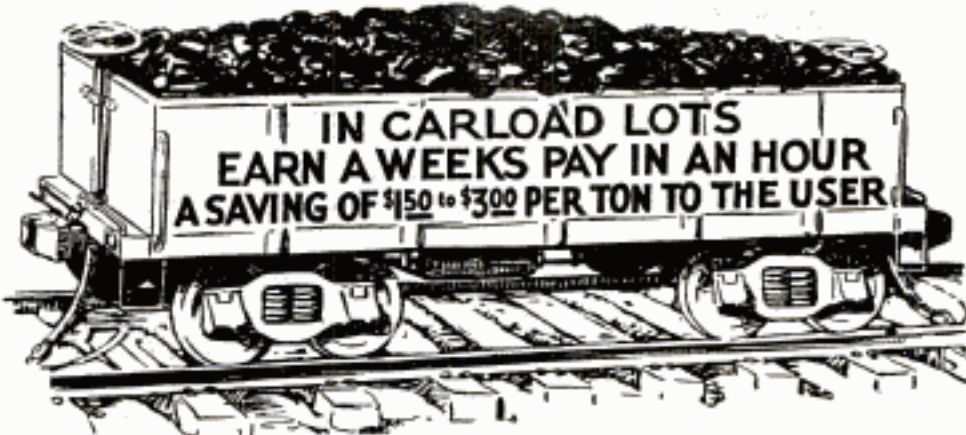

**WE are the largest firm in the United States exclusively delivering coal direct from car to consumer without the use of any coal yards.**

Stores, factories, schools, garages, banks, hotels, hospitals, churches, public buildings, and homes can save hundreds of dollars per year by buying their coal through our salesmen. We want salesmen who will solicit carload orders all or part time. No experience or capital necessary in selling our coal. We do not require you to collect bills or take care of deliveries. You just take the orders. No sample case needed in this line. Just carry our portfolio "Coal Facts." No coal user can get away from them.

**You Can Do as Well as Our Other Men and Make \$2000 to \$7000 per Year**

*Earn a Week's Pay In An Hour—Liberal Drawing Account Arrangement*

**COAL ORDERS ARE BIG ORDERS. THERE HAS NEVER BEEN A BETTER SIDELINE**

Season now opening up. Write for full details of our offer and state territory covered.

**WASHINGTON COAL COMPANY, 826 Coal Exchange Bldg., CHICAGO, ILL.**

Mr. J. Montgomery of Illinois sold five cars his first day, commission \$125.00.

Mr. Hepburn of Iowa sold nineteen cars of coal first month, commission \$475.00. Very next month he increased his sales to twenty-nine cars making \$725.00 for one month's work.

Mr. J. C. Reames of South Dakota sold twenty-three cars his first month making \$575.00.

Mr. Jay Stiles of North Dakota sold twenty-one cars his first month, profit \$525.00.

Mr. H. C. Oldberg of Wisconsin sold eight cars of coal his first day, commission \$300.00.

Mr. Wallace of Michigan, selling only in spare time, sold six cars of coal in one week, commission \$150.00.

## MEN GET BUSY!

Biggest profits ever known are being made by our salesmen. Coal is a necessity and easily sold on our plan.

### Collapsible Garment Hanger

Wonderful space saver for crowded wardrobes and closets in homes, hotels, halls and business places. Occupies no more space, yet holds four times as many garments as one hook. Made of best steel. Lasts a life time. Highly appreciated and endorsed by all users. Send for circular or \$1.00 for sample **N.W.**. Complete satisfaction guaranteed or money back without question.

**B. D. GAUSE MFG. CO., ELKHART, INDIANA**



### The Johnson Folding Pocket Rule

The Johnson Folding Pocket Rule is made of Spring Nickel Silver, accurately and distinctly graduated. It can be used as a Square, Hook-rule, Caliper gauge, Protractor, Triangle or Tri-square, and can be applied to practically all classes of mechanical work. Versier reads to one-half degree. Center Joint has fibre bearings which will not become loose and will remain firmly at any angle.

No. 40—6" Rule \$2.50; No. 45—12" \$3.50. Including customs costs. Money refunded if not satisfied. Catalogue on request.

**E. P. JOHNSON RULE MFG. CO.**  
565 W. Washington Blvd., Chicago, Ill.

### SEND NO MONEY Big 3 foot Telescope in 5 Sections

See people and objects miles away just like they were close, see Moon and Stars as you never did before. Brass bound, useful and entertaining. "Could tell color of aeroplanes 4 miles away!"—Mrs. Yarrington.  
"Watch my boy arrive at school 10 miles away!"—Mrs. Horn.  
"Read numbers on freight cars mile away, see mountains on moon!"—A. C. Palmer. Thousands pleased.  
SPECIAL OFFER. Send just your name, and we will pay you \$1.85 plus few cents postage. Satisfaction Guaranteed or money back.

**FERRY & CO., 630 Jackson Blvd., Dept. A177, Chicago, Ill.**

"Have been watching submarines 8 miles off the coast."—P. Gerson.

### The Gregg Football Game

A scientific game developed on correct football principles, using the new 1924 football rules. Not a children's toy played with spinners, cards or dice, but a game of wits and strategy played by two teams on a small football field. Each player of Gregg Football is his own Captain and Quarterback and directs his team as he thinks best. At your dealer's or postpaid direct for \$2.50.

Write for illustrated folder.

**ALBERT A. GREGG CO., Dept. M West Jefferson, Ohio**

### HANDS UP!

GET one of these little beauties right now, and protect yourself against hold-up thugs, rowdies, etc. and at the same time it serves as the best novelty cigarette case ever invented.



Made exactly like the real thing! Just pull the trigger, back flip the lid showing a full package of your cigarettes. Lots of fun scaring your friends and at the same time useful and a great protector.

Made of light weight metal, gun metal finish, 4 3/4 inches long. Sold exclusively by us. Order at once, supply limited. \$1.75 each. Special introductory price. **PAY POSTMAN** on delivery our price plus postage. Money back if not satisfied.

**PATHFINDER COMPANY**  
Dept. HK2B 534 Sixth Avenue New York

### MAKE YOUR FORD INTO THIS SPORT CAR—SAVE \$50 to \$150 WITH Red-i-Kut Life-Size Patterns \$6.40

Famous Red-i-Kut Life-size patterns and pleasure-fit instructions show you how you can easily convert your Ford into this Fast, Sexy, Sport Car as thousands have done, with easily obtained materials. No need to lay up the car. LOOK AT WILFRED ENO'S PAL—Eno says, "Total material cost with steel and paint for my Pal only \$11.25. It took me just 2 Sundays to build it and I sure am proud to hear them say, 'He built that amazing sport car.' I never cut any steel or did any woodwork before but one can't go wrong with Kumpel patterns." (Overland City) St. Louis, Mo. The "Pal" with pressed metal streamline rear,

Life-size patterns for each part of the body so you can't go wrong, picture instructions and CONICAL DISK WHEEL PATTERNS Only \$6.40 delivered. Order now while we can make good delivery, and really enjoy these wonderful days in your "Pal." Keen, Glassy, Up-to-the-minute. You can build it. Over 11,000 in use. Don't hesitate. Swing Lo Underlaid Irons, no frame cutting kind, only \$7.01. Send for color for new assortment of other distinctive sport body patterns from \$3.50 up. —"Red-i-Kut" Steel, "Swing Lo" Irons, "Big" Tops and "Geezus" Windshields. Order Right Now. Keenool Co., 49 Kumpel Bldg., Guttenberg, Iowa



38-inch, Easy-riding seat.

GLASS SNAP COMPLETE



**\$200**  
**SELECTIVITY**  
 for  
**\$8.50!**

## Make Every Night Silent Night!

TRAP OUT THE INTERFERENCE

Selectivity — which is merely the ability to cut out interference — is the dominating difference between the very expensive sets and the moderately priced ones. Why pay \$50.00 to \$200.00 extra for increased selectivity, when for \$8.50 you can get a FERBEND WAVE TRAP which will absolutely cut out any interfering station, no matter how loud, how close by or how troublesome.

### Add a Ferbend Wave Trap to Your Set

You will find it a valuable addition. It is designed and manufactured complete by us, after years of careful experimenting. It is not to be confused with imitations hastily assembled from ordinary parts. The price is \$8.50. Shipment is made parcel post C. O. D. plus a few cents postage. If you prefer, you can send cash in full with order and we will ship postage prepaid. Send us your order today.

**FERBEND  
 ELECTRIC  
 COMPANY**

15 E. So. Water St.,  
 CHICAGO

Descriptive Folder  
 on Request

**FERBEND  
 Wave Trap**

We guarantee that the Ferbend Wave Trap, when properly connected to any workable receiving set, will tune out any interfering station.



## Rings Bells Without Batteries

Avoid the annoyance of having bells out of order. At a nominal cost you can install this little device which will ring electric bells, buzzers, annunciators, electric heat regulators, door-openers, etc., from the same current that lights your home.

**ONLY \$2.00**  
 Canada \$3.00

### Air-Way Bell Ringer Transformer

Connects direct to lighting-current, and eliminates forever the use of troublesome dry batteries. Does not use enough current to register on meter. Buy it from any electrical dealer, or we will send it anywhere postpaid upon receipt of price. Your money back if you are not satisfied.

JOBBERS, DEALERS, AGENTS—Write for selling proposition.

**AIR-WAY ELECTRIC APPLIANCE CORPORATION**  
 Toledo, Ohio

## ALL-AMERICAN

### AMPLIFYING TRANSFORMERS

Largest Selling Transformers in the World

### SPECIAL OFFER!

All-American diagram and circular describing Power Amplification; also Book of Hook-ups containing 22 tested circuits. Send 4c in stamps.

**RAULAND MFG. CO., 200 N. Jefferson St., CHICAGO**  
 Pioneers in the Industry

## MIRACO GETS 'EM FROM COAST TO COAST

PRICE ONLY \$29.50

At rock-bottom prices you get the efficiency of sets costing three times as much. Users tell us that Miraco Radio frequency receivers pick up stations from coast to coast. Operate either on dry cells or storage battery. Solid mahogany cabinets — finest workmanship throughout. Order direct or send for bulletin.

Two tube outfit . . . . \$29.50  
 Four tube outfit . . . . \$4.50

DEALERS—AGENTS—Write for proposition quickly—it's a winner!

**THE MIDWEST RADIO COMPANY**  
 807 Main Street, Cincinnati, Ohio

## FREE Radio Text Book and Catalog

A Post Card Brings It

### CONTAINS 75 VACUUM TUBE HOOK-UPS

300 ILLUS. 500 RADIO ARTICLES

All Armstrong Circuits: These important circuits are explained clearly, all values being given, leaving nothing to puzzle you.

Also 75 full, clear diagrams, explanations and instructions for all important vacuum tube circuits, from the simplest to the most advanced. How to make a wave-trap — how to increase wave length of set — aerial data — tube data — battery data — reflex — regeneration — radio amplifiers — audio amplifiers — loud speakers — tables of component parts, and endless other radio subjects covered in simple, understandable way.

The 75 diagrams in book form alone would cost you \$1 to \$3. Get this all FREE. Send for it right away. Offer limited.

**RADIO SPECIALTY COMPANY, 98 E. Park Place, N. Y. City**

## Radio Wherever You Go

### Vacation — Outing — Touring

This year go with **Radio**. Camp, fish, hunt, tour with **Radio**. Make your vacation complete. Live up the rainy days and long, dull evenings. Take the new, wonderful **Ozarka Portable, Long-Distance Receiver** with you. Get the sports returns—the concerts—the special features of hundreds of broadcasting stations. And, best of all, you'll have it for home use when you return. **Ozarka** is built for long distance—1000 miles is not unusual. Simple to operate. Convenient and light to carry. Only weighs 10 lbs. complete. Case is 16x10x5 inches. Completely equipped with aerial, "A" and "B" Batteries, three No. 199 tubes, and one set of head phones. Ready for instant use. Price complete ready to listen in \$65.00. Extra phones \$5.50. Big demand. Order at once. Send \$10.00, pay balance on delivery. Satisfaction guaranteed.

### Local Representatives Wanted

**Ozarka Radio** offers the greatest opportunity to make money. Big market—easy sales. Over 1800 **Ozarka Agencies** now doing wonderful business. Some territory now open. You're interested, so write today for the "Ozarka Plan," but don't fail to give name of your county.

**OZARKA, Inc., 65 N. Peoria Street, CHICAGO**



## Como Duplex Transformers

(Push Pull Power Type)



Price  
**\$12.50**  
Per Pair

The Como Duplex system of audio frequency amplification (push-pull) gives the maximum volume without distortion and tube noise. There is a combined filtering action which assures perfect results when ordinary amplification transformers fail. Can be used as a single-stage, two-stage, or a three-stage amplifier.

### The World's Standard Push Pull Transformer

Send for copy of "How to Build a Power Amplifier."

**COMO APPARATUS CO.**

446 Tremont St. - BOSTON, MASS.

**CATALOG** L-25-148  
PAGES  
FREE!

#### Super - Heterodyne — Neutrodyne !

New Complete Branston Kits, including Oscillator Coupler, Antennae Coupler, 3 Inter. R. F. Trans. and Special Transfer Coupler. **\$36.50**  
Complete Kit lists .....

Aeae 30 Kilocycle R. F. Trans. **\$5.00.** All American 2,000 to 10,000 Meter Trans. **\$6.00.** Hilo Antennae Coupler **\$8.00.** Oscillator Coupler, **\$7.00.** Gen. Fada Neut. Parts, 5 Tube, **\$65.60,** 4 Tube, **\$64.00.** Kit, **\$25.00.**

**AMERICAN RADIO MFG. CO.**  
WHOLESALE DISTRIBUTORS  
Dept. O 6 WEST 14TH ST. KANSAS CITY, MO.

## Build Your Own Radio



You don't have to know anything about radio to build our new "LITTLE WONDER" set. 2,000 miles has been the range secured on this marvelous outfit. Costs no more to build this set than price of parts for a cheap one-tube set. Simple, easy instructions. Specially fitted parts, partly assembled. Make sets for your friends and earn money

in spare time. Get baseball and other reports this summer. Also political speeches, concerts. Write TODAY for free information. **K-D RADIO BUILDERS, Room 240, 415 So. Dearborn St., Chicago, Ill.**

## Radio Safeguards

**SOLDERALL**  
SOLDERS ALL  
JOINTS PERMANENTLY **25¢**

**STORM KING**  
LIGHTNING ARRESTER  
APPROVED BY THE NATIONAL  
BOARD OF FIRE UNDERWRITERS

**\$1.00**  
AT ALL  
DEALERS

**SOLDERALL CO., Newark, N.J.**



*Cunningham*

## RADIO TUBES

*The Standard Tube for  
All Makes of Radio  
Receiving Sets*

It is the Vacuum Tube that has made possible the broad and far-reaching application of radio telephony. Cunningham Vacuum Tubes, standard for all makes of receiving sets, are the product of the creative genius of the engineers of that great scientific organization, the Research Laboratory of the General Electric Company.

**Patent Notices** Cunningham tubes are covered by patents dated 2-18-08 and others issued and pending. Licensed for amateur, experimental and entertainment use in radio communication. Any other use will be an infringement.

*The care and operation of each model of Receiving Tube is fully explained in our new 40-page "Radio Tube Data Book." Copies may be obtained by sending ten cents to our San Francisco office.*

### Prices on Cunningham Tubes Now in Effect

C-301A—5 Volts 1-4 Ampere filament...	\$5.00
C-299—3 Volts .06 Amp. Dry Battery Det. and Amp. ....	5.00
C-300—5 Volts Gas Content Detector...	5.00
C-11—1.1 Volts .25 Amp. Dry Battery Det. and Amp. Special Base.....	5.00
C-12—Similar to C-11 with Standard Base	5.00

*E. J. Cunningham Inc.*

Home Office:  
182 Second St. 154 W. Lake St. 30 Church St.  
SAN FRANCISCO CHICAGO NEW YORK



## If You Use a Blow Torch You need TURNER at once

to take care of those endless odd jobs that seem always bobbing up.

### TURNER BLOWTORCH

*Safe as a Candle*

is **ABSOLUTELY SAFE**. In addition to being the only safe blow torch in the world, it has such a wealth of improvements that the home without it is positively handicapped. In a jiffy, it delivers a flame 400 degrees hotter than ordinary torches. An intensifying baffle that enables you to get perfect results with any grade gasoline or kerosene. Comfortable pistol-grip handle. Twin Needle System prevents orifice troubles—so common with ordinary torches. Safety Valve and leakproof, sturdy tank. Easy to use, handle and operate. Lifetime service. No home should dare be without it. At your hardware store, or direct

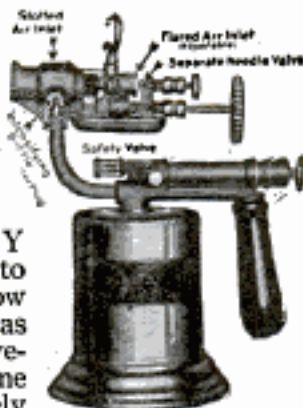

—get it now— **\$8.25**

### THE TURNER BRASSWORKS

Industry Ave., SYCAMORE, ILL.  
The World's Largest Exclusive Manufacturers of Blow Torches, Fire Pots and Brazers



## Save 1/2 Cost of New Tubes

### VACUUM TUBES REPAIRED

Guaranteed equal to new. Send in your burned out or broken tubes by P. P. All repaired tubes returned P. P., C. O. D. We try to repair and return within 48 hours.

**Harvard Radio Laboratories**  
200-204 Old Colony Ave., So. Boston, Mass.



## ARLINGTON

### Complete RECEIVER

NOTHING ELSE TO BUY **\$7.50**

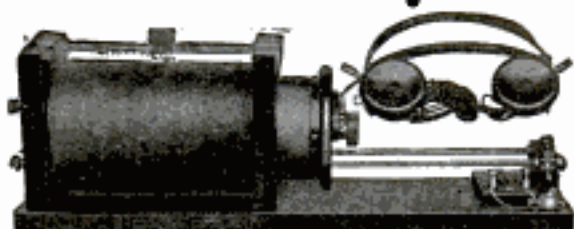

Here is a crystal set for the beginner. Brings in local broadcasting on all wave lengths and code signals up to 4,000 meters. Everything complete, head set, antenna, receiving set, and all insulators, etc., all for the unheard-of price of \$7.50.

Send your order at once, get into radio, you will find the future has big opportunities and big salaries for those who know.

**HECCO ELECTRIC COMPANY**  
911 Sheridan Road Menominee, Michigan

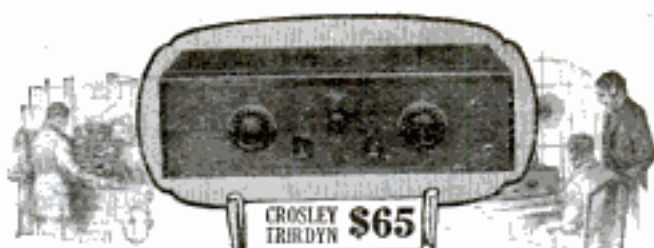

## Approved by Over 200 Experts New Crosley Engineering Achievement

A three tube set with five tube efficiency—the greatest selectivity with the minimum effort—positive calibration to any wave length between 200 to 600 meters. These are only a few of the many advantages offered in the remarkable new Crosley Tridyn Radio Receiver.

It took us a year of constant experimenting to perfect this exceptional instrument. Then we shipped 200 to experts in every part of the United States, to let our judgment be correct. Their opinions were unanimous—"the last word in radio accomplishment"; "ease of logging and selectivity remarkable"; "this set should go over big," etc.

The Crosley Tridyn in range, volume and selectivity is the equal of any five tube receiver on the market. Greater volume will, of course, be obtained through the use of storage battery tubes, but it will function well in any type and can be used with either indoor or outdoor antenna.

There will be a great demand for the Tridyn, licensed under the Armstrong U. S. Patent No. 1,113,149.

See it at your Dealer's today.

### CROSLEY

Better—Cost Less  
Radio Products

The Crosley Radio Corporation  
POWEL CROSLEY, Jr., President

Formerly  
The Precision Equipment Company and Crosley Manufacturing Company  
615 Alfred Street CINCINNATI, OHIO

## AMPLION

The World's Standard Loud Speaker

EVERYTHING IN  
**Radio**  
CATALOG  
**FREE**



GENUINE  
**UNIVERSAL**  
KNOB  
AND SCALE  
**\$1.16**  
POST PAID



Replace present Dials with UNIVERSALS—make your set 100% more selective. Log stations accurately by dial numbers. One knob tunes vernier fine or rough at will. Write for free Radio Catalog. Quick service. Reasonable prices. Money back guarantee. Address: Department C6, Atwood-King, Inc., 163 W. Washington St., Chicago

## ATWOOD KING

INC.

### RADIO PARTS AT CUT PRICES

Largest stock in New York. Everything brand new and first-class. Orders shipped quickly and carefully. Prices include delivery. We can sell for less than others because we buy in big quantities, pay spot cash, and ask only a small profit.

**SEND NO MONEY** Just pay postman on delivery. Reference Corn Exchange Bank, Terminal Branch (capital \$10,000,000). Satisfaction Guaranteed.

Transformers, All-American, 3-1, 5-1, 10-1. (\$4.75) . . . . .	\$3.45
Tubes, O-T 2, 4-v., dry cell; made by DeForest. (\$6.00) . . . . .	3.95
Tubes, RCA WD-11, or WD-12, 1 1/2-volt, dry cell. (\$5.00) . . . . .	4.30
Head Phones, Little Tattler; always satisfactory. (\$4.00) . . . . .	2.95
Head Phones, Baldwin "C"; double; none better. (\$12.00) . . . . .	8.45
Couplers, Genuine Capitol All-Wave 150-3000 meters. (\$7.00) . . . . .	5.45
Variometers, Liberty, moulded; 150-600; best. (\$7.00) . . . . .	2.95
Loud Speakers, Perfectone, adjustable; excellent. (\$15.00) . . . . .	11.45
Loud Speaker Units, Blue Streak; single; any horn. (\$3.45) . . . . .	2.45
Neutrodyne Kits, Work-Rite, Hazeltine patents. (\$17.50) . . . . .	14.25

**FREE!** With your first order we will send you free a \$288 in. radio station map of the United States and a set of 31 Decalcomania name transfers for your panel.

Send for Bargain Catalog Book crammed full of sets, parts, accessories and diagrams. **WRITE FOR IT TODAY!** LIBERTY M. O. HOUSE, Dept. R163, 106 Liberty St., New York



**NEW**  
**Lung Developer**  
**Makes**  
**"Deep Breathing"**  
**EASY!**

*Increase Your*  
**CHEST EXPANSION**  
*One Inch in Five Days*



**Develops**  
**Neck, Chest,**  
**and Shoulders**  
**to Striking**  
**Beauty**

*Automatic Resistance Gives*  
**GREAT LUNG POWER—**  
*Perfect "Breath Control"*

## Double Your Breathing Capacity

### THE PSYCHO-EXPANDER

This wonderful new invention will enable any man or woman to thoroughly master correct breathing; increase the chest expansion 2 to 5 inches; enlarge the chest to its full beauty; fill out the hollows of neck, shoulders, arms, develop a beautiful classic figure, recharge the system with renewed strength—power—vitality. Nothing like it ever invented before—registers automatically your correct chest expansion and cubic inches breathing capacity.

The principle of the PSYCHO-EXPANDER is that which gives to Great Singers and Grand Opera Stars such perfect health and charming physical development.

**Wonderful Invention for Singers, Speakers, Teachers, YOU!**  
**PERFECT BREATH CONTROL** and richer tone quality of the voice now assured. Results amazing for everyone who desires to improve in voice and health. It is a positive fact that many who have practiced so-called "deep breathing"

for years, have been able to increase their chest expansion one inch in less than one week with this invention—and take into the lungs without conscious effort a greater quantity of oxygen with each normal breath. You know what this means—new life—better health—more energy—beauty—superb physical development—a charming voice and personality—even longer life.

**Men—Women—**You have NOT been LIVING before. Write for our valuable new book, "FRESH AIR BEAUTY"—filled with startling facts that will surprise you—with letters hard to believe, telling of the merits of the PSYCHO-EXPANDER.

**PSYCHO-EXPANDER CO.**  
 Dept. M, 1900 So. University Ave., Denver, Colo.

Please send quickly your valuable new book—"FRESH AIR BEAUTY"—and full information of your Special 10-Day Offer.

Name.....

Address.....



No. 608

### FROST-RADIO

SEE this handy, low priced, single-hole, panel-mounting battery switch at your dealer's. A big value in a quality product.

List 30c

HERBERT H. FROST, Inc.  
 154 West Lake Street, Chicago

FROST-RADIO

## Wrestling Book FREE



Learn to be an expert wrestler. Know scientific wrestling, self-defense, and jiu-jitsu. Develop a splendid physique, and have perfect health. Join this popular school and learn by mail. The famous world's champions—the marvelous

### Frank Gotch and Farmer Burns

offer you a wonderful opportunity. Wrestling is easily and quickly learned at home by mail. Men and boys write now for splendid free book. Learn all the science and tricks. Be able to handle big men with ease. Accept this wonderful offer NOW. Send for free book today, stating your age.

Farmer Burns School of Wrestling, A977, Range Bldg., Omaha, Neb.

## GIVEN VACUUM TUBE RADIO SET

Can receive 100 miles and more,

**RUSH** your name to learn how you can get a Vacuum Tube Radio Set

**WITHOUT COST**  
 Don't delay, write today for FREE RADIO PLAN.

HOME SUPPLY CO.  
 Dept. 67  
 131 Duane St., N. Y. C.



*Your money goes farther with Murdock*

**MURDOCK** Radio Phones are one of the best 'phone values on the market. They are famous for their ruggedness, clarity and volume reproduction. The new flat headband permits you to wear Murdocks for hours without discomfort.

Get a pair of Murdocks today and test them out. They are fully guaranteed. Write for **FREE BOOKLET**—"The Ears of Radio."

WM. J. MURDOCK CO.  
 349 Washington Avenue, Chelsea, Mass.  
 Branch Offices: Chicago and San Francisco.

STANDARD SINCE 1904



# Diamonds

## Here at 60% of Market Price

Never in three quarters of a century have we offered such amazing bargains. Hundred of money-saving opportunities in latest Diamond Bargain List, equalling those shown here.

Here's why we can offer such remarkable values: This 75 year old firm—rated at over \$1,000,000.00 capital—the largest and oldest diamond banking institution of its kind in the world has made loans on Diamonds, Watches, and other jewels in excess of \$25,000,000.00.

### Why Pay Full Prices Costs Nothing to See

Thousands of unpaid loans. Must sell now. Diamonds, Jewels, Watches and other Gems of unusual qualities—at an entirely different price basis—viz: loan values not market values. At our risk we send you any bargain you wish for absolutely free examination. No red tape. No obligation. Don't buy unless satisfied you can not match the bargain at 60 per cent more. Diamonds of desirable quality at \$225 per carat. Yes, some even lower priced—also, finest gems obtainable at higher per carat—but proportionately low bargain prices. Our bargains have guaranteed loan values also, unlimited exchange privilege at full prices.

## Latest List Diamond Loans

Send at once for latest list. Thousands of unpaid loans and other special advantages bargains described in full detail with exact weight, color, quality, etc. Get details of Free Examination offer. No obligation. List is free.

### Mail Coupon Now



**\$38<sup>50</sup>**  
1/2-3/8 Ct  
Perfectly Cut



**\$186**  
1-3/32 Ct.  
Blue White



**\$55**  
2-2/32 Ct.  
Show Cluster



**\$62**  
1/4 Ct  
White Gold

*For Weddings, Graduations, Etc.*

**Only**  
Savoyette  
Foot Office

**Jos. DeRoy & Sons,**  
1921 DeRoy, Bldg., Pittsburgh, Pa.

Without obligation, send me free, your latest Bargain List of Diamonds, Watches and other jewelry.

Name.....  
Address.....  
City..... State.....

# WINDOW SIGNS



## AGENTS 500% PROFIT

### Genuine Gold Leaf Letters

#### GUARANTEED TO NEVER TARNISH



For store fronts, office windows, Bank windows, Office Doors, Panels, Board Signs, Trucks, Automobiles and Glass Signs of all kinds. Anyone can put them on and make money right from the start without previous experience. All you have to do is to show your samples; the letters are very attractive and easy to sell. Letters costing 4c sell for 25c. One agent says: "Your Letters are the best thing I have seen in years: I have made \$125.00 the first week and still going strong." Paul Clark says: "Smallest day \$28.70." H. Gilder made \$835.00 in six weeks.

## \$60 TO \$200 A WEEK

### GENERAL AGENTS—

It is easy to appoint sub-agents for this line. We pay you 20% cash commission on all orders we receive from local agents appointed by you anywhere. We allow you 50% discount on your own orders. You can sell to nearby trade or travel all over the country, as you please. Large demand for window lettering everywhere. Write today for free sample, full particulars and liberal offer to general agents.

**Metallic Letter Co., 433-B N. Clark St., Chicago**

# MOTORCYCLES

## ONE YEAR TO PAY



Know the joy of owning—for business or pleasure—a **Harley-Davidson, Excelsior, Henderson, Indian, Cleveland,** or any other standard make; thoroughly rebuilt in our own factory.

Write for Free Bargain Bulletin and Easy Payment Plan.

**HAVERFORD CYCLE CO. OF PENNA.**  
America's Largest Cycle House  
Established 28 Years  
503 Market St., PHILA., PA., Dept. P. M.

## Custom-Made Tops Less Than Half Price

### EASILY ATTACHED



Full instructions sent. Complete tops with beveled plate glass, tacks, fasteners and welts. Free delivery 1,000 miles. For all cars; special prices on Stars, Overland Fours, Dodges and Chevrolets. Describe your car. Samples and money-saving Bulletin free.

**Automobile Trunks for Running Board or Rear Platform.**  
**S-C PRODUCTS CO., 767 Nicholas Bldg., Toledo, O.**

# RADIO

## Long Distance Set \$21<sup>98</sup>

### Everything You Need NOTHING ELSE TO BUY



Produces astonishing results. Receives music, speeches, information, instruction, sermons, etc., from broadcasting stations hundreds of miles away, usually a thousand or more. Satisfaction Guaranteed. Easy to operate. Cheapest means of entertainment ever devised. No knowledge of radio or electricity required. No money in advance. Bargain—only \$21.98 for everything needed.

**Send for Radio Book Free** Cramped full of useful information for all, especially beginners; and cut prices on parts and sets. Don't delay—write today.

**LIBERTY M. O. HOUSE, Dept. 1636, 108 Liberty Street, NEW YORK CITY**



**SPECIAL 30-DAY OFFER**

## \$25

# \$9000 a Year Money-Maker

That's what Anderson of Mansfield, O., earned with this wonderful target practice machine—the biggest novelty hit in the country. In two days one machine collected 1803 pennies—just think! Figure your profits. If you had 10 to 100 machines working for you EVERY DAY, you'd count your profits in four figures—your bank account would grow in leaps and bounds. Hundreds of machines now in operation earning \$200 to \$500 yearly each—regular mints for profit. Get one—put it in a billiard room, a store, a park or a club—then watch it hatch pennies! Regular price one outfit, \$35. **Special 30-day offer, \$25, or 6 for \$98, or 10 for \$177.** Send for your first outfit today. \$5 deposit—balance on delivery. Absolutely guaranteed mechanically perfect. Also write for exclusive selling rights—big money opportunity.

## PISTOL TARGET MACHINE CO. 5835 W. 22nd Street CHICAGO ILLINOIS

This target practice machine makes lots of fun. Everybody wants to try their skill. Penny in slot from pistol—if it hits bull's-eye, it comes back in slot at no cost to shooter. A most fascinating game of skill. Only a few of them will make you big money—many of them will make you a fortune.



# Turn Your Ideas Into Money

Develop your creative ability; let your talents push you ahead; make your genius and mechanical skill count. It matters not whether you are interested in light manufacturing, repairing, or experimental work; whether you are a mechanic, engineer, inventor, amateur or student; whether you work in metal, wood, or composition material, you can get along faster, develop your ideas better, and get results easier with the aid of

## The New Model "B" Baby Grand Lathe



Sturdily built of best quality materials. Capable of producing precision work with wide speed range. Operates same as large lathe. Thousands in use. Highly recommended by skilled mechanics. Not a toy—practical and dependable. Unique design, plus standardized methods of manufacture, makes possible an unusually serviceable tool at surprisingly low price. Sold only direct to user on money-back guarantee.

Write for illustrated story, complete description and prices.

**Watson Mfg. Co.**

106 Watson Bldg.  
Toledo, Ohio

Self-Filler DE LUXE Style Pen

### "INDEPENDENT"

All the best features of a Fountain. Lasts longer. Writes smoother. Improves handwriting. Eliminates fatigue. GUARANTEED.

**\$2.00**

By Mail

14 Kt. White Gold Point. Chased Rubber Holder. Lever Filler. Pocket Clip.

Your Name in Gold Inlay, 25c.

Write for Pen Catalog. Agents Wanted.

J. C. Ulrich & Co., 161 Washington St., New York  
Known the World Over for 40 Years.

## AGENTS

Make \$10 to \$20 daily selling Premier Knife and Scissors Sharpener.



## 200% PROFIT

or more. 9 out of 10 women buy. Produces keen edge quickly. Sells for 50c.

PREMIER MFG. CO.  
Dept. 29, DETROIT, MICH.

## "MOTO-ROW"

—The Ideal Combination  
Power and Row-Boat

Power when you want it—easy to row when rowing is necessary—the "Moto-Row" assures you of both.

The "Moto-Row" is 16 ft. long, 4 ft. beam, 14 inch depth. Equipped with 2 H. P. motor, housed under stern deck. Natural finished and copper fastened.

Here is a thoroughly practicable dual-purpose boat for fishermen, hunters and other sportsmen, at a moderate price. Write today for full particulars and prices.

BELLE ISLE BOAT & ENGINE CO.  
DETROIT, MICHIGAN



## You Men Are Alike

When I learned what 1,000 men wanted in a Shaving Cream, I knew what millions wanted

By V. K. Cassidy, Chief Chemist

GENTLEMEN:

I asked 1,000 men what they most desired in shaving cream.

We worked 18 months to perfect for you the ideal shaving cream. We made up and discarded 130 separate formulas.

We had before us all the other shaving creams created. We knew that countless men used each.

After 130 trials, we made a shaving cream which no man yet has matched. It excels in lather, in quickness, in durability. It excels in fine after-effects. It excels above all, in strong bubbles.

### We ask a test

We ask a test at our cost—a ten-shave test. We will then accept your verdict. If we serve you many times better than others we want your patronage. If we fail, we don't. Please, in fairness to yourself and us, mail this coupon to us.

### 5 things you wanted

It multiplies itself in lather 250 times, so a tiny bit suffices for a Super-strong bubbles support the hairs for cutting. No hairs falling down.

It acts in one minute. Within that time the beard absorbs 15% of water. The palm and olive oil blend leaves fine after-effects. The soap itself is a cosmetic.

It maintains its creamy fullness for ten minutes on the face.

To add the final touch to shaving luxury, we have created Palmolive After Shaving Talc—especially for men. Doesn't show. Leaves the skin smooth and fresh, and gives that well-groomed look. Try the sample we are sending free with the tube of Shaving Cream.

The Palmolive Company (Del. Corp.)  
360 North Michigan Ave., Chicago, Ill.

PALMOLIVE  
SHAVING CREAM

© P. Co. 1924



### 10 SHAVES FREE

and a Can of Palmolive After Shaving Talc  
Simply insert your name and address and mail to: Address for residents of Wisconsin, The Palmolive Company (Wis. Corp.), Milwaukee, Wis., Dept. B-748. Address for residents other than Wisconsin, The Palmolive Company (Del. Corp.), 360 North Michigan Avenue, Chicago, Ill., Dept. B-748. 2241A



## LUMINOUS PAINT

**Make Your Watches, Clocks, Etc., Visible by Night**

The very latest discovery in the scientific world, hitherto, practically unobtainable except at an exorbitant price, we have at last succeeded in producing this remarkable LUMINOUS PAINT, which, applied to the surface of any article, emits rays of white light, rendering it perfectly visible in the dark. THE DARKER THE NIGHT, THE MORE BRILLIANT IT SHINES. Quite simple to use. Anyone—you can do it, a little applied to the dial of your watch or clock will enable you to tell the time by night. You can coat the push buttons or switch plates of your electric lights, match boxes, and innumerable other articles; make your own Luminous Cigarettes, Luminous Rosaries, etc. Small bottle, price 25c. Larger sizes, 50c and \$1 postpaid.

## Serpent's Eggs

Box contains 12 eggs. When lit with a match, each one gradually hatches itself into a snake several feet long, which curls and twists about in a most life-like manner. Price per box, 10c postpaid, 3 for 25c.



## Potmend

Mends Ironware, Agate-wares, kettles, pots, pans, boiler, etc. Also copper, aluminum, lead boxes, iron pipes, cracks in stoves, broken china, porcelain, brick-draws, blazes, crockery, woodenware, marble, etc. Comes in powdered form. Just mix with water and apply. HARDENS LIKE IRON. Ready to use for a small crack. PRICE 15c, 3 for 40c, postpaid.



## Midget Bible

**GREAT CURIOSITY**  
Reading Bible in the World. One of a postage stamp—200 Pages. Said to bring good luck to the owner. A genuine work of art. Most to be seen to be appreciated. Make good money selling them to friends, church societies, etc. PRICE 15c each, 3 for 40c, 12 for \$1.35, 100 for \$7.50.



## STAGE MONEY

With a bunch of these bills, it is easy for each person of limited means to appear prosperous by flashing a roll of these bills at the proper time and peeling off a genuine bill or two from the outside of the roll, the effect created will be found to be all that can be desired. Prices, postpaid: 25 Bills 15c, 50 Bills 25c, 125 for 50c, or \$3.50 thousand.



## Wonderful X-Ray Tube

A wonderful little instrument producing optical illusions both surprising and startling. With it you can see what is apparently the bones of your fingers, the lead in a lead pencil, the interior opening in a pipe stem, and many other similar illusions. A mystery that no one has been able to satisfactorily explain. Price 10c, 3 for 25c, 1 dozen 75c. Johnson Smith & Co.



## Good Luck Ring

A VERY striking and uncommon ring. Silver finish, skull and crossbones design, with two brilliant, flashing gems sparkling out of the eyes. Said by many to bring Good Luck to the wearer, hence its name, Good Luck Ring. Very unique ring that you will take a pride in wearing. ONLY 25 CENTS.

## The Dying Pig



The most laughable novelty yet produced. Made of rubber, and you have only to blow it up and stand the pig on his feet, when he begins to squeal as he slowly collapses and finally lies down and dies in the most natural manner. You can blow him up as often as desired, and each time he will go through the same performance to the great amusement and delight of your friends. Price, 15 cents; 3 for 40 cents; one dozen \$1.35, mailed.

## Popular Watch Charms

**ONLY 15c**  
3 for 40c; \$1.35 doz.

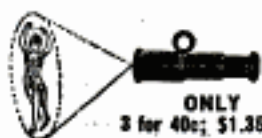

Very pretty little curiosities and decidedly novel. Fitted with Magnifying Lenses that enlarge the pictures to a very surprising degree. In fact, it seems almost incredible that a clear picture could be possible in such small compass, and how sharp and distinct they show up when you look through. Come in assorted sizes—Actresses, views of Panama Canal, Lord's Prayer in type, etc.

## Mystic Skeleton

A jointed figure of a skeleton 14 in. in height, will dance to music and perform various gyrations and movements while the operator may be some distance from it. **10c pd.**



## NEW BOOK ON ROPE SPLICING

A most practical handbook giving complete and simple directions for making all the most useful knots, hitches, rigging, splices, etc. Over 100 illustrations. All about wire rope attachments, lashing, blocks, tackles, etc. 37 Heraldic Knots illustrated. Of great value to mechanics, riggers, carpenters, boatmen. Price 20c ppd.



## MAGIC FLUTE

Wonderfully Sweet Toned and Musical. The Magic Flute, or Humador, is a unique and novel musical instrument that is played with nose and mouth combined. There is just a little knack in playing it which, when once acquired, will enable you to produce very sweet music that somewhat resembles a flute. There is no fingering, and once you have mastered it you can play all kinds of music with facility and ease. When played as an accompaniment to a piano or any other musical instrument, the effect is as charming as it is surprising.



## BLANK CARTRIDGE PISTOL

Protection against Burglars, Tramps & Dogs



Prices 50c \$1.00 Post-paid

Well made and effective; modelled on latest type of Revolver; appearance alone is enough to scare a burglar. When loaded it may be as effective as a real revolver without danger to life. It takes standard 22 Cal. Blank Cartridges obtainable everywhere. Price 50c, superior quality, \$1.00 post-paid. Blank Cartridges, by express, 50c per 100. Johnson Smith & Co., Dept. 129, Racine, Wis.

## DANCING BEAUTIES

Get a Kinemograph and see the picture move. France's latest sensation. A great surprise. Is worth twice what they cost. Are made of solid brass, highly polished and very durable. Satisfactory of your money back. **50c**



Johnson Smith & Co., Dept. 129, Racine, Wis.

## BOYS! BOYS! BOYS!

## THROW YOUR VOICE

Into a trunk, under the bed or anywhere. Lots of fun fooling the teacher, policeman or friends.



Never Fails. A 32 page book on ventriloquism, the Ventrillo, ALL FOR 10 CENTS

## 1000 Silk Remnants

for patching, Crazy Quilts, Sofa Cushions, Head Rests, Pin Pads etc. Large pieces, all colors and shades. Sure to delight you. For 10 Cents stamps, we send a large package and Book of quilt designs. 8 packages. 25c. 1 pound makes a lovely large quilt. Price 5c postpaid. Our silk is the best. JOHNSON SMITH & CO., Dept. 129, RACINE, WIS.

## LOOK 35c LOOK

Wonderful instrument. Greatest thing yet. Nine separate articles in one. Everybody delighted with it. Odd, curious and interesting. Lots of pleasure as well as very useful. It is a double Microscope for examining the wonders of nature. It is also an Opera Glass, a Stereoscope, a Burning Lens, a Reading Glass, a Telescope, a Compass, a Pocket Mirror, and a Laryngoscope—for examining eye, ear, nose and throat. It is worth all the cost to locate even one painful cinder in the eye. Folds flat and fits the pocket. Something great—you need one. Don't miss it. Sent by mail, with 420 page Novelty Catalog. **Only 35c or 3 for \$1.00**



## Resurrection Plant

One of the most wonderful plants known. Possesses the strange power of turning in a few minutes from an apparently lifeless, dry herb to a BEAUTIFUL LIVING FERNLIKE PLANT of a dark green color. Simply place the plant in saucer of water, it will open up and start to grow in 20 minutes. When taken out it will dry up and go to sleep until placed in water again. Fine house plant—summer or winter. 10 cents each or 8 for 25c. **AGENTS WANTED** post paid. JOHNSON SMITH & CO., Dept. 129, RACINE, WIS.



Address orders for all goods on this page to  
**JOHNSON SMITH & CO.**  
Dept. 129 RACINE, WIS.  
Our large catalog (420 Pages) of all the newest and best novelties, unobtainable elsewhere, free with every order.



**\$100 to \$200 Per Week**

**We Teach You How to Make It**  
 Money—big money—is waiting for you to come and get it. No matter where you live nor what your experience, we teach you how to make money.  
*Special Proposition Open Now*

**Fireite Sells on Sight**  
 TRADE MARK

Fireite amazes everyone who sees it used. A single demonstration often makes a dozen sales. It has saved many thousands of dollars of property damage. Men, women and children are astounded and fascinated by the ease with which it puts out an alarming fire. It is no exaggeration to state that Fireite is one of the easiest to demonstrate and fastest sellers ever made. Why? Because it is so simple a child can use it with one hand. **It always works**—(wonderful secret composition). No pump nor mechanism. Beautiful and long lasting. The low price is within the means of everyone—50% less than most others. Sold to every home, school, garage, factory, office, store, hotel, etc., wherever shown.

**AGENTS and MANAGERS WANTED**  
 In All Territory Not Taken  
 You can make big money using all or part of your time. We supply everything for your success. This is an **unusual opportunity** for a sound, substantial, permanent income. Write for our agent's—or manager's—special proposition today before it is withdrawn.

**FIREITE CO., Dept. 2, Masontown, Pa.**

**\$6.50**

**LITES-IT**  
 AUTOMATIC POCKET LAMP

**NO BATTERIES**  
 Current is Generated by Movement of Lever

The most practical Electrical Pocket Lamp ever invented. Think of it—no batteries. A simple movement of the hand generates a current that throws a powerful light. Has beautiful aluminum case—nothing to wear out—lasts a lifetime. Ideal for Sportsmen, Motorists, Miners, Watchmen, Camping Parties and should be in every home.

**ORDER NOW!**

—while our supply is big—the enormous demand will soon be ahead of our large production facilities. Don't wait—send \$6.50 by Postal or Express money order. We ship postpaid. Price in Canada \$6.75. Dealers write us on your letterheads for attractive sales proposition.

**Agents: Ask us to write you how to make big money selling the LITES-IT.**

**UP-TO-DATE MACHINE WORKS**  
 2913-15 So. Wabash Ave. Dept. 618 Chicago, Ill.

**GET RID OF THIS**  
*with no effort at all!*

Here is the easiest way in the world to rid yourself of that useless, joke-inviting, health-menacing paunch! Simply fasten on *Dr. Lawton's Automatic Waistline Reducer*—and the flabby flesh will vanish. Absolutely *automatically!*  
 For men and women.

## DR. LAWTON'S AUTOMATIC WAISTLINE REDUCER



Hour by hour, with every breath you take and every step you make, the *Waistline Reducer's* Vacuum Applicator massages away unwanted bulge. Made of soft, pliable, glove-like rubber. Fits snugly and comfortably to the figure. Weighs but few ounces. Flexible as a handkerchief.

### SATISFACTION A SURETY

*Dr. Lawton's Automatic Waistline Reducer* is sold under a guarantee bond of absolute satisfaction.

Your money back if you do not like it when you get it. Write now—this minute—to Dr. Lawton for full description, convincing literature and low price. Mail the inquiry blank below now to

### DR. THOMAS LAWTON

Dept. L, 19 W. 70th Street, New York City

Dr. Thomas Lawton, Dept. L, 19 W. 70th St., New York City

Dear Sir:—Send me complete description of Dr. Lawton's Automatic Waistline Reducer, convincing literature and illustrations, and tell me how low it is priced. This obligates me in no way.

NAME.....

STREET.....

TOWN..... STATE.....

## The Fansteel Balkite Battery Charger

for Radio "A" Batteries is noiseless, bulbless, and practically indestructible. It has no moving parts. Price \$19.50 (\$20 west of Rockies).

**FANSTEEL PRODUCTS CO., Inc., North Chicago, Ill.**

**Imperial Sanitary Floor**

Put on like Plaster  
 Wears like Iron  
 -waterproof  
 fireproof  
 resilient  
 noiseless  
 dust-less

Base and Floor  
 one solid piece

A composition material easily applied in plastic form over practically any kind of floor. Laid about 3/8 inch thick. Imperial floor does not crack, peel or come loose from foundation. A continuous, fine-grained, smooth, non-slipping surface. No crevices to gather grease, dirt, dust, disease germs or moisture.

Ideal Floor for Kitchens, Pantry, Bath Room, Laundry, Porch, Garage, Restaurant, Theatre, Hotel, Factory, Office Building, Railroad Station, Hospital—wherever a beautiful, substantial floor is desired. Several practical colors. Full information and sample FREE of your first and second choice of colors.

**Imperial Floor Co., 313-315 Halstead St., Rochester, N.Y.**

A Success for 15 Years





## PLAY Your Way to Success and Social Popularity

The man or woman, boy or girl, who can play the Saxophone finds a cordial welcome everywhere. For school, lodge, church or home entertainment the Saxophone has no equal. No other instrument has ever won such universal popularity in so short a time because no other instrument has that rich appealing tone and is productive of so many surprising orchestral effects. Many of the leading saxophonists in the country have proved that the Saxophone is a legitimate instrument. Only recently a very successful saxophone recital was given in Carnegie Hall. In most cases these artists are playing—

# BUESCHER

## TRUE TONE SAXOPHONES

The same kind we offer to you on easy payments—if it is not convenient for you to pay cash. We also allow 6 days' trial—in your own home. You will enjoy every minute while you are learning and soon be able to entertain others, with profit and advancement to yourself.

### EASY TO PLAY—EASY TO PAY

Write for Free Saxophone Book today. Then select the instrument you want. Within an hour you can play the scale—within a few weeks play popular hits and in 90 days take your place in band or orchestra. Write for the Free Book today.

### Buescher Band Instrument Company

Everything in Band and Orchestra Instruments

2559 Buescher Block

Elkhart, Ind.

Buescher Band Instrument Co.  
2559 Buescher Block, Elkhart, Ind.

Gentlemen: I am interested in the instrument checked below:  
Saxophone..... Cornet..... Trombone..... Trumpet.....  
(Mention any other instrument interested in.)

Name.....

Street Address.....

Town..... State.....

## In 15 Minutes



Good-  
bye  
Hot  
Summer  
Stoves!

## Any Range a Real Gas Stove

No more sweltering kitchens in Summer—no more fires to build—no more dirty coal, ashes or unsightly scuttles—no more smelly, sooty kerosene stoves—no more slavery to a hot kitchen stove in Summer!

The Oliver Oil-Gas Burner—in fifteen minutes makes your present coal or wood range a real gas stove that turns on and off with a valve. Gives much or little heat—when you want it—a twist of your wrist. Just like using city gas!

### Wonderful Baking and Cool Kitchens

Best of all you can bake with your own range oven—better than ever before. Sixteen models to fit every range or cook stove. Absolutely safe. Lasts a lifetime; 200,000 Olivers already in use. Special Low Introductory Price.

### FREE Book—Mail Coupon

Write quickly for Free Book showing how women are freed from Summer Drudgery over red hot stoves. Send letter or card to

**OLIVER OIL-GAS BURNER CO.**

Oldest and Largest Manufacturers of  
Oil-Gas Burners in the World.

656 Oliver Bldg.

ST. LOUIS, MO.

### AGENTS!

Oliver distributors make big money—\$300 and more a month. Oliver gives Fords away to producers. Big season, just starting. Write at once for details and Free Sample Case Offer.



## Big loads are easy for Auto-Wheel

Two, three, four happy boys are an easy load for the sturdy Auto-Wheel Coaster Wagon. Auto-Wheel Coasters are built for hard play. See how the body is put together. Not just nailed, but mortised. Auto-Wheel Coasters are so strong that we use them in our factory for carrying loads up to 1000 pounds (half a ton).

## Auto-Wheel Coasters and Auto-Carts

Write for catalog of all models of the Auto-Wheel and the Auto-Cart (for little brother and sister). If you send names and addresses of three coaster wagon dealers in your town, telling which sell Auto-Wheel, we give you a year's subscription FREE to the "Auto-Wheel Spokes-man," our magazine

**AUTO-WHEEL COASTER CO., Inc.**  
NORTH TONAWANDA, N. Y.





When the gas tank's dry, cuss words don't help. But SURE-O-GAS makes it impossible to drain the tank completely. No extra tank. No complicated connections. Just a valve anyone can install in five minutes. Pin a dollar bill to this ad. Write your name and address on the margin for a SURE-O-GAS valve and full instructions for installing. Your money back if not entirely satisfactory. Agents write for our liberal proposition.

*Every Ford should have one.*

**THE OTWELL COMPANY**  
6535 Livernois Ave. Detroit, Mich.



## Take a look at a genuine CRESCENT WRENCH

Pick it up. Grip the handle. Notice the feeling of ready power and ability it puts into your hand.

Twirl the thumbscrew. Notice how easily and smoothly the jaw moves to exact adjustment. Notice the narrow, yet super-powerful jaws, effective in cramped quarters where other wrenches are helpless. For general utility, there is nothing to equal it.



**CRESCENT TOOL COMPANY**  
210 Harrison St., Jamestown, N. Y.  
**CRESCENT TOOLS**

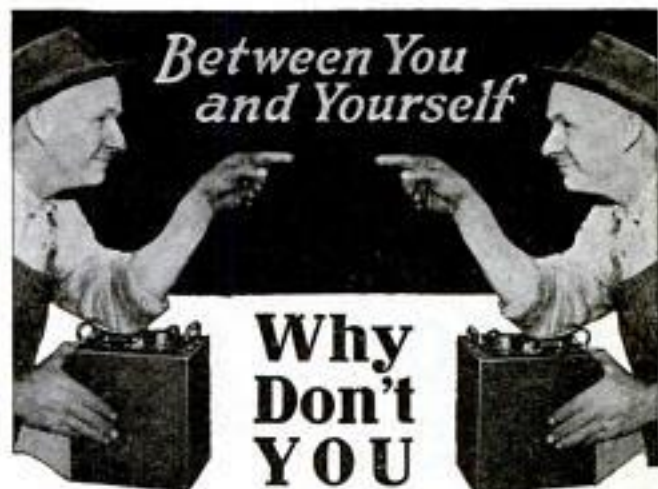

## Make Big Monthly Profits CHARGING BATTERIES!

You can easily add \$150 to \$300 monthly to your income with an HB Constant Potential Battery Charger. Battery charging is one of the biggest money-makers in the automotive service field. An HB charges batteries in a few hours that old-style outfits take 2 or 3 days to recharge. No experience is needed to operate an HB outfit—you can start it bringing you big profits the day it arrives. Thousands of HB Battery Chargers are in use, making big profits for the owners. There's a big opportunity for you, too!

## HB Battery Charging Quickly and Easily Pays for Itself

A small cash payment puts an HB 8 Hour Battery Charger in your shop, ready to set up and operate. Quickly and easily pays for itself on terms of only \$20 monthly, just a small part of the increased profits you make from 8 hour charging service. Every HB is built complete in our shops, not merely "assembled" by a sales agent. Sold to you complete with bus bars, connecting cable, etc., that other makers charge extra for. Big production and direct selling let us save you \$35 to \$115 in first cost alone on an HB over other outfits. Exclusive patented features make an HB the best outfit on the market, and your biggest money-maker. Cannot reverse. HB Patented Voltage Regulating Winding eliminates delicate regulators, insures constant voltage.

## Free 30 Day Trial on Money-back Guarantee

Order your HB outfit on trial and use it 30 days. If it does not fulfill every claim we make—cut charging costs, bring new business, make big profits, and give more complete satisfaction than any other equipment—you return it, and we will refund every cent you have paid us. Our positive guarantee of satisfaction - or - money-back gives you complete protection. Send your name and address for full information. Right now is the time to start making big battery charging profits.

*More HB  
Constant  
Potential  
Battery Chargers  
are in use  
than any other  
Make*

**HOBART Bros. Company**  
Box M6, Troy, O.





# I Want Men!

**Own Your Own Business—In  
Your Own Town. Make from  
\$5,000 to \$25,000 a Year!**

I must have at once one hundred ambitious men to own and manage, in your own home town, or elsewhere if you wish, our retail chain stores selling staple items (accessories, parts and supplies) for Ford cars at lowest prices ever known.

I have a proven, big money-making business. Our stores now operate throughout the country. By our plan you *undersell all competition* and own outright a steady, permanent year-round business.

You need know nothing of this business; experience is unnecessary. Any man of average industry and intelligence can follow my instructions and build a big, money-making business.



E. W. COWELL

## No Town Too Small

My plan protects you, as I place only one store in a locality. You take full charge at once, and sell *nationally known products* at less than competition can buy for. We supply everything needed—advertising, lists of buyers—*ready to pay you their money.*

If you are live, ambitious, want to own your own business and have a few hundred dollars capital, write or wire me *now* for full details and plain proof of what others are doing today and every day with our sure-fire plans. This is the chance you have been looking for. Grasp it NOW.

**E. W. COWELL, 618 South Dearborn Street, Chicago, Ill.**

# KERMATH

BOAT ENGINES

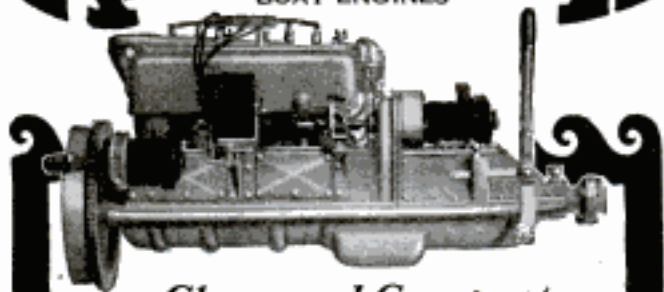

## Clean and Compact

The smartness and dignity of your runabout or cruiser will be augmented by a Kermath marine motor.

Its ease of operation and its dependability eliminate embarrassing situations.

Particular design and painstaking manufacture keeps away with spattering oil and grease—keeps the boat clean.

Remarkable economy of gasoline and oil gives a longer cruising radius.

Kermaths operate the finest boats. 80% of the good boat builders use it as standard equipment.

There is a Kermath for every type or size of boat.

3 to 50 H. P.

**KERMATH MANUFACTURING CO.**  
5886 Commonwealth Ave. Detroit, Mich.

*A Kermath Always Runs*

Send  
for this  
Bulletin  
it is **FREE**  
**POSTPAID**



## Prices of Bench Lathes

SIZE	Quick Change	Standard Change
9" x 3'	\$231.00	\$201.00
11" x 4'	278.00	238.00
13" x 5'	344.00	294.00

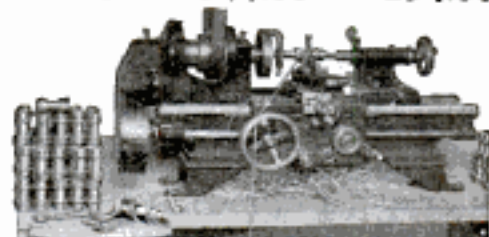

**South Bend Lathe Works**  
555 E. Madison St. South Bend, Ind.



# Read These Statements

*Then blame yourself if you do not make*

## \$200 a Week

You know it is against the Postal laws to make misleading statements. All right, we don't have to.

Ted Gnau started out with this amazing musical invention and averaged \$37 a day for four months. In 120 days he made exactly \$4,455. Can you beat it? We can.

We have records to prove that M. I. Mayer and George W. Phelps—team mates—split over \$20,000 in one year. Can you beat it? We can.

Note what this amazing musical invention has done for H. T. Gratz. From a clerk to one of the best high class salesmen, who made \$6,000 in less than one year. He says, "The old record I carried with me is that favorite, 'I Love You Truly,' and although it is badly scratched up, I expect to get at least \$5,000 more out of it. Here's the way I make it pay me a big income. I just put it on my Serenola—my marvelous new portable phonograph—and begin to play it for folks. Everyone is astonished to find that such a beautiful phonograph, with such a wonderful tone, so clear and pure, can be closed up like a suitcase and carried with you anywhere. And when they learn the price and the easy terms—it means an order, nine times out of ten. I have taken as high as 43 orders in one week."

### The Serenola is a Wonder

Something new and different. Sells easily and quickly. Does more than machines costing five times its price. Just the thing for the porch, garden, picnic or camp. Plays any record. **Fully guaranteed.** John McCormick says, "When it comes to the use of all makes of records, your machine does a better job of reproducing than any other I know of."

### RUSH THE COUPON

It will not obligate you to get the facts. We will show you the easiest, quickest, simplest plan for making big money that you ever heard of. If you are interested in an opportunity to make \$200 a week, cut out the coupon and mail it at once. Next week you will be making big money.

**PERRY-LUDLOW COMPANY**  
S-4848, DAYTON, OHIO



### A Clean Cut Sales Plan

We are not asking you to buy Serenolas and then leave you to shift for yourself. We have no territory for sale. What we have to offer the right kind of a man is a complete, practical and clean-cut plan of operation. All you have to do is demonstrate and take orders. We take care of all deliveries, collections, etc. If you have never made \$200 in one week, then you are going to make it from now on, if you act quickly. And \$200 is a conservative figure to set, it is a figure you can pass if you are ambitious and willing to hustle. To make \$16 before noon every day is one of the easiest things to do with this amazing musical invention. Show the Serenola—play one or two records—and you are more than likely to find that you have made \$8 for a few minutes' pleasant work.

### New Plan—Free Demonstrator

As soon as we receive the coupon below, or your letter or postal, we will send you full details about the Serenola, our sales plan, and also tell you how you can get a Serenola for demonstrating purposes without cost to you.

**Perry-Ludlow Company**  
S-4848, Dayton, Ohio

Mail me at once full particulars about the Serenola. State how I can get my demonstrating machine without investing any money.

Name .....

Address .....

City.....State.....



**MAKE MORE MONEY!**

**\$3,000  
PROFIT IN  
4 MONTHS!**

**CRISPETTES**

**GEORGE ALEXANDER** of Pennsylvania made \$3000.00 in 4 months making and selling CRISPETTES with this outfit. (Nov. 7th, 1923).

Jacob Gordon, New Jersey, (November 2nd, 1923), says: "Profits over \$4000.00 in 2 months"! Mesner of Baltimore \$250.00, in one day! M. L. Cronen, Ohio, (November 3rd, 1923), writes: "Doing big business—sold over 200,000 packages Crispettes last year". Mrs. Lane, Pittsburgh, says: "Sold 8,000 packages in ONE day".

**We Start You In Business**

Crispettes easy to make, easy to sell. We furnish everything—complete outfit, secret formulas, raw materials, full directions, wrappers, etc. No experience needed. Little capital starts you on road to wealth. Open a retail store of your own. Sell wholesale to groceries, drug stores, etc.

**Build a Business of Your Own**

Crispettes sell fast everywhere. Everybody likes them. They're a delicious confection. We'll tell you how to build a business of your own. Start now, in your town.

**Profit \$1,000 a Month Easily Possible**

Send for illustrated **BOOK OF FACTS**. Tells how many people in small towns and big cities are making big successes of Crispette Business. Shows how, when and where to start. Full of valuable information. It's FREE. Write now. Postal brings it.

**LONG EAKINS COMPANY**  
628 HIGH STREET SPRINGFIELD, OHIO

**Add to the appearance of Your Ford!**

Send for Ford Owners  
Cut-Rate Catalogue  
**\$1.00**  
for set  
of 4

Here's an inexpensive way of giving your Ford a ready and distinctive appearance. Put on **Lincoln Aluminum Hub Caps for Fords**

They are made especially hard aluminum of heavy gauge, the threads are strong and will not slip even when the heaviest oil is forced into the hubs. They are highly polished and retain their attractive finish. Put them on and give your Ford a handsome and distinctive appearance.

**PARTS-A-FORD CO.**  
1414 S. Michigan Ave., Chicago, Ill.

**Camp in Comfort**

"OUTDOOR" Auto Tents embody patented features found nowhere else. Made of High Quality. Close Coast specially woven drill, absolutely water-proof, mildew-proof and shadow-proof. Umbrella Tents have sewed in floor cloth; some with or without center pole; can be equipped with Cot Transoms (patented).



"Outdoor" Tourist Bungalow Exclusive Patented outfit. Folds to fit running-board. Nothing like it. Comfortable, complete, compact. Includes double bed, table, benches, covered trunk, and shelves for supplies. Up easy, quick, durable, waterproof.

WRITE TODAY for complete catalogue of Tents and Camp Equipment—sent FREE.  
**United States Tent & Awning Co.**  
Edward H. Lindholm, President  
731 North Sangamon Street CHICAGO, ILL.

**Vacation Days Are Sport Car Days**  
**Go Where You Will—Every Mile's a Thrill**

**AERO MODEL (Pointed Rear)**  
10 other models with standard roadster rear, side doors, fenders, etc.

**SPORT BODIES —\$2900**  
Complete new and a few Sport Rebuilt Fords, \$95 Up



**UNDERSLUNG FIXTURES**

4, 8 and 16 Overhead Valve Heads Sport Fenders for Underslung and Standard Fords.

Come in and see the largest and most beautiful display of Ford speed and sport roadster bodies and equipment in the East. Large illustrated Catalog Free.

**THIS MONTH'S SPECIALS**

	PRICE	NOW	PRICE	NOW
Underslung Fixtures, 3:1 or 2½:1 Gears.	\$12.50	\$9.95	Speed & P's Camshaft, Pr. Bucket Seats, pd.	\$19.00 11.95 9.95

Satisfaction or Money Back Guarantee. 50% with order, balance on delivery

**T. V. FORD SPEED & POWER EQUIPMENT MFRS., 250 West 54th Street, New York**

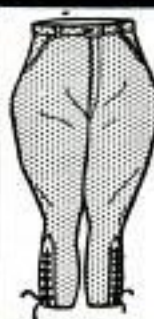
**OLIVE DRAB  
WOOL BREECHES**  
**\$1.50**

Like cut—new—in sizes from 32 to 40 waist. Strong, light weight wool, for summer wear—Made for Home Guards.

Catalogue Free

**W. STOKES KIRK**

1627-PM North 10th St., Phila., Pa.

**Used 110-Volt A. C. Guaranteed Motors**

Look and run like new



25 Cycles with Cord Plug and Pulley  
1/4, 1/6, 1/8 H. P. Speed, \$14.50

Split Phase..... 15.00

Rep. Ind. .... 22.50

Just the thing for the work bench. G. E. Westinghouse, R. & M., Emerson and others.

Nichols Motor Service Shops, Willoughby, O.

**Branston D. L. Honeycomb Coils**  
and Geared Back and Front Panel Mountings  
**BEST for SELECTIVE TUNING**

Superior construction and venier adjustment give better results in your set. Licensed under DeForest Patents. Send 2c for new Radio Manual with 3 Honeycomb Coil "Hook-ups."

**CHAS. A. BRANSTON, Inc.**  
819 Main St. Buffalo, N. Y.  
In Canada—Chas. A. Branston, Ltd., Toronto

**SPORT VISORS**

Just the thing for Motorists, Tennis or Golf players—on the beach. Protects the eyes from the sun—weighs less than 2 ozs. Transparent, unbreakable. Adjustable to any size head. No C.O.D. orders filled. By mail prepaid **50c**

**Criterion Cap Co., 37 W. 20th St., New York**



**MAN WANTED** by largest concern of its kind. Part or full time. EXPERIENCE UNNECESSARY. OUR MEN GETTING UP TO \$200.00 WEEKLY. Lowest Prices.  
**RED SEAL COAL COMPANY**  
354 Coal Exchange Building, Chicago, Illinois



# 57 Miles on a Gallon of Gasoline

I have been granted United States Letters Patent on a new automatic self-regulating automobile accessory which is a world beater. Under actual tests, with this device attached, automobiles have made as high as fifty-seven miles on one gallon of gasoline. It removes carbon from the cylinders and prevents spark plug trouble and over-heating. It can be installed in five minutes by anyone. It is the greatest gasoline, time, money and trouble saver in the history of the automobile industry. I have named it the Stransky Vaporizer and Decarbonizer. In the time this remarkable invention has been on the market the demand has grown rapidly. I have some splendid territory still open. I need State and County distributors. Do you want to earn

## \$250<sup>00</sup> to \$500<sup>00</sup> a Month

The Stransky Vaporizer and Decarbonizer is one article that practically sells itself. Previous selling experience is not essential in this business. If you have the energy and ambition to call on car owners and show them this amazing invention they will buy on sight. I stand squarely behind every Vaporizer and Decarbonizer I sell. I insist upon your being satisfied. I will supply you with free advertising matter, will send you practical sales suggestions and will help you in every way to make a big success of this business. If you have a car of your own, so much the better. If not, earn one by selling my Vaporizer and Decarbonizer.

## Join These Big Money-makers

Don't just wish that you could make a lot of money. Seize the opportunity to do it. What man has done, man can do. The people who wrote the letters from which the following extracts are taken were just ordinary, every-day people like you and I. You have the same grand opportunity they have. You can cash in on this opportunity the same as they have done. Read their letters, then decide to grasp this amazing opportunity and send in the coupon at once

### Best Sellers I Ever Saw

One day I sold one hundred eleven and another two hundred three. They are the best sellers I ever saw.—S. J. Brawley.

### In One Hour Sells Seventeen Vaporizers

The results of an hour's work—seventeen men gave me an order for Vaporizers.—J. W. Cronk.

### Sells Five Hundred in One Day

My best day's sales were five hundred Vaporizers, the next was three hundred and fifty, at another time I sold twenty-three in thirty-five minutes, and at another time twenty-seven in forty-five minutes.—W. F. Eberlein.

Address J. A. Stransky, Pres.

**J. A. Stransky Mfg. Co.**  
1000 Main Street, Pukwana, S. Dak.

### Had Sold Ten in Twenty-five Minutes After They Arrived

I sold ten in twenty-five minutes after I got them.—E. R. Jackson.

## Mail This Today!

### J. A. Stransky Mfg. Co.

1000 Main Street, Pukwana, S. Dak.

Attention: J. A. STRANSKY, Pres.

I am interested in your new Vaporizer and Decarbonizer. I would like to try out a sample at your risk. Also please give me your big Money-making proposition to distributors. This does not obligate me in any way.

Name.....

Post Office:.....

St., or R. F. D. ....

State.....





## *Do Your Tools Recommend You for the Job?*

**N**O matter how skillful you are, there's a certain added respect and admiration that a tool kit of good tools brings you from the boss you work for. He knows good tools—he can tell a carefully selected tool kit—and he knows the man who owns such a tool kit is the careful, thoughtful man he wants for the job.

The right kind of tools in your tool kit is a good advertisement for you, no matter where you go.

Brown & Sharpe tools are tools you can rely on to add to your good reputation. They are made by the first and largest maker of precision tools in America. They are known world-wide for their steadfast reliability and high quality. Send for our Small Tool Catalog.

**BROWN & SHARPE MFG. CO.**

Providence, R. I., U. S. A.

# **BROWN & SHARPE TOOLS**

*"The Standard of the Mechanical World"*



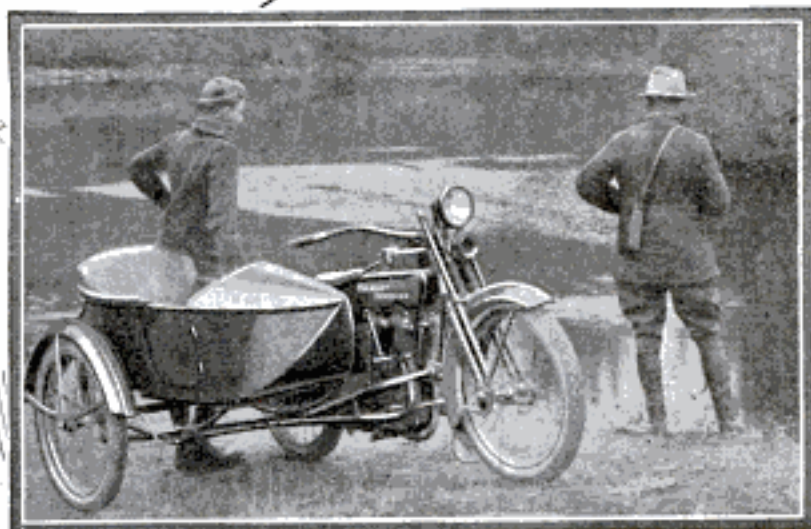

## More Fish! More Sport!

IF you like to fish, and if you'd enjoy swift, smooth jaunts away from the city's humdrum — get a *Harley-Davidson* this summer!

Where automobiles turn one way to follow the dusty parade — you speed the other, to hidden lakes where all the fish aren't "educated"! You can fish *three* lakes — in one afternoon — with a 1924 *Harley-Davidson* to whisk you from one to another!

Extra speed from the lightweight alloy-pistoned motor; Alemite lubrication (first on any motorcycle); easy-riding, full-floating sidecar; handsome olive green finish, maroon striped; wonderfully economical (50 miles for a dollar — gas, oil, tires and all)!

*Ask your dealer for a demonstration ride — free. Send us the coupon (at the right) now.*

HARLEY-DAVIDSON MOTOR COMPANY  
DEPT. P MILWAUKEE, WIS.

# Harley-Davidson

## The Motorcycle

Money-making sales opportunities in open territories. Write for particulars.

Harley-Davidson  
Motor Co., Dept. P  
Milwaukee, Wis.  
Send me free, postpaid, new catalog showing 1924  
models in actual colors.

Name \_\_\_\_\_

Address \_\_\_\_\_



# ELECTRIC LIGHTING FIXTURES

FROM FACTORY TO YOU AT FACTORY PRICES  
COMPLETE WITH GLASSWARE, ALL WIRED—READY TO ATTACH

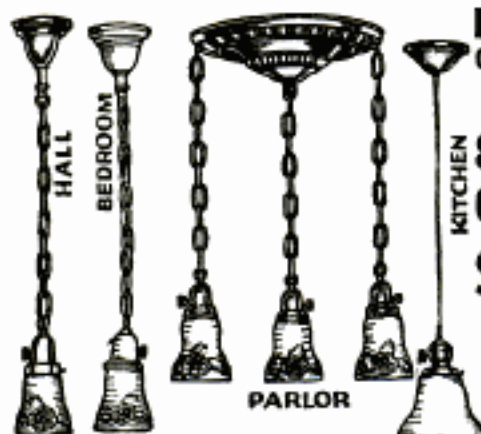

**8 ROOM Complete Set**

**\$13.95**  
Val. \$30

**5 ROOM CEILING SET COMPLETE \$19.50**  
Val. \$35



Living Room, \$6.75

Dining Room, \$7.00



This sturdy set is made of solid Brass, Satin or Flemish Finish. Highly polished Alabaster White Glassware—Completely wired with all the necessary attachments ready for installation—no extras necessary. **\$13.95 Complete**



DINING ROOM



Bed Room, \$4.25

Kitchen or Bath, \$1.50

Hall, \$2.25

The above fixtures can be purchased individually

### A RARE BARGAIN!

Latest creations now being installed in all modern up-to-date homes. Set shipped complete including glass shades and bowls, all wired ready to be hung. No extras required. Fixtures are made of genuine brass. You have a choice of Brushed Satin Brass, Jap Gold or White Enamel Finish. Glassware is of a beautiful white Alabaster Satin finish. Fixtures are of an artistic Patriotic pattern. This set regularly sold for \$35.00. Will last a lifetime. Specially priced . . . **\$19.50**

### WE PAY FREIGHT CHARGES

If you send cash, check or money order with your order. We also ship C. O. D. express, collect. Satisfaction Guaranteed or Money Refunded. **WRITE FOR FREE CATALOGUE**

The above fixtures can be purchased individually—Mention fixtures of \$13.95 set  
Hall \$1.50, Dining Room \$3.75, Bed Room \$1.50, Parlor \$4.75  
Kitchen \$1.25, Big Bed Room \$2.50, Porch \$1.00, Bath Room \$1.25

**UNITED LIGHTING FIXTURE CO., Inc., 280 Bowery, NEW YORK CITY, Dept. R**

Saws Logs—Falls Trees—  
Buzzes Branches  
—Does Belt Work  
M-Tear  
—Cuts  
or Easy Terms.

**One Man Saws 15 Cords a Day!**

—Easy with the OTTAWA Log Saw! Wood selling for \$3 a cord brings owner \$45 a day. Use 4 H. P. Engine for other work. Wheel mounted—easy to move. Saws faster than 10 men. Shipped from factory or nearest of 10 Branch houses. Write for FREE Book—"Wood Encyclopedia"—today.

**OTTAWA MANUFACTURING CO.**  
1741-T Wood Street, Ottawa, Kansas  
Room 1741-T Magee Bldg., Pittsburgh, Pa.

## Diamond Sensation



**AT LAST!!!**

Amazing new discovery of **RAJAH GEM** startles Jewelry World. Can be put to acid or file tests, dazzles and sparkles like a diamond costing several hundred dollars.

### AGENTS

**Making \$100** weekly introducing these magnificent gems. Sample case free. Write quick.

**RAJAH DIAMOND CO.**  
Dept. 60 Salisbury, N. C.

## We Want Agents at \$50 to \$90 a Week

**New Invention—Just Out.** Needed in every home every day. Patented. Nothing else like it. Low priced—**Sells on sight.** Sharpens any kitchen knife, paring knife, carving knife, bread knife, or shears and scissors in **ten seconds.** Mechanical masterpiece. A child can use it. Just put knife in slot—turn crank—sharpens both sides at once automatically. **We want representatives at once—men and women hustlers.** Get this position where **profits start first day.**

### No Experience Necessary—200% Profit

Make as much money next week as these men are making now. J. C. Lewis, of Kansas, says: "I have sold one hundred sharpeners in four days." Hobart Kerr, of Md., writes: "The women can hardly wait till they get them." Herbert Cain, of Ky., sold nine after supper. At the end of the first day, J. W. Gordon, of Pa., writes: "I sold two dozen and I sold to everyone I saw." Wm. G. Hall, of N. J., says: "I think it is great. I sold six in about one-half hour. The machine is a mighty fine proposition. I am a mechanic and I know what I am talking about." You can make this money. **WRITE TODAY. TERRITORY FREE. Get busy at once.**

**QUICKEDGE SHARPENER CO.** 106 Sharpener Bldg.  
159 West Pearl St. Jackson, Mich.

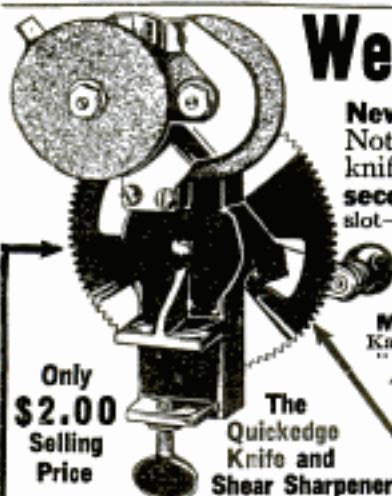

Only \$2.00 Selling Price

The Quickedge Knife and Shear Sharpener





## The Phones with the New Idea

**N** & K Head Sets mark a new era in radio reproduction—an era of *clearness* and *naturalness*. Designed especially for the reception of *musical tones*, they record the entire range of the human voice and of musical instruments with extreme clearness and freedom from distortion. This is due to mechanical design different from that of any head set produced in America. The *extremely careful quality of workmanship* used is almost impossible to obtain in this country.

### Sold on a comparison basis

If, when you use N & K Phones on your own radio set, you do not find that they reproduce all the tones more clearly and naturally than any set you ever used before, and if they do not fit more comfortably, the store where you bought them will refund your money, promptly and cheerfully. We protect dealers and replace any returned phones.

N & K Head Set, Model D, 4000 ohms, has extra large diaphragms and ear caps, insuring better reproduction, better comfort and the exclusion of outside sounds. Sanitary, leather-covered head bands. Six feet of stout cord. Retail price \$8.50. Write for "The Phones the Fans Are Talking About," interesting new descriptive folder.

### TH. GOLDSCHMIDT CORPORATION

Dept. M 6, 15 William St., NEW YORK

Exclusive Distributors for U. S., Canada and Mexico



Imported

## PHONES

DEALERS: N & K Phones provide the high spot in the radio stocks of dealers all over America. Backed by advertising and strong sales co-operation, they are proving attractive profit-makers. Packed in cartons of ten, with display material.





# FREE—Book on Wood Finishing



Ask for a FREE copy of the Johnson Book at any store displaying our Service Department Sign shown below. If no store in your locality has a Johnson Service Department, fill out and mail coupon.



*Johnson's Wood Dye comes in all sizes—from half pints to gallons. It is conveniently put up in fine reseal glass jars.*



**O**UR book gives complete instructions for finishing all wood—hard or soft—old or new. Tells how inexpensive soft woods such as pine, cypress, birch, etc., may be finished so they are as beautiful and artistic as hard wood. Explains just what materials to use and how to apply them. This book is the work of experts—beautifully illustrated in color—gives covering capacities—includes color charts, etc.

## Johnson's Wood Dye

Johnson's Wood Dye is very easy to apply—it dries in four hours and will not rub off or smudge—penetrates deeply, bringing out the beauty of the grain without raising it. Made in seventeen popular shades, which may be easily lightened, darkened or intermixed. Full directions on every label.

Johnson's Wood Dye has many uses, for both the artisan and amateur. **Architects** and **contractors** specify it for coloring woodwork and flooring in new buildings. **Painters** and **decorators** use it with equal satisfaction on new and old woodwork of all kinds. **Housewives** delight in it for doing over old furniture and for coloring reed and wicker baskets, etc. **Manual training teachers** and **pupils** use it for finishing their models. **Upholsterers**, **furniture repairers** and **cabinet makers** find it "just the thing" for their work—old and new.

S. C. JOHNSON & SON, P. A. 6, RACINE, WIS.  
"The Wood Finishing Authorities"  
(Canadian Factory—Brantford)

Please send me, free and postpaid, your Instruction Book on Wood Finishing and Home Beautifying.

MY DEALER IS.....

My Name.....

Address.....

City & State.....



**S. C. JOHNSON & SON**  
"The Wood Finishing Authorities"  
Racine, Wisconsin



**I Want  
Agent  
Users**



# **CORD TIRE FREE and \$300 a Month!**

See how easy it is in your spare time to ride around, show and take orders for Mellinger, Hand Made, Oversize Cord Tires. Money rolls in; your prices defy competition; 70,000 users endorse these 12,000 mile guaranteed Tires. Big saving to tire buyers. I send you FREE the Master Salesman Kit as illustrated and if you will boost Mellinger Tires I have a surprising offer that will give you one of these oversize Cords Free for your own car.

**Earn Big Money** I don't ask you to risk one cent. Make your car an asset, not an expense. No matter what you have been doing, whether you live in the city or country, the MELLINGER PLAN starts you in business, all or part time and without capital or experience. Store keepers, farmers, garagemen, clerks, young fellows discontented with mere jobs at small salaries, all sorts of people got this MELLINGER PLAN and their financial success was remarkable.

**12,000 Mile Guarantee** and lowest wholesale prices in America saves car owners money and amazes everyone; makes money roll in for Mellinger Agents. Write me Right Now and get my inside figures and discounts, together with full details of the MELLINGER PLAN which is unequalled in money making possibilities. I will prove to you that it is the biggest opportunity you ever heard of. I ship tires prepaid on approval.

## **NEW BALLOON TYPE CORD**

Now Ready. Greatest achievement in tire history. Fits any wheel or rim. No extra expense. Greater Mileage—Greater Comfort. Sidewalls more flexible—30% lower air pressure.

## **SUCCESS LIKE THIS YOURS**

**Elbert Irwin**, Indiana, sells 34 tires and 34 tubes amounting to more than \$600 in cash in one month. He got a free set of tires and profits of \$210.00.

**Keighby**, Idaho, sells \$900; **Hirchcliffe**, Pennsylvania, sells \$1500 the first month; **Franklin**, Pennsylvania, sells \$600 a month. Thousands of others cashing in.

**Marshall Demerot**, an Ohio agent, within six months after his appointment is ordering 14 tires at a time. On just one such order his profit at regular retail prices is over \$60.00.

**George Zocher** of Illinois got a free set of tires and on his first month's sales orders netted a profit of approximately \$116.00.



**I Send This Master Salesman Kit FREE**

and in 5 minutes you can demonstrate tire secrets the average dealer knows nothing about. All in well bound portfolio with good size samples of fabric, cord, rubber, cross sections cut from tires and pure gum tubes.

**Get This Free Book**



## **If you own a car**

**Write Me Quick.** Don't buy anyone's tires until you see these amazing values on your own car. **THINK OF IT.** Oversize Cord Tires for less than fabrics used to cost. If there is no authorized Mellinger agent in your neighborhood, I want one owner to show and recommend Mellinger Tires. I will ship these magnificent Cord tires prepaid. Be the first from your locality to get my confidential offer. **MAIL THE COUPON TODAY—RIGHT NOW.** Don't miss it.

**B. L. MELLINGER, President**

**MELLINGER TIRE & RUBBER CO.**

**745 GRAND AVENUE**

**KANSAS CITY, MO.**

References: Any Bank or Trust Co., or Any Publication. Capital \$600,000.

### **Mail This Coupon Now!**

**Mr. B. L. Mellinger, Pres.**  
**1745 Grand Ave., Kansas City, Mo.**

Send me Free Book, Wholesale Prices and how, without investing money, I can become your authorized agent and get a free tire for my own use.

Name .....

Address.....

Copyrighted material





45 minutes' toasting develops  
its aristocratic flavor — the  
enormous production makes  
possible its democratic price

**LUCKY STRIKE**

"IT'S TOASTED"

