

POPULAR MECHANICS MAGAZINE

WRITTEN SO YOU CAN UNDERSTAND IT

REG'D. TRADE MARK, GREAT BRITAIN, No. 410426

REG. U. S. PAT. OFF.



ABRAHAM LINCOLN'S
FIRST INVENTION
PAGE 360

In 50 Days You Step Into a Real Job for Life at Big Pay

McSweeney Trained Men are Reaping a Harvest of Wages
Be an Auto, Tractor and Electrical Expert



Read what G. W. Smith, a McSweeney School Graduate, writes:

Dear "Mac":—
 Since completing your course I have made \$800 a month with my garage and agency. I owe this all to you.
 G. W. Smith,
 W. Alexandria, Ohio



Here is a McSweeney student working on a modern dynamo. Nothing electrical puzzles these fellows.



"McSweeney Training was the best investment I ever made."
 Colby Lord, Oakland, Maine.

More than 13,000,000 Autos and 1,000,000 Tractors and General Electricity need you. **ARE YOU READY? ARE YOU PREPARED?**

Do Wages From \$40 to \$150 a Week Appeal to You?

If so, sign and mail immediately the coupon below.
I'll Pay Your Railroad Fare to Cincinnati and Board You for 8 Weeks

Write for My Special Tuition Offer

The Rahe School of Cincinnati, Ohio, which, through the untiring efforts of J. H. McSweeney is rated among the best schools in the world, will now be known as the **McSweeney Auto, Tractor & Electrical School of Cincinnati, Ohio.**

McSweeney has successfully managed more Auto Schools than any man in the United States, and will now devote his entire time and attention to the McSweeney School of Cincinnati.

"Mac" has trained thousands of men. They are making good. Read what they have to say. Many own their own garages. They are making real money.



The Great McSweeney School

Are You Satisfied With Your Pay Envelope?

Are you contented? Ever wonder what you will be earning 10 years from now? Would you like to be your "own boss," like to be somebody in your town; like to have work at **real wages every Day?** Then you need to know what the **McSweeney Auto, Tractor and Electrical School** means to you, your pocketbook and your future.

Complete Auto, Tractor and Electrical Course Included

McSweeney offers without cost to every student complete instruction in general electricity: house wiring, motor and generator construction and automotive electricity.

What Does the McSweeney School Mean to Me?

Ask yourself that question—then read the answer here. Here you learn everything about the auto and tractor—engine, ignition, starting, lighting, carburetor, vulcanizing, welding, batteries, clutches, gears, differentials—absolutely everything. In 50 days you can tackle any auto or tractor in any condition and "put it on its feet."

Here Is Your Chance to Clinch Your Future—Don't Delay a Day

Send for my great Free Catalog—it tells the entire wonderful story. You work with tools. No textbooks. You learn on real autos—real engines—real tractors. Full electrical course included free.

McSweeney Auto, Tractor & Electrical School
 Desk 142, Ninth and Walnut Sts., CINCINNATI, OHIO

Without any obligation, send me your "big free book," "The Evolution of Transportation." Also information regarding special temporary tuition offer.

Name

Street

City State

(No facilities for colored students.)



McSWEENEY
AUTO, TRACTOR and
ELECTRICAL SCHOOL

Ninth and Walnut Sts.
CINCINNATI, OHIO

Successors to Rahe Auto & Tractor School, Cincinnati, Ohio

A Radio Statement to the Public

KEEPING its pledge to the public, the Radio Corporation of America has concentrated its vast research and engineering forces upon the solution of certain fundamental problems facing the art—problems which have become more apparent as broadcasting stations and radio receivers multiply.

The phenomenal expansion of the radio industry, and the universal and ever-increasing appeal of radio represent an outstanding development of the present century—for this industry has grown from infancy to maturity in a space of but two years. . . .

Briefly stated, there is today a necessity for

—*A radio receiver providing super-selectivity*—the ability to select the station you want—whether or not local stations operate. A selectivity which goes to the theoretical limits of the science.

—*Super-sensitiveness*—meaning volume from distant stations—along with selectivity.

—*Improved acoustics*—more faithful reproduction of broadcasted voice and music than has ever been possible before.

—*"Non-radiating" receivers*—a new development—a type of receiver which, no matter how handled, will not interfere with your neighbor's enjoyment.

—*More simplified operation*—a super-receiver requiring no technical skill, thus making the greatest achievements of entertainment immediately available to all members of the family.

—*A receiver for the apartment house* and populated districts, requiring neither aerial nor ground connection.

—*Another type of improved receiver for the suburban districts*, equally capable to that above, for use where the erection of an aerial presents no problem.

. . . .

Painstaking search in quest of these ideals has led to new discoveries, setting new standards of excellence and performance—discoveries, which have established:

First—that improved acoustics are possible—a matter of scientific research and not of haphazard design—for truly melodious reception.

Second—that dry battery operated sets can be so designed as to give both *volume* and distance.

Third—that the regenerative receiver is susceptible to marked improvement providing selectivity, sensitiveness and simplicity of operation hitherto deemed impossible of accomplishment.

Fourth—that the Super-Heterodyne—the hitherto complicated device requiring engineering skill to operate—could be vastly improved—improved in sensitiveness and selectivity—and simplified so that the very novice and the layman could enter new regions of entertainment and delight.

Watch For Further Announcements

Radio Corporation of America

Sales Offices:

233 Broadway, N. Y. C. 10 So. LaSalle St., Chicago, Ill. 433 California St., San Francisco, Cal.

Radiola

REG. U. S. PAT. OFF.

This One



NBD9-6YX-2P9N

*"Stop Depreciation BEFORE IT BEGINS—
BUILD WITH CYPRESS AT FIRST!"*

Tide Water
Cypress
"The Wood Eternal"

"is the World's Standard Specialty Wood for its particular uses—not merely an alternative commodity."

We recommend "Tidewater" Cypress only where it is best for you. Builders and prospective builders will be intensely interested in the following excerpts from the U. S. Government Report on Cypress—Bulletin 95, Dept. of Agriculture, Forest Service:

"CYPRESS is put to almost every use as an interior trim for houses natural color or stained contains little resin thus affords a GOOD SURFACE FOR PAINT, WHICH IT HOLDS WELL popular for kitchens, where it is subjected to dampness and heat *shrinks, swells or warps but little* For the parts of houses exposed to the weather it serves equally well. AS SIDING IT PRACTICALLY WEARS OUT BEFORE IT DECAYS made into porch columns it retains its shape, *holds paint*, and has sufficient strength It is placed as cornice, gutters, blinds and railing, and *is much used for Porch Floors and Steps* Much CYPRESS lumber is employed in the construction of *SILOS* The FARMER puts the wood to many uses ITS LASTING PROPERTIES FIT IT WELL for curbs *Resistance to decay* fits it for stable floors and timbers near the ground, as well as for gates, especially for fence posts one of the best available woods for picket fences, because it *shows paint well* and holds it for many years, *but lasts a long time without it* widely used for this purpose It is PRE-EMINENTLY FITTED for *greenhouse construction* where it is called upon to *resist dampness, excessive heat, and all the elements that hasten decay* sash, frames, benches, boxes, and practically all else the builder needs" (etc).

(You know the conservatism of Government Reports)

When planning a Mansion, a Bungalow, a Barn, a Garage, or just a Pasture Fence, remember—

"With CYPRESS You BUILD BUT ONCE"

SOUTHERN CYPRESS MANUFACTURERS' ASSOCIATION
1219 POYDRAS BLDG., NEW ORLEANS, LA., or 1219 GRAHAM BLDG., JACKSONVILLE, FLA.

INSIST ON TRADE-MARKED "TIDEWATER" CYPRESS AT YOUR LOCAL LUMBER DEALER'S. IF HE HASN'T IT, LET US KNOW.



Shmead and Colors Listed 347 Hard Woods in
 Pocket Photograph 394 Paper making 416

Popular Mechanics Magazine

200 E. Ontario Street, Chicago, U. S. A.

H. H. WINDSOR, Editor

London: Hachette & Co.,
 16-17 King William Street, Charing Cross, W. C. 2

Paris: Hachette & Co.,
 111 Rue Reaumur

Melbourne, Australia
 The Australasian News Co.

ISSUED MONTHLY

SUBSCRIPTION:

SINGLE COPY, 25 CENTS

In United States and its possessions, also Canada, Cuba, and Mexico, per year, postpaid - \$3.00

To all other countries in the Postal Union - 3.50

All subscriptions are discontinued at expiration. Please examine the date printed on your wrapper.

Entered as Second Class Matter Sept. 15, 1935, at the Post Office at Chicago, Illinois, under Act of March 3rd, 1879.

Entered as Second Class Matter at the Post Office Department, Canada.

Published monthly by POPULAR MECHANICS CO.

Copyright, 1924, by H. H. Windsor.

Copyright in Australia. Copyright in France

No. 41

Contents for March, 1924

No. 3

Accidents, Medical Tests for Autoists to Reduce	379	Fish—Third of All Caught Used in U. S.	374
Actors Prefer Carving to Playing in Movies	374	Floors on Felt-Lined "Chairs" Prevent Sounds	347
Air Fleets, Navy Builds Its Own	423	Flour Made of Sugar Beets Is Suitable for Baking	398
Airlane in Church Painting Has Saint as Patron	335	Frost, Salt Imitates Damage Done by	432
Airship, Pullman Luxuries in	394	"Fuel" Needed by Human Body Told by Its Heat	401
Alarm, Light Touching Electric Eye Acts as	330	Gases from Asphalt Roads Cause Death in Japan	378
Ants, Olive Oil in Bottle Lures to Death	399	Gasoline Can with Dial in Neck	372
Ark, Modern, Is Built to Escape Tidal Wave	350	Gasoline Has Fuel Rival in Vegetable Extract	358
Artists from Orient Build Mosque in Paris	364	Gem Scents Soothe or Excite Wearer	436
Ash Piles Are Made to Yield Millions	343	Glasses Dried and Polished by Electrical Buffer	412
Auto Bodies Made of Fabric End Squeak and Rattle	358	Gold Still Taken from 70-Year-Old Mine	416
Auto Castings Made of "Dust" from Blast Furnace	427	Golf Course on Roof	340
Auto Stage Depot Has Comforts of Hotel	372	Grader, Road, Digs Ditch and Plows Snow	430
Bank, Coin in Slot Operates Calendar	373	Grinder Oilstone, Sharpens Woodworkers' Tools	486
Bathing Pool for Wild Birds	388	Hacksaw, Power, Has Gap in Head	486
Bell and Buzzer Batteries Replaced by Transformer	422	Hair, Dog, Woven into Cloth	406
Belt Allows Baby to Crawl but Prevents Falls	406	Hammer, Power, Is Adapted for Light Smithing	483
Bicycle, Railroad, Aids Guard to Fight Forest Fires	407	Hangar for Giant Zeppelins Is Made Movie Studio	364
Boat, Flying, Is Kept Steady with Under-Water Wings	353	Heater on Faucet Takes Little Electric Current	435
Boiler Tests Show Big Increase in Power	417	Hippopotamus Trained to Draw Cart	341
Bottle, Turning a Nut Stops and Prevents Leakage	379	Horse Will Be Zoo Curiosity in Century	342
Brick Dug from Ruins Tells of Ancient Empire	400	Hospitals, Knockdown, Aid in Quake Relief	376
Brief-Case Built into Grip	342	Hunting Suit Helps in Stalking Water Game	416
Brush, Medicine Dropper in	413	Ice Card Held in Place by Spring Clip	389
Bugs Cost Farmers Billions	433	Ignition, Inclosed, Is Proof against Bad Weather	389
Buildings, Man-Made Quakes Test Stability of	406	Indian Craftsmen Show Skill in Silver Gifts	399
Burner Falls When Heated on One Side	400	Initials on Windows Look Tidy	417
Camera for Surveying Saves Both Time and Labor	335	Iron, Electric, with Three Heats	379
Camera Takes "Movies" at Touch of Button	333	Japan Is Enlarged by Quake	366
Camera Takes 2,000 Photos a Second	348	Japanese Quake Loss Placed at Billions of Dollars	412
Candle Is Grooved to Give Better Light	416	Jewels, Making Paste, Grows into Thriving Business	387
Car, Cable, with Step-Up Seats Climbs Mountain	352	Key Has Adjustable Teeth	334
Chain, Giant, of Revolution Defies Time and Rust	348	Kitchen in Cabinet Saves Space	373
Chair Seat, Porous Pad for	378	Ladder on Auto Bus Unfolds to Reach Baggage Rack	344
Check Endorsement Saves Time in Banks and Offices	426	Lamp Beneath Hood of Auto Keeps Motor Warm	432
Chicle Quest Beats Highway to Tropics	408	Lathe, Single-Speed Wood	485
Cities of Holy Land Unearthed by Americans	341	Lightning Rod's Use Grows, an Aid to Radio	364
Cities, Sacred, to be Linked by Rail and Water	343	Lincoln, Abraham, an Inventor	361
Clock Feeds Poultry and Turns on Lights	340	Lock, Automatic, for Window	352
Cloth Is Shrunk and Sponged by Steam in Boiler	422	Magnets Lay Nails Straight in Packing Boxes	330
"Coal Bin" for Locomotives Loads Two Cars at Once	353	Map, Details of Countryside Reproduced on	378
Coal Diggers and Dynamite Oust Homes	436	Marble, Artificial, So Real It Deceives Experts	380
Coal Is Saved by Air Drawn Down Hundred-Foot Stack	401	Medicine Dropper in Brush Stops Waste and Stains	413
Coal Mine Four Miles in Sea	432	Milling Tool Produces Finished Hexagons	484
Coal-Testing Black Diamonds by the Spoonful	391	Minds, Schooling, to Direct Skill of Hands	395
Connecting-Rod Tool Has Wide Range of Uses	484	Model Making Unites Business Men	327
Copper-Aluminum Alloy Has Many Uses	484	Monkeys with Forked Tails Sought in China	375
Cotton Picker Gathers Crop and Binds It in Bale	379	Motion Pictures of Lips Aid Deaf to Speak	379
Couples Handle Guards Lives of Brakemen	438	Motion Pictures—Soldiers Drive War Chariots	349
Cowboys Back O' the Yards	355	Motorcycle Jumps Eighty-Four Feet Through Air	427
Crows Measured by Meter on Auto Dashboard	372	Motorcycle Limousine Built on Side Car	331
Dam Saved from Flood by Arch	432	Mountain Split in Many Holes by Dynamite	375
Desert Secrets Bared by Modern Magic Rug	368	Movie Camera Holder Makes Tripod Needless	426
Divers Bring Fresh Waters from Under-Sea Springs	344	Movies Many Centuries Old	383
Dredges, Electric Seagoing, Built by Army	394	Mummies as Ornaments Become Fad	363
Eagles, Tons Slain in Alaska to Protect Fish	399	Music—Figures Replace Notes to Aid String Players	334
Electric Locomotive Is Victor in Tug-O-War	333	National Park System, Bat Cave Made Part of	427
Elephants Aid Builder Test Floors' Strength	382	Navy's Electric Fleet Has Power for Giant Tasks	366
Enamel from Cotton Resists Heat and Dries Rapidly	406	Oil, Eucalyptus, Rivals Gas	340
Exercises in Hammock Help to Reduce Weight	342	Oil to Protect Rail Tracks	352
Fan on Furnace Spreads Heat and Air	363	Oil, "Town Loo" Drilling for, Cause of Great Waste	426
Farms in Cities Predicted in Seventy-Five Years	363	Papering the World to Make Crops Grow	429
Fire, Pistol Discharge Stops	437	Pencil on Finger Ring Folds in Mounting	389
Fire, Water Curtains Guard Walls of Skyscraper from	391	Photo Press Rivals Speed of Printing	424

[Continued on Page 4]

Concrete Tower 350.

Brown Rot in Plums 392

Copyrighted material

Pipe Bowl to Smoke Cigar	380
Planets' Actions Shown by Motor Driven Globes	351
Pliers, Grip Is Locked by Handle Ratchet	383
Plow Digs as Handles Are Worked	358
Poison for Coyotes Replaces Traps and Saves Cattle	426
Powder Puff in Ring Has Mirror in Setting	373
"Prairie Schooners" to Recall Pioneer Days	413
Prize Offers and Announcements	487
Pumps, Mountain Stream Runs for Town	427
Pyrometer Measures Heat Radiated from Work	485
Quarry, Abandoned, Is Turned into City Park	431
Radio—Balancing Condenser for Loop Aerials	439
Radio—Beacon Gives Fliers Their Bearings in Fog	343
Radio—Broadcasting Station Uses Novel Headset	439
Radio—Building a Five-Tube Neutrodyne Receiver	441
Radio—Carrier Chain Aids Battery Users	440
Radio—Direction Finder to Point Wave Sources	389
Radio—Farmers Quick to See Merits of	440
Radio—Grid Leak Has Fine Adjustment	444
Radio—Lead-In Fits Under Windows	444
Radio—News May Be Broadcast to Army Men	443
Radio—Novel Crystal Detector	444
Radio—Novel Exhibits at Hub Show	440
Radio—Novel Transmission Experiment	439
Radio—Phone-Tip Jacks Make Plugs Unnecessary	444
Radio—Ribbon Antenna Has No Advantages	440
Radio—Simple Window Aerial	443
Radio—Speedy Telegraph Service for Fans	443
Radio—Switch Plug Has Novel Features	440
Radio—Two-Element Tube Needs No B-Batteries	443
"Rag Market" and "Flea Fair" Offer Paris Bargains	438
Railway Ties, Concrete, Have Wooden Plugs for Spikes	388
Redmanol Cut-Off Wheels Latest Development	485
River Jordan Is Harnessed to Light Holy Land	382
Rock Weighing Forty Tons Moved Three Miles	400
Sand for Railroads Safety Costs Millions Yearly	399
Science Notes for Daily Use	488
Science Turns the Holy Land into Rich Garden	383
Screwdriver, Power-Driven, Sets Nuts	344
Screwdriver, Rubber Handle, Keeps Blade Tight	413
Seas, Secrets of, Told by "Bottle Paper"	350
Seeds Buried Five Centuries Burst into Growth	351
Ships, Loading on Difficult Shores	414
Ships, 27,000 Now in Nation's Fleet	437
Shoes Recall Ancient Craft	376
Signal, Electrical, Tell When Battery Is Filled	407
Skyscrapers, Women Play Part in Building	373
Sleigh Road into Far North to Open New Land	437
Spark Plug Tester Fits in Pocket	374
"Sponges, Chemical," Take Odor from Refrigerator	353
Spotlight Glare, Shield Ends	347
Stack Falling Tells of Giant Forces at Work	331
Stage Wonders Work of Hidden Toilers	385
Steering Wheel, Button on, Dims Auto Lights	351
Store Drops Several Feet, Business Continues	407
Store, Uncle Sam's Ten Cent	431
Stores, Block Raised on Stilts to Build	438
Sugar, Corn, Is Made Cheaply	376
Talking with Eyelids, Police Learn	335
Tank, Spherical, for Gasoline, Stops Leaks	388
Tape, Metal, Stops Danger of X-Ray Burns	358
Tapping Attachment Saves Taps	483
Tobacco Smoke Not Harmful	340
Tractor Snowplow's "Wings" Cut Away Drifts	412
Traffic Marker for Streets Built of War Junk	351
Tree Trunk is Post Office	382
Trees, Which Are Best for Town and City	419
Tribes Found in Ceylon Is Laughter-Proof	373
Trolley, Trackless, Costs Less to Run Than Motor Bus	437
Tunnel Under Roof of World to Enrich Nation	380
Valve, Re grinding Unnecessary with "Seatless"	486
Valve Silencer Stops Wear and Noise	374
Vegetable Peeler Shaves Thin Parings	341
Wallpaper, from Stone Age to	402
Washer, Electric, in Cabinet Is Safe and Attractive	350
Washer with Sponge Spray Protects Auto Finish	401
Watch Has Only One Hand	383
Water, Sixty Miles of Pipe to Bring from Mountains	334
Weather Men Proved Nearly Always Right	423
Well Sunk in Bed of River to Find Depth of Rock	366
Wind, Sound of "Siren" Measure Speed	342
Wire Service for Drawings—Opened in France	341
Wood Carvers' Rival Sculptured Work with Art	330
Wood, Sawdust Is Turned into	342
World Events Are Screened from Pages of Magazine	351
Worms, Powder Used to Kill on Golf Greens	371
Worms that Dance on Waves Puzzle to Science	366
Wrench, Automatic Pipe, Grips Like Hand	483
X-Rays Made by Glow Worms	432

SHOP NOTES

Angles, Vertical, Field Protractor for	463
Auto Body, Correcting Listing	454
Auto Finishers Tack Rag	448
Auto Mechanic Kink	447
"Belter" for Concrete Road, One-Man	457
Brass-Cutting Tools, Lubricating	447
Casement Sash Groover	449
Cleaner, Kink for	449
Draft, Back, Preventing in Ventilating Pipes	456
Dustpan, Street-Cleaners	448
Faucet, Improved	452
Flywheel Prevents Light Fluctuation	453
Gas-Tank Plug, Bar for Unscrewing	453
Gates, Hog-Proof	455
Grain Conveyor, Cheap	445
Ink, Oilcan Spreads Stamp	463
Jointer, Building an Eight-Inch	450
Ladders, Safety Rung for	456
Mechanical Powers, Part I	458
Nail Heads, Cutting	456
Oil-Hardening Pan for Small Work	454
Pencil Sharpener Adapted for Draftsmen	455
Pipe Joints, Paste for	452
Pipe, Riveting Sheet Metal	446
Pipes, Repairing Leaking Suction	448
Piston Used as Pattern	453
Pneumatic-Tube System, Alarm for	447
Punch Set, Novel Drift Pin	446
Scaffold, Adjustable	464
Scale Protector, Platform	454
Seat for Wagon Spring	447
Stamps, Repairing Large Rubber	457
Torch, Cutting Circles with	464
Turret-Lathe Work, Removing Burs on	463
Upholstering Tool, Simple	457
Varnish Jobs, Stopping Dirt in	454
Varnish Work, "Pick-Up-Stick" for	449
Weeder for Small Crops	464
Whitewash, Better	449
Wire Tightener Acts as Gate	448
Wrench, Adding to Convenience of Pipe	455
Wrench, Emergency Pipe	463

AMATEUR MECHANICS

Bed, Improved Bough	467
Bookcase, Jogging Wall for	471
Carburetor Bowl, Repair for	478
Casters, Cork	476
Clutch, Cure for Grabbing	476
Collars, Using Old	475
Fishing Boat, Bucket Reduces Speed	468
Furs and Woollens, Cleaning White	468
Furs, Method of Stretching Green	467
Garbage-Can Holder	481
Garden, Manuring the Farm	482
Glass, Drawing on	471
Gloves, Finger Grips for	475
Golf Balls, Renewing	473
Heater, Homemade Auto	470
Heating Pad, Electric, Keeps Engine Warm	474
Jack, "Automatic" Car	481
Lathe, Bench, Simple Design	477
Lighting, Using Auto Battery for Lamp	479
Mats, Simple Method of Making Rag	472
Motor, Building a Small Turbine	465
Mud Chain, Effective	471
Photos, Firelight	480
Powder, Container, Safety Flash	471
Propeller, Increasing Effectiveness	472
Rag Strips, Fastening	476
Rat Poison	466
Sewing-Machine Heads, Tools Made from	469
Shutter Released for Self-Timer	474
Sign Hanger, Inexpensive	468
Silencer for Auto	466
Soldering-Iron Handle, Protecting	476
Spring Action, Brass Strips Improve	472
Stove, Making Inconspicuous	475
Stove, Simple Camp	475
Sulky Covers, Keeping in Place	482
Truck Stakes, Clips Prevent Loss	476
Valves, Easily Made Small	473
Washing-Machine Cylinder Hoist	480
Water Tank, Preventing from Freezing	474
Wheelbarrow for Concrete	475
Windows, Preventing from Steaming	467
Woollens and Furs, Cleaning White	468

Written, Aluminium. Rivets Cells in Range 417

DRAKE'S PRACTICAL MECHANICAL BOOKS

THEY WILL RAISE YOUR PAY—

ORDER ON 5-DAY TRIAL

The books listed below will perfect you in your chosen trade—pave the way to the big positions. Written in non-technical language—easy to read and understand. **Every book covers its subject completely. An entire course of instruction condensed into one volume.** Your choice sent postpaid—you benefit 5 days—money refunded in full if not entirely satisfactory. Order direct from this page.



1924
Edition

Automobile Books

- Automobile Starting, Lighting and Ignition, by Manly. [Pub. Jan. 1924.] 700 pp. Leatherette \$3.00
Brookes' Automobile Handbook, 1924 Edition. Leatherette \$2.00
Ford Motor Car, Truck and Tractor, by Manly. Cloth \$1.50
Starting and Lighting Troubles, Remedies and Repairs, by Manly. Leatherette \$3.00
Automobile Battery, Care and Repair, by Manly. Leatherette \$2.00
Automobile Catechism and Repair Manual. Leatherette \$1.50
Tires and Vulcanizing, by Tuford. Cloth \$2.00
Gas and Oil Engine Handbook. Cloth \$1.50
Automobile Upkeep and Care, by Manly. Cloth \$1.50
Motorcycle Handbook, by Manly. Cloth \$1.50

Shop Practice Books

- Sheet Metal Workers' Manual. Leatherette \$2.00
Oxy-Acetylene Welding and Cutting. Cloth \$1.25
Slide Rule and Logarithmic Tables. Leatherette \$2.00
Handbook for Millwrights. Cloth \$2.00
Modern Blacksmithing. Cloth \$1.25
Machine Shop Practice. Cloth \$2.00

ORDER DIRECT FROM THIS PAGE—ON OUR MONEY-BACK PLAN

The books listed above are only a few of the many in our catalogue, which you will receive promptly after filling out and mailing us the attached coupon. For quick action order direct from this page—cross name of each book wanted and send in with price quoted. We prepay postage and send the books on our money-back plan.

FREDERICK J. DRAKE & CO.

PUBLISHERS

1008 Michigan Ave., Chicago

Drake Books Are For Sale at All Book Stores

Mail Coupon For Free Catalogue
Your Guide to Home Study

- Mechanical Drawing and Machine Design. Cloth \$2.00
Pattern Making. Cloth \$1.50

Carpentry Books

Cloth Binding

- Modern Carpentry, 2 vols. \$3.00
The Steel Square, 2 vols. \$1.00
Wooden Boat and Shipbuilding. \$1.50
Modern Estimator. \$1.50
Timber Framing. \$2.00
Builder's Architectural Drawing. \$2.00
Concretes. \$1.50
Practical Bungalows. \$1.00
Low Cost Homes. \$1.00
Roof Framing, by Van Gasbeek. \$1.50
Stair Building and Hand Railing. \$1.50

Electrical Books

- Telephony, Including Automatic Switching, by Smith. [Pub. Jan. 1924.] 500 pp. Leatherette \$2.50
Practical Applied Electricity. \$2.00
Alternating Current. \$1.50
Electric Motor Control Systems. \$1.50
Wiring Diagrams and Descriptions. \$1.50
Electrical Tables and Data. \$1.50
Armature and Magnet Winding. \$1.50
Modern Electrical Construction. \$1.50
Modern Electric Illumination. \$1.50
Electricians' Operating and Testing. \$1.50
Motion Picture Operation. \$1.50
Drake's Electrical Dictionary. \$1.50
Electric Motors, D. & A. \$1.50
Electrical Measurements and Meter Testing. \$1.50
Drake's Telephone Handbook. \$1.50
Easy Experiments. Cloth \$1.25
Wireless Telegraph and Telephone Handbook. Cloth \$1.25
Telegraphy Self-Taught. Cloth \$1.25

Steam Engineering

- Swingle's Handbook for Steam Engineers and Electricians. Leatherette \$4.00
Examination Questions and Answers for Marine and Stationary Engineers. Leatherette \$2.00
Steam Boilers. Leatherette \$2.00
Swingle's Catechism of Steam, Gas and Electrical Engineering. Leatherette \$1.50

Painting Books

- Scene Painting and Bulletin Art. Cloth \$4.00
A Show at Sho' Cards. Cloth \$4.00
Sign Painting. Cloth \$4.00
Strong's Book of Designs. Cloth \$4.00
Strong's Art of Show Card Writing. Leatherette \$4.00
Signist's Alphabets. Cloth \$1.50
Modern Painter's Cyclopaedia. Cloth \$2.00
Automobile Painting. Cloth \$1.50
Estimates, Costs and Profits, Painting and Decorating. Cloth \$1.50
New Hardwood Finishing. Cloth \$1.50
The Amateur Artist. Cloth \$1.50
New Stencils. Cloth \$1.25
Chalk Talk and Crayon Presentation. Cloth \$1.25

Farm Books

- Farm Mechanics. Cloth \$1.25
Farm Buildings. Cloth \$1.25
Farm Engines. Cloth \$1.25
Traction Farming. Cloth \$1.50

Business and Reference Books

- Better Business Letters. Cloth \$1.00
Better Business English. Cloth \$1.00
Better Advertising. Cloth \$1.00
Finger Prints Simplified. Cloth \$1.25
Practical Bricklaying. Cloth \$1.25
Practical Instruction for Detectives. Cloth \$1.00
Practical Plumbing. Cloth \$1.50
Hot Water Heating. Cloth \$1.50
Elementary Chemistry. Cloth \$1.50
Courses in Civil Service. Cloth \$1.50
Cyclopedia of Recipes. Cloth \$1.50
American Star Speaker. Cloth \$1.50

Modern Languages

By Prof. P. S. Allen, U. of Chicago

- French without a Teacher. Cloth \$1.25
Spanish without a Teacher. Cloth \$1.25
German without a Teacher. Cloth \$1.25
Everyday French. Cloth \$1.25
Everyday Spanish. Cloth \$1.25

FREDERICK J. DRAKE & CO.
1008 Michigan Avenue
Chicago, Ill.

GENTLEMEN:—Please send me free, postage paid, your illustrated catalogue which lists and describes over 100 Practical Mechanical Books for Home Study.

My name is

and my address

I Can Train You For A \$3500 Hotel Job in 20 weeks



The Hotel Business offers wonderful opportunities to the trained man or woman! Now fourth largest industry in America. Hundreds of high-salaried executive positions now standing open—waiting for the trained worker. You can easily qualify for one of these big-paying jobs—in your spare time at home. No previous experience necessary.

I Guarantee to Teach You

in my 50-lesson home-study course on hotel work, all that the leading hotel experts know about the business—men making from \$5,000 to \$50,000 a year! My students are eagerly sought by the biggest and best hotels in the country. You won't have to look for a job. Big pay, fine living, free meals and apartment, fascinating work—these are only a few of the many advantages of hotel work.

Send for FREE Book

20 Years' Experience in 20 Weeks is what this wonderfully complete course gives you. Course prepared by Clifford Lewis, a hotel expert of national reputation. Endorsed by managers of such hotels as Biltmore, Waldorf-Astoria, Copley-Plaza, Commodore, etc. Interesting free book explains all. Send for it today.

LEWIS HOTEL TRAINING SCHOOLS

Founded 1916. The Original Hotel Training School

CLIFFORD LEWIS, President

Room L-330 Washington, D. C.
The National Institute for Hotel, Restaurant and Tea Room Training



Some men and women seem to attract success, power, wealth, health and attainment with very little conscious effort; others conquer with great difficulty; still others fail altogether to reach their ambitions, desires and ideals. Why is this so?

The Master Key will tell you why. No one can read it and not be a changed person. None but will emerge from its magic pages with a firmer grasp of the future—a surer understanding of what he can do.

The Master Key is a key with which many are converting loss into gain, fear into courage, despair into joy, hope into fruition.

A copy will be sent to you without cost or obligation of any kind if you will address

CHARLES F. HAANEL, 214 Howard Bldg., St. Louis, Mo.

\$50-\$300 a Week



Paint Cars in Auto Plants



Repaint Cars For Dealers



Own Your Own Shop



Be Head of Big Business

BIG PAY

made painting autos. You can do it. Highest paid work in whole motor car industry. You can step right into a job that starts you on road to success.

Most fascinating of all work. You can do the work as well as anyone else. Big pay right from start—every opportunity for advancement. You can make more money

PAINTING AUTOS

Work in big auto and body plants or for auto dealers. Jobs open all over country. Demand for men greater than supply. Work year round and always under most pleasing conditions. Also unlimited opportunity if you start auto painting shop of your own. Easily make

\$3,000—\$15,000 Year

We positively can teach you auto painting—exactly as done by master auto painters. You can go right from here to position. Pay big right from start. In few weeks we qualify you.

COME or WRITE

Come to Detroit; visit our school; see for yourself. Largest, finest equipped school of its kind in world. Only place where you can be taught by the "Wall System"—the system which teaches you everything and the right way from the start, in quickest possible time. School has highest endorsements and recommendations. Students from all parts of the country. Graduates holding best of positions everywhere—many own their own business. Or, write for facts. Send letter today. Act quickly.

ADDRESS

Detroit Auto Painting School
1410 Van Dyke Ave.
Detroit, Mich.

WE
FIT
YOU
FOR
BIG
PAY
IN
FEW
WEEKS

BART CHALK-TALK
If you can draw a little, you can do the Bart Chalk-Talk. Send 4c in stamps for Chalk-Talk folder and complete catalog of art and Chalk-Talk Supplies.
Bart Supplies, 508 Euclid Bldg., Minneapolis, Minn.

How to Box 40c
By Terry McGovern, James J. Corbett, J. Gardner Smith, M.D., Arthur P. Keeley and Gus. E. Keeley.
How to Box to Win, How to Build Muscle, How to Punch the Bag and How to Stand, Walk or Run.
This interesting book written by experts is known also as "The Book of Health and Strength." It will greatly assist everyone in keeping fit, in putting them in condition to master a strenuous undertaking either physical or mental.
68 illustrations. Size 4 1/2 x 7 1/2 in. Paper copy, 135 pages
SHREWSBURY PUBLISHING CO.
5371 West Lake Street, CHICAGO, ILL.

Learn Music

Make More Money

Never before such a demand for musicians as now. Not enough trained people to supply the positions open at theaters, clubs, hotels, amusement parks, orchestras and private entertainments everywhere. Big salaries waiting for those who can qualify. Learn to play an instrument and double or triple your earning power. Many musicians make as high as \$200 weekly.

Learn at Home—In Spare Time!

By the University Extension method, you can quickly and easily master any instrument. Experts will teach you by mail in your spare time. No special talent or previous study required. Thousands successful through this training. Write and mention instrument preferred. Postcard brings information.

UNIVERSITY EXTENSION CONSERVATORY
702 East 41st Street, Dept. 916 Chicago, Illinois

ELECTRICITY

THE BIG PAY TRADE

In Electricity there is a wide range of opportunity for the **trained** man—the man that knows the business **thoroughly**. In Hawkins Electrical Guides you find complete information and instruction, from the Basic Principles to Modern Methods and Short Cuts.

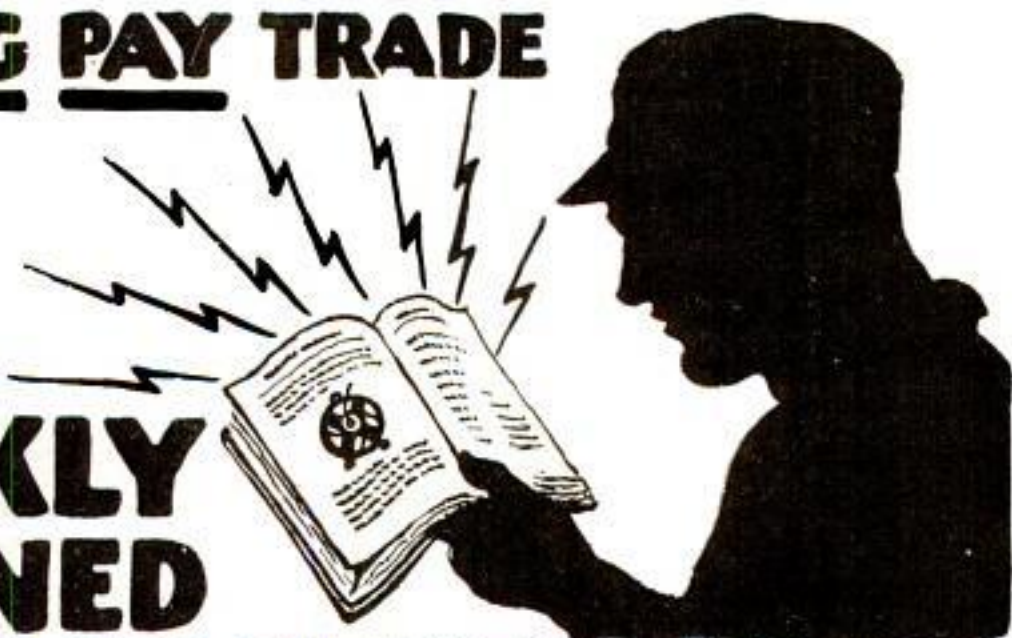

QUICKLY LEARNED BY EASY SPARE-TIME READING

Free
Exami-
nation
Coupon
Below!

No need to worry about getting a job or holding a job if you have a practical working knowledge of electricity. **Electricity** is the most Important Factor today. This is the Age of Electricity. Electrical Workers that really know electricity

are in demand! The way to keep in close touch with the progress made in electrical work is to consult these Guides daily for study, reference and review. **Hawkins Guides** will protect you from mistakes, check leaks, waste and increase your earning power.

HAWKINS ELECTRICAL GUIDES

3500 PAGES—4700 PICTURES—\$1 A VOLUME—\$1 A MONTH—10 VOLUMES

Know the facts in Electricity. They mean more money and better position for you. Hawkins Guides tell you all you need to know about Electricity. Every important electrical subject covered so you can understand it. Easy to study and apply. A complete, practical working course, in 10 volumes. Books are pocket size; flexible covers. Order a set today to look over.

LEARN ALL ABOUT THESE IMPORTANT POINTS

Magnetism—Induction—Experiments—Dynamamos—Electric Machinery—Motors—Armatures—Armature Windings—Installing of Dynamamos—Electrical Instrument Testing—Practical Management of Dynamamos and Motors—Distribution Systems—Wiring—Wiring Diagrams—Sign Flashers—Storage Batteries—Principles of Alternating Currents and Alter-

nators—Alternating Current Motors—Transformers—Converters—Rectifiers—Alternating Current Systems—Circuit Breakers—Measuring Instruments—Switchboards—Wiring—Power Stations—Installing—Telephone—Telegraph—Wireless—Bells—Lighting—Railways. Also many Modern Practical Applications of Electricity and Ready Reference Index of the ten numbers.

FREE Not a cent to pay until you see the books. No obligation to buy unless you are satisfied. Send Coupon now—today—and get this great help library and see if it is not worth \$100 to you—you pay \$1 a month for ten months or return it.

THEO. AUDEL & CO., 72 Fifth Ave., New York City

Please submit me for free examination, HAWKINS ELECTRICAL GUIDE, (Price \$1 a number). Ship at once prepaid, the 10 numbers. If satisfactory, I agree to send you \$1 within seven days and to further mail you \$1.00 each month until paid.

Name.....

Occupation.....

Employed by.....

Home Address.....

Reference.....

PM Mar. 24



OVER 5000
READERS
HAVE
OK'D
THIS
SET



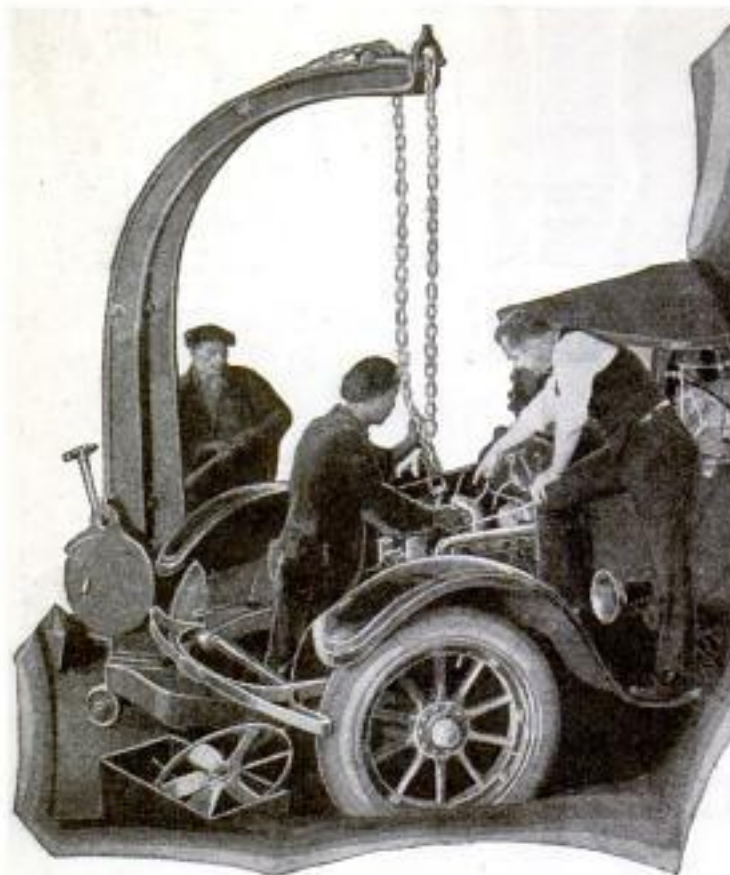

Be An **AUTO EXPERT**
Make \$75 to \$200
A WEEK

Learn
at Home
to **BOSS**
THE JOB!



B. W. COOKE, Directing Engineer

CHICAGO AUTO SHOPS

I WILL make you a successful **AUTO EXPERT**, prepare you to go into business for yourself, train you for positions paying \$3,000 to \$10,000 a year. Keep your job, stay home—just loan me a part of your spare time. As Directing Engineer of the big **CHICAGO AUTO SHOPS**, I know what training you need and I give it to you. I train you the "JOB-WAY"—not with books. Go into the best-paying business on earth—get your share of the thousand million dollars spent every year to keep Autos, Trucks and Tractors running!

I TRAIN YOU

AT HOME!

My home-training makes Auto **EXPERTS!** I prepare you to **BOSS THE JOB!** My "JOB-WAY" instruction makes you **MASTER** of every branch of Automobile work—Mechanical, Electrical, Battery, Ignition, Farm Power plants, Welding, Brazing, Vulcanizing, Garage Management, Salesmanship, etc. I guarantee satisfaction or to refund every penny of your money.

AUTO BOOK FREE!

Start Now! I'll help you start and help you succeed!

Inducements you cannot resist right now to ambitious men. Easy terms, within reach of everybody. Special Offer Now. Coupon

brings your greatest opportunity—mail it to me right away!

B. W. Cooke, CHICAGO AUTO SHOPS
Directing Engineer
Dept. 316, 1553 W. Madison St., CHICAGO

B. W. COOKE, Directing Engineer
Dept. 316, 1553 W. Madison Street, CHICAGO

Please send me Free Book and complete information about your "Job-Way" training at home. Tell me about the opportunities today for Auto Experts. I am mailing this promptly to secure **FREE REPAIR OUTFIT** and the reduced prices and special terms you offer now.

..... NAME
..... ADDRESS
..... CITY..... STATE
..... AGE..... OCCUPATION

MAIL COUPON TO-DAY!

EXPERTS WANTED!
\$3,000 to \$10,000 a year!

The "best-paying business on earth" is hungry for **EXPERTS!** Where else can you find such opportunities as in the **AUTO** business? 15 million Autos, Trucks and Tractors to keep going, 50 million tires to repair, 15 million starting, lighting and electric systems to maintain, 15 million batteries to service and replace. *Man alive!* Wake up to this rich money-making opportunity!

GO INTO BUSINESS!
Make \$5,000 to \$15,000 a year!

There are thousands of opportunities to go into business for yourself, with small capital. Auto Experts run big service stations, make up to \$15,000 a year! The same wonderful opportunity is waiting for you. My "Job-Way" instruction prepares you for it.

My "Job-Way" training makes successful high-price AUTO EXPERTS!

FREE OUTFIT
Big repair and testing outfit free to my students! Mail coupon for my remarkable offer. Use it to do my **JOBS**, use it to make money, use it to make this training pay for itself!

FREE JOBS
My big Employment Department helps my graduates get big pay jobs without one penny of cost.



The \$12 a week mechanic who became a millionaire!

TWENTY-THREE years ago, John C. Wahl was working as a mechanic in Peoria, Illinois, at \$12 a week.

To-day, he is a millionaire—having an income that runs into six figures—nationally and internationally known as the inventor of the Wahl Adding Machine, the Wahl Fountain Pen, and president of The Wahl Company, manufacturers of the famous Eversharp pencil.

It is interesting to note that the change for the better in the life of John C. Wahl came the day he saw an advertisement that hit him straight between the eyes. As he puts it, "it told how the International Correspondence Schools could make a draftsman of a fellow without interfering with his daily work." That day, John C. Wahl enrolled and started to build for the future. His present success is proof that he builded well.

"Pick the line of work you like best," he said the other day, "and stick to it. Study hard and success will take care of itself. Nothing is impossible when a man really makes up his mind that he's going to get ahead."

John C. Wahl is just one of thousands of I. C. S. students who have made good in a big way. The lives of such men should be an inspiration and a guide to every man who wants a better job and a bigger salary.

If the I. C. S. can smooth the way to success for other men, it can help you. If it can help other men to go forward to better jobs and bigger salaries, or to success in businesses of their own, it can help you, too.

At least find out *how* by marking and mailing this coupon. It doesn't obligate you in any way to do this, but it may be the means of changing your entire life.

MAIL THE COUPON TO-DAY!

INTERNATIONAL CORRESPONDENCE SCHOOLS

Box 3586-D, Scranton, Penna.

Without cost or obligation, please tell me how I can qualify for the position or in the subject before which I have marked an X:

BUSINESS TRAINING COURSES

- | | |
|---|---|
| <input type="checkbox"/> Business Management | <input type="checkbox"/> Salesmanship |
| <input type="checkbox"/> Industrial Management | <input type="checkbox"/> Advertising |
| <input type="checkbox"/> Personnel Organization | <input type="checkbox"/> Better Letters |
| <input type="checkbox"/> Traffic Management | <input type="checkbox"/> Show Card Lettering |
| <input type="checkbox"/> Business Law | <input type="checkbox"/> Stenography and Typing |
| <input type="checkbox"/> Banking and Banking Law | <input type="checkbox"/> Business English |
| <input type="checkbox"/> Accountancy (Including C.P.A.) | <input type="checkbox"/> Civil Service |
| <input type="checkbox"/> Nicholson Cost Accounting | <input type="checkbox"/> Railway Mail Clerk |
| <input type="checkbox"/> Bookkeeping | <input type="checkbox"/> Common School Subjects |
| <input type="checkbox"/> Private Secretary | <input type="checkbox"/> High School Subjects |
| <input type="checkbox"/> Spanish | <input type="checkbox"/> French |
| | <input type="checkbox"/> Illustrating |
| | <input type="checkbox"/> Cartooning |

TECHNICAL AND INDUSTRIAL COURSES

- | | |
|---|--|
| <input type="checkbox"/> Electrical Engineering | <input type="checkbox"/> Architect |
| <input type="checkbox"/> Electric Lighting | <input type="checkbox"/> Blue Print Reading |
| <input type="checkbox"/> Mechanical Engineer | <input type="checkbox"/> Contractor and Builder |
| <input type="checkbox"/> Mechanical Draftsman | <input type="checkbox"/> Architectural Draftsman |
| <input type="checkbox"/> Machine Shop Practice | <input type="checkbox"/> Concrete Builder |
| <input type="checkbox"/> Railroad Positions | <input type="checkbox"/> Structural Engineer |
| <input type="checkbox"/> Gas Engine Operating | <input type="checkbox"/> Chemistry |
| <input type="checkbox"/> Civil Engineer | <input type="checkbox"/> Pharmacy |
| <input type="checkbox"/> Surveying and Mapping | <input type="checkbox"/> Automobile Work |
| <input type="checkbox"/> Metallurgy | <input type="checkbox"/> Airplane Engines |
| <input type="checkbox"/> Steam Engineering | <input type="checkbox"/> Navigation |
| <input type="checkbox"/> Radio | <input type="checkbox"/> Agriculture and Poultry |
| | <input type="checkbox"/> Mathematics |

Name.....
 Street.....
 Address..... 11-21-23
 City..... State.....

Occupation.....
 Persons residing in Canada should send this coupon to the International Correspondence Schools Canadian, Limited, Montreal, Canada.

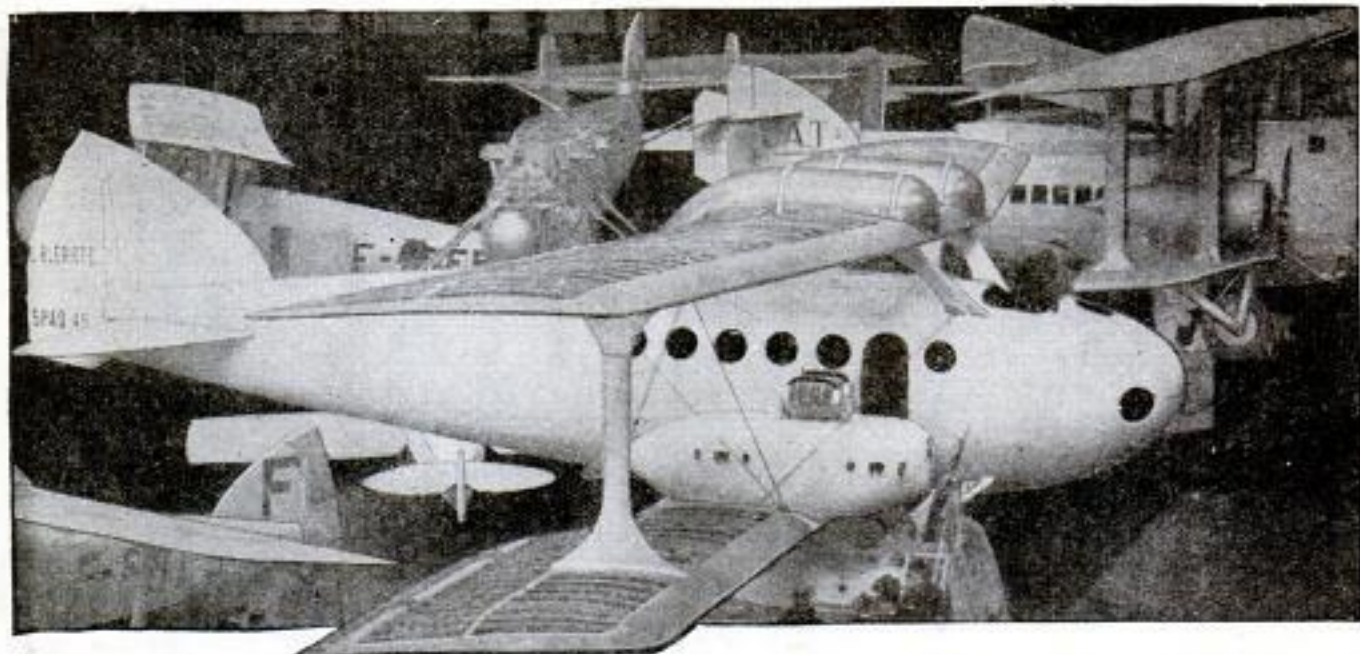

Quick Success in Aviation Fascinating—Daring—Big Paying

To young men of daring, no other field of work will offer such a fascination, such high pay, nor such opportunities for quick success as the field of Aviation. As yet, aviation is practically in its infancy. NOW is the time to get in.

Amazing Opportunities in Airplane Industries

In the automobile industry and in the moving picture business hundreds of men got rich by getting in at the start. They made their success before others woke up. Today, these lines offer no greater opportunities than a hundred and one others. BUT AVIATION IS NEW. Get in while the opportunity is big. All over the country there will be a clamor for trained men. It will not be a question of pay, but of getting capable men.

**HERE ARE REAL
POSITIONS, \$50 TO
\$150 PER WEEK**



View in an Airplane Factory

Aeronautical Instructor, Aeronautical Engineer, Aeronautical Contractor, Airplane Repairman, Airplane Mechanician, Airplane Inspector, Airplane Salesman, Airplane Assembler, Airplane Builder.

AMERICAN SCHOOL OF AVIATION
3601 Michigan Ave., Dept. 1193, Chicago, Ill.

Without any obligation, send me your Free Book, "Opportunities in the Airplane Industry," also information about your Course in Practical Aeronautics.

Name.....
Street.....
City..... State.....

A Sure and Easy Way to Learn Aviation—at Home



A New Job—The Aerial Postman

The study of aviation is almost as fascinating as the actual work. Every lesson is full of interest. That is why it is easy to learn aviation. You do not have to make yourself study—it is like reading an interesting book that tells you things you have always wanted to know. Only one hour each evening will give you the basic training in a surprisingly short time. You need only a common school education.

One of my students, James Powers, Pa., says, "I am indeed surprised that such a valuable Course can be had from such practical men for so little cost."



A New Seven-Passenger Airplane

Personal Instruction by Experienced Men

Men who have had actual experience give you personal attention. They select the lessons, lectures, blueprints and bulletins. They tell you things that are essential in everyday practice. Each lesson is easy to read and understand.

Big Book of Opportunities FREE

Send coupon at left for New Book, just out, "Opportunities in the Airplane Industry." It is interesting and instructive. It will show you many things you never knew before about aviation. Due to shortage of paper we could get only a limited supply of these books—send the coupon before they are all gone.

AMERICAN SCHOOL OF AVIATION
3601 Michigan Ave., Dept. 1193 Chicago, Ill.

Master **ELECTRICITY** by Actual Work

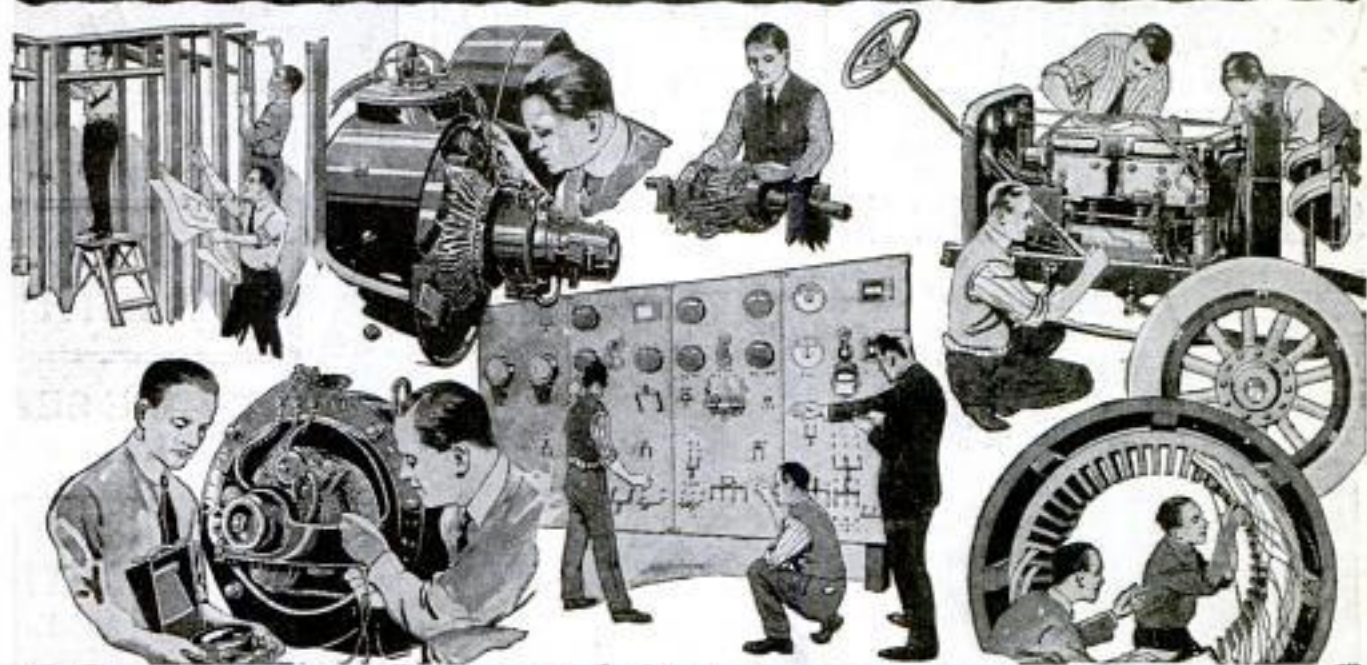

In the Great School of **Coyne** in 3½ Months

- 1—At a residence school—not a correspondence school
- 2—At national institution of 25 year's standing
- 3—Located in the Electrical Center of the World
- 4—You need no previous instruction or education

Only by actual practical training on every kind of electrical apparatus can you become a real Electrical Expert capable of commanding big money. With such practical training as given at COYNE, you become a real ELECTRICAL EXPERT in 3½ months! We don't make "paper electricians." Hundreds and hundreds of men are constantly coming to COYNE with no other equipment than their Common Sense and their Ambition—and in 3½ months' time they go out into the world ready to make a name for themselves and earn Big Money! We will start you right at the beginning—put you to work under the eyes of experts on motors, generators, autos, batteries, radios, power plants, switchboards and hundreds of other electrical devices—doing actual repair and installation jobs.

\$200 to \$600 a Month

By this "learn by doing" method of practical training, a man is "on the job" just as if he were employed by an electrical concern. He is not "green" when he goes out to look for work because Coyne training duplicates the actual work "out in the field." It's the EXPERTS that are getting the big money. Almost before you realize it, you will be a real Electrical Expert capable of making \$200 to \$600 a month or you can go in business for yourself and make \$3,000 to \$20,000 a year.

Send for Free Book

Send today for the big Free Book and Details of our special offer of Free Railroad Fare. Make up your mind today that you are going to learn electricity in a practical way so that you will be an ELECTRICAL EXPERT. The coupon brings full information—send it today!

COYNE ELECTRICAL SCHOOL
1300-1310 W. Harrison St., Dept. 13-53, Chicago

Earn While You Learn

We help students to secure jobs to earn a good part of their living expenses while studying. We give you a Free Course in Radio, a Life Scholarship which enables you to study as long as you want, and assists you to a position after graduation.

Free R. R. Fare

COYNE ELECTRICAL SCHOOL, Dept. 13-53
1300-1310 W. Harrison St., Chicago, Ill.

Please send me free your big catalog and your special offer of free railroad fare.

Name

Address

CARPENTERS

LET THIS NEW AUDEL SET SOLVE YOUR PROBLEMS

POCKET SIZE—
FLEXIBLE
COVERS—
3100 ILLUSTRATIONS
— 1500
PAGES

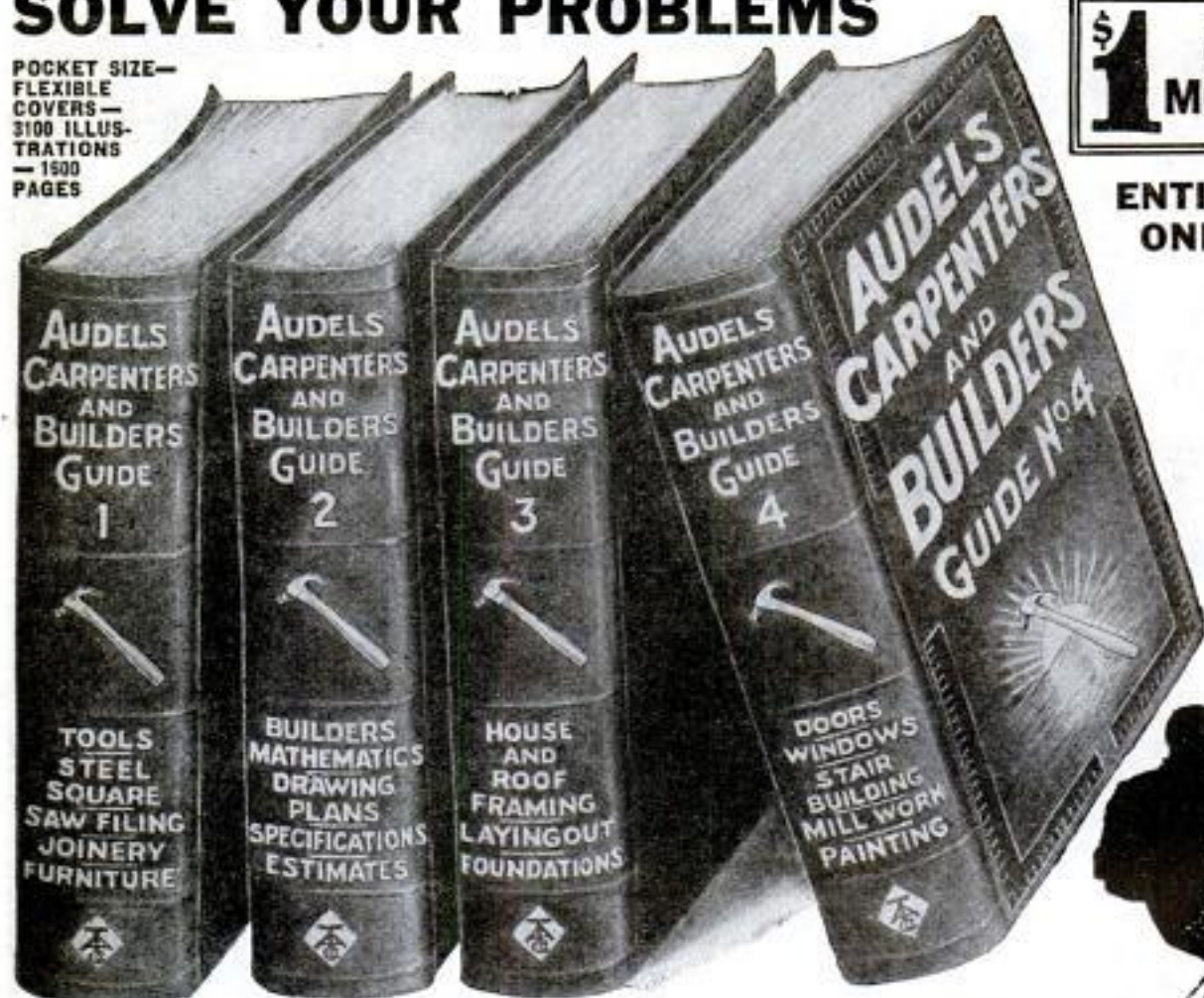

\$1 PER MONTH

ENTIRE SET ONLY \$6

JUST OUT!

Audel's Newest Set, Concise and up-to-date FOUR Handy Volumes

QUESTIONS AND ANSWERS—CLEAR ILLUSTRATIONS—SHORT CUTS THAT MAKE YOU A BETTER WORKMAN AND INCREASE YOUR PAY

Just available—Audel's Carpenters and Builders Guides—the short cut, professional information you want. A Guide that keeps you in close touch with your work and shows you how you may increase your earning power. No need to guess or take chances. Every day you have before you in this set, exact, practical, useful information to help you with your daily work.

HOW To Handle the Job That Puzzles YOU

There are thousands of examples of modern construction and building work—new methods, new ideas, proved efficiency plans, short cuts, time saving suggestions, new ways that cover the entire theory and practice of modern carpentry. Every point is easy to read and understand and clearly illustrated with sketches and forms. Inside Trade Informa-

tion for Carpenters, Builders, Joiners, Building Mechanics and all Woodworkers on—Care and Use of Tools—How to Use the Steel Square—File Saws—Make All Kinds of Joints—Draw and Read Plans—Write Specifications—Make Estimates—How to Frame Roofs and Houses—Lay Out Work—Put in Foundations—Full Instruction on In and Outside Building Work—Stair Building—Saw Mill Work—Practical Painting—Thousands of Short-Cuts that save time and money—Information usually obtained only by hard experience.

NO MONEY!

MERELY SEND COUPON AND LOOK THE SET OVER AT THEO. AUDEL'S RISK

FREE EXAMINATION
Not a cent to pay until you see the books. No obligation to buy unless you are satisfied. Fill in coupon in pencil. Send now—today—get this great help library for carpenters and builders.

THEO. AUDEL & CO., 72 5th Avenue, NEW YORK CITY
Send me for free examination AUDEL'S CARPENTERS AND BUILDERS GUIDES 4 numbers. If satisfactory I will send you \$1 with \$1 tags and mail \$1 monthly until \$6 is paid.

Name.....
Address.....
Occupation.....
Employed by.....
Reference.....
P. M. Mar. 24



Tighten Your Grip on a Trade

Be An Electrical Expert At \$75 to \$200 a Week

Every up-to-date fellow knows what a future there is in electricity. Big pay—fascinating work on land or sea—rapid advancement in a field where jobs are ten times more numerous than trained men to fill them, where \$75.00 a week is just a fair starter, where top notchers pull down ten thousand dollars or more a year—in a field, where any man if he wishes, can easily have a business of his own, have men working for him, **be his own boss!** But what the average young man does NOT know, is what a simple, easy, A-B-C sort of a job it is to get started.

You Can Start Right Now!

Yes, you. You don't need a thing you don't already have! You can read. You can write. You can figure. You can think. And in your breast is the fire of ambition—the desire to get ahead! All right, that's all you need—we can help you just as you are—just as we have helped scores, yes, thousands of other two-listed young fellows determined to get out of the rut and into the electric field—into work that will be pleasant—easy—and all in your home, during spare time.

Fascinating Home Study As You Hold Your Old Job

With the help we will give you, you can slip right into one of these big pay—be-man jobs and never lose a day's work. After a few weeks' start, you can earn enough in installation and electric repair jobs alone to more than pay for the Course and lay a foundation for an Electrical Contracting or Repair Shop Business of your own. When the proper time comes, we will tell you the easy way to go about doing it.

The Most Practical, Thorough and Condensed Electrical Course Ever Written

This is the only home study electrical course that gives you the combined practical and theoretical training you must have before you can be a successful electrician without which you cannot succeed—with which you cannot fail.

Written not by ONE man, with the narrow one-man viewpoint, but by 22 of the brainiest, most successful, electrical experts ever drawn from the field of practice and theory. Gives you the complete mastery of the subject—qualifies you as electrical expert to boss jobs—fits you right into the kind of a job you want—and does it in shortest time—at lowest cost—with the

Most Binding Guarantee of Results Ever Offered!

Satisfaction guaranteed or no sale! We not only SAY we can make you an electrical expert, we Guarantee it! If you are not absolutely satisfied when you have finished our Practical Electrical Course, we will refund every nickel you sent us.

FREE! Experimental Outfit Worth \$30
 Drafting Course Worth Another \$30
 Big Electrical Library Worth \$25

Find out all about our offer. Find out about the thousands who have taken this course in preference to all others and MADE GOOD. Find out about the Electric Library—four elegant volumes—worth \$25, but free. About the free Drafting Course worth another \$30. The free Experimental and Demonstration Outfit, including a real, not a make-shift Electric Motor, Wheatstone Bridge, etc.—the most scientific, high-grade and complete Experimental Outfit ever supplied with a Course in Electricity. Get all the facts without obligation, without expense! Just send the coupon!

American School

Dept. E-374

Drexel Ave. and 58th Street, Chicago

FREE Electrical Coupon

American School, Dept. E-374, Chicago

Please rush all information relative to your Course in Electricity. This obligates me in no way whatever.

Name.....

Address.....



Be Your Own Boss



Be a Leader

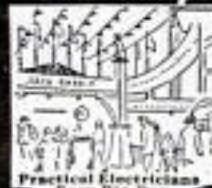

Practical Electricians Earn Big Pay



Own Your Own Electric Shop



Big Money As Power House Boss



Ignition Experts

Head the Pay-Roll

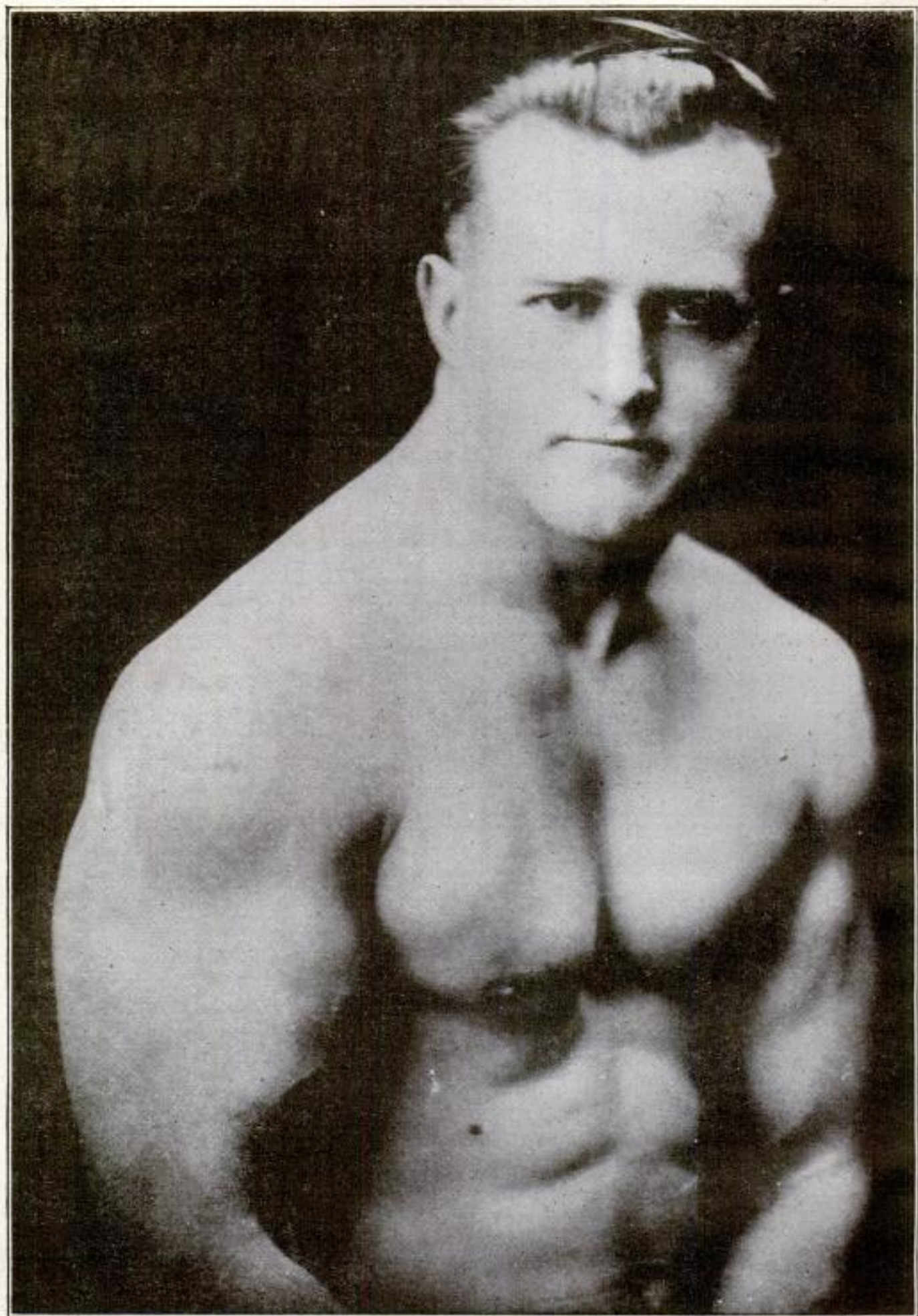

EARLE E. LIEDERMAN, *America's Leading Director of Physical Education*

If a Jelly Fish Could Slap a Rat in the Face

he would do it. But he can't. He has no arms. Neither does he have a backbone. How much worse off is a man who was given a good backbone and a pair of arms—and won't use them.

No Excuse We excuse the jelly fish. He never had anything to work on. But there is no excuse for a flabby, round-shouldered and flat-chested specimen of a man. You were given a perfect framework for a body. You were meant to rule the world, but there is hardly an animal alive which does not show better sense than you do.

Cut It Out, Fellows

Brace up and be the man you were meant to be. Don't try to imitate a jelly fish. Get some pep into you and make a real *He* man out of yourself. Come on and let me help you. I'll shoot a thrill into you that will make your old spine quiver with excitement. I'll build up that chest, broaden those shoulders and give you the huge, muscular arms of an athlete. And that's not all. Your lungs will start pumping real oxygen into your blood, purifying your entire system. Those old cobwebs in your brain will disappear. Your eyes will radiate the life within you. You will have a spring to your step, and every move you make will show new life and energy.

It's Not Too Late

I don't care what your present condition is. The weaker you are, the more noticeable the results. All you need is a framework and enough ambition left to say "I'm ready. Let's go!" I'm going to put one full inch on your arms in just 30 days. Yes, and two inches on your chest. But that's only a starter. Then watch 'em grow. I'll put pep into your old backbone and build up every muscle on your body so that your own friends won't know you. This is no idle talk, fellows. I don't promise these things—I guarantee them. Come on then and make me prove it. That's what I like.

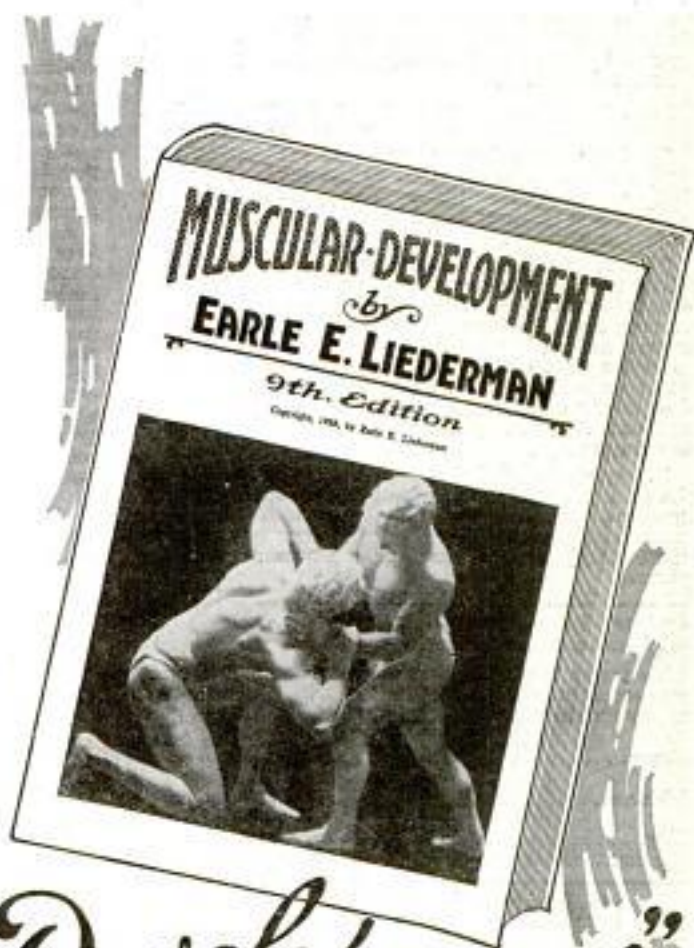

Send For My New
64 Page Book—

"Muscular Development"

IT IS FREE

It contains forty-three full page photographs of myself and some of the many prize-winning pupils I have trained. Many of these are leaders in their business professions today. I have not only given them a body to be proud of, but made them better doctors, lawyers, merchants, etc. Some of these came to me as pitiful weaklings, imploring me to help them. Look them over now and you will marvel at their present physiques.

EARLE E. LIEDERMAN

Dept. 2003, 305 Broadway, New York City

EARLE E. LIEDERMAN

Dept. 2003, 305 Broadway, New York City

Dear Sir:—I enclose herewith 10 cents, for which you are to send me, without any obligation on my part whatever, a copy of your latest book, "Muscular Development." (Please write or print plainly.)

Name

Street

City State

"How I Became Popular Overnight!"

"They used to avoid me when I asked for a dance. Some said they were tired, others had previous engagements. Even the poorest dancers preferred to sit against the wall rather than dance with me. But I didn't 'wake up' until a partner left me standing alone in the middle of the floor.

"That night I went home feeling pretty lonesome and mighty blue. As a social success I was a first-class failure. At first I wouldn't believe that you could teach by mail because I always had the idea that one must go to a dancing class to learn. But I figured I could risk 10c—especially since you guaranteed to teach me.

How Dancing Made Me Popular

"Being a good dancer has made me popular and sought after. I am invited everywhere. No more dull evenings—no bitter disappointments! My whole life is brighter and happier. And I owe it all to Arthur Murray!

"I was astonished to see how quickly one learns all of the latest steps through your diagrams and simple instructions. I mastered your course in a few evenings, and, believe me, I surely did give the folks around here a big surprise when I got on the floor with the best dancer and went through the dance letter perfect. Now that I have the Murray foundation to my dancing I can lead and follow perfectly and can master any new dance after I have seen a few of the steps.

"My sister's family have all learned to dance from the course I bought from you and it would do your heart good to see how fine her little kiddies dance together after quickly learning from your new method of teaching dancing at home without music or partner."

Arthur Murray, Studio 63,
801 Madison Ave., New York City.

To prove that I can learn to dance at home in one evening you may send the FIVE FREE LESSONS. I enclose 10c (stamps or coin) to pay for the postage, printing, etc.

Name.....
Address.....
City..... State.....
Also at 150 Southampton Row, London, England.

Learn Any Dance in a Few Hours

Whether you want to learn the Fox-trot, One Step, Waltz or any of the new dances, you won't have any trouble in doing it through Arthur Murray's new method. More than 90,000 people have learned to dance by mail, and you can learn as easily.

Arthur Murray is the World's foremost authority on social dancing. Through his new improved method of teaching dancing by mail he will give you the same high-class instruction in your own home that he would give you if you took private lessons in his studio and paid his regular fee of \$10 per lesson.



Posed by Mabel Ballin, Famous Movie Star, and Arthur Murray, the World's Famous Dancing Instructor

Five Dancing Lessons FREE

So sure is Arthur Murray that you will be delighted with his amazingly simple methods of teaching that he has consented for a limited time only to send FIVE FREE LESSONS to all who sign and return the coupon.

These five free lessons are yours to keep—you need not return them. They are merely to prove that you can learn to dance without music or partner in your own home. Write for the five lessons today—they are free. Just enclose 10c (stamps or coin) to pay cost of postage, printing, etc., and the lessons will be promptly mailed to you. You will receive (1) The Secret of Leading, (2) How to Follow Successfully, (3) How to Gain Confidence, (4) A Fascinating Fox-trot Step, (5) A Lesson in Waltzing. Don't hesitate. You do not place yourself under any obligation by sending for the free lessons. Write today.

ARTHUR MURRAY, Studio 63, 801 Madison Ave., New York

GOV'T. HELP NEEDED

All men, women, boys, girls, 17 to 65, willing to accept Government Positions, \$117-\$250, stationary, at or near home, or traveling, write Mr. Ozment, 111 St. Louis, Mo., immediately.

BE A DIAMOND EXPERT!



Do you know that of two diamonds of equal size one may be worth a hundred times as much as the other? Who can distinguish them but an expert? My short, easy course will make you a diamond expert in a few months! Get it before you buy your next diamond—it will save you money!

FREE! GENUINE Diamonds if you enroll at once \$5,000 to \$15,000 a Year!

Be a diamond expert and go into business for yourself on only \$25 or \$50 capital! We will show you how! Be a diamond expert and become independent. The diamond business is a gentleman's business. Success in any other line of business means \$5,000 a year—success in the diamond business means up to \$15,000 a year! Millions of dollars are paid out every year for diamonds! Jewelry houses everywhere need diamond experts—always pay high for expert opinions. Diamond experts are rare!

Write for free booklet

My booklet "Paying Diamond Knowledge" telling you how to start in the diamond business will be sent to you absolutely FREE! Contains new and amazing and startling facts about diamonds. Write now!

CODINGTON SCHOOL OF DIAMONDS

4911 N. Rockwell St., Dept. 121, CHICAGO, ILLINOIS

Anyone CAN LEARN

No talent or experience necessary. Fascinating work. Pays big money. Complete instruction book sells abroad. Alphabets, Colors, How to Write Points, Show Cards, Window Board and Wall Signs, Ready made letters, Gliding, Tricks of the Trade, also gives 100 Alphabets and Designs. Book bound in flexible int. leather-goldedges, and four ball bearing Show Card Pens. Sent postpaid \$3.00. C.O.D. 10c ex. Ogilvie Pub. Co., 57 Ross St., Dept. 50, N. Y. City

\$3

EARN MONEY IMMEDIATELY— WE FURNISH EQUIPMENT TO START !!

LEARN WATCHMAKING

and become independent. Good-paying positions secured. Easy to learn. Send for FREE CATALOG.

ST. LOUIS WATCHMAKING SCHOOL, Dept. 5, ST. LOUIS, MO.

FREE BOOK

How to Learn Piano

LEARN PIANO

This Interesting Free Book

shows how you can become a skilled player of piano or organ at quarter usual cost. It shows why one lesson with an expert is worth a dozen other lessons. Dr. Quinn's famous Written Method includes all of the many important modern improvements in teaching music. Brings right to your home the great advantages of conservatory study. For the beginner or experienced player. Endorsed by great artists. Successful graduates everywhere. Scientific yet easy to understand. Fully illustrated. All music free. Diplomas granted. Write today for free book. Quinn Conservatory, Studio PM63 598 Columbia Road, Boston 25, Mass.

I Tell You

This Free Book Will Show You The Way to Amazing Salary Increases

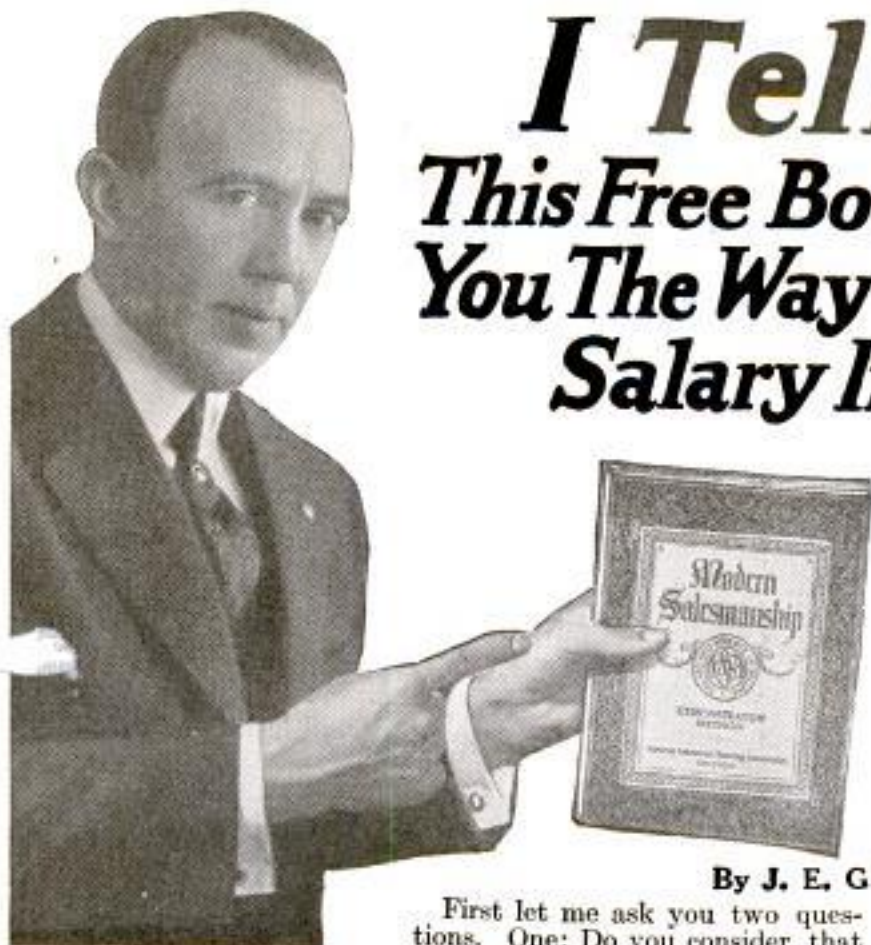

I only ask that you risk two cents on the strength of my word that the contents of this amazing book will show you the way to a prosperity that you never dreamed possible, in a fascinating field that you never thought of entering. This book is now free. Read my offer.

By J. E. GREENSLADE

First let me ask you two questions. One: Do you consider that you are as intelligent as the average mail-clerk, farmhand, office clerk, mechanic, or bookkeeper?

Second: If you suddenly found yourself with all the money you needed to spend, wearing the best clothes, living in a fine neighborhood, driving a good car and belonging to the best clubs—but having to make good in a job that paid \$10,000 a year, would it scare you? There are men to whom \$10,000 a year is so much that the idea of earning it themselves never occurs to them. They will always be in routine jobs at low pay. Their dreams will never come true. But yours will if you will absorb what I am going to tell you.

Now, in one quick step you can enter the field where opportunities in your favor are ten to one—the Selling field. You know that Salesmen top the list of moneymakers—that the salesman is his own boss—that his work is fascinating, interesting and highly profitable! But the thing you doubt is your own ability. All right, but you can become a first-class, money-making salesman in an amazingly easy way.

Proof That Salesmen Are Made—Not "Born"

The story of six men who once thought salesmen were "born," who did not believe they were "cut out for selling," is on this page.

Thousands of men like these six men who formerly thought salesmen were "born," are now enjoying magnificent earnings in the selling field. They were bookkeepers, mechanics, farmers, clerks—even doctors, lawyers and ministers—but in a few months after writing to the National Salesmen's Training Association they were out in the field selling—and making more money than they had ever hoped to make.

Sounds remarkable, doesn't it? Yet there is nothing remarkable about it. Salesmanship is governed by rules and laws. There is a certain way of saying and doing things, a certain way of approaching a prospect to get his undivided attention, certain ways to overcome objections, batter down prejudice, and overcome competition.

Just as you learned the alphabet, so you can learn salesmanship. And through the NATIONAL DEMONSTRATION METHOD—an exclusive feature of the N. S. T. A. System of Salesmanship Training—you gain actual experience while studying.

Years of Selling Experience in a Few Weeks

The N. S. T. A. System of Salesmanship Training and Employment Service will enable you to quickly step into the ranks of successful salesmen—will give you a big advantage over those who lack this training. It will enable you to jump from small pay to a real man's income.

Remarkable Book, "Modern Salesmanship" Sent Free

With my compliments I want to send you a most remarkable book, "Modern Salesmanship."

It will show you how you can easily become a master Salesman—a big moneymaker—how the N. S. T. A. System of Salesmanship Training will give you years of selling experience in a few weeks; how our FREE employment service will help select and secure a good selling position when you are qualified and ready. And it will give you success stories of former routine workers who are now earning amazing salaries as salesmen. Mail the coupon today. It may be the turning point in your life.

National Salesmen's Training Association
Dept. 12-C Chicago, Ill.

National Salesmen's Training Association
Dept. 12-C, Chicago, Ill.

I simply want to see the facts. Send me free your book, "Modern Salesmanship," and Proof that I can become a Master Salesman.

Name.....

Address.....

City..... State.....

Age..... Occupation.....

READ!

\$9,000 First Year

Ellis Sumner Cook, 20 E. Jackson Blvd., Chicago, left a \$25 a week job and last year made \$9,000!

\$100 a Month to \$100 a Week in Only 3 Months

H. D. Miller, another Chicago boy, was making \$100 a month as stenographer in July, 1922. In September, 3 months later, he was making \$100 a week as a salesman.

\$150 to \$500 a Month

W. P. Clenny, of Kansas City, Mo., stepped from a \$150 a month clerkship into a selling job at \$500 a month. He is making \$850 a month now.

\$6,500 a Year

M. V. Stephens, of Albany, Ky., was making \$25 a week. He took up this training and now makes five times that much.

Small Pay to Big Earnings

J. H. Cash, of Atlanta, Ga., exchanged his \$75 a month job for one which pays him \$500 a month.

Now Sales Manager at \$10,000 a Year

O. H. Malfroot, of Boston, Mass., stepped into a \$10,000 position as a SALES MANAGER—so thorough is this training. All these successes are due to this easy, fascinating and rapid way to master certain invincible secrets of selling.





Are You Earning Big \$100 a Week?

**J
O
B
S
Open**

Would you like to be a star salesman? Men who have mastered salesmanship—who are really proficient—name their own salaries. \$5,000 to \$10,000 a year and better not uncommon. Big money and opportunities in business always open to men who can SELL. Success in selling field leads to highest executive positions. Demand enormous. Old theory about "born salesman" exploded. Any man of average intelligence can now learn to sell thru scientific coaching. Training, the secret. Write today for free book, "MODERN SALESMANSHIP." It tells how you can quickly get into the selling game and win your way to the big-pay jobs. Learn in spare hours at home principles and methods of ablest sales organizations in America. Successful salesmen report sales doubled and trebled thru scientific study of salesmanship under LaSalle Problem Method. Low tuition fee—easy terms. Write now for information.

LASALLE EXTENSION UNIVERSITY
The Largest Business Training Institution in the World
Dept. 364-SR Chicago, Illinois

Gentlemen: Send without obligation to me information regarding course indicated below:

Modern Salesmanship

LaSalle is the largest business training institution in the world. It offers training for every important business need. If more interested in any of these courses, check here:

- | | |
|--|--|
| <input type="checkbox"/> Business Management | <input type="checkbox"/> Modern Business Correspondence and Practice |
| <input type="checkbox"/> Higher Accountancy | <input type="checkbox"/> Modern Foremanship and Production Methods |
| <input type="checkbox"/> Traffic Management—Foreign and Domestic | <input type="checkbox"/> Personnel and Employment Management |
| <input type="checkbox"/> Railway Station Management | <input type="checkbox"/> Expert Bookkeeping |
| <input type="checkbox"/> Law, Degree of LL. B. | <input type="checkbox"/> Business English |
| <input type="checkbox"/> Commercial Law | <input type="checkbox"/> Commercial Spanish |
| <input type="checkbox"/> Industrial Management | <input type="checkbox"/> Effective Speaking |
| <input type="checkbox"/> Efficiency | <input type="checkbox"/> C. P. A. Coaching |
| <input type="checkbox"/> Banking and Finance | |

Name.....

Present Position.....

Address.....

PLAY TEN-TEN-TENNESSEE!
ON HA HA

THE TENOR BANJO JAZZ

No Previous Musical Knowledge Necessary—Quick—Easy—Positive
Prof. Barker's method is so simple and easy that you quickly play any and all of the popular dance hits just as you have heard them played in dance or orchestra, on the stage—everywhere.

**JAZZ NEW ORCHESTRA STYLE
NEW EASY WAY—FUN GALORE**

Just Mail a Post Card for Details of our remarkable FREE Tenor Banjo Offer—simply write: "I am interested"—BUT DO IT TODAY.

First Hawaiian Conservatory of Music, Inc.
Desk 60
233 Broadway
(Woolworth Bldg.)
New York City

Special courses under
Japanese Teachers:
Violin—Guitar
Viola—Ukulele
Instrument Free

**FREE
A Beautiful
Tenor
Banjo**

WRITE JOKES

EARN FROM \$50 TO \$150 PER WEEK

writing jokes, epigrams and humorous stories for publications. Tremendous demand for material. Our short course in Humor Writing teaches you to write humorous material that sells. Learn in your spare time—earn in your spare time. Complete marketing plan and markets furnished.

Write for full particulars

AMERICAN INSTITUTE OF HUMOR
Office J, 414 Park Bldg., Cleveland, Ohio



STAMMER

If you stammer attend no stammering school till you get my large FREE book entitled "STAMMERING, Its Origin and the Advanced Natural Method of Cure," bound in cloth and stamped in pure gold. Ask for special tuition rate and a FREE copy of "The Natural Speech Magazine." Largest, best equipped and most successful school in the world for the cure of stammering; stuttering, etc. No sing-song or time beat. Write today, The North-Western School, 2317 Grand Ave., Milwaukee, Wis.



Wonderful, new device, guides your hand; corrects your writing in few days. Big improvement in three hours. No failures. Complete outline FREE. Write C. J. Ozment, D-34, St. Louis, Mo.

WANTED—BY U. S. GOV'T

Railway Mail Clerks, City Mail Carriers, Rural Carriers, City Postal Clerks, Clerks at Washington, D. C. Income Tax Auditors.

\$1140 TO \$3000 A YEAR

STEADY. SHORT HOURS. Long vacations with pay.

MEN—WOMEN 18 OR OVER

Mail coupon immediately.

Don't delay.

FRANKLIN INSTITUTE, Dept. G178, Rochester, N. Y.
Kindly send me, entirely free of charge, (1) A full description of the position checked below; (2) Sample examination questions; (3) Free copy of illustrated book, "Government Positions and How to Get Them;" (4) A list of U. S. Government Jobs now obtainable; (5) Tell me how to get the position here checked.

TEAR HERE

— Railway Postal Clerk (\$1600 to \$2300) — Customs Positions (\$1100 to \$2000)
— Post Office Clerk (\$1400 to \$1800) — Internal Revenue (\$1100 to \$2000)
— City Mail Carrier (\$1400 to \$1800) — Rural Mail Carrier (\$1800 to \$2600)
— Income Tax Auditor (\$2040 to \$3000)

Name.....

Address.....

EXTRA! Branch just opened at Detroit to meet the growing demand for **McCARRIE-TRAINED EXPERTS**



Easiest, pleasantest work you ever saw! Your own boss, money and success yours from the very beginning. You can start with a "shoe-string." We prepare you in a few months to run a business of your own, to do any job. Common schooling, ability to use your fingers **ALL YOU NEED!**

Jobs at \$60 to \$125 a Week!

In a business where there are many times as many jobs as Experts, salaries are high, hours are easy, opportunities are everywhere! McCarrie-trained Experts always get the preference—Dentists everywhere recognize the high-standing of our graduates. No books here—learn with tools and instruments. Start quick—get ready in 12 weeks for your big opportunity! *Mail Coupon today!*

RUBBER PLATES

Learn to make partial upper or lower plates with soldered, cast or wire clasps, with palatal bars; with lingual bars. McCarrie-trained Experts learn to make full rubber plates of every type, including Vulcanite base-plates, butted gums, carved gums, etc.

CROWNS

Here's only a small part of your practical training in Crown-work: Two-piece, seamless, open-face, Richmond, cast-base porcelain, Carmichael, split-pin, carved (swaged) cusp, cast cusp, etc.

BRIDGE WORK

Complete training in both fixed and removable bridge-work. Interchangeable teeth, gold dummy, Sanitary, porcelain dummy jobs—Roach, Gilmore, Bischoff and all forms of cast-clip work is taught—not with books but in actual Laboratory.

METAL BASE DENTURES

Cast bases of Aluminum, gold, Watt's metal, etc. are included in your training. Both centrifugal and air pressure casting machines are used. Free Catalog contains complete list of subjects in course.



FREE!
R.R.
Fare
to
Chicago

This Dental Laboratory Expert earns \$20 a day!

What's the use of training for the old, overcrowded trades? If you're going to prepare for big-salaried jobs or a profitable business of your own **GET INTO THE NEWEST PROFESSION**—*"Laboratory Dentistry."* Biggest opportunity for success of the century, because there are ten times as many jobs as men to fill them, because there are a dozen cities crying for Laboratories for each **EXPERT** capable of operating one!

60,000 DENTISTS NEED LABORATORY WORK!

Only a few hundred Laboratories in all the U. S.—most of them in Chicago and New York. Dentists can't afford to do their own mechanical jobs. They can buy the services of a Laboratory Expert at \$3.00 an hour and sell their own time at \$6 to \$15 an hour. Dentists will encourage you to learn mechanical work, start a "Lab" of your own, give them quicker service than sending to Chicago or New York. Dentists can't wait and keep their patients waiting.

OPEN a LABORATORY of your OWN!

Boos in Minneapolis is reported to employ 125 men and to clear \$40,000 to \$50,000 a year. *J. W.* of Chicago started a couple of years ago **ALONE**. Today he employs 60 Experts and his Laboratory is one of the biggest in the U. S. Start with the same tools you use in this big **SCHOOL-LABORATORY**. Start your own Laboratory with as little as \$100 investment. No limit to profits you can make in this wonderful new profession.

INTERESTING CATALOG—FREE!

Right this minute we can place 150 Dental Laboratory Experts in locations where they can make \$5,000 to \$20,000 a year. But you can't cash in, take advantage of these OPPORTUNITIES until you're **TRAINED**. Catalog tells you how quickly and easily you can get ready, how hundreds of others have **SUCCEEDED!** Tells you how you learn in few months **BY DOING ACTUAL LABORATORY JOBS** under world's greatest Mechanical Dentists! Brings you **FREE R. R. Fare** offer and other big inducements. *Write for free Catalog today!*

EARN while you LEARN!

Day students make all or part cost of course by part-time night work. Night students can find plenty of good jobs in Chicago "to see them thru." We'll help you!

McCarrie School of Mechanical Dentistry

Dept. 601, 34-36 W. Lake St., Chicago

McCarrie School of Mechanical Dentistry, Dept. 601, 34-36 W. Lake St., Chicago

Without obligation, please send me your **Free R. R. fare offer** and free catalog with complete information about how I may become a Dental Laboratory **EXPERT**.

Name

St. No. or R. F. D.

City State



Own Your Own Home by Building Homes for Others



American School

The American School is not a money-making corporation, but, like resident schools and colleges, is chartered strictly as an "Educational Institution, not for profit."

More than 200 famous engineers and educators prepared the special instruction papers for our students.

For over a quarter of a century, Big Engineers, Educators and Business Men have recommended the American School. They know that our long experience as an educational institution guarantees the best training at lowest possible cost.

Every man should own his own home. Every man wants to but doesn't seem to get ahead fast enough to do it. Why not get in the building business and build your own home—after having made enough to do it through building homes for others?

Did you ever stop to think as you gazed at a big, modern building what its construction entailed? It started with a hole in the ground—then a foundation was laid—and then, miracle-like, the timber or steel frames were raised and the building completed. You can build your business career the same way, but before you go ahead with your plans, you must have a FOUNDATION. Training gives that foundation. The American School supplies you the training. You study at home from lessons compiled by twenty experts in Building and Contracting problems. They give you the benefit of their wonderful knowledge learned by having gone through the mill. They guide and direct you until you can go out and take a big job paying real man-size money.

It Costs Only 2c to Get Started

Send no money. Just fill out the coupon below, check the occupation you are interested in. If it isn't Building and Contracting, check what you are interested in. If you are undecided we'll send you full information and advice on what line you ought to take up and how to succeed in it. Here are but a few of the subjects covered in the Building and Contracting Course:

Estimating, Carpentry and Masonry, Blue Print Reading, Building Regulations, Stair Building, Use of Steel Square, Water Supply and Drainage, Buying Material, Heating and Ventilating.

If you are interested in making more money and decide to take an American School Course, you will find the cost well within your reach—and the terms of payment easy. You get our positive money-back guarantee with your first payment. We practically insure your success. Fill out the coupon NOW and stop wishing and dreaming about what you hope to do—just START AND DO IT. You'll never regret the day you took the step.

AMERICAN SCHOOL, Dept. G 374, Drexel Ave. & 58th St., Chicago

© A. S. 1923

American School, Dept. G 374, Drexel Ave. & 58th St., Chicago Send me full information on the subject checked.

- | | | | |
|--------------------------------------|---------------------------|---------------------------|---------------------------|
| ... Architect | ... Sales Manager | ... Business Law | ... Foremanship |
| ... Building Contractor or Carpenter | ... Cert. Pub. Accountant | ... Lawyer | ... Sanitary Engineer |
| ... Automobile Engineer | ... Accountant & Auditor | ... Machine Shop Practice | ... Surveyor (& Mapping) |
| ... Automobile Repairman | ... Bookkeeper | ... Photoplay Writer | ... Telephone Engineer |
| ... Civil Engineer | ... Draftsman & Designer | ... Mechanical Engineer | ... Telegraph Engineer |
| ... Advertising Manager | ... Electrical Engineer | ... Shop Superintendent | ... High School |
| ... Business Manager | ... General Education | ... Employment Manager | ... Fire Insurance Expert |
| ... Financial Manager | ... Personal Analysis | ... Steam Engineer | ... Wireless Radio |
| | | | ... Undecided |

Name

Address Occupation

AUDEL'S GUIDES ANSWER YOUR QUESTIONS IN A PRACTICAL WAY

YOUR FOREMAN WILL QUICKLY NOTICE THE SUPERIOR QUALITY OF YOUR WORK

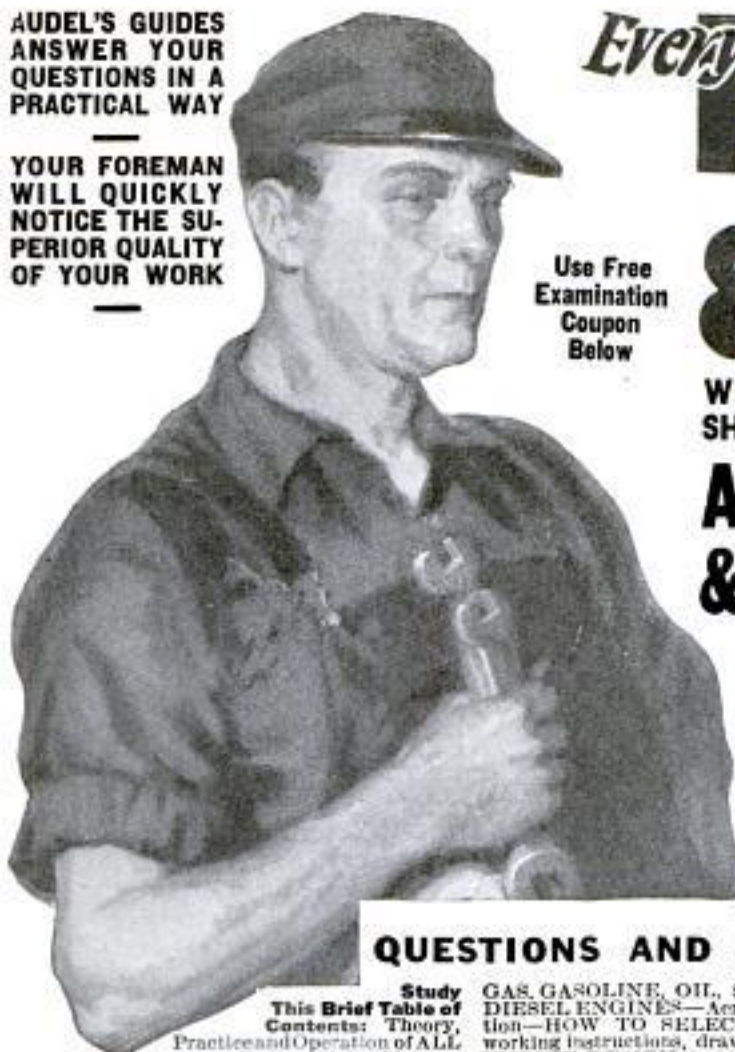

Use Free Examination Coupon Below

Every ENGINEER & MECHANIC

WILL FIND PRACTICAL INFORMATION ON SHORT CUTS AND MODERN METHODS IN
AUDEL'S ENGINEERS & MECHANICS GUIDES

Every Engineer, Mechanic and Electrical Worker will welcome this new master set. It will answer your problems.

It will help you with your daily work.—A sure source of advancement and higher pay. Complete up-to-date information that is thoroughly and easily explained on every branch of modern engineering and electrical practice. **The entire set costs you only twelve dollars—knowledge and instruction that has cost thousands of dollars and years of time—yours for \$12.00—\$1.00 a month.**

QUESTIONS AND ANSWERS TEACH YOU QUICKLY

Study This Brief Table of Contents: Theory, Practice and Operation of ALL Steam Engines, Valve Motions

—VALVE SETTING; complete information on all engines and pumps—CORLISS ENGINES and the Theory, Construction and Operation of all Steam Engines, including UNIFLOW and POPPET VALVE ENGINES, and LOCOMOBILES—Locomotive-Marine Engines; Turbines; Rotary Engines—the Indicator—Lubrications—PRACTICAL MANAGEMENT. How to use Indicator—

GAS, GASOLINE, OIL, SEMI- and FULL DIESEL ENGINES—Aeroplanes and Aviation—HOW TO SELECT AN ENGINE, working instructions, drawings on STEAM ENGINE DESIGN, including rules and formulae, Theory and Construction of ALL Steam Boilers; Heat-Combustion; Fuel and Flue Gas Analysis—CO₂ recorders—Characteristics of Boilers—Materials—Construction of all types of Boilers. (THE LATEST PRACTICE.)—Boiler Construction—Mechanical Stokers—Oil Burners—Setting—Chimneys—Mechanical Draught—HOW TO SELECT A BOILER—Complete instructions and draw-

ings on BOILER DESIGN based on A. S. M. E. BOILER CODE—OPERATION, including installation, FIRING; care and repair of Steam Boilers—Pipes, Fittings and Pipe Fitting—Heating and Ventilation—Refrigeration—Cooling Towers—Condensers—Distilling Apparatus—Elevators—Cranes and Hoisting Machinery—Ropes and Cables—Splicing—electric wiring in ALL branches; compendium of practical electrical engineering as an aid for engineers and electricians in obtaining a license—57 chapters—ready reference index, covering entire field of Modern Electricity.

AUDEL'S MASTER SET 8754 ILLUSTRATIONS 4750 PAGES

POCKET SIZE—FLEXIBLE COVERS

TURN SPARE TIME INTO CASH BY STUDYING THE GUIDES

Take a volume with you where ever you go. They can be easily slipped in and out of your coat pocket without damage. Study the questions and answers. Fifteen minutes a day study will increase your pay.



FREE EXAMINATION

Not a cent to pay until you see the books. No obligation to pay unless you are satisfied. Send coupon now—today and get this new master set for engineers.

Pay only \$1 a month.

THEO. AUDEL & CO., 72 Fifth Avenue, NEW YORK CITY

Please submit me for free examination. AUDEL'S MASTER SET FOR ENGINEERS AND MECHANICS ship at once prepaid, the 8 numbers total cost \$12.00. If satisfactory, I agree to send you \$1 within seven days and to further mail you \$1 each month until paid.

Name.....
Occupation.....
Employed by.....
Home Address.....
Reference.....
P. M. Mar. 24

BOYS



Learn Electricity

How would you like to earn two or three dollars every evening after school and prepare yourself for a fine big job at the same time? Here's the opportunity of a lifetime for you fellows who like Electricity. Begin right now to prepare yourself for a regular man's size job in this fascinating field. Your chances for a big success are simply wonderful—the pay is big (\$70 to \$200 a week) and advancement comes swift and sure.

I Will Train You at Home

Look What This Boy Is Doing

"Although the school term is coming to a close, and I am pretty busy with my examinations, I manage to keep up with my electrical studies and work.

"I guess I forgot to tell you I am now in business for myself. Am doing fine, but owe it all to you. If it had not been for your Course, I, being under age, could not have secured my license in this town. But I got it, and now have all the work I can do, averaging \$20 to \$30 a week through spare time work.

"I went out on a job tonight after school, on which I made \$3 and brought home another on which I made \$2.50—\$5.50 for 4 hours work and no material furnished by me."

ROGER SMITH,
1215 Chestnut St.
Greenville, N. C.

With my easily learned, spare time Electrical Course I will train you at home like I have trained hundreds of other boys who are now big successful men. It will not interfere with your school work and you can earn more than the small cost of the course doing odd electrical jobs in your spare time. The Course pays for itself. I will show you how to get this work and how to do it. Some of my boy students make \$10 to \$15 a week this way.

Tools, Apparatus and Radio Course FREE

Send me the coupon below and I will tell you all about the big outfit of tools, apparatus and instruments and a new Radio Course that I am giving to my students for a limited time. I will send you my big interesting Electrical Book and a sample lesson, too—all Free. You will be tickled with the things I will send you Free. Mail the coupon right now.

L. L. COOKE, Chief Engineer
Chicago Engineering Works
Dept. A-13 CHICAGO

Use This "FREE OUTFIT" Coupon

L. L. COOKE, Chief Engineer,
Chicago Engineering Works,
Dept. A-13, 2150 Lawrence Ave., Chicago

Send me your Free Outfit Offer, your big Electrical Book, Sample Lesson and particulars of your Electrical Course and Free Radio Course. This will not obligate me in any way.

Name

Address

For use of boys 15 years old or more.

We Teach COMMERCIAL ART

Meyer Both Company, the largest Commercial Art Organization in the World offers you an unusual opportunity for practical training, based upon twenty-three years of success. This nationally known organization each year produces and sells to advertisers over 15,000 commercial drawings. Meyer Both instruction is the difference between successful fact and experimental theory. This well paid profession equally open to men and women. Home study instruction.

Get Facts Before You Enroll in Any School

Ask the Advertising Manager of the leading newspapers in your city, anywhere in the United States, Canada, England or Australia about the Meyer Both Company—let them tell you about us. Write for our illustrated book telling about the success of our students—for one-half the cost of mailing—four cents in stamps.

MEYER BOTH COMPANY

Department of Art Instruction

Michigan Ave. at 26th St., Dept. 16 CHICAGO, ILL.

Note—To Art and Engraving Firms: Secure practical artists among our graduates. Write us.

Learn to Mount Birds



Learn at home by mail, to mount birds, animals, game heads; tan furs, make rugs and robes. Complete lessons. Easily and quickly learned by men, boys and women.

FREE Write today for Free Taxidermy Book. Tells all about it. Every Sportsman, Hunter, Trapper and

Nature lover should know this wonderful fascinating art. Save your trophies. Big profits! Success guaranteed. Our school is 20 years old—75,000 graduates. Investigate today. Write for Free Book.

Northwestern School of Taxidermy

1773 Elwood Bldg., Omaha, Neb.

Learn Expert Auto Painting



There is Big Money in auto painting and refinishing. Our Home Study Course in Practical Auto Painting will enable you to do the finest work and earn big wages. Wonderful opportunity for new money-making business of your own.

FREE circular tells all about this big new business. Be first. Write quick.

CHICAGO COLLEGE OF AUTO PAINTING
Dept. 34, 140 S. Dearborn St., CHICAGO, U.S.A.

MUSIC LESSONS FREE

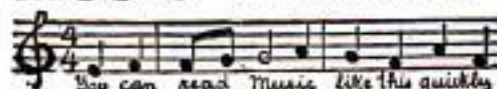

You can read Music like this quickly

IN YOUR OWN HOME

Piano, Organ, Violin, Mandolin, Guitar, Banjo, etc. Beginners or advanced players. One lesson weekly. Illustrations make everything plain. Only expense about 2c per day to cover cost of postage and music used. Write for FREE booklet which explains everything in full.

AMERICAN SCHOOL OF MUSIC, 51 Lakeside Building, CHICAGO

LEARN WATCH REPAIRING

Be a watchmaker—you can learn this profitable trade by correspondence in a few weeks in your own home by the DeSelms Chart System. After you complete the course you will know a watch from A to Z. You will know just what the matter is and how to repair one. When you graduate you will be a practical watchmaker and repairer and competent to fill any position. Positions for our graduates. Ask for our Free Book. It explains our system and terms.

THE DeSELMS WATCH SCHOOL
23 Perry Street ATTICA, INDIANA



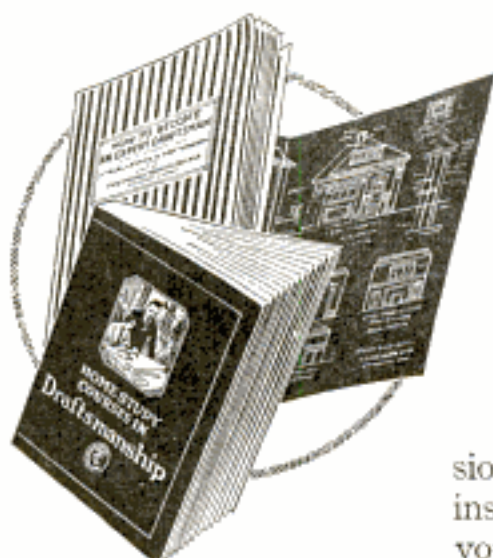

FREE TRIAL LESSON

Send the coupon and get this lesson in Drafting. It will show you how well qualified you are to take up this great profession. Also shows the Chicago Tech. method of instruction by mail. Find out about all this before you enroll or pay a penny. Mail the coupon now.

DRAFTING

Train in Spare Time—Double Your Income

Put yourself in the big pay class. Get expert training in Drafting under the Chicago Tech. experts. Be master of a profession in which there are not enough highly skilled men to fill the paying jobs that are open. The Chicago Tech. method of training men by mail gives you a finished, practical education in Drafting—in your own home in spare time. Just a few hours a week and you get a thorough training under the personal direction of experts.

Get Your Instruction Under Practical Men

Enrolled at Chicago Tech. you are instructed by practical engineers—not by mere theorists. These men have been "through the mill." They know just what problems you will have to solve in actual practice and show you how to master them. No time wasted on unnecessary studies. You get this training at a low cost and on easy terms, and you graduate early.

The Big Job Will Be Ready When You Are

Everywhere there is a call for capable Draftsmen—men who can take hold of important work and see it through. Men of this kind are always in demand at high salaries by railroads, manufacturers, architects, contractors, electrical works and other big industries. Chicago Tech. training which you can get by mail or in day or evening classes at the College in Chicago will make you the man wanted for the big positions that are open to highly trained men.

Chicago Tech. training increased my salary 300%.
F. L. Cary.

Successful in own business as a result of Chicago Tech. training.
O. L. Rosin.

Have had my pay raised \$73.70 a week since I took Chicago Tech. course.
S. Schrier.

To Employers:

Chicago Tech. men are practical. Write to us when you need Draftsmen.

Chicago Tech. Men Succeed

Every year Chicago Tech. graduates step into the ranks of successful men. You find them everywhere employed at high salaries or in business for themselves—independent and prosperous because they have the practical knowledge that enables them to handle the kind of jobs which command big pay.

FREE Drawing Outfit

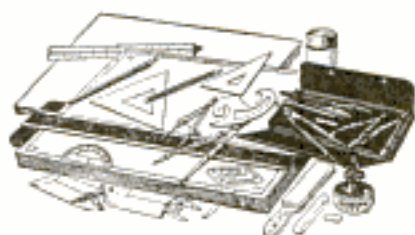

Enrolled in the Chicago Tech. Home Study Drafting Course you get this complete Drawing Outfit (Retail price \$25.00) without extra cost (or you are given a credit on fees if you have an outfit).

Send the Coupon

Mail the coupon and get the Free Trial Lesson—also catalogs and full information about the Chicago Tech. Method of teaching Drafting by mail. Find out about the opportunities that Drafting offers to ambitious men. No cost to you—no obligation. Send the Coupon.

Chicago Technical College

Dept. 330, Chicago Tech. Bldg., 118 E. 26th St., Chicago, Ill.

Without cost or obligation on me please send instructive matter about opportunities in line I have marked with "X."

- Drafting.** (The Big Salary Course)
No experience necessary. Free Lesson sent now.
- Building Trade Course.**
For men in the building lines.

Name

Address

Postoffice

State

Chicago Technical College Dept. 330, Chicago Tech. Bldg.
118 E. 26th St., CHICAGO, ILL.



Learn By Doing!

Every phase of all branches of

ELECTRICITY

Taught By Actual Practice

In America's foremost institution for trade training.

Established 1902

No Books Used

Individual Instruction

Start Any Day

A SPECIAL and SEPARATE Course in Ignition, Auto Lighting and STARTER Systems.

Write for FREE 64-Page Catalog

THE NEW YORK ELECTRICAL SCHOOL
44 West 17th Street NEW YORK CITY

Whatever Your Question;—be it the pronunciation of Fascista, the spelling of a puzzling word, the location of Esthonia, the meaning of soviet, realtor, vitamin, etc., this Supreme Authority—

WEBSTER'S NEW INTERNATIONAL DICTIONARY

contains an accurate, final answer. 407,000 Words. 2700 Pages. 6000 Illustrations.
Regular and India-Paper Editions. G. & C. MERRIAM CO., Springfield, Mass.

Write for specimen pages, prices, etc. and FREE Pocket Maps per POPULAR MECHANICS



"THERE'S MONEY IN IT"

AT HOME

LEARN TELEGRAPHY

AT HOME

MORSE AND WIRELESS



TEACH YOURSELF

in half usual time, at trifling cost, with the wonderful Automatic Transmitter, **THE OMNIGRAPH**. Sends unlimited Morse or Continental messages, at any speed, just as an expert operator would. Adopted by U. S. Government, and leading Universities, Colleges and Telegraph Schools. 3 Styles. Catalog free. **OMNIGRAPH MFG. CO., 16-22 Hudson St., NEW YORK**

If you own a Radio Phone Set—and don't know the code—you are missing most of the fun.

BE AN ARTIST

Comics, Cartoons, Commercial, Newspaper and Magazine Illustrating, Panel Crayon Portraits and Pastels. Our simple method teaches your talent in spare time. By Mail or Local Classes. Write for terms and list of successful students. **ASSOCIATED ART STUDIOS, 87-B Flarion Building, NEW YORK**

WHY NOT spend Spring, Summer and Fall gathering butterflies, insects? I buy hundreds of kinds for collections. Some worth \$1 to \$7 each. Simple outdoor work with my instructions, pictures, price-list. Send 10c (not stamps) for my Illustrated Prospectus before sending butterflies. **MR. SINCLAIR, Dealer in Insects, Dept. 6, CEAN PARK, CALIF.**



WANTED

RAILWAY MAIL CLERKS
\$1600 to \$2300 Year
MEN—BOYS, 17 UP

WRITE IMMEDIATELY

Steady work. No layoffs. Paid vacations
Travel—see the Country

Common education sufficient. Mail coupon today—SURE



FRANKLIN INSTITUTE, Dept. C-180, ROCHESTER, N. Y.

Sirs: Send me without charge, (1) Specimen Railway Mail Clerk Examination questions; (2) List of government jobs now open to men, 17 up; (3) Send list of examination places; (4) Send free illustrated book, "How to Get Government Positions."

Name.....

Address.....

YOU CAN PLAY THE HAWAIIAN GUITAR

Just Like the Hawaiians!

Because Our Native Hawaiian Instructors Will Show You How!

Be the Most Popular Member of Your Set, Play "When You Walked Out," "Ten Ten Tennessee," "Stella," "Louisville Lou." All the Late Song and Dance Hits. You can play First Selection in Half an Hour and Harmonious Chords AT ONCE.

Here is your chance to get in the swim—to learn to play the most fascinating of all instruments, the Hawaiian Guitar, just as the Hawaiians do, and in an amazingly short time. Our method is so simple, plain and easy that you begin a piece your first lesson. In half an hour you can play it! Thousands of successful students prove this to be true. It is quite astonishing to find the ease with which you can master the Hawaiian Guitar—no matter how little your knowledge of music may be you can positively learn to play by our plain and easy method:

Expert Hawaiians Teach You to Quickly Master Their Secrets of This Fascinating Music

The instructions you receive from such world famous experts as Lawrence Kalaluki, Walter Kotomoku, Frank Ferrer, Carl Seville and others are invaluable. No other Conservatory can even begin to give you the expert teaching and knowledge you gain through us. And remember, while it is conceded that the Hawaiian Guitar produces the sweetest music, yet its mastery by you will be simple and quick, since there are

ONLY 4 EASY MOTIONS

to learn to be able to play any music—popular, dance, classical, native Hawaiian airs, or old time melodies and hymns. Just think of it! You need never have read a musical note in your life! For that matter, even though you haven't the slightest knowledge of any musical instrument we guarantee to teach you how to play just like the Hawaiians!

A Complete Conservatory Course!

Never before has such a complete and easily understood Conservatory Course in Hawaiian Guitar been offered. We are able to grant you this opportunity of quickly learning how to play the Hawaiian Guitar through acquiring the services of real Hawaiians to teach you.

How well this has been accomplished is proved by the fact that this is the only Conservatory teaching Hawaiian Guitar exactly as played by the Hawaiians. It is your good fortune as well as ours, that these Native Masters of Hawaiian Guitar came to this Conservatory to teach—and best of all

We Furnish Everything

When you enroll as a student in this Conservatory you receive FREE a handsome, sweet toned Genuine Hawaiian Guitar—valued at \$15.00—52 especially arranged lessons and 52 carefully selected pieces of music, as well as all necessary picks, Steel Playing Bar, etc. There is nothing extra to buy, everything is furnished.

SEND FOR DE-TAILS TODAY

of this remarkable course—simply fill in the coupon, mail to us and we'll gladly send you full details of our complete Conservatory Course and FREE Hawaiian Guitar Offer! We know you will not let another day go by without enrolling as a student in this Conservatory, once you learn how quickly and easily you can master this most popular of all instruments—the Hawaiian Guitar—So mail the Coupon NOW.

First Hawaiian Conservatory of Music, Inc.
Dept. 48, 233 Broadway (Woolworth Bldg.) N. Y.

Special Courses Under Famous Teachers: TENOR-BANJO
VIOLIN, BANJO-UKULELE and UKULELE



FREE

This Genuine
HAWAIIAN
Guitar—

A Real
\$15.00
Value



MAIL THIS COUPON NOW!

First Hawaiian Conservatory of Music, Inc.,
Dept. 48, 233 Broadway, (Woolworth Bldg.), New York

Please mail at once full details of your 52 easy lessons and FREE Hawaiian Guitar offer. This, of course, does not obligate me in the least.

Name

Address

City State

(Please PRINT name and address clearly)



Are You Reaching for the Truth?

I will tell you
FREE

Under which Zodiac Sign were you born? What are your opportunities in life, your future prospects, happiness in marriage, friends, enemies, success in all undertakings and many other vital questions as indicated by ASTROLOGY, the most ancient and interesting science of history?

Were you born under a lucky star? I will tell you free, the most interesting astrological interpretation of the Zodiac Sign you were born under.

Simply send me the exact date of your birth in your own handwriting. To cover cost of this notice and postage, enclose twelve cents in any form and your exact name and address. Your astrological interpretation will be written in plain language and sent to you securely sealed and postpaid. A great surprise awaits you!

Do not fail to send Birthdate and to enclose 12c.
Print name and address to avoid delay in mailing.

Write now — TODAY — to the

ASTA STUDIO, 309 Fifth Ave., Dept. 138, New York



New Easy Way to Learn CARTOONING

You can now quickly learn to make comics, sport cartoons, animated and serious cartoons, etc. Cartooning is lots of fun—and fun that pays big money! Learn cartooning at home in spare time this amazingly easy way.

SEND FOR FREE BOOK

Mail postcard or letter today for Free Book on Cartooning. It tells all about this easy method perfected by one of America's most successful cartoonists—also is filled with interesting facts about cartooning. Mail card TODAY! Give Age if under 16 years.

Washington School of Cartooning
Room 303, 1113-15th St., N. W., WASHINGTON, D. C.



MEN WANTED

Prepare as Firemen, Brakemen, Electric Motormen, and colored Train Porters. Hundreds put to work. No experience necessary. 600 more wanted. Name position you want.
RAILWAY INSTITUTE Dept. 35 Indianapolis, Ind.

LEARN ENGINEERING

Great Demand for Practical-Technical Men. Big Salaries. Wonderful Opportunities. Beautiful New Building. Extensive Laboratory and Shop Equipment. Not a trade school but a Practical-Technical College. Faculty of Trained Experts. 3 mo. courses in Practical Electricity and Steam. 1, 2 and 3 year courses in Mechanical and Electrical Engineering. Architectural, Structural, Mechanical Drafting. Day and night. Degrees awarded. 22nd year. Write for catalog D.

FINLAY ENGINEERING COLLEGE, Kansas City, Mo.

PIANO JAZZ

By Note or Ear. With or without music. Short Course. Adult beginners taught by mail. No teacher required. Self-Instruction Course for Advanced Pianists. Learn 67 styles of Bass, 180 Syncopated Effects, Blue Harmony, Oriental, Chime, Movie and Cafe Jazz, Trick Endings, Clever Breaks, Space Fillers, Sax Slurs, Triple Bass, Wicked Harmony, Blue Obligato, and 247 other Subjects, including Ear Playing and Musical Invention. 110 pages of REAL Jazz, 25,000 words. A Postal brings our FREE Special Offer.

Waterman Piano School, 253 Supera Theatre Bldg., Los Angeles, Cal.

LEARN WATCHMAKING AND ENGRAVING

Earn while learning. Most practical watch school. Individual instructions. Graduates in great demand. Book free.
Chicago School of Watchmaking, Dept. 20, 4840 Lincoln Ave., Chicago

POSITIONS OPEN IN HOTELS

PAYING UP TO \$400 AND \$500 PER MO.

You can easily qualify for one of many good hotel positions open by preparing in spare time at home. Hotels looking to us for *trained* men and women—many positions open. Opportunities without comparison as to salaries paid, rapid advancement, luxurious surroundings. You can prepare without previous experience in few weeks' time. Training endorsed by leading hotel executives.



Let Us Train You

Send for full particulars as to *big future* for you in hotels, successful graduates, easily-mastered training. Cost moderate; pay as you learn. We help you secure a position. Send coupon today for free booklet No. H-166.

Standard Business Training Inst.
Carlton Court, Buffalo, N. Y.

Send Free Booklet No. H-166.

Name _____

Street _____

City _____

These Books FREE For One Week

Send no money—just fill out the coupon. After you receive the full set of books, express collect, read them over and test them out for seven days. If you don't want them, send them back at our expense. If you decide they will do for you what they have done for more than 100,000 others, pay \$2.80 within one week and \$3 each month thereafter until the special price of \$21.80 is paid. This amounts to only ten cents a day. Mail coupon NOW if you want a bigger, better job at higher wages.



All Automobile Engineering Facts at Your Fingers' Tips

Six Complete New Books for Study or Reference
Also Year's Consulting Membership in
American Technical Society—FREE

Here's the most practical set of books ever written on automobile engineering. Each book is brimful of information about the various phases of this work, 2,600 pages, 2,300 pictures and diagrams, 125 blue prints on every subject. Practical problems are solved in everyday language. They make automobile engineering as plain as day. Completely cross indexed for ready reference.

Know All About Automobiles and Earn Big Pay

These are just the books for the man who wants to know all about automobiles and fit himself for a big-paying job. They are interesting from start to finish and crammed with information. A little regular reading in them during spare hours will soon equip you for

the automobile business. Then after you get into the auto game, you'll still have them for reference.

Let These Books Solve Your Daily Problems

To the man now engaged as a mechanic or shop foreman, these books will give a world of help. They dig deep into the technical angles and theories and explain them in everyday words. If you have trouble on any point, you'll find the answer in these books. They are the work of fifteen auto experts who know from experience, the problems and difficulties of the shopman.

Repair Your Own Car

The car-owner will find these books extremely valuable as an aid in repairing his own car. Think of the heavy repair bills this will eliminate. Think of the money you can save.

© A.T.S. 1923

FREE Consulting Membership

A resident consulting staff of 18 practical experts is waiting to solve for you any auto, tractor or motorcycle troubles that you may have. A letter or a wire to the American Technical Society will bring you an immediate answer and the solution to your problems. This advisory staff of practical automobile men plus your library of Automobile Engineering will enable you to handle successfully any auto job. These men know all the latest methods and the newest and best ways of doing things. Let this pay-raising consulting staff be YOUR SILENT PARTNER. Use this service daily if necessary.

This free consulting membership offer is good for a limited time only and can be withdrawn without notice.

American Technical Society
Dept. A-319 Chicago, U. S. A.

AMERICAN TECHNICAL SOCIETY, Dept. A-319
Chicago, U. S. A.

Please send me a set of Automobile Engineering, for seven days' FREE EXAMINATION, shipping charges collect. I will examine these books thoroughly, and if satisfied, will send \$2.80 within seven days and \$3 a month until I have paid the special price of \$21.80. If I decide not to keep the books, I will return them within one week at your expense. It is understood that if I keep the books I am entitled to a FREE Consulting Membership in the Automotive Division of the Society.

Name.....

Address.....

Reference.....

(Please fill out all lines, give local merchant, banker or employer as reference.)

Musical



Novelty Instruments

Not toys—but high-grade practical instruments for Symphony or Jazz orchestras. Great for solo work at Club, Lodge or Legion gatherings or home entertainments. Anyone can play with a few simple lessons, furnished with each instrument.

Musical Pitch Fork **Glassophone** **Jazz-O-Nette**
Mando-Zi Harp **Musical Saw** **Hohmer Sax**

Free Trial Try any of these instruments for 15 days. If not satisfied, if you can't learn to play it quickly and easily, return at our expense. Remarkably low prices. **Easy Time Payments**—Send today for new, illustrated catalog describing complete line.

MUSSEHL & WESTPHAL
404 S. Water Street Ft. Atkinson, Wis.

LAW BOOK FREE

Send for it today

Whether you are a corporation president or a clerk, capitalist or wage earner—whatever your ambition is—this book will be of vital interest to you—be of direct positive value. It tells you frankly about the amazing secrets of successful lawyers and law trained men in business. It proves conclusively how a law education will quickly fit you for a better position and higher pay. It shows true stories of successful men who before taking this course slaved for practically nothing. Three year course covers preparation for bar examination. Degree of LL.B. conferred. Earn

\$5,000 to \$12,000 a Year

as a lawyer or law trained man in business.

Read at home—aided by reading course.

Moneyback guarantee if not satisfied upon completion. Low fee, easy monthly terms.

Includes complete up-to-date 13 volume library by the highest authorities. Send for free book now. No obligation to you whatever.

HAMILTON COLLEGE OF LAW

431 S. Dearborn St., Dept. 63

Chicago, Ill.



Representatives WANTED

POPULAR MECHANICS MAGAZINE

offers

YOU

An opportunity to represent it in taking subscriptions in your community. We pay

VERY LIBERAL COMMISSIONS

to responsible parties to act as our agents in their community taking subscriptions to Popular Mechanics—the

EASIEST SELLING MAGAZINE

If you cannot devote your entire time to this work you will find it a very profitable way of spending your leisure hours.

Our agents, some with little or no previous experience, are earning from \$2 to \$5 an hour during their spare time.

Write us today for full particulars.

Popular Mechanics Magazine
210 East Ontario Street
CHICAGO

STUDY AT HOME

Directed by

The University of Chicago

Courses in English, History, Chemistry, Business, Education, Mathematics, Psychology, and 35 other subjects command credit toward a Bachelor degree. Begin any time. Address 15 Ellis Hall, University of Chicago, Ill.

A FILE

Stop Forgetting

Make Your Mind an index from which you select facts, figures, names, faces. Develop concentration, self-control; overcome bashfulness, forgetfulness.

Write today for FREE memory and concentration test and illustrated booklet, "How to Remember."

PROF. HENRY DICKSON
Dept. 7053 Evanston, Ill.

NOT A FILE

Learn to **PAINT SIGNS and SHOW CARDS**

Big field—unlimited possibilities—increasing demand for men with creative ideas. Our course develops ability and originality. Work intensely interesting.

EARN \$25 TO \$75 WEEKLY

You can do it if ambitious. Successful graduates everywhere. Our course thoroughly covers every phase of work. Our graduates command big salaries. Write for outline, samples, guarantee and Free Credit Offer.

Detroit School of Lettering, 623 O. S. L. Bldg., Detroit, Mich.

Look Here!



I WILL MAKE YOU A DRAFTING EXPERT



If you're earning less than \$75.00 a week GO INTO DRAFTING. I guarantee to train you AT HOME, the JOB-WAY, with actual Drafting Room jobs. Send for my free book, find out about the wonderful opportunities to earn *big money* in this easy, fascinating business. Drafting Experts are close to the Boss, are first in line for promotion to executive positions.

\$250 to \$400 a MONTH!

Common schooling all you need. I train you by my copyrighted "JOB-WAY" instruction. I train you thoroughly in Drafting by giving you actual Jobs to do. Most complete training, only instruction that makes Drafting EXPERTS. No books or useless theory to waste your time. My graduates are SUCCESSFUL—employers ask for Coyne-trained Draftsmen. So I guarantee to satisfy you or to refund every penny of your money.

Learn at Home!

Thousands of big-salaried jobs, all over the country, looking for DRAFTING EXPERTS! Railroads, factories, builders, architects, ship-yards, auto plants, Cities, Countries, States, the U. S. Government—all hungry for Drafting Experts. Man alive, wake up to your biggest opportunity!

Experts' Outfit FREE! "JOB-WAY" training makes you a DRAFTING EXPERT quick be-

cause you learn to do actual jobs with the same professional instruments you will use when employed at a big salary. To encourage you to START RIGHT NOW, I will give you with my course this costly outfit without one penny of cost! Coupon brings complete information.

DRAFTING BOOK FREE!

Mail Coupon Today!

Address **CHIEF DRAFTSMAN
COYNE SCHOOL OF
DRAFTING**

1-9 S. Ashland Ave., Dept. 319
CHICAGO, ILL.

FREE!



MAIL COUPON TO-DAY!

**Chief Draftsman
COYNE SCHOOL OF DRAFTING
1-9 S. Ashland Ave., Dept. 319, Chicago, Ill.**

Without obligating me in any way, please send me your book, "Drafting, the Foundation of Industry" absolutely free. Also complete information of your rapid home-study Drafting course, free instruments and special offer.

Name

St. No.

City State



This Man Earns \$3500 to \$5000 a Year

—WORKING WITH A DENTIST—
THREE MONTHS' TRAINING
QUALIFIED HIM TO DO IT

There are thousands of these positions awaiting trained men in this profitable profession. After just a few months of specialized training hundreds of men will have become full-fledged members of the dignified profession of

MECHANICAL DENTISTRY

They will have the technical knowledge and skill to enable them to earn several thousand per year. You can be among them. 2500 more Dental Mechanics are needed right now and the Dental Profession is constantly calling for graduates of the four great schools of this institution; salaries from \$35 to \$45 a week to start, with advancement up to \$125 a week.

FREE PARTIAL SCHOLARSHIPS

In order to meet this urgent demand for the men we train, we are offering for a limited time Five Partial Scholarships. You will want to get in on this exceptional offer—so don't delay. NOW is the time!

JUST COMPARE

Compare the unusual opportunities this profitable professional trade offers with what you are now doing—the earnings, the pleasant, dignified occupation. Compare also our ability to train you and put you in touch with the right opportunity—our four large, well-equipped schools, over 30 years of experience in this one line, our wide acquaintance with the Dental Profession throughout the nation!

SEND FOR CATALOG AND SCHOLARSHIP OFFER

Describes the field and why the demand. Shows how students "Learn by Doing" actual work through practical, individual instruction, day or evening sessions. Shows how you can "Earn while Learning."

BODEE DENTAL INSTITUTE

136 West 52d Street, NEW YORK

PHILADELPHIA BUFFALO BROOKLYN
1305 No. Broad St. 1226 Main St. 15 Flatbush Ave.

BODEE DENTAL INSTITUTE: Without obligation to me send me a Free Copy of your catalog and complete details of the Free Partial Scholarship Plan No. 2.

Name

Address

Learn Write



I Teach by Mail

I can make a good penman of you at your home during spare time, no matter where you live or how poorly you now write. My simplified system has shown thousands the way to good penmanship during the past twenty-five years—it CAN and WILL do the same for YOU.

My beautifully illustrated 32-page Book
"How to Become a Good Penman" **FREE!!**

It contains many beautiful specimens of penmanship showing what others have accomplished by the Tamblin System, with testimonials and general information about our system. (Your name elegantly written on a card if you enclose stamp for postage.) Ladies taught as successfully as men. Write Today, Address
F. W. TAMBLIN
418 Ridge Bldg. Kansas City, Mo., U. S. A.

F. W. Tamblin

FREE



\$20 Fine Tone Musical Instruments

We have a wonderful new copyrighted system of teaching **Note music by mail!** To first pupils in each locality we will give free a \$20 superb Violin, Tenor Banjo, Ukulele, Hawaiian-Guitar, Banjo, Mandolin, Banjo-Ukulele, Banjo-Mandolin, Cornet or Banjo-Guitar absolutely free. Also teach Piano and Organ. Very small charge for lessons only. Four lessons will teach you several pieces. Over 100,000 successful players. We guarantee success or no charge. Complete outfit free. Write today, Dept. 167. No obligation.
SLINGERLAND SCHOOL OF MUSIC, 1815 Orchard Street, CHICAGO, ILLINOIS

"STAMMERING Its Cause and Cure"

You can be quickly cured if you stammer. Send 10 cents, coin or stamps, for 288 page cloth bound book on Stammering and Stuttering. It tells how I cured myself after Stammering and Stuttering for 20 years. **BENJAMIN N. BOGUE**
6907 Bogue Building, 1147 N. III. St. Indianapolis

LEARN TO DRAW AT HOME—IN YOUR SPARE TIME

From the school that has trained hundreds of successful cartoonists and illustrators—now earning from \$50 to \$200 and more a week, The Landon Picture Chart Method of teaching makes original drawing easy to learn. Send 6c in stamps for full information and chart to test your ability. Also state your age and what kind of drawing you like to do.



THE LANDON SCHOOL 1438 Nat'l Bldg. CLEVELAND, O.

SONGS Clean, catchy hits that everybody likes. Ballads, comic songs, novelty songs,coon songs; full sheet music with beautiful colored covers. Ideal for public entertainment or home diversion. Hundreds of plays and entertainment books. Big catalog free.
T. S. DENISON & CO., 623 So. Wabash Ave., Dept. 200, Chicago

LEARN WATCH REPAIRING



You can learn by our modern and original system of instruction every part of the **Watch Repairing Trade** at home as good or better than at a shop. You can earn money while learning and secure a well paying position or start in business after completing our course of instruction. Good watch repairers are always in demand and earn from \$30 to \$70 per week. For particulars apply to the **Wisconsin School of Watch Repairing**
166 Mason St., MILWAUKEE, WIS.



He Starts at \$5,200 a Year

One hundred dollars a week! And only a few years ago his weekly wage was less than \$30. Didn't dream he could do it when he first took up the study of Higher Accounting under the LaSalle Problem Method; but he just couldn't help getting ahead—so he wrote—because he found it the most interesting thing he ever tackled.

Knew nothing about bookkeeping, but LaSalle quickly gave him the necessary foundation. Then, step by step, he was trained in the practical work of Cost Accounting, Auditing, Business Law, Organization, Management, Finance, Income Tax Procedure—not theoretically, mind you, but by the solving of actual problems lifted bodily from business life. As a result, he sits as Auditor at a big mahogany desk and commands a salary of \$5,200 a year.

Unusual Opportunities in Accounting

Typical, this man's experience, of that of thousands of ambitious men who have found their path to success in the LaSalle Problem Method. Never in the history of business has the need for trained accountants been so great or the rewards so attractive. The files of LaSalle Extension University contain literally thousands of letters reporting rapid advancement—incomes doubled, tripled and quadrupled as the result of home-study training. During three months' time, 1,193 LaSalle members wrote to the University telling of the "raises" they had got as a result of their training. *The average increase per man was 89 per cent.*

These men were not unusual; they had no "pull" or "luck;" they got their start by signing just such a little coupon as appears directly below this text. Mark the coupon, sign and mail today—and get the facts. We will promptly send you complete information regarding the training you are interested in; also a copy of that inspiring book, "Ten Years' Promotion in One." "Get this book," said a prominent Chicago executive, "even if you have to pay five dollars for it." We will send it free.

Remember, the cost of LaSalle training is small and can be covered in easy monthly payments, if you so desire. The decision that you make this moment is important. Mail the coupon now.

LaSalle Extension University

The Largest Business Training Institution in the World
Dept. 364-HR Chicago, Illinois

Please send me catalog and full information regarding the course and service I have marked with an X below. Also a copy of your book, "Ten Years' Promotion in One," all without obligation to me.

Higher Accountancy

Training for positions as Auditor, Comptroller, Certified Public Accountant, Cost Accountant, etc.

Other LaSalle Training Courses

LaSalle is the largest business training institution in the world. It offers training for every important business need. If more interested in any of these courses, check here:

- | | |
|--|--|
| <input type="checkbox"/> Business Management | <input type="checkbox"/> Banking and Finance |
| <input type="checkbox"/> Modern Salesmanship | <input type="checkbox"/> Modern Foremanship and Production Methods |
| <input type="checkbox"/> Traffic Management | <input type="checkbox"/> Personnel and Employment Management |
| <input type="checkbox"/> Railway Station Management | <input type="checkbox"/> Expert Bookkeeping |
| <input type="checkbox"/> Law—Degree of LL. B. | <input type="checkbox"/> Business English |
| <input type="checkbox"/> Commercial Law | <input type="checkbox"/> Commercial Spanish |
| <input type="checkbox"/> Industrial Management Efficiency | <input type="checkbox"/> Effective Speaking |
| <input type="checkbox"/> Modern Business Correspondence and Practice | <input type="checkbox"/> C. P. A. Coaching |

Name.....

Present Position

Address

Be a Certificated "Electrical Expert"

You, Too, Can Learn
to Boss This Job

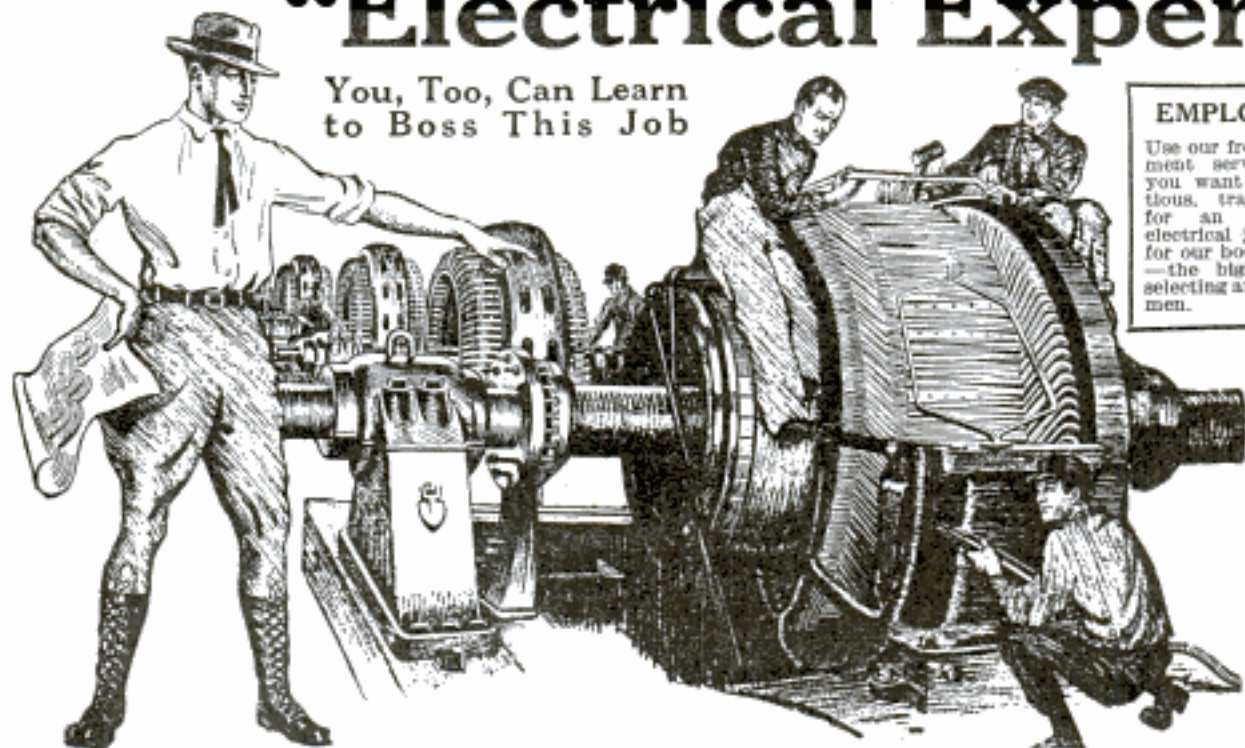

EMPLOYERS

Use our free employment service when you want an ambitious, trained man for an important electrical job. Send for our book "Men"—the big story of selecting and training men.

"Electrical Experts" Earn \$12 to \$30 a Day WHAT'S YOUR FUTURE

Now you earn \$15 or \$20 or \$30 a week. In the same six days as an Electrical Expert you can make \$70 to \$200 a week, and do it easier—not work half so hard. Why then remain in the small-pay game, in a line of work that offers no chance, no big promotion, no big income? Fit yourself for a "Bossing" job—

Be an "Electrical Expert"

Today even the ordinary Electrician—the "screw driver" kind—is making money—big money. But it's the trained man—the man who knows the whys and wherefores of Electricity—the "Electrical Expert"—who is picked out to "boss" the ordinary Electricians—to boss the Big Jobs—the jobs that pay

\$3,500 to \$10,000 a Year

Get in line for one of these "Big Jobs" by enrolling now for my easily learned, quickly grasped, right-up-to-the-minute, Spare-Time Home-Study Course in Practical Electricity.

Age or Lack of Experience No Drawback

You don't have to be a College Man; you don't have to be a High School graduate. As Chief Engineer of the Chicago Engineering Works, I know exactly the kind of training you need, and I will give you that training. My Course in Electricity is the most simple, thorough and successful in existence, and offers every man, regardless of age, education, or previous experience the chance to become, in a very short time, an "Electrical Expert," able to make from \$70 to \$200 a week.

FREE—Electrical Working Outfit—FREE

With me, you do practical work—at home. You start right in after your first few lessons to work at your profession in the regular way. For this you need tools, and I give them to you absolutely free—a whole kit, a complete outfit, one that would cost you \$12 to \$15.

Your Satisfaction Guaranteed

So sure am I that you can learn Electricity—so sure am I that after studying with me, you, too, can get into the "big money" class in electrical work, that I will guarantee under bond to return every single penny paid me in tuition, if, when you have finished my Course, you are not satisfied it was the best investment you ever made.

Use This "FREE OUTFIT" Coupon

L. L. COOKE
The Man Who Makes "Big-Pay" Men
Dept. 13, 2150 Lawrence Ave., Chicago

Dear Sir: Send at once Sample Lessons, your Big Book, and full particulars of your Free Outfit and Home-Study Course, the Free Radio Course—all fully prepaid—without obligation on my part.

Name.....

Address.....

Occupation.....

Guarantee Backed by a Million Dollar Institution

Back of me in my guarantee, stands the Chicago Engineering Works, Inc., a million dollar institution, thus insuring to every student enrolled, not only a wonderful training in Electricity, but an unsurpassed Student Service as well.

It's this service that makes "Cooke" training different from any other training. It's this service plus "Cooke" training, that makes the "Cooke" Trained Man the "Big-Pay Man," everywhere.

Be a "Cooke" Trained Man and earn \$12 to \$30 a day—\$70 to \$200 a week—\$3,500 to \$10,000 a year.

Get Started NOW—Mail the Coupon

This coupon entitles you to my Big Electrical Book, and sample lessons Free—use it—get in on the ground floor of the nation's biggest and most fascinating industry. Be a Cooke Trained Man, and a Big-Pay Man. Let me show you how.

Mail the Coupon To-day!
L. L. COOKE, Chief Engineer

CHICAGO ENGINEERING WORKS
Dept. 13 2150 Lawrence Ave. CHICAGO

The "Cooke" Trained Man is the "Big Pay" Man

Classified Advertisements

WORLD'S BEST WANT AD MEDIUM

Advertisements in this section, 25 cents per word, each insertion, minimum 10 words, payable in advance.
To be inserted under proper classification in April issue, copy should be in our office February 18th.

ADVERTISING AGENCIES

To secure agents or salesmen or for selling farms and reaching investors, use classified (want) ads in largest newspapers and magazines. Price list No. 30 sent free. Ankrum Advertising Agency, 20 W. Jackson Blvd., Chicago, Ill. The largest classified advertising agency in the U. S.

25 WORDS—335 Rural Weeklies \$14.25.
Ad-Meyer Agency, 4112-M Hartford, St. Louis.

A SERVICE agency for magazine and newspaper classified advertisers. Complete advertising service free of charge. We edit and place your copy. Send for our free list and explanation. Sweet & Phelps Advertising Agency, 212 E. Ohio St., Chicago.

FOR ADVERTISERS

4 PAGE—45 Magazines—\$5. Copy 15c.
Arthur Marchener, Slaking-Spring, Penna.

I WRITE booklets, folders, letters, complete follow-up for manufacturers, mail-order dealers. Long experience. Write for prices. L. Taylor, Box 44M, Preport, Ill.

INTERNATIONALIZE Your Business!!! Sell! Trade! Buy! Everything! Everywhere! Ads: 1c word; \$1.00 inch. Circulation International! Subscription: Six Months (trial only) 25c; Copy 10c. International-Opportunity, Brookings, S. Dak.

ADVERTISE, hundred magazines, three issues, 10c word. Pennell-Company, Covington, Ky.

ADVERTISE in 325 Illinois Country Newspapers. 24 words \$10.00. Keator, Hartford Bldg., Chicago, Ill.

"BEE" Advertising is productive. 3c per word classified and \$1.50 per inch Display. Sample 10c; None free. "The Mail Order Bee," 5309 Forest, Kansas City, Mo.

"NATIONAL ADVERTISER," Year—25c. Advertising: page—\$7.50; word—1c. Vernon Anderson, Conrad, Mont.

INCH Display 100 magazines thrice \$8.
Beck, 5406 Alaska, St. Louis.

ADVERTISE in 24 Big Sunday Newspapers, 24 words \$15.00. Catalog listing 1,000 leading Dailies, Weeklies, Magazines, 4c stamps. Union Advertising, Baltimore Bldg., Chicago.

SALES PROMOTION

25 YEARS' Experience developing \$50 to \$50,000 daily sales by mail, magazine, newspaper campaigns. Letters, circulars, booklets written. \$13,540 profit second quarter followed \$2,139 loss preceding quarter after client adopted my direct-mail plans and copy. Submit details of sales problems for Free preliminary diagnosis. Ten years Sales Promotion Manager Larkin Co., a thirty-million dollar corporation. James C. Johnson, 118A Woodbridge Ave., Buffalo.

400 FORCEFUL, Effective, Business-getting Letters, prepared in typewritten form. Covers practically every kind of business; \$5.00 prepaid. Particulars free. J. Rodgers Hoggard, Windsor, N. C.

AUTOMOBILE SUPPLIES

AUTOMOBILE gears, shafts, bearings and springs, in new parts at very low prices. Differential and transmission gears, fiber timing gears, axle shafts, drive shafts, Timken, Hyatt, New Departure, connecting rod and crankshaft bearings for most all makes and models of cars. Prices quoted on request. Auto Tire & Parts Co., 501 Broadway, Cape Girardeau, Mo.

REMANUFACTURE Fords—most profitable business on earth—\$14,355.00 Made on 300 complete jobs. \$850.00 completely equips shop with tools recommended by Ford Motor Company. Circular. K. R. Wilson, Buffalo, N. Y.

RECHARGING Batteries Paying Big Profits With Constant Potential 8-Hour System. Profits \$100 to \$400 monthly. Easy \$20 monthly payments bring this Equipment. Start your own money-making business. Write Hobart, Troy, Ohio.

FOR Sale—Miller Steam Vulcanizer—gasoline fuel, good as new. \$125 takes it. Original cost \$300. W. H. Losch, Jersey Shore, Pa.

BARGAINS—Guaranteed Radiators—Dodge \$19.95, Maxwell, \$21.50, Chevrolet 4-90 \$16.95, and many others. State make and model required. Sport Bodies built to order; send sketch. Independent Radiator Co., 1119 Wabash Ave., Chicago, Ill.

WE'VE Got Everything in New and Used Auto Parts, Accessories and Supplies, for all makes and models of cars. Engines, Transmissions, Clutches, Axles, Wheels, Rims, Tires, Radiators, Gears, Axle Shafts, Bearings, Magnets, Starters, Generators, Collis, Batteries, Etc., Etc. Ours is the largest stock of its kind in the world. Our Motto is "Service, Quality, and Low Price." Write for catalog and bargain lists. Warshawsky & Company, Inc., World's Largest Car Wreckers and Replacement Parts House, Phone Calumet 7315, 1915-35 S. State St., Chicago, Ill. No Branches.

COUNTY and district distributors now being placed on greatest accessory ever produced for Ford cars and trucks; made by machine organization in Cleveland, specializing on automotive production since 1907; installations already made on largest industrial fleets in the country; Ed Dunn of Akron sold 400 sets in less than 3 months; a bona fide automotive product, for Fords only. Address The Taylor Machine Co., 1917-21 East 61st Street, Cleveland, Ohio.

AIR Compressors, Fully Automatic. Guaranteed, \$29 monthly, paid by increased business automatic air service brings. Particulars free. Hobartco, Troy, Ohio.

SPARK Plugs, Champion X for Fords 40c, other cars 57c. Boyce Motometers Universal \$5.50. Other bargains. R. O. Helwig, 7921 S. Loomis St., Chicago.

SAVE \$25 on your next Top Recovering. See Page 154.

STEAM Automobile Owners: Inclose stamp for "list" Acme Boilers, Burners, Engines. Everything for Steam Automobile and Launch. "Doc" Paine Steamer Company, Denver, Colo.

MICROMETERS for one dollar—measures five inches inclusive. See advertisement under "Machinery."

RECHARGERS for all magnetos, \$3.00. Benner Manufacturing Company, Webb City, Mo.

AUTOMOBILE parts for all cars. Lowest prices. Save money; get our wholesale catalogue. State make of car, model and parts wanted. Parts shipped immediately from stock. We refund your money if not satisfied. Mechanics Gear Co., 2706 No. Halsted St., Chicago.

AUTO and Truck Parts. Save 25-30%. New and used motors, gears, axles, bearings, springs, generators, \$10 up. New Zenith, Johnson, Rayfield, Stromberg carburetors, \$7.50 up; new waterproof Simms and Berling magnetos, \$15; Ford retopping, \$4-\$6; other cars, \$12 up. Brighman Auto Exchange, 321 Windsor Ave., Hartford, Conn.

AUTOMOBILE owners, garagemen, mechanics, send for free copy America's popular motor magazine. Contains helpful, money-saving articles on repairing, overhauling, ignition, carburetors, batteries, etc. Automobile Digest, 507 Butler Bldg., Cincinnati.

AUTOMOBILE Parts—Used parts for most any car at half factory list prices. Allen, Briscoe, Buick, Cadillac, Chalmers, Chevrolet, Dodge, Dort, Grant, Hudson, Hupmobile, Oakland, Overland, Oldsmobile, Reo, Studebaker and many others. Send list of parts wanted. Maxwell Bros., 4106 Olive St., St. Louis, Mo.

AUTOMOBILES

PATENTS Procured. Send sketch or model today for examination, prompt report and advice. No charge for preliminary advice. Write for free Booklet and blank form on which to disclose your idea. Highest references. Promptness assured. Clarence A. O'Brien, Registered Patent Lawyer, 53-C Security Bank Building. Directly across the street from Patent office, Washington, D. C.

BUILD It Yourself—A Real Automobile that any handy man or boy can build. A low-slung, speedy cycle car. Power supplied by famous 2½ H. P. Shaw Motor. Send stamp today for Descriptive Circulars or send 25c for Complete Book of Easy-to-Follow Plans. Shaw Mfg. Co., Dept PM-1, Galesburg, Kans.

PATENTS—Write for our Guide Books and "Record of Invention Blank" before disclosing inventions. Send model, or sketch and description of your invention for our free opinion of its patentable nature. Highest references. Reasonable terms. See advertisement on page 88. Victor J. Evans & Co., 185 Ninth, Washington, D. C.

AUTOMOBILE owners, garagemen, mechanics, send for free copy America's popular motor magazine. Contains helpful, money-saving articles on repairing, overhauling, ignition, carburetors, batteries, etc. Automobile Digest, 507 Butler Bldg., Cincinnati.

RACING Bodies for Fords and Chevrolets 490. Send for free particulars. Our book "How to Build a Ford Racer" sent on receipt of 25c. Central Auto Supply Company, Dept. 120-C, Louisville, Ky.

M. P. LAUGHLIN—Patents—Engineer—Attorney—Specializing Power-Automotive Inventions. 48 East 41st St., New York.

FOR FORD OWNERS

FORD Repair Book Free: A very complete and well illustrated book explaining how to make repairs on most every part of your Ford. We offer this book free with a nine months' subscription to Ford Owner and Dealer Magazine—at only \$1.00. Everyone interested in the Ford car should read this big magazine of about 200 pages monthly. It clearly explains the things you want to know about cutting down the cost of operation, the engine, ignition, transmission, carburetor, etc. Send Today and get the valuable Repair Book Free. Ford Owner and Dealer Magazine, 539 Montgomery Bldg., Milwaukee, Wis.

35 MILES per gallon Fords; spend five minutes; attachment free. Agents wanted. Gas Fertilizer Co., 529 Inter-Southern Bldg., Louisville, Ky.

UNDERSLING with "RKO" Swing Lo Irons. See "Red-i-Kut" ad page 167.

WONDERFUL New Spark Plug patented. Burns kerosene and oil. Distinctly different from all other plugs; starts easy, more heat, life, pep in motor, ideal for motors pump oil, guaranteed. Sample \$1.50. Agents wanted. Motor Spark Co., Montegabel, Pa.

FORD owners, stop that ruinous chatter on your car. Install Bredar's Ball Shim. Price, \$1.10. Write for Information. Nic Bredar's Shim Mfg. Co., Rock Island, Ill.

AUTOMOBILE owners, garagemen, mechanics, send for free copy America's popular motor magazine. Contains helpful, money-saving articles on repairing, overhauling, ignition, carburetors, batteries, etc. Automobile Digest, 507 Butler Bldg., Cincinnati.

MOTORCYCLES, BICYCLES & SUPPLIES

CYCLE Car, Light Weight. Power supplied by Motorcycle Engine. Equipped with twenty inch Pneumatic Tires. Price \$115.00. Set of Ice and Snow Runners included Free with every car ordered now. Shaw Manufacturing Company, Cycle Department, Galesburg, Kans.

50% OFF. Used parts in stock for Shaw, Excelsior, Henderson, Reading, Harley, Rogers Side Cars, Eclipse clutches, cylinder grinding. Central Motorcycle, 913 Washington, Chicago.

SEND for our Bargain Bulletin and Money Saving Message. It will save you money on Motorcycles, Side Cars, Motor wheels, Repair Parts and Accessories. Some used parts at less than half. Cleveland and Ace Motorcycles our specialty. See our ad on page 124. American Motor Cycle Co., 2045-5-7 W. Chicago Ave., Chicago.

SEND for big list of slightly used motorcycles on the easy payment plan. Howard Cycle Co., Trenton, N. J.

SAVE Money on motorcycle accessories and salvage parts; all leading makes. Big discount. Send for catalogue. Tulsa Motor & Cycle Co., 202 So. Lansing, Tulsa, Okla.

MOTORCYCLE Riders make big money demonstrating and selling internationally famous flexible sidecars and other products in open territories. Special Discount on Demonstrating car and liberal Commissions on Sales. Flexible Co., 328 Water Street, Loudonville, Ohio.

DON'T buy a Bicycle Motor Attachment until you get our new catalogue and prices. Also runs washers, pumps, and shop machinery. Shaw Mfg. Co., Dept. 27, Galesburg, Kans.

WONDERFUL bargains in reconditioned motorcycles. Priced as low as \$35. Sidecars from \$25 up. Every one expertly rebuilt and guaranteed in absolutely first-class condition. Don't delay. Send 2c for big, new catalog showing 1924 bargains. Agents wanted everywhere. Western Supplies Co., 359 Hayutin Bldg., Denver, Colo.

1922 HARLEY-DAVIDSONS, \$135; 1921, \$115; 1920, \$85; 1919, \$65; 1917, \$50; 1914, \$45; 1915, \$40; 1914, \$35. Guaranteed. Money refunded if not satisfied. Circular free. Wisconsin Cycle Sales Co., 720 National Ave., Milwaukee, Wis.

MOTORCYCLE Sidecars—Bargain Prices on Experimental and Discontinued Models. Write Flexible Co., 328 Water Street, Loudonville, Ohio.

USED parts for all motorcycles, cheap. State wants. Schuck Cycle Co., 1922 Westlake, Seattle, Wash.

'19 INDIAN 3 Speed \$75.00. '20 Indian 3 Speed \$95.00. '21 Indian 3 Speed \$125.00. Howard A. French Company, Baltimore, Md., Washington, D. C.

OVERSTOCKED—200 Used Motorcycles. Must be sold at once. We have Harley-Davidsons, Indians, Hendersons, Excelsiors, Clevelands. Prices \$25.00 up. Write for our Bargain List. Myer Brothers, Dept. B, 15 Berkeley St., Boston, Mass.

AVIATION

TEN lessons in the air, of twenty minutes each, will make you a pilot, by our advanced method of training. This, together with our five week shop course at \$100.00, makes America's oldest aircraft factory, the most popular flying school. Work after class hours guaranteed. Heath Airplane Co., Chicago, Ill.

WILL exchange hundred horsepower. Gnome aeroplane engine, practically new, for good radiohone receiver. Box 702, Mobile, Ala.

ENGINES—Benz, Mercedes, Fiat, Beardmore, Isotta, Liberties, cheap. Detroit Marine-Aero Engine Co., 7924 Ripelle Street, Detroit, Mich.

WE can teach you to fly and establish you in the commercial flying business for little money. Universal Air Service, Parkersburg, Pa.

COMPLETE Scale Plans, with Building-Flying Instructions for following 3-ft. Model Aeroplanes, 25c each postpaid: JND-2; DeHavilland; N.C.-4; Curtiss Tractor; Bleriot; Nieuport or Taube Monoplanes; Cecil Peell Biacer. Complete catalogue 48 pp., 5c. Ideal Aeroplane Co., 165 1/2 Spring St., New York.

SEND 10c for our latest aeronautical catalog listing a complete line of airplane goods at reduced prices. Sted blue prints \$1.75, Jersey aviator helmets 95c; resistal goggles \$2.00. Heath Airplane Co., Chicago, Ill.

HELMETS, Goggles, airplanes, motors. Bargain Offer! Pair Resistal Goggles, leather helmet, pair plain goggles worth eleven, yours for Five Dollars. Money back if not satisfied. Marvin A. Northrop, 200 Builders, Minneapolis, Minn.

AIRPLANES, \$350 to \$1,500. Motors, 28 to 200 H. P. Propellers, \$3 up. Leather coats, \$10 to \$15. Smith Machinery Co., Houston, Texas.

WANTED—6 cyl. 45 H. P. Anzani Motor. E. J. Dunham, Hamburg, N. Y.

PATENTS Procured. Send sketch or model today for examination, prompt report and advice. No charge for preliminary advice. Write for free Booklet and blank form on which to disclose your idea. Highest references. Promptness assured. Clarence A. O'Brien, Registered Patent Lawyer, 58-C Security Bank Building, Directly across the street from Patent office, Washington, D. C.

SEND one dollar for beautiful pair of sterling silver wings mounted on stick or bar pin with safety catch. Wear one to boost aviation. Money refunded if not absolutely satisfactory. Wallace Aero Company, Davenport, Iowa.

THREE foot model aeroplane. Small cost. Circulars free. Aero Shop, 2050 Hurbit Ave., Detroit, Mich.

HEATH propellers represent the most efficient method of aerial drive. Each propeller individually designed for the particular work to be done, as laid out by America's oldest aeronautical engineers. Propeller catalog 4c. Ford Airplane, or Motorcycle Airplane circulars 4c each. Heath Airplane Co., Chicago, Ill.

80 H. P. LERHONE Airplane Motor. Brand New, Propeller, Tools, \$75. MacLachlan, St. Regis, Ocean Park, Calif.

"BUILD an Airplane." Motorcycle Engine Monoplane Plans, \$1. "Sportford" Biplane Plans, \$2.50. "Knockdown Planes," \$100 up. Illustrated Circular Free. Aviation Engineering Co., Lawrence, Kansas.

THE American School of Aviation announces a new correspondence course in Mechanics of Aviation. A thorough training in Practical Aeronautics. American School of Aviation, Dept. 1868, 3601 Michigan Ave., Chicago, Ill.

WELDING

\$2.00 BUYS a complete soldering outfit. Herbert Clemesch, Garber, Iowa.

BOOKS AND PERIODICALS

FICTION Writers' Question Book helps you write stories that sell. \$2 postpaid (money order). Brattle Book Co., Cambridge 38, Mass.

500 THINGS To Sell by Mail. Remarkable new publication, workable plans and methods. Loose-leaf, cloth binder. Prepaid \$1.00. Charles International Co., Box 275, 1416 Broadway, New York City.

THE Key to Success—A course of mind building which opens the door to health, power and prosperity. Former price \$30. Now in bound volume only \$3. Order today, or send stamp for particulars. New Era Studio, Dept. M, 219 North 18th St., St. Louis, Mo.

IF interested in art publications, address Dunbar, Boston 24, Massachusetts.

BUY everything wholesale. Wonderful book listing firms, 25c. Mosurt, 153-D Maple, Newark, N. J.

BOOK—"Poems of Inspiration and Action" (was \$1.00), now—Only 25c postpaid! Hansen Company, Brookings, S. Dak.

FREE—Fun and Postcard magazine. Pin-Ko, 944 Clark, Toledo, Ohio.

USED Books, Extra Bargains. Lists Monthly. Higens's, A2441 Post, San Francisco.

NEW Mail Order Directory. Send Address. G. Shaver, Publisher, Oil City, Pa.

BOOKS on love, human nature, dreams, better writing, poetry, hypnotism, spiritualism, health, etc. Two intensely interesting books 25c with catalogue free. E. Smetana Company, Owosso, Mich.

THE 20th century business Encyclopedia containing 128 pages of valuable knowledge for the working man, and will pay its price in business information ten minutes after you have it in your hands. Price \$1.00 postpaid. Johnson's Variety Store, New Suffolk, N. Y.

FREE—Our Rare, Instructive and Entertaining Book Catalog. Wright & Son, 601 S. Ind. Ave., Peoria, Ill.

HINDU Psychology, Secret Sciences. Illustrated Catalogue, lesson 25c. Adaros, 116 South Michigan, Chicago.

"MASTER KEY" \$2.50. "Power of Will" \$3.00. Coze's 50c; all \$5.00. Phipps, 1014 Belmont, Chicago.

"LIGHTS, Colors, Tones and Nature's Finer Forces," covering Vibrations; Odie-Auras; Cold-lights; Radio; Inventions; 270 pages. Satisfaction guaranteed; \$2.00. Circulars Free. M. Stevens, Publisher, 242 Powell, San Francisco.

FREE—Send for my Newthought. Self-culture, Occult, Mystic and Scientific book literature. Martens Publisher, Burlington, Iowa.

WRITERS, Study at home. Thirty textbooks, and criticism and advice regarding markets for manuscripts. Catalogue. Correspondence invited. James Knapp Reeve, Editor, Franklin, Ohio.

INDUSTRIAL Alcohol. Wright's book everybody wants. Full directions for making with drawings of necessary apparatus. \$2.50 postpaid. Spon & Chamberlain, 120 P. M. Liberty Street, New York, N. Y.

AMERICA'S greatest employment magazine wants co-publishers everywhere. Rare money-making opportunity. Particulars and copy of magazine, 10c. Employment News, Hyannis, Mass.

PICTURES AND POSTCARDS

EXCHANGE Postcards, Fascinating Magazine information, 5c. "Universalist," 1034P West Eighteenth St., Chicago, Ill.

JOIN live postcard club. Membership list including catalog 10c. Harvey Teeple, Decatur, Ind.

SOUVENIR postcards of Asheville (In the land of the sky), 25c per dozen, Box 831, Asheville, N. C.

NOVELTIES, CURIOS, ETC.

WEIRD Fascinating Curio from Wyoming. Genuine Rattlesnake rattle—fine specimen—mounted—biological data, 50 cents. D. C. Wilhelm, Gillette, Wyo.

KILLIAN'S Komical Kalling Kards. "Every Kard a Laugh." 10c brings complete assortment with novelty catalog. Killian, 1390 Temple, Detroit, Mich.

312 CODES in One; The Universal Multicode. Wonderfully simple, simply wonderful. No one can read your private messages. Something new. Send for yours today. 50c postpaid. Charles L. Smith, 8114 Crockett Blvd., Los Angeles, Calif.

LATEST Parisian novelty, something new, 50c. Agents wanted. Jack Ferdia, 1520 So. Ridgway Ave., Chicago, Ill.

GAMES, ENTERTAINMENTS AND PLAYS

VENTRILOQUISM taught almost anyone at home. Small cost. Send 2c stamp today for particulars and proof. George W. Smith, Room M-845, 125 N. Jefferson Ave., Peoria, Ill.

REPRODUCE your own voice—See "Voice-graph," phonograph columns—This issue.

SEND Dime for new exciting game; have plenty of fun. Herman Krug, 1 East 42nd Street, New York, N. Y.

200 KINDS Iron, wood and wire puzzles. Lender and illustrated list 10c. Western Puzzle Works, St. Paul, Minn.

PLAYS, musical comedies and revues, minstrel music, blackface skits, vaudeville acts, monologs, dialogues, recitations, entertainments, musical readings, stage handbooks make-up goods. Big catalog free. T. S. Demison & Co., 623 So. Wabash, Dept. 11, Chicago.

"TREASURE Isle."—The great game! Fun and Excitement for all. Your Toy Store or Post Paid \$1.00 (Canada \$1.25). Satisfaction guaranteed or Money Back. Gem Publishing Co., 1313 Engineers Bldg., Cleveland, O.

MAGIC TRICKS, BOOKS, AND JOKERS' NOVELTIES

MAGIC—Tricks, Books and Supplies. For Amateurs as well as the great professionals. Anyone can learn through our instructions. Feature Acts in Mind Reading, Spiritualism, Rope Ties, etc. Large Illustrated Professional Catalog, 20c. Chicago Magic Co., 140 S. Dearborn St., Dept. B, Chicago, Ill.

"POOFOO English" makes all laugh. Booklet 25c. Ballay, Petries Corners, N. Y.

MAGIC Goods, Cards, books, novelties, tricks. Catalogue free. C. Penner, 2401 Jefferson, Louisville, Ky.

FREE—Our puzzle, trick, game, joke, Novelty Catalog. Wright & Son, 601-G Ind. Ave., Peoria, Ill.

BOOKS—Novelties—Magic, Catalogue Free. Leonard Novelties, Box 757, Milwaukee, Wis.

HYPNOTISM Easily learned. Lessons guaranteed. Postpaid \$1.10. Smith Publishing Co., Springfield, Mass. Dept. 3.

"VENTRILOQUISM"—Complete instruction book 10c. Peerless Supply, 95 Elm, Flushing, N. Y.

GREAT Puzzle for Thinkers—Ten Cents. Box 457, Daniphan, Mo.

VENTRILOQUISM, Complete instruction book 10c. Magic catalog free. Schimpf, Box 454, Berwyn, Ill.

10 AMAZING Card Tricks and catalogue 10c. "Novelco," 68 Houghton, Worcester, Mass.

MAGICIAN'S Nickeled Pistol \$1.00. Seven tricks and four catalogs 25c. Gilmaglio, Morgan Park, Chicago.

NEW and Original Magic. Massey, 205 pages, 28 page plates. \$3.15 postpaid. Spon & Chamberlain, 122 P. M. Liberty Street, New York.

TRICKS, puzzles, jokes, magical apparatus, plays, stage supplies, mind-reading, sensational escapes, 160-page illustrated professional catalog, 10c. Oaks Magical Co., Dept. 548, Oshkosh, Wis.

STAMP COLLECTING

SNAPS—200 different stamps, 10c; 60 different United States Stamps, 12c. With each order we give free our price list of sets, packets, albums, etc., and our pamphlet which tells "how to make a collection properly." Queen City Stamp Company, Room 36, 604 Race, Cincinnati, Ohio.

BEST one-cent approvals in America. F. P. Hand, 1117 So. 60th St., Philadelphia, Pa.
FINE Packet 100 different (mostly unused), including Congo, Nyassaland, San Marino, and small album. All for 6c to Approval Applicants. World Wide Stamp Co., Albuquerque, N. M.

SET German Air Post, Eight different China Ships, and 50 different unused Hungary, cataloging over \$1.50. Millimetre scale, ruler, and perforation gauge. To those requesting our new Sudden Service approvals—Se. Fennell Stamp Co., Dept. P2, Fullerton Bldg., St. Louis.

ZAMBESIA, Zanzibar, Abyssinia, Herzegovina, Allenstein stamps, menagerie collection, album, 10c. Liberty, 3974 Arsenal, St. Louis, Mo.

EXCHANGE Stamps of all Countries. Membership 25 cents. International Stamp Club, 4002 Brooklyn Ave., Seattle, Wash., U. S. A.

STAMPS sent on approval at 70% discount. Reference required. Emory Renoll, Hanover, Pa.

DESIRABLE stamps half catalog. References required. Richards, Box 223, Findlay, Ohio.

\$1.00 CATALOGUE value for dime and postage. Sound Stamp, Owen Sound, Ontario.
100 DIFFERENT foreign and big catalog, 10c. Stanton, Niantic, Conn.

PATHE Special Bargain, 100 new Europe, cat. over \$2.00, for only 8 cents to approval applicants. Perforation gauge, mm. scale, price list and one Premium Certificate Free. Send reference, please, and try our approval service. Pathe Stamp Co., 521 Woodward Ave., Atlanta, Ga.

GERMANY, Provisionals, Million and Billion values, the stamps with a future, unused and used sent on approval against references. Also general approvals with Premium. Yonkers Exchange, Yonkers, N. Y.

WE want your Duplicate Stamps in Exchange; will give you good trade. Finest Approvals 50% and lower. 1,000 American Hinges and Premium Set 10c. Albums, Packets, Sets and Accessories, cheap. Big List free. Reference required. Supreme Stamp Co., 2, Bradford, Pa.

12 FIUME and Latvia free to serious approval applicants. Bae, Storm Lake, Iowa.

PREMIER Package catalogues \$10. Contains 25 exceptional stamps. Price \$1.00. Approvals, discounts to 80%. Reference. International, 2117 Regent Pl., Brooklyn, N. Y.

STAMPS—500 all different, just arrived from Europe. While they last 50c. 1,000 var. as above \$1.75. Our prices plus quality can't be beat. Free set 14 varieties to applicants 1c. Approvals. Elmer, 39 Court St., Boston.

FREE, 50 different to approval applicants, postage 2c. 1,000 hinges and 100 different stamps 15c. Whelan, Box 174, Jersey City, N. J.

\$5.00 FOR 10c. 200 all different (mostly unused) from Latvia, Trinidad, Newfoundland, etc.; Red Cross set, airplane set, small album and bargain lists—all for 10c (stamps will do) to approval applicants. Victoria Stamp Co., London, Canada.

200 MIXED Foreign stamps 5 cents, approvals. Nielsen, 3244 Whipple St., Chicago.

HONDURAS 1913-14, 1c—1p complete, 50c (Catalog value \$2.75.) Nickles, 122 Florida, Washington, D. C.

NEW United States 8c unused Airplane stamp, also 50 French Colonials, for 25c. Jacob Fischer, 4230 Crystal St., Chicago.

100 DIFFERENT, including Austrian Triangle Stamp, 10 cents. Sonnee Stamp Co., 675 Ivy, St. Paul, Minn.

30 DIFFERENT Newrops, German Air Mail Set. Free to applicants for my 1, 2, and 3c net approvals; also my high-priced stamps at 50% discount. Chas. W. Schmidt, 3227 Benner St., Wissinoming, Philadelphia, Pa.

100 DIFFERENT stamps to approval applicants 4c. Walter Oliver, 813 Richmond Buffalo, N. Y.

FREE, unused German set. Pre-war value; millions of dollars sent to approval applicants at 60% discount. Reference required. J. de Jong, 516 West 162nd St., New York, N. Y.

STAMPS ON approval 1/4 cent up. Free Premium. Herbert Keigwin, Middletown, N. Y.

"RITE-RITE" pencil free to every new customer sending 10c for our 100 varieties New Europe, including Danzig, Poland, Lithuania, etc., and asking for selection of Fenway net approvals. Best on the market. Fenway Stamp Co., Fenway Station, Boston, Mass.

A DOVER Bargain Stamp Outfit! 250 Peelable Hinges, 50 all diff. stamps: Fiume (triangle), Nyassa, French Cols. (Pictorials), Malay (Tiger), etc.; 20 Vars. War and New Europe, 5 Blank Approval sheets, 26-page list and Bargain list, all for only 10c to those asking to see my choice 50% approvals. L. B. Dover (Dept. C), Clayton, Mo.

600 MIXED U. S. old and new, 10c. 1,000 Hinges 10c. 100 different Foreign 10c. Album 15c. Approvals, Weatherby, Medina, Ohio.

FREE—25 different U. S. Stamps with 80% approvals to reliable parties, 75 different U. S. Stamps 25c. C. Seidenberg, Merton, Wis.

300 DIFFERENT stamps 25c; 500 50c. Fred Onken, 639 79th Street, Brooklyn.

UNIVERSAL Packet, 100 varieties, all over the world, 10 cents. Covert Stamp, 39 State, Rochester, N. Y.

1,000 UNITED STATES and Foreign Postage Stamps mixed 25 cents, 5 different Angola 5 cents, 10 different Argentine 5 cents, 20 different African 5 cents, 20 different Asia 5 cents, 5 different Cape of Good Hope 5 cents. Chas. W. Parker, 77 Kensington Heights, Meriden, Conn.

ROUMANIA, 23 different 10c. post paid. Free premium with approvals 1/4c up. L. Newberry, San Lorenzo, Calif.

50,000 COINS, medals, paper money, daggers, Indian relics, curios, antiques. Catalogue free. Nagy, 31P South 18th, Philadelphia.

STAMPS cataloguing \$5.00—\$1.00. State countries desired. Frederic Chaffee, Faribault, Minn.

2,000 DIFFERENT stamps \$5.35; 1,000, \$1.45; 500, 45c; 300, 25c. Michael, 5353 Calumet, Chicago.

STAMPS, 100 all different. Postage 2c. Lists free. P. M. Quaker Stamp Co., Toledo, O.

\$3.00 FOR 12c! 100 different Newrops, Catalogued \$2.00 Red Cross set, Airplane set, Perforation gauge, Millimetre scale, Fine wallet, 5 approval sheets, 250 hinges scarce packet from Nyassa, Abyssinia, etc., price list and approvals—all for 12c to approval applicants. Atlanta Stamp Co., Box 532, Atlanta, Ga.

ON Approval: Jumbo books containing 500 different at one cent each. Also books of two, three, four, five, eight and ten cents each. 20,000 varieties. \$5 deposit required, returnable on demand. Cheapest and best way of enlarging collection. Lee Tubbs, 4021 First, San Diego, Calif.

BIG \$4.00 outfit and premium to approval applicants 10c. Buckley, 712 Bowen, Dayton, Ohio.

300 FOREIGN 25c; 25 stamps free, including stamp and coin list. A. McCreery, Chatham, Ontario.

25 DIFFERENT Poland 10c; 50 different U. S. 10c; 30 different Sweden 10c; 1,000 different stamps \$1.50. R. H. Carlton, 360 W. So. Temple, Salt Lake City, Utah.

FREE—53 Diff. Ireland, Barbadoes, Bermuda, Dominican, Malay, etc., gauge premium, for 2c postage. 100 Diff. U. S. 22c—25 Bulgaria 9c. Hawkeye Stamp Co., Cedar Rapids, 39, Iowa.

100 STAMPS 2c to approval applicants. Charles F. Jewett, 726 Hickory St., Syracuse, N. Y.

FREE—"Leader" Pkt. to approval applicants sending 2c stamp. Earl Stamp Co., 1811 26th Ave. North, Minneapolis, Minn.

FREE—50 varieties to approval applicants sending 2c. Richard P. Lamprecht, Valparaiso, Ind.

250 MIXED stamps and souvenir photo, 10c. Phil Lunsted, Cape Cottage, Maine.

500 DIFFERENT Stamps 32c. 1,000, \$1.20, to approval applicants. Stadler, 437 Beach Ave., Bronx, N. Y.

PACKET of 23 stamps, no two countries alike. Packet hinges. Set of \$1 and \$2 U. S. Rev., all for 5c. Mention paper. Miami Stamp Co., Toledo, Ohio.

FREE! Loose Leaf Postage Stamp Album at rate of 8 pages each month given with subscription to monthly Journal. Send 2c stamp for prospectus. United Stamp Co., Marquette Bldg., Chicago, Ill.

20 UNUSED stamps free. All different. Postage, 2c. Fisk Stamps, Toledo, Ohio.

158 GENUINE Foreign Stamps, Mexico War Issues, Venezuela, Salvador and India Service, Guatemala, China, etc., only 10c. Finest approval sheets 50 to 60%. Agents Wanted. Big 72-p. Lists Free. We Buy Stamps. Estab. 20 years. Hussman Stamp Co., Dept. 54, St. Louis, Mo.

FREE—Two sets Nyassa, 20 Diff. British Colonies Barbados and Jamaica pictorials and a packet of hinges—all for a request for my 1, 2 and 3c net approvals, none better. Chas. T. Egner, 4821 Frankford Ave., Frankford, Phila., Pa.

24 VARIETIES Cuban stamps, 10 cents. List of 6,000 low-priced stamps free. Address Chambers Stamp Co., 111P, Nassau St., New York City, N. Y.

MYSTIC'S "Mysterious" Packet! Contains stamps from the lands of cannibals, heathens, sun worshippers, and wild savages. Included are Travancore, Malay, Dutch Indies, Liberia, Siam, Africa, Abyssinia, North Borneo, Nyassaland, Zanzibar, etc. This wonderful packet containing 110 all different (mostly unused) for only 8 cents to approval applicants. Mystic Stamp Co., Dept. 8, Camden, New York.

FREE, Dollar Stamp Free to applicants for my 60% approvals. Norman Shultz, Colorado Springs, Colo.

STAMPS, 50 varieties, Africa, Brazil, Peru, Cuba, Mexico, etc., 10c. 50 different U. S., 25c; 1,000 mixed, 40c; 1,000 hinges, 10c. List free. C. Stegman, 5948 Cote Brilliante, St. Louis, Mo.

105 CHINA, etc., stamp dictionary, list, 2c. Album (500 illustrations), 3c. Bullard, Sta. A, Boston.

FOREIGN Stamp Collection Sent Free. Cornish Company, Schenectady, N. Y.

NYASSA Giraffes and packet of 53 different scarce stamps. Fiume Triangle, large \$1.00 U. S. Rev., millimetre scale, perforation gauge and ruler for only 9c. To introduce our Sudden Service approvals. Fennell Stamp Company, Dept. P, Fullerton Bldg., St. Louis, Mo.

DANZIG Free—Nice Set Danzig Stamps with Biggest Lists Issued, 2c. Postage. Midland Stamp Co., Station E2, Toronto, Canada.

FRENCH Colonies Free—Pretty Picture Set. Native Chiefs, Tigers, 2c Postage. Empire Stamp Company, 342 Lippincott, Toronto, Canada.

BIG Variety Packet Foreign Stamps Free for 2c postage. Gray Stamp Company, Station E10, Toronto, Canada.

RARE COINS

THREE nice foreign copper coins with new selling list No. 9 for 10 cents. J. C. Stephens, 1702 So. Main St., Elkhart, Ind.

MAIL This slip with your name and address and 10 cents and you'll get a large U. S. Copper Cent nearly as big as half dollar, and large 50-page illustrated coin catalog. You'll find it fascinating and profitable. Send Now. B. Max Mehl, Numismatist, Mehl Bldg., Dept. P, Fort Worth Texas. Largest rare coin establishment in the United States.

21 DIFFERENT foreign coins 50c. 10 different foreign bills 50c. Oddebon, Independence, Mo.

CALIFORNIA gold quarter 27c; half 52c; 1797 cent 60c; trade dollar \$1.25. A. Wylie, Wheaton, Ill.

40 OLD coins, all different, \$1.00. 20 large U. S. cents, all different dates, \$1.25. 200 different Germany city bills \$1.00. Claud Denney, Box 315, Dallas, Texas.

55 DIFFERENT Foreign coins, \$1.00. Two-cent piece. List 10c. Emil Vogel, 417 East Jefferson St., Fort Wayne, Ind.

ROMAN coin 1,500 years old, 25c. Duro, 25 Mulberry, N. Y. City.

OLD Money Wanted. Will pay Fifty Dollars for nickel of 1913 with Liberty Head (not Buffalo). We pay cash premiums for all rare coins. Send 4c for large Coin Circular. May mean much profit to you. Numismatic Bank, Dept. H, Fort Worth, Texas.

I BUY and sell old coins. Ebery Flemings, Gatesville, Ga.

\$2 TO \$500 each paid for hundreds of Old Coins. Keep all Odd or Old Money. It may be very valuable. Send 10c for New Illustrated Coin Value Book, 4x6. Get posted. We pay cash. Address Clarke Coin Co., Ave. 2, Le Roy, N. Y.

OLD Coins. Large Spring selling catalogue of coins for sale, free. Catalogue quoting prices paid for coins, 10c. William Hessler, 101 A Tremont St., Boston, Mass.

CALIFORNIA gold, 1/4 size, 27c; 1/2 size, 52c; three-cent-piece and catalogue, 10c. Norman Shultz, Colorado Springs, Colo.

FOR BOYS

HORIZONTAL Steam Engine for Boys to build. Blueprint 25 Cents. South Buffalo Engine Co., Buffalo, N. Y.

BOOKS—"Ventriloquism," "Toymaker Book," "Boy Electrician," 10c each, all for 25c. G. Elsea, Bowling Green, Ohio.

BOYS and Girls—Make easy money in spare time. Write today for particulars. No obligation. The Fertaps Company, Anderson, Ind.

GREATEST Radio offer ever made. See pages 152 and 153.

MOUTH-ORGAN Instructor, 25c. Learn in one hour. G. Elsea, Bowling Green, Ohio.

CAMERAS AND PHOTO SUPPLIES

PHOTOGRAPHIC equipments and accessories of every description are listed and illustrated in our 178-page catalogue. It will pay you to secure a copy which is issued free, as our prices are low. We also deal in used goods which are sold under the same guarantee as new goods. Ask for our Bargain Book. Central Camera Co., Dept. E-79, 124 S. Wabash Ave., Chicago, Ill.

4"x6" OIL tinted print, in antique gold frame, from your favorite film, for \$1.50. Satisfaction. Film returned. Brush & Needle, Charlevoix, Mich.

PHOTOGRAPHS burned on china by 2,000 degrees. Never fade. To set into monuments. Catalogue free. Fred Abendroth, Forest Park, Ill.

IMPROVEMENT suggestions. Three your prints criticised 25c. Colorphotography explained 10c. "Non-touch" Autochrome method 20c. Blake Whiting, Branford, Conn.

FILMS developed, prints made. Write for Price List today. Z. Koscielniak, 17214 Lament, Detroit, Mich.

SPECIAL! Beautiful "Old Master" Enlargement, 8x10, 11x14 or 14x17. "Sepia or Oil" from negative or photo, \$1.00. Finest equipped plant in America! Film Artists Productions, Box 417, Los Angeles, Cal.

SUPERIOR Enlargements from your choice negatives. Retouched, Embossed with one inch borders, double weight stock. Unsurpassed quality and workmanship. Money with orders. 5x7 50c. 6x8 60c. 8x10 75c. Linn Photo Co., Dept. E, Lansing, Mich.

HAVE You a Camera? Write for Free sample of our big magazine, showing how to make better pictures and earn money. American Photography, 116 Camera House, Boston, 17, Mass.

SUPERIOR quality finishing and enlarging. Trial offer: Any size 6 exposure roll developed and printed, 25 cents. 8x10 enlargement unmounted, 30 cents. Carhuff Photo Finishing Co., 2129 W. Van Buren St., Chicago, Ill.

BIG Money Saved on Photographic Lenses and Apparatus—goods exchanged; repairing done. Ralph J. Golsen, 1128 Argyle St., Chicago, Dept. P.

MODERN Photography in all its branches now taught by mail. New Successful Method. Students earning \$300.00 while learning. Big Opportunity. Write for particulars and unusual offer open for short time. Dept. 3431, International Studios, Inc., 3401 Michigan Ave., Chicago.

KODAK Films—Special trial offer; your next kodak film developed, 5c—prints, 2c each. Moser & Son, 1917 St. James Ave., Cincinnati.

FILMS Developed. Special Trial Offer. Any Size Kodak film developed 5c, prints 2c each. Trial 6x10 Enlargement in handsome folder 40c. Overnight Service. Roanoke Photo Finishing Co., 209 Bell Ave., Roanoke, Va.

MOTION PICTURES

FILMS, 100 feet \$1 postpaid; 300 feet \$3; Comedies \$5; Educational reels \$5. Dealers Supplied. Films rented. Pathoscope Projectors \$125. Pathoscope Films, 1 1/2 cents foot. \$250 motor driven suit case Projector \$75. Sacrificing movie cameras. Ray, 324 5th Avenue, New York.

COMEDIES, Westerns, Features, \$5.00—\$7.50 per reel. Send for list. E. & H. Film Distributing Corp., Box 565, Birmingham, Ala.

EDISON Picture Machines \$45.00. Powers Motor Drive \$65.00. Films \$2.00 Reel Up. Send Stamp for list. National Film Brokers, 3907 Summit Street, Kansas City, Mo.

MOVING Picture Film one cent foot. Candee, 551 South Salina St., Syracuse, N. Y.

Film dirt cheap. Features, Westerns, Animal Comedies, Dramas, Scenics, \$3 per reel. Nobody can beat us. Peerless Film Exchange, 136 So. Wabash Ave., Chicago.

WONDERFUL Opportunities for Making Fortunes in this business. No Experience needed. Complete Theatre Outfits sold on Easy Terms. Free Catalog. Monarch Theatre Supply Co., Dept. P, Memphis, Tenn.

O BOY! The Bass "Bargaingram" for this month will astonish you. Think of a complete Professional Motion Picture Camera, Tripod, Film, ready to start in a news weekly studio or commercial motion-picture film for only \$74.50. Dozens of other items just as good. Write for your copy at once. Hundreds of Bass' customers have become financially independent making motion pictures. The 575-page "Cinema Handbook" for only \$3.00 postpaid. The 52-page "Bass Catalogue" is free! Write or wire at once! Bass Camera Company, 105 North Dearborn St., Chicago, Ill.

MOVIE Films for Home, School, Church and Theatres. Comedy, Drama, Cartoon, Cowboy, Indian, Jungle, Religious, Historical, Fairy, Travel, Voodoo and Educational subjects. \$5.00 per reel up. Complete List. Monarch Theatre Supply Co., Dept. G, Memphis, Tenn.

HENRI DEFRANNE announcing that he has purchased 500,000 feet of film consisting of one-reel comedies, educational, news weekly subjects and two-reel comedies, also five-reel features. The greatest offer—1,000 feet of single reels at \$5.00. Two-reelers at \$10.00 to \$15.00 and five-reelers from \$25.00 to \$100.00. A marvelous opportunity! Write or wire your needs, all films in perfect condition. DeFranne Importers, 169 North Dearborn St., Chicago, Ill.

AMERICA'S Greatest Fortunes made in the Motion Picture Business. We furnish Complete Theatre Equipment on easy payments. Openings everywhere. Catalog Free. Monarch Theatre Supply Co., Dept. F—724 South Wabash Ave., Chicago.

FREE to Writers—A wonderful little book of money-making hints, suggestions, ideas; the A B C of successful story and play writing. Absolutely Free. Just address Authors Press, Dept. 12, Auburn, New York.

MAKE money writing photoplays; details free to beginners. No correspondence course. Producers League, 250 Walsworth, St. Louis.

BIG Money Nightly—Good assortment. Complete Outfit, installment plan. Splendid Home Outfit, \$25.00. Ralph J. Golsen, Dept. M, 1128 Argyle St., Chicago.

\$\$\$ FOR Ideas. Photoplay plots accepted any form; revised, criticized, copyrighted, marketed. Advice free. Universal Scenario Corporation, 208 Security Bldg., Santa Monica and Western, Hollywood, Calif.

ACT Quick! Only a few more left—Motion Picture Projectors, Mazda illuminated, with 1,000 feet of film, \$37.50, worth double. Send for photograph! Shipped C. O. D. for examination on receipt of deposit. DeFranne Importers, 169 North Dearborn St., Chicago, Ill.

\$35.00 PROFIT nightly. Small capital starts you. No experience needed. Our machines are used and endorsed by government institutions. Catalog free. Atlas Moving Picture Company, 482 Murton Bldg., Chicago.

SCENERY TO RENT

SETTINGS for Opera, Plays, Minstrels. Plush drops. Address Amelia Grain, Philadelphia.

EDUCATIONAL AND INSTRUCTION

MAKE Jewelry—Fascinating work, easy to learn. Allows you always to have beautiful hand-made jewelry—infinitely superior to the machine-made variety of the shops—for yourself and to give as presents. \$10 for 15-lesson course. Material for two scarf-pins and complete tools needed for every article in course included free. Remember—you make two finished articles of jewelry in your first lesson! Send ten dollars or write for booklet. New York School of Jewelry Making, 110 East 23rd Street, New York.

HOMESTUDY, Law, Shorthand, Typewriting, Secretary, 1532 Broadway Avenue, Grand Rapids, Mich.

MAKE 'em Laugh! (Nothing pays better.) I teach how by mail. Sample lesson 10c. Jack Pansy, P.M., 157 East 47th, New York.

MEN'S Clothes, Ladies' Suits and Coats. We teach you by mail how to cut and make. Particulars Free. Ford, 3805 Mossdale, Richmond, Va.

USED educational matter bought, sold, exchanged. Bulletin free. Instruction Correspondence Exchange, 1968 Broadway, New York.

SELF-EXPRESSION: Write (sell) poems, stories. Editing, typing, revision. Blake Whiting, "Author Service," Branford, Conn.

JOURNALISM—Photoplays—Short Stories. Plot Chart and Copyright Book free to those wishing to enter above professions or to dispose of manuscripts on Commission. (The Service offered is given by Professional Authors and Editors of high standing.) Harvard Company, 431, San Francisco, Calif.

SHORTHAND, Automatic Vowel System. Write today. C. K. Mathews, 115 Common St., Shreveport, La.

LEARN Penmanship; Instructions 25c (Silver). Prince, 130 W. 104, New York.

BE a Hypnotist. Professionals make big money; parties, stage, everywhere. Amateurs make friends; helping, puzzling, entertaining. Hypnotism profitable, instructive, mystifying. Easily learned. Short course. Reasonable rates. Medici, 3144 W. 15th, Chicago, Ill.

LEARN Photographic Journalism, paying outdoor business. Stamp. Taytexco, 28 School, Boston.

SHOW-CARD writing a pleasant, profitable profession easily and quickly learned by our new, simple, graphic block system. Artistic ability not necessary. We teach you how. Distance no object. Full particulars and booklet free. Wilson Methods, Limited, Dept. 53 C, East Richmond, Toronto, Canada.

BACTERIOLOGY instruction, urinalysis outfit, \$25. Bacteriology College, Petries Corners, N. Y.

SHORTHAND in 3 weeks; written with longhand characters; speedy, legible. Representatives wanted. Dickinson, 331M Altman Building, Kansas City, Mo.

BE a Laboratory Expert. Earn \$300.00 to \$500.00 a month. Study Microbiology, Bacteriology, Laboratory Technology, Sanitation. Interesting Extension and Residential Courses. Diplomas and Degrees granted. 71-piece Urinalysis Outfit Free to students. Write for Free 48-page Prospectus Today. Int'l Physicians and Surgeons College of Microbiology, Room 955, 550 Garfield Ave., Chicago, Ill.

CAN You Draw? Make money giving Chalk-Talks. Particulars. Truman's Studio, Box 585, Perryville, Ohio.

WORLD-ROMIC System, Masterkey to All Languages. Primers, \$1.94 each language: Cantonese, English, French, German, Italian, Portuguese, Russian, Spanish, Swedish. Pronunciation-Tables, 50c each language. Dictionaries, grammars, 4,000 languages, of 1,700,000,000 people: Afrosmitic, Amerindic, Eurindic, Indopacific, Siberic, Sinindic. Languages Publishing Company, 8 West 40th Street, New York.

WRITE articles, stories, news, in spare time for newspapers and magazines. Big pay. Copyright book free. Press Syndicate, 553, St. Louis, Mo.

YOU can have a business profession of your own and earn big income in service fees. A new system of foot correction; readily learned by anyone at home in a few weeks. Easy terms for training; openings everywhere with all the trade you can attend to. No capital required or goods to buy, no agency or soliciting. Address Stephenson Laboratory, 1 Back Bay, Boston, Mass.

DOUBLE Entry Bookkeeping mastered in 60 hours with 8 keys; guaranteed; diploma. Our graduates lead in bookkeeping, auditing, accountancy, balance sheets, and financial statements. International Bookkeeping Institute, Dept. 8, Springfield, Mo.

USED books and educational matter bought, sold, exchanged. List 1,000 items free. Students' Exchange, 47-A West Forty-second Street, New York, N. Y.

ARTIFICIAL Marble, sanitary flooring instructions, ornamental casting, concrete plaster, papier-mache decorations, garden furniture, statuary, Rubber-moulds, Electrometallurgy, particulars and 200 illustrations free. Chris Mahler, Box 125, Huntington, N. Y.

BOOKKEEPING in a Week, \$1 Postpaid. Dukes, 1857 Walton Ave., New York.

"WHAT to Invent for Profit" free. Patent News-N, Washington, D. C.

SHOW Card Writing, a pleasant, profitable profession. Quickly and easily learned through our new, simple method. No canvassing or soliciting. We show you how, no matter where you live. Full particulars and booklet free. American Show Card System Limited, 203 Adams Building, Toronto, Canada.

WHAT'S Your Future? Develop Winning personality, be popular. Personality makes success. Free literature. Write today. P. S. Bureau, Box 349, West Palm Beach, Fla.

USED educational matter, books, etc., sold, rented and exchanged. Big list free. Lee Mountain, Pisgah, Ala.

RADIO OUTFITS AND SUPPLIES

SELLING Standard Radio Sets and parts on commission. Big discounts. Pay me when you sell. Gilbert B. Swanson, Cambridge, Ill.

SUBSCRIBE to "QST," foremost monthly radio magazine telling clearly the how and why of everything latest and best in Radio. Price \$2.00 yearly, including year's membership in The American Radio Relay League, the National, non-commercial amateur organization which Does Things. Write, enclosing remittance to "QST," Kennedy Bldg., Hartford, Conn.

FOR the price of a headset, you can have an Ackerman Loud Speaker so the whole family and your friends can hear and enjoy the fine broadcasting. Horn made of heavy (non-vibrating) metal, 21" high, 11" bell, complete with special loud speaking unit, ready for immediate use without extra batteries, only \$9.50. Colors: plain black or brown satin finish, also special Alligator grain in black and green. Sold on money back guarantee. Loud Speaking Unit only for use with phonograph \$4.00. Ackerman Brothers Company, Inc., 301 West 4th Street, New York.

DX—ONE Tube Regenerative Sets \$12.00. Oswalt, 3219 West 82, Cleveland, Ohio.

FOR Sale—Single Dial Radio sets. A revolution of simplicity. 10 days' trial. Radio store, 1508 460, Winona, Minn.

WANTED—Representative in every town to sell Ray-Dee-Artercraft Nationally Advertised Products. Large Profits. Small Investment. Ray-Dee-Artercraft Instrument Co., Redlands, Calif.

GREATEST Radio offer ever made. See pages 152 and 153.

REPRODUCE your own voice—See "Voiceograph," phonograph columns—This issue.

RADIO Parts Manufacturing Company—1249 Marlboro, Detroit, Michigan, have many genuine bargains. Send card today for list. New detector tubes \$2.95 and \$3.00. 23 plate condensers for \$1.75 just sample of savings.

1-TUBE long range radio set. Coast-to-coast reception, assembled in cabinet, \$9.50; complete with tube, phones, batteries, aerial, etc., \$19.25. Nothing else to buy. World's biggest radio buy. Send for folder. State Radio Co., 6548 State St., Chicago.

TWO Philadelphia stations tuning London used Turnit Adjustable Gridleaks. There's a reason. Fits standard mounts; \$1.00 postpaid, insured, Charles Bonine, 20 South Fifteenth Street, Philadelphia.

A \$70.00 BLUE SEAL "Guaranteed" Radio (4 tube set) at owner-agent's price of \$52.50. A \$45.00 Throphone Loud Speaker at owner-agent's price of \$36.00. Cash with order. Liberal discounts to agents on other accessories. This information furnished on receipt of 25c in stamps. This charge is made to keep out the "simply curious" and can be deducted from first order. Dept. 4, Blue Seal Mfg. Co., 1406-08 S. Michigan Ave., Chicago, Ill.

MANUFACTURE synthetic radio crystals from our formulas. Easily made without special apparatus. Sensitive over entire surface. Complete instructions and two sample crystals, one dollar. Ritter Mfg. Co., 314 Washington Street, Brooklyn, N. Y.

2,650 MILES Distance with one tube. Any Novice understands our Simplified Instructions, including Panel Layout and Photo 25c. Vesco Radio Shop, Box PM-117, Oakland, Calif.

RECHARGING Radio Batteries Pays Big Profits. Full particulars free. Radio Hobart, Troy, Ohio.

COMPLETE Radio set for receiving broadcasting, postpaid \$3. Includes receiver, head-phone, aerial, and insulators. Specialty Sales Bureau, 1429B Milton St., Grand Rapids, Mich.

RADIO Generators, 500 Volt, 100 Watt, \$28.50 each. Battery Chargers \$12.50. High Speed Motors, Motor-Generator Sets, all sizes. Motor Specialties Co., Crafton, Pa.

LOUD Speaking Crystal Set. Broadcastings heard throughout house. Easily constructed. Instructions complete 25c. Catalog free. Steinmetz Wireless Mfg. Co., Eastend, Pittsburgh, Pa.

TELEGRAPHY

TELEGRAPHY—Both Morse and Wireless—taught thoroughly and quickly. Tremendous demand. Big salaries. Wonderful opportunities. Expenses low; chance to earn part. School established fifty years. Catalog free. Dodge's Institute, H St., Valparaiso, Ind.

TRADE SCHOOLS

LEARN Plastering. Earn \$10.00 to \$20.00 per day. Write today. D. W. Sparklin, Federalsburg, Md.

GET out of low wage rut. Make \$12-\$30 day. Positions everywhere. Demand greater than supply for qualified automobile painters. We teach you in 8-10 weeks. Get facts. Have eyes open to wonderful new opportunity. Investigate. Write, Detroit Auto Painting School, 1411 Van Dyke, Detroit, Mich.

PAINT Automobiles, Trim Automobiles. Become a Certified Electrician, Auto Battery Builder, Ignition Expert on Starting and Lighting, Metal Finisher, and a complete course in Auto-Repairing, Bricklaying and Plastering. We fit you for a big money job. Make you an expert able to step right into a position paying \$45 to \$100 per week. You are paid while learning. Come to Detroit, the Automobile hub; the world's wonder City. Write today. Standard Trades School, 416 Woodward, Detroit, Mich.

YOU can't do better for Your Future Than Learn a Big Paying Trade. Write for our Free Catalogue of Sign Painting, Show Card Writing, Pictorial Painting, Decorating, Paperhanging, Graining and Marbling, Auto Painting. Chicago Painting School, 145 West Austin Ave., Chicago, Ill.

BE a Bricklayer; Good pay, outdoor work that is always interesting. Course is eight hours a day, five days a week, for six months. Tuition is \$100.00, one-half payable on entrance and one-half in three months. We have openings for a limited number of day students. Send for circular and give your age, and previous work. Associated Building Employers, Grand Rapids, Mich.

BUSINESS OPPORTUNITIES

A RARE Opportunity: Men and Women Make enormous Profits. Article costs 5c, sells quickly for \$1.00. Can make \$15 to \$30 daily. Particulars Free! Write quick. Smith Specialties Co., 71 Plank Road, Waterbury, Conn.

THE Great Wheat Secret. Market swings not caused by manipulation, but by a Great Natural Force dominating this grain. Up-swings and declines easily forecasted. Secret of immense value to Traders, Millers, Brokers, anyone interested in cash wheat or futures. Eye-opening folder free. Write today. Market Forecaster Co., Dept. M, Topeka, Kans.

BIG profits, manufacturing Magical Wand Rheumatism Remedy. Guaranteed formula. Instructions, \$1.00. Emory Vermilyea, Moorefield, W. Va.

WORTH-WHILE opportunities for profits are constantly offered. Write for information. Dept. M, Paul Kaye, 149 Broadway, New York.

MAKE \$15 daily Building Truck Bodies, Speedsters, Propeller-driven Vehicles, Cabinets, Library tables, Etc. We furnish hardware. Drawings at \$1.25 per set. Ed Melton & Son, Clovis, N. Mex.

LEARN Candy Making. Make big profits at home or in shop. Big demand for good candy. Easily, quickly learned through our correspondence course. Write today for booklet 1-3. The Candy Institute, Sixty West Fifteenth Street, New York.

MAKE \$3.00 hourly. Electric Lawn Mower Sharpening. 415 South Lawndale Ave., Kansas City, Mo.

MAKE toys and novelties at home. Big profits. Instructions and 200 illustrations, 25c. Astralite Company, Sharpsho, Pa.

MAKE big money in the coming business. Big future. Send \$1.00 for drawings and instructions for nickel plating business. No capital. Practically no competition. Dunbar's, Brookline, Mass.

ARTISTIC people may learn profitable work. Particulars for stamped envelope. Morey Studio, Ottumwa, Iowa.

FREE Gift: A \$10,000 yearly profit for you. Successful business man offers free opportunity for you to start a business of your own. No security required. Full explanation by return mail. Enclose self-addressed envelope; I furnish the stamp. Edward Baker, 149 Main St., Oneonta, N. Y.

MONEY in 250 kinds common wild roots and herbs. Get posted, 25c (coin). V. C. Robinson, Maryville, Mo.

GET out of low wage rut. Make \$12-\$30 day. Positions everywhere. Demand greater than supply for qualified automobile painters. We teach you in 8-10 weeks. Get facts. Have eyes open to wonderful new opportunity. Investigate. Write, Detroit Auto Painting School, 1412 Van Dyke, Detroit, Mich.

50 SUCCESSFUL Money Making Enterprises. Steartins Company, Inc., Waltham, Mass.

NICKEL plate automobile accessories, hardware, electrical parts. Big profits. Requires no capital. Simple battery process. Write today. Webster Engineering Co., Webster Groves, Mo.

A TEA ROOM or Cafeteria will make you a fortune—you can operate one of your own or manage one for others. We teach you in a few weeks and put you in touch with positions and money-making opportunities—earn \$5,000 a year—be independent. Write today for book "Pouring Tea for Profit." Lewis Tea Room Institute, Bureau L-31, Washington, D. C.

PATENTS—Write for our Guide Books and "Record of Invention Blank" before disclosing inventions. Send model or sketch and description of invention for examination and instructions. No charge for the above information. See advertisement on page 88. Victor J. Evans & Co., 192 Ninth, Washington, D. C.

START a Brake Rebuilding Service Station. Millions of cars all require reining. My Hi-Speed methods get the business and make you money. Give a (30) minute service on Fords, without removing transmission cover. Write me today for facts about a New Business Opportunity that will make you independent. M. L. McQuay, 54 South Street, Washington, Pa.

PUBLISH small magazine of your own; start Mail Order Business. 50 Magazines and ad cost \$1.00. You get half on orders. Sample magazine and plan 10c. Harvey Teeple, Deratur, Ind.

MEN who are willing to work up to a General Agency, appoint agents, organize territory for line of hosiery, sold direct to consumer. Very small amount of capital required. Advancement sure for workers. Mac-O-Chee Company, Room 2583, Cincinnati, Ohio.

25 MAILORDER Magazines and Papers 25c. Hansen Company, Brookings, S. Dak.

CEMENT Masons, Plasterers, Contractors. Build successful business, stuccoing old and new buildings with Everlastone Indestructible Stucco; also installing Corkstone Floors over worn-out flooring. Write immediately for agency proposition. Everlastone Corporation, 119 N. Collington Avenue, Baltimore, Md.

ATTENTION! You can have a business of your own. Establish and operate New System Real Estate Business, brokerage and insurance agency in your community. Office at home. Earn \$5,000 year. Representatives wanted everywhere. Send stamp free booklet. Hayes Realty Association, Cincinnati, Ohio.

START manufacturing in your own home! A wonderful Mail Order line. Profits unlimited. Very small capital. National Laboratories, Dept. 56, Elizabeth, N. J.

PATENTS Procured; Trade Marks Registered—A comprehensive, experienced, prompt service for the protection and development of your ideas. Preliminary advice gladly furnished without charge. Booklet of information and form for disclosing idea free on request. Richard B. Owen, 30 Owen Bldg., Washington, D. C., or 2276-R Woolworth Bldg., New York.

PATENTS Procured. Send sketch or model today for examination, prompt report and advice. No charge for preliminary advice. Write for free Booklet and blank form on which to disclose your idea. Highest references. Promptness assured. Clarence A. O'Brien, Registered Patent Lawyer, 58-C Security Bank Building, Directly across the street from Patent office, Washington, D. C.

FORMULAS, Processes, Trade-Secrets—Different, dependable, profitable. Catalog free. B. Thaxly Co., Washington, D. C.

MAKE money. Start mail business. 20 Gift-Edged Plans Free. Star Bureau, 1918 North St., Philadelphia, Pa.

START a Radio Business in your community selling well advertised sets and parts which we sell you at dealer prices. Make \$50.00 weekly in spare time with our plan. Write for information. Waveland Radio Company, Desk 17, 1027 North State Street, Chicago, Ill.

ADVERTISE and have your business and personal mail come to my office—mail forwarded. Information free. Room 5, 816 1/2 Chestnut, St. Louis.

MAKE Money, at Home, Quickly, easily, steadily, spare time, new, simple mail order plan. No canvassing, manufacturing or goods carried. Details free. Edw. Barroll, 3614 California Ave., St. Louis, Mo.

BE a Laboratory Expert. Earn \$300.00 to \$500.00 a month. Study Microbiology, Bacteriology, Laboratory Technology, Sanitation. Interesting Extension and Residential Courses. Diplomas and Degrees granted. 71-piece Urinalysis Outfit Free to students. Write for Free 48-page Prospectus Today. Int'l Physicians and Surgeons College of Microbiology, Room 971, 350 Garfield Ave., Chicago, Ill.

GO into the Crispette business. Everybody likes Crispettes. You can make a lot of money. We start you. Write for facts. Long Eakins, 1939 High St., Springfield, Ohio.

PAINT Attractive Sign and Showcards with the aid of Letter Patterns. Samples for Stamps. John P. Rahn, A2433 Greenview Ave., Chicago.

MAKE 'em laugh! It pays. Helps win success. I teach how, by mail. Sample lesson 50c. Jack Pansy, (BPM), 157 East 47th, New York.

MILLIONS supplied corporations. Stock, bond, issues wanted. \$50,000 upwards. Guaranteed service. Write: "Financing," 60-501, 32 Union Square, New York.

EARN \$20.00 Daily. Be an Expert Automobile Refinisher—Manufacture Auto Supplies—Specialties. Big Demand. We teach you how at Home. Start shop; small outlay. Autoseco, Sheboygan, Wis.

LEARN Mail Order Business. "Financial Success" booklet 25c. Circular for Stamp. Textco, 28 School, Boston.

LEARN how to make a Mail Order success. Send \$1.00 for "The Mail Order Book" for twelve months. Sample 10c—none free. 5309 Forest, Kansas City, Mo.

FIFTY "Money-makers" for Mail Dealers. 50% profit. K. Home, 1957 Warren, Chicago.

INVENTORS—Write for our Guide Book, "How to Get Your Patent" and Evidence of Invention Blank. Send model or sketch of your invention for our prompt opinion of its patentable nature. Randolph & Co., Dept. 435, Washington, D. C.

MAKE Money at Home—making toys. We show you how. Send \$1 for complete working drawings and instructions. DeKalb Designing Co., Decatur, Ga.

REAL Estate Business of your own or position worth \$5,000? Our Graduates can choose. Training at home prepares you in short time and we aid you to make good. Bulletin free. Penn Realty School, 19th and Ellsworth, Philadelphia, Pa.

I MADE Big Money Spare Time Evenings. Mail Order business, booklet for stamp tells how. Sample and plan, 25c. Free 12 articles worth \$3. Alpine Scott, Cohoes, N. Y.

CONVERT each spare moment into cash. My dignified methods, requiring no merchandise nor peddling, will enable you to increase your income tremendously, without study, capital, experience or delay. Clark, Box 798, Dallas, Texas.

PATENTBOOK, 139 mechanical movements and illustrations, sent free. Labinsere, 3 Park-row, New York.

I MADE \$30 a Week Home. French Breadmaking. 15 years' experience; Free Booklet tells. Ashbrook 67, Marengo, O.

\$3,000 BUSINESS from Odd-job Contracts. Character, industry and handiness essential. Openings limited. Williams Service, 3836 Clinton, Minneapolis, Minn.

MANUFACTURE Extracts and other necessities, 200% profit; we tell you how. Write White Manufacturing Drug Co., 1325 Laidlaw Ave., Cincinnati, O.

INCH Display Advertisement 166 Magazines Thrice \$15. Year \$50. Page \$100. Wood's Popular Service, Atlantic City, N. J.

SILVERING Mirrors! My exclusive French Tartaric method opens enormously profitable business. Booklet free. H. Barstow, 514 33d Street, Oakland, Calif.

MAIL Order Business is your opportunity. Brenner's Famous Handbooks teach how to start small, grow big. Sell merchandise, service, ideas; enormous profits. Spare time to begin. Get complete set, 11 books, \$3.00, and be posted. Brenner, 335 Walnut, Philadelphia. Descriptive Catalog and big batch interesting mail order information, 25c. None free.

BIG money writing photostays, stories, poems, songs. Send for free copy America's greatest magazine for writers. Tells you how to write and sell. Writer's Digest, 603 Butler Bldg., Cincinnati, Ohio.

EXCEPTIONAL Opportunity for Sales Manager capable of handling state distribution. Marvelous new Adding Machine. Retail \$15. Work equals \$350 machine. Tremendous possibilities. Unlimited profits. Write quick for details. Lightning Calculator Co., Dept. B., Grand Rapids, Mich.

WE Start You in Business, furnishing everything; men and women, \$30.00 to \$100.00 weekly operating our "New System Specialty Candy Factories" anywhere. Opportunity lifetime; booklet free. W. Hillier Hagedale, Drawer 4, East Orange, N. J.

ENTER a new business. Earn \$3,000 to \$6,000 yearly in professional fees making and fitting a foot specialty, openings everywhere, with all the trade you can attend to; easily learned by anyone at home in a few weeks, at small expense; no further capital required, no goods to buy, job hunting, soliciting or agency. Address Stephenson Laboratory, (1) Back Bay, Boston, Mass.

"GET into the Specialty Manufacturing Business" or "Why Work for Others?" may sound good to you, but you won't succeed in that business unless you possess Formulas that are absolutely reliable, the same required by leading manufacturers supplying the Best. Don't be bunked into buying a Collection of cheap "Formulas" and expect to succeed. Send today for my valuable literature and Formula Lists and Real Money-Makers in the Specialty Manufacturing Business. 26 years supplying the Best. Miller, Chemist, 805 De Leon St., Tampa, Fla.

"HOW to Sell Patents" free. Patent News-H, Washington, D. C.

GOOD money easily earned at home spare time silvering mirrors; no capital. Free instructive book tells how. Patterson & Co., Brookville, Ky.

RAISE guinea pigs. Pay better than poultry or rabbits; easy to raise; little space required. We guarantee market. Particulars and booklet how to raise free. Cavies Distributing Co., 3102 Grand Ave., Kansas City, Mo.

DOLLARS yearly in your Backyard No mushroom dope. Particulars free. Metz, 313 East 89th, New York.

"SCHEMER Magazine," Alliance, Ohio, prints big profit schemes; one subscriber making \$25,000 from three; another \$10,000 from one. Try your luck. Year, only \$1.00; three months, 25c.

MARBLE mixing instructions, covering wood or cement flooring 1/2 inch thick, fire-proof, waterproof, low cost, sanitary, all colors. Particulars, 200 illustrations free. Chris Mahler, Box 122, Huntington, N. Y.

EARN \$10 daily silvering mirrors, plating and refinishing metalware, autos, chandeliers, bedsteads, headlights. Outfits furnished. E. Decle Laboratories, 1133 Broadway, New York.

STOP Plodding! Be Successful. Operate a Tire Repair Shop. Make big profits in any locality. We teach you and furnish complete equipments \$108.00 up. Book of Opportunity free. Hayward's, 1305 South Oakley Avenue, Chicago.

LEARN the collection business. Good income, quick results. Interesting booklet, "Skillful Collecting" free. National Collectors Assn., Long St., Newark, O.

\$3,000 TO \$6,000 Yearly. Want it? Others are making it. Send check or money order today for our invaluable books "How to Sell Real Estate," \$3.00—and "How to Conduct Real Estate and Insurance Business," \$1.50. Absolute satisfaction guaranteed. Free catalogs. Realty Book Co., Dept. 52, Cleveland, Ohio.

CHEMICAL Expert furnishes manufacturing formulas with complete working directions, resulting products possessing distinct individuality and merit. Processes perfected. All lines. No lists of worthless stock formulas but reliable individual service. Charges reasonable, correspondence invited. Dr. Arthur VanHeeden, 508 South Oakley Boulevard, Chicago.

MANUFACTURE Ready-Made Gold Window Sign Letters. Unlimited Profits! We furnish complete instructions, accurate patterns. Absolutely no experience required. Wonderful Business Opportunity! Particulars. Wilsterling, 3151 Abbott Court, Chicago.

"WHAT to Invent for Profit" free. Patent News-C, Washington, D. C.

MONEY-MAKING Opportunity; learn how; valuable information; send stamp. Skarm, 2926 Lorina, Berkeley, Calif.

LEARN destroying superfluous hair permanently without scar. Complete instructions \$1. Bem. Zitka, Fairview, Mass.

OPEN a rental bureau in your city under unique "Personal Inspection" plan. No capital required. Ask for details. Washington Service Bureau, District National Bank Bldg., Washington, D. C.

START and Operate Your Own Business. Our System proprietary specialty manufacturing offers wonderful opportunity to make \$100 to \$500 weekly. Openings everywhere. Either men or women. We furnish everything and show you how. Big explanatory book, "The Open Door to Fortunes" free. Write for it now. National Scientific Laboratories, 208 Monroe, Richmond, Va.

FREE Advice: How to be successful in real estate. Particulars, Macdonald Co-operative Realty Co., San Diego, Calif.

CHEMISTRY

CHEMICAL Processes, Analysis, Research. Technical Information, Consulting Chemist, Madison, Maine.

STUDY Bacteriology, etc. Big demand 70 Piece Urinalysis Outfit Free to Students. Write for Free Prospectus today. International Physicians and Surgeons College, Room 954, 550 Garfield Ave., Chicago.

EXPERIMENTERS—Complete supplies for the chemical laboratory. Catalog 5c. National Scientific Supply Co., 241 Pa. Ave., Washington, D. C.

PRODUCTS formulated, duplicated, improved, cheapened. Ethical Harding, Box 1029 P, Chicago.

YOUR chemical problem solved and working process furnished Five Dollars. Write me. W. Stedman Richards, Consulting Chemist, address, Box 2402, Boston, Mass.

CHEMICAL Service. Formulas, analysis, methods, experiments. Jacob Shuyter, Chemist, 2525 East St., Davenport, Iowa.

FORMULAS AND TRADE SECRETS

FORMULAS—Best that Chemical Science can devise. Not "Better Sort" Formulas, but Guaranteed Reliable processes in all lines. Stamp brings Valuable Literature and Latest Summer Sellers from an Analytical Chemist. Miller, Chemist, 807 De Leon, Tampa, Fla.

500 FORMULAS, including Luminous Paint—Renewing Dry Batteries—Mechanics Soap—Gas Tonic—25c. Catalog Free. Ideal Book Shop, 5501-P2, North Robey, Chicago.

5,000 RECIPES, \$1.25. Best formulas and processes for every business, trade or occupation are in "Youman's Guide." Many never before published. Worth \$1.25 each. 530 pages. Paper cover \$1.25. Cloth \$2.00, postpaid. Book catalog free. Wells and Edwards, Department X, 852 George, Chicago.

FORMULAS—Guaranteed. Catalog Free. Restovall Laboratories, 4047-P3, North Whipple, Chicago.

500 VALUABLE Formulas 25c. Formula Literature free. Harvey Teeple, Decatur, Ind.

HARMLESS, non-intoxicating, universal, economical alcohol substitute, 50c. Thomas, Box 1029, Chicago.

GENUINE soap formula 25c. Made at home. Cheap. Big profit. V. Glenn Casner, Repton, Ky.

FORMULAS Free. Get my proposition. Leighton, Ph. G., Phenix, R. I.

BIG, interesting formula catalog free. National Scientific Laboratories, 208 Monroe Street, Richmond, Va.

FORMULA for tanning Free to any address. R. N. Gilley, Carlton, Texas.

1,000,000 FORMULAS, 1,016 pages, \$2. 500 Formulas Free if you order quick. Ideal Book Shop, 5501-M3, North Robey, Chicago.

AGENTS WANTED

BEATS Owning a Store. "This new way of selling beats owning a store. Any earnest worker can easily make \$4,000 to \$5,000 a year net without investment or financial risk," says William Garden, former merchant, who started with us two years ago. Other former merchants now happy and prosperous with us are De Longe, Pack, Carter, Hogen, Lee, and Pack. They earn as much or more than ever; have no investment or financial worries and are building a constantly growing business. We are now making the best suit that we ever produced retailing at \$31.50. Our values are remarkable. Our fit and style so good that you can sell the best trade. Every fabric is virgin wool. Every garment tailored to order. Our all wool summer suits retail for \$21.50. Both the \$31.50 and \$21.50 lines are red-hot sellers. We have openings for men who are looking for a permanent connection and have the courage to depend solely on their own industry for success. Such men will find a wonderful opportunity with us. Write for full information, Dept. 800, J. B. Simpson, Inc., 831 Adams St., Chicago.

SELL Wall Emblems—All Lodges, High-Grade Agency offer to real producers. Substantial returns. Permanent, Kier Fraternal Emblem Co., 443 So. Dearborn St., Dept. 10, Chicago.

AGENTS, Men and Women: Sell Photo-Pillow-Tops, the old reliable money maker for five agents. \$1.50 for sample roll starts you in business for yourself. Sales waiting for you everywhere. Write today. Canvasograph Company, 6215 Wentworth Ave., Chicago.

WHY Work for others? Start and operate your own business. Our system proprietary specialty business offers wonderful opportunities to make \$100 to \$300 weekly. Openings everywhere. We furnish everything and show you how. Booklet free. National Scientific Laboratories, 208 Monroe, Richmond, Va.

FREE Sample. "Rain Shield Wiper." Retail \$1.00—Costs (25c). Sold, Clear and Rainy Days. No Cloth—No Paste—No Attachment. (1) Bub keeps Windshield Clear (48) Hours. Experience unnecessary. NuLife Corporation, Hartford, Conn.

MOST Wonderful Seller. 96c profit every dollar. No stock to carry. License unnecessary. Sample free. Mission Factory PM. 519 No. Halsted, Chicago, Ill.

GENUINE Gold Leaf Letters anyone can put on store windows. Guaranteed to never tarnish. Large profits. Enormous demand. Free samples. Write today. Metal-lic Letter Co., 435-A North Clark, Chicago.

AGENTS: Finest new line of Cresco Raincoats you ever saw. Also full line of top coats. All made in our own factory. \$12 a day easy. Full or spare time. Big paying business. Your money every day. Steady income. Outfit and sample furnished. Improved Mfg. Co., Coit 278, Ashland, Ohio.

NEW Patented Household Article; 300% profit; sold on Money Back Guarantee; everybody buys; wonderful money maker. Specialty Mfg. Co., 745 Lincoln Bldg., Detroit.

AGENTS, you can't find a better seller than Pulson's Metal Polish. Show what it will do and sale is made. Sample free. Reginald Pulson, Randolph, Mass.

AGENTS wanted for our burned in china portraits used for monuments. Good profits, little competition. Give reference. Abendroth, Forest Park, Ill.

AGENTS—Big Side Line. Appoint solicitors. Box 22, Paragould, Ark.

AGENTS—Get our big sample assortment, free. Tea, coffee, extracts, spices, food products, things people eat. 210 fast sellers. Harley Co., 312 Harley Bldg., Dayton, Ohio.

SUIT Free to Agents. Tailoring agents, raincoat men, and salesmen of other lines—get in touch with us at once. We have most powerful selling proposition in field. Our line offers finest quality suits made to order all at one amazing low price, including big profit for agent. We supply finest swatch line outfit showing big cloth samples in handsome carrying case and give every active agent his own suit absolutely free. Lines are going fast. Write for yours at once. Address Dept. 341, Knickerbocker Tailoring Company, 131 So. Peoria St., Chicago.

AUTO owner tire agent wanted each locality to use and take orders for handmade Mellinger fabric and cord tires; guarantee bond 8,000 and 12,000 miles (no seconds); shipped prepaid on approval; get your tires free; no capital or experience required; make \$100 to \$300 weekly. Write for wholesale prices and sample kit. Address, Mellinger Tire Co., Dept. 200, Kansas City, Mo.

FIREBUG Automatic Carbon Burner—Costs 20c, sells \$1. Not liquid. Guaranteed seller. Write for free sample. Accessories Manufacturers, 4526 Xerxes St., Minneapolis, Minn.

WONDERFUL! Starring! Amazing! Our Ex-Cel Luminous Crucifix and Magical (Luminous) Necklace shine brilliantly in the dark. Sell on first demonstration. Big profits to you. Write for further particulars, or better still, send for sample and territory protection immediately. Crucifix \$1.50, Necklace \$1.00, postpaid. W. G. Hannan Co., Dept. B, 37 E. 18th St., Chicago.

SELLS Like Blazes! New, Instant Stain Remover. Fine Premium every sale. Big Profits. Outfit free. Write quick. Christy, 15 Union, Newark, New York.

75 WEEKLY Selling Nestle Guaranteed Hosiery. Your pay daily. All styles and colors; also Pure Silk, 4 pairs, \$5.50. Special monthly bonus. Sample outfit furnished. Nestle Hosiery Mills, Dept. 175, Philadelphia, Pa.

GOLD Mine for Salesmen. New invention, a complete outfit. Washes and dries windows, sweeps, scrubs, mops, etc. Costs less than brooms. Over 100% profit. Greatest year 'round seller. Write Harper Brush Works, 132 2nd St., Fairfield, Iowa.

EARN \$30 to \$35 extra every week taking orders for our high-class tailoring made-to-measure suits from \$14.95 to \$39.50. Your own clothes at low wholesale prices. No experience necessary. Write for our Big Free Sample Outfit. The Progress Tailoring Co., Dept. C-142, Chicago, Ill.

TOOT SWEET: Dispers foot odors. Overcomes perspiration. Excellent sideline. Big profits. Toot Sweet Co., Mason City, Iowa.

HERE They Are: Fifty Fast Sellers, everybody needs and buys. Fifty Dollars Weekly easily made. B & G Rubber Co., Dept. 526, Pittsburgh, Pa.

AGENTS—make \$500.00 month selling electric lighted vanity cases. Every woman buys. Commission advanced. We deliver, collect. Sample \$2.25. Spangler Mfg. Co., 160 N. Wells, Chicago.

THESE Advertisements of mine have appeared in Popular Mechanics for sixteen years. Hundreds of Successful Manufacturers today owe their success to my formulas and valuable information. Majority started with practically nothing. You can do the same—write today for my valuable literature relative to my Guaranteed Manufacturer's Formulas for making Non-Thermic Ice-Saving Cloths, Delicious Beverages for Home, Bottlers and Fountain sale. Pure Food Products, Non-Alcoholic Flavors, Launderite Washing Marvel, Zebest, greatest stain remover, Sta-Combed, Marcel Hair Curler, and latest Toilet specialties, Mexican Yucca Soap, Laundry Soaps, Flynox, Sensol, and all latest disinfectants. Amazon Tire Repair, Toy Rubber Balloons and all latest selling goods in all lines. Don't compare these with "junk" commonly offered. Analytical work carefully done. Highest references. Miller, Chemist, Tampa, Fla.

PORTRAITS, photo pillow tops, frames, sheet pictures, medallions, merchant's signs, water-proof and tea aprons, guaranteed hose, toilet requisites, luminous crucifixes; catalog, 50 specialties free. 30 days' credit. Jas. C. Bailey Co., Desk A-3, Chicago.

27,000 RECORDS guaranteed with one Everplay. Wonderful invention eliminates needles for phonographs. New; different. Cannot injure records. \$15.00 daily easy. Free sample to workers. Everplay, Desk 36, McClurg Bldg., Chicago.

AGENTS, our suits retail \$19.50 and up. You make \$3.00 to \$12.00 on each sale. Free suit, cash bonus and big special rewards to agents who will sell one suit a week or more. Details free. Chicago Tailors' Ass'n., Dept. 477, Sta. C, Chicago.

PAST sellers, big profits. Jones, 2935 Austin St., Oakland, Calif.

AGENTS: Big profit. Genuine Gold Leaf Window Letters, anyone can put up. Scripts and 57 varieties. Chicago Letter Company, 632 South Dearborn St., Chicago.

SALESMEN—Hustlers wanted; \$20 daily calling on merchants. Ford car furnished. Daily necessity in attractive "self-selling" counter displays; over 100% profit each for merchants and salesmen; enormous repeat business; permanent employment or side line. Elcor Corporation, 421 Maryland Building, Washington, D. C.

MEN and women make more money taking orders for CleanO washing powder and soap chips. Dehaven Mfg. Co., 188 No. LaSalle St., Chicago.

MAKE Money in your Spare Time. Easy to make \$1 to \$2 an Hour by following our instructions. No Money or Experience Necessary. Write today for particulars. Costs nothing to investigate. American Products Co., 1793 American Bldg., Cincinnati, O.

LIBERAL Proposition for Live Men—selling new product. Removes iron rust, medicine, mildew, ink, grass and fruit stains. Bleaches clothes, cleans straw hats. Write for free sample and start taking orders. C. H. Stuart & Co., 6967 B'way, Newark, New York.

AGENTS—\$6 to \$12 a day. Take orders for Aluminum handle Cutlery Set. Brand new. We deliver and collect. Pay you daily. Sample to workers. The Jennings Mfg. Co., Dept. 1768, Dayton, Ohio.

AGENTS, make over \$100 every week selling Nu-Way Mending Fluid. 150% profit—a sale every two minutes. Mends hosiery and all fabrics quicker and better. Every housewife buys. Write for outfit quick. Nu-Way Laboratories, Inc., Dept. T-1, Mt. Healthy, Cincinnati, Ohio.

ANSWER This—Take a big step towards success! Agents making \$60 to \$100 weekly selling our Sanitary Rubber Household Necessities. Particulars free. American Rubber Products Company, Dept. 298, Pittsburgh, Pa.

\$100.00 WEEKLY Taking Orders for Raincoats. Special Agents' Price \$2.95. Outfit Free. Biggest Line. Consumers Mfg. Co., 728 Roosevelt, Chicago.

AGENTS, Quadruple your money. Quick-foam Cleanser excels for every soap purpose. Washes clothes, cleans Pots, Pans, Silver, Metalware, Marble, Porcelain. Sure repeater! A. Huber Products Co., Filmore Ave., Kirkwood, Mo.

MONEY! Silvering Autolights, Radiators, Mirrors, Tableware, Stores, Outfits. Methods free. Clarence Sprinkle, Dept. 28, Marion, Ind.

AGENTS: Become Independent. Miles Adjustable Automobile License Plate Holders sell on sight. Easily attached; unique and attractive. Prevents Plates from being bent, crumpled or broken. Approved by the Dept. of State. Send \$1.00 for sample and price list. Exclusive territory to those who qualify. Write Miles Specialty Co., 629 W. Willis Ave., Detroit, Mich.

ONCE a Customer, Always a Customer. Every man likes Pitkin's "2 in 1" Velvet Shaving Cream. No other Cream like it. Softens the beard quickly without rubbing. No After Shaving Lotion needed. Sold direct to consumer through our factory representatives. Never sold in stores. \$60.00 a week clear profit easily made. Muland sold 500 tubes in one week. Write today for territory. Send 15c in stamps for full sized tube and proposition. J. M. Pitkin & Company, 615 Commercial Building, Newark, New York.

FREE Au-Tow-Line! Special advertising offer. Limited number distributed. Send name and address to Metal Fibre Rope Co., 1817 Vermont, Toledo, Ohio.

SELLS Like Lightning; Big Profits; New Ironing Wax Pad and Asbestos Rests; Clamps Board; Perfumes Clothes; Outfit 10c. Yankee Mfg's., 380 Atlantic Ave., Brooklyn, N. Y.

\$500 MONTHLY taking orders Union-made Rain garments, \$2.25. Outfit Free. Full commission advanced. Promptest deliveries. We deliver, collect. Eastern Raincoat Co., 923 Roosevelt, Chicago.

START in a permanent business of your own selling guaranteed Hosiery and Underwear direct from mills. No capital or experience is needed; many representatives make \$3,000 to \$5,000 per year. Become our district manager—get others working for you. Write for details to Malloch Knitting Mills, 543 Grant St., Grand Rapids, Mich.

\$50 TO \$75 weekly; selling complete line hosiery, silk knitted scarfs, silk neckties; big commissions; full or part time; we deliver and collect. Pennsylvania Hosiery Mills, 1703 Ludlow St., Philadelphia, Pa.

AGENTS: \$75.00-\$100.00 weekly taking orders for popular price-smashing raincoats. \$3.98. Largest commission advanced. Prompt shipment. We collect. Free coats. Eagle Raincoat Co., 619 Mid City Bank Building, Chicago.

EVERYBODY uses extracts. Sell Duo Double Strength Extracts. Complete line household necessities. Big repeaters. Write today. Duo Co., Dept. E1, Attica, N. Y.

AGENTS—Send for sample "Fretnot"—the washday wonder. Be convinced you can do a whirlwind business. You can clear at least \$20 to \$100 weekly, according to spare or whole time. You don't have to talk; if she doesn't buy at sight, leave sample; she will be looking for you long before you are able to make the rounds again. Samples furnished free. Premiums for your customers. Exclusive territory guaranteed to agents who can produce. Credits given. Don't call. P. M. Motter & Sons, 20 E. Jackson Blvd., Chicago.

SELL Madison "Better Made" Shirts direct from our factory to wearer. No capital or experience required. Easily sold. Big profits. Write for free samples. Madison Mills, 503 Broadway, New York.

AGENTS: \$16 a day. Latest improved portable talking machine. Does more than machines costing five times its price. Built in just like a suitcase. Fully guaranteed. Pay you daily. Write Perry-Ludlow Co., Class 1962, Dayton, Ohio.

AGENTS—Our full line of Guaranteed Hosiery for men, women, children is the easiest and best selling proposition you ever saw. Must satisfy customer or new hose free. Our new styles of finest silk hose lead them all. Write for samples. Parker Mfg. Co., Sample 378, Dayton, Ohio.

AGENTS: \$40 a week selling guaranteed hosiery for men, women and children. Must wear 12 months or replaced free. Write for sample outfit. Thomas Mfg. Co., Class 162, Dayton, Ohio.

AGENTS: fastest, easiest seller auto dimmers. Every motorist prospect; sells on sight; easy to attach; send one dollar for sample set. Money return guarantee if not completely satisfied. Auto Light Dimmer Co., 576 Union Arcade, Pittsburgh, Pa.

AGENTS—\$240 a month. Take orders for well known line of household specialties, food flavors, toilet preparations, etc. Full or spare time. Build a big permanent business. Must satisfy or money back. Write for free sample outfit and offer. C. H. Stuart & Co., 5567 B'way, Newark, New York.

AGENTS—to sell ladies' \$12.00 vanity cases at ½ price. Genuine leather, gold plated equipment, electric lighted. Sample, \$3.00, cash or C. O. D. Money back guarantee. Child's vanity 79c. Red Seal Leather Co., Elkhart, Ind.

AGENTS—\$15 a day—Easy, quick sales—Free Auto—Big weekly Bonus—\$1.50 premium Free to very customer. Simply show our Beautiful 7-Piece Solid Aluminum Handle Cutlery Set. Appeals instantly. We deliver and collect. Pay daily. New Era Mfg. Co., 803 Madison St., Dept. 21-X, Chicago.

WONDERFUL Invention—Eliminates all needles for photographs. Saves time and annoyance. Preserves records. Lasts for years. 12,000,000 prospects. \$15.00 daily. Free sample to workers. Everplay, Desk 323, McClurg Bldg., Chicago.

AGENTS, Salesmen, Demonstrators, you will have the devil's own time trying to find a better seller than "Zippo." If there was such a thing we'd have it. Splendid profit on 50c "Go Getter" repeat article that sells on ten second demonstration. Works While You Watch It. Demonstrates value, while others waste time making claims. New Discovery! Greatest Scientific Triumph of the age. It's the berries. Haven't room to tell our story here. Write immediately. Karam-Smith Co., 603 Boxan St., Ft. Wayne, Ind.

WHY Work for others? Start and operate your own business. Our system proprietary specialty business offers wonderful opportunities to make \$100 to \$500 weekly. Openings everywhere. We furnish everything and show you how. Booklet free. National Scientific Laboratories, 288 Monroe, Richmond, Va.

AGENTS' experience unnecessary. 16 hosiery numbers, from 25% to 120%; 18 neckwear patterns, over 120%. Write for free samples. We deliver, single sales; 10% bonus to district managers. Dept. 1139, The Lexington Co., Lexington, Ky.

AGENTS Wanted—A new clothing plan. Our agents make seven dollars a day on only three sales. Big repeat business because our cloth is real high-grade worsted and our plan is new and gives your customer a suit made by his own tailor. Alden Worsted Mills, Box 1521, Providence, R. I.

\$5 TO \$15 daily easy—Introducing New Style Guaranteed Hosiery. Must wear or replaced free. No capital or experience required. Just show samples, write orders. Your pay in advance. We deliver and collect. Elegant outfit furnished. All colors—grades including silks, lises, heathers, Mac-O-Chee Hosiery Company, Room 2363, Cincinnati, Ohio.

YOU can sell any place; No Dust Brooms, No Dust Floor Brushes, and Automobile Washers. Entirely new. Liberal profits. Hanson Mfg. Co., 3945 Lake St., Chicago.

MAKE \$31.00 Profit—Cost you \$1.50. Complete Gold Monogramming Outfit. Transferred instantly on Automobiles, Trunks, Bags, Windows. Experience Unnecessary. Free Samples. NuLife Monogram, Hartford, Conn.

SEND Me to the Darn E-Z Laboratories, Dayton, Ohio, and I will show you how their representatives are making big money selling Darn E-Z Universal Fabric Cement, either full or spare time.

DISTRIBUTORS and Agents: Make 100 to 200% profit selling our complete line Automobile Polishes and Gas-O-Pep Tablets. They keep the new car from getting old; make the old car look and run like new. Gas-O-Pep Tablets guaranteed to increase mileage, prevent and eliminate carbon at practically no cost. Build a permanent business for yourself; customers sure repeaters. Exclusive territory available. Write us to-day. Taylor Products and Mfg. Co., 24 West Naghten, Columbus, Ohio.

GET out of low wage rut. Make \$12-\$50 day. Positions everywhere. Demand greater than supply for qualified automobile painters. We teach you in 8-10 weeks. Get facts. Have eyes open to wonderful new opportunity. Investigate. Write. Detroit Auto Painting School, 1406 Van Dyke, Detroit, Mich.

SALES Agents. Men or women. \$240 a month. Steady employment. Take orders for Jennings New Guaranteed Hosiery for men, women, children. Written guarantee with each pair to wear and give satisfaction or new hose free. All styles. Finest silk hose. Low priced. Write for complete line of samples. Big money for spare time. Jennings Mfg. Co., Dept. 368, Dayton, O.

TAILORING Agents: \$6.00 to \$10.00 profit every sale. Virgin wool suits \$25.50. Profits in advance. We deliver and collect. Greatest line in America. Write for free sample outfit. Fred Kauffmann, Dept. A 921, 1300 W. Harrison St., Chicago.

AGENTS—Sell "Instant Shine" Metal Polishing Cloths, 25c; costs 7½c. Sample free. Instant Shine Polish Company, Utica, N. Y.

AGENTS and Canvassers, men or women, sell our Radium Luminous jewelry and earn 200-300 dollars monthly! Best selling articles you ever came across. Exquisite novelty in daylight; shines amazingly in the dark. Sells at Sight. Merritt Jewelry Co., Inc., 93 Nassau Street, New York City.

GREATEST Radio offer ever made. See pages 152 and 153.

RHEUMATISM Conquered by wonderful new discovery, after doctors failed. No stomach dosing. Quickly relieves sprains, strains, sore muscles. Sold on money back guarantee. Agents wanted—big commission and \$5.00 bonus on every dozen. Nu-Rhu Co., Box 343, Cincinnati, Ohio.

EARN \$2,500 to \$5,000 per year. Men and Women we will train you in twenty weeks at home to be expert salesmen. We guarantee graduates position in City or Traveling. Particulars free. Address Dept. P. M., Chicago Salesmen's Training Institute, 2709-11 Rosworth Ave., Chicago, Ill.

ANY man handy with paint brush or light tools can start new mechanical business on nearly nothing; needed everywhere; nearly all profit; experience not required. John Brackland, 1457 So. Ninth, Philadelphia, Pa.

CLARKE Earned \$718.00 Selling Pull-em-up Kuff Buttons. Fifty other meritorious Jewelry Specialties that sell like wildfire. Master Jewelers, Sheboygan, Wis.

AGENTS Wanted—Sell silk underwear direct to consumer. Rapid seller—liberal commission, exclusive territory. Mrs. Gage, Levy Building, Elizabeth, N. J.

SEND 25c for quart best ink made. Indelible paper; washes from clothing. 300% profit. Get busy. Acidproof Ink Co., Nicetown, Philadelphia, Pa.

PORTRAIT Agents, Dealers, get your Portraits and Bromide Prints direct from Manufacturer; lowest prices, prompt service. Lincoln Portrait Co., 1923 Hudson Ave., Chicago, Ill.

MAH-JONG—Now going big. Actually sells itself. Retail price within reach of all. Large profits. Sample complete game \$1.00. Central Supply Co., 1037 3rd St., Milwaukee, Wis.

KOATLOCK—Absolutely new. No competition. Quick and easy seller. How many overcoats in your territory? Each needs a patented KoatLock. Here's the story. Lock your coat on any hook, ask some one to take it down—when they see it's locked, they want one. KoatLock insures against theft. Replaces cloth hanger. Takes up no more space. Attached permanently under collar. Cannot be seen. Absolutely eliminates broken hangers. Will outlast garment. A cinch to sell. Make big money. Send 25c now for sample and proposition. Sargent Products Co., Inc., Dept. B, 47 W. 34th St., New York City.

GET posted—Good prices paid for butterflies, insects. See Sinclair display advertisement, page 24.

AGENTS—Sell the best Wringer Mop made. \$1 profit on each sale. Other fast selling specialties. Write today. Newton, 1338 West 104th, Cleveland, Ohio.

\$100.00 WEEKLY easy selling Oriental Perfumes and Cosmetics. Highest profit. Sample case and illustrated catalogue absolutely free. Romola Parfumerie, Inc., Chicago.

AGENTS—Experienced in selling hosiery, and who can handle selling organizations. 25% commission guaranteed; additional commission according to ability to produce. Cherokee Silk Co., Louisville, Ky.

DISTRIBUTORS wanted for new rheumatic ointment. Enormous demand. Remedy Co., 1019 N. J. Ave., Washington, D. C.

200% PROFIT. Valuable inside information free. Mail order men, agents, beginners. Nite Mail Order & Supply Co., 609 27th St., Denver, Colo.

THE AGENT'S CRIER, 373 Chauncey St., Brooklyn, N. Y. Postal brings copy.

NEW Auto Accessory. Costs 6c. Retail \$1.50. "Free Sample." Box 494-M, Hartford, Conn.

BE your own boss. Earn \$2-\$3 hour with Luxcel hosiery; everyone wears stockings; free booklet tells how. Hopkins Hosiery Co., 453 Washington St., Boston.

PORTRAIT Agents—For clean, snappy finished portraits, quick service and lower prices, try us. Quality Service Portrait Co., 2014 Rice St., Chicago.

\$10.00 A DAY Easy. Quick sales every home. Complete line. Pure Foods, Quality Soups, Perfumes, Beauty Products, Spices, Extracts, Towels, Jewelry. Highest Grade Rubber Goods, etc. Big money-making offers. Catalog, outfit free. Write now. Western Products Co., Dept. G9, 600 N. Oakley, Chicago.

GOLD Leaf Sign Letters; make and sell; profits exceed 1,000%; immense demand; particulars free. Johnston Co., Quincy, Ill.

50% CLEAR profit selling fast selling patented automobile spring riders. Quickly attached. No drilling. Martineck Company, Corona, N. Y.

SPARE Time—Big Profits. Outfit, Particulars, 25c. Western Sales, Willernie, Minn.

300% PROFIT: Whirlwind Seller. Tremendous repeater. "Kleanrite." Marvelous Discovery. Washes clothes without rubbing. Premiums for customers. Sells 25c. You make 18c. Free samples make easy sales. Write quick. Bestover Products Co., 1941-K3 Irving Park, Chicago.

IF you want good live agents—fellows who can get the business—ask no how others are doing it. I'll gladly render the necessary assistance. Geo. P. Baker, Mgr. Classified Advertising, Popular Mechanics Magazine, Chicago.

AGENTS, both sexes, we manufacture and control new household article. Fast seller. Big profits. Exclusive territory. Write now. Connolly, 123 Liberty St., New York.

\$12 DAILY easy, introducing ladies' and men's sweaters in silk, wool and artificial silk; 23 colors. Latest novelties. Going like wildfire. You simply show samples we furnish; take orders; we deliver and collect. Your Pay Daily. Mac-O-Chee Sweater Company, Form 1102, Cincinnati, Ohio.

REPRODUCE your own voice—See "Voclograph." phonograph columns—This issue.

AGENTS—Sell "Kazzone." Wonderful new specialty. Sensational Wildfire Seller. Auto Owners buy on sight. Guaranteed. 100% profit. Sure repeater. Demonstrating Sample. Instructions, terms, territory, all 10c Postage. Myers & Co., 22 Baird, Cambridge, Ohio.

AGENTS: Men or women—our new renewable fibre broom is a wonder. \$8.00 to \$12.00 a day easily made right in your home territory. Write quick for special offer and free book "The North Ridge Way to Better Pay." North Ridge Brush Co., Dept. 43, Freeport, Ill.

DAINTY, French Perfume Flasks. Ladies wild for them; fit in vanity cases; entirely new; demand enormous; big profits. McCallister, Importer, Phelan Bldg., San Francisco, Calif.

ONE razor blade is good for three months if sharpened with our "Clitmax" outfit. Agent's sample 25c. Bogart Co., 1619 Broadway, Brooklyn, N. Y.

BUILD a lasting business. In your own community, with the Wateriser. Big profits—cumulative—clean cut. James B. Lund, Manufacturer, 19 S. La Salle, Chicago.

MAKE dollar an hour easy cleaning windows for residents. New, easy method; no experience or capital. Details free. Alfred Hansen, 122 W. 30th St., Los Angeles, Calif.

BATTERY Restorer makes old sulphated batteries operate like new. Send Dollar for trial carton. Agents wanted. Wayside Corporation, Sibley, Mich.

HANDKERCHIEFS, "Kwality" line. Factory prices to agent-cannassers. Write for the plan of this dependable business. Turnover Company, 18A East 17th St., New York.

CHEAPEST Self-Wringing Mop made. Big Seller, 100% profit. Eastway Company, 463 St. Paul, Baltimore, Md.

AGENTS: A sale in every home for our beautiful dress goods, silks and general yard goods. Quick sales! Big profits. Large book of nearly 1,000 handsome fabric samples furnished to agents. Write today. National Importing & Mfg. Co., Dept. 6X, 573 Broadway, New York, N. Y.

AGENTS—100% profits. Fast-Selling novelty for Lodge members. Emblematic Belt Co., Ashland, Ohio.

YOU can be your own boss with our Key-Check outfit. Good for \$5 a day stamping names on pocket key checks, fobs, etc. Sample check with your name and address, 20 cents. Pease Die Works, Dept M, Winchester, N. H.

SELL Komik Display Cards, airbrushed window cards, price tickets, card holders, etc. Big demand. Komik Advertising Co., Cambridge, Ohio.

FORMULAS, Processes, Trade-Secrets—Different, dependable, profitable. Catalog free. B. Thaxly Co., Washington, D. C.

SELL Rubber Rugs, duplicating rag rugs in appearance. Every home a prospect. Small samples free. Trump Bros. Rubber Co., Akron, Ohio.

TAILORING Agents make \$10.00 every sale. Wonderful line all wool fabrics—\$25.50. New way selling gives you big profit. Pull or part time. We give complete instructions. Write for full information—free sample outfit. Kahn Bros., Dept. A-101, 500 S. Throop St., Chicago.

FORMULAS—Dependable manufacturing formulas with complete working directions. Charges reasonable. Write me. S. Viggins, Chemist, 135 Meadow St., Pittsburgh, Pa.

AGENTS to sell men's hats direct from factory. Guerlin Hat Co., South Orange, N. J.

\$3.50 AUTOMATIC Adding Machine. Quick, profitable seller. Guaranteed accurate as highest priced machines. Exclusive territory granted. 75,000 already sold. Can be sold anywhere to anyone having adding of any kind to do. Act quick. Bassett Co., 1438-D Hollywood Avenue, Chicago.

NEW Office Specialty. Minute Demonstration means sure sale. 100% repeater. Big Profits. Odorine, 119 South Fourth, Philadelphia, Penna.

TERRITORY open for electrical necessity. Sells for 25c, 50% profit. Write for particulars or send one dollar for samples and supply. Helite Fuse Co., 2919 Bay St., Los Angeles, Calif.

CASH in on this quick seller. Wings cleared \$1,080 with Never Fail Razor Sharpener in six weeks; Purdy, \$49.50 first day. Applewhite, also inexperienced, six orders in thirty minutes. No end to ready buyers. Exclusive territory for quick workers. Be first. Address Never Fail Company, 159 Allen Bldg., Toledo, Ohio.

WHY Work for others? Start and operate your own business. Our system proprietary specialty business offers wonderful opportunities to make \$100 to \$500 weekly. Openings everywhere. We furnish everything and show you how. Booklet free. National Scientific Laboratories, 208 Monroe, Richmond, Va.

AGENTS: Largest line of metal household specialties. Quick, easy. Big Profit Sellers. Write now. General Products Co., 348 Mulberry Street, Newark, New Jersey.

AGENTS—Make \$10 to \$30 daily selling the famous Nerv-Ease Foot Comforts. Big demand. Over 100% profit. Write today. Manhattan Products Co., 2520D Bailey Ave., New York.

ASTOUNDING invention starts Fords instantly, coldest weather, doubles mileage. Big profit. Super, 1306 Fondulac, Milwaukee, Wis.

MAGIC Polishing Cloth—great seller—big profit. Get our proposition. Newton Co., 61 Main St., Newark, New York.

AGENTS sell Dan-D, Iron Rust, Spot and Stain Remover, 150% profit; sample 20 cents. Particulars free. Dan-D Products Co., Box 69, Augusta, Ga.

MEN'S Shirts Easy to Sell. Big demand everywhere. Make \$15.00 daily. Undersell stores. Complete line. Exclusive patterns. Free Samples. Chicago Shirt Manufacturers, 241 W. VanBuren, Factory 211, Chicago.

YOU can make \$75.00 to \$100.00 a week selling our big line of 150 articles, used constantly in every home. Write us, we will send you our handsome \$15.00 Sample Case Outfit on trust. Federal Pure Food Co., Dept. PP, Chicago.

SHEEP Wool Moccasins, Polishers, Dust-ers. Box 26, East Boston, Mass.

ABSOLUTELY free, box Bassett's Native Herbs sent to introduce. For constipation, indigestion, rheumatism, headache. Big money selling all or part time. Established 1879. Bassett, Dept. 1, Columbus, Ohio.

LIVE Hustlers! Supply attractive, catchy article to movie shows, stores, etc. New business with big possibilities. Only small investment. Big profits. Hundred-thousands will be sold. Write immediately. Kraft, Box 896-Fm, San Francisco, Calif.

AGENTS—If you have formerly sold felt rugs, write for our new proposition concerning new goods. It's a winner. Newark Felt Rug Company, 27-C 16th Ave., Newark, N. J.

BIG Money and Fast Sales. Every owner buys Gold Initials for his auto. You charge \$1.50; make \$1.35. Ten orders a day easy. Write for particulars and free samples. American Monogram Co., Dept. 40, East Orange, N. J.

EXCLUSIVE agents \$225 weekly. Genuine gold letters for store windows. Free samples; selling instructions. Chicago Window Sign System, 6226-A Kimbark Avenue, Chicago.

OWNER-AGENTS—Patented Automatic Instrument "Starts" Automobile "Zero" Weather—Removes Carbon—Increases Mileage 10-40%—Guaranteed. Wonderful "Necessity"—Enthusiastic Users Everywhere. Spectacular Demonstration—Quick Seller—Immensely Profitable. Easily Attached "Any" Motor. If You Want "One Free," Communicate Immediately. Wizard Manufacturing Company, Rochester, N. Y.

AGENTS: Big Money Selling Great Household Necessities. Sample 25c. Webster Co., 2545 N. Clark St., Chicago, Ill.

AGENTS! Make money selling Men's Rubber Belts with fancy buckles—black, cordovan and gray, plain, stitched and walrus grain. \$12.00 per gross. Sample 15c. Star Belt Company, Akron, Ohio.

TAKE this tip. County Rights for the Exclusive Sale of Domestic Science Can Openers will make you more money in less time than anything on earth. This new invention opens any can (round or square) instantly, turning down edge as it cuts. This prevents cutting the hand and leaves the empty can useful for many purposes. Any child can operate this Modern Marvel. Entirely different from all others. Every demonstration means a sale. Sells for 50 cents. Just out, territory going fast. Write for particulars our guaranteed contract and confidential price list in quantities. State territory desired. No time to lose. (Better save time and send \$3.00 for trial dozen by parcels post prepaid, or send 50 cents for sample.) Ajax Co., Desk 35, 3040 W. Pico St., Los Angeles, Cal.

USE our handsome catalog; get orders from every home for Dr. Blair's famous home products. Liberal pay. Dr. Blair Laboratories, Dept. 524, Lynchburg, Va.

AGENTS make \$50.00 a week selling our Daily Purchase and Sales Record. Indispensable for making Income Tax Report. Profitable side line. Small sample. Easy seller. Pershing & Co., Dept. C, South Bend, Ind.

LIVE Agents make \$10 day selling Eureka Strainer and Splash Preventer for every water faucet. Takes on sight. Widely advertised and known. Get details today. A. B. Seed Filter Company, 73 Franklin, New York.

WONDERFUL Scientific Discovery: "Blue-White Sapphires" rival finest diamonds, \$3 carat. "Rainbow Sapphires" changes color, greenish purple to ruby red, \$3 ct. "Meteor Sapphires" like golden Diamonds, \$2 ct. Pearls, Watches, Diamonds, solid gold mountings; new sales idea; wholesale prices; be our agent. Pauer (Importer), 152 Dewitt, Buffalo, N. Y.

AGENTS Wanted—Something New—Fire Fighter sells easily. Makes a spectacular demonstration; car owners, homes, factories, stores, practically buy on sight. Our men make \$10.00 to \$50.00 a day; exclusive territory. If you wish to establish a business of your own with unlimited possibilities for making big money, write us today. Fyr-Fyter Co., 163 Fyr-Fyter Bldg., Dayton, Ohio.

LARGE Corporation wants a Service Man in every town to paste up its signs on store-keepers' windows. Excellent opportunity for reliable party. Steady work. No experience necessary. We also have attractive proposition for agents and salesmen. Guarantee Sign Service, 363 West Superior, Chicago.

AGENTS—Stamping names on Pocket Key Protectors; sample Check with your name and address, 25c. Stamping Outfits, Emblem Checks, Check Fobs, Name Plates. Hart Mfg. Co., Desk 2, 293 Degraw St., Brooklyn, N. Y.

AGENTS make 500% profit handling Auto Monograms, New Pictures, Window Letters, Transfer Flags; Novelty Signs. Catalog Free. Write Hinton Co., Star City, Ind.

RUSSIAN, German, Austrian, Soviet money. Sensational sellers. Cheap, attractive, giveaway advertising for Agents, Merchants. Big Circular Free. 100 banknotes \$2.00, splendid assortment. Hirsch Importing, 70 Wall St., New York.

AGENTS—Our soap and toilet article plan is a wonder; get our free sample case offer. Ho-Bo-Co., 2725 Dodder, St. Louis.

MAKE money silvering mirrors, all kinds plating, knives, spoons, auto headlights. Outfits furnished. Free booklet. International Laboratories, Dept. 25, 311 Fifth Ave., New York.

INSTANT Weld. Repairs largest punctures without cement or heat. Lenn's profit one day, \$50. Write quick. Free sample; territory going fast. Tourists' Pride Mfg. Co., Desk T, Minneapolis, Minn.

AGENTS: Where to buy 12,000 articles. Wholesale. Actually worth \$50. Enclose stamp. Wholesale Supply Co., Valdosta, Ga.

TAILORING Agents. Make \$50 to \$100 a week selling all wool 2 piece suits at \$21.50. Also our famous virgin wool suits at \$31.50—none higher. Commissions daily. Beautiful assortment of 6x9 swatches free. No experience needed. Can use spare time workers—if hustlers. Write J. B. Simpson, Inc., Dept. 750, 843 West Adams St., Chicago.

TO secure agents or salesmen or for selling farms and reaching investors, use classified (want) ads in largest newspapers and magazines. Price list No. 30 sent free. Ankrum Advertising Agency, 20 W. Jackson Blvd., Chicago, Ill. The largest classified advertising agency in the U. S.

HUSTLERS clear \$7.50 to \$15.00 daily! Big opportunity. Become exclusive agent for low-priced, widely advertised, fast-selling automobile pedal pads. Drivers buying on sight. Fit any car. Experience unnecessary. Free set to agents. Territory going fast. Write today—Carter, 6332 Evans Ave., Chicago.

PATENTS Procured. Send sketch or model today for examination, prompt report and advice. No charge for preliminary advice. Write for free Booklet and blank form on which to disclose your idea. Highest references. Promptness assured. Clarence A. O'Brien, Registered Patent Lawyer, 55-C Security Bank Building, Directly across the street from Patent office, Washington, D. C.

PORTRAIT and Medallion Agents—Our Goods Will Make You Big Profits; delivery guaranteed; prompt shipments; low prices; send for latest catalog. Adam J. Kroll & Co., 602 Blue Island Ave., Chicago.

SELF-THREADING Needles find sales in every home. Fine sideline, easy to carry. Big profits. Sample free. Prentice-Lee, 145 East 23rd St., New York.

RADIO Agents Wanted. We appoint you our representative in your community and furnish you with many of the standard well advertised sets and supplies, at a price that will allow you a handsome profit when sold to friends in your territory. Write for agent's proposition. Desk 14, Waveland Radio Company, 1027 North State Street, Chicago, Ill.

AT Last—World's Greatest Adding Machine. Almost human. Retail \$15; work equals \$300 machine. \$500 monthly easily made, demonstrating to stores, offices, garages, factories. Simple, easy; adds, subtracts, multiplies, divides automatically. Speedy, accurate, durable, handsome. Five year guarantee. Tremendous demand, amazing profits. Liberal trial offer. Protected territory. Write quick. Lightning Calculator Corp., Dept. F, Grand Rapids, Mich.

AGENTS, \$10 to \$25 a day. No investment. Free outfit. Best values. Largest commissions. World Raincoat Co., 659-B Morris Park Ave., New York.

POLMET—The Wonderful Polishing Cloth that cleans all metals without liquid, paste or powder. Approved by "Good Housekeeping" and "Modern Priscilla"—sells fast at 25c. Sample free. Gale & Co., Inc., 15 Edinboro St., Boston.

WE start You Without a Dollar. Soaps, Extracts, Perfumes, Toilet Goods. Experience unnecessary. Carnation Co., Dept. 201, St. Louis.

"HOW to Sell Patents" free. Patent News-O, Washington, D. C.

MAIL-ORDER houses and distributors; we pack big profit beauty creams, face powders, perfumes, toilet preparations with your label. Chemist, 944A No. Clark, Chicago.

AGENTS clear \$50.00 weekly selling Opaline Portraits. Expense money advanced. Credit given. Big line now ready. Samples and Catalog free. Consolidated Portrait Co., Desk 2, Chicago.

PATENTED Cigar Lighters with Glass Advertising Front. Also Electric Cigar Moisteners. Wonderful Sellers. No Competition. Big Steady Profits. Proof, Cuts, Sales Plan Free. Drake Mfg. Co., Dept. M, Milwaukee, Wis.

WE have the finest needle case. \$50.00 to \$200.00 weekly. Send 10c for sample; sells 25c. Empire Specialties Co., 1549 N. Wells, Dept. 301, Chicago.

AGENTS, Sell Anti-Mist Compound. Keeps rain, steam and snow off of windshields and eye glasses for 24 hrs. Send 25c for sample and particulars. A. W. Brust, 270 S. Seeley Ave., Chicago, Ill.

DUSTLESS Sponge Cloth. New Invention. Retail (50c)—costs (16c). (1) Rub Cleans, Polishes Automobiles, Pianos, Furniture. NuLife Sponge, Hartford, Conn.

CALIFORNIA Rosebuds selling like hot cakes. Agents selling money; new stuff. Big profits. Catalog free. Mission Factory PM, 519 No. Halsted, Chicago, Ill.

AGENTS—Best seller: Jem Rubber Repair for tires and tubes; superadhes vulcanization at saving of over 800 per cent; put it on cold, vulcanizes itself in two minutes, and is guaranteed to last the life of the tire or tube. Sells to every auto owner and accessory dealer. For particulars how to make big money and free sample, address Amazon Rubber Co., Amazon Bldg., Philadelphia, Pa., Dept. 505.

SUCCESS in Business and Personal Affairs! Read character by handwriting and features. Conlin System. Low price for entire course. Write. H. E. Conlin, Dept. B, 21 St. John's Place, Buffalo, N. Y.

AGENTS—Steady income. Large manufacturer of handkerchiefs and dress goods, etc., wishes representative in each locality. Factory to consumer. Big profits, honest goods. Credit given. Send for particulars. Preport Mfg. Co., 59 Main St., Brooklyn, N. Y.

WHY Work for others? Start and operate your own business. Our system proprietary specialty business offers wonderful opportunities to make \$100 to \$500 weekly. Openings everywhere. We furnish everything and show you how. Booklet free. National Scientific Laboratories, 248 Monroe, Richmond, Va.

AGENTS: Can start you in Mail Order Business Immediately. Been at it 17 years. Small capital needed. Particulars stamp. Home Business Expert, Valdosta, Ga.

\$50-\$200 A WEEK. Genuine Gold Letters for store windows. Easily applied. Free samples. Liberal offer to general agents. Metallic Letter Co., 438-D, North Clark, Chicago.

WE Pay \$50 a Week and expenses and give a Ford Auto to men to introduce poultry and stock compounds. Imperial Co., D-23, Parsons, Kan.

AGENTS—Good salary and commission selling "Batskyl," new rat and mouse exterminator; ready for use; no bait required; non-poisonous; rodents die outside premises; no odor. Empire Specialties Co., 1549 N. Wells, Dept. 301, Chicago, Ill.

AGENTS sell Wolverine Laundry Soap. Wonderful repeater and good profit maker. Free auto to hustlers. Wolverine Soap Co., Dept. B37, Grand Rapids, Mich.

GET Our Free Sample Case—Toilet articles, perfumes and specialties. Wonderfully profitable. La Derma Co., Dept. A, St. Louis, Mo.

AGENTS—Clever Invention! Inkspoon makes every pen a fountain pen. Past office seller; big profit, demand increasing everywhere. Exclusive territory offered. Sample free. H. Marul Company, Tribune Bldg., New York, N. Y.

AGENTS: Big returns, fast office sellers; particulars and samples free. One Dip Pen Co., 2 Daily Record, Baltimore, Md.

AGENTS: \$60.00 weekly selling newest sensation; Leather Link Belts going over big. Easy, quick sellers. Big profits. Write quick. Victory Belt Co., 1772 Wilson, Chicago.

AGENTS—Silk fibre knitted neckties sells the whole year round; send \$38.00 for a gross, 100% clear profit; dozen \$3.25; if you can't sell them we will refund your money. Raymond Mfg. Co., 132nd St. and Madison Ave., New York.

MAKE \$17 daily—Finest Extracts, Food Products, Toilet Preparations, Household Necessities. Credit: Sample Case Free. Write for amazing offer. Perkins Products, B-6, Hastings, Nebr.

AGENTS: Big profits. Best and cheapest window letters made. Easily applied. Dime brings five samples. Particulars free. Stalwhite Co., 1115 Second Ave., New York.

AGENTS. Make \$10 to \$20 daily, selling small kitchen necessity. Over 200% profit. Sells rapidly everywhere to nine out of ten women. New plan make sales easy. Premier Mfg. Company, Dept. 813, Detroit, Mich.

MAKE \$8 a day selling Imported Bamboo Fountain Pen, Whirlwind seller. Free sample. Mohler, Dept. 5, 416 S. Dearborn, Chicago.

EARN \$10 daily silvering mirrors, plating and refinishing metalware, autos, chandeliers, bedsteads, headlights. Outfits furnished. E. Dele Laboratories, 1133 Broadway, New York.

WE pay \$200 monthly salary, furnish car and expenses to introduce our guaranteed poultry and stock powders. Bigler Company, X368, Springfield, Ill.

MEN Wanted. We have positions open now that will pay from \$45 to \$100 a week. We are organizing a sales force to introduce the Cole Visible Gasoline Gauge, a low-priced, scientifically accurate instrument for Ford and Chevrolet cars. Prevents running out of gas. Guards against short measure. Fits on instrument board—always in sight. Big selling records. We want one good man in each county. Campaign is just beginning. We will help you start. Capital not necessary. Territory going fast. Write quick to The Stemo Engineering Co., 119 Webb St., Dayton, Ohio.

RUG Salesmen—Get next to the biggest seller of the year—Loomrite Felt Rugs. Sell at sight at \$2.50, cost \$15 dozen. Big, complete Rug Catalog, Free. Malsley-Payne Mfg. Co., 104-D Hanover St., Boston, Mass.

WANT Distributing Agents everywhere for Hanslick, the new original powdered handsoap. Removes grease, grime, ink, paint, and most anything from the hands without injury to the skin. Every mechanic and auto-owner, everybody who gets his hands dirty will be a customer. A great opportunity for a hustler to get in business for himself. Full information free. Send 10 cents, coin or stamps, for liberal sample can. Solar Products Company, 122 West Lake Street, Chicago.

MAN in each town to plate auto parts, reflectors, bathroom fixtures, refinish beds, mirrors, chandeliers; by new method. No capital or experience required. Simple plan of manufacturing at home starts you in big money-making business. Outfit furnished. Free particulars and proofs. Gun Metal Co., Ave. H, Decatur, Ill.

A SERVICE agency for magazine and newspaper classified advertisers. Complete advertising service free of charge. We edit and place your copy. Send for our free lists and explanation. Sweet & Phelps Advertising Agency, 214 E. Ohio St., Chicago.

MAKE \$25 to \$50 Week, representing Clow's Famous Philadelphia Hosiery, direct from mill—for men, women, children. Every pair guaranteed. Prices that win. Free book "How to Start" tells the story. George Clow Company, Desk 31, Philadelphia, Pa.

AGENTS Everywhere! Women's and children's guaranteed shoes direct to wearer. We deliver. A. P. Condon, Sales Manager, The Allen Shoe Co., 110 Summer St., Boston, Mass.

EARN big money fast applying gold initials to autos. Every owner buys—\$1.35 profit on \$1.50 sale—particulars and samples free. Write quick. Lithogram Co., Dept. 17, East Orange, N. J.

EASY, pleasant work for Mechanics, Shop Men, Clerks, during spare hours; will add many dollars to their salaries. Also want persons who can give full time. Big wages assured. Novelty Cutlery Co., 67 Bar St., Canton, Ohio.

SELL Necessities. Everybody needs and buys the "Business Guide." Bryant cleared \$300.00 in July, Send for sample. It's free. Nichols Co., Box 4-B, Naperville, Ill.

AGENTS get Kiosquik the newly invented door spring. Whirlwind seller. Retails for 50c. You make 100% or more. Sell 50 to 80 a day easy. Write for 43c sample and easy starting offer. Kiosquik Mfg. Co., Dept. A, 17 West 42nd St., New York.

HIGH-GRADE SALESMEN WANTED

SALESMEN—You can easily make \$40 to \$80 weekly taking orders for best fitting, rich looking, all wool, made to order men's suits and overcoats (guaranteed) \$18.50 and \$28.50; each garment "Larver" Moth Proofed; same goods sell in retail stores at \$35-\$50; we deliver, collect and furnish advertising. Tailoring experience unnecessary. Spring outfit shipped for free examination. Give experience and two business references for full particulars. Wholesale Direct Tailors, Dept. 102, Buffalo, N. Y.

FREE suit for tailoring salesmen who will advertise and wear it in connection with sale of our suits. Write for particulars. The American Tailor, Dept A431, Harrison and Throop Sts., Chicago.

WANTED—Tailoring Salesmen, make \$60 to \$125 per week. Biggest merchants in many towns have started with our line. We are the largest made-to-measure tailoring house in the country, furnishing elaborate sample equipments, including 500 all-wool fabrics. You make your own profits from \$8.00 to \$15.00 on each order. Guaranteed absolute satisfaction, perfect fit, best workmanship, or no sale. Write for line and all accessories to be sent free. Tell us all about yourself. Address N. O. Perry, Sales Manager, Box 483, Chicago, Ill.

SALESMEN—Crew Managers. You will have the devil's own time trying to find a better seller than "Zippo." If there was such a thing we'd have it. Splendid profit on 50c "Go Getter" repeat article that sells on ten second demonstration. Works While You Watch It. Demonstrates value while others waste time making claims. New Discovery! Greatest scientific triumph of the age. It's the berries. Haven't room to tell our story here. Write immediately. Karam-Smith Co., 6693 Bozart St., Port Wayne, Ind.

SALESMEN given protected territory to sell Doublewear Shoes direct from factory to wearer. Our new measure board insures perfect fitting. Write for particulars and list of open counties. Doublewear Shoe Co., Manufacturers, Minneapolis, Minn.

TAILORING Salesmen: Share \$100,000.00 bonus and big advance commissions taking orders for snapped direct-to-wearer line on earth; virgin wool custom tailored suits \$28.00. Representatives are furnished a high-grade tailoring shop in one elaborate case. House of Campbell, State and Congress St., Chicago.

TAILORING Salesmen. Handle fastest selling line of clothes at \$25, \$30 and \$35, with big commissions. Write for particulars. Lisner Tailoring Co., Cincinnati, Ohio.

\$700 MONTH for Salesmen—Am rounding out 1924 sales force. Proposition is right. No competition. Virgin territory to assign. My men averaged \$5,000.00 to \$8,000.00 for past year. Buffalo representative averaged \$700.00 month. I offer unusual opportunity to salesmen who qualify. Write at once. Address C. R. Coppock, Salesmanager, National Advertising Service, Inc., P. O. Box 62, LaGrange, Ind.

LIGHTNING Strange Battery Compound. Charges discharged batteries instantly. Eliminates old method entirely. Gallon free to agents. Lightning Co., St. Paul, Minn.

\$50.00 WEEK easy selling Boys' clothes. Low price, \$11.95. Undersells retail stores by 50%. Big profits in advance—we deliver and collect. Outfit free—write for full information. Wright & Co., Dept. A-621, Congress and Harrison Sts., Chicago.

SALESMEN: Extra money in your spare time. Window signs complete with 200 changeable letters; 12 window placards. Retails \$3. Every store a prospect. Sample prepaid \$2. Alfred Woolfs, 79 Wall Street, New York.

SIDELINE—make \$25 to \$50 weekly spare time, appointing news dealers to handle our three big, established publications. Means new customers for dealer, easy profits for you. Write Dealer Dept. W. D. Boyce Co., 502 N. Dearborn St., Chicago.

SALESMEN—Carry as sideline new quick selling drug and department store specialty. Have increased income. Roussel Laboratories, 763 Hippodrome Annex, Cleveland, Ohio.

WANTED—Salesmen for Boiler Compounds, Belt Treatments (Dressing), also 200 different kinds of Paints, manufactured by us, the largest company of its kind; sold directly to Industrial Plants and Institutions. If your application is approved, I will call on you personally anywhere in United States and start you off right. Hoelzer, 32 Union Square, New York.

WANTED—Salesmen or Agencies to distribute Escaline. Fuller Company, 86 St. Lawrence Street, Portland, Maine.

SALESMEN: Earn big money selling Pictorial News Service for window display all or part time. Dispatch Service, 297 West 25th Street, New York.

QUICK money-makers (main, sideline). Every merchant needs our "Peerless" Income Tax Record; also "Zim's Peerless Collector." Creditors' Association, E-312, McKnight Bldg., Minneapolis, Minn.

NOTHING to sell. Our self explanatory order-blanks sells the prospect. Ukollect System, New Orleans, La.

EIGHT Quick-Selling Auto Accessories! Windshield Cleaners, Side-wings, Grease Retainers, etc. Low prices, Big profits. No investment. Salesmen write quick to Jubilee Company, 43 Sta. C, Omaha, Neb.

SPLENDID proposition—sell gummed tape. Rapidly replacing twine. \$50.00 to \$150.00 weekly—full or part time. Sager Company, Manufacturers, Dept. 8 103, 1637 Roosevelt Road, Chicago.

SALESMEN: High Powered men for a high grade proposition. Sell long distance radio sets to all dealers. Men can make \$5,000 to \$8,000 yearly. New, unique selling plan. Big repeat business. Standard Radio Co., Dept. 12, Cedar Rapids, Iowa.

SALESMAN: If you think in terms of \$6,000 this year write me. Strong retail store line. Advertised nationally. Established company. Liberal weekly advance to producer. The Continental Co., 1920 Euclid Ave., Cleveland, Ohio, Dept. 200.

SALESMEN—Get into the tailoring game—one of the most profitable of all lines in the selling field. Experience isn't necessary. We show you how to take measures, teach you how to sell our line and supply you with everything necessary to go out and make from \$10.00 to \$20.00 a day from the very first day. Our selling outfit is the finest of its kind ever gotten together and shows more than 100 large cloth samples of finest woolsens. You do no delivering. You just write your orders. We do the rest. Your profits run high and you get into this most profitable of all lines, write us quick. Address Dept. 804, Goodwear Chicago, Inc., 344 W. Adams St., Chicago.

SALESMEN! Opportunity Knocks! Do you believe that you are in a class with the best one hundred salesmen who will read this? Combine your selling ability with Motion Picture Publicity. This is a permanent business field for you as your own boss with full commissions on renewals. We are operating on a large scale in nearly every state, at present making an intensive campaign in all territory East of the Mississippi River. Your income will be according to your effective efforts. Sales and advertising course and vigorous sales help! \$1,000.00 per month may be earned by men who follow instructions. Drop a postal card in the box today! Alexander Film Company, 3389 South Broadway, Denver, Colo.

SALESMEN—Crew Managers—Agents: Get our Assortment High Grade Toilet Articles. Guaranteed product. Big ten worth \$5.40 prepaid for \$1.60. Big Six worth \$2.85 prepaid for 85c. Midwest Drug Co., 185 E. Naghten St., Columbus, Ohio.

EVERYONE Buys Every Day some part of our line. You can take orders for complete line of groceries, paints, roofing, motor oils, tires and radio sets, from institutions, boarding houses and private families. We deliver and collect. Our goods are nationally known and guaranteed quality; just show samples and secure large orders. No capital or selling experience necessary. Heavy orders make a steady profitable business. Address Hitchcock-Hill Company, Dept. 235, Chicago. Reference: any bank or express company.

MAKE \$120 Weekly in Spare Time. Sell what the public wants—long distance radio receiving sets. Two sales weekly pays \$120 profit. No big investment, no canvassing. Sharpe of Colorado made \$955 in one month. Representatives wanted at once. This plan is sweeping the country—write today before your county is gone. Ozarka, 802 Washington Blvd., Chicago.

DISTRIBUTORS, Salesmen, Agents wanted everywhere to handle the Money Rim Tool; quick, easy sales; big profits; chance to earn \$300-\$500 monthly; trade and consumer buy on sight; monopoly rights to those who mean business. Get opportunity folder today. Money Rim Tool Co., Blissfield, Mich.

AEKO—Salesmen to sell Auto acc. as side line; can carry sample in vest pocket; sells on sight. Big comm. Write for sample. Allen Specialty Co., 2751 West Lake Street, Chicago.

WHY Work for others? Start and operate your own business. Our system proprietary specialty business offers wonderful opportunities to make \$100 to \$500 weekly. Openings everywhere. We furnish everything and show you how. Booklet free. National Scientific Laboratories, 208 Monroe, Richmond, Va.

WORLD'S Fastest Selling Auto Accessory! County distributors wanted; write today. G. L. W. Spring Oiler Co., San Diego, Calif.

BEST Seller: Jem Rubber Repair for tires and tubes; supersedes vulcanization at saving of over 80%; put it on cold, vulcanizes itself in two minutes, guaranteed to last life of tire or tube; sells to every auto owner and accessory dealer. Get particulars how to make big money and free sample. Amazon Rubber Co., Philadelphia, Pa., Dept. 510.

SALESMEN Wanted. Amazing Invention—almost human. The Little Draftman—a wonderful labor saver, automatically opens furnace or boiler while owner sleeps. Pays for itself in fuel saved. Simple, efficient, can be installed by anyone in five minutes. 100% profit. Thousands being sold. \$25 daily easily made. Act quick. Address: Little Draft-Man Co., Dept. A, Grand Rapids, Mich.

FOUR \$7.50 sales to merchants net you \$20.00 daily. Sayers Systems, 2803 Sheffield Ave., Chicago, Ill.

\$1.00 PROFIT on Every \$5.00 sale. "Free Sample"—New Specialty. (Money Getter.) Every Storekeeper, Doctor, buys quickly. Experience unnecessary. Territories open. Box 596, Hartford, Conn.

TRAVELING Salesmen calling on retail stores wanted by large manufacturer to sell unique line of business-boosting articles. Year round, fast selling, main or side line. If not earning \$150 weekly, address Khaser Works, 222 Charles St., Boonville, N. Y.

\$60-\$200 A WEEK. Genuine Gold Letters for store windows. Easily applied. Free samples. Liberal offer to general agents. Metallic Letter Co., 438-B North Clark, Chicago.

CALIFORNIA Rosebuds selling like hot cakes. Agents coming money. Absolutely new. Big profits. Catalog free. Mission Factory SP, 519 No. Halsted, Chicago, Ill.

SALESMEN Can make \$5.00 a day selling our Calendars, Pencils, Signs, Advertising Novelties, Yardsticks, Whistles, etc. Liberal terms. Sells entire year. Fine side line. Local and traveling agents. Model Calendar Co., Dept. 226, South Bend, Ind.

1,000 DOLLARS monthly proposition. Particulars free. A. Yonover, 1637 Roosevelt Road, Chicago.

TAILORING Salesmen—Fastest selling line, suits, overcoats, made to measure—\$32.50—one price, all wool. Profits in advance. Biggest old reliable house. W. D. Smith & Co., Dept. 66, established 1895, Chicago.

SALESMEN—Sideline pays five to ten dollars a day taking orders for Specialty printed gummed advertising and Match Box Stickers. Write for proposition, samples, etc., today. Beardley's Printery, Rock Island, Ill.

HELP WANTED

\$5 To \$15 daily easy. Introducing New Style Guaranteed Hosiery. Must wear or replaced free. No capital or experience required. Just show samples, write orders. We deliver and collect. Your Pay in Advance. Outfit furnished—all colors, grades, including silks. Mac-O-Chee Hosiery Company, Room 2903, Cincinnati, Ohio.

U. S. GOVERNMENT Positions. \$100 to \$250 month. Quick increase. Become Railway Mail Clerks—City Mail Carriers—Postoffice Clerks. Income Tax Auditors. Steady work. No strikes—no layoffs. Pleasant—interesting. Short hours. Paid vacation. Influence unnecessary. Schedule examination places—free. Men—Women, 18 up. Write Franklin Institute, Dept. G-3, Rochester, N. Y.

CLERKS for Government Postal and other good positions \$1400-\$2300 yearly. Experience unnecessary. Full particulars free by writing G. W. Robbins, Civil Service Expert, 411 Burchell Bldg., Washington, D. C.

SALESMEN, we pay larger commissions than any other Brush House in the Country to men selling our line of Sanitary Twisted-Wire Brushes, Sanitary Wire Grip Brush Co., 15 Mercer St., New York.

FIREMEN, Brakemen, Baggage-men. Sleeping car, train porters (colored). \$140-\$200. Experience unnecessary. 819 Railway Bureau, East St. Louis, Ill.

TRAVEL. Railway Mail Clerks wanted. \$133-\$192 month. Schedule examination places—free. Write, Franklin Institute, Dept. G-20, Rochester, N. Y.

MEN to introduce the Finest Combination Kitchen Cutlery set—Housewife's Friend. Sells on sight. Every house and office a prospect. Wonderful seller—new plan. \$1.25 premium with each set. Can sell separate pieces also. Samples free. Mac-O-Chee Cutlery Company, Stand 1103, Cincinnati, Ohio.

RAILWAY Postal Clerks—Start \$133 month. Railroad pass; expenses paid; questions free. Columbus Institute, E-2, Columbus, Ohio.

GREATEST Radio offer ever made. See pages 152 and 153.

MEN Wanted to learn Motion Picture Operating. Short course at actual work, small tuition. Write, H. Vogt, 216 Western Surety Bldg., Sioux Falls, S. D.

MEN wanting Forest Ranger, Railway Mail Clerk and other govt. positions, write for particulars. Mokane, B12, Denver, Colo.

START Business for Yourself. \$35 to \$100 weekly taking orders for Fashion Maid line quality guaranteed Silk Hosiery. Full or part time. Exclusive territory. No capital or experience required. Capable representatives given District Managerships. Folding case furnished displays goods attractively. Fashion Maid Company, 12 E. McMillan Street, Cincinnati, Ohio.

RAILWAY Mail Clerks, \$133 month. Men 18 up. Particulars free. Franklin Institute, Dept. G-20, Rochester, N. Y.

GOVERNMENT positions pay \$1,400 to \$3,600 yearly. Many openings. Annual vacations and sick leave with full pay. Common education sufficient. Write today for our free booklet telling how to obtain one of these desirable lifetime jobs. Chicago Civil Service College, A-41 Kesner, Chicago.

SALESMEN—Agents. Men. Women. hustlers. Town, country. Hand woven Felt Rugs. Needed homes, offices, bungalows. 100% profit. Territory to producers. Samples—two sizes \$4.50 C. O. D. National Felt Rug Company, 9 Fair Street, Paterson, N. J.

WHY work for others? Start and operate your own business. Our system proprietary specialty business offers wonderful opportunities to make \$100 to \$500 weekly. Openings everywhere. We furnish everything and show you how. Booklet free. National Scientific Laboratories, 208 Monroe, Richmond, Va.

SALESMEN—Become Independent. Own your business; experience unnecessary; selling our \$7,500 Accidental Death, \$50 Accident, \$25 Sick Weekly Benefits; \$12.50 yearly; other amounts proportionate. Guaranteed steady income from renewals. \$250,000 deposited Insurance Department. Registration Dept. A, Newark, N. J.

WANTED—Men 18 up. Commence \$133 month. Steady. Railway Mail Clerks. Travel—See country. Schedule examination places—free. Write immediately. Franklin Institute, Dept. G-20, Rochester, N. Y.

MONEY! Silvering Autolights, Radiators, Mirrors, tableware, stoves. Outfits. Methods free. Clarence Sprinkle, Dept. 28, Marion, Ind.

EARN \$10 daily silvering mirrors, plating and refinishing metalware, autos, chandeliers, bedsteads, headlights. Outfits furnished. E. DeCle Laboratories, 1182 Broadway New York.

MEN—Age 18-40, wanting Railway Station-Office positions, \$115-\$250 month, free transportation, experience unnecessary. Write Baker, Supt., 74 Wainwright, St. Louis.

ALL men, women, boys, girls, 17 to 65, willing to accept Government Positions, \$117-\$250 traveling or stationary. Write Mr. Ozment, 101 St. Louis, Mo., immediately.

WANTED: Railway Mail Clerks—\$1,000 to \$2,300. Exams everywhere. Write today for full information. Patterson, Civil Service Expert, Box 4025, Rochester, N. Y.

WRITE articles, stories, news, in spare time for newspapers and magazines. Big pay. Copyrighted book free Press Syndicate, 555, St. Louis, Mo.

MAKE money writing Photo-plays; details free to beginners. No correspondence course. Producers' League, 230 Wainwright, St. Louis.

WANTED—Boys—Men. Learn Auto Repairing. \$30 week. Sample lessons free. Franklin Institute, Dept. G-401, Rochester, N. Y.

GET posted—Good prices paid for butterflies, insects. See Sinclair display advertisement, page 24.

BE a Finger Print Expert. Write, American Finger Print System, 1966 Broadway, New York.

INVENTORS desiring to secure patents should write for our book "How to Get Your Patent," tells our terms and methods. Send sketch for our opinion of its patentable nature. Randolph & Co., Patent Attorneys, 626 F. Washington, D. C.

OUR genuine gold window sign letters are an excellent money-making proposition for handy men. Slann Sign System, Bethune Ave. E., Detroit, Mich.

SILVERING Mirrors, French plate. Easily learned; immense profits. Plans free. Address, Wear Mirror Works, Excelsior Springs, Mo.

WANTED—Men 18 up. Commence \$133 month. Steady. Railway Mail Clerks. Travel—See country. Schedule examination places—free. Write immediately. Franklin Institute, Dept. G-20, Rochester, N. Y.

STORIES, poems, plays, etc., are wanted for publication. Good ideas bring big money. Submit manuscripts or write Literary Bureau, 522, Hannibal, Mo.

\$60-\$200 A WEEK. Genuine Gold Letters for store windows. Easily applied. Free samples. Liberal offer to general agents. Metallic Letter Co., 438-C, North Clark, Chicago.

FINGER Print Experts—Excellent paying positions; particulars free. Finger Print Headquarters, 183 East 79th, New York.

INFORMATION

COMPLETE, accurate, information on any subject \$1. National Information Bureau, 1429X Milton St., S. E. Grand Rapids, Mich.

LEGAL questions answered, unbiased opinions rendered, cases cited, guaranteed correct for \$1.00. Edgar Keller, Augusta, Mont.

RELIABLE, accurate, information on any subject. Clippings, \$1.50. I. B. I., Box 411, LaCrosse, Wis.

BUSINESS SERVICE

DELAWARE Incorporator. Charters; Fees Small; forms. Chas. G. Guyer, 901 Orange St., Wilmington, Del.

TYPEWRITERS AND SUPPLIES

TYPEWRITERS All Makes. Save one-half. Thoroughly rebuilt in our factory by the famous "Young Process." Fully guaranteed. Free trial. We handle all standard makes. Cash or sold on easy terms. Write for Catalog. Young Typewriter Co., Dept. 5623, Chicago, Ill.

UNDERWOOD Typewriters at far less than manufacturers' price; rebuilt, all worn parts replaced, guaranteed good as new. Cash, installment payments. Write for Catalog 1513, Shipman-Ward Mfg. Co., estab. 1892, Montrose and Ravenswood Ave., Chicago, Ill.

ALL Makes, rebuilt, refinished and guaranteed ten years, shipped privilege 30 days' trial. Oliver's, Remingtons, Underwoods, others, \$15.00 up. Get our prices and agents' proposition. Typewriter Exchange, 2316 University Ave., New York City.

TYPEWRITERS, all standard makes, \$10 up. Fully guaranteed. Free trial. Write for complete illustrated lists. Northwestern Typewriter Exchange, 320 West Goethe Street, Chicago.

TYPEWRITING

EXPERT Typing: 50c per 1,000. Perkins, 711 Brady, Davenport, Iowa.

ALL kinds of typewriting done. B. Hunt, 294 South Street, Jamaica Plain, Mass.

ADDING MACHINES

NEW \$3.50 Automatic Adding Machine. Makes adding easy for anyone. Guaranteed accurate as highest priced machines. 75,000 pleased owners already. Capacity 9999,999.99. Postpaid \$3.50. Bassett Co., 1458-C Hollywood Avenue, Chicago.

FREE Trial. Marvelous new Adding Machine. Adds, Subtracts, Multiplies, Divides, automatically. Work equals \$350.00 machine. Price only \$15.00. Speedy, durable, handsome. Five-year guarantee. Used by largest corporations. Write today for catalog and free trial offer. Lightning Calculator Co., Dept. E, Grand Rapids, Mich.

DUPLICATORS AND DEVICES

STENCIL Duplicators—Note \$3.00. Letter \$4.00. Hand Use. Typewriting—Handwriting. On Approval. Primes Specialty Co., 3-31, Primes, Pa.

YOU can make 50 to 100 copies of a letter, notice, etc., at a cost of three cents on a Heyer Quality Duplicator. Write for free trial offer. The Heyer Duplicator Co., 14 S. Wells St., Chicago, Ill.

"MODERN" Duplicators save Time, Labor, and Money. Gets business. Reproduces Typewritten or Penned Letters, Drawings, Lessons, Music, Menus, Bids, Notices, Specifications, Maps or anything in one or more colors. Prints Two per minute. Special Sale On 30 Days' Free Trial. \$2.25 up. Booklet Free. J. E. Durkin-Reeves Co., Pittsburgh, Pa.

RUBBER STAMPS

RUBBER Stamps. Unique Gummed Labels. Popular prices. Postal brings list. McPherson Print, Middletown, Conn.

PRINTING, ENGRAVING AND MULTIGRAPHING

GUMMED Labels! Interesting Samples Free! Edward Harrison, "Attractive Printing," Baltimore.

250 BOND Letterheads or Envelopes \$1.50. Geyer Printery, Box 886A, Dayton, Ohio.

1,000 CIRCULARS, Book paper, two-color 6x3, \$5.00. 9x12, \$8.00. One color 6x9 \$4.00, 9x12, \$7.00 "See," 5509 Forest, Kansas City, Mo.

1,000 HAMMERMILL Letterheads or Envelopes, \$4.00. Full Line Samples Free. Quality Printshop, Marietta, Ohio.

5,000 5 1/2 x 8 1/2 CIRCULARS, \$9.50; 5,000 envelope slips, \$4.50; 5,000 post cards, \$9.00, postpaid. Good's Printery, Harrisonburg, Va.

MONOGRAMMED Stationery. 200 sheets bond paper, 100 envelopes, \$1.00. Samples. Service Printery, B-167, Norfolk, Va.

1,000 HAMMERMILL letterheads, envelopes, \$3.25; 250, \$1.25 postpaid. Samples Free. Trob Press, 98 Providence, Worcester, Mass.

AUTOMATIC Cardpresses—prints 100 cards minute. Information free. Habben, 3127 Locust, St. Louis.

ENVELOPES or Shipping Tags at sensible prices. Richard Elliott, 305 South Third, St. Louis.

200 PRINTED 8 1/2 x 11 Hammermill Letterheads, Envelopes, Billheads or Business Cards \$1.00. Postpaid. Race Printery, Hudson, N. Y.

500 PRINTED Hammermill bond letterheads \$2.75; 1,000 \$4.50. Cards, envelopes, tags, statements same price. 200 6x7 Hammermill bond and 100 envelopes \$1.00. Finest work, postpaid. Spillane, Red Lake Falls, Minn.

PERSONAL Stationery. 200 sheets 6x7, 100 envelopes, name and address printed, \$1.00 postpaid. Good's Printery, Harrisonburg, Va.

100 BOND letterheads or envelopes, 50c. 500 \$2. O-B Co., Fargo, N. D.

1,000 "NEARGRAVURE"—printed Letterheads \$3.50 Postpaid. Samples. Soliday's, Knox, Ind.

250 WHITE 24-lb. envelopes \$1.10. Beck Print, 5406 Alaska, St. Louis.

GILT lettered Advertising-Pencils for you. Buy direct; save entire middleman's profit. Samples free (no agents). Address S. Musial & Co., 10-12 Lincoln St., Yonkers, N. Y.

500 TWO-COLOR Letterheads \$2.75. Sample free. "Superior", 1825 Roosevelt, Indianapolis.

500 GUMMED Labels. Name and Address. 50c. Eastern Label Co., Clintonville, Conn.

QUALITY Printing! Reasonable Prices! Tell us your wants and let us quote our Money-Saving prices. Best Work. We print anything. Ernest Pantus, 525 South Dearborn Street, Chicago.

PRINTING Outfits—Presses, type supplies, type novelties. Send stamp for catalogue. Model Press, York, Penna.

JOB Printing. All Kinds—Cards to Catalogues. Quality work. Smith-Roberts Printing Co., Watseka, Ill.

PRE-USED Printing Presses. Type and supplies. List for stamp. Popular Bargains, Richmond, Pa.

WE print everything. Stationery, Booklets, Catalogs, Circulars, Samples. Commercial Press, Batavia, Ohio.

250 LETTERHEADS, 250 white envelopes, printed and mailed, \$3.00. Samples printing free. Sunco, Mohawk, N. Y.

1,000 LETTERHEADS or Envelopes, \$3.00. Sent Prepaid. Samples Free. Monitor Press, Morrisville, Pa.

EMBOSSSED Stationery, business or personal. Samples for stamps. Daniels Co., Pittston, Pa.

225 BOND letterheads, envelopes, billheads, cards, \$1.25 each. Combination, \$1.00. Economic Press, Leonia, N. J.

FOR MEN

ARE you old at forty? See our advertisement on page 148 of this issue. The Electro Thermal Company, 2131 Main St., Steubenville, Ohio.

FOR SMOKERS

HABANA Cigars direct from factory at unheard of prices. 100 Har-a-Tobies (banded), \$4.45 delivered. An excellent smoke. Satisfaction guaranteed or mun-e-bak. Lambert Brothers, St. Petersburg, Fla.

BOATS AND LAUNCHES

16' ROWBOAT—easily made. Construction blueprint 30c. Wee-Sho-U Co., West Market, Detroit.

"HOW to make your boat leakproof." Send for booklet. L. W. Ferdinand & Co., 152 Kneeland St., Boston, Mass.

RAZORS AND BLADES

SAFETY Blades resharpened, 2c single, 3c double; guaranteed service. Test Edge Co., 1525 Plum St., Steubenville, Ohio.

BLADES resharpened, 3c any make; guaranteed service. Standard Safety Razor Corp., Pittsburgh.

BLADES, resharpened, one edge 3c; double 3c. New York Edge Co., Glen Cove, N. Y.

FURS

HAVE your raw furs made into beautiful garments. Enormous savings. Catalog free. Arthur Feller Fur Co., 25 N. Dearborn St., Dept. F. M. 4, Chicago, Ill.

DIAMONDS, WATCHES AND JEWELRY

21 JEWEL Watch \$4.99! All makes about half regular price. Agents wanted. List free. Rex Co., Andover, Ohio.

WATCHMAKERS: Earn highest wages. Understand adjusting thoroughly. Circular free. Write Walter Kleinlein, Publisher, Waltham, Mass.

PEARLS—South Sea Island—50c. McKenzie, Box 9, Long Beach, Cal.

OPTICAL GOODS

FOR Quick Sale! One Carl Zeiss Prism Telescope 12, 24 and 42 Power, Complete with Heavy Leather Carrying Case and Especially Adapted Panoramic Tripod, \$137.50. One Bausch and Lomb Student Microscope Complete, \$27.50. Send for Photograph. De-Franco, Importers, 109 N. Dearborn St., Chicago, Ill.

FOR THE HOME

GRANDFATHER Clock Works, \$5.00. Build your own case; Instructions free; make good profits selling your friends. Clock works with chimes for old or new cases. Write for full particulars. Clock Co., Ruffner St., Philadelphia.

LOOMS—Only \$9.90—Big money in weaving rugs, carpets, portieres, etc., at home, from rags and waste material. Weavers are rushed with orders. Send for free loom book, it tells all about the weaving business and our wonderful \$9.90 and other looms. Union Loom Works, 480 Factory St., Moonville, N. Y.

ANTIQUES, WAR RELICS AND INDIAN GOODS

RELICS from Europe's Battlefields, Firearms, helmets, medals, etc. Illustrated catalogue with sample War Photographs, 25c. Lieut. Welsh, 2117 Regent Pl., Brooklyn, N. Y.

INDIAN Relics—24 page Clearing Catalog for stamp. Grutzmacher, Mukwonago, Wis.

HUNTING Bows, relics, minerals, geology, stamps, butterflies. Thousand Indian articles. Catalogue 10c. Indiacraft—P—Co., 406 Connecticut, Buffalo, N. Y.

PHONOGRAPHS AND RECORDS

HEAR Ye! Hear Ye! Science scores again; men, women, boys and girls—everybody,—regard this if you want a real, genuine thrill, the mystery of the phonograph is solved, simplified so that you may now hear your own voice ripple forth in beautiful volume, on any make or style phonograph, right in your own home. Also perfect reproductions of the saxophone, mouth organ, piano, and all other string and wind instruments. If you are away from home, send a message back in your actual voice. Just think of it, this thoroughly complete introductory offer consisting of one supersensitive double disc record, cutting needle and sounding horn, sent prepaid, all for one dollar; hustling, live wire representatives wanted everywhere. Order right now; be convinced; then repeat the order. Voice-o-graph, Dept. T. 79-B, Washington, D. C.

BUILD your own Phonograph. We furnish everything. Write for catalog and free Blueprint offer. American Phonograph Co., 3515 North Crawford, Chicago.

BUILD Your Phonograph. Quality phonographs. Quality Serenado motor and motors of other types. Electric Motors, tonearms, reproducers, amplifiers, case materials, accessories. Free blueprints and building instructions. Big saving. Wonderful results. Prompt delivery. Catalog mailed for ten cents. Hoosier Manufacturing & Supply Co., 313 Baldwin Block, Indianapolis, Ind.

BUILD your own phonographs. We can supply you with motors, tone arms and all accessories at wholesale prices. Write for catalogue AX. Pleasing Sound Phonograph Co., 204 East 113th St., New York, N. Y.

SUPERIOR equipment at lowest price for building fine phonographs. Superior Phonographs Co., Erie, Pa.

MUSIC AND MUSICAL INSTRUMENTS

I PAY Cash for Saxophones, band and orchestra instruments. Ship for estimate or state your price. I prepay return charges if my offer not acceptable. River Forest, Ill., State Bank my references. Chicago Band Instrument Exchange, 3533 S. Dearborn St., Chicago.

GREAT song hit entitled "Midnight Rose." Fox Trot. Copy by mail—30c. Phonograph record—75c. Player-Piano Roll—\$1.25. Levi Bryant, 4508 Champlain Ave., Chicago, Ill.

COMPLETE, easy self-instructors—Saxophone, Violin, Piano, Drums, Accordion, Mouth-organ, 25c each. G. Elisea, Bowling Green, Ohio.

CORNETISTS—Trumpeters—Saxophonists—Clarinetists. Send for "Free Pointers." Name instrument. Virtuoso School, Concord, Mass.

WRITE Songs. Big money and reputation. Write for information. J. Gordon Pub. Co., 291 N. Home Ave., Chicago.

"MUSIC Composed" to words. Bauer Bros., (formerly of Sousa's Band), Oshkosh, Wis.

I WANT Song Poems. Casper Nathan, 1252 Bryn Mawr, Chicago.

VIOLINS, Deep, Mellow, Soulful—on credit. Easy terms for wonderful instrument. Get details today. Gustav F. Henning, 2424 Gaylord St., Denver, Colo.

PATENT ATTORNEYS

PATENTS Procured; Trade Marks Registered—A comprehensive, experienced, prompt service for the protection and development of your ideas. Preliminary advice gladly furnished without charge. Booklet of information and form for disclosing idea free on request. Richard B. Owen, 30 Owen Bldg., Washington, D. C., or 2276-R Woolworth Bldg., New York.

H. F. LOWENSTEIN, Registered Patent Attorney, Technical expert. McLachlen Building, Washington, D. C.

MILLIONS spent annually for ideas! Hundreds now wasted! Patent yours and profit! Write today for free book—tell how to protect yourself, how to invent, ideas wanted, how we help you sell, etc. American Industries, Inc., 500 Kresge Bldg., Washington, D. C.

PATENTS, Trade-Marks, Copyrights and Patent Litigation. Write for advice and instructions how to proceed, costs, etc. Hand Book with illustrations of 100 Mechanical Movements sent free on request. Albert E. Dieterich, Patent Lawyer and Solicitor, 621-B Ouray Bldg., Washington, D. C.

EDWARD C. SASNETT, 516 McGill Building, Washington, D. C., formerly a Principal Examiner in the United States Patent Office.

THE PATENTOME is free. A liberal education in patents. Anderson & Son, attorneys, estab. 1865. 635 F St., N. W., Washington, D. C.

PATENTS. Let me assist you in obtaining your valid Patent rights. Personal service. Promptness assured. George Van Den Berg, Barrister Bldg., Washington, D. C.

PATENTS. My own attention to all business. Twenty years' experience. Charges reasonable. Booklet on request. C. E. Trahnor, 808 H Northwest, Washington, D. C.

INVENTORS—Send for form "Evidence of Conception" to be signed and witnessed. Form, fee schedule, information free. Lancaster and Allwine, 221 Ouray Bldg., Washington, D. C.

PATENTS and Trade-Marks obtained. Prompt service. Write for our new book on patents. Established in 1889. D. Swift & Co., 369 7th St., Washington, D. C.

INVENTORS: Record invention legally before disclosing to others. Our Invention-Record and Data Sheet shows how. Sent free and valuable information given on patent procedure, costs, etc. Report on patentability includes copies of patents nearest your idea. O'Connell & O'Connell, Jenifer Bldg., Washington, D. C.

PATENTS Procured. Send sketch or model today for examination, prompt report and advice. No charge for preliminary advice. Write for free Booklet and blank form on which to disclose your idea. Highest references. Promptness assured. Clarence A. O'Brien, Registered Patent Lawyer, 58-C Security Bank Building, Directly across the street from Patent office, Washington, D. C.

TRADEMARKS \$35; Design patents \$35; Copyrights \$5; Booklet Free; 20 years experience. Sanders, Registered Patent Attorney, 7 Rand-McNally Building, Chicago.

MONROE MILLER, Ouray Bldg., Washington, D. C., Patent Attorney; Mechanical, Electrical Expert. Free Blue Book gives candid advice.

BE Cautious—Selling your invention successfully depends upon your taking certain precautions before disclosing or patenting. First get "Bulletin 5A." It's free. American Patents Corporation, Barrister Building, Washington, D. C.

PATENTS. My fees in installments. Advice book free. Frank Fuller, Washington, D. C.

PATENT SENSE—"The book the inventor keeps." Free. See Lacey ad, page 98.

PATENTS—Write for our Guide Books and "Record of Invention Blank" before disclosing inventions. Send model or sketch of your invention for Examination and Instructions. No charge for the above information. See advertisement on page 88. Victor J. Evans & Co., 934 Ninth, Washington, D. C.

"INVENTOR'S Advisor," the valuable Patent book with 139 mechanical movements and illustrations, sent free upon request. M.M. Labiner, Patent Attorney, 3 Parkrow, New York.

INVENTORS! Write for new plan telling how and where to sell commercially acceptable inventions—whether Patented or Unpatented. Results assured. W. L. Greene, Jenifer Bldg., Washington, D. C.

JACOBI & JACOBI, 290 Ouray Bldg., Washington, D. C. Record your Ideas on Record of Invention Form. Sent Free with Book. Highest references. Write today.

PATENTS. Booklet free. Highest references. Best results. Promptness assured. Send model or drawing for preliminary examination. Watson E. Coleman, Patent Lawyer, 644 G Street, Washington, D. C.

INVENTORS—Write for our Guide Book, "How To Get Your Patent" and Evidence of Invention Blank. Send model or sketch of your invention for our prompt opinion of its patentable nature. Randolph & Co. Dept. 430, Washington, D. C.

INVENTORS should write us for our book, "How to Obtain a Patent," which clearly sets forth what may be patented and the necessary steps to protect an invention; it describes the procedure in patent office and tells about assignments, licenses and trade marks, and gives many useful facts about patents which every inventor should know; many persons well versed in patent matters have pronounced the book the best of its kind they have ever read; it is written so you can understand it; copy free upon request. Talbert & Talbert, Patent Lawyers, 481 McGill Bldg., Washington, D. C.

BEFORE patenting, technical experts and inventors expecting to manufacture their inventions should write for information and reference based on service rendered on validity reports and research work. Horace L. Woodward, 704 9th, Washington, D. C.

PERCY S. WEBSTER, Savings and Loan Building, Stockton, California. Long established organization. Send for free book on Patents.

COMMERCIALIZE your ideas according to My Cooperative Plan before patenting. Booklet Free. Ralph Burch, Patent Lawyer, Jenifer Building, Washington, D. C.

INVENTORS: Careful Patent Office searches safeguard against applying for patents on unpatentable inventions; they aid in pre-determining the commercial value of inventions, and the extent of protection which patents will afford. Read the free treatise, "Reducing Inventions to Property Rights." Lester E. Baggett, 629 F Street, Washington, D. C.

INVENTORS: Send sketch or model of invention for opinion concerning patentable nature and exact cost of patent. Book "How to Obtain a Patent," sent free. Tell what every inventor should know. Established twenty-eight years. Highest references. Prompt service. Reasonable charges. Address Chandies & Chandies, 456 Seventh, Washington, D. C.

PATENT, trade-mark, copyright specialist. Free duplex conception form. Personal service exclusively. M. E. Jones, Lawyer, 509 Seventh, Washington, D. C.

INVENTORS—"How to sell ideas before getting patents," and Evidence of Ownership document free on request. Inventor's Economy Guide Company, 3 Fendall Building, Washington, D. C.

PATENTS promptly procured. Personal, careful and efficient service. Highest references. Moderate fees. Send sketch or model for actual search and advice. George P. Kimmel, Master of Patent Law, 54-C Loan and Trust Bldg., Washington, D. C.

HERBERT JENNER, patent attorney and mechanical expert, 696 F Street, Washington, D. C. I report if patent obtainable and exact cost. Send for circular.

"INVENTORS' Guide" free on request; gives valuable information and advice for all who have original ideas or improvements. Frank Ledermann, Registered Attorney and Engineer, 15-P Park Row, New York.

PATENTS, Trade marks, copyrights, Prompt, personal, reliable service. Over 36 years' active practice. Write for terms. Book free. Address E. G. Siggers, N. U. Bldg., 918 F St., Washington, D. C.

FOR INVENTORS

ELECTRICAL and radio inventions of merit manufactured royalty basis or bought outright. We have large manufacturing plant and selling force. Write fully today. Manufacturing Sales Agency, 186 N. LaSalle St., Chicago, Ill.

PATENTS—Send for Booklet. Contains valuable information for inventors. Our charge for search of Patent Office records \$5.00. Prompt service, twenty years' experience. Talbert & Talbert, 500 McGill Building, Washington, D. C.

INVENTORS: We develop your invention to practical use; make necessary drawings, models; expert engineering counsel; before or after Patent; also help market your invention. Investigate. (No attorneys or brokers.) Caston-Guay Engineers, Washington, D. C.

PATENT applications filed \$20; deferred \$15; Inventors' Service, 11 Broadway, New York.

PATENTS Procured; Trade Marks Registered—A comprehensive, experienced, prompt service for the protection and development of your ideas. Preliminary advice gladly furnished without charge. Booklet of information and form for disclosing idea free on request. Richard B. Owen, 30 Owen Bldg., Washington, D. C., or 2276-B Woodworth Bldg., New York.

MONROE MILLER, Ouray Bldg., Washington, D. C., Patent Attorney; Mechanical, Electrical Expert. Before proceeding, read free Blue Book.

PATENTS. If you have an invention which you wish to patent you can write fully and freely to Munn & Co. for advice in regard to the best way of obtaining protection. Please send sketches, or a model of your invention and a description of the device, explaining its operation. All communications are strictly confidential. Our vast practice, extending over a period of seventy-seven years, enables us in many cases to advise in regard to patentability without expense to the client. Our Handbook on Patents is sent free on request. This explains our methods, terms, etc. in regard to Patents, Trade Marks, Foreign Patents, etc. "Scientific American" contains Patent Office Notes, Decisions of interest to inventors and particulars of recently patented inventions. Munn & Co., Solicitors of Patents, 623 Woodworth Bldg., New York; Scientific American Bldg., Washington, D. C.; 861A Tower Bldg., Chicago, Ill.; Hobart Bldg., San Francisco, Calif.

INVENTORS' Educator: 900 Mechanical Movements, 50 Perpetual Motions. How to procure and sell patents. Mechanical Movements greatly assist Inventors, suggest new ideas. Explains how to select an attorney and avoid Patent Sharks. Price \$1.50. Postage Free. Albert E. Dieterich, 621 Ouray Building, Washington, D. C.

PATENTS Procured. Send sketch or model today for examination, prompt report and advice. No charge for preliminary advice. Write for free Booklet and blank form on which to disclose your idea. Highest references. Promptness assured. Clarence A. O'Brien, Registered Patent Lawyer, 58-C Security Bank Building, Directly across the street from Patent office, Washington, D. C.

CASHING in—If you have a practical, useful invention to sell, write us promptly. American Patents Corporation, Barrister Building, Washington, D. C.

PATENT Application on simple invention prepared for \$15. A. M. Benner, Olympia, Wash.

I SELL Patents. Established in 1900. The Service you have looked for, but I doubt if you have ever found. Charles A. Scott, 773 PM Garson Avenue, Rochester, N. Y.

LACEY Patent Sense. See page 98.

INVENTORS—Write for our Guide Books and "Record of Invention Blank" before disclosing inventions. Send model or sketch of your invention for our free opinion of its patentable nature. See advertisement on page 88. Victor J. Evans & Co., 157 Ninth, Washington, D. C.

INVENTORS, Sell your patented or unpatented ideas direct to reliable manufacturers and dealers. Send descriptions and \$5.00 for names and addresses. M. H. Heinke, 308 Richmond Ave., Port Richmond, New York City.

PATENTS sold for cash or royalty; quick action. Blanchet & Co., 347 5th Ave., New York.

INVENTORS—Ideas—sell them—let them earn money for you. Deal direct with the firm that can manufacture and market. Write us for our plan that protects your interests. Factory 162, Thomas Mfg. Co., Dayton, Ohio.

WE Develop your ideas into commercial shape for presentation to purchasers, making working models, drawings, experiments or tests. Courtesy, efficiency, secrecy and ample equipment; 39 years' experience. Ducorron-Rich Engineering Co., 504 Pacific Mutual Bldg., Los Angeles, Calif.

CASH paid for practical ideas or patents for useful automobile accessories. Dept. 106, Hayes-Ionia Service Co., Grand Rapids, Mich.

BE Cautious—Selling your invention successfully depends upon your taking certain precautions before disclosing or patenting. First get "Bulletin 5." It's free. American Patents Corporation, Barrister Building, Washington, D. C.

THE Inventors Institute bulletin explains patent thefts, "Sealed Evidence" protection, and our working plan. Write 511 Star Bldg., Washington, D. C.

HAVE You an Invention! If so, write for our free book, "How to Get Your Patent" tells our terms and methods. Send model or sketch for our opinion of its patentable nature. Randolph & Co., Dept. 144, Washington, D. C.

GET your own patents. Application blanks, complete instructions \$1. Cutting Sons, Campbell, Cal.

UNPATENTED Ideas can be sold. I tell you how and help you make the sale. Particulars free. Write W. T. Greene, Jenifer Bldg., Washington, D. C.

PATENT Application Blanks free to inventors. Patent News-D, Washington, D. C.

MODEL Making and experimental work. Modern shop; expert workmen. Manufacturing. Lamson Electrical & Mfg. Co., 625 W. Jackson, Chicago.

TO sell your Patent. Write me; experienced handling. Immediate action. Address Arthur S. Billings, Suite 491 Dekum Bldg., Portland, Ore.

PATENTS FOR SALE

FOR Sale or Royalty—a Grease-cup attaching means. For further particulars address Albert Migl, Yoakum, Texas.

FOR Sale—Patent on a Wall-papering machine which trims, pastes and places the paper in a single operation. This is a time and labor-saving device which proves very valuable. Will sell outright or royalty. For full particulars, address Stanley Pytlak, McElchen, W. Va., Box 64.

MUST Sell Patent Pending No. 559,081, for Carrying and Protecting Automobile Curtains when not in use. Manufacturing cost less than 50c. A. P. Kyle, Glenmora, La.

MUST sell immediately, broad patent, commercially sound and practical. Canadian patent No. 235,382, containing 16 claims. U. S. patent pending. Triflers need not apply. Ernest A. Lange, Claresholm, Alta., Can.

OFFERS Wanted—Outright or Royalty—"Gravity Seal" Aluminum Milk Bottle Spout. Particulars on request. J. Reizner, Box 92, So. Milwaukee, Wis.

FOR Sale—Clutch Lock Fordson Tractor, No. 1,425,494. Money Maker. No reasonable offer refused. Alfred Merrill, Washington, N. J.

STRIKINGLY novel Baby Carrier; an adornment to mother, a beneficial support to baby. Royalty basis to progressive concern. Address: Blekastad, Southworth, Wash.

PUNCTURE proof inner tube for autos. Fits any size tire. Outright or Royalty. E. L. Hodge, Remson Ave. and Horton Place, Far Rockaway, N. Y.

SPARK-PLUG, floating member absolutely protects against carbon and oil, tested under all conditions. Will defy competition. Outright or Royalty. Walter Schneider, New Butler, Wis.

OUTRIGHT or Royalty: U. S. Patent 1,379,896 on Brushing, Scrubbing and Mopping Machine. Good proposition. K. Dubicki, 925 Jameson St., Flint, Mich.

SALE or Royalty. Patent just allowed. Proven Arch Builder. Light spring steel, shock absorbing. Hand adjustable to any height of arch. Heel and Metatarsal attachments. Corrects all manner of foot displacements. Enormous demand already created. Hundreds of testimonials. A million in this. Dr. Lewis, 1446 Court Place, Denver, Colo.

BABY Bed—collapses into a neat package to be carried on hand, under fliwer seat or checked with baggage. Serviceable in home, hotel, picnic or camp. Neatest thing out for tourists. W. H. McWilliams, 4334 Paseo, Kansas City, Mo.

ASPHALT Pavement Cutter, 1,366,647; 20 men's work; many other uses; costs \$100, sells \$500, repaid in week's use; moved like go-cart; electric motored; extremely simple, light, strong; everybody indorses. Royalty plan. Guillemet, 3529 Mission, San Francisco.

OUTRIGHT or Royalty: Sectional Piston Rings; No Rebering Cylinders. William Lovatt, 312 Lincoln Road, Brooklyn, N. Y.

CENTERING Tool cheaply constructed and efficient in operation. Will sell outright or place on royalty. 727 Ford Bldg., Detroit, Mich.

WIND-DRIVEN electric generator. Means free electricity on farms. Also toothbrush which straddles the teeth, brushing both sides at once. Chas. E. Carroll, Newport, Ark.

THE patent right of a newly invented brass is now on the market. This brass is time, labor and tool saver. Shavings as long as those from hard rolled steel. For further information write Otto Najacht, 1602 N. Wells St., Chicago.

PLIER with ratchet attachment makes it any kind of tool. E. M. Loftus, 438 Laurel Ave., St. Paul, Minn.

FOR Sale, Outright—Fountain Pen Clip. Patented Nov. 4, 1919. U. S. A. No. 1,320,946. E. Tischler, 143 Jericho Turnpike, Floral Park, L. I., N. Y.

NEW Invention for swimmers. Outright or royalty. Wm. M. Haines, 512 S. Santa Fe, Chanute, Kans.

SPINDLE body adjuster for automobiles. No. 1,442,139. Max H. Feist, Tautle, Wash.

NEW invention. Nest of "8" wrenches. Twelve tools in One. Invaluable for mechanics, engineers, chauffeurs. Easily, cheaply manufactured. Outright or royalty. M. A. Smith, Box 53, Cottonwood, Ala.

WANTED—Partner to pay patent fee on valuable invention. Will give one-third interest. Write J. W. N. Jordan, Elida, New Mexico, E. Star Route.

OUTRIGHT or Royalty—A safety pin that is safe. U. S. Patent pending. H. Westberg, 65 Ann St., Guelph, Ontario.

FOR Sale—Street and Station Indicator, for street cars, subways, elevated and railway trains; will sell outright. Driven by electricity. James Joseph Reid, 544 Lincoln Way East, South Bend, Ind.

CLOCK-BANK—Must drop coin to wind clock. Patent pending. Valuable claims allowed. Model in use two years. Very simple design. Tremendous field virtually untouched. Need money to develop best commercial model. Will sell part interest. R. H. McMinn, 5014 Glenwood Ave., Chicago.

SALE or Royalty—Greenhouse cut flower support. Wm. Robinson, Morton Grove, Ill.

FOR Sale or Royalty—Cigarette Rolling Device. Patent allowed July 14, 1923. If interested, address Peter J. Gallagher, 267 Monmouth St., Jersey City, N. J.

PATENTS For Sale: To sell, buy or obtain patents, write Patent News-P, Washington, D. C.

IMPROVED Rail-Joint. Number 1,272,498. Railway Tie. Number 1,266,139. Outright or royalty, or will exchange for other property. Full particulars. M. S. Monday, Deputy Court Clerk, Atoka, Okla.

YOU have a worth-while patent, haven't you. Why don't you tell our two million readers about it? Most of them are specially interested in patents and new inventions. Ask me to tell you how other inventors successfully sold their patents. Geo. F. Baker, Manager, Classified Advertising, Popular Mechanics Magazine, Chicago, Ill.

SURVEYING INSTRUMENTS

NEW and used surveying instruments direct from factory. Satisfaction guaranteed or money refunded. Wissler, 619 Broadway, St. Louis.

MODELS AND MODEL SUPPLIES

MODEL Steam Engines, Boilers, Boats, Model Ship and Naval Fittings, Model Makers' supplies. Send 20c for new, enlarged illustrated catalogue and handbook. Baibe Mfg. Co., Dept. D, 5214 Woodland Ave., Philadelphia, Pa.

MODELS and Tools made to order. Arthur Schmidt, 394 Canal St., New York.

INVENTORS—Write for our Guide Books and "Record of Invention Blank." Send model or sketch of inventions for our free opinion of patentable nature. See advertisement on page 88. Victor J. Evans & Co., 165 Ninth, Washington, D. C.

WE make working models for inventors and do experimental work and carry a complete stock of brass gears and model supplies. Send for catalogue. The Pierce Model Works, Tinley Park, Ill.

SPECIAL machine builders, tool and die makers, inventors' models, production work of all kinds. Let our factory be your factory and save money. Quality Hardware & Machine Co., E. Ravenswood and Thorndale Aves., Chicago, Ill.

MODEL Making and experimental work; Modern Shop, expert workmen. Manufacturing. Lamson Electrical and Mfg. Co., 625 W. Jackson, Chicago.

PATENTS Procured. Send sketch or model today for examination, prompt report and advice. No charge for preliminary advice. Write for free Booklet and blank form on which to disclose your idea. Highest references. Promptness assured. Clarence A. O'Brien, Registered Patent Lawyer, 58-C Security Bank Building, Directly across the street from Patent office, Washington, D. C.

MANUFACTURING

METAL-CRAFT—Eventually Metal-Craft. Competent Engineers, Designers, and Producing Organization await your commands on dies, stamping, die-casting, deep pressing, screw machine and wire products. Plating, Enameling, Burnishing, Wrapping and Packing to your specifications. Very reasonable. Large, completely equipped plant. "Your problem is our challenge to serve." Metal-Craft Manufacturing Company, Box 259-M, Chicago.

LET us manufacture it for you. Can quote low prices and can furnish a product you would be proud of. Ideas worked out and simplified. Models made. Metal parts made to drawings or sample. Simplex Tool Co., Woonsocket, R. I.

BOLTS, nuts, rivets. O. L. Dickey, 48 Trask, Bayonne, N. J.

OUR factory will make your models, manufacture your articles as well as build your tools, dies and fixtures. Standard Die & Specialty Co., 817 W. Washington Blvd., Chicago, Ill.

WIRE goods made to order. Cooley Mfg. Co., 524 N. Western Ave., Chicago.

EXPERIMENTS developed, dies, models and manufacturing machine designing. Estimates and information promptly given. Address Schroer Bros. Machine Works, 512 East 25th Street, Kansas City, Mo.

PATENTED Articles, Models, Brass Work, Machine Construction; Dies Made. Baum's Metal Specialties, Kansas City, Mo.

LONG established manufacturer of auto accessories which are daily sold by practically all wholesale and retail accessory houses will consider manufacturing and distributing new automobile products, capable of equally wide sale through same channels. Patented articles preferred. Address Auto Accessory Manufacturer, 1512 North American Bldg., Chicago, Ill.

SCREWS, nuts, screw machine products, all metals. Autocrew Works, 355 West Broadway, New York City.

IRON, Brass, Aluminum Castings, Models, Patterns, Light Manufacturing. Welch Brothers Co., North Chicago, Ill.

WE can design and manufacture special machinery of every description, automatic or semi-automatic. Jigs, fixtures, punches, dies, and special production tools of all kinds. The John Steptoe Company, Stock Yards Station, Cincinnati, Ohio.

PATTERNS, wood and metal. Models, tools and dies. Brass, bronze, aluminum and iron castings. Screw machine work, production work of all kinds. Write Modern Machine & Pattern Co., Terre Haute, Ind.

MACHINERY, TOOLS AND SUPPLIES

ONE 16"x36" Pratt and Whitney metal planer \$175. One 24"x12" Reed engine lathe \$300. One 15" Hender shaper \$225. One 20" drill press \$65.00. Complete line machinery and supplies. Cincinnati Machinery Supply Co., 218 E. Pearl Street, Cincinnati, O.

LATHES—We must sell our stock of 137 bench lathes. Swing 7 in. Between centers 18 in. Ideal for the experimenter or inventor. Not a toy. Special price \$42.50. Write for details. Mechanical Equipment Co., P. O. Box 725, Chicago, Ill.

SPECIAL labor saving machinery designed and built. Punches and Dies and other special tools furnished for manufacturing work. Simplex Tool Company, Woonsocket, R. I.

CONCRETE Building Block Machines and Molds. Catalogue free. Concrete Machine Co., 303 South Third St., St. Louis, Mo.

MICROMETER (New Type) as accurate as \$50.00 set. Easier to read. Endorsed by all leading mechanical and scientific magazines. Measures 1/8 to 5 inches. Price, \$1.00. Robert L. Schaap, 356 Cumberland Street, Brooklyn, N. Y.

STEPTOE'S medium priced line of Shapers, Milling Machines, Lathes, and Die Slotters will reduce your manufacturing costs. Established since 1843. Catalog upon request. The John Steptoe Company, Stock Yards Station, Cincinnati, Ohio.

ENGINES, MOTORS AND DYNAMOS

STEAM Engines. One H. P. \$18.00; 1/2 \$12.00. Practical Power Units. James Chambliss, Bessemer, Ala.

SMALL Gasoline, Steam Engine, Dynamos, Motors, Storage Batteries, etc., new and secondhand. Bargain Bulletin 133 free. Dynamic Manufacturing Co., First National Bank Bldg., Chicago.

BIJUR Generators, brand new, 6 volts, maximum output 22 amperes at 2000 r. p. m. Government paid \$45.00 each, our price \$10.00. General Sales Company, 1919 S. Michigan Avenue, Chicago, Ill.

MOTORS—G. E. 1/4 hp. \$15.00—1/2 hp. \$22.50—1 hp. \$32.50. Generators 8v, 10 amp. \$15—32 v. 500 watt \$20. Other sizes low prices. Motor Specialties Co., Crafton, Pa.

GOVERNORS to control Auto Engines when used as stationary engines. Circulars. Candes-Smith Governor Co., Springfield, N. Y.

FOR MECHANICS

PATENTS—Write for our Guide Books and "Record of Invention Blank" before disclosing inventions. Send model or sketch of your invention for examination and instructions. No charge for the above information. See advertisement on page 88. Victor J. Evans & Co., 181 Ninth, Washington, D. C.

BLACKSMITHS

SENSATION of the season; the new Hossfeld Wrenchless Universal Bender; bends eye bolts, U's, Angles, etc. Bends 1 1/2 in. standard Pipe cold. Also rolls perfect Automobile Spring Eyes. Machine can be instantly set for any kind or size of work without the use of a wrench. Simple, Powerful, Inexpensive. Send for circular. Universal Iron Bender Co., Inc., Winona, Minn. Representatives Wanted.

BLACKSMITHS, Listen! Make more money doing hard jobs easy with Toy's Modern Methods of Master Machine Blacksmithing. Forging and Solid Welding, Tool Dressing and Tempering to a standard with colored tempering charts. All for One Dollar. Samples Free. W. M. Toy, Sidney, Ohio.

FOR SALE—MISCELLANEOUS

MAMMOTH Pecan samples \$1.40. Music rubber stamps, rubber type. W. Karstaedt, Dayton, Ohio.

KEY Check Stamping Outfit—Alphabet, Figures, Hammer, Gauges, arvil, sets Key Tags; Name Plates in Wooden Case. Cost \$15.00; sell everything for \$3.50. Mrs. Douglas, 483, Sixth Ave., New York.

HEMSTITCHING and Picoting Made Easy. This attachment does very beautiful work on all machines. Made of finest materials; fully guaranteed. Price with full instructions and sample of work, \$2.50. Oriental Novelty Co., Drawer 11, Waco, Texas.

AUTOKNITTER (three cylinder); value \$25.00. Make offer. Blake Whiting, "Author Service," Branford, Conn.

\$100.00 EDISON Chrome Nickel 6 volt 100 ampere hour storage batteries at \$19.50. Any voltage and different amperages carried at corresponding low prices. Government stock and guaranteed perfect. Wonderful batteries at equally wonderful prices. Edison Storage "B" battery plates for radio at 2c per pair. Add 35c per 100 for postage. All parts for making that rechargeable Edison plate at low prices. B. P. Smith, "Pioneer dealer," 31 Washington Ave., Danbury, Conn.

LET'S Swap! Buy! Sell! Whatya got? What'dya want? Four months dime. International Opportunity, Brookings, S. Dak.

100 MILLIONS German Mark Banknotes \$5.00. Rivers Hicks, Kentville, Nova Scotia.

WANTED—MISCELLANEOUS

OLD gold, silver and platinum for cash. Penn Laboratories, 222 Market St., Newark, N. J.

GREATEST Radio offer ever made. See pages 152 and 153.

OLD sparkplugs bought. Send postal for information. General Products, 898 8th Ave., New York City.

CASH for old gold, silver, platinum, watches, diamonds, magnet points, gold crowns, false teeth, and other valuables. Merchandise returned if offer unsatisfactory. Busch Products, Dept. 50, 144 Fifth Ave., New York.

MAIL us your discarded Jewelry, Gold, Crowns and Bridges, Watches, Diamonds, Silver, Platinum, and old False Teeth. Money promptly mailed. Goods returned if offer refused. United States Smelting Works, (The Old Reliable), Dept. 71, Chicago.

CASH Via Wire Within One Hour. Simply Mail Jewelry, Diamonds, Old Gold, Platinum Points, Unused U. S., Canadian, Postage, Thrift, Stamps, Bonds, Silver, Teeth, Job-Lots, Anything Valuable. Valuables Held Returnable Ten Days if Price Unsatisfactory. L. Simon, Reliable Refiner, 315 Hippodrome Bldg., Cleveland, Ohio.

REAL ESTATE, FARM AND ORCHARD LANDS

OWN Your Own Orange Grove in Fruitland Park, Florida's finest lake-jeweled highland section, way above sea level. A few dollars a month will buy it. Melons, sweet potatoes, etc., offer quick profits. We can produce you a better orange grove for less money than anyone in the State and in Florida's greatest section. Fruitland Park is best. We can prove it. Write for book of actual photographs, the interesting story of a Fruitland Park farm and why crops help pay for it. Lake County Land Owners' Association, 93 Palm Row, Fruitland Park, Lake County, Florida.

WANT to hear from owner having farm for sale; give particulars and lowest price. John J. Black, Chippewa Falls, Wis.

ONE Acre, ten Pecan and forty Orange trees \$120. \$10 monthly. Guaranteed care. Ultimate production \$1,000 yearly. Suburban Orchards Co., Dept. M, Biloxi, Miss.

BUY these bargains by mail; \$73 for 122 acres choice lake frontage, \$75 for 25 acres, trout stream accessible. \$97 for 50 acres, beautifully wooded—shooting, \$105 for 50 acres, hunting camp site. \$49 for small acreage, Georgian Bay. \$125 for good acreage, big game district. \$215 for large acreage, hunting camp site. \$285 for mining claim, may be worth a million. Also beautifully situated hunting camps and fishing lodges, where there is real hunting and fishing. Summer cottage sites, islands of all sizes, heavily wooded acreages all situated in Muskoka, Georgian Bay District, with its ten thousand islands, Algonquin Park with its 300 lakes, Highlands of Ontario, Lake of Bays, and the famous Muskoka Lake region. All offered at 10 cents on the dollar of their value, and on easy monthly payments of \$5.00 and upwards. Send for illustrated list of the above and one hundred other properties seized and sold for taxes. If you are interested in the forthcoming boom in Canadian Gold and Silver mines, and would like a mine all your own for two or three hundred dollars send for list 240A. Every property is fully described and offered at a stated price. Send no money. Send for list today, so you will have first chance. If you wish you may make the payments to your local trust company. Tax Sale Service, 72 Queen Street, West, District 15, Toronto, Ontario, Canada.

FOR Sale—Three full sections in McKenzie County and two sections in Billings County, North Dakota. Each section contains land suitable for crops, balance for cattle. Each section has valuable deposits of lignite which some day will alone be worth many times the present value of the land. This part of the state is developing very rapidly with good schools within easy access. As owner cannot use this land himself, will sell one or more sections at a price which almost anyone can afford to pay. Address W., care Popular Mechanics, 200 East Ontario St., Chicago.

THE Government offers you free, Islands for fur farming, Timber claims, Homesteads near transportation, Placer and Quartz claims, Coal, and Oil leases in Alaska. Opportunities galore. Send two dollars for information and twenty by thirty inch colored map. Whether you want to trap, prospect, or locate in business, if 'tis in Alaska, we furnish it. Alaska Bureau, Box 726, Seattle, Wash.

125 ACRES—Season's Crops, 9 Cattle, Furniture, Horse, Tools. Only 1 1/2 miles depot town, good buildings. Woman must sell; all \$1,900. Less than half cash. Page 25 illus. Bargain Catalog. Copy free. Strout Farm Agency, 150P Nassau St., N. Y. City.

GOOD Farm Lands! Near hustling city in Michigan; 20, 40, 80 acre tracts; clay loam soil; \$10 to \$50 down; balance long time. Write today for booklet. Swigart Land Co., P-1259, First Nat'l Bank Bldg., Chicago.

ATTENTION—"Get acquainted." Cash for your property, Farm, Hotel or Retail Store, no matter where located; confidential service. Hayes' Business Agency, Cincinnati, Ohio.

SELL your property quickly for cash, no matter where located. Don't pay big commission. Particulars free. Real Estate Salesmen Co., Desk B., Lincoln, Neb.

\$5.00 DOWN, \$5.00 monthly; 10 acres unimproved poultry, fruit, stock, woodland; \$100; Orarks. Fishing, hunting, trapping. Alfred Zimmerman, 1800 N. Fifth, Kansas City, Kan.

FARM Wanted—Sell for cash, in any state. No big commissions. R. A. McNown, 312 Wilkinson Bldg., Omaha, Neb.

DOGS AND PETS

NEWFOUNDLAND pups, registered stock, Birky's strain, Amou Birky, Fisher, Ill.

CHICKS: Leading varieties. Our big illustrated chick book free. Comfort Hatchery, Box 732, Windsor, Mo.

SILVERBLACK Foxes \$300.00. Time Payments. Muskrats. Arthur Schumacher, Lockland, O.

DOGS and Birds of all kinds. Wm. Bartlett, Woodsee, Ill.

POULTRY

ALUMINUM Chick Feeder for Feed, Grit, Milk or Water. Simple, safe and sanitary. Chicks cannot get feet into contents. Send 30c, cash or stamps, for one postpaid. Money back if not satisfied. American Poultry Journal, 418-523 Plymouth Ct., Chicago.

PLANS for Poultry Houses. All styles. 150 illustrations; secret of getting winter eggs, and copy of "The Full Egg Basket." Send 25 cents. Inland Poultry Journal, Dept. 74, Indianapolis, Ind.

PIGEON KEEPER—Largest and best illustrated monthly, \$1.50 for 12 months, 15c a sample copy. American Pigeon Keeper, 412 Merton Bldg., Chicago, Ill.

PERSONAL

150 "FUNNY" Parodies on Latest Songs, "Yes! We Have No Bananas Today," etc., 25c. P. M. Collins Co., 197 Fulton Street, Brooklyn, N. Y.

ARE You Old at Forty? See our Advertisement on page 148 of this issue. The Electric Thermal Company, 2131 Main Street, Steubenville, Ohio.

ASTROLOGY—Stars tell Life's Story! Send birthdate and dime for trial reading. Eddy, 1085 B, Suite One, Kansas City, Mo.

UNUSUAL Horoscope—Six pages, consisting of extensive four-page Special Horoscope, Astro-Analysis, and two-page valuable guide giving daily and monthly advice covering entire year. Send 50c and birth date. Money returned if dissatisfied. Prof. Bolles, Box 5, Fordham Station, New York, N. Y.

TOBACCO Kills manly Vigor. Quit easily. Cigarettes, chewing, smoking, snuff conquered or no charge. Small sum if satisfactory. Stops craving; harmless. Full treatment on trial. Perkins Co., 34-A, Hastings, Neb.

TOBACCO or Snuff Habit cured or no pay. \$1.00 if cured. Remedy sent on trial. Superba Co., TP, Baltimore, Md.

FREE—Information of a scientific nature that has brought happiness through perfect health to thousands. No charge; no obligation. Enclose stamp for reply. C. O. Wood & Co., Colorado Springs, Colo.

FREE—Stop using tobacco. We will give free information how to conquer habit easily and permanently. Results guaranteed. Anti-Tobacco League, Box K, Omaha, Neb.

YOUR Horoscope—Business, Character Changes, Friends, Enemies. Send birth date and ten cents (stamps) for remarkable test reading. Zanya, 202-C, W. 105th St., New York City.

MISCELLANEOUS

LOCKSMITHING, complete 500 tricks of the trade, new edition, many added features, \$1.50; money back if dissatisfied. H. Routson, 3406 Andover St., Oakland, Calif.

GET posted—Good prices paid for butterflies, insects. See Sinclair display advertisement, page 24.

ARE You Old at Forty? See our advertisement on page 148 of this issue. The Electric Thermal Company, 2131 Main Street, Steubenville, Ohio.

PEARLS—South Sea Island, 50c. McKenzie, Box 9, Long Beach, Cal.

AUTOMATIC Adding Machines \$3.50, delivered. Guaranteed accurate as highest priced machines. Quick, easily operated. Bassett, 1458-E Hollywood Avenue, Chicago.

ARTIFICIAL Eyes, \$3. Booklet free. Denver Optic, 559 Barclay, Denver, Colo.

HOMEOPATHIC and Biochemic preparations sent postpaid to all parts of the world. Manual and booklets free. Halsey Bros. Co., 111 N. Wabash Ave., Chicago, Ill. Established 1855.

CUTS anybody can make. Simple, cheap process, \$1. Specimens, particulars, 2c stamp. M. Day, Windfall, Ind.

ROCKS and Minerals for sale—hundreds of varieties—price List Free. Peter Zedac, 157 Wells St., Peekskill, N. Y.

MONEY in Minerals. Many common minerals have market value. List 10c. Minerals tested. Mineralogist, Joplin, Mo.

CONCRETE Handbook, for the Amateur. We have just published a book describing 173 ways of using concrete in the home, shop and on the farm, with full directions for doing these things yourself with ordinary tools. 138 illustrations. It is "written so you can understand it." Price 50 cents, postpaid. Popular Mechanics Book Dept., 206 E. Ontario St., Chicago.

ART Metal Workers—You will find our book "Metal Work and Etching" a complete manual on making book ends, desk sets, pad corners, paper knives, letter openers, stationery racks, rocking blotters, desk calendars, arts and crafts jewelry, etc.; 96 pp., illus. Price 50 cents postpaid. Popular Mechanics Book Dept., 206 E. Ontario St., Chicago.

MECHANICS! You will seldom if ever get stuck on a job if you keep on hand for quick reference a 16-volume set of Popular Mechanics Shop Notes. At the price of 50 cents a volume, any one of the several thousand time and labor-saving kinks may save you the cost many times over. Any of the volumes may be purchased separately at the same price. Popular Mechanics Book Dept., 206 E. Ontario St., Chicago.

NEW KIND OF HEAT BURNS 95% AIR

Gives Three Times the Heat of Coal or Wood



Here's a new way to get as much or as little heat as you want—at the simple turn of a little valve.

A St. Louis inventor has discovered a wonderful new kind of heat that burns 95% air and yet gives three times the heat of coal or wood. What this means to the householder in these days of mounting coal prices can readily be seen. Besides the expense-saving there are also big labor-saving features.



No worry about heat when you can get 3 times the heat of coal by just turning a valve. No coal, wood, ashes.

With this invention in the home there are no more fires to build, bank or watch—no more dirty, heavy coal to carry and lift—no more clouds of ashes to breathe or back-breaking scuttles to empty—no more heating problems—no more cold rooms in Winter—no more suffering from lack of quick fires in uncertain Fall and Spring—no more worries about coal shortages, poor quality or high prices.

This new kind of heat therefore has really ended the days of woman's

back-breaking servitude to a hot, mussy, stove or furnace! The wonderful invention of Mr. B. M. Oliver of St. Louis, in one minute, turns any coal or wood burner into a modern, up-to-date gas stove.

Mr. Oliver calls his invention the Oliver Improved Oil-Gas Burner, because it uses 95% air and only 5% coal oil (ordinary kerosene)—the cheapest fuel there is, turning them into an actual gas that burns with an intensely hot, clean flame. It is cleanly and also saves its cost in cleaning bills alone.

This invention can absolutely be depended upon to heat rooms in coldest Winter weather—it gives 3 times the heat of coal. But you needn't worry about the high price of coal. Install this amazing new kind of heat and you can snap your fingers at coal shortages, poor quality or high prices.

The Oliver Improved Oil-Gas Burner is made in sixteen different models to fit any kind of cook stove, heating stove or furnace. It doesn't change your stove and simply sets in firebox. It is easily slipped in, in one minute—is absolutely safe and lasts a lifetime.

Just turn the valve and you have heat—as much or as little as you need. Physicians recommend the Oliver as a sure safeguard against colds, influenza, etc.

Now, once and for all time you can do away with household dirt and drudgery. End ashes, dirt, smoke, odor, chopping, shoveling, carrying, dirty heavy coal and wood. Mr. Oliver will be glad to send you immediately **FREE ATTRACTIVE BOOKLET**, "New Kind of Heat," telling all about this amazing new invention. Shows exactly how it works, how it is different from all other burners and tells how you can use it in your stove, 30 days, FREE. The famous Oliver Iron-Clad, Money-Back Guarantee protects you.

If you write at once you will be in time to receive Mr. Oliver's very low, introductory price offer. Get your Oliver installed immediately, before cold weather sets in.

OLIVER OIL-GAS BURNER CO.

Oldest and Largest Manufacturers of Oil-Gas Burners in the World
C-57 Oliver Building, ST. LOUIS, MO.

Mr. Oliver is anxious to obtain agents interested in filling the tremendous demands, all over the country for his new invention. Oliver agents earn as high as \$250 a month—\$25 a day spare time is easy. Exclusive territory. Big, all season seller. Write for Special Offer.



The ideal thing for this winter when coal prices are high and you want to save work, time and expense.

Down goes the price!

BOXING \$1.67
Jiu-Jitsu
Wrestling Was \$5.00

Think of it! For only \$1.67 you can now have the famous Marshall Stillman Course—the same identical \$5.00 course by which Marshall Stillman has taught boxing, jiu-jitsu and wrestling to over 4,000 men! You can have it on 10-day trial. Send no money with order.

Over 80 complete lessons—six volumes, hundreds of pages, and over 200 illustrations—all for \$1.67, or less than 3 cents a lesson!

Marshall Stillman teaches you right in your own home. You learn all the fundamentals of boxing and the blows and guards used by the top-notchers—the Benny Leonard Triple, the Jack Dempsey Triple, the Fitzsimmons Shift, etc. All the secrets of the ring, all the fine points of feinting, ducking, clinching, breaking ground, judging distance and timing—including three lively rounds of *Shadow Boxing* to develop speed and confidence. In short, you will become a good boxer in quick time—able to box rings around that "fellow who thinks he knows it all"—and for only \$1.67.

In *Jiu-Jitsu* you will learn how to disarm an opponent, how to break a stranglehold, etc., and, in *Wrestling*, the Gotch Toe Hold, Stecher Scissor Hold, the Head-lock, etc.

With the course you get a Free History of 69 Famous Boxers, with their pictures and "inside" stories about them.



SEND NO MONEY. Simply fill in and mail the coupon. When you have the course in your hands, deposit 67 cents (plus the actual postage) with the postman. Then examine the course for ten days—try it out thoroughly. At the end of ten days, either send us the small balance of \$1.00 in final payment, or return the course and we'll send your deposit back. Marshall Stillman Association, Dept. 1224-C, 42nd Street and Madison Avenue, New York.

Coupon
MARSHALL STILLMAN ASSOCIATION
Dept. 1224-C, 42nd St. and Madison Ave., New York

You may send me on approval the Marshall Stillman Course. I will deposit 67 cents (plus the actual postage) with the postman, with the understanding that if, after 10 days, I wish to return the course I may do so and my money will be instantly refunded. If I keep the course, I am simply to send you \$1.00 in final payment.

Name.....

Address.....



All These
FREE

Drawing Table
Drawing Outfit
Pocket Rule

\$90 Drafting Course FREE

In addition to all of my other offers, I have also made arrangements whereby you may get a regular \$90 Drafting Course entirely free for getting two additional students. I have determined to do all I can in preparing draftsmen for the thousands of calls which are being made for them by offering every inducement possible to ambitious men anxious to succeed in a big way.

Salaries Up To \$250 and \$300 a Month

I don't give you just a "course in drafting" and then let you shift for yourself. I guarantee to train you until you are holding a permanent position paying you a salary of at least \$250 a month. I can make this guarantee because I limit and select my students. I know that the men I take as students if they will follow my practical instruction, are certain to land a big money-earning job. So write me today for my free book, "Successful Draftsmanship." It's FREE.

Write Today!

The coupon shown on a postcard or letter will bring my book telling you all about the career of a draftsman and all about other very exceptional offers I am making, such as, for instance, a fine folding drafting table which I am giving now to my students. Write at once!

Chief Draftsman Engineer's Equipment Co.
1951 Lawrence Ave. Div. 13-53 Chicago, Ill.

Chief Draftsman, Engineer's Equipment Co.
1951 Lawrence Ave., Div. 13-53 Chicago, Ill.

Without any obligation whatever, please mail your book, "Successful Draftsmanship," and full particulars of your liberal "Personal Instruction" offer to few students.

Name.....

Address

.....Age.....



\$95 an Hour!

"Every hour I spent on my I. C. S. Course has been worth \$95 to me! My position, my \$5,000 a year income, my home, my family's happiness—I owe it all to my spare-time training with the International Correspondence Schools!"

Every mail brings letters from some of the thousands of I. C. S. students telling of promotions or increases in salary as the rewards of spare-time study.

What are you doing with the hours after supper? Can you afford to let them slip by unimproved when you can easily make them mean so much? One hour a day spent with the I. C. S. will prepare you for the position you want in the work you like best. Yes, it will! Put it up to us to prove it. Mark and mail this coupon now!

INTERNATIONAL CORRESPONDENCE SCHOOLS

Box 5591-D, Scranton, Penna.

Without cost or obligation, please tell me how I can qualify for the position or in the subject before which I have marked an X:

BUSINESS TRAINING COURSES

- | | |
|--|---|
| <input type="checkbox"/> Business Management | <input type="checkbox"/> Salesmanship |
| <input type="checkbox"/> Industrial Management | <input type="checkbox"/> Advertising |
| <input type="checkbox"/> Personnel Organization | <input type="checkbox"/> Better Letters |
| <input type="checkbox"/> Traffic Management | <input type="checkbox"/> Show Card Lettering |
| <input type="checkbox"/> Business Law | <input type="checkbox"/> Stenography and Typing |
| <input type="checkbox"/> Banking and Banking Law | <input type="checkbox"/> Business English |
| <input type="checkbox"/> Accountancy (including C.P.A.) | <input type="checkbox"/> Civil Service |
| <input type="checkbox"/> Nicholson Cost Accounting | <input type="checkbox"/> Railway Mail Clerk |
| <input type="checkbox"/> Bookkeeping | <input type="checkbox"/> Common School Subjects |
| <input type="checkbox"/> Private Secretary | <input type="checkbox"/> High School Subjects |
| <input type="checkbox"/> Spanish <input type="checkbox"/> French | <input type="checkbox"/> Illustrating <input type="checkbox"/> Cartooning |

TECHNICAL AND INDUSTRIAL COURSES

- | | |
|---|--|
| <input type="checkbox"/> Electrical Engineering | <input type="checkbox"/> Architect |
| <input type="checkbox"/> Electric Lighting | <input type="checkbox"/> Blue Print Reading |
| <input type="checkbox"/> Mechanical Engineer | <input type="checkbox"/> Contractor and Builder |
| <input type="checkbox"/> Mechanical Draftsman | <input type="checkbox"/> Architectural Draftsman |
| <input type="checkbox"/> Machine Shop Practice | <input type="checkbox"/> Concrete Builder |
| <input type="checkbox"/> Railroad Positions | <input type="checkbox"/> Structural Engineer |
| <input type="checkbox"/> Gas Engine Operating | <input type="checkbox"/> Chemistry <input type="checkbox"/> Pharmacy |
| <input type="checkbox"/> Civil Engineer | <input type="checkbox"/> Automobile Work |
| <input type="checkbox"/> Surveying and Mapping | <input type="checkbox"/> Airplane Engines |
| <input type="checkbox"/> Metallurgy | <input type="checkbox"/> Navigation |
| <input type="checkbox"/> Steam Engineering | <input type="checkbox"/> Agriculture and Poultry |
| <input type="checkbox"/> Radio | <input type="checkbox"/> Mathematics |

Name.....

Street.....

Address..... 11-21-23

City..... State.....

Occupation.....

Persons residing in Canada should send this coupon to the International Correspondence Schools Canadian, Limited, Montreal, Canada.



WANTED MEN AND WOMEN TO LEARN PHOTOGRAPHY!

Photographers and Photo-Engravers earn \$200 to \$500 a month. The field is uncrowded. Learn these profitable and fascinating professions. Taught by largest and best college of its kind in the world. Established over 30 years. Demand for our graduates far exceeds supply. Good positions secured. Tuition and living expenses low.

Get this FREE Book! Write today for free beautifully illustrated book describing wonderful opportunities in this field.
Illinois College of Photography, Box 434, Effingham, Ill.

BE A JAZZ MUSIC MASTER



PLAY PIANO BY EAR

Play popular song hits perfectly. Hum the tune, play it by ear. Self-instruction—no teacher required. No tedious ding-dong daily practice—just twenty brief, entertaining lessons which you master

At Home in Your Spare Time

Send for FREE BOOK. Learn many styles of bass and syncopation—trick endings, fill-ins, etc.

Niagara School of Music
Dept. 642 Niagara Falls, N. Y.

Send for this Free Book

ARTIST'S OUTFIT FREE

Write quick for our remarkable offer. Learn NOW at home, in spare time, by our new instruction method. Commercial Art, Cartooning, Illustrating, Designing. Delightful, fascinating work in big demand. \$50.00 paid for one drawing. Handsome book free explains everything. SEND FOR IT TODAY

WASHINGTON SCHOOL OF ART, Inc.
Rm. 303, 1115-15th St. N.W., Washington, D.C.

Write and Speak MASTERLY ENGLISH



Learn correct English with Sherwin Cody's new invention. No rules to memorize. Like a fascinating game. Spare-time study, 15 minutes each day, quickly gives you masterly command of English. Interesting booklet sent free. Write today. Sherwin Cody School of English, 53 Beale Building, Rochester, N. Y.

EARN \$35 TO \$100 A WEEK

AS A MECHANICAL DRAFTSMAN. Write today for Free Book telling how we train you in spare time, at home, and help you secure a position. Fine set of professional Drafting Instruments furnished Free. Write today. COLUMBIA SCHOOL OF DRAFTING
Dept. 2304, 14th & T Sts., N. W., Washington, D. C.

13 WEEKS FOR 15 CENTS

The Pathfinder

SHOWS THE WAY THROUGH THE JUNGLE OF EVENTS

You've heard your neighbor praise the Pathfinder, the wonderful weekly news and story magazine with over half a million subscribers. Unbiased digest of national and world affairs. 'Chock full of just the kind of reading you want. Fun, fashions, question box, books, health—entertainment and instruction for all. Exciting serial and short stories. Send 15c (coin or stamps) today for this big 31 paper 13 weeks. Money back if not satisfied. PATHFINDER, 552 Langdon St., Washington, D.C.

\$50
to
\$125
PER WEEK
AUTOMOBILE

**J
O
B
B
S**

Here's your opportunity to raise your earning power in 8 short weeks

Never before in automobile history has there been such a demand for expert automobile mechanics and salesmen. If you are at all inclined toward getting into the wonderful automotive industry there's a \$50 to \$125 per week job waiting for you.

Ready Now

Hundreds of requests for Greer Graduates are now on our books waiting to be filled. Even with our large student enrollment we cannot supply the demand. We want more two-fisted, ambitious men. We need YOU—NOW.

Employment Guaranteed

We are so swamped with requests for trained men that for a time we can guarantee employment at top wages to all Greer Graduates. Enroll now. In 8 short weeks you can graduate as a Certified Automobile Engineer with a big job waiting at big pay.

Earn While Learning

If you are in need of assistance while training, we will get you an "earn-while-you-learn" job. With this help you can easily work your way through a Greer Course and soon qualify for a big job and the big money. Be sure to mail the coupon for full details.

Day and Evening Classes

Your work need not interfere with your instruction. Complete Greer Course includes Machine Shop Practice, Truck, Tractor and Automobile repairing in the big Greer Shops, Lighting, Starting, Ignition, Welding, Tire Repairing, Storage Batteries, Driving, Shop Management, Selling — everything you need in preparation for a lifetime of pleasant work and big earnings.

We Pay Railroad Fare to Chicago

This special offering is made to help fill the many automotive jobs we now have open. Mail the coupon for FREE BOOK and all the details of our offer.

**Greer Automotive
Training Shops**
2053 S. Wabash Avenue
Chicago, Ill.



**Mail this
COUPON
At Once**

ERWIN GREER, Superintendent
2053 S. Wabash Ave., Chicago, Ill.

Please send me FREE Book "How to Succeed in the Automobile Business" and full information about your "earn-while-you-learn" proposition.

NAME

ADDRESS

LEARN Modern Barbering

NEW EASY WAY

Earn \$50 to \$150 EACH WEEK



NO matter what you are now doing, no matter how much you earn, our amazing new system of training for the barbering profession enables you to step into this clean, pleasant, profitable business in a few short weeks. Start right in earning \$50 to \$150 a week.

J. E. McGregor, of New Orleans, writes: "I have never been out of a job since you sent me to the one from the Post Graduate department a year ago. I have saved up a nice bank account. I am glad I learned Modern Barbering with you."

F. Erbat, of Chicago, writes: "I own my own home! I have my own automobile! I am independent! Have made it all since graduating from your school five years ago."

What Moler System Means to You

Our national advertising educates the public to the safety, comfort and economy of Moler post graduate work. It makes you the sought-after barber in your locality. It keeps your chairs filled and turns profits into your pocket. You as graduate are a part of a national institution which assures steady, profitable business. Through no other method can you get this.

We Equip Your Shop on Easy Terms

If you own your own shop your success is assured. If you are a worker you are assured of steady employment.

Send for This
Free Book
Today

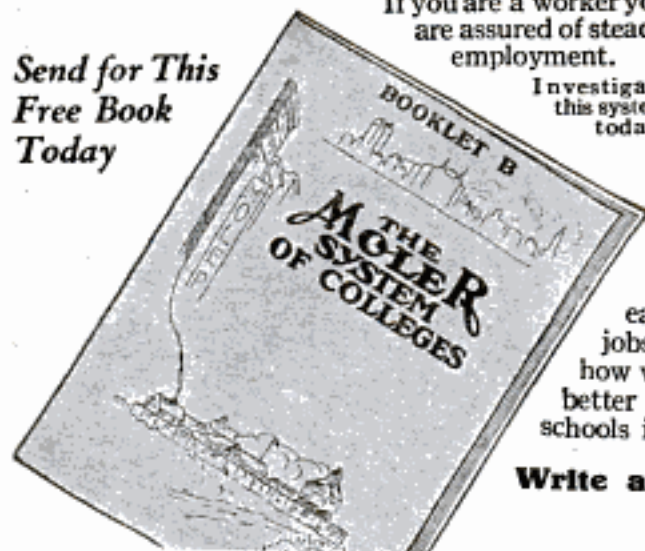

Investigate
this system
today.

We Train You to Be An Expert IN A FEW WEEKS

You want to get ahead—you want to make more money—big money. Our short, practical course gives you a complete training in modern barbering, including the electric hair cutter, the mechanical massage and scientific treatments. It also affords a study, if one desires, on hair and skin—it makes you an expert and expert barbers are always in demand.

Easy Work Always Busy BIG PAY

A trade that enables you to travel and see the world—one that pays in tips and commissions in addition to salaries. Moler System graduates are in great demand and have no trouble in securing good jobs.

Write for Free Book

Our catalog that we mail free tells how we enable you to earn while learning, how we put you into the best city jobs, how we equip your shop on easy payments. In fact, how we take you just as you are, make your life's work easier, better paying and more independent. We have 33 branch schools in leading cities. We have one near you.

Write anyone of the following addresses for our booklet B. Do it today.

MOLER SYSTEM OF COLLEGES

Address Nearest Branch →

Please send me without obligation on my part your Booklet B.

Name.....

Address.....

City.....State.....

The Moler System of Colleges

157 Third Ave. New York, N. Y.	215 Huron Rd. Cleveland, Ohio	23 N. Forsyth St. Atlanta, Ga.
105 S. Wells St. Chicago, Ill.	1045 Cass Ave. Detroit, Mich.	80 N. 2nd St. Memphis, Tenn.
810 N. 6th St. St. Louis, Mo.	1229 17th St. Denver, Colo.	910 Main St. Dallas, Texas
544 Main St. Kansas City, Mo.	110 S. 14th St. Omaha, Nebr.	712 Franklin Ave. Houston, Texas
206 E. 4th St. Cincinnati, Ohio	513 E. Water St. Milwaukee, Wis.	430 W. Houston St., San Antonio, Texas
	1005 Canal St. New Orleans, La.	

"I Have Only Begun My Climb!"

—Yet the man who said this had already increased his income, thru home-study training, 250 per cent!

Do you remember how tall the ladder looked to you as a little child?

Perhaps the majority of us have still something of the child in us, because no matter what we attempt—*if we have never tried it before*—the "ladder" that would take us over the top looks as tall as a steeple!

We at LaSalle are reminded of this common and very human trait a hundred times a day.

Obstacles that look like mountains to the man earning \$20 a week become mole-hills when that man moves up into the \$40-a-week class.

But *again* he sees mountains ahead of him, namely, the tasks performed by the man who earns \$90 a week!

He renews his studies, works out the practical problems of that position in his spare time, and almost by magic the peaks that block his path shrink to pleasant and inviting hills. All in a day's work he moves up again—this time to the \$90-a-week class.

Thus *on and on* he can go—provided he keeps his mind active and receptive. And strangely enough, when he finally handles the biggest tasks of his life, he is likely

to find that those tasks are actually less of a strain on his powers than the two-by-four job which he swung when he was earning only "twenty-a-week!"

By way of illustrating the expanding viewpoint of the man climbing to greater responsibilities, here are two letters—the first from a man making approximately \$4,000, the second from a man making twice that income:

"With a meager knowledge of bookkeeping, obtained thru three successive terms at night school, I found myself in the Disbursing Office of the Navy Yard, Puget Sound at Bremerton. My entrance salary amounted to about \$95 per month. Simultaneously I enrolled with LaSalle Extension University, and tho my lessons were put out under unusually difficult conditions, I succeeded in completing about 50 per cent of the entire course.

"Several opportunities for advancement presented themselves, and finally, in 1920, I accepted one to transfer to the Office of Cost Inspector, U. S. N., where my duties could not possibly have been satisfactorily discharged without the training and knowledge derived from my course. Substantial salary increases followed and I was enabled to assume more interesting and important duties than before.

"I also soon found demand for my services among commercial firms, and for over a year and a half have had my salary limited only by lack of time to handle more work. In fact, I have had more than I cared for upon several occasions. Incidentally, my combined salary has increased, since commencing the course, from 200 per cent to 250 per cent over that received at the time I enrolled. In the future I will be able to command even higher wages, for I believe that I have only begun my climb up the ladder."

C. M. DOLGNER, Washington.

"My income is now a trifle in excess of \$8,000 a year, and I am just beginning to grow. I can hardly find words to tell you of the inspiration that the course has given me. I have recently enrolled for your full law course and expect to complete my business education with LaSalle."

CHARLES S. JONES, Texas.

It is interesting to note, in connection with Mr. Jones' letter, that he, too, had made his start upward only three years before—and that his first rung was a salary of only \$100 a month.

You Cannot Stand Still Will You Slip—or Climb!

There are men who lie down at the foot of the

ladder and bask in the sun. They're the street-corner fellows, the clock-watchers, the chaps who worry for fear they'll be given too much to do.

We know, of course, that you are not in this latter class, because if you were you would not be reading these lines—you'd have turned the page before you had read the first paragraph.

But just what stuff ARE you made of?

If you are the sort who starts things but *fails to see them thru*, you will hardly gain

by the opportunities which this text will bring you.

If, on the other hand, you are not only a "self-starter" but a "go-getter," these opportunities will benefit you greatly. And now—this very moment—is the time to ACT.

LaSalle Extension University

The Largest Business Training Institution in the World

Dept. 364-R

Chicago, Illinois

Upon request, the book, "Ten Years' Promotion in One," and material completely descriptive of the course and service that interests you, will gladly be sent without cost or obligation. Indicate your choice by checking, and write below your name and address.

- | | |
|---|--|
| <input type="checkbox"/> Business Management | <input type="checkbox"/> Modern Business Correspondence and Practice |
| <input type="checkbox"/> Modern Salesmanship | <input type="checkbox"/> Modern Foremanship and Production Methods |
| <input type="checkbox"/> Higher Accountancy | <input type="checkbox"/> Personnel and Employment Management |
| <input type="checkbox"/> Law — Degree of LL. B. | <input type="checkbox"/> Expert Bookkeeping |
| <input type="checkbox"/> Traffic Management | <input type="checkbox"/> Business English |
| <input type="checkbox"/> Railway Station Management | <input type="checkbox"/> Commercial Spanish |
| <input type="checkbox"/> Commercial Law | <input type="checkbox"/> Effective Speaking |
| <input type="checkbox"/> Industrial Management Efficiency | <input type="checkbox"/> C. P. A. Coaching |
| <input type="checkbox"/> Banking and Finance | |

Name.....

Present Position.....

Address.....



ELECTRICITY

**Earn \$3500 to \$10000 a year
as an Electrical Expert**

What's Your Future?

Now you earn \$20 or \$30 or \$40 a week. In the same six days as an Electrical Expert you can make \$70 to \$200 and make it easier—not work half so hard. Why, then, remain in the small-pay game, in a line of work that offers no chance, no big promotion, no big income?

Fit yourself for a "bossing" job—

**Be An
"Electrical
Expert!"**



Today even ordinary Electricians—the "screw driver" kind—are making money—big money. But it's the trained man—the man who knows the whys and wherefores of Electricity—the "Electrical Expert,"—who is picked to "boss" the ordinary Electricians—to boss the Big Jobs—the jobs that pay \$3500 to \$10,000 a year.

Some Features of Cooke Training That Make SUCCESS Certain

1. Practical Money-Making Instruction—no useless, high-sounding theory.
2. Free Electrical Outfit.—Finest outfit ever sent out for home experiment and practical use.
3. Free Employment Service. (Helps you get a good job.)
4. Free Consulting Service. (No chance to get stuck on anything, while studying or afterward.)
5. Free Subscription to Engineering Magazine.
6. Free use of my Electrical Laboratory.
7. Extra Courses Free—Radio—Electrical Drafting.—Business—Automobile Electricity—Mine Electricity and Special Lessons on Health and Thrift.
8. Spare Time Work—Special earn-while-you-learn lessons.
9. Reduced prices on all Electrical Supplies.
10. Cash Refund Guarantee Bond.

These features are all explained in my big Free Book—the "Vital Facts"

The "COOKE" Trained Man is the

NEEDS YOU!

*I will train you at home
to fill a Big Pay Job*

\$3,500 to \$10,000 a Year

Get in line for one of these "Big-Pay Jobs" by enrolling now for my easily learned, quickly-grasped right-up-to-the-minute, Spare-Time Home-Study Course in Practical Electricity.

Age or Lack of Experience No Draw-Back

You don't have to be a High School graduate—it isn't even necessary that you should have finished the grades. As Chief Engineer of the Chicago Engineering Works, I know exactly the kind of training you need, and I will give you that training. My course in Electricity is the most simple, thorough, successful and practical in existence, and offers every man, regardless of age, education, or previous experience, the chance to become in a few short months, an "Electrical Expert," able to make from \$70 to \$200 a week.

Earn While You Learn

With me you do practical work—at once. In my first few lessons I show you how to make money doing Electrical work in your spare time. (Over half of my students are paying for their course in this way.) I show you also, how to get started in business for yourself, and then help you to get started.

FREE—Electrical Working Outfit—FREE

To do spare time work you'll need tools, etc. These I give you—Free—a whole kit including measuring instruments, a real electric motor (no toy), and other things—the greatest value ever given by any School.

Your Satisfaction Guaranteed by a Million Dollar Institution

I absolutely guarantee to return every penny paid me in tuition if, when you have finished my Course, you are not satisfied in every way with my instruction. And back of me, in my guarantee, stands the Chicago Engineering Works, a million dollar institution.

Nothing Like "Cooke" Training Anywhere

"Cooke" training is different because it's the most practical and most successful. It's best because it's backed up by the greatest Service to students ever known. It's this Service, plus "Cooke" training, that makes the "Cooke" trained man the "Big Pay" man everywhere. Become a "Cooke" Trained Man yourself, and earn \$12 to \$30 a day—\$70 to \$200 a week—\$3500 to \$10,000 a year.

Investigate! Mail Coupon

Get the Vital Facts. Let me send you free my big new book on The Future of Electricity. Let me tell you more about the big demand for "Cooke" trained Electrical Experts. Sign and send me Coupon below.

L. L. COOKE, Chief Engineer
Chicago Engineering Works, Inc.
2150 Lawrence Avenue
Dept. 513 CHICAGO, ILL.

Send for
this **FREE**
book

The
**Vital
Facts**

mail this coupon NOW

L. L. COOKE, Chief Engineer
Chicago Engineering Works, Dept. 513
2150 Lawrence Ave., Chicago, Ill.

Dear Sir:—Send at once the "Vital Facts" containing Sample Lessons, your Big Book, and full particulars of your Free Outfit and Home Study Course—all fully prepaid, without obligation on my part.

Name.....

Address.....

City and State.....

Occupation..... Age.....

"Big Pay" Man!

Get Into This

You Can

Follow in the lead of Beyer, shown on the opposite page, and scores like him who have taken advantage of the amazing money-making possibilities in the automobile, truck and tractor business. Here is a chart of facts—authentic figures which point out the opportunities. If you are ambitious and seeking a money-making opening, here's your chance—a chance to cash-in to a degree that will satisfy your highest aims.

Thousands of competent garages, battery shops, auto electrical shops, tire and welding shops are needed now. Trained men can run them.

14,500,000
Automobiles in U.S.

70,000,000
Tires to be repaired.

12,000,000 Batteries,
14,000,000 Ignition
Systems and only
50,000 Garages.



and welding shops are needed now. Trained men can run them.

Learn Autos, Trucks and Tractors in the Heart of the Industry

Without any previous experience—just a liking for mechanics—you can learn the auto business from A to Z in a few weeks at the Michigan State Automobile School—the factory endorsed school in Detroit—the heart of the industry. Then step out, equipped with knowledge and training, to a future of certain, big money making. You have distinctive advantages, learning the business here. It's the fountain head of the automotive industry. You are taught under factory endorsed methods. You learn both theory and practice on latest equipment. Go through the great Ford plants. Visit the other auto factories—learn their methods first hand—and it all means greater opportunities and more certain success. The Michigan State Automobile School, in Detroit, the automobile center, is the logical place to learn the automobile business.



mobile School, in Detroit, the automobile center, is the logical place to learn the automobile business.

Read What Factories Say:

DODGE BROTHERS

INCORPORATED
DETROIT, U. S. A.

"We believe the Michigan State Automobile School of this city to be an exceptionally high class school, and no doubt a diploma from this school would assist materially in obtaining employment with high class automobile dealers."



BUICK MOTOR COMPANY

"We believe the MICHIGAN STATE AUTO SCHOOL, Detroit, would best meet your requirements, as its course of technical training is most thorough and complete in every detail."

THE STUDEBAKER CORPORATION OF AMERICA

"We do not know of a better automobile school than the MICHIGAN STATE."

PACKARD MOTOR CAR Co., DETROIT

"We do not believe you would make any mistake in attending this school if you wish to become thoroughly experienced in the automobile business."

Learn in a Few Weeks—Start Now

A thorough training in Detroit, at the Michigan State, is the thing that fattens the pay envelope if you are working for others, or puts more profit in business for yourself. You can take a full Automotive Course, or specialize in any one of its money-making branches; you can be an Auto Electrician; a Tire Expert; a Battery Service Man; a Repair-Man; a Welder; a Machinist; or specialize in motorized farming, with truck, tractor and farm electric-lighting and farm engine training. Course includes training in Garage Management, Business Methods and Selling. Classes are always open. You need make no special arrangements—you can start at once—now—and that's the thing to do.

Life Scholarship Your enrollment entitles you to a life membership, with privilege of our service any time you want it. Many students come back to brush up on latest automotive ideas and new equipment. It doesn't cost a penny extra. The position of the Michigan State (The Detroit Auto School) in the heart of this industry, insures most thorough, most practical, systematic training, at a cost so low and terms so easy that any man, anywhere, can afford it.

Earn While You Learn If necessary we can assist students to secure part time work to earn a small amount each week. Or students who wish to take our evening course will be assisted to full time day jobs. Ask for details, and when writing please explain your circumstances fully.

MICHIGAN STATE AUTOMOBILE SCHOOL

303 Auto Bldg.

DETROIT, MICHIGAN

The Factory Endorsed School

Big Money Business

Have Success Like This

Here is L. O. Beyer—merely one of thousands of Michigan State students who have achieved success far beyond their fondest hopes. What these men have done you can do. The opportunities are now greater than ever. There are more autos—more trucks—more tractors and every year adds to the money-making possibilities. You have ambition—you want success. Success is certain if you are willing to work for it. You can have independence—be your own boss—stop the plodding and get into work you like. You can earn big money, be prosperous, happy and independent. Beyer is no exception, we have graduates who have made as high as \$10,000 in less than a year. These records may seem amazing, but they are true. It is all done through head and hand training at the Michigan State. Decide now to give yourself the training that will pay you big and establish you in a successful life work.

Detroit-Trained Auto Men Earn More Money

Detroit-trained men are preferred. Your diploma from the Michigan State is a valuable money-making asset—an advantage that you can get from no other school. The Michigan State Automobile School is known the world over. Wherever autos are used—Detroit-trained men get the best jobs, highest pay. Auto, truck, tractor factories employ M. S. A. S. graduates. Leading factories, dealers, service stations, garages, shops and farms want men who have trained their heads as well as their hands—the M. S. A. S. Detroit-kind.

Good Positions Open

The demand for men who know automotive mechanics and electricians is greater than the supply. We have more calls than we can fill. The training in Business Management and Salesmanship included in our courses makes our graduates especially valuable. The years ahead are predicted to be the biggest years of the industry. Every Detroit plant has increased its production. Most are working over-time. All are behind on orders, and that means certain money-making advantages to men who start in the business now.

Mail This Coupon

Get all the interesting facts from our big catalog. It's a book of information concerning your future that you must not fail to get. It gives complete information about all courses. It's illustrated with photos of classes, school, equipment and graduates. It tells you how you can get a good paying job—how you can go into business for yourself with little capital. Let us send it to you FREE without obligation. Mail the coupon or send us a postcard today. Write now. (We do not enroll colored students, except for our Home Study Course.)

Michigan State Automobile School
A. G. ZELLER, Pres. and Gen. Mgr.
303 Auto Bldg., 3729 Woodward Avenue
DETROIT, MICHIGAN

Expert in Electrical Service, Auto Repairing and Welding

Deary, Idaho

Michigan State Automobile School,
Detroit, Michigan.

Dear Mr. Zeller:

I am in business for myself in Deary, this being my sixth year. I employ three men in the shop, while garages in neighboring towns reported they were having a hard time keeping their men busy.

I own an exceptionally fine equipment and can handle any kind of work. I have an Acetylene Welding department and have added a special electrical department this year, in fact hold a registered dealer's contract on Delco and Remy ignition parts, also carry a large stock of Connecticut and Atwater-Kent parts.

The training I received in your Welding Department and your special electrical course has paid me larger dividends per dollar than any money I ever spent, and I can certainly recommend the Michigan State to any young man wishing to better his condition in life. Very truly yours,

L. O. BEYER.



FREE CATALOG
MICHIGAN STATE
AUTO SCHOOL

Mail Coupon To Day

Michigan State Automobile School 303 Auto Building,
DETROIT, MICHIGAN

Send me FREE and without obligation your 100-page catalog and Auto School News, giving complete information about Detroit-training to make the most money.

Name.....

Street or R. F. D.....

City.....State.....

Do you prefer to start your training at home

or at our School in Detroit?.....



"They've tripled your salary, dear"

"I TELL you, Tom, it was a lucky day for both of us when you sent in that I. C. S. coupon. You'd never be where you are to-day if you hadn't decided to study in spare time just when you did."

Spare-time study with the I. C. S. is winning promotions for thousands of men and bringing happiness to thousands of homes all over the world. In offices, shops, stores, mines, mills and on railroads, I. C. S. trained men are stepping up to big jobs, over the heads of older men, past those whose only qualification is long service. There is a job ahead of YOU. Some man is going to be picked for it. The boss can't take chances. He is going to choose a trained man with sound, practical knowledge of the work.

Get busy right now and put yourself in line for that promotion. You can do it in spare time in your own home through the I. C. S., just as thousands of other men and women have done.

The first step they took was to mark and mail this coupon. Make your start the same way—and make it right now.

Mail the coupon to-day!

INTERNATIONAL CORRESPONDENCE SCHOOLS
Box 5588-D, Scranton, Penna.

Without cost or obligation, please tell me how I can qualify for the position or in the subject before which I have marked an X:

BUSINESS TRAINING COURSES

- | | |
|--|---|
| <input type="checkbox"/> Business Management | <input type="checkbox"/> Salesmanship |
| <input type="checkbox"/> Industrial Management | <input type="checkbox"/> Advertising |
| <input type="checkbox"/> Personnel Organization | <input type="checkbox"/> Better Letters |
| <input type="checkbox"/> Traffic Management | <input type="checkbox"/> Show Card Lettering |
| <input type="checkbox"/> Business Law | <input type="checkbox"/> Stenography and Typing |
| <input type="checkbox"/> Banking and Banking Law | <input type="checkbox"/> Business English |
| <input type="checkbox"/> Accountancy (including C.P.A.) | <input type="checkbox"/> Civil Service |
| <input type="checkbox"/> Nicholson Cost Accounting | <input type="checkbox"/> Railway Mail Clerk |
| <input type="checkbox"/> Bookkeeping | <input type="checkbox"/> Common School Subjects |
| <input type="checkbox"/> Private Secretary | <input type="checkbox"/> High School Subjects |
| <input type="checkbox"/> Spanish <input type="checkbox"/> French | <input type="checkbox"/> Illustrating <input type="checkbox"/> Cartooning |

TECHNICAL AND INDUSTRIAL COURSES

- | | |
|---|--|
| <input type="checkbox"/> Electrical Engineering | <input type="checkbox"/> Architect |
| <input type="checkbox"/> Electric Lighting | <input type="checkbox"/> Blue Print Reading |
| <input type="checkbox"/> Mechanical Engineer | <input type="checkbox"/> Contractor and Builder |
| <input type="checkbox"/> Mechanical Draftsman | <input type="checkbox"/> Architectural Draftsman |
| <input type="checkbox"/> Machine Shop Practice | <input type="checkbox"/> Concrete Builder |
| <input type="checkbox"/> Railroad Positions | <input type="checkbox"/> Structural Engineer |
| <input type="checkbox"/> Gas Engine Operating | <input type="checkbox"/> Chemistry <input type="checkbox"/> Pharmacy |
| <input type="checkbox"/> Civil Engineer | <input type="checkbox"/> Automobile Work |
| <input type="checkbox"/> Surveying and Mapping | <input type="checkbox"/> Airplane Engines |
| <input type="checkbox"/> Metallurgy | <input type="checkbox"/> Navigation |
| <input type="checkbox"/> Steam Engineering | <input type="checkbox"/> Agriculture and Poultry |
| <input type="checkbox"/> Radio | <input type="checkbox"/> Mathematics |

Name.....
Street..... 11-21-23
Address.....
City..... State.....

Occupation.....
Persons residing in Canada should send this coupon to the International Correspondence Schools Canadian, Limited, Montreal, Canada.

Learn How to WRESTLE



In Your Own Home
By Mail

Yes, learn to become an expert wrestler right in your own home, by mail from the greatest wrestler the world has ever known. He an athlete, be strong, be healthy. Learn how to throw and handle big men with ease. Learn to defend yourself. All taught in our course of lessons, and illustrated with hundreds of charts and actual photographs by

Farmer Burns and Frank Gotch

Farmer Burns, "the grand old man of the mat," taught Frank Gotch, the World's Champion, all he knew about wrestling, so Gotch said. He will now teach you Scientific Wrestling—Physical Culture—Jiu-Jitsu—Self Defense. Every man and boy in America, no difference what age, needs this wonderful course of lessons. Write today—your name, age and address on a postcard or letter brings you our fine book absolutely free, no obligation of any kind. A splendid book on wrestling and physical culture. Write today stating your age.

Farmer Burns School of Wrestling 1773 Railway Bldg., Omaha

This Wrestling Book FREE

Learn Photography at HOME

Make \$75.00 a Week on the Side

Establish yourself as a Photographic Expert quickly—during your spare time—under a leading photographer. I'll show you how to start your own business—and command a large salary. Send for your trial offer—It costs nothing. Act at once. A postal will do. H. R. VANT, INTERNATIONAL STUDIOS, Inc., Dept. 1193, 3601 Michigan Ave., Chicago, U.S.A.



FREE

Fine Tone
\$20 Musical Instruments

We have a wonderful new copyrighted system of teaching note music by mail. To first pupils in each locality we will give free a \$20 superb Violin, Tenor Banjo, Ukulele, Hawaiian-Guitar, Banjo, Mandolin, Banjo-Ukulele, Banjo-Mandolin, Cornet or Banjo-Guitar absolutely free. Also teach Piano and Organ. Very small charge for lessons only. Four lessons will teach you several pieces. Over 100,000 successful players. We guarantee success or no charge. Complete outfit free. Write today, Dept. 148. No obligation. SLINGERLAND SCHOOL OF MUSIC, 1915 Orchard Street, CHICAGO, ILLINOIS



Eliminate the Electrician Everybody's Electrical Handbook

(New edition) tells how to safely do wiring for bells and lighting, also repair electrical appliances. 99 per cent of trouble in appliances can be fixed in a few minutes, yet you pay dollars to have it done. This is the most complete book on everything electrical in the home. Send No Money just your name and address, pay postman \$1.00 plus a few cents postage, or send a dollar bill with order. Money back if not satisfied. Circular Free. HOME BOOK CO., 389 Ed Arcade Bldg., Cleveland, Ohio

ART SUPPLIES

giving prices on all kinds of practical ART SUPPLIES, PENCRAFT SUPPLY SERVICE, Dept. P, 949 Broadway, NEW YORK CITY

STAMMER NO MORE

Kill the fear of stammering. Re-education the key. The widely famed Hatfield Method fully outlined in an accurate, dependable, worthwhile book—"HOW TO STOP STAMMERING." It has inspired thousands. Free copy today. THE HATFIELD INSTITUTE, 109 N. Dearborn, Chicago, Ill.



I Teach Penmanship by Mail

Small Cost, Spare Time. Write for my Free Book, "How to Become an Expert Penman." It contains specimens and tells how others became expert writers by the Ferris Method. Your name written on card if you enclose stamp. Write today.

T. M. TEVIS, Box 25K, CHILLICOTHE, MO

You! can be a \$500 Auto Expert!



“What Big-Pay Work Can I Learn Quickest?”



J. R. Bayston, M.S.A.E., Pres.
CHICAGO AUTOMOTIVE INSTITUTE

Originator of the “Job-Way” System of Training
I give you this Tool Kit FREE and train you to use it



18 Piece Master Mechanics' Tool Kit FREE!

This Complete \$15.00 outfit doesn't cost you one penny! Full size, everything you need to do the “Jobs.” 75 lessons, 150 Jobs, 12 lectures and many Free features in the C. A. I. course. And “Cigarette Money” pays for it!

“THE C. A. I. JOB-WAY TO BIGGER PAY!”

LOAN me an hour of your spare time a day! I'll guarantee to put you in the \$100.00 a week class quicker than you can learn any other big-pay work! **Don't quit your job! Stay home!** Thousands of men **no better than you** are making big salaries, holding down important jobs, earning enormous profits in their own business. I know how you can do the same, and I'll tell you how!

Learn Auto Repairing! Learn Automotive Electricity! Learn Vulcanizing, Welding, Battery!

My copyrighted “Job-Way” system teaches you in an hour what ordinarily takes a month to learn! The speed with which C. A. I. students get ALL the work of the complete course has astonished educators everywhere! So simple a school-boy can understand it. Think of it! 13,000,000 autos to repair each year—13,000,000 batteries to service—13,000,000 ignition systems to keep going—65,000,000 tires to sell and repair—3,000,000 trucks to overhaul. Do you realize how hungry employers are for competent men? Do you know what they're willing to pay for Automotive Experts? Can you imagine the opportunities today to make big money in a business of your own?

Coupon Brings FREE BOOK and FREE LESSON!

I don't ask you to risk a penny. I know you can learn to earn \$3,000 to \$8,000 a year as an Automotive Expert. So I guarantee in writing to return every cent of your money if you don't think it's the most profitable investment you ever made. I want you to send for my free book, read the free lesson, find out about my wonderful “Job-Way” method. See why I offer the most complete Automotive course for the least money, and on easiest payments. Mail Coupon or postal today!

MEN WANTED!

Thousands of big-pay jobs open right now, all over the U. S. Our Employment Service FREE to both students and graduates, reaches employers in every part of the Country. Look at this:

Master Mechanics	\$3,000 to \$8,000
Electrical Experts	- - \$3,600 up
Garage Manager	- - 3,000 up
Battery Expert	- - 2,400 up
Expert Welder	- - 2,400 up
Salesman	- - 3,000 up
Tractor Engineer	- - 2,400 up

My graduates earn money fast enough to go into business. Own your own Garage, Battery Station, Ignition Service, Repair or Welding plant.



Mail Coupon for
FREE BOOK!

Bigger-Pay Coupon!

J. R. Bayston, M.S.A.E., Pres.
Chicago Automotive Institute
Dept. 1773, 536 So. Clark St., Chicago

Without a penny of expense or the slightest obligation, please send me Free Book about your rapid course in Automotive Master Mechanics, and Free Tool Kit offer. Explain your money back guarantee. I want to see a Free Lesson, too.

Name.....

Address.....

CHICAGO AUTOMOTIVE INSTITUTE
J. R. Bayston, Pres., Dept. 1773, 536 So. Clark St., CHICAGO

LEARN AT HOME THE C.A.I. JOB-WAY

Police Sergeant Charles E. Pearce who erected and operated the first successful police radio station in the world—a former student of the Radio Institute of America.



Radio— your chance

From no knowledge of radio—to licensed operator. From operator up the opportunity ladder to the big job at the top. And a life of fascinating interest, well paid. That is every man's chance now that the famous course of America's oldest radio school is offered for home study.

The Radio Institute of America is conducted under the auspices of the Radio Corporation of America, the greatest radio organization in the world. This insures the most thorough and up to date instruction and therefore means preference for positions when you earn your government license.

The demand for trained men is great—and growing. Now, no matter where you live you can study at home under the best instruction. Write today! Get your start—and grow with radio.

Advanced Radio Course

Great popular demand by the advanced student, experienced amateur, and wireless operator has led to the opening of an **ADVANCED HOME STUDY RADIO COURSE**, specializing in C. W., I. C. W., telephone and radio measurements. Investigate!

Radio Institute of America
(Formerly Marconi Institute)
Established 1909

326A Broadway, New York City

Indicate by a cross X the course you are interested in:

Radio Institute of America,
326A Broadway, New York.

Please send me full information about radio opportunities today, and your

COMPLETE RADIO COURSE
ADVANCED RADIO COURSE

Name.....

Address.....

.....

.....

.....

.....

.....

.....

.....

Get Your
Copy of the
**NEW
GIBSON
BOOK**
Free



Stringed instruments are more popular than ever—offer great opportunity for profit and pleasure.

The Gibson Book illustrates and describes The NEW Gibson Master-tone banjo, with its many exclusive features—marvelous tone, easy to play. Also gives complete information on all other Gibson "easy to play" instruments—mandolin, mandola, mando-cello, guitar, mando-bass.

Easy Payments. Write today.

GIBSON, Inc.

311 Parsons St.

Kalamazoo, Mich.

ELECTRICAL men with training are in demand. For more than a quarter of a century this school has been training men of ambition and limited time, for the electrical industries. Condensed course in **ELECTRICAL**

ENGINEERING enables graduates to secure good positions and promotions. Theoretical and practical Electricity, Mathematics, Steam and Gas Engines, Mechanical Drawing. Students construct dynamos, install wiring and test electrical machinery. **COURSE IN ONE YEAR**



Thoroughly equipped fireproof dormitories, dining hall, laboratories, shops. Over 3000 men trained. Write for catalog. 31st year began Sept. 26, 1923.

BLISS ELECTRICAL SCHOOL

104 TAKOMA AVENUE, WASHINGTON, D. C.

LEARN PIANO TUNING

MAKING TRIALS
OF TRUE TONE

By
**TUNE-A-
PHONE**



We furnish our accurate teaching device with tools, action model and lessons. Diploma given graduates. 25th year teaching this art by correspondence. Write today for free booklet and guarantee plan.

WILES BRYANT SCHOOL 30 BRYANT BLDG. AUGUSTA, MICH.

LAW STUDY AT HOME
Become a lawyer. Legally trained men win high positions and big success in business and public life. Greater opportunities now than ever before. Lawyers earn \$3,000 to \$10,000 Annually. We guide you step by step. You can train at home during spare time. Let us send you records and letters from LaSalle students admitted to the bar in various states. Degree of LL.B. conferred. Thousands of successful students enrolled. Low cost, easy terms. We furnish all text material, including fourteen-volume Law Library. Get our valuable 128-page "Law Guide" and "Evidence" books FREE. Send for them—NOW.
LaSalle Extension University, Dept. 364-1 Chicago, Ill.

HOW TO BECOME A PROFESSIONAL PHOTOGRAPHER
EARNING \$35 TO \$125 A WEEK



Three to six months' course. Motion Picture, Commercial, Portraiture. Practical instruction. Modern equipment. Ask for Catalog No. 49.

N. Y. INSTITUTE OF PHOTOGRAPHY
NEW YORK CHICAGO BROOKLYN
141 W. 36th St. 630 So. Wabash Ave. 505 State St.

MINSTRELS Musical Comedies and Revues, with full instructions for staging. You can stage your own show with our books. Full line of plays, music, cross-fire, monologues, afterpieces, vaudeville acts and makeup. Catalogue Free.

T. S. DENISON & CO., 623 So. Wabash, Dept. 19, CHICAGO

TELEGRAPHY

BOTH MORSE AND WIRELESS taught thoroughly. Big salaries; tremendous demand. Oldest, largest school. Endorsed by Telegraph, Railway, Wireless and Government officials. Expenses low—opportunities to earn large portion. Catalogue Free.

DODGE'S INSTITUTE, Jones Street, Valparaiso, Ind.



\$2500 Reward!

For the Capture of an Unknown Man

Twice he had entered the St. Clair Mansion. What was he after? Who? What was in danger?

Berteau, the famous detective, had warned St. Clair that the mysterious marauder would come again. And now—a noise in the passage! The creak of an opening door. A shot in the dark! A capture!

Is this wounded stranger the mysterious intruder? Who could tell? Yet Berteau identified the man without hesitation and won the \$2500 reward.

How did he do it? Easy enough for the Finger Print Expert. He is the specialist, the leader, the *cream* of detectives. Every day's paper tells their wonderful exploits in solving mysterious crimes and convicting dangerous criminals.

More Trained Men Needed

The demand for trained men by governments, states, cities, detective agencies, corporations, and private bureaus is becoming greater every day. Here is a real opportunity for YOU. Can you imagine a more fascinating line of work than this? Often life and death depend upon finger print evidence—and big rewards go to the expert. Many experts can earn regularly from \$3,000 to \$10,000 per year.

Learn at Home in Spare Time

And now you can learn the secrets of this science at home in your spare time. Any man with common school education and average ability can become a Finger Print Expert in a surprisingly short time.

Course in Secret Service

FREE

For a limited time we are making a special offer of a professional Finger Print Outfit, absolutely Free, and Free Course in Secret Service Intelligence. Mastery of these two kindred professions will open a brilliant career for you.

Write quickly for fully illustrated free book on Finger Prints which explains this wonderful training in detail. Don't wait until this offer has expired—mail the coupon now. You may never see this announcement again! You assume no obligation—you have everything to gain and nothing to lose. Write at once—address

University of Applied Science
Dept. 13-53, 1920 Sunnyside Avenue, Chicago, Ill.

UNIVERSITY OF APPLIED SCIENCE

Dept. 13-53, 1920 Sunnyside Ave., Chicago, Illinois

Gentlemen:—Without any obligation whatever, send me your new, fully illustrated, FREE book on Finger Prints and your offer of a FREE course in Secret Service Intelligence and the Free Professional Finger Print Outfit.

Name

Street Address

City and State



High School Course in Two Years!

You Want to Earn Big Money!

And you will not be satisfied unless you earn steady promotion. But are you prepared for the job ahead of you? Do you measure up to the standard that insures success? For a more responsible position a fairly good education is necessary. To write a sensible business letter, to prepare estimates, to figure cost and to compute interest, you must have a certain amount of preparation. All this you must be able to do before you will earn promotion.

Many business houses hire no men whose general knowledge is not equal to a high school course. Why? Because big business refuses to burden itself with men who are barred from promotion by the lack of elementary education.

Can You Qualify for a Better Position

We have a plan whereby you can. We can give you a complete but simplified high school course in two years, giving you all the essentials that form the foundation of practical business. It will prepare you to hold your own where competition is keen and exacting. Do not doubt your ability, but make up your mind to it and you will soon have the requirements that will bring you success and big money. **YOU CAN DO IT.**

Let us show you how to get on the road to success. It will not cost you a single working hour. Write today. It costs you nothing but a stamp.

American School

Dept. H374, Drexel Ave. and 58th St., Chicago

American School

Dept. H374, Drexel Ave. and 58th St., Chicago

Send me full information on the subject checked and how you will help me win success.

- | | |
|------------------------------|----------------------------|
| Architect | Lawyer |
| Building Contractor | Machine Shop Practice |
| Automobile Engineer | Photoplay Writer |
| Automobile Repairman | Mechanical Engineer |
| Civil Engineer | Shop Superintendent |
| Structural Engineer | Employment Manager |
| Business Manager | Steam Engineer |
| Cert. Public Accountant | Foremanship |
| Accountant and Auditor | Sanitary Engineer |
| Bookkeeper | Surveyor (& Mapping) |
| Draftsman and Designer | Telephone Engineer |
| Electrical Engineer | Telegraph Engineer |
| Electric Light & Power | High School Graduate |
| General Education | Fire Insurance Expert |
| Vocational Guidance | Wireless Radio |
| Business Law | Undecided |

Name.....

Address.....

Agents Wanted

to sell the finest **\$31⁷⁵**
ALL-WOOL
 tailored-to-measure
 Suits and Overcoats
 at the sensationally
 LOW PRICE of

You get your profits in advance

Understand that \$31.75 is the price for which you sell to your customers. Understand that at this price you give Guaranteed ALL WOOL Fabrics, hand-tailored, Serge and Alpaca lined. Understand that this price includes a very handsome profit for yourself, and above all understand that you get these profits in advance—cash in hand—every time you take an order.

Now is the time to sign up!

The selling outfit we supply is the greatest thing of its kind ever gotten out. It's put up in a handsome carrying case containing everything necessary to do business—large size swatch samples, more than 100 of them—all guaranteed All-Wool—a handsome fashion portfolio showing all of the very latest style models—elaborate supply of advertising matter—in short everything necessary to enable you to go right out and make from \$75.00 a week up, from the very start, as so many other GOODWEAR men are doing. We can use a few more good men. Experience isn't necessary. Ambition and willingness to work are the required qualifications. If you have them, we'll take you and train you and guarantee to make a successful money-making salesman out of you. When you write tell us about yourself. Address Dept. 803.

GOODWEAR Chicago, Inc.
 West Adams Street at Peoria Chicago

MOVING PICTURE MACHINE GIVEN

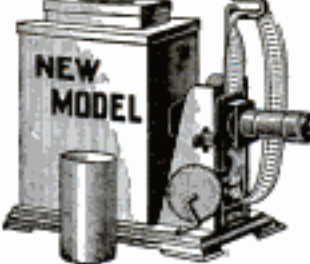

New Model Oil or Electric Moving Picture machine with film—ALL GIVEN for selling 28 pkgs. Bluine at 10c a pkg. Write for them. We send them postpaid. When sold return \$2.80 and we send machine, film and extra premium free set of admission tickets, all charges prepaid.

BLUINE MFG. CO., 856 Mill St., Concord Jct., Mass.

MUSIC LESSONS FREE

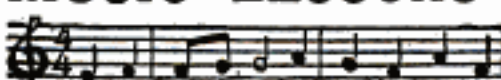

IN YOUR OWN HOME
 You can read Music like this quickly
Piano, Organ, Violin, Mandolin, Guitar, Banjo, etc.
 Beginners or advanced players. One lesson weekly. Illustrations make everything plain. Only expense about 2c per day to cover cost of postage and music used. Write for FREE booklet which explains everything in full.
AMERICAN SCHOOL OF MUSIC, 30 Lakeside Building, CHICAGO

PIMPLY SKIN made WELL

When a few applications of this wonder-working lotion has cleared faces of **pimples, blackheads, acne eruptions** on the face or body, **barbers itch, eczema, enlarged pores, oily or shiny skin**, you can realize why **CLEAR-TONE** has been tested and approved in over **100,000 Test Cases**. The simplicity of the treatment, and **The Story of How I Cured Myself** are all explained in my free booklet, "**Clear-Tone Skin**." Write for your copy today and learn of the results gotten by thousands of men and women.



E. S. GIVENS, 128 Chemical Bldg., Kansas City, Mo.

LEARN AUTOS IN LOS ANGELES!



GREATER OPPORTUNITIES IN CALIFORNIA



Learn the auto business where autos are thickest and opportunities greater. Statistics show California has greatest wealth per capita, finest climate, nearly a million and a half motor cars, and more paved roads than any other state!

Learn the auto business in Los Angeles, where over 10,000 cars are sold per month. There is an automobile in California for every four persons. Besides this, hundreds of thousands of tourists visit the state every year, with their cars. Think of the tremendous business here for garages, mechanics, electrical workers, trouble shooters, tire men, etc.!

YOU CAN LEARN the auto business at National Automotive, just as thousands of others have done. Here at National we teach you auto-electrical work, transmissions, axles, motors, vulcanizing, machine shop, etc., in fact *all kinds of auto work*, all in one great course, for one **LOW** tuition fee.

We CAN and WILL help you get started in this great business. Students come to National from points as far east as Massachusetts. Why? To get **SPECIALIZED NATIONAL TRAINING** that brings success.

Catalog Free! Send the coupon today, **NOW**, for the big **FREE** 84 page catalog, "The Gateway of Golden Opportunity" that explains all about National Automotive; opportunities in California; how we get you a spare time job so you can earn living expenses while attending school; and the many special features of National Training.

It will only take a minute to tear out and send in the coupon. Others are doing it, investigating, coming to school, graduating, forging ahead to success.

SO CAN YOU!

**NATIONAL AUTOMOTIVE SCHOOL,
DEPT. 58, 4004 S. FIGUEROA,
LOS ANGELES, CAL.**

Please send me your 84 page free catalog
"The Gateway of Golden Opportunity"

Name _____

Address _____

National Automotive - Los Angeles



"We pay him \$100 a week"

AND he's worth every cent of it. Came here several years ago asking for a job. He got just that—a small job at a small salary.

"Then I forgot about him—hardly knew he was on the payroll until one day I got a letter from the International Correspondence Schools telling me that he had enrolled for a course of home study. It was remarkable the way he went ahead.

"We pay him \$100 a week now and he's going to be earning even a larger salary some day. I wish we had more men like him."

HOW do you stand when your employer checks up his men for promotion? Does he think of you? Is there really any reason why you should be selected? Ask yourself these questions fairly. You must face them if you expect advancement and more money.

One hour after supper each night spent with the I. C. S. in your own home will prepare you for the position you want in the work you like best.

Yes, it will! Put it up to us to prove it. Without cost or obligation, just mark and mail this coupon.

INTERNATIONAL CORRESPONDENCE SCHOOLS Box 5587-D, Scranton, Penna.

Without cost or obligation, please tell me how I can qualify for the position or in the subject before which I have marked an X:

BUSINESS TRAINING COURSES

- | | |
|--|---|
| <input type="checkbox"/> Business Management | <input type="checkbox"/> Salesmanship |
| <input type="checkbox"/> Industrial Management | <input type="checkbox"/> Advertising |
| <input type="checkbox"/> Personnel Organization | <input type="checkbox"/> Better Letters |
| <input type="checkbox"/> Traffic Management | <input type="checkbox"/> Show Card Lettering |
| <input type="checkbox"/> Business Law | <input type="checkbox"/> Stenography and Typing |
| <input type="checkbox"/> Banking and Banking Law | <input type="checkbox"/> Business English |
| <input type="checkbox"/> Accountancy (including C.P.A.) | <input type="checkbox"/> Civil Service |
| <input type="checkbox"/> Nicholson Cost Accounting | <input type="checkbox"/> Railway Mail Clerk |
| <input type="checkbox"/> Bookkeeping | <input type="checkbox"/> Common School Subjects |
| <input type="checkbox"/> Private Secretary | <input type="checkbox"/> High School Subjects |
| <input type="checkbox"/> Spanish <input type="checkbox"/> French | <input type="checkbox"/> Illustrating <input type="checkbox"/> Cartooning |

TECHNICAL AND INDUSTRIAL COURSES

- | | |
|---|--|
| <input type="checkbox"/> Electrical Engineering | <input type="checkbox"/> Architect |
| <input type="checkbox"/> Electric Lighting | <input type="checkbox"/> Blue Print Reading |
| <input type="checkbox"/> Mechanical Engineer | <input type="checkbox"/> Contractor and Builder |
| <input type="checkbox"/> Mechanical Draftsman | <input type="checkbox"/> Architectural Draftsman |
| <input type="checkbox"/> Machine Shop Practice | <input type="checkbox"/> Concrete Builder |
| <input type="checkbox"/> Railroad Positions | <input type="checkbox"/> Structural Engineer |
| <input type="checkbox"/> Gas Engine Operating | <input type="checkbox"/> Chemistry <input type="checkbox"/> Pharmacy |
| <input type="checkbox"/> Civil Engineer | <input type="checkbox"/> Automobile Work |
| <input type="checkbox"/> Surveying and Mapping | <input type="checkbox"/> Airplane Engines |
| <input type="checkbox"/> Metallurgy | <input type="checkbox"/> Navigation |
| <input type="checkbox"/> Steam Engineering | <input type="checkbox"/> Agriculture and Poultry |
| <input type="checkbox"/> Radio | <input type="checkbox"/> Mathematics |

Name.....
Street..... 11-21-23
Address.....

City..... State.....

Occupation.....

Persons residing in Canada should send this coupon to the International Correspondence Schools Canadian, Limited, Montreal, Canada.



DRAWING IS A WAY TO FORTUNE

Ali Hafed, a Persian farmer, sold his acres to go out and seek his fortune. He who bought the farm found it contained a diamond mine which made him fabulously rich. Ali Hafed overlooked the great opportunity at his door to go far afield in search of wealth—which illustrates a great truth.

EARN \$200 TO \$500 A MONTH

If you like to draw, develop your talent. Your fortune lies in your hand. Present opportunities for both men and women to illustrate magazines, newspapers, etc., have never been excellent. Publishers are buying millions of dollars' worth of illustrations each year. The Federal Home Study Course has been prepared by such famous artists as Noyes McMein, Norman Rockwell, Charles Livingston Bull, Cass Briggs, Sidney Smith, Fontaine Fox and fifty others. Each student gets individual personal attention. No previous training is necessary. Every step is clear and simple. FREE, illustrated catalogue on request. Shows work of students and testimonial letters. Complete outline of course with all the details. Just write your name and address in the margin and send it to us.

Federal School of Illustrating

389 Federal School Bldg. Minneapolis, Minn.

THE JIMMY De FOREST Physical Training System

De Forest has trained or conditioned Ex-President Roosevelt, Elbert Hubbard, Supreme Court Justice Mahoney and many other leading men. Send 10c for booklet on CO-ORDINATION OF MIND AND MUSCLE.

JIMMY De FOREST, Box 3, 347 Madison Ave., New York, N.Y.

Learn Watchwork, Jewelrywork and Engraving.

A fine trade commanding a good salary, and your services are always in demand. Address **Norological**, Dept. P, Bradley Institute, PEORIA, ILL., for our latest catalog.

FINE SUIT FREE

Tailoring Agents Wanted

Spare time will do. Big Pay. Easy work. No experience needed. Only two sales a day gives you \$50.00 a week. I give every active agent a beautiful made to measure suit for himself absolutely free, so he can wear it and show the fine class of tailoring we make. You get this fine suit free, really free, in addition to your big cash profits, just as soon as you take a few orders.

We supply you with the finest tailoring outfit with over 200 big cloth samples, everything you need and full instructions to start right in making from \$50.00 to \$100.00 a week. Write quick for this new sensational tailoring offer, the best ever put out. Tailoring agents everywhere get my new offer. If you want to make big money and get a fine suit free, address

L. E. ASHER, President

BANNER TAILORING CO., Dept. 174 CHICAGO



MEN WANTED! Now As Never Before!

Let these men—Directors of the Associated Electrical Engineers—help YOU to succeed

**\$15.00
to \$35.00
a day in
Electrical
Work—**



A. E. E. BOARD OF ENGINEERS ANNOUNCE AMAZING IMPROVEMENT IN ELECTRICAL HOME TRAINING—OLD METHODS "SHELVED"

Big Pay Electrical Field Now Open to Any Ambitious Man

Do you want to earn \$75 to \$200 a week as an electrical expert? Do you want to get a share of the millions that are being spent in the electrical industry—the fastest growing industry in the world today?

You can do it—now!

For now, at last, electrical home training is offered by a system that takes out all the "kinks"—a training that is absolutely free from technicalities, theories, and things the average man finds it hard to understand.

How the New Way Was Found

Here's electrical home training that's different from any that has ever been offered before!

It is the product of the combined efforts of a powerful group of technical men and educators—the men selected to act as Directors of the Associated Electrical Engineers of America. These men have taught thousands through home training. They have worked "out on the job." They have

TO EMPLOYERS

Our members are the kind of ambitious men that you need in your business—men who believe in electricity and have the vision to grasp opportunity. Write and we will put you in touch with the men you need

studied all that has been done in this great field—and out of their long experience they have found the new, simplified method that is making it easy for ambitious men to get a thorough training in electricity—quickly and at low cost.

Schooled or Unschooled—You Can Understand this Course

The practical-minded engineers of the A. E. E. have made their training so clear and sensible that you don't need a high school or college education to get at the "solid meat" in their System of Electrical Training. You learn by *doing*, not by theory! All you need is education enough to read plain, every-day English. There aren't any frills in the A. E. E.'s simplified training.

You Get Into the Big-Money Class Quickly

By starting you right from the ground up and giving you good, sound, practical information from start to finish, we carry you over the shortest route to the big pay jobs that are now so plentiful in the great electrical field. We know you want action—quick advancement—and our engineers have devised the system that lets you get it!

Wonderful Working Outfit FREE

To let you learn *by doing things*, we supply you with the most practical and complete electrical working outfit ever devised by a home training school. And it doesn't cost you a cent extra. Radio and Automobile electrical training, too, are thoroughly covered in this course.

Backed by Legal Guarantee

The man who becomes a member of the A. E. E. and takes up our course of training, doesn't run any risk at all. Every

penny of the small fee you pay is returned to you if you are not thoroughly satisfied when you finish your training.

With this protection to rely on, you owe it to yourself to investigate the money-making possibilities of the great electrical field and the training system we offer.

BIG FREE BOOK Tells the Story

Our great new book, just off the press, is ready for you. Don't delay! Ask for it now—on the coupon below.

SEND TODAY



Here's Opportunity's Wide Open Door

ASSOCIATED
ELECTRICAL ENGINEERS
Dept. 134, 537 South Dearborn St.,
Chicago, Illinois

Without any obligation, please send me FREE, your 64-page book on Electricity and full details of how I can make big money as a member of the Associated Electrical Engineers.

Name.....

Address.....

Associated Electrical Engineers OF AMERICA

Dept. 134 537 S. Dearborn Street, Chicago

Trained Men Make Big Money in the Auto Business



Six weeks at the Cleveland Auto School will give you a training that is second to none. More than 7,000 of our graduates are now earning big wages in all branches of the business. Many own their own garages and are prosperous and respected members of their communities. You can do the same. A new class starts soon. Write now for full information.

THE CLEVELAND AUTO SCHOOL, 1814 East 24th Street, CLEVELAND, OHIO

WANTED

RAILWAY MAIL CLERKS
\$1600 to \$2300 Year
MEN — BOYS 18 UP.

MAIL COUPON IMMEDIATELY

Steady work. No layoffs. Paid Vacations
 Common education sufficient:
TRAVEL—SEE YOUR COUNTRY



FRANKLIN INSTITUTE, Dept. G179, Rochester, N. Y.

First: Send me without charge, (1) Sample Railway Mail Clerk Examination questions; (2) Send List of U. S. government jobs now obtainable; (3) Send free illustrated book, "How to Get Government Jobs."

Name.....

Address.....

BE AN ENTERTAINER

200 PAGE ILLUSTRATED MAGIC BOOK FREE

Contains latest magician's effect—Great Stage Illusions—Handcuff Escapes—Spirit Tricks—Card Tricks—Jokes—Be popular—go everywhere and entertain.

WRITE US TODAY FOR CATALOG.

HEANEY MAGIC CO., Desk M, BERLIN, WIS.



LEARN TO GET DOLLARS OUT OF WATCHES.
 WATCH-REPAIRING, ENGRAVING, JEWELRY REPAIRING.

WRITE NOW.

ENICAR

TRADE

SCHOOL

230 W MONUMENT SQUARE,

RACINE, WIS.

Mystic Sheik Ring \$1



If you want good luck, wear this ring. Amazing stories are told. A faithful reproduction of the Power Ring of an ancient Egyptian Pharaoh, decorated with his head and intertwined serpents (the emblem of eternal wisdom), set with gorgeous Pharaoh Ruby and Emerald in solid gold filled. Pin a dollar to name and address and rush to us. \$1.15 C.O.D. Increase your power. Act now.

ZODIAC CO.,
 Dept. 808 415-85th St.,
 Brooklyn, N. Y.

Be a JAZZ Artist!

Quickly Learn to Play Your Favorite Instrument in Spare Time at Home— for a few cents a lesson.



Don't be just a listener. Be a performer! Play the kind of music that puts life into a party. Make yourself popular. Earn money. Quickly learn your favorite instrument. It's easy, now! A surprising new method puts you ahead fast. And it's the pleasantest way you ever heard of.

You don't have to know a note at the start. Everything is made absolutely clear. And there are no trick numbers or other "stunts." You learn to play from regular notes. And the entire cost averages only a few cents a lesson!

Piano, violin, saxophone, traps—or any other instrument. Pick your favorite. Practice at home, where no one can bother you. And you'll be amazed how soon you play melodies instead of just scales.

Actually, this wonderful method costs only a fraction of what old, slow methods cost. And many students earn several times the price of the whole course by playing in orchestras, etc., only a few months after beginning. Others say their popularity is worth ten times what they paid.

You're reading this at a lucky moment. The usual low price of the complete course has been cut in half by a special offer—available to those who speak up quick. All you have to do is send the coupon for the free booklet describing the course and the special offer. No obligation. Just a big chance.



LEARN TO PLAY ANY INSTRUMENT

Mandolin	Saxophone
Drums and Traps	Piano
Harmony and Composition	Organ
Sight Singing	Violin
Ukulele	Banjo
Piccolo	Clarinet
Trombone	Flute
Hawaiian	Harp
Steel Guitar	Coronet
Voice and Speech Culture	Cello
Automatic Finger Control	Guitar

Don't delay. Hundreds will want to come in on the special offer. We will also send an Illustrated Folder which proves better than words how delightfully quick and easy the famous Print & Picture Method is. Mail the coupon today—if you want to become an accomplished player in the easiest, best and quickest possible way! Act now. U. S. School of Music, 73 Brunswick Bldg., N. Y. C.

U. S. SCHOOL OF MUSIC, 73 Brunswick Bldg., New York City
 Please send me your free book "Music Lessons in Your Own Home," also, Illustrated Folder, and particulars of your Special Offer. I am interested in the following course:

Name of instrument or course.....

Name.....

Address.....

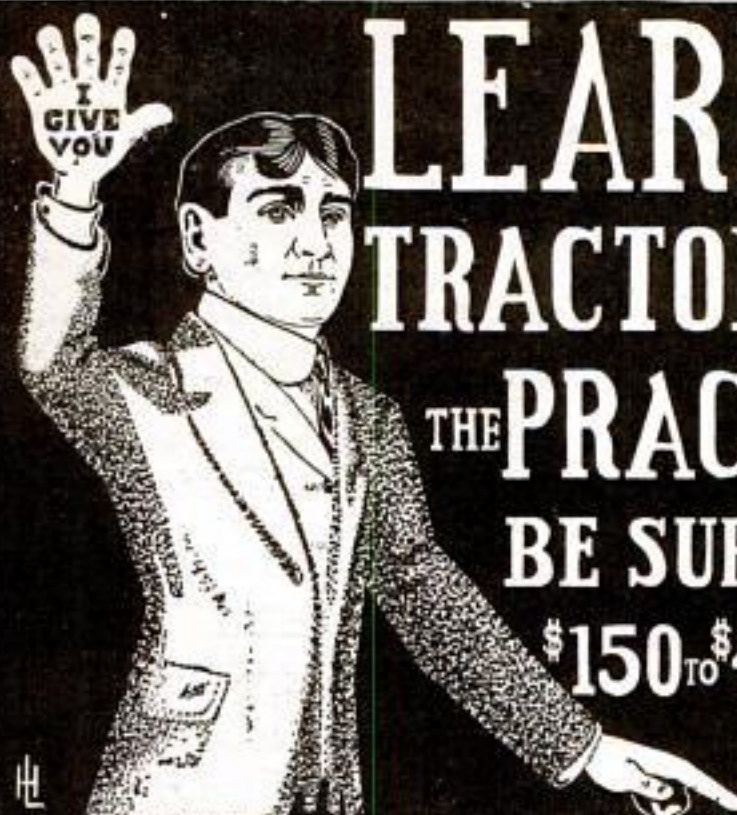

LEARN AUTO AND TRACTOR BUSINESS THE PRACTICAL WAY

BE SURE OF A JOB AT \$150 TO \$400 PER MONTH

THIS IS THE WAY YOU WILL WORK



Work on Real Tractors

No Books
—
No Studies
—
All Practical Work



Repair Shop Practices

Sworn Proof of Success in 8 Weeks IN AUTO BUSINESS

I GUARANTEE TO TEACH YOU THIS BIG PAY TRADE
I teach you the practical way only, with real tools; no books, studies, or blackboard work. Kerr jumped from \$1,248 to \$2,496 a year; Loss jumped from \$24 week to \$75 week; Hartmann's profits average \$400 monthly; I trained them and will do the same for you. Come to my big school shop and work with real tools on actual jobs on automobiles, tractors, trucks and aeroplanes. Just think! 15,000,000 automobiles need attention. You can see the wonderful opportunity awaiting you as a practical, trained mechanic.

YOU CAN OWN YOUR OWN BUSINESS
You, too, can own a business of your own, the same as many of my students are doing, who are making more money than they ever dreamed of making before they took my practical training course. **THINK!**—you make money for others—why not for yourself?

YOU LEARN ALL BRANCHES
My complete auto and tractor course covers all branches of the automobile business. I teach you all about automobiles and tractors, how to build, repair and run them, how to repair tires and radiators, battery repairing, the care and repair of farm lighting plants, welding, salesmanship and garage management, and I give you a complete electrical course which covers every electrical apparatus on automobile, tractor and aeroplane.

MY STUDENTS IN DEMAND EVERYWHERE
Ohio State Practical trained men are in tremendous demand everywhere, because everybody knows they are trained right. This is your life's opportunity, as I positively guarantee to teach you the business in every department. No previous experience necessary and common education is sufficient.

READ WHAT MY STUDENTS SAY
Send for your personal copy of my big 72-Page Copyrighted Book, "Sworn Proof of Success in 8 Weeks in Auto Business." This wonderful, illustrated Catalog is full from cover to cover of pictures of my students at work on actual repair jobs in my big school.

MAKE \$10,000 A YEAR
It gives actual letters from boys I trained and who are now making as high as \$10,000 a year in the automobile, tractor, electrical and aeroplane business. My Catalog also carries endorsements from people who know what you have a right to expect from a training school. I want you to read these things for yourself, so you will know that the Ohio State Practical Motors School is worthy of your utmost confidence and can and does put its students in line for real jobs at big pay.

Write for Catalog NOW!

WHITE STUDENTS ONLY

Ohio State Practical Motors School
D10-3 CINCINNATI, OHIO

D10-3
Send me your FREE 72-Page Copyrighted Catalog of Sworn Proof of Success in 8 Weeks in Auto Business.

Name

Street or R. F. D.

Town..... State.....

Mail this Coupon NOW →

Be Popular, Admired Magnetic, Successful It's Easy! It's Fun! Free Book Tells How



Lionel Strongfort
Perfect Man

The whole secret of compelling personal attractiveness lies in a really strong and well-developed body. But you need not go through a long, hard grind of exhausting physical training to develop yourself. You can now possess the athletic appearance, the charm, the vital powers of a radiant Manhood easily and quickly. All you need do is follow a few simple rules, a few easy movements, that I want to tell you about FREE.

New Book Tells All

Let me send you a copy of my great new book containing a full and complete description of my amazing Science which makes physical supermen out of weaklings. It will show you how to put REAL MUSCLES on your arms, shoulders, chest, back and legs in just a few weeks' time.

Ten Minutes' Easy Play-Time a Day!

That's all it takes. And the results are almost beyond belief. You gain a splendid physique that women admire and men envy. You become magnetic, popular, in demand socially. You acquire the six-cylinder vitality that literally compels business success.

Exhilarating! Wonderful!

Through my exclusive discovery of the workings of Natural Forces, the gaining of marvelous muscular development is easy and as natural as breathing. Best of all, the muscles I put on you are the outward sign of an inward vigor that means buoyant, bounding health. Rich, red blood racing through your veins, exhilarating, energy-giving. No aches—no pains! A glorious knowledge that it is good to be alive!

Happiness Is Yours NOW!

A copy of my epoch-making book, describing my methods in full detail, is yours for the asking. Just fill out the coupon below and mail to me with ten cents (one dime) to cover mailing expense. You'll be glad you did. Put a cross opposite the subjects on coupon on which you want special confidential information. Start TODAY on the road to Health, Happiness, and Social and Business Success.

LIONEL STRONGFORT

PHYSICAL AND HEALTH SPECIALIST

Dept. 1379

NEWARK, NEW JERSEY

Confidential Consultation Coupon

LIONEL STRONGFORT, Dept. 1379, Newark, N. J.—Without obligating me in any way, please send me your 54-page book. I enclose a 10c piece (one dime) for mailing expense. Also send me FREE information on subjects marked (x) below.

- | | | |
|-------------------|---------------------|------------------------|
| .. Colds | .. Bad Breath | .. Billiousness |
| .. Catarrh | .. Poor Circulation | .. Rheumatism |
| .. Too fat | .. Nervousness | .. Increased Height |
| .. Too thin | .. Fear | .. Skin Disorders |
| .. Headache | .. Dependency | .. Stomach Disorders |
| .. Rupture | .. Poor Memory | .. Vitality Restored |
| .. Kidney Trouble | .. Debility | .. Muscular Developm't |
| .. Neuralgia | .. Constipation | .. Great Strength |

Name.....

Age..... Occupation.....

Address.....

NO.1 NO.2
\$2.63 \$3.25

**WEAR SEVEN FREE
DAYS**

OUR MARVELOUS MEXICAN DIAMONDS

have delighted thousands of customers for 18 years. They positively match genuine diamonds. Same perfect cut, same dazzling play of rainbow fire. Stand intense acid test of side by side comparison with genuine. Noted experts positively need their experience to detect any difference whatever. Perhaps the gems you admire on your closest friends are MEXICAN DIAMONDS and you never knew it. Test a MEXICAN DIAMOND FREE! you risk nothing. Wear it seven days side by side with a genuine diamond. If you see any difference, send it back; it won't cost you a cent.

HALF PRICE TO INTRODUCE

To introduce to new customers, we quote these prices which are all you pay and just half our catalog prices.

No. 1—Ladies 1 ct. Solitaires, fine 14k gold L. \$2.63
No. 2—Gents Heavy Tooth Belcher, 1 ct. gem, 14k gold L. \$3.25
No. 3—Ladies 3 stone Duchess ring, fine platinum finish, two 1/2 ct. first water Mex. diamonds, one blue sapphire, \$5.90
No. 4—Gents Ex. Heavy Gypsy ring, platinum finish, black inlay on sides; 1 1/2 ct. first water Mex. Diamond. \$4.98

SEND NO MONEY

Just send name, address and slip of paper that meets around ring finger to show size. Say which ring you want. We ship promptly. On arrival, deposit price with postman. If you decide not to keep it, return in 7 days and we'll refund your money. Write TODAY. Agents wanted.

MEXICAN DIAMOND IMPORTING CO.
Dept. ET LAS CRUCES, N. MEX.

Exclusive Controllers of Mexican Diamonds for 18 years.

ELECTRICITY LEARN AT HOME

Send for catalog which tells how Burgess Home Training enables men and boys to get good jobs and keep them. BURGESS ELECTRICAL SCHOOL, Dept. P3, 741E, 42nd Street, CHICAGO



"BECOME A LIGHTNING TRICK CARTOONIST"

HAVE FUNNY CHAIR TALKING. SEND \$1.00 FOR SWIFT PROGRAM OF TRICK DRAWINGS WITH INSTRUCTIONS BY A PROFESSIONAL CARTOONIST. SATISFACTION GUARANTEED. CIRCULAR FREE. BALDA ART SERVICE, D.I. OSHKOSH, WIS.

Perfect Health Absolutely FREE through a Natural Law

Address ALOIS P. SWOBODA

1237 Berkeley Bldg.

NEW YORK

Try This on Your Hair 15 Days



Then let your mirror prove results Write Today for FREE Trial Offer.

Your hair need not thin out, nor need you become bald, for there is a way to destroy the microbe that destroys the hair. This different method will stop thinning out of the hair, lifeless hair, remove dandruff, darken gray hair or thinned-out or increasing baldness, by strengthening and prolonging life of the hair for men and women. Send your name now before it is too late for 15 days' free trial offer. **AYNES CO., 3932 N. Robey St., M390 Chicago**

DON'T WEAR A TRUSS

BE COMFORTABLE—

Wear the Brooks Appliance, the modern scientific invention which gives rupture sufferers immediate relief. It has no obnoxious springs or pads, Automatic Air Cushions bind and draw together the broken parts. No knives or plasters. Durable. Cheap. Sent on trial to prove its worth. Beware of imitations. Look for trade-mark bearing portrait and signature of C. E. Brooks which appears on every Appliance. None other genuine. Full information and booklet sent free in plain, sealed envelope.

BROOKS APPLIANCE CO., 215 State St., Marshall, Mich.



MR. C. E. BROOKS

Only 50 days Between You and Big Money in AUTOMOTIVE ELECTRICITY



Four Times His Former Salary

"I was making \$40 a week as Head Bookkeeper when I took up your training. Last week I made \$175, and lastly a week passed in which I don't make at least \$100. No labor either. I locate the trouble and the mechanics do the work."

"HENRY L. LUDLOW, Indiana."

**Come to Chicago
or Train at Home
for this New Field
that Covers 78% of
AUTOMOBILE
TROUBLES**



Makes \$1000 a Month

"I trained with you 7 weeks. Then I started right to work with a big garage. Averaged about \$100 a week. After 4 weeks I opened my own shop. Find it easy to get any price I choose to charge. Clearing over \$1000 a month."

"W. C. ELLERD, Neb."

YOU'D probably be willing to take a four year college course if you could earn \$132.00 a week when through. But you don't have to. **FOR YOU CAN BE READY IN FIFTY DAYS** to earn that much and more, just like any number of my former students are doing. Get my book that gives the facts and figures.

Big Jobs Open

This fascinating new profession is clamoring for men. Garage and Repair Shop Owners can get all the ordinary mechanics they need. Mechanics can learn in a shop, but Auto-Electrical Experts are study-trained. That's why shops can't get the man who knows automobile electricity. And yet they have to have him. Auto-owners will no longer pay for 10 hours' service while an ordinary mechanic fiddles around trying to find what is wrong. When you consider that 78% of all automobile troubles are electrical troubles you'll realize why the car owners are combing the market for experts. My free book will give you some surprising facts.

No Experience

Best of all, you can get in this big pay profession in 50 days—without knowing about electricity or automobiles beforehand. If you can read and write, you can succeed. We teach you everything in a practical, brass tacks way, which my book explains fully.

Amazing New Way to Train

When the government needed Auto-Electrical Experts for the war there was no time to waste. Men had to be trained 100% right and sent out almost overnight. The man who invented the 50-day method was the man to whom Uncle Sam went for help. Results were amazing. Never before had such a thing been accomplished by anyone. A complete, practical, thorough training in 50 days. So remarkable that after the war, and at a great cost, it was made available to Ambu students only.

Ambu has even improved on the original plan by **not admitting more than 20 men to a class. No other school does this** and the smaller the class the more you learn. When my graduates are grabbed up at big salaries; when men like Ludlow jump from a \$40 a week bookkeeping job into an income of \$175 a week as Automotive Electrical Expert; when fellows who want to be their own boss, like Ellerd, clean up \$1000 a month; everybody simply **HAS** to agree that Ambu Training can't be beat. Get my book and see the proof.

Get Out of the Grease

I know what a demand there is for my graduates. I know what remarkable earnings they are making. I know how employers are glad to get their services. I have hundreds of letters that show how Ambu graduates "make good." I'll send you copies of them; tell you to write these former pupils; let them tell you what a fascinating, easy profession it is. In my free book I show you how you can get paid big for headwork, not handwork; how you keep out of the grease, lifting, labor, etc., which the ordinary mechanic has to do.

Get FREE Book

Everything is explained in a remarkable eye-opening book that will be a revelation to you. It shows how my graduates are equally expert whether they come to classes here in Chicago or **LEARN IN SPARE TIME AT HOME.**

Get it at once. It is free. If you act quick you'll also be able to take advantage of a most unusual short-time offer I am making. Mail coupon today.

C. J. BUCKWALTER, Pres.

AMBU ENGINEERING INSTITUTE

Dept. 13, 2632 Prairie Ave.

CHICAGO



C. J. Buckwalter, Pres.
AMBU ENGINEERING INSTITUTE
Dept. 13, 2632 Prairie Ave., Chicago

Please send me FREE Book and complete information about the big-pay, unworked field of Automotive Electricity. Explain also your remarkable short time offer.

Name Address City State

EXERCISE!



CHARLES ATLAS

Twice pronounced the World's Most Perfect Man, winning two \$1,000 First Prizes and a Diploma for Physical Perfection. No other living man claims this title.

But do it
Scientifically
and have a
Development
you are proud of

Summer is coming and bathing suits will soon be in style—a man's figure is exposed to the stares of everyone. What will your friends think of yours? Every woman admires a well-developed powerful body. "Skinnies" and "fatties" will be out of luck. But, cheer up; you needn't be one of those they scorn and poke fun at!

Through my instructions you can take off or put on weight wherever you desire. Muscles that are powerful—yet beautiful and symmetrical—will make you the admired instead of the pitied. By JULY you will be a PERFECT MAN—strong, healthy, athletic—with a development the whole world will envy. In three months under my instructions you will be another

man—YOU'LL be proof that perfect men are MADE and not BORN.

Now there is no excuse for YOU to remain a weakling. The secret of how to become a PERFECT MAN by summer is fully explained in my new, big colored book,

"Secrets of Muscular Power and Beauty"

It is lavishly illustrated with large page photographs of myself and many of my pupils. It will fill you with ambition to become a REAL MAN. It shows you how easy it is to make your dreams come true. You will not be obligated in any way. CLIP THE COUPON RIGHT NOW—it will mark the beginning of a new and better life for you.

FREE! Everyone who answers this Ad. will have an opportunity of securing SIX large photographs of myself ABSOLUTELY FREE.

CHARLES ATLAS

96 Fifth Avenue Dept. P. M. 324 New York City

MAIL THIS NOW!

CHARLES ATLAS, Dept. P. M. 324, 96 Fifth Ave., N. Y. C. Please send one of your big, colored books, "SECRETS OF MUSCULAR POWER AND BEAUTY." I enclose a dime to help cover wrapping and mailing charges. This places me under no obligation.

Name

Address

City State

(PLEASE WRITE OR PRINT PLAINLY.)

DRAW CARTOONS

Cartoonists Trained by W. L. EVANS

MAKE MONEY

SOME of the cleverest cartoonists in America today are former students. They studied during their spare time and are now making good money. Cartoonist Evans' system of teaching is so simple, easy and practical that it is not hard to learn to draw originals. The school has a long established reputation and is recommended by well-known cartoonists because they know the students are handled right.

If you like to draw, send us a sample of your work, either a copy or an original. You may have more ability than you think. We will send you a portfolio of cartoons and full details about the school.

The Course is NOT EXPENSIVE

THE W. L. EVANS SCHOOL OF CARTOONING

821 Leader Bldg. CLEVELAND, OHIO



MONEY IN POULTRY

HOW TO RAISE POULTRY FOR PROFIT

RAISE POULTRY for PROFIT

We teach you how. Easily learned at home. We have successful students in all parts of the world. Our proven methods make success certain—indorsed by leading Agricultural Colleges. Send today for Free Book, "How to Raise Poultry for Profit."

THE NATIONAL POULTRY INSTITUTE
Dept. 312-A
WASHINGTON, D. C.



BE THE "BOSS"!

\$60

DON'T WORK for OTHERS

to \$100 weekly writing SHOW CARDS



Learn to make Show Cards—by Miller Mail Method in 60 days—no experience needed. We establish you in own shop, any locality, worth \$60 weekly, up; furnish all material and plan to secure orders from local merchants to do right at home, evenings, if desired. Get into this fascinating, easily learned, profitable business. Cost low—terms easy. Illustrated matter & terms FREE.

EMPIRE INSTITUTE
151 W. 42nd St. New York

These Books Helped 280,000 Men to Bigger Pay

Think of it, 280,000 men are getting Big Money because they own a set of these books. These men do not have to go to school—they need no special training—but, they got into the Big Pay Class with a set of these pay-raising reference books and the Free Consulting Membership. These books and the Membership are their Silent Partners—Always ready to help—Always at hand to advise. Every question is answered and every problem solved.

No matter what kind of work you are doing, don't you think you could learn something from twenty to thirty of the biggest experts in that line? The world's greatest experts have prepared these books to help men who want to advance into BETTER JOBS and BIGGER PAY. Each set is written in plain, every-day language that anyone can understand. There are no puzzling technical terms. They are written in a simple, understandable way that makes them doubly practical. You can put what they teach right to the test in your daily work—you can profit by them at once—you can refer to them dozens of times daily to solve some new problem—you can use their knowledge as a stepping stone to that better position you have had your eyes on for some time—and make them bring to your pockets that fatter pay envelope you have yearned for.

Reference Books That Make Happy Days of Pay Days. Select Your Own Line From This List for Week's Free Use

5 vols. Carpentry and Contracting—was \$37.50 now.....	\$19.80
12 vols. American Law and Practice (including free reading course and 250 page book of standard legal forms)—was \$97.50 now.....	49.80
8 vols. Applied Electricity—was \$60.00 now.....	29.80
6 vols. Auto Engineering—was \$45.00 now.....	21.80
9 vols. Civil Engineering—was \$67.50 now.....	34.80
8 vols. Business Management—was \$52.50 now.....	29.80
7 vols. Steam and Gas Engineering—was \$52.50 now.....	24.80
4 vols. Sanitation, Heating and Ventilating—was \$30.00 now.....	14.80
4 vols. Fire Prevention and Insurance—was \$30.00 now.....	14.80
6 vols. Modern Machine Shop Practice—was \$45.00 now.....	21.80
4 vols. Telephony and Telegraphy—was \$30.00 now.....	14.80
4 vols. Drawing—was \$30.00 now.....	14.80

Free Consulting Membership

A resident consulting staff of from 15 to 20 practical experts is waiting to solve for you any difficulty that you may have. A letter or a wire to American Technical Society will bring you an immediate answer and the solution to your problems. This advisory staff of practical men plus your working and reference library will enable you to handle successfully any job in your line. These men know all the latest methods and the newest and best ways of doing things. Let this pay-raising consulting staff be YOUR SILENT PARTNER. Use this service daily if necessary.

This Free Consulting Membership Offer Is Good for a Limited Time Only and Can Be Withdrawn Without Notice

Use Books Free for One Week—Send No Money

—just fill out the coupon. After you receive the full set of books, express collect, read them over and test them out for seven days. If you don't want them, send them back at our expense. If you decide they will do for you what they have done for more than 280,000 others, pay \$2.80 within one week and \$3 each month thereafter until the special price is paid. This amounts to only ten cents a day. Mail coupon NOW if you want a bigger, better job at higher wages.

Here's your opportunity, if you want to EARN MORE MONEY. Remember, we are taking all the chances—you pay NOTHING unless you are absolutely eager to after seeing the books. Isn't this about the fairest proposition you ever saw in print?

AMERICAN TECHNICAL SOCIETY

Dept. X-319

Chicago, U. S. A.

AMERICAN TECHNICAL SOCIETY, Dept. X-319, Chicago.

Please send me a set of for seven days' FREE EXAMINATION, shipping charges collect. I will examine these books thoroughly, and if satisfied, will send \$2.80 within seven days and \$3 a month until I have paid the special price of \$..... If I decide not to keep the books, I will return them within one week at your expense. It is understood that if I keep the books I am entitled to a FREE Consulting Membership in the Society.

Name.....

Address.....

Reference.....

(Please fill out all the lines, give local merchant, banker or employer as reference.)





in
47
days

**I Trained
 Their Own
 I Will
 do it
 For You**

Look here man! See those pictures. The owners of these garages are getting *dollars* while others pick up pennies. Why? Because I took these men and 60,000 others and fitted them to own their own shops and garages. I did it for them. I can do it for you and I will. In 47 days you can be ready for real money in the auto and tractor business. These men didn't have any more education than you have. But they spent two cents to find out what I could do for them. I ask you just one question—**DO YOU WANT TO BE YOUR OWN BOSS—DO YOU WANT BIG MONEY?** Then read this offer and spend two cents for my big \$1.00 catalog. I'll prove that I can repeat for you.

I Start You in the Biggest Field There Is for Profits

Tire shops, garages, vulcanizing shops, repair shops, filling stations—that's what my students start and earn big incomes from. You know how the auto and tractor field is growing. And how aviation and radio are throwing the door wide open to men who know their stuff. Right now I can't keep up with the demand for men. 20,000 of my students have their own places. The other 40,000 successful are holding the big jobs at pay ranging from \$150 to \$500 a month, and still the calls come pouring in. I'm not promising you a nice, easy, white collar job or business of your own—don't get me wrong. But if a garage or shop, or big money job like these don't beat the "soft snap" white collar jobs at poor pay, then these other students don't know what's worth having.

You Learn With Tools—NOT BOOKS

Everyone of the 60,000 men I've trained is living proof that the **SWEENEY SYSTEM** is the sure way to success in this great field. By my System you learn with tools—not books. When you get through you know! And you can come to the Sweeney School and be trained for so little that it's no wonder a lot of big auto men marvel how I do it.

LET EXPERTS TRAIN YOU RIGHT

Every one of my specially picked instructors is a recognized expert who personally answers to me for every step of your training. Only in this way could I have built the remarkable record of the Sweeney School; only in this way could I have stayed here in Kansas City 15 years and prospered and made so many other men prosper. My instructors know just exactly what you need to make you a real expert—a **Sweeney Trained Man**, always in demand.

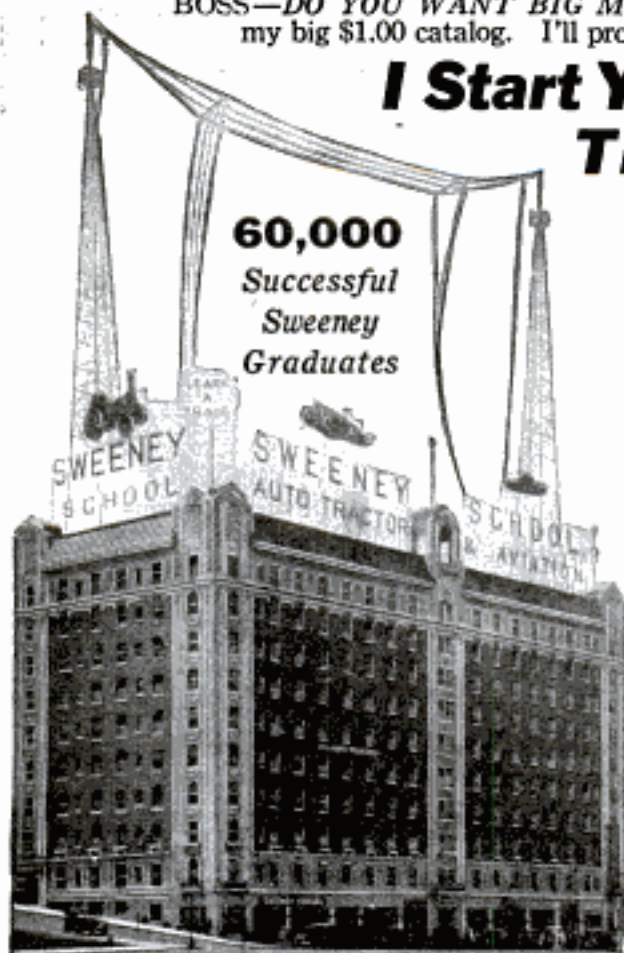

FREE COURSE IN
RADIO

**LEARN A
 Sweeney
 SCHOOL OF AUTO
 37-C SWEENEY BLDG.**

These Men To Have Garages and Shops



In Atinsworth, La., Clayton Eden owns this fine garage and he says he has all the business he can do. He's a Sweeney trained man so it was easy for him to make good.

NATIONAL GARAGE
ROY ATKINSON, PROP.

Roy Atkinson, Everett, Mo., had \$14 only when he persuaded his dad to send him from the farm to me. Now he owns the garage above worth \$4,785.

This FREE BOOK Started 60,000 Men to Big Money—It Will Start You!

Think of it! You have the same chance this minute that these men had. They did exactly what you can do. Send for my book. They started with a two cent stamp. I risked my dollar book against that stamp, as I'll do with you. I proved my case with them, and I trained them in 47 days and lifted them out of nothing into something big. I want to send you my book too, telling you all about my school—its \$200,000 worth of equipment—reading clubs—swimming pool—gymnasium—the spirit and surroundings which make it so wonderful a place of training. I want to tell you more about the Sweeney System—and the FREE RADIO COURSE. Start Now! Be independent—own your own business. Use that stamp now! and send me this coupon—it's your first step to real success. No colored students accepted.



GARAGE IN AUSTRALIA OWNED BY SWEENEY STUDENT

Would you like to own a profitable garage like this one that a Sweeney student has in Australia. He's prosperous now.



I'LL PAY YOUR RAILROAD FARE

I just want to add that I'll pay your railroad fare to Kansas City, "The Heart of America," to start you right in the Sweeney School. From any point in the United States I'll refund your fare. But the first thing to do is to make this one step. Send me the coupon so I can send you my book.

EMORY J. SWEENEY, President,
37-C Sweeney Bldg., KANSAS CITY, MO.

EMORY J. SWEENEY, President
37-C Sweeney Bldg., KANSAS CITY, MO.

Please send me, without obligation to me, your beautifully illustrated 64-page catalog, and your special offer for FREE R. R. FARE.

Name _____ Age _____

Address _____

City _____ State _____

TRADE
new
TRACTOR-AVIATION
KANSAS CITY, MO

NOW ONLY \$2.80 DOWN



AMAZING OFFER! 12 massive volumes — a complete LAW COURSE in book form — a bare fraction of the usual cost! Sent for 7 days' FREE examination. No money down!

12 Big LAW BOOKS

This world-famous library needs no introduction. It is the recognized authority among schools, colleges and practitioners everywhere. It covers every phase of the law including International Law, Patent Law, Mining and Irrigation, Federal Courts and procedure. Nothing is omitted. Think of it—a complete law course in book form, written by the highest authorities in interesting, fascinating form. Prepared especially for home reading, with quiz questions on every subject.

SPECIAL LAW OFFER Reduced from \$110.00

Here is your easiest, quickest and cheapest opportunity to get a legal training at a bare fraction of the usual cost. A complete law course covering all subjects for bar examination. Business firms and corporations are looking for the man who knows law. Gain a knowledge of law and you can command an executive position—a position of responsibility at big pay. Make these 12 massive volumes of over 5,000 pages your law school. Splendidly bound in rich law buckram with red and black labels and titles in gold.

Send No Money FREE READING COURSE

We will ship the complete Law Library right to your home or office for full 7 days free examination upon your simple request. Examine and study them 7 days free. If you decide to keep them pay \$2.80 on delivery and the balance in small monthly payments of \$4.00 until the special price of \$46.80 is paid. If not satisfied the \$2.80 payment is refunded on return of books.

Regular price \$110. Think of it—a saving of \$63.20—and a full year to pay. Act quick as this cut price offer holds good only on 482 sets. So rush the coupon.

THE JOHANSEN CORPORATION, 813 Marshall Bldg., CHICAGO
Please send your 12-volume Home Study Course in Law for 7 days' examination, shipping charges collect. I will pay \$2.80 on delivery as initial payment and \$4 a month thereafter until \$46.80 is paid, or return the books within 7 days at your expense and have initial payment of \$2.80 refunded.

Name

Address

Employed by Age

\$10 required with order outside of United States.

PICTURES HAWAIIAN GUITAR

Show you how to play

in half an hour!

Greatest musical invention of the age. You don't have to know any music at all. Only four motions to learn. No previous musical knowledge necessary. We show you pictures of these so clearly that in half an hour you can play the famous Hawaiian song ALOHA OE and other popular favorites.

HAWAIIAN TEACHERS GIVE YOU PERSONAL ATTENTION

No wonder our pupils say "Easiest, quickest way to play we ever heard of!"

ONLY COURSE GIVING FREE PHONOGRAPH RECORDS

So You Know You Are Playing Right
No wonder thousands have learned this quick easy way. So can you. Just send us your name and address on a post-card, and we will send you circular in colors, giving full details of entire course, so you can prove to yourself right away that this easy picture method is the course which will teach you to play Hawaiian Guitar right away. Send the postcard now. 52 PIECES POPULAR MUSIC FREE.

If you are interested in learning to play the Tenor Banjo, write us for circulars.

of beautiful tone and genuine Hawaiian correct model with full equipment for a limited time only to students who enroll in our conservatory.

FREE \$18 HAWAIIAN GUITAR

New York Conservatory of Music
Desk 52-M, 212 Fifth Avenue, New York

of beautiful tone and genuine Hawaiian correct model with full equipment for a limited time only to students who enroll in our conservatory.



Learn Auto and Tractor Business

EARN \$150 TO \$400 A MONTH

Greater opportunities than ever for **Rahe Trained Motor Mechanics**. Learn here in Six to Eight Weeks. WRITE TODAY for special low tuition rate. Free R. R. fare and board and room offer. No colored enrollments.

RAHE AUTO & TRACTOR SCHOOL
Dept. 1750, 11th & Locust Sts., KANSAS CITY, MO.
Dept. 1750, 316 Forbes Street, PITTSBURG, PENN.

Electrical Course

In Book Form

Here is the quickest, easiest, cheapest way to learn electricity. Think of it! A complete electrical course in book form. No tiresome lessons with a lot of mathematics. Just plain everyday electrical facts—the very things and the only things you need know to hold down a good paying job. Written and simplified by 27 of the biggest men in the electrical field. 8 big books—4100 pages and 2300 pictures.

Electricity Means Success

—Good Pay and a Good Job. You can succeed in electricity. It's one of the best paying fields open to young men who know.

You do not have to give up your present position, just a few pleasant hours spent in the evenings on this subject, and success is yours.

FREE TRIAL!

Just mail the coupon—don't send a cent. We send books for a week's free use. Look them over yourself, and see how thoroughly and completely everything about electricity is explained in them.

American Technical Society
55th St. & Drexel Ave. Dept. E-319

American Technical Society, Dept. E-319 Chicago

Send me your 8 volume set of Electrical Books for a week's free use. I will either return the books in 7 days or remit \$3.00 and pay you \$3.00 each month until a total of \$25.00 is paid.

Name

Address

Employed by

Copy this coupon on larger sheet if more convenient



Imagine *the* Amazing Things They Could Tell You

IF a cave man could come out of the distant past to tell you of his prehistoric life—if Columbus could sit in your library and describe his experiences—if Steinmetz and Darwin, Franklin and Pasteur, Archimedes and a host of others whose discoveries have marked epochs in the progress of science were there to talk to you—what amazing things they could tell you! What a fascinating evening you could spend listening to their stories!

And the things they would talk about, the absorbing stories they would tell of their lives and achievements, are all woven into one great narrative of the miracles of science and presented in

The OUTLINE of SCIENCE

Edited by Professor J. Arthur Thomson

The romance of a thousand thrills is this, revealing the whole wonder world of science—the romance of the heavens—the ascent of man—the invisible world—marvels of animal, insect, bird, fish and plant life—miracles of electricity, wireless, chemistry and hundreds more. So that you may know more about this epoch-making work which tens of thousands are now reading, the publishers have prepared

An Illustrated Booklet *Yours for the Asking*

This profusely illustrated little book, with four plates in full color and over thirty half-tone pictures taken right out of *The Outline of Science* tells how professor Thomson and his associates have told the story of all scientific achievement from the beginning of time. It is a remarkable story of rare interest. And it is yours—free. Just send the coupon—no obligation and no expense.

G. P. PUTNAM'S SONS
Dept. 218 2 West 45th St., New York



G. P. PUTNAM'S SONS, Dept. 218
2 West 45th Street, New York.

Send me by mail, without cost or obligation on my part, the free booklet with four color plates and over thirty half-tone illustrations, describing *The Outline of Science*.

Name

Street and No.

City and State

Occupation

Learn Cartooning



BRANNER

WINNIE WINKLE

When I consider the small investment I made in taking your course and the enormous profits I am making now I feel like a profeer.

M. M. Branner.



GENE BYRNES

REG'LAR FELLERS

I attribute my success to the thorough and highly competent course I received from you.

Gene Byrnes.



FRECKLES

More words cannot express my appreciation of the course of lessons I received from the Landon School.

Merrill Blosser.



EDWINA

"CAP" STUBBS
No one could take your course and regret it — your instructions made it possible for me to do the work.

Edwina Dumm.

At Home in Your Spare Time by the World Famous Landon Picture Chart Method

YOU can learn to make original drawings with the aid of this remarkable method, just as easily as you learned to write. A series of big picture charts with each lesson of this great course, explains step by step, just how to proceed in making original drawings of your own. Every detail of cartoon drawing is fully covered throughout this complete course. Instructions on originating cartoon ideas are also included. A complete criticism service gives you the full benefit of the experience of one of America's foremost newspaper artists.

Newspapers want more cartoonists and comic artists trained to do snappy original work. That's why they are constantly employing Landon-trained cartoonists, who are now earning [from \$50 to \$200 and] more a week.

RESULTS TELL THE STORY

Here are four of the famous characters created by Landon students who have attained national reputations as Comic Strip Cartoonists. Hundreds of former students of this School are producing cartoons on political and national affairs, sports, comic strips, etc., for leading newspapers and syndicates all over the United States and Canada. Many newspapers now employ from two to five students of this School; one big newspaper employs nine. Many successful students who prefer to work at home are selling their drawings by mail. The record of results produced by this School is evidenced in the increased demand by Newspaper Editors for Landon graduates.

Send NOW for complete information and sample Picture Chart to test your ability. Please state your age.

The Landon School
1238 National Bldg., CLEVELAND, O.

BE A RAILWAY TRAFFIC INSPECTOR

POSITION GUARANTEED

PAYING

\$110⁰⁰—a Month

and Expenses Upon Graduation



Earn Up to \$250 per Mo. in this Uncrowded Profession

MANY favorable opportunities for trained Railway Traffic Inspectors—advancement rapid with experience. Fascinating, out-door work; opportunities for extensive travel; report direct to railway executives.

Prepare at home in spare time. Upon graduation, position is GUARANTEED paying at least \$110 a month and expenses or your money is refunded.

Appreciates Value of Training

Mr. Solomon Burstein writes: "I thank you for the diploma and also for your kind assistance rendered to me while studying your course in Traffic Inspection."

"There were some lessons easy and some difficult but taking it all in all your course was presented to me in such a way that even the difficult lessons were not so hard after all. I also appreciate your extra assistance you gave me on subjects I did not understand in your lessons."

"I have recommended two of my friends to take this course."

Hundreds of Openings

Railways need more trained Traffic Inspectors. We must supply them. YOU can qualify, quickly, easily. Cost moderate; easy terms. Send coupon today.

Standard Business Training Institute
BUFFALO, N. Y.

Standard Business Training Institute
Buffalo, N. Y.

Send me, entirely free, Booklet No. D-63, giving full particulars about course in Railway Traffic Inspection.

Name _____
Street _____
City _____

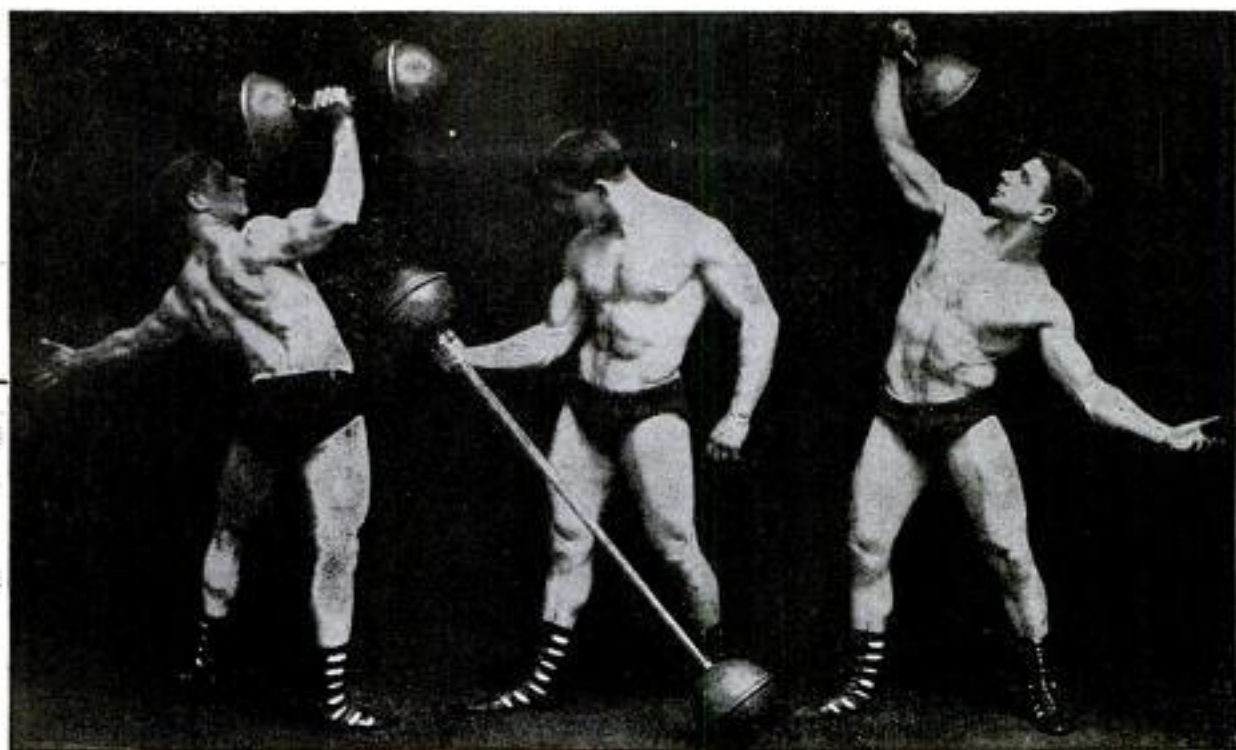

In these pictures Mr. Klein is posed with a "Milo Duplex" Combination Bar-Bell; one of the many types of bar-bells we manufacture.

WHAT IS A BAR-BELL?

A BAR-BELL is simply a long-handled dumb-bell. It has many advantages over a pair of dumb-bells. For instance, it is far easier to handle a 50 lb. Bar-bell than two 25 lb. dumb-bells. Again, with a bar-bell you can do certain back and leg exercises where it would be awkward to handle a pair of dumb-bells. The bar-bell became

THE GREATEST of ALL BODY-BUILDERS!

when the adjustable feature was added—for then it became possible to employ the **progressive method** of exercise which has proven to be the only way in which a man of below-average physique can gradually but steadily improve his build, his muscular development and his stock of organic vitality until he becomes a physical superman—the very pattern of health, strength and manly beauty.

By Using a Bar-Bell You Can Become a Physical Superman

With every bar-bell we sell, we give courses in training to suit the individual purchaser. Our pupils vary in age from fourteen years to as old as sixty-four. We have seen slender young pupils gain as much as **twenty pounds** in weight, and **six inches** in chest measurement in the first six weeks they were under our training. We have taken stout, middle-aged parties and shown them how to regain the fine proportions, the elasticity and the vigor of athletic youth. We get orders from hundreds of business men and office workers, and we show them how it is possible to get the greatest possible results in the shortest possible time. (Possibly forty per cent of our patrons are indoor men.) One of our greatest delights is taking husky farmers, outdoor workers, and gymnasium devotees and show them what **real strength** and development is like. Every case is individual with us and we have handled so many different kinds of health-seekers, shape-seekers, and strength-seekers that it is hardly possible your case would present any new problems for us.

We Give Unlimited Service and An Absolute Guarantee

With us it is not a case of giving you so many "lessons" and then forgetting you. You are our pupil as long as you own the bar-bell you buy from us. You may be in such condition that we can give you the kind of developing work that makes you gain at a rate so rapid that you will be amazed. Or it is possible that you are in such a run-down or absolutely undeveloped state that we will have to start you with the bell adjusted to very moderate weights, put you on a mild progressive schedule, and **coax** your body to its proper proportions and teach you how to accumulate a stock of reserve vigor and health. All of which is part of our job, and what you pay us for. All our goods are sold on the same understanding. If within ninety days after enrolling you are not satisfied with the results, you can return your outfit and have your money refunded. For years we have kept a careful record and find that the proportion of returns is $\frac{1}{4}$ of 1 per cent. In other words we satisfy 299 out of every 300 customers. (We never expect to be perfect.)

We Make Adjustable Bar-Bells of All Varieties

Every outfit we make is a combination affair, which can be used as a bar-bell, a dumb-bell or as a pair of kettle-bells. Every part of each outfit is adjustable in weight. Some types have hollow spheres which can be loaded with iron plates of assorted sizes (this type is shown in the picture). Other types load both with lead shot and iron plates. Still others have no covering spheres, but consist just of an assemblage of iron plates and the different handle bars. We make bar-bells of **Different Styles—Different Sizes—Different Prices**, but every outfit we make can be adjusted to such a moderate weight that it can be easily handled by the weakest and smallest man, and yet can be almost instantly adjusted to a weight that would tax the strength of Samson.

Send at once for our big booklet, "Health, Strength and Development and How to Obtain Them," and the special pamphlet, "How Much Can I Improve—At 20 Years—At 30—At 40 Years."

BOTH FREE ON REQUEST

THE MILO BAR-BELL CO.
Diamond and Third Sts., PHILADELPHIA, PA.

M-3-24

THE MILO BAR-BELL COMPANY
Diamond and Third Sts.
Philadelphia, Pa.

"Gentlemen: Please send me without obligation on my part your free booklet, "Health, Strength and Development and How to Obtain Them." Also your pamphlet entitled, "How Much Can I Improve at 20—at 30—at 40 Years?"

Name

Address

City

State

Big Pay

in the Automotive Industry

after 10 weeks' training at the

Stewart Automobile

School in New York

THOUSANDS of successful graduates will testify to the excellent training they received while learning all branches of the automobile industry in the big, well equipped shops of the Stewart Automobile School. But the best proofs are the businesses which they own, the big pay jobs they are holding down and the places in the world's greatest industry which they occupy.

You can do it too—

The Stewart system of personal instruction guarantees you thorough training and complete satisfaction before you leave the School.

Read the guarantee in our catalogue.

Our instructors are the best obtainable. They study your individual needs and adapt their teaching accordingly. It is on the principle of personal interest and personal instruction that the School has achieved the enviable reputation it enjoys in the automobile industry.

The Stewart Automobile School was founded in 1909 and has prospered for 15 years. It has been growing steadily all that time. But never has the principle of personal instruction been lost sight of. The Stewart School is *not* a factory, where men come in one end and go out the other. It never will be. "Quantity production" is not our aim. "Quality instruction" is.

Only 10 weeks—then you can hold down a big-pay job

There are more big-pay jobs in the automobile industry than there are trained men to fill them. One of these jobs is waiting for *YOU*. You should act at once to take advantage of this opportunity.

The fully illustrated catalogue, which you will receive without charge when you send in the coupon below, explains, in detail, our remarkable combination shop course and the various special courses you can take.

Send for this free catalogue today.

Do not put it off. Learn the advantages of preparing yourself, right in the heart of New York, for this great opportunity and how we will help you to "earn while you learn."

The actual photographs will show you how our students work with *tools*, not books. Hundreds of other interesting and valuable facts are in the catalogue.

Do not delay—Act NOW

You cannot afford to wait. The opportunity is here. It is up to you. Your catalogue is waiting for your name and address. *Write today.*

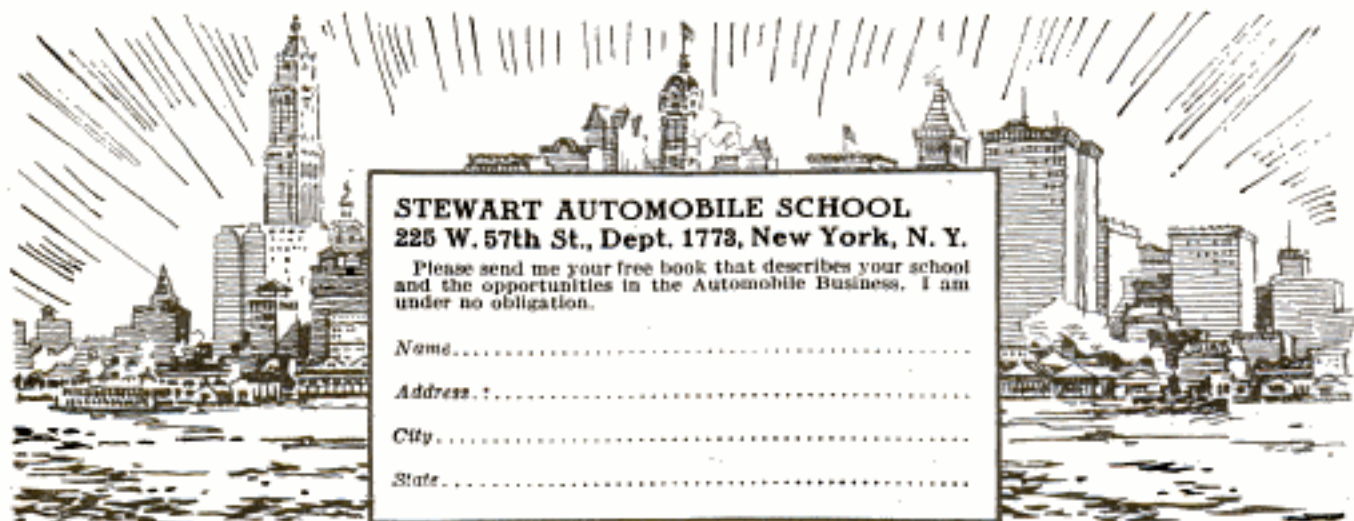

STEWART AUTOMOBILE SCHOOL
 225 W. 57th St., Dept. 1773, New York, N. Y.

Please send me your free book that describes your school and the opportunities in the Automobile Business. I am under no obligation.

Name.....

Address.....

City.....

State.....

How I Average \$12 a Day in RADIO WORK

By Howard Houston

"YES, Mr. Crosby, I'll have the set installed to-night . . . yes, all ready to 'listen in' . . . sure you'll be able to get Washington by 9 o'clock."

Another hour and a half job! And another ten dollar bill in my pocket! It all seems like a dream. But let me tell you the whole story from the very start.

A few months ago, I was driving a bread wagon, selling bread to retail stores. I had a good route though, and if I do say so myself, I had built up a pretty good business. But try as I could, thirty-five dollars a week was all I could make that job pay.

I'd be working there now if it hadn't been for Mary. We'd been 'keeping company' for about two years, and everything was all set for our getting married as soon as I would be earning more money. But the old job didn't hold out much promise—and I didn't see how I was qualified for any other work that would pay more.

It was Mary who gave me the tip. "You can't earn big money," she said, "unless you're some kind of a specialist. Learn some line of work—become an expert in it." But what business, profession or trade was there that wasn't overcrowded? Where could an ambitious fellow stand a good chance to earn big money and get ahead. Stenographers, accountants, clerks—all down the line—every well established line of work was overcrowded, and the pay was small.

Then Mary said, "Why not find a new field?" That was a good thought. The men who went into the railroad business early "cleaned up." The same was true of the movie game, the automobile business—but what was the coming field? What new development was there that looked like a new promising industry?

We both jumped to our feet. "RADIO."

Why hadn't we thought of it before! All around us was the evidence of the tremendous development of Radio. The broadcasting stations sprouting up all around—the rapid increase in Radio Stores—new radio manufacturing plants—everybody talking about the latest radio program. Radio had captured America almost overnight—and thousands of men who were on their toes were due to make fortunes out of it.

Thousands of Men Needed

The very next day after I had finished my route, I went to several radio business firms. "Sure, there was an opening. Oh, they'd pay big money—but did you know Radio?"

That was my cue. Learn Radio. Become a Radio Expert—and I did!

Well, that really is my whole story. I've only started. I've followed the path of least resistance. Sort of built up a business of my own installing, building, and repairing radio sets. Any small job pays me at least \$5—and usually \$10. I can easily make from \$50 to \$100 a week—and more as I get my work systematized.

What Mary and I have got to decide after our honeymoon—oh yes, we are soon having a very quiet wedding—what we must decide after that—is which end of Radio will be best. You see there are dozens of different kinds of work in this field, it's so big. I've already had several offers—one to take charge of a radio department, another with a broadcasting station, another to give radio entertainments, and a good offer as superintendent of construction in a radio plant. What we want to decide on is which will not only pay the most money now but will lead to the most rapid advancement in the future.

Easy to Learn Radio at Home in Spare Time

Just a word about this Radio business. Some fellows think you've got to have some training before you start to learn Radio. That's bunk. I didn't know the difference between an amplifier and a doorknob before I started. But let me give you a tip. Don't experiment with your radio course. Get the best. The National Radio Institute has been teaching Radio ever since 1914. The government recognizes its course by allowing credits to its graduates when they are trying for a license, so you see you can be confident you're getting the best training possible—and that means a lot.

Send for Free Book "RICH REWARDS IN RADIO"

Incidentally, the National Radio Institute publish a mighty interesting book on Radio. They send it out without cost to anyone who wants to learn about Radio. It is filled with facts, photos, and figures on the Radio Industry, and tells all about its course which quickly prepares you right at home in spare time for one of the big pay positions in Radio.

Take my advice—and Mary's—and send for that, no matter how little you know of Radio, or what your plans are. Just mail the coupon for it now!

NATIONAL RADIO INSTITUTES, Dept. 15CA, Washington, D. C.

Please send me without cost or obligation your Free Book "Rich Rewards in Radio" which tells all about the opportunities in Radio, and how spare time study at home will qualify me for a big paying radio position. Also full details on your Free Employment service.

Name.....Age.....

Address.....

City.....State.....



"I've got Washington—and it's coming over clear as a bell."

Pick Your Own Job!

<p>Railway Mail Clerk \$1600 to \$2500 a year 6 days on, 6 days off. Paid all the time. Opportunity for travel.</p> <p>Post Office Clerk \$1400 to \$1800 a year 8-hour day. 15 days' vacation, 10 days' sick leave with full pay. Promotion to positions paying \$5400 a year.</p> <p>City Mail Carrier \$1400 to \$1800 a year 15 days' vacation, 10 days' sick leave with full pay.</p> <p>R. F. D. Mail Carrier \$1800 to \$2600 a year A fine job for men in small towns or on farms. 15 days' vacation, 10 days' sick leave with full pay every year.</p>	<p>Customs Inspector \$4,000 to \$6,000 a day Yearly bonus of \$240.</p> <p>Departmental Clerk \$1100 to \$2000 a year and up 7½-hour day. 30 days' vacation, 30 days' sick leave with full pay every year. Extra bonus every year of \$240.</p> <p>Postmaster \$1000 to \$3500 a year Now a Civil Service position. Carries with it great honor and importance. In small towns a very profitable job.</p> <p>Internal Revenue Men \$4,000 to \$6,000 a day Yearly bonus of \$240. Other fine jobs listed in FREE CATALOG. Write for it today.</p>
---	--



I'll Show You How to Get It

Which of these splendid positions do you want? Choose it now, and I will show you how to get it in the easiest, quickest way. I have helped thousands now holding well-paid Government positions, and I can help you, too. For years I was official Civil Service Examiner, and I know just how to train you to pass examinations with high rating, so you SURELY QUALIFY for first positions open. I guarantee my instruction gets you the job you want—or it won't cost you a cent!

Stop Worrying About the Future Get one of these splendid Civil Service positions and your worries about work and pay are ended. Pay is from \$1,100 to \$3,000 to start; work is steady, hours are easy, you get vacations with pay. Work at home, in Washington, or travel. Examinations for some positions coming soon. Get ready now.

FREE Big Book About U. S. Civil Service

If you are an American citizen, 18 years or older, you can get a Government Civil Service position. Find out how you can easily qualify, in your spare time at home, for one of the positions shown in the panel above. Send at once for my handsome 46-page book about the U. S. Civil Service. Get the facts about how I can help you land a steady, good-pay position with the Government. Mail coupon or postal card at once.

Arthur R. Patterson, Principal
Patterson Civil Service School
83 Wisner Bldg., Rochester, N. Y.

PATTERSON CIVIL SERVICE SCHOOL
83 Wisner Building, Rochester, New York

Send me your big FREE BOOK and tell me how I can secure a position with the U. S. Government paying from \$1,100 to \$3,000 a year to start, with excellent chances for advancement. This doesn't cost me a penny.

Name

Address

City.....State.....

Professor Harry S. Six, for 21 years head of music dept. of New York University, who personally teaches you. His new picture method enables you to play a real piece of music the first day.



You can Play this Tenor Banjo Same Day You Get It! I'LL SHOW YOU HOW!

My New Picture Method

of teaching TENOR BANJO is so easy that you will play a real piece of music the first day. Pupils say, "Why didn't anyone think of such an easy way before? We never knew we could learn to play so quickly. Your course is wonderful." No knowledge of music needed.

I Play It for You First

This is the only course in existence that gives you free phonographic records of myself playing the piece you are learning. It's just as if you were getting the lessons from me in person. You learn to play by my quick and easy method, and then on the phonographic record I play it for you.

Be Popular

Remember that you get my personal attention all through your full course of 52 lessons. Every letter you get will be signed by me—Professor Harry Six—because it's my job to see that you learn to play right away. You will play right off with my method—next week you'll be in more advanced pieces—and in a short time you'll be playing Bee's Knees, Crying for You. You've Got to See Mama Every Night, and all the popular airs.

Popular Songs FREE

With each of the 52 lessons we give absolutely free a popular song, so you will know all the favorites.

Professional Full Size Tenor Banjo FREE!

For a limited time only to students who enroll in our conservatory we will give absolutely free \$18.00 full size professional tenor banjo. This is a big offer for people who love music and who have never been able to produce it. Send us your name and address on a post card for circular giving full particulars on just how Professor Six has been able to teach thousands to play—and how he can teach you so you will play from the first lesson on. Send the post card today, as Professor Six can give his personal attention to a limited number only, and you want him.

NEW YORK CONSERVATORY OF MUSIC
212 Fifth Avenue, Desk I-M, New York

Get this Wonderful Book without cost



It is written by the man who has trained many of the world's greatest strong men. It tells you how to develop

Vitality, Energy, Endurance, Nerve Strength, Muscular Strength, Perfect Physique.

My new 64 page book, "Building Better Bodies" is just off the press. It contains the kind of clearly written information you want, including 30 halftone illustrations of my pupils now among the professional ranks. It tells you, if you are weak and underdeveloped, how to grow strong; if strong, how to grow stronger. It explains how to develop the lungs and muscles—a strong heart and vigorous digestion—in short, how to improve health and strength internally as well as externally.

PROF. TITUS as he is today

If you will send me 10c in coin or stamps to help pay postage and wrapping, I will mail you a copy at once. Send TODAY—NOW

PROF. H. W. TITUS 105 E. 13th St., Dept. 56 NEW YORK CITY

ELECTRICITY

offers
\$3000 to \$10000
Jobs After Only
20
WEEKS TRAINING
in Your Own Home!

Remarkable "Shop Type Home Training System" trains you for the Higher Paying positions in Electricity—and gives you an authorized diploma endorsed by the Lincoln Institute of Technology.



FREE!

Here is an amazing booklet that is showing hundreds the way to big money in electricity. Sent you absolutely free, without obligation, by mailing the coupon below.

Amazing S & H Shop Type Training Prepares You Quickly for the Better Job

DON'T be satisfied to become an ordinary Electrician. Our remarkable new method enables you to Aim Higher, and Get Higher—it places the Big Pay jobs at the top of the profession at your disposal. It is different from all other courses.

A Master Course

This new system was designed by S. V. Smith, called by his friends the "Electrical Wizard" because of his ability to teach electricity and because of the reputation and high positions attained by those whom he has taught.

This Shop Type Home Training System—which makes you so efficient—is an exclusive copyrighted feature of S & H Training.

It gives you all the theoretical knowledge of electrical principles that is taught in Technical Universities—with a diploma actually certified by the Lincoln Institute of Technology. That is something the student of no other Electrical School can get.

Actual Shop Methods in Your Own Home

But, in addition, it gives you the Practice that a man gets only from doing practical work, which is something the College student does not get. The men at the head of big Electrical Plants—the men in the \$10,000 jobs—must have both the Theory and the Practice. S & H and Lincoln "Tech" Training gives you both.

If you are able to read and write ordinary English, we can train you to do house wiring, central station and power house operation, automotive and tractor electricity, electric welding, armature winding, motor and generator work, etc., so that when you are in charge of a plant you can tell every man in it

what to do and how to do it. Because Mr. Smith has devised numerous shortcuts, this Extra Training takes no longer than the ordinary courses.

Free Outfit

To all who send coupon at once, Mr. Smith offers, Free, a complete outfit of Electrical Apparatus, Instruments and appliances for experimental and practical home shop work. By enrolling now you will be entitled to this outfit—but you must send coupon immediately.

Free Employment Service—Act Quick!

Do this today. Get our big catalog giving information about this amazingly rapid and easy course. Read in it the letters from other students who have attained big success through S & H Training. This catalog will also explain the remarkable service rendered our students by the S & H Employment Bureau. This service is offered absolutely free. Mail coupon now.

S. V. SMITH

S & H ELECTRICAL WORKS

Dept. C-1 1422 West Monroe Street, Chicago, Ill.

Affiliated with the Lincoln Institute of Technology

Mail for FREE Offer

Chief Engineer Smith, S & H ELECTRICAL WORKS
 Dept. C-1, 1422 West Monroe Street, Chicago, Ill.

Please send me catalog and full information about the remarkable S & H Course, your Free Outfit, your Employment Bureau, etc. This information is free and does not obligate me in any way whatsoever.

Name.....

Address.....

City..... State.....

McGraw-Hill HANDBOOKS

The Standard
Reference
Books
of the
World

THE combined sale of the HANDBOOKS listed below is close to 300,000—convincing proof of their popularity with the practical man. Each of these HANDBOOKS is the standard in its field—the book by which all others are judged. These books make the day's work easier and the pay envelope bigger.

American Machinists' Handbook

758 pages, profusely illustrated, flexible, \$4.00

This is the world's most widely used technical reference book. It is the one book that every machinist, toolmaker and draftsman should have. Its 758 pages are packed with tables, formulas, kinks and shortcuts that will be found constantly useful.

American Electricians' Handbook

323 pages, 900 illustrations, flexible, \$4.00

Croft's American Electricians' Handbook is undoubtedly the most complete—the most useful electrical handbook ever written. Jammed to the covers with helpful facts and figures on every phase of electrical work. Over 47,000 copies in use.

Tulley's Handbook of Steam and Electrical Engineering

1072 pages, 600 illustrations, flexible, \$4.00

This book has helped thousands of men to pass examinations for an engineer's license. It covers in one handy volume everything the steam engineer wants to know about engines, boilers, pumps, indicators, condensers, electricity, etc. Now in its sixth edition.

Dibble's Plumbers' Handbook

629 pages, 316 illustrations, flexible, \$4.00

This book covers practical plumbing work from A to Z. It contains the latest methods in plumbing and sheet metal work and will prove itself worth many times its price to the master plumber and his helpers.

Good's Ford Car, Truck and Tractor Repair

229 pages, 32 illustrations, flexible, \$2.00

This book was written by Alfred A. Good, formerly director of the Ford Motor Company's Service School. It shows repairmen, garage mechanics and owners the most efficient way to repair products of Ford factories.

Hall's Handbook of Business Correspondence

1048 pages, illustrated, flexible, \$5.00

Written by one of America's foremost advertising men. A book for every man who wants to know how to write effective business letters.

Just Send the Coupon

Pick out the book that interests you most and we will send it to you for 10 days Free Examination. No obligation, no money in advance.

10
Days
Free
Examination

FREE EXAMINATION COUPON

McGraw-Hill Book Co., Inc.
370 Seventh Avenue, NEW YORK

Send me for 10 days' examination the book or books checked below:

- | | |
|--|--|
| <input type="checkbox"/> American Machinists' Handbook | <input type="checkbox"/> American Electricians' Handbook |
| <input type="checkbox"/> Tulley's Handbook for Engineers | <input type="checkbox"/> Dibble's Plumbers' Handbook |
| <input type="checkbox"/> Good's Ford Car Repair | <input type="checkbox"/> Hall's Business Correspondence |

I agree to remit for the book selected or return it to you postpaid within 10 days of receipt.

Signature.....

Res. Address.....

City and State.....

Your Employer.....

Your Occupation.....

PM 3-24

What About Radio in 1925?

Can You Keep Pace with Its Progress?

While RADIO is now a very big institution, it is true, nevertheless, that there will be many new developments, some new parts, and many new "hook-ups" before RADIO attains its final state of perfection. Can you keep track of all these changes—to-day, to-morrow, in 1924, and in 1925?

LEFAX RADIO HANDBOOK PERPETUALLY UP-TO-DATE!



LEFAX RADIO HANDBOOK always keeps pace with new developments in Radio—the book is loose-leaf, and every month to every purchaser of the book is sent additional pages that keep the book up-to-date. No extra charge for this service for one year. Written by the two chiefs of the RADIO dept. U. S. Bureau of Standards. Fine imitation morocco leather cover.

Price \$5 postpaid, complete with year's service
POPULAR MECHANICS BOOK DEPT.
200 E. Ontario St., CHICAGO

POPULAR MECHANICS LATHE HANDBOOK NO. 1



Popular Mechanics NEW LATHE HANDBOOK

Contains the experiences of 106 successful lathe operators in the U. S. and in the principal foreign manufacturing countries. 83 articles tell how to make special lathe tools and attachments. 33 tell

how to make gauges and indicators. 23 describe special devices for holding work. 9 special lathe centers are explained. 29 articles tell how to do unusual jobs on the lathe. 28 tell how to do boring and drilling jobs. 11 are on thread cutting. And 32 describe special methods for miscellaneous lathe work.

212 Illustrations The pictures make it easy for a beginner to understand the descriptions which are essentially for those experienced in lathe work. Every article, however, is written so anyone can understand it, and every kink has been thoroughly tested.

377 Items Indexed No matter on what sort of lathe job you need help, you are almost sure to find it by referring to the index of Popular Mechanics New Lathe Handbook. Within the book itself, the articles are classified by the subjects that are of most concern to lathe users. For example, you will find the articles on special lathe tools grouped so that you have several ideas on tools before you at one time.

Remarkably Low Price Although this book includes some of the most valuable helps ever collected for lathe operators, the price is extremely low. It is the same as the price on all Popular Mechanics Handbooks—**50c**

Send 50c today for Popular Mechanics New Lathe Handbook.

POPULAR MECHANICS PRESS
Room 503, Popular Mechanics Bldg., Chicago, Ill.



Would you like to earn \$5,000 or more a year? Be an AUTO EXPERT!

You may
have
your
choice
of
these
jobs

Turn Your Idle Hours Into Golden Dollars

You want big money—a real job. My training fits you to get both. You don't have to leave home; you don't have to give up your present job; you don't have to risk a single dollar. My system of home training will fit you for a great money-making position in a few short months. All you need to become a master automotive expert is ability to read and write—and ambition to get ahead. I'll do the rest—in fact, when you enroll with me it's just like having

Your Success Guaranteed

Automotive Expert
\$3,000 to \$8,000



Automotive Electrician
\$3,600 to \$10,000



Manager or Owner
\$3,000 to \$12,000



Be trained in the only school of its kind headed by a **Practical, Experienced Automotive Expert.** I know the bigness of the field. I know what every man has to know to win. I know how to point out the way to success—and big money. 14,000,000 passenger cars need attention, 2,000,000 trucks demand service. Farmers insist on experts for their tractor repairs. Aviation engineers make enormous salaries and the industry is just starting. There are wonderful positions open in every phase of automotive work—thousands of them—waiting to be filled. You can have your choice if you "know how."

LEARN AT HOME THE C.A.I. JOB-WAY

Auto Repairing Automotive Electricity Vulcanizing Welding • Battery

Give me an hour a day and I'll qualify you to pull down a real income. My original C. A. I. Job-Way System of training is the only practical way to learn automotive work. Anyone can understand my lessons. Every lesson makes you expert on some particular job. Experts get the big pay. I can't begin to tell you all of the C. A. I. advantages here. Write today for

This Great Book FREE

It tells all about the most gigantic industry in the world. It tells you how to become a big man in that industry. This book shows exactly what the "Job-Way" system is. It explains my big

FREE TOOL KIT OFFER

It tells of the success which C. A. I. has brought to others. Don't send a penny. Use the postal card or mail the coupon below.

Don't wait, mail the Coupon Today

CHICAGO AUTOMOTIVE INSTITUTE

J. R. Bayston, M. S. A. E., Pres.

Dept. 9773, 536 South Clark Street, CHICAGO, ILL.

MEN WANTED!

Thousands of big-pay jobs open right now, all over the U. S. Our Employment Service FREE to both students and graduates, reaches employers in every part of the Country. Look at this:

Master Mechanics	\$3,000-\$8,000
Electrical Experts	3,600 up
Garage Manager	3,000 up
Battery Expert	2,400 up
Expert Welder	2,400 up
Salesman	3,000 up
Tractor Engineer	2,400 up

My graduates earn money fast enough to go into business. Own your own Garage, Battery Station, Ignition Service, Repair or Welding Plant



MAIL
Today

THE
\$5,000 COUPON
USE IT NOW

J. R. Bayston, M. S. A. E., Pres.

Chicago Automotive Institute
Dept. 9773, 536 S. Clark St., Chicago, Ill.

Without a penny of expense or the slightest obligation, please send me Free Book about your rapid course in Automotive Master Mechanics, and Free Tool Kit offer. Explain your money-back guarantee. I want to see a Free Lesson, too.

Name.....

Address.....



"There's One Man We're Going to Keep"

"Ed Wilson, there, is one of the most ambitious men in the plant. I notice that he never fools away his spare time. He studies his International Correspondence Schools Course every chance he gets.

"It's been the making of him, too. He hasn't been here nearly so long as Tom Downey, who was laid off yesterday, but he knows ten times as much about this business.

"I'm going to give him Tom's job at a raise in salary. He's the kind of man we want around here."

HOW do you stand in your shop or office? Are you an Ed Wilson or a Tom Downey? Are you going up? Or down?

No matter where you live, the International Correspondence Schools will come to you. No matter what your handicaps or how small your means, we have a plan to meet your circumstances. No matter how limited your previous education, the simply-written, wonderfully-illustrated I. C. S. textbooks make it easy to learn.

This is all we ask: Without cost, without obligating yourself in any way, put it up to us to prove how we can help you. Just mark and mail this coupon.

INTERNATIONAL CORRESPONDENCE SCHOOLS Box 5590-D, Scranton, Penna.

Without cost or obligation, please tell me how I can qualify for the position or in the subject before which I have marked an X:

BUSINESS TRAINING COURSES

- | | |
|--|---|
| <input type="checkbox"/> Business Management | <input type="checkbox"/> Salesmanship |
| <input type="checkbox"/> Industrial Management | <input type="checkbox"/> Advertising |
| <input type="checkbox"/> Personnel Organization | <input type="checkbox"/> Better Letters |
| <input type="checkbox"/> Traffic Management | <input type="checkbox"/> Show Card Lettering |
| <input type="checkbox"/> Business Law | <input type="checkbox"/> Stenography and Typing |
| <input type="checkbox"/> Banking and Banking Law | <input type="checkbox"/> Business English |
| <input type="checkbox"/> Accountancy (Including C.P.A.) | <input type="checkbox"/> Civil Service |
| <input type="checkbox"/> Nicholson Cost Accounting | <input type="checkbox"/> Railway Mail Clerk |
| <input type="checkbox"/> Bookkeeping | <input type="checkbox"/> Common School Subjects |
| <input type="checkbox"/> Private Secretary | <input type="checkbox"/> High School Subjects |
| <input type="checkbox"/> Spanish <input type="checkbox"/> French | <input type="checkbox"/> Illustrating <input type="checkbox"/> Cartooning |

TECHNICAL AND INDUSTRIAL COURSES

- | | |
|---|--|
| <input type="checkbox"/> Electrical Engineering | <input type="checkbox"/> Architect |
| <input type="checkbox"/> Electric Lighting | <input type="checkbox"/> Blue Print Reading |
| <input type="checkbox"/> Mechanical Engineer | <input type="checkbox"/> Contractor and Builder |
| <input type="checkbox"/> Mechanical Draftsman | <input type="checkbox"/> Architectural Draftsman |
| <input type="checkbox"/> Machine Shop Practice | <input type="checkbox"/> Concrete Builder |
| <input type="checkbox"/> Railroad Positions | <input type="checkbox"/> Structural Engineer |
| <input type="checkbox"/> Gas Engine Operating | <input type="checkbox"/> Chemistry <input type="checkbox"/> Pharmacy |
| <input type="checkbox"/> Civil Engineer | <input type="checkbox"/> Automobile Work |
| <input type="checkbox"/> Surveying and Mapping | <input type="checkbox"/> Airplane Engines |
| <input type="checkbox"/> Metallurgy | <input type="checkbox"/> Navigation |
| <input type="checkbox"/> Steam Engineering | <input type="checkbox"/> Agriculture and Poultry |
| <input type="checkbox"/> Radio | <input type="checkbox"/> Mathematics |

Name.....
Street..... 11-21-23
Address.....

City..... State.....

Occupation.....

Persons residing in Canada should send this coupon to the International Correspondence Schools Canadian, Limited, Montreal, Canada.

Electricity

A Practical Training

In this great profession will make your successful future a certainty. The School of Engineering of Milwaukee has specialized for 19 years in training young men for

Electrical Engineering

With a B. S. Degree in 3 Years.

Institute of Electrotechnics (Academic and Electrical Training) — 12 to 30 months, depending upon previous education. Electrotechnicians are in great demand and draw Big Pay. **Commercial Electrical Engineering**—1 year for high school graduates. **Automotive Electricity**—a 3 to 6 months' course will make you a highly paid specialist on all types of starting, lighting and ignition systems. **Armature Winding**—and **Motor Generator Repair**—through 3 months' course. **Practical Electricity**—6 to 12 months' course to become a Master Electrician.

We will **AID YOU EARN YOUR WAY THROUGH COLLEGE**, through our practical plan of co-operative industrial employment. Based and room at cost. Student activities, orchestra, daily broadcasting WIAO.

SPRING TERM NOW OPEN. Write TODAY for latest catalog and full details. Mention age, education, and course of interest.

SCHOOL of ENGINEERING of Milwaukee

PM3-24 415 Marshall Street, Milwaukee, Wisconsin



BE A CARTOONIST

ARTISTS GET BIG MONEY

We can teach you drawing in your home during spare time. Successful artists earn from \$40 to \$250 a week. Thousands of publishers and advertisers need the work of good artists. The **MODERN METHOD** is an easy way to learn to draw original pictures. Write today for full particulars showing opportunities for you. State your age.

THE MODERN INSTITUTE OF ART
7 East 42nd Street Studio 103 New York City

STOP USING A TRUSS

Do Away With Steel And Rubber Bands

FREE TRIAL



Inner surface is made adhesive to secure the PLAPAO-PAD firmly to the body, keeping the PLAPAO continually applied and the pad from slipping. No straps, buckles or springs attached. Soft as velvet—easy to apply.

It's the Non-Slip- ping, yet Non-Rigid Pad and What is Within It That Counts

FREE to 5,000 Truss Sufferers

To the extent of 5,000 sufferers who may apply I will send, ABSOLUTELY FREE, a sufficient quantity of the Plapao to positively convince them that this is the only logical, common-sense way of treating rupture. Plapao is a highly astringent medication placed within the Plapao-Pad and being absorbed through the skin, creates a wonderful feeling of relief and at the same time tends to strengthen the weakened muscles and thus permanently close the rupture opening. The process of recovery is natural, so you'll have no use for a truss—you can throw it away forever! Old and young have testified under oath that the Plapao-Pads cured their rupture—many of them long-standing, aggravated cases—without delay from work. Patent allowed in U. S. and foreign countries. Awarded Gold Medal at Rome and Grand Prix at Paris.

Send No Money—for a sufficient quantity of the Plapao is sent without charge to enable you to give it a thorough test; you pay nothing for this trial now or ever. Write for it and full information today. Address **Plapao Laboratories, Block 1427 St. Louis, Mo.**

PATENTS

TRADE MARKS-COPYRIGHTS

PROTECT YOUR IDEAS

ANY NEW article, machine, design or improvement thereof, or any new combination of parts or improvements in any known article which increases its efficiency or usefulness, may be patented, if it involves invention.

If You Have Any New Ideas

which you feel are useful, practical and novel, take prompt action to protect your rights. If you have invented any new machine, or new combination of parts, or improvement, or any new design or process, SEND DRAWING, MODEL OR DESCRIPTION of it for information as to procedure to secure protection.

Write Today for Blank Form

"Record of Invention"

USE THE COUPON attached, and immediately upon its receipt I shall send you this form to be returned to me with drawing, description or model of your idea; promptly upon receiving your idea I shall write you fully as to procedure and costs.

No Charge for Above Information



DRAFTING and SPECIFICATION ROOM of CLARENCE A. O'BRIEN, Registered Patent Attorney, Washington, D. C.

All communications are held in strict confidence. My personal, careful and thorough attention is given to each case. I offer you efficient, reliable and prompt service—based upon practical experience. Highest references.

WRITE TODAY for free book "How to Obtain a Patent." This book will give you valuable information, and it may save you much time and effort. Send for it NOW

My practice is devoted exclusively to United States and Foreign Patents and Trade Marks. Write me freely, frankly and with full confidence; it is very probable that I can help you. Write TODAY.

CLARENCE A. O'BRIEN

REGISTERED PATENT ATTORNEY

MEMBER OF { Supreme Court of the United States, Court of Appeals District of Columbia } Practice Confined to THE BAR OF { Supreme Court District of Columbia United States Court of Claims } Patents and Trade Marks 70-C Security Savings & Com'l Bank Bldg., directly across street from U. S. Patent Office, Washington, D. C.

CLARENCE A. O'BRIEN, Registered Patent Attorney, WASHINGTON, D. C. 70-C Security Savings & Com'l Bank Bldg., directly across street from U. S. Patent Office Please send me your free booklet "How to Obtain a Patent" and blank form "Record of Invention" without any obligation on my part.

**FREE
COUPON**

Name

Address

(IMPORTANT: WRITE OR PRINT NAME CLEARLY)



PATENTS

Seventy-seven Years of Practice

THE firm of Munn & Company filed its first application for a patent in 1846, and for seventy-seven years has endeavored to keep pace with the inventive genius of the United States.

An experience of many years is at your disposal. If you have an invention which you wish to patent, send your sketches or model together with a description of your device, explaining its operation, and you will receive prompt, courteous attention.

Write for our Handbook on PATENTS

A full and complete booklet on Patents, Designs, Trade-Marks, Foreign Patents, Copyrights, Labels and Patent Office Practice with an explanation about our methods, terms, etc.

All communications strictly confidential.

Keep in touch with the inventions of the world by reading

SCIENTIFIC AMERICAN

The MONTHLY MAGAZINE with a special appeal to every man of inventive genius. Recent rulings of the Patent Office, descriptions of the latest patented inventions, legislation and court decisions affecting patents, are noted in this authoritative publication.

MUNN & COMPANY

Patent Attorneys

672 Woolworth Building, New York City

Scientific American Building, Room 2
625 F Street, Washington, D. C.

Suite 801, Tower Building, Chicago, Ill.
601 Hobart Building, San Francisco, Cal.

Please Mention Popular Mechanics

PATENTS

To the Man with an Idea

I offer a comprehensive, experienced, efficient service for his prompt, legal protection and the development of his proposition.

Send sketch, or model and description, for advice as to cost, search through prior United States patents, etc. Preliminary advice gladly furnished without charge.

My experience and familiarity with various arts frequently enable me to accurately advise clients as to probable patentability before they go to any expense.

Booklet of valuable information and form for properly disclosing your idea free on request. Write today.

Richard B. Owen, Patent Lawyer
9-303 Owen Building, Washington, D. C.
2276-E Woolworth Bldg., New York City

PATENTS

Trade-Marks, Copyrights and Patent Litigation

Write for advice and instructions how to proceed, costs, etc. Hand Book with illustrations of 100 Mechanical Movements sent free on request.

ALBERT E. DIETERICH

Patent Lawyer and Solicitor

Successor to Fred G. Dieterich & Co. 621A Ouray Bldg., Washington, D. C.

PATENTS

Patent Litigation
Trade Marks
Copyrights

Handbook of instructions, "How to Protect Inventions," sent free on request.

R. H. FRAVEL, Patent Lawyer

Formerly of the U. S. Patent Office Examining Corps
Room 207, Stewart Bldg. WASHINGTON, D. C.



PATENTS

Send us sketch or model for patentability opinion and exact cost of patent. Our book "How to Obtain a Patent," sent free on request. It tells how to apply for Patents, Trade Marks, Foreign Patents, Copyrights, etc.; gives information on Patent Procedure; tells what every inventor should know. Thousands of Inventors, who are our clients, are our references.

Chandlee & Chandlee, 25 Years' Experience.
455 7th St. Washington, D. C.

PATENTS

C. L. PARKER
Formerly Member Examining
Corps, U. S. Patent Office
PATENT LAWYER
MCGILL BLDG.
WASHINGTON, D. C.

Patents, Trade Marks, Copyrights, Patent Litigation

Handbook for Inventors, "Protecting, Exploiting and Selling Inventions," sent free upon request.

This Book
FREE!



There may be a fortune for you in this **FREE** book about Inventions

Invention is the easiest way to earn a fortune. Little ideas have made millions of dollars for their inventors. This wonderful book explains how fifteen famous inventors now teach you the secrets of successful invention—in your own home

HOW would you like to be the inventor of the Gillette Safety Razor, who makes **TWO AND ONE-HALF MILLION DOLLARS** a year? Wouldn't you gladly be the inventor of the snap fastener whose profits were so big that he paid an *income tax* of \$29,000? Wouldn't you willingly change places with the inventor of the President Suspenders who is now worth \$5,000,000?

Other inventors have made thousands of dollars from such common things as the crimped hair-pin, the metal tip shoe-laces, the paper safety match, the ordinary wire paper clip. These inventions are so simple that probably *thousands* of people thought of them but only *one* man DID anything about the idea when it came to him.

Proof YOU Can Invent

Perhaps even now you have splendid ideas for inventions but the only reason you have not developed them is because you believe you were not born to be an inventor; that inventors are men who invent things as naturally as other people work as bookkeepers, mechanics, doctors or farmers.

Invention is not guesswork or blind luck. Inventors themselves say that invention is based upon exact laws which *anyone* can learn. It is merely a matter of first *seeing* something to be fixed and then of *thinking* of some principle which will fix it. That is all—that is *everything* to invention. Brought down to its plainest definition, invention is merely the science of "fixing things."

What Edison Says

Could you ask the advice of any greater authority than Thomas A. Edison? He says: "*Invention is a Science and should be taught as a profession.*"

And now, for the first time, you can actually learn invention as a profession—exactly as other people are learning electricity, mechanics, law, medicine. The Bureau of Inventive Science offers you the first course in practical invention ever devised. No special mechanical or technical training is needed. Fifteen famous inventors have written down the easy-to-learn principles of Inventive Science so that everybody can read them and learn to use them. The ability to invent was *born* in you. All you need to become successful is this easy, fascinating training which will develop your ability so it will be worth real money.

New FREE Book

This wonderful course teaches invention by actual practice right in your own home. With each lesson you are sent at least one practical problem in invention. This absorbing exercise in solving actual inventive problems sharpens your instinct to fix things and gives you an unforgettable, instinctive habit of thinking inventively which is worth more than you realize. The lessons and exercises are so simple, so easy to understand, so interesting that they seem more like a pleasant game than like instruction which can make you a successful inventor.

A wonderful new book, just printed, tells you more about the Bureau of Inventive Science and its simple new course in invention. It costs nothing, so send the coupon at once. This bureau is not connected with patent attorneys or manufacturers. Its only purpose is to teach you the principles of practical invention used by every successful inventor. Write for the FREE BOOK now. There may be a fortune in it for you.

BUREAU OF INVENTIVE SCIENCE
Dept. 33, Wisner Bldg., Rochester, N. Y.

BUREAU OF INVENTIVE SCIENCE
Dept. 33, Wisner Building, Rochester, N. Y.

Please send me your free book, "The Science of Invention."

Name.....Age.....

Address.....

City.....State.....

15 great inventors teach you every step in inventive science.

- How to develop your imagination
- How to develop your ideas
- How to get the facts you need for inventions
- How to keep legal records of ideas
- How to use scientific principles of mechanics.
- How to avoid wasting time on impractical inventions
- How to apply for a patent
- How to organize a company
- How to protect your rights
- How to market a patent

and hundreds of other vitally important facts which EVERY successful inventor knows and uses.

PATENTS

TRADE-MARKS and COPYRIGHTS

OUR OFFER: No Charge for Examination and Instructions

Have You Any New Ideas?

Your First Step: Before disclosing an invention the inventor should write for our blank form "Record of Invention." This should be signed and witnessed and returned to us together with model or sketch and description of the invention for examination and instructions.

No Charge for the Above Information



Our Three Books Mailed FREE to Inventors

Our Illustrated Guide Book

How to Obtain a Patent

Contains full instructions regarding Patents. Our Methods, Terms, and 100 Mechanical Movements illustrated and described; Articles on Patent Practice and Procedure, and Law Points for inventors.

Our Trade-Mark Book

Shows the value and necessity of trade-mark protection and gives information regarding Trade-Marks and unfair competition in trade.

Our Foreign Patent Book

We have direct agencies in all foreign countries and secure foreign patents in the shortest possible time and at the lowest cost.

Prompt Attention

Reasonable Terms

Highest References

*All Communications and Data Strictly Confidential.
Interference and Infringement Suits Prosecuted.*

FREE COUPON

Victor J. Evans & Co. Patent Attorneys

**Main Offices: 722-724 9th Street, N. W.,
WASHINGTON, D. C.**

Write Today.—Just fill in your name and address below and send to nearest office and we will send you Free of charge our Patent Books.

Name.....

Address.....



Our Chicago Office
Suite 1114 Tacoma Building



Our Pittsburgh Office
Suite 514 Empire Building



Our San Francisco Office
Suite 1010 Hobart Building



Our New York Office
Suite 1007 Woolworth Bldg.



Our Philadelphia Office
Suite 714-15 Liberty Bldg.



Our Washington Office
Victor Building

BE YOUR OWN LANDLORD

Thousands of Former Renters NOW OWN Their Own Good Paying Farms in CANADA

No matter how hard you work or what you sacrifice no man can overcome the lack of natural opportunity. High priced, low average yield lands collect their penalty before you harvest a single crop. Facing these odds and the possibilities of drought, pests, crop failure, run-down soil or possibly poor improvements, wouldn't you be better off farming with natural opportunities in your favor? Thousands of farmers that were hard up against the discouragements that face you now will tell you and show by their experience that in Canada they gained happiness, success, real independence. Some have been able to pay for their farms from the value of one year's crop.

\$20⁰⁰
Per Acre
Average
Price

Canada's rich black loam gives high yields per acre. Average prices for farm products should give you independence and success. There are still good farms and millions of acres of fertile land in Canada at very reasonable prices and terms. Convenient marketing facilities, railroads, grain elevators and stock yards, towns, cities, good roads, schools, churches, agricultural colleges and universities provide modern recreational and educational advantages that are the equal of your own.

NEW AND ATTRACTIVE TERMS LOW TAXES—INCREASING VALUES

To assist actual farmers purchasing land the Canadian National Railways have adopted a new policy of terms of payment which will make it easy to acquire title from the proceeds of the farm. The farmer need not fear adverse crop years. Our terms will protect him. You can buy land unsurpassed for fertility along the lines of the Canadian National Railways for an average of \$20.00 an acre. No tax at all on buildings, improvements, animals, machinery or personal property.

THE RENT YOU ARE PAYING WILL BUY A FARM IN CANADA

The price of fertile farm land is so low that many renters unable to succeed in high priced land districts, find it easy to pay for their farms in Canada. Large yields per acre mean more money. The work you put into your farm builds up something you own—not something to hand back to the other fellow.

Canada's opportunities are not restricted to Renters only. Here you can buy several times as much acreage for the money you now have invested in land. The fertile soil produces bigger crops per acre. That means more money—and the chance to get the rise in value on much larger acreage. Here there is land for expansion—and land on which to set up your sons.

SPECIAL EXCURSION RATES

Reduced railway fares are in effect for landseekers and their effects to encourage inspection along the lines of the Canadian National Railways. Personally conducted excursions will also be arranged.

GET FREE BOOK TODAY

Our free illustrated book tells what others have gained by going to Canada. Read the book. You'll be convinced there is a better chance for you. Send your name and address for the book now—today—before it's too late. Let us help you—our advice is free and without obligation. **Send now!**

L. B. BOYD, Supt., Land and Colonization Dept.
Canadian National Railways, Desk 433
4th and Jackson Sts., St. Paul, Minn.

Get This
FREE
Illustrated
Book
Today



MIXED FARMING IN CANADA PAYS BEST

Canada's 1923 wheat crop broke all previous records. In 12 years Canada has won 11 Wheat Championships and many awards in Live Stock Championships.

But Canada does more than produce one-fifth of the world's wheat supply. It is the center of increasing activity in mixed farming. World's records in wheat, oats, beef, dairy and poultry are proving that Canada is ideal for diversified farming. Canada has an ever increasing number of creameries to care for the rapidly growing dairy industry.

L. B. BOYD, Supt.,
Land and Colonization
Dept., Canadian National
Railways, Desk 433
4th and Jackson Streets
St. Paul, Minn.

Dear Sir:—Please send me your free illustrated book on Canada.

Name

Address.....R.F.D

Town.....State.....

**CANADIAN
NATIONAL
RAILWAYS**

PATENTS

Booklet Free Highest References Promptness Assured Best Results
Send drawing or model for preliminary examination

ALL BUSINESS GIVEN PROMPT AND PROPER ATTENTION

WATSON E. COLEMAN, Patent Lawyer, 644 G St., Washington, D. C.

Can You

think of a simple, practical idea that will fill one of the many requests we have on file for new inventions? It may mean a fortune for you. Thousands of things are needed **right now**. Your brains can help. Send today for our great new book—

"Inventions and Trade-Marks, Their Protection and Exploitation" and learn more about making money from ideas than you ever knew before. It tells many things that are wanted, too.

**A postal will do—
It is free**

We Help Our Clients

without charge, to get the dollars out of their ideas—having facilities none others possess. Advice free. Don't delay—get the book at once.

American Industries, Inc.
200 Patent Dept.
WASHINGTON, D. C.

**Patents
Advertised
For Sale Free**
in Invention and
Manufacturing Supplement

Published for the man with an idea. Send for free sample copy. One year's subscription, 50c

Have You An Invention?

If so the **WORLD PROGRESS** will show you how to **PROTECT AND PROFIT FROM YOUR IDEAS**
Sample copy free. One year's subscription \$1.00.
Send for free book,

"WHAT TO INVENT"

containing **SUGGESTIONS TO INVENTORS** as to Inventions Needed. We invite manufacturers to address us regarding inventions they want.

WORLD PROGRESS PUB. CO., Inc.
Room 203 Victor Bldg. WASHINGTON, D. C.

INVENTORS who derive largest profits know and heed certain simple but vital facts before applying for Patents. Our book **Patent-Sense** gives those facts: free. Write **Lacey & Lacey, 646 F St., Washington, D. C.** ESTABLISHED 1869.

PATENTS

REGISTERED PATENT ATTORNEY SINCE 1905
CHARLES W. LOVETT SECURITY BLDG. LYNN MASS.
(SEND FOR FREE BOOKLET)

BLUE BOOK ON PATENTS

gives instructive information and candid advice.
MONROE E. MILLER, PATENT LAWYER
411-2 Ounay Building WASHINGTON, D. C.
ELECTRICAL AND MECHANICAL EXPERT

PATENTS Let me assist you in obtaining your valid Patent rights. Personal service. Promptness assured.
GEORGE VAN DEN BERG Barrister Bldg., Washington, D. C.

INVENTORS PROTECT YOUR IDEAS

Send for our Guide Book, **HOW TO GET A PATENT**, and Evidence of Invention Blank, sent Free on request. Tells our terms, methods, etc. Send model or sketch and description of your invention and we will give our opinion as to its patentable nature.

RANDOLPH & CO.
600 F St., N. W., WASHINGTON, D. C.

NAME.....
STREET.....
CITY..... STATE.....

2 Pair of Trousers

With This **ALL-WOOL** Fancy Serge Suit

Brown
or Blue

Only
\$100
DOWN
6 Months to Pay
Total Price \$27.50

This is a wonderful opportunity for you to get in on one of the greatest values ever offered. A lucky buy makes it possible to sell you these fine suits with extra pair of trousers at such an unheard of bargain. Supply is limited so decide at once. The price will have to go up as soon as these remarkable bargains are snapped up. Make sure of your suit NOW. The extra pair of trousers will double the life of the suit. Write today.

These suits are all Whitman Worsted thoroughly shrunk, hand tailored, cut and made under best supervision and carefully selected pattern and styles. All wool guaranteed. Also guaranteed to fit perfectly.

Business men's model—3 piece—coat, pants and vest. Coat cut in most conservative and dignified style. Made in latest 3 button style, full lined, medium weight for all seasons. Vest with 5 buttons, no collar. Pants can be worn with or without belt. Sizes 34 to 46. Trousers 29 to 46. Order by No. 5744.

We have this same suit in young men's style. Latest model, very snappy. Two button, narrow shoulder, form fitting coat, full lined. Belt for pants only. Sizes 34 to 42. Trousers 29 to 42. Order by No. 5745.

Both suits come in Navy Blue or Brown Worsted.
(We always send Brown unless you state color wanted.)
Pants may be had with or without cuffs.

State size of suit if you know it—if not, be sure to give your weight, your chest measure, taken over vest, for coat. Waist and inseam measure for trousers.

Order Today!

You can't afford to miss this chance to get a high grade all wool worsted suit with extra pair of trousers at this astounding bargain price. If not satisfactory in every way your money will be refunded at once. If satisfied as we know you will be you can take 6 months to pay. You take no risk. Just send coupon with \$1.00. But do it TODAY!

Babson Bros., 19th St. and Marshall Blvd., Dept. 13-53 Chicago

Enclosed please find \$1.00. Send me the three piece Whitman worsted suit with extra pair of trousers at advertised price. If I am not satisfied when I receive the suit I can return it and get my money back. If satisfied I will pay the advertised rate of \$27.50, payments to be made \$4.00 monthly.

My weight is..... My measurements are:
Coat (chest.....) Trousers (waist.....inseam.....)
Color desired (check) Navy blue Brown Trousers (check)
Order No. (check) 5744 5745 with cuffs without cuffs

Name.....

Address.....

City..... State.....

Are You the Boss? —or Are You Riley?

THE BOSS gives the orders—Riley takes them and does what he is told. Both started the same, had equal ability to begin with. Riley works harder than the BOSS and gets less money. What is the answer?

Training did it. Your brain is an engine that needs fuel. Study and training supply the fuel that makes it go. And when you mix brains with your work you **SIMPLY CANNOT HELP BUT GET AHEAD.**

Be a Contractor or Builder

Fit yourself for a big job in the Contracting or Building business. Train for it right at home. The Course is easy to learn, is simple but thorough, is taught by experts who have made it their life study. We teach you Estimating, Blue Print Reading, Building Regulation, Use of Steel Square, Water Supply and Drainage, Heating and Ventilating, etc.

The cost is low, terms easy, results quick and sure. Our money-back guarantee insures satisfaction. Thousands are earning **BIG MONEY** in this business today. Get ready to get yours. Fill out the coupon now. Check the Course you are interested in. It costs you nothing but a 2c stamp for full information. It will mean much for your future.

American School

Dept. G-374-A
Drexel Ave. & 58th St.
CHICAGO

© A. S.
1923



"Riley—Take up These Bricks"

"All Right Boss"

AMERICAN SCHOOL,
Dept. G-374-A, Drexel Ave. & 58th St., Chicago
Send me full information on the subject checked.

- | | |
|-------------------------------------|--------------------------|
| .. Architect | .. Business Law |
| .. Building Contractor or Carpenter | .. Lawyer |
| .. Automobile Engineer | .. Machine Shop Practice |
| .. Automobile Repairman | .. Photoplay Writer |
| .. Civil Engineer | .. Mechanical Engineer |
| .. Advertising Manager | .. Shop Superintendent |
| .. Business Manager | .. Employment Manager |
| .. Financial Manager | .. Steam Engineer |
| .. Sales Manager | .. Foremanship |
| .. Cert. Pub. Accountant | .. Sanitary Engineer |
| .. Accountant & Auditor | .. Surveyor (& Mapping) |
| .. Bookkeeper | .. Telephone Engineer |
| .. Draftsman & Designer | .. Telegraph Engineer |
| .. Electrical Engineer | .. High School |
| .. General Education | .. Fire Insurance Expert |
| .. Personal Analysis | .. Wireless Radio |
| | .. Undecided |

Name

Address

Occupation

U.S. PATENTS



SEND FOR THIS FORM

DON'T LOSE YOUR RIGHTS TO PATENT PROTECTION

Before disclosing your invention to anyone send for blank form "EVIDENCE OF CONCEPTION" to be signed and witnessed. A sample form together with printed instructions will show you just how to work up your evidence and establish the same before filing application for patent. As registered patent attorneys we represent hundreds of inventors all over the United States and Canada in the advancement of inventions. Our schedule of fees will be found reasonable. The form "Evidence of Conception," sample, instructions relating to obtaining of patents and schedule of fees sent upon request. Ask for them—a post card will do.

PATENTS AND TRADE MARKS



480 Ouray Bldg. Washington, D. C.
Originators of forms "Evidence of Conception."

GEARS ALL KINDS SMALL

The most accurate made and prices reasonable. We carry a complete line of gears in stock for immediate shipment. Can also quote on special gears of all kinds. Send us your inquiries. WRITE FOR CATALOGUE.

CHICAGO STOCK GEAR WORKS
105-109 S. Jefferson St., CHICAGO

Wrestling Book FREE

You can learn to be an expert wrestler at home—during your spare time. The book tells you how. The world's marvelous undefeated champion and his trainer **Frank Gotch and Farmer Burns** will now teach you. Learn wrestling, self-defense and jujitsu easily at home by mail. Know all the science and tricks. First chance to learn from world champions. Men and boys, here is your great opportunity. Send for free book today stating age. Burns Sch. of Wrestling 8773 Railway Bldg., Omaha, Neb.

LEARN TO PITCH

Lessons by "MATTY" WALSH, WHITE, JOHNSON, RUCKER, WOOD — **PITCH THE FADE-A-WAY, SPITTER, KNUCKLER, SMOKE BALL, etc.**, clearly described and illustrated by 56 Pictures. Entire COURSE OF LESSONS sent p. p. for **25c.** J. C. DORN, 721 S. Dearborn St., Dept. 85, Chicago, Ill.

How to Dance 50c and What to Dance POSTPAID

This is the latest book published and will teach you the latest jazz, the one-step, the waltz, with the best variations of the fox-trot, all of which when danced properly are graceful and pretty. In addition it also contains some of the older and well known dances. The steps are so simply explained that these can be learned very easily, and for 50c you can become a modern and expert dancer. The information given in this book will make it unnecessary to take expensive lessons. Bound in Kraft paper covers. Size 4 3/4 x 7 1/4". Pages 128. Postpd. 50c.

SHREWSBURY PUBLISHING CO.
5311 West Lake Street, Chicago, Ill.

\$90 Drafting Course FREE

There is such an urgent demand for practical, trained Draftsmen that I am making this special offer in order to enable deserving, ambitious and bright men to get into this line of work. You get your course FREE for getting two additional students. I will teach you to become a Draftsman and Designer until you are Drawing a salary of \$250.00 a month. You need not pay me for my personal instruction or for the complete set of instruments. But you must take advantage of this special offer at once.

\$300 a Month Salary— \$450 on the Side at Home!



Chief Draftsman Dobe

That's the kind of money my drafting students make. Read what this one says:

"As a beginner I am doing fine. Am earning a salary of \$300 per month, besides I made over \$450 at home the last two months, drawing plans for private parties. The practical drafting training you gave me by mail put me where I am in less than six month's study. Thank you for all your personal interest and help you gave me so far."

(Signed) J. B.

(Name and address upon request)

I Guarantee

To Train You Until You Are
Placed in a Position Paying
up to \$250 and \$300 a Month

Write and I'll tell you how I make you a first-class, big-money-earning draftsman in a very few months! I do this by a method no other man nor institution can imitate. I give you personal training at home by mail until you are actually placed in a position paying up to \$250 and \$300 a month. Six thousand draftsmen are wanted every month.

Free Book

Send Coupon Today 

No matter what plans you have for the future. Get this great book—"Successful Draftsmanship." Find out about the simply marvelous opportunities ahead now. How the world needs draftsmen, engineers, architects and builders. What great salaries and possibilities there are! Send coupon for free book today.

Chief Draftsman, Engineers Equipment Co.
1951 Lawrence Ave. Div. 93-53 Chicago, Ill.

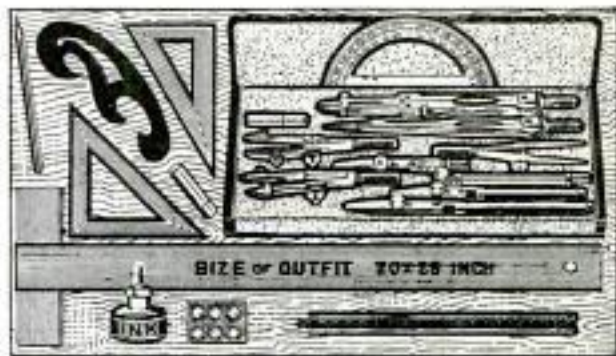

This Outfit FREE

And more—I give you a whole set of drafting tools the minute you become my student. You get every tool you need. A magnificent set of instruments which will build your success in draftsmanship.

Chief Draftsman, Engineers Equipment Co.
1951 Lawrence Ave. Div. 93-53 Chicago, Ill.

Without any obligation whatsoever, please mail your book, "Successful Draftsmanship," and full particulars of your liberal "Personal Instruction" offer to few students.

Name..... Age.....

Address.....

Post Office..... State.....

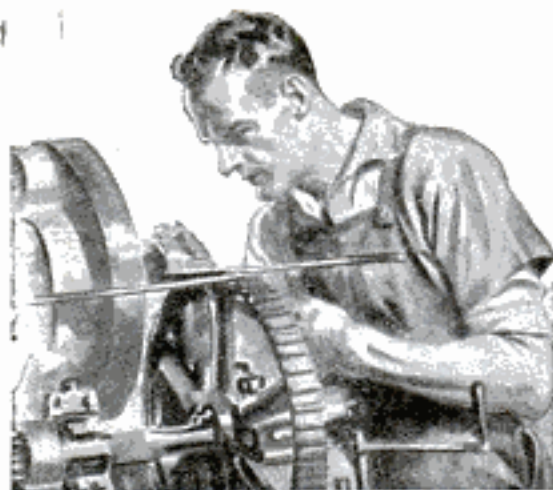

He's Patented Four Inventions

AND he's only one of scores of inventors who got their first real start through spare-time study with the International Correspondence Schools.

Jesse G. Vincent, Vice President of the Packard Motor Car Company, inventor of the Packard Twin Six and co-inventor of the Liberty Motor, is a former I. C. S. student.

So is John C. Wahl, inventor of the Wahl Adding Machine and the Eversharp Pencil; W. E. Hallett, inventor of the Hallett Tandem Gas Engine; H. E. Doerr, Chief Mechanical Engineer, Scullin Steel Company, and W. J. Libby, inventor of the Libby Mine Hoist Controller.

HERE'S the same coupon—the same opportunity that these men had. There's still a chance for you to get ahead if you will only make the start.

One hour after supper each night, spent with the International Correspondence Schools in the quiet of your own home, will prepare you for the position you want in the work you like best.

Yes, it will! Put it up to us to prove it. Without cost or obligation, just mark and mail this coupon.

INTERNATIONAL CORRESPONDENCE SCHOOLS Box 5592-D, Scranton, Penna.

Without cost or obligation, please tell me how I can qualify for the position or in the subject before which I have marked an X:

BUSINESS TRAINING COURSES

- | | |
|--|---|
| <input type="checkbox"/> Business Management | <input type="checkbox"/> Salesmanship |
| <input type="checkbox"/> Industrial Management | <input type="checkbox"/> Advertising |
| <input type="checkbox"/> Personnel Organization | <input type="checkbox"/> Better Letters |
| <input type="checkbox"/> Traffic Management | <input type="checkbox"/> Show Card Lettering |
| <input type="checkbox"/> Business Law | <input type="checkbox"/> Stenography and Typing |
| <input type="checkbox"/> Banking and Banking Law | <input type="checkbox"/> Business English |
| <input type="checkbox"/> Accountancy (Including C.P.A.) | <input type="checkbox"/> Civil Service |
| <input type="checkbox"/> Nicholson Cost Accounting | <input type="checkbox"/> Railway Mail Clerk |
| <input type="checkbox"/> Bookkeeping | <input type="checkbox"/> Common School Subjects |
| <input type="checkbox"/> Private Secretary | <input type="checkbox"/> High School Subjects |
| <input type="checkbox"/> Spanish <input type="checkbox"/> French | <input type="checkbox"/> Illustrating <input type="checkbox"/> Cartooning |

TECHNICAL AND INDUSTRIAL COURSES

- | | |
|---|--|
| <input type="checkbox"/> Electrical Engineering | <input type="checkbox"/> Architect |
| <input type="checkbox"/> Electric Lighting | <input type="checkbox"/> Blue Print Reading |
| <input type="checkbox"/> Mechanical Engineer | <input type="checkbox"/> Contractor and Builder |
| <input type="checkbox"/> Mechanical Draftsman | <input type="checkbox"/> Architectural Draftsman |
| <input type="checkbox"/> Machine Shop Practice | <input type="checkbox"/> Concrete Builder |
| <input type="checkbox"/> Railroad Positions | <input type="checkbox"/> Structural Engineer |
| <input type="checkbox"/> Gas Engine Operating | <input type="checkbox"/> Chemistry <input type="checkbox"/> Pharmacy |
| <input type="checkbox"/> Civil Engineer | <input type="checkbox"/> Automobile Work |
| <input type="checkbox"/> Surveying and Mapping | <input type="checkbox"/> Airplane Engines |
| <input type="checkbox"/> Metallurgy | <input type="checkbox"/> Navigation |
| <input type="checkbox"/> Steam Engineering | <input type="checkbox"/> Agriculture and Poultry |
| <input type="checkbox"/> Radio | <input type="checkbox"/> Mathematics |

Name.....

Street.....

Address.....

City..... State.....

Occupation.....

Persons residing in Canada should send this coupon to the International Correspondence Schools Canadian, Limited, Montreal, Canada.

Men! Earn

\$ 000.00
A YEAR

and more

**AS
AUTO
EXPERTS**

Our complete auto and electric course will start you on the road to success. Thousands graduated earning Big money. Enroll today. Pull yourself out of the rut. We pay your fare to Pittsburgh. Established 14 years and still growing.

Pittsburgh School of Automobile Eng.,
405 Penn Ave.,
Pittsb., Pa.

Dept. 243

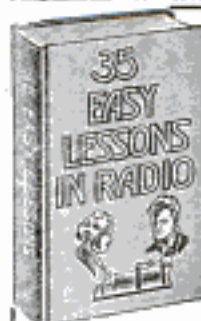

THIRTY-FIVE EASY LESSONS IN RADIO **50c**

A systematic course of elementary principles written in a simple and concise lesson course, easily understood. Thousands have taken up Radio for entertainment and are operating their own amateur sets.

This book embodies all the principles and application of everyday radio for the home and in business. Paper cover.

Price postpaid **50c**

SHREWSBURY PUBLISHING COMPANY
5311 West Lake Street CHICAGO, ILL.

LEARN The
BUSINESS of Advertising

QUICKLY BY MAIL

We guarantee to teach you. It's easy to learn—and easy to get into! Make the start *this week*. This free book tells how.

\$75 to \$100 a Week

—frequently paid beginners. There is **no limit** to opportunities which men and women trained in advertising meet on every hand.

FREE AD-WRITER'S COMPLETE WORKING OUTFIT

Wonderful outfit of working instruments given free on special offer. Write for details before offer expires. We will also send you free and prepaid this stirring book on advertising. Tells you everything you want to know about getting into this fascinating field.

Write today. Postcard will do.

Page-Davis School, Dept. A39, Chicago

Eveready offers the right battery for every radio use!

EACH Eveready Radio Battery represents thirty years of battery building experience. Each Eveready Battery represents millions of dollars invested in men, methods and machinery. Overseeing Eveready production is the greatest battery laboratory known to science, where every particle of raw material is required to pass Eveready's exacting tests. To insure Eveready serviceability, batches of Eveready Batteries are constantly being set aside for performance tests. And, finally, daily shipments keep dealers supplied with fresh Eveready Batteries, packed full of power.

To be certain of battery satisfaction, insist on Eveready Radio Batteries.



EVEREADY Radio Batteries - they last longer



The radio dry cell triumphant

For economical, satisfactory radio, light the filaments of your dry cell tubes with the Eveready Dry Cell Radio "A" Battery. Will unfailingly outlast any other at $\frac{1}{8}$ ampere current. Full instructions for getting this Economical Eighth, on labels and in our booklets. This battery will exceed your expectations in economy and performance.

Equal to all demands

Power flows from your "B" Battery, power that gives life to your headphones or loud speaker. Whatever the tube or tubes you use, Eveready "B" Batteries will give you maximum results. Eveready "B" Batteries are made in six sizes, for all possible uses. Always use the biggest possible battery, for it contains more energy in proportion to cost, and lasts longer. Illustrated, No. 764, vertical, $2\frac{1}{4}$ volts.



This battery is a wonder worker

Eveready's biggest contribution to economical and more satisfying radio is the Eveready "C" Battery, a triple-use, universal battery. It will make the loud speaker respond with a new fullness and naturalness of tone, and save much money by making the "B" Battery last still longer. Connect it with the grids of audio frequency amplifiers and notice the big difference. Can also be used as an "A" Battery for 199-type tubes in portable sets, and as a "B" Battery booster. Eveready Radio Battery No. 771—use it!

NATIONAL CARBON COMPANY, Inc., New York and San Francisco

Headquarters for Radio Battery Information

CANADIAN NATIONAL CARBON CO., Limited, Factory and Offices: Toronto, Ontario

Informative and money-saving booklets on radio batteries sent free on request. If you have any radio battery problems, write to G. C. Furness, Manager, Radio Division, National Carbon Co., Inc., 207 Manley Street, Long Island City, N. Y.

"THE AIR IS FULL OF THINGS YOU SHOULDN'T MISS"

H590

Wide World Photos
229 W. 43rd St.
New York



**Ship Tossed
High on Rugged Coast**

Grounded on the sands in a bay off the coast of Cornwall, a staunch motor schooner was tossed like a chip upon the rocks where it was left high and dry by the receding tide. The boat's powerful engines were unable to free it from the clutches of the shoals, and after a day of battle against the sea, it suffered a fate like that which has overtaken sailing vessels and many small, fragile craft wrecked against the steep cliffs that line the shore.

Chicago Society of Model Engineers
55 W. 64th 7826 Coler Ave. Chicago

Popular Mechanics Magazine

REGISTERED IN U. S. PATENT OFFICE

WRITTEN SO YOU CAN UNDERSTAND IT

Vol. 41

Telephone South Shore 0429
MARCH, 1924

Hemlock 5093 No. 3



Model Making Unites Business Men ⁴²³⁴

THROUGH a recent exhibit of many products of skilled craftsmanship, attention has been directed to one of the unique organizations in the country—the Chicago Society of Model Engineers.

Banded together by the lure of a common hobby and with no thought of gain, the members pursue their regular occupations as lawyers, brokers and business executives during the day, but at night they retire to their workshops to construct miniature locomotives, steam rollers, torpedo boat destroyers and marine power plants.

Twice every month they all meet in a little laboratory in the heart of Chicago's business district to discuss problems or to avail themselves of the more complicated machines that are not available in their homes. To reach this shop they have to climb eight flights of stairs. A glance inside reveals what appears to be a toy factory or a Lilliputian foundry in full blast, but a closer inspection shows that the machines being built are not playthings, nor are the workers busy with any ordinary tasks.

Toiling with the diligence of a fireman, a staid business man is shoveling coal into the tender of a perfect model of a Pacific

type locomotive capable of pulling 900 pounds. He is the maker of the engine and stops work long enough to describe the mechanism. It is constructed of steel, copper and brass on a three-quarter inch scale. The boiler will generate 85 pounds of steam, and enough fuel is carried for a three hours' run. The model is complete in every detail including air brakes. Spare hours for two years were devoted to the task of fashioning the engine and it is not yet completed.

"I would not like to sell it," the builder replies to a question. "I didn't make it for that purpose."

Nearby is a complicated model of a triple expansion marine engine and boiler of the Yarrow type. The power plant with shaft and propeller attached, is an exact duplicate, except in size, of that commonly installed in large ocean liners. Piston rods and the propeller shaft move as compressed air is let in through a small pipe.

Then there are replicas of German and English types of railway locomotives complete with air brakes that operate, quickly stopping the engines as they glide over small tracks. Inside one of the boilers twenty-six flues have been installed exactly as they are in the large locomotive,

55 10 W. 64th St



for these craftsmen are not content with outside appearance alone.

Other miniatures include various kinds of marine engines, a speed launch, small steam rollers, stationary engines, and a torpedo boat destroyer run with steam generated from a blow torch flame. Tiny lathes, a model of a breech loading coast artillery gun that fires a .38 caliber cartridge, small sailing vessels, and many machines yet in the process of development.

Founded in 1914, the society has grown from the three men who met at the invitation of the founder to a membership of 172. Non-resident members are scattered from Vermont to California. Frequently, a model maker from a remote section happens into Chicago and explains that he cannot proceed with his machine because of lack of parts, or because he is stopped by some technical problem he is unable to master. The materials are found by his fellow members, and the confusing question worked out with the aid of others who have had engineering training.

One unique feature of the society is that

there are almost as many occupations represented as there are members. Engineering training is not demanded to make anyone eligible to join. The only requirements are that the applicant must be at least eighteen years old, a stipulation put in because it was believed that younger persons might damage the club's equipment, and that the candidate must "love mechanics."

When meetings are in session or the members are at work, it is a common sight to see a court reporter getting ideas from a plumber on how to install flues in a boiler, a musician and a lawyer discussing a knotty problem in valves with a locomotive designer, while an auditor, a high school teacher, and a book publisher receive help in interpreting a blue print from a draftsman.

Technically trained members are in the minority, but their knowledge is a great help to the others, and this sharing of experience is one of

the chief benefits of the society, the members declare. Ages run from 18 to 71 years, and the men are free to design and construct any sort of machine that strikes their fancy.

All work is done from drawings and with special tools that have been purchased for the use

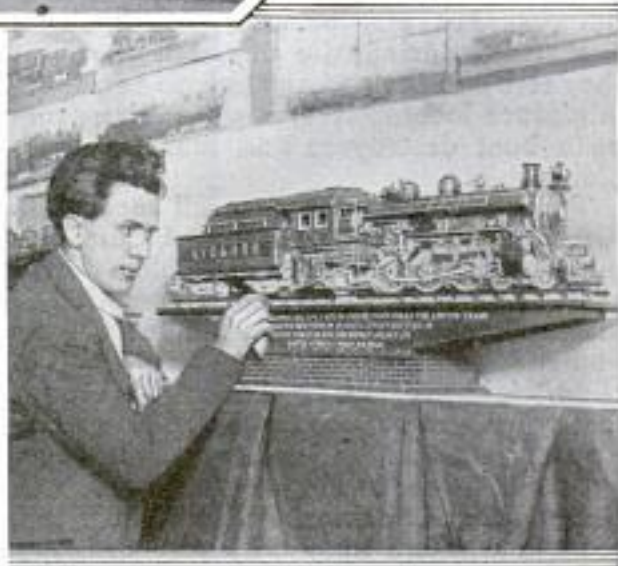
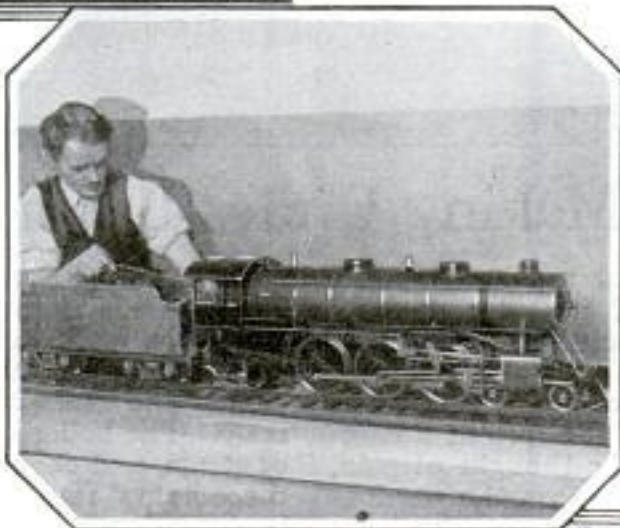

Miniature Locomotives that Run, the Work of Model Builders, Constructed during Their Leisure Moments

of the organization or are owned privately by the members. Most of the model engineers have workshops in their own homes, and construction done there is supplemented at the club shop where the benefit of suggestions from others may be received.

The society had its inception in the mind of a draftsman who had been fashioning models of electrical machines as a pastime and desired the assistance and companionship of others who, he thought, might be interested in the same sort of recreation. Meetings were first held in a downtown office, but a workshop was later rented and equipped.

The plan of the founder, that the club should be devoted wholly to model making as a recreation and not for profit, has been strictly followed. One member in the East recently used his skill to assist a large railroad company in preparing a model of its "crack" locomotive for display in an advertising parade and has also made models of the engines used by the Central Railway of Brazil, but he is perhaps the only one who has done any strictly commercial modeling. The others follow the work simply as a pastime.

"It's a relief after a day in the office to put on working clothes, get out my tool kit and tinker away at my model,"

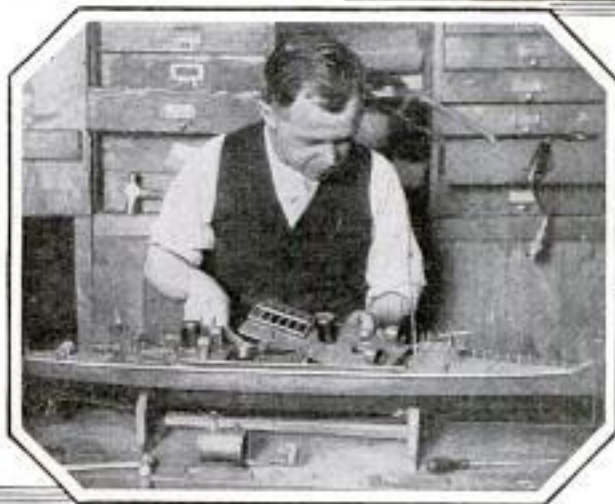

said one of the members, a clerk. "I forget all about cares of the day. I learn valuable facts about machinery and pick up many interesting and worthwhile bits of knowledge from the other members in the club. Model making is a more satisfactory recreation than golf, for it can be pursued regardless of the weather.

Then, too, the women folk like it because it keeps us men home."

"A powerful locomotive, to my mind, is one of the handsomest and most inspiring things in the world," said another member. "I get a lot of satisfaction in trying to make a model of one, just as an artist. I suppose, gets delight in painting an image of what he considers beautiful."

A permanent museum in which the models will be displayed for historical and scientific purposes and branch chapters of the society in other cities are contemplated by the organization.

In the meantime, the collection of skillfully fashioned machines increases as lathes turn and tools are guided by the hands of the craftsmen who have found pleasure and benefit in their hobby.



Steam Engines, Fast Boats and Complicated Marine Power Plants Are Exactly Duplicated in Miniature

WOOD CARVER'S ART RIVALS SCULPTURED WORK

4490



Preparing Pieces of Wood for Assembling in Carved Pictures that Get Their Colors from Natural Shades of Lumber. Right and Left Are Specimens of Finished Panels

Rivaling the art of sculpture, figures produced by a wood carver contain bits of material that give them an appearance resembling natural colorings. In cutting and assembling pieces of rare lumber, it is said that the craftsman has found a new

method of forming the subjects. Entire panels, ornamented by delicately marked moldings, are created by his tools in imitation of framed pictures, with scenes of bird life as their principal features. The wood is shaped in relief for lifelike effects.

LIGHT TOUCHING ELECTRIC EYE ACTS AS BURGLAR ALARM

4540

As sensitive to light as a human eye, an electric device has been made in Germany that is intended to be placed in vaults, and other dark places where valuables are

stored, to act as a burglar alarm. The flame of a match, the opening of a door or the barest glimmer of light admitted by an intruder, is sufficient to complete an electrical circuit and set off an alarm. So small that it may be hidden on a desk, behind a clock or beneath a pile of papers, the electric eye, which consists of a small cell filled with the chemical element called selenium, is covered during the day.

—4601

MAGNETS LAY NAILS STRAIGHT IN PACKING BOXES OR KEGS

To lay nails straight in containers, a packer equipped with magnets is reported to have been built by a Swiss inventor. The machine is said to be able to fill kegs, boxes, or paper cartons and to handle wire rods, hairpins, knife blades and fishhooks with equal ease. The articles to be boxed up are poured into a huge vibrating hopper in lots of about a thousand pounds and are straightened out on large trays below.



Electric Eye Used to Detect Thieves, a Glimmer of Light Being Sufficient to Sound an Alarm

*Prof. A. Böcher,
 Sp. Berlin, Germany.*

*Bocher & Co.,
 Elektrotechnische Fabrik
 Platz vor dem neuen Tor, Berlin, NW 90, Germany*

card missing

POPULAR MECHANICS

4293

WATER CURTAINS GUARD WALLS OF SKYSCRAPER FROM FIRE

So that it can be surrounded by curtains of water to protect it from fire in adjoining buildings, a sprinkler system has been installed on the roof of a Cincinnati skyscraper. This was done after a disastrous conflagration in Chicago proved that a supposedly fireproof building is not immune from the intense heat that is radiated from blazing structures near by. The sprinklers are so arranged that streams of water can be shot directly upon the wire glass windows from the seventeenth to the lower floors. A steam pump, with a capacity of 750 gallons a minutes, and an electric pump, of 1,800 gallons' capacity, placed twelve feet above the basement as a precaution against floods, provide the necessary pressure. The pipes are of galvanized iron and are fastened by connections in holes drilled into the building.

LIMOUSINE FOR MOTORCYCLE BUILT ON SIDE CAR 41531

For carrying a passenger in comfort during all sorts of weather, a side car for a motorcycle has been designed with a limousine top by a German manufacturer. The attachment is upholstered, and seats one person. A door with a glass panel opens the full length of the covering, and the floor is within one step of the ground. The body is built along regular automobile lines and is beautifully finished. Windows can be lowered to admit air, or the entire hood can be closed in rough weather. Owing to the small size of the vehicle, it can traverse narrow or crowded streets with less difficulty than the ordinary cabs.

International Newsreel Corp. 326

W. Madison, Chicago 331

CRACKS AS STACK FALLS TELL OF GIANT FORCES AT WORK

41582

How the forces of gravity, an explosive and air pressure act, is shown in a remarkable photograph of a smokestack,



Falling Smokestack with Cracks Showing Clearly the Tremendous Forces Pulling It to the Earth

taken as it plunged to the earth in England. Great cracks along its side indicate where the blast exerted an upward pressure, destroying the balance of the column. Then gravity pulled it downward relentlessly. The upper part, however, fell more slowly than the lower, because of the greater resistance of the air and its smaller mass. The bricks, of which it was estimated there were more than 575,000 in the stack, will be used for building.



Left, Limousine Side Car that Carries One Passenger, Attached to Motorcycle; and Right, Showing the Wide, Full-Length Door that Makes Entrance and Exit Easy for Occupant

Techn. Photographische Archiv, Berlin
Friedenau, Handjerystrasse 62
Postfach 42, Germany

*International
326
W. Madison
Chicago*

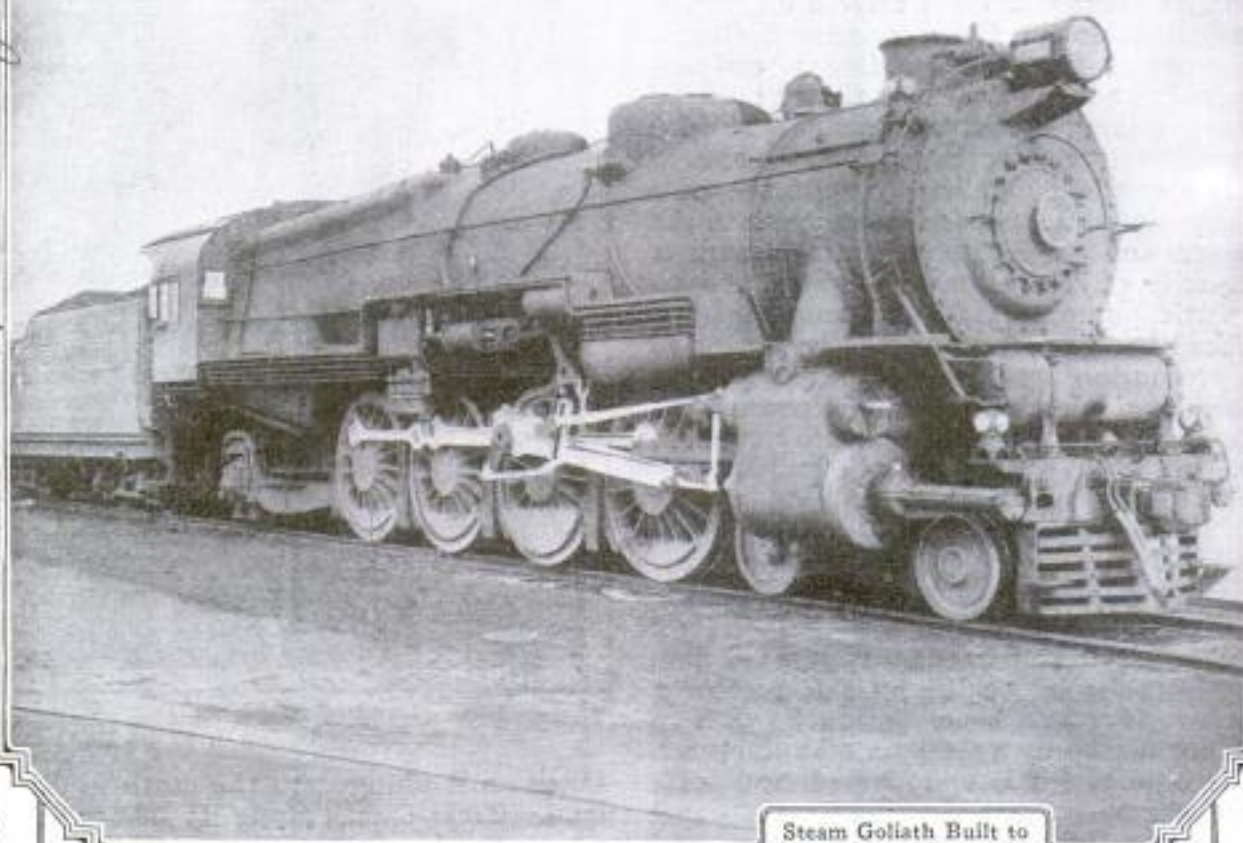

Steam Goliath Built to
Negotiate Mountain
Grades with Heavy
Trains of Freight

—
Electric Locomotive
that Equals Its Coal-
Burning Rival in Speed
and Strength

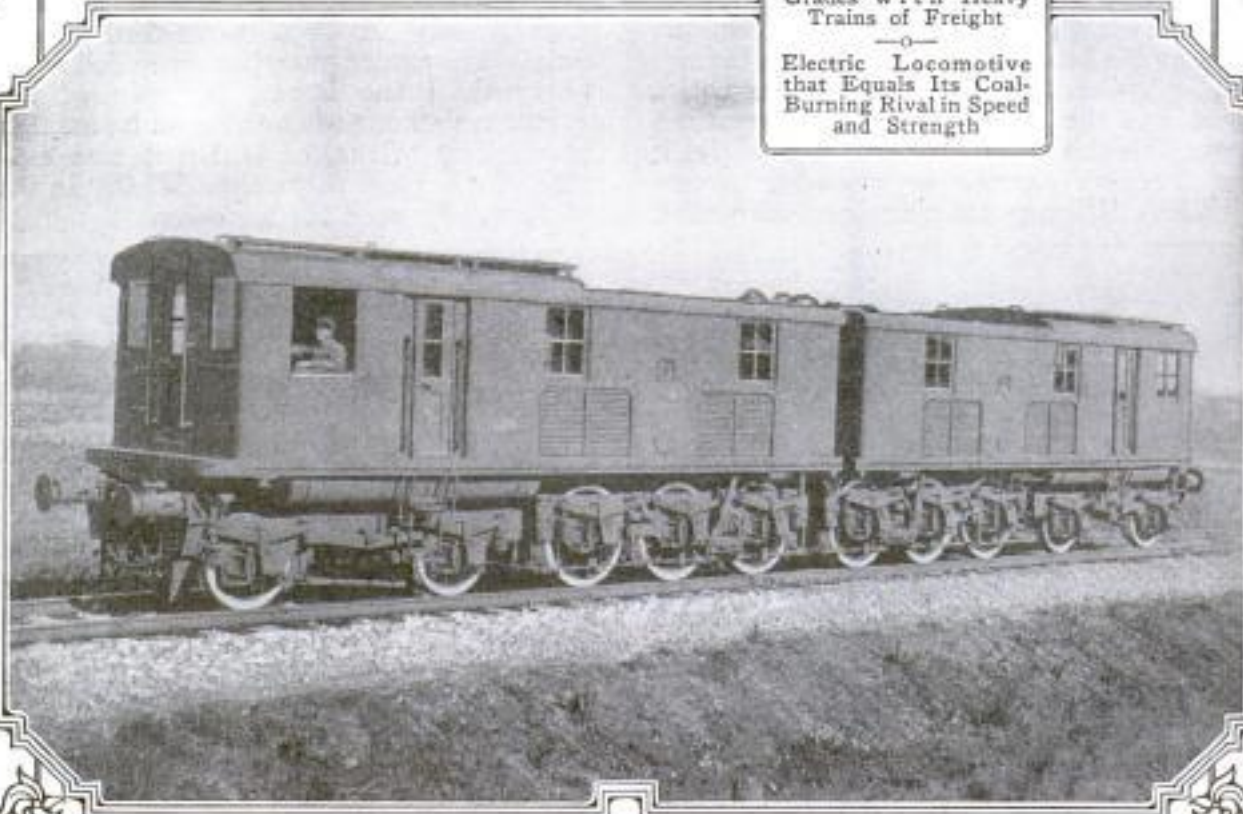

ELECTRIC LOCOMOTIVE IS VICTOR IN TUG-O'-WAR

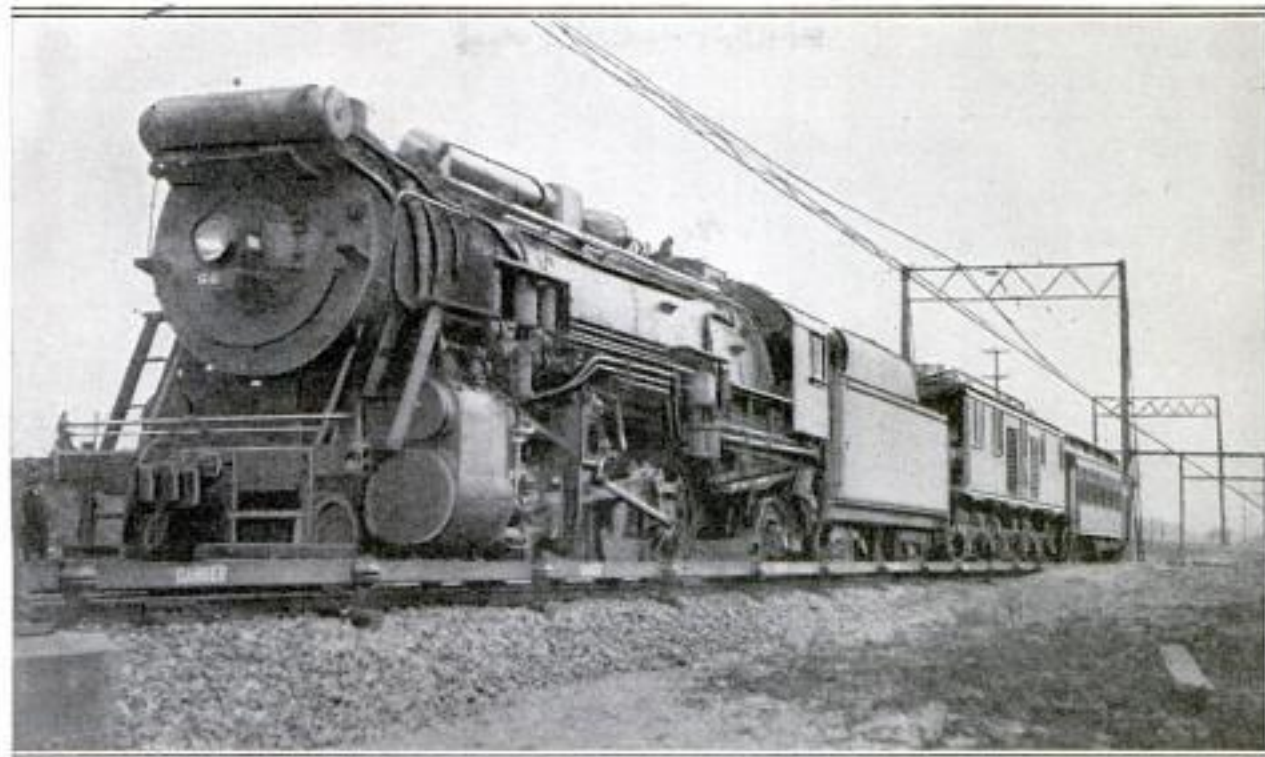

"Tug-o'-War" between Two Giants of the Rails, a Steam Locomotive Constructed for a Mexican Railroad and an Electric Engine Designed for Use in France

Two monsters of the rails, one operated by electricity, or "white coal," and the other by steam, staged a spectacular tug-o'-war at Erie, Pa., recently before railway officials from all parts of the country. Puffing and snorting, with its huge driving wheels turning ahead, the steam loco-

motive was pulled backward, despite its utmost efforts to hold its own. Both engines were of the same weight. The steamer is one of ten built for service in Mexico, where it will haul freight over grades twice as steep as those usually found in the United States.

⁴⁵⁹¹
HANDY CAMERA TAKES "MOVIES"
AT TOUCH OF BUTTON

At a touch of a button on a motion picture camera designed somewhat like a pair of field glasses and carried conveniently by the side in a handy case, "movies" and other scenes can be taken without the use of a tripod, complicated focusing apparatus or a bothersome crank. A spring mechanism released by the button turns the reel which holds the equivalent of 250 feet of standard film, or 4,000 separate views, in one loading. A telescopic view finder at the side shows exactly what will appear on the negative, and the camera is so easily manipulated that with one hand, a fisherman may take pictures of the fish he is attempting to land with the other. It may be used with tripod if desired and is loaded in daylight. For use with the camera a small projector has been made which shows flickerless pictures in sizes ranging from that of a calling card to seven feet by nine

feet. The machine can be used with direct or alternating current, stops, starts and reverses at the touch of a button, and is equipped with a current regulator that weighs only three ounces. The film is non-



Landing Fish with One Hand and Taking "Movies" of Struggle with the Other

inflammable and may be halted at any place in the reel for a "still."

Bell + Howell Co., 801 Larchmont Ave. Chicago.
no price

*Bell + Howell Co.,
1801 Larchmont Ave.
Chicago*

Comt. Walter M. Wolff
 c/o American Consular Service
 334
 Berlin, Germany. Voss Strasse 12
POPULAR MECHANICS

ADJUSTABLE TEETH ON KEY FIT INTO CHANGEABLE LOCK

So they may be changed from one adjustment to another, a lock and key have

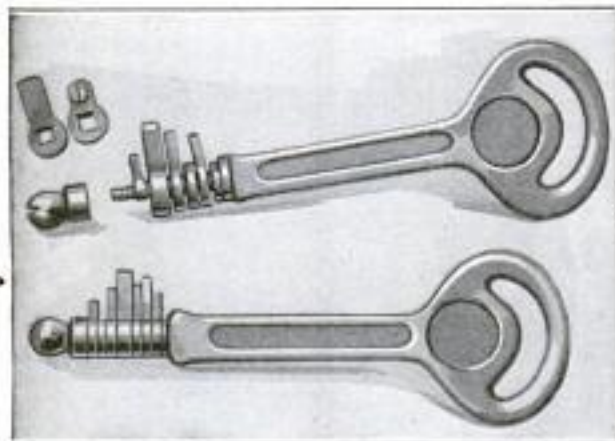

Adjustable Key Teeth that Can Be Changed to Fit Any Position of Lock's Levers

been patented in Germany with a loose arrangement of teeth. The levers and springs of the lock can be set in several different combinations and the key has

detachable teeth that can be placed in corresponding positions. House owners can prevent intruders from becoming acquainted with the plan of the lock by resetting it frequently. If the key is lost another can be secured and the entire device changed. They are easily attached, and may be set by an inexperienced person.

SIXTY MILES OF PIPE TO BRING WATER FROM MOUNTAINS

To bring mountain water to Tulsa, Okla., from a source sixty miles away in the Spavinaw hills, a pipe line five feet in diameter is being laid. Scheduled to be completed early in the spring, it will carry the fluid to a community of 100,000 persons at the rate of 25,000,000 gallons a day. The water will be brought to a low spot within five miles of the city by gravity, and from there pumped to a second reservoir on the highest of the surrounding hills. The system is declared to be one of the longest gravity pipe lines in the world, and will cost approximately \$7,000,000.

FIGURES REPLACE NOTES TO AID STRING PLAYERS

So beginners and those not familiar with the musical scale may easily play stringed instruments, players have been patented that "finger" the notes. Made to fit the necks of banjos, mandolins, and similar devices, the apparatus has numbered keys that relieve fingertips from contact with the tough cords and aid the student in mastering melodies. Scores are printed

with figures to correspond with those on the player, instead of being written in the usual symbols and characters. The appliance can be quickly attached and is made entirely from metal. It may be moved to any position on the keyboard to suit the performer.

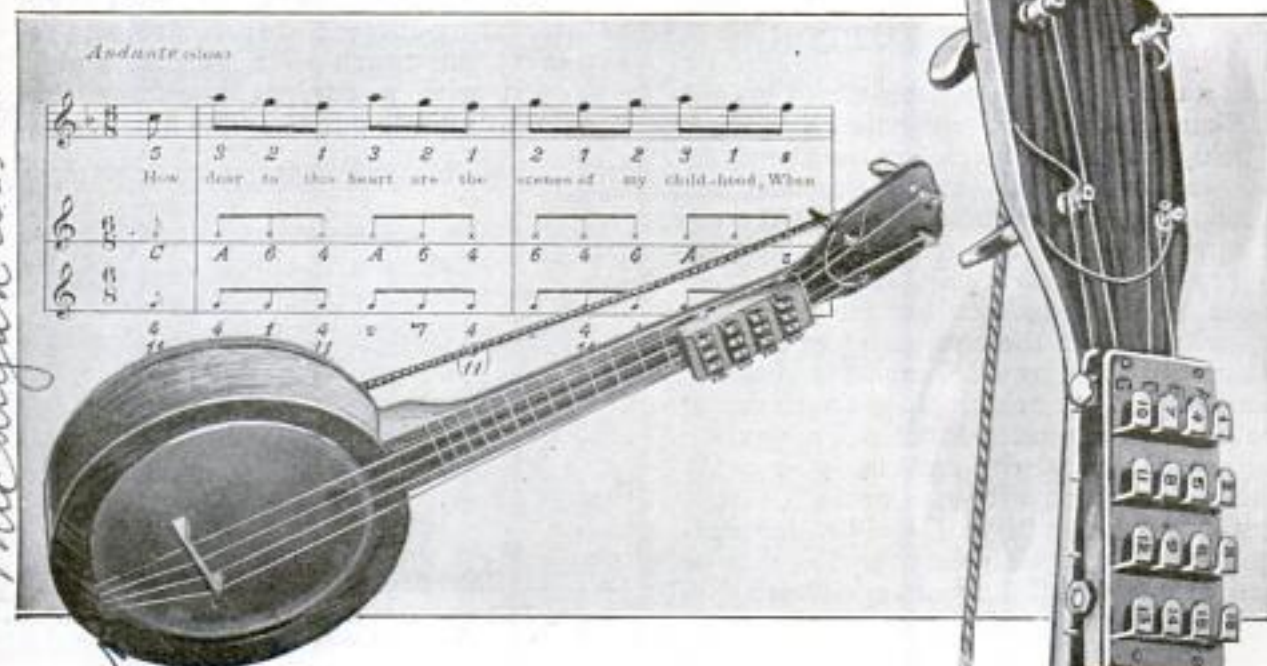

Fingerboard for Stringed Instruments Worked According to Figures Instead of Printed Notes and which Gives Protection from Sharp Cords

No other information

44 53

Reed Novelty Co., 547 N. Michigan Av., Chicago
 And of business 10/20/22

no price

**AIRPLANE IN CHURCH PAINTING
HAS SAINT AS PATRON** 4488

Adapting the airplane, locomotive, and automobile to motifs for religious frescoes, a French artist has achieved unique results in the decorations on the walls of the new church of St. Christopher, the patron saint of those engaged in hazardous occupations, recently completed in Paris. The figure of the saint is seen protecting a falling aviator, an engineer, and a speeding autoist. The machines, shown in detail, form the chief note in the designs and the imminence of danger is effectively suggested. The building has become known as the "sportsmen's church," and the novel decorations have caused wide comment.



**CAMERA FOR SURVEYING SAVES
BOTH TIME AND LABOR** 4610

For registering ground dimensions, a photographic system of surveying, recently devised by a London, England, man, is said to produce results of greater accuracy than the ordinary methods. In using a camera instead of the transit, it is claimed that fewer field operatives are necessary and that the office work of mapping the plot from the records can be divided among as many persons as desired, thus saving much time for completion of the task. In setting down the measurements of the land formations from the photographs, it is said, no difficult mathematics are necessary. More data are also gathered by the process, and since the same man seldom does the field work and makes up the drawing, the one doing the drafting has an exact picture of the area to guide him. In a recent test the system measured dimensions of rises and depressions within a half of one per cent of absolute accuracy.



J. W. Esordou.

**POLICE LEARN EYELID TALKING
TO BALK THE CRIMINAL** 4522

Detectives in Canada are being taught a code by means of which they can communicate with one another by dropping, raising or other movements of the eyes, and also how to "talk" secretly by means of finger touches, by twisting of a cigar, fingering of a mustache and twiddling fingers behind the back. This is being done so that they can transfer their thoughts when in the presence of criminals or prisoners. It is declared that communication with the eyelids can be as rapid as the ordinary man typewrites.



*New York Series
12/16/22*

4559
336

Cont R. W. Pulcifer, 96 Penna R. A. 323 A Wello St, Chicago

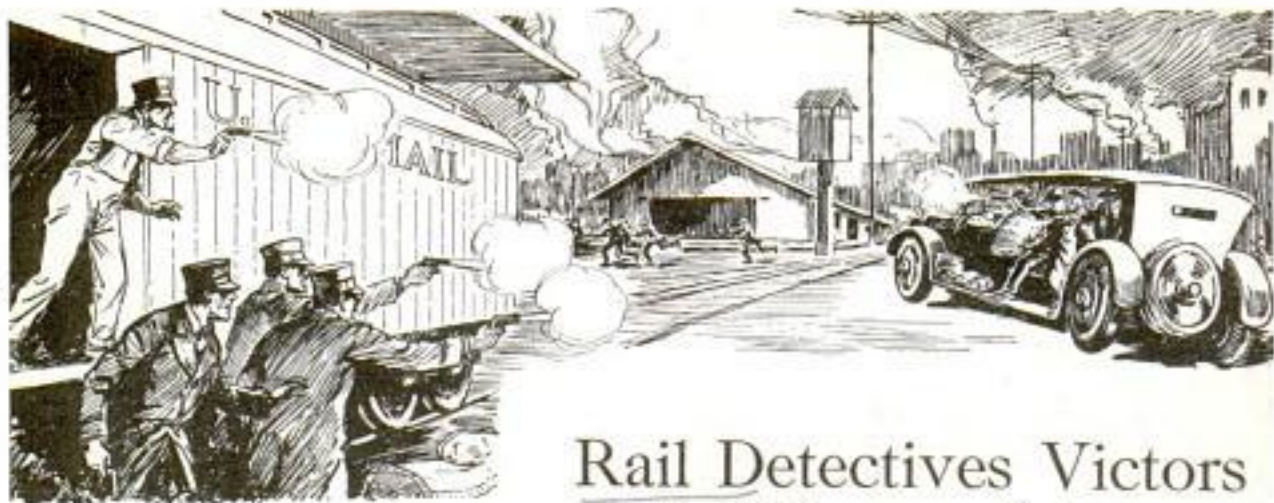

Pistol Battle Between Mail Guards and Would-Be Robbers

Rail Detectives Victors in War on Crime

WHERE are the James boys and the "Bill" Daltons of yesteryear? What has become of the picturesque train robber who, with a gun in each hand and his eyes boring his victims from above a black silk handkerchief, backed away to his pony, flung the Wells Fargo pouch of gold across his saddle bow, cut loose with a parting volley of bullets, and galloped off across the prairie trails to lead pursuing posses through nights of hard and fruitless riding?

Gone? Not a bit of it! He has changed his game, that's all. He may have lost his picturesqueness—which any railroad detective will assert he possessed only in fiction—but he has simply turned to new paths in his hopeless struggle against law and order. His pony has been superseded by the automobile. Smooth concrete roads are his prairie trails of today. And his loot is carried away in car-load lots by motor truck.

For the masked desperado of other days, a gunman still, has gone to robbing freight trains; not that it is less hazardous, but because it holds out a false lure of greater profit. At a recent meeting of railroad detectives in Chicago, one veteran estimated the railroads in Illinois alone lost approximately \$10,000,000 in

merchandise through freight car thefts in 1922. Other officials, however, say this figure is far too high and point out that the losses are constantly decreasing.

One of the greatest factors in cutting down the number of robberies is the railway police—or special agents, as they are better known. Through the organization of squads of "train riders," picked marksmen, armed with shotguns and rifles, who convoy valuable shipments, thievery is being made too costly to be profitable. Other rifle squads, riding in high powered motor cars, are nightly patrolling the highways that parallel the rights of way. Any of these men, if asked about the days when the Younger band and the Daltons made life miserable for trainmen and passengers in Missouri, will declare the depredations then were insignificant as compared to the problems the railroad police have to meet today.

It was the late William A. Pinkerton, the man most feared by train and bank robbers during the years they terrorized the west, who stripped the Missouri desperadoes of the halo of bravery and the garb of glamor bestowed upon them by the writers of lurid fiction. In an account of the operations of the principal holdup gangs between 1875



Freight Packages Broken Into and Looted by Thieves, the Contents Being Thrown Off Train

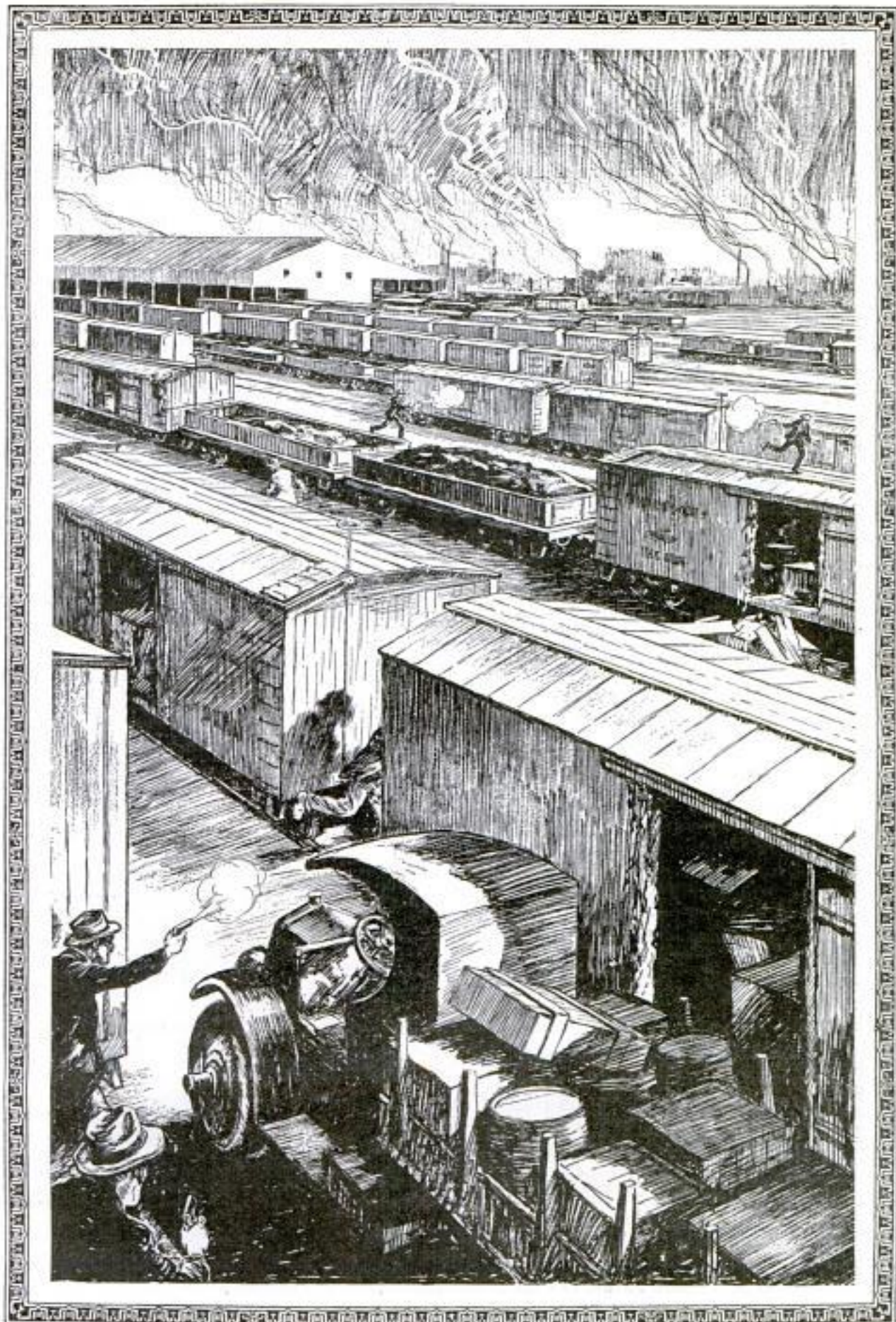

Running Pistol Battles with Thieves while Dodging Around Freight Cars in Dimly Lighted Terminals Add to the Thrills and Danger in the Lives of Railway Detectives

and 1907, he pictured them all as a lot of "cowardly assassins," and so they remain to this day.

Just as a crime wave swept along in the wake of the civil war, so the epidemic of train robberies followed the world war, according to the special agents. History repeats itself. At first the thefts were mostly of silk. Then special guards were placed aboard the trains and the number of these robberies declined. One such recent shipment was valued at \$12,000,000. It was carried in forty-six cars and accompanied by twenty-five armed guards. Then prohibition came, and the thieves turned their attention to alcohol and liquor. This class of robbery reached the peak in 1920 and 1921. Now all these shipments are heavily guarded until they reach the consignee.

"There hasn't been a silk robbery in a long time now," said one veteran, "and we haven't lost a quart of alcohol in months."

Just after the war came a series of mail robberies in which the loot ran into millions. Most of these holdups were committed, however, either after the mail sacks had been thrown from the trains or were being carried to the depots. These thefts became so numerous the war department placed armed marines on all mail trains and also on the postal trucks. There hasn't been a big mail robbery since.

It used to be that most freight car thefts were committed in the yards at the large terminals, but these yards are now efficiently patrolled, 1,800 special police being assigned to duty in the yards of the Chicago district alone. The result is that the majority of robberies occur on the road while the trains are moving. How, the average person asks, can a whole freight car load of stuff be stolen while the train

is going forty miles an hour? Listen to Chief J. Boyle of the Pullman Company's police force, and a member of many a posse that chased old-time train robbers across Missouri. He describes the modern method of operation as follows:

"The thieves are tipped off as to the number of the car and the kind of goods it contains. They hide on top of it and pry open the door after the train leaves the yards when the darkness hides the thieves from the train crew. The rumble of the wheels drowns out the sound as they begin throwing out the packing cases, cartons, barrels or boxes. The thefts always are committed where a highway parallels the tracks, where their confederates can pick up the loot with motor trucks."



Gamblers Using Marked Cards on Crack Train Trapped by Detective

To stop this practice, the roads are using shotgun crews in automobiles to patrol the highways near the tracks. Occasionally these squads come upon the thieves in the act of loading their trucks and the battle is on. The train riders usually ride in empty gondolas so they can watch both sides of the cars. Many a running battle over the lurching tops of box cars is fought between them and the thieving gangs, but the public seldom hears of the incident. A few lines in the newspaper announce that John Jones, a railroad detective, was found shot to death in the so-and-so yards, and that's the end of it.

"Talk about the James boys!" exclaimed L. J. Benson, chief of a force of nearly 3,000 detectives employed on the Chicago, Milwaukee & St. Paul system. "Some of these freight thieves have got them beaten forty ways. Get into a pistol argument with some of these birds dodging in and out among freight cars on a dark night and you'll get all the fun you're looking for."

And I have yet to hear of one of my men going the other way when under fire."

Another feature of the special agent's work is the protection of passengers on crack trains from swindlers and gamblers. For instance, a passenger on one of the fast limited trains running between New York and Chicago was approached by a stranger who asked if he played bridge. Responding in the negative, he was informed that but one other member was needed to complete the foursome and that, although bridge was their favorite game, pinochle would be played if he so desired. The passenger refused, but shortly after noticed a young man trailing the inquirer back to a compartment, and later return with a rather discontented look upon his countenance. The two struck up a conversation which ultimately drifted to gambling.

Overhearing the conversation, a gentleman, apparently an ordinary business man, joined in the discussion, and later solicited their co-operation in an endeavor to "get the goods on" the two card sharks who occupied the compartment. His credentials proved him to be a railroad detective. After dinner the special agent and one of the passengers adjourned to the club car to enjoy a quiet smoke and a social game of cards. It was not long before two men approached, and one, the individual who had extended the invitation to join his party for a game of bridge or pinochle, suggested that they go back to their compartment and have a little game.

This invitation was accepted, and as the

detective started to shuffle the deck of cards with which he had been playing, one of the strangers suggested, "Let's get a brand new deck." He rang the porter's bell, and in a few minutes the game was on. As it progressed, the bids were raised and the winnings of the gamblers increased.

Departing in seemingly good faith, the victims sought the porter. The detective made known his identity, and a rapid succession of questions that form a part of every grilling caused the porter to admit that he had supplied marked cards. The confession was drawn up in writing, signed by the porter, and the two swindlers were arrested at the next stop.

Few people realize that they are purchasing personal property insurance, if it may be termed as such, when buying railway tickets. The detectives, however, also act as a guard against pickpockets and wearing apparel thieves. One tells of a passenger who had fastened a highly valued, diamond stickpin on the underside of his necktie which he, in turn, placed in the pocket of his trousers upon retiring. The next morning it was missing and later was recovered from a pawn dealer.

Assisting county authorities, the special agents also conduct investigations of the causes of the death or injury of employes, patrons and trespassers and help in the promotion of measures for public safety.

In the Chicago district the crossing watchmen on the Pennsylvania railroad help to gather data in a campaign to prevent careless driving by motorists.

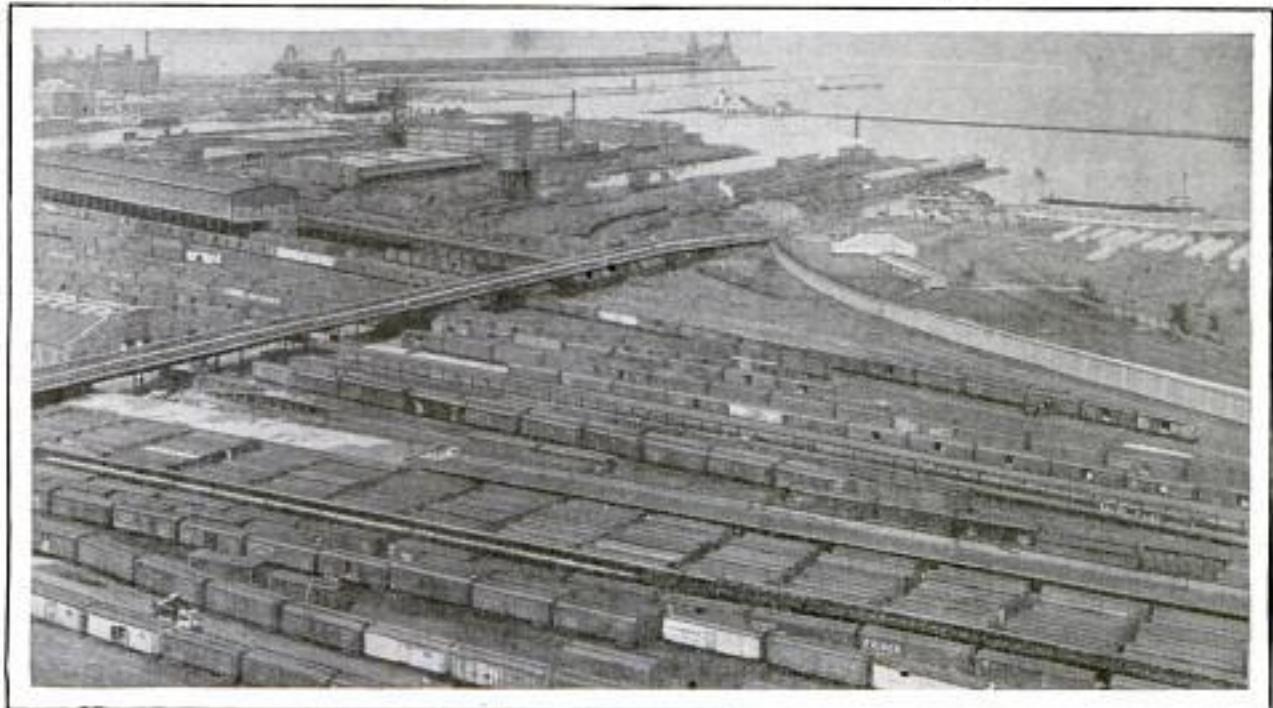

One of the Great Railway Terminals Constantly Guarded by Detectives

GOLF COURSE ON ROOF HELPS PLAYERS TRY CLUBS

Laid out on the roof of a hardware establishment in a canyon formed by office buildings, a nine-hole golf course in Atlanta, Ga., is said to be of great aid to practicing players, and beginners. High wire screens prevent the balls from dropping into the street below, and putting is permitted only at half the holes. Where full swings are allowed, canvas walls stop the flights

of the "pellets." Oiled sand is used for the "greens" to give a resiliency resembling that of grass. Instructors are available, and patrons of the store's golf department can test the various weights and "fits" of new clubs on the miniature fairways.

TOBACCO SMOKE NOT HARMFUL ACCORDING TO MINE TEST

4479
To test the effect of tobacco fumes, three men were confined in a closed chamber where the air was so smoky that it was impossible to see across the room. The atmosphere was so irritating to the eyes that it was necessary to wear goggles. After an hour and a half, samples of the air and the blood of the smokers were taken for analysis. The experiment was made by the bureau of mines, and, as a result, it was decided that the harm from smoking indoors, or in mines, is negligible.

4608 EUCALYPTUS OIL RIVALS "GAS"

Refined eucalyptus oil is reported to have been found practical as a substitute for gasoline as fuel for engines. When a mixture of the fluid and gasoline, benzol, or alcohol is used, it is claimed that no carbon can form on the motor parts. Experiments recently made have shown that 25 gallons of the liquid can be extracted from 1,000 pounds of the eucalyptus leaves.

12/13/1923
Auto Industry

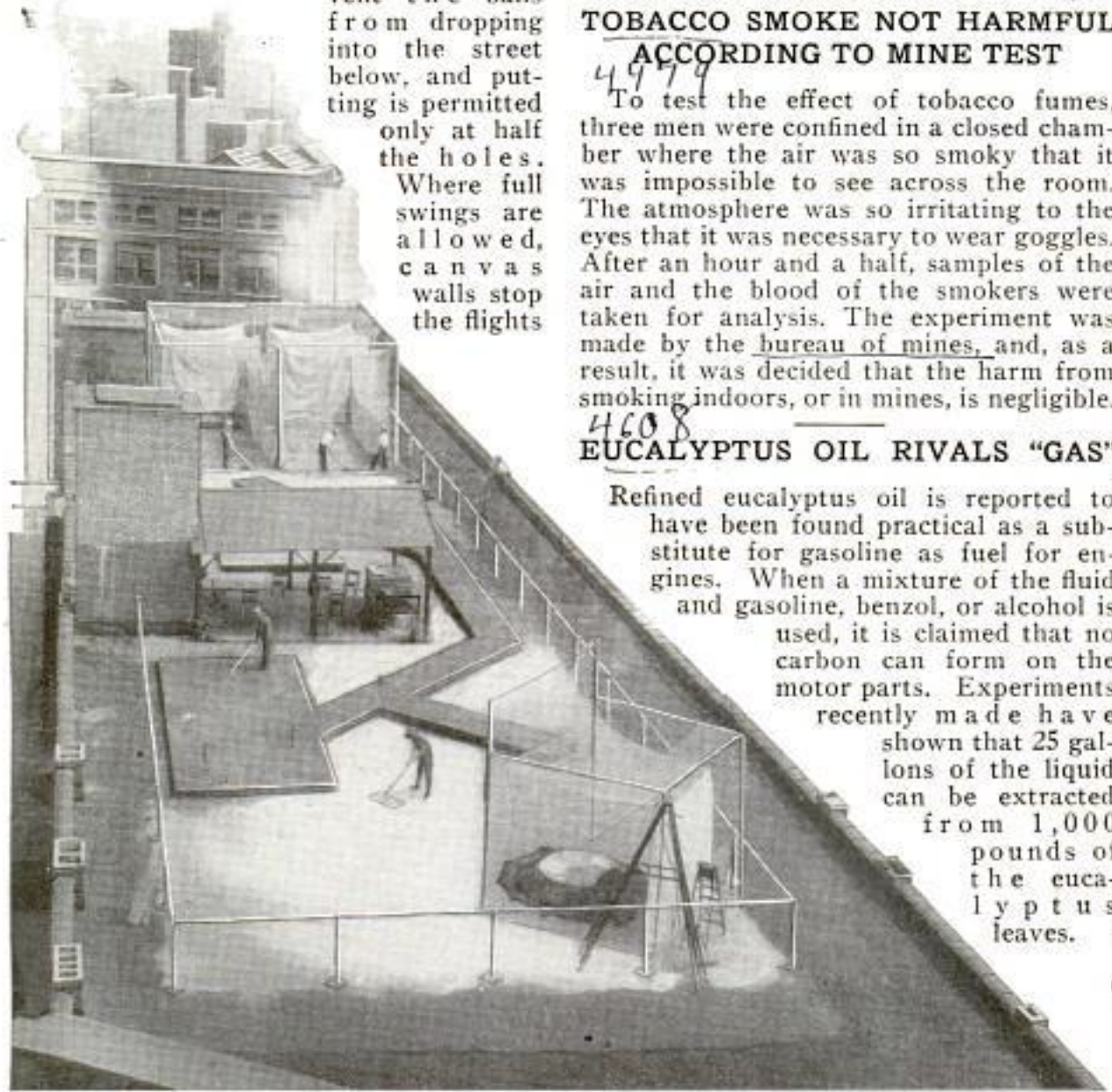

Roof-Top Golf Course where Players May Practice and Try Out New Clubs; Heavy Canvas Walls Retard the Flight of Balls when Full-Swing Strokes Are Permitted

4577 ALARM CLOCK FEEDS POULTRY AND TURNS ON LIGHTS

Poultry can be supplied with grain automatically at any desired time from a feeder operated by an alarm clock. The apparatus scatters the material in proper amounts over a 20-foot space, insuring the fowls sufficient exercise in gathering it. A

switch attachment can also be made to turn electric lights on and off without interfering with the feeding mechanism. The device can be hung to the ceiling of a coop or placed over a yard, and is designed to do away with much of the care required from attendants. It is claimed that it can be filled and set for work in a few minutes.

Automatic Time Poultry Feeder Co, Inc.,
Home Savings Bank Bldg, Fairmont
W. Va.
Copyrighted material

New York Times
12/16/23

POPULAR

MECHANICS

4525

BURIED CITIES OF HOLY LAND UNEARTHED BY AMERICANS

Five layers of earth, each of which contains traces of a separate civilization, one upon another, have been exposed by American excavations at Beth Shean, fifty miles north of Jerusalem. The hill where the digging is in progress overlooks the whole surrounding country, and from earliest times was used as a habitation and stronghold. Conqueror after conqueror planted his armies there. Past it runs the road where went all the travel from Syria and Mesopotamia to Egypt, following the River Jordan south toward Suez and the Nile. Relics already have been found of Arabic, Byzantine, Roman, Greek and Egyptian occupation. There also, it is believed, David, the psalm singer, vanquished the armies of Saul, and, in 1918, the Britons routed the Turkish forces.

4545

CIRCUS "HIPPO" IS HARNESSSED AND TRAINED TO DRAW CART

After considerable coaching at the hands of an animal trainer, "Lotus," a circus hippopotamus enjoying winter quarters in California, was taught to haul a two-wheeled cart. A V-shaped tongue attached to a broad band around the creature's back made traces unnecessary. A bridle of strong leather with the reins attached to the jaws completed the harness, and aided in directing the "river horse" which seemed to enjoy its "stunt" as it walked to its pool and back. Hippopotamuses are said usually to show little intelligence, but they are capable of great



Giant "Hippo" Harnesssed and Hitched to Circus Cart, About to Give Trainer a Ride

speed when in flight from an enemy, or while rushing to an attack after being wounded.

International

Miss. Staines,
Victoria St., S.W.1,
London Eng. 341
4449
PEELER SHAVES THIN PARINGS
FROM ROUGH VEGETABLES

Vegetables of irregular shape are pared evenly and quickly on an automatic peeler recently invented. The machine is so ad-

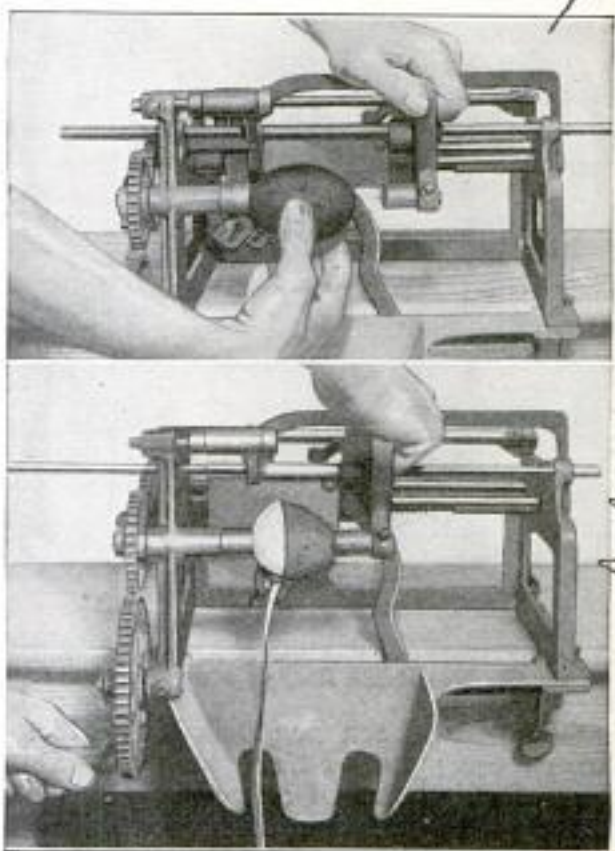

Automatic Peeler with Self-Sharpening Knife that Pares Vegetables Evenly as Spindles Revolve

justed that as the spindle turns, a broad knife follows the contour of the vegetable regardless of its shape. The blade can be set for peelings of different thicknesses, and sharpens itself as the crank is turned. The device is safe, as the cutter is out of reach of the fingers. Vegetables are quickly put on the spindle or removed, and waste is prevented, as parings can be cut as thin as desired.

4616

WIRE SERVICE FOR DRAWINGS IS OPENED IN FRANCE

Plans, designs and manuscripts are being accepted by the French government telegraph and transmitted by wire between Lyons, Paris and Strasbourg. It is expected that eventually the letter system will be extended to all the larger cities. The patented devices used are said to be so perfect that a transmitted signature is valid. The cost is relatively small, depending on the dimensions of the manuscript or drawing.

New York Times
12/22/23

Woods Metal Co. of Johnston, N.H.

Molby Revolving Hammock Co.,
 342 *Baldwin City* **POPULAR MECHANICS**
City, Mo.

EXERCISE IN HAMMOCK HELPS TO REDUCE WEIGHT

To exercise the parts of the body in which fat accumulates, and help users improve their physical condition, a revolving



Exercising Hammock that Serves as Gymnasium for Reducing Weight and Keeping Muscles in Order

hammock has been invented. It is said to stretch the spine and the muscles, stimulate circulation, and reduce weight. The device consists of a metal framework, with stirrups at one end and head grip at the other. A strap goes under the chin. Canvas webbing, shaped like a "Y", supports the body.

Price - \$22.50
- \$25.00 4505

HORSE WILL BE ZOO CURIOSITY IN CENTURY, EXPERT SAYS

Due to the adoption of motor power, horses will become extinct in a hundred years, says a scientist of the University of California, now studying the subject. In spite of the fact that the number of the beasts is on the increase, a century will find them only as inmates of zoos in America, he says. For the purpose of preserving their forms for future students of animal life, the expert has started a collection of specimens of all kinds of horses. Even those types that have not, as a rule, been used as burden bearers are expected to pass away in this country.

4564

BRIEF-CASE BUILT INTO GRIP

To save baggage space, a traveler's grip is being manufactured with a compartment that can be used as a brief-case. With it,

max slamm co, chgo.
newark, N.J.

wearing apparel and books and papers can be carried in one package, arranged so that any part of the case can be quickly reached. The container is strongly built of heavy leather and opens at the top in two sections, permitting a full view of the inside and allowing great freedom when extracting articles.

SAWDUST IS TURNED INTO WOOD

To be used as substitute for wood, a composition, containing about fifty per cent sawdust mixed with chalk and chemicals, which is then highly compressed into a solid mass, has been developed by a European scientist, it is reported. The finished substance is declared to answer all construction requirements of timber, and to be as hard as oak, though not subject to decay, and combustible only at very high temperature.

Christian Science Monitor
12/19/23

SOUNDS OF "SIREN" MEASURE

4527 SPEED OF THE WIND

For measuring the velocity of wind, Abbe Rousselot, of the College of France, has invented a machine that indicates the speed by sounds it gives off when air passes through openings in an upright cylinder. Buttons at the base release sixteen different sets of vents, which by the pitch of their notes, determine what rate of air motion is causing the tones. Devel-

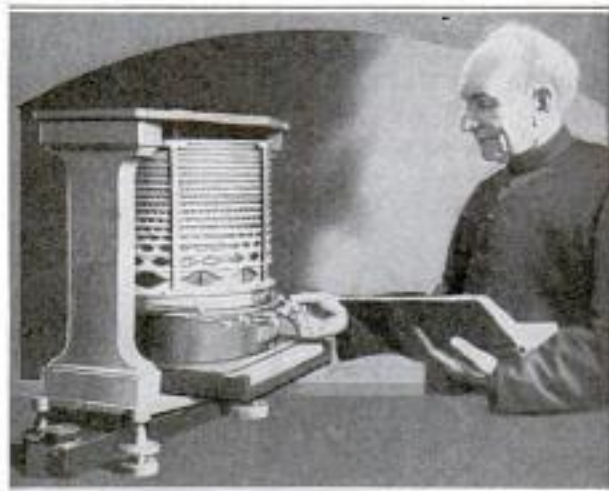

Copyright, Keystone View Co.
 Instrument that Tells Speed of Wind by Giving Forth Sounds Caused by Motion of Air

opment of the "siren," it is believed may result in delicate instruments to inform aerial experts of the condition of the upper strata before taking flights in aircraft.

ⓄA can of crushed coke placed in an ice box or basement is highly effective in absorbing unpleasant odors.

Chicago Daily News
12/14/23
Molby Revolving Hammock Co.,
Baldwin City, Kans.

no other information

SACRED CITIES TO BE LINKED BY RAIL AND WIRE



General View of Mecca, One of the Sacred Cities, Noted for Its Great Mosque with Its Spacious Courtyard, which Every Moslem Is Expected to Visit at Least Once

Mecca and Lhasa, the sacred cities of the Moslems and the Buddhists, may soon break through the isolation of centuries, a native syndicate having been formed to finance a railway between Medina, the burial place of the prophet, Mohammed, and Mecca, the city of his birth. There are, of course, other so-called sacred cities, such as Kerbela in Mesopotamia, and Meshed, in Persia. While it was possible for a Christian to enter the last named, and even to penetrate into Kerbela, provided he was accompanied by a Moslem guide, until comparatively recently on no consideration were they allowed to approach Mecca or Medina, while, up to the present, Lhasa has also been, in reality, a closed city. Not very many Europeans have made safe journeys to the sacred cities. Mecca lies in a valley some 70 miles from Jedda, a port on the Red Sea, and 248 miles from Medina, and the construction of a railway between these two points will prove difficult, as the country is rough, barren, and mountainous. Another sign that the traditions of ages are breaking down is seen in the action of the Grand Lama of Lhasa, the headquarters of the Buddhists, in Tibet, in ordering that his capital be connected with India by telephone. Lhasa is situated in a lonely valley, surrounded by tall mountains, and is dominated by Potala Hill, on which stands a single huge edifice where dwell thousands

of red-robed monks. In the center of the city is the Jokang, the most sacred temple in all Lhasa, for there is housed the most famous idol in the world, an immense statue of Buddha. It is said to be a faithful image of the great teacher. He is shown in a darkened recess of the cathedral illuminated by innumerable butter lamps and having for his companions two great gilded idols of other gods. It wears a crown of gold set with precious stones, while across its breast are many necklaces of gold, also set with jewels.

RADIO BEACON GIVES FLIERS 4396 THEIR BEARINGS IN FOG

Set up at a fixed location, a radio beacon to guide airmen in cross-country flights, and to aid naval aviators in finding their bases, has been tested. Fog and darkness will have little effect upon its usefulness. The instrument rotates to the right, and flashes signals every five seconds, the distance between any two impulses which follow each other being 30 degrees. Starting at the north, which is zero, a distinctive code signal, say, for example, two dots, is sent out. The flier, who has picked up the station, waits for the initial flash, and then, with his watch in hand, counts those which come after until he hears both dots with equal intensity. This gives him his compass bearing for landing.

Literary Digest
 Nov. 24, 1923
 Copyrighted material

with
**LADDER ON AUTO BUS UNFOLDS
TO REACH BAGGAGE RACK**

44 92

To make easier the placing of luggage on its roof, an automobile bus has been



Folding Ladder on Auto Bus that Permits Easy Loading of Luggage on Roof of Car

made with a light, metal ladder that is hinged in the middle, attached to the body. The contrivance can be unfolded so that its lower end will rest on the ground. This arrangement is said to leave more room for the comfort of the passengers, since cumbersome bundles do not need to be held on the seats or placed on the floor. Absence of such obstructions saves time at stops as patrons can enter and disembark quickly.

**DIVERS BRING FRESH WATER
FROM UNDERSEAS SPRINGS**

Scarcity of accessible wells and seasons of drought compel men in various parts of the world to risk life and limb and engage in laborious toil to get their supplies of fresh water. Before artesian wells were drilled, native divers at Basra, on the Persian Gulf, swam to the bottom of the shallows and obtained drinking water by inverting skins over the upward column that flowed from a sweet, submarine spring. In the mountains of Morocco, a cavern in an extinct volcano has long supplied residents of an upland village. Natives of northern Yucatan get much of their water from subterranean pools discovered ages ago by the Mayas in deep gorges and chasms of the

region. Men creep along perilous ledges, and descend rudely made ladders leading from one level to another, on their trips, with calabash gourds for carrying the precious liquid swung below the hips on thongs wound about the forehead. Torches are required to light the way along the dark paths, and near one ruined city of the peninsula, from the evidence of smoke-stained walls and foot-worn rocks that lead to a chasm well, scientists declare that the cavern was visited by water-carriers at a time when Thebes was a flourishing city and Tutankhamen was king.

POWER-DRIVEN SCREWDRIVER

4456 ALSO WILL SET NUTS

For driving or extracting screws and setting or removing nuts, an attachment fixed to a motor-operated flexible shaft has been designed. It is of special advantage when used to reach spots that are difficult for the hand tool, and can accomplish its work in a fraction of the time required with ordinary utensils. The appliance can be stopped without shutting off the motor by turning a release clutch near the handle. Two grips are provided so that sufficient pressure can be put upon the point from almost any position. The parts for the different tasks can be interchanged in a



Motor-Operated Screwdriver and Nut Setter that Does Fast Work in Difficult Positions

few moments. A light-weight iron stand on rollers supports the machine.

Blowing red-hot rivets through a tube is displacing the old and dangerous method of throwing them from the forge to the workman on steel structures.

*Emb. N. Sournear,
Thunderley, Southern
England.*



Bit of Badly Charred Paper

As It Looked After Treatment

Ash Piles Are Made to Yield Millions

Blackened Sheets of Carbon, Representing Fortune in Currency and Bonds Are Restored through Photo-Chemical Process

By H. H. DUNN; 27 22 Prince St., Berkeley, Calif.

THOUGH science has not yet succeeded in preventing conflagrations by which whole cities are destroyed, chemistry and photography hand in hand, have just come forward with a revelation whereby burned documents can be restored and redeemed.

By this discovery more than half a million dollars worth of currency, stocks and bonds were saved from the ashes of a fire at Astoria, Ore. By it millions more will be saved from the ruins of Tokyo and other Japanese cities. Had it been known when the scientists uncovered Pompeii, the vast libraries of that lava-scarred city could have been rescued. If men had discovered the proper combination of chemicals and the correct use of the camera, millions of dollars worth of papers and currency would have been redeemed from the San Francisco fire of 1906, and the losses in that disaster would have been greatly reduced.

The composition and application of the chemicals, in fact the entire process by which these charred remains of wealth, fragile as soap-bubbles, are made to reveal their value,

their character and, what is more valuable still, their recorded numbers, was discovered only a few months ago by Dr. Edward O. Heinrich, lecturer on criminology and criminal investigation in the University of California. He was led to it through work with chemicals in the hunting down of erasures and alterations in the forgery of checks, wills, deeds, titles and "raised" paper currency. From the same source, he brought the eye of the camera to bear on the subject, even calling upon the microscope to assist.

The process is based on the fact that documents, i. e., paper of all kinds, are not burned when tremendous heat is applied for a long time to the exterior of a bank vault or other supposedly fire-proof receptacle. Instead, the paper is destructively distilled, the hydrogen or other components being driven off as gases, and the carbon in the paper, the ink, and even lead-pencil writing, remaining, all concealed in the thin, fragile, black sheets, which are left behind. If the vault is opened before it has had time to cool, the sheets of carbon



burst into flame and are destroyed, or reduced to such flimsy ash that they cannot be saved. If, however, the vault is allowed to cool every document in it can be saved.

The method used by Dr. Heinrich was first applied to the contents of the vaults of the Astoria National Bank and the Columbia Trust and Savings Bank, in Astoria. The sheets of carbon are put into a tray of chemical. This solution strengthens and slightly glazes the sheet of carbon, and brings out the lines left by the mineral in the ink of the writing or printing, and the graphite in the penciled script. The majority of the papers then can be read with the unaided eye, but in complicated cases, such as wrinkled papers, very thin sheets, or those on which weak ink has been used, it is necessary to call in either the enlarging camera or the photo-microscopic instrument, which brings the writing or printing up to such size that it may be read on the photographic plate.

"Deciphering of the printing and writing on these sheets is a question of the ability of the eye of the operator to distinguish shades of black," says Dr. Heinrich. "Straw paper, for example, gives a brown-black ash, while the iron inks, usually used in writing and printing, give a dead-black. Pure linen paper, however, also gives dead-black ash, and the only way in which the writing and printing on it can be deciphered is by tilting the sheet at all angles until the one at which the lettering appears

is reached. The cheap pulp papers give a gray-black, on which the coal-black of ink is even more easily seen. Lead-pencil writing, after passing through fire, gives a silvery gray line, comparatively easy to read, provided that the writing was legible in the first place.

"In working with the documents left from the Astoria conflagration I made an interesting discovery—that, by wetting my finger on my lips and applying the saliva to the sheet of carbon, I could very frequently change either the color of the paper or the color of the ink sufficiently to be able to read the lines written on the former. Another interesting fact which came out at the Astoria fire was that plain Manila envelopes, of good quality, are the best containers for valuables. Leather pouches, in which currency and documents are kept, most frequently boil up like milk when subjected to heat, and so gum up the papers that it is almost impossible to separate them."

Diamonds, rubies and sapphires stood up well under the heat and were restored to good condition when cleaned with the chemical. Pearls, opals and corals, however were so badly cracked and their luster so dimmed as to render them virtually valueless. Gold and silver coins, of course, melted and were rescued as bullion. Documents such as deeds, transfers of title, marriage licenses, and divorce decrees, all of which had been recorded, were thrown away when the numbers were obtained.

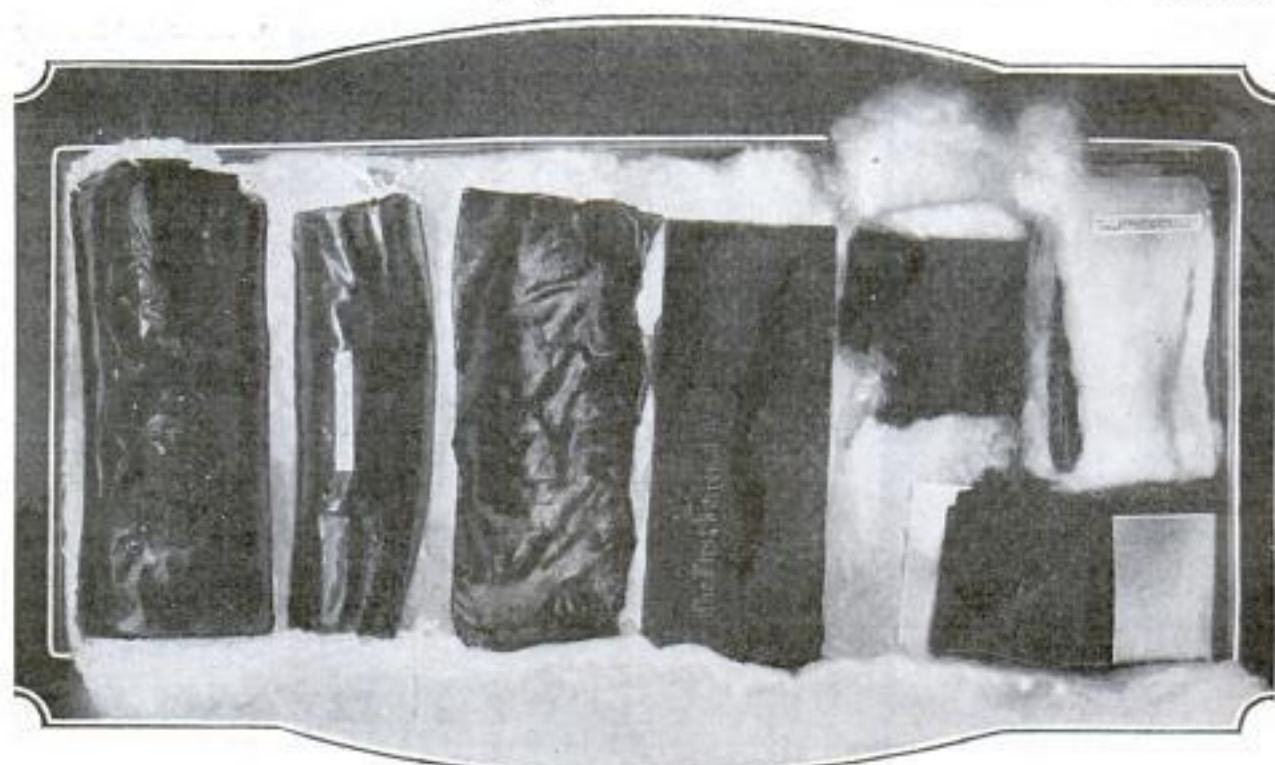

Fortune in Burned Stocks, Bonds, and Certificates Restored by Chemical and Photographic Treatment after Having Been Reduced to Bits of Blackened Carbon

SOLDIERS TURN ACTORS TO DRIVE WAR CHARIOTS

4470



Squadron of United States Cavalry Horses and Troopers in Gilded Chariots Dashing Across Sandy Plain to Depict an Egyptian Battle Scene for the Motion-Picture Camera

United States cavalymen took the role of Egyptian warriors in a motion-picture production a short time ago, and, in elaborately decorated chariots, swept across a sandy plain. The vehicles were fashioned closely after those of antiquity, with no

springs or seats, open at the rear so the warrior could leap in or out with ease, and large enough for only the fighter and his charioteer, who did the driving. Quivers full of arrows, and rich ornaments identified the chariots of the Egyptians.

SHIELD ENDS SPOTLIGHT GLARE TO AVERT AUTO WRECKS

4469

Spotlight rays that usually are projected upward and are lost, or confuse other motorists and pedestrians, are focused directly upon the road by a lamp of recent design, which has silvered reflectors and two lenses, so adjusted that dangerous glare is removed. A top shield effectually projects the full radiance



of the light upon the roadway, allowing persons' approaching the car to see it clearly.

Wassie Mfg. Co. 121 W. 35th St. New York

OVER THOUSAND COLORS LISTED

4460

Colors of every tone and shade, to the number of 1,400, are displayed in an index recently issued. There are no duplicates in the list, which was compiled from the productions of dye makers all over the world. Many scores seem exactly alike to the eye, but tests show that they are not. America sent samples from twenty-nine factories, while England and Germany were each represented by thirty-two.

Kansas City Times 12/1/23

FLOORS ON FELT-LINED "CHAIRS" MAKE ROOMS SOUNDPROOF

4471

To make rooms proof against outside noises, floors, ceilings and partitions placed upon chair-shaped, felt-lined supports are isolated from surrounding surfaces, and no vibrations can be communicated to them. Soundproofing by the common use of layers of felt or other material, has been found largely ineffective as vibrations are readily communicated by nails driven through the insulation. The "chairs" completely cut rooms off from outside noises by separating the sides from those adjoining. An absorbing blanket of cinders fills the space between and under the nailing strips and insures added quiet. The cushions also give resiliency to dance floors, bowling alleys and gymnasiums, and their use has been found of special benefit in the construction of hotels and large office buildings where noisy machinery is installed in rooms above those occupied by guests or workers.



Stevens Partition and Floor Headings Co. 14 E. Jackson Blvd. Chicago

Sample of My ers + Colomets Bradford, England

Copyrighted material

CAMERA TAKES TWO THOUSAND PHOTOS A SECOND

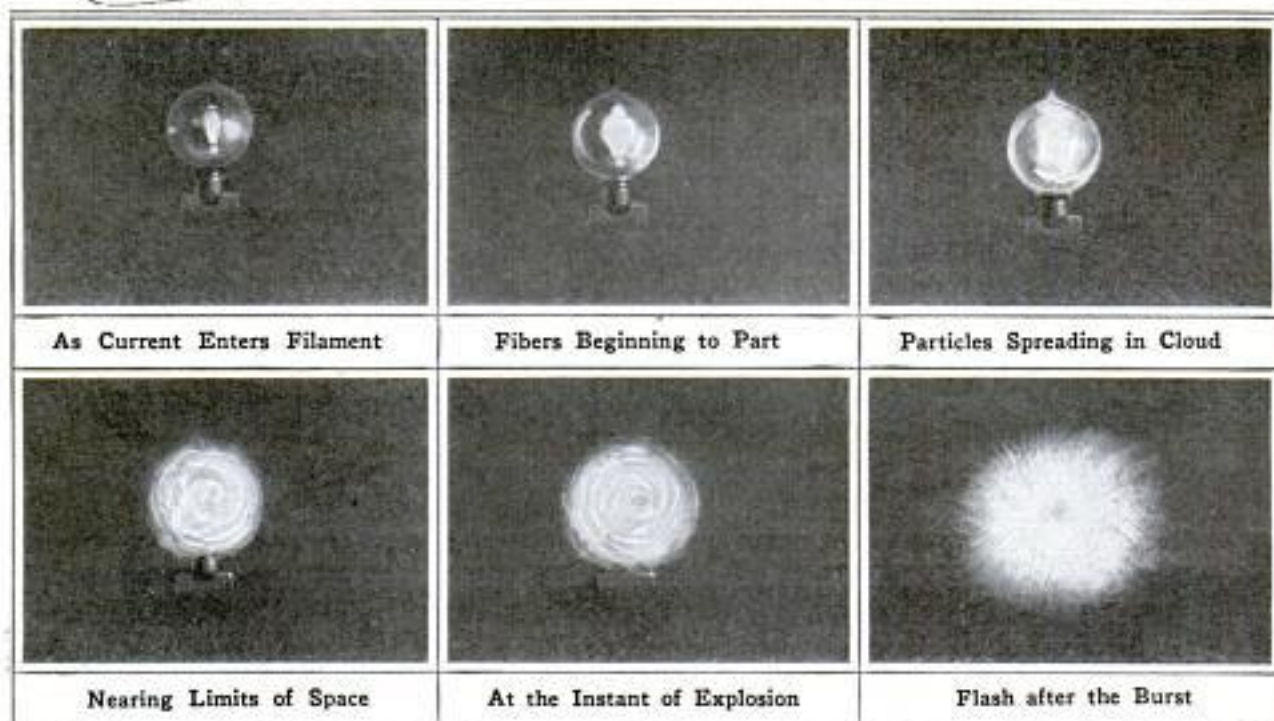

With Unerring Truth the Speed Camera Registered the Stages of Action in the Explosion of an Electric-Light Bulb that Was Subjected to an Overcharge of Current

With a motion-picture machine capable of taking pictures at the rate of 2,500 a second or 900,000 an hour, experimenters recently obtained unusual photographs of the breaking of a glass vacuum globe by the impact of a small hammer. Probably the most interesting fact recorded by the camera was that the side of the bulb opposite the hammer was first perforated by minute particles of glass hurled against it by the inrush of air as it entered where the tool had struck. Owing to sub-

sequent cracking on the globe, those small breaks grew larger and through them a cloud of fine powdered glass emerged. Between the picture showing the instant of impact and that of the bulb in almost total collapse, there was an interval of a very small fraction of a second. Only $\frac{1}{25}$ of a second was occupied in recording the entire experiment, from the time the hammer neared the bulb until it was nothing more than a pile of finely broken glass the result of the impact of the blow.

GIANT CHAIN OF REVOLUTION DEFIES TIME AND RUST

Although they were submerged in the Hudson River for five years, and have been exposed to the weather since the days of

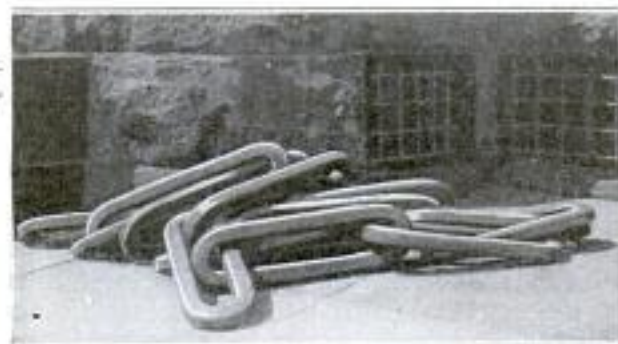

Great Chain Made During the Revolutionary War that Has Defied Time and Weather

the Revolutionary war, iron links in the famous Putnam chain that helped keep the enemy from reaching inland forts, show little sign of rust. Several of them have been on exhibit for more than two years in front of the Chicago Historical Society's building, but rains and snows have had practically no effect on them. Hand-forged from ore dug in mines near Sterling, N. Y., the huge chain, 500 yards long and weighing 186 tons, was floated on rafts and logs just beneath the surface of the water in six weeks after General Putnam had issued the order for its construction. One hundred and eighty-two men worked at the task of forging and smelting the ore. Though only hand tools were available, the links, some of them more than three and one-half feet long, were symmetrically and perfectly welded.

4576
 Prof. G. S. Shackwell

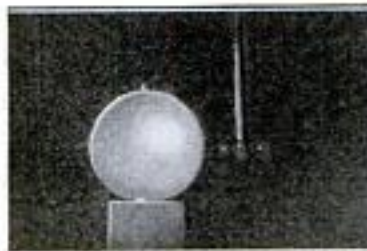

Hammer About to Break Globe



First Effect of Impact



Pieces Forced through Other Side



Rush of Air Bursts Walls



Effect Opposite Blow



Nearest Surface Starts Cracking



Sphere Begins to Crumble

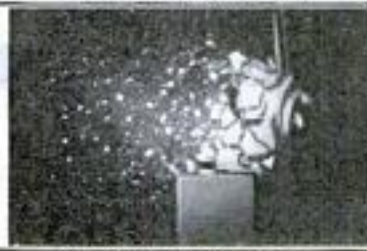

At Point of Disruption



Bulb Completely Shattered

Hammer Breaking Glass Bulb; Action Occupying 1-25 of a Second Is Recorded by High-Speed Camera

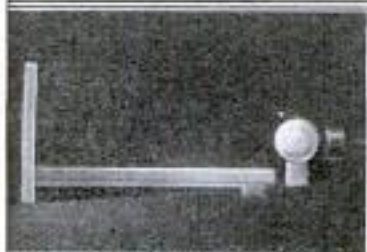

Wooden Pin Meets Ball

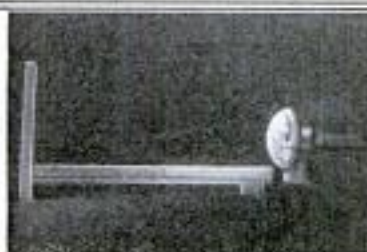

Rubber Gives Before Moving

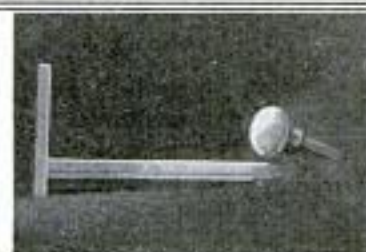

Beginning to Expand Again

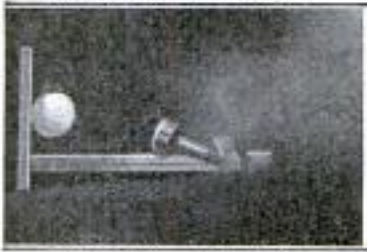

Bulb Strikes Steel Plate



Flattening Against Target

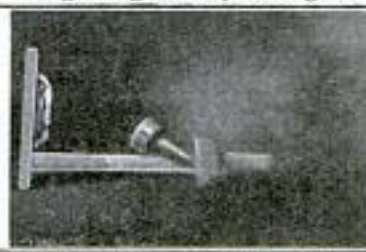

Entirely Collapsed, Fiber Broken



At Start of Rebound

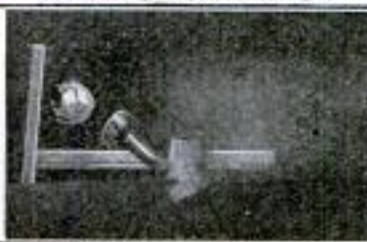

Bounce Causes Elongation



Original Form Regained

Movements of Rubber Ball Shot at Steel Plate Are too Slow for Super-Rapid Photography

4308 MODERN ARK IS BUILT TO ESCAPE TIDAL WAVE

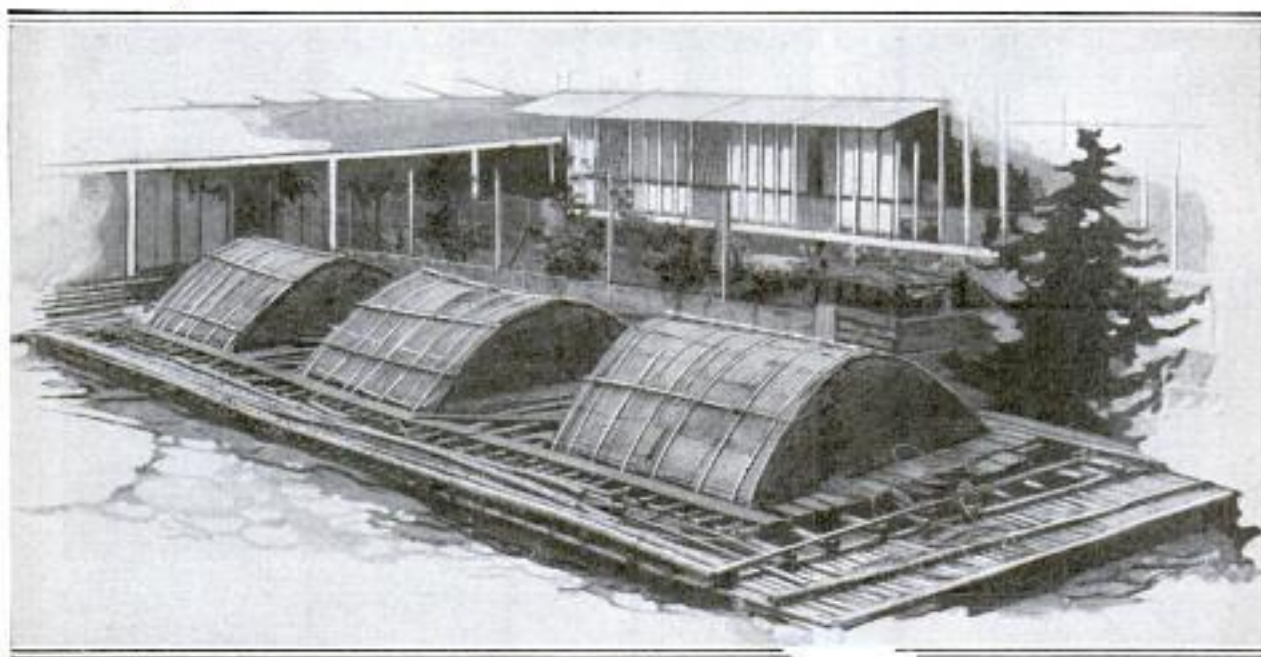

Bamboo "Ark" Built by Chinese Family as Refuge in

Fearing that the tidal wave that swept Yokohama also would destroy the city of Iloilo in the Philippine Islands, Chinese residents there hastily constructed a raft of bamboo and were prepared to flee to it if the inundation occurred. The rude craft

was 84 feet long and 33 feet wide, and in three hutlike cabins were stored provisions for several days, and bolo knives with which the owners expected to fight off anyone else seeking to climb aboard. The feared inundation did not take place.

ELECTRIC WASHER IN CABINET IS SAFE AND ATTRACTIVE

Safe in operation and attractive in appearance, an electric washing machine has been designed in which all the gears and working parts are inclosed in a steel cabinet with hinged doors which permit easy access to them but lessen the danger

of clothing catching in the wheels. The tub is constructed of insulated copper and will keep water near the boiling point for approximately five hours. Oscillations allow eight distinct movements of the water.

SECRETS OF THE SEVEN SEAS TOLD BY "BOTTLE PAPERS"

To learn the speed and direction of ocean currents, government experts use "bottle papers." Accurate knowledge of these drifts is important to navigation, and the safety of hundreds may depend upon it. Small slips, with directions for their return printed in the principal languages, are given to ship captains, to be sealed in flasks and thrown overboard. Months or years later, some return. One floated nearly across the Atlantic and back, and another crossed the widest part of the Pacific in a little over two years. A third, dropped near the Cape of Good Hope, was picked up on the western coast of Australia.

Engineers are planning a concrete tower 1,200 feet high to be used as a wireless station.

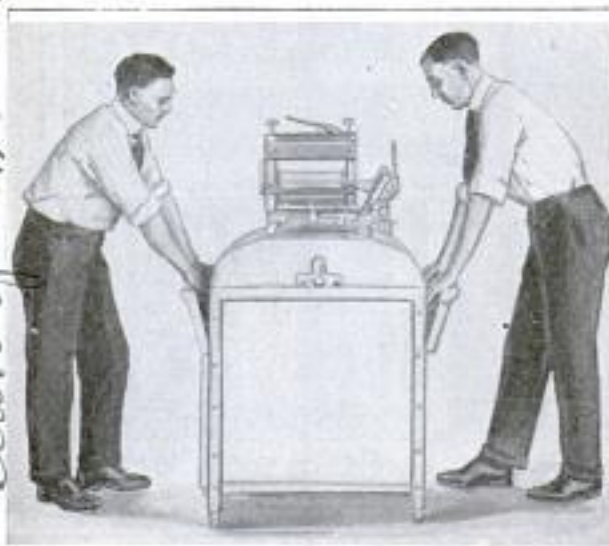

Washing Machine with Parts Inclosed in Cabinet to Promote Safety and Add Attractiveness

The Voss Washing Machine Co.,
St. Louis, Mo.

ACTION OF PLANETS IS SHOWN BY MOTOR-DRIVEN GLOBES

To illustrate the workings of the solar system, the various seasons, night and day, and the different phases of the moon, a

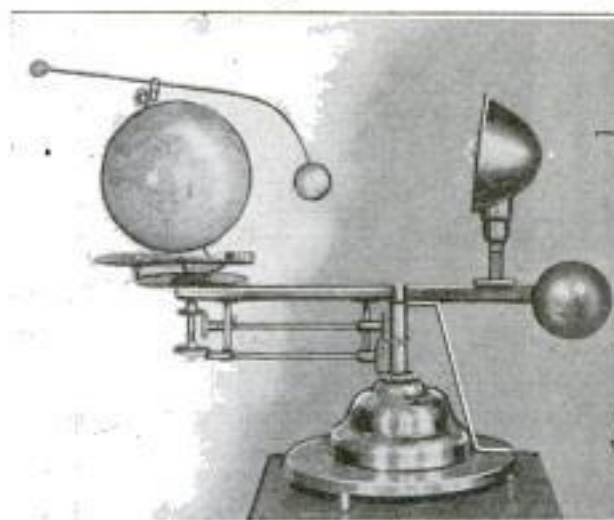

Automatic Globes that Show Movements of Earth and Sun and Illustrate the Seasons

Patented Sept. 26, 1923

device has been patented which consists of several globes, among them one representing the earth, and another the sun. These are revolved by an electric motor and a system of gears. An electric lamp illuminates the "sun," the rays lighting half of the other spheres as they travel about in their orbit. Thus the hands of the demonstrator are left free to point out different phases of the action.

4424 DIMS AUTO LIGHTS

So the motorist can without reaching to the instrument board, dim his headlights while driving at night, a button has been made that can be operated by a slight pressure of the finger without lifting the hand or releasing the grip on the steering wheel. The wiring from the switch to the lamps is so simple that it can be adjusted by almost anyone without the aid of a mechanic. It is believed that the use of the dimmer will help to avoid risk of accidents which might occur while the motorist is manipulating a control button located elsewhere in the car as he need not leave an erect position or take his gaze from the road ahead.



Price \$2.50.

SEEDS BURIED FIVE CENTURIES BURST INTO GROWTH

Discovered under layers of peat at the edges of the Gobi desert in Manchuria, lotus seeds, believed to have been buried more than five hundred years ago, were made to grow in the laboratory at an eastern university. They attracted the attention of a Japanese professor, who saw children digging them out of the ground and eating them. The layers of peat, in places fifteen feet deep, protected the seeds from injury and decay. The spot where they were found is supposed to have once been a pond into which they fell from the trees that grew along the banks.

TRAFFIC MARKER FOR STREETS BUILT OF WAR JUNK

Condemned war materials were made over into a traffic marker to run a line down the center of the pavement in Minnesota recently. These marks reduce the danger of accidents. An overhauled truck was fitted with a fifth or marking wheel with a solid tire, taken from another vehicle. The rubber was cut down to four inches in



Traffic Marker, Made from Condemned War Materials, Used to Help Prevent Accidents in Minnesota

width, and paint was piped from a tank to drip upon it. Speed of operation was about 20 miles an hour.

WORLD EVENTS ARE SCREENED FROM PAGES OF MAGAZINE

Clippings and illustrations from Popular Mechanics Magazine were flashed on the screen by means of a reflecting device before members of the Young Men's Christian Association of Riga, Latvia, recently. Lively interest was manifested by the spectators in the pictures of time and labor-saving inventions, remarkable facts and occurrences of note gathered from all over the world by the publication.

Capt. Bert L. Mitchell
Jura Alunana, Latvia
Riga, Latvia

See also
Mr. Acme Scientific
Bellurian Co., Portage, Wis.
Mr. J. Rogers
530 Bond Bldg., Washington, D.C.
Mr. J. A. Selari Co.,
530 Bond Bldg.,
Washington, D.C.

Penang Hills Railway

352

POPULAR MECHANICS

Penang Straits Settlements

CABLE CAR WITH STEP-UP SEATS CLIMBS MOUNTAIN

4324

Running over a track that, in its total length of 1 1/4 miles, rises 2,070 feet above the sea, a railroad in Malaya carries passengers to the heights in 24 minutes. This feat has opened up residential sites which

long bolts anchor the rails to the masonry. The cars carry 40 passengers each, and are built in step formation, one compartment above another, to conform to the grade of the track. They are equipped



Climbing Out of a Steep Tunnel, this Step-Seated Car Ascends the Mountain Side Pulled by a Cable Winding on Drum at the Summit of the Grade

will relieve white men of many of the ills they suffer in the tropics, at low altitudes. The rugged formation of the slopes made necessary cuts and viaducts with a combined length of over 1/2 a mile. Owing to the fury of storms, the roadbed is constructed upon concrete and granite, and

with brakes that act upon the rails like pincers. A cable connects the two cars to the drum of a powerful stationary engine; one car goes up while the other descends. Before reaching the summit, the right of way passes through one of the steepest tunnels in the world.

AUTOMATIC LOCK FOR WINDOW TO FOIL INTRUDER

4371

Automatically locking when closed, a window appliance recently marketed can be fitted to almost any kind of sash. As the



Lock Automatically Secures Windows when Sash Is Pulled Down, and Door Stop, at Right

frame goes into place, the device adjusts itself to prevent the window's being opened from the outside. It also permits the window to be fastened in any position, and can be easily put on. A similar attachment for doors also is being made.

OIL TO PROTECT RAIL TRACKS

To stop rust on railroad tracks and make the steel fixtures last as long as the chemically treated ties, an eastern road has worked out a plan of oiling its rails, track bolts, tie plates, and other fittings of like character. The cost of putting on this coating is not high, and the saving effected on any one item of the track structure is said to justify the practice.

Isbrand & Specialties Co.
3103 W. Isbrand Ave
Chicago

Literary Digest
12/10/20

Used by Messrs. Kashkavanna
Western
Railroad

12/6/23

4401 **FLYING BOAT IS KEPT STEADY WITH UNDERWATER WINGS**

So that a seaplane may alight upon rough water safely, and to prevent dangerous rolling, a boat bottom has been designed with stabilizing planes below the water line. These wings slope upwards and outwards, so that when the craft heels over, the immersion is progressive, and is therefore increasingly resisted by the water, thus tending to keep the craft upright. As hydroplanes are usually top-heavy, and offer a big surface to the wind, great difficulty has been encountered in protecting them from waves. For this reason, floats or boat hulls have been made very stout and strong, qualities not usually obtained when extreme lightness is desired. By decreasing the weight, it is hoped that the hull fitted with underwater wings also will aid the seaplane in rising.

4397 **"COAL BIN" FOR LOCOMOTIVES LOADS TWO CARS AT ONCE**

Coaling railroad engines is now being done through a massive hopper capable of feeding two locomotives at the same time.



Coal Hopper with Two Chutes that Make Possible Loading Two Tenders at Once

4409 **"CHEMICAL SPONGE" TAKES ODOR FROM CLOSED COMPARTMENTS**

To absorb food odors and gases frequently found in refrigerators and pantries, a "chemical sponge" has been made that occupies no more space than a teacup. Placed in a laundry closet or in a trunk, it will take up moisture and prevent damp odors from saturating the clothing. Surrounding the container is a perforated metal jacket which protects the interior and permits the passage of air to the solu-



Absorbent Deodorizer in Perforated Container that Occupies Small Space in Refrigerator or Closet

tion. The deodorizer will last for several months, is harmless and its presence cannot affect the most delicate foodstuffs.

Price - \$1.00.

There are now 145,000 radio sets on the farms throughout the country, which receive crop reports from 150 government wireless stations, according to recent estimates.

Inquiries to - Holley Mfg. Co., A-804, 18 E. 41 St. New York.

Stationed beneath a chute, the tender is fed with the fuel from a huge chamber having a capacity of hundreds of tons. Two large tubes make possible the double operation. The loading station, which is constructed directly over the tracks, is said to perform its work rapidly and without the usual wastage of coal.

4378 **MANY NEW USES FOR PAPER LOWERING SUPPLIES**

Recently discovered uses for paper are yearly making greater inroads on available supplies, and, with the production in the United States decreasing, a substitute is considered a growing necessity. The production of all grades in this country for 1921 was 5,356,317 short tons, as compared to 7,334,614 short tons in 1920. Flexible and durable garments are now manufactured from paper from the mulberry tree. Paper cooking bags, bottles, grain sacks, and horseshoes have been on the markets for some time.

Kansas City Journal
12/2/23

13 E 16 St. N. Kansas Co., Denver, Kansas City, Mo. 780-6-6000

Rock Island Station at Haileyville, Okla.



With a Gay Bandanna Around His Neck, the Modern Cowboy Presents as Vivid a Picture in Boots and Spurs as the Old-Time "Puncher," and Is Just as Skillful

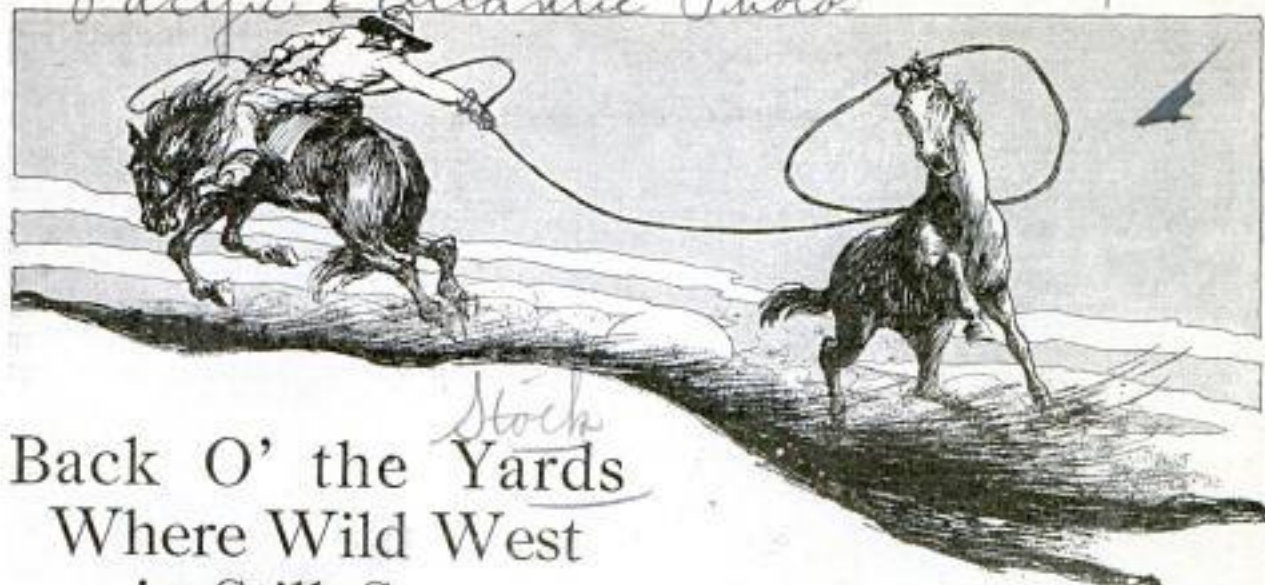

Back O' the ^{Stock} Yards
Where Wild West
is Still Seen
Every Day

WITH the cutting up of the great ranges, the vivid cowboy with his wide sombrero, gay bandanna, chaps and spurs is fast fading into a dim shadow on the flickering screen of movieland.

Surrounded by towering buildings, clanking switch engines and a wilderness of tracks, the never-old drama of the wild west also is vanishing from one of its last strongholds—the Chicago stockyards.

Cattle still pour into Packingtown from their peaceful homes on the Texas plains or the prairies of Kansas or Oklahoma, but gone is the time when the 500-acres of pens represented a live part of a far-flung frontier.



Cattle Being Herded into Pens at the "Yards" after Their Arrival from Western Ranges

Cowboys are still to be seen in and "back-o'-the-yards," but they are city cowboys, although they can ride a horse just as well as the old timers who used to accompany the cattle to market. Nowadays, the railways feed, water, and exercise the animals so that the shipper does not have to send his cowboys with them. On arrival they are herded into pens by men who, in most cases, have grown up in the district, but who can rope a steer with as much skill as their brothers of the plains.

With the arrival of the cattle, there is a bustle of activity. Bulls bellow, horses neigh, and men shout. Whips crack as the cowboys prod on a lazy or bewildered animal. Here is where the arts and tricks of the cowboys are most needed, for if a cow or bull starts running and gets mixed up with another herd, the whole drove would attempt to follow, resulting in endless confusion. Often, as the animals are being taken from one pen to another, a steer will break loose.

"Close the doors!" is the shout then.

"Go get 'im, kid!" one of the riders will whisper to his horse, and the animal is down the alley after the fugitive like a flash. When he is within fair distance, the rider twirls a rope and lets it out with a long fling, and it settles over the bull's neck as neatly as though there was no other place where it possibly could fall.

The horse has been through similar incidents many times before and springs back sharply on its haunches when the bull is lassoed. The force of its sudden halt brings the animal to the ground, and a moment later a sadder but a wiser member of the bovine family is being chaperoned back to its playmates. The thing is done as well as though it was one of a hundred similar occurrences at a round-

up on the Miller Brothers' 101 ranch, down at Marland, Okla.

These city cowboys are as proud of their mounts as the "punchers" of the old days ever were and they take as good care of them. Some of their horses cost \$350 or more, while the rest of them are bound to hit the mark somewhere between \$100 and \$250. The saddles are matters of as much

the pens they are inspected by the buyers, of whom there are 300 or 400, all mounted on horses. These men make their bids dependent on market conditions and thousands of dollars will change hands without the signing of a single paper. "Weigh 'em to Swift," one will say of a \$10,000 lot before the scale ticket is made out. From the pens to the coolers where the meat is chilled, takes exactly thirty-five minutes. That is all the time required to transform a steer from a living animal into human food.

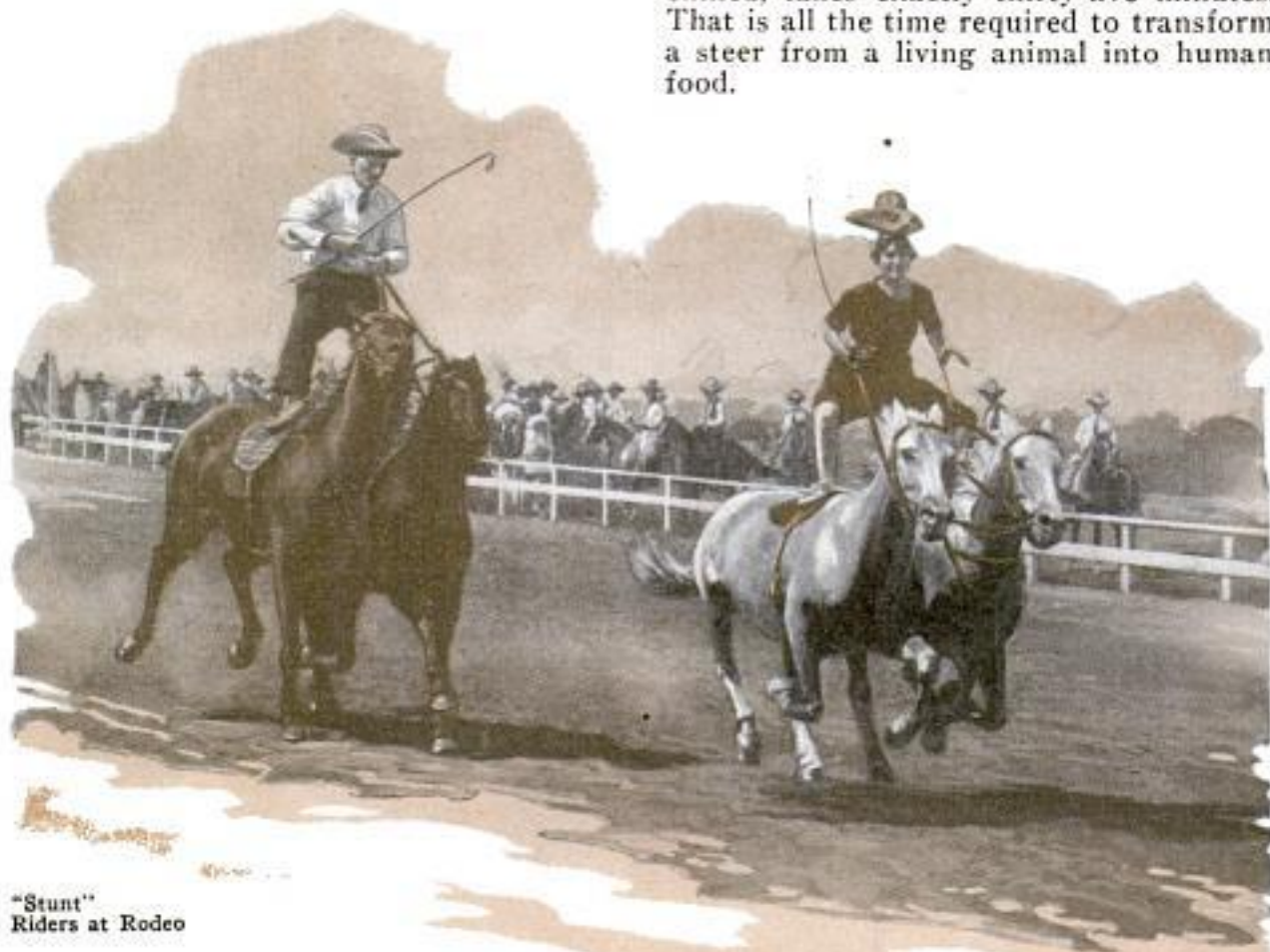

"Stunt"
Riders at Rodeo

care to the horsemen, too. A person who rides a great deal always takes an intense pride in his horse and its equipment, just as an experienced motor car driver likes to see his machine looking its best.

The horses are highly trained. They know their work and they do it with a business-like sincerity. If their rider is herding a drove of cows along an alley or from one pen to another, the horse will see that the animals keep walking straight along on their paths. When a gate bars the way, the horse will go up to it and turn sideways, so the rider can unlatch the barrier without dismounting. When the gate is opened, the horse walks through, then turns sideways to it again, so it can be closed. The horses on hay wagons can open and close many of the gates themselves by a nudge of the nose.

After the cattle have been sorted into

With the shipments to the stockyards totaling approximately 16,000,000 head a year, so efficient is the process of dressing and so expert are the workmen, that the capacity of a single department in one of the larger plants is 250 cattle per hour. So perfect is the way of handling bacon, for instance, that it is sliced, weighed and packed in cartons without being touched by hand. All of the coolers where fresh meat is handled are maintained at an even low temperature by circulating very cold brine

through pipes suspended from the ceiling or wall. More than 3,000 sides of beef can be stored in one of the coolers where the temperature is kept several degrees above freezing, which chills, but does not freeze the meat. In addition to its own refrigerating apparatus, one of the big plants uses 250,000 tons of natural ice a year, principally in the cooling tanks of freight cars.

Over two-thirds of the beef that supplies the nation with food is raised in the west, but most of it is eaten in the east. About thirty per cent of every animal is waste, 1,000 pounds on the hoof producing only 550 pounds of meat, but little is allowed to go to waste. Even the fine hair in the ears of steers is cut and made into camel's hair brushes. It takes the hair from the ears of twenty-five steers to produce one pound. Another very valuable by-product is soap, a combination of fats, vegetable oil and caustic. In manufacturing it, the ingredients are mixed together in steam-coil lined kettles three and four stories deep. The capacity of each of these is from ten to twelve carloads of soap.

When sufficiently boiled, the liquid is poured into a molding truck and solidifies into a large cake weighing up to a thousand pounds. This is put on a cutter and sliced into slabs, then into strips and again into cakes. These are wrapped by machinery having a capacity for 45,000 bars a day. Even the wood shipping containers are nailed with a special device. Wherever

possible, laborious handwork has been supplanted by specially designed machines.

When shipped into the Union Stock Yards, livestock is consigned to various commission firms, members of the exchange. The animals usually arrive at night and are unloaded in the morning before the market opens. The weighing is under the supervision of the Union Stock Yard and Transit company, which issues a certificate of weight covering the sale. The scales are tested frequently by city inspectors and the seller is free to check the weights.

The pens making up the yards cover about a square mile. "Packingtown," composed of some twenty-five plants, occupy about half of this area. The day's activity begins long before the rest of the city is out of bed with the unloading of the cattle. Spurred on by the quaint cries of the drivers, the animals are sorted, fed and placed in separate pens for the inspection of the mounted buyers.

Among them may be noted men of the range type. These are the brand inspectors—detectives of the cattle world—many of them being former cowpunchers. They are employed by the western cattle raisers associations. If a shipper tries to market a steer branded with any except his registered mark, the brand inspector singles out the animal and sees that the lawful owner receives the proceeds of the sale, thus eliminating the cause of many hot disputes.



Brand Inspectors Who Protect Buyer and Seller at the "Yards"

4343

358

POPULAR MECHANICS
28 Manchester St. W.,
METAL TAPE TO GUIDE X-RAYS
STOPS DANGER OF BURNS

London, England

Improvement in X-ray treatments is said to have done away with the danger of burns to patients. The beam, like an elec-

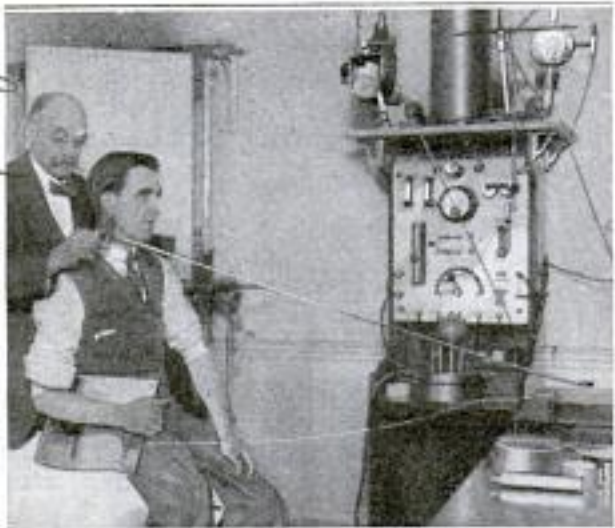

Patient Being Treated with X-Rays Guided on Metal Tape to Prevent Burns

tric current, can be conducted by a metallic tape to almost any point, even into an adjoining room, it has been found. The results obtained from this method are reported to be as satisfactory as those under the old system. A copper plate is placed between the tube of the machine and the affected tissues under treatment, and the metal ribbon conductor is attached to it.

Discovered by Henry Myerson, Radio Photographer and X-Ray Specialist.

Small quantities of ether, ammonia and castor oil added to alcohol

from foot-rests on which the farmer stands. The weight of the person handling it gives the necessary hold in the ground, and an upright crossbar, when pushed forward and backward, forces the blade to dig the furrows. Its direction is kept straight by a guide.

GASOLINE HAS FUEL RIVAL
IN VEGETABLE EXTRACT

4359

As a substitute for gasoline, "natalite," a vegetable extract, first made in South Africa, is said to produce more power to the gallon when used as motor fuel. Although mostly alcohol, the new fluid contains several other ingredients that give it valuable properties. It is claimed that a fire fed by it can be easily extinguished by water, making it an aid to safety. It has also been said that it will not dilute lubricating oils to the same extent as gasoline and similar solution will.

The Rudder, Nov. 1923

AUTO BODIES MADE OF FABRIC
END SQUEAKS AND RATTLES

4391

Fabric, which holds its shape, is durable and is washed or dusted easily, is being employed successfully in place of metal in the bodies of a French automobile, celebrated for its silent-running qualities. With the car windows, held in rubber grooves, and the panels manufactured of

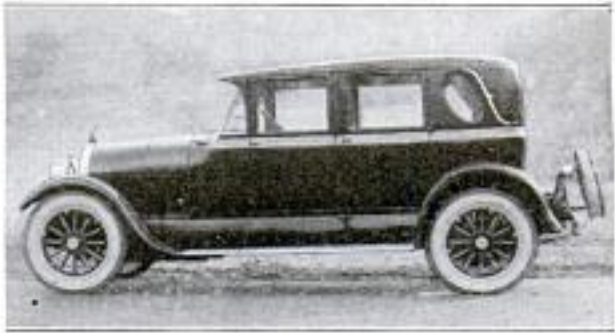

Automobile Body of Leather-Like Fabric that Looks like Metal and Does Not Squeak

the leatherlike material, squeaks and rattling common to bodies of steel construction are said to be entirely removed. Limousines and landalettes of this construction can be built for little more than ten per cent above the cost of the open or touring-type cars, it is said. Though heat and severe blows may blister the covering, its composition is such that in a short time the swellings disappear. It is not scratched or marred by ordinary dusting or washing and saves time necessary in polishing enameled surfaces.

Literary Digest 12/1/23

Copyrighted material

PLOW OPERATED BY MAN DIGS
AS HANDLES ARE WORKED

43

For the cultivation of small pieces of land with less labor than spading by hand, a portable plow, operated by one man, has been designed by a German inventor. The implement is said to have been tested recently, with good results. It is worked



Road Grader Operated by a Long Lever that Requires Services of Only One Man

TIDE FREES VESSEL WHEN TUG FLEET FAILS

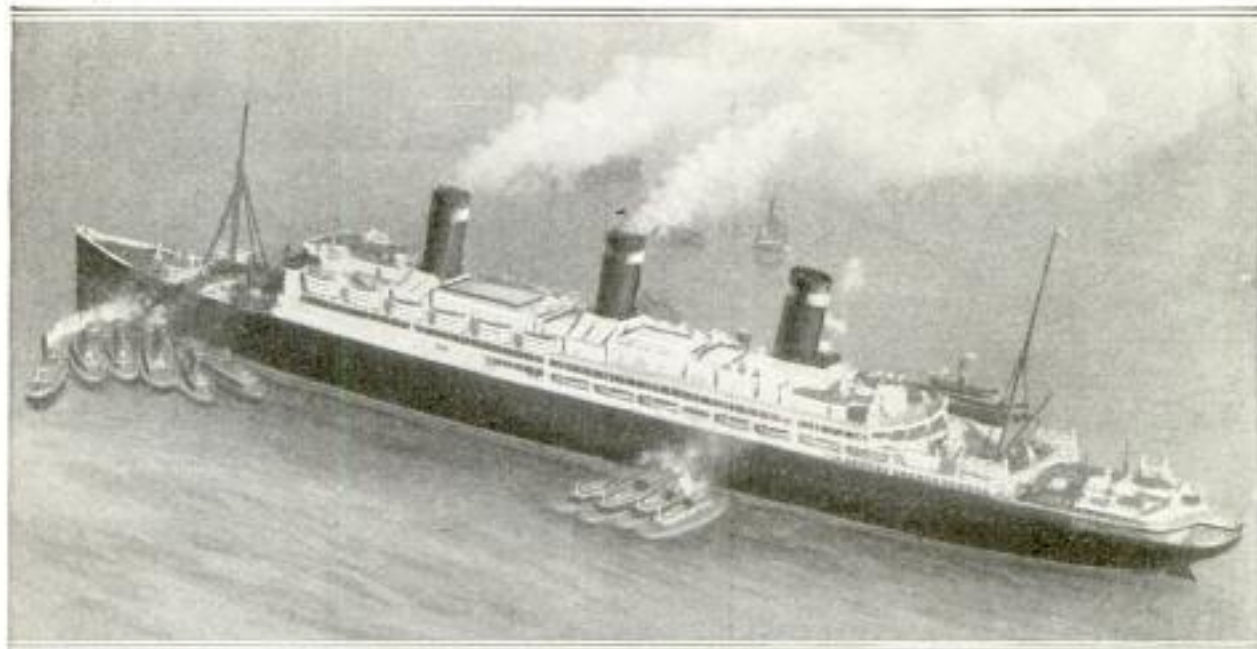

Some of the Fleet of Powerful Tugs that Attempted to Haul the Giant Liner, "Leviathan," from the Grip of a Concealed Mud Bank in New York Harbor, Before the Tide Freed It

After a fleet of powerful tugs had failed to free the giant ocean liner, "Leviathan," when its prow became stuck in a mud bank in New York harbor recently, the incoming tide easily floated the great vessel. Despite the fact that but a small part of the hull was imbedded in the mire, it was impossible to move the boat with its own

power. Although straining at their burden for hours, the towing craft were unable to budge the steamer until the rise of the water caused a greater depth. Later, divers were sent down to the floor of the bay at that point and are reported to have discovered damage done to water mains that pass under the water near the spot.

HUNDRED-POUND TOPAZ MINED IN WILDS OF BRAZIL

4398

Weighing over a hundred pounds, a topaz, recently discovered by an American explorer engaged in a gem-hunting expedition in Brazil, is believed to hold the world's record for size. Triangular in shape, it measured nine inches by ten by seventeen, and casts its yellowish gleams with a sparkle equal to similar stones of the smaller varieties. The curio is now the property of a Chicago museum, where it graces a prominent place among like exhibits.

Field

THOUSAND-YEAR-OLD CANOES FOUND BY DREDGERS

4599

While dredging the bottom of a lake in New Jersey, workmen raised the remains of three large canoes, thought to have been built by Indians who lived almost 1,000 years ago. Experts believe that the boats were preserved by being entombed in peat ever since they sank.



Copyright, Underwood & Underwood.

Huge Topaz that Would Make Settings for Hundreds of Rings Is Museum Curiosity

new York Times 12/20/23

4454

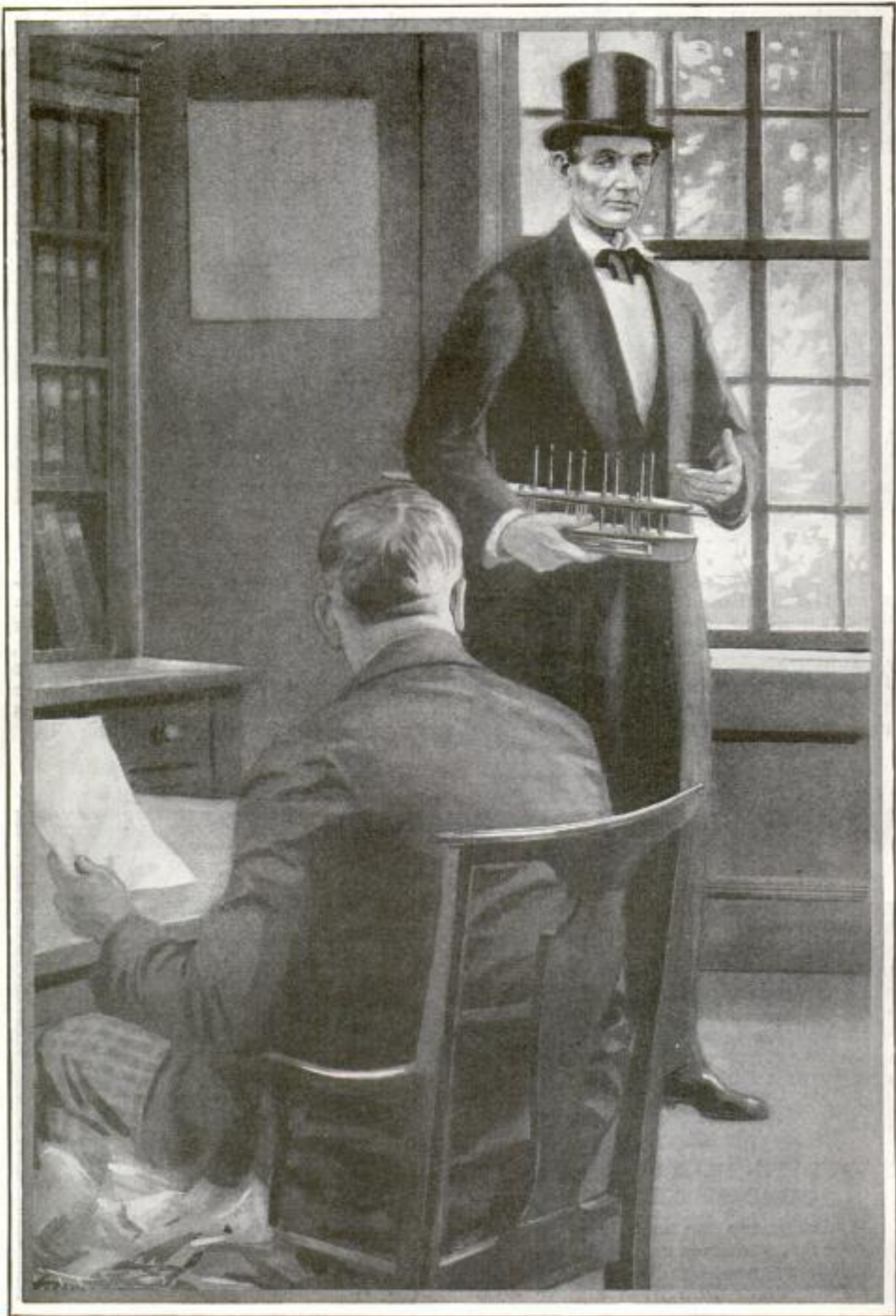

Abraham Lincoln Showing Whittled, Wooden Model of His Only Invention to W. H. Herndon, His Law Partner, Who, It Is Recorded, Did Not Think Much of It

ABRAHAM LINCOLN AN INVENTOR,
PATENT RECORDS REVEAL



WHILE every schoolboy is familiar with the life of Abraham Lincoln—a pioneer home, few books, hard labor at all the many trades of the frontiersman and the battle to save the Union and abolish slavery—few know that he also was an inventor.

To his genius as a statesman a united nation today bears witness, but only a rude model in the archives of the National Museum at Washington remains to give mute evidence that he possessed an inventive ability that alone, if followed, might have won him enduring fame.

Appearing as though it had been whittled out of a shingle and a cigar box, the model is about eighteen or twenty inches long, and bears the inscription: "6469, Abraham Lincoln, Springfield, Illinois. Improvement in method of lifting vessels over shoals. Patented May 22, 1849."

The apparatus consisted of a bellows placed in each side of the hull of the craft, just below the water line, and worked by an odd, but simple, system of ropes and pulleys. When the keel grated against the sand or obstruction, the bellows were designed to be filled with air; and thus, buoyed up, the vessel was expected to float over the shoal.

It is declared that the idea for this

device probably originated when he was twenty-one years old and started out

for himself by contracting to build a flat-boat to take a few barrels of produce to New Orleans, for which he was to receive twelve dollars a month. Before beginning the journey, he split 400 rails for every yard of brown jeans dyed with white-walnut bark that were necessary to make him a pair of trousers.

After proceeding as far as New Salem, the crude craft stuck on a mill-dam and there for twenty-four hours it hung, the bow in the air and the stern in the water, the cargo slowly settling backwards and shipwreck almost certain. With most of the residents of the town looking on and shouting advice, Lincoln unloaded the boxes and barrels into a neighboring boat and tilted his craft. Then by boring a hole in the end extending over the dam, the water was let out. This done, the boat was shoved over and reloaded. Twenty years later he embodied this experience in the curious invention for getting vessels over shoals, the final inspiration resulting from a journey between Niagara Falls and

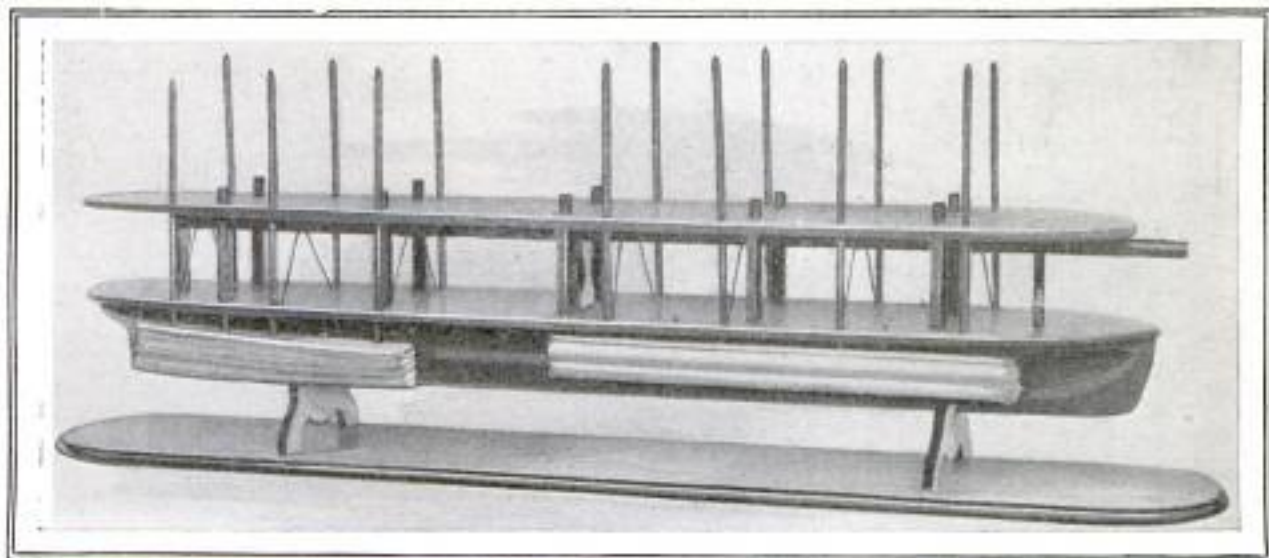

Model in the National Museum at Washington, the inscription on which reads: "6469, Abraham Lincoln, Improvement in Method of Lifting Vessels over Shoals; Patented May 22, 1849."

his home in Springfield, Illinois.

On his way westward, the boat on which he made part of the trip was stranded in shallow water and had to be pried loose. First a large pole was driven into the mud and then a winch and rope were attached to it to pull the steamer free. When Lincoln reached home he began to build the model representing his idea, whittling at it in his law office while talking on its merits and the revolution it was going to work in river transportation. It is recorded that his partner, W. H. Herndon, did not think much of it and sought to discourage him.

But when the future president returned to his seat in congress, he took the miniature with him. "One morning he walked into my office with a model of a western steamer under his arm," said Z. C. Robbins, a lawyer, in describing the incident. "After a friendly greeting, he placed it on my desk and proceeded to explain the principles embodied therein that he believed to be his own invention, and on which, if new, he desired to secure letters patent. I speedily came to the conclusion that his idea was of value and procured a patent."

Lincoln's inventive ability and his interest in mechanics, however, were shown in many other ways. Although he himself said that he had never gone to school more than six months in his life, he fitted himself for a position as deputy surveyor in a few weeks by reading all the books he

could find on the subject. According to tradition, he was too poor to buy a chain and, instead, used a long, straight grape vine. He also acted as pilot for the first steamer to make the trip from Beardstown to Springfield.

After he became president, and in the opening days of the civil war, the need for arms opened the way for inventors and Washington was overrun with men having guns to test. Mr. Lincoln took the greatest interest in these new arms and it sometimes happened that when an inventor could get nobody else in the government to listen to him, the president would personally test his gun. One such incident is told by a former clerk in the navy department. He accompanied Mr. Lincoln to the lawn south of the White House, where the president fixed up a target cut from a sheet of white congressional note paper.

"Then pacing off a distance of about eighty feet," writes the clerk, "he raised the rifle to a level, took a quick aim and drove the round of seven shots in rapid succession, the bullets shooting all around the target like a gatling gun and one striking near the center.

"I believe I can make this gun shoot better," said Mr. Lincoln, and took from his vest pocket a small wooden sight which he had whittled from a pine

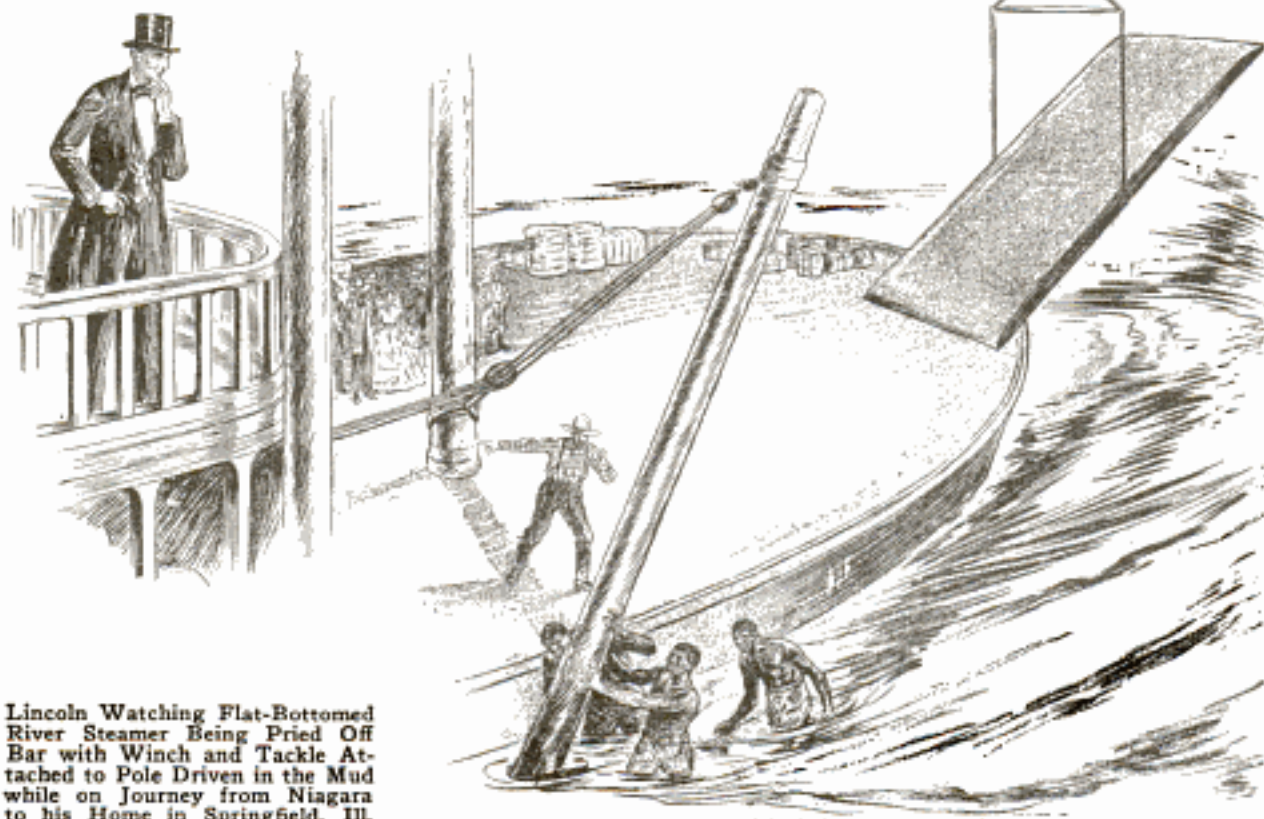

Lincoln Watching Flat-Bottomed River Steamer Being Pried Off Bar with Winch and Tackle Attached to Pole Driven in the Mud while on Journey from Niagara to his Home in Springfield, Ill.

Pacific & Atlantic

stick, and adjusted it over the sight of the carbine. He then shot two rounds and of the fourteen bullets, nearly a dozen hit the paper."

Mr. Lincoln also interested himself in balloons and was one of the first persons in this country to receive a telegraphic message from a balloon sent up to make observations on an enemy's works across the Potomac river.

During Lincoln's career as a lawyer, he enjoyed particularly work in which mathematical or mechanical problems were involved. In 1855, he was retained as one of the counsel for John M. Manny, of Rockford, Ill., manufacturer of reaping machines, who had been sued by Cyrus H. McCormick, owner of patents granted in 1845 and 1847. If McCormick had been successful in his contentions, Manny would have been enjoined, his factory stopped and a claim of \$400,000 damages demanded from his firm.

Another noted case involved the future of western commerce. A steamboat had struck one of the piers of a bridge built by the Rock Island railway across the Mississippi river and burned. The trial was a dramatic episode in the war long waged by the river men against the plains beyond. For decades the stream had been the willing burden-bearer of the west. Now, however, the railroad had come to carry the traffic which the river claimed. The boat men claimed that the great waterway could not legally be obstructed by a bridge.

Lincoln argued the case for the railroad, his speech being full of nice mathematical calculations designed to show that the accident was the fault of the pilot. The pith of his contention was that "one man had as good a right to cross a river as another had to sail up or down it."

In this connection, he is said to have drawn a vivid picture of the future of the great west lying beyond the river, and argued that the necessities of commerce demanded that the bridge across the river be a conceded right. In this view he was sustained by the court's decision.

**FARMS IN CITIES PREDICTED
IN SEVENTY-FIVE YEARS**

Small farms within the city limits, double and triple-decked streets, and greatly enlarged traffic accommodations of all kinds, will be needed by New York within the next seventy-five years, it is predicted, to care for the 29,000,000 inhabitants who by that time are expected to call the city their home.

*Christian Science
Monitor 12/11/23*

**STATUES OF MUMMIES START
FAD AS ORNAMENTS**

Using characters in Egyptian history as subjects, manufacturers have founded a new industry by making bronze-colored



Bronzed Terra-Cotta Mummy Statue of a Princess Being Removed from Baking Kiln

mummy statues of terra cotta. Art of this sort is in demand in hotels and civic centers for purposes of interior decoration. These realistic antiques, life size or larger, are said to be faithful replicas of originals in famous museums, and it is claimed that they possess the lasting qualities of marble or bronze.

**FAN ON FURNACE TO SAVE FUEL
SPREADS HEAT AND AIR**

To save coal by forcing heat to all parts of a house, a fan made for attaching to a furnace is said to ventilate the building at the same time. By driving warm air away from the fire before it can mix with waste gases, the blower reduces the amount of fuel energy that is usually drawn off by the chimney. Since it keeps fresh drafts continually circulating through the ventilators, more healthful conditions are believed to exist with its use than under other methods. It is claimed that the device, which operates by electric motor, maintains even temperatures throughout the dwelling and that it can be used for cooling during summer months without detaching it from the furnace.

*Miles Furnace Fan Co,
340 Leader News Bldg
Cleveland, Ohio*

4493
4570
4485

Copyrighted material

Cont. George F. Paul,
364 900 Wellsworth Bldg
Chicago

MOSAIC ARTISTS FROM ORIENT
BUILD MOSQUE IN PARIS

4613

Artisans skilled in the designing of mosaics have been sent from Morocco to Paris to assist in the construction of a Mohammedan mosque there. For several



Assembling the Block of a "Puzzle Picture" that Will Adorn Paris Mosque

months, they have been engaged in fashioning the intricately patterned decorations for the building. The designs are first put together on flat boards. The blocks, thousands in number, are then assembled in much the same way that a puzzle picture is pieced together. Color harmonies are achieved that rival the shades of the softest tapestries. Great mechanical as well as artistic ingenuity is needed to fit the pieces into solid, smooth surfaces. The workers are being housed in the already finished rooms of the mosque which will have, with the mosaics, elaborate decorations in cedar wood, and will also provide homes for student members of the Mohammedan faith while they are in Paris.

LIGHTNING ROD'S USE GROWS:
AN AID TO RADIO 15

Disled by a published announcement, Popular Mechanics Magazine, in its January issue, printed an article which said that the use of lightning rods was dying out. Upon investigation, it has been found that this statement is entirely erroneous. Including small plants, there are now more than thirty establishments manufacturing lightning rods in the United States. Their output in 1922 was approximately 9,500,000 linear feet, according to the reports of the department of commerce. Recommended by the weather bureau and by many scientific bodies, lightning rods are now sold and manufactured under conditions totally

different from those that prevailed in the days of the "ballyhoo" agents who disposed of worthless outfits at exorbitant prices. They are now considered so efficient that more than sixty per cent of the farm buildings in Illinois are equipped with them, forty-four per cent in Ohio and nearly fifty per cent in Iowa. Figures received from 121 insurance companies in fifteen middle-western and eastern states where thunderstorms are common, show that the rods have afforded one hundred per cent protection in many communities over periods of from one to five years. One hundred and thirty companies reported that the average loss on unrodded buildings struck by lightning was \$200 and on rodded buildings only \$10. Use of the rods has become so widespread that the bureau of standards has prepared official specifications for them which will be made part of the national electrical code. That lightning rods are scientifically sound in principle is also evidenced by the fact that Underwriters' Laboratories maintain and operate a comprehensive inspection program whereby the installations made by the thirty-five manufacturers who subscribe to their service are thoroughly inspected and labeled. The final approval or certificate of compliance with established standards appears on each installation in the form of an etched aluminum master label. With the popularity of the radio, a new use has been found for the rods, as they have proved an excellent ground connection and also afford extra protection to aerials during storms.

HANGAR FOR GIANT ZEPPELINS
4319 IS MADE MOVIE STUDIO

Instead of building a large new structure in which to carry on its work, a German motion-picture producing company has taken over one of the big hangars formerly used to house Zeppelin airships. It affords the advantage of permitting the building of huge temples, lofty towers, and tall city walls, and staging plays throughout, all indoors. One of the stories acted out before the camera in the hangar studio is "I. N. R. I.," which deals with the dramatic episodes during the beginning of Christianity. One scene of the piece portrayed the city of Jerusalem in realistic imitation of its existence over 2,000 years ago.

☐ Vandyke brown is one of the slowest-drying colors known to the painter, and should always be mixed with plenty of japan drier.

Lightning Rod manufacturers
Association 25 E. Jackson Blvd.
Chicago

Underwriters
Laboratory. Chicago

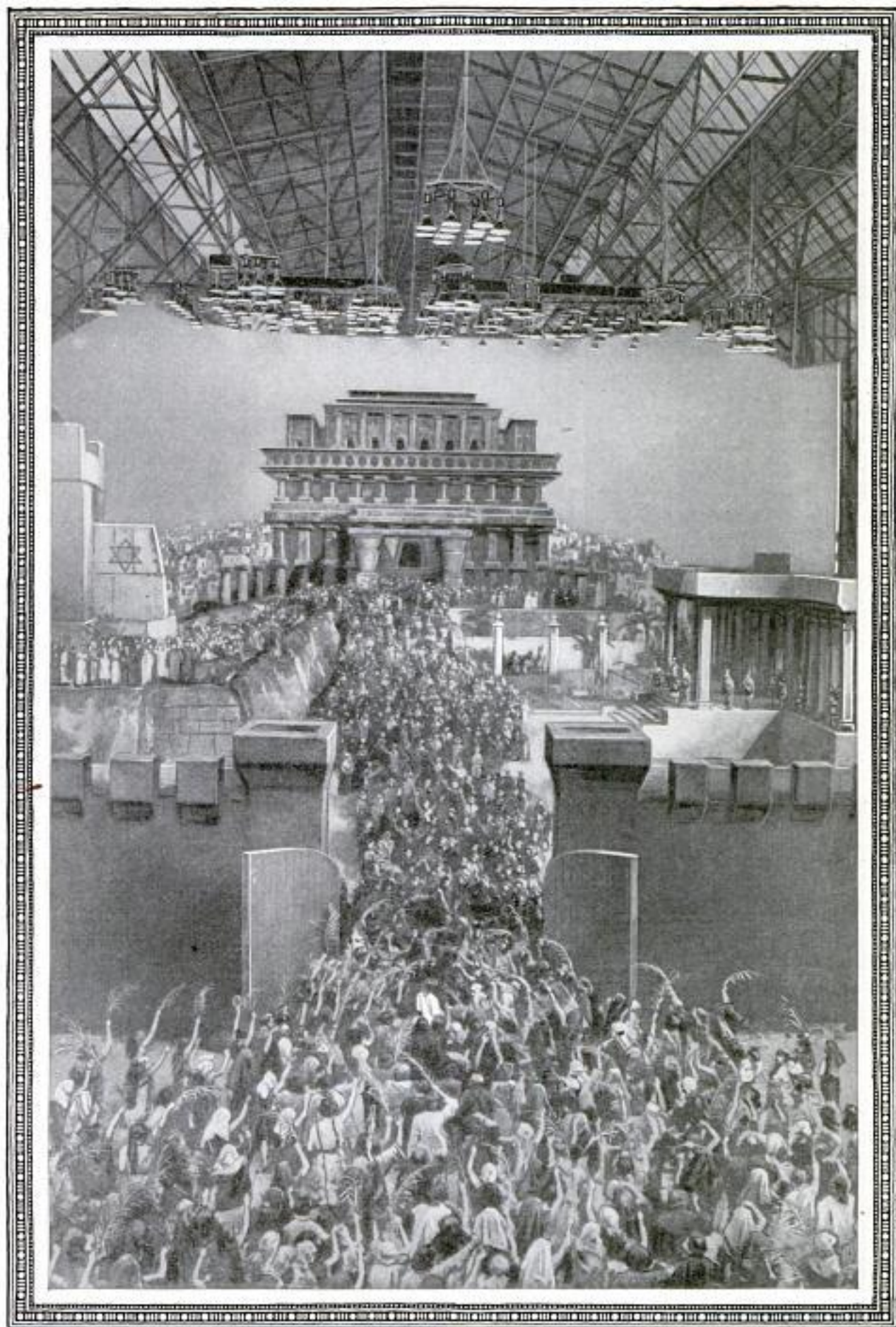

Courtesy of the Sketch

One of the Mammoth "Movie" Sets Erected in a Former Zeppelin Hangar, Showing Scene from a Biblical Film, which Portrays the Career of Jesus of Nazareth

4863 **WORMS THAT DANCE ON WAVES
ARE PUZZLE TO SCIENCE**

Millions of tiny worms that "dance" in the moonlight on the surface of the sea during the egg-hatching season, and trans-



form the waves into the appearance of vermicelli soup, have been observed off Samoa, the Antilles, and the coast of France. They appear at the first and last quarters of the moon and in the months of May, September, October, and November only. They are so small that it is estimated that more than 1,000,000 occupy the space within the radius of a small lantern.

4318 **NAVY'S ELECTRIC FLEET HAS
POWER FOR GIANT TASKS**

Electric energy generated by the six battleships propelled by electricity now numbered among the navy's fighting craft, according to engineers, if applied to other tasks could furnish sufficient power to run 3,200 street cars or pull forty-eight passenger trains. A mountain of solid rock 5,000 feet high and the same distance through the base, if placed on an immense jack, could be lifted by the force required to operate the vessels, at the rate of a foot a day. Connected to pumps, it is enough to drain Lake Michigan at such speed that the level would be reduced 10 feet a year, or it could light, heat, and furnish power to 600 towns with populations of 5,000. Were it possible to use the energy in artillery, 200 tons of shells could be shot onto the moon each day.

4518 **JAPAN IS ENLARGED BY QUAKE
AND SHORE LINE CHANGED**

As a result of the recent earthquake, Japan's area has been considerably extended. Also there has been a marked change in the shore line around Sagami bay, the center of the disturbance. According to experts, the bay is many fathoms deeper and rocks, heretofore immersed, are showing, forming small islands, while residences built on the seashore have considerable stretches of land between them and the beach.

4420 **WELL SUNK IN BED OF RIVER TO FIND DEPTH OF ROCK**

To determine the depth to which pillars must be sunk to rest on bedrock, the Oregon authorities drilled a well in the bottom of the Willamette River at Harrisburg, where a great bridge is

soon to be built. The structure will be supported by reinforced concrete columns, resting upon a foundation of solid rock, probably 100 feet, or more, below the surface, and rising fifty feet above low-water mark.



Drilling Down to Bedrock in the Willamette River to Determine the Necessary Depth for Caissons

Com. Alfred Power,
1879 ^{Moss & Englemans Ave}

Chicago Daily News, 12/15/28

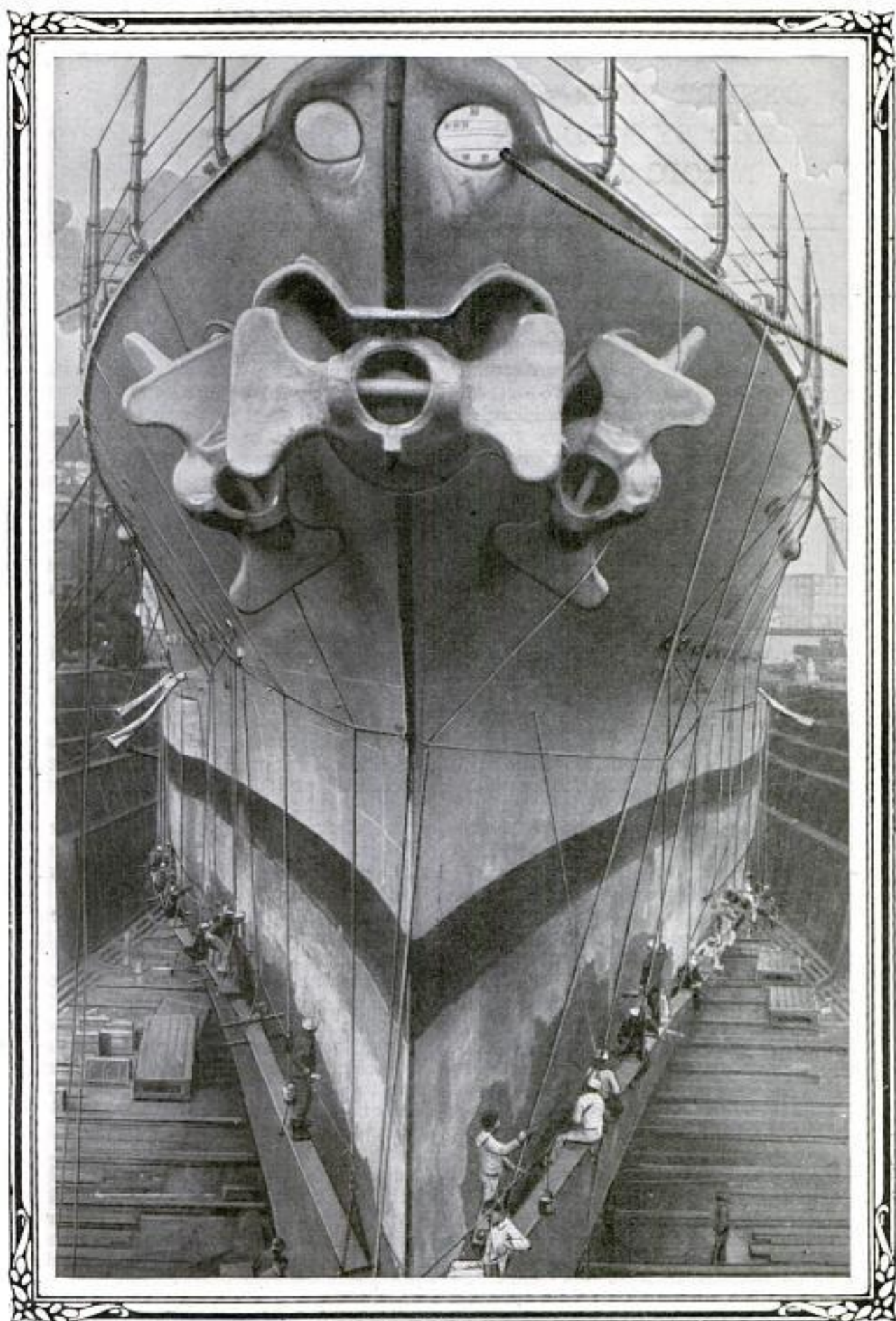

Fighting Face and Mammoth Anchors of the Electrically Propelled Warship "Colorado"; a Swarm of Workers Are Applying the First Coats of Paint to the Ironclad Hull

4054

*Syndicate Bldg.
East Oakland, Calif.*

DESERT SECRETS BARED BY MODERN MAGIC RUG

By H. H. DUNN ²⁷²²
Prince St. Berkeley Calif.

FLYING some hundred miles a day over the barren deserts of western Nevada and southeastern California is the method of riding his hobby in his hours of recreation adopted by one millionaire of the West, though he is not interested in aviation. He is F. M. Smith, better known for the past half-century as "Borax" Smith, the man who found a million dollars hidden in the dry lakes of Death Valley.

His hobby is chemistry and the analysis of dry soils of barren parts of the world, and, though he has been devoting most of his spare time to it for the past twenty-five years, he has not yet exhausted the varying soils and mineral deposits of the American desert. Mr. Smith is 75 years old; fifty years ago, he was a wood cutter in the Nevada desert, supplying fuel on contract to mines of that section. He discovered the mineral values of the drainage basins in Nevada's bad lands, and, later in the great sink of Death Valley, more than 400 feet below sea level.

The world of business paid him more than a million dollars for his discoveries, and he tried various pastimes, yacht racing, in which he once won the King Edward Cup; horse racing, in which he also was a winner; travel took him three times around the world; the collecting of rare books and statuary engaged him for a time. But a quarter of a century ago, he returned to his first hobby, the study of chemistry, and the carrying on of original experiments in it, which had entertained him in his hours of rest in the little cabin built during his years as a wood contractor on the desert.

Ten years ago, he lost the bulk of his fortune, and returning to the desert at the age of sixty-five, started to build up another in the land he knew best. Today he is again in the millionaire class, but that is another story, since he has retained through all the years of fortune and failure and fortune again, his "side line," as he calls it, of chemical experiment and study. When he struck the upgrade, about eight years ago, he removed from its desert set-



ting the cabin in which he had made his first step toward wealth, and installed it, under a roof, on the grounds of his home. Inside it he placed all the equipment of a first-class and far-advanced chemical, soil and mineralogical laboratory. In front of the cabin, from a tripod of silver birch trunks, hangs the old iron kettle, in which he cooked his own food, and in which were reduced many of the mineral salts of the desert, while he was living alone in the waste spaces.

Today, Mr. Smith devotes at least two hours, and often more, of every day to experiments with soils, samples of saline deposits, minerals, and rocks from the deserts of the West. Through his work have been discovered a number of valuable deposits of minerals, but to these he devotes no attention, other than to announce them to other men.

"Let them go after 'em, if they want to," he says. "I would rather find out what is inside of a mountain on the desert than cut it up and sell it."

In the old days, Mr. Smith walked to find his samples of strange minerals; then he rode a mule, which grew into a team. From that he moved up to an automobile, which he equipped with solid truck tires, and thus was able to drive over cactus, boulders and other desert obstructions, far from railroads or highways. Now when he goes to the desert on what he calls his "personal prospecting trips," he flies in an airplane, lands when he sees a soil, hill or rock formation which is new to him, and studies it as long as he desires. Flying out at random from any one of several different towns, at one of which he has instructed his pilot to meet him, he watches the earth beneath until he sees something new, or something which attracts his attention by its difference of color, formation or elevation. Landings can be made by airplanes at almost any point on the American desert, and there is always

enough level land for the take-off, so that he is enabled to reach little-known and less-explored regions in a flight of two or three hours, make investigations, take samples, and return to the railroad station, all in time for dinner in the evening of the same day on which he started.

This would seem to be a rather strenuous hobby for a man who has seen seventy-five years on this globe, especially when it is followed by close application to the test-tube, the retort and the furnace in his little chemical laboratory at his home. But to him it is far easier than any of the other methods by which he has studied the subject for a quarter of a century.

"At last, I've got speed," he said to me as he showed me a lump that looked like white clay, and in which he had found and identified traces of twenty-seven minerals. "All my life in this pastime of mine, I have been hampered by the immense distances of the desert, and lack of speed in transportation. Now, I can laugh at the distance, and I know more about the desert than I ever did before. Indeed, I have learned more about it in the past two years with an airplane than I learned in fifty years before with walking, mule riding, mule driving, and motoring.

"The desert is the world's greatest natural storehouse of chemicals and we can find there vast deposits of many useful minerals in the form of saline salts," he continued. "Of the presence of most of these on the desert, man has no inkling, largely because they have been deposited by evaporation, and, consequently, are

found only in the driest, most distant and least-explored, as well as most inaccessible, sections. There are thousands of square miles in Nevada, Arizona and California which a white man has never seen, and hundreds of square miles that even an Indian would hesitate to enter. The airplane lays these open to the view of man and to the study of chemists. The man who looks for fortune on the desert is more apt to be rewarded by death, but the one who seeks there for practical, worth-while knowledge, will find more than he can assimilate in a lifetime."

As an example, Mr. Smith, with his airplane and his test-tubes, discovered a mountain of gypsum, a three-mile dike of borate of lime, and a hill of almost solid sulphate of magnesia (Epsom salts), in the heart of the Muddy Mountains of Nevada, a bit of the desert which is not inhabited, even by Indians, and so far as known, has been crossed only once by white men. Mr. Smith found lumps of the three minerals in old washes at the foot of the range. Curiosity led him to fly into these mountains, to endeavor to learn whence the fragments came. He found all three deposits, and there they still are, for, beyond making public his discoveries, the interesting old westerner takes no further steps. Whenever he makes a find of this kind in the desert, he tells the world about it through the newspapers, and then lets the world do what it pleases with the discovery.

On one of his flying trips into the desert of southwestern Nevada, he saw beneath



Cabin in Which "Borax" Smith Lived Fifty Years Ago, When He Was Woodcutter on the Desert; Now in Garden of His Home Where It Is Used as a Laboratory

370
4054

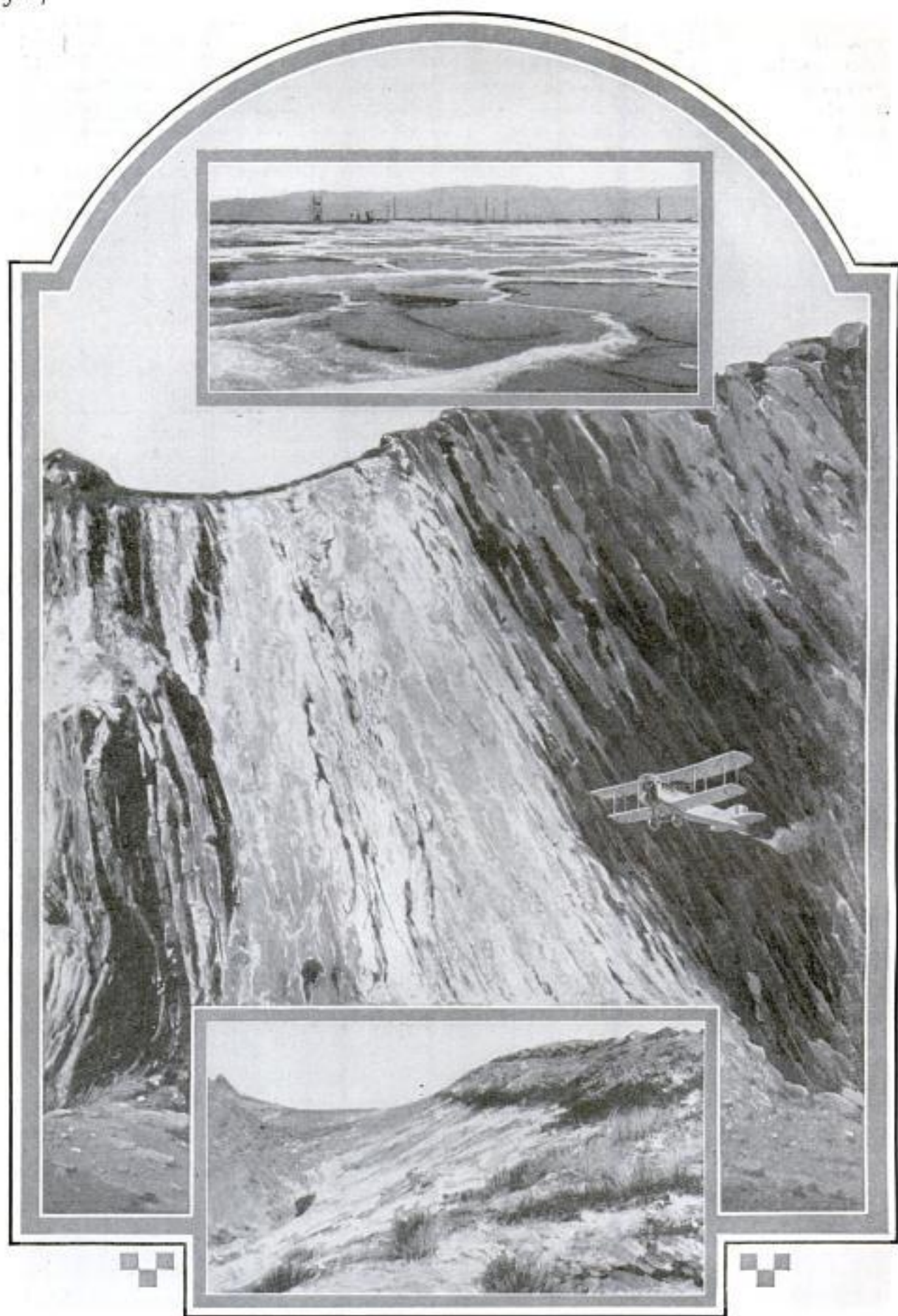

Above, Vast Deposit of Mineral Salts; Center, Flying Along Dike of Lime; Below, Hill of Gypsum. All Discovered by Smith in His Trips Across the Desert

the plane a flat, gray field. Descending to examine it, he discovered it to be of the same color, and apparently of the same composition, as the lower end of the Imperial Valley, the tremendously fertile delta of the Colorado River. Chemical analysis of samples he gathered made in his fifty-year-old cabin, confirmed the first thought, but the question of how this large deposit of alluvial silt came into being in the heart of a dry desert where there are no rivers and where a fraction of an inch of rain falls once every four or five years, is a mystery which not even the expert has been able to solve.

"If water could be put on that plain," he says, "it would be the most productive farm in America—and some day it will be done, but the chemists and engineers will have to show us how."

On another flying trip, Mr. Smith stopped at a spring to take on a supply of

water. He was looking at a piece of "float" gypsum, when an Indian on horseback rode up, who informed him that he knew a ledge of this material. The pilot of the plane and the millionaire desert chemist flew on the Indian's directions and found, at a distance of some twenty-five miles, not a deposit of gypsum, but a ledge of asbestos. Landing to investigate, they found, however, that it was a small deposit of not much value.

In the bed of one of the "dry lakes" of the California desert, Mr. Smith has found as many as fifty-two minerals, all either in the mud, which half-baked, formed the bottom of the lake to a depth of about 20 feet, or encrusted along the shore in crystalline form.

The hobby is a rather expensive one, but the results of it have been of value, not alone to Mr. Smith, but to the country as well.

zinc plates, iron and copper, with the zinc plates of iron and copper from which they are made.



Rugged and Desolate Desert Mountains—Hunting Ground of 75-Year-Old Pioneer

POWDER USED TO KILL WORMS THAT SPOIL GOLF GREENS.

Golf greens in some parts of California have been cleared of earthworms by a method which does no injury to the sod. The damage caused by these pests was so great that experts were experimenting with a gas to destroy them. Before their tests were concluded, however, a powdered compound of chemical salts of iron and

copper was tried. Dusted lightly over the closely mowed lawn, and heavily sprayed immediately after, with water, it acted quickly. Within a few minutes, worms came to the surface to die and those remaining underground were killed.

Land crabs annually do considerable damage in truck farms in Florida by devouring and injuring the young and tender vegetables.

*1 cmt. Russell L. Lunn,
629 Call Bldg.
San Francisco, Calif*

*California Copper Co., San Francisco, Calif.
629 Call Bldg.*

CROPS MEASURED BY METER ON AUTO DASHBOARD

4405

For recording the measurements of fields planted in various crops, a meter at-



Meter for Dashboard of Automobile that Automatically Measures Fields Planted in Various Crops

tached to the dashboard of an automobile has been included in the equipment of the Department of Agriculture. The instrument is operated from the same gearing mechanism used for an ordinary speedometer. Each crop may be recorded on its particular section and the dimensions of the "stands" are shown in feet. At the right of the device is a scale that registers the

4337

AUTO "STAGE" DEPOT HAS COMFORTS OF BIG HOTEL

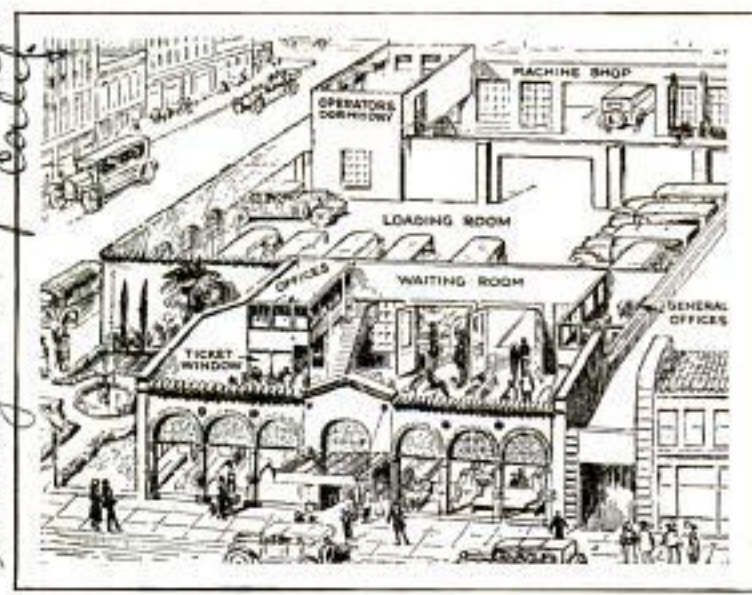

Automobile "Stage" Depot with Accommodations that Rival Those of Modern Hotels

total distances covered in miles and the number of trips made. As each patch of a certain kind is measured, it is added to the total. Each scale is labeled and has a button which must be pressed to throw it into action. Ten principal crops are provided for as well as idle ground and pasture land.

DIAL IN NECK OF GASOLINE CAN TELLS THE EXACT MEASURE

4557

To test the exact amount of gasoline delivered by a pump, a special measure has been made with a dial in its neck. This shows at a glance any errors and the correct amount over or under the number of gallons ordered. When the gauge is properly set, being adjustable and removable, it may be sealed so that it cannot be tampered with.



Ⓢ Toughness of the skin, and firmness of the flesh of different varieties of plums, are an index to the susceptibility of the fruit to brown rot disease.

Motor Transport Co. Stage Depot, San Diego, Calif.
 Motor Transport Co. Cambridge, 39

Motor Transport Co. Stage Depot, San Diego, Calif.

WOMEN PLAY PART IN BUILDING OF MODERN SKYSCRAPERS

4519

That the needs of women must be given as much attention as is accorded the sinking of the foundations of a modern skyscraper, is disclosed in the report of the National Association of Building Owners and Managers. This consideration is reflected chiefly in planning for adequate and attractive rest rooms which, it is declared, can no longer be classed as luxuries. Also, human frailties must be taken into consideration, including the habits of messenger boys penciling corridors and jumping down the stairs. The pencil habit has given rise to the term "pencil line" for the height of marble wainscoting, which is raised to such a level that marks may be easily cleaned from the walls. Awning fires are being prevented through dipping of the fabric in a fireproofing substance.

POWDER PUFF HIDDEN IN RING HAS MIRROR IN SETTING

4509

Concealed beneath the setting of a signet ring of novel design is a minute powder box, puff, and mirror for the toilet. The stone is fastened on a hinge and snaps tightly shut over the small holder. The looking glass is under the setting and is

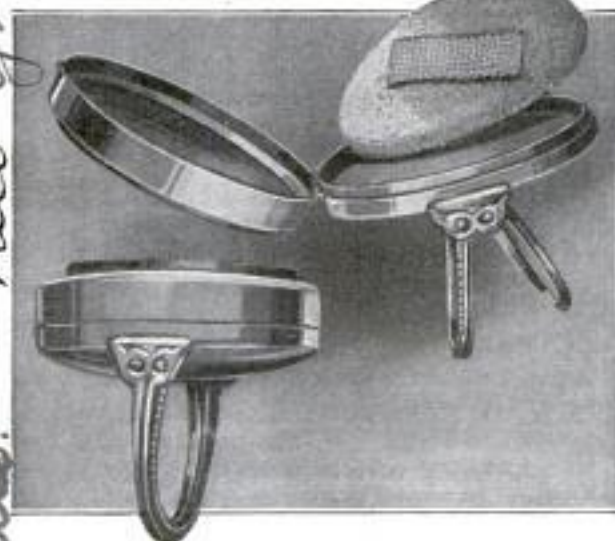

Signet Ring Containing Powder Puff and Mirror behind Setting Open and Closed

tilted at a convenient angle when the top is unclasped.

□ We want all our readers to write us freely and often whenever they wish additional information on articles published in this magazine. Address Bureau of Information, Popular Mechanics, Chicago.

CABINET KITCHEN SAVES SPACE IN SMALL APARTMENTS

4507

Combining kitchen, pantry, and refrigerator into small space, a convenient article of furniture, especially adapted for use in



Copyright, Underwood & Underwood
Compact Cooker, Refrigerator and Storage Cabinet for Apartments Where Space Is Limited

three-room apartments, is now on the market. Lockers for storing ice are at the bottom, so that perishable foods placed above are cooled. There are drawers for utensils and supplies, and ample cooking space. With this cabinet, one may prepare a meal, eat it and clear it away without leaving the chair.

LAUGHTER-PROOF TRIBE FOUND IN WILDS OF CEYLON

4508

For more than 2,000 years, it is said, laughter has been unknown to the Veddas, a tribe of aboriginal inhabitants of Ceylon, who have maintained a secluded existence in caves and jungles of the region. Cut off from other peoples and subsisting on bats, owls, and crows that they shoot with arrows, these strange people are said to have lost entirely the sensation of laughter. They are thin and flabby, and a fat man is unknown to them. Efforts of a scientist, who recently visited them, to produce smiles by tickling them on the soles of their bare feet or in the ribs, met with no success. Their stony countenances did not even wiggle.

Auckland Weekly

Copyrighted material

Co he at 7. the at 1
no price. need York City
L & D. Lock. 35 & 47th Ave.

Comedy Theatre 41st St.
Broadway, New York City

*Simpler Electric Co.,
54 Sandy Park Road
Bristolington, Bristol, England*

NOTED ACTORS PREFER CARVING TO PLAYING IN MOVIES

4584

Actors in the famous Oberammergau Passion Play, who came to the United States to raise money to save the people of



Passion-Play Actors Displaying Samples of Beautiful Carvings to Be Sold for Charity

their village from post-war starvation, refused offers of more than \$1,000,000 to produce their performance for the movies. They declared that to accept would be to violate a tradition that has been observed for generations. Instead, they followed their craft of wood carving in the hope of selling their wonderful handiwork to raise the much needed funds.

Art. 1111

VALVE SILENCER STOPS WEAR AND PUTS END TO NOISE

4533

To stop the noisy tapping of the valves in the overhead-type automobile engine,

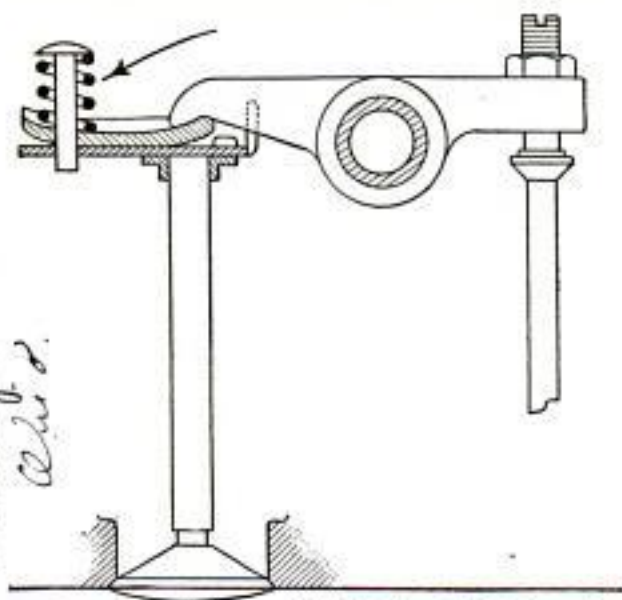

Rocking-Chair Silencer, Held in Place by Spring, that Silences Noisy Overhead Valves

35¢ each.

*The Guardian Appliances Co.
2570 Superior Av. Cleveland*

a silencer has been made that embraces an arm feature worked out from the rocking-chair idea. Placed on top of the valve stem, the arm is held in constant contact with the tappet by a spring, and rocks back and forth as the valve opens and shuts. It keeps the motor running smoothly, eliminates play and minimizes wear.

TESTER CLEANS SPARK PLUGS

446 7AND FITS IN POCKET

Resembling a cartridge, and small enough to be easily carried in a vest pocket, a combined tester and cleaner for automobile spark plugs has a stiff brush at one end and two contact wires at the other. Both appliances are concealed by a cylindrical cover while not in use. If a plug is found to be missing, it can be removed and quickly cleaned. Metal strands are provided among the bristles to dislodge carbon. A leather cover is furnished to protect the device against damage.

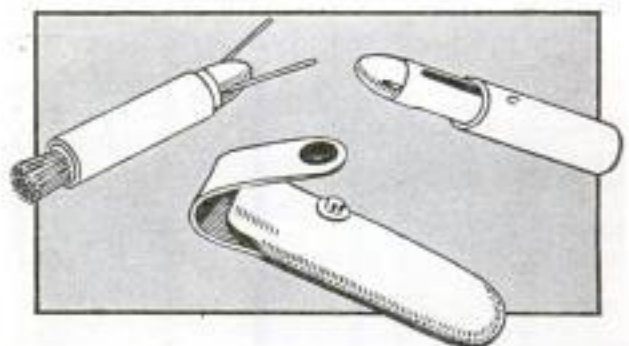

Combined Tester and Cleaner for Spark Plugs that Opens Up when Cover Is Moved

THIRD OF WORLD'S FISH CATCH IS USED IN THE U. S.

4548

That Uncle Sam eats great quantities of fish is proved by recent figures showing that the world annually levies a tribute upon the seven seas of 500 million dollars' worth of this kind of food, of which Europe collects approximately half, the United States nearly a third, and the remainder of mankind the other sixth. In terms of weight, the portion collected by America amounts to 2,600 million pounds, including shellfish. Three-fourths of this reaches the markets in fresh condition; the remainder goes to the consumer as canned, salted, and smoked fish.

Kansas City Star 12/12/23

Those wishing further information on anything described in the editorial pages can obtain it by addressing Bureau of Information, Popular Mechanics Magazine,

MOUNTAIN SPLIT BY DYNAMITE IN MANY HOLES



Tons of Earth Displaced on Mt. Shasta, California, to Make Way for Dam Site: Taken Two Seconds After Explosion Started, Picture Shows Its Downward Sweep

To prepare ground for the construction of a dam connected with a California electrification project, tons of earth on Mt. Shasta were displaced by a single blast of dynamite divided up in over 200 holes. The

borings ranging from 16 to 30 feet were filled with the powder. The explosion, which was heard miles away, left a huge rent in the wooded slopes of the mountain, the earth rolling down into the stream.

MONKEYS WITH FORKED TAILS SOUGHT IN CHINA 4392

Forked-tailed monkeys, described in Chinese literature as inhabiting the fastnesses of the province of Kweichow, are among the objectives of a scientific expedition to explore that region. Some doubt is held as to the existence of such a species. However, the skin of a huge monkey, believed to have been a member of the largest non-anthropoid species in existence, was exhibited recently by an explorer, who had shot the animal while hunting in the wilds of the territory and indicates that a variety of simian, yet unknown, may be found. The district has been visited by few white men. It lies back of the high mountain ranges that form the watershed of the Yangtze River and is said to be as large as Missouri and as populous as Pennsylvania.

Literary Digest
11/24/23

COIN IN SLOT OF "MUST SAVE" BANK OPERATES CALENDAR 4355

Thrift is made to operate a daily calendar in a "must save" bank. A dime automatically changes the date while an extra nickel is required on the first, tenth, twentieth, and thirtieth of each month. The insertion of a quarter alters the name of the month. Thus in a month of 31 days at least \$3.55 must be deposited to rotate the calendar. For "conscience" money, a special slot is reserved which receives coins up to half a dollar and folded bills.



Speer-Rosefelt
Calendar Bank Co.
216 Water St., Milwaukee
U.S.

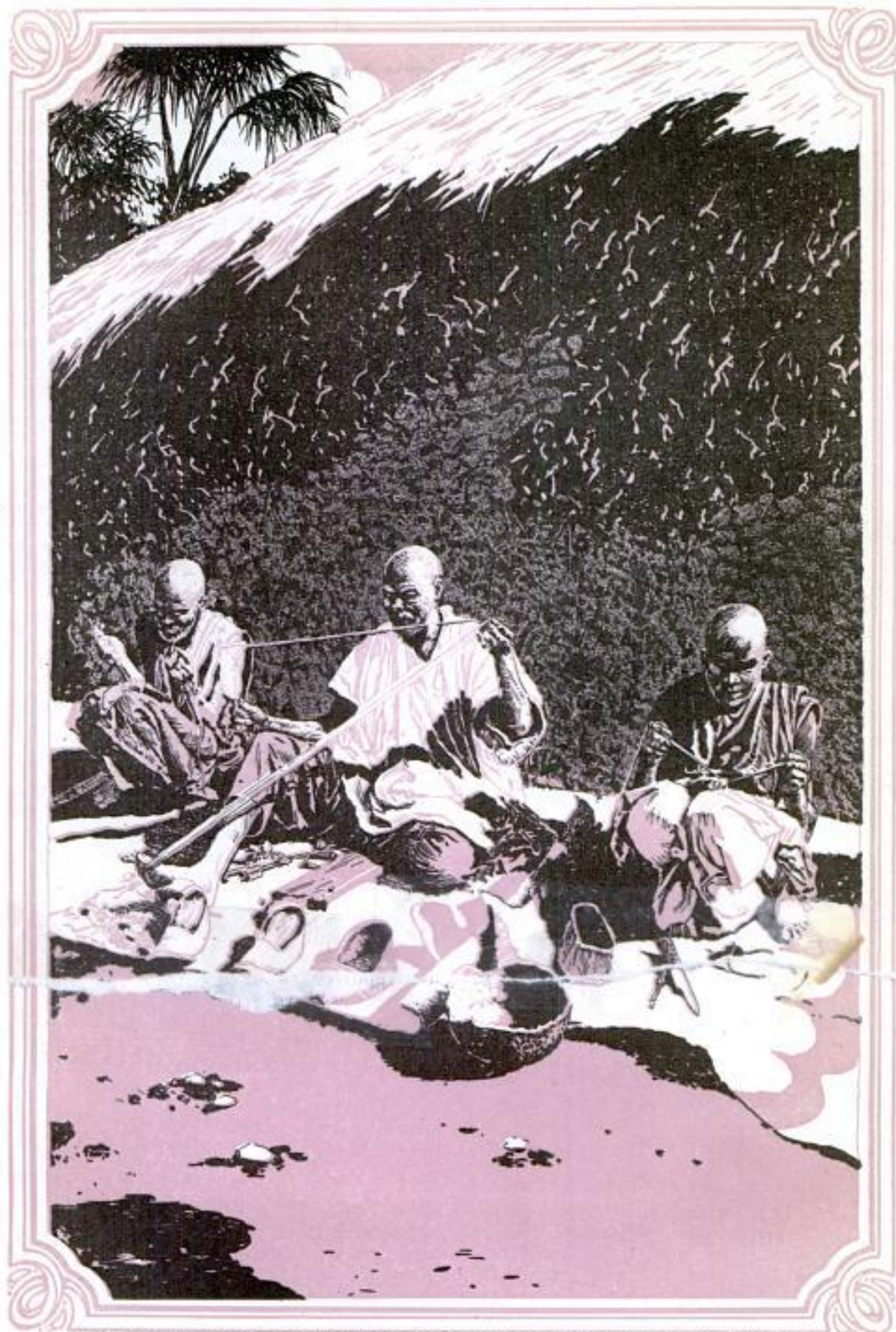

Native "Cobblers" Plying Their Trade in a Tropical Village, Indifferent to the Sun's Burning Rays

Made in London

4399 **DETAILS OF COUNTRYSIDE REPRODUCED IN MAP**

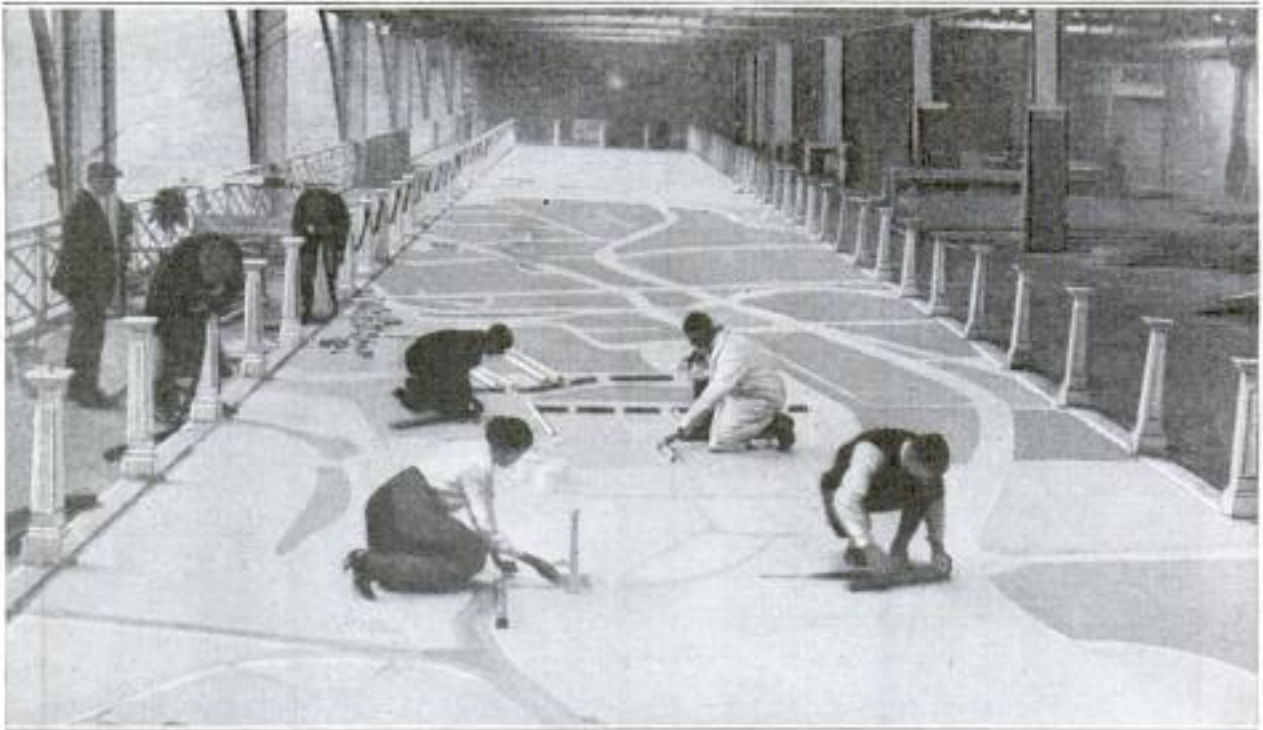

Detailed Map of Famous Old Road Showing Landmarks and Structures Drawn to an Exact Scale

Every hill, valley, river or other landmark of a famous English countryside has been reproduced in miniature with lifelike fidelity to detail, on a great map made by students during their leisure hours. In

it are combined the craftsmanship and art of the surveyor, painter, sculptor, and natural scientist. In form and coloring it is startling in its realism although built on the scale of a toy wonderland.

4332 **POROUS PAD FOR CHAIR SEAT
KEEPS SOFT AND COOL**

Cushions that shape themselves to the ordinary chair-bottom without tacks or other fastenings, and that do not wrinkle, have been recently marketed. The pads consist of three layers of rubber fused into

is claimed that these chair-cushions furnish a cool, comfortable seat which is easily cleaned, and last for a considerable time because of a certain amount of ventilation permitted by the tiny air cells.

4360 **GASES FROM ASPHALT ROADS
CAUSE DEATH IN JAPAN**

Gases arising from heated asphalt roads are said to have caused the loss of many lives during the fires that followed the recent earthquake in Japan. Melting under the high temperatures produced by the flames, the surfaces of the highways and streets paved with the material became so soft that the sticky masses halted the flight of many persons. Aged and exhausted persons, and children, found it difficult to make rapid progress because their feet became stuck in the taffylike substance. Poisonous fumes overcame a great number of those whose escape was thus delayed. Engineers and officials in the stricken areas are said to have planned future roads to be built of materials that do not form gases as well as resist intense heat.

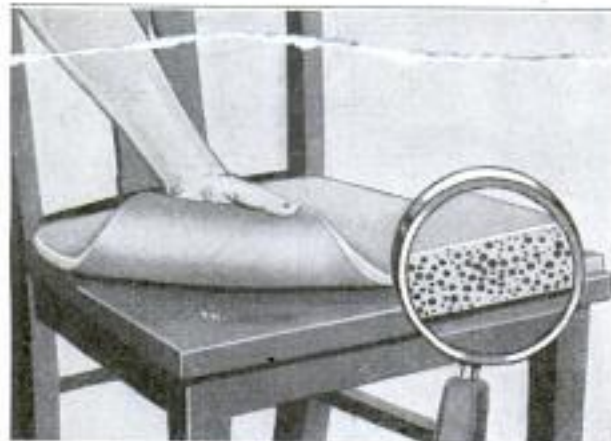

Cushion that Keeps Its Place without Fastenings and Shapes Itself to Ordinary Chairs

one. The two outer sheets are solid, but the inner one is porous like a sponge. It

*Cont. N. Sakata, & Co.
American Trading Co.,
Tokyo, Japan.*

*Sumatra Rubber Co.,
Salem, Ohio*

12/1/23

MEDICAL TESTS FOR AUTOISTS TO REDUCE ACCIDENTS

4390

To curtail the number of automobile accidents, proposals are being discussed in France to subject all applicants for motor licenses to strict medical examinations to test eyesight, hearing, and action of the heart and nerves. "Stunts" similar to those to which potential aviators are subjected to determine their sense of equilibrium also are being recommended for the motorist to see how easily he becomes dizzy or loses his sense of direction. Inquiry after serious smashups has shown frequently that a driver was deaf, was suffering from defective vision or had some other handicap which a previous examination would have disclosed. Optical tests are now required in certain states.

4375

THREE "HEATS" OF ELECTRIC IRON SUIT IT TO ANY FABRIC

To furnish several "heats," suitable to a variety of fabrics, an electric iron with three different hot stages has been made. Merely by adjusting plugs, the separate

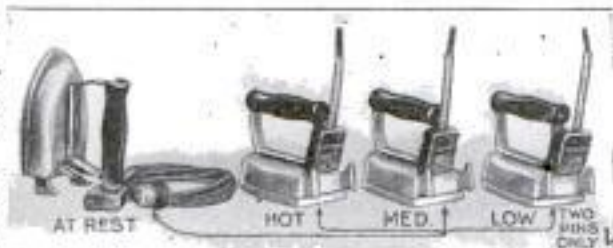

Electric Iron that Produces Three Different "Heats" Suited to Fabrics of Various Weights

temperatures can be produced. It is said that the utensil saves much time in pressing heavy cloths, because it does not chill while worked at high speed and extreme heat, and can be regulated down to a point where it is impossible to injure the most delicate material.

COTTON-PICKER GATHERS CROP AND BINDS IT IN BALE

4458

To pick cotton by suction, an automatic machine has been built that is said to gather an acre of the crop faster and cheaper than could be done by hand. It consists of a tower, and horizontal arms having a spread of thirty-five feet. These have holes in the under side. The ripe product is drawn by vacuum into the hollow gatherers, carried along to a central chute, compressed into bales, and dropped out at the rear.

New York Times
12/9/23

MOTION PICTURES OF LIPS AID THE DEAF TO SPEAK

By means of motion pictures of the lips of a person speaking, the deaf, children with defective speech, and foreigners are



Taking Stereoscopic Motion Lip Pictures with Special Camera to Aid in Speech Instruction

greatly assisted in their efforts to talk correctly and to interpret sounds by lip-reading. A specially devised camera takes a series of "close-ups," the "model" pronouncing the words taking great care to move his lips in the precise positions for forming the sounds. The pictures are shown with the words and symbols to accompany them, supplying a graphic "pat tern" for the pupils to follow.

TURNING A NUT STOPS BOTTLE, AND PREVENTS LEAKAGE

Leakage from bottles can be prevented by a stopper recently invented, that has a wingnut to fasten the cover tightly to the vessel.

On the mouth of the flask, a rubber disk is firmly pressed against the rim. With this seal, there is no need to destroy any part of the cork to remove it. Simply turning the nut loosens the device, and it can be put on again after a portion of the contents has been taken out, or may be fitted to another container of a similar size.



Whenever you find that you wish to know more about any article in the magazine, write our Bureau of Information.

Waage Electric Co., Chicago
12-148 Jefferson St.
Australia
invented

St. Milwaukee
29 W. 39th St. New York
Grate Cut Mfg. Co.
1055-18th St. W. Va.

Built by Moffat Tunnel Commission
 1731 Arapahoe St., Denver
 POPULAR MECHANICS
 for the Moffat Tunnel District, Colo.
 380
 4438
TUNNEL UNDER ROOF-O'-WORLD TO ENRICH NATION

Ever since the days of David H. Moffat, other railway men have cherished the ambition to penetrate the mighty barrier of the Rockies with a tunnel that would bring eastward the riches lying on the western side of the Continental Divide, and now this vision is about to be realized, groups of busy workmen being engaged on the great engineering project.

To appreciate the magnitude of the task, it is necessary to realize some of the difficulties of operating trains over the present route by way of the storm-swept Rollins Pass. At the summit is Corona, 11,600 feet above sea level. For two miles snow-sheds stretch out protecting roofs, doing their best to make it possible to run trains during the winter in Cloudland. Trainmen must fight every inch of the way to reach these snowy heights, and after a brief rest they must wage another equally bitter battle to take the train safely down the treacherous grades and around the tricky curves. To surmount the grades, four and five Mallet engines, built especially for mountain work, are needed to pull a single train. And yet it requires nearly fourteen hours to cover one ninety-mile stretch of road.

When the six-mile tunnel is finished, in about three years, twenty-three miles will be cut from the present distance, resulting in a tremendous saving in time and operating costs. On the eastern slope, the bore begins about three miles above Tol-

land at an elevation of 9,198 feet, and it will therefore be far enough below timber line so the tracks will be protected from huge snowdrifts. The western portal will be 113 feet lower. The tube is to have a peak, or high point, in the center, so it will drain readily. The plan is to drive the work from both slopes, using an eight-foot water tunnel, located at a distance of seventy-five feet from the transportation tube. By means of cross cuts, communication will be established between the two. When completed, it will be electrified. Fires will be banked in the steam locomotives before they enter, to simplify the problem of ventilation. Suction fans also will be installed.

Although Moffat did not live to see his dream of opening up a new commercial empire realized, the tunnel will stand as a monument to his vision. Geologists declare northwestern Colorado alone has sufficient high-grade coal to supply the entire United States for 1,500 years; and its shale beds will produce much more oil than has yet been taken from the wells of the United States. The further claim is made that enough ammonium sulphate can be produced as a by-product to fertilize all the farms of the Mississippi basin. Also, there are in this district 3,900,000 acres of vacant public land open to entry, and 353,000 acres of state school lands.

When the tunnel is completed, it will top these treasures and bring them to the doorways of the nation both in east and west.

The Sherlock Holmes Pipe Co., 325 Madison Terminal Chicago

PIPE BOWL TO SMOKE "CIGAR" KEEPS CLEAN, STAYS LIT

Constructed to smoke tobacco made up in "cartridges" with cigar wrappers, a pipe that has a two-piece bowl is being offered by a mid-west concern. It is claimed that it does not require frequent cleaning, since moisture and nicotine pass into a well in the bottom section where a pad absorbs them. The filler cannot touch the material of the bowl, which keeps the flavor of the tobacco sweet and unaffected, it is said.



Air spaces around and below the "pack" are designed to prevent the smoke becoming hot to the taste, and slow-burning qualities insure a light, even when the smoker lays the pipe aside for a short period. The tobacco wads are compressed by machine and are furnished in a box to fit the pocket.

ARTIFICIAL MARBLE SO REAL IT DECEIVES EXPERTS

Although efforts to imitate marble are old, recent improvements have resulted in a product so perfect as to deceive even the eyes of experts. Great care and skill are required in making the artificial product to duplicate the flaws, clouds, and pictures of nature. Ground marble, burnt gypsum, cement, and wax polish are some of the materials employed. Whatever colors are desired are added.

Dr. W. Mr. Sherlock
 708 W. W. Paschall
 Adv. Agency Inc. Cornish
 Old Chicago

W. W. Hesse, Civil Engineer, Casel, Id. *Copyright material*

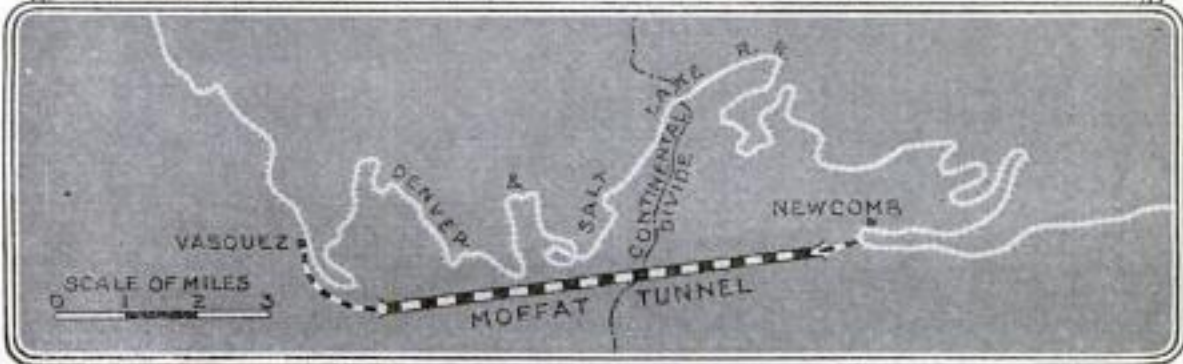
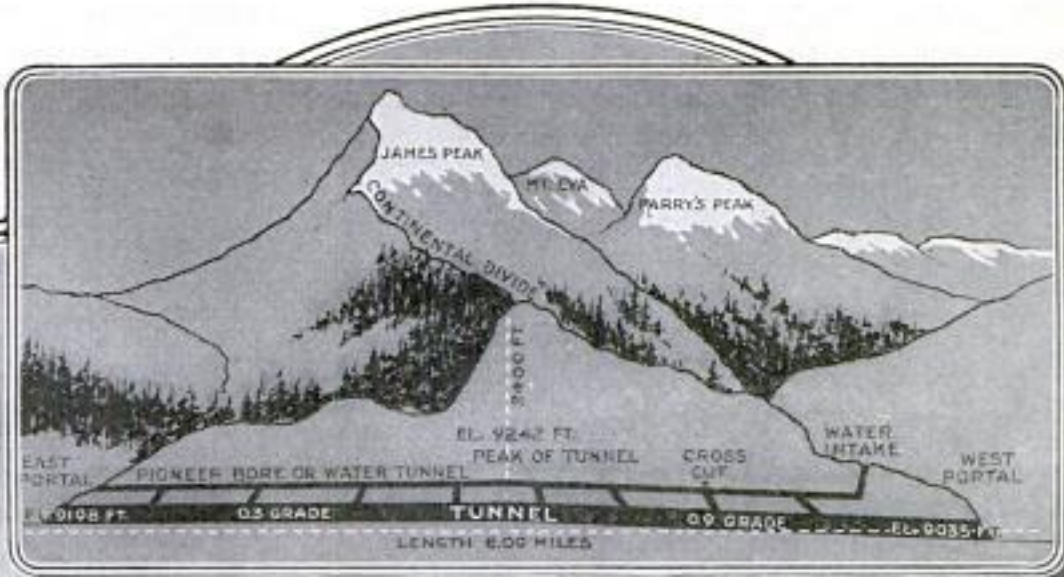

Great Moffat Tunnel that Will Penetrate the Mighty Barrier of the Rockies and Bring Eastward the Riches Lying on the Western Side of the Continental Divide

Moffat Tunnel Commission, 1931, Craythorn Denver, Colo.

Emb. J. J. Harris, 7437 Paxton Ave. Chicago

POPULAR MECHANICS

ELEPHANTS AID BUILDER TEST FLOORS' STRENGTH

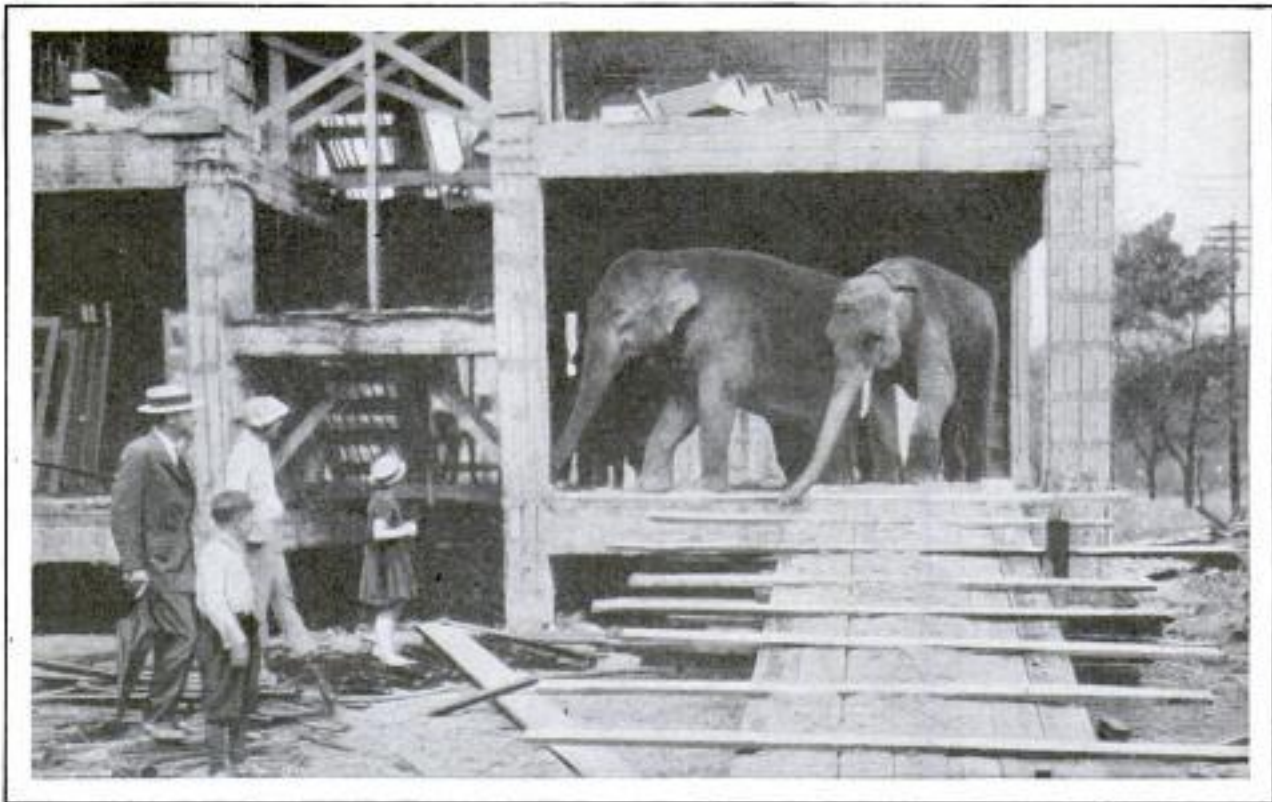

Testing Floors of New Building by Having Two Large Elephants Walk Over Them

After completing the floors of an apartment house, a St. Louis inventor of a construction system tested their strength by having two large elephants pass over them. The beasts usually hesitate to tread on any

bridgelike structure until they have assured themselves of its ability to support them. The combined weight of the pair was about 7,000 pounds, but they walked through the building without mishap.

Illustration
TREE TRUNK IS POSTOFFICE FOR ENTIRE COMMUNITY

Covered with letter boxes, a giant tree has been turned into a postoffice by res-

idents of a small community near New York City. Around the single trunk are grouped twenty-eight depositories from which mail is regularly received or collected. Because of its central location, the spot also serves as an open-air civic center and meeting place.



Getting Mail from Community Postoffice on Tree Trunk that Serves Score of Families

RIVER JORDAN IS HARNESSSED TO LIGHT HOLY LAND

All Palestine soon is to be supplied with electricity through the harnessing of the River Jordan. Jerusalem is to have a sanitary system, a lighting plant, and street cars. Great areas of land, at present sterile and arid, are to be reclaimed and made productive. After extensive surveys, a corporation has chosen a site, three miles south of the Sea of Galilee, on which to erect a huge plant, install turbines, and harness the historic River Jordan. It is said that enough power can be generated there to fill nearly every industrial need of the entire country, including electrification of the network of railways.

Emb. P. Cornfield, Editor,
The Palestine Weekly,
Box 255, Jerusalem.

Located at Lafayette and N. of East Tremont Aves. Bronx. N.Y.

382
4437

Copyrighted material

Seibel Air Spring Co. Inc.

785 Market St.

POPULAR MECHANICS

San Francisco, Calif.

AIR-SPRING SEAT FOR AUTO BUS INSURES RIDER'S COMFORT

By applying air springs to a parlor car chair for automobiles and motor busses, passengers are insured comfort when the car is passing over rough ground, as the position of the passenger on the seat is not changed materially by the action of the chassis springs. The shock-absorbing device is in a cylinder underneath the seat. The upholstery need not be as heavy as ordinarily is the case. As there is no rubbing between the rider and the back of the seat, the wear on the clothing is reduced.

Universal

ONE-HAND WATCH MARKS TIME IN FIVE-MINUTE INTERVALS

Time of day can be learned in a glance at the dial of a one-hand watch, designed by an eastern manufacturer, which shows

the hours marked in five-minute intervals. Because of its simple mechanism, it does not easily get out of order. It is especially suited to outdoor use and serves all practical purposes of the two-hand time-piece where periods of less than five minutes are

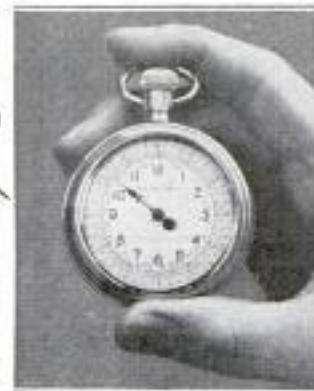

not important to the user. It is easy to set, less confusing, and can be plainly read at night or by nearsighted persons.

GRIP OF PLIERS IS LOCKED BY HANDLE RATCHET

Locking its grip automatically, after securing a hold, a combination of pliers and wrench is in the market. A ratchet arm, attached to one handle, engages the lower



Ratchet Pliers that Automatically Lock Their Jaws after They Have Secured a Hold

side of the opposing jaw. To free the mechanism the clamping device is pushed aside. It can adjust itself to any "nip" within the range of the tool.

SCIENCE TURNS THE HOLY LAND INTO RICH GARDEN

Orange-growing has become an industry represented by a yearly shipment of a million cases of the fruit in Palestine. Thirty years ago, according to a correspondent



Gathering Crop of Oranges in Irrigated Orchard Growing on Level Land of Palestine

of this magazine, hardly more than 3,000 boxes entered the world market from that country. The most modern scientific methods have been applied in the development of what was, a short time ago, an almost barren waste. Big tractors, motor pumps, and deep wells for irrigation have replaced primitive methods. A large packing plant has been built where the product of the trees is sorted and sized. Each orange is polished, wrapped, and placed in an airtight crate, all within a few hours from the time it is plucked. While the coastal lands yield the bulk of the agricultural output, the hills inland are also becoming covered with farms and vineyards. Lemons, apples, and grapes, together with olives and grains, are grown on terraces cut into the hillsides, and bee-raising is carried on in those areas where the land is less responsive to cultivation. Other tracts are sown in cereals to provide food and fodder for the workers and their animals.

MOVIES MANY CENTURIES OLD

That the Chinese had moving-picture entertainments 3,000 years ago, is said to have been proved by recent investigations. The designs were painted upon long rolls of paper, similar to the films of today. These were slowly drawn through a lantern-like box, and viewed through a slit. An older type was made by arranging cuts on disks strung on an endless string.

One Hand Watch Pa. Warren Pa.

Emil P. Cornfield Editor The Palestine Weekly, Dept 255, Jerusalem.

nd.

E. M. Loftus, 438 Laurel Ave., St. Paul, Minn

Kansas City Times

12/4/25 printed material

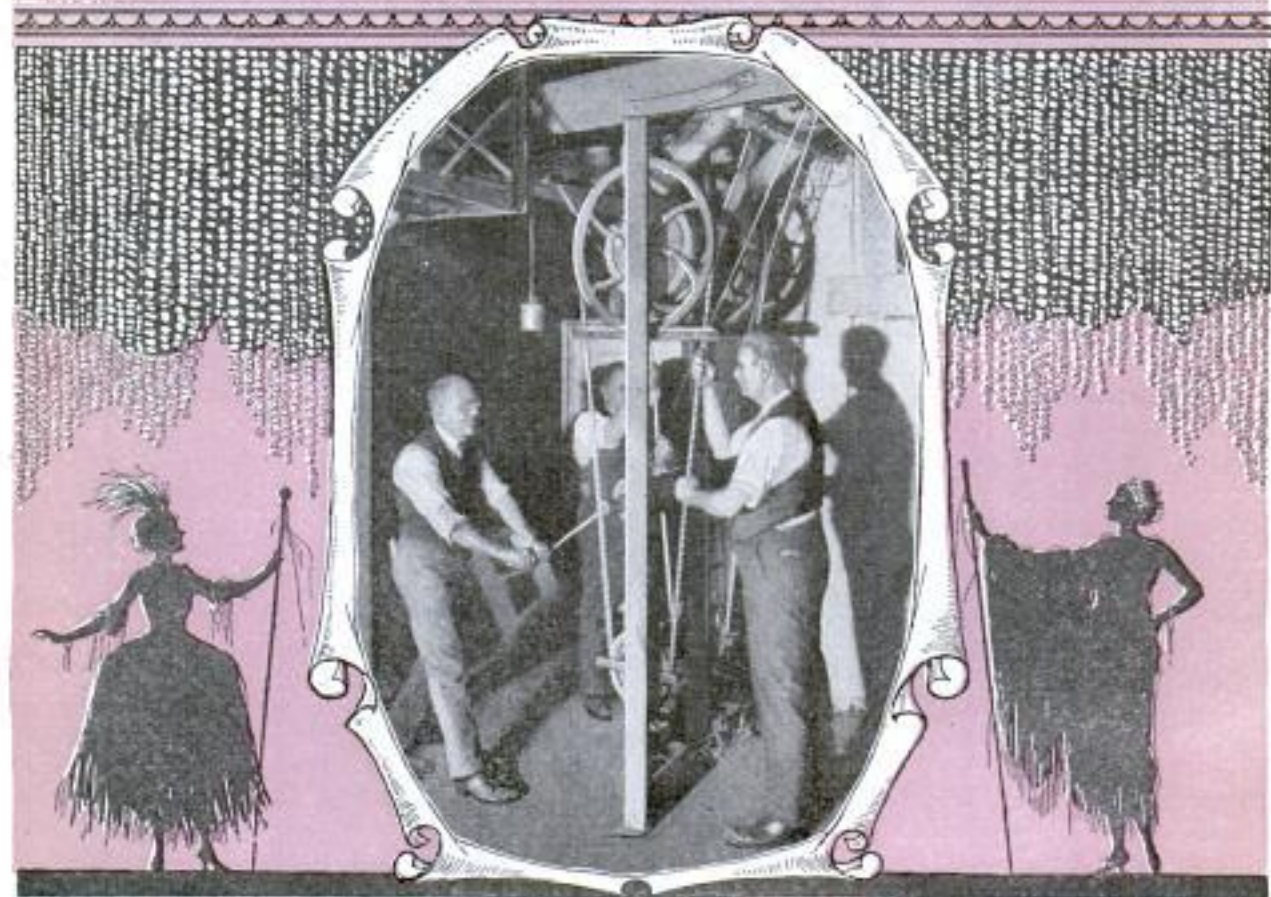
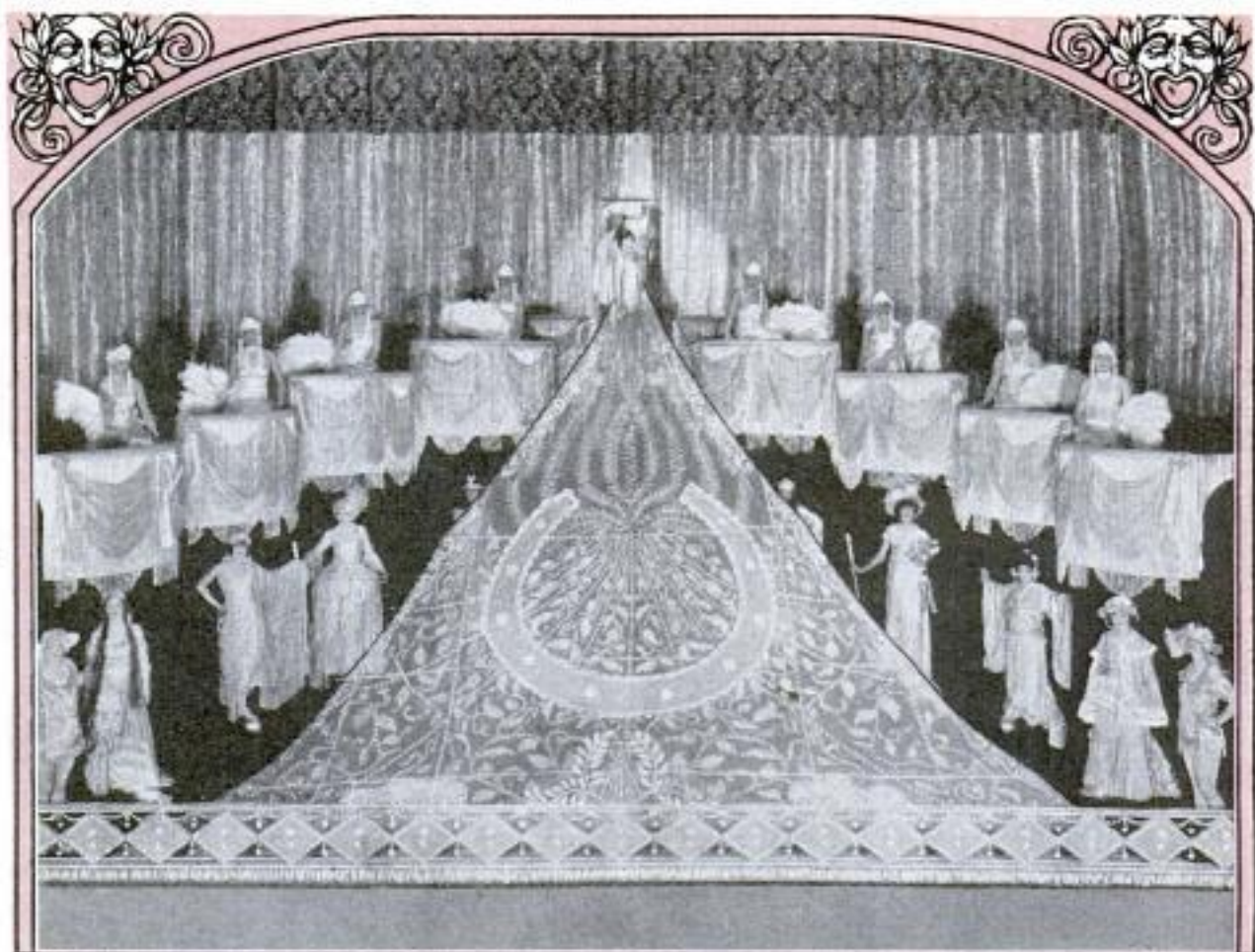

Courtesy, Music Box Review
 Above, Appearing to Grow from the Floor, a Crystallike Lace Train Is Unwound from Reels under Stage.
 Below, Winding in Flexible Floor Strip to Give Passageway for Curtains

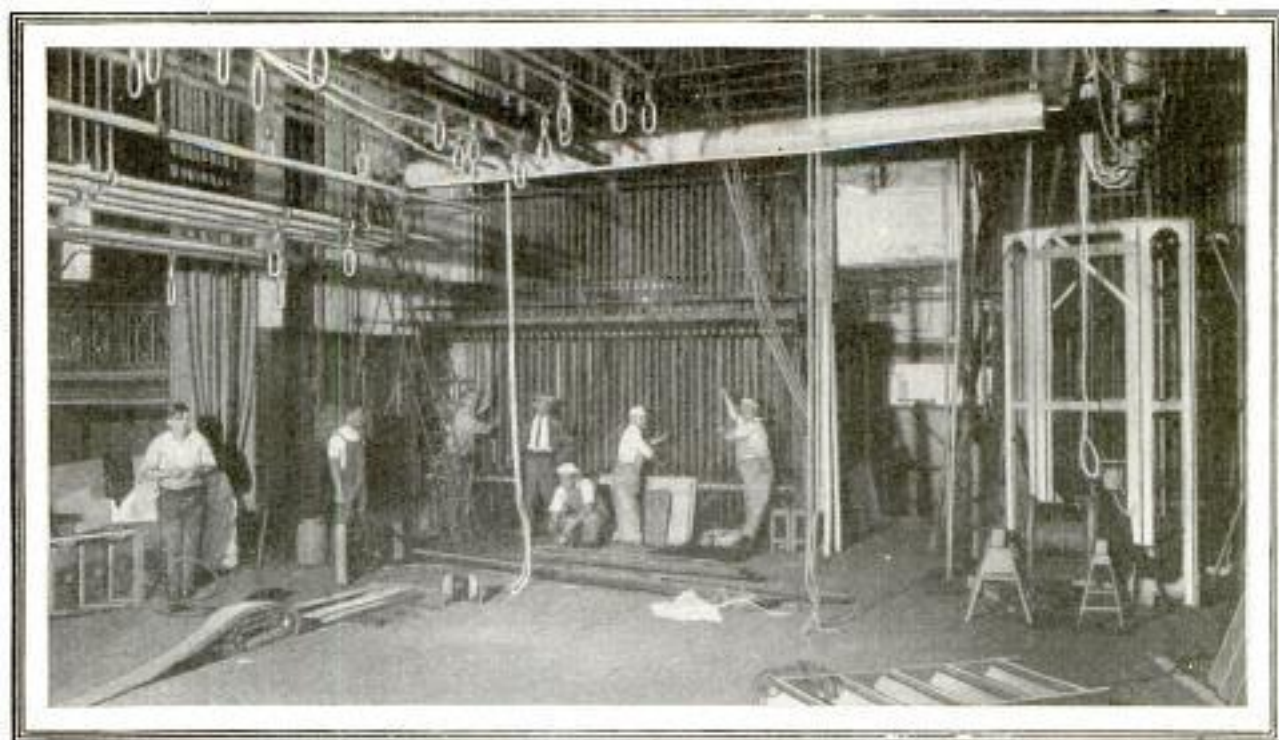

Tons of Massive Iron Weights Hidden in a Net of Guy Ropes Control the Balance of Gaudy Curtains and Tintseled Drapes that Lend Sparkle and Splendor to Stageland's Art

Theater

Stage Wonders Work of Hidden Toilers

Tintseled Fairylands Rise from Piles of Painted Drapes While Silent Wheels and Brilliant Lights Add Realism to Scene

TUCKED far behind the footlights of the stage, twenty-five tons of huge counterweights aid in controlling the movements of acres of spangled drops and curtains in the wonderlands of a production that is resorting to concealed machinery to increase the effects of theatrical arts.

Instead of the usual painted canvas walls that rise and fall from high over the stage, tintseled and bronzed draperies, lacelike net works of metallic cloth, and shimmering fringed curtains are drawn from beneath the floor balanced by weighted chains and ropes. Figures impersonating gaudy birds of the wilds are sent up through the platform on silent elevators, to burst suddenly from the midst of brilliant plumage into rays of light that rival the rainbow hues.

Windlasses and cranks help to carry on to the stage huge striped columns and mounds, which are set in motion at a given signal to the attendants, who operate complicated machines to give revolving motions to the ribboned shafts. When the scene is ended, the mass of cumbersome properties disappear in a twinkling through the stage floor on elevators that convey them to their storage spaces.

The carpenters' craft is called upon to build up frameworks that support immense burdens, but which are themselves unseen by the audience. Stairways that defy detection afford a means for the actors to ascend to dizzy heights among realistic trees bearing feathery fronds that rival the plumage of the forests. From the depths of their foliage, the songs of birds proceed, in imitation of the noisy denizens of woodlands. To produce such sounds, reedlike whistles are blown by hidden players who stand so that the walls of the structure will direct the notes upward and outward.

Wherever the aid of machinery can accomplish a difficult spectacle, it is ingeniously harnessed to the properties. And with it, myriads of colored lights are fixed to flash and rotate from the mysterious depths of the property room below the fringe of footlights. Sturdy electric motors wind up the reels that carry hundreds of ropes belonging to delicately woven tapestries that seem to hang in midair. Every loop and pulley is familiar to the stage mechanics who are intrusted with the proper releasing of thousands of pounds of materials that rest in frames tied far up in the

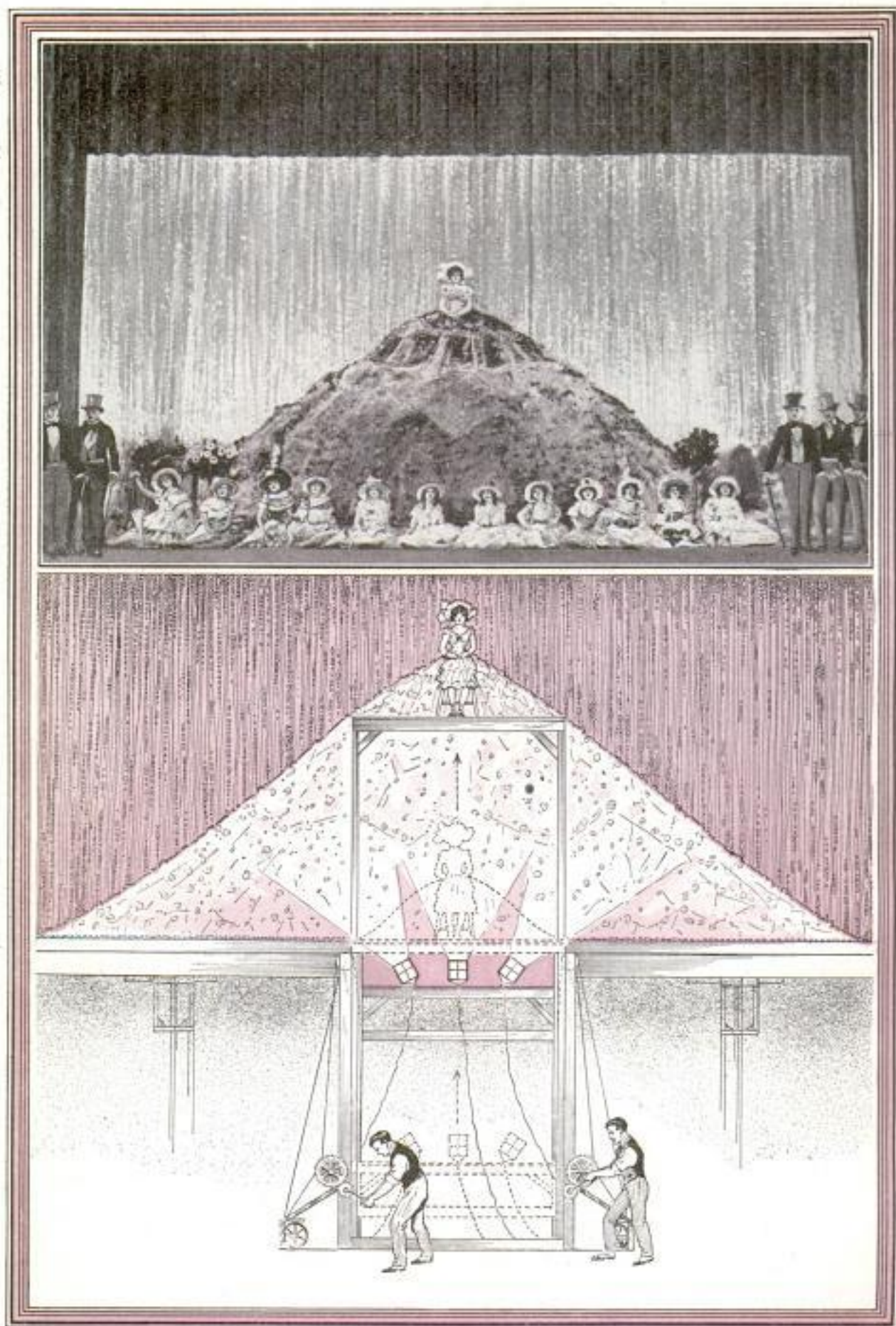

Above, Wearer of Marvelous Crinoline Gown Raised to Display Its Illuminated Beauty. Below, Elevators Operated Beneath Stage to Lift Platforms that Support Player and Carry Flood Lights

Courtesy, Music Box Revue

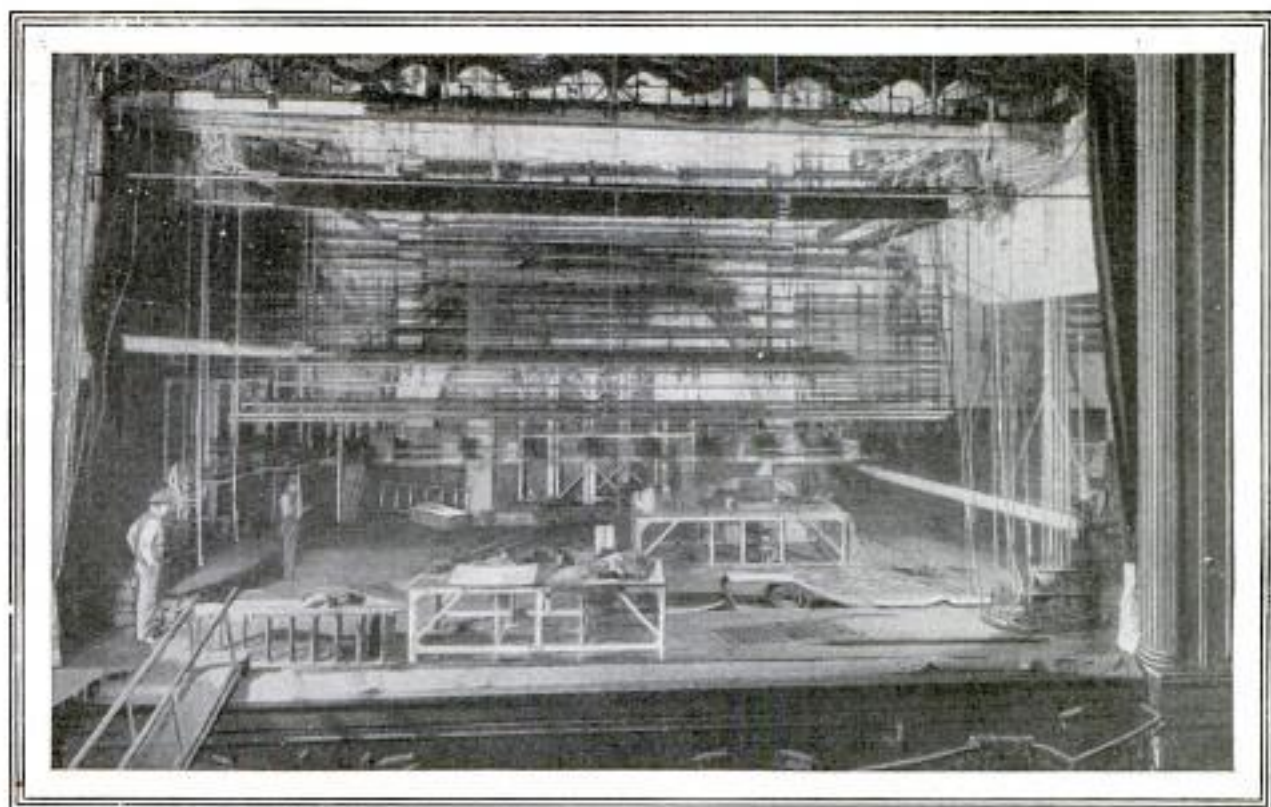

Every Inch of the Modern Stage Is Carefully Planned to Accommodate Its Portion of the Important Mechanical Properties that Help to Form Spectacular Settings of Big Productions

lofty recesses of the "flies." Cues are closely watched, and no movement is made until the signal comes from the directing source. The loosening of a guy line or the throwing of a switch at the wrong moment might result in disaster that would take weeks to repair.

The electric control panel is carefully guarded from careless hands. One or two men are trained in its operation, and during the entire performance they never leave it. Flood lights that illumine the sets are all governed from this central point. After they have been placed by the property men, they are connected to wires leading to the switch panel, so that

at all times distribution of light is in the hands of the electricians.

During a principal scene in the Music Box Revue, which employs these arrangements, one of the cast climbs a steep stairway dragging with her an immense train that seems to be attached to her gown. It is so wide and heavy that it is necessary to unwind it from a reel fixed close under the stage, and to attach it to invisible wires passing over pulleys on a steel frame placed at the top of the steps. A windlass manned by a mechanic on the stage level reels the metal rope on a drum, until the marvelous robe stretches the full height and width of the setting.

MAKING PASTE JEWELS GROWS INTO THRIVING BUSINESS

Although the art dates back many centuries, the manufacture of artificial and imitation gems has been stimulated enormously by modern commerce. Synthetic rubies and sapphires set beside real diamonds are not now scorned in the smartest shops. And they are so cunningly made that they bear close comparison with real precious stones. Although the Babylonians, Egyptians and Romans excelled in making paste jewels, the art has been brought to a fine state of perfection only

in recent years. A special kind of glass, known as "strass" is used. This is developed by fusing white sand, red lead, borax and several other elements. When a colored gem is desired, pieces are crushed into a fine powder and coloring substances are added. The mixture is then fused and annealed. Cobalt is the coloring used for blue stones, copper for green, gold for red and manganese for purple. Most of the imitations lose their luster in a few months, because their softness causes them to be extensively scratched and acted upon by fumes and air-borne acids.

Philadelphia Public Ledger
12/16/23

SPHERICAL TANK FOR GASOLINE STOPS LEAKS

4430

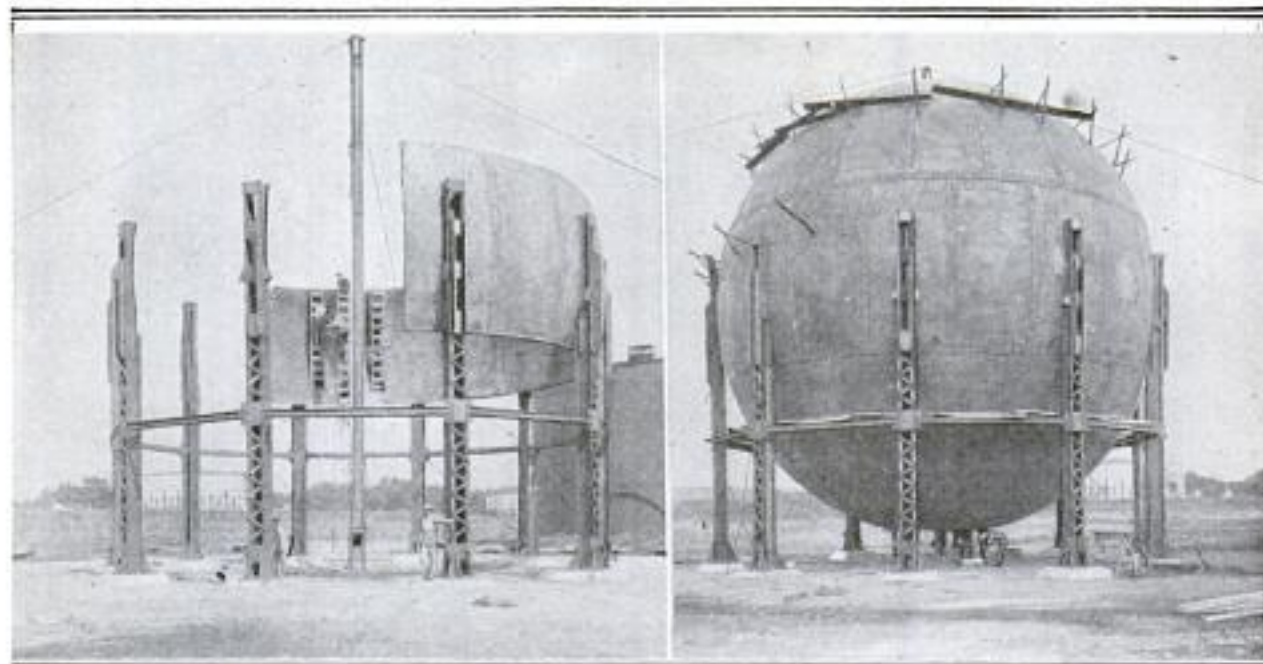

Gasoline Tank Built in the Form of a Globe so that Pressure May Be Equalized, Thus Preventing Distortion and the Consequent Loss through Evaporation

Because of the tendency of gasoline to evaporate quickly, unless stored under pressure, a "leakless" tank has been made in the shape of a sphere to prevent the usual loss. With the ordinary cylindrical container it has been found that the application of pressure tends to bulge out the

walls, thus causing the leaks. It is claimed that this tendency is eliminated in the globular form, as the pressure is more equally distributed over the entire sphere. The new-type tank is fifty feet in diameter, weighs 140 tons, and will carry 1,250 tons of gasoline.

BATHING POOL FOR WILD BIRDS
MINIATURE OF OLD MILL

Wild birds visiting the grounds surrounding the home of a New Jersey man can enjoy a pool built in imitation of a

midst of a flower-decked lawn and is made of colored stones collected from many parts of the state. The tiny millwheel revolves under weight of the stream of water that feeds the basin. The top of a tower and the wheel shed are formed from 5,000 small shingles, and 10,000 small nails were used to fasten them in place. Construction of the miniature required about a year, the builder using his spare time.



"Old Mill" Bird Bath Erected for Benefit of Feathered Visitors to the Surrounding Grounds

famous old water mill of the neighborhood. The unique structure stands in the

CONCRETE RAILWAY TIES HAVE WOODEN PLUGS FOR SPIKES

Concrete railway ties, used on a section of a right of way in northwestern India, have proved to resist wear and weather equally as well as wooden ones, according to a report. It is believed their employment will result in great savings of lumber and labor, since they will not require replacing as frequently as the timber. The cement beam consists of two blocks tied together with steel straps. The rails are fastened on by means of spikes driven into treated-wood plugs set in the concrete.

Emb. Robert H. Moulton,
Com. L, Board of Trade

Compressed Air
Magazine 12/23
Copyrighted material

*Emb. J. E. Winters
District National
Bank Bldg. Chicago -389*

**AUTO ON ABANDONED RAILWAY
RUNS ON FLANGED WHEELS**

To prevent an entire community from being deprived of railway transportation, a small motor car has been fitted with flanged wheels, to carry passengers over the rails of a short line in Maine. The company has discontinued service over a twelve-mile branch and abandoned it.

Motor Car 12/6/23

**PENCIL ON FINGER RING FOLDS
IN MOUNTING**

Folding into a space beneath the setting, a tiny pencil has been made to be carried in a finger ring. It can be used while the



piece of jewelry is being worn, and cannot be detached, as it is fastened to the metal by a hinged joint. A slot in the side of the mounting permits sufficient extension for writing when the point is pulled out, and a new lead can be put in by unscrewing a cap.

**WIND-PROOF ICE CARD IS HELD
IN PLACE BY SPRING CLIP**

For holding the ice card so that wind cannot blow it away, or the wrong figure be turned upward, a strong spring clip has

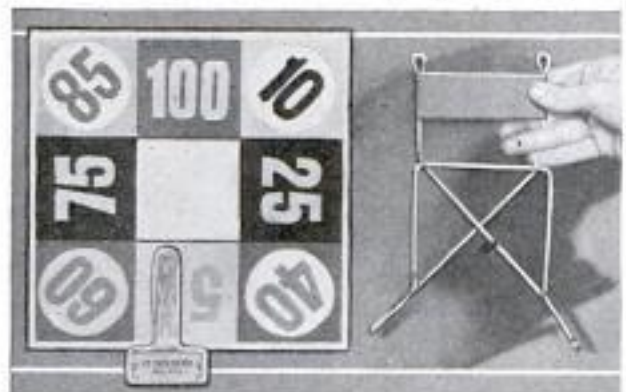

Ice Card Held Tightly in Spring Clip, and Larger Style for Big Cards

been perfected by a woman who was annoyed repeatedly at the discomfort of losing the card in storms and by its falling from an upper window. The device is made in two styles, a wider spring being better suited to large cards. The holder is fitted with little trouble to porch or window frame, binding the card safely.

*Harrison Co.
Union City, Ind.*

**DIRECTION-FINDER FOR RADIO
TO POINT WAVE SOURCES**

To show the direction from which wireless waves flow, an instrument is being tested that is expected to help in locating broadcasting sources. It also will be of value in aiding distressed sea and air craft which have lost their way, to summon help without the need of technical details of their exact loca-



Testing Radio Direction-Finder on Roof of Hangar Occupied by Giant Dirigible, Shenandoah

tion. In night flying, the location of airplanes could be estimated by the directions from which their radio calls come. The device is undergoing trials on the roof of the hangar that houses the giant dirigible, Shenandoah.

**INCLOSED IGNITION IS PROOF
AGAINST BAD WEATHER**

Designed for gas engines which are exposed to all sorts of weather, a leak-proof ignition system with all its working parts inclosed within the combustion chamber has been patented by a Canadian inventor. A cast-iron spring, which is not affected by heat, is used. It is said to be noiseless at all speeds, is not hindered by carbon, and because of the absence of cams, bearings, and joints in moving parts all wear is confined to the ignition points and the spring.

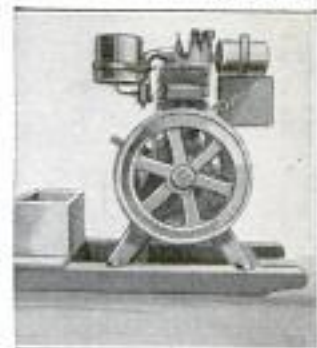

*W. A. Steffendorf
Hall P. O.
San Diego, Calif.*

*Fred Blawie & Co.,
1631 N. Halsted, Chicago*

*4468
4470
4356*

11,700

Copyrighted material

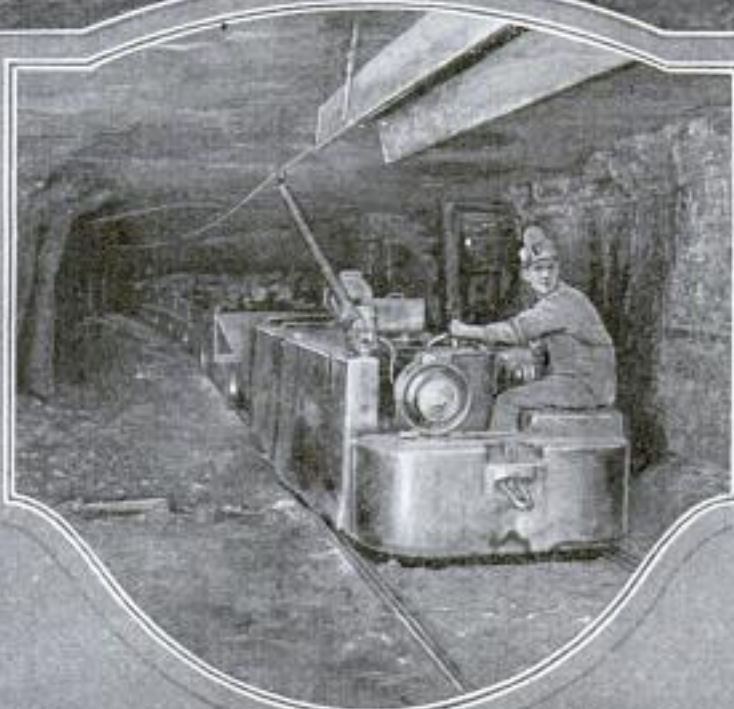
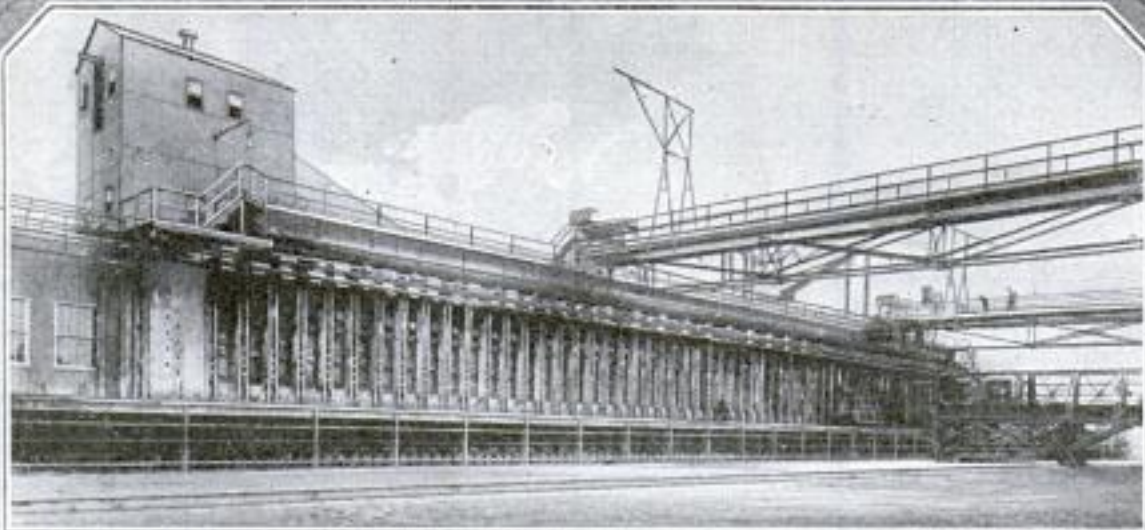

Coal Loading Docks, Coke Ovens, and Electric Mine "Mule," Three Links in Great Industry upon which the Nation Is Largely Dependent for Heat and Power.

Contrib. Mrs. Edna M. Colman, 5604-14th St.
N.W., Washington, D.C.

Testing Black Diamonds By the Spoonful

Uncle Sam's Experts Tell Amount of Heat in Fuel from Pinch of
Coal Powder in Seeking Substitutes 4033

THERE is no economic question so vitally bound up with the comfort and welfare of the nation as the fuel problem, particularly since anthracite has soared into the luxury class while still remaining a necessity.

As the supply diminishes, the interest in the heating qualities of hard coal, and the possibility of having to adopt some substitute, have kept this problem in first place in the public mind. Hence, the experiments conducted by the Bureau of Mines, though made only for the government, have been watched with eagerness for any light they might throw upon the fuel question of the householder and factory owner.

At the Pittsburgh experiment station there is a testing furnace forty feet long, with a boiler at one end. Here are used methods by which Uncle Sam's experts can determine from half a teaspoonful of powdered coal, the quantity of heat to be expected from a barge load of the same fuel. Other tests show whether the coal is high or low in worthless moisture, undesirable ash, valuable carbon, or inflammable volatile matter.

For analysis, the black diamond samples are sent into the laboratory in three-pound, galva-

nized-iron containers with close-fitting screw tops, made moisture proof by being wrapped about the joining of cap and can with electrician's tape. If the coal in the can is coarser than one-fourth inch, it is passed through a jaw-crusher which reduces all of it to one-fourth inch, or finer, and then through a roll-crusher.

Then a number of pans, holding about a thimbleful each, are placed in a drying oven. The temperature is so low that none of the volatile matter is driven off. Superheated air, purified by passing through sulphuric acid, circulates through the oven and carries off the moisture liberated by the heat. Next, the sample is weighed, and, from the loss, the percentage of moisture in the entire lot of coal is determined.

Larger pieces of the fuel are rolled and crushed until they are the equivalent in size of fine gunpowder. This is weighed into a platinum crucible and heated in an electric furnace at a temperature that leaves only a small residue in the form of coke—chiefly ash, and fixed carbon. The volatile matter driven off is the gaseous, combustible part. The carbon represents the similar solid, combustible matter, the latter giving far greater heat units. To determine the amount of ash, another tiny sample of the coal is placed in an open retort which is gradually heated, and then it is burned until there is nothing more to be consumed. The result is ash

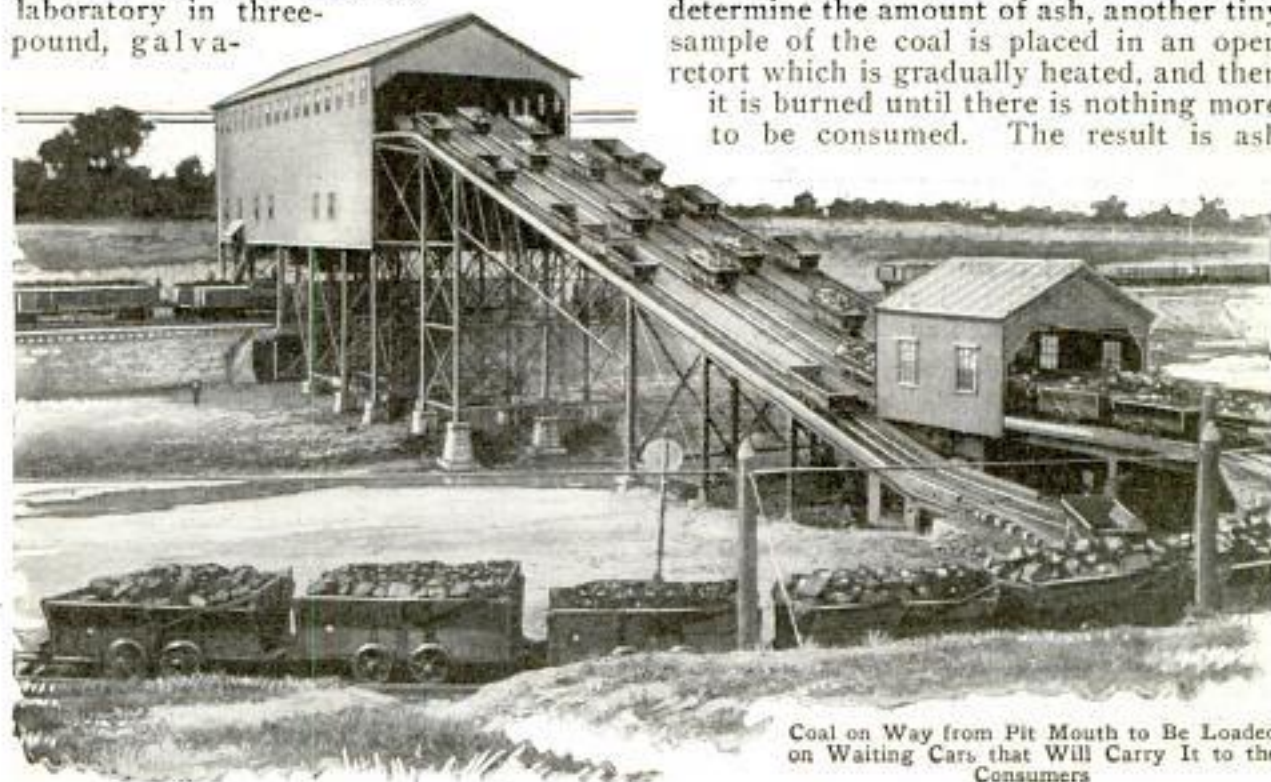

Coal on Way from Pit Mouth to Be Loaded on Waiting Cars that Will Carry It to the Consumers

4033
 composed of iron, lime silica, and other substances, that cause clinkers in the furnaces and interfere with the perfect combustion.

Later, these magicians, with their tests of coal by the spoonful, determine its heat-giving power, expressed in thermal units, or the amount of heat required to raise the temperature of one pound of water one degree. At first glance this apparatus appears to be merely a tank, about ten feet long, lighted from within by electric bulbs and filled with water actively agitated, in which is placed a number of cans whose tops just reach the surface.

Electric wires attached to glass tubes connect with these cans which contain about four pounds of water, a small propeller blade to keep the contents in motion, and a thermometer.

Most important of all, is a "bomb" in which the actual heat test is made. This is a hollow steel cylinder with walls thick and strong enough to resist a pressure of 800 pounds. This is filled with a pinch of coal dust, and pure oxygen, more than enough to secure the combustion of the fuel, is then forced into it until the pressure is 400 pounds. The "bomb" then is placed in the can and an electric spark is flashed through a tiny fuse wire, igniting the fuel and leaving nothing but the ash. Thermometers give the exact amount of heat produced.

The results of each of these separate tests, for heat, for ash, carbon, moisture, and volatile matter, go back to the desk, where the coal samples were first received. Each one carries the serial number of the sample, and the results are added to the data furnished with the container by the shipper. To give the best results, coal should be low in moisture and ash, high in fixed carbon, but not necessarily rich in volatile matter. The same tests are applied to the various substitutes for anthracite.

When the value of coal as a fuel was first

discovered, the demand was so slight and the coalfields so vast, that little or no care was used to prevent waste. Now the demand is so great that Uncle Sam's experts have been experimenting, investigating,

and scouring the country for something to offer when the hard coal supply becomes exhausted.

Virginia produced recently a small field of semi-anthracite now being developed to capacity. This coal is smokeless and compares favorably with the anthracite, as to heat values and ash content, when properly prepared. It is to be marketed in briquettes and in smaller sizes than the regular anthracite of Pennsylvania. Arkansas, also, has produced a fair grade of coal that is really a product between the

regular anthracite and a bituminous coal.

From several standpoints, coke is declared to be the most satisfactory of all fuels next to anthracite, particularly in the matters of cleanliness, smokelessness, and convenience in handling. It is the product left in the beehive ovens as the residue after distillation of certain grades of bituminous. Mixed with small coal, it gives forth most satisfactory heat. An amalgam made of coal dust combined with oil is also on the market and gives a generous supply of heat. Briquettes of anthracite and smokeless bituminous have also been made, but have not come into general use.

Another fuel that for a time gave great promise of abundance in supply in the West is lignite, but, so far, it has not proved the fuel bonanza that was predicted. It is an immature coal that, according to natural processes, requires centuries for its proper maturity.

In surveying the coal situation, the conclusions have all been based upon the convenient sizes best known to domestic use, egg, chestnut and pea coal. The smaller fragments have not been considered as hard coal, but as a by-product which has for years been sold as a competitor of bituminous.

FIRING A RESIDENCE HEATER WITH SOFT COAL

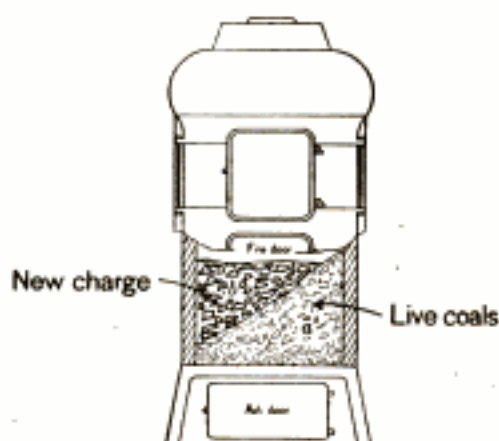

By firing the new charges alternately on one side and then the other, as shown above, less smoke is emitted and the fuel is more completely burned than when the fuel is spread evenly.

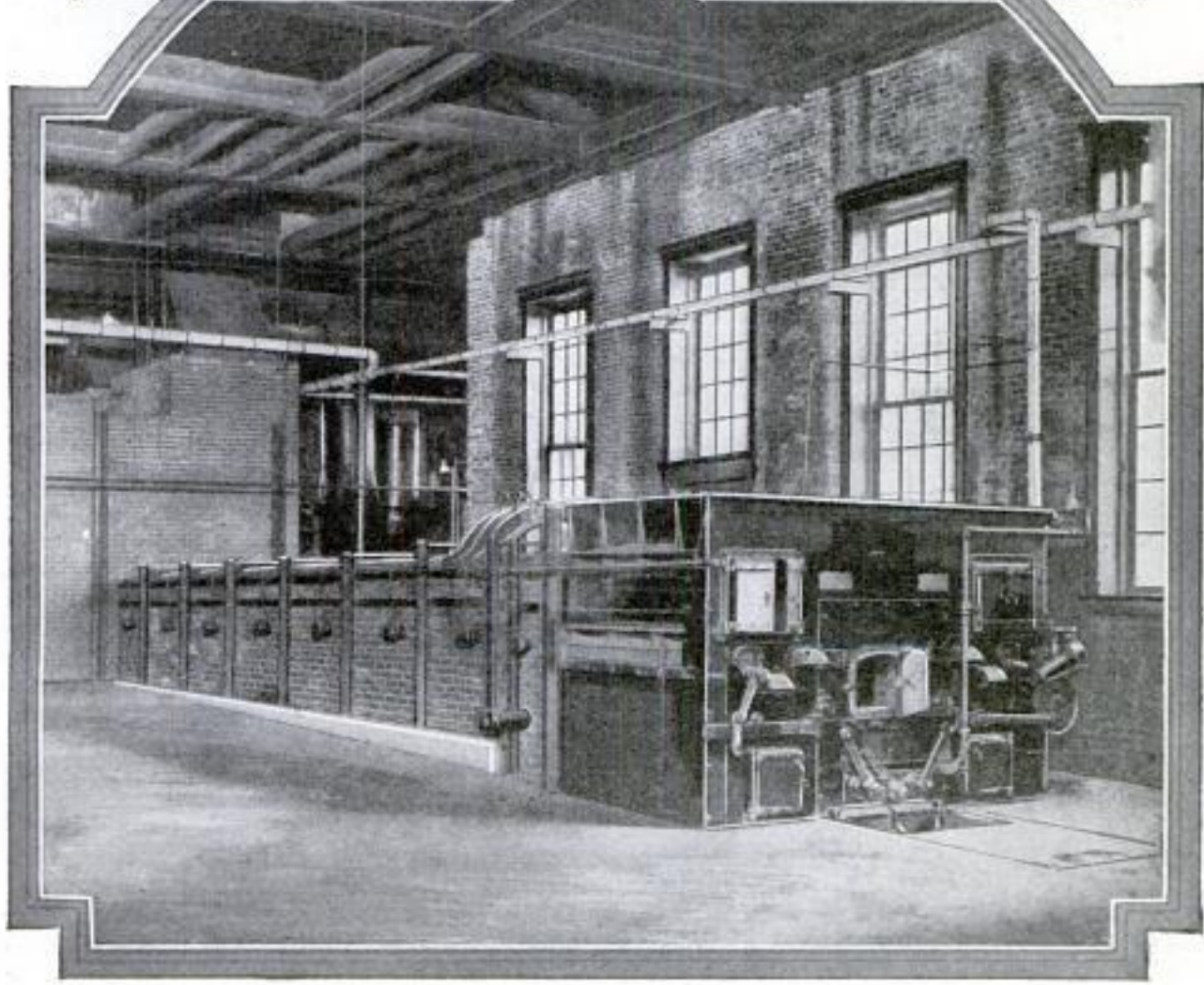
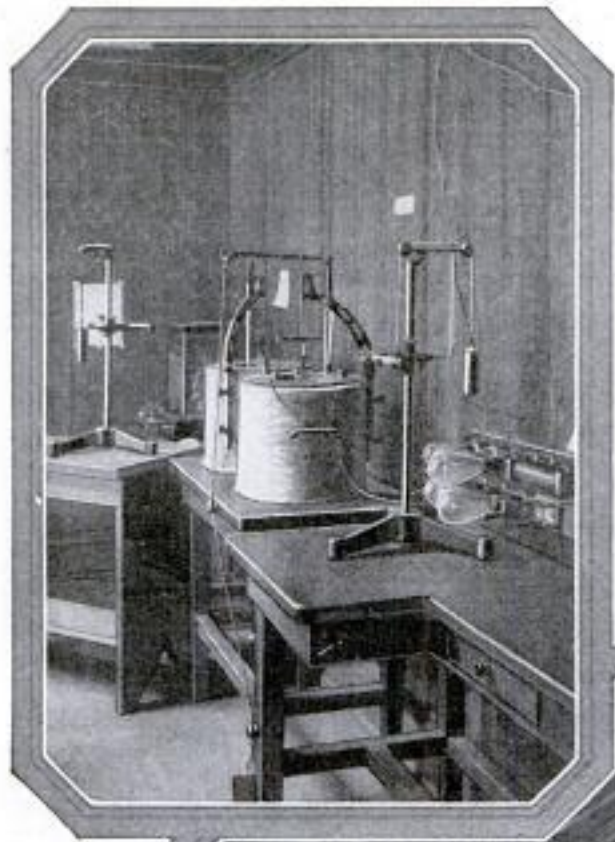

Copyright, Chimedinst Studio

Government Coal Testing Apparatus in which Pinches of Powdered Fuel Are Forced to Yield Their Secrets so that Amount of Energy May Be Exactly Determined

427825

Park Place New York City

ELECTRIC SEAGOING DREDGES ARE BUILT BY ARMY

Electrically operated throughout, from propellers to whistles, two seagoing dredges have recently been completed and launched by the army engineer corps for service in keeping harbor channels open. They are the first ships of their kind built, and they are expected to reduce greatly the cost of operation and to prove of increased value because of higher speed and efficiency of the dredging machinery. Power is furnished by large Diesel engines. Electricity is employed for operating all auxiliary apparatus in the ships, for cooking, heating, ventilating, and lighting. The boats' movements are controlled directly from the pilot house, the navigating officer being able to start, stop, change the speed or reverse the

engines without signaling below. While similar in appearance to other seagoing vessels, these ships are designed inside on a radically different plan than that of an ordinary steamer. The entire section amidships is occupied by two rows of hoppers, with an open space where sea water is visible. In this "well" is the actual dredging machinery, a large suction pipe attached at one end to an 800-horsepower pump and carrying on the other end, a large casting or "drag" to loosen the bottom as the boat moves slowly along. As the sand and silt are sucked up through the pipe, they are discharged into the hoppers and later carried out to deeper waters, where they are dumped.



An Electrically Operated Ship, a Seagoing Dredge for Harbor Service Being Launched by United States Army

Arrived

PULLMAN LUXURIES IN AIRSHIP FOR TWENTY PASSENGERS

4579

Passenger accommodations that will rival those of a luxurious steamer, or railroad train, are being fitted into the LZ-126, the Zeppelin now nearing completion in Germany for the United States government. The ship will have space for twenty persons in addition to the crew in the main gondola behind the commander's quarters. The cabins will be fitted up like pullman sleeping car compartments with four beds so arranged that the upper and lower tiers will form seats during the daytime. Folding tables, mirrors, lavatories, and large three-sectioned windows in each cabin also

are provided. The kitchen will be lined with aluminum, and all cooking is to be done with electricity. At full power, the ship will have a maximum speed of approximately seventy-six miles an hour, and its cruising rate will be about sixty-seven miles. It will have a radius of nearly 13,500 under normal conditions.

¶ Not much larger than a watch, a phonograph which can be slipped into the pocket and has space for ten double disk records has been invented by a Hungarian. The sound produced by the machine is said to be so amplified when it is placed on a tumbler that the tiny instrument can be used to provide music for dancing.

no other information
Copyrighted material

The Zeppelin Co. Friedrichshafen Germany

4448 Cmt. A. E. Pitney,

5422 Kenmore Ave

Chicago



Some of the Ornamental Objects Made by Youthful Students Learning Their Trades in the Cement Shop of the Mooseheart School where all Kinds of Building Materials Are Molded

Schooling Minds to Direct Skill of Hands

Book Learning Taught as Aid and Guide to Youth Trained in Profitable Trades Before Taking up Careers

ONE of the most striking examples of modern education for work with hand and brain is to be seen in the home and school for children at Mooseheart, Illinois.

The institution, founded by the Loyal Order of Moose to provide training for dependent orphans of deceased members, is under the direction of highly experienced educators who supervise the studies and direct the home life of the pupils. More than a million dollars are furnished annually to the school for the carrying out of the work. A regularly credited high school, part of the institution, graduates the students ready for college or university, if they prefer; but in every case the scholar is equipped with a trade whereby he can earn his way through life by work of the hands.

Each department of the vocational schools is in charge of skilled teachers who know the trades that are involved thoroughly, and have specialized learning along the lines of their application to the various problems that ordinarily arise in the processes of the particular work. All equipment is of the latest type of tools and machinery. Shop organization is patterned after that in use among the most

successful industrial concerns and the most up-to-date practices are followed. The system of organizing, distributing, and routing work is that endorsed by modern factory methods, so that the pupils get training in minor executive lines connected with their actual practice in the trades.

With approximately 1,500 inmates in the establishment, it equals in population a fair sized town. And, when all of its utilities and conveniences are included with the territory covered by the buildings, it represents no small demand for the necessities of modern life.

In the machine shop the scholars turn out practically all of the lathe and bench work required by this miniature city, making and repairing tools and farm implements, and producing bolts, nuts, and numerous small parts for the automobile garage and the fleet of cars which is consigned to its care. In addition, some of the heaviest tasks in connection with fixing the machines is performed right on the grounds by the youthful students under the direction of the teachers.

In the carpenter shop, may be seen industrious scholars handling all sorts of job work for Mooseheart, specializing in the

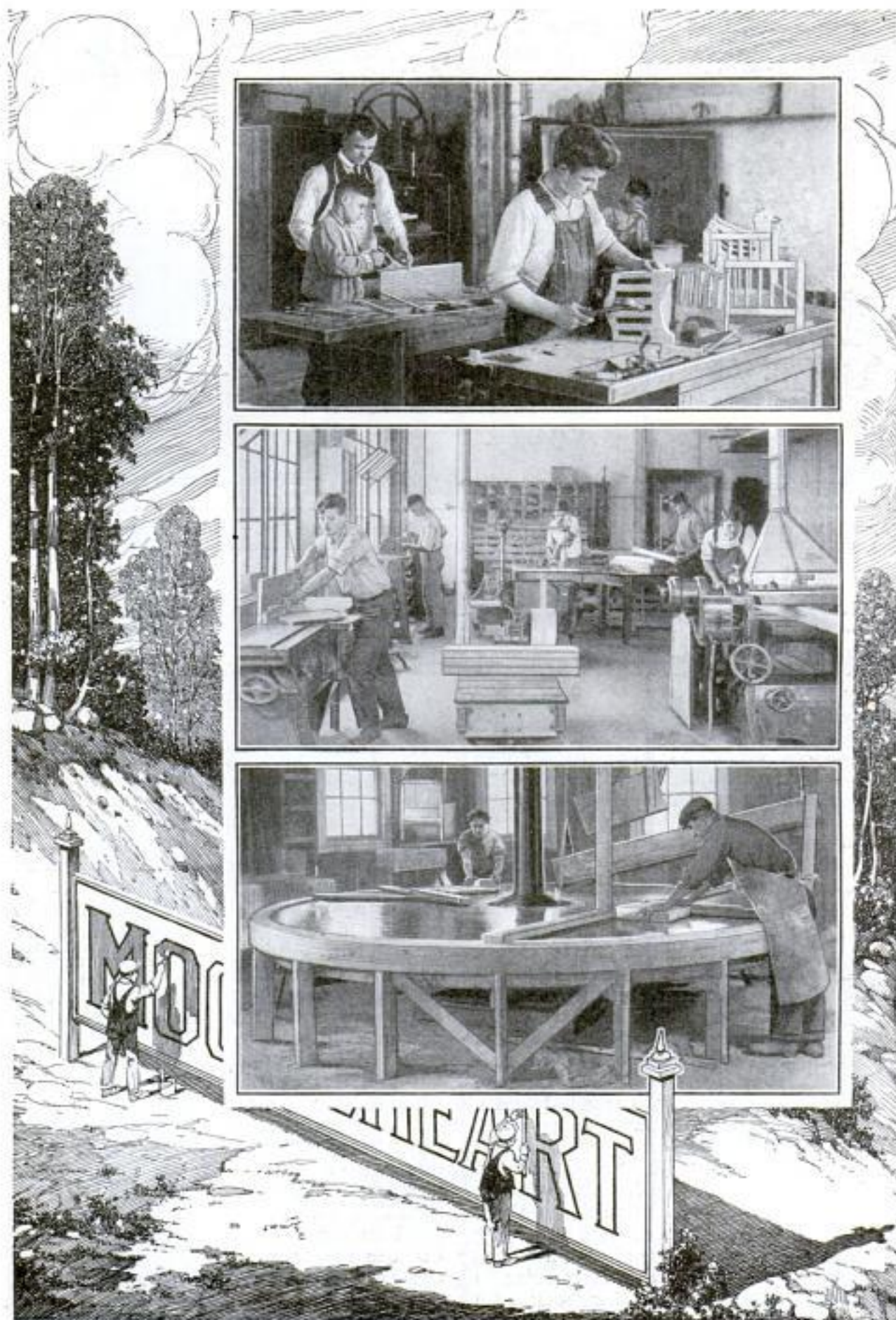

Top, Making Toy Furniture during Pre-Vocational Training; Center, Apprentices in Wood Mill of Carpenter Shop, and, Below, Surfacing Cement Blocks. Bottom, Part of Class in Sign Painting

4448



Teaching Girl Scholars of Mooseheart School to Design and Weave Decorative Baskets as Part of the Training that Provides Them with Useful Knowledge of Profitable Crafts

making of children's furniture for the use of younger wards in the nurseries and kindergartens. Most of such materials are designed by the students, who also produce ornamental articles that are shipped throughout the United States and Canada.

One of the most complete ornamental cement plants is to be seen as a department of the vocational school. All the cement building materials used in the area are here made by the young apprentices. In the grounds are garden seats, urns, bird baths, sun dials and pillars and posts that add a touch of art to their surroundings. All are molded from raw materials in the cement "schoolroom." Many of the articles are sent in great quantities to large stores in New York, Chicago, and other big cities where they are sold. New processes and kinds of cement surface finishes, as well as many new and original designs, have been created in the shop by instructors and students. Its graduates have had pronounced success in finding their ways through big businesses which require services such as they have to offer.

The printery is a modern book, job, and edition plant where numberless copies of all sorts of folders, dodgers, pamphlets, and finely bound volumes are run off. Near by is a sheet metal shop, where all of the ware and supplies of that kind are made up for the use of the school and the home. So widely known has the nursery and landscape gardening department become, that it is said experts from many surrounding states visit the institution for plants and shrubbery grown under the care of the scholars in that branch of the school's learning.

Everywhere is abundant attractive work to invite the youthful mind to labor. Dairy farms are at hand to supply the youngsters and their supervisors with fresh products, and a poultry yard furnishes its share of the necessities even while the student studies the care and raising of domestic fowls. Practical work is found for the boys in the garage, where a knowledge of automobiles and their repair is ready to be spread before the seeker. Paint shops are established to keep the buildings attractive and well-appearing, and here a course in the trade is available, coupled with



Vocational Student Putting the Finishing Touches on a Cement Urn Made with the Help of His Classmates

training in sign-painting and decorating.

Girls at Mooseheart are taught dress-making and become expert in household management and the domestic arts. If they are inclined to other lines of effort, they can learn stenography, general office work or nursing. Many of them have taken up the profession of teaching.

Only about one-fourth of the graduates of Mooseheart choose to go on with higher studies in colleges and universities, using their vocational training in the trades of industry to earn their ways through the courses. Sometimes they go in for engi-

ing, such as landscapes, and pencil sketching are taught, but clay molding in decorative subjects and similar work in bas relief are practiced. Dress design and the making of artistically colored ornamental articles are among the special studies arranged for the girls.

When the charges reach the age of twelve years, they are put to work on a three-months' pre-vocational study as a test period to permit the scholars to select the trades in which they desire to specialize. More than ten such courses for the boys and an equal number for girls are avail-



Modeling Class of Boys where Sketched Designs Are Copied in Relief in the Form of Panels and Insets to Be Mounted on Artistic Objects of Cement Work

neering and chemistry, but in every case they are so educated that either hand or brain can be employed to finance their studies.

During their stay at the school, the scholars are taught the value of a proper amount of recreation. Within the limits of the grounds are woods and streams where delightful pastime is afforded. In season, the boys go trapping along the river for small fur-bearing animals that invariably find a ready market in the vicinity of the place. Agriculture and its interesting revelations attract quite a large number of the scholars to that study and with graduation from the high school, it is further pursued in higher courses at the colleges or universities of the country.

The school runs all year round. Vacations are included in the work of the pupils, for everything is provided for summer camps, canoeing, swimming, and fishing in the lakes and streams. Athletic fields are layed out and at least two hours each day are spent in physical exercise that is directed by competent instructors.

Classes in art work are held for both boy and girl students, whereby they can get a foundation from which to extend their pursuits in such training. Not only paint-

able. The actual work on the study does not begin until the tenth grade of the educational course has been reached. The vocational subjects are taught, at first, only an hour and a half a day, taking turn with the other studies necessary to prepare the youthful apprentices for proper training in the application of schoolroom knowledge to the crafts that equip them for profitable careers.

4552

FLOUR MADE OF SUGAR BEETS IS SUITABLE FOR BAKING

Flour suitable for baking cakes and sweet bread, and said to be of high food value, is being manufactured in France from dried sugar beets. Water, which forms approximately seventy-two per cent of the bulk of the vegetables, is first evaporated by chopping them into small pieces and subjecting them to intense heat. From 375 pounds of raw beets, 100 pounds of dried material is obtained. This is then ground into a fine meal. The large amount of sugar is declared to adapt the substance especially to baking cakes and puddings, and, because of the high temperature to which the beets are exposed, the flour is said to be entirely free from germs.

Chicagopolis News
12/17/23
Copyrighted material

4544

SILVER GIFTS SHOW SKILL OF INDIAN CRAFTSMEN

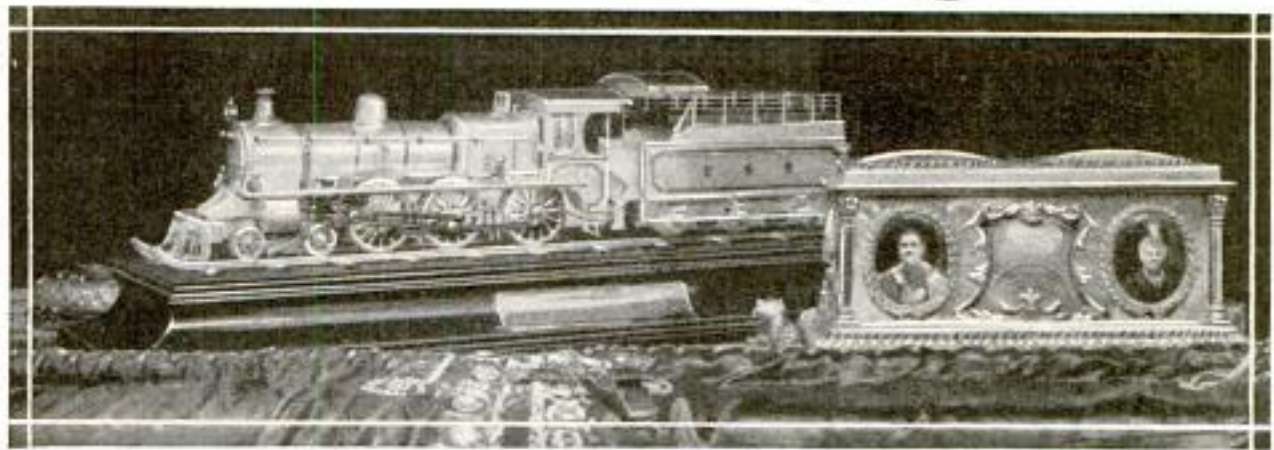

Unique Tokens Fashioned from Beaten Silver Lavishly Decorated and Modeled by India's Skilled Metal Workers to Show the People's Regard for a Retiring Province Governor

Skilled Indian silversmiths, world famous for their cunning in fashioning beaten ware, exercised their ingenuity recently in making gifts to present to an outgoing governor of Bombay, Sir George Lloyd. A cask, incense burners, and a model of a locomotive on one of the state railways, each polished, engraved, and embellished

with elaborate designs were molded from metal as expressions of the regard of the citizens for the official. The pieces reflected the high efficiency the Indian craftsmen have attained. Beaten work of gold and silver that adorns their temples is among the finest examples of the art in the world.

SAND FOR RAILROADS' SAFETY COSTS MILLIONS YEARLY

4612
Cmt. James O. Hays
Hays Journal, Chicago

While big figures are used in telling the cost of safety to the railways, the amazing item to the average person is the amount spent for sand. Four tons are required for every mile of road in the United States, according to the figures of one trunk line with 7,500 miles of track. As this road is in the middle west and south, where mountains are not encountered, the figures given are regarded as conservative. The cost of putting the sand into the engine box is placed at \$2.50 a ton as an average minimum. For all the roads, the yearly cost is estimated at \$2,637,070. For the most part the sand is brought from river bottoms and dried by waste steam at the round house.

herds of desirable forest animals and other wild fowl also is charged to the eagles. The number of the feathered giants slain since a law against them was passed, it is estimated, would cover a strip of ground thirty-three miles long, if they were stretched out with wings extended.

OLIVE OIL LURES TINY ANTS TO DEATH IN BOTTLE

4412

Attracted by a bottle of olive oil, after they had infested the upper floors of a steel and concrete building, tiny red ants



dug a path at the side of the cork to reach the fluid. The insects first found a small hole in the stopper from which they started their "tunnel." After gaining the inside, they were unable to escape, and fell into the liquid and died. The vial was kept in an office on the seventh floor of the structure, where the pests found it.

TONS OF ALASKA EAGLES SLAIN AS PROTECTION TO FISH

88

Because they are said to prey on salmon and other valuable fishes, about 150 tons of bald eagles are reported to have been killed in Alaska during the past six years. While bounties are offered for their extinction, experts claim that little damage is done by these kings of the air. After spawning, it is said, the salmon die, and it is upon the spawned-out ones that the huge birds mainly feed. Depletion of the

Literary Digest
12/22/23

Cmt. C. A. Lovell 720
Rorabaugh-Wiley Bldg
Hutchinson, Kans.

Keystone View Co. Inc.

400

91-7th Ave
New York City

POPULAR MECHANICS

FORTY-TON ROCK ON ROLLERS
MOVED THREE MILES

4526

Resting on a platform that moved on wooden rollers and tracks, a huge boulder, weighing more than forty tons was hauled

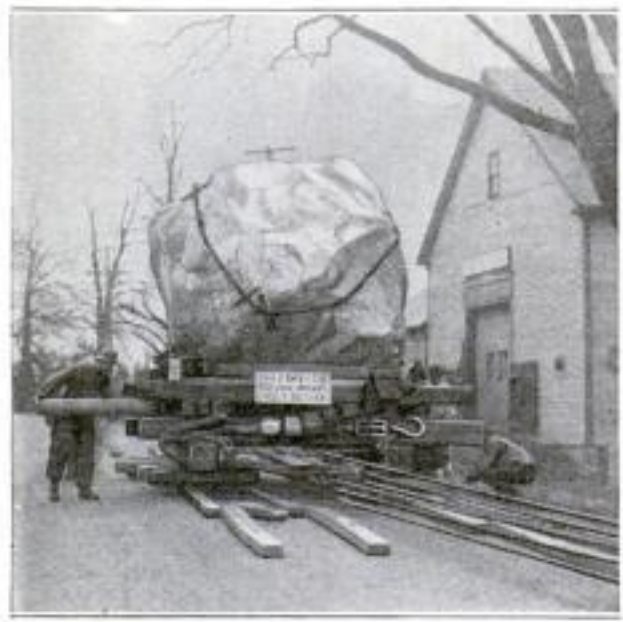

Copyright, Keystone View Co.
Giant Boulder Being Moved along a Highway on Its Three-Mile Journey to a Park

over a state highway in Massachusetts to a park, where it will be used as a monument. Heavy cables wound by windlasses pulled the rock, and the timbers and round pins were carried ahead after the big burden passed over them. On one side of the stone is a large, flat surface on which it lay during the journey. To this level face will be attached a bronze panel to explain the purpose of the boulder.

4520

BRICK DUG FROM RUINS TELLS
OF MOST ANCIENT EMPIRE

Dealing with events 2,100 years before the Christian era, an inscribed brick has been found in the ruins of Kish, capital of one of the first empires. The excavations, which have been carried on by an expedition in Mesopotamia, revealed the remains of a lofty tower, that, according to the lettering, was rebuilt more than 4,000 years ago. It is predicted that, with the opening of other chambers, written history, seventy centuries old, may be discovered. The searchers believe that stories of the flood spoken of by the Bible will be confirmed by records lying in the library of the ruined temple.

Chicago Daily News
12/14/23

IRON BURNER FALLS WHEN HEATED ON ONE SIDE

Excessive heat, applied to only one side of a tall, sheet-iron refuse burner in a western lumber mill, caused the huge walls to buckle and collapse. Investigation showed that a large quantity of sawdust and lumber scraps had collected on one side of the burner and close to the metal wall. This became overheated when

the rubbish was ignited, and, softening under the high temperature, finally collapsed under the weight from above. The burner was built on a concrete base seventy feet in diameter and was more than 100 feet high. An air space had been left between the double walls, but proved insufficient to prevent the unusual accident.

Emb. Mrs. Emma H. Morton
181-14th St. Portland Ore.

4556



Burner Completed

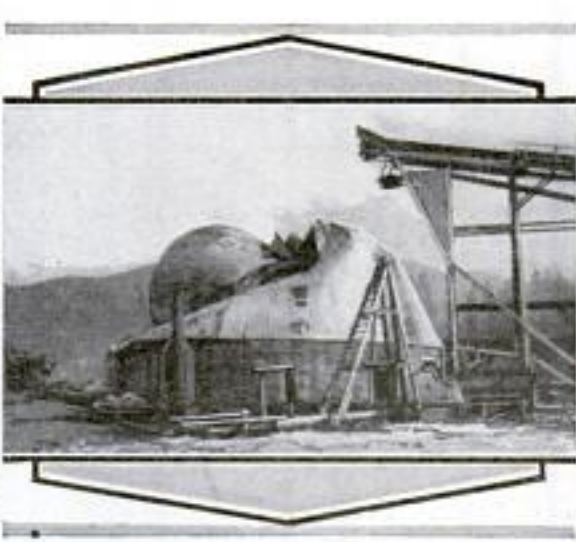

What Heat on One Side of Interior Did to Huge Burner the Walls of Which Were of Iron

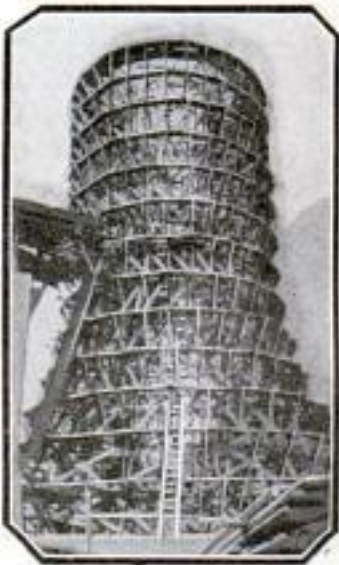

Under Construction

4561 Tests at Carnegie Institute

POPULAR MECHANICS
of Washington, Washington, D. C. #401
"FUEL" NEEDED BY HUMAN BODY TOLD BY ITS HEAT

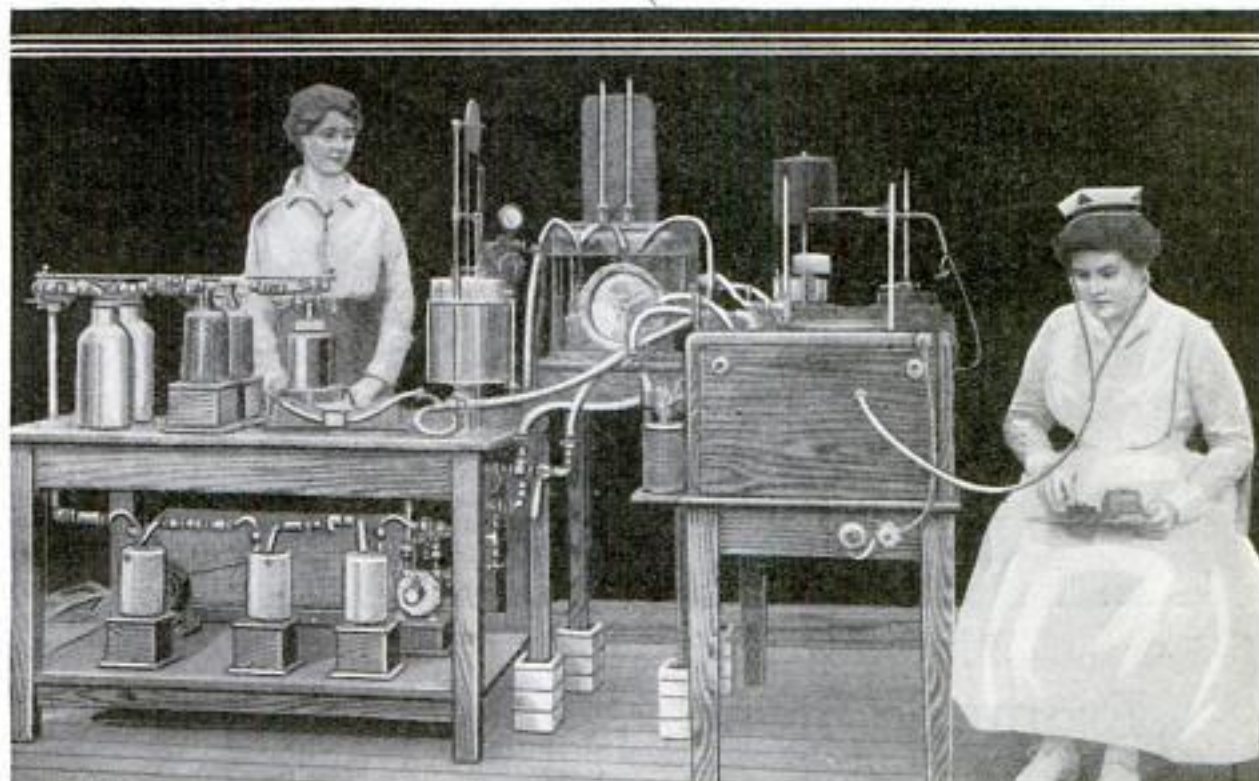

Instruments that Measure the Heat Production of the Human Body and Register Activity of the Pulse to Tell Amount of Food Needed to Replace Expended Energy

For measuring the needs of the body for food, a device has been made which registers the amount of heat produced by the human system. Children are tested at intervals of two or three months for the first four years of life in order to gauge the energy they consume. Nourishment required by them is estimated from the volume of heat generated by their bodies in ordinary activity. Men and

women are subjected to similar experiments to learn their minimum food needs to offset the expenditures of strength in every-day movements. Infants are placed in a chamber where instruments show the supply of air breathed and measure the carbon exhaled. Even while asleep, the activities of babies' bodies can be studied and their "fuel" requirements told.

COAL IS SAVED BY AIR DRAWN DOWN HUNDRED-FOOT STACK

4589 Owing to the shortage of coal, German engineers have made an investigation of the fuel problem, the results of which showed that the air in the neighborhood of steel works is much drier at a height of a hundred feet than at the ground level. This is due, it was said, to the great amount of heat dissipated by the furnaces and boilers. In making steel, it was found, dry air needs less coal than damp air for combustion, and so large suction towers were erected through which the air needed for the blast furnaces was drawn. It is estimated that many thousands of tons of coal were saved in consequence, one pound of water eliminated from the air saving three tons of fuel.

Cml. ca. Aldroyd, 127
Abbey Road, Barrow-in-Furness, England.

WASHER WITH SPONGE SPRAY PROTECTS AUTO FINISH

4575 Removing dirt and grit from the sponge as fast as they collect, a spray washer, especially suited to polishing automobiles, has been made. A continuous stream of water flows through a long, hollow nozzle



and into the sponge. With this device, it is easy to reach underneath or on top of the car, and, because the swab is always free of sediment, the finish is less likely to be marred. The tubing is covered with rubber, so it will not scratch polished surfaces. It also will clean windows.

Collins Mfg. Co., York Co., Pa.
Hammer.

Mr. Peter J. Koch, 3411 Clifton Ave.

POPULAR MECHANICS

Cincinnati, Ohio.

402

3827

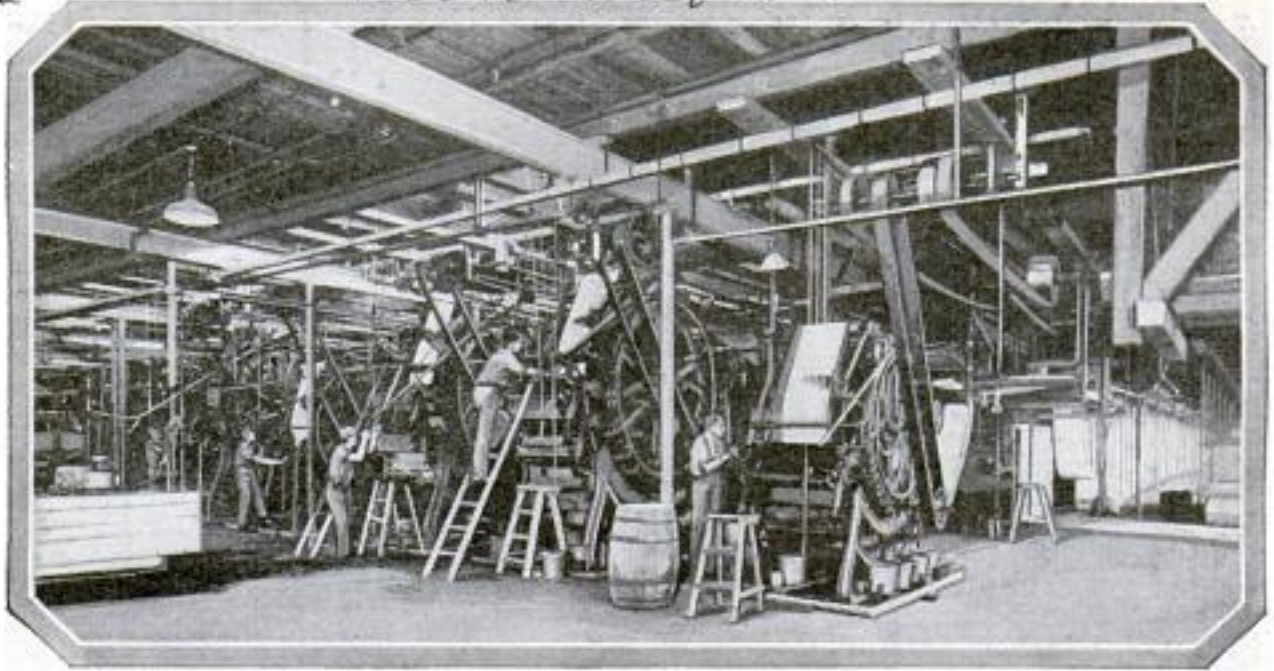

Battery of Presses Turning Out Endless Streams of Wallpaper

From the Stone Age to Wallpaper

Patterns of Today Reflect Designs, Coats of Arms and Tapestries
First Used During the Middle Ages in Europe

ALTHOUGH the manufacture of wall-papers is one of the most interesting branches of the paper industry, comparatively few persons are familiar with its details or with how its development has kept pace with the progress of mankind from the earliest ages.

In the modern mill waste paper of various kinds—catalogue trimmings, office records and overissue newspapers—is reduced to pulp together with a certain amount of chemical, coloring matter and sizing. Since the output of this process does not have the color or texture necessary for the background, a coating of china clay, or plain ground color, is applied before printing.

Then patterns are selected and a careful count is made of the colors involved. Many fine papers have eight hues and

some even have twelve. This number and the grades of color largely determine the price at which the finished product is sold.

In general appearance, the printing machines resemble those used in textile mills. There is a great difference, however, in the rolls. For wallpaper, these consist of maple with the designs outlined in strips of sheet brass. From the original pattern prepared by the artist, a series of transfers are made—one for each color.

These are then traced on the wooden rolls and skilled workmen proceed to cut lengths of sheet brass strips, bend them to conform with the curves of the design and then hammer them firmly into the surface of the roll. Where solid masses of color are required, the spaces between the strips are filled in with specially prepared felt. When the design has been completed, the



Wood Rolls upon which Patterns Are Outlined in Strips of Sheet Brass Hammered Firmly into Place by Skilled Craftsmen, the Spaces Being Filled with Prepared Felt

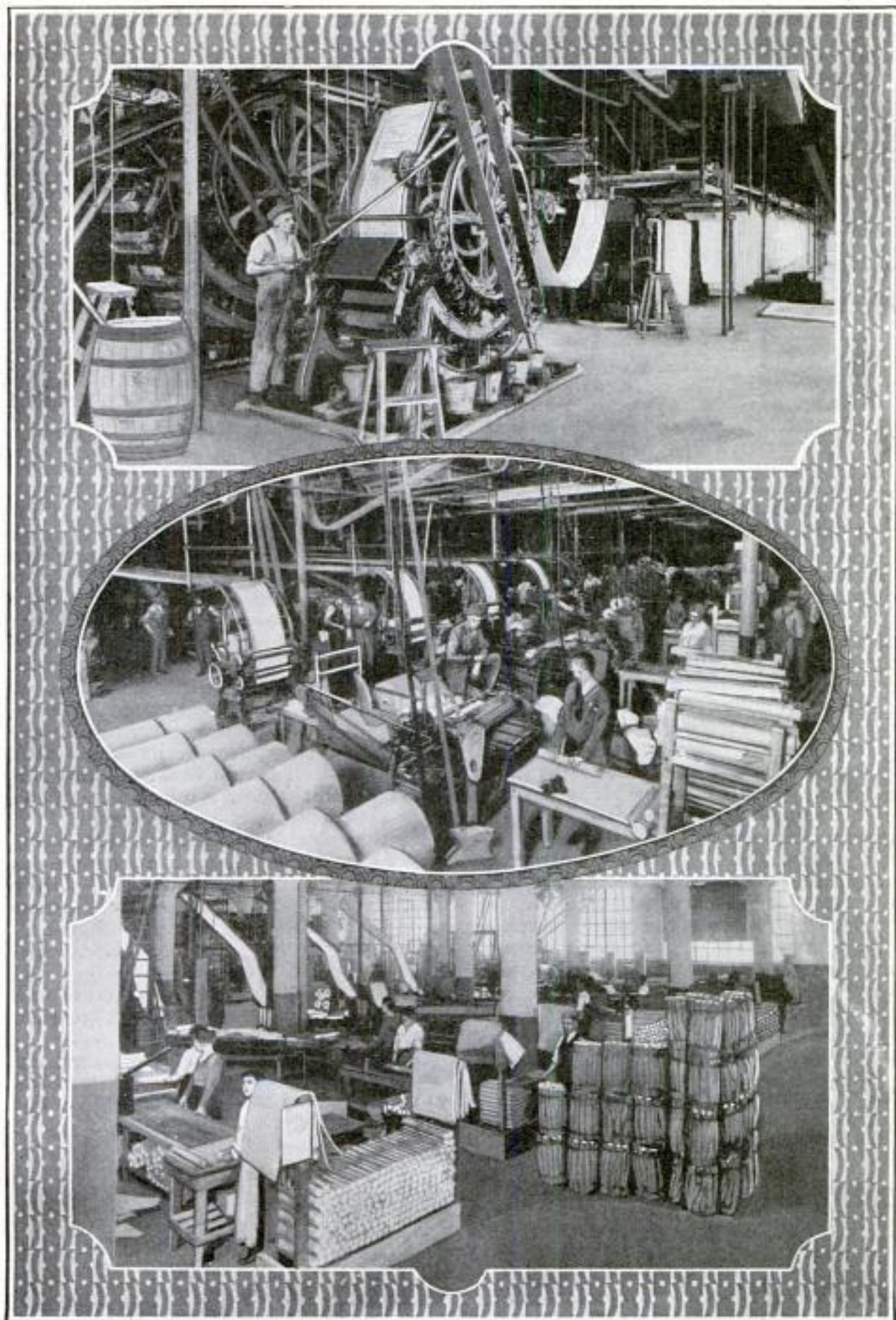

After Passing through the Great Printing Machines where Every Roll Adds Its Separate Color, the Wallpaper Is Dried, Sorted and Wrapped in Preparation for Shipment

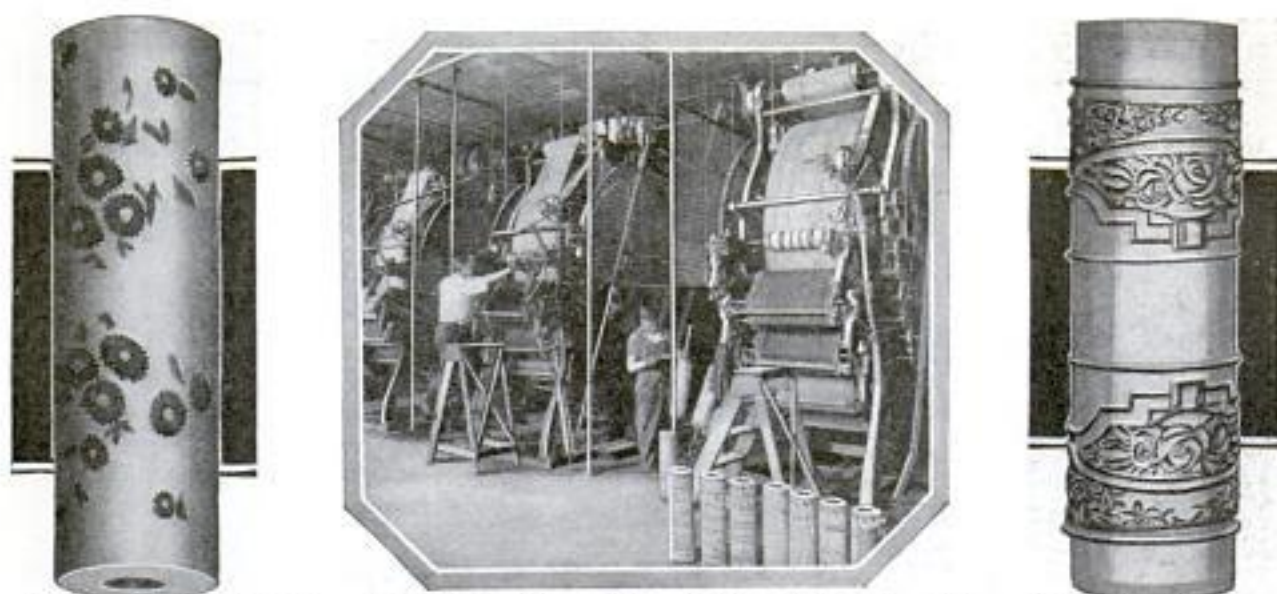

Printing Rolls with Patterns Outlined by Strips of Brass Packed with Felt and Three of the Great Presses which Resemble Those Used in Textile Mills

surface formed by the protecting strips is ground in a lathe until uniform, so that it will print evenly.

Paper is fed to the machines from a reel just in front of which is a short belt conveyor. Several yards of paper are carried on this in the form of loose folds, giving sufficient leeway to permit change of rolls without stopping the press. Passing through the printer, each roll contributes its particular color. As the paper emerges bearing the complete design, it is picked up by a series of moving space bars and carried in short festoons underneath a duct from which warm dry air issues.

With some patterns, this completes the process. In others, however, subdued effects are produced by overprinting the whole design with a sort of screen, usually in white. Embossed effects also may be obtained by running the paper between rollers having raised surfaces. Special papers include oatmeals and varnished tile. The surface of the former consists of colored or tinted stock containing comparatively fine particles of sawdust. In the latter, the design is printed from engraved rollers and the entire surface is coated with transparent spirit varnish.

In its use in modern homes, wallpaper

resulted from the demand for refinement and comfort. In the earlier days the entire household, servants, and all, lived in the "great hall." Then the need for more privacy was felt as culture developed, and the "with-drawing room" was introduced for the women of the house. From this term the modern word "drawing-room" is derived. The knights who took part in the crusades were so completely inclosed in armor as to be unrecognizable. In order to establish their identity, each one adopted a distinguishing emblem, which was painted on their shield and embroidered on their surtout, or outer coat. When they returned from the campaign they hung their shields and helmets on the walls of their castles, and these made such decorative effects that along came the interior decorator who elaborated on the idea and painted these devices on the walls, which also were adorned with handworked tapestries.

Among the motifs used were floral and animal forms—fruit tied in bunches with leaves and flowers and festoons.

And so today, these same patterns are found in exterior and interior decoration everywhere, and in wallpapers they are in constant evidence.



When Placed in the Printing Machine, the Maple Rolls, Similar to Those Shown Above, Are Supplied with Ink by Means of a Short Felt Band



Wallpaper Coming through Embossing Rolls (at Top); Transferring Artist's Designs to Printing Rolls (Bottom), and Hammering Strips of Brass into Maple Cylinders (in Center)

44 406 47

Copenhagen, Denmark

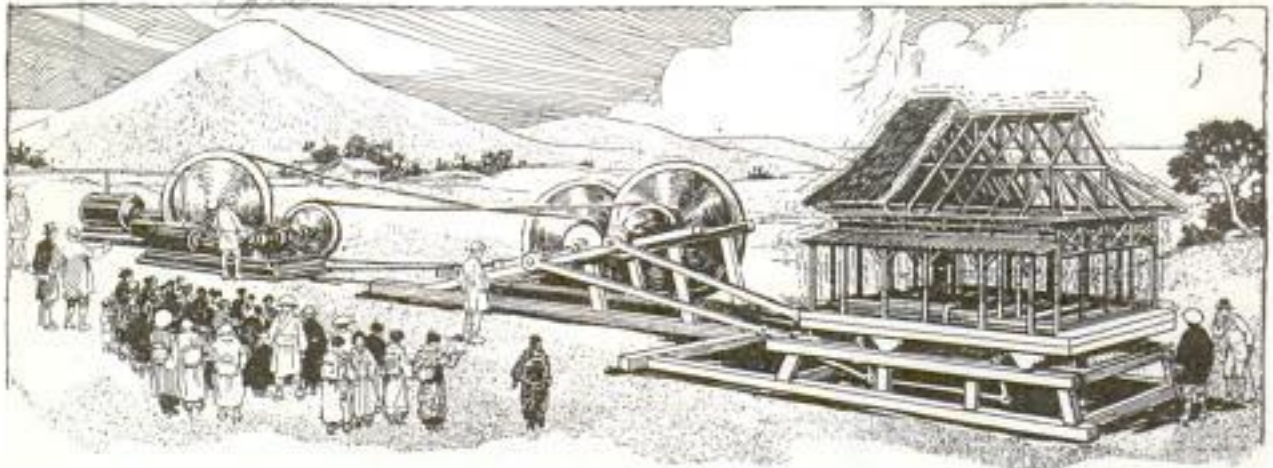

Trying to Shake a Building to Pieces with a "Quake-Maker" that Produces with Varying Intensity Vibrations of a Real Earthquake on a Moving Platform

Tests to determine the type of building best adapted to withstand earthquakes are made on a machine which reproduces, with realistic intensity, the horizontal and vertical vibrations caused by a genuine tremor. The device is the invention of two Japanese professors, and consists of a platform on which a model house is constructed on a reduced scale. The base is then made to sway and shake as the surface of the earth does in a seismic disturbance, by means of levers. The longer the

house is able to withstand the vibrations, the better suited it is to resist the earthquake's power. Results of the recent disaster and of many previous occurrences like it, have proved that fires, gaining rapid headway in crumbled buildings, have frequently caused more damage than the actual vibrations of the earth. A type of construction that will be immune in heavy shocks is sought by builders in countries where such disturbances are likely to occur.

BELT ALLOWS BABY TO CRAWL BUT PREVENTS FALLS

To protect infants from falling, a belt with wire legs has been invented, which allows them to sit or crawl about in comfort and safety. It consists of a girdle that is laced about the waist. Attached to are three wire legs, which hold the child upright when in a sitting posture, but offer no obstruction when it desires to crawl about the floor.

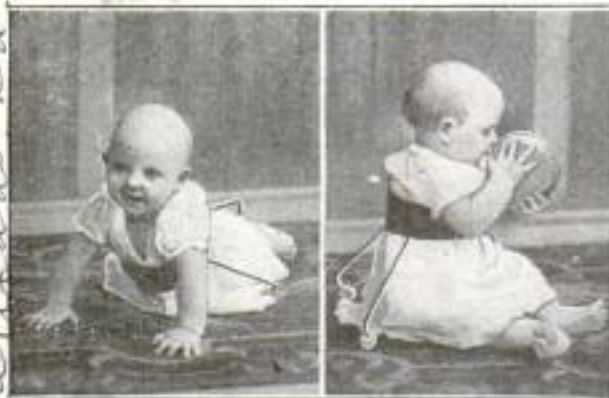

Belt Adjusted; the Legs Prop the Infant Up to Prevent Falling Backwards

ENAMEL FROM COTTON RESISTS HEAT AND DRIES RAPIDLY

After many years of experimentation, chemists have developed a finish for wood and metal which, it is claimed, is so durable, tough and hard that it will resist high degrees of heat, hot or cold liquids and hot plates or dishes. It is described also as absolutely waterproof. This enamel is now in use in many wood and metal working industries, including the manufacture of automobiles and furniture. It is made from a solution developed from cotton.

DOG HAIR WOVEN INTO CLOTH

To demonstrate the value of its beautiful, white coat as raw material for weaving cloth, a Samoyed dog, a species best known in the Arctic circle, was exhibited at a lecture of the Royal Society of Arts in London. The hair used is from the combings—the undercoat that comes naturally twice a year. It was said that the commercial possibilities of garments made from this product have been proved.

Brenville Mfg Co. Inc. Letter read 5/20/20 5497 508 Magazine Feb New Orleans La

E. J. du Pont de Nemours, Chemical Products Div

4611 Parlin, N.Y.

Brass World, Dec 1923

Christian Science Monitor 12/22/23

Vertical

SMOKE SCREEN TEST OF SAILS TO HELP PLANE DESIGN

4400

From the study of the action of a smoke screen on the sails of a boat in an effort to gain increased speed, improvements in the wing design of airplanes are expected. The action of the smoke was photographed with a slow motion picture camera so that the flow of air and its effect could be studied. One instance in which aeronautical experience already has been used by yacht designers is in the cutting down the resistance of rigging. In the latest Shamrock, a fabric sleeve was fitted around the mast to carry the outline smoothly into the line of the sail. It has also been suggested that a rigid sail, modeled after an airplane wing, would result in greater speed, but practical difficulties in construction were declared to make its general adoption unlikely.

— 4309

STORE DROPS SEVERAL FEET, BUT BUSINESS CONTINUES

Defects in the shoring under the foundation of a concrete grocery store caused the structure to settle several feet to a steep angle while it was being moved recently. By rigging improvised steps, the proprietor



Even Windows Didn't Break When This Concrete Store Building Tilted on Its Side

was able to conduct "business as usual" until the building was righted. Because of the rigid construction and comparatively light weight of the store, it was damaged only slightly by the accident, even the large window panes withstanding the shock.

Pacific & Alaska

☐ Hawaii is reported to have more than twice as many motor cars and trucks as there are in the whole of China.

RAILROAD BICYCLE AIDS GUARD TO FIGHT FOREST FIRES

4493

To enable members of a forest patrol to cover their areas in the shortest possible time, light four-wheeled cars, that travel on the tracks of railroads, have been built.



Railroad Bicycle to Enable Members of Forest Patrols to Travel Speedily through Their Areas

The machines are propelled by pedals and the rider sits on a frame resembling that of a bicycle. Space for carrying tools and other equipment is furnished by a wire basket at the front. In case of fire in the woods, the guard can quickly reach a point on the railroad near the scene of trouble. If necessary an assistant can accompany him on the vehicle.

ELECTRIC SIGNAL TELLS WHEN BATTERY IS FILLED

4416

Storage-battery cells are fitted with the exact amount of water needed, and spilling the electrolyte over the tops is avoided, with a nozzle equipped with a signal light. When the proper level is reached, an electrical contact is formed which lights a lamp. The stream is shut off by releasing a spring trigger that clamps tightly over the



Nozzle Which Has Signal Light that Flashes When Cell Is Full of Water

connecting hose. Thus cells may be filled accurately and quickly in dark places and given the proper amount of water.

Electric Storage Battery Co. Allegheny Ave. 1916 St. Phila.

Cont. S. C. Winters, Sleerich National Bank Bldg. Washington, D.C.

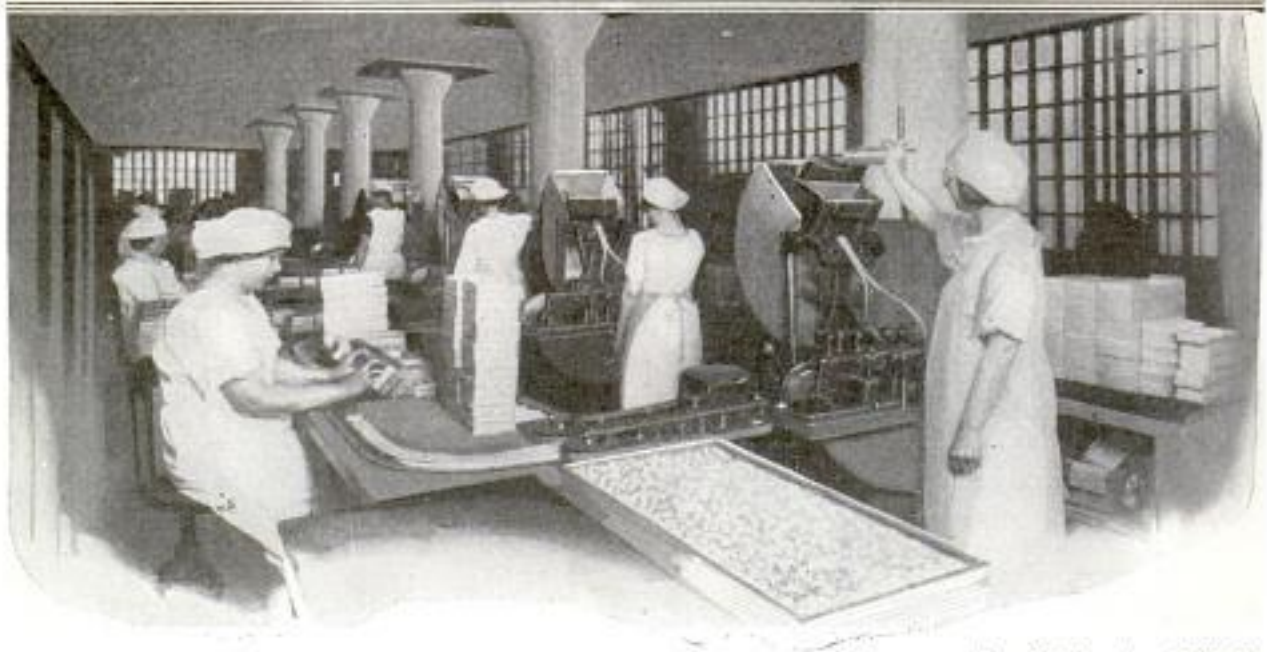

Copyright, American Chicle Co.
Automatic Weighing and Boxing Machine that Packs Sugar-Coated Chewing Gum Pellets. During Its Entire Trip through the Factory, Human Hands Do Not Touch the Chicle

Chicle Quest Beats Highway to Tropics

World's Taste for Chewing Gum Once Known to Ancient Aztecs Builds Giant Industry in Few Decades

WITH well over a million dollars a week being spent in America for chewing gum, an enterprise that was launched amid much doubt on the part of the public, not so long ago, has become a leading industry.

It has been only a few decades since it was discovered that the combination of chicle and sugared flavors made a pleasing confection and in that short span of time, its use has become so common that today it is estimated the delicacy claims 75,000,000 devotees in America alone. Abroad, too, the demand for the sweet has caused abundant exportations of the commodity which now is known to almost every people under the sun.

The chewing habit in general is neither new nor limited to any one locality. Every nation and practically every race practices the custom in some form. In India, it has been the betel nut and the lime. Mate leaves afford enjoyment to the people of Paraguay. The Peruvian Indian rests from his labors several times a day to partake of coca leaves with almost as much formality as attends the Englishman's service of tea.

Even chicle, itself, the base of chewing gum, is not a modern find. When the

Spanish explorers invaded Mexico, they found Aztec women chewing it quite as universally as their sisters of civilization now do. Mexico is one of the principal sources of chicle, which is gathered in nearly all of the South and Central American countries. The substance is the sap of the sapodilla tree, more commonly known as the sapota, which grows in a wild state throughout the tropics of the western hemisphere. It is a gum resin much like rubber, and is both cultivated and collected in much the same manner. Modern plantations add to the products of the forests, vast tracks of land having been planted with the trees to supply the growing demand.

The sap is collected during the rainy season, when it flows freely. A series of V-shaped incisions is cut spirally in the bark by the native workman, who scrambles up the tree armed with a keen-edged machete. The openings must not be too deep, for though deep cuts produce heavier flows, they also result in the quick death of the plant.

The chicle, resembling rich milk, flows from the incisions into a receptacle at the base of the tree, rapidly thickening and turning yellow under contact with the air.

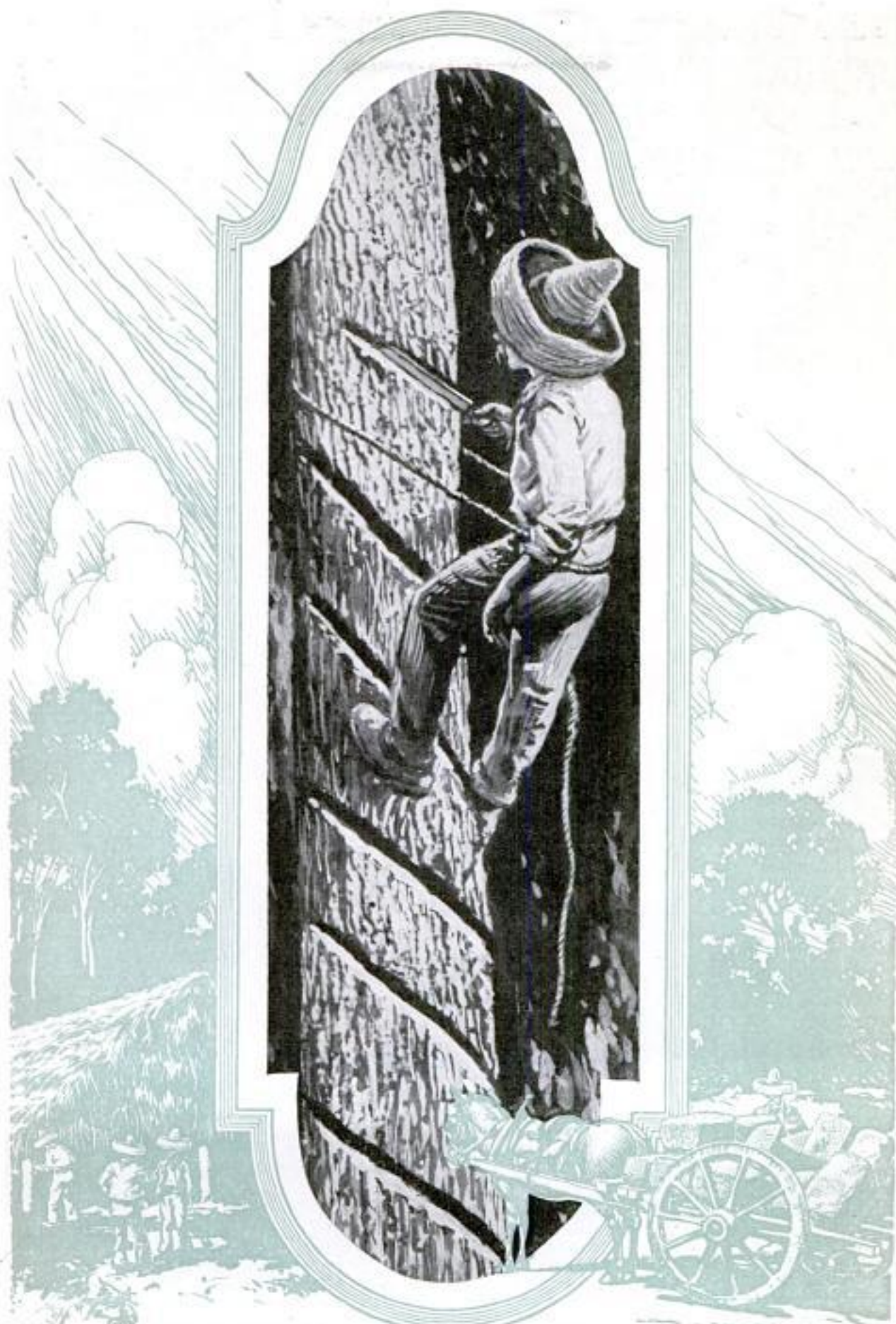

Native Worker of Tropics Cutting Spiral Grooves in Sapota Tree. Through the Winding Channel Sap Flows to a Receptacle on the Ground to Be Cooked into Chicle

4264
410

Native women gather it daily and carry it to camp where it is boiled in great kettles or rude vats to rid it of moisture. This cooking process causes the fluid to take on a grayish shade. The chicle is then made up into irregular loaves and is ready for shipment.

This production, at the source, though performed chiefly by cheap and unskilled labor, calls a vast army of workmen and huge sums of capital into service. From Mexico alone approximately \$2,000,000 worth of the raw material is exported each year.

The chicle loaf, when it arrives at the American market, weighs about 25 pounds. At its destination, the factory, it is put through various processes of boiling and purification and emerges a silvery gray color. Paraffin wax is occasionally used at this stage as an adulterant, but such methods are not generally practiced. Machinery kneads the cleaned gum with sugar and essential oils that flavor it, rolls it into sheets, cuts it into bars, and wraps them in paper which protects the product until it reaches the hands of the consumer.

Americans are said to spend twice as much for the confection as for pianos and other musical instruments, and England, where the delicacy has only recently been introduced to popular favor, parts with a sum reported to equal \$1,000,000 a year for chewing gum. France's people spend annually about \$383,000 for it.

Gum-chewing in the countries of the Allies was given great impetus during the war. British troops who had

learned of the refreshing qualities of gum at sports, quickly took to it in the trenches and even as an actual boon when water was scarce.

In France the delightful substance first acquired real popularity when the American troops began to pour into that country. The children were the first ones among the residents of the barrack communities to become acquainted with the sweet. "Chewing gomme, s'il vous plait."—"Chewing gum, please,"—became a familiar request from them to the soldier from the New World. The child invariably gave morsels of the tidbit to grown-ups and the fashion began to spread, even among the peasants.

However, virtually every people who comes in contact with the western traders has to some degree been won to the chewing-gum fad. Recent export figures reveal that the confection is being shipped from the United States to no less than 75 countries and colonies scattered the world over. While the supply sent to Central European states is somewhat smaller than those going elsewhere, the balance is made up by importations of Asiatic nations and Australia on the other side of the globe. Trial exports to the oriental continents amounted to a half million dollars in a single year, and included large shipments to the Philippines, Japan, and India.

Even South American races have turned to the finished product. The total capital invested in the chewing-gum industries was recently estimated to be \$30,000,000, a gain of \$20,000,000 since 1914.



Battery of Immense, Revolving Coating Vats which Add a Sweet, Flavored Covering to Tiny Balls of Chicle. After Dipping, They Are Placed on Trays to Cool and Harden

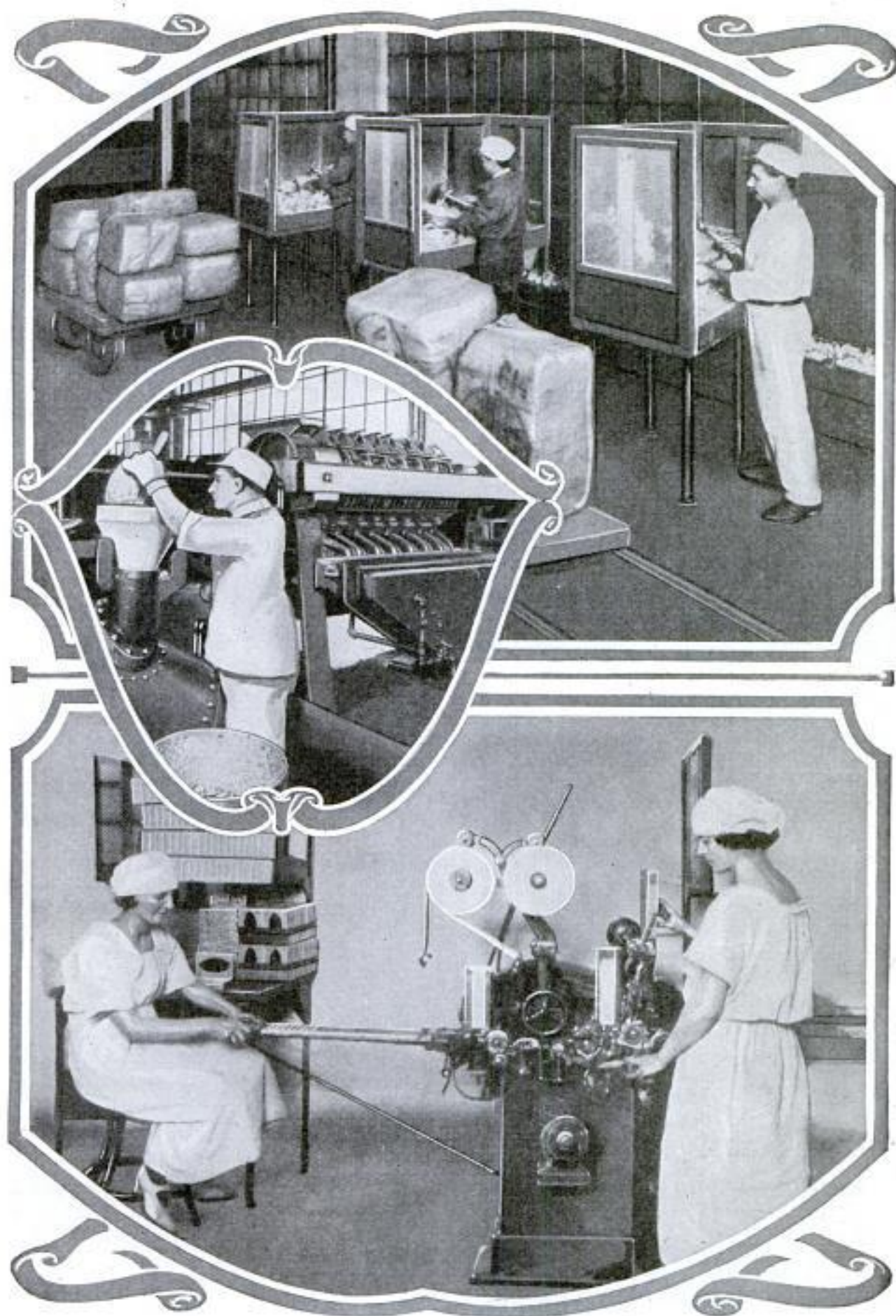

Above, Crumbling Chicle for the Crushers. Center, Putting Powdered Gum in a Steam Drum Connected to a Filter. Below, Automatic Wrapper Covering and Bundling Finished Sticks

4433

TRACTOR SNOWPLOW'S "WINGS" CUT AWAY DRIFTS

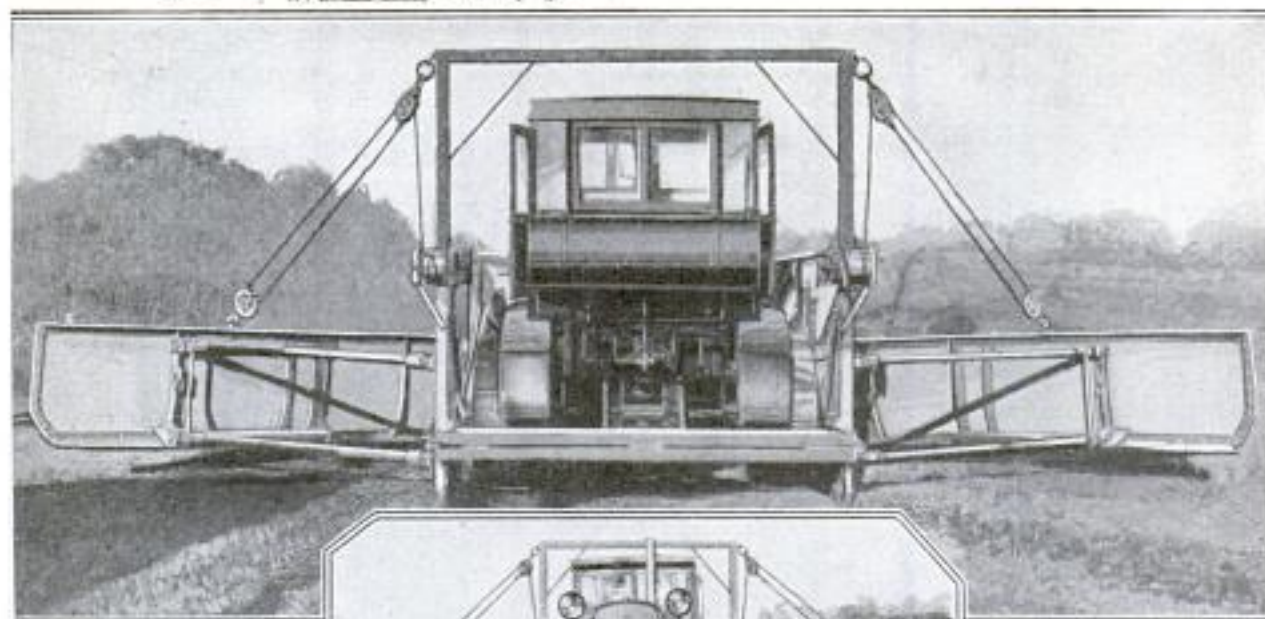

With a "V"-shaped nose that bores through deep or crusted drifts, a tractor snowplow, that clears a path twenty-eight feet wide has been built. The wings, or scrapers, are so adjusted that they can be folded or extended according to the depth of the snow, being raised or lowered by winding drums. The front is adjusted by a hydraulic jack con-

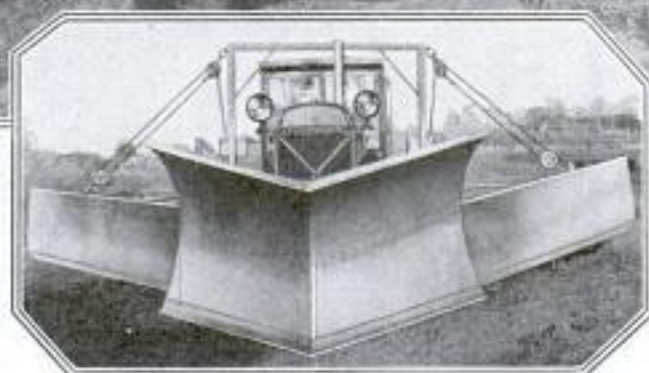

Front and Rear Views of Powerful Motor Snowplow that Clears Wide Path in Drifts

trolled from the cab. The main frame is supported by four sled runners to give it a solid base, and the "nose" is hung from a sub-frame which can be raised two feet from the surface when

the tractor is turned or run over dry ground. The plow is especially adapted to rolling, or irregular country, and is economical in operation.

GLASSES DRIED AND POLISHED BY ELECTRICAL BUFFER

4450

Glass tumblers are dried quickly and given a high polish, free from finger marks or streaks, in an electric buffer that consists of a small cabinet containing five cir-

cular pieces of soft cloth that rotate rapidly on spindles run by electricity. The tumbler is inserted so that the center disks fill the inside of the glass. The other four quickly dry and polish the surface. A blast of hot air circulates through the cabinet to keep the cloths dry and to aid in polishing.

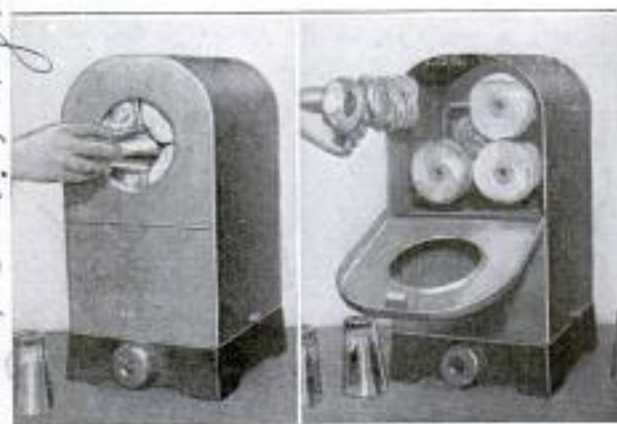

Cabinet with Rotating Cloth Buffers Run by Electricity to Shine and Dry Glasses

JAPANESE QUAKE LOSS PLACED AT BILLIONS OF DOLLARS

4484

Interesting statistics regarding the commercial losses suffered in the recent Japanese earthquake are contained in a letter from Yanuma & Co., Ltd., Tokyo, Japan, to this magazine:

"It is aggregated as the most exactitude figure," the letter states, "that the houses broken and burned are 600,000, and the suffering people losing homes are 2,500,000, while 100,000 people lost their lives and 250,000 wounded badly, and the remaining peoples, officials, large commercial organ-

(Mrs. Starnes, Victoria St. London, S.W. 1, England.)

Mr. J. Ireland
 31, Lower Moseley St.
 Manchester Eng.

izations and firms are providing their business in the temporary barracks as their homes and damaged buildings or offices:

Chief Buildings and Houses	
80 Official Buildings	280 Factories
180 Police Stations	45 Theaters
12 Embassies	28 Churches
25 Newspapers	350 Office Buildings
24 Clubs	9,125 Big Firms
42 Hospitals	600 Big Hotels
48 Schools	1,500 Big Restaurants
150 Primary Buildings	114 Banks

Firms, Stores, Offices and Houses

Tokyo.....	411,000
Yokohama.....	23,000
Others.....	116,000

Total.....550,000

Damaged, Burned and Ruined in Railway and Tramcars

30 Buildings	25 Stations
12 Warehouses	21 Locomotives
416 Passenger Cars	893 Freight Cars
1,031 Tram Cars	

Post Office, Telegraph and Telephone Offices Burned or Ruined

Buildings.....	40
Poles, cable and burned telephone apparatus.....	46,000

Burned or Broken Bridges

Larger.....	15	Smaller.....	170
-------------	----	--------------	-----

"Total loss for the said damage is informed about five thousand million dollars, while the insured amount is eleven hundred million dollars."

RUBBER HANDLE KEEPS BLADE OF SCREWDRIVER TIGHT

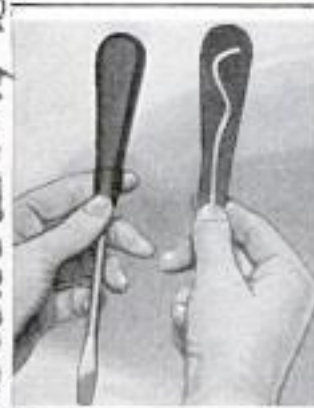

Anchored in a rubber handle, a screwdriver blade has been made, which, it is claimed, cannot turn or work loose. As the tool is completely insulated, it is of special value to electricians. The part embedded in the handle is

twisted in such a way as to give it additional strength.

CURB STRIP PROTECTS GRASS

To accommodate persons waiting for cars and to preserve the small lawn between the sidewalk and the street, a Buffalo, N. Y., contractor put a strip of concrete fifteen inches wide inside the curb. The "platform" became popular and served to attract attention to the house, a two-family affair so constructed that the front entrance to the lower flat was from the main street and that to the upper apartment from a side thoroughfare.

R. E. Lowner, 268 Linden Ave. Buffalo, N.Y.

"PRAIRIE SCHOONERS" TO RE-FALL PIONEER DAYS

447

Recalling the days of the pioneer settlers, a monster parade of "prairie schooners" is being formed from all parts of the



"Prairie Schooner" Ready for Cross-Country Trip to Join Propaganda Parade through Nation's Capital

country by a farmers' organization to spread its propaganda. The covered wagons and teams are to be furnished by those members and sympathizers living at ten-mile intervals from a central point. Signs and legends explaining the cause for which the movement has been created will deck the canvas sides of the old-fashioned vehicles, and the horses will be draped in lettered banners. The occupants will be garbed in the styles popular among the frontier folk of the '50's. It is purposed to have all of the wagons travel to Washington, D. C., and unite for a pageant in the capital.

MEDICINE DROPPER IN BRUSH STOPS WASTE AND STAINS

To apply antiseptics to wounds without staining surrounding tissues or clothing, is the purpose of a combined dropper and brush now on the market. The device is equipped with a cotton wad at the open end through which the lotion is forced. The rubber end at the top of the stem can serve as a stopper, allowing the instrument to remain in the medicine bottle when not in use, and making it a convenience for the home cabinet.



One-third of the silk used in the United States is said to be artificial.

Mrs. F. H. Whetmore Co., 140 Pearl St. New York

The Sumatra Rubber Specialties Co., Salem, Ohio

Mitchell McConney Mfg. Co. Hornethead Rd.

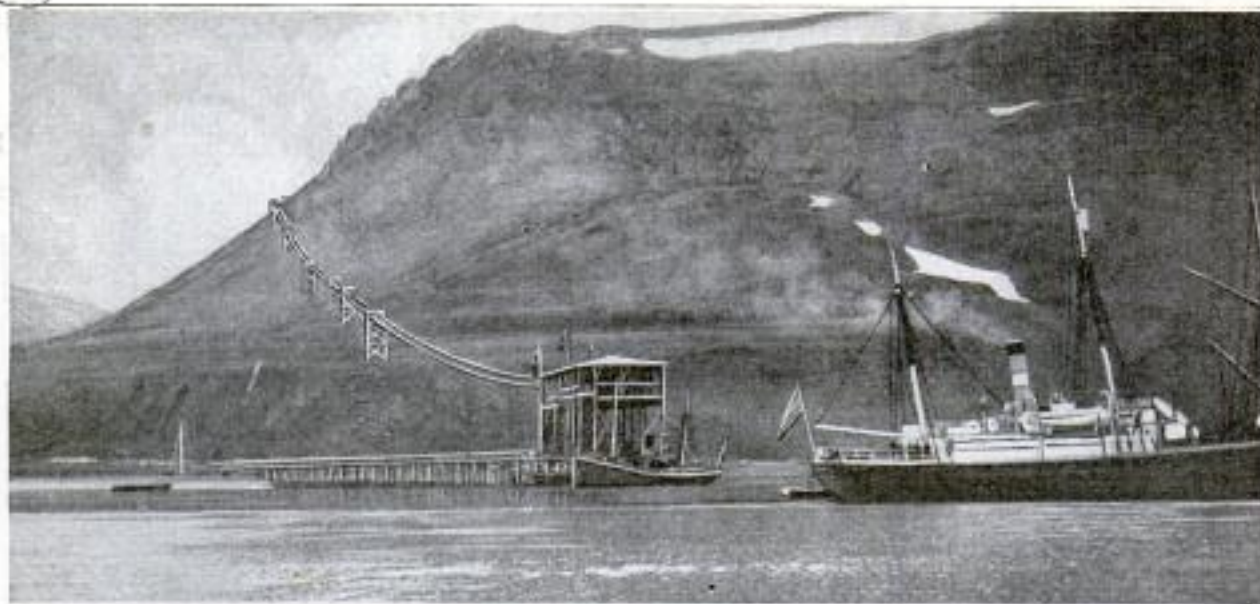

After Traversing Lofty Mountain Ranges and Yawning Ravines this Aerial Cableway Descends to the Quiet Harbor where Its Burdens Are Transferred to Freighters for Overseas Transport

Loading Ships on Difficult Shores

LADING ships lying off rugged coasts that make their near approach impossible is being accomplished by cable "railways" suspended from hilly heights to bunkers or triples built on piles far out in the water. Where ore mines are located in the vicinity of the sea, it has been found profitable to carry the material across valleys and ridges by conveyors traveling on overhead tracks of wire rope, instead of shipping to a distant port where facilities are to be found for harboring the boats as well as loading them from wharves. Often vessels are prevented from anchoring close to shore, where their cargoes await, by

rough seas that last for days. Some shippers at such points have provided the aerial tramways to convey their products to the holds that are to carry them to mar-

kets. At a place on the shores of New Caledonia a loading station has been erected several hundred yards out in the water. Connecting it with the land, is a cable conveyor system which not only serves to place ore cargoes aboard freighters but also carries back shipments of provisions, stores, and even mail for those living in the near inland. Frequently, the rise or fall of the tides seriously interferes with the rapid transfer of freight to and from steamers which have but limited time to

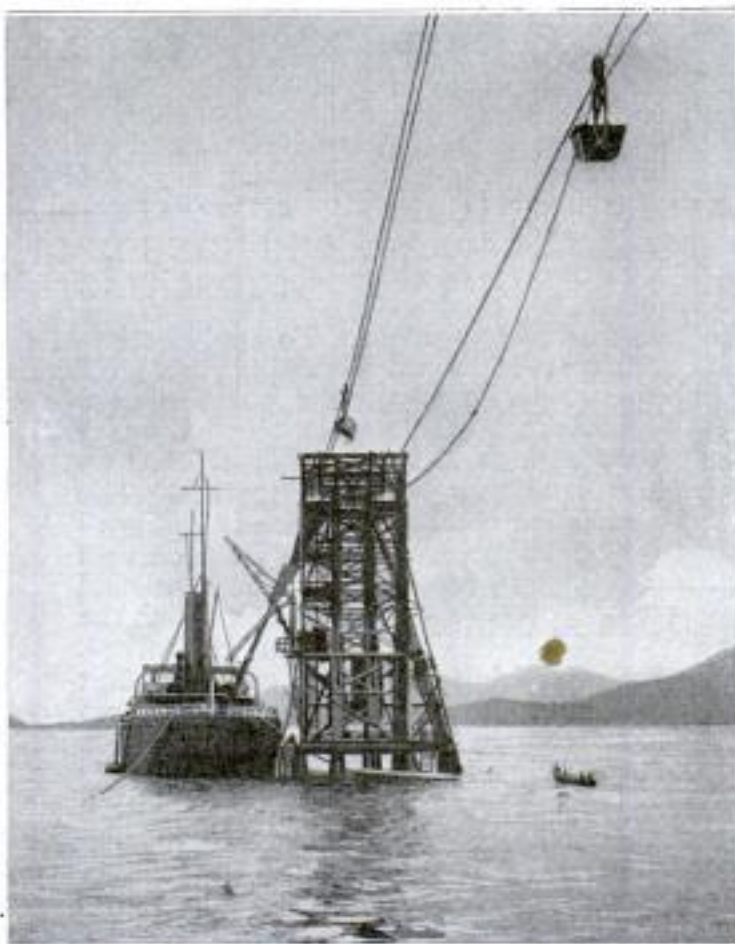

Sturdy Structure that Helps to Defy Rocky Coasts

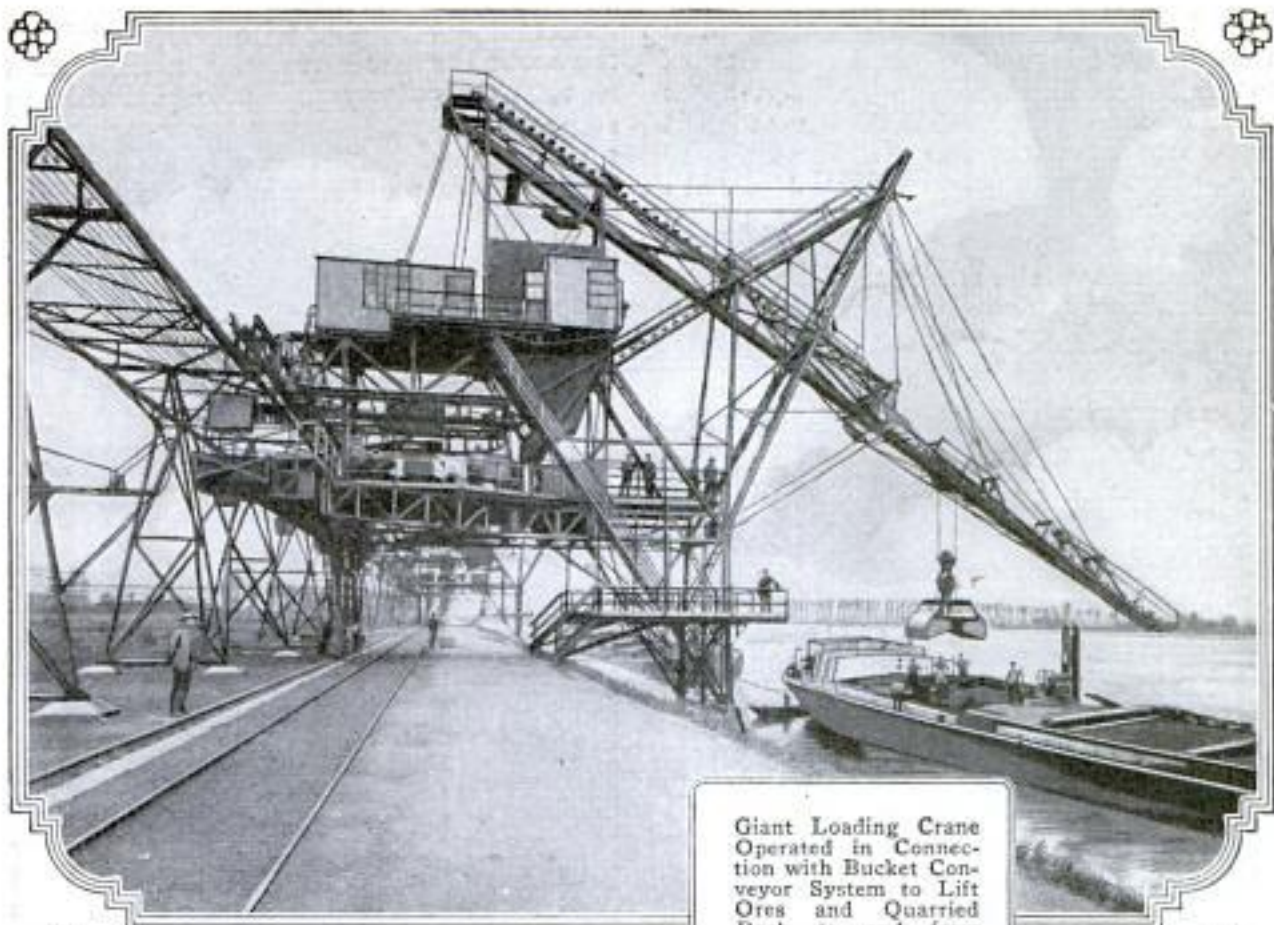

Giant Loading Crane
 Operated in Connection
 with Bucket Conveyor
 System to Lift
 Ores and Quarried
 Rock to and from
 Barges

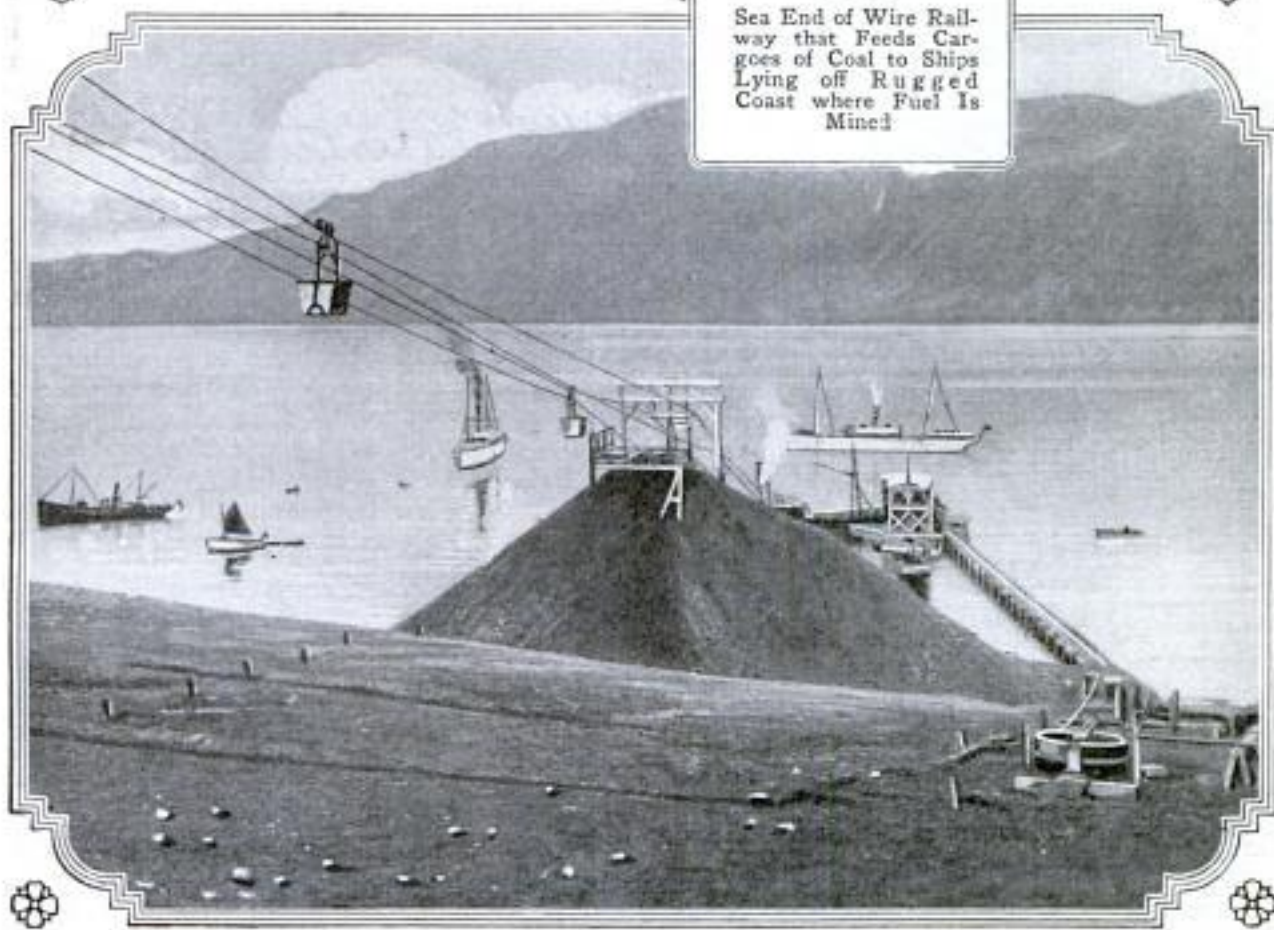

Sea End of Wire Rail-
 way that Feeds Car-
 goes of Coal to Ships
 Lying off Rugged
 Coast where Fuel Is
 Mined

spend at such places. By means of a double-track structure great volumes of material can be handled without the loss of a minute. One such arrangement is known to have transferred more than 500 tons of ore from a bunker on the coast to a ship lying far at sea. Mountains, otherwise difficult to pass, and deep ravines that make overland transportation almost impossible, have been successfully sur-

mounted by stringing wire "pathways" for the swift buckets on wheels, across them to nearby waterways. It is said that in some instances the expense required to carry freight from these points to the nearest seaports would render their cost so high that competition in the market would be useless for the producers. Perishable goods in this way are also quickly transported to their destinations.

**INFLATED HUNTING SUIT HELPS
4344 IN STALKING WATER GAME**

To enable hunters to approach their quarries in deep water without giving alarm, a buoy that can be inflated with air



Copyright, International Film Service
Waterproof Hunting-Suit with Inflated Buoy to Enable Sportsmen to Approach Quarry without Noise

has been attached to the upper part of a waterproof hunting suit. The wearer can paddle about with his feet, and also have a steady rest for his gun. The bag, when blown up, is about 12 inches in diameter.

**GOLD STILL FLOWS FROM MINE
4445 WORKED FOR SEVENTY YEARS**

Owners of one of the deepest mines in the world, at Morro Velho, Brazil, have installed a powerful cooling and ventilating system. In the lowest borings, more than a mile below the surface, the thermometer now registers ninety-eight, but the rock temperatures are from thirteen to twenty-two degrees higher. Miners must rest frequently, and two hours of working time are taken daily in getting to the lower

levels and coming up again. Although there are immense quantities of ore in sight, enough to keep the stamp mills busy for several years, the great depth of the shaft, and the high cost of operation, may cause a shut down, and if this should occur, the entire district would lose its means of living. The property has been exploited for seventy years, and its annual output is about 2,500,000 dollars.

4481 *Source*
HARD WOODS IN PAPER-MAKING

Through the discovery of a process by which hard woods can be manufactured into paper, it is believed that some of the forests supplying material for the pulp, can be conserved. Beech, maple, and birch have been found to be available under the new method. Bond, ledger, book and other high-grade papers, are said to be turned out from hard-fibered timbers.

Newton Falls Paper Co. Waterbury, N.H.
**TRIANGLE CANDLE IS GROOVED
TO GIVE BETTER LIGHT 4453**

Light-giving power of candles has been increased by British chemists who made them in triangular form, according to recent reports. The three sides are grooved the full length of the stem in order to give a free path to air, which, it is believed, flows freely upward to the wick. Owing to their shape, they are said to fit almost any holder. Where the socket is small, the corners of the candle can be easily shaved



Triangular-Shaped Candle with Grooves to Increase Light-Giving Powers and Eliminate Waste

off and the end pressed into the opening. The three flat sides result in a saving in space when packing.

Coul. A. Aldroyd 127, Abbey Road, Barrow-in-Furness, England.

Mrs. Capt. Stenon?

*Carl R. Slawner,
268 Linden Ave.
Buffalo, N.Y.*

POPULAR MECHANICS

"ELECTRIC MAN" CLIMBS STAIRS TO SHOW WAY TO STORE

To attract prospective customers to his store on the second floor of a building, a merchant in Buffalo, N. Y., shows the way by a moving electric sign that depicts a man climbing stairs leading into a front window of his establishment. Each trip taken by the incandescent "patron" consists of six steps, and with every upward movement the figure grows smaller, until it seems to disappear through the opening. When the journey is completed, the power is flashed off for a few seconds, after which the action is repeated.

*Dr. Edgar L. Allenard
Edwardsville, Ill.*

RANGE OF ALUMINUM VIOLIN INCLUDES TONES OF 'CELLO

Made of aluminum, a violin, said to include the tones of the 'cello in its range, has been tested. Somewhat crude in appearance, it differs in shape from the ordinary type. Every part of the instrument, including the strings, was constructed by the inventor, laboring alone. Only one small piece of wood was used. There are no "f" holes, as perforations take their place. The sounds evoked are resonant, octaves may be played without stretching the hand, melody and accompaniment are simultaneous, and three sustained tones may be held.

INITIALS ON WINDOWS SAVE GLASS AND LOOK TIDY

Neat initials painted on the panes of skyscrapers under construction in Chicago recently gave the buildings a tidy appearance while they were being finished, and helped to advertise them as well as warn workmen that the glass was in. The plan attracted wide attention and proved a pleasing contrast to the usual smears that are placed on the windows. The sharply outlined letters were visible for blocks and rows of them, the height of the structures, made the buildings conspicuous.

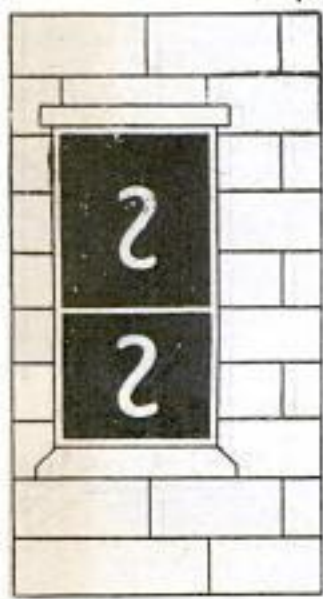

*Chicago Tribune
12/9/23*

*Dr. W. W. L. A. Emmelt
Consulting Engineer
General Electric Co*

MERCURY BOILER TESTS SHOW BIG INCREASE IN POWER

Power from a plant in which turbines for generating electricity are driven both by mercury and water vapor from the same

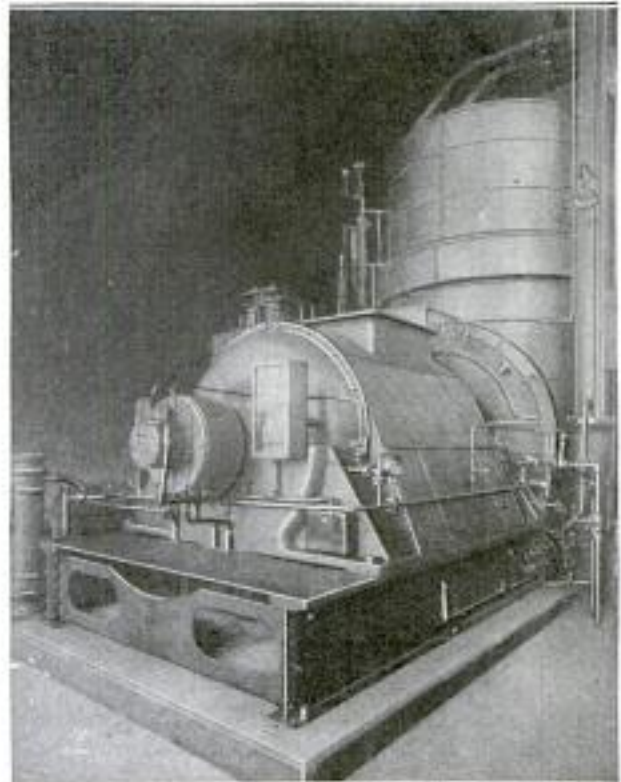

Mercury-Vapor Engine that Showed Great Increase in Efficiency in Recent Tests

fuel source, resulting in a gain of about fifty per cent in power to a pound of fuel, is declared to be the outstanding achievement of a new boiler recently tested. During the experiments it was found that no form of packing or corking of the joints would resist the mercury vapor. It is said that the development of arc and acetylene welding has made such apparatus possible. The process involves the vaporization of mercury in a boiler, driving of a turbine by the vapor and the condensation of the exhaust in a cooler where its latent heat is delivered to water, and thus used to generate steam at pressure suitable for use in existing engines. The condensed mercury runs back by gravity into the boiler. The result is that the temperature range is more than doubled, and the efficiency consequently greatly increased. The mercury boils much like water, except that its density is much greater and its boiling temperature much higher.

In an emergency, when the auto-jack handle has been forgotten, the crank handle can usually be used instead.

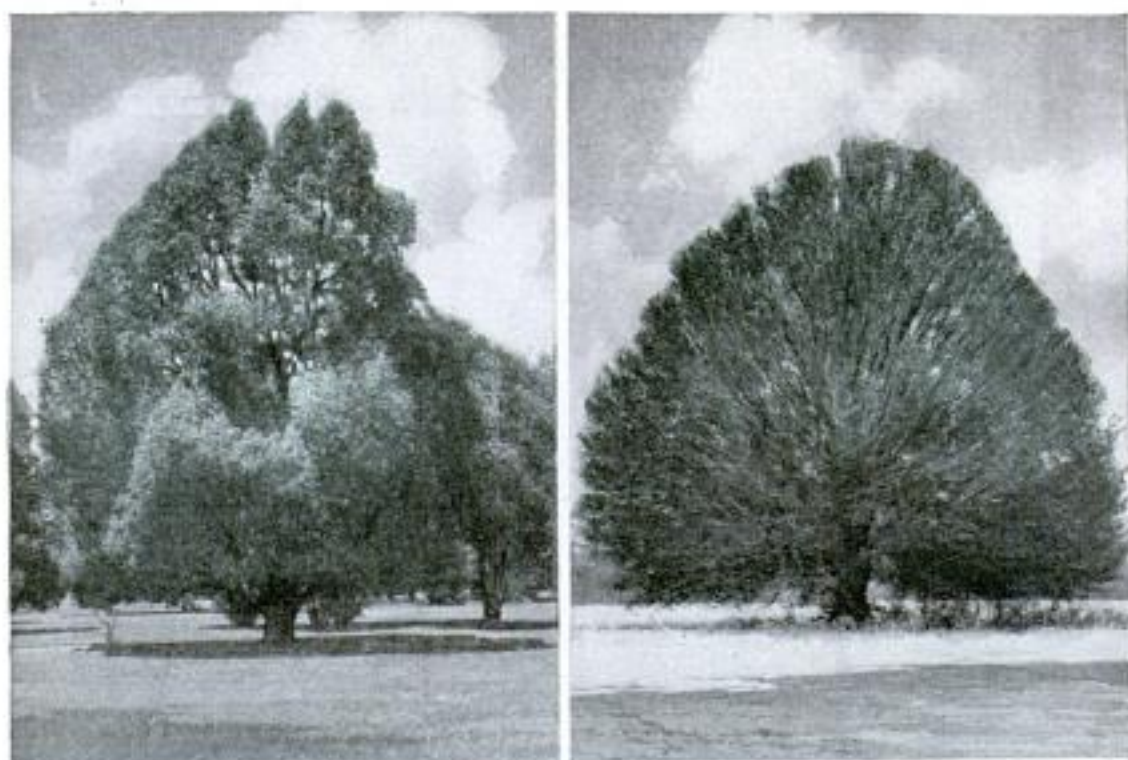

Camphor Tree (Above, at Right) which Will Endure More Frost than the Orange; a Darlington Oak (at Left), and, Below, the Elm, a General Favorite for Street Planting

What Trees Are Best for Town and City?

Government Experts Find that the Sturdy Oak Is Generally Better Suited than the Maple for Street Planting

By ROBERT L. MOULTON

WHICH trees will do best in town and city streets?

If we may judge by the frequency with which the maple is found in most parts of the country, this tree is generally regarded as best adapted to street planting. Yet, according to the department of agriculture in a recent bulletin, oaks are really more desirable.

It is probable that more oaks have not been grown because of the belief that they are slow, and because in the North they are rather difficult to transplant. A white oak, however, which is one of the slow-growing varieties, will reach the same height as a sugar maple in the same period of time, and maples have been used much more widely than oaks for street ornamentation, despite many unsatisfactory characteristics.

This conclusion has been reached after a long period of experimentation conducted by government experts with a variety of trees in different localities. Elms are given second place in desirability for city streets, and sycamores third. Except the Lombardy species, most varieties of poplars are not recommended.

Before ornamental tree-planting is undertaken, a number of important points must be given attention. Trees native to one part of the United States may not thrive in another. Some are objectionable because their roots penetrate defective sewers, while others grow their roots so near the surface that they have a tendency to heave or crack sidewalks.

Only vigorous trees that will withstand the dust and smoke of a city should be planted to ornament the streets. The root system should be hardy, not easily affected by unusual soil conditions, by restricted feeding areas, or by root pruning, in case im-

provements are made. The shape of the top of the tree should be suited to the width of the street. It should be rather high headed, or easily trained to that form, and of open growth.

Of only a little less importance is the character of the foliage masses, whether dark or light, heavy and somber, or open and airy, and also whether the foliage has vivid autumn colorings. The resistance of the tree to fungi, insect pests, and tree diseases, is another important consideration. Varieties that bear showy flowers, fruits, or nuts are usually undesirable for street planting. Palms do not make good shade trees, although they are effective in formal planting. Only in the most southern parts of the country, and in western California, should evergreen trees be used. Magnolias, live oaks, and a few other broad-leaved evergreens, may be planted in these regions. Where there is lack of sunshine in winter, due to short or cloudy days, it is desirable to admit all the light possible by using only deciduous varieties.

In all sections, trees differ greatly in the time when they put out their leaves in the spring and lose them in the fall. Narrow streets should be planted with tall, slender trees like the Lombardy poplar, or in some cases with small trees. Broad streets may be planted with spreading trees; or, if provided with a central-parking space, with moderate-sized trees in the center and on

the sides, or with trees on the sides suited to the space, and formal trees in the center. As a rule, native trees that have been tried out successfully in other towns should be given the preference.

For use within reach of ocean spray, or on sandy lands near the coast, the red oak, and the red or scarlet maple, are suitable as far south as Charleston, S. C., while the



Street and Sidewalk Cracked by Shallow, Spreading Roots of the Popular Silver Maple



Because of Its Thick Foliage, the Oak (at Top) Is Known as One of the Best Varieties for Street Planting; a Row of California Pepper Trees Are Shown Below



Honey Locust Trees Fringing City Street

sweet gum and the live oak are equally good from Norfolk southward and along the Gulf of Mexico. The red oak, sweet gum, red maple, and eastern live oak are all grown successfully along the Pacific Ocean, while the California live oak can be used from San Francisco southward.

In the heart of a city, where the greatest difficulty is experienced in getting trees to grow, the Ailanthus, or tree of heaven, will probably thrive when nearly all other kinds fail. The staminate and pistillate flowers of this species are borne on separate trees. Only the pistillate trees should be used, as the odor of the blossoms of the staminate trees is very objectionable for about ten days in late spring. These may be produced by grafting, or by propagating from suckers, or root cuttings, from such trees if they have not been grafted.

The American elm, sometimes called the white or water elm, is one of the handsomest of shade trees. It has been the standard tree of New England, giving to the roadsides and village streets the characteristic appearance which is so attractive to summer visitors. It is tall and spreading, and where planted as near together as is customary on streets and roads, the effect is that of an arch formed by the growing together of their spreading tops. It is of rapid growth, long lived and comes into leaf early in the spring. Be-

cause of the attacks of the leaf beetle and the European bark louse, many handsome trees have been severely damaged or killed before communities were properly equipped for fighting them, but with careful spraying these insects may be kept in check. On account of the existence of the pests, and because they are gradually spreading to new territory, tree planters should consider carefully whether it is advisable to plant the elm.

All of the oaks are hardy, most of them long lived, and generally they are free from disease and insect attacks. The red oak is probably the best for street planting in most sections of the United States. It is a large, oval, open-headed tree of rapid growth. Under good conditions, it will grow four feet in a single season. Like the other oaks, it is slow in coming into leaf in the spring, but holds its foliage late in the fall. The leaves usually turn a brilliant red before they drop. The live oak, a noble and majestic tree, is adapted only to the extreme southern states. As its name indicates, it is an evergreen, and is of slow growth, but, wherever it is found, it is the pride of the people.

Although not as satisfactory as usually has been supposed, the red maple is one of the most widely distributed American trees. It is found from Canada to the Gulf of Mexico, and west to the Rocky Moun-

tains. Its leaves are the smallest of the eastern native maples, but it grows large and is usually of upright outline. It is better adapted to suburban conditions than to city streets, and is one of the few trees that succeed well near the ocean. It has bright-red blossoms before the leaves appear, and the young leaves and fruits are also red. The mature leaves begin to color early, some branches as early as the middle of July, assuming brilliant reds and yellows and staying on longer than those of the sugar maple. This handsome tree is not as much used as it deserves to be.

The silver maple is probably more used for street planting through the whole United States than any other tree, although it is one of the least desirable. It is usually planted because it is quick growing, but it is not more rapid in growth than several other trees, that are much better.

CLOTH IS SHRUNK AND SPONGED BY STEAM ON ROLLER

Cloth for suits is quickly shrunk and sponged on a machine built especially for small tailoring shops. Steam generated from a gas-heated boiler passes into a perforated revolving drum on which the goods

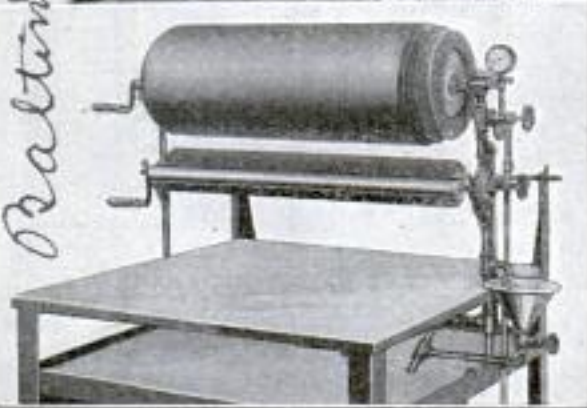
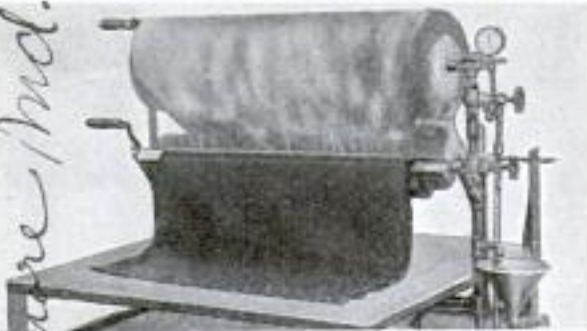

Sponger that Forces Steam through Fabrics to Shrink Them for Tailoring into Suits

are wound from a reel below. Pressure forces the vapor through the threads of the fabric in any quantity desired, a release

There are three serious objections to its use as a street tree. The first is its brittle wood, which at an early age is easily broken by ordinary windstorms. The second is its shallow rooting, which has a tendency to destroy pavements, and also makes it difficult to grow grass near by. The third is its tendency to decay; the tips of the limbs frequently die, leaving the whole top of the tree bare of leaves, and the wood decays quickly, especially if the bark is broken. For this reason it does not stand pruning as well as other street trees, and it probably has been pruned more ruthlessly than any other, unless it is the Carolina poplar. It should never be severely deheaded, or, as it is popularly called, "dehorned," as the stubs will practically never heal over, and from these cuts decay will start, which, in a very few years, will rot the center of the limbs and trunks.

valve at the side affording constant control. A brass roller on the drum presses the cloth, guides, and straightens it. The apparatus is safe, simple, easy to operate and costs little to install. The base forms a convenient table on which the bolts of goods are laid and is used as a work bench when the sponger is not needed.

BELL AND BUZZER BATTERIES REPLACED BY TRANSFORMER

Designed for reducing direct current to low voltage for the operation of electric signals, clock systems, burglar and sprinkler alarms, bells, buzzers and many other devices commonly run by batteries or motor generators, a transformer of simple construction has proved effective. It contains no rotating or vibrating parts, is economical, current being drawn only when contacts are made. It is also equipped with signal lamps that indicate irregularities on any circuit. It is safe, simple to install and carries no maintenance expense, being automatic in operation.



The Escholtz Co.
Madison Wis.

Copyrighted material

Everlasting Sponging Machine Co.
 44 18
 40 W. Baltimore St.
 Baltimore, Md.

NAVY BUILDS OWN AIR FLEETS IN GOVERNMENT FACTORY

Many of Uncle Sam's future air fleets will be planned and erected in a government factory built at a navy yard in Philadelphia, according to recent reports. Part of the big plant is already in operation and in case of need, it is said, hundreds of aerial craft could be turned out in a short time. The proposed additions will put the works among the largest of their kind.

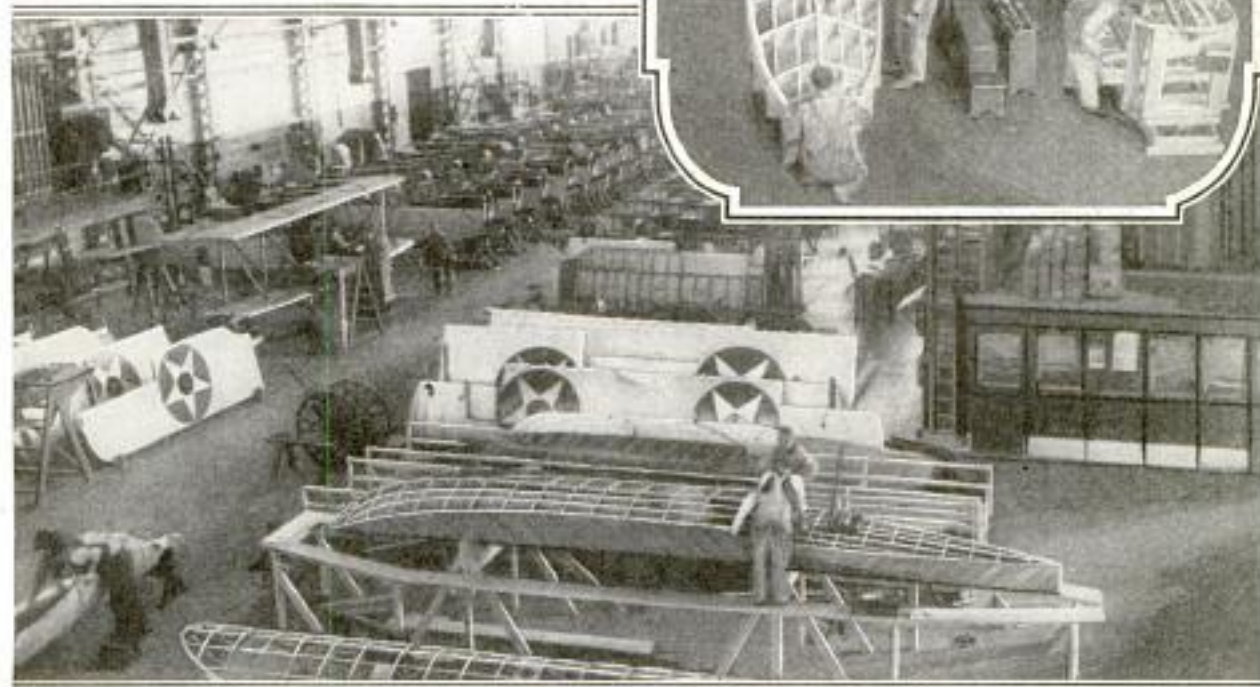
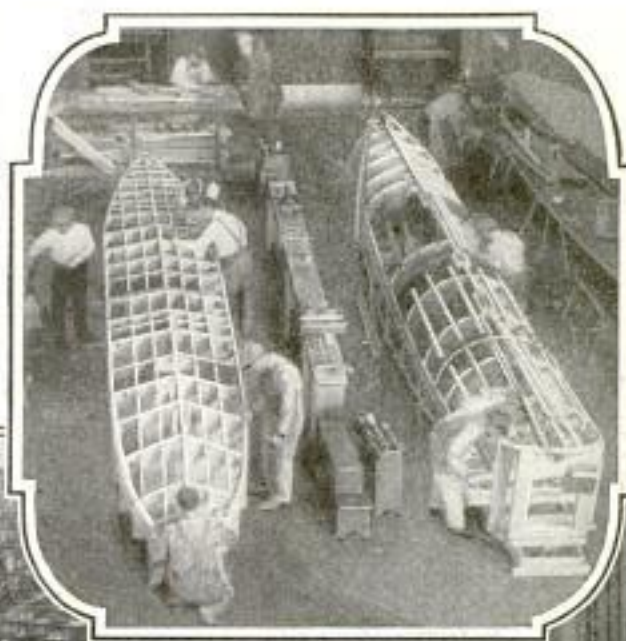

Copyright, Underwood & Underwood

Assembling Planes on Erecting Floor of Navy's Aircraft Plant that Will Be Among World's Largest Airship Factories. Above, Getting Body Frames Ready for Covering

RECORDS PROVE WEATHER MEN NEARLY ALWAYS RIGHT

Winter means hardship, not only to those exposed to it, but to the scientists responsible for forecasting the weather for the United States, as they are rated and graded like pupils in a school. Their every prediction is compared with the actual ensuing conditions, and when they are wrong, down goes a black mark for them. With the coming of cold and snow, the difficulty of keeping a high average of accuracy is increased for two reasons: There are more storms to keep track of, and they move across the country twice as fast as in summer. With a velocity of from 600 to 900 miles a day, compared with 300 to 400 miles during the warm months, these disturbances from the Arctic regions sweep down from the northern border, almost without warning. Only when they are signaled by Canadian stations at Medi-

cine Hat and Prince Albert does the weather bureau know they are coming. When the forecasters step up before the charts on which the conditions prevailing in their districts are marked, they stake their reputations that they can accurately predict the kind of weather that will occur over several states within twenty-four hours. For instance, if the weather man says "rain," the records for the day for which he is predicting must show precipitation of at least $\frac{1}{100}$ th of an inch. If he says "probable showers" and winds do not occur, his prediction is counted a failure. But, despite these handicaps, the records show that the weather men have been right eighty-eight per cent of the time in their predictions.

Approximately 6,000 new species of insects are found and classified each year by scientists.

Kansas City Times
12/12/23

Photo Press Rivals Speed of Printing

Machine Automatically Develops, Prints, and Dries 30,000 Pictures,
Taken by a Camera, in an Eight-Hour Day

By A. N. MIRZAOFF

4021

EQUALING the speed of high-powered printing presses, a photograph machine used by a Chicago concern, finishes nearly 4,000 copies of its product in an hour.

Instead of a type form this device begins its process with the negative, passes the paper stock through a developing bath, exposes the film over it, and fixes the print, before carrying the sheet on to the drying machine where the strip is wound on a roll.

The operations are not confined entirely to pictures. Letterheads, sales letters, bill forms, and ornately decorated stationery are rapidly turned out complete with genuine photographic finish rivaling that of the most up-to-date studio. It is claimed that in accomplishing the work in this manner, a task usually requiring the attention of fifteen men is done by less than half a dozen people.

From the time the first end of the sensitized roll of paper is inserted into the machine until it emerges from the drying compartment, there is no stop in its development. Any number of subjects can be placed on one negative and if lettered matter is desired, this, too, can appear in any position in company with illustrations.

Exposure is made by a "lamp house" through which the paper must pass. Strong lights are here adjusted to give any amount of necessary illumination to the negative. The length of the exposure is controlled by a regulator that times the duration which ordinarily occupies from one-tenth of a second to two seconds, according to the requirements. As each exposure ends, a shifting device pulls the paper a limited distance

through the machine to make way for the next operation.

Development is automatically governed by a bar which raises and lowers the paper as it passes over a roller in the bath. An acid rinse follows, which arrests the developing process so that a uniform finish will appear on all pieces of a lot.

In order to "fix" the print, it is subjected to a hypo solution, and is sprayed with water from six strong jets to insure a thorough washing. Before it is drenched again, the sheet goes through a hardening fluid where the film with which it is covered is made hard and tough to resist wear that results from handling. Powerful wringers then squeeze all surplus water from the stock in order to make the task of the drier an easy one. Two gas-heated drums evaporate the remaining moisture as the strip is carried over them and hot silver-plated rollers at the same time ferrotype the product and give a high-gloss finish to the surface. The dry rolls are finally slit into lengths of four feet and the different photo-prints are separated by a cutting machine.

Where an entire letter or page is to be printed by the photograph press, the matter is first set up in type and a perfect proof of it is exposed before the camera. From the negative an unlimited number of copies can be made. The sensitized paper stock is delivered in rolls of a thousand feet in length.

The eyes of the watchful attendants are always on the delicate apparatus and sign of any irregularity in the machine's motion is sufficient cause for halting it for investigation. All work in the room is done under yellow light.

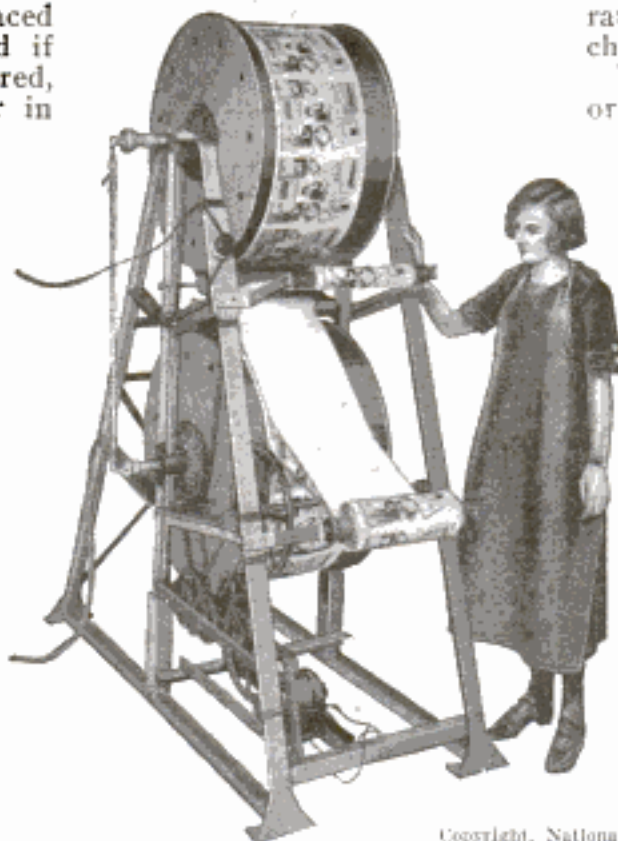

Copyright, National Commercial Film & Photo Corp.

Gas-Heated Drying Drums where Moisture Is Removed from the Paper Ribbon which Is then Wound in Rolls

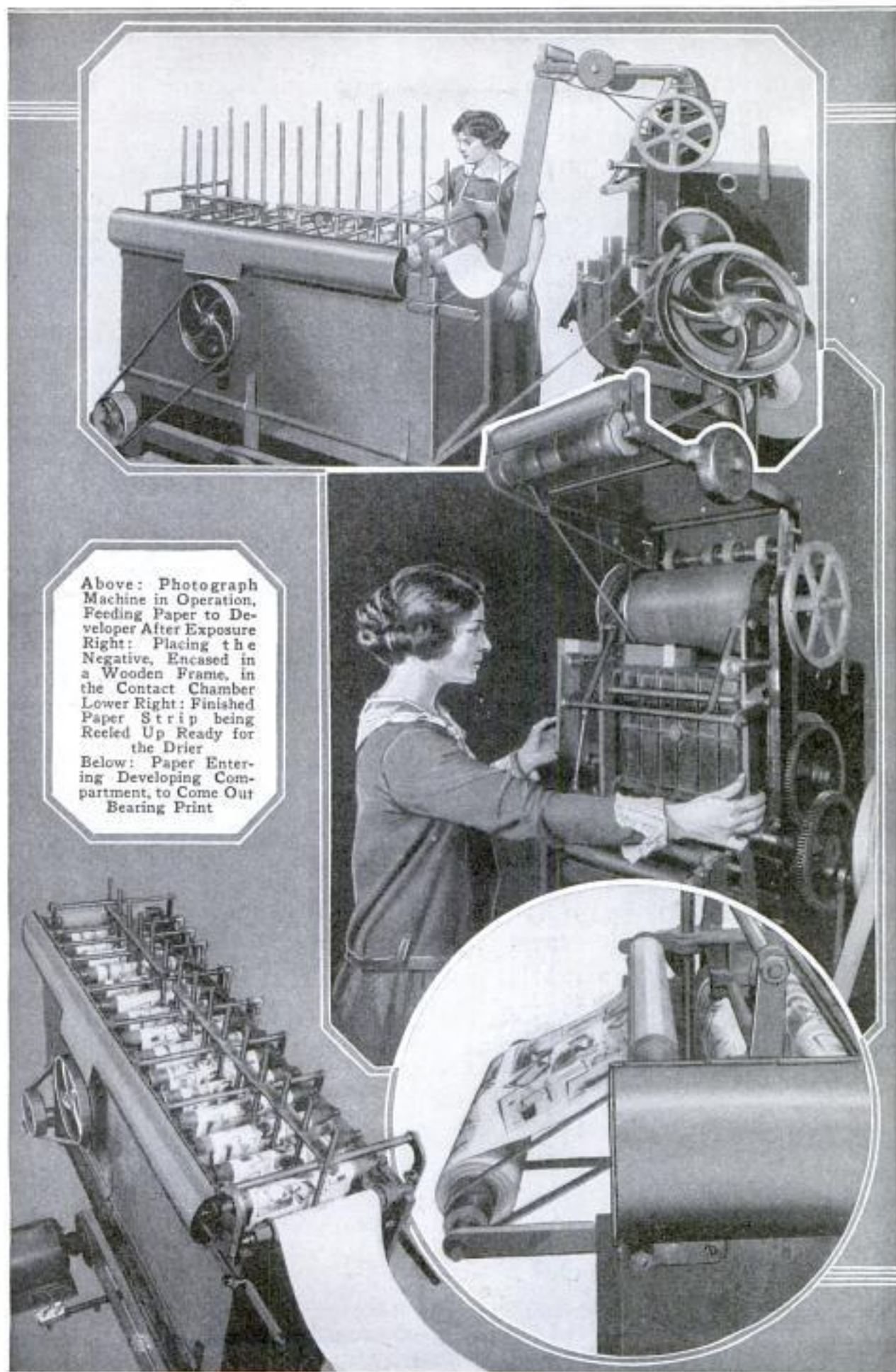

Above: Photograph Machine in Operation, Feeding Paper to Developer After Exposure
 Right: Placing the Negative, Encased in a Wooden Frame, in the Contact Chamber
 Lower Right: Finished Paper Strip being Reeled Up Ready for the Drier
 Below: Paper Entering Developing Compartment, to Come Out Bearing Print

dr. Herr. A. H. Es. Hokers
c/o 478 N. O. Ned. Vliegtuigenfabriek Hokers
 POPULAR MECHANICS
Box 84, Amsterdam, Holland.

MOVIE CAMERA HOLDER MAKES USE OF A TRIPOD NEEDLESS

4585 So that motion pictures may be taken without the need of supporting the camera on a tripod, a frame holder that fits



Holder for Movie Camera that Permits Its Operation Without the Need for the Usual Tripod

about the shoulders, has been invented by a Dutch airplane expert. It is expected that this will be particularly serviceable in taking views from planes and in positions where it is impossible to use the ordinary tripod. Because of the speed at which the exposures are made, a solid rest, which also will leave the operator's hand free to turn the crank, is a necessity for the camera.

4626

POISON FOR COYOTES REPLACES TRAPS AND SAVES CATTLE

More than 75,000 coyotes were killed by poison last year, according to recent government estimates. In the past few years this method has been replacing trapping in many localities in the west. One man in the Lemhi national forest in Idaho, by use of an automobile, maintained a poison line 700 miles in length. The result is said to have been a great saving to stock raisers, especially sheep men.

"TOWN-LOT" DRILLING FOR OIL CAUSE OF GREAT WASTE

Unusually close spacing of oil wells, or what is known as "town-lot" drilling, has been responsible for great waste in many petroleum fields in the United States, according to a report by the department of

Science Supplement
12/11/23

the interior. This form of development has become a factor in southern California. In the Santa Fe Springs project, wells are being drilled on adjacent town lots, some of which are not more than 120 feet apart. Because of the great depth and high cost, it is predicted that many of these wells will not pay for themselves. Although oil can be recovered more rapidly and in larger amounts with a great number of wells, if they are drilled before the gas pressure is reduced, too rapid exhaustion of oil and gas may cause the rapid approach of edge water, pocketing large quantities of oil.

CHECK ENDORSER SAVES TIME IN BANKS AND OFFICES

4578 To save time in preparing large numbers of checks for clearing houses, an automatic machine for endorsing them as they are listed has been invented for banks and other financial offices. It is designed to stand near the lister and as checks are inserted, it prints in clean-cut, legible letters from metal dies, the bank's endorsement,



Endorsing Machine and Lister in Background Used as a Unit in Handling Checks

and stacks them right side up in the same order that they were in the original pile. As checks are listed before they are sent out, with this device, the two operations, listing and endorsing, are done practically at the same time, thus saving extra handling. It is easily cleaned, is noiseless, runs by a small motor and requires little attention. If checks are dropped in on a "slant" they are automatically straightened before the impression is made. The metal dies, fed from a regulated ink well, print more legibly than rubber stamps and are easily changed.

Cummins Perforator Co
4740 Ravenswood Ave
Chicago

Chicago Tribune
12/24/23

**AUTO CASTINGS MADE OF "DUST"
 FROM BLAST FURNACE**

4598

"Dust" from a blast furnace at one of the large automobile manufacturing plants in the middle west has been found to contain nearly fifty per cent iron ore, and is now being reclaimed for the manufacture of cylinder castings. Sufficient material for making 600,000 of the parts, each weighing eighty-two pounds, is in one of the heaps that have collected outside the furnace. A special plant where the substance is to be mixed with iron borings and fused into chunks of proper size and weight to be handled in the molds is being erected. Gas flames are passed over the dust and the process is aided by a large percentage of coke collected from the blast furnace.

4538

**GREAT BAT CAVE IS MADE PART
 OF NATIONAL PARK SYSTEM**

By a proclamation of the president, Carlsbad Cavern, an immense cave in New Mexico, has become part of the national park system. Although not yet thoroughly explored, the cavity is known to consist of many great chambers that harbor thousands of bats. The ceilings are so high at some points that rays from torches fail to penetrate to their arched recesses. The total length of its hallways and rooms is more than three miles, and the floor is almost 200 feet below the entrance, while it is believed that the deepest parts may lie 1,000 feet lower than the rugged door-



Gigantic Stalagmites that Rise, Sentinellike, from the Dark Depths of Carlsbad Bat Cavern

way. Experts say that the soft limestones, from which the opening has been carved, may reveal spectacular conditions equaling any other like formation now known.

Chas. S. A. Winters
District National Bank
1212 1/2 Washington, D. C.

**MOTORCYCLE IN JUMP COVERS
 EIGHTY-FOUR FEET IN AIR**

4547

After speeding down a steep incline, a motorcyclist at Boise City shot through the air for a distance of eighty-four feet,



Motorcycle and Daring Rider Hurtling Eighty-Four Feet through Air in Exhibition Jump

during an exhibition to illustrate the strength of his machine. A height of nine and one-half feet was attained at the summit of the arc described by the soaring motor and its rider. The fall was broken by a specially prepared landing ground, and little injury was done to the man or motorcycle by the "flight." The movement was so rapid that distortion was apparent in the photograph although a rapid lens was used. Skill and daring were required to hold the machine on a straight course and insure a good "take-off," in order to prevent a disastrous "spill."

4517

**MOUNTAIN STREAM RUNS PUMPS
 FOR TOWN'S WATER SUPPLY**

Dropping a distance of 180 feet, a mountain stream used as part of the water supply of Redlands, Calif., operates a turbine connected to a deep-well pump. As the water is raised to the surface, it joins the flow of the stream, and the combined volume is discharged into a tube leading to another pump. Here the same process is carried out, the three streams finally being united and passing into the reservoirs that supply the town with water.

Cont. Charles W.
Esuger, Union
League Club Post.
7 Taylor, San Francisco

3831 Paraffine Companies
 34 40 First St.
 POPULAR MECHANICS
 475 Brannen St. San Francisco, Calif

Mulch paper - asphalt-treated felt.

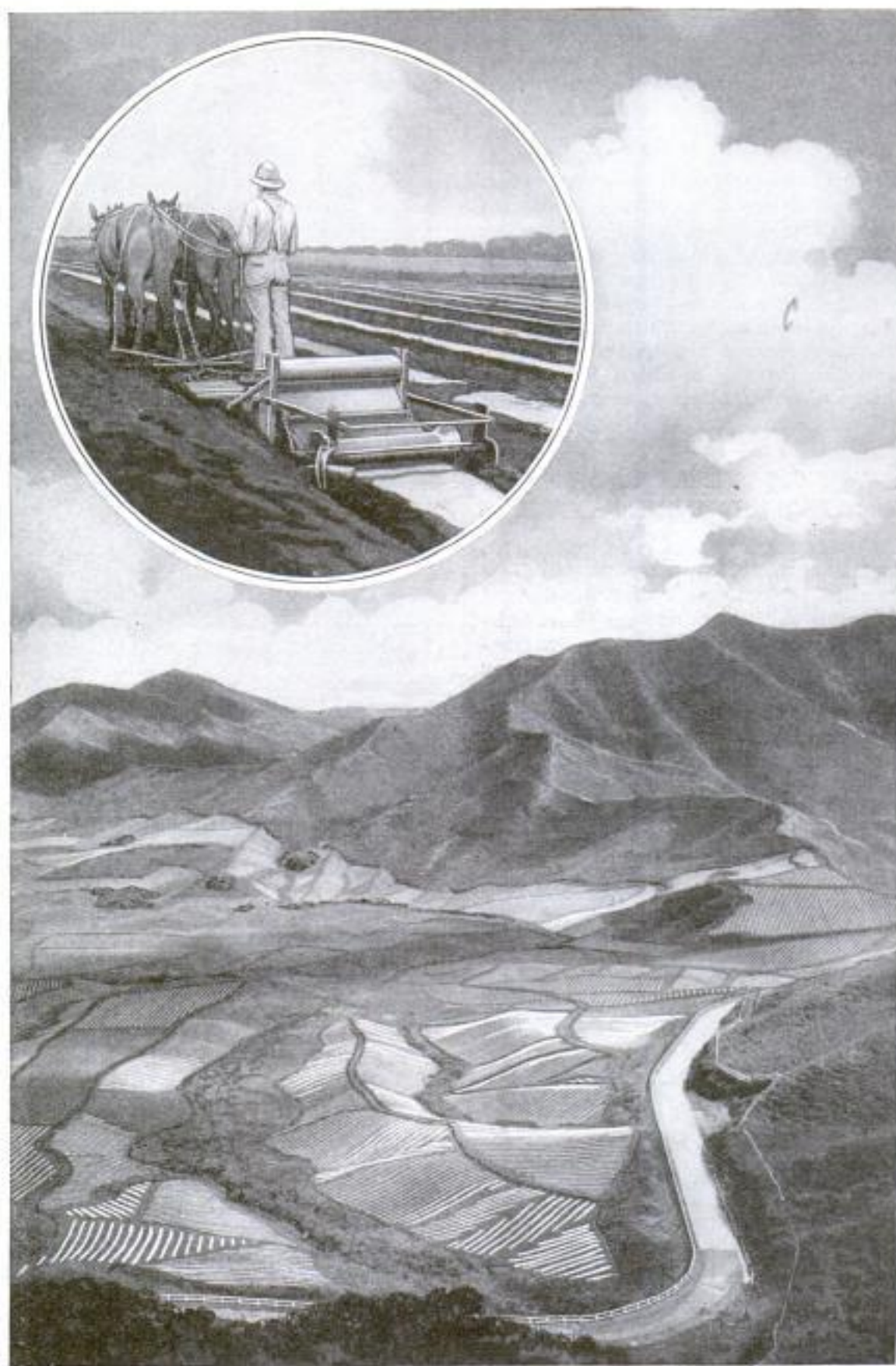

Pineapple Plantation Covered with the Strips of Mulch Paper; Insert, Laying Paper, Showing How Earth Is Turned Over Edges to Keep the Wind from Blowing It Away

See also June, 1922 - 830.

3831

Papering the World to Make Crops Grow

See also June, 1922 - 830.

STRIPS of paper, three feet wide and less than one thirty-second of an inch in thickness, have increased the production of pineapples in the Hawaiian Islands by more than forty per cent. Laid in a field of sun-grown Sumatra tobacco, in Florida, the same kind of paper increased production more than fifty per cent. Papering fields of tomatoes in California raised their yield by some sixty per cent, while strawberries, their roots so protected, produced forty per cent more berries than the same varieties planted in a neighboring and unpapered field.

For fifteen months or more, prior to 1923, experiments in the papering of pineapple fields in Hawaii were carried on with uniformly the same results. This year, more than 4,250 miles of paper were laid,

prevention of baking of the soil, and the removal of the necessity for cultivation throughout the crop life of the pineapple, which is about five years.

The device is the discovery of C. F. Eckart, the Burbank of the Hawaiian Islands. It consists of the laying of a mulch paper, made of asphalt-treated felt, not dissimilar to a thin roofing paper, in rows across the field. In this paper, six inches from each edge, and, therefore, twenty-four inches apart in the center, holes are punched with a trowel, and the pineapple cuttings, "ratoons," are set in these holes. As the paper is laid, the earth is turned up over the edges, to hold it flat and to prevent it from blowing away. The plants are set "staggering" in adjacent lines, so that while the rows along the

See also June, 1922 - 830. information on machine used

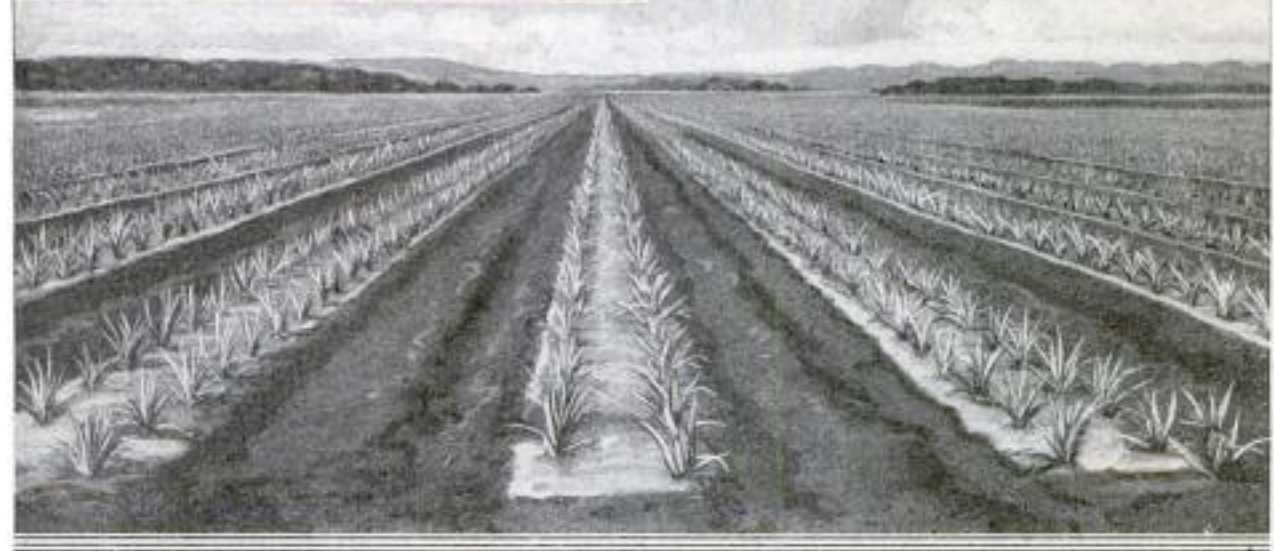

Pineapples Growing through Paper: Above, Laying Paper with Tractor

at a cost of approximately \$250,000, on the pineapple plantations of Hawaii. The result is an increase of from twenty-five to sixty per cent in the production of the pineapple plants, an average of at least forty per cent; the elimination of weeding, which costs on the average \$45 per acre; the conservation of moisture; the

paper are even, those across the field are not.

The same method used in the planting of the pineapples is adopted in the setting out of tobacco, tomato, cabbage or other plants. Experiments are now being conducted on the use of the paper with grapes, and with flowering plants, in short, with

all crops which have a high value per acre. It also has been applied with success to sugar cane in the Hawaiian Islands. Not only does it increase the amount of production of each plant, but it increases the size of the fruits or vegetables or the number and size of the leaves.

The paper virtually puts every plant root into a forcing hothouse. The roots are kept shaded, heat is retained as is also moisture, the combination necessary to the greatest root and plant growth, and weeds, being unable to pierce the paper covering, cannot grow. The use of the paper, by this combination of retained heat and moisture, has extended the area in which pineapples can be produced profitably to higher altitudes and colder temperatures in the Hawaiian Islands than ever before. In Florida, the increase in individual fields of sun-grown tobacco has reached as high as seventy-one per cent, but this is above the average. In the culture of tomatoes, the increase in yield ranged from twenty-one per cent to 168 per cent, under widely varying conditions.

Surface evaporation from the area cov-

ered with the paper is so greatly reduced that it is virtually negligible, the moisture being conserved entirely for the use of the plant. This reduction of surface evaporation to a minimum eliminates the undesirable and often disastrous caking and cracking of the soil. Heat loss by evaporation of surface moisture also is prevented, producing and maintaining additional warmth in the soil. The paper receives the direct impact of the raindrops and so prevents the soil from packing. Some of the papers used are perforated with many small holes, so as to allow moisture from rain, dew, and fogs to seep slowly through, increasing the moisture so stored in the soil beneath the paper.

The paper is applied by hand, with men carrying the rolls on steel rods, and other men following behind with hoes to cover the edges with a binder of earth; by machine layers, drawn by horses, with special devices for the turning in of the binder of earth; and, on level fields, by double machines, laying two rows at a time, drawn by a tractor. These machines also lay their own earth binder.

Machinery

ONE-MAN ROAD GRADER DIGS DITCH, PLOWS SNOW

Doing the work of many men and horses in grading roads and clearing snow from highways, a grader run by a kerosene engine requires the attention of but one

Where it is operated on hard, level, surfaces, heavy rubber tires are employed. Detached implements can be furnished for grading, scraping and scarifying roads, or

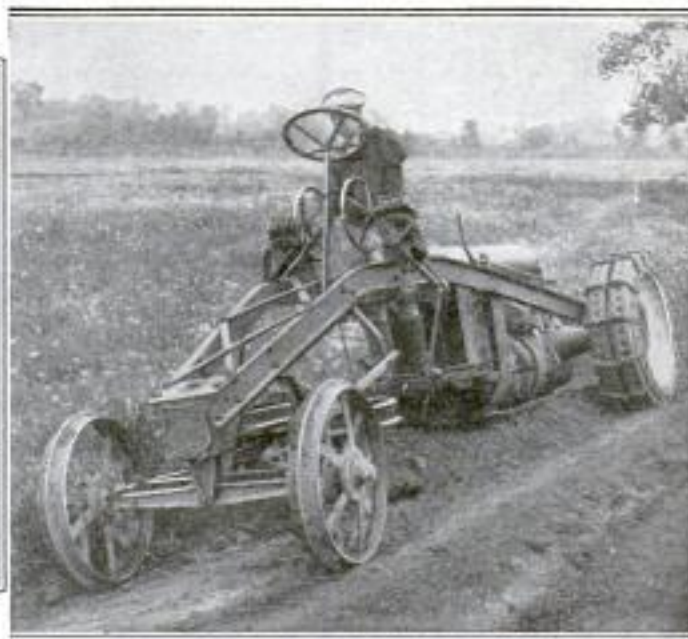

Road Grader Operated by Kerosene Engine that Requires Services of Only One Man

man when in operation. The machine may be fitted with flanged wheels for work in soft soil, or "crawler" treads, similar to those seen on "tanks," can be attached.

digging ditches. It can also serve to lift icy crusts from paved streets during winter weather. Its low cost of operation fit it for duty where economy is important.

The Wahr Co., 533 Chestnut St. Milwaukee, Wis.

4409

4428 Col. Kenneth Rotharmel

POPULAR MECHANICS

431

1599 Conway Bldg. Chicago
ABANDONED QUARRY IS TURNED INTO CITY PARK

Abandoned by its owners, an old cement quarry in San Antonio, Tex., was taken over by the authorities and made into an attractive park. Under the magic of landscape artists, an unsightly pit became a sunken Japanese garden and lily pond. The forbidding walls afforded excellent locations for animal dens, and the chimney of the ancient kiln was transformed into an ornamental tower, and vining shrubbery was planted to cover its rugged sides.

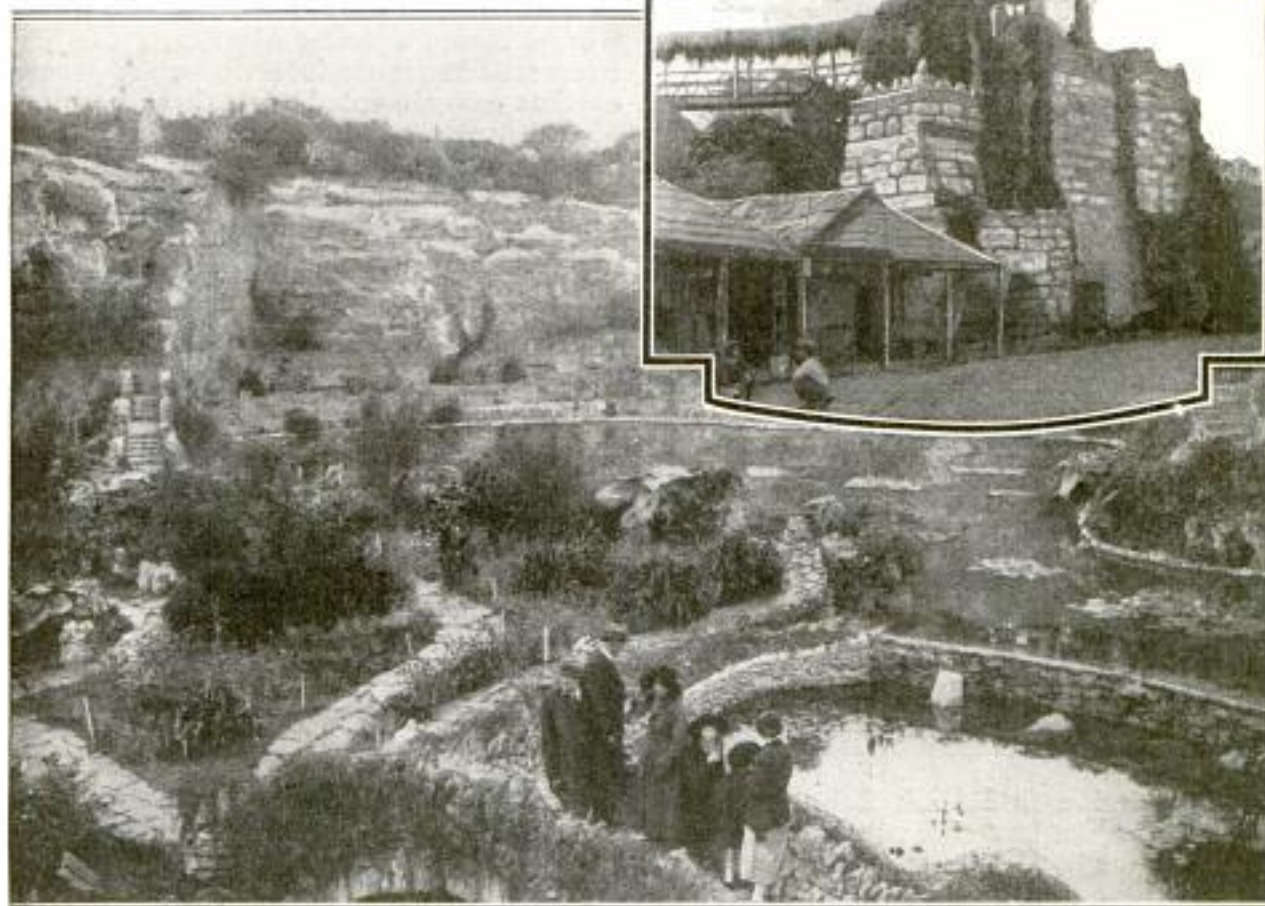

Terraced Gardens and Ponds of Public Park Layed Out on Site of Abandoned Cement Quarry; Above, Old Kiln Whose Crumbling Chimney Was Converted into an Ornamental Tower

**UNCLE SAM'S TEN-CENT STORE
SELLS COPIES OF PATENTS**

4549

Although it is not generally known, Uncle Sam runs one of the biggest ten-cent stores in the world, selling printed copies of patents to the number of 200,000 every month. It costs six cents each to print them, fifty linotypes being kept busy eight hours a day all through the year on this work alone. The work costs around \$1,000,000 yearly, which comes back into the treasury with at least \$200,000 profit. In addition to the copies sold, two

million extra are sent to libraries all over this country and to foreign countries in exchange. Also, there are held in the patent office, subject to sale, fifty million copies of various devices. These cost the government \$3,000,000, and have a sale value of \$5,000,000.

¶ Popular Mechanics Magazine does not publish the name of maker or seller of any device described in its pages, but this information is kept on file and will be furnished free by addressing our Bureau of Information.

Kansas City Times
12/15/23

ARCH SAVES DAM FROM FLOOD, PREVENTING LOSS OF LIFE

4452 Buttressed and braced with concrete, a high dam, of the multiple-arch type near-



Spillway of High Dam Braced by Concrete Arches that Held Back Heavy Floods

ing completion in British Columbia, was put to a severe test recently, when heavy rains tremendously increased the pressure behind the unfinished structure. A landslide carried away the penstock, so that the weight could not be relieved in the normal way, and the water rose so rapidly that the contractors, fearing collapse, ordered persons living on the flats below to flee to safety. But the structure defied the flood and was completed rapidly when the waters subsided. The strong arch construction of the dam was considered an important factor in preserving it.

DAMAGE WORKED BY FROST

IMITATED BY SALT 4503

To imitate the effects of ice and frost on building materials, the government bureau of standards has found that salt and high temperatures can be used to

Indianapolis News
12/14/23

counterfeit the action of winter elements. During experiments with waterproofing compositions and protective mixtures for stone, a piece of lime rock was soaked in a salt solution. When the moisture was evaporated by heat, it left the pores of the stone filled with the crystals. As these expand when dried, they exert a pressure among the grains and pits of the rock similar to that of frost.

4551

X-RAYS MADE BY GLOWWORMS

That properties peculiar to X-rays may be contained in the light emitted by glowworms is the opinion of some scientists, expressed in recent interviews. A Japanese has experimented with three hundred of the worms, and their rays, filtered through cardboard and copper plates, were said to have shown elements closely resembling those given off by various radioactive minerals.

Indianapolis news 12/17/23

COAL MINE FOUR MILES IN SEA

4502 Coal is being mined under the sea for more than four miles from the coast of England. The veins are found to be 1,500 feet beneath the ocean floor and the field is about twenty miles along the shore and extends out for ten miles. Nearly a century ago, a mine owner contracted for the deposits, but only in recent years has the industry developed methods whereby the fuel could be extracted.

Indianapolis news 12/14/23

LAMP BENEATH HOOD OF AUTO KEEPS THE MOTOR WARM

4489 To prevent automobile radiators from freezing and to keep the motor warm, a lamp designed to be conveniently inserted underneath the engine hood on winter nights, has been devised. It is safe and maintains sufficient warmth to protect the parts in low temperatures. Its initial cost is small, it requires but little oil and eliminates the difficulties of starting the car when the engine is cold.



International
see heater Feb. 1926. 208

cannot locate
maker or agent.

Falls Creek Anyox, B.C.



Plant Experts Seeking Foreign Insect Pests

Army of Bugs Costs Farmers Billions

War on Hordes of Invading Pests from Abroad Keeps State and Government Scientists Busy the Year Round

By EARLE W. GAGE,

Ashville, N.C.

ONE of the greatest wars the world has ever known continues, disarmament conferences to the contrary. Yet few realize the critical condition confronting the human family in this great combat of man against the enormous forces of injurious insects which attack us from every point.

The average person knows of neither the amazing number of these hordes battling against him nor of the army of trained men and institutions engaged in the struggle, but conservative estimates place the annual crop loss of the American farm at four billion dollars as a direct result of the onward march of the insects of the field. They have multiplied so fast that their present destruction of orchards, gardens, farm crops, forests and animal life is estimated to approximate more than \$8,000,000 every twenty-four hours. Their havoc would be much more than this were it not for the work of the plant and animal experts of state and federal departments.

Spectacular and widespread destruction of crops is by no means the only harm worked by these pests. Their existence

constitutes one of the chief hazards which the farmer encounters, bringing up his cost of production and ultimately the price which consumers must pay for their food and clothing. Experiments made by the scientists of the different states and the United States department of agriculture would indicate that the production of ten of the more important cereal, fruit and vegetable crops was reduced more than 650,000,000 bushels by plant diseases in a single year. In the same year, the cotton crop was reduced nearly 1,750,000 bales by the same agency.

Of all these insect hordes and diseases, there are relatively few that are native to America. Like many other harmful things, pests and diseases have trooped in after civilization, and have been carried in many ways from one country to another, until they have spread their destructive work practically over the world map.

Although many of the pests have come to us from Europe, Asia has contributed its share of them. Prominent among these for its destructive activities, is the San

Jose scale, which came to us from China and has now become widespread throughout the United States. This one little immigrant has cost the country upward of \$200,000,000 for its board and lodging. Orchardists have been forced to make expenditures for apparatus and spray materials totaling about \$10,000,000 a year to combat its ravages.

The Oriental peach moth, which came from Japan on a lot of imported cherry trees, has only started its spread and depredations. It affects practically all deciduous

fruits, and bids fair to be as destructive as the well-known codling moth, the cause of wormy apples, and which eats a large hole in our \$300,000,000 annual apple crop.

The Japanese beetle has already gained such firm foothold that, in view of its habits and prolonged flight, it probably can defy extermination and may ultimately overspread the country. It attacks nearly all fruits and also many garden vegetables and corn.

The introduced diseases of forest trees, such as the pine blister, chestnut blight, and the enemies of the cereal and forage plants, are, however, vastly more expensive lodgers than those named, consuming

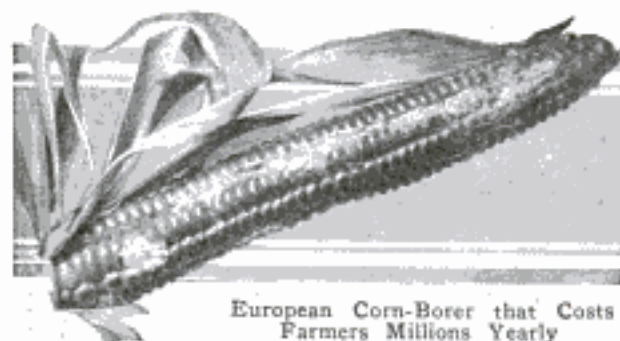

European Corn-Borer that Costs Farmers Millions Yearly

at least \$1,000,000,000 worth of timber each year.

If the hundreds of foreign pests that have become permanent factors in Ameri-

can agriculture and horticulture, had been kept out, America would have enjoyed a tremendous advantage over the old world, says Dr. Charles L. Marlatt, of the federal

horticultural board, who is in charge of the "Ellis Island" maintained by Uncle Sam to keep undesirable parasites out of the United States.

The department of agriculture recently compiled a list of the dangerous insect enemies of plants in foreign countries which for the most part have not as yet gained entrance into the United States, and found there are some

3,000 of them, all regarded as menaces.

"Most of those already here have come in shipments of living plants, and many of them with florist and ornamental stock," Dr. Marlatt asserts. "In many instances

the imported or ornamental, or other plant, has been a mere incidental carrier of the new enemy.

For example, the European alfalfa weevil, which is reducing the output of alfalfa in half a dozen states, was introduced with soil in which was bedded imported plants sent to Utah, where it secured its first foothold. Other weevils of foreign origin, affecting clover and other plants, were similarly introduced.

"Some enemies have come upon us in different ways: The Hessian fly with straw; the Argentine ant as a stowaway in a cargo entering New Orleans; the European corn borer with a shipment of broom corn from Italy."

Some idea of the excellent work of the plant experts have been doing is indicated by their achievement for only a portion of this service. There were received from Holland 1,051 infested shipments, involv-



Insects at Root of Plant



Andean Potato Weevil

ing 148 kinds of insect pests; from Belgium, 1,306; France, 347; England, 154; Japan, 291; and Germany, 12.

The worst enemy the cotton plant has is the pink boll worm, the larva of a minute moth. The larvae feed in the bolls and destroy the forming lint. It came from India by way of Egypt some twenty years ago with importations of cotton. It reached Texas from Mexico, where it has reduced the growers' income by millions of dollars each year, while Congress has spent more than \$3,000,000 in combating it.

To guard against recurrence of this, all cotton shipments from foreign countries are now subjected to the "third degree"—that is, the bales are put into a huge steel cylinder by means of a movable platform. The cylinder is hermetically sealed and the air exhausted, the vacuum assuring penetration of a disinfecting gas to the very center of the bale, destroying all insects that may be therein. Uncle Sam has the world's largest fumigating plant, and each cylinder has a capacity of more than 100 bales of cotton at one time, permitting a shipload of cotton to be treated in a few hours.

As our immigration officers must be on the lookout for smuggling, so the plant immigrant officials must watch for contraband importations. A woman custom inspector at Laredo, Tex., for example, took a bag of alligator pears, in which were found dangerous insect pests, from a woman's skirts. To the unaided eye, the appearance of a plant may be normal, yet

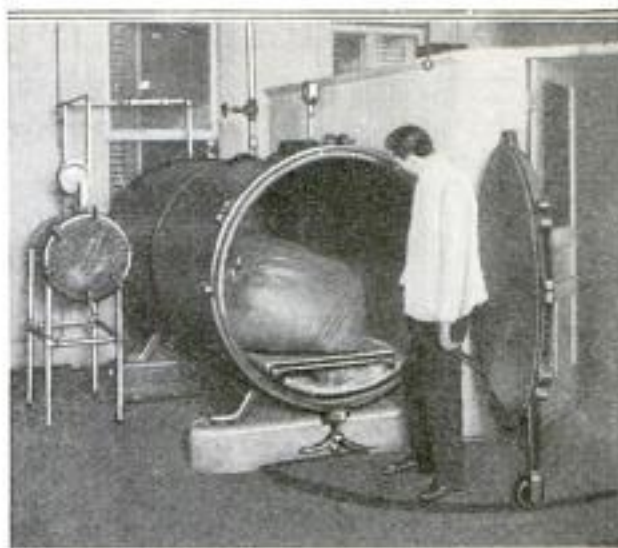

Vacuum Cylinder for Fumigating Cereal, Plant, and Cotton Shipments Received from Europe

when subjected to a powerful magnifying lens, millions of tiny eggs may be seen. This was found true of a recent importation of trees, having harmless-looking cracks in the bark, which the lens showed to be filled with the eggs of the camphor thrip, a pest which threatens failure to the promising camphor industry.

To combat these pests an army of government investigators is kept busy the year round. The work involves the development of a chemical means of warfare, the production of effective insecticides, the use of flames, the airplane to spread poisons and other mechanical measures. In addition, a rigid inspection service is maintained at every port of entry.



Japanese Beetle that Is Expected to Spread over the Country

COAL DIGGERS AND DYNAMITE OUST HOMES



Steam Shovels Tearing Deep, Winding Excavation Along Streets of Residential City where a Rich Vein of Coal Was Discovered to Run Close to Surface of Ground

Steam shovels, locomotives, and dynamite have invaded a residential section of a Pennsylvania city to mine a rich vein of coal that was recently found under the district. Yawning gorges have been blown and dug into the earth at the sides of the streets, where the rumble of heavy machinery is punctuated with blasts of ex-

plosives. Great lengths of railroad track have been laid in a winding path through the neighborhood to carry the mined fuel away. Guard rails were built on the brinks of the deep openings to prevent accidents to unwary pedestrians. Thousands of tons of soil, rock, and anthracite coal have been torn from the land since operations began.

South Scranton, Pa.
Hot 710 Electric Co., New York
535 Seventh Ave., New York

^{water}
ELECTRIC HEATER ON FAUCET
TAKES LITTLE CURRENT

Containing a small electric heater attached to a wall socket, a faucet which furnishes either hot or cold water has been designed. A cord in a flexible brass tube conveys the current from a wall plug. The



Faucet Water Heater Fitted on Bowl and Diagram Showing Flexible Cord Socket Connection

\$2.500

device supplies a stream near the boiling point at the rate of twenty-five gallons an hour, and is especially adapted to home and office use. Electrical terminals are grounded in the water so that shocks are avoided. The appliance is economical, as it consumes electricity only when water is being used, is durable and easily installed.

⁴⁵²⁴
EXPERT SAYS SCENTS OF GEMS
SOOTHE OR EXCITE WEARER

Some precious stones, such as the emerald, have been shown by experiments to give a pleasant, subtle scent when reduced to powder, while others, among them diamonds, have a disagreeable odor, according to a French expert. He declared that jewels influence the temperament and sentiments of those who wear them, some possessing a soothing effect, while others irritate.

No patent number

New York Times

12/10/23
Copyrighted material

**TWENTY-SEVEN THOUSAND SHIPS
 NOW IN NATION'S FLEET**

4536

American ships in the merchant marine now number 27,017 ships, of 18,284,744 gross tons, according to the report of the commissioner of navigation. Engaged in foreign trade, there were 1,958 vessels, and in the coastwise voyages, 1,575 ships. Two hundred and ninety-eight vessels were lost during the year, 139 were sold to alien flags, and 628 abandoned. Minor officers and seamen shipped, reshipped and discharged during the twelve months were 583,110. Including those on government and commercial ships, there are now 21,967 transmitting radio stations in the United States, and over 2,000,000 receiving points.

**SLEIGH ROAD INTO FAR NORTH
 TO OPEN NEW TERRITORY**

4534

Opening up a vast territory, heretofore unexploited by the white men or Indians, a sleigh road is being completed in British Columbia from Fort St. John to Fort Nelson, a distance of 170 miles. It is expected that this highway will reduce freight rates to the far north and will develop a great fur trade.

**TRACKLESS TROLLEY COSTS LESS
 TO RUN THAN MOTOR BUS**

4302

Trackless trolley busses, having a seating capacity equal to that of single-decked motor coaches, are declared to have proved a success in both England and China. It is claimed that they are cheaper to operate than the gasoline-driven type and can compete successfully with surface railway lines. With extension collectors, the trolley busses have a radius of about fifteen feet on either side of the wires.

**PISTOL DISCHARGE STOPS FIRE
 AT PULL OF TRIGGER**

4491

Shaped like a pistol, a fire extinguisher which shoots a forceful stream of flame-smothering liquid into a blaze at a pull on the trigger, has been invented and tested with favorable results in England. The instrument is noiseless, is handled easily and the heart of the blaze can be reached



Effective Fire Extinguisher that Works like Pistol to Shoot Stream into Flames

quickly by the concentrated jet which spurts to a considerable distance from the muzzle. The fluid is contained in cylinders loaded into the pistol. Because of its compact shape and small size it can be kept in a drawer for instant use. In a trial test, flames from a wardrobe saturated with oil were put out in a few moments by "fire" from the handy gun.

Rotting of wood is not due to the elements, nor to direct chemical action. It results from the activity of low forms of plant life which nourish themselves on the wood and thus destroy it.

German. made by B. F. Alchemflech.
 Berlin, W. 30. Haberlandstr. 4.
 Germany.



Left, Trackless Trolley Bus that Has a Leeway of 15 Feet on Each Side of the Feed Wire; Right, Interior of Coach Showing Driver's Cab

General Electric Co. Chicago office
 Illinois Merchants Bank Bldg
 Copyrighted material

BLOCK RAISED ON STILTS TO BUILD STORES

4546

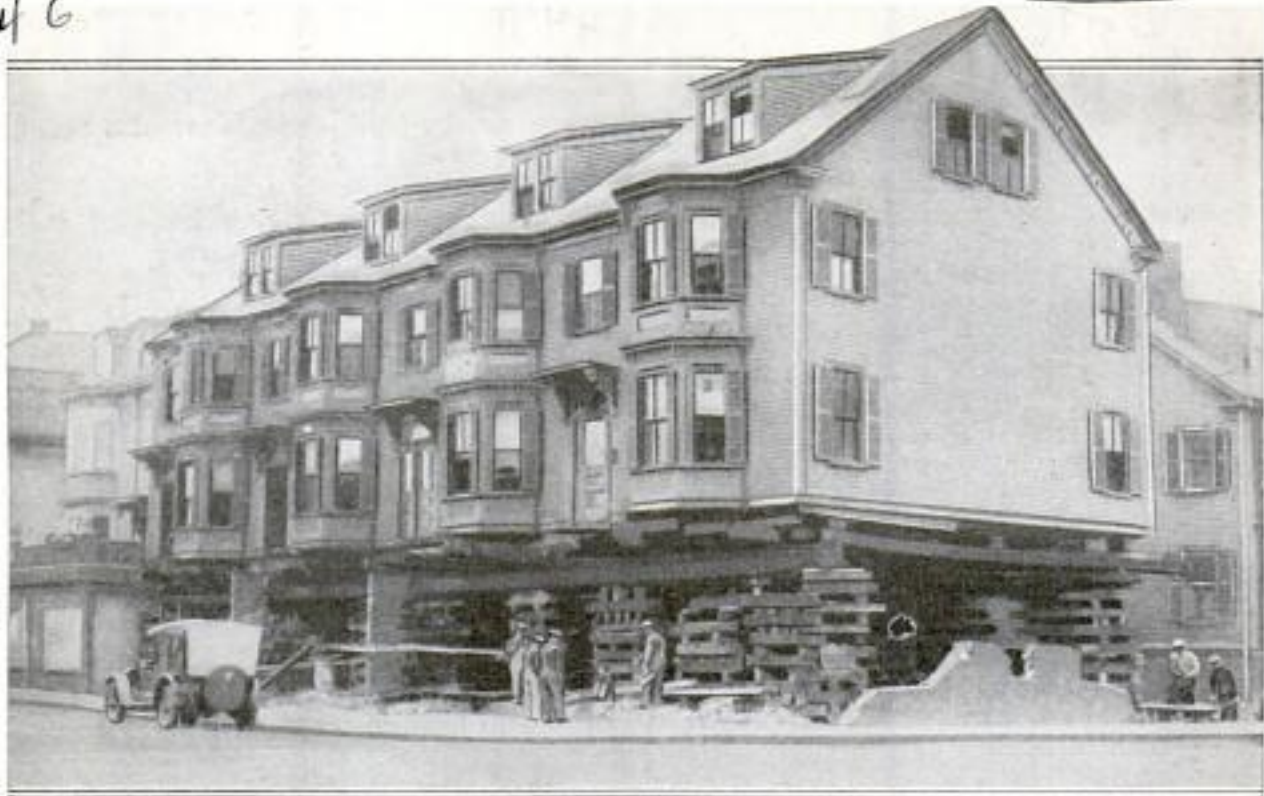

Block of Houses Raised Fourteen Feet; Although Only an Inch of Space Separated the Structure from an Adjacent Building, the Movement Was Made without Affecting It

To make room for the construction of stores underneath a block of houses ninety feet long, and weighing 300 tons, engineers in Boston put jacks and timbers under the wooden structures and raised them to a height of fourteen feet. There was only about an inch of space between the houses

and adjoining property, but so precisely was the raising done that the adjacent building was scarcely scratched. While the block rested on its stilts, brick walls and partitions for the stores were built up, and the wooden buildings let down upon them.

CAR COUPLER HANDLE GUARDS LIVES OF BRAKEMEN

4563

Hazards encountered by brakemen on switch engines are lessened by a coupler with handles which help in guiding it into the lugs beneath cars and prevent it from getting out of control. With the ordinary

type, a single miscalculation, or sudden jar, carried the danger of injury or death for the switchman.

"RAG MARKET" AND "FLEA FAIR" OFFER PARIS BARGAINS

4529

With all kinds of odds and ends neatly sorted into piles, the "Rag Market," is the Mecca of bargain hunters in Paris. In the olden days, it was called the "Flea Fair." There may be found rusty chains, keys, old clocks, parts of lamps, piles of rags and heaps of furs, for the most part too many to be touched, except with a stick or umbrella. Then, there is every possible kind of furniture, faded, tattered and scratched. The prospective buyers are composed of every class, from the poorest French to obvious sightseers and student bargain hunters, looking for an old bit of brass, a strip of embroidery or, perhaps, a mirror.

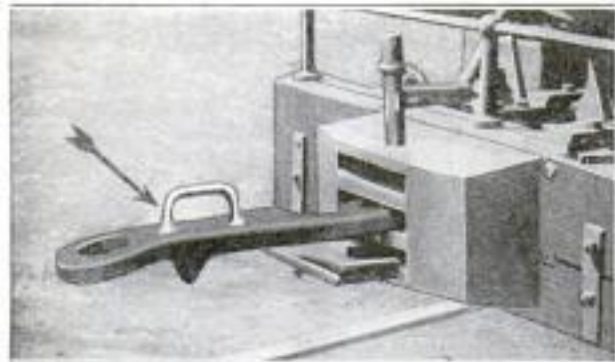

Handle on Coupler Arm of Railroad Freight Car to Aid Switchmen in Avoiding Injury

Christian Science Monitor 12/16/23

Used by Interstate Iron & Steel Co., Chicago



Broadcasting Station Uses Novel Headset

WDAP, the broadcasting station of the Chicago Board of Trade, located at the Drake Hotel, Chicago, has a couple of novel headsets which are used to test the transmission from any point in the studio.

The set is a combination phone and receiver; the receiver unit is a 50-turn coil, wound on a bakelite tube firmly fastened to the headband, and connected to a small crystal detector screwed to a piece of wood spanning the top of the tube. With the headset on, the transmission of the concerts, lectures, etc., can be checked from any part of the studio or instrument room, without the necessity of sitting down at the standard receiving set. The connections are simple, and are shown in the upper detail of the illustration.

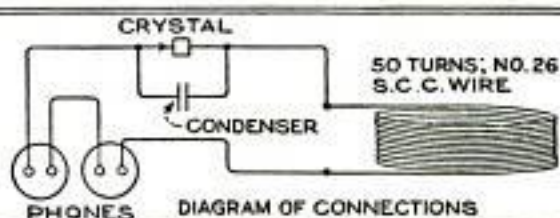

Above, Connections of Test Receiver; Left, View Showing Detector; Right, Headset in Use

Balancing Condenser for Loop Aerials

When using a loop aerial in orienting and directional experiments the capacity effect between the aerial and ground or near by objects often causes distortion and prevents an accurate minimum determination.

A balancing condenser will usually serve to reduce this effect and facilitate accurate tuning. The condenser is preferably mounted on the loop and is made by screwing two sheets of thin brass on a piece of fiber or bakelite measuring 3 in. square. These plates are covered with a sheet of clear thin India mica, glued on. A semicircular washer made of sheet brass is attached to a rod, which is passed through a hole in the center of the panel, and is fitted with a knob at the other end. The movable plate is

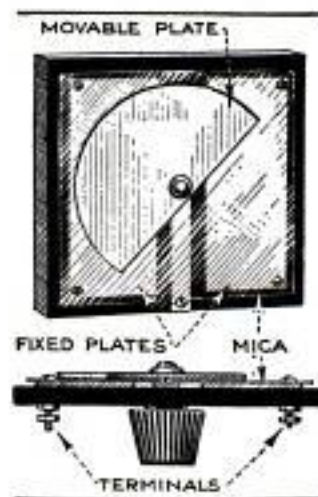

grounded, and the fixed plates connected to the ends of the loop. Rotating the knob will result in the balancing out of ground-capacity effects, and will improve the operation of the apparatus as a whole.—Thos. E. Benson, Philadelphia, Pa.

A Novel Transmission Experiment

Two seconds to travel fourteen times around the equator! It seems impossible, but that is the record of a signal recently sent from New York to Poland. The signal was sent to Warsaw, where it was made to actuate the transmitter and was reflected back to New York. On its return it was again reflected to Warsaw and so on, back and forth, each time with diminishing intensity, until at last, after forty double journeys, it became inaudible. Each double journey represented 9,000 miles, so that all told the distance traversed was close to 360,000 miles, or nearly fourteen times the distance round the earth at the equator. As wireless waves travel with the speed of light—186,000 miles a second—the time taken was approximately two seconds. Puck's promise to "put a girdle 'round the earth in forty minutes" was nothing to this.

Novel Exhibits at Hub Show

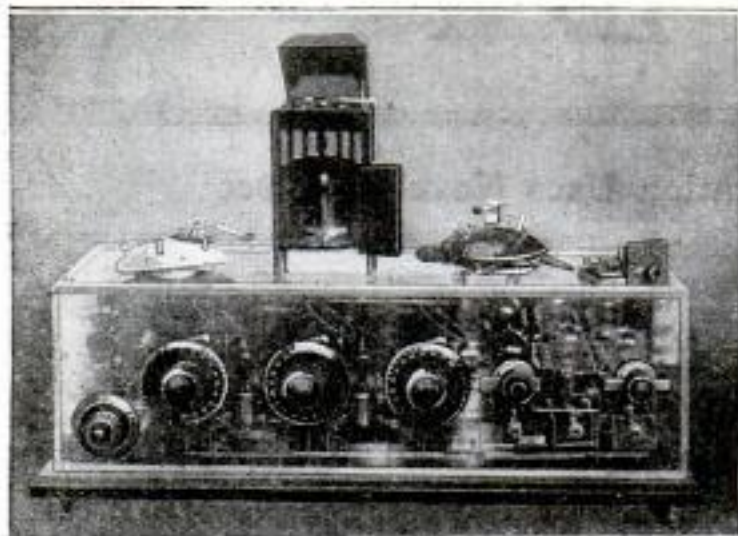

Group of Original Radio-Receiving Sets Shown at Radio Show in Boston

A group of novel radio-receiving sets was entered by amateurs in the Boston radio show. Among others were a five-tube neutrodyne set completely inclosed in glass, using the same material for the instrument panel, two crystal sets, one mounted on a clam shell, the other on a stuffed turtle, and a set mounted in a miniature phonograph cabinet, made by a 15-year-old boy. The novel sets attracted a great deal of interest from patrons of the show. The ingenuity of radio-set builders manifests itself in strange forms sometimes, but the surprising thing about it is that these freaks work, and usually work well.

R.
Chain Carrier Aids Battery Users

Hitherto, the battery carrier has been a tool for use in service stations only, but with the vast increase in the number of individual users of storage batteries due to radio, one manufacturer has realized that

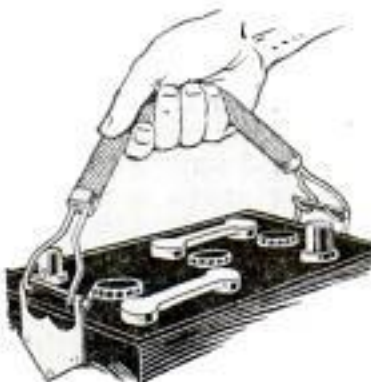

a neat, light carrier would be of assistance to the radio fan, and has designed a very serviceable one. The carrier is made of strong chain, closely covered with flexible material that provides a comfortable grip, and provided with strong hooks on each end to engage the handles of the battery. This carrier will lighten the task of carrying the battery to the service station, or from the instrument to the charger, for recharging.

Ribbon Antenna Has No Advantages

According to the Bureau of Standards, there is little advantage to be gained by the use of copper ribbon as an antenna. The ribbon aerial has been often recommended, especially for crystal sets, on account of its greater "skin effect," but the Bureau experts say that not only is this so slight as

to be negligible, but that the ribbon is not so likely to be permanent as a wire aerial due to the greater stresses to which it is exposed in sleet and wind storms.

Farmers Quick to See Merits of Radio

Surveys made by agents of the U. S. Department of Agriculture indicate that there are more than 150,000 radio sets on the farms of the country, or an average of about 54 per agricultural county all over the country. The farmer has been very quick to appreciate the advantages of radio for practical and social purposes, and has been one of the steadiest buyers of radio equipment.

R.
Switch Plug Has Novel Features

Two headsets may be used at the same time, or either one alone, on a new plug. A headset and a loud speaker may also be attached to the plug, and tuning may be done by means of the headset, switching to the loud speaker simply by turning the knob on the plug. Headset and loud speaker can be used at the same time, or either one alone, through the 4-way switch. This will prove exceedingly convenient, as it not only saves the extra jack, but simplifies tuning and switching.



Flour Way Co., Springfield, Mass. \$1.50.

American Chain Co., Bridgeport, Conn.

Sold by Manhattan Electrical Supply Co. 114 St. Paul St. New York



BUILDING A FIVE-TUBE NEUTRODYNE RECEIVER

BY F.L. BRITTIN

Part II—Adjusting and Tuning the Set

THE secret of successful operation of a neutrodyne receiver lies in the accurate adjustment of the neutralizing condensers or neutrodons which are connected to the radio-frequency amplifying tubes. The adjustment consists in tuning the radio frequency tubes up to maximum signal strength in the usual way, then removing the tubes and insulating the filament-circuit prongs so that when the tubes are replaced in the sockets they will not light, and finally sliding the brass tube on the neutrodons to the position where the signals are reduced to minimum strength, or, if possible, entirely eliminated.

If there is a broadcasting station in the immediate vicinity the adjustments can be made while the

station is operating, but if the nearest station is quite distant a buzzer circuit of the kind shown in the illustration is necessary. It is best, however, to use both methods and to check the results of one against the other before soldering the brass tubes on the neutrodons in their permanent positions.

The buzzer circuit consists of a dry cell, a 13-plate variable condenser, buzzer, push button, or better, a switch, and an inductance of 70 turns of No. 22 double-silk covered wire, wound on a bakelite or cardboard tube about 3 in. in diameter. This inductance applies only to wave lengths of 200 to 600 meters, which are used by the stations broadcasting music and popular entertainments. The connections must be accurately made according to the diagram, and the circuit is then hooked on the aerial binding post of the neutrodyne

receiver set, while the ground binding post of the set is securely connected to a cold-water pipe, wherever most convenient. The buzzer apparatus should be placed about 10 or 15 ft. away from the receiver so that there will be no interference due to mutual inductance.

The neutrodon of the first radio-frequency tube, which is located at the extreme left-hand side of the set when facing the panel, is the first to be adjusted. Start the buzzer and push in the plug of the filament jack, which will light up the filaments of all the tubes when the vernier

rheostat and the power rheostat are turned up; the latter, however, is not turned on at present. Push the phone plug into the phone jack and

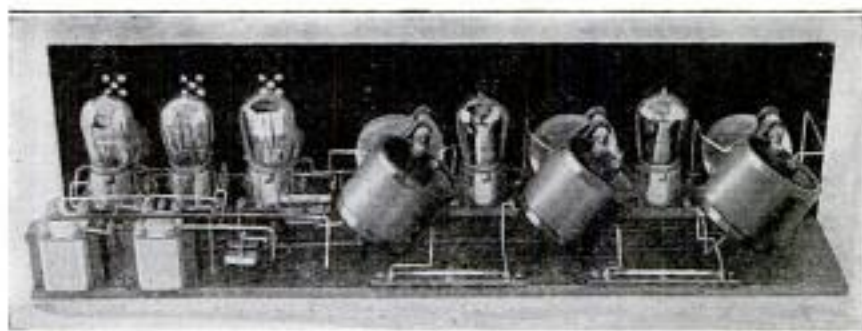

Rear View of Neutrodyne Receiving Set Showing the Arrangement of the Instruments

turn up the vernier rheostat to the point where a strong hissing sound is heard, which is the sensitive working point of the detector tube. Rotate all three dials of the neutroformers to the point where the buzzer signals can be heard loudest. As soon as this point is reached the dials will be in step, that is, they will all be turned to approximately the same point.

Now remove the first radio-frequency tube and slightly readjust all three neutroformer dials until the signals are again as strong as possible. Before replacing the tube, fix a piece of paper over the end of one of the filament prongs; these are the ones nearest the panel when the tube is placed in the socket. Small gummed labels are very handy for this purpose. To be sure that the prong is properly insulated, turn up the power rheostat a little after replacing the tube in its socket. If

the tube remains unlit everything is in readiness to proceed and the power rheostat is turned off again.

With the filament circuit cut out, but the grid and plate still connected, it is necessary to reduce the strength of the signals or eliminate them entirely, which is done by moving the brass tube on the first neutrodon. When the signals are as faint as possible the first tube is removed from its socket and the signals will come in loud again, and by replacing it with the filament prong still insulated, the signals will again be inaudible or nearly so. This is the desired adjustment of the brass tube on the neutrodon, which should be permanently fixed with a drop of solder after its correctness has been carefully checked, and after the neutrodon of the second radio-frequency tube has been similarly adjusted.

The gummed label is taken off the prong and the tube reinserted in its socket, after which the filament circuit of the second tube is insulated with a gummed label and the second neutrodon is then adjusted in the same way as the first. Always see to it that the neutroformer dials are adjusted to maximum signal strength before adjusting the neutrodons to minimum signal strength.

In adjusting the neutrodons it will sometimes be found that the signals strength can hardly be reduced. In such cases, it is necessary to connect the wire from the grid of the tube to the center clip of the neutrodon instead of the end where it is usually connected. This provides a greater capacity range for the neutrodon and permits the builder to get weaker signals.

As mentioned previously, it is a good idea to make tests with a local loud broadcasting station before finally soldering the neutrodons. Turn on all the tubes, with the instrument connected to the regular antenna, and pick up the broadcasting sig-

nals. By rotating the dials over the entire range it should be possible to receive the signals without any whistling, beat notes, etc., which indicate undesired oscillation. If such interference is heard, the entire instrument should be readjusted, taking each step singly as before, and it may be necessary to separate some of the wiring if the trouble persists.

The neutrodyne receiving set is tuned in a different manner from the ordinary radio receiver. First turn up the power rheostat to the correct position for the type of tubes that are used, and with the vernier rheostat turned off entirely, plug in the loud speaker or phones, and push in the battery plug in the filament jack, which

will cause the filaments of the amplifying tubes to light. Then turn the vernier rheostat up slowly until a loud hissing noise is heard from the loud speaker or phones. Turn the vernier rheostat back just below this point, and turn the second and third neutroformer dials to about the same position. Rotate the dial of the first neutroformer very slowly until it reaches a point where the signals from a broadcasting station will be brought in. This point is

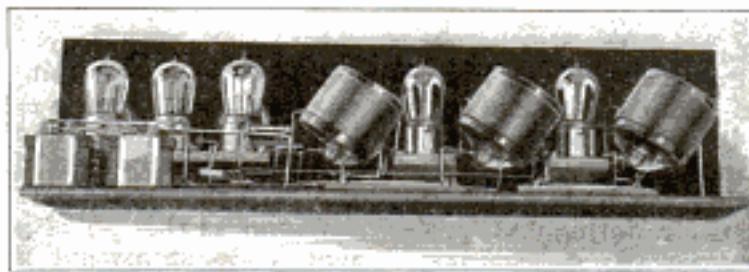
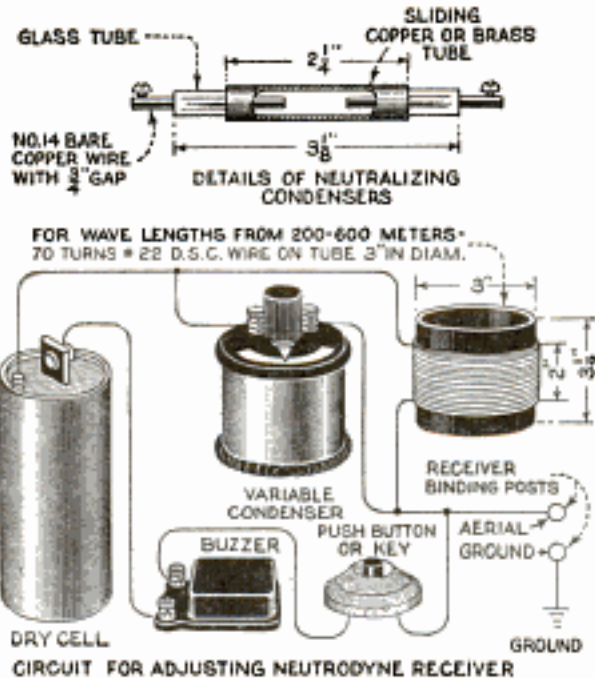

Above, Buzzer Circuit for Adjusting Neutrodyne Receiver. Upper Detail Shows Construction of Neutrodon; Below, Another View of Rear of Set

usually about 10 or 15 degrees above or below the corresponding points on the other neutroformer dials. Carefully readjust these and also the vernier rheostat, to increase the strength of the signals. Tuning should be accomplished very slowly and not in a jerky manner. This is important to remember, especially when tuning in to long-distance stations. The second and third neutroformer dials are adjusted to the particular wave length of a broad-

casting station to which one is desirous of listening in, and the first neutroformer is adjusted to bring the signals in loudly

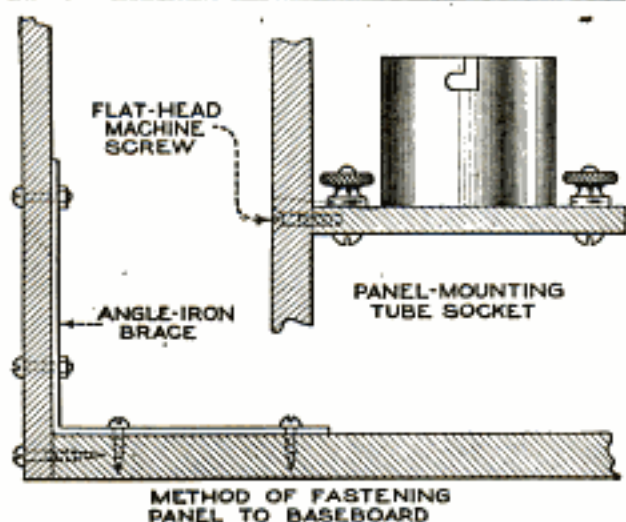

Method of Fastening Socket Bases to Panel and of Fastening Panel to Baseboard

and clearly. The second and third dials are then set to correspond with the first.

News May Be Broadcast to Army Men

Outlying naval stations and ships of the Navy have for some time been supplied with daily news through the Navy Press, which transmits from NAA at Arlington every evening. Army posts may have a similar service, if a scheme now under consideration by the War Department goes into effect.

Army posts at the Philippines and Hawaii would receive bulletins at least once a week from a high-powered station on the Pacific Coast. These bulletins would also be transmitted to forces stationed in Panama, Cuba, Alaska, and Porto Rico, and be picked up by isolated posts in this country. General orders to all posts might be announced by radio, to save the expense of cable and telegraph tolls.

Two-Element Tube Needs No B-Batteries

Makers of reflex-circuit sets will be interested in a tube that has recently made its appearance. The tube has but two elements, hence its name—the "diode." It is said to combine the clear reproduction of the crystal with the sturdiness and reliability of the tube, and to operate on less than $\frac{1}{2}$ amp. from a single dry cell. No B-batteries are required. It is adapted for use in all reflex circuits, and requires no adjustments for changes in wave length.

*Electrad, Inc.,
428 E. Broadway
New York*

Speedy Telegraph Service for Fans

One evening recently the editor of this magazine tuned in station WSD at Atlanta, Ga. The concert was so good, and reception so perfect, that he thought the station might like to know of it and immediately sent them a telegram. Twenty-five minutes later he heard his own message broadcast from the station. The speed of the telegraph service impressed him so much that he wrote a letter of commendation to the local superintendent of the Western Union, and received, in reply, another surprise. Not only was the twenty-five-minute service common, it was, in the opinion of the superintendent, exceedingly slow! Inquiry elicited the fact that, after a recent concert by the Chicago Board of Trade broadcasting station—WDAP—at the Drake Hotel, Chicago, a total of 4,400 messages were delivered in one night. Most of these came from districts within a radius of 500 miles, and the average time, from filing to delivery, from large centers where the messages did not need relaying, was 4 minutes. From small stations, where relaying was necessary, the average time was slightly more, but one small station sent a message, from filing to delivery, in 2 minutes! This is real service.

Simple Window Aerial

Various kinds of indoor aerials are advocated for buildings where any other type is impossible; one of the most effective is shown in the illustration. Two spreaders of heavy iron wire or light iron rod, a little shorter than the width of the window, are bent with an eye at each end, and one in the center. The two spreaders are connected with a number of the light curtain springs that are widely used instead of curtain rods. The efficiency of the aerial depends to a great extent upon the number of springs used. The spreaders are suspended between the top and bottom of the window casing, insulators being used as shown. The springs are drawn up tightly so that they will not touch each other, and the aerial will not swing.



52 Willow St., Springfield

Phone-Tip Jacks Make Plugs Unnecessary

For plugging in as many sets of phones or loud speakers as desired, and connecting them either in series or in parallel, a new

phone-tip jack will be found cheap and useful. No plugs are necessary, as the jacks fit all sizes of phone-cord terminals, and the installation is very simple; it is necessary only to drill a 1/4-in. hole in the panel, insert the shank, and clamp the bus wire under

the locknut. The contact made is positive, and the jack grips firmly, while at the same time permitting the tips to be withdrawn easily.

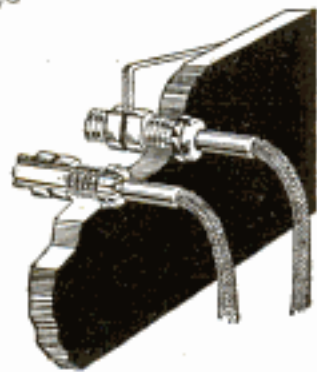

A Novel Crystal Detector

Crystal detectors of the usual type in use on radio-receiving sets have some drawbacks, which prove to be very annoying when a person is listening in to a broadcast concert. The "cat-whisker" wire has the disadvantage of being easily dislodged by slight vibrations, such as caused by a person walking over the floor. This throws the point off the sensitive spot on the galena, and stops reception in the midst of an interesting program. Very often it takes considerable time to find another sensitive place, and thus a good part of an evening's entertainment is lost.

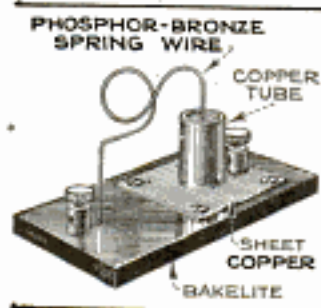

A detector that cannot be thrown out of contact is shown in the illustration. Instead of touching the crystal at only one spot, the wire is in contact with it at numerous points, as the crystal is pulverized, and

any vibration taking place simply moves a different set of sensitive grains into contact with the wire.

The detector consists of a base, made of bakelite or similar material, two binding posts, a small copper sheet, a short copper tube, and a length of No. 20 or 22 phosphor-bronze spring wire. The copper tube is soldered to the sheet and the latter is attached to the base by means of small wood screws. The spring wire is bent to

the shape shown and is attached to one binding post, while the other binding post is connected to the copper sheet. The tube is then filled with the pulverized galena or other sensitive mineral, to about 1/8 in. from the top. This is done with the use of a piece of paper creased in the center, allowing the grains to slide into the copper tube. The galena should not be ground too finely and must not be touched with the fingers, as the oil on the skin of the fingers is sufficient to make the particles nonconductive, which will stop the reception of music and of signals. It is surprising how this type of detector always retains contact between many sensitive grains, thus enabling steady reception, no matter how much vibration there may be. If a radio enthusiast has a number of dirty, but sensitive crystals in his laboratory, he can clean them by immersion in medicated alcohol, taking care not to touch them with the fingers after cleaning. This will save the expense of buying new ones, as these will be found to give just as good service as new crystals.

Lead-In Fits under Windows

Fitting under a closed window, a flexible lead-in now on the market should prove popular with radio fans. The lead-in is thin and flat, and can be bent to any shape to fit closely to the window ledges. It is covered with a fireproof, insulating material which prevents grounding of circuits on wet window sills, and eliminates the necessity of drilling holes and fitting porcelain tubes in the window frames. Tabs are provided at the ends for soldering the down lead from the aerial and the lead to the instrument. The fitting will prove of special benefit to radio enthusiasts living in apartments, where the drilling of window frames is usually prohibited.

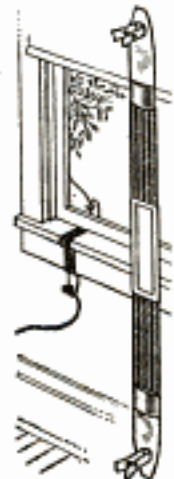

Grid Leak Has Fine Adjustment

Eliminating circuit noises, moisture-proof, and nonmicrophonic, are the claims advanced for the latest variable grid leak. Each movement of the knob gives a definite resistance over a range of from 1/4 to 10 megohms. The instrument is neatly designed and suitable for panel mounting.

Electrad, Inc., 428 E. Broadway, New York

Electrad, Inc. 75¢
428 E. Broadway
New York City



All Shop Notes published in 1923, in book form—from our Book Department.

A Cheap Grain Conveyor

By R. A. FRANKLIN

UNLOADING heavy grain sacks into the granary by hand is by no means an easy task and a conveyor for this purpose is of considerable usefulness. But, taking into consideration the price of a conveyor and the fact that it is used only a few days in each year, most farmers prefer the old method of filling their granaries by hand.

A conveyor that does the work just as well as a purchased one, and costs much less, can readily be made at home from materials available on every farm. The frame is made of two side boards and a bed board of 1 by 12-in. material, the bed board being nailed between the side boards in the manner shown in the lower left-hand detail of the illustration. The side boards must extend about 15 in. beyond the bed board at each end, so that there will be plenty of room for the rollers on which the conveyor chain runs. The rollers are cut from a 6-in. fence post and are drilled lengthwise in the center for a $\frac{3}{8}$ -in. iron rod, which is driven through and serves as a journal.

Holes of the same size are drilled through the side boards and steel or brass sleeves used as bearings. The journal of the lower roller is extended on one side and a drive pulley is attached. A 2 or 3-hp. gasoline engine, belted to this pulley, provides sufficient power to run the conveyor. Sprockets of equal size are securely screwed to the ends of the rollers, and two chains, taken

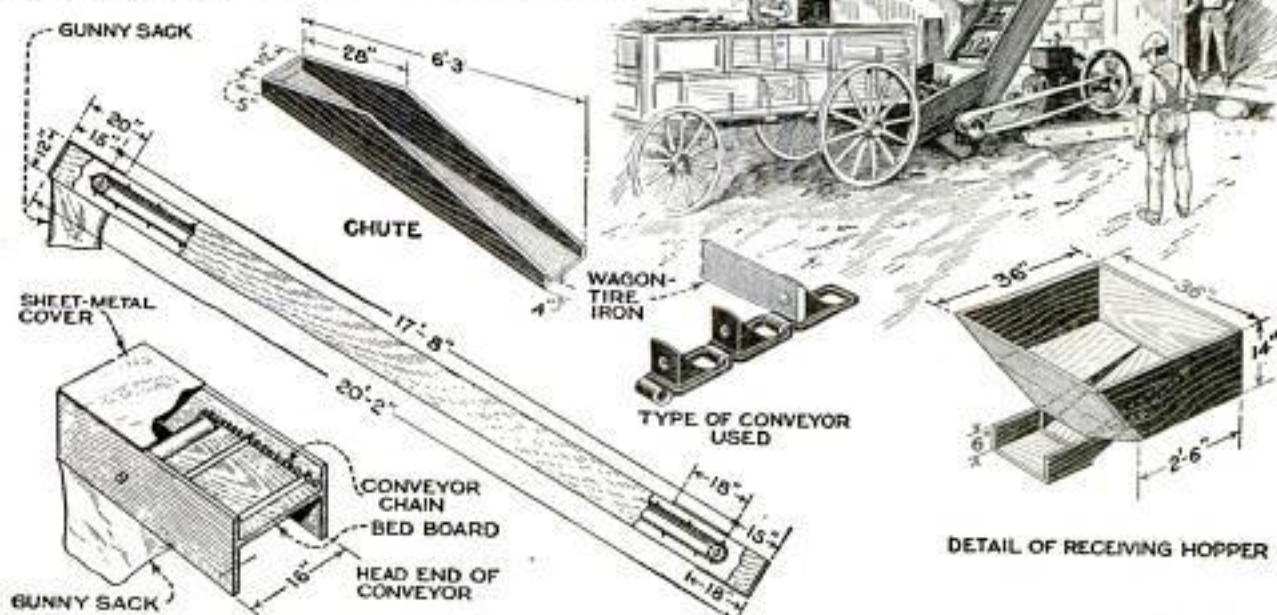

A Homemade Grain Conveyor that Can Be Made from Materials Available on Every Farm, and Costs Approximately \$18: It Is Run by a Two or Three-Horsepower Gasoline Engine

from an old silage-cutter conveyor, are run over the sprockets, and both ends of the chains connected to make them endless. Lengths of wagon-tire iron are straightened and used as crossbars of the chains; they are spaced about 1 ft. apart, and are bolted or riveted to the links of the chain as shown. The top surfaces of the rollers are flush with the surface of the bed board on the top side so that the chain will run snugly over the board and onto the rollers.

At its upper or head end, the conveyor is provided with a sheet-metal cover to prevent the grain from being scattered. A canvas gunny sack is attached under the head to receive the grain and direct it into a wooden chute, which in turn distributes the grain into the bins. This chute is made

of 1-in. material and measures about 6 ft. in length; its shape and dimensions are clearly indicated in the detail. A receiving hopper, into which the grain can be shoveled from the wagon, is provided at the lower end of the conveyor; it is made of 1-in. boards and built as shown in the lower right-hand detail. Cleats are nailed to the side boards to hold the hopper in place. The grain shoveled into the receiving hopper is automatically taken up by the conveyor and discharged into the granary.

In building a conveyor of this kind, the cost was approximately \$18, which is much less than the cost of a manufactured one. It was used during the threshing season for 8 years by the builder and his neighbors with whom he "changes work," and can still be used for many years.

Novel Drift-Pin Punch Set

Mechanics, especially those employed in the automotive industry, will appreciate a drift-pin punch set of the kind shown in the illustration. A set of this kind has been

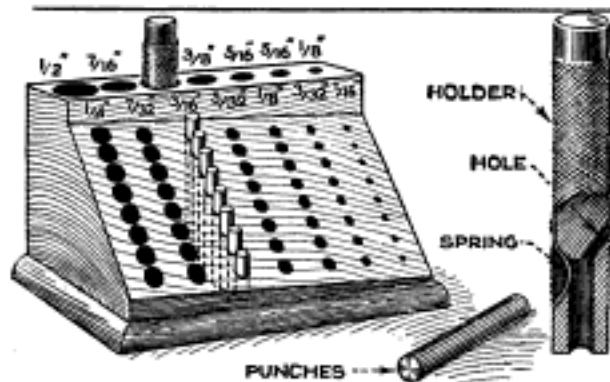

Drift-Pin Punches That Replace the Common Type, Which Are Easily Broken

used for 7 years and has been found to save considerable time and trouble, as cases are met hourly where cotter pins, straight pins, taper pins, etc., have to be removed as carefully as possible. After ordinary straight-drift punches were broken or bent, these punches were used and the work done without any trouble.

The punches are made of drill rod, hardened and drawn to a brownish-purple; they range in size from $\frac{3}{16}$ to $\frac{1}{2}$ in. in diameter, and are of varying lengths to be used progressively as the pin is driven out. Holders are provided for each size, of the same material as the punches, and hardened and drawn to a dark-blue color. The end of each holder is drilled as shown, a small hole being drilled through the side to permit the punches to be driven out in case of breakage. On the other side a slot

is cut to take a spring that keeps the punches securely in place in the holder. A wooden block is drilled as shown to hold the punches and holders in an orderly way so that any size can be located without trouble.—S. H. Candy, Montreal, Can.

Riveting Sheet-Metal Pipe

Anyone who has riveted together sections of sheet-metal pipe knows the difficulties involved in placing and holding the small rivets, and will appreciate the following method, which has been found very practical.

A sheet-metal band is made to fit fairly closely on the steel bar or stake on which the pipe is riveted, and a slot is cut in it as shown to hold

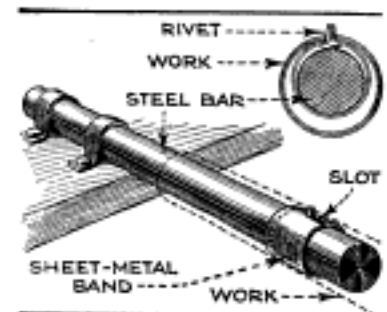

the rivet. The two sections of pipe to be riveted are slipped over the bar, the ends brought together over the rivet and a hammer and rivet setter used in the usual way to force the rivet through the metal. It is surprising how much time can be saved by this method and how easily and neatly the work can be done.—L. H. Georger, Buffalo, N. Y.

¶ To make a paint of dry white lead of the proper consistency requires about half its weight of linseed oil; dry zinc white will take nearly its own weight in oil.

Lubricant for Brass-Cutting Tools

Anyone familiar with copper and its alloys and other soft metals, knows that when chipping them, the chips tend to adhere to the surface of the tool and interfere with the cutting edges. The same is true when filing, drilling, and sawing. An excellent method of preventing this trouble is to use water as a lubricant. A can or tray of water is located near by so that the tool can be constantly dipped in it. The water avoids the gumming or clogging of the chips between the teeth of the saw, in the flutes of the drill, and on the surface of the file.

Simple Spring Seat for Wagon

Common farm wagons without springs do not provide much comfort for the drivers and therefore the simple wooden spring seat shown, which is constructed similarly to a spring board for diving purposes, will be greatly appreciated by teamsters and farmers. A seat of this kind can be made from two 1-in. boards about 10 or 12 in. wide and just as long as the regular wagon seat, and two 6-in. pieces of the same material. The long lengths are nailed to the short pieces, the short ones being spaced about 12 in. apart at one end. A pad or cushion on the seat provides additional comfort.—L. H. Unglesby, Baton Rouge, Louisiana.

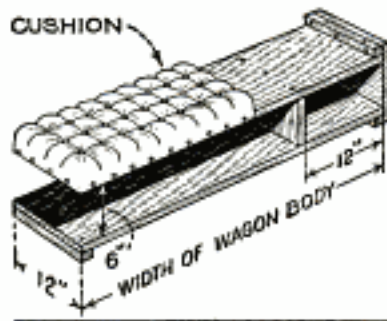

Common farm wagons without springs do not provide much comfort for the drivers and therefore the simple wooden spring seat shown, which is constructed similarly to a spring board for diving purposes, will be greatly appreciated by teamsters and farmers. A seat of this kind can be made from two 1-in. boards about 10 or 12 in. wide and just as long as the regular wagon

A Kink for the Auto Mechanic

Working underneath automobiles is usually a very annoying task as particles of dirt and grease constantly fall into the worker's eyes. This trouble can easily be prevented by using a pair of goggles, which can readily be made from a piece of celluloid, cut to the shape shown in the illustration. A piece of rubber or string is tied on, as shown, to serve as a headband.—William Calvert, Vickery, Tex.

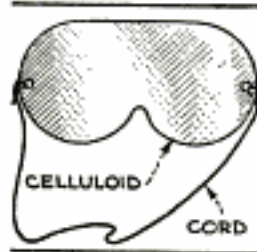

Alarm for Pneumatic-Tube System

Persons familiar with pneumatic-tube systems in large stores realize the inconvenience caused customers by delay of the

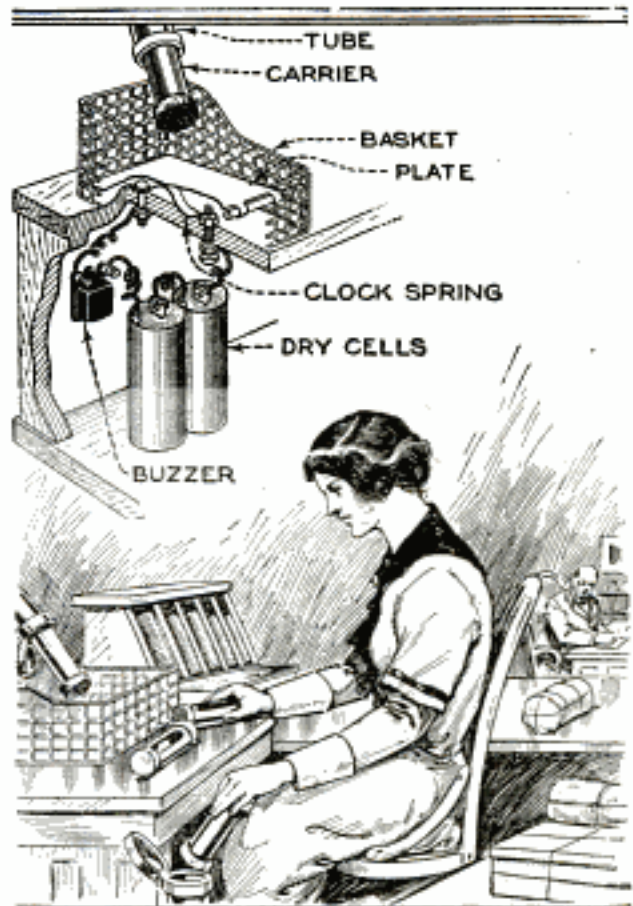

A Buzzer Connection to the Receiving Basket of a Pneumatic Tube Announces Arrival of Carrier

cashiers to open the carriers immediately when received, as it often occurs that they are allowed to lie in the baskets for several minutes before they are even noticed. This trouble was eliminated in a large department store by providing a buzzer which was sounded automatically by the weight of the tubes in the receiving basket. The arrangement is clearly shown in the illustration.

A sheet of brass is cut to fit inside of the basket over the bottom, allowing about $\frac{1}{4}$ -in. space on each side, and three "fingers" are left on one end to hinge on a rod as shown. Two $\frac{1}{8}$ -in. holes are drilled through the shelf on which the basket rests, for stove bolts, and a short length of clock spring, attached to one of the bolts, is bent as indicated so that a slight pressure on the brass plate will cause it to touch the other bolt and thus close a circuit that sounds the buzzer. A carrier dropping into the basket immediately starts the buzzer, which continues to sound until the carrier is taken out.—Marshall W. Gelette, New Bedford, Mass.

Street-Cleaner's Dustpan

Municipal street-cleaning departments will find the dustpan shown in the illustration of considerable usefulness. It is simply a piece of heavy sheet metal, bent

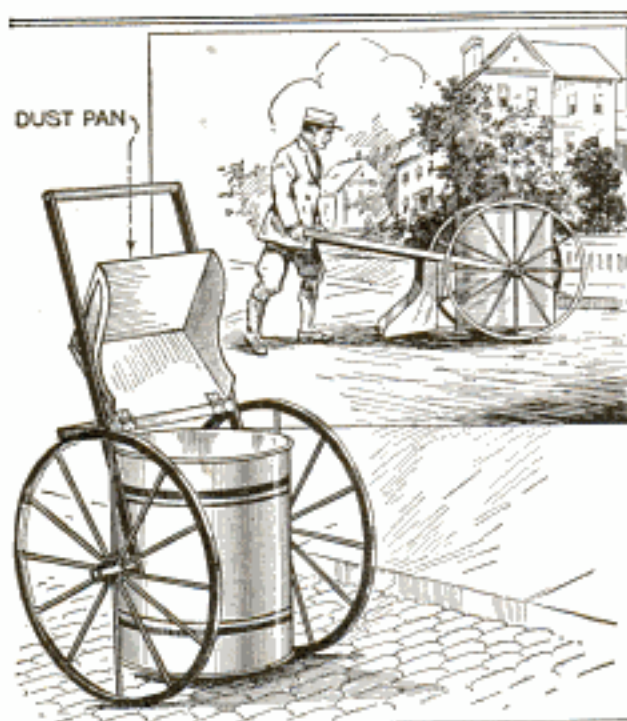

Convenient Dustpan for Street Cleaners. It Can Be Swung Over and Emptied by Raising the Handle

to the shape indicated and hinged to the frame of the dust carrier so that it can be dropped when sweeping dirt onto it, then swung over and the contents emptied into the can. The can swings freely on the axle so that it is always in a vertical position. A flat-iron bar, which is attached to the handles and constitutes part of the frame, extends below the handles to support them when the cart is left standing.

Repairing Leaking Suction Pipes

Leaking suction pipes, whether large or small, can easily be repaired. In a government power house a 4-in. underground suction pipe, attached to a steam pump, began to leak at the ends of a coupling where the threads had become corroded. The earth was removed around the coupling and a wooden form built of 1-in. material. The form was 18 in. square, open on the top, and the ends were each made of two pieces and had a $4\frac{1}{2}$ -in. hole for the pipe to pass through. A mixture of cement and plaster of paris was then packed into the box around the leaky coupling and allowed to set for an hour, which was sufficient, due to the proportion of plaster of paris. Then the pump was started again

and the leak was found to be effectively stopped. The cost of doing this was, of course, much less than the installation of a new coupling. Many mechanics forget that on a suction pipe there is no internal pressure, and that the only thing to guard against is leakage from the outside to the inside of the pipe. A knowledge of this fact will often save expensive repair jobs.—James E. Noble, Toronto, Can.

Tack Rag for Auto Finishers

A tack rag for automobile finishers can be made very easily by thoroughly saturating a piece of cheesecloth with rubbing varnish. Spread the rag out until almost dry, then fold and it is ready for use. By wiping off the car body or parts to be varnished with the rag all dust and lint will be removed, leaving a very clean surface.

As the tack rag is usually folded the danger of fire due to spontaneous combustion is always present, therefore it is a good idea to destroy all tack rags and scraps around the finishing room every evening and make new ones the following day. This can be done in a few minutes.—Vernon F. Clayton, Detroit, Mich.

Wire Tightener Acts as Gate

Although it is handy to have many gates on the farm, wooden gates are easily broken by cattle running against them, and steel gates are expensive. However, a simple homemade gate, which cannot be broken easily and is not expensive, is shown in the illustration. It consists of lengths of $\frac{1}{2}$ -in. iron rod, with one end bent to an S-shape, and the other end bent to form a hook. Each fence wire is

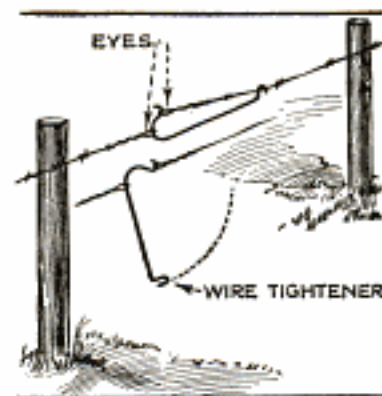

cut in two, midway between two posts, and the ends are turned back and twisted around to provide eyes, which are hooked on the S-shaped ends of the rods. Then by bringing the other ends of the rods over the wire, they will be stretched just as tightly as before and will be held in this position securely, while the hooks are easily dropped to afford a passage.—Alphonse F. Wolters, Albany, Minn.

A "Pick-Up Stick" for Varnish Work

Automobile finishers find it very annoying to discover a nicely finished panel covered with lint, brush hairs, or dirt. If there is not too much of this, however, it can readily be removed by means of the "pick-up stick" described in this article.

Take equal parts of rubbing varnish and turpentine, mix thoroughly and place in a warm place near a steam pipe or stove. After a few weeks the mixture will be very gummy and may be rolled between the fingers like putty. Prepare a small ball of this and place it on the ends of a short stick, about 15 in. long. Before the varnish has set, or become too tacky, look it over carefully for dirt. Any particles can readily be removed by touching them lightly with the ball on the stick. If the varnish is too dirty it is the best policy to remove it and do the job over.—Vernon F. Clayton, Detroit, Mich.

Hand Groover for Casement Sash

Grooving the bottom edges of a casement sash to form water drips is, at best, a slow and tedious job, but it can be greatly expedited by using the simple homemade tool shown in the illustration. It consists of a hardwood block about $\frac{3}{4}$ by $1\frac{1}{4}$ by 7 in. in dimensions, with a saw kerf 1 in. deep cut in the $\frac{3}{4}$ -in. edge, about $\frac{1}{4}$ in. from one side. Make another block $\frac{1}{4}$ in. by $1\frac{3}{4}$ in. by 7 in. to act as a "fence," slip a 5-in. length of old compass-saw blade into the saw kerf, allowing the teeth to project about $\frac{1}{8}$ in., and drive a wood screw into each end of block and fence to keep the whole assembly together firmly. In use the fence is pressed against the outside of the sash and the tool slid back and forth, applying pressure to force the saw teeth into the wood.

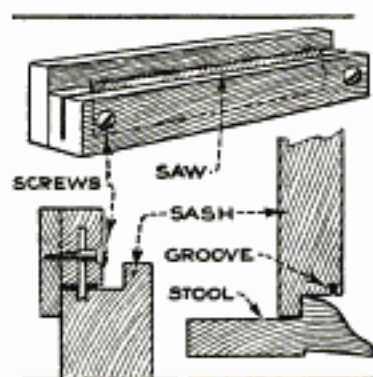

Never put an inside patch in a slit tube, where the slit is over 1 in. long, because this will weaken the tube. However, when the slit is small, about $\frac{1}{4}$ in. long, an inside patch can be used. A slit tube should always be cut on the bias before repairing.

A Kink for the Cleaner

Intended for use in cleaning and dyeing establishments, the device shown in the drawing provides a quick and easy method of slipping bags over finished

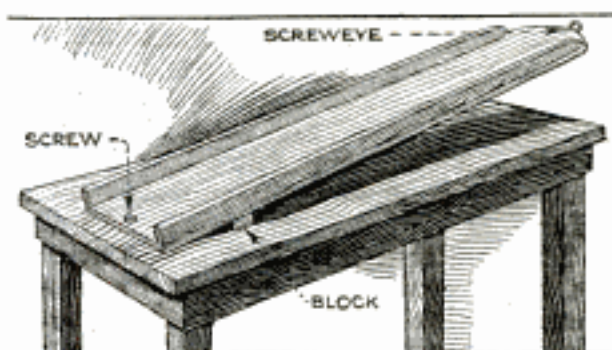

Fixture that Aids in Covering Freshly Cleaned Clothing with Bags

work. In general appearance it greatly resembles a springboard; one end is fastened to the table by a screw or bolt, and a strip of wood is nailed under the board near the end, so that the other end is elevated a few inches above the table. The board is about 6 ft. long and just wide enough for the bags to be slipped over easily. Strips 1 in. deep are nailed to the sides, as indicated, and a large screw-eye in the end of the board completes the device. In use the clothes are laid on the board and the hanger hooked in the screw-eye, leaving everything ready for the bag to be slipped over the end of the board. When the bag is in place the hanger is unhooked from the eye, the hook pulled through the end of the bag, and the bag, with the work inclosed, is removed from the board.—A. C. Cole, Chicago, Ill.

Better Whitewash

When the main generating tank of an acetylene farm-lighting plant is cleaned, a milky, white liquid is drained out and thrown away as it is considered useless. This liquid makes excellent whitewash, however, which will not peel off like ordinary whitewash. It is applied in the same way if it is thick enough; if not thick enough it is allowed to stand in an open vessel until enough of the superfluous water has evaporated to give the mixture the right consistency. After application there may be a faint odor of acetylene left in it, but this will soon disappear. If two coats are applied the first should be thoroughly dry before the second is put on. The white material in this kind of whitewash is calcium hydroxide, which is practically the same as water-slaked lime, but more adhesive.

BUILDING AN EIGHT-INCH JOINTER

By J. V. ROMIG



SMALL bench jointer makes a fine addition to the small workshop woodworking department, and the building of one that can be operated by a fractional-horsepower motor from a light socket presents no very great difficulties.

Where accurate work is necessary, a jointer is essential, and work done on the machine is finished in much less time than if done by hand, and with considerably less effort.

The jointer described in this article can be made easily and cheaply by anyone familiar with machine work. Happily, no castings are necessary, as all parts are of standard structural shapes, pipe, and flat and round bars, easily obtained and worked up.

The work table is made of 8-in. channel iron, of standard weight. The table is divided in two, the rear half being fixed, while the front section is mounted so as to enable the operator to adjust the depth of cut. The pedestal is of pipe, fitted with flanges top and bottom, as shown in the illustrations.

The table is first worked up, in one piece, if the channel selected is true and straight. A light cut is taken over the top and sides, to make them all square with each other. The channel is now cut in two, and the center edges curved to form the clearance for the cutter head, as shown in the side elevation. In order to lock the two halves in their proper relative position, $\frac{1}{2}$ -inch side plates, $2\frac{1}{2}$ in. wide, are used, and these are screwed to the rear half of the channel as shown in the plan and section A-A. The plates are cold-rolled bars.

The mechanism used to elevate the front half is a differential screw, the table rising

and falling on two guide rods passing through angular slots cut in the channel sides.

The rods are $\frac{1}{2}$ in. in diameter, threaded on both ends. One end of each is screwed tightly into a hole tapped in the right-hand side plate, and fastened by means of a locknut. The other ends pass through clear holes drilled in the left plate, and carry knurled-head clamp nuts or knobs, which fasten the table tightly between the plates when the machine is being used.

The holes are first drilled in the side plates, then the front half of the table is clamped in position with its top exactly in the plane of the rear half, and the position of the holes

scribed through. This marks the exact location of the center of each slot. It is well to drill a few small holes on a line at right angles to each end of the slot, to provide room for handling the file when making the slots straight and true to size. It will be seen, by reference to the side elevation, that a movement of the front half toward the center will cause it to rise, and vice versa.

This motion is secured by means of the differential screw, riding in two

nuts, as shown. One nut is screwed to the channel section, the other is slipped over the front rod. To compensate for the vertical travel of the table, the latter nut is slotted a little vertically. The first nut is tapped $\frac{3}{8}$ in.—24 threads per in., the second $\frac{1}{2}$ in.—13 threads per in. The screw is turned and threaded accordingly, and terminates in a long, knurled handle. The action of the differential screw is ideal for fine adjustments, as each turn advances or withdraws the table an amount equal to the difference between the pitches of the two threads.



Simple and Easily Built Jointer for the Small Woodworking or Pattern Shop

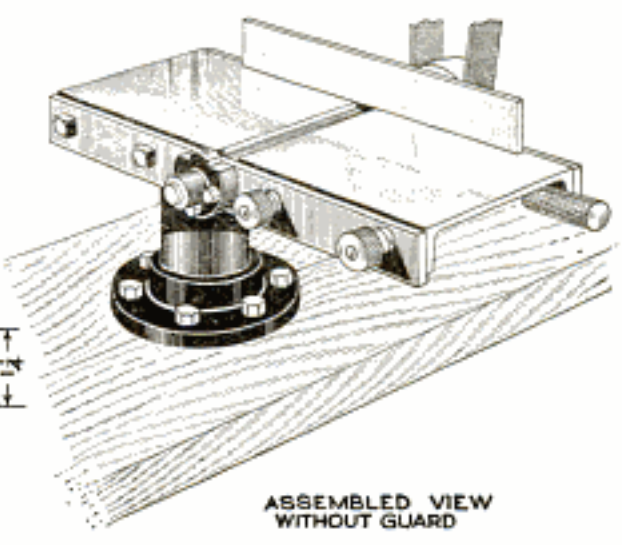
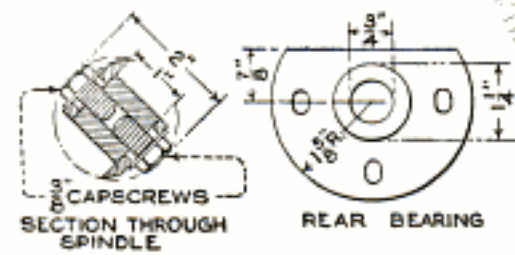
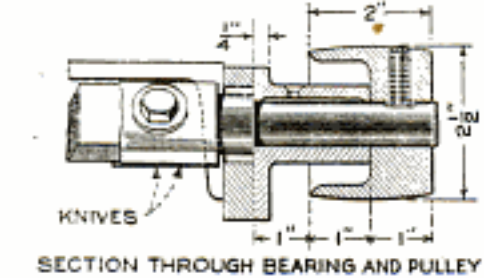
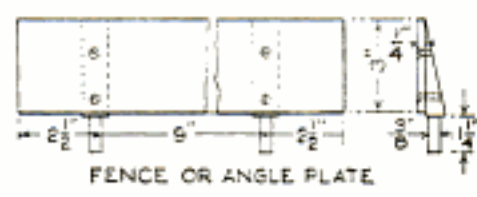
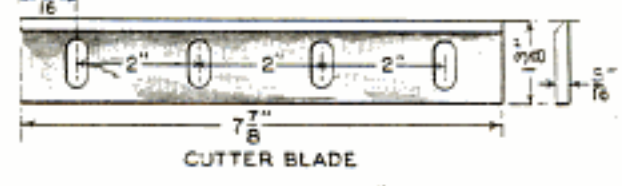
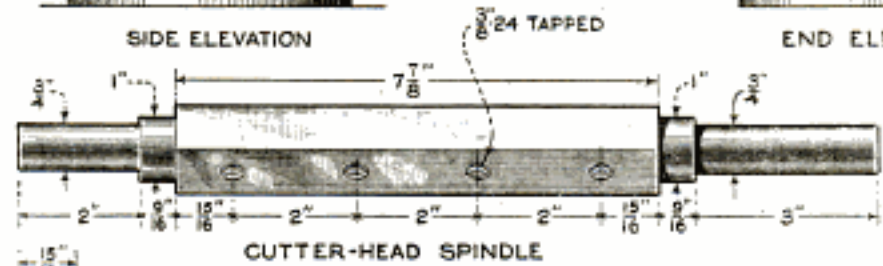
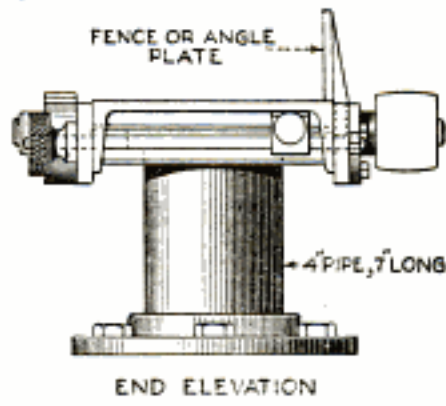
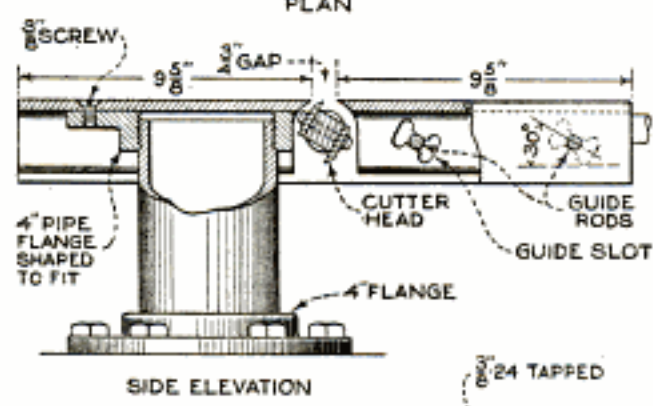
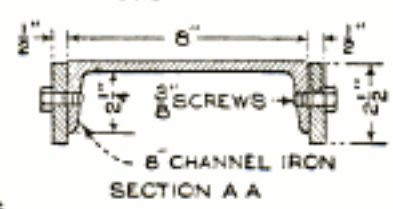
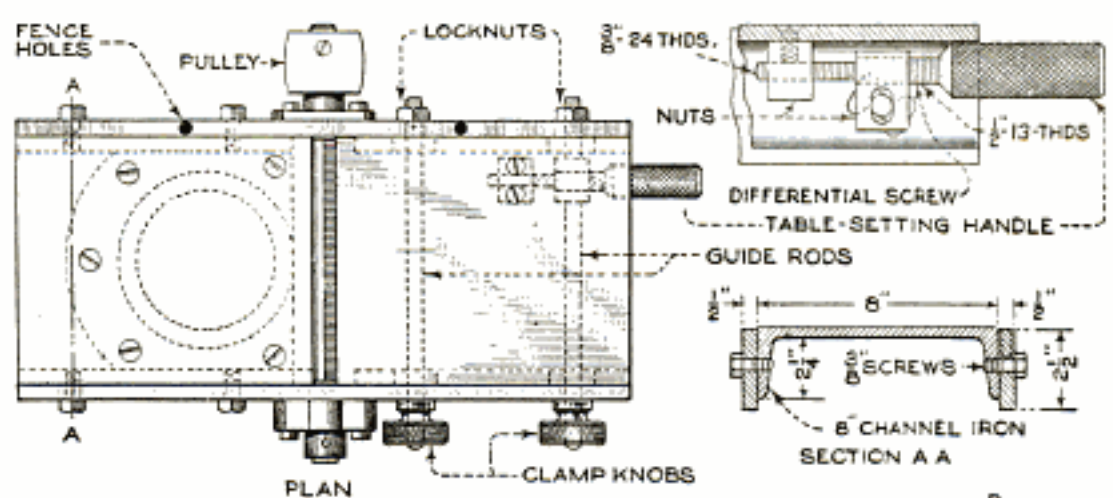

Full Details of Construction of the Homemade Bench Jointer. No Castings are Necessary, and All Material is Standard, and Easily Obtainable

The cutter head is turned from a piece of 1-in. square cold-rolled steel to the dimensions shown. The center portion is left square, and to it are fastened the cutter blades, made of $\frac{3}{16}$ -in. cast-steel

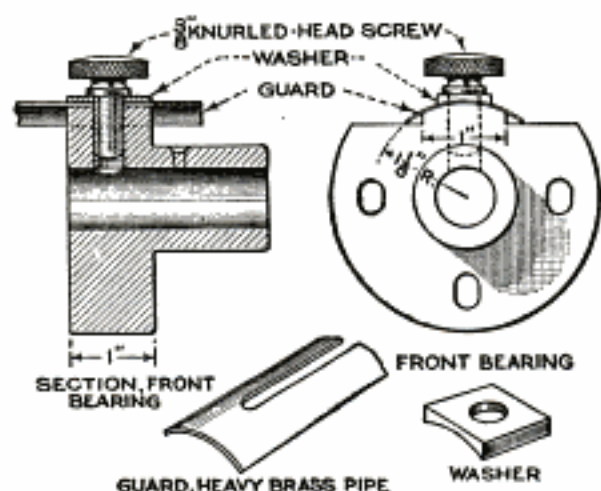

Detail of Adjustable Brass Guard, Attached to Left-Hand Bearing

stock. The journals of the shaft should be exactly round and straight, and be highly polished to run easily in the bronze bearings. Next to the journals, a short portion of each end is turned to 1 in. diameter, providing a thrust surface to keep the head central in the bearings. The head is drilled and tapped for $\frac{3}{8}$ in.—24 capscrews, which hold the blades. The holes are drilled and tapped through.

To permit the blades to be adjusted, the holes in them are slotted as shown, and the screws made with very short heads, to provide clearance. Thin washers are used below the heads.

The bearings are made of bronze-bar stock, and the bearing holes are elongated slightly to permit adjustment of the height of the cutter bar. The left-hand, or front bearing is slightly different from the rear one, to allow a guard to be attached. The details of the guard are shown so clearly that no description is necessary. The cutter head is driven by a $2\frac{1}{2}$ by 2-in. pulley fastened by a $\frac{3}{8}$ -in. headless setscrew. The pulley may be turned from the solid, from steel or cast-iron bar stock, and should be crowned slightly.

The pedestal is made of 4-in. pipe, screwed into two flanges, as shown. The flanges are screwed on very tight, and a freshly made mixture of litharge and glycerin should be applied to the threads before screwing up, to make the joints as tight as possible. The upper flange is shaped on three sides to fit in the channel, and the latter is fastened to it with five $\frac{3}{8}$ -in. flat-head screws.

The fence or angle plate is made of $\frac{1}{4}$ by 3-in. flat-steel stock, and is fitted with two supports or braces with round ends, which are a neat push fit in the right-hand side plate. The surface of the fence must be exactly at right angles to the table top.

When finished and assembled, all non-working surfaces should be painted or enameled, leaving the machined surfaces bright.

Paste for Pipe Joints

A mixture of soap and graphite painted on the threads of the filling plugs of gasoline tanks makes them easy to unscrew. The mixture will last longer than any kind of oil or grease, as these are quickly cut by the gasoline, while the soap and graphite mixture is not so readily affected. This mixture can also be used to make tight joints on gasoline pipes and it is easier to break joints made with it than when made with the mixture of litharge and glycerin generally used for this purpose. A mixture of Portland cement and oil applied to pipe threads also makes a tight-fitting joint on cold-water pipes.

An Improvised Faucet

In an emergency a faucet good enough to control the flow of liquid from a tank where the pressure is not great can be improvised from a tee and a short length of threaded pipe to fit. The side outlet

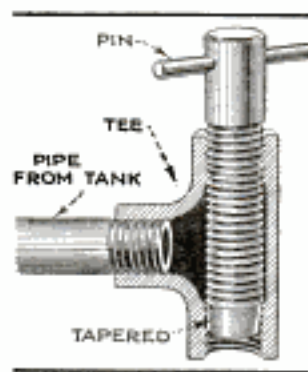

of the tee is screwed onto the pipe leading from the tank, and the short pipe, after threading, is tapered on the end so that it jams against the threads on the bottom of the tee, when tightened up. The faucet is completed by drilling a

hole through the pipe near the top and driving in a pin. If no machine is available for tapering the pipe and drilling the hole, the first operation can be done with a file, continuing the work until the pipe shows a bearing mark all around where it touches the threads in the tee, and the second can be done by filing a slot on the top and driving in a flat handle instead of a round one. A faucet of this kind takes little time to make, and will answer for many tanks where ordinary faucets are used.

Bar for Unscrewing Gas-Tank Plug

Threaded plugs on tank trucks used for handling gasoline often become so tight that it requires considerable effort to unscrew them, making the use of some kind of a bar necessary. A good bar for this purpose is a length of $\frac{1}{2}$ -in. round iron or steel rod, about 16 in. long. The bar is forced into a length of $\frac{1}{2}$ -in. rubber hose, a little longer than the bar. This makes the rod less likely to slip, and it is apparent that dangerous sparks cannot be struck with a bar thus protected.—B. E. Dobree, Victoria, Can.

Old Piston Used as Pattern

Occasionally it is necessary to replace pistons on "orphan" cars, and unless the piston happens to be of a standard size that is used by other makes of cars, it must be made specially. However, the expense of patterns and coreboxes can be eliminated by using one of the old pistons for making the molds. The piston is cut in half lengthwise as shown. The two halves are held together with a flat-iron

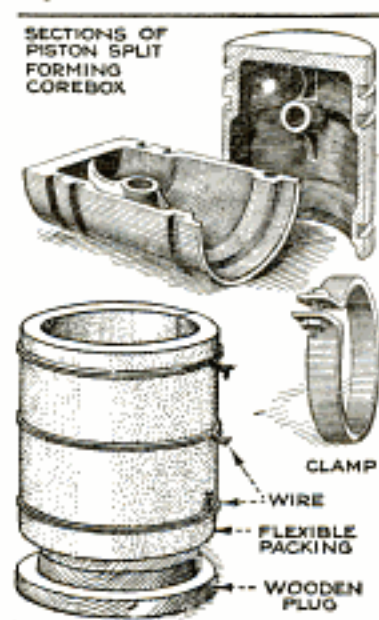

clamp, while ramming up the core. Facings is provided on the outside by means of a layer of flexible packing or other material about $\frac{3}{16}$ in. thick, tied securely with twine, and the impression is made in the flask after closing the open end with a circular wooden disk.

The venting of the mold and provision for risers are details that are carried out in accordance with the regular procedure. It is also possible to core the wristpin hole, although it does not matter much as drilling this hole does not take very long.

Uniformity in weight of the finished piston depends much on the coring inside, and therefore the cores should be made as uniform as possible. The piston heads may vary a little in thickness but this can be remedied by turning down the top of the piston.

Flywheel Prevents Light Fluctuation

When small gasoline engines, especially those of the hit-and-miss governed type, are used for running lighting generators, they will, even if provided with heavy fly-

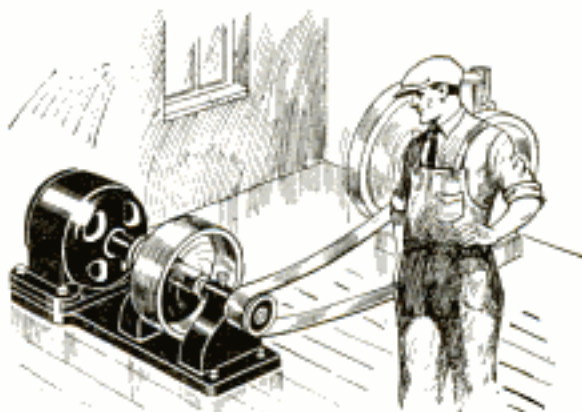
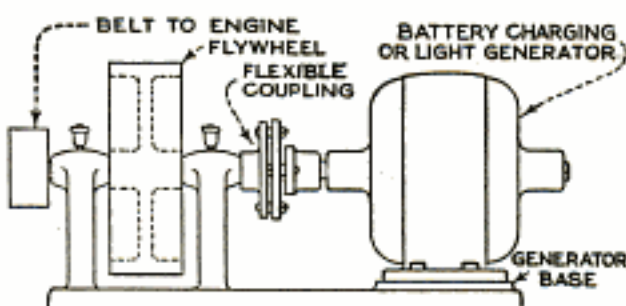

Additional Flywheel Added to Generator Prevents Flickering of Lights

wheels, cause more or less flickering of the lights, due to their irregular speed. This trouble can be lessened considerably by providing an additional flywheel, coupled to the generator shaft as shown in the illustration.

A cast-iron base is made for both generator and flywheel, the flywheel being supported separately so that little strain is exerted on the bearings of the generator. The shafts of both flywheel and generator must be in perfect alignment and should be connected by means of a flexible coupling. The flexible coupling can be of stock pattern, or made by bolting heavy leather or fabric disks between two flanges. The flywheel, which should be smaller than the engine flywheel, and run at a greater speed, is very effective in keeping the speed of the generator constant.—H. H. Parker, Oakland, Calif.

☞ To prevent a graphite crucible, or any other kind of crucible, from scaling, keep it in a warm, dry place. Never place a new crucible directly in the furnace without first allowing all the moisture to dry out. Before using it, place it upside down in the furnace, and heat until red; then turn over and use for the regular melt.

Platform-Scale Protector

When a car loaded with several tons of castings was pushed across a small platform scale, the capacity of which was far

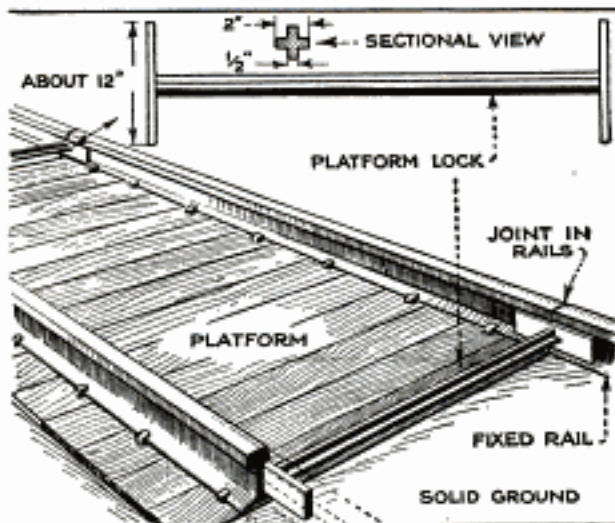

Protecting Platform Scale from Loads Beyond Its Rated Capacity

below the total weight of the castings, the result was a broken set of knife-edges. Still it was necessary to keep this scale on the main line of traffic to weigh certain castings at long intervals.

To keep the platform from deflecting when the heavy loads passed over it, two I-bars were fitted snugly between the head and base of the rails, at the joints between the movable platform rails and the fixed rails. The bars were steel castings, with heads $\frac{1}{2}$ in. thick and 12 in. long, and the connecting bars were cast in the form of a cross, as shown in the sectional view. Whenever it was necessary to use the scale for weighing, the I-bars were slipped past the joint so that the platform was free to move up and down.

Correcting List in Auto Body

Listing of automobile bodies on one side is a natural consequence of the constant weight of the driver on this side. Other contributing causes are the torque of the engine and heavy jars on this side due to dropping into a hole in the road. Some manufacturers take these factors into consideration when making the springs by adding to their thickness and curvature on one side to compensate for this tendency. On closed cars the listing seems to be more pronounced after a short period of use, and this deducts considerably from their value.

A simple method that will effectively cure listing for a long time on transverse

springs, such as used on the Ford, is to turn the spring end for end, and tighten well the center bolts that hold the body on the springs. In the case of semielliptic or cantilever springs, the rear springs are transposed, and if necessary also the front ones. A spirit level is much more dependable than the eye in determining whether the body is level or not.—G. A. Luers, Washington, D. C.

Stopping Dirt in Varnish Jobs

The following kink will be found invaluable to automobile finishers and finishers of fine furniture, as it reduces dirty-varnish jobs to a minimum.

With a $\frac{1}{2}$ -in. camel's-hair brush, apply a coating of light-bodied and pale shellac around the door openings, body moldings, windshield stanchions, and in all places where dirt or pumice stone are apt to lurk, before varnishing. In this way the dirt present, which should be as little as possible, will be held in one place rather than be brushed over the large panels where it will be readily noticed.

Oil-Hardening Pan for Small Work

An oil pan for hardening small pieces in oil is shown in the illustration. It was made to overcome the difficulty of cooling such work quickly enough to harden the entire surface. To accomplish this the work cannot be held in tongs or pliers while dipping, and if simply dropped in the oil tank the result is just as bad because the oil immediately surrounding the work becomes hot, which delays the cooling

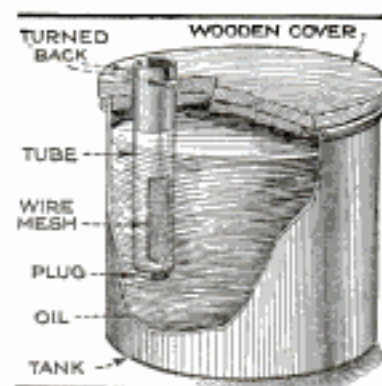

and tends to leave the pieces soft. The round oil tank illustrated was fitted with a wooden cover, made up of two thicknesses of wood nailed together and rounded off, the bottom piece fitting inside the tank and the top piece on the edge. The pan in which the work is held consists of a length of 2-in. tube, the bottom end of which is plugged, and the top end slotted with a saw and turned back to form supporting ears. Two rectangular holes are cut in the side as shown, and a piece of wire mesh is inserted

cover them. A hole is drilled in the cover near the edge for the tube, and the small seated pieces are then dropped in the tube. The cover is then revolved quickly so that the oil will circulate freely through the tube and in this way the entire surface of the work is exposed to constantly changing oil, which makes for proper hardness. When removing the pieces the tube is lifted out slowly to allow the oil to drain.

Pencil Sharpener Adapted for Draftsmen

Pencil sharpeners of the ordinary type do not give the lead the chisel-like edge that is required by draftsmen. By a slight modification, however, these sharpeners can readily be adapted to cut down the wood to suit the draftsman. This alteration consists in enlarging the small hole at the narrow end of the sharpener to a diameter equal to that of the pencil lead, and grinding away the edge of the cutter blade at that end so that it will only cut the wood of the pencil and not touch the lead. The lead end can then be rubbed down to a chisel edge on sandpaper. Pencils

sharpened in this way look much neater than if sharpened with a knife, and there is no danger of breaking off the exposed section of the lead.—C. A. Oldroyd, Barrow-in-Furness, England.

Adding to Convenience of Pipe Wrench

It is often impossible to use pipe wrenches in "tight" places because the movable jaw is too large to get behind the pipe. A good method of remedying this trouble was devised and used in the pipe-fitting department of the U. S. Navy Hospital at Portsmouth, N. H. An extra jaw of the same size is obtained and the head ground down as shown in the illustration. It is then substituted for the regular one in tight places and will be found to be of considerable assistance. Of course, this jaw will not be as strong as the other and therefore it must be used with care.—L. E. Fetter, Portsmouth, N. H.

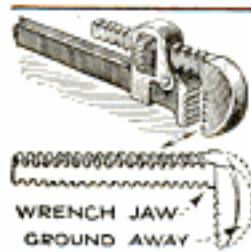

Hog-Proof Gates

It is common practice to run hogs in the same field as cattle. To allow the cattle the liberty of passing into adjoining

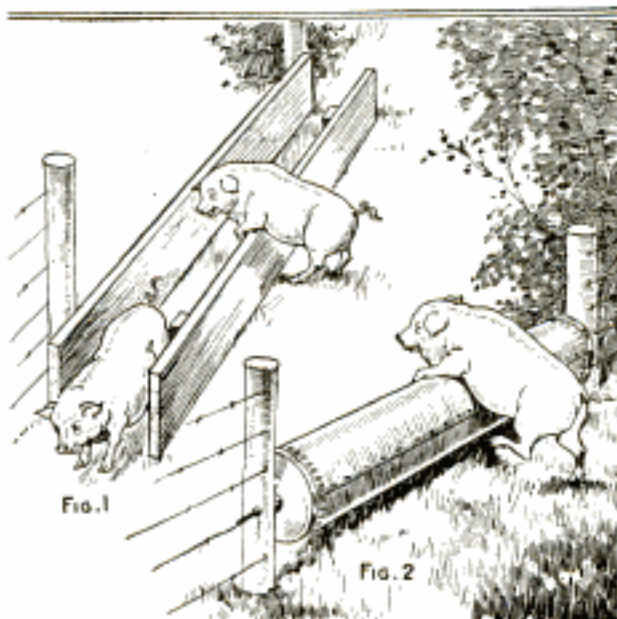

Two Simple but Effective Gates to Keep Hogs in a Pasture

fields and at the same time prevent the hogs from doing so, a special kind of gate is required. Two types of such gates, that have been found very effective, are shown in the illustration. Fig. 1 shows a gate consisting of two wide planks, one nailed to the gate post and the other arranged parallel to it, with a space of about 2 ft. between. The second plank is nailed to strong stakes that are securely driven into the ground. The hogs can climb over this plank because they can approach it at right angles, but cannot get over the other because the second is so close. A hog (this has been proved many times) will usually climb over the first plank into the chute, and run along it back into the yard, thinking, apparently, that it has accomplished its purpose.

An equally effective gate, which involves the use of an old hot-water tank, is shown in Fig. 2. It is drilled in the center at each end for a heavy gas pipe or iron rod, which is also passed through the gate posts as indicated, allowing the tank to rotate freely. The hog can get on the tank as indicated but the moment the hind legs are clear of the ground the weight on the tank causes it to turn and the hog promptly returns—a rather provoking situation for the hog, but it works.

☐ A dull milling cutter wears out faster than a sharp one and does poor work.

Safety Rung for Ladders

Lamp trimmers, painters, and electricians, who are required to use ladders to ascend steel poles, will find the device

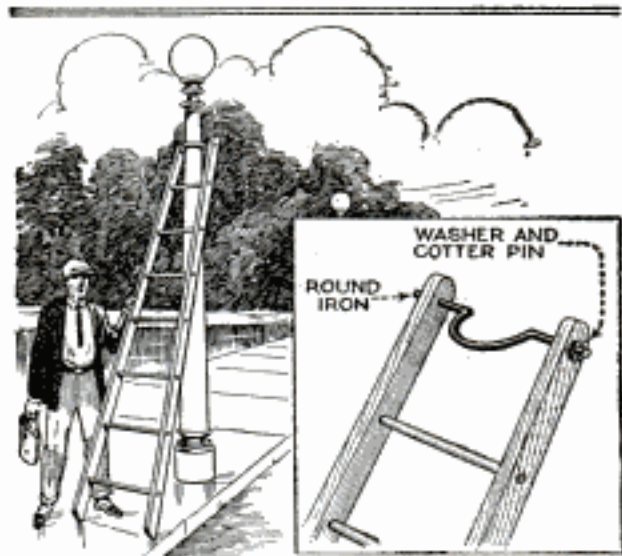

A Curved-Iron Rod Ladder Rung Prevents Ladder from Slipping to One Side

illustrated to be very effective in preventing the ladder from slipping over to one side. The device is simply a length of 1-in. iron rod, bent to the curvature of the poles and substituted for the top rung of the ladder. It is allowed to swing freely but is securely held in place by washers and cotter pins as indicated. The bar will immediately adapt itself to the pole and the danger of the ladder slipping sidewise is eliminated. This method was used by the painters of a traction company to paint bands on the poles, designating car stops.

Cutting Nail Heads

Common wire nails with the heads removed often make excellent pins for various purposes. When a sufficient number of such pins are required the operation of cutting off each head with the cutting pliers is much too slow, and a quicker method of doing the work is necessary. A device with which a number of nails can be cut in a few seconds is shown in the illustration. It consists of

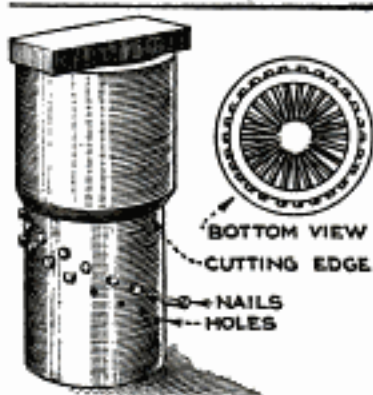

two short lengths of steel tubing, one piece a neat sliding fit inside the other. The internal piece is drilled with rows of holes to fit the nails, the holes being laid off in spiral lines as indicated. One end of the external piece is ground to a sharp cutting edge and casehardened. The internal tube is loaded with nails pushed in the holes from the outside and the external tube dropped over it. Then a piece of metal is placed over the top, and the tube pressed down in a drill press, arbor press, or screw press. A press is used in preference to a hammer, as the pressure is applied steadily and evenly. With the holes in the internal tube laid out as shown, only one head will be cut at a time, so that very little pressure is required.

Preventing Back Draft in Ventilating Pipes

Type-setting machines, vulcanizers and other machines employing gasoline burners for heating require some outlet for the fumes in order to keep the atmosphere of the room in a healthful condition. The most effective arrangement is to connect the heating appliance with a chimney, but as this is often impossible many shops employ a small pipe which is allowed to project through the wall or a nearby window. There is, however, a disadvantage in this arrangement, in that there is often a back draft which causes the fumes and smoke to fill the room and also extinguishes the flame in the burner. This trouble, which was experienced in one shop, was remedied by inserting a Y-joint in the length of pipe so that the lower branch opened into the room as shown in the illustration. This did not materially interfere with the draft of the pipe but the back draft of cold air entering from the outside naturally flowed along the bottom of the pipe and was conducted out into the room as indicated by the arrows. The gases, being warmer than the incoming air, maintained a current along the upper side of the pipe and passed out without interference.

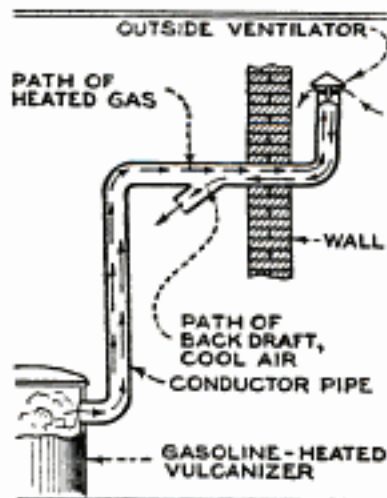

One-Man "Belter" for Concrete Road

The usual method of finishing a cement road is to "belt" it. This is done by drawing a heavy piece of canvas or rubber belting, a few feet longer than the width of the road, back and forth across its surface, the work being done by two men, one at each end of the belt. A simple device which requires only one man for this operation is shown in the illustration.

The device consists of a pipe frame mounted on three wheels, somewhat similar to the hand-power speeder used by signal men on railroads. The belt

is swung from a length of pipe, which is bent to the proper shape, and mounted in bearings on a wooden cross-piece, and the transverse motion of the belt across the

surface of the pavement is obtained by means of a lever at one side of the frame.

As the belt is worked back and forth by means of the lever, the whole frame is pushed ahead on the wheels, which ride on the edge of the side forms; the stakes that hold the forms are driven down a trifle deeper than usual to clear the flanges of the wheels. The pipe frame supporting the belt is so pivoted that it can be swung up clear of the surface when moving the entire device backward or forward to a new position.

The frame also

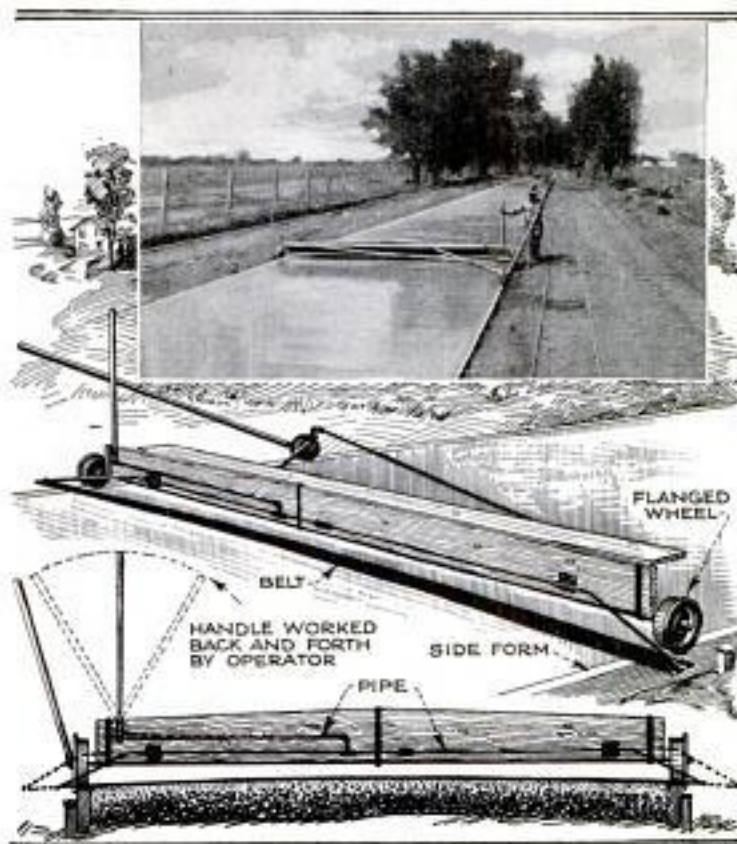

Homemade "Belter" for Concrete Roads, Moved and Operated by One Man

supports a bridge by means of which the finisher can reach any part of the pavement without stepping on the soft concrete.—T. J. Harris, Chicago, Illinois.

Simple Upholstering Tool

One often wonders how the plaits in automobile upholstery are stuffed so evenly and without the lumps usually found if the work is done by hand. This is accomplished by using cotton wadding inserted under the plaits with the device shown in the illustration. This is merely a hardwood stick slightly narrower than the plaits, with a strip of canvas or similar cloth of the same width tacked



to the end. Several thicknesses of cotton

wadding are piled on the stick, the canvas strip is then pulled back tightly over the wadding and the device is inserted into the plait. A second piece of wood of the same width is inserted under the canvas to press the wadding down while the other piece of wood and the canvas strip are removed.

Repairing Large Rubber Stamps

It often occurs that one letter of a large rubber stamp is spoiled and this leaves the whole stamp useless. However, the stamp can easily be repaired and this will save the price of a new one. A piece of smooth leather belting of suitable thickness is obtained and a letter cut out of it, as near a duplicate of the broken one as possible. By trying the stamp out after inking it and making an impression the high spots can be noted. These are then rubbed down by means of a piece of pumice stone.

MECHANICAL POWERS

By CARL W. MITMAN

Curator

DIVISIONS OF MINERAL AND
MECHANICAL TECHNOLOGY
UNITED STATES NATIONAL
MUSEUM



Copyrighted, E. H. Windsor

FOR many months the National Museum in Washington has been designing and building an unusual set of models of remarkable interest. These illustrate most simply and clearly the fundamental principles of the various Mechanical Powers. These models show at a glance, what textbooks have heretofore taken pages to describe. This is the first of a series of articles by Curator Mitman—who is himself an engineer of great ability—which not only explain in simple language what every mechanic and inventor who designs or builds a machine must know, but also tell how any one can exactly duplicate for himself the complete identical set of models in the National Museum. Mr. Mitman tells how to do this with ordinary tools and at practically no expense for materials.

For schools teaching physics or manual training, the opportunity is now presented for the first time of duplicating the set of these models in the National Museum. If one or more classes each year will build a few of the models, which should bear the nameplate of the class, in the course of two or three years the school will possess not only lasting monuments to the classes, but acquire, without cost, the full set for use of all future students, and which can be available to all local mechanics and inventors for all time.

These articles, which will run through many months to come, are being published for the first time and should be preserved for future reference.

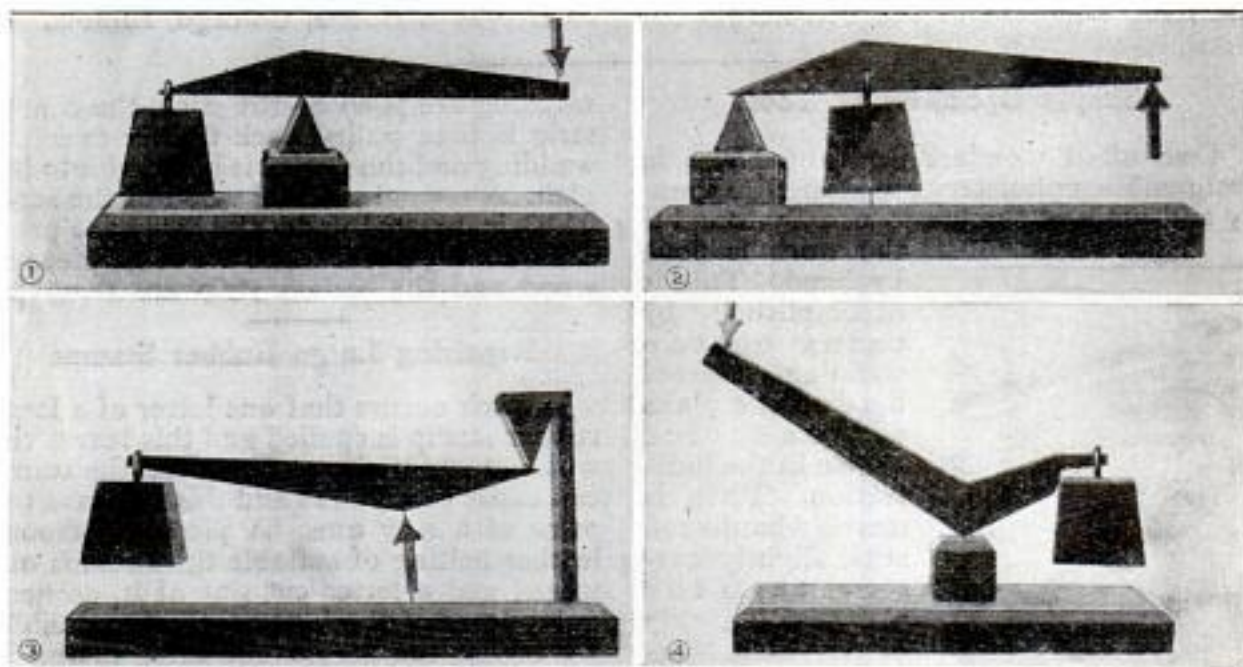

Fig. 1, Completed Model of First-Order Lever; Fig. 2, Model of Second-Order Lever; Fig. 3, Finished Model of Third-Order Lever; Fig. 4, Model Illustrating Angular Lever

Part I—Simple Levers

MECHANICS treats of the action of forces, and their effect. A force is usually defined as any cause tending to produce or change motion. It has only one element, namely, the push or pull exerted. Work, on the other hand, is the result of two elements, force and motion, and work done is the product of force and distance. The mechanical powers, the lever, pulley, screw, etc., depend for their action upon a fundamental principle of mechanics known as the "principle of work." This states that, disregarding friction and other losses, the work done by an

This applies equally to a simple lever and to a complex mechanism, and, incidentally, to the "perpetual motion" machine.

Strictly speaking, the lever is a simple machine and is also the simplest element of a machine. It consists essentially of a rigid bar, straight or bent, which has one point fixed, about which the rest of the lever can turn. The fixed point is called the fulcrum and the perpendicular distances from the fulcrum to the points where the applied force and resisting force act, are called the arms of the lever. When the lever is straight and the applied force

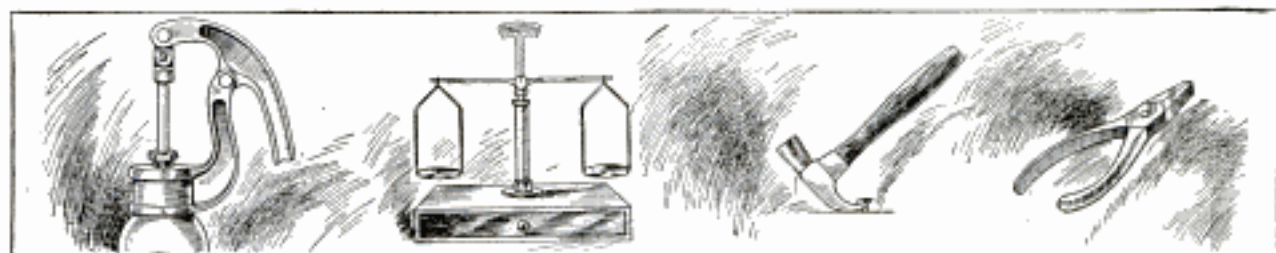

Everyday Examples of the Application of the Principle of Levers of the First Order

applied force always equals the work done against the resisting force. To illustrate this principle consider a lathe in operation. A force, such as the pull of the driving belt, is applied in a given direction at one or more points. The product of this force and the distance through which it moves measures the work that is put into the lathe. The applied force is transmitted to the point where the operation is to be performed (the chuck), but in its transmission the force is changed in direction and amount both by the arrangement of the gearing and by the resisting force of friction, all of which the applied force must overcome. Now, at the chuck the original force, somewhat modified, overcomes a further resistance in any required direction, for example, the resistance of metal, held by the chuck, to a cutting tool. The product of this resistance and the distance through which it is overcome measure the work done by the lathe. Stated simply then: Work put into a machine equals friction losses, etc., plus work done by machine. No machine can be made to do work unless a somewhat greater amount of work (sufficient to cover losses) is applied by some outside agent.

and resisting force act perpendicular to the lever, it is usual to distinguish three classes or orders:

First order. Where the applied force (represented by an arrow) and the resisting force (represented by a weight) act on opposite sides of the fulcrum, as shown in Fig. 1. This order of lever generally gives a mechanical advantage. Its practical use is exemplified by a claw hammer when drawing nails, a pair of simple scales, and the brake of a pump. Double levers of this class are scissors and pliers.

Second order. Where the applied force and resisting force act on the same side of the fulcrum but the former at a greater distance than the latter from the fulcrum, as in Fig. 2. This order always gives a mechanical advantage. Examples of this class are a wheelbarrow, a cork squeezer, a crowbar (with one end in contact with the ground), and an oar (assuming that the blade is in water and at rest); while a double lever of this class is represented by a pair of nut crackers.

Third order. Where the applied force and the resisting force act on the same side of the fulcrum but the former acts at



Illustrations Showing How the Second-Order Lever Is Applied to Common Tasks

a smaller distance than the latter from the fulcrum (Fig. 3). In this order of lever there is a mechanical disadvantage. An

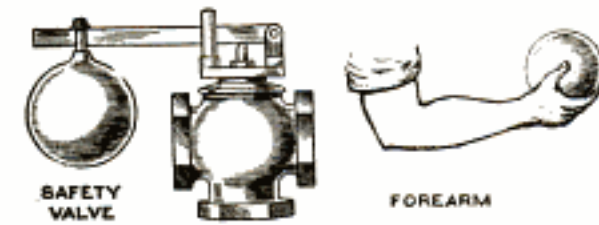

Common Examples of Third-Order Levers

example is a steam-boiler safety valve, also the human forearm when supporting a weight in the palm of the hand. In this latter instance the elbow joint is the fulcrum and the tension exerted by the muscles is the applied force. An example of a double lever is a pair of sugar tongs.

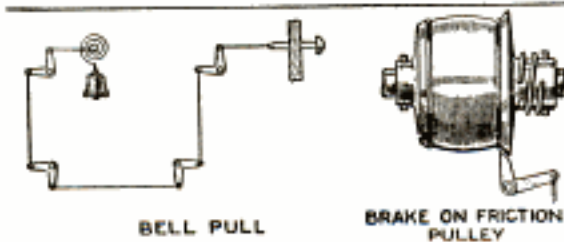

Everyday Applications of Angular Levers

It is easy to conceive of conditions where the use of a straight lever in a machine could not be made. For such conditions the angular lever is available. Probably its earliest use was in ringing bells, hence its more popular name "bell crank." The angular lever works under exactly the same principles as the straight lever and is similarly divided into three classes or orders. Having treated of the three orders of straight levers, however, only the first order of angular lever is illustrated here (Fig. 4). The bell crank is usually a right-angled lever, but, as will be observed, any angle may be used.

The lever, as well as all the other so-called mechanical powers, is of use to man because: First, they enable him to lift weights or overcome resistances much greater than he could deal with unaided. Second, they may cause a motion imparted to one point to be changed into a more rapid motion at some other point, and third, they enable a force to be applied at a more convenient

point or in a more convenient manner. On the other hand, whatever mechanical advantage is obtained by the use of these powers is gained at a proportionate diminution in speed. No work is ever gained by the use of a machine, though mechanical advantage is generally obtained. All of which may be stated in that old saying, "What is gained in power is lost in speed."

The specifications given below are for the construction of stationary or fixed models, but there is no reason why the same parts cannot be made to operate. Furthermore, it is quite feasible to demonstrate the relative advantages of the various types of levers with these models by simply substituting for the wooden weight, representing resisting force, a series of graduated standard weights and using a spring balance attached to the applied force arm to measure the force required to move the various weights. The question as to the amount of power gained by the use of levers will be discussed in the next chapter.

For the model of a simple lever, first order, the materials required are:

- Base, 9" x 3" x $\frac{1}{4}$ ".
- Fulcrum block, $\frac{3}{8}$ " x $\frac{1}{2}$ " x 1" high.
- Fulcrum, base $1\frac{1}{2}$ " square x $\frac{3}{8}$ ".
- Lever arm, 7 $\frac{1}{2}$ " long, $\frac{1}{4}$ " wide, $\frac{3}{8}$ " deep at apex.
- Weight (resisting force), base $1\frac{1}{4}$ " square, top $1\frac{1}{4}$ " square, side $1\frac{1}{2}$ " high.
- Arrow (applied force), 1 $\frac{1}{4}$ " long, $\frac{1}{4}$ " thick, $\frac{1}{2}$ " wide across barbs, $\frac{1}{4}$ " shaft.

Square and face the base and block with a finish bevel on top of each. On the center line of the base and 2 $\frac{3}{4}$ in. from its end, secure the block by gluing and bradding from beneath. On the center line of the block, and with its longest dimension par-

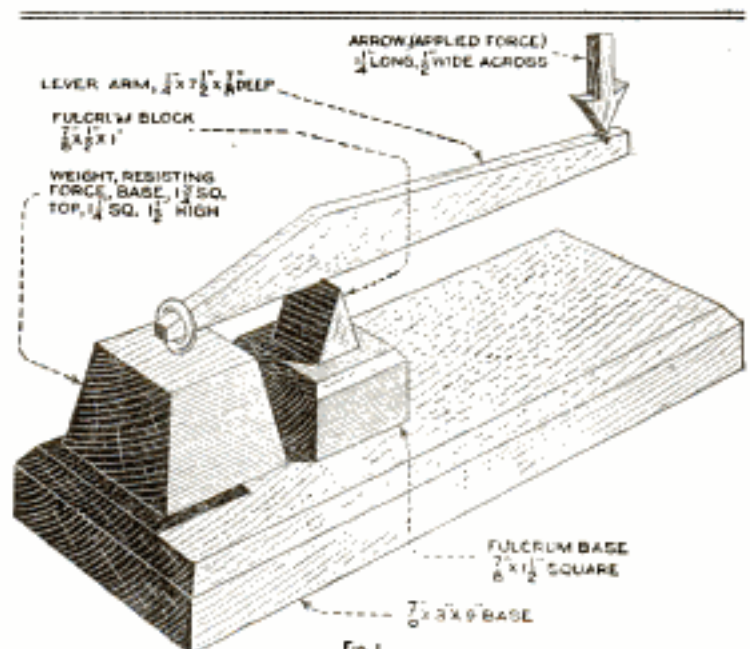

Showing How the Model of the First-Order Lever Is Constructed, with Full Dimensions

allel to the center line, secure the fulcrum by gluing and toenailing. The weight is attached to the lever arm by cutting on

ning parallel to the center line. The weight is secured to the lever arm by opening a screw-eye, by which the weight is handled, and running it through a hole bored close to the bottom edge and under the apex of the lever arm. This point of suspension should be one-third of the distance from the fulcrum. The combination of lever arm and weight is secured to the fulcrum and base by invisible brads. The applied-force arrow is inserted in a small notch cut very close to the extremity of the force arm of the lever. Finish as desired.

For the model of the simple lever, third order, use the following material:

Base, 9" x 3" x $\frac{1}{8}$ ".
Fulcrum gallows, consisting of three pieces:
Pillar, $3\frac{3}{4}$ " x $\frac{3}{4}$ " x $\frac{1}{4}$ ".
Arm, $1\frac{1}{4}$ " x $\frac{3}{4}$ " x $\frac{1}{4}$ ".
Fulcrum, base $\frac{7}{8}$ " x $\frac{1}{2}$ ", side 1" high.
Lever arm, $7\frac{1}{2}$ " long, $\frac{1}{4}$ " wide, $\frac{7}{8}$ " deep at apex.
Weight (resisting force), base $1\frac{3}{4}$ " square, top $1\frac{1}{4}$ " square, side $1\frac{1}{2}$ " high.
Arrow (applied force), $1\frac{1}{4}$ " long, $\frac{1}{4}$ " thick, $\frac{1}{2}$ " wide across barbs, $\frac{1}{4}$ " shaft.

Square and face the base and finish with a bevel. Equally divided on the center line of the base, and $\frac{1}{2}$ in. from the end, cut a mortise $\frac{3}{4}$ in. x $\frac{1}{4}$ in. x $\frac{3}{8}$ in., in size. Square and dress the pillar and arm of the gallows and secure the arm on top of the pillar by glue and brads. Secure the fulcrum to the under side of the gal-

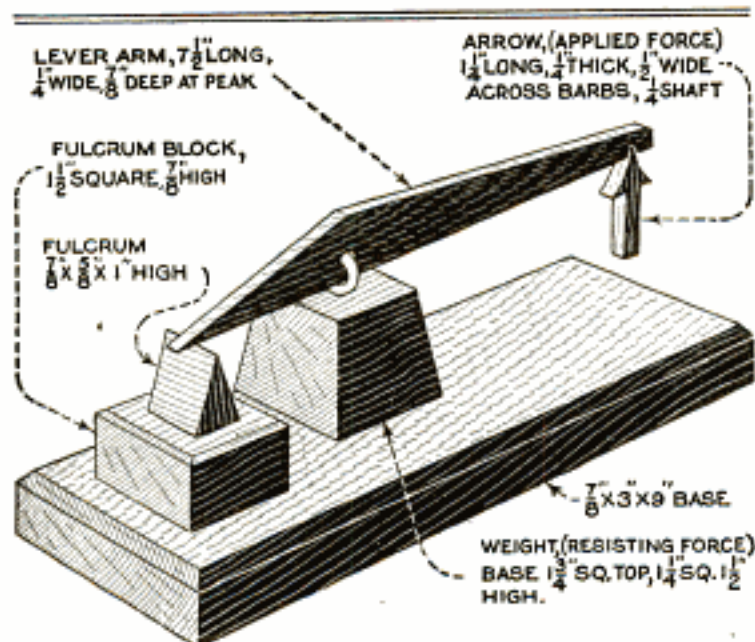

Fig. 2

Details of Model of a Lever of the Second Order, with Sizes of Parts

the shorter end a small notch which will accommodate the screw-eye used as a handle for the weight. The applied-force arrow is attached closely to the force arm of the lever by inserting it in a small notch. This assembly of lever, force arrow and weight is secured to the fulcrum by the use of an invisible brad as a dowel, inserting the brad into both the peak of the fulcrum and the lower side of the lever arm at a point under the apex, which should be one-third of the distance from the end of the lever. Finish as desired.

For the simple-lever model, second order, the following materials are used:

Base, 9" x 3" x $\frac{1}{8}$ ".
Fulcrum block, $1\frac{3}{4}$ " square x $\frac{1}{4}$ ".
Fulcrum, base $\frac{7}{8}$ " x $\frac{1}{2}$ ", side 1" high.
Lever arm, $7\frac{1}{2}$ " long, $\frac{1}{4}$ " wide, $\frac{7}{8}$ " deep at peak.
Weight (resisting force), base $1\frac{3}{4}$ " square, top $1\frac{1}{4}$ " square, side $1\frac{1}{2}$ " high.
Arrow (applied force), $1\frac{1}{4}$ " long, $\frac{1}{4}$ " thick, $\frac{1}{2}$ " wide across barbs, $\frac{1}{4}$ " shaft.

Square and face the base and block with a finish bevel on top of each. On the center line of the base, and $\frac{1}{2}$ in. from the end secure the block by gluing and bradding from beneath. On top of this, glue and toe the fulcrum with its longest dimension run-

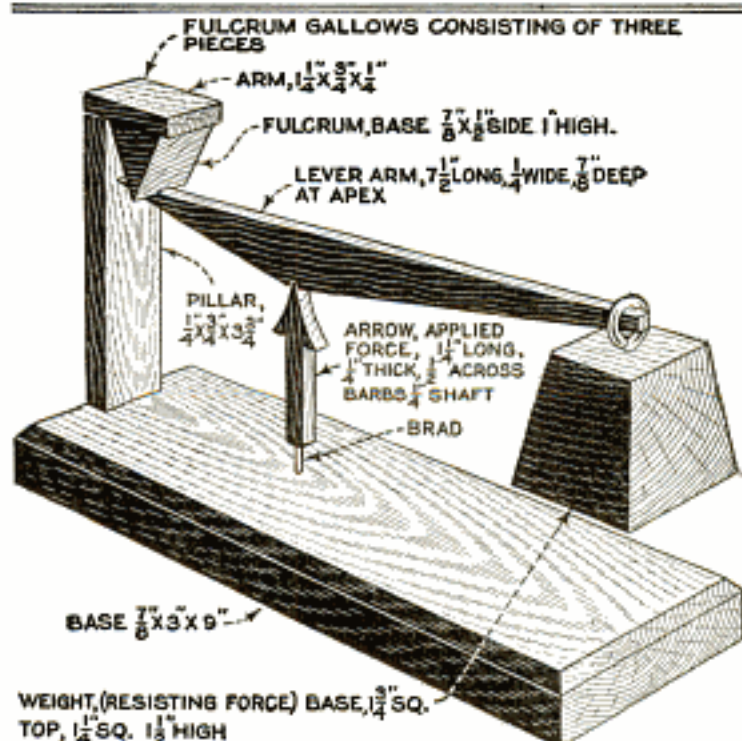

Fig. 3

Drawing of Model Illustrating Principle of Third-Order Lever

lows arm by glue and brads. Insert this assembly into the mortise and secure by glue. On the long end of the lever arm fasten the weight by accommodating the screw eye, used as a handle, in a small notch cut on the flat edge of the lever arm. Secure the applied-force arrow to the apex of the fulcrum by inserting its point in a notch. This assembly is fastened to the remainder of the model by bradging the toe of the lever arm to the peak of the fulcrum, using a brad as a dowel to support the force-indicating arrow in a vertical direction. Stain, finish, and polish in any manner desired.

For the angular lever; first order:

Base, 9" x 3" x $\frac{3}{8}$ ".

Fulcrum block, $1\frac{1}{2}$ " square by $\frac{3}{8}$ ".

Angular lever:

Force arm, 6" by $\frac{1}{4}$ ", 1" at apex, $\frac{1}{2}$ " at end.

Weight arm, 3" x $\frac{1}{4}$ ", 1" at apex, $\frac{1}{4}$ " at end.

Weight (resisting force), base $1\frac{1}{4}$ " square, top $1\frac{1}{4}$ " square, side $1\frac{1}{2}$ " high.

Arrow (applied force), $1\frac{1}{4}$ " long, $\frac{1}{4}$ " thick, $\frac{1}{2}$ " wide across barbs, $\frac{1}{4}$ " shaft.

Square and face the base and block, with finish bevel on top of each. Upon the

center line of the base and 4 in. from the end secure the block by gluing and bradging from beneath. The angular lever may

be constructed in either of two ways, the simplest being to lay out the dimensions given upon a one-quarter inch board, placing the arms at an included angle of 130°, and sawing out the arm. Another method, which would be more economical in wood, and would obviate the danger from weak grain, would be to build up the angular lever from two pieces, joining them at the apex with a halved-to-

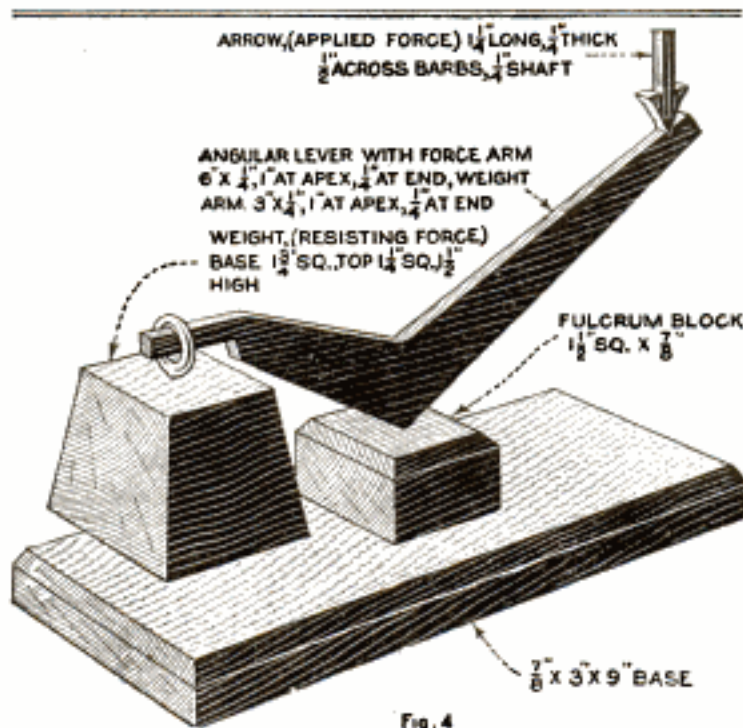

FIG. 4

Model of Angular Lever of the First Order, with Dimensions of All Details

gether lapped joint. The weight is attached to the short arm of the angular lever by inserting the screw eye, used as a handle, in a small notch and cutting away a portion of the weight arm to allow the weight to swing vertically. The applied-force arrow is secured to the force arm of the lever by inserting the point in a small notch. This assembly is secured to the block by using a brad as a dowel, inserting this into both the apex of the lever and the center of the block. Finish as desired.

Homemade Ladder Hook

A ladder hook, attached to the upper end of a ladder as a means of holding it in place securely, is a measure of safety as well as convenience. One that is simple to make is shown in the illustration. It consists of two $\frac{5}{8}$ -in. steel rods and two collars. The largest rod is 4 ft. long and is bent at both ends, one end to fit the rungs of the ladder and the other end bent into a semicircle about 6 or 8 in. in diameter and ground to a point. The other rod is 2 ft. long and has one end bent to fit the ladder rungs. The collars are large enough to accommodate both rods, as shown in the cross section. After the rods are slipped

into the collars and adjusted on the top rungs of the ladder as shown, the setscrews in the collars are tightened down to hold the rods securely. The hooks must clamp the rungs of the ladder firmly so that they will not slip sideways.

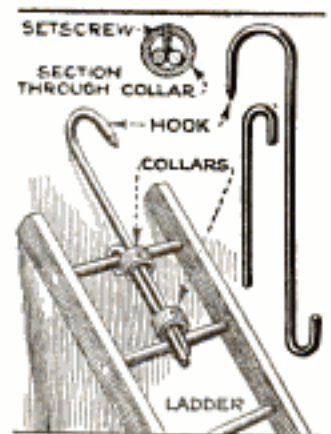

When lubricating broaches, direct the stream into the hole at the top.

Oil Can Spreads Stamp Ink

Applying ink to stamp pads by pouring some ink out of the bottle and then spreading it over the surface of the pad with a knife, is a slow and inconvenient task, and in doing this one is very likely to get the hands soiled with the ink, which is extremely difficult to remove. A much better method of applying stamp ink is to use an oil can with a short spout and a fairly large outlet.

Removing Burrs on Turret-Lathe Work

Half the time ordinarily required for filing off burrs on turret-lathe work can be saved on many jobs by using two files arranged as shown in the accompanying drawing. This method was employed in a shop producing a large quantity of brass collars, the wire edges on both sides being

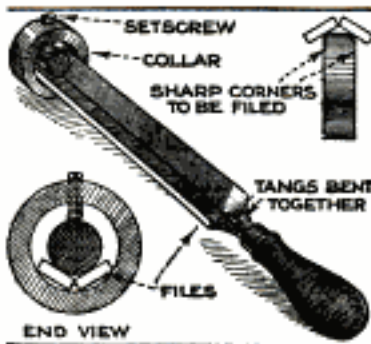

removed in one operation.

The files are held in proper position by a collar and a loose piece of rod, slipped through the collar as shown. The tangs of both files are bent

inward and driven into an ordinary file handle. By varying the size of the rod and the diameter of the hole, the files can be set to suit different widths of work.

An Emergency Pipe Wrench

When unscrewing a cap from a gas pipe that projects through the wall, it frequently happens that the nipple turns instead of the cap. The nipple is usually so short that a pipe wrench cannot be used to hold it and therefore other means must be employed. Clamp a narrow iron bar and a nail set or punch on the nipple by means of a C-clamp as shown in the illustration, to hold the nipple securely, and the cap can then be unscrewed quite easily, and without any further difficulty.—Edwin M. Love, Alhambra, Calif.

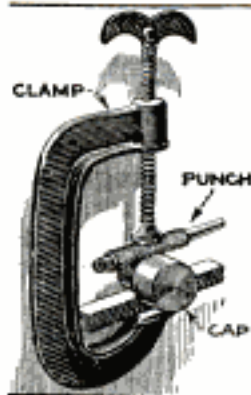

Field Protractor for Vertical Angles

Vertical angles for railroad fills and embankments, altitudes for topography, etc., can easily be determined by using a simple

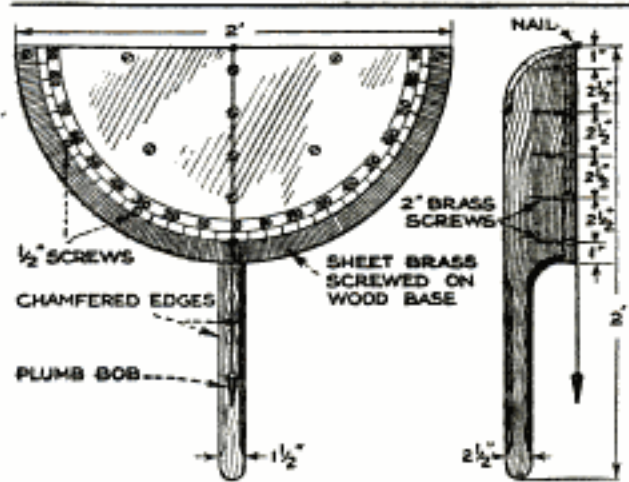

A Simple Homemade Hand Level Which Will Prove of Assistance to the Amateur Surveyor

protractor of the kind shown in the illustration. It is made from a piece of heavy sheet brass, cut to a semicircular shape having a radius of 1 ft., and graduated into degrees from 0 in the center to 90 at either side. The graduating marks and numerals are etched on, which is done by first covering the brass with a thick film of asphaltum varnish or wax, and, when dry, scratching through it with a sharp scriber. The brass is then etched by applying a solution consisting of 16 parts of nitric acid in 160 parts of water, and 6 parts of potassium chlorate in 100 parts of water, the two solutions being made separately and then mixed together. Whenever an acid and water are mixed the acid must always be poured into the water; never the water into the acid, in order to avoid accidents. Nitric acid also causes severe burns and its fumes are highly poisonous, which makes it necessary to handle it with extreme care.

After the brass is etched to the desired depth, the wax is removed and the plate is screwed firmly to a 1/2-in. wooden base of the same size and this is screwed to a wooden handle as shown. The handle also serves to prevent the base from warping or splitting. A nail is driven into the upper part of the handle and a plumb bob suspended from it. The wooden parts of the instrument are made of hard, tough wood, such as maple or beech, varnished or oiled.

In use the instrument is held so that the plumb bob will swing freely and when it is at rest the angle can be read by an assistant.—J. J. Brehm, Baltimore, Md.

Weeder for Small Crops



Homemade Weeder for the Early Cultivation of Small Crops Such as Soy Beans and Small Corn

A homemade weeder of the kind shown in the photograph has been found to be an excellent tool for the early cultivation of soy beans and small corn. It is made by joining together two weeders, side by side as shown, and hooking them to the frame of an old corn cultivator. With a team of horses hitched to this improvised weeder, and a small boy driving, a surprising acreage of ground can be cultivated in one day. It roots out the small weeds and grass without damage to the crop.

Cutting Circles with Torch

The cutting-torch attachment shown in the photo will be found useful when cutting off the corners of square plates and other similar work where the torch moves in a circular path. A piece of flat plate, bent over to fit the torch tubes, is drilled through the side and squared out for a nut, into which a pointed, headless screw threads. This completes the attachment with the exception of a piece of flat brass, bent over the top of the screw to pre-

vent it from marring the tube. In operation, the work is laid out from a center as usual, and the end of the pointed screw placed on the center before commencing the cut. The attachment is slid along the torch tubes to the required position and locked by turning the screw.

An Adjustable Scaffold

Painters and paperhangers often use a scaffold made by extending a plank between the steps of two stepladders. As the height of ceilings varies, the plank can be raised or lowered one or more steps to suit the worker, but the change of a foot in the height of the scaffold is often too much. For this reason the hooks shown in the photo will be found very convenient, as with their use, the scaffold can be raised or lowered to any desirable height. The hooks are made of $\frac{1}{2}$ -in. iron rod, bent as indicated, and threaded for almost their entire length. A 14-in. length of flat steel, $\frac{1}{4}$ in. thick and 2 in. long, is drilled at each end to fit loosely on the hooks, and nuts are screwed on, as shown, to hold the bar at any point. The hooks are hung on the steps and the plank is placed over the bars. Four hooks and two steel bars form a complete set.

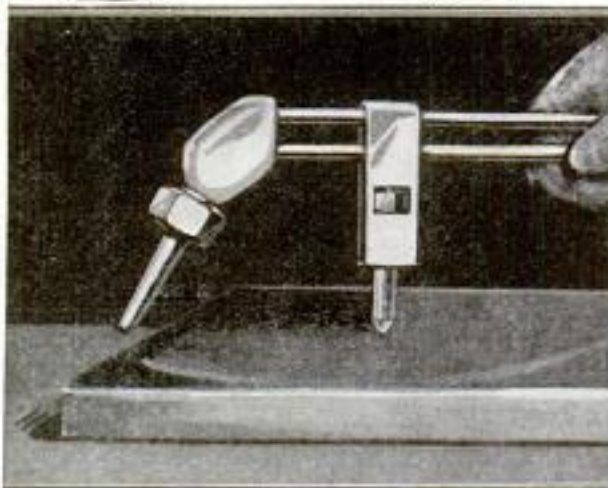
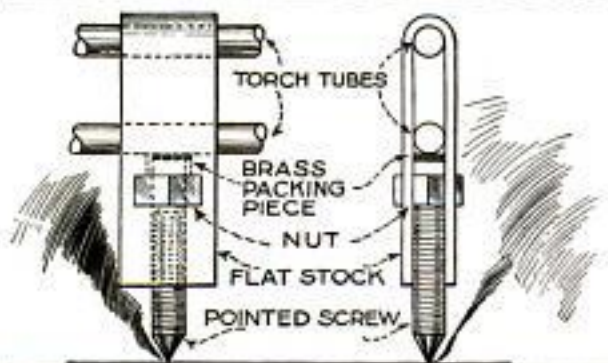

Simple Attachment for a Cutting Torch, Which Is of Great Assistance in Making Circular Cuts

Ⓞ A fine feed must be used on milling-machine work that is likely to be easily sprung.



AMATEUR MECHANICS

Building a Small Turbine Motor

By B. FRANCIS DASHIELL

A SMALL turbine motor can be used in a number of ways and the one described in this article will operate on steam, compressed air, or the ordinary house water supply. As a water turbine, its efficiency is very high.

The construction work can be done in the experimental shop, and complete dimensions and plans are given herewith in the accompanying drawings. A pattern should first be made for the housing and cover plate, after which the parts may be cast at a foundry in either iron, brass, or babbitt metal, prefer-

ably iron. The entire details of the turbine housing are indicated in the drawing, but the cover plate was not detailed, as it should merely be $\frac{1}{4}$ in. in thickness and shaped so as to match the housing at all points. A base flange is made on the cover plate, the same as that on the housing, and the remaining portion of the top flange is constructed so that when the cover is screwed to the housing, a complete flange coupling is obtained for the bolting on of an ordinary pipe coupling.

After the casting has been made, it should be smoothed up in the

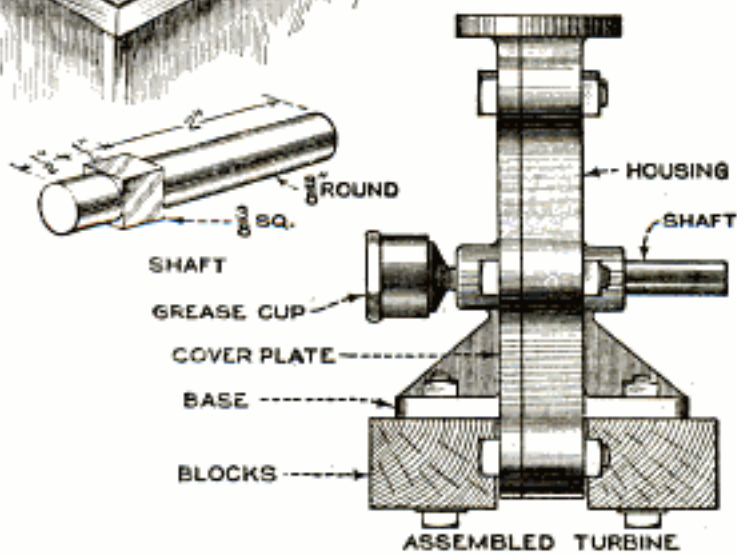
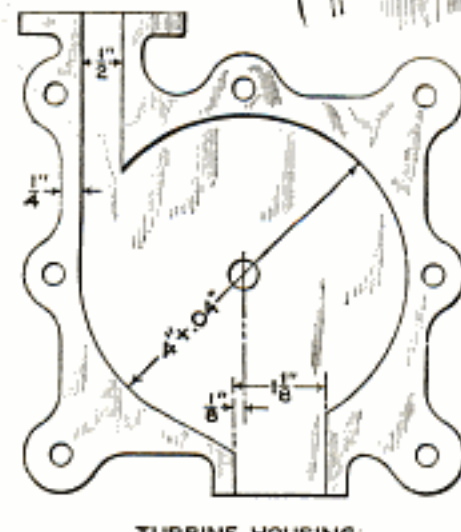
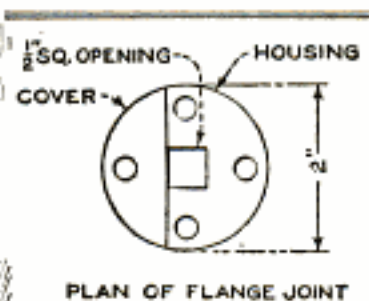
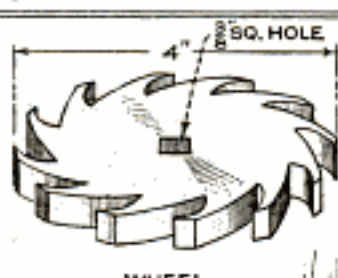

Details of Construction of Simple Turbine for Operation on Steam, Water, or Compressed Air, Which Can Be Built in the Small Workshop and Used for a Variety of Purposes

shop. A light cut should be taken in a lathe so as to bring the inside diameter of the wheel housing to the proper size. The face of the housing should be trued up as well as the cover plate. If this is carefully done, the wheel should rotate within its housing, making a perfect running contact with its sides as well as with the periphery of the wheel. Such a perfect sliding fit will add much to the power obtained from the turbine. Drill the shaft hole in the housing, using a $\frac{3}{8}$ -in. drill. The shaft hole or bearing in the cover plate is not drilled all the way through, but only $\frac{1}{2}$ in. in depth. The rest of this hole is smaller and threaded so as to take a small grease cup, which should be screwed in place. Drill all necessary capscrew holes, and tap those in the housing.

The wheel may be a rough casting which has been turned up to an exact 4 in. in

diameter. The two sides should be ground or planed down parallel, so the wheel will be exactly $\frac{1}{2}$ in. in thickness. A $\frac{3}{8}$ -in. square hole is cut in the center for the shaft. This shaft is made up of a piece of $\frac{3}{8}$ -in. square stock, turned down at the ends, but still retaining the $\frac{3}{8}$ -in. diameter. No key is required to hold the wheel on the shaft as it is impossible for either to move after the cover plate has been bolted in place.

The turbine should be bolted down to two heavy pieces of timber to hold it in position and permit free exhaust or drainage for the waste or overflow, of steam or water. A support may be so arranged that the turbine can be direct connected to a generator for the production of electricity for charging batteries, etc. A small pulley can be fitted to the shaft and used to operate light machinery.

Additional Silencer for Auto

The illustration shows an additional silencer for the automobile exhaust pipe. It consists of a piece of $\frac{1}{2}$ -in. sheet iron, cut out as shown and bent to the shape of a cone. The narrow end is clamped to the short section of exhaust pipe that extends from the muffler, and the wide

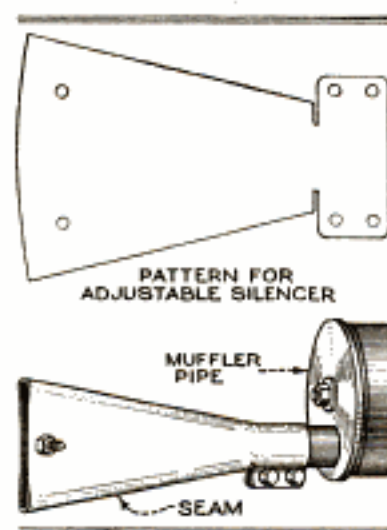

end has two holes drilled through it near the edge, and is fitted with a bolt so that the size of the opening can be varied. Of course, this attachment causes additional back pressure, and it should therefore be used in the city only.

When motoring through the country at a greater speed than is customary in the city, it is best to remove the bolt so that the exhaust gas can escape quickly, and there will then be no danger of overheating the engine. The best method of determining the size of the cone is to use the "cut-and-try" method, with a piece of paper as a pattern. The edge of the sheet-metal cone is joined with a seam, made by bending over the edges about $\frac{1}{4}$ in. and hammering them down with a light

hammer. With the silencer nearly closed, the exhaust causes only a slight whistling sound that can hardly be heard at a distance of 20 or 30 feet.

Rat Poison

The most effective means known for destroying rats is to poison them. Powdered barium carbonate is an inexpensive mineral, and one that is excellent for this purpose.

Other poisons commonly used are phosphorus, arsenic, and strychnine. The use of phosphorus is attended with danger from fire, arsenic is uncertain in its action, while strychnine is readily detected by rats and is too fast in its action to make its use desirable in buildings. Powdered barium carbonate, however, is effective, inexpensive, and relatively safe. It should be thoroughly mixed and worked into soft baits in the proportion of 1 part of the mineral to 4 parts of the selected food. Water is added in sufficient quantity to make the baits moist. Food moistened to the consistency of soft mush is particularly acceptable to rats in dry weather. The barium carbonate should be sifted over sliced baits and rubbed well into them with the fingers or a knife. The slices should be thin and should be moistened if necessary to attain as nearly as possible the 1 to 4 ratio. Soft baits may be mixed with the hands or with a spoon. Barium carbonate has the advantage of being slow in its action so that the rats affected by it have time to leave the premises in search of water or to return to their burrows before they succumb. Baits that are likely to

sour under the influence of warmth should be removed daily and fresh bait substituted; if left exposed in warm places for more than a day they will sour and the resulting acid will give them a bitter and highly objectionable taste and odor.

Poison used in chicken inclosures should be put in places that are inaccessible to the chickens, as behind or under boxes, and it should be very wet, or of such a nature that the rats cannot drag it out.

A variety of baits used separately not only gives the rat a choice of foods, but tends to make it less suspicious. One kind of each of the following classes of food mixed with barium carbonate is recommended: Meats such as hamburger steak, sausage, fish, liver, bacon and the like; vegetables and fruits such as thin slices of muskmelon, apple, tomato, or cucumber, canned corn, or squash or pumpkin seed, mashed banana, boiled carrot or baked sweet potato, and cereals. Kitchen scraps and garbage can be worked into the ration to advantage.

Barium carbonate is a relatively mild poison, but the danger from accidents cannot be over-emphasized. It should be kept out of reach of children and irresponsible persons, and from domestic animals and fowls. In case of accident the antidote is an emetic consisting of mustard or salt dissolved in warm water. Vomiting can also be induced by inserting the finger in the back of the throat.

Method of Stretching Green Furs

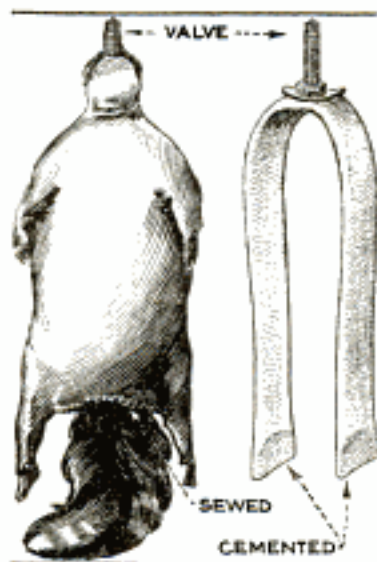

Old inner tubes can be used to advantage for stretching green furs. The tube is cut off to a suitable length and the ends cemented together as shown in the illustration. It is then put in the fur and after the valve is drawn through the mouth, and the rear part of the fur sewed up, the tube is inflated with an ordinary automobile tire pump. This method will stretch the skin uniformly without distorting or injuring it in any way.—H. H. Siegele, Emporia, Kan.

Improved Bough Bed

To make an exceptionally comfortable bough bed for the camp does not take much more time than is usually consumed

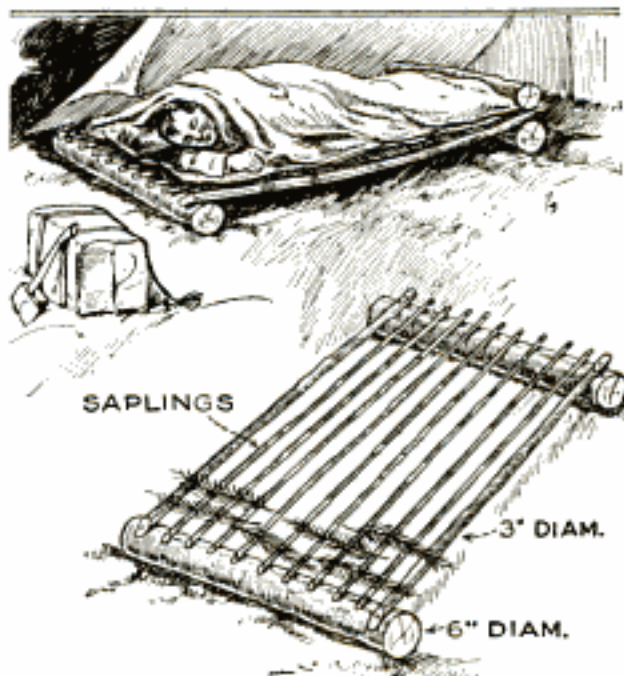

A Comfortable and Healthful Bough Bed for Campers, that Can Be Made as Easily as the Ordinary Type

in the building of an ordinary one. Two logs, about 4 ft. long and 6 in. in diameter are used for the end pieces, and to them are nailed several 7-ft. lengths of springy, green saplings of uniform diameter—about $1\frac{1}{2}$ in., these having been trimmed down to free them from offensive projections and spaced about 3 or 4 in. apart. The saplings on the sides should, however, be about 3 in. in diameter. A 4-in. log can be used across the bottom end to hold the blankets down, which will be appreciated considerably on cold nights. A mattress about a foot thick is then made by placing small twigs across the saplings. Due to the air space underneath, a bough bed of this kind is much more healthful than a bed built on the ground.—R. Melrose, St. John, Can.

Preventing Windows from Steaming

Steamed and frosted windows are a source of annoyance to many housewives as the moisture not only obstructs the view but also soils the glass through the accumulation of dust when sweeping or cleaning. A cloth bag containing a few spoonfuls of tobacco, placed in the water used to wash the windows, will overcome this trouble and will also impart a clear, crystal effect that is very pleasing.—G. E. Hendrickson, Argyle, Wis.

Inexpensive Sign Hanger

Substantial and attractive metal signs can readily be made from lengths of pipe and fittings and a piece of sheet metal.

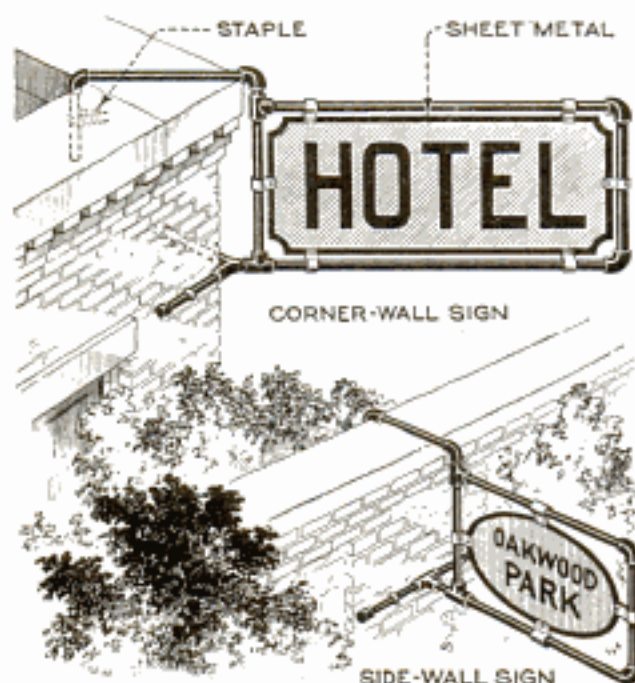

Substantial Signs Made from Pipe and Fittings and Heavy Sheet Metal

The hanger is attached to a building as shown in the illustration; no guy wires or bracing of any kind are required to support it, still it is so solid that the strongest winds will not loosen it. Two different designs are shown; one for mounting the sign at right angles to the sides of a building and the other for mounting it on a corner so that it can be seen from two streets. The sign itself is a piece of heavy sheet metal attached to the pipe frame by means of metal clips, passed around the pipe and riveted to the edge of the sheet metal as shown.

Bucket Reduces Speed of Fishing Boat

According to manufacturers' statistics about 90 per cent of the detachable rowboat motors are purchased by pleasure anglers who go trolling for trout, salmon, or other fresh and salt water game fish. However, the disadvantage of using these motors for this purpose is that they cannot be throttled down to run slowly enough for trolling, without being fitted with a special low-pitch trolling propeller, which the manufacturers provide as an accessory. One man, experiencing this difficulty, tied an ordinary galvanized-iron water pail to the stern of the boat with a 15-ft. rope so that the bucket would serve as a small "sea anchor" and retard the speed of the boat.

The resistance of the bucket dragging astern was sufficient to give the boat the exact trolling speed desired when the motor was operated with throttle half open.

A bucket is part of every angler's equipment and its use for this purpose saves the expense of purchasing a special trolling propeller, which entails the constant bother of changing propellers.

Cleaning White Woolens and Furs

Garments are often dry cleaned at home but the result obtained in the case of white woolens or furs is not always satisfactory. However, the simple trick described below can be employed by anyone, and the results will prove a pleasant surprise.

After the woolen or fur has been washed and rinsed in gasoline, it should be wrung or shaken out thoroughly and placed in a deep pan. A pound or two of white flour should then be sifted over and rubbed into the article. After allowing the article to dry on the line, the flour is whipped out, leaving the garment in a cleaner and whiter condition than usual after cleaning. This is due to the fact that the flour sifts into the fur or fabric and absorbs the dirt with the gasoline that cannot be wrung or shaken out. When whipped out, the dry flour naturally carries the dirt with it.

Pulling Car Out of Mud

When stuck in mud the lone autoist need not despair as long as he has a pair of good chains with him, for, with their help, the car can usually be run out of the mud, providing of course, it is not too deep. One end of a chain is fastened around the tire and to the spokes of a rear wheel, as shown in the drawing, while a short, stout iron bar is pushed through the links at the other end of the chain and a tow rope tied to this bar. If no iron bar is handy or it is too large to be pushed through the links, the tow rope is tied to the

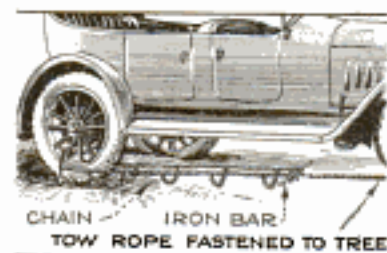

last cross chain. The other end of the tow rope is securely tied to a tree located in front of the car, slightly toward the side. By applying power to the wheel, it will run along the chain for a foot or more. The operation is repeated until the wheel is out of the mud.

Tools Made from Sewing-Machine Heads

By RUPERT A. ANDERSON

VERY effective small machine tools for the amateur's shop can be made from discarded sewing machines. The drill press shown in the illustration has as its most important feature a sewing-machine head. This was adapted for the job with very little alteration, and saved a great deal of time and work.

The materials needed are: A sewing-machine head complete with spindles and bevel gears in the top; a base, in this case taken from an old cream separator; a set of 6-in. fast and loose pulleys; a set of cone pulleys (made from Ford fan spindles and crankshaft pulleys); shafts of suitable size for head and chuck; small countershaft bearings; a chuck, and a few pieces of auto-frame channel iron and flat bar steel.

The first thing to do after getting the machine head is to decide on the vertical-spindle travel; about 3 in. is suitable for most purposes. The needle-bar end of the head is then sawed off, leaving the bearing flush with the end, and the end of the head dressed off to the shape desired. Both bearings are then reamed to the same size, which should be standard so as to take a cold-rolled steel spindle. The lower end of this spindle is threaded to fit the chuck, which may be a breast-drill chuck, and which may have to be fitted to a sleeve, which, in turn, is fitted to the spindle. The other end is grooved to take a small split washer, used as a thrust bearing. This groove is cut a little farther above the head than the travel of the spindle.

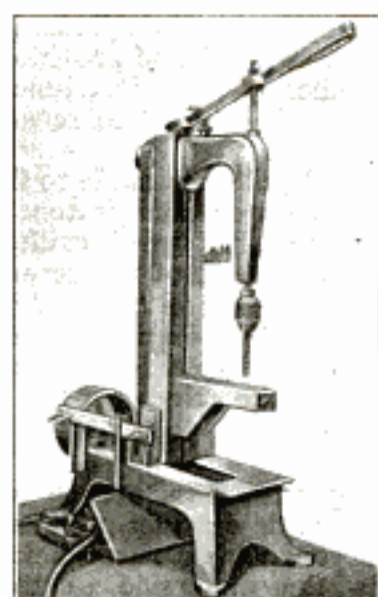

THREADED FOR CHUCK

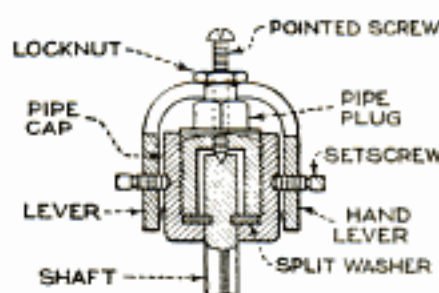

THRUST-BEARING DETAIL

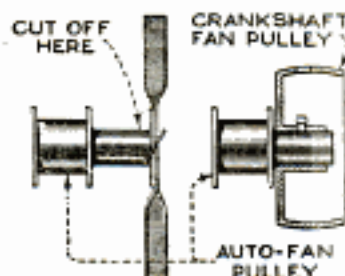

CONE PULLEYS

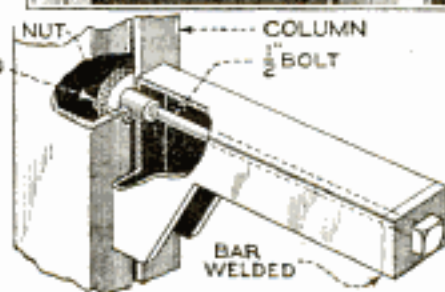
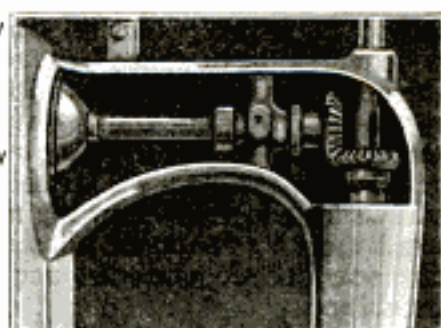

ELEVATING TABLE

SHAFT
DETAIL OF DRILL PRESS

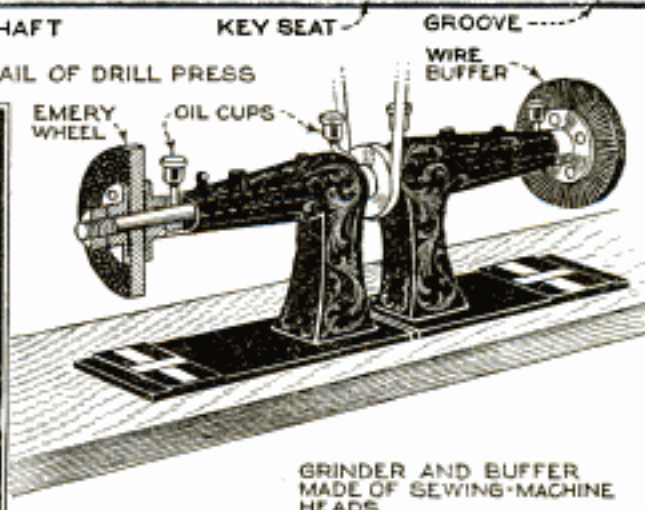
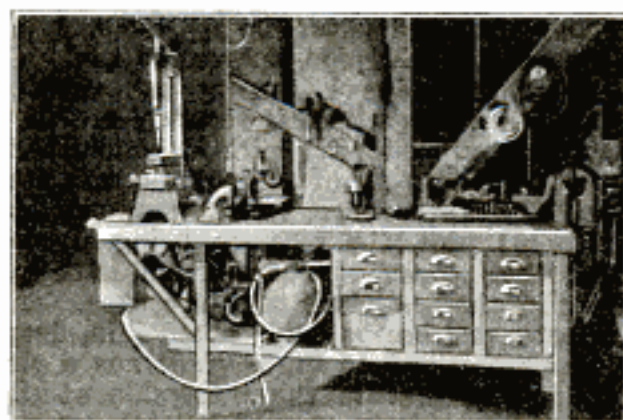

GRINDER AND BUFFER
MADE OF SEWING-MACHINE
HEADS

Upper Left, Finished Drill Press; Upper Right, Gearing in Head; Center, Details of Construction; Lower Left, Bench, with Drill in Place; Lower Right, Grinder and Buffer

The thrust bearing holds the spindle up when running idle and pushes it down when drilling. It may be made from a pipe cap and plug as shown in the detail; the plug is drilled to clear the spindle at one end, and for a pointed setscrew at the other. The screw bears against the center in the end of the spindle, and the plug locks the split washer to the shaft and pipe cap. The hand lever is pivoted to the cap by two pointed screws, bearing in drill spots.

The bevel gear is keyed to the shaft, the key being a sliding fit in the gear, and somewhat longer than the required travel. The gear is kept meshed with its mate by a plate fastened to the head under it. The horizontal shaft is now put in, and the head packed in grease.

Two pieces of the channel iron are cut to the desired height and bolted together, webs out, with spacers on the bolts so as to leave $\frac{1}{2}$ in. of space between the edges of the flanges. The standard thus made is mounted perpendicularly on the base, by means of small angle plates, and the head screwed to the upper end, using the same screws as used on the sewing machine. The head must be mounted absolutely square, as upon this depends the accuracy of the machine.

The method of making the cone pulleys is clearly shown, and demands no explanation. The countershaft may be fitted

wherever desired, but is neater if mounted on the base. If this is done, the fast and loose pulleys should overhang, so that the belt can be run downward, if desired. A spring is attached to the rear end of the flat-steel hand lever to keep it raised when not in use.

The illustration at the lower right shows in detail the elevating table, which also must be exactly square with the standard. This may be altered so as to allow it to swing to the sides, which would allow work to be drilled that otherwise could not be handled.

In making the grinder and buffer shown in the lower illustration, two sewing-machine heads of the same height are selected. The needle-bar ends are cut off as before, the ends dressed off smooth, and the bearings reamed to standard size. The heads are then mounted on a base, and are held in line by the spindle. The spindle is threaded right and left hand, and provided with nuts and washers to fit. The inner washer at each end is threaded to screw on the spindle.

A small V-grooved pulley is made to fit closely between the heads, and fastened with a headless setscrew. If a hole is drilled in the shaft to take the end of the screw there will be little danger of the pulley slipping. The pulley should be fitted so as to prevent end play. Providing oil or grease cups completes the grinder.

Homemade Auto Heater

The comfort of winter auto riding can be greatly increased by installing a heater of the type shown in the drawing. It

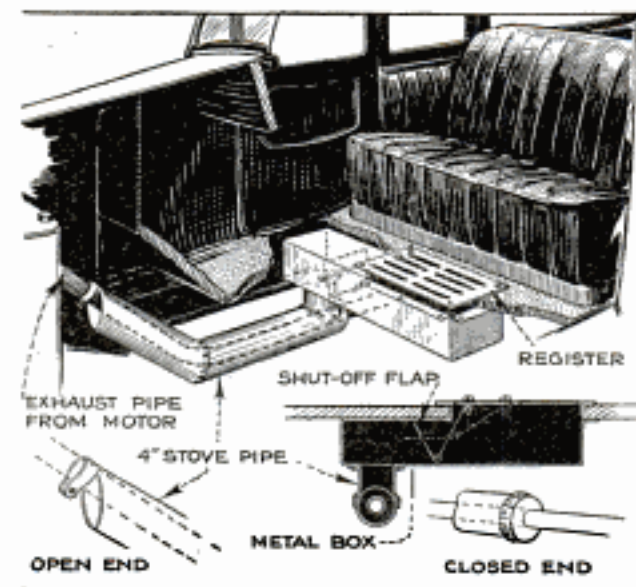

A Homemade Heater Adds Considerable Comfort to Auto Driving During the Cold Winter Months

consists of a length of 4-in. stovepipe, which is hung on the exhaust pipe as shown, and connected with a sheet-metal box, fastened to the underside of the floor. A hole is cut in the top of the box, and in the floor, to allow the heated air to enter the car. There is no danger of getting any exhaust gas or foul air into the car, as fresh air, rushing through the radiator enters the open end of the stovepipe, and after being warmed by the hot exhaust pipe, enters the car.

The stovepipe is cut at one end to form a clamp, which is securely attached to the exhaust pipe with a small stove bolt. The length of stovepipe consists of sections, to conform to the shape of the exhaust pipe, the sections being riveted together securely. The rear end is closed so that the heated air cannot escape. The sheet-metal box is made about 2 in. deep, 6 in. wide, and 16 in. long; it has a circular hole cut in the underside at the point where it is connected to the stovepipe and a rectangular hole on top about 5 by 9 in., so that a 5 by 9-in. register can be fitted over it. A number of holes,

drilled in the floor, would serve the purpose of a register, but would not present such a neat appearance. A shut-off flap is provided inside of the box, so that the heat can be shut off if desired. The flap is made of sheet iron, fitting loosely in the box as shown, and operated by a screw sliding in a slot in the register, the screw being connected to the flap with a length of stiff wire.

Drawing on Glass

Writing or drawing on glass is not very easy as the ink will not take well unless the surface has been sized. A good size for this purpose can be made by adding 3 or 4 drops of good glue to an ounce of water, and stirring or shaking the water until the glue is well dissolved. The size should be used at once as it will not keep very long, due to the evaporation of the water.

Before applying the size, the glass must be cleaned well. A few drops of the size are then poured on, spread over the surface evenly by turning and tilting the glass, and the glass is then set on a level surface to allow the size to dry. When thoroughly dry, the coated side is ready to be written or drawn upon.

Effective Mud Chain

When the rear wheel of an automobile is sunk in mud nearly up to the hub, it is impossible to get the chain on around the tire, and the motorist then has quite a job trying to get out. In such cases a chain that fits over half of the tire has been found to be of considerable assistance. An old chain is used for the purpose; it is cut in two and

one half is slipped over the upper part of the tire as shown. Two 4-in. lengths of chain, having the hooks attached, are cut from the other half of the chain, and used to fasten the ends of the half chain on the wheel. A piece of cloth or leather wrapped around the short chains will keep them from scarring the wheel.—Grover Brinkman, Okawville, Ill.

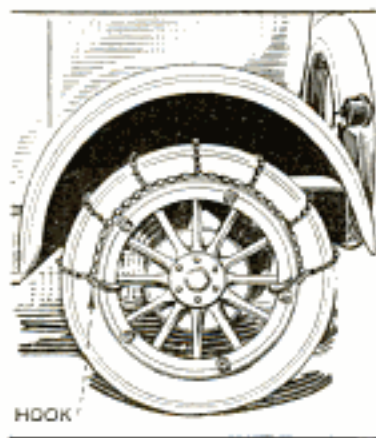

Jogging Wall for Bookcase

In order that the bookcase in the living room should be flush with the inside surface of the wall, a Nebraska home builder

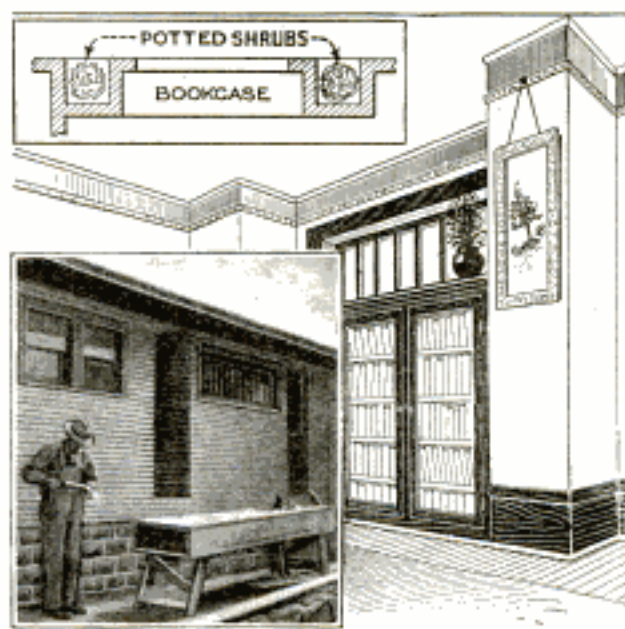

Jogging a Wall Makes the Bookcase Flush with Interior Surface. Left, View of Outside of Wall

jogged the wall of a bungalow in the manner shown in the illustration, which provided places for potted shrubs outside, and added a touch of distinction and beauty to the architecture of the house. The upper detail shows the plan of this arrangement. A multiple-sash window was provided over the bookcase and this added considerably to the appearance of the room, besides providing more light.—Dale R. Van Horn, Walton, Neb.

Safety Flash-Powder Container

Because of the accidents occurring from the explosion of photographer's flash powder, the safety flash-powder container shown in the illustration was devised. This container does not guarantee against explosion but reduces its force to a minimum. It consists of a length of brass tubing with a cork inserted in each end. Should the powder explode, it will blow the two end corks out of the tube, which is better than having particles of glass fly in all directions, as happens when a bottle "blows up."—H. A. Palmer, Toledo, Ohio.

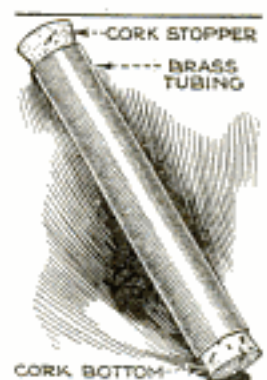

Simple Method of Making Rag Mats

Excellent doormats can be made at home from strips of rag or burlap. The strips must all be of the same width and twisted until they are about the thickness of a finger. The strips are tacked, about 4 in. from one end, to a length of

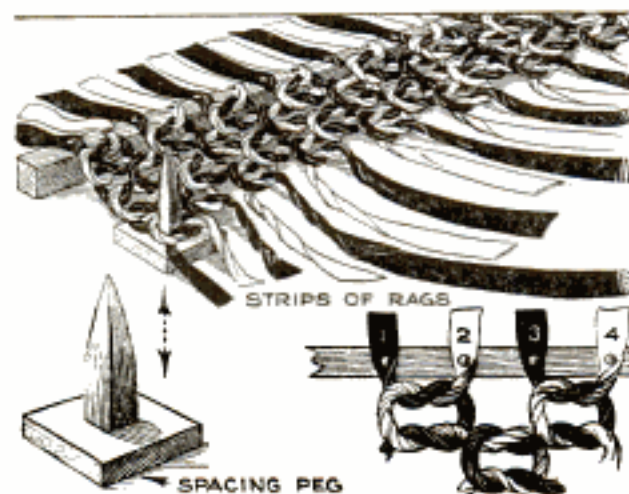

Simple Method of Making Rag Mats: Strips of Rag are Twisted and Then Woven Together with Square Knots of Uniform Size

wood, and are spaced $\frac{3}{4}$ in. apart. The width of the mat depends on the number of strips used, which must be an even number.

After fastening the length of wood to a table or bench, the strips are ready to be woven, which is done by tying them together with "square" knots until the mat is completed. The first knot is tied with the first and second strips, the second knot with the third and fourth strips, the third knot with the fifth and sixth strips, and so on to the end. The second row of knots is begun by tying the second and third strips, then the fourth and fifth strips, and so on. The knots are all tied in the same way, and the method of doing this is plainly shown in the detail. A spacing peg must be used, so that all the knots will be of the same size; the knot is tied around the peg, which is then slipped out. The peg should be about 1 in. square and tapered to a point.

Increasing Effectiveness of Weedless Propeller

There are numerous weedless boat propellers on the market but the majority of motorboat owners who have attempted to drive their boats through heavy kelp, sedge grass, or other aquatic vegetation will testify that the average weedless boat propeller is usually about as weedless as a

nonskid tire is actually nonskidding on a wet asphalt pavement.

The writer recently visited the Los Todos Santos Islands off the west coast of Mexico in a motor boat. In order to get to these islands it was necessary to drive the boat through vast kelp beds that were so thick that the boat, even though equipped with a so-called weedless propeller, could scarcely move more than a few hundred yards without the screw becoming fouled by the kelp, making it necessary for a member of the party to go overboard and disentangle the weeds. However, the trouble was finally eliminated by removing the propeller and sharpening the edges. As the propeller was made of bronze the job was easily accomplished by means of a file. After being sharpened, the propeller cut through every bit of seaweed it came in contact with, and no more trouble was experienced. The weed-cutting ability of the sharpened blades is aided by their shape, which gives them a cutting motion similar to a barber's stroke in shaving.—J. E. Hoag, Los Angeles, Calif.

Brass Strips Improve Spring Action

Automobile springs soon become rusty, and this causes so much friction between adjacent leaves that they do not work properly, unless proper attention is paid to lubrication. Their action can be improved considerably by inserting brass strips between them, as shown in the drawing.

These strips have smooth surfaces and will not rust, enabling one leaf to slide over another with the least friction, and offsetting lack of lubrication. The strips are cut from $\frac{1}{16}$ -in. sheet brass, to a length

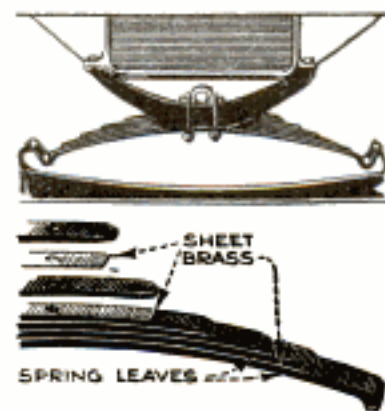

and width corresponding to that of the spring leaves. A hole is, of course, drilled through the strips for the center bolt of the spring, and they are then assembled with the leaves as shown in the lower detail.

☞ To insure prompt reply and safe receipt, when writing to the Bureau of Information, please write name and address plainly.

Easily Made Small Valves

MANY of the mechanisms made in the experimental shop require valves. On experimental machinery, $\frac{1}{8}$ and $\frac{1}{4}$ -in. valves are usually large enough, but even these are rather expensive, and, as described in this article, simple and effective valves can quite easily be made, either for high or low-pressure use.

The simplest form of valve is the straight-flow type made by cutting a piece of brass or steel hexagon stock, 2 in. long, drilling a hole in the center, and tapping it $\frac{3}{8}$ in.—

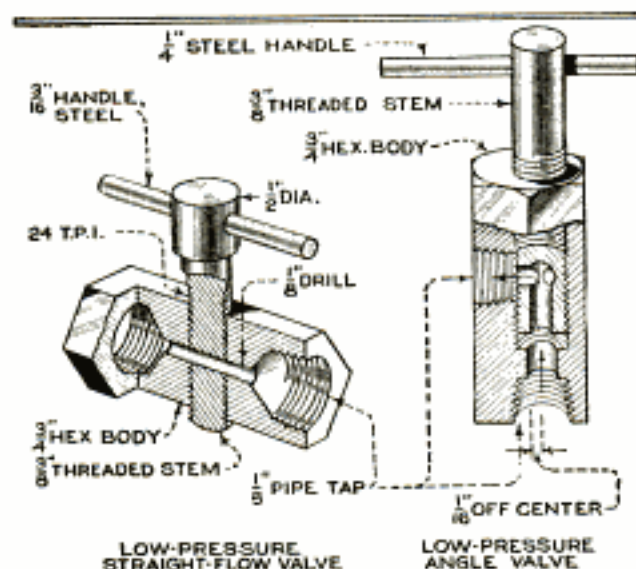

Low-Pressure Straight-Flow and Angle Valves Made from Stock Material

24 threads. Make a stem of the same material and thread it so that it will fit snugly into the body. Fit the stem with a $\frac{3}{16}$ -in. handle, and screw it into the body until it projects a few threads on the bottom, with the handle parallel to the body. Drill a $\frac{1}{8}$ -in. hole axially through body and stem, enlarging the ends so as to allow them to be tapped for $\frac{1}{8}$ -in. pipe. When the handle is turned at right angles to the body, the flow will be stopped. This valve is quite satisfactory for low pressures, if made accurately, and is very simple to make.

The low-pressure angle valve is also made from a 2-in. length of $\frac{3}{4}$ -in. hexagon stock. In this case the $\frac{3}{8}$ -in. tapped hole is drilled lengthwise, not quite through, and $\frac{1}{16}$ in. off center. Fit the stem tightly as before, and drill a $\frac{1}{8}$ -in. hole through its center from the bottom of the body. This hole breaks into another drilled through the side, as shown, and both holes are enlarged and tapped as before. The stem of this valve has a handle that projects more on one side than the other, and the handle points in the

same direction as the side opening or port, thus acting as a guide in using the valve. A half turn opens or closes the valve.

For high-pressure work on gas, liquid, or steam lines, a valve must be used that will not only stand the pressure safely, but will seat tightly when closed. Many mechanics would throw up their hands if asked to make a straight-flow valve for high pressure out of stock material, but it can easily be done. The features mentioned above are incorporated by using heavy hexagon stock for the bodies, and tapered valve seats and stems.

For the straight-flow valve, a piece of 1-in. stock, 2 in. long, is used, and into a hole bored through its center is forced a vertical seat-and-stem piece. The upper and lower ends of the hole must be countersunk, and, after the vertical member is in place, the joints are welded or brazed. This piece is drilled along its axis, and

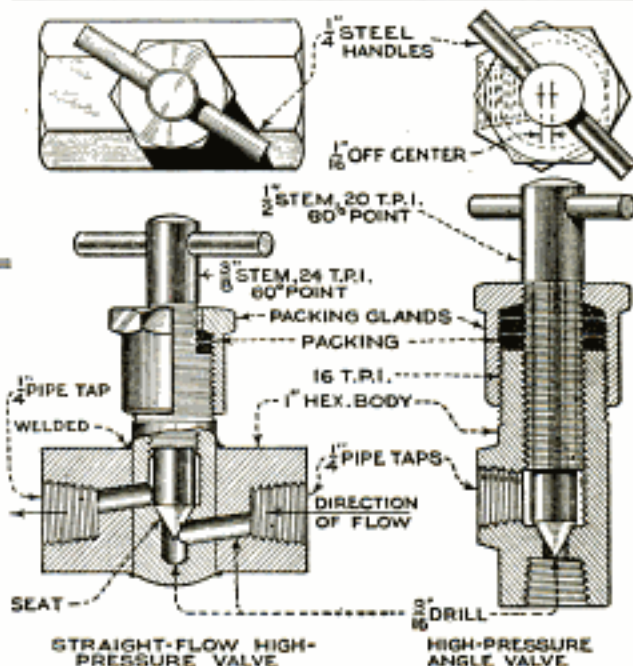

Stronger Valves, Made for High Pressure, from Similar Materials

tapped $\frac{1}{2}$ in.—20 threads, or $\frac{3}{8}$ in.—24 threads, for the stem. The bottom of the hole is machined to a 60° taper, and a $\frac{3}{16}$ -in. hole is drilled for a short distance below the seat, to provide clearance for the point of the stem. The outside of the vertical member is threaded, and a packing-gland nut made and fitted, using two pieces of $\frac{1}{8}$ -in. packing. The valve stem is made of steel, threaded, tapered to a 60° point, and fitted with a $\frac{1}{4}$ -in. handle. After the valve has been assembled, the $\frac{1}{4}$ -in. pipe-tap holes are drilled, and then the $\frac{3}{16}$ -in. passages. The latter holes must

be drilled at an angle, as shown, to avoid drilling into the valve seat.

The angular type of high-pressure valve is of simpler construction. The body is also of 1-inch stock, with the center holes and the turned and threaded parts $\frac{1}{32}$ off center. This leaves a thick wall for the side outlet, which is threaded for $\frac{1}{4}$ -in. pipe. The $\frac{1}{2}$ -in. stem is fitted and packed in the same manner as the straight-flow stem.

These valves will stand up to 300 lb. pressure, are easy to take apart for repairs or cleaning, and are quite safe for either gases or liquid.

Electric Heating Pad Keeps Engine Warm

An electric heating pad, of the kind used for household purposes, can be used to advantage for keeping the automobile engine

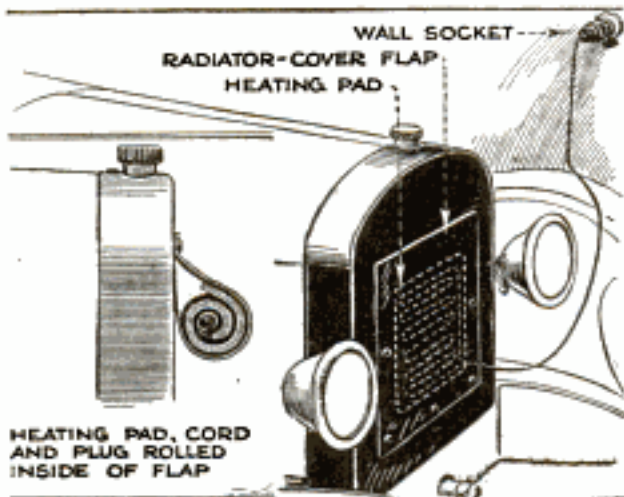

An Electric Heating Pad Used for Keeping the Radiator Warm during Cold Weather

warm during cold nights. It is simply connected to the garage lighting circuit, and sewed on or otherwise fastened inside of the flap of the radiator cover so that it can be rolled up as shown in the left-hand detail. At night it is unrolled, and the plug on the extension cord screwed into the garage lighting socket. The heating pad hanging against the radiator keeps the water warm and causes it to circulate slowly through the engine. This prevents the oil from "gumming," and consequent running down of the battery in an effort to turn the stiff engine.

Ⓢ Sharpening indelible pencils near gray cloth, and allowing the dust to settle on the pieces, has been found to damage this material in cotton mills. The "lead" makes a deep stain which shows when the goods, about to be dyed or bleached, are passed through a moistening process.

Shutter Release for Self-Timer

Unable to find a self-timer for use on cameras with a lever-shutter release, an attachment was made to hold a self-timer of the ordinary kind, and used successfully. The attachment consisted of a strip of sheet brass, bent so that it fitted tightly on the bed of the camera, and a smaller piece, soldered to the bottom of the timer and with the edges bent so

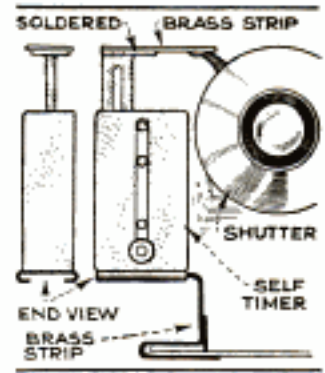

as to slide over the end of the clamp. Another small piece of brass was soldered to the top of the plunger rack so as to rest on the shutter-release lever. In use, the timer was mounted as shown in the drawing, and operated in the usual way.—J. S. Opferman, Pittsburgh, Pa.

Preventing Water Tank from Freezing

Usually the stock-watering tanks on the farm freeze up very easily, unless the water is kept in constant motion. A method that was found very effective in preventing this is shown in the drawing. A 12-ft. pit, about 2 ft. in diameter, was dug next to the water tank and was walled up with broken stone and bricks; concrete can, of course, be used if desired. A pipeline consisting of $1\frac{1}{2}$ -in. pipe and elbows, was arranged as shown, both ends terminating in the tank at the top and bottom, and the pit was then filled

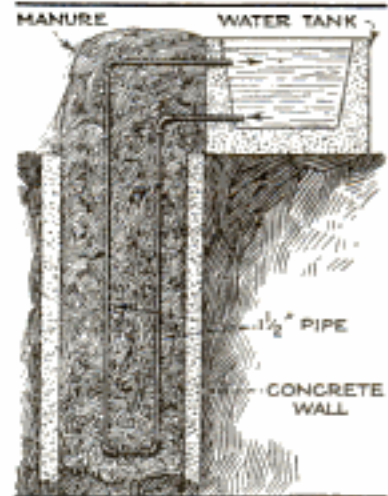

with fresh manure. The cold water in the tank naturally runs down the pipe leading to the bottom of the tank, while the water already in the pipe rises in temperature, due to the heat given off by the manure, and flows out of the other end of the pipe, causing a slow but continual circulation which keeps the water in the tank from freezing.

Finger Grips for Gloves

When working outdoors during cold weather when it is necessary to wear gloves, it is rather troublesome to remove them in order to pick up small objects such as screws or nuts. This difficulty can easily be overcome by placing a small coin such as a dime or a penny inside of the glove, in the tips of the thumb and index finger, thus providing two flat surfaces between which a small object can readily be pinched or picked up.—Charles I. Reid, New York City.

Using Old Collars

Old linen collars make excellent tags for packages that are sent by parcel post or express. These tags take ink well and are strong enough to remain attached for the longest journeys. A hole is punched through the tag, near one corner, and a length of stout cord is used to tie it to the parcel. About 6 or 8 tags can be cut from one collar.—Mabel Chase Rundlett, North Adams, Mass.

Making the Heating Stove Inconspicuous

Because our grate was found insufficient for heating the house in a semi-tropical climate, it became necessary to put a

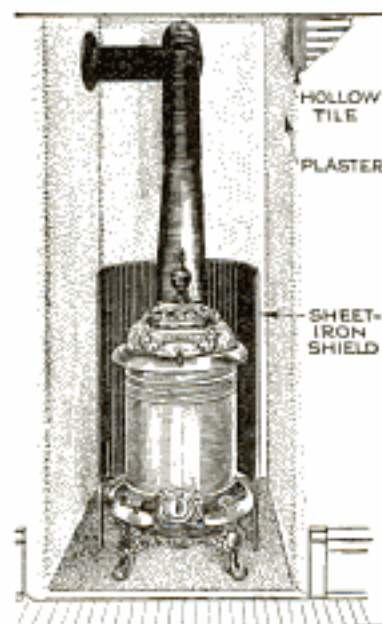

small stove in the dining room, but this crowded the room, which was small, and also detracted considerably from its appearance. The illustration shows how the trouble was overcome. An opening was cut from the dining room into the pantry just back of the chimney, and a space just large enough for the stove was lined on three sides with hollow tile, to protect against fire; the surface was then plastered. The tile wall was found to keep the heat in well and this effected quite a saving of fuel. A sheet-iron shield was provided behind the stove to protect the plaster from excessive heat.—Jack Spottswood, Jacksonville, Fla.

Wheelbarrow for Concrete

Carrying concrete, sand, and water, or "slops" is greatly facilitated by using a wheelbarrow of the type shown in the

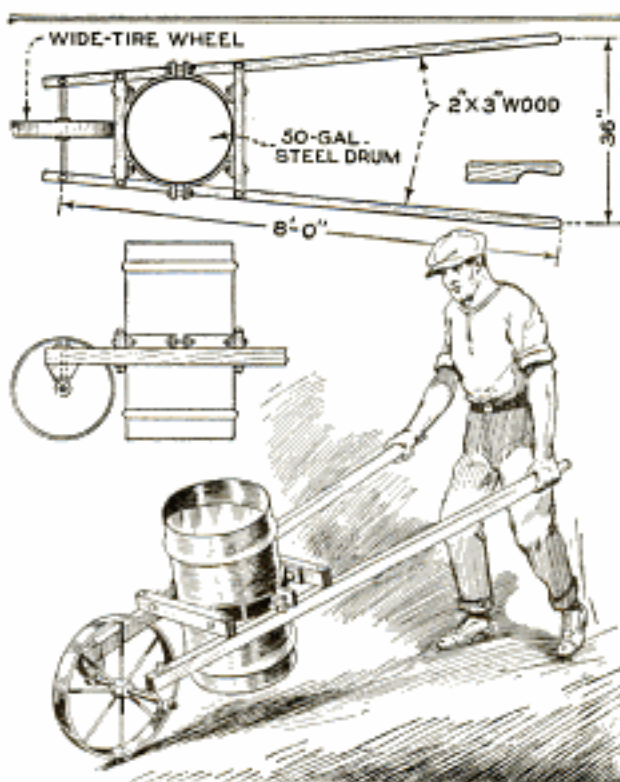

Handy Homemade Wheelbarrow for Carrying Concrete, Water, Sand, and Similar Materials

drawing. A wheel from an ordinary wheelbarrow, or from an old discarded farm implement is used. The frame is made of 2 by 3-in. hardwood about 8 ft. long, and built as shown. The handles are set about 3 ft. apart so that the barrow can be easily balanced. Two cross pieces of the same material are bolted to the handles and are spaced to accommodate a 50-gal. steel drum as shown, metal straps being provided to hold the drum in place tightly. The drum can be set solidly on the ground.

Renewing Golf Balls

A cheap and practical method of renewing old golf balls is to fill the cracks with white rubber cement, which can be obtained at any drug store. After filling the cracks, the entire surface of the ball is painted. By repairing the balls in this way there are no bumps or cracks, which have a tendency to influence the course of the ball, and the whitened surface will show up well. It is a good idea to wash the balls in cool soapy water before going to the grounds as this helps to retain the old luster and removes stains.—Fred A. Loper, Adams, Neb.

Clips Prevent Loss of Truck Stakes

As soon as the stakes used on motor-truck bodies become worn at the lower ends, it is almost impossible to keep them

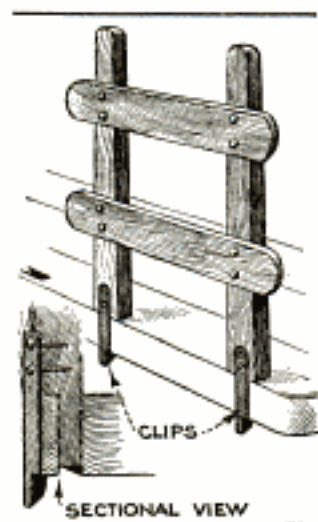

in place when the truck is empty and bounces over rough roads or streets; they are consequently often lost. This trouble can be successfully eliminated by the provision of clips of the type shown in the illustration. Each clip is made from a piece of $\frac{1}{8}$ -in. strap iron about 8 in. long and 1 in. wide. Two screw holes are drilled through it as indicated, so that it can be attached to the stake with wood screws. The other end is cut and bent to form a latch that catches under the truck floor or side, and holds the stake in place securely.

Fastening Rag Strips

Rag strips used for making rugs are usually sewed together, but a much better method is shown in the illustration. A slit is cut in the ends of the strips to be connected and the other end of one strip is passed through both slits, as shown, so that when pulled tight, a smooth union is made that is not lumpy. A considerable saving of time is effected by this method.



Cork Casters

For medium and light-weight furniture, common corks of large size have been found very serviceable as casters, and in many respects superior to ordinary roller casters or polished metal "domes." Because of their resiliency they yield somewhat, causing the piece of furniture to stand level and solid, and, being soft, they cannot scratch or mar the most highly polished floors but instead gradually wear away themselves. To fit them to the furniture, a hole is drilled in the bottom of each leg for a cork, the hole being, of

course, equal to the center diameter of the cork and a little more than half as deep.—Glen McWilliams, Detroit, Mich.

Cure for Grabbing Clutch

To overcome the grabbing tendency of a clutch on a light car, a driver installed an additional pedal plate, attached to the regular pedal by means of four bolts and coil springs, the bolts fitting loosely in holes drilled for them and the springs keeping the plates separated. The bolts used are $\frac{1}{4}$ in. in diameter and $2\frac{1}{2}$ in. long. They are slipped through holes drilled in the lower plate and reamed out so that the bolts can slip in and out easily when the pedal is under pressure. The auxiliary plate, being the same shape and size as the regular plate, is drilled and tapped to receive the screw ends of the bolts. Before assembling, 2-in. open coil springs, made of No. 10 brass wire, are placed over the bolts, which are then screwed into the threaded holes in the auxiliary plate until they project just a trifle; the ends are then hammered over to keep the bolt from unscrewing. Pressure applied on the pedal causes the clutch to take hold gradually, and all grabbing is eliminated.

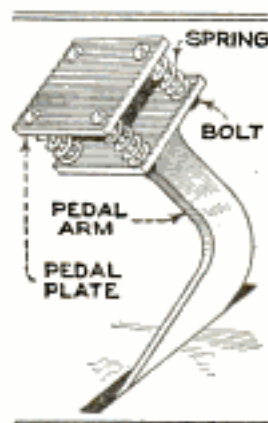

Protecting Soldering-Iron Handle

Everyone who uses a soldering iron has experienced the annoyance of having the handle burned off. This is not always an actual burning of the wood but often a charring, caused by the stem of the iron becoming hot. A simple method of overcoming this is to drill out the handle to about twice the size of the iron stem and fill it with molten lead, which will stick firmly to the sides of the hole, and, while the metal is still hot, seat the stem in it. This metal will never become hot enough to char the wood and besides forming a durable handle also balances the iron.



A Bench Lathe of Simple Design

By RODGER L. SIMONS

EVERY budding mechanic craves a lathe on which to develop his ideas, and the one shown in the drawing is not only easily built, but is strong and substantial, and meets the simple needs of the amateur. The only tools needed for making this lathe are those found in the small shop, plus a set of pipe-threading dies; in the absence of the latter any pipe fitter or plumber can do the necessary threading. The machine is assembled as in the drawing. The joints should be screwed up tightly, and white lead should be smeared on the threads before assembling, to make the parts go together more easily and hold them together securely. If the builder has a small taper reamer, it would be well to drill a hole through each joint, ream it out, and drive in a taper pin.

For a lathe with a bed about 2 ft. long, 1-in. pipe, with fittings to correspond, is a good size to use. When assembling the headstock, care should be taken to see that the two tees through which the spindle runs are exactly in line. A 1-in. bushing is screwed into the ends of each tee and the inside threads are drilled out to make a smooth bearing surface for the spindle, or, if

any difficulty is encountered in aligning the spindle, it can be blocked in position and the tees filled with babbitt. The spindle should be driven out before the babbitt cools, and the bearings reamed to a nice running fit. The spindle is a piece of $\frac{3}{4}$ -in. pipe or rod, turned and polished to a true and smooth bearing surface. If one has a friend who is fortunate enough to possess a lathe, this smoothing and polishing can be done very easily. A thread is cut on one end, onto which a $\frac{3}{4}$ -in. floor flange is screwed as a faceplate. A disk of wood can be used as a pulley until the machine is completed, when a regular wooden cone pulley may be turned, sanded, and fastened to the spindle. A collar

should be made from a small piece of round-steel stock and fastened with a setscrew to the outer end of the spindle. The bed is made from a piece of $1\frac{1}{8}$ -in. cold-rolled steel, threaded on each end for 1-in. pipe, and with a deep, narrow keyway along its whole length, on the upper side.

Holes are drilled in the tailstock and tool rest, tapped, and machine screws, with the ends turned to fit in the keyway, inserted. The screws slide in the keyway and hold the two movable members in line. The tool rest is built up from two 1-in. tees connected by a short nipple and with the long parts, or run, of each at right angles to the other. One

tee slides on the bed and the other projects toward the operator; the upper end of the latter is provided with a 1-in. bushing in which the threads have been drilled out. The rest itself is a simple forging that can be made by a blacksmith; the shank is threaded for $\frac{1}{2}$ -in. pipe, and a $\frac{1}{2}$ by $\frac{3}{4}$ -in. bushing, with the external threads filed off, is screwed on and the two placed in the tee. A thumbscrew should be provided to tighten the rest at any height, and to prevent it from turning.

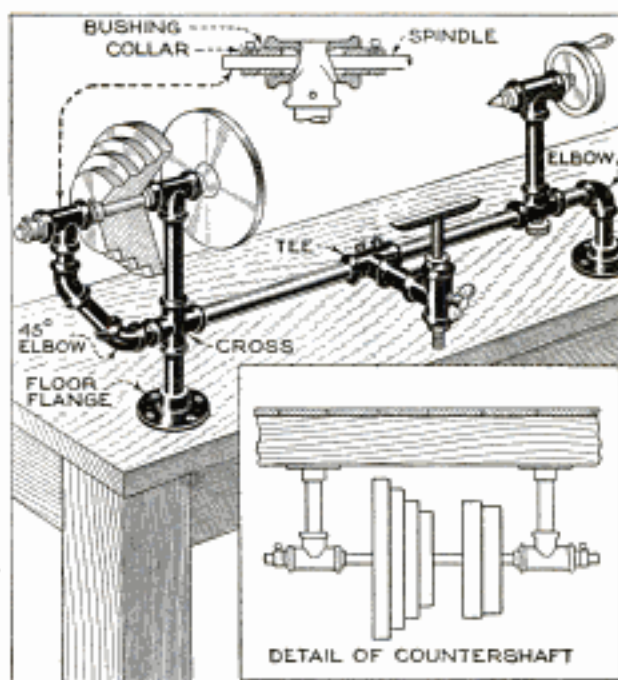

Simple Lathe for the Amateur, Made Almost Entirely of Pipe and Fittings

ing. The tailstock is made by screwing a $\frac{3}{4}$ by 1-in. bushing into the short end of a 1-in. tee, a long $\frac{3}{4}$ -in. nipple in the bushing, and a $\frac{3}{4}$ -in. tee on the end of the nipple. The runs of the tees should be parallel. A $\frac{1}{2}$ by $\frac{3}{4}$ -in. bushing, the internal threads of which are drilled out smooth, is screwed into each end of the upper tee. A piece of steel bar, of the same diameter as $\frac{1}{2}$ -in. pipe, is threaded on one end, and a center point ground on the other to serve as a tailstock spindle; a handwheel is fastened on the threaded end with locknuts. Thumbscrews should be provided to tighten the tailstock to the bed, and the spindle to the tee. In both the tool rest and tailstock the tees that

slide on the bed must have their threads filed off to allow them to slide freely. The standard supporting the tailstock end of the lathe is built by screwing a 1-in. elbow on the threaded end of the bed, a 1-in. bushing into the open end of the elbow, a long $\frac{3}{4}$ -in. nipple into the bushing, and a $\frac{3}{4}$ -in. flange onto the nipple, as in the drawing.

A countershaft is easily made; a long 1-in. nipple is screwed into a 1-in. flange, a tee is screwed onto the nipple, and a 1-in. bushing screwed into each end of

the tee. The inside threads of the bushings should be drilled out smoothly to form the shaft bearing. Two such assemblies are mounted on the floor or ceiling in such a manner that the openings in the bushings are in exact alinement. A steel shaft, of the same size as the drill with which the bushings are drilled, is fitted with a cone pulley of the same size and proportions as the one on the lathe, and with tight and loose pulleys for starting and stopping the machine, and a simple belt shipper is provided.

A Simple Camp Stove

Finding that a mixture of earth and gasoline would burn with a fine hot flame, even if the earth were wet, an ingenious camper devised the simple portable camp



A Very Simple but Efficient Form of Gasoline Camp or Touring Stove

stove shown in the drawing. It consists of a wide, shallow tin can having a row of holes punched through the side along the upper edge. The can is about half filled with earth, then about $\frac{1}{4}$ pt. of gasoline is poured over the earth and thoroughly mixed with it. Upon lighting this mixture, it burns with an intense heat for about fifteen minutes, which is ample time for preparing coffee. Three tin cans, one a little smaller than the other so that they can be telescoped into each other to save space when carrying, have been found very convenient on camping trips.—J. B. Smoller, Atlantic, Iowa.

☛ To restore the color of a shellac surface that has become white in spots, hold a heated iron over the spots.

Removing Water from Mortar

When mixing concrete it often occurs that too much water is added, making the mixture too thin to work properly. Of course, more sand and cement can be added, but this is not always desirable, as it increases the quantity of concrete, and this may not be necessary. A good method of removing the excess of water is to place a few common bricks in the mixture for a few minutes, and it will be found that the bricks absorb so much of the water that the mixture soon becomes workable. A common brick, when thoroughly dry, will absorb about a pint of water.—R. Rittenhouse, Rockingham, North Carolina.

Repair for Carburetor Bowl

The nut holding the bowl of a Ford automobile carburetor in place has a tendency to loosen due to the continual vibration, and the loose bowl then allows a considerable quantity of gasoline to be wasted. The frequent tightening of the nut soon strips the fine thread on the brass overflow pipe on which it screws, making a new part necessary. However, on carburetors of this type, the simple repair shown in the drawing can easily be made and will not interfere with the moving parts. This repair will hold the bowl in position securely and the nuts will not need to be tightened more than once, as lock washers are provided to keep them tight. The U-bolt is passed over the body of the carburetor and a steel disk, drilled to fit the legs of the bolt and the end of the overflow pipe, is fastened on with nuts.



Using Auto Battery for Camp Lighting

An automobile-lighting battery will furnish a convenient source of current for a few lights around a camp or small country house, especially during the summer, when the car is used a great deal, and it is sometimes necessary to use the excess current by burning the lights during the day. One way to obtain the current for the purpose mentioned is to plug in to the dashlight and connect to the lighting circuit, but this means that all the lights must be switched on when the outside lights are used.

A permanent connection to the battery itself is better, and the opening through the battery box, where the regular lead comes through, is usually large enough to permit a second heavy wire to be brought out. A heavy lead clamp, as shown in the drawing, may be made, to fasten to the battery-terminal lug or nut, but great care must be taken in fastening this, to prevent it from working loose and causing a short circuit. In the drawing the clamp is shown held to the terminal nut by a nut and bolt; then a sharp-pointed brass setscrew is set into the lead nut to keep the clamp from slipping.

A flexible lead, preferably of armored cable, or heavy flexible wire incased in circular loom, is soldered or bolted to the clamp and brought out through the battery box alongside the regular lead wire. A standard porcelain-base double-plug fuse block is bolted to the frame, or dash, as close to the battery box as possible, to protect the battery and wiring from an accidental short circuit or overload. Beside the fuse block, a standard porcelain socket is mounted. If these parts are to be bolted direct to the frame, it is well to place rubber gaskets under the porcelain bases and rubber washers under the screw heads, in order to keep the vibration from loosening the fastening or breaking the porcelain.

The fuse block and socket may also be attached to a wooden block instead of directly to the frame. Unless the fittings are inside the dash, some sort of cover should be placed over them, except when in use, to keep out dirt and oil. If the lighting circuit is of the grounded type, one side of the socket is connected to the frame; otherwise, two leads must be brought from the battery.

To use the auxiliary lights, it is only

necessary to remove the cover from the socket, and plug in with a standard porcelain attachment plug and cap, and none of the machine lights need be used.

In case a permanent installation is not

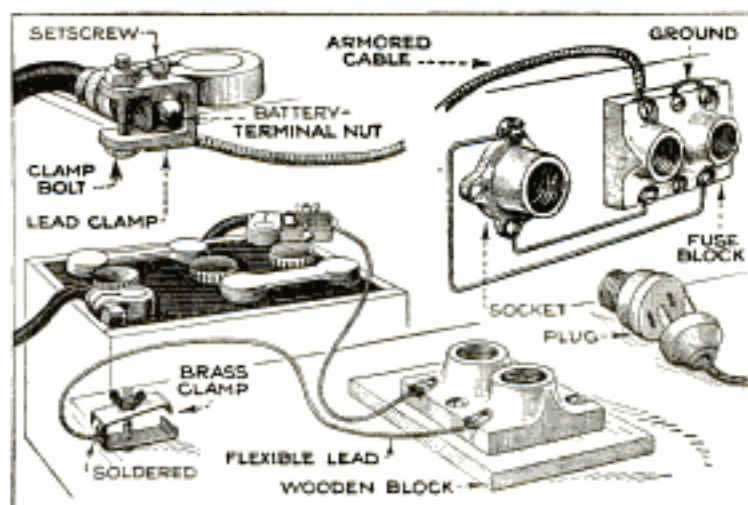

An Arrangement for Drawing Current from the Storage Battery of an Automobile for Lighting the Camp or Summer Cottage

desired, the outside leads may be directly connected to the fuse block, which is fastened to a piece of board, as shown in the lower drawing. Two heavy leads are attached to the other side of the fuse block and carried to the battery terminal and frame. Clamps are made from heavy spring brass and the flexible leads soldered to them; the end of the brass strips are bent over and teeth filed in them to grip the battery terminal. The necessary pressure is applied by wing-nuts and bolts. Both terminals may be gripped, or one clamp attached to the frame, if a grounded circuit is used. The fuse block is placed on the floor, or frame, as near the battery box as possible.

The board, fuse block, and wire may be carried in the machine, or left in place and the machine driven up within reach for attaching. In use, the machine is driven into position, the floorboard removed, the clamps are attached to the battery terminals, or to one of the battery nuts and the frame as may be necessary, and the lights switched on. Of course, a socket and plug can be attached to the board as in the permanent installation. This last arrangement has been used to illuminate a small two-story ranch house with success, the automobile being kept on the ground floor and a lead of heavy lamp cord, with fuse block and clamps attached, being coiled up under the ceiling, ready and convenient for use in the evening.

Washing-Machine Cylinder Hoist

It is a back-breaking job to lift the wooden cylinder out of some types of electric washers after washing, and for this reason the cylinder is often left in the tub, which, of course, prevents it from drying thoroughly and may cause mildew. This trouble can be eliminated by providing a small hoist of the kind shown in the drawing. The block-and-tackle arrangement is suspended over the washing machine and enables a woman to raise the cylinder out of the tub with a minimum of exertion.

The essential parts of the arrangement are a single and double pulley, both about 1 in. in diameter, a wooden block, and some strong clothesline. The cylinder is attached to the single pulley with a length of rope, $\frac{3}{8}$ in. holes being drilled in the sides about 1 in. from the ends to admit

the hooks provided on the ends of the rope. Another length of rope is tied at one end of the single-pulley eye and passed over the pulleys as shown. This arrangement reduces the pull on the free end to one-third of the pull necessary if only one pulley be used. A cleat should be provided on the wall so that the rope can be tied while the cylinder is left suspended so it may dry.

The wooden block on which the double pulley hangs is not essential but is very convenient. It is made of oak about 8 in. in length, and runs on a wooden rail, supported by wooden hangers bolted to the ceiling joists with carriage bolts. The rail should be about 4 ft. long so that the cylinder can be swung clear of the washer and lowered to the floor.—Donald A. Price, Chicago Heights, Ill.

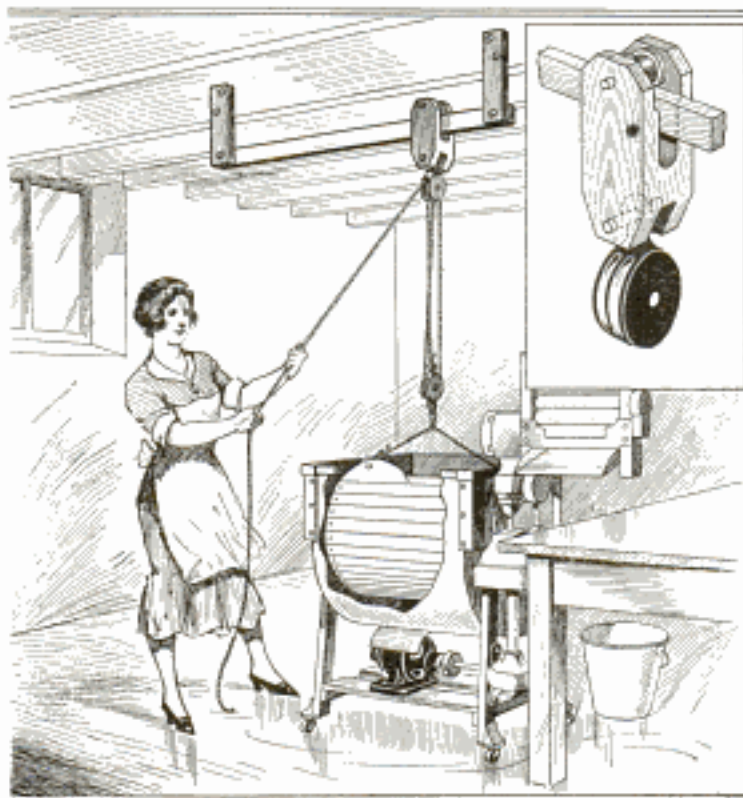

A Convenient Block-and-Tackle Arrangement Used for Hoisting the Cylinder Out of the Washing Machine

Firelight Photos

Numerous methods are suggested for coloring pictures to imitate firelight, most of them depending upon the staining of the entire picture with some dye, but few giving satisfactory results. However, a combination of dyeing and chemical toning will give a satisfactory effect. By staining an entire picture light orange and toning the dark portions red, a fine imitation of firelight is obtained.

Any developing paper can be used. For the best results, the picture should be printed deeply; the print is first immersed in a bath consisting of 10 grs. of potassium iodide, and 20 grs. of potassium ferricyanide, dissolved in 1 oz. of water. This solution should be made in quantity as required, and the potassium must be the red prussiate crystals, not

the yellow. The picture, immersed in this solution, will bleach away almost entirely, but must be left in the bath half an hour longer to convert the nitrate on the print completely into iodide of silver. This chemical is capable of taking up or "mordanting" many aniline dyes, but not all of them. The dye, which is red in case of firelight scenes, is then applied; lanafuschine is the dye to use. After washing out the dye completely, another color such as yellow or orange, in the case with campfire scenes, is applied to the print to stain it completely and to deepen the red tint in the shadows. In this way the print can be dyed almost any color and tint desired. A good dye is necessary for successful work. The quality of any red dye can be seen when the print is washed; if any of the whites remain tinted, the dye should be rejected.

This process of coloring can also be applied to moonlight pictures or landscapes, using blue or green dyes, or even liquid water colors with a brush, as the print will take almost any aniline dye. It is not necessary to place the print in the dye, but better to apply the dye with a brush, paying no attention to the outlines of the picture, as the dye will act only on the chemical portion. If the dye is not strong enough after washing, a second application is made.

This process is also a splendid one for coloring lantern slides, as the silver can be dissolved entirely in an ordinary fixing bath during the process. The slides will be of a soft and delicate appearance and can be tinted with water colors afterward. A French experimenter recommends the following dyes: For red, lanafuschine brillante S L; blue, cyanol d' alizarine B F; yellow, jaune de quinoeline; green, vert brillante d' alizarine; violet, violet lanacyl B.

A Garbage-Can Holder

Keeping garbage and refuse in covered cans is a step toward prevention of disease, but it is of frequent occurrence that the garbage cans in alleys are accidentally tipped over by careless handling, by wagons and autos being driven against them, or by dogs, and the contents, emptied over

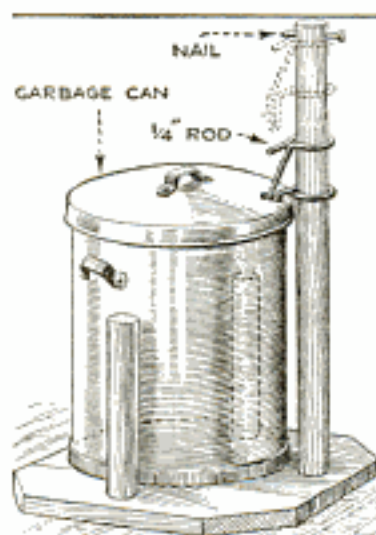

the ground, become a breeding place for flies and bacteria. To prevent the cans being upset in this way, many people drive posts or iron pipes into the ground around them, but it then becomes quite a task to lift them out when they are full. A much better method of holding them is shown in the illustration. This holder consists of a heavy wooden base and three uprights, the center one fitted with a catch made of $\frac{1}{4}$ -in. iron rod and bent to the shape indicated. A slot or hole is cut in the cover to receive the end of the catch. When the can has to be removed, the catch is raised and the can pulled from under it.—E. K. Wehry, Cedar Rapids, Iowa.

"Automatic" Car Jack

When working on the rear end of an automobile, or under it, it is usually necessary to jack up one end of the car to provide more space to work. The illustration

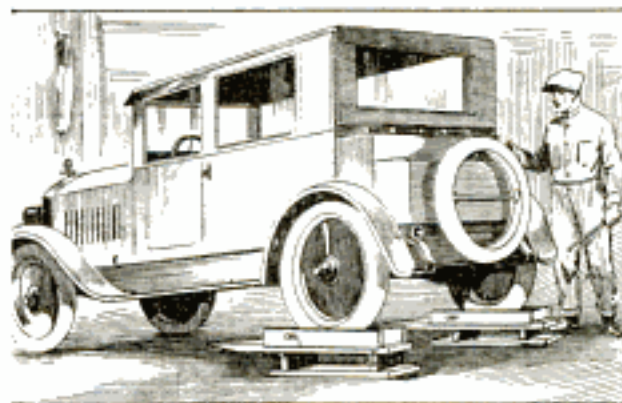
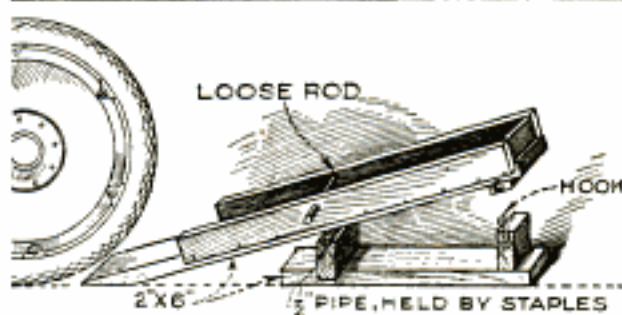

A Pair of Simple Homemade Automobile Jacks that Are Not Only Convenient but Quite Safe

shows a pair of simple homemade jacks for this purpose. They are made of 2 by 6-in. unplanned lumber, and constructed as shown in the upper figure, each consisting of a 2 by 6-in. base, two support blocks, and a top board of the same material. The top board is pivoted on one of the support blocks by means of a piece of $\frac{1}{2}$ -in. iron pipe, loosely held in place by large staples; it must be about twice as long as the base and beveled at one end as shown, this end being slightly heavier than the other so that the board will fall to the position indicated in the upper figure.

The jacks are placed close to the wheels at the front or rear, and the car driven on. A hook is provided on one support block to keep the top board down, and a short length of iron pipe or rod, fitting loosely in holes drilled through the sides of the top, prevents the wheels from running off the jack while the work is being done, thus making the work perfectly safe.—F. S. Root, Fall River, Mass.

☛ A worthless clock can be used in the sick room to indicate the next time medicine is to be given by setting the hand at the proper position.

Keeping Sulky Covers in Place

During cold weather when it is necessary to have the child well covered in the sulky, the blanket often works loose and one end drags in the mud or against one

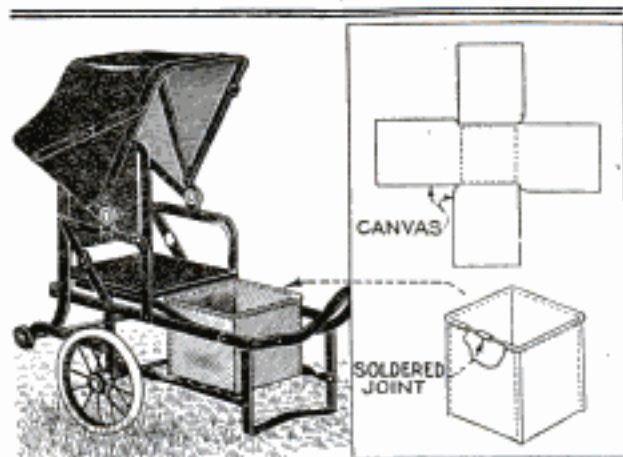

A Canvas Basket on a Sulky Has Been Found Useful for Keeping the Blanket in Place

of the wheels. This trouble can be avoided by tucking the lower ends of the blanket into a small canvas "box" of the kind shown in the illustration.

The box is made of two strips of heavy canvas, 10 in. wide and 36 in. long. These strips are cut and placed across each other as shown in the upper detail, and sewed together as indicated by the dotted lines, the outer ends being hemmed. Through the hems a length of No. 8 wire is passed, which is bent to a square just a trifle larger than the width of the sulky frame, so that it will rest on the latter. The ends of the wire are soldered together, which is done by bending a small piece of tin around the wire and dropping solder between. If desired, the box can be made of black oilcloth to match the sulky frame. Besides keeping the blanket in place, the basket keeps the child's feet warm, and it can also be used to hold packages when shopping. When the sulky is folded the box is placed in the seat.—E. D. Fahling, Tama, Ia.

Increasing Effectiveness of Spot Light

Putting the automobile spot light in front of the radiator and down close to the ground has been found to increase its effectiveness considerably. This may be accomplished by clamping it to the bumper, body frame, apron, spring, or an auxiliary bracket bolted to the latter. It is not advisable to fasten it to the front axle, however, as the constant jarring will soon ruin the lamp. Care must be taken that the light is behind the bumper, to pro-

tect it from damage in case of a slight collision, and just high enough to clear obstructions in the road; the level of the axle is about the right height.

The advantage of this position is obvious; it brings the light down where it is needed and provides a strong light with a wide ray, which will not blind an approaching driver. In rain or foggy weather the usefulness of a spot light located in this position is unquestionable. A small push-button switch on the dash is connected in the circuit to operate the spot light independent of the other circuits. The wires are run under the frame or under the hood—N. T. Peterson, Corvallis, Ore.

Manuring the Farm Garden

One of the problems in keeping a large house garden on the farm is that the soil must usually be richer than the other farm land, and therefore it must be fertilized liberally. The usual farm manure spreader is not of much use for this purpose as it spreads the manure too thinly, and to spread the manure over a three-acre tract is too much work to be done with a fork. An Oklahoma farmer solved the problem by allowing his cattle to run in the garden during the winter. In order to have the manure spread evenly, he built the movable feed rack shown in the photo; moving the rack occasionally keeps the manure spread evenly over the garden. It consists of two wheels and an axle from an old

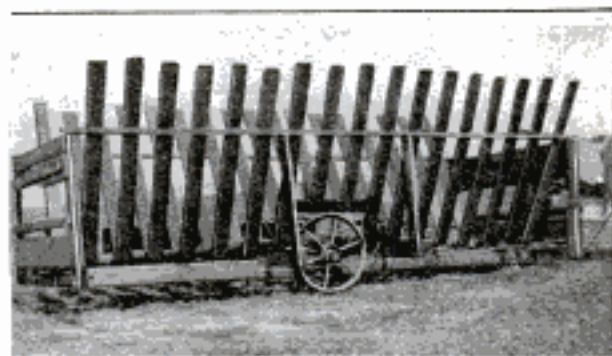

A Movable Feed Rack in the Farm Garden Tends to Effect an Even Distribution of Manure

mower, a frame of 2 by 6-in. lumber, and slats of 1 by 6-in. lumber.—J. M. Collins, Kansas City, Mo.

☞ Pure benzine should be used to clean watch hair springs, and it should leave no film on the metal. Pure grain alcohol is also very effective, but denatured alcohol usually leaves a film.

**AUTOMATIC PIPE WRENCH GRIPS
 LIKE HAND** 101-m

Where an instant grip is important, without the necessity of adjustment, as in screwing up or loosening pipe in awkward positions, a pipe wrench recently put on the market will prove of great value.

The design of the curved jaw is such that a number of its teeth are in constant engagement, thus a uniform grip is obtained that will not permit the wrench to slip. This prevents wearing of the teeth, and crushing of the pipe.

The outstanding feature is the automatic action between the heavy jaw and the toothed head, with which a powerful grip is obtained by a simple push on the handle. It is unnecessary to put a hand on the head, which makes the wrench exceedingly useful in places where it is necessary to have one hand free, or in dangerous positions, as when tightening loose pipes or couplings where scalding steam is escaping. For gripping pipes or conduits which are known to be highly charged with elec-

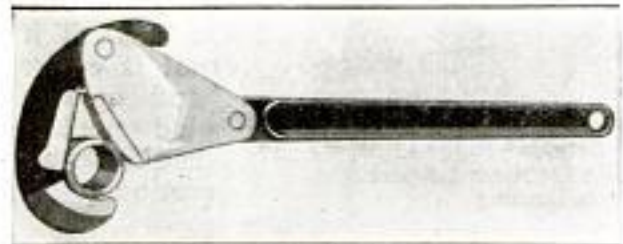

Automatic-Grip Pipe Wrench That will Not Slip or Crush the Pipe

tricity, an insulating covering for the handle is provided, which, with the one-hand action, makes the tool perfectly safe.

**POWER HAMMER IS ADAPTED
 FOR LIGHT SMITHING** 78-m

Smithing work ordinarily performed under hand sledges, and too small to be forged under a steam hammer, may now be done by power, using a hammer recently placed on the market.

The tool will handle material up to 2½ inches thick, and the hammer is under the complete control of the smith, so that a blow of any desired force may be struck. The maximum blow is about four times as heavy as that delivered by a human helper or striker, and the machine attains a rate of 140 blows a minute. The hammer head can be traversed along the face of the anvil to any desired point by means of a pedal, so that there is no delay in locating the hammer over the hardy holes in the anvil, for

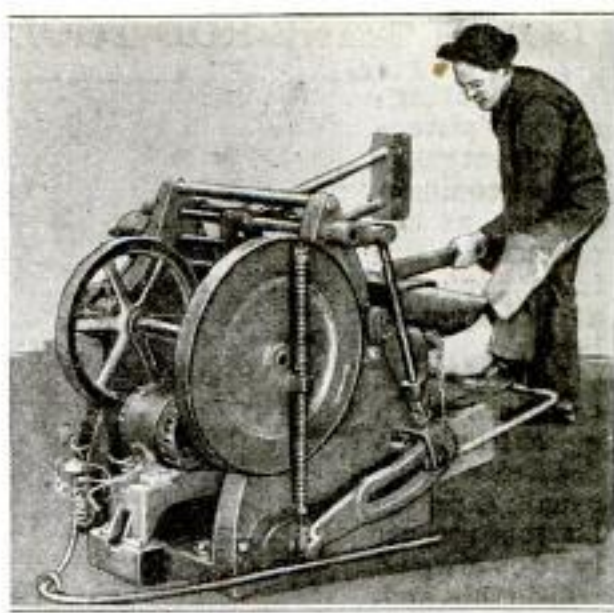

Forging Light Work with a New Power Hammer, Which Is under the Complete Control of the Smith

swaging, punching, etc. The work is always struck exactly at right angles to its face, due to the parallel-arm mounting of the hammer, and the force of the blow is directly controlled by the amount of pressure applied to the foot pedal. The tool requires only 1 horsepower.

**TAPPING ATTACHMENT
 62 m SAVES TAPS**

By controlling the driving force applied to the tap through springs, and eliminating the usual friction drive, it is possible, in a new tapping attachment, to set the spring tension accurately so as to allow over-running to occur with a minimum safety margin, before tap breakage or strain occurs. The setting remains constant, since lubrication and temperature conditions do not affect the spring tension. Hence considerable time is saved, and the tap is always run under the most effective cutting conditions. When once adjusted, the tapper will continue to function satisfactorily until a different job is to be set up. A tapper with these advantages will quickly save its initial cost by increasing production and reducing tapping expenses.



*Queen's Gate Works, London, Eng.
 Pawson & Collins, Kensington, S.W.7.*

*Blacker Engineering Co,
 Grand Central Terminal
 New York City*

Elk Machine Tool Corp.

POPULAR MECHANICS

484 243 W. 17th St.,

CONNECTING-ROD TOOL HAS WIDE RANGE OF USES

79 m. New York City

Connecting-rod and piston-alignment gauges are common enough, as are reaming fixtures for connecting-rod bearings, but a fixture that combines both operations is decidedly unusual. A portable tool recently developed will do this, and, in addition shave and burnish the big-end bearings, eliminating scraping.

The lower part of the frame of the tool carries the shaving and burnishing arbor, which is adjusted, for

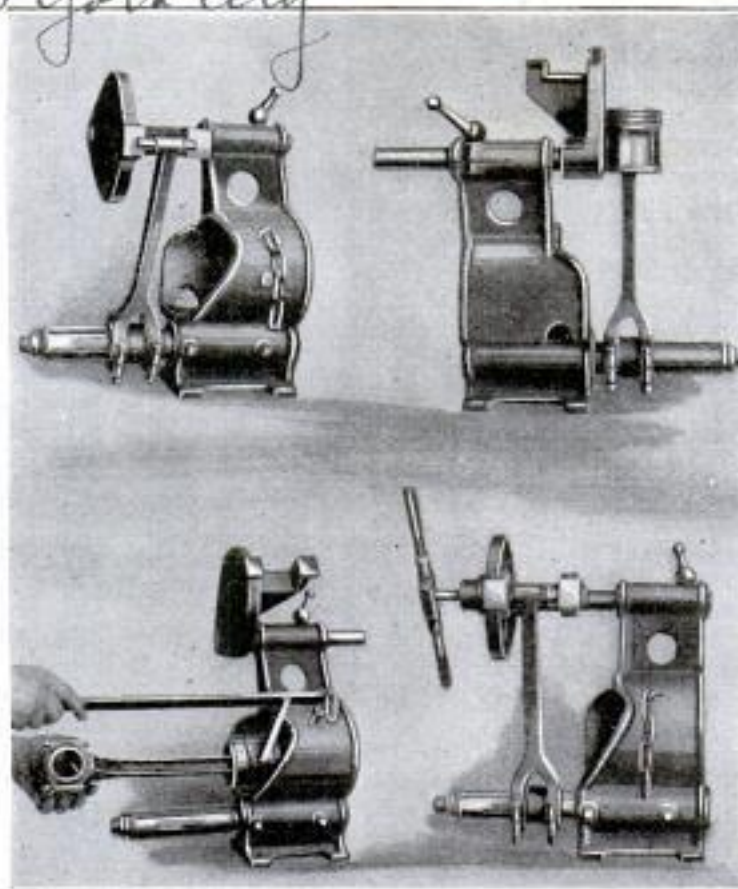

Upper Left, Testing Alignment of Wristpin; Upper Right, Testing Piston; Lower Left, Forcing Out Wristpin; Lower Right, Reaming Wristpin Bushing

both operations, by means of micrometer screws. The upper part of the fixture carries a gauge attachment that not only is used for gauging the alignment of wristpins and pistons, but also as a guide for reaming the wristpin bearings. A short chain is attached to the body of the tool, and a lever may be used in connection with this for forcing wristpins out of pistons. The tool is entirely hand operated, and performs six different operations.

MILLING TOOL PRODUCES FINISHED HEXAGONS

While intended primarily for work on valve nuts, a new hexagon-milling tool can also be used in the production of oil cups, "locomotive nuts," gauges, and plumbing fixtures. The tool will drill, face, and mill the sides of the hexagon at once; this is accomplished by a simple planetary motion of three cutters, each having two cutting edges. The sides of the hexagon are not perfectly straight across, but the curvature produced is so slight that it is

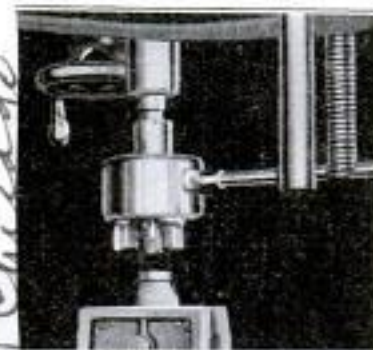

not at all objectionable. The tool can be used in an ordinary drill press, in conjunction with a simple fixture to hold the work and guide the body of the tool. The cutters are easily removed, sharpened, and

replaced, and are interchangeable. The miller is made for pipe sizes running from 3/8 to 1 1/2 in. but can be equipped with cutters to suit any standard.

COPPER-ALUMINUM ALLOY HAS MANY USES

A new alloy of copper, aluminum, and iron, which can be applied to an unusual number of purposes, has recently become available. It is lighter than steel, while possessing a tensile strength of 75,000 to 100,000 pounds per square inch.

The alloy is made in various grades, for different uses. The softest grade may be used for packing, or parts requiring a soft bronze; the next grade for bearings on high-speed machines, or where light pressures are the rule; and the third grade, for bearings, bushings, gears, worms, etc., where extreme toughness and resistance to wear are required. Both of the latter grades rapidly take on a surface like polished glass, and will not crystallize. A fourth grade is highly resistant to the action of most commercial acids and alkalis, and of superheated

American Metal Products Co., 34th & Burnham St., Milwaukee, Wis

Vertical text on the left margin: 'Metric Milling Tool Co.', '108 N. Jefferson St.', 'Chicago', 'Sells sold', '4/15/25'

steam, and is of exceptional strength; the hardest grade is used where conditions demand a metal harder than chrome-nickel steel, and it practically cannot be machined. The alloy is of a bright golden-yellow color, is easily polished, and does not tarnish. It can be forged, cast, drop-forged, rolled, and drawn; it is not affected by heat, and annealing does not take out its spring.

PYROMETER MEASURES HEAT RADIATED FROM WORK

Utilizing the direct heat radiated from the body of which the temperature is to be measured, a pyrometer radically different from others of the same general type, has now made its appearance.

The instrument is small and compact, and may either be used as a portable pyrometer or permanently installed at the measuring point, giving continuous and accurate readings on either indicating or recording instruments. It may be installed in places where neither rare nor base-metal couples can be employed.

A lens in the radiation set collects the heat rays and focuses them on a small element inclosed in a glass tube from which the air is exhausted. The thermoelement generates a small electric current, which is measured, in the usual manner, on indicating or recording instruments. At the opposite end from the objective or collector lens is the ocular lens for focusing the instrument. For very high temperatures, with glaring

General Electric

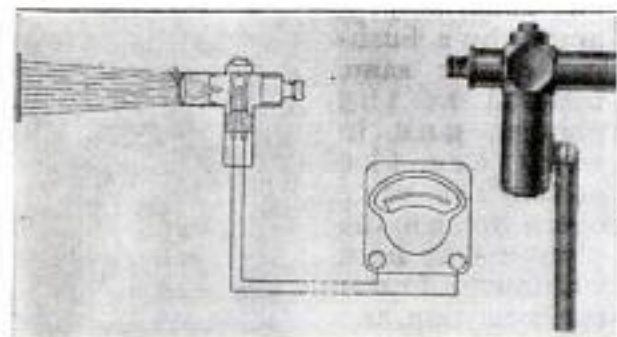

Left, Sectional View of Pyrometer, Showing Lens System and Wiring; Right, Complete Pyrometer

rays, a red glass is placed over the eyepiece, so that adjustments may be made accurately, without harm to the eyes.

¶ We want all our readers to write us freely and often whenever they wish additional information on articles published in this magazine. Address Bureau of Information, Popular Mechanics, Chicago.

SINGLE-SPEED WOOD LATHE FOR SMALL WORK

Small turning operations, which make up a great share of the work in many

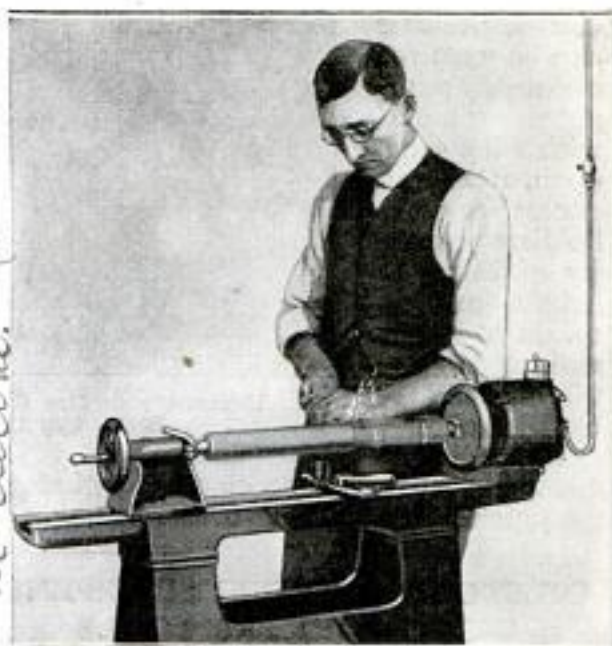

Single-Speed Woodturning Lathe with Direct-Drive Motor Headstock

woodworking plants, may be done very speedily and economically on a new lathe. The 1/4-hp. driving motor is built into the headstock, and is completely inclosed. It is directly connected to the spindle, which is mounted on ball bearings, and runs at a constant speed of 3,400 r.p.m. This speed, the makers claim, is scientifically and practically correct for work up to 6 in. in diameter—the maximum capacity of the lathe. The swing is full 5 in. over the tool rest, 7 in. on the faceplate, and 24 in. between centers.

The machine can be moved at will, but is heavy enough to stand rigidly without vibration.

Complete \$150.00
Without base and base \$125.00

REDMANOL CUT-OFF WHEELS

105-**LATEST DEVELOPMENT**

Carborundum cut-off wheels are now being marketed in which the binding element is a phenol resin of the same family as bakelite. This will not soften or melt, and gives an open, porous wheel structure that tends to produce a free, clean-cutting wheel, which will cut without binding.

It is claimed that these wheels effect considerable saving in time, stock, and labor in cutting stellite, high-speed steel, general steel alloys, and miscellaneous cut-off work. The diameters range from 8 to 14 in.; thicknesses from 3/4 to 1/8 inch.

Carborundum Co.
Niagara Falls

J. W. Wallace & Co., 14-21 Jackson Blvd
Chicago

97-m **POWER HACKSAW HAS GAP IN HEAD**

Utilizing the principle of the gap-bed lathe, a 13 by 16-in. power hacksaw of a new type has just been announced. When the gap is closed, the saw can be used for ordinary purposes, while, with the gap open, it has an excess work-holding capacity of 24 in. in height, and 16 in. in width, making the total capacity 16 by 37 inches.

With the gap open, the work can be clamped either to the finished vertical face of the bed, where

four T-slots are provided, or directly to the base, which is provided with three clamping slots. The base has a water trough extending entirely around it, which carries the cooling medium back to a reservoir located at the rear of the base, from whence it is pumped into a distributing pipe.

The machine is equipped with a six-speed stroke mechanism, and the blade pressure or feed can be varied at will.

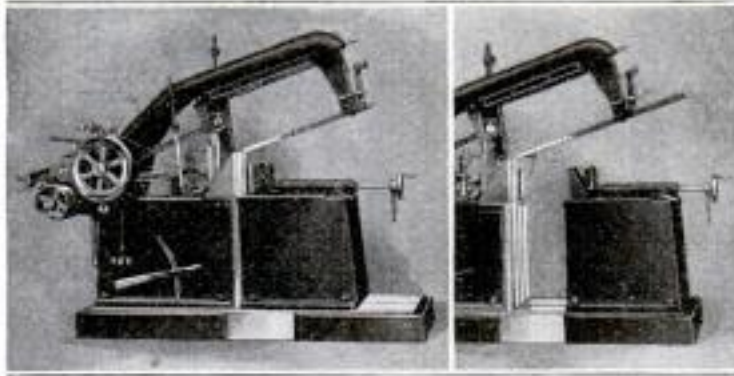

Left, Hacksaw with Gap Closed, as Used for Ordinary Work; Right, Gap Open for Large Work

OILSTONE GRINDER SHARPENS WOODWORKERS' TOOLS

Plane bits, chisels, gouges, and other woodworkers' tools, which usually are ground on grindstones and edged on oilstones, may now be sharpened on an oilstone grinder. The machine is equipped with two oilstone wheels, kept constantly saturated with kerosene, or other oil, which flows, by capillary action and centrifugal force, from the centers of the stones to their outer surfaces, thus keeping the pores

free cutting. The stones are effectively guarded, and are arranged with a table that acts as a tool rest. The table is also equipped with a sliding tool-holder, which has a micrometer feed. A cone, and a leather stropping wheel are mounted directly on the motor shaft.

The cone is used for the inside of curved edges, irregular-shaped tools, etc., and the stropper for removing burrs, and for smoothing cutting edges. The machine is so arranged that four workmen



can use it at once; it may be operated from a lamp socket, and, as it need not be bolted down, used wherever current is available.

REGRINDING IS UNNECESSARY WITH "SEATLESS" VALVE

Freedom from the usual troubles associated with valve seats is assured in the design of one recently introduced. This valve is closed and opened by means of a smooth cylindrical plunger moving through two jointing rings of flexible material, separated by a bushing of the same material as the plunger, and in which are the ports. The valve opens when the plunger has been withdrawn from the lower ring, and only the lower end of the plunger is exposed to the scoring action of the steam or gas, which does not touch the softer material. Even the scoring away of 1/2 inch of the plunger has no effect on the tightness of the valve when closed. There is no stuffing box, as the screwed spindle is cut off from the body of the valve by the upper jointing ring. The valve is kept tight simply by screwing down the gland nuts.

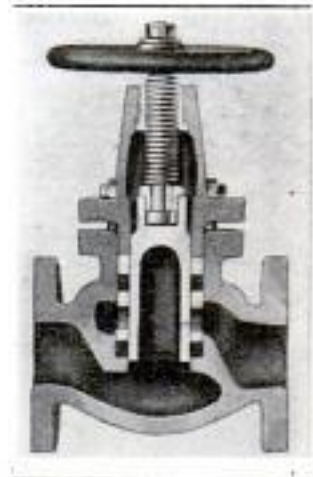

Klinger Patents, Ltd.
130 Southwark St.
London, S.E.1. Eng.

Oliver Machinery Co. Grand Rapids, Mich.

Thomas & Co.
East Haddam
Conn.

Prize Offers and Announcements

4403

THOUSANDS OF DOLLARS AND GOLD MEDAL IN ADVERTISING PRIZES

In an effort to improve advertising, Edward W. Bok, donor of the world peace plan prizes, will give a gold medal and \$8,500 annually. For the year October, 1923, to October, 1924, the awards will be grouped under three classifications. The gold medal will be given to the individual who is voted to have done the most to raise the standards of advertising during the year; three prizes of \$1,500 each will be awarded for planning advertising campaigns and for research work in the field; four awards of \$1,000 each will be presented for individual advertisements of excellence. The prizes will be known as the Harvard Advertising Awards and will be distributed by the graduate school of Harvard University.

Dear Wallace Johnston,

THOUSANDS OF DOLLARS FOR "FIRST NOVEL" OFFERED IN COMPETITION

Any resident of the United States who has not already published a novel in book form is eligible to a prize of \$13,500 to be given through Curtis Brown, Ltd., literary agents of New York City, for a story which is considered best for publication as a book, a magazine serial, or for adaptation as a motion picture. Any book royalties that run over \$1,000 will go to the author on usual terms. The prize is offered by Dodd, Mead & Co., Pictorial Review and the Famous Players Lasky Company. Manuscripts should be in the hands of the agents at 116 West Thirty-ninth Street, New York City, before June 1, 1924.

FIFTY HEALTH COURSE SCHOLARSHIPS TO BE AWARDED TO TEACHERS

Elementary teachers in the first nine grades in cities of 50,000 population or over are eligible to fifty scholarships of \$500 each for a year's study in health education at an accredited institution. The awards are made by the American Child Health Association, 370 Seventh Avenue, New York City, of which Herbert Hoover is president, and the Metropolitan Life Insurance Company. They are given to raise the standards of health education throughout the country. Twenty teachers in each city must compete, and the work on which they will be judged must cover a period of six consecutive months ending not later than May 15, 1924.

TWO THOUSAND DOLLARS OFFERED WRITER OF ADVENTURE STORY

Royalties and a prize of \$2,000 are offered by the Atlantic Monthly Press, 8 Arlington Street, Boston, Mass., for an adventure story, not less than 60,000 words in length, on the character and excellence of the stories of the late Charles Boardman Hawes, after whom the award is named. Manuscripts must be sent in before October 1, 1924. Interest of plot and of actors in the story will be considered in making the decision.

POET WHO WRITES SONNETS ABOUT CITIES TO WIN SEVENTY-FIVE DOLLARS

To increase interest in the sonnet form of poetic expression, Poetry Review offers a prize of \$75 for the best sonnets about cities. Preference will be given to poems in the strict Petrarchan form. The contest closes May 31, 1924. Entries should be sent to Mrs. Alice Hunt Bartlett, American Editor, Poetry Review, 27 West Sixty-seventh Street, New York City.

NEWSPAPERS OFFER SMALL CASH PRIZES FOR JOKES, RECIPES AND SAYINGS

For short letters containing suggestions for menus, recipes, bright sayings of children, jokes and many other anecdotes, the following publications pay from \$1 to \$5 for material accepted:—The Chicago Sunday Tribune; Boston Advertiser; Wisconsin News, Milwaukee, Wis.; Plain-Dealer, Cleveland, Ohio; Daily News, New York; Good Housekeeping, 119 West Fortieth Street, New York; Household Journal, Batavia, Ill.; Grit, Williamsport, Pa.; Science and Invention, 233 Fulton Street, New York; Woman's World, 107 South

Clinton Street, Chicago, Ill.; Farm Journal, Philadelphia, Pa.; Boston Post; Courier Journal, Louisville, Ky.; St. Louis Sunday Globe Democrat; The Denver Post, Denver, Colo.; Washington Post; Home Occupations, Des Moines, Iowa.

AWARDS TO SCHOOL CHILDREN TOTAL THREE THOUSAND DOLLARS

Prizes totaling \$3,000 will be awarded school children for the best essays of 500 words or less on the subject "The Characters I Liked Best in David Copperfield and Why," or "What Scenes and Characters I Should Like to See Included in a Seven-Reel Motion Picture of David Copperfield." Contestants twelve years old, or younger, are eligible to the first subject, those thirteen years, or over, to the second. Essays should reach Encore Pictures, 35 West Forty-fifth Street, New York City, before midnight, March 3, 1924.

STORIES OF THRILLING EXPERIENCES TO WIN FIFTY DOLLARS

Three prizes, \$25, \$15 and \$10 are offered for the best stories submitted to the "My Most Thrilling Experience" department, of Ace-High Magazine. Narratives must not exceed 2,000 words in length and the veracity of the details should be vouched for by some responsible person. Manuscripts should be sent to the Reader's Publishing Corporation, 799 Broadway, New York City.

ESSAY ON "WORLD RENAISSANCE" TO WIN ONE THOUSAND DOLLAR AWARD

Orient, 132 Nassau Street, New York City, will award \$1,000 to the writer of the best essay on "The World Renaissance," the subject for the 1924 competition conducted by the magazine. The purpose of the contest is "to bring together the elite of the East and West in the domain of art, literature and science."

FIVE HUNDRED DOLLARS FOR BEST ESSAY ON MAN WHO BEFRIENDED COLUMBUS

For the best essay on Archbishop Diego de Deza, who as exchequer of the Kingdom of Seville and confessor of Queen Isabella and King Ferdinand, befriended Christopher Columbus when he was seeking aid to make his voyage of discovery, \$500 will be paid. Manuscripts should be sent to Rev. Thomas M. Schwertner, O. P., editor of the "Rosary Magazine," 939 Lexington Avenue, New York City.

SINGLE SONNET OR GROUP WILL REWARD WRITER ONE HUNDRED DOLLARS

One hundred dollars have been offered through "The Bookfellows" for the best sonnet or group of sonnets submitted before April 1, 1924. Details of the contest may be learned from Flora Warren Seymour, 4917 Blackstone Avenue, Chicago, Ill.

TWO HUNDRED PRIZES TO TEXTILE MEN FOR PRACTICAL SUGGESTIONS

Two hundred and sixteen prizes, ranging from \$100 to \$5 each, \$2,000 in all, are offered to textile men for discussions concerning various manufacturing branches of the industry, factory management, suggestions for improving processes, uses, defects discovered and ways that have been evolved for meeting problems of the trade. Articles should be sent to the editor of The American Wool and Cotton Reporter, 530 Atlantic Avenue, Boston, Mass.

HIGH SCHOOL OR COLLEGE STUDENTS PAID FOR WINNING ESSAYS IN MAGAZINE

Students regularly enrolled in high schools or colleges that use the Atlantic Monthly as a textbook are eligible to prizes of \$50, \$25, and \$10 offered in an essay contest. Six awards in all will be given, three to high school and three to college students. Essays submitted must be endorsed by the instructor and must reach the Atlantic Monthly Company, 8 Arlington Street, Boston 17, Mass., by April 12, 1924.

BOYS AND GIRLS UNDER SIXTEEN TO GET PRIZES FOR ESSAYS ABOUT PAINT

Boys and girls under sixteen years of age are to be given 403 prizes of \$100 to \$1 for stories not over one hundred words in length describing some article in the home that needs paint or varnish and for lists of neglected surfaces observed in buildings, offices, stores and other places. Addresses of the owners of the buildings should be sent. The contest closes March 1, 1924.

Stories must be addressed to Prize Committee, Save the Surface Campaign, Box 60, The Bourse, Philadelphia.

ONE HUNDRED DOLLARS ROYALTY OFFERED FOR THREE-ACT PLAYS

Royalties of \$100 for two or three performances will be paid by the Drama Branch of the Community Arts Association of Santa Barbara, Calif., for original three-act plays submitted directly by the authors.

Science Notes for Daily Use**GAS TO COOK DINNER FOR SIX PERSONS COSTS LESS THAN FOUR CENTS**

Sufficient gas to prepare a dinner for six persons costs only 3.3 cents at the rate of \$1.00 per 1,000 cubic feet, according to experiments recently conducted by the United States Department of Agriculture. The entire cost of the meal consisting of Swiss steak, escalloped potatoes, spinach, bread, butter, rice pudding, coffee, cream and sugar was \$1.474 at current market prices.

HOW BEES KEEP WARM IN HIVES

When the temperature falls to fifty-seven degrees Fahrenheit or below, bees in their hives form clusters about the combs to keep warm. Beating their wings and wriggling about, those on the inside of the mass, generate heat which warms the others. Those on the outside lie still and close together, forming almost perfect insulation. Tests have shown that this method is so effective that there may be seventy-five degrees difference in temperature between the interior and exterior of the cluster within a distance of only four and one-half inches. Bees have been known to work themselves to death trying to keep warm.

ETHER INJECTED INTO BACKWARD BUSHES STIMULATES GROWTH OF BUDS

Ether injected into the base of rose bushes, or other shrubs, that are backward, will cause dormant buds to swell and the plant will regain a healthy condition, according to experiments made by Prof. David Lumsden of the federal horticultural board. The drug is administered by a hypodermic needle at the base of the stem and near the roots. Only a few drops are needed, and after this treatment, the bush is said to be immune from ordinary diseases.

ONLY RED-BLOODED ANIMALS ARE HARMED BY CARBON MONOXIDE GAS

Only slight injury is caused by carbon monoxide gas to animals that do not have red blood, reports of specialists of the United States Department of the Interior show. Cockroaches were kept alive without lessening their activities at an experiment station in Pittsburgh in an atmosphere which contained sixty per cent carbon monoxide gas and only twenty per cent oxygen. The presence of live roaches in mines was thus shown to be no indication that the air is safe for men to breathe. The most reliable tests for poisonous gases in mines are made with canaries. These birds are so sensitive to the carbon monoxide, and other deadly fumes, that they have been known to be overcome in three or four minutes when there was only .25 per cent of the gas in the air.

OZONE AS AN AIR-PURIFIER

Tests to determine the value of ozone for purifying the air in buildings are being made by the United States Department of the Interior in co-operation with the bureau of mines. In the oxidizing powers of the gas, engineers see possibilities that may make it valuable in refreshing the air, removing odors and destroying bacteria. Ozone has also been proposed for bleaching and

sterilizing textiles. The tests are expected to show whether injurious oxides of nitrogen are produced by the gas, to what extent it can be employed without harmful effects to breathing and ways to measure the quantity of ozone and oxides in air so treated. Tests, so far have shown, it is said, that oxides are not produced in harmful amounts by ozone ventilation apparatus.

WIRE SCREENS FINER THAN SILK CLOTH TEST QUALITY OF CEMENT

Wire sieves of finer texture than that of silk cloth are required in testing various grades of cement. Ordinary silk dress lining contains 81 threads to the inch, a silk handkerchief of good quality, 110 threads and the best silk dress goods, 187 threads. But to sift the fine cement dust, a screen with 200 wire threads, each smaller than a human hair, is required. There are 40,000 holes to the square inch in a sieve of this kind, and a mile of the slender wire is needed to weave a square foot of the mesh.

AFTERNOON HOURS WETTEST OF THE DAY WEATHER RECORDS SHOW

Late afternoon and evening hours from five o'clock to eight o'clock are the wettest, according to records of the weather bureaus. In some parts of the country, twice as much rain falls between those hours as does from nine o'clock in the morning until noon. This is due to the fact that in the morning hours, rising temperatures enable the atmosphere to hold more moisture, and when the mercury falls in the later hours, cooling currents cause rain fall. This peculiarity is more pronounced in warm than in cool weather, and is illustrated by frequent thundershowers in the afternoons.

PANELS OF WOOD STRIPS GLUED TOGETHER ARE STRONGER THAN STEEL

Panels of plywood, thin layers of wood cut by machine and glued together so that the grain of one layer is at angles to that of the two adjacent layers, are stronger than those made of steel, experiments have proved. The method of construction has been particularly valuable in building airplanes. Before it was known, wing ribs of wood weighed 7.95 ounces and were capable of holding a weight of only nineteen pounds. Those made of plywood are now able to hold a weight of 274 pounds and weigh only 5.12 ounces.

REMOVING ODORS FROM MILK

Unpleasant odors in milk, frequently caused by various kinds of green feed given to the cows just before milking time, are largely eliminated by aerating the milk in specially prepared apparatus and in changing the feeding hour. Tests made by the United States Department of Agriculture show that green alfalfa, corn and turnips eaten by cows just before they were milked produced strong odors. Fifteen pounds of turnips fed an hour before milking time resulted in noticeable taints, while increasing the amount to thirty pounds greatly intensified them. The quantity fed after milking had practically no effect. Although careful aeration has been found to remove many odors, some of them cling in the cream.

IN accordance with the editorial policy of this magazine never to accept compensation in any form for what appears in our reading pages, and also to avoid all appearance of doing so, we are obliged to omit the name of the maker or the seller of any article described. This information, however, is kept on file and will be furnished free, by addressing Bureau of Information, Popular Mechanics Magazine, Chicago. [Editor.]



Marshaling the Telephone Forces

In the simple act of lifting the telephone receiver from its hook every subscriber becomes the marshal of an army. At his service, as he needs them, a quarter of a million men and women are organized in the Bell System. One skilled corps of the telephone army moves to place him in talking connection with his neighbor in the next block, in the next state or across the continent. Another highly trained corps is on duty to keep the wires in condition to vibrate with his words. Still others are developing better apparatus and methods, manufacturing and adding new equipment, and installing new telephones to increase the subscriber's realm of command.

The terrain of the telephone army is the whole United States, dotted with 14,000,000 instruments, all within range

of the subscriber's telephone voice. Even in the remote places this army provides equipment and supplies. Its methods of operation are constantly being improved, that each user may talk to his friends with increased efficiency. Millions of money are spent in its permanent works. Yet its costs of operation are studiously held to the minimum, that the subscriber may continue to receive the cheapest as well as the best telephone service in the world.

The permanent objective of the Bell System army is to meet the telephone needs of the nation—a hopeless task were not its command unified, its equipment adequately maintained and its personnel trained in the latest developments of telephone art.



AMERICAN TELEPHONE AND TELEGRAPH COMPANY
AND ASSOCIATED COMPANIES

BELL SYSTEM
One Policy, One System, 12

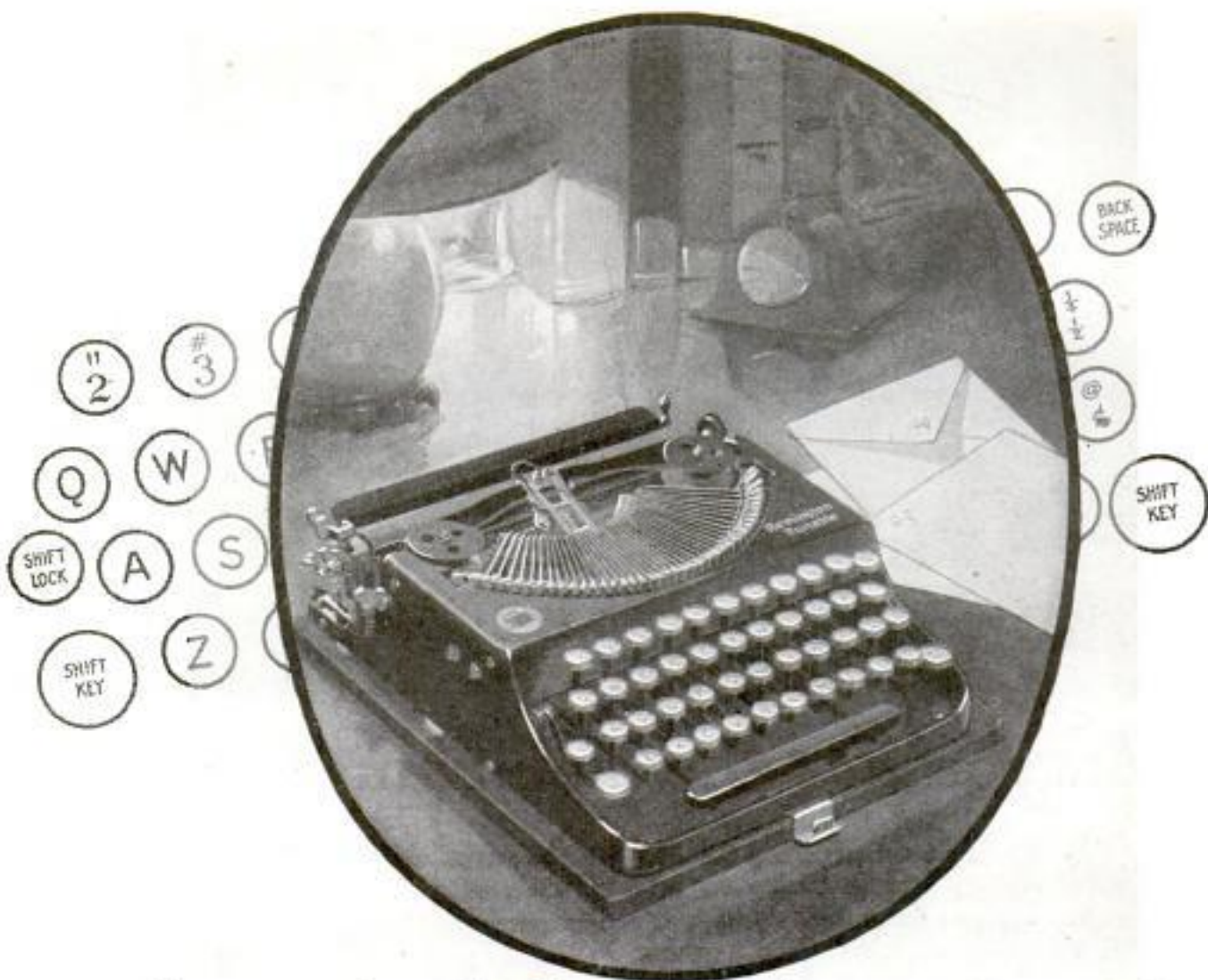

The complete keyboard makes writing easier

The Remington is *that* portable with the four-row keyboard (42 keys)—just like the big machines. No shifting for figures. Everything arranged according to the business standard. Simplest to learn and easiest to operate.

It is compact, light, and easily carried in a handy case. Then there is the baseboard already attached—that makes writing convenient in any place or position.

To countless people who write—much or little—the Remington Portable lends an indispensable aid.

Examine the Remington Portable. Sold by all Remington branches and over 3,000 dealers. A demonstration will prove to you its adaptability for all personal writing.

Convenient time payments, if desired. Let us send you "For You—For Everybody". Address Department 12.

We believe we make the best typewriter ribbon in the world, and its name is PARAGON

REMINGTON TYPEWRITER COMPANY
374 Broadway, New York

REMINGTON PORTABLE
LEADER — IN SALES AND POPULARITY

Magnetos come apart quickly

When you use "Yankee" Ratchet Screw-drivers on them. Every motor mechanic, or car-owner who does his own repairing, knows how long it takes to overhaul a magneto.

"YANKEE"

Ratchet Screw-drivers

save time by quickly driving and drawing the many small, wobbly magneto screws. The knurled washer on No. 15 particularly is handy for it enables you to start small screws with thumb and forefinger.

Only one grip is needed for each screw you drive, or draw. All the endless grip-and-let-go of the ordinary screw-driver is done away with. No man who has ever used "Yankee" Ratchet Screw-drivers could be induced to work any other way.

No. 10 and No. 11 come in 2", 3", 4", 5", 6", 8", 10" and 12" blades.

No. 15 comes in 2", 3", 4", 5", 6" and 8" blades. Diameter of blade, 3-16".

No. 11 is same as No. 10, except Ratchet Shifter which moves across instead of parallel with tool.

*Dealers everywhere sell
"Yankee" Tools*

North Bros. Mfg. Co.
Philadelphia, U. S. A.

"YANKEE" TOOLS

Make Better Mechanics



Some other "YANKEE" Tools

Ratchet Bench Drills
Ratchet Hand Drills
Ratchet Breast Drills
Ratchet Chain Drills
Plain Screw-drivers
Automatic Push Drills
Ratchet Tap Wrenches
Removable Base Vises

Send for this FREE Tool Book

All the famous "Yankee" Tools are pictured and described in it. Hand, breast, chain and bench drills; tap wrenches, vises, etc. Write for it today.



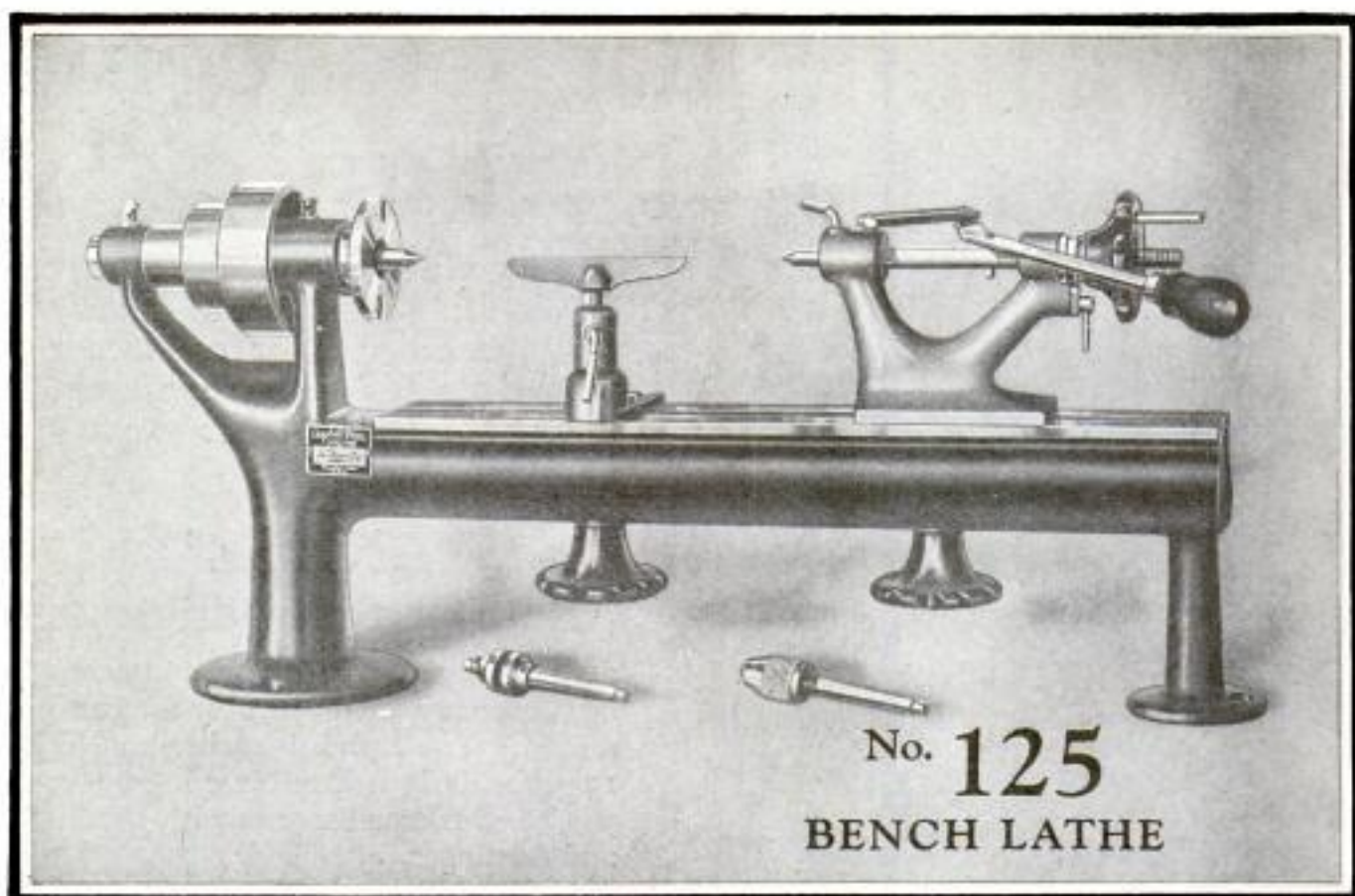

A bench lathe for your home shop

Have a *real* workshop—one where you can do all sorts of turning or boring jobs yourself.

This bench lathe is just the right size for you. Length over all, 25 inches; height, 11½ inches; swing, 7 inches; extreme distance between centers, 12 inches. Weighs only 30 pounds.

Well-made and finished with black and red enamel. The bed is milled. All working parts handsomely polished. Cone pulley has three steps—1½,

2½ and 3½ inches in diameter.

Included with this lathe are an adjustable tee rest, slotted face plate, saw arbor, drill chuck and a No. 1 Morse taper shank.

This bench lathe is just one of the many tools made by Goodell-Pratt for the craftsman. Write for the Goodell-Pratt Catalog. It illustrates and describes each of the 1500 Good Tools. A postcard will bring a copy—free.

No. 125
Bench Lathe
PRICE \$36

No. 132
Slide Rest
PRICE \$16

No. 130
Counter Shaft
PRICE \$11

DEALERS: Write for prices, terms, etc., on this popular bench lathe, as well as on other Goodell-Pratt Tools

GOODELL-PRATT COMPANY, GREENFIELD, MASS., U. S. A.

Toolsmiths

MAKERS OF MR. PUNCH

GOODELL-PRATT

1500 GOOD TOOLS

"A Columbia, please"

for—

Doorbells
 Buzzers
 Ringing burglar alarms
 Protecting bank vaults
 Calling Pullman porters
 Running toys
 Telephone and
 telegraph
 Lighting tents and
 outbuildings
 Gas engine ignition
 Tractor ignition
 Starting Fords
 Firing blasts
 Motor boat ignition
 Heat regulators
 Electric clocks
 Radio "A"



THAT'S how to ask for a sure-to-be-good dry cell. Name it! Insist on Columbias! There's a snappiness to their power that you'll like. It lasts. You get more battery life for your money. Slow to spend their strength—quick recovery as they rest. Always fresh, because dealers sell them so fast. Most economical

battery you can buy. You seldom need new ones. Great for radio dry cell tubes.

Columbia Dry Batteries are sold by electrical, hardware and auto accessory shops, marine supply dealers, implement dealers, garages, general stores. Fahnestock Spring Clip Binding Posts on Columbia Ignitor at no extra cost.

NATIONAL CARBON COMPANY, INC., New York, San Francisco
 CANADIAN NATIONAL CARBON CO., Limited. Factory and Offices: Toronto, Ontario

Columbia Dry Batteries

—they last longer



© N. Y. Edison Co.
From Underwood

New York City is lighted by millions of MAZDA lamps, a brilliant example of the fact that out of every 100 people in the United States 37 live in electrically lighted homes.

The best lighted country

Ever since man discovered he could conquer darkness with artificial light, civilization has been marching on.

Our country leads the nations of the world in the proportion of people who live in electrically lighted homes and enjoy the advantages of electrically lighted streets.

Lighting the streets—and the highways too—carries electricity through town and country so that all may enjoy its benefits.



This is the mark of the General Electric Company, an organization of 100,000 men and women engaged in producing the tools by which electricity—man's great servant—is making the world a better place to live in.

GENERAL ELECTRIC

Complete RADIO Outfit

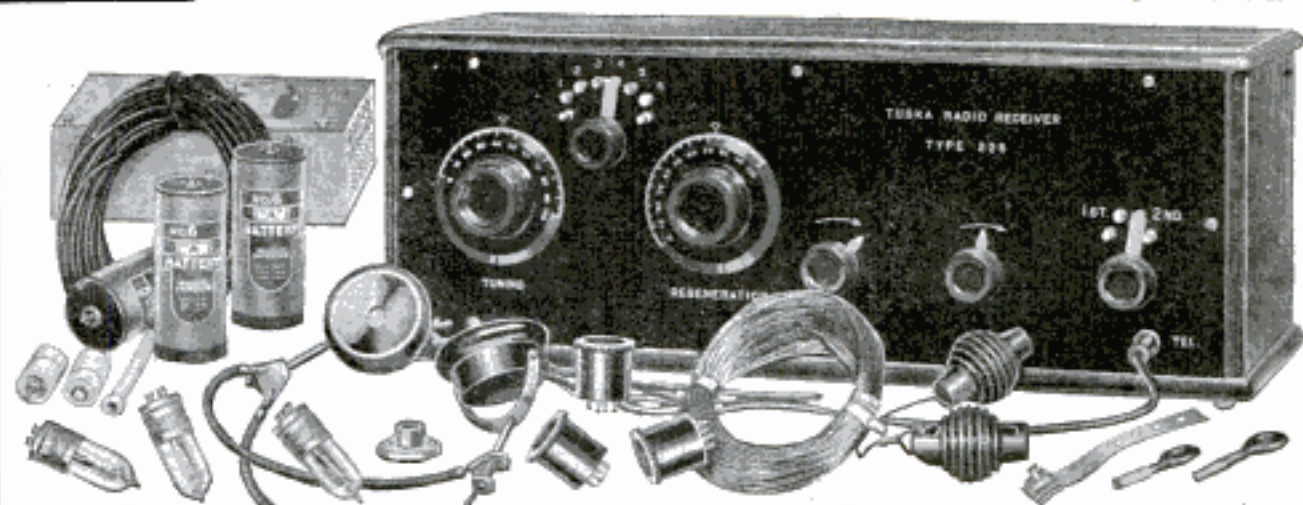

\$5

Down Puts This Famous **TUSKA**

**Armstrong Regenerative 3-Tube Outfit
in Your Home
Balance in Easy Monthly Payments**

NOW everyone can have the finest radio receiver and amplifier that is made. No need to put up with inferior equipment. For here we are offering you the set designed and built complete by Mr. C. D. Tuska, the famous Radio Engineer. It comes to you complete with all the accessories you need, for just a five-dollar payment. Take advantage of this new way of selling radio. Get an outfit that will give you permanent satisfaction. Send the coupon below for our Great Special Offer, made for a limited time only.

The Perfected Radio At Last!

So simple to tune that it is just the thing for the beginner. Yet so perfect that it will delight the most hardened "radio fan" who has long been searching for the ideal circuit. Its long range will bring in stations never heard before, so loud and clear that a loud speaker will delight the whole family. Wonderfully selective. With it interference, internal noises and annoying body capacity are forgotten.

Send Coupon for Great Special Offer

Just mail this coupon. Get all the details without any obligation. Don't think of buying a radio set without finding all about this new and better way. Very easy terms. Free Trial. The highest quality of radio equipment possible to own. Send coupon NOW.

BABSON BROS. 2843 West 19th Street
Dept. 13-53 CHICAGO, ILL.

No Accessories to Buy

The radio outfits we sell are absolutely complete. Most others make an offer on the bare set and leave you to buy all the extras like tubes, phones, etc. in addition. The outfit we offer you now includes, the Regenerative Receiver and 2 step Amplifier all enclosed in a solid mahogany case. Also the batteries, head-phones, tubes, aerial, lightning arrestor, and full wiring installation equipment. You start operating without investing another single penny. Your \$5 payment brings it all.

UV 199 Tubes and Dry Cells Reduce Upkeep to Almost Nothing

Equipped with 3 of the latest type of dry battery tubes, which use only .06 ampere current. Most perfect tube, both for detecting and amplifying. Battery expense reduced to the absolute minimum.

BABSON BROS., Dept. 13-53
2843 West 19th Street, Chicago, Ill.

Please send me your special offer on a Complete Tuska Radio Outfit on terms of \$5 down and monthly payments.

Name _____

Address _____



At Last!

A Wall Safe for Every Home

Yes! The guaranteed Bulldog Wall Safe — sold at our amazingly low price, for only \$1.00 down — at last makes possible "a safe in every home."

Now you can protect your valuables. Now you can keep your important papers right at home and know they're safe. The Bulldog Wall Safe is not merely for rich homes. It is for every home that contains anything worth treasuring — be it money, jewels, documents, heirlooms, or anything else. YOU need a Bulldog Wall Safe. It is both fire-proof and burglar-proof, and you can install it yourself.

Homes are being robbed or burned every day. Yours may be the next. Why take chances? Find out about the Bulldog. Write us today.

\$1.00 Brings you the
**BULLDOG
WALL SAFE**
Then Small Monthly Payments

And, for an astonishingly low price you get the utmost in strength, convenience and security! The Bulldog is built of the strongest steel, asbestos lined, and has exactly the same efficiency as the highest priced office safes. It cannot be picked nor forced, nor opened by sound or touch, because it operates without resistance and without sound. Once installed, it becomes a part of your wall, and unless you use the combination, it can neither be opened nor removed. Let us prove all this. Mail coupon today.

You Install It Yourself

You yourself can easily install the Bulldog in your wall or any carpenter will do it for you in a jiffy. Or, if you prefer, you can sink the safe right into your flooring, and hide it so no burglar would ever know of its existence! But in this small space we cannot begin to tell you all about the Bulldog. Mail the coupon for the whole story.

You can test the Bulldog before you buy. Get our special offer

Mail Coupon Now For Special Offer

Learn all about the Bulldog and get our special offer at once. Don't wait till someone steals treasures that you can never replace! Don't wait till they are destroyed by fire! Find out about the Bulldog Wall Safe NOW. Mail the coupon TODAY!

Babson Bros. 19th Street and California Ave. Dept. 13-53 CHICAGO

Gentlemen: Please send me, without the slightest obligation on my part, your special offer on the Bulldog Wall Safe, together with complete descriptive literature.

Print name and address plainly

Name.....

Address.....

SAVE MONEY
Get This Book

HANDY MAN BOOK

Install Your Own
PLUMBING & HEATING
NEW EASY WAY - SAVE HALF

25c
Reg. Price 50c

Brings you this big Plumbing and Heating Encyclopedia-Catalog. Write for your copy today without fail.

Guaranteed Heating Plants

Our Handy-Man Book shows how. Big 256-page well-bound encyclopedia of Plumbing and Heating Outfits, Systems, Supplies, Fixtures and Accessories—10,000 items—illustrated. Hundreds of floor plans, elevations, diagrams, trade secrets, money and trouble-saving hints, etc. "How to save coal in heating," "Easy repair methods." Every householder, contractor, farmer, mechanic, institution needs this book. Shows how to save wages, work and materials.

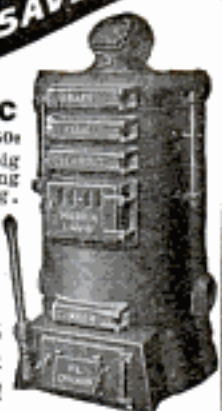

Hot Water Boiler

Big Handy Man Book

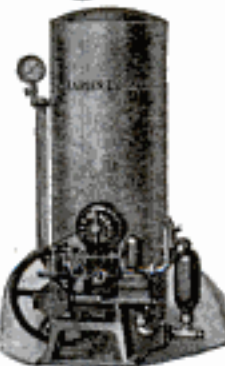

Water Supply System

Tells how we help you plan and install. From rough sketch or description we supply working plans and clear instructions. We loan the tools needed. Any handy man can install. This is the place to buy on money-back guaranty. Plumbing Outfits and Supplies; Water Systems; Hot-Air, Water or Steam Heating Plants; Radiators, Pipes, Boilers or Septic Disposal Tanks.

Send 25c for Yours Today

We have spared no effort or expense to complete this remarkable and instructive book. To keep from sending it broadcast to disinterested persons, we request a deposit of 25c, which will be refunded on your first order — or send for our FREE Bulletin. Write today and save half.

HARDIN-LAVIN CO.

50 Years
at 4547-57
Cottage Grove Ave.,
CHICAGO



Bathroom Outfit

\$25 A DAY Selling Suits

Fifth Ave. New York Custom Tailors

We want agents to sell advertised brand all wool tailored to measure suits and overcoats, direct to wearer. Lowest prices, sell on sight. No capital or experience required. Big line, swatch samples free. Biggest commissions paid daily. Auto free to Agents. Write **MONARCH TAILORING CO., 100 Fifth Ave., Dept. 1, NEW YORK**

I Made \$100,000

in less than five years as a

REAL ESTATE SPECIALIST

Started during my spare time, with no experience, and less than \$5 capital. If you want to learn the secret of my success and follow my money-making method, send your name and address at once to American Business Builders, Dept. 6, 1133 Broadway, New York. They send full information free, telling you how you can build up an independent, profitable business of your own by using my amazingly successful system.

The Phones that the fans are all talking about

YOU have been hearing radio enthusiasts tell about "That imported head set with the wonderful tone"; "The head set with the big phones"; "The set that is so comfortable to put on." It's the N & K 4000 ohm Phones that they are talking about.

Hundreds of amateur radio stations tested N & K Phones the past year. Of these, 90 per cent call N & K the best they ever used.

Here are the reasons: The *scientifically correct design* based on years of research, *perfect workmanship*, *extra large phones*, 2¼ inch diaphragm. As a result N & K Phones have clear, mellow tone, broader range—good equally on high and low tones; greater comfort to the wearer; exclusion of outside sounds. The casing of nicked brass—instead of stamped aluminum—provides a perfect sound chamber, and a special device insures absolutely uniform distance between diaphragm and poles. The headbands have a sanitary covering of genuine leather.

If your regular radio dealer is not yet stocked with N & K send us his name and \$8.50 and we'll ship you a pair at once. Descriptive folder on request.

TH. GOLDSCHMIDT CORP.

Dept. M-3 15 William Street, New York City



**"Get The World
With N&K"**



Imported PHONES

Dealers:

N & K Head Sets mean easy sales, excellent profit. Use them to demonstrate your radio sets, especially the small ones, and you'll sell the set every time. There are no come-backs on N & K Head Sets. As one dealer says after handling them for a year: "I have yet to see one pair come back for repairs." We are exclusive distributors for U. S. and Canada. We guarantee them fully and carry a complete stock of spare parts. Packed in display cartons of ten phones, with window trim, counter display, folders and mounted proof of our March 15th

SATURDAY EVENING POST FULL PAGE to appear also in April Popular Mechanics. Until district jobbers are announced, wire orders direct to us.

—MORE INFORMATION—

Dept. M-3, Th. Goldschmidt Corp.
15 William St., New York, N. Y.

Please send me folder describing your new Model D4000 N & K Head Set in detail.

Name

Street

City State

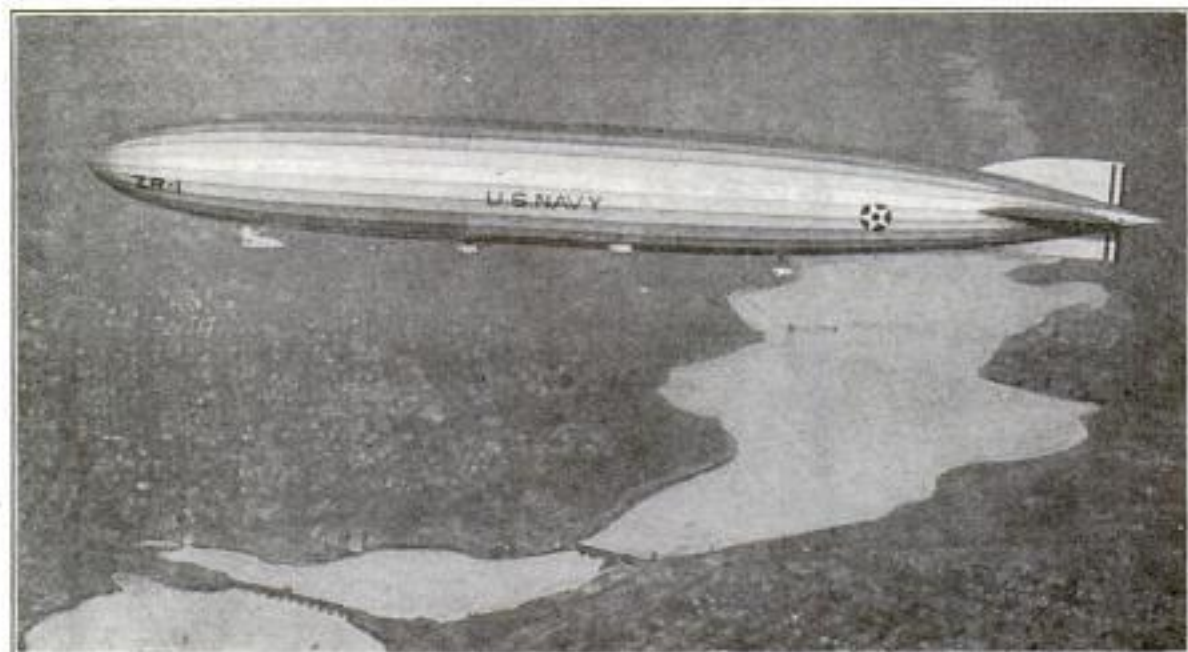

When Perfection Depends on Accuracy

Forty men—soaring 2000 ft. above the earth—miles from a repair shop—in this monster bird of the air—

Only their utmost belief in the accuracy of its minutest details could lead them to so confidently leave earth behind. Such confidence could only come from their knowledge that flawless materials, the most skilled workmanship, and the world's finest and most accurate tools entered into its construction.

Brown & Sharpe Tools, "The Standard of the Mechanical World" for accuracy, insure the utmost confidence that the result will be mechanical perfection.

If it's Brown & Sharpe—it **must** be right.

Use our Small Tool Catalog as your buying guide.

BROWN & SHARPE MFG. CO.

PROVIDENCE, R. I., U.S.A.

BROWN & SHARPE TOOLS

"The Standard of the Mechanical World"

now Only

\$14²⁴ Down

(Magneto Equipped)

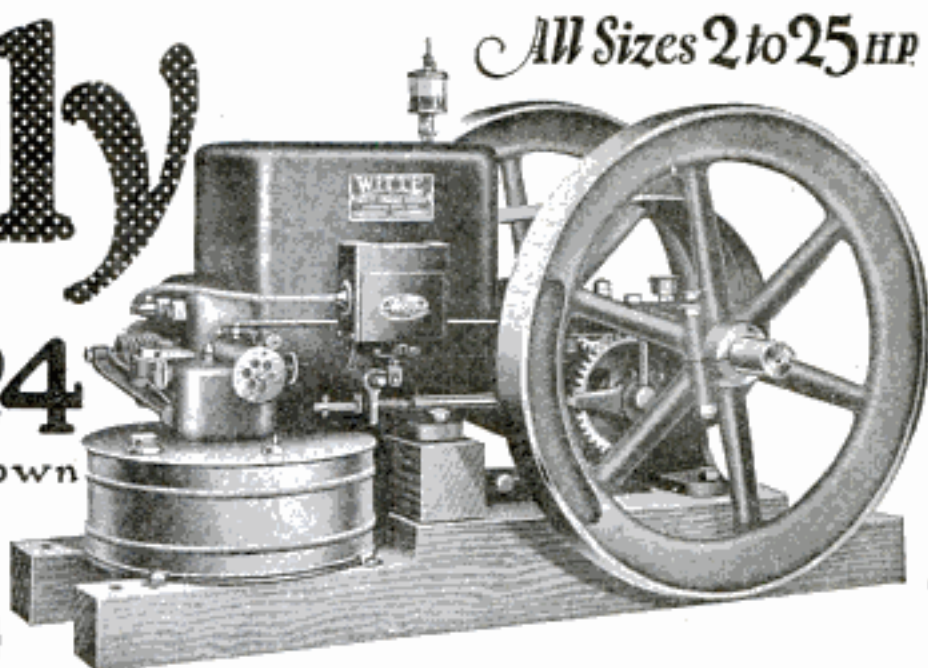

All Sizes 2 to 25 HP

Puts this THROTTLING GOVERNOR WITTE on Your Place

Here's a revolution in farm power—now a cheap, dependable engine is within the reach of every progressive person—you can make \$1,000.00 or more extra profit every year you have a Witte Engine working for you.

BURNS KEROSENE, GASOLINE, DISTILLATE or GAS!
(NO SPECIAL ATTACHMENTS NECESSARY)

Here's the standard engine value—the WITTE Throttling-Governor ENGINE which burns kerosene, gasoline, distillate or gas without any special attachments. With the WITTE you are no longer at the mercy of fuel fluctuations—you get steady, dependable power and always use the cheapest fuels.

An All-Purpose Engine

The WITTE delivers the big surplus of power that you need for the larger heavier jobs but can also be speeded down to handle small jobs at a minimum fuel cost. Easily moved from place to place—the WITTE answers every power need on the place. Trouble-proof and so simple to operate that a boy can tend to it. Makes all farm work easy and cheap—Louis Knoche says: "I didn't know a WITTE could show me such a profit. I do all the chores easily and quickly and have saved the wages of several hands this year. The engine works like a charm and I have kept it going steadily ever since I got it."



Built By The Man Who Sells Them

I build my engines and I sell them—I have been doing this for over forty years. Over 100,000 satisfied customers say that the WITTE is the one engine that can be relied upon all the time. And because I build the WITTE and sell it direct to you I give you a price that no one can equal on such a high-quality engine. I deal with you personally—if there is any problem confronting you in the purchase of an engine, write me PERSONALLY and I'll help you. ED. H. WITTE.

Equipped with the Famous Wico Magneto

THE WITTE comes equipped with the Wico Magneto—the most perfect system of high tension ignition known. A guarantee that the WITTE will always have a fat, hot spark and give perfect performance in all climates, under any weather condition or temperature. Far superior to the old-style battery-equipped engine—it combines dependability and economy all the time.

Lifetime Guarantee

The WITTE ENGINE is guaranteed for a lifetime of hard, steady work—mechanically perfect, built of only the best selected material in the largest factory of its kind in the world.

Sold Direct From Factory to You

I employ no salesmen—the WITTE ENGINE is sold direct from my factory to you at the lowest price in history and I give you nearly a year to pay on any size, 2 to 25 horse-power.

90 Days' Free Trial

So confident am I that the WITTE ENGINE will make you money day in and day out that I offer to let you try a WITTE 90 days at my risk and if it's not right, I simply say—"I'LL MAKE IT RIGHT AND IT WON'T COST YOU A CENT." Can I make a fairer offer to prove to you that now you can buy cheap, dependable farm power that is sure to show a profit?

Ed. H. Witte

WITTE ENGINE WORKS

1746 Oakland Av., KANSAS CITY, MO.
1746 Empire Bldg., PITTSBURGH, PA.

Without obligating me in any way, please send me at once your big engine book and full details, prices, etc.

Write for my FREE Engine BOOK Now

Write me today—no obligation whatever, for my big free illustrated engine book that shows the low prices! on this remarkable engine. Gives full details of operation and shows the way to the biggest profit year you will ever have.

—ED. H. WITTE, Pres.

Witte Engine Works

1746 Oakland Avenue, KANSAS CITY, MO.
1746 Empire Building, PITTSBURGH, PA.

Name.....
Address.....
City.....State.....

LOFTIS

BROS. & CO. EST'D 1858

DIAMONDS WATCHES



"Virginia" Diamond Ring
Blue White, perfect cut Diamond. The ring is 18-K Solid White Gold, carved and pierced. Special at \$75. Only \$7.50 with order or on delivery, then **\$1.75 A WEEK**

GENUINE DIAMONDS Guaranteed

Cash or Credit



Loftis Carved "Perfection" Diamond Ring
Blue White, perfect cut Diamond, set in White Gold prongs. Ring is 14-k Solid Green Gold. Bridal Blossom design.
\$50



"Sylvia" Diamond Ring
Blue White, radiant, perfect cut Diamond. The ring is 18-K solid White Gold, carved and pierced. Special at \$100. Only \$10 down, then **\$2.50 A WEEK**
Also bargains at \$75 to \$600



Rectangular Wrist Watch
Ribbon Bracelet
18-k White Gold, 17 Jewels, \$29.75; 14-k White Gold, 15 Jewels, \$24.85. Delivered on first payment of \$8.00, then \$1.00 a Week thereafter.



17 Jewel ELGIN
No. 15—Green Gold, engraved, assorted patterns, guaranteed 25 years, \$32
Size, gilt dial
Terms: \$3.25 Down then \$1.00 a Week until paid.

High-Grade Railroad Watches
Guaranteed to Pass Inspection
HAMILTON No. 992
21 Jewels, Adj. to 5 Positions, \$56
Gold filled, 25 year case

ILLINOIS "BURN SPECIAL"
21 Jewels, Adj. to 5 Positions, \$50
Gold filled, 25 year case

ELGIN'S LATEST RAYMOND
21 Jewels, 8 Adjustments. Runs 49 hours one winding.
Gold filled, 25 year case \$55

Special Values

Diamond Rings	25.00
Diamond Bar Pins	25.00
Diamond Scarf Pins	15.00
Diamond-Set Onyx Rings	15.00
Men's Watches	15.00
Peart Necklaces	10.00
Mesh Bags, fine mesh	15.00
Wedding Rings	5.00
Diamond Cuff Links	25.00

Send for Catalog

LOFTIS NATIONAL CREDIT JEWELERS
BROS. & CO. EST'D 1858
108 N. State Street, Chicago, Ill.
Stores in Leading Cities

Diamonds, Watches, Jewelry Wonderful Values

We import Diamonds direct from Europe and sell direct by mail—a great saving to you.

Our Diamonds are distinctive in beauty, blue white, perfect cut, of great brilliancy.

SEND FOR CATALOG

Over 2,000 illustrations of Diamond-set Jewelry, Watches, Wrist Watches, Pearls, Mesh Bags, Silverware, etc. Select as many articles as you wish and have all charged in one account. Sent prepaid for your Free Examination.

Satisfaction Guaranteed or Money Refunded

Catalog Explains Everything

"HOMES OF DISTINCTION"



A beautiful book of 68 pages, showing homes in many styles, one and two story, with floor plans and complete descriptions, costs, etc. Garage supplement will be furnished FREE with home plan book. Blue prints and specifications furnished for any design.

Price ONE DOLLAR postpaid

SCROGGS & EWING
Architects
610-P Lamar Bldg., Augusta, Georgia

SEND for the INTERNATIONAL CATALOG

Our net price list. Full line of auto bodies and accessories for Fords at Wholesale Prices. Save big money on bodies by buying direct from factory.



INTERNATIONAL BODY WORKS, Dept. 7, 914 W. Ohio Street, CHICAGO, ILL.

MOTORCYCLE BARGAINS

Save 25% to 65%

on Slightly used and Rebuilt Motorcycles, Side Cars, Johnson Motor Wheels, Evans Power Cycles, Bicycles. Send for Free Bargain Bulletin and Money Saving Message. Getting hundreds of bargains in used, rebuilt and new machines, supplies, accessories, etc.

AMERICAN MOTOR CYCLE CO.
Dept. 327, 2047 W. Chicago Avenue, CHICAGO



HEAVY COPPER CANS

LOWEST PRICES

direct from the largest manufacturers. Made of extra cold rolled, heavy copper with screw top, either brass or copper. Spun cover. Best can made at prices that cannot be duplicated. Prompt shipment in plain strong box.

Other makes and shapes in our catalog No. 18.

Write for it FREE

HAGEN IMPORT CO., 42 N. 8th St., PHILADELPHIA, Pa.

3 gal.	\$ 3.50
5 "	4.75
8 "	7.25
10 "	9.25
15 "	12.25
20 "	16.25
25 "	19.25
30 "	24.25

A NEW WAY TO GET YOUR CLOTHES ABSOLUTELY FREE



and Make Big Money during your spare time—something different, better, bigger, more liberal than any offer ever made. Lower prices—better clothes—bigger cash profits—express or postage paid on everything.

DOUBLE PAY

Free Clothes and Cash Profits Besides. You can easily earn \$30.00 cash, extra, every week during your spare time, taking orders for our made-to-measure clothes. We don't ask you to use your cash profits for your own clothes. That's not our way of doing business. Ours is a new and better plan.

Fifty-six stylish, real cloth garments—FREE colored fashion plates; inside wholesale prices—everything FREE. Just drop us a line today and we will send complete outfit FREE.

SPENCER MEAD CO. Dept. C-245 Chicago



*Harris
Homes
Beautiful*

**Permanent Built!
—Now Within Your Reach**

The combined efforts of thirty great departments in experimenting and testing materials and methods of construction have produced for you a **GUARANTEED** home, expert machine cut, bundled and marked—the last word in building economy.

Not One Penny in Advance

So sure are we of the super-excellence of our material and our **GUARANTEED** Ready-Cut System that we will ship you any **HARRIS HOME** without the payment of one cent down. Our plan Book explains our liberal terms fully.

BUILDING MATERIAL! FREE BOOK OF PLANS!

For over a quarter of a century, thrifty wise buyers have realized that here is the open door to real economy, whether it be a brand new home or material for improvements or repairs. The latest edition is waiting for you, contains our **FREE PLAN OFFER** and photographic reproductions, with floor plans and specifications of 100 beautiful homes. Mail coupon today.



Plumbing and Heating!!

Hot water and heating systems, warm air heating plants, pipeless furnaces and plumbing material of every kind—the product of America's leading makers. Our mammoth plumbing stock offers unlimited possibilities for you to save money. Our heating plants are guaranteed to heat your home in any weather with big fuel economy.



Bathroom Outfit Complete!

Consists of white porcelain enameled bathtub, 5 ft. long, complete with fittings, washdown closet outfit with white vitreous china earthenware bowl and tank fitted with mahogany seat and cover. Lavatory complete with indexed faucets, trap and supply pipes. *This is but one of Many Wonderful Values in guaranteed Plumbing in Our Big Complete Stocks. Mail the Coupon!*

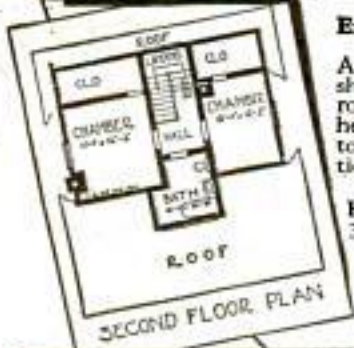

Expert Engineers Waiting to Help You

A rough sketch of your building showing number and size of rooms, doors, windows and height of ceiling is all we need to give you complete information and low prices.

Dept. PG-7
HARRIS BROTHERS CO.
35th and Iron Sts., Chicago.



MAIL THIS COUPON

HARRIS BROTHERS CO.
Dept. PG-7, Chicago
These books are **FREE** and sent postpaid. Mark an "X" in the squares to indicate which ones you wish.

<input type="checkbox"/> Harris Home	<input type="checkbox"/> Book of "Presto-up" Houses and Garages
<input type="checkbox"/> Book of Plans	<input type="checkbox"/> Plumbing and Heating Book
<input type="checkbox"/> Building Material	
<input type="checkbox"/> Catalog	

Name.....
Address.....

Free Book of Plans



TRADE MARK REG.
WURLITZER
SUPREMACY IN MUSICAL INSTRUMENTS

Try It In Your Own Home

You may now have any known musical instrument for a week's free trial in your own home. Play it as much as you wish. See how easy it is to learn. There is no obligation to buy—no expense for the trial. You may return the instrument at the end of a week if you decide not to keep it.

Wurlitzer instruments are known the world over for unusual tone quality and excellence of workmanship. They are used by the greatest musicians, bands, and orchestras.

Easy Payments

If you decide to buy, the Wurlitzer plan makes it easy for you to own the instrument you want. Payments are conveniently arranged in small monthly sums—a few cents a day will pay.

Special combination offers on complete outfits—velvet lined case, all accessories, self-instructor, etc.—everything you need at practically the cost of the instrument alone.

Send For Free Catalog

The greatest musical catalog ever published—over 3000 articles—every known instrument described and illustrated—many of them shown in full colors. Gives you lowest prices and all details of the Wurlitzer plan.

Send This Coupon

The Rudolph Wurlitzer Co., Dept. 1773
117 E. 4th St., Cincinnati 329 So. Wabash Ave., Chicago
120 W. 42nd St., New York 250 Stockton St., San Francisco

Send me, absolutely free, your new illustrated catalog of musical instruments. Also tell me how I may try any instrument in my own home at your expense, and how the Wurlitzer plan makes it easy for me to buy. No obligation.

Name

Address

City..... State.....

Instrument

(State instrument in which you are interested.)

Copyright 1933, The Rudolph Wurlitzer Co.

FREE TRIAL

Whether you have one belt or a hundred we want you to try **DETROIT Wire Hook BELT LACING**



at our expense. We will send postage paid, this complete outfit including large box of belt hooks to lace every kind and thickness of belt together with a (Vise Tool) belt lacing machine.



If you want the outfit after trying it, send us your check for \$5, if not return it at our expense. Laces belts for one cent an inch. Used by International Harvester Co., Advance Rumely Co., and thousands of others.
Outfit \$5.00. Assorted lacing \$1.50 per box. Tool \$3.50.

Detroit Belt Lacer Co., Detroit, Mich.

21 Jewels
Nothing less than 21 Ruby and Sapphire Jewels is good enough for the Burlington masterpiece.
Quality and Style
Adjusted to the second-temperature—synchronism—positions. 25 year Gold Strata Case, in 100 exquisite designs. Only \$1 down. Balance in small monthly payments. Send for free book.
Burlington Watch Company
19th Street and Marshall Boulevard
Dept. 13-53 Chicago, Illinois

AGENTS! If you are making less than \$150 a week, better write for information about selling SAAL HEAVY OIL SYSTEMS.
H. G. SAAL CO., Dept. 1201, 1600 Montrose Ave., CHICAGO

Drive This Beautiful Raceabout Instead of Your OLD FORD



Choice of Four Colors; Fiat or the Bullet Nose Rad-instor Shell. Send for 1934 Free Catalog of New Auto Aasen', Bodies and Speed Equipment. Direct from Factory.

AMERICAN TOP AND BODY CO., Park Ave. DELPHI, IND.

GUARANTEED 5 YEARS

KENNEBEC canoes are so well built that we guarantee them five years. Extra wide safety feature. Beautifully finished, low priced and perfectly balanced. SEND FOR FREE CATALOG of latest 1934 models in canoes and rowboats and name of dealer.

Kennebec Boat & Canoe Co., Dept. M41, Waterville, Me.



KENNEBEC CANOES



\$3
DOWN

and it's YOURS

The Greatest Typewriter Bargain Ever Offered

Right now we are making you the greatest typewriter offer you ever dreamed of—an eye opener. This wonderful standard Shipman-Ward Rebuilt Underwood only \$3.00 down. Ten days' free trial and the easiest monthly payments, shipped direct to you from our big factory.

10 Days' Free Trial From Factory to You

Yes, only \$3.00 down puts this genuine late model Shipman-Ward Rebuilt Underwood in your home. You can try it, test it, and then decide. See for yourself how new it is, how it writes. You must be satisfied. Your \$3.00 unconditionally returned if at the end of ten days you are not satisfied. The entire transaction will not cost you one cent.

EASY Monthly Payments

Little more than rental. Balance of payments so small you will hardly notice them, while you enjoy the use of this wonderful machine. You don't have to scrimp and save to pay cash. All at a big saving to you.

5 Year Guarantee

With every typewriter we give a written guarantee. These machines are rebuilt like new by the famous SHIPMAN-WARD PROCESS. Equipped with late improvements. You can't tell them from a new machine. The world's standard typewriter, the same models as sold by the Underwood Typewriter Company today, at a big saving to you. Act now! Get this splendid offer and save money.

These machines are shipped direct from our factory—the largest typewriter rebuilding plant in the world. They are rebuilt by the famous SHIPMAN-WARD PROCESS. Developed through 30 years in the typewriter business. Through our money saving methods of rebuilding and elimination of a large expensive sales force we are able to make this wonderful money saving offer to you. **ACT TODAY**, take advantage of it and you will **SAVE MONEY**. **ACT NOW!** Mail this coupon today.

Free Book of Facts

Write for this free book of facts explaining Shipman-Ward's wonderful system of rebuilding typewriters. We show you exactly how it's done. How you are able to buy them. Complete and valuable information about the typewriter industry, both instructive and educational.

FREE with Every Typewriter

A complete course in touch typewriting. You don't have to know how to operate a typewriter. You can learn to operate this machine in one day. We also give free a waterproof cover and all tools that come with a typewriter.



All Shipments made direct to you from our modern factory—the largest typewriter rebuilding plant in the world.

FREE BOOK COUPON

SHIPMAN-WARD MFG. CO.
2123 Shipman Bldg.
Montrose and Ravenswood Aves.
CHICAGO

Send by return mail your wonderful offer of Shipman-Ward Standard Rebuilt Underwood, also your book of facts. (This is not an order and does not obligate me in any way.)

NAME.....

STREET.....

POST OFFICE.....STATE.....

SHIPMAN-WARD MFG. CO.

2123 Shipman Bldg., Montrose and Ravenswood Aves., Chicago

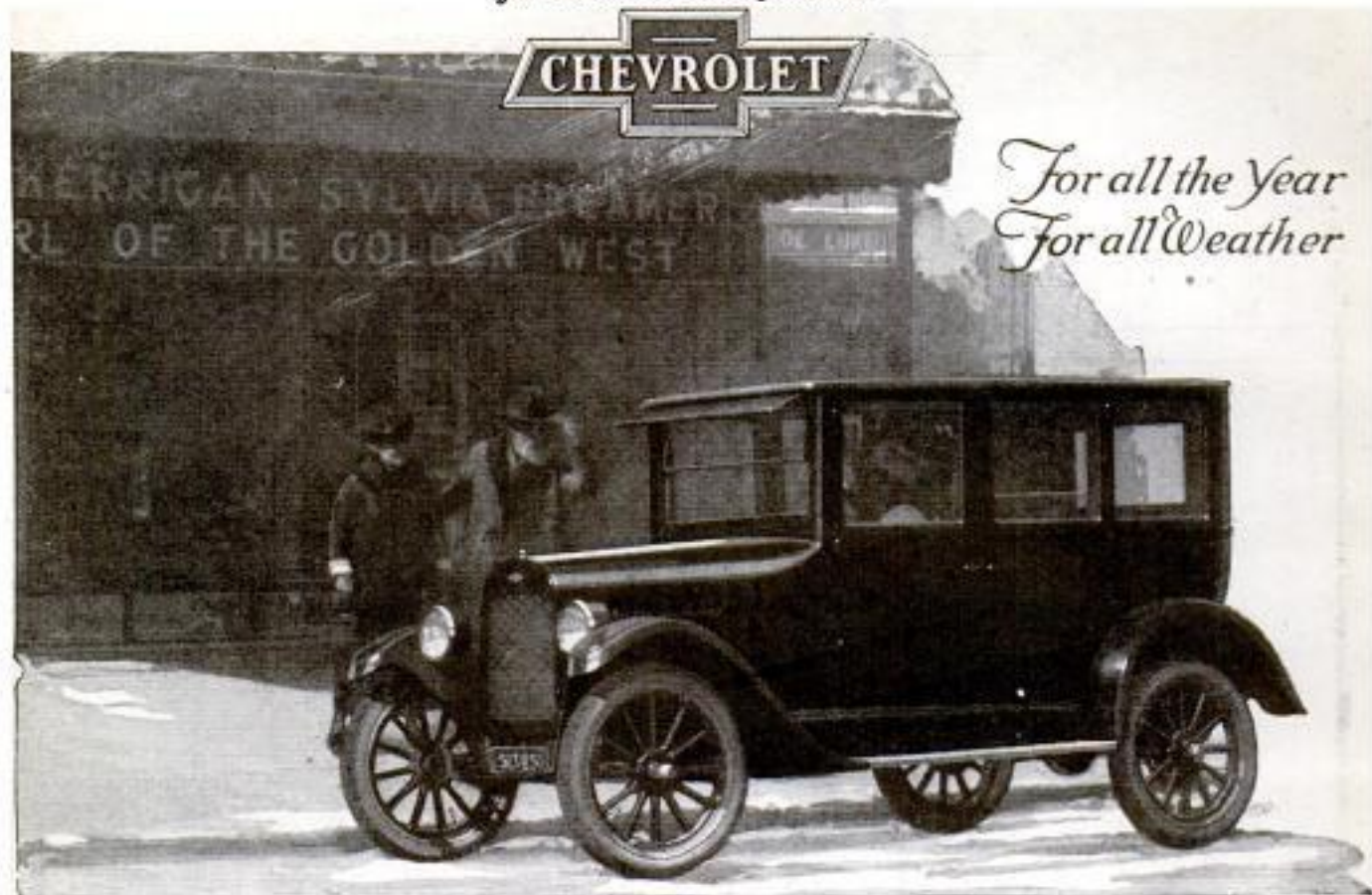
for Economical Transportation*For all the Year
For all Weather***Superior Sedan****\$795**

f. o. b. Flint, Mich.

Prices f. o. b. Flint, Mich.

Superior Roadster	-	\$490
Superior Touring	-	495
Superior Utility Coupe	-	640
Superior 4-Passenger Coupe	-	725
Superior Sedan	-	795
Superior Commercial Chassis	-	395
Superior Light Delivery Utility Express Truck Chassis	-	495
	-	550

**The Lowest Priced,
High Grade All-Year Sedan**

The Superior Chevrolet Sedan is distinctly high-grade in appearance and workmanship. It is so economical to operate and maintain that it is feasible for either one passenger's daily use, or for the evening and Sunday requirements of the average family of five.

Recent improvements have added further to its remarkable dollar value. Larger brakes give increased ease and safety of driving. The front axle has been straightened and raised 1½ inches to take care of deeply rutted or sandy roads. The improved springs are of chrome-vanadium steel, yielding increased riding comfort.

These and other less important changes have been made in line with our constant aim to maintain quality leadership in economical transportation.

Chevrolet Motor Company, Detroit, Michigan*Division of General Motors Corporation*

Five United States manufacturing plants, seven assembly plants and two Canadian plants give us the largest production capacity in the world for high-grade cars and make possible our low prices.

Chevrolet Dealers and Service Stations everywhere. Applications will be considered from high-grade dealers only, for territory not adequately covered.

Choose the keyboard yourself

Something new in typewriters ---- an "individualized" keyboard to fit your work exactly. Mail the coupon! Get all the facts about this remarkable machine. Learn how easy it is to own one



Corona is just as good as it looks! It has every convenience, including the wide carriage, the two-color, automatically-reversing ribbon, back spacer, margin release, self-spacing carriage return, etc.

The new "XC" MODEL CORONA

TELL us the kind of work you do, and we will show you your own keyboard—fitted with the very characters you need!

Think of the joy of being able to write just what you want to write instead of turning out makeshift work with a typewriter that lacks the keys you need most.

Why this machine fits your work so well

First of all, it has ninety characters, six more than the ordinary office typewriter. That is the secret of its wonderful convenience—its adaptability to *your work*.

It is not a freak machine—nor is it complicated. It is simply a regular Corona, with every modern improvement—with 6 extra characters added to the keyboard.

Choose your own keyboard

Do you want a full range of fractions? You can have them. Or we can give you chemical or medical symbols, mathematical signs and exponents, or a full set of accents for foreign languages.

With a machine like this, typewriting becomes a real pleasure. You'll do better, neater work with far less effort.

Corona has an eighteen-year record of Proved Durability. It is the best typewriter investment you can make.

And the price is low

Only \$55 for this 90-character model, including the neat carrying case—and with a keyboard of your own selection. (The price of the 84-character Corona is still \$50.)

Don't delay. Mail the coupon and let us tell you the address of a Corona store where you can see this new machine. There's no reason why you should deny yourself the pleasure and the profit of owning a typewriter that is really adapted to your work.

MAIL THIS COUPON

CORONA TYPEWRITER COMPANY, INC.
108 MAIN ST., GROTON, N.Y.

Without any obligation, send me complete Corona literature and the address of the nearest Corona dealer.

NAME.....

OCCUPATION.....

ADDRESS.....

Exit Variocoupler

Enter Erla Selectoformer



Superior worth of Erla audio transformers, shown in their exclusive ability to amplify three stages without distortion, improves any set. \$5



Erla condensers alone carry a certificate of accuracy on their labels. Look for the words "Tested Capacity" when buying. 35c to 75c ea.

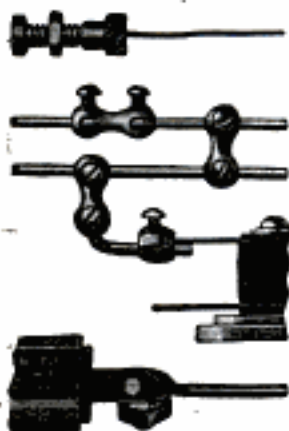

Assembly of radio apparatus is enormously simplified by Erla solderless connectors, made in sizes and styles for every purpose. List, 3c to 5c

Combines Improved Properties of Coupler and Wavetrap

Again Erla contributes notably to radio advancement. Erla Selectoformer, replacing alike variocoupler and wavetrap, greatly increases volume and selectivity in radio receivers, at the same time reducing cost.

Selectoformer, as the name implies, operates simultaneous as a selector and transformer, picking off of the antenna the one wavelength desired and amplifying it to normal strength.

Thus is avoided the interference common to receivers that depend for selectivity upon tuning the coarse antenna system. Also, because of the amplification brought to bear, there is eliminated the loss of energy encountered in wavetraps of conventional type.

With Selectoformer, distant signals come in loud and clear, even with powerful local broadcasting in progress. Tone quality, likewise, is greatly improved, through reduction of static and other disturbances.

For complete details regarding this and other Erla improvements, including latest reflex circuits, ask your dealer for Erla Bulletin No. 20, or write, giving your dealer's name.

Electrical Research Laboratories
Dept. J 2515 Michigan Ave., Chicago

ERLA



Supreme beauty and strength are combined in Erla sockets, with heavy, nicked shell cast into moulded Bakelite base. Many other advantages. \$1



Patented telescoping rim of Erla bezels fits any 3/8" to 1/2" panel, neatly screening openings required for tube ventilation. Nickel or enamel, 20c



Reliable and clear reception is assured through the Erla fixed crystal rectifier, requiring no adjustment and lasting indefinitely. List \$1



Erla semi-fixed crystal rectifier enables accurate initial adjustment to individual circuit characteristics. No attention required. List \$1

You men who are looking
for something real—read this



W. E. Findley of Texas

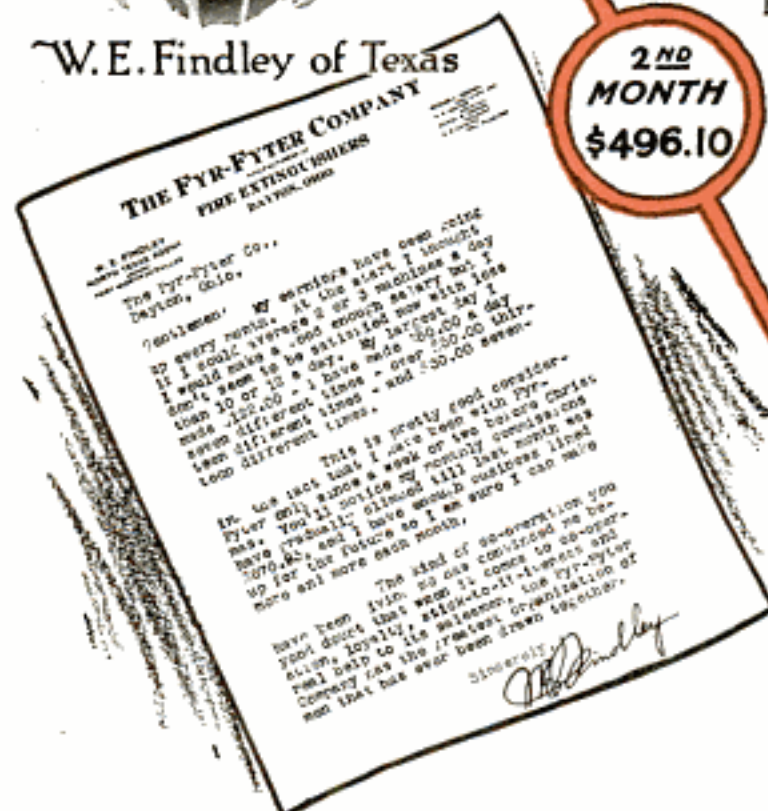

1ST
MONTH
\$366.70

READ how W. E. Findley of Texas has jumped into the big money class with us in a few short months—and how his commission checks keep going up and up. Read what Findley himself says in his own letter—and he is only one of a great many ambitious men who have found the way to bigger pay with Fyr-Fyter.

Look at these earnings

E. W. Cregan of New York made \$443.03 last month. J. B. Francis of Indiana made \$311.33. Clyde Kunkel of North Dakota made \$244.20. J. D. Beckwith of New York made \$327.00. F. R. Bickel of Indiana made \$320.91. F. E. Mendenhall of Illinois writes, "I average \$100 every half week—made \$140 my first day." James Ryan of Kentucky says, "Thanks to your splendid co-operation I made \$130.00 my first week." Glenn Howard of Oklahoma says, "My earnings are going up each month, have made over \$100 in a single day." L. D. Payne of Iowa writes, "My first year with you shows my net earnings well over \$4,000.00."

2ND
MONTH
\$496.10

We need more men

Here's something REAL for you. There is a tremendous market for the new Super Model Fyr-Fyter Extinguishers in every section of the United States—they are Approved and Labeled by the National Board of Fire Underwriters. Everyone who owns anything that will burn is a real live prospect and you have four different priced machines with unique selling plans that enable you to reach into all pocketbooks.

3RD
MONTH
\$539.45

Fyr-Fyter offers YOU a REAL opportunity regardless of your past sales experience—here's a big dignified selling proposition that enables you to earn constantly increasing commission checks—every fire creates more orders for you—and you can have exclusive territory. Get in on this!

If you want these kind of steadily increasing monthly commission checks then write or wire us at once!

The Fyr-Fyter Company 4230 Fyr-Fyter Building
DAYTON, OHIO, U. S. A.

World's largest exclusive manufacturers of 1 and 1½ Quart Fire Extinguishers

4TH
MONTH
\$670.93

AMPLION

The World's Standard Loud Speaker

You Never Tire of the Amplion

THE most striking thing about the Amplion is that its reproduction is never tiring. Its perfect rendition, absence of harshness gives you a thrill that is pleasing and refreshing.

No matter if it's voice or instrument, the charm is there. The message has lost nothing in its flight through space. It holds you and entralls you just as if you were listening to the original.

The Amplion is made in several sizes to suit all occasions and pocket books from \$18 for the Junior model to \$66 for the Concert type

Ask your dealers to let you hear the Amplion. You owe it to yourself to hear the world's standard loud speaker before you buy.

Folder of styles and prices on request.

Patentees:
Alfred Graham & Company

Signal Electric Mfg. Co.

Sole U. S. Distributors Menominee, Mich.

BURNDUPT OF CANADA, Ltd.

Canadian Distributors
172 King Street, W.,
Toronto



*Amplion
Beauty
AR-15*
\$46.00



*Phonograph Unit
AR-35—\$24.00*



*Amplion
Dragon
AR-19*
\$40.00



*Amplion Junior
DeLuxe AR-45*
\$26.00



*Amplion Portable
AR-61—\$50.00*



*Amplion
Junior
AR-39*
\$18.00

The Supremacy of the AMPLION is the Supremacy of Actual Performance

Amazing Liquid charges Storage Batteries in four minutes

**Without any electric device of any kind!
Revolutionizes present charging methods!**

This is unquestionably the most revolutionary discovery in the electrical field in years. Batteries can actually be charged without any dynamo or electrical service. This marvelous liquid accomplishes chemically the same result which has heretofore been done electrically. And does it in most cases INSTANTLY, but where the batteries are more or less sulphated or are in very bad condition it may take three or four minutes. Compare this, however, with the thirty to seventy-two hours necessary the old way.

STARTLING EXPERIENCES

"Always Ready" Battery Solution has been tested and tried in scientific laboratories and its almost magical results proven, but here are the actual experiences of a number of our dealers:—

"Have just serviced my hundredth battery—only four gave any trouble. Under the old plan at least half would have been worthless." J. L. ROWE, Indiana.

"Used your Battery Solution today in seven-year-old Detroit electric, condemned 8 months ago and placed in storage. Results were amazing and the car is now running fine." PEORIA STORAGE BATTERY CO., Peoria, Ill.

RENEWS LIFE OF BATTERIES

The life of any new battery will be prolonged and perfectly dead batteries revived by the use of this liquid. It will not injure the hands. This, in itself, is a distinct advantage as the standard storage battery solution is high in sulphuric acid.

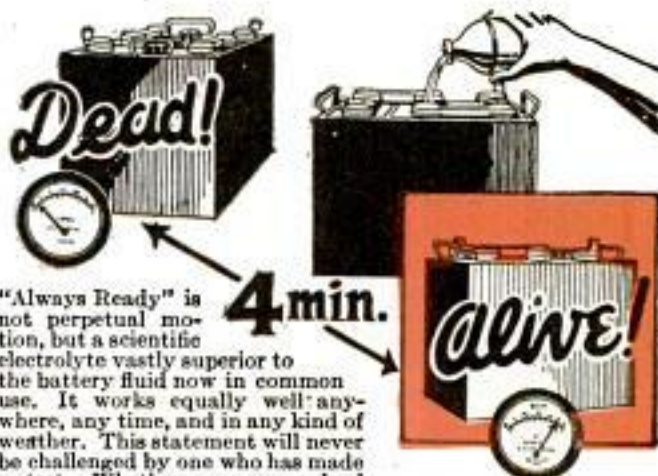

"Always Ready" is not perpetual motion, but a scientific electrolyte vastly superior to the battery fluid now in common use. It works equally well anywhere, any time, and in any kind of weather. This statement will never be challenged by one who has made a test. Whether you use a lead plate storage battery for automobile, radio, farm lighting plant or any other purpose, you will find the easiest and most profitable way to operate it will be by using "Always Ready." If used for radio, you will notice aside from remarkable permanency and vigor, that the "frying" sound is practically eliminated.

Bottled Electricity

"Always Ready" Battery Solution may truthfully be called "bottled electricity." All that is necessary to bring a dead storage battery to life is to pour out the old solution, wash it out carefully, and pour in "Always Ready." No line charging is necessary. This marvelous liquid starts instantly the electrical activity which makes your storage battery perform. Battery, of course, must not be broken.

Dealers and Agents

Any Automobile dealer or Battery Service man will realize the tremendous profit possibilities of "Always Ready" Solution.

Instant service, low cost and large profits make it this year's GREAT OPPORTUNITY.

Write or telegraph for territorial arrangement. We have a special trial offer to Live Dealers.

"Always Ready" Battery Solution Co.
Halsted & Addison Sts., Chicago, Ill.

Forty Million

lead plate batteries are estimated to be in use in the United States alone. Each must be charged frequently by placing upon an electric line with high priced equipment for from 30 to 72 hours. Batteries charged in this way have been notoriously short lived because of the imperfect chemical action. Now this is no longer necessary. Simply pour in "ALWAYS READY" and your battery is ready for use.

Ready for Use "Always Ready" comes ready for instant use. No preparation required. Simply dump out the old solution, wash out the cells with clear water, pour in "Always Ready," turn the switch and "it's ready to go!"

SPECIAL "TEST PRICE" OFFER

"ALWAYS READY" BATTERY SOLUTION CO.
Halsted and Addison Sts., CHICAGO

Enclosed herewith find my remittance of \$..... for which please ship to me by express the following—

(\$2.75) Half gallon bottle of "Always Ready" Battery Solution—enough for 1 battery.

(5.00) Full one gallon bottle of "Always Ready" Battery Solution—enough to service 3 batteries.

Please check the shipment desired.

Shipment to be made to me immediately, boxed and packed, F. O. B. Chicago.

Name.....

Address.....

City.....State.....



Save $\frac{1}{3}$ on Guaranteed Radio Equipment

**Write us a post card—
Address Dept. 6-R**

and we will send you free this 52 page catalogue of radio sets and parts. It also contains explanation of radio terms, map and list of broadcasting stations and much radio information, including an explanation of successful hook-ups and circuits.

You will be amazed at the low prices Ward's quote. A complete tube set having a range of 500 miles and more, including tube, head set, batteries, and antenna equipment, as low as \$23.50.

This catalogue contains everything for the expert and amateur. Complete sets and every improved part for building sets, all the most up-to-date devices—at the lowest possible prices.

Headquarters for Radio

Montgomery Ward & Co. is headquarters for Radio, selling everything direct by mail without the usual "Radio-profits." Why pay higher prices? Ward quality is the best and the prices will often save you one-third. Everything sold under our Fifty Year Old Guarantee—Your Money Back if You Are Not Satisfied. Write today for your copy of this complete 52-page Radio Book.

**Write to our house nearest you
Address Dept. 6-R**

Chicago Kansas City St. Paul Portland, Ore.
 Ft. Worth Oakland, Cal.

**This Radio
Catalogue
FREE**

Established 1872
Montgomery Ward & Co.

The Oldest Mail Order House is Today the Most Progressive

SENSATIONAL SALE

GUARANTEED TYPEWRITERS



This is the famous L. C. Smith typewriter which has set the world's standard for quality and service for over twenty years. Perfect machines, Standard size, Keyboard of Standard Universal arrangement, 42 Keys, writing 84 characters—universally used in teaching the touch system. The entire line of writing completely visible at all times; has the tabulator, the two color ribbon, with automatic reverse, the back spacer, ball bearing type bars, ball bearing carriage action, ball bearing shift action. This ball bearing construction makes it much easier to learn operating on the L. C. Smith than any other typewriter. Also it gives unlimited speed—beyond the limits of human possibilities. Every late style feature and modern operating convenience. Comes to you with everything complete: tools, cover, operating book and instructions—nothing extra to buy. You cannot imagine the perfection of this beautiful typewriter until you have seen it. We do the most perfect and highest class job of rebuilding known to the typewriter industry. We have sold thousands of these perfect late style machines at this bargain price and every one of these satisfied customers had this splendid, strictly up-to-date machine on five days' free trial before deciding to buy it. We will send it to you F. O. B. Chicago for five days' free trial. It will sell itself, but if you are not satisfied that this is the greatest typewriter you ever saw, you can return it at our expense. You won't want to return it after you try it, for you cannot equal this wonderful value anywhere.

FREE COURSE OF INSTRUCTION in the Touch System of typewriting given with every order. The best and quickest method of learning. Specially adapted to the L. C. Smith.
FREE BOOKLET giving description of this machine and other models, also Valuable Typewriter Information, sent on request.

Only \$1.00 down, then a few dollars a month and the machine is yours. This is absolutely the most generous typewriter offer we ever made. Why rent a machine when your rent money will buy one? Think of it—buying a perfect, late model highest grade \$102.50 Typewriter at a bargain price.

The Famous L.C. Smith Model No. 5

Just send \$1.00 with the coupon and the machine will be shipped at once. Then after 5 days if you are convinced that it is the best typewriter you ever saw, keep it, send us \$4.15 and then send us \$4.00 a month until our bargain price of \$57.15 is paid. All cash, \$53.05, just a little more than half its original price.

FREE TRIAL

If you don't want it, return it and receive your \$1.00 back. We will pay the return express charges. This machine is guaranteed just as if you paid \$102.50 for it. It is standard. Over a half-million people own and use these typewriters and think them the best ever manufactured. The supply at this price is limited; the price will probably be raised when the next advertisement appears, so don't delay. Fill in the coupon today—the typewriter will be shipped promptly. There is no red tape. We employ no collectors—no chattel mortgage. It is simply understood that we retain title to the machine until full \$57.15 is paid. You cannot lose. It is the greatest typewriter opportunity we have ever offered. Get the coupon in the mails today—SURE.

SEND NOW—BEFORE THEY'RE GONE
SMITH TYPEWRITER SALES CO.
 300-360 E. Grand Ave., Chicago, Ill.

Send This Free Trial Coupon NOW

SMITH TYPEWRITER SALES CO.,
 300-360 E. Grand Ave., Chicago, Ill.

I enclose \$1.00 as evidence of my good faith. Ship me the L. C. Smith Model No. 5, F. O. B. Chicago. After five days' trial I will send you \$4.15 and then \$4.00 per month thereafter as rent until the \$52.00 balance of the Special \$57.15 sale price is paid. The title to remain in you until fully paid for. It is understood that I have five days in which to examine and try the typewriter. If I choose not to keep it, I will carefully repack it and ship it back to you and you will return my \$1.00 deposit. It is understood that you give the standard guarantee.

Name..... Street.....
 City..... State..... Business or
 Two..... Employer.....
 References.....



"You Bet he'll pass it"

"Nothing comes back from the Inspector after it's been O. Kayed by this Starrett 'Mike.' But it's not so surprising at that, when you stop to think about it. He uses a Starrett himself."

STARRETT MICROMETERS ARE BETTER

here's why—

EASILY READ—notice the large Barrel and the clean-cut, distinct graduations.

SLEEVE ADJUSTMENT—a recognized triumph in tool design. Easier and more exact than the usual anvil adjustment.

IMPROVED RATCHET STOP—A wonderful aid to accurate gauging.

PERFECTED LOCKING DEVICE—A slight turn of the nut locks the spindle firmly.

STARRETT DESIGN, WORKMANSHIP and FINISH—assure you of a Micrometer that is not easily sprung, is simple to adjust, and is good for years and years of reliably accurate service. This Starrett 226 is supplied singly or in sets (combinations from 0 to 3 and 0 to 6 inches) as desired.

THE L. S. STARRETT CO.

*The World's Greatest Toolmakers
Manufacturers of Hack Saws Unexcelled
ATHOL, MASS.*

Write for a free copy of the Starrett Catalog for a complete description of every Starrett Micrometer. Ask for No. 22 "AP"



No.
226

Use Starrett Tools



Make A Gas Range out of Your Old Stove in Five Minutes

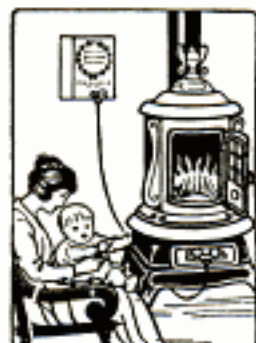

FOR HEATING STOVES

The Standard Oil Burner fits any heating stove. Heats your living rooms in a few minutes on the coldest day. Think of keeping your home at an even, beautiful temperature all day, without constant filling, shaking and poking.



IDEAL FOR FURNACE

The Standard Oil Burner can be installed in any hot air, pipeless, steam or hot water furnace. So simple and safe a child can light and regulate it. Clean, even heat all over the house, all the time.

Think of it! Your old coal or wood stove can be made into a regular gas range in less time than it takes to tell you about it. You don't have to alter your stove one bit. You don't even have to bore a hole or insert a bolt. Just set a marvelous new kind of burner in your fire box, attach it to a tank of coal oil by means of a copper tube, turn a valve, strike a match, and instantly you have a heating flame as steady, reliable and easy to adjust as city gas, at one-third the cost.

WHY HOME-MADE GAS IS CHEAP

The burner mentioned above is the Standard Oil Burner, a wonderful device that mixes 96% air and 4% kerosene (common coal oil) to form a gas whose heat is two or three times as great as that from coal or wood, and as convenient and easily controlled as city gas. You get instant heat at the turn of a valve. There's no waste of fuel or time in starting a fire. Light it only when you need it—no need to "keep the stove going" to save building a new fire, like you do with coal and wood. No need to sweat and slave in a hot kitchen all summer.

SPECIAL PRICE AND 30 DAYS' TRIAL to the first user of a Standard Oil Burner in your community. Act quickly and get the benefit

FREE BOOKLET

STANDARD OIL BURNER CO. Dept. 14-A
103 North Main St., St. Louis, Mo.

SAVES HOURS OF DRUDGERY

The Standard Oil Burner saves you all the exhausting, disagreeable work of carrying heavy buckets of coal, splitting firewood and hauling dirty ashes. Burning gas does away with smoke, soot and dirt—makes your housework easy and lessens your weekly wash. Your meals are prepared quicker. With the Standard, you don't have to stay in the kitchen constantly while food cooks. A turn of the valve regulates the heat. Once installed, you'll wonder how you ever did without a Standard.

of this generous offer. Make this trial on our absolute Money-Back Guarantee.

Use Coupon to get our attractive Booklet, HOME HEATING.

Agent Made \$200 in One Day

The Standard sells like hot cakes. A demonstration means a sale nearly every time, because the Standard fills a long felt need. Everybody wants one. In a single day I made \$200.
WM. J. FINLAY, Agent
Webster Groves, Mo.

AGENTS WANTED

Big money is being made by our agents selling Standard Oil Burners. Start Now. Sells easier in Spring than any other season. Part time or full time work. Exclusive territory. We give you every help in selling. Write today for money-making proposition.

ONE USER WRITES:

I find the use of coal oil in the Standard 51% cheaper than coal, and 64% cheaper than gas. In convenience, cleanliness and comfort coal does not compare with it.

STANDARD OIL BURNER CO., Dept. 14-A
103 N. Main St., ST. LOUIS, MO.

Send Free Book on Home Heating and details of 30-days' trial offer with Money-Back Guarantee. I am checking the burner I am interested in:

Furnace Heating Stove Kitchen-Stove or Range

I may want to take the Agency for Standard Oil Burners. Send details

Name..... Address.....
City..... State.....

WANTED! AGENTS AT \$50 to \$90 a Week

New Invention—Just Out!

Needed in every home every day. Patent just applied for. Nothing else like it. Supplies

what every housewife has wished for, for years. Perfected after long experimental work by mechanical experts. Low priced—anyone can use it—sells on sight. We want three hundred representatives at once—men or women hustlers—to advertise, accept orders and manage deliveries for our new **Quickedge Knife and Shear Sharpener**. Sharpens any kitchen knife, paring knife, carving knife, bread knife or shears and scissors in **ten seconds**. Agents are taking orders at every house—wiring for rush shipments. Write today for this opportunity to make \$10 to \$20 every day.

Make \$400⁰⁰ Next Month

This little machine is a mechanical masterpiece. A child can use it. Just put knife in slot—turn crank—grinds automatically—draws blade to keen, sharp, perfect, lasting edge at **absolutely correct bevel for daily use**. Nothing to adjust—nothing to change—nothing to get out of order—**absolutely guaranteed**—will last for years. Once they see it and use it, women will not do without it for several times its cost. **Easy to make big money** if you will just follow instructions and work faithfully. **No charge for territory—200% profit for agents**. Business supplies capital. Exclusive protection, co-operation and assistance. Failure impossible. Nothing to risk. Success assured.

No Experience Required

Just take one of the machines to any house and show it—give a ten-second demonstration upon the dullest knife in the house; **the order is yours right on the spot; instantly**. No talking necessary. No argument. The machine simply sells itself, and stays sold. Every customer becomes your friend. They tell others, your profits double and multiply. Leave one hundred on trial over night. Collect the cash for every one of them next day. **The machine will do its own talking**, it is so easy to operate, no explanations or instructions are necessary. Secure your county now; **FREE**. Get started right now and—

Make As Much Money Next Week As These Men Are Making Now

J. C. Lewis, of Kansas, says: "I have sold one hundred Sharpeners in four days." Kerr, of Md., writes: "The women can hardly wait until they get them." Herbert Cain, of Ky., sold nine after supper. At the end of his first day, J. W. Gordon, of Pa., writes: "I sold two dozen, and I sold to every one I saw." Wm. G. Hall, of N. J., says: "I think it is great. I sold six in about one-half hour. The machine is a mighty fine proposition. I am a mechanic and I know what I am talking about." Peter Courtland, of Mich., writes: "I received your Sharpener and opened it in a barber shop. I ground his shears and I got an order for one right on the spot." H. A. Henkel, of Va., says: "I have examined it and find it a wonderful little machine. The workmanship is simply perfect." Frank King, Colo., says: "Sample received Saturday, sold ten today. Sell to most every house." Forest Webb, of Pa., says: "Went out Monday afternoon and about three hours and received one dozen orders." H. Tillery, of Tenn., wrote: "I took three orders first hour. When you sharpen an old, dull knife, dull as a hoe, in less than a minute, they sit up and look." Ray Carter, of Mass., writes: "I went out two days and have orders for thirty sharpeners." John Durr, of Wis., also says: "I have sold thirty in two days."

You can make this money. SEND NOW. Territory Free. GET BUSY. WRITE TODAY.

The Quickedge Sharpener Co.
103 Sharpener Building, JACKSON, MICHIGAN

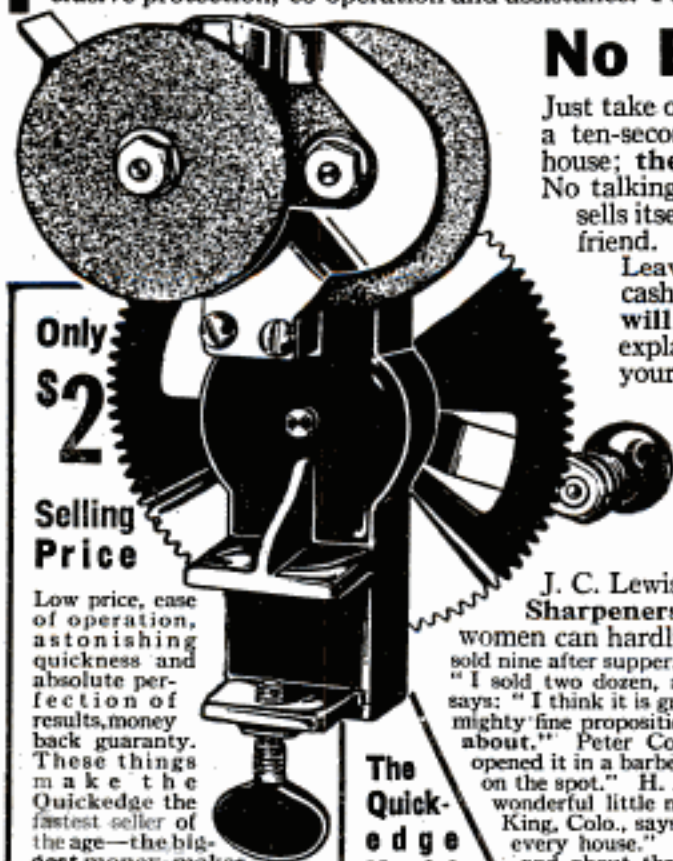

Only
\$2
Selling
Price

Low price, ease of operation, astonishing quickness and absolute perfection of results, money back guaranty. These things make the Quickedge the fastest seller of the age—the biggest money-maker for agents, general agents and managers ever invented.

Write Today

Send for application blank and complete information today—free. Investigate. Get the proof. Don't delay. Write a postal card or letter right now. Territory is being assigned very fast. Get your county now—free. Write today.

**The Quick-
edge
Knife
and Shear
Sharpener
Grinds Any
Kitchen
Knife or Shears
in 10 Seconds
ABSOLUTELY
GUARANTEED**

21 Jewel Santa Fe Special

Sent
on

Approval

21 Perfect Jewels
Adjusted to Positions
Adjusted to Temperature
Adjusted to Isochronism
Adjusted to the Second
25 Year Gold Strata Case
Your choice of Dials (including
Montgomery R. R. Dial)
New Thin Models. All sizes.

WHILE other watch dealers are raising their prices, asking you for larger monthly payments, and making payment terms harder for you to meet, we are offering you our new model Santa Fe Special, no advance in price, no money down, easier terms and smaller monthly payments. We realize the war is over and in order to double our business we MUST give you pre-war inducements, better prices, easier terms, and smaller payments.

Send No Money Without one penny of advance payment let us place in your hands to see, to examine, to inspect, to admire, to approve a real masterpiece in watch creation. Our determination to this year double our sales of the world famous Santa Fe Special and Bunn Special Watches prompts this matchless offer.

Santa Fe's "New Elite"

This Artistic dependable Ladies' Wrist Watch, fitted with genuine Illinois Springfield movement. A perfect timepiece. Beautiful 14 Karat *white or green solid gold* case. Many designs—Ask for New Watch Book showing New Elite case designs in color. Watch sent on approval and sold on payments.

Page 12 of Our Watch Book Is of Special Interest to You!

Ask for our Watch Book free—then select the watch you would like to see, either the famous Santa Fe Special or the 6 position Bunn Special, and let us explain our easy payment plan and send the watch, express prepaid, for you to examine. No money down. **REMEMBER**—No money down—easy payments buys a master timepiece—a 21 Jewel guaranteed for a lifetime at about half the price you pay for a similar watch of other makes. No money down. A wonderful offer.

SANTA FE WATCH COMPANY
36 Thomas Building TOPEKA, KANSAS
"Home of the Great Santa Fe Railway"

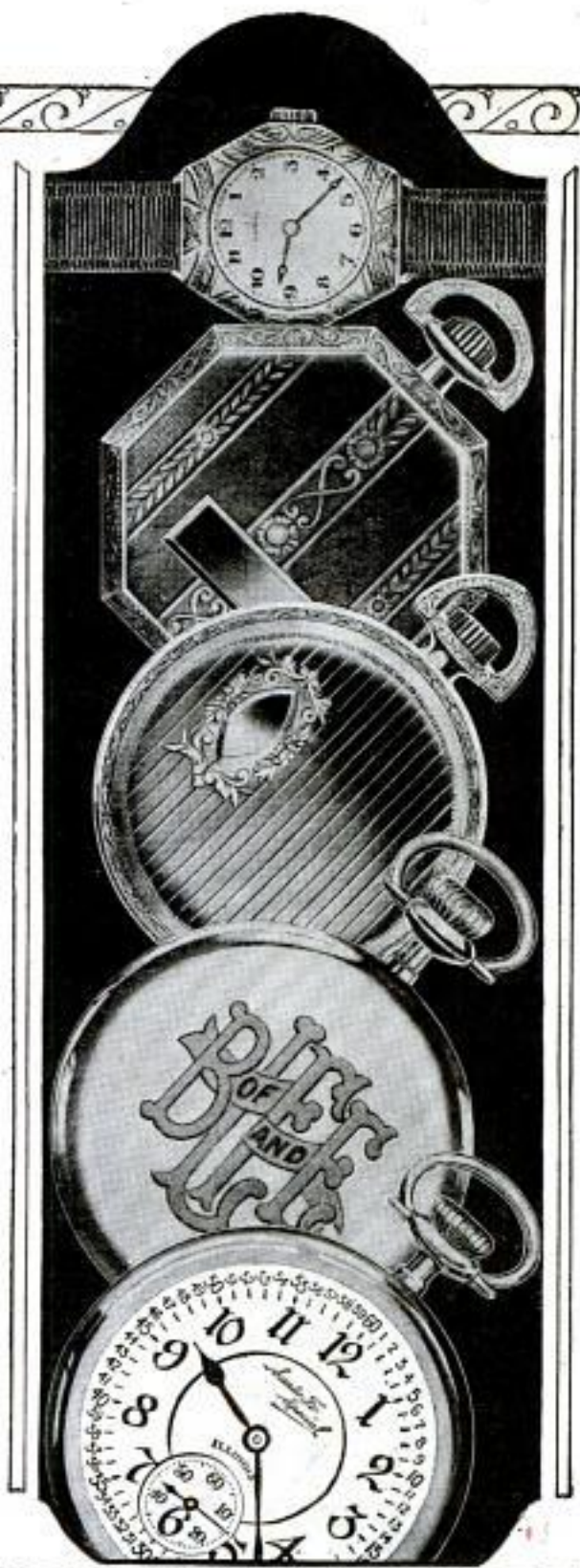

SANTA FE WATCH CO.
36 Thomas Bldg., Topeka, Kansas

Please send prepaid and without obligation your Watch Book free, explaining your "No Money Down" Offer on this Santa Fe Special Watch.

Name.....

Address.....

State.....



Are Your Brakes Obedient?

THE problems of driving today call for brakes that almost think for themselves. At least, brakes that obey your call instantly.

Multibestos, the Brake Lining with the Interlocking Weave, is always ready for the hidden emergency and is famous for the long time it retains its ability to take hold.

MULTIBESTOS THE BRAKE LINING with the Interlocking Weave

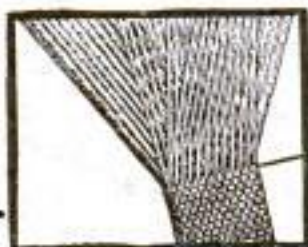

Auto Maps — Up-to-date — 10c

SEND 10c and address of concern that usually relines your brakes, and we'll send you an absolutely up-to-date Rand McNally Touring Map showing any state you wish. Size 28½ x 34 in. Be sure to state points you wish to visit. Order now.

MULTIBESTOS COMPANY
Dept. P-3 Walpole, Mass., U. S. A.

FORDS-34 Miles

on Gallon of Gasoline
with Air Friction Carburetor



We guarantee all other cars nearly double present mileage, power and flexibility, make hills on high formerly difficult on low. Models for any car, truck, tractor, marine or stationary engine. Makes old cars better than new. See wonderful mileage guarantees for other cars.

Ford.....34 ml.	Reo.....24 ml.	Chevrolet.....32 ml.
Buick 4.....30 ml.	Chalmers.....23 ml.	Maxwell (25).....30 ml.
Buick 6.....24 ml.	Olds 6.....23 ml.	Nash 6.....23 ml.
Hudson.....20 ml.	Paige 6.....20 ml.	Lincoln 8.....17 ml.
Hupp.....25 ml.	Oakland 6.....24 ml.	Stebber Lt. 6.....23 ml.
Dodge.....28 ml.	Overland 4.....32 ml.	Cole 8.....17 ml.

If your car is not mentioned here send name and model for particulars and our guarantee on it. AGENTS WANTED.

SENT ON 30 DAY'S FREE TRIAL

You can drive any car in heaviest traffic without shifting gears. Starts off on high in any weather without priming or heating—no jerking or choking. No more foul spark plugs or carbon in cylinders. No leaking of gas into crank case. Try it 30 days on our guarantee of money back if not entirely satisfied. No strings to our guarantee. YOU ARE THE JUDGE. Anyone who can handle a wrench can attach it. No boring of new holes or changing of operating mechanism. Write today.

AIR-FRICTION CARBURETOR CO.
718 Raymond Bldg. Dayton, Ohio, U. S. A.

LYON BODIES

Send For Our
1924 BOOK OF
BARGAINS

Containing a full line of bodies and accessories at exceptionally low prices. Buy direct from the factory.



\$27.50
AND UP

AUTO TIRE SALES CO.

Body Division Dept. P18
1346 S. Michigan Ave., Chicago

Easy Now to Keep Your Windshield Clear IN RAIN, FOG OR STORMS

Amazing new discovery rubbed on windshields gives absolutely perfect vision in rain, fog, sleet and snow. Takes 30 seconds to apply and makes driving safe in worst weather. No more accidents from blurred windshields. Endorsed by Safety First people. Agents make \$15 a day easy. Lloyd Miller, Missouri, sells sixty first day. 100% profit. Walk into any place and make amazing demonstration that gets your money in 3 minutes. No experience in selling necessary to make Master Demonstration with outfit we furnish free.

FREE Motorists everywhere wanted to try STA CLEAR. Simply send name today for free sample. No cost, no obligation. Try on your own car free. Get your sample today.

Alexander Laboratories 59 Gateway Station
Kansas City, Missouri

Easy to Build this SHAW Cycle Car

Here's a Real Automobile with a Real Motor that any handyman or boy can build. The SHAW Speedster carries two passengers anywhere. Power supplied by famous 2½ H. P. Shaw Motor. If you have a Shaw Motor get plans. If not, we supply everything. **A Real Automobile!** Write for FREE particulars or send 25c now for Easy-to-follow plans. Write today!

SHAW MFG. CO.

Dept. 37-5
Galesburg,
Kansas



My Life Work

The finest Shaving Cream you will ever know

By V. K. Cassady, Chief Chemist



Follow with Palmolive After Shaving Talc. An invisible way to that well-groomed look.

GENTLEMEN: I have devoted my life to soap chemistry. We have here developed some of the greatest soaps created. One of them—Palmolive—is the leading toilet soap of the world.

Our greatest ambition for years has been to perfect the supreme Shaving Cream. And we have done that, beyond question. Millions of men now concede it.

Our first step was to ask 1,000 men what they most desired in a Shaving Cream. All of them agreed on four things.

But one requirement, and the greatest of all, is something no

man mentioned. They were not scientists. They did not know the prime requirement in a shaving soap. That is, strong bubbles which support the hairs for cutting.

We made up 130 formulas which we discarded. Each was better than the one before. But none, in our opinion, reached the utmost in a Shaving Cream.

Then we attained, by many times over, the best Shaving Cream in existence.

Now we ask you to try it—at our expense. Let the results show if we have excelled the rest. Send the coupon for trial tube.

Excels in 5 ways

It multiplies itself in lather 250 times, so one-half gram suffices for a shave.

It softens the beard in one minute. No hot towels, no finger rubbing.

It maintains its creamy fullness for ten minutes on the face. Super-strong bubbles support the hairs for cutting.

The palm and olive oil blend acts as a lotion, leaving fine after-effects.

© P. Co. 1924

10 SHAVES FREE

Simply insert your name and address and mail to
THE PALMOLIVE COMPANY
Dept. B-597, 360 N. Michigan Ave., Chicago, Ill.

Pepsodent
REG. U.S. PAT. OFF.

The New-Day Dentifrice

FREE 1000 Illustrations **ELECTRIC FIXTURE CATALOG!**

Write today for your copy. Save 50% direct from Manufacturer. No Middleman's Profit. OUR SPECIAL: 8 Room Electric Set, ready to hang, \$24.50—Other bargains.

UNITED LIGHTING FIXTURE CO.
280 Bowery Dept. 120 New York



TAILORING SALESMEN

We Pay You Salary and Commissions

Greatest money-making line in America. Made to measure suits, overcoats, one price, \$33.65, express prepaid, all wool, all wool linings, hand tailored, finest workmanship. No extra charges for style or oversize. Blazer advance commissions, weekly salary besides. Protected territory. Apply at once.

GREAT WESTERN TAILORING CO.
Dept. P, 837-841 W. Jackson Blvd. CHICAGO, ILL.

THE NEW WAY TO MEND AND DARN Hosiery and All Fabrics

Mrs. Cross' Takes 1/10th as much time as needle and thread.

NU-WAY Guaranteed to stand washing, boiling and ironing. Saves trouble, work, expense and time.

Mending Fluid Send 50c for Large Tube.

Write for Free literature AGENTS WANTED

The New Way Laboratories, Inc., C-3 ML Healy, Cincinnati, O.

SWEATERS SAVE 20%-30%

Any Style or Design for Men, Women, Boys, Schools, Clubs, Teams

Order direct from mill. Save from 20% -30%. Pick any style, any color, size or design from our regular stock or special to order. Finest virgin wool and pure worsted only. Custom tailored workmanship of highest grade. Closest knit. Warm, soft, snug. Real beauties you will be proud to wear.

FINEST QUALITY AT BARGAIN PRICES

FREE Always holds shape. Most customers get from 3 to 5 years wear easily. Can endure severe wear and retain bright, fresh appearance. Biggest values in history. Workmanship guaranteed. Prices slashed. Unusual chance to save. Special offers to schools, clubs, teams. Write for free illustrated catalog.

AMERICAN KNITTING MILLS 1538 Clybourn Avenue Dept. 21 CHICAGO

I OFFER YOU \$200 A WEEK AND A

Buick
TOURING CAR

We want men and women in every community to demonstrate and take orders for Comer All-Weather Coats. New offer enables you to earn \$200 a week and a Buick Touring Car. No collecting or delivering. No experience needed. Mail the coupon now for full details.

The Comer Mfg. Co., Dept. BW-592, Dayton, O.

JUST MAIL THIS NOW

The Comer Mfg. Co., Dept. BW-592, Dayton, O.

Without obligating me in any way, please tell me how I can make \$200 a week and get a Buick Touring Car.

Name _____

Address _____

Print or write plainly

Diamonds

Here at 60% of Market Price

Never in three quarters of a century have we offered such amazing bargains. Hundred of money-saving opportunities in latest Diamond Bargain List, equaling those shown here.

Here's why we can offer such remarkable values: This 75 year old firm—rated at over \$1,000,000.00 capital—the largest and oldest diamond banking institution of its kind in the world has made loans on Diamonds, Watches, and other jewels in excess of \$25,000,000.00.

Why Pay Full Prices
Costs Nothing to See

Thousands of unpaid loans. Must sell now. Diamonds, Jewels, Watches and other Gems of unusual qualities—at an entirely different price basis—viz: loan values not market values. At our risk we send you any bargain you wish for absolutely free examination. No red tape. No obligation. Don't buy unless satisfied you can not match the bargain at 50 per cent more. Diamonds of gemstone quality at \$225 per carat. Yes, some even lower priced—also, finest gems obtainable at higher per carat—but proportionately low bargain prices. Our bargains have guaranteed loan values also, unlimited exchange privilege at full price.

Latest List
Diamond Loans

Send at once for latest list. Thousands of unpaid loans and other special advantage bargains described in full detail with exact weight, color, quality, etc. Get details of Free Examination offer. No obligation. List is free.

Mail Coupon Now

Order
Diamonds
Watch Office

Jos. DeRoy & Sons,
1918 DeRoy, Bldg., Pittsburgh, Pa.

Without obligation, send me free, your latest Bargain List of Diamonds, Watches and other jewelry.

Name.....
Address.....
City..... State.....





NEW Leaping Frog

FUN FOR ALL THE FAMILY

Keeps you guessing when—where he will jump next, never twice the same. All metal—attractively painted. Everybody's talking about this laughable toy—get yours today, 15c each, 2 for 25c.

BOYS—our catalog of other specialties. Agents Wanted. **MAKE MONEY**—sell 'em to your friends. **FREE.**

PITTS NOVELTY SALES CO., 561 W. Washington St., Chicago

Learn to Play SAXOPHONE

EASY PAYMENTS

"C Melody" Artists' Model Saxophone

Boy, it's a WOW! As easy to play as one-finger tunes on a piano—easiest fingering, easiest blowing, richest TONE "Sax" ever! The choice of teachers and professionals all over the world. Now offered direct from factory at wholesale price, on small payments!

10 MONTHS TO PAY!

Thousands of snappy young fellows have made their **ARTISTS' MODEL SAXOPHONE** pay for itself in spare time earnings! Now at least you can be Everybody's Favorite—you can turn your saxophone playing into pleasure and profit!

FREE TRIAL—Sensational offer right now! Big complete outfit on 6 DAYS' FREE TRIAL! Consists of \$10 case, self-instruction book, sheet music, reeds, strap, pearl keys, etc. \$1 reserves your Saxophone. Small first payment, then only \$5 a month!

Request quality **PROFESSIONAL** Saxophone now within your reach. Write for catalog today!

Standard Music Co., Dept. 1922, P. O. Box 503, Chicago

CATALOG FREE!



Have one for the house and one for the garage

TAKING pliers from the garage for odd jobs around the house often results in needless annoyance. A good way to avoid inconvenience is to have one Crescent MOTOR KIT Plier for the car and another one for use around the house. They are equally indispensable for either place. Five and six inch sizes, 50c each, at hardware or accessory stores.



REGISTERED
TRADE MARK

CRESCENT TOOL CO.
Jamestown, N. Y.

Originators of the
CRESCENT WRENCH
CRESCENT TOOLS

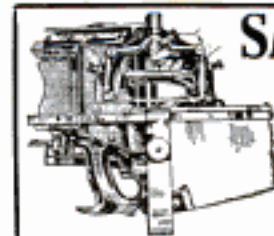

SAW FILING PAYS

Buy a Foley Saw Filer and Setter and establish an independent, profitable business. Prices and catalog on request. Territory open to interested parties.

FOLEY SAW TOOL CO.
3613 Portland Ave., Minneapolis, Minn.

THE SCREWDRIVER THAT HOLDS THE SCREW

As Good as a Third Hand in Assembling anything from a Watch to an Automobile

Appeals Especially to Radio amateurs and professionals. A wonderful (patented) improvement.

Jobbers, Dealers and Agents. Favorable discounts

\$1.00 Postpaid **THE COBURN TOOL CO., 114 Bedford St., Boston**

CLASS PINS

FREE CATALOG GIVE NAME OF SCHOOL OR CLUB AND NUMBER IN CLASS

Either pin illustrated made with any 3 letters and 2 figures, 1 or 2 colors enamel Silver plate, 25¢ ea., \$2.50 doz. Sterling silver, 40¢ ea., \$4.00 doz. Write for catalog of sterling and solid gold pins and rings.

3499 **Bastian Bros. Co. 549 Bastian Bldg., Rochester, N.Y. 3529**



"Lighting Fixtures"

READY TO HANG
(Direct from Manufacturers)

Completely wired, including glassware. New designs. Send for catalogue No. 24. Send for **DEALERS' proposition.**

ERIE FIXTURE SUPPLY CO.
STA. A **ERIE, PA.**



\$1662⁰⁰ Earned IN ONE SEASON

A NEW BUSINESS—BIG BUSINESS

A Business to Enthuse Over—The "Ideal" Lawn Mower Sharpener

W. F. Kendt,
1476 Main St., Buffalo
writes:

I sharpened 994 lawnmowers last season, and the receipts were \$1662.00 which is not bad for a side line."



A wonderful invention that sharpens lawn mowers scientifically—quickly—perfectly; does the work as nothing else can.

Fred C. Milkert of Melrose Park, Ill., writes:

"The Ideal Lawnmower Grinder put me in business, starting in the basement of my home and forcing me now for the third time to move into bigger quarters. Today the dream of my life—a shop of my own—is realized. With a machine like yours and a little hustle any man can have a business of his own and be independent."

You Start Now No town too small. Lawn mowers are dull—owner doesn't know where to get them sharpened. Mowing the lawn dreaded because of dull or improperly sharpened mower. Lawn mowing healthful, invigorating and pleasant when Mower is "Ideally" sharpened. You do the work scientifically—you are in big demand.

Lawn Mowers Sharpened to Razor Edge—

People glad—owners delight in mowing lawn with mower sharpened on an "Ideal." Mower runs light—click-click-click and the grass is cut. Build permanent business for yourself. Start now!

Write Today Get our proposition **Free**—We have detailed illustrated book to send you. Write today for our proposition.

The Fate-Root-Heath Company
Dept. 39, 801 Bell St., Plymouth, Ohio

USE THIS—Mail it Today

The Fate-Root-Heath Company
801 Bell Street, Dept. 39, Plymouth, Ohio
Please mail at once details of your complete proposition.

Name _____

Address _____

MAKE MORE MONEY TORIT ACETYLENE TORCH NO. 13

For soldering, heating, melting, tempering, auto radiator repairing, battery repair work, and for all kinds of small jobs requiring a hot flame instantly. Usually pays for itself in a single day.

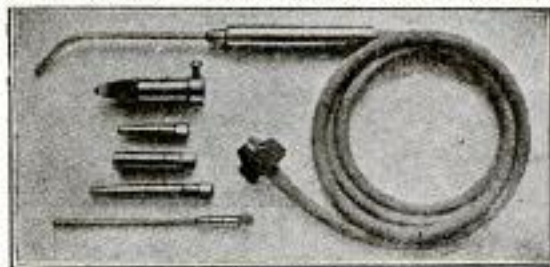

USES ACETYLENE GAS ONLY

Torch with 4 tips for different kinds of work, soldering copper, 5 ft. tubing and connection for auto-acetylene tank.....\$7.50
Order from your jobber. If he cannot supply you send your order to us.
St. Paul Welding & Mfg. Co., 177 W. 3rd St., St. Paul, Minn.

SARGENT PLANES

See them at your hardware store.

Write for booklet.

SARGENT & CO., 49 Water Street, New Haven, Conn.

61 INCHES HIGH

11 1/2 INCH BLOWER

PRICE \$8.85

WILL LAST A LIFE TIME

WILL WELD A 4 IN. WAGON TIRE

WONDER FORGE

"Better than I expected," says Carl Jeffrey. "Certainly worth the money," writes Fred Harford. "Good as the day I bought it, twenty years ago," says Wm. J. Johnson. A Wonder Forge saves time and money. Made of steel. Portable. Highly geared. Delivers terrific blast. Extra large blower. Produces a white heat. Is ideal for welding, shaping, dressing and tempering tools. Guaranteed to equal any \$15 forge on the market. Price \$8.85 shipped direct to you on receipt of order and name and address of your dealer.

Send for free catalog today.

C. A. S. FORGE WORKS
Box 400 SARANAC, MICH.

RELIABLE WATCHES at LOW PRICES

MODELS 2.00

Ingersoll

TO 10.00

Develop Your Ideas at Home

With the help of a

Boice Junior Bench Saw

Do your ripping, mitring, grooving, rabbetting, tenoning, sanding, grinding, and many other operations with surprising ease and accuracy. Top 10" x 13". Saws 1 1/2" stock. Dados 3/8" x 3/4". Machine built entirely of metal. Extremely accurate. Driven by 1/4 or 1/2 h. p. motor. Portable. Attaches to any light socket. Write for descriptive literature on Boice-Built Bench saws, lathes, drills, jointers, band saws, and motors.

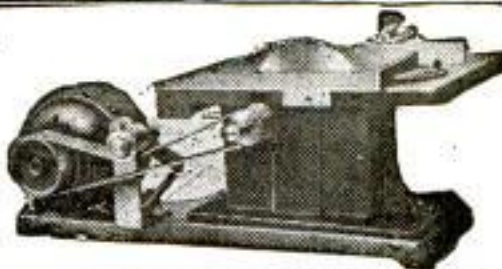

W. & J. Boice, Dept. P. M. 3, 1730 Norwood Ave., Toledo, Ohio

Send
for this
Bulletin
it is **FREE**
POSTPAID



Prices of Bench Lathes

SIZE	Quick Change	Standard Change
9" x 3'	\$231.00	\$201.00
11" x 4'	278.00	238.00
13" x 5'	344.00	294.00

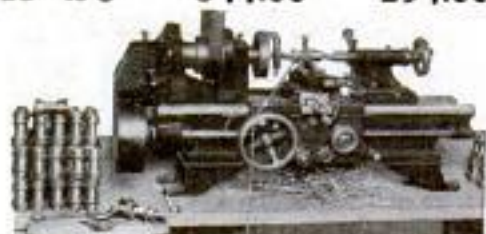

South Bend Lathe Works

555 E. Madison St. South Bend, Ind.

Make your Lathe into a Milling Machine

to cut key-ways, square shaft ends, etc. Fits on the tool post of your lathe.

This price only for a limited time. Send your order promptly.

Write for Catalog of Lathes and Attachments

The Sebastian Lathe Company
107 Culvert Street Cincinnati, Ohio



This Milling Attachment
Only \$20
CASH WITH ORDER

Two Models of the New Simore Tool "Lightning-Change"

Three blades in the handle—blades selected and produced by gravity instantly—change blades in two seconds.

Model No. 12 has a keen steel knife blade as shown and two screwdriver blades. Handle blued to prevent rust, blades best grade steel, a beautiful tool. Sent postpaid for only \$2.25.

Model No. 11 same as No. 12 except has three screwdriver blades. Sent postpaid for only \$1.80. We accept money order or your check. Ask your dealer or write direct.

Dealers and others invited to write for information on Simore tools.

THE SIMON & SKIDMORE MFG. CO.
Dept. 5-3 SANTA ANA, CALIFORNIA



The
Tools
That are
Different

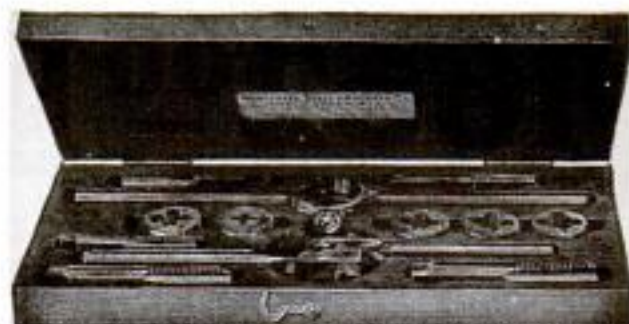

5 SIZE TAP AND DIE SET, ONLY \$3.00 FOR THE HOME - THE FARM - THE WORKSHOP

DIRECT FROM THE FACTORY TO YOU!
Our No. 12 Automobile Set furnished in our highly finished chestnut box contains 5 each taps and dies (1-4, 5-16, 3-8, 7-16 and 1-2"), in the S. A. E. thread, 1 die stock, and one tap and reamer wrench.

Our No. 11 Set is the same as No. 12 except that the thread is U. S. S. instead of S. A. E. You are purchasing a splendid set at a very low figure. Send us your order at once and be one of our many satisfied customers. Let us also send you one of our circulars illustrating our full line of Handy Tools.

WORCESTER STEEL PRODUCTS CO. Dept. 24, 25 Union Street, Worcester, Mass., U. S. A.



It is the well known quality of **CRESCENT** machines that justifies you in selecting one of them each time you have need for wood working machinery. The **CRESCENT** line is better than ever and will always give you satisfaction in every particular. Ask today for catalog of hand saws, saw tables, jointers, shapers, planers, borers, planes and matchers, swing saws, disk grinder, cut off table, hollow chisel mortiser, variety wood worker, Universal wood workers.

THE CRESCENT MACHINE CO., 83 Columbia Street, Leontia, Ohio

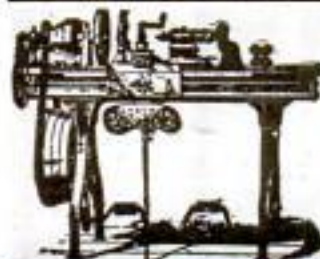

LATHES

9 to 18-inch Swing

List price \$165 and up according to size. When ready to buy send for Lathe Catalog and prices.

W. F. & John Barnes Co.
100 Ruby Street, ROCKFORD, ILL.

New 1/4 H. P. 110 volt A. C. Guaranteed Motors

60 cycle, complete with cord, plug and pulley

Gen. Elec. 1725 speed, \$16.00

Gen. Elec. 1/4 H. P. Rep. Ind. 39.00

Master 1/4 H. P. Rep. Ind. 52.50

Master 1 H. P. Rep. Ind. 60.00

Special values in rebuilt motors.

HYRE ELECTRIC CO.

615-T S. Dearborn St., Chicago, Ill.



PILLIOD

Tool Cases Excel

Machinists, Tool Makers and Carpenters find them most satisfactory in construction, appearance, service and price. Immediate shipment.

Booklet describing 20 styles on request.

THE PILLIOD LUMBER CO.

Dept. 1 Swanton, Ohio



AGENTS WE START YOU WITHOUT A DOLLAR

Famous Garnation Products—Creams, Soaps, Extracts, Perfumes, Toilet Goods, Household necessities. Widely known line; 200 items, 100% profit, repeat orders enormous. We give agents big concessions. Experience unnecessary. Write today. **Carnation Co.**, 144 St. Louis, Mo.

ALVAN CLARK TELESCOPES

Famous throughout the world as the highest grade Astronomical and Terrestrial Instruments. Now bringing to you at a reasonable price, these wonderful instruments—a source of pleasure and education—for the home—the school—the college. Send for circular and prices.

ALVAN CLARK & SONS CO.
Makers of the great "YERKES" and "LICK" Telescopes.
55 Henry Street Cambridge, Mass.



The first machine to get

Parks' "Jewel"

\$75

complete
with
1/2-in.
Band
Saw



The machine you need most in your shop is a Parks "Jewel" Band Saw. Speeds up every job, enables you to turn out accurate work rapidly, takes 90% of the tiresome handwork out of cabinet-making. Strong 2-inch angle steel frame, tilting table, ball-bearing saw-guides, 22-inch rubber-faced wheels, tension adjustment. Guaranteed 10 years.

Send for Parks' catalog of Lathes and Combination Woodworkers.

THE PARKS BALL-BEARING MACHINE CO.

1500-1540 Knowlton St.

CINCINNATI, OHIO

Canadian Factory: 200 Notre Dame East, Montreal, Canada

PARKS

WOODWORKING MACHINES

BURN YOUR NAME ON TOOLS

WITH
ARKOGRAF

Protect your tools from theft. Write any name, engrave any design on metal with electricity like writing on paper with pen or pencil. Complete outfit \$3.50, prepaid anywhere. Interesting descriptive circular free. Write today. Agents Wanted. Arkograf Pen Company, 401 East Couch St., Portland, Oregon



TOOL CHESTS
of **QUALITY**

for Machinists and Tool makers are shown in our free catalog. Write for it today.

H. Gerstner & Sons

403 Columbia St., Dayton, Ohio

SEND NO MONEY
2 GENUINE DIAMONDS $\frac{4}{100}$ Each

CUT STONES—NO CHIPS

Solid Gold
\$25

14 kt. White Gold Top.
Gold Emblem Inlaid
in Genuine

Hope Ruby

Can also be had in genuine
black onyx

Can be had in all Lodge
emblems and in all INITIALS
(Old English). Send size
of finger and ring will be
sent for inspection.

Buffalo Jewelry Mfg. Co., "The Mail-Order House"
Dept. P, Brisbane Bldg., Buffalo, N. Y.



This  Reg. Trade Mark
guarantees you genuine diamonds.

D J G M S H Any
Letter

ATKINS

METAL CUTTING SAWS



Use
Atkins
"Non-Breakable"
Hack Saw
Blades

Cut Faster — Do Not Break

ATKINS AAA Non-Breakable
Hack Saw Blades are made of
selected steels, hardened and tem-
pered by an exclusive gas and oil
process which makes the cutting
edge extremely hard and the back
unusually tough and flexible.

This not only prevents blade breakage, but
makes them cut faster and easier.

You can reduce your metal-cutting costs by
using Atkins Hack Saw Blades. Let us prove
it. Tell us what metal you cut, enclose ten
cents and we'll send you a sample blade that
will give you remarkable cutting results.

No matter what wood or metal-cutting you
do, there are Atkins Saws to save you time,
labor and money. Ask for our free book-
lets on the saws you're interested in.

Get This FREE Book

"Saws in the Shop"



Is a 32-page book
that's full of prac-
tical suggestions on
metal-cutting, and
general shop informa-
tion. Every man
who buys or uses
saws will find it help-
ful. Just write your
name and address
and dealer's name

on the margin
of this page
and mail it
to us.

Do It NOW

E. C. Atkins & Co., Inc.
Dept. P, Indianapolis, Ind.

Makers of "Silver Steel" Saws and Tools

Going to Build Remodel or Repair?

DON'T think of planning a new home or repairing an old one without copies of our two free books.

Our Building Material Catalog shows latest ideas and most advanced styles for everything in building. We ship everywhere everything in the way of high grade lumber roofing, doors,

windows, porchwork, screens, builder's hardware, paints, wallboard, interior woodwork, plumbing, heating and water supply outfits—all at money saving prices direct to you. Plan Book shows skillfully planned homes of all kinds, bungalows, city houses, suburban residences, country homes, barns. Tells you how to get building plans FREE. Write today. No obligation.

Let us develop plans from your rough sketches. Send your material bills for free estimate price.

Catalog of 8000 Price Bargains

Beautifully Illustrated PLAN BOOK

CHICAGO MILLWORK SUPPLY CO., 1414 W. 37th St., Chicago, Ill.
PLEASE SEND ME YOUR FREE BOOKS

Name _____

Town _____

State _____

Occupation _____

St. No. _____

Books Are Free



Material Complete for Houses from \$500.00 Up

Different from all others—the NEW BENJAMIN

AIR RIFLE

Made on a different principle from all other Air-Rifles.

The Benjamin is really a strong air-pump used to compress the air in the air chamber to any degree of power desired. From one to six strokes of the pump give all the force necessary. Each additional stroke gives increased power. The Benjamin works on the same principle as all air-drills and air-hammers—with this difference:

You control the shooting force as you desire. Look at this block of hardwood. It shows how Benjamin power is regulated as you wish.

You can't have accidents with a Benjamin. It's safe, always, because you control the power. The Benjamin never loses shooting force, and has no springs to get out of order or shake your aim. Write us for an interesting folder about this wonderful air-gun.

If your dealer does not handle same, send direct to 100897

(PRICE \$5) POSTPAID BENJAMIN AIR-RIFLE & MFG. CO., 615 N. Broadway, St. Louis, Mo.

Ask your dealer for demonstration.



Pacific-Coast Representatives THAYER & BOWER Los Angeles, Calif., and San Francisco, Calif.



Superior Automobile Trouble Light

Only \$1 postpaid, or C. O. D. if you wish

Made of highest grade materials, furnished in either single or double contact, complete with 10 ft. cord, 2 c. p. bulb, guard and socket. Order yours today.

INSTITUTE MFG. CO.

Dept. 203, 311 Main St., WORCESTER, MASS.



WHITE FLAME

BURNERS make your old kerosene lamps and lanterns give a brilliant white light better than electricity or gas. Doubles your light. Saves oil. NO WAX TO BREAK. Guaranteed Safe and Reliable. Delights every user. Send now for complete sample postpaid 50 cents, stamps or coin, 3 for \$1.25. Money Back if Not Satisfactory. Live Representatives Wanted. Exclusive Territory. WHITE FLAME LIGHT CO., 68 Clark Bldg., Grand Rapids, Mich.



Beautiful HOUSES \$900 and BUNGALOWS

CAN BE BUILT FOR AND UP This and many others in my new book, Building Plans for Modern Homes, will save you hundreds of dollars. One of the most complete and comprehensive books of plans ever published by any architect. New edition just off the press. Nearly 600 floor plans and photographs of bungalows, Colonial houses, etc., costing from \$200 up; gives sizes and cost to build.

Sent postpaid for \$2.00



FREDERICK H. GOWING ARCHITECT

101 Tremont St., BOSTON, MASS.

\$3 Cash Buys Typewriter



Balance Only \$5 Monthly

Save 35 to 60% on all standard makes—Underwood, Royal, Remington, etc. Every machine thoroughly rebuilt and GUARANTEED. Try five days at our expense before you buy.

WRITE at once for Free Descriptive Circular and Special Low Prices.

5 DAYS FREE TRIAL

WYNN TYPEWRITER EXCHANGE 13 Alliance Bldg. Kansas City, Mo.



"Been on a vacation Bill?"

"No, Jim—I've stopped smoking. Gained six pounds in a week. You know how I used to smoke—a package of cigarettes and a cigar or two a day—it sure had some hold on me. But I'm cured—

took a scientific home tobacco treatment—fixed me up in two weeks.

"Wasn't hard on me at all—noticed improvement the first day—I feel like a new man. It didn't interfere with my work—didn't leave any druggish after-effects—the money I saved in the last two weeks has paid for the treatment alone.

"Why don't you take it? It has cured men like you and me for over forty years—it is a doctor's individual prescription that sure fixes you up. Just send the coupon for full information NOW. No obligation. All correspondence is strictly confidential."



A Doctor's Prescription

The Keeley Institute, Dwight, Ill.

Please send me, without any obligation on my part, your free booklet which will tell me how to rid myself of the tobacco habit.

Name _____

Town _____

Street _____ State _____ P. M.-3

Spencerian Personal Steel Pens

When buying pens—here's a point to remember: There's a Spencerian Personal Steel Pen to fit *your* hand, perfectly. Everyone of the many styles is of special Spencerian steel with finely worked, hand-made points. Result—a longer-lasting, smoother-writing pen than you ever used before.

SPENCERIAN
PEN CO.

349 Broadway, New York

A sample card of one dozen assorted pens for a time and our hand-writing booklet free.



No. 1—College, fine point, double elastic



No. 28—Congressional; speedy and flexible.



No. 40—Medium point, all-around ability.



No. 42—Gold and dome pointed; smooth action.



R 6393. Heavy sabreclipblade, curved pen blade and scribing blade. Stag handle.

What Remington Steel In a Pocket Knife Means to Craftsmanship

MANY a man has thought his days for making things with a knife were over.

Now look at him—happy doing ingenious and practical things. All the old knack has come back—brought to the front again by finding a pocket knife that is a real tool for a craftsman.

Thanks to Remington.

See the Remington Knives at your dealer's knives for fishermen, campers, farmers, mechanics, carpenters—knives for everybody. Specific Knives for Specific Purposes.

See that the name Remington is stamped on the heel of the blade.

Write for circular on Remington Carpenter's and Mechanic's Knives.

Remington Arms Co., Inc., New York City
Established 1816

Remington

THE AUTHORITY IN FIRE ARMS, AMMUNITION AND CUTLERY

Also Makers of Remington Cash Registers

FASTEN IT WITH AN **AJAX** EYELET FASTENER

Binds Paper, Cardboard, Leather, Cloth
It Saves Time by Punching the hole, feeding the eyelet and clinching it in one operation. Order from your Stationer
Machine Appliance Corp.
Dept. P. M. BROOKLYN, N. Y.



Send for 48-Page Catalog

Showing Lionel Electric Trains and Accessories in full colors. WRITE TODAY. Address Department 14.
THE LIONEL CORPORATION, 48-52 E. 21st St., N. Y. C.



\$4.00 Adding Machine

The Gilson Adder will do your figuring easily, quickly and with absolute accuracy. Capacity 109,999,999 or \$1,099,999.99. It adds, subtracts, multiplies and divides and automatically carries from one column to the next. Made with aluminum case and steel operating parts, size 3 1/2" x 6" x 3 1/4". Written Two-Year Guarantee. Catalogue Free. Price, postpaid, \$4.00. Your money back if you are not satisfied.

Gilson Slide Rule Co., Niles, Mich.

21 Jewel Burlington

\$1
Down

Adjusted to the Second—Temperature
—Isochronism—Positions—21 Ruby
and Sapphire Jewels—Cased in a 25
year Gold Strata Case. Only \$1 down
will bring you this masterpiece.
Write today for free book to

Burlington Watch Company
19th Street & Marshall Boulevard
Dept. 93-53 Chicago, Ill.

MAKE MORE MONEY!

\$3,000 PROFIT IN 4 MONTHS!

CRISPETTES

GEORGE ALEXANDER of Pennsylvania made \$3000.00 in 4 months making and selling CRISPETTES with this outfit. (Nov. 7th, 1923).

Jacob Gordon, New Jersey, (November 2nd, 1923), says: "Profits over \$4000.00 in 2 months!" Mesner of Baltimore \$250.00, in one day! M. J. Cronen, Ohio, (November 3rd, 1923), writes: "Doing big business—sold over 200,000 packages Crispettes last year". Mrs. Lane, Pittsburgh, says: "Sold 8,000 packages in ONE day".

We Start You In Business

Crispettes easy to make, easy to sell. We furnish everything—complete outfit, secret formulas, raw materials, full directions, wrappers, etc. No experience needed. Little capital starts you on road to wealth. Open a retail store of your own. Sell wholesale to groceries, drug stores, etc.

Build a Business of Your Own

Crispettes sell fast everywhere. Everybody likes them. They're a delicious confection. We'll tell you how to build a business of your own. Start now, in your town.

Profit \$1,000 a Month Easily Possible

Send for illustrated BOOK OF FACTS. Tells how many people in small towns and big cities are making big successes of Crispette Business. Shows how, when and where to start. Full of valuable information. It's FREE. Write now. Postal brings it.

LONG EAKINS COMPANY
328 HIGH STREET SPRINGFIELD, OHIO

Genuine
DIAMOND
Mounted in
1/2 Karat Setting \$2 down

**NO RED TAPE
—NO DELAY**

Simply send \$2.00 for this price - smashing diamond ring offer.

A perfectly cut, guaranteed blue-white, genuine diamond is set in a 1/2 Karat white gold cup. Latest design, hand engraved mounting of 18 K.

TEN MONTHS TO PAY

We take all chances—if you are not satisfied at the end of ten days, return the diamond ring to us and your deposit will be refunded. After trial pay balance \$4.75 a month for ten months. Price only \$49.50. A legal guarantee bond as to quality and value accompanies each ring. **ORDER NOW.**

FREE BOOK OF GEMS
Complete Jewelry Catalog sent FREE on request. **FULL YEAR TO PAY** on everything in our two million dollar stock. Address Dept. 1013. Established 1896

ROYAL DIAMOND & WATCH CO.
170 Broadway - New York

Print Your Own Stationery

Cards, circulars, labels, tags, book, menus, paper Press, \$12. Larger \$25. Job Press \$150 up. Save money. Print for others. **BIG PROFITS.** All easy, rules sent. Write factory TODAY for press catalog. TYPE, cards, paper. **THE PRESS CO. D-37, MERIDEN, CONN.**

"73 Years Young"

Is my age writes H. B. Ruth, Colorado man, yet for years Mr. Ruth suffered with prostate gland disorder. "Used medicines with no avail—had about given up hope until a Doctor recommended your treatment," he writes.



Thousands of men like Mr. Ruth are finding renewed health and vitality thru a wonderful discovery that has brought the most amazing results in Prostate trouble, frequent nightly risings, sciatica, aches in back and feet and chronic constipation. Statesmen, Bankers, Lawyers, Doctors use and endorse this method. Yet you can use it right in your own home—no drugs, electric rays or book—a simple but quickly effective new hygienic principle. No matter what your age—or what you have tried, find out about this discovery at once. "Why Many Men Are Old at 40" is the **FREE BOOK** title of an interesting book that will be sent absolutely free. You may find relief from these distressing conditions the same as thousands of other men. Write at once to **THE ELECTRO THERMAL COMPANY, 2131 Main St., Steubenville, O.**



Get Factory Prices

Home Heating Plans FREE!

Write and get factory-to-you prices on the finest quality furnace made—pipe or pipeless style of installation. Blue prints free.

\$10 Down—Easy Payments

Quick shipment. Money back guarantee. Save 1/3 to 1/2. Bargain Book Free—Write Today. Stoves, ranges, furnaces, etc. More than one-half million booster customers. Write today.

Kalamazoo Stove Co.
394 West Rochester Ave.
Kalamazoo, Michigan



"If I hadn't been all through it myself, I wouldn't have the assurance to tell you to 'cheer up.'"
ERICKSON.

Those who wear them say:
ERICKSON LEGS are Wonderful
because they do not chafe, overheat or draw end of stump.



If you have had a recent amputation send for new booklet on **TEST LEGS** for beginners.
E. H. ERICKSON CO.
38-A Washington Av. N.
MINNEAPOLIS MINN.

The Beginning—(1912)

CRIPPLED FIVE YEARS**Infantile Paralysis**

This is Claude Snyder, whose leg and foot were deformed by Infantile Paralysis for 5 years before coming to McLain Sanitarium. Pictures were taken 7 months apart. Read parents' letter and write them:

We cannot thank you enough for what you have done for our son, Claude. We are proud of his foot and never lose an opportunity to say a good word for McLain's. Will be glad to answer all letters.

MR. AND MRS. GEO. SNYDER,
Francisco, Indiana.

Parents of Crippled Children

should know about McLain Sanitarium, a thoroughly equipped private institution devoted exclusively to the treatment of Club Feet, Infantile Paralysis, Spinal Disease and Deformities, Wry Neck, Hip Disease, Diseases of the Joints, especially as found in children and young adults. Our book, "Deformities and Paralysis," and "Book of References" sent free.

McLAIN ORTHOPEDIC SANITARIUM
902 Aubert Ave., St. Louis, Mo. GR537

**DEAFNESS IS MISERY**

I know because I was Deaf and had **Head Noises** for over 30 years. My invisible Antiseptic Ear Drums restored my hearing and stopped Head Noises, and will do it for you. They are Tiny Megaphones. Cannot be seen when worn. Effective when Deafness is caused by Catarrh or by Perforated, Partially or Wholly Destroyed Natural Drums. Easy to put in, easy to take out. Are "Unseen comforts." Inexpensive. Write for Booklet and my sworn statement of how I recovered my hearing.

A. O. LEONARD, Suite 226, 70 5th Avenue, New York City

Men's Shirts

From factory to wearer. Easy to sell. Big demand everywhere. Make \$15 daily. Under-sell stores complete line. Exclusive patterns. No experience necessary. Free samples.

Chicago Shirt Manufacturers,
241 W. Van Buren St., Chicago, Factory 228

Clear-Tone
FOR

PIMPLES

Your skin can be quickly cleared of Pimples, Blackheads, Acne Eruptions on the face or body, Enlarged Pores, Oily or Shiny Skin. \$1,000.00 Cold Cash says I can clear your skin of the above blemishes. WRITE TODAY for my FREE Booklet—"A Clear-Tone Skin"—telling how I cured myself after being afflicted for fifteen years.

FREE

E.S. GIVENS, 129 Chemical Bldg., Kansas City, Mo.

Great *New* Invention

for seekers of

Health Power Beauty



Elco Health Generators at last are ready for you! If you want more health—greater power to enjoy the pleasures and delights about you, or if more beauty is your desire—write! Ask for the book on these inventions which has just been prepared. It will be sent to you without cost. It tells you how Elco Health Generators aid you in leaving the lethargy and hopelessness of bad health and weakness behind forever. Re-vitalize yourself. Bring back energy. Be wholly alive. Write today!

10 Days Free Trial—Write for FREE BOOK



These great new inventions generate *High Frequency Violet Ray, Mechanical Vibration, Medical Electricity and Ozone.* Combined or separate.

They operate on the electric light in your home or on their own motive power at less than 50 cents per year. Elco Health Generators are positively the only instruments which can give you in one outfit Electricity, Violet Ray—Vibration and Ozone—the four greatest curative agents. Send coupon below. Get the Free Book NOW!

**For All These:**

Rheumatism	Asthma
Gout	Hay Fever
Lumbago	Sore Throat
Neuralgia	Catarrh
Sciatica	Deafness
Headache	Insomnia
Neuritis	Pain
Nervousness	Development
Circulation	Skin Disease
Weakness	Pimples
Paralysis	Scalp Disorders
Eye Trouble	Obesity

MAIL the COUPON for FREE Book!

Do not put this paper down without sending the coupon. Don't go on as you are with pains and with almost no life and energy. You owe it to yourself to be a better man or woman. You were put here to enjoy life—not just to drag through it. So do not rest another day until you have put your name on the coupon here. That will bring the whole story of these great new inventions. Do it today—now.

Health
Power
Beauty

Lindstrom & Company
442-448 North Wells Street, Dept. 13-53, Chicago, Ill.
Please send me your free book, "Health—Power—Beauty" and full information on your 10-day Free Trial Offer.

Name.....

Address.....

State your ailment and receive our expert advice
REPRESENTATIVES WANTED

NO MONEY IN ADVANCE



Marvelous CAMERA On Free Trial

The new Mandel-ette—the camera sensation of the age—sent on approval, absolutely without a penny in advance, just to prove what a wonderful invention it is. Just send coupon below today—no money.

Makes Finished Photos INSTANTLY

Takes and makes in ONE MINUTE a perfect, finished postcard photo, size 2 1/2 x 3 1/2 in. Think of it, complete pictures one minute after you take them. Camera size is 4 1/2 x 5 x 7 in. **No Films—No Plates—No Darkrooms—** None of the fuss or bother of ordinary cameras. Load in daylight 16 to 50 postcards at one time. Special lens makes sharp pictures at all distances. Pictures develop and print automatically. Can't over-develop. No experience necessary; simple instructions sent with outfit.

We Trust You

We'll send the complete Mandel-ette including tripod on 10 days approval. If not satisfied, return it. But if you are delighted with this quick, easy way of taking pictures, send us only 50¢ a week until our special price of \$10 is paid. Send coupon now—no obligation—no risk on our offer.

THE CHICAGO FERROTYPE CO.
2309 W. Erie St., Desk 18 Chicago, Illinois
Send me one complete Mandel-ette Camera Outfit including tripod, supply of postcards and instructions. If satisfied, I will keep it and pay you 50¢ a week until I have paid \$10.00. Otherwise I will return it at the end of 10 days.
Name.....
Address.....

Agents—\$54 a Week

Everybody needs food. Our new selling plan gives customers better quality and lower prices. Men and women representatives wanted now. \$54 a week and free automobile. No experience or capital required. 350 Zanol Products—all fast sellers. Pure food products, toilet preparations, soaps, etc. All needed in every home. Big orders. Big profits. Steady, repeat business. Write quick.



American Products Co.

234 American Bldg., Cincinnati, Ohio

BURN Home Made GAS In Your Old Wood or COAL STOVES

Change your coal or wood stove into a gas stove in 3 minutes. A Child can do it. Burn kerosene Vapor Gas—hotter than coal or wood and costs less. Safe and simple.

FREE TRIAL

Just turn a valve and get even heat instantly. No ashes, no dirt, no smoke, no wood to chop or carry. No fires to build and feed. No fuel wasted. Cooks and bakes better. No damage to stoves. Makes its own gas from common coal oil, cheapest, cleanest fuel. Guaranteed five years. Money back if not satisfied after 10 days' trial.

Write for FREE folder with proof and SPECIAL OFFER.

SIMPLEX UTILITIES MFG. CO.

310 Simplex Bldg.

1428 No. Wells St., Chicago



AGENTS
WANTED

Make Big Money

SELL
from our New
Outfit

Tailoring Agents

Earn big cash profits in advance taking orders for our fine tailoring from friends and neighbors. \$65 to \$95 a week, all or spare time. We deliver orders and collect.

Profits in Advance

Our plan gives you quick, ready money, profits paid daily, work where and when you like, get your money as you go along. Orders come easy with our fine samples. No dinky outfit like every Tom, Dick and Harry carries.

Tailored to Order

Folks like our swell clothes, tailored to measure, perfect fit and style. Get your own clothes at special wholesale price. You'll be delighted with our low prices and fine big, all wool samples, beautiful fashions all in classy

FREE Buckram cover, snap fastener; also booklet, tells how to make Big Money, all Free, write at once.

WASHINGTON
TAILORING CO., CHICAGO
159 W. HARRISON ST. Dept. C-345





DIVINE RED DEVIL Water Motors

Simple—strong—durable. Wonderful little workers for all sorts of household and shop uses. Thousands in use. For all light power purposes. Attaches to faucet.

Two sizes: 4"—\$4.25
6"—\$6.75

The higher the water pressure the more work they do.
Send today for catalogue.
Divine Water Motor Company
Utica, N. Y.

We Pay \$9 a Day



Taking orders for New Serenola. Wonderful invention. Does more than machines costing many times its price. Easily carried with you anywhere. Built in, just like a suitcase. Fully guaranteed.

\$50 TO \$100 A WEEK!

Get started at once. No experience needed. We deliver and collect. Pay you every day. Work full or spare time.

Write or wire us for terms and territory.

PERRY-LUDLOW CO.
S-2848 Dayton, Ohio

AGENTS Something New!

HERE'S the latest bonanza for five wires—the Burns Bread Knife. Entirely new patent. Different from all others. Cuts bread clean without tearing or making crumbs. Lasts for years. Retail for only \$1.00 or can be used as premium with our line of over 200 fine house hold specialties.

14 in.
Long

**\$8
\$10
a Day**

Here's proof that we have a winner. LONGCORE, N. J., made \$14 in five hours; FRANK, Nebr., averages \$1.00 per hour every working day. MRS. MOSER, Pa., says it is easy to make \$10 a day with our line. Some good territory still open, but write quick for terms and free Outfit offer.

C. H. STUART & CO.
967 Union Street Newark, New York



Buy Today 10 Months to Pay \$2⁰⁰ Down Makes Any Article YOURS

Any article you select sent for your thorough examination and approval—you need send only \$2 as deposit. After you convince yourself that the article you have selected is an exceptional value, keep it. You can pay the balance in 10 easy, monthly remittances. Unless you are thoroughly satisfied, deposit will be returned immediately. **GUARANTEE VALUE BOND** with every diamond, 7½% yearly increase in value. **GUARANTEED!** Transactions strictly confidential. **NO RED TAPE—NO DELAY!**

SWEET Diamonds possess a rare blue white color, and are scientifically cut for maximum brilliancy, fire, snap and animation.



P.M.1

7 perfectly cut and matched diamonds, PLATINUM set. White gold top. 14K. shank. \$48.50.



P.M.2

Radiant diamond of superior quality, perfect cut. Engraved 18K. W.G. ring. \$50.00.



P.M.3

Men's ring, with sparkling, perfect cut diamond, 14K. shank. Engraved white gold ornaments. \$60.00.



P.M.4

Fine quality, blue white diamond set in 14K. gold Engagement ring. White gold prongs. \$60.00.



P.M.5

Dainty, 15 jewel wrist watch. Engraved, 14K. white gold case. Sapphire set crown, silk grosgrain ribbon, white gold fittings. Guaranteed against repairs for a year. \$18.50.



Dept. 64H

"THE HOUSE OF QUALITY"
CAPITAL \$1,000,000.

LW·SWEET INC.

1650-1660 BROADWAY, NEW YORK

FREE
Our new Diamond Book 'Gifts for every occasion': Diamonds and Watches, Jewelry, Novelties, Silver and Toiletware. 3000 exceptional values—10 months to pay. Write to

We Pay \$7 a day

taking orders for
**Can't Clog
Coal Oil Burner**



Most perfect burner ever invented.

Intense blue flame. Can't clog up. Turns any coal or wood stove into a gas stove. Heats oven to baking point in 10

minutes. Cheapest fuel known. Low priced. Sells everywhere. Nothing else like it. Not sold in stores. Write quick for sample.

PARKER MFG. CO., BURNER 878, DAYTON, OHIO

**1000 SHOT
ALL STEEL
MAGAZINE
AIR RIFLE**

**WE GIVE
TO BOYS
WITHOUT COST**

Choice of six guns (on four easy plans) for selling our Magic Healing

**HAMILTON
22 CAL.
HUNTING
RIFLE**

Wav-o-lens at 25c box. We Trust You! Order Seven Boxes Today On Postal Card—w/encd promptly, prepaid. Easy to sell—used in every home. Return money as instructed, choosing your gun according to one of the plans shown in our Big Premium List. Also 200 other Gifts or Big Cash Commission if you prefer. If you are prompt, a special Free Gift.
Waverly Co., 210 Tower Bldg., Monongahela, Pa.

**SELF-FILLING INK PENCIL
"INDEPENDENT"**

Guaranteed Improved Fountain Pen. Eliminates fatigue. Promotes efficiency. Writes uniform. A business necessity.

\$2 By Mail

Meets all requirements. Self-filling, non-leakable, safety cap. Attached clip. Smooth writing gold style point.

Your Name in Gold—25 Cents Extra

AGENTS WANTED

J. C. ULLRICH & CO., 161 Washington St., New York

Make \$60 to \$100 A WEEK

**New 300 Candle Power
Lamp—Burns 96% Air**

Introduce wonderful patented invention. Burns only 4% fuel—cheap kerosene or gasoline. Uses less than wick lamps. Greatest advancement in lighting of the age. Table lamps, wall lamps, hanging lamps, lanterns. Powerful, brilliant, soft, restful white light—like daylight. Brighter than a score of wick lamps. No Smoke—No Soot—No Odor.

FREE Outfit Offer Easy to earn big money. No experience—no capital required. Work all or spare time. Simply take orders. We deliver and collect—pay you big commission same day. Vivian of Minn. made \$400 in 39 days. Green of N. Y. made \$33 in one day. Hundreds making \$10 to \$40 a day. Get territory quick. Big season now on. Write today for free catalog and special agent offer.

The Akron Lamp Co., 103 Lane Bldg., Akron, O.



\$5⁹⁵ Brings this Range Direct from Factory

Pay balance in small monthly payments. 200 other late styles in stoves, ranges and furnaces to select from. Save 15 to 25% on your order and get the finest quality in America. 500,000 satisfied customers say Kalamazoo direct-to-you is best.

FREE Bargain Book

Sensational values on every page. 30 days' free trial. Quick, safe delivery. Bank Bond Guarantee. Your money back without question. Send today.

KALAMAZOO STOVE CO.
392 Rochester Ave., Kalamazoo, Mich.

24 Hour Shipments

**A Kalamazoo
Direct to You**



WORLD'S RADIO SETS AND GIVEN

You may have your choice of practically any fine radio set made. Or, if you prefer to build your own set, you may select the best standard parts to be had without a penny's cost to you.

We will give you batteries, tubes, phones, loud speaker units, phonograph attachments, battery chargers for just a few of your spare hours acting as our representative in your community.

This wonderful offer is made by

Popular Mechanics Magazine

to secure increased circulation in your neighborhood. Hundreds of thousands now read it. You will find it easy to get others to do so. Just a little of your spare time will entitle you to share in this GREAT RADIO OUTFIT DISTRIBUTION now under way.

Don't wait until some one else has covered your territory. Get "your oar in first."

The Radio Receiving Sets we offer are all high grade standard Radio equipment, and will be delivered to you express prepaid and FULLY EQUIPPED, so that you will not have to buy a single part.

**FILL OUT AND MAIL US ATTACHED
COUPON IMMEDIATELY**



GREATEST RADIO

FINEST STANDARD PARTS AWAY!

Popular Mechanics Magazine

also offers you parts, such as rheostats, wave traps, tubes, condensers, sockets, induction coils, tuners, grid leaks, blowtorches, variocouplers, variometers, transformers and phones, as well as diagrams showing you how to "hook up" your choice of six well-known circuits. All parts are those of standard manufacturers guaranteeing their products.

WE SEND OUTFIT FREE

We supply everything you need to become a successful representative and it doesn't cost you a single cent. WRITE TODAY for beautifully illustrated folder describing many Radio outfits, units and parts which you may have for a little of your spare time. If you prefer, you may have real money for the few hours you give us. But don't delay; send right now for full particulars and our representative's FREE outfit. Name two references.

Popular Mechanics building is devoted exclusively to the production of this great magazine.



POPULAR MECHANICS MAGAZINE, Room 408, 210 East Ontario St., CHICAGO

Please send me, without obligation, full particulars about your SPECIAL RADIO SET OFFER.

Name.....

Street.....

City..... State.....

OFFER EVER MADE

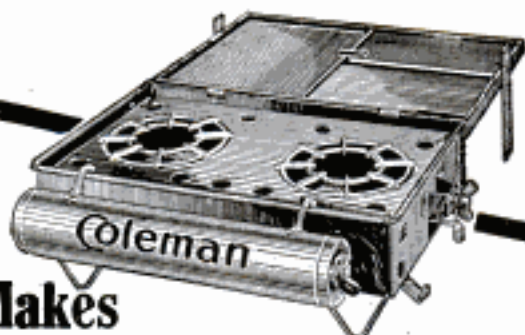

Makes Camp Cooking a Pleasure

Have good "eats" of all kinds, anytime, anywhere you go! The COLEMAN Camp Stove bakes, boils, roasts; fries, broils, toasts. Gives quick action! The only camp stove with all these exclusive COLEMAN features: Built-in Oven; Built-in Wind Baffle; Swinging Fuel Tank always connected; Built-in Pressure Tank and Funnel; Quick Hot-Blast Starter that gives full cooking heat in 2 minutes; Warming Cabinet that keeps food hot and heats your tent on chilly days. Fuel is common motor gasoline. Stove folds up like a suit-case.

The COLEMAN Camp Stove is sold by Hardware, Auto Accessory and Sporting Goods Dealers. Write for Descriptive Literature and name of dealer near you who sells the COLEMAN. Address: Camping Dept. PM-14.

THE COLEMAN LAMP COMPANY, Wichita, Kansas
Philadelphia Chicago Los Angeles Toronto, Canada

(14) Coleman Camp Stove

RE-MANUFACTURE FORDS
Start a FORD Service Station
The MOST PROFITABLE BUSINESS ON EARTH

FORDS REMANUFACTURED BY THE FACTORY PROCESS

SQUARE DEAL GARAGE

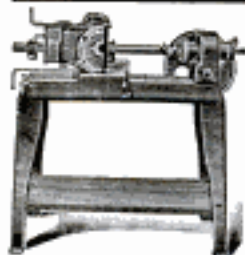

\$14,355.00 Profit on 300 Jobs

Facts and figures from hundreds of KRW Equip Shop Records.

9,000,000 Fords Need Repairs

Are you getting your share of that business?

\$850 Completely equips your shop to RE-MANUFACTURE Fords

We can furnish entire equipment for cash or on easy payment plan. Ford Motor Co. recommend these tools. Catalog.

K. R. WILSON, 12 Lock St., Buffalo, N. Y.

Drive 100 Tacks and Save \$25

on your next Top or Best recovering. Fords \$5.20 to \$10. Chevrolets \$7.00 to \$15. All other cars \$9.25 to \$22. Our Plate Glass Lights enhance the value of your car. Side Curtains \$9.25 up. Seat Covers \$2.50 to \$32. Quality and fit the best. Our instructions make it easy to apply. Send for samples. Our prices include delivery at your door. Eastern orders shipped from Ohio.

Auto Equipment Co., 1055 So. Broadway, Los Angeles, Calif.

**\$520 up
Delivered**

"Old Town Canoes"



Lazin'
down a lazy stream

A SUMMER afternoon—the fresh clean smell of the woods—and a stream shimmering like a polished mirror. It's a perfect "Old Town" day.

"Old Town Canoes" are so light and easy to handle. They are low in price too. \$64 up. From dealer or factory.

The new 1924 catalog is beautifully illustrated. It shows all models in full colors. Write for your free copy to-day.

OLD TOWN CANOE CO.
1463 Middle Street, Old Town, Maine, U. S. A.



Catch Fish, Eels, Mink, Muskrats and many other fur-bearing animals, in large numbers, with my New, Folding, Galvanized Wire Mesh Traps. They catch them like a fly-trap catches flies. Made in all sizes. Strong and durable. Write today for Price List, and my Special FREE Offer on best baits known for attracting fish and animals.

J. F. GREGORY, Dept. 102, Lebanon, Mo., U.S.A.

MORE THAN 25000 FISHERMEN

have written for HILDEBRANDT'S HINTS on flies and spinners. It's chock-full of live tips about catching every game fish on all kinds of tackle. HILDEBRANDT baits are efficient and sportsmanlike. Write for your copy of HILDEBRANDT'S HINTS to-day. No obligation.

The JOHN J. HILDEBRANDT CO.
439 HIGH STREET LOGANSPORT, IND. **FREE**

Fish Bite like hungry wolves, any season, if you bait with **Magic Fish Lure**.

Best Fish Bait ever discovered. Keeps you busy pulling them out. **\$1 Box Free** to introduce our fish and animal traps. Write today. Agts. Wtd. Walton Supply Co., Dept. C-1, St. Louis, Mo.

Start Making Big Profits
CHARGING BATTERIES



20 Monthly Pays
for Your Outfit

\$300 PROFIT Monthly from HB 8 Hr. Battery Charging

Own your own big money-making battery charging business. Small cash payment brings you HB 8-hour charging outfit. Easy terms of only \$20 monthly let your profits pay balance with nice surplus besides. Thirty day free trial on money-back guarantee. HB patented voltage-regulating winding absolutely prevents reversing. Saves current. You can easily clear \$150 to \$200 every month. Hundreds of HB users, with no previous experience are making big money. You can, too. HB 8-hour Charging puts your shop ahead of competition, draws trade. Write today for Bulletin 327.

HOBART BROS. CO. BOX M36 TROY, OHIO

Pays For Itself ~ Earns Big Profits

HB 8 HOUR BATTERY CHARGING PAYS BIG

\$200 to \$300 Profit Every Month

GET FACTORY PRICES
ON GALVANIZED

ROOFING

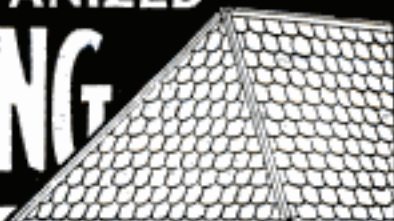

EDWARDS
"REO" Metal Shingles

Absolutely rust-proof—edges as well as sides. Not the space of a pin point exposed to weather. Also fire and lightning proof. Reduce insurance. Outlast buildings. Need no repairs—and all roofing expense. Easy to lay—one man can do the work—hammer and nails only tools needed. Lay over old shingles if desired. Patent Interlocking Device makes water tight seams—all nail heads covered—no rust or leaks possible.

Exclusive "Tightcote" Process

Put all Edwards Galvanized Roofing in a class by itself. Bend, twist, strike it with a hammer as much as you like—you can't loosen or scale off the galvanizing—due to our "TIGHTCOTE" process which practically makes zinc covering a part of the metal sheet. No other galvanized roofing can withstand this test.

FREE Roofing Book Don't buy roofing until you get our big free book, describing Edwards famous "Tightcote"



THE EDWARDS MFG. CO.
300-350 Pike St. CINCINNATI, O.



Corrugated



Patent Side Lock
No nail heads in sight or exposed to the weather



Brick Siding

Roofings, Sidings, and Ceilings, and our lowest factory prices. We sell you direct and save you in-between dealers' profits. Write for Roofing Book No. 150.

Low-Priced Garages

Lowest prices on Ready-Made Fire-Proof Steel Garages. Set up any place. Send postal for Garage Book showing styles.



A Gasoline Gage for Your Dash

Money-back



Guarantee

Tired of "running out of gas"? Tired of depending on an old-fashioned tank gage? Tired of climbing out to wipe off a muddy, greasy gas-tank dial—of overflows at the filling station—of short measure—of peeking under trunk racks—of that "uneasy feeling"?

The "R-K-D" Dash Gasoline Gage goes on your instrument board, right before your eyes. It tells you, from the seal, just how much gas is in your tank—makes it as easy to read the gas in your tank as the miles on your speedometer.

Have your gasoline gage right before your eyes, where it belongs—on your instrument board.

Send us your check for only \$9.50 (\$10.00 west of Rockies), with the name and model of your car, and we will ship you, prepaid, an "R-K-D"

Gage. Put it on your car, and give it a good hard test. Then, if you don't like it—if you don't think it is about the best investment you ever made—send it back, and we will return your money without delay or argument. We guarantee the "R-K-D."

The "R-K-D" Dash Gas Gage is a handsome, accurate electrical instrument—yet so simple that you, or your garage man, can install it without the slightest trouble. It will last the life of your car.

The "R-K-D" is inexpensive. But even if it cost three times as much, you would soon save its price by avoiding overflows and short measure—not counting its safety and convenience.

Begin right away to enjoy the relief the "R-K-D" will bring you. Remember, if you don't like the "R-K-D," we send back your money. Order today.

The Reiter-King-Dugan Co., Akron, Ohio

We Pay \$8 a Day



taking orders for Inside Tyres—inner armor for automobile tires. Positively prevents punctures and blowouts. Guaranteed to give double tire mileage.

We Want 2000 Representatives

Easy to get orders. Every auto owner a prospect. Old worn-out casing will give three to five thousand miles more service. Use over and over again. Demand enormous. Write quick and get started.

AMERICAN ACCESSORIES CO., B-1876, Cincinnati, Ohio

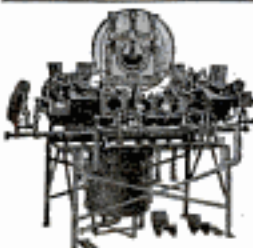

Steady Work

in a fast growing business with Vanderpool Latest Improved Vulcanizer. Made in America.

Ask for Catalog

Vanderpool Co., Dept. 3P, Springfield, Ohio

F. H. DIBB, Agent for British Isles
26 Fairfield Rd. Winchester, England

SHAW MOTOR ATTACHMENT MAKES YOUR BIKE A MOTORCYCLE!

A high grade 2½ H. P. motor attachment quickly clamped on any bike frame. Speed 4 to 40 miles an hour. 90 to 125 miles per gallon of gas. **Special Low Price Now!** Write today for Complete Description and Special Low Prices on SHAW Motor Attachments and the SHAW Complete Motorcycle. **SHAW MANUFACTURING COMPANY**
Dept. 37 Galesburg, Kansas



MOTORCYCLES



RELIABLE STANDARD MAKES that you can **DEPEND** on. Enjoy the glorious experience of going wherever you like—wherever you like. The price is within your means—35% to 50% less than others. These machines are slightly used, thoroughly overhauled or rebuilt. Send for catalogue

MYEROW BROS.,
15 Berkeley St. Boston, Mass.

Be the first to use
SMOOTH-ON No. 1

and get the credit
for the saving!

SMOOTH-ON stops leaks in auto radiators, bursted water jackets, gear cases, tanks, heating boilers and radiators, tanks, water, gas and steam pipes, etc., in one simple application. Keeps bolts, nuts, grease cups, hub caps, etc., from loosening and dropping off. Makes handles tight on tools, kitchenware, door knobs, canes, etc. Joins iron, brass, lead, aluminum, wood, concrete or glass to each other, and holds well in many places where nothing else can.

Get
This Book
Free

Needed in every home, auto and workshop and when used as directed makes big savings and stops many nuisances.

144-Page Repair Book FREE

if you mention this magazine.

**SMOOTH-ON
REPAIR
BOOK**

Seven kinds of Smooth-On are made each for specific purposes. Get Smooth-On No. 1 in 6-oz., 1-lb. or 5-lb. tin at nearest hardware store.

SMOOTH-ON MFG. CO.
Dept. 37
574 Communipaw Avenue
JERSEY CITY, N. J.



Cleaning Up Some Of The Railroad Troubles by using **WHITING-ADAMS BRUSHES**

Sweep out the germs, and sun and air
will do the rest.

Send for Illustrated Literature

JOHN L. WHITING-J. J. ADAMS CO., Boston, U. S. A.

Brush Manufacturers for Over 114 Years and the
Largest in the World

WINDOW SIGNS



AGENTS 500% PROFIT
Genuine Gold Leaf Letters
GUARANTEED TO NEVER TARNISH



For store fronts, office windows, Bank windows, Office Doors, Panels, Board Signs, Trucks, Automobiles and Glass Signs of all kinds. Anyone can put them on and make money right from the start without previous experience. All you have to do is to show your samples; the letters are very attractive and easy to sell. Letters costing 3/4c sell for 25c. One agent says: "Your Letters are the best thing I have seen in years. I have made \$125.00 the first week and still going strong." Paul Clark says: "Smallest day \$28.70." H. Gilder made \$835.00 in six weeks.

\$60 TO \$200 A WEEK

GENERAL AGENTS—It is easy to appoint sub-agents for this line. We pay you 20% cash commission on all orders we receive from local agents appointed by you anywhere. We allow you 50% discount on your own orders. You can sell to nearby trade or travel all over the country, as you please. Large demand for window lettering everywhere. Write today for free sample, full particulars and liberal offer to general agents.

Metallic Letter Co., 433-B N. Clark St., Chicago

WHY NOT IMPROVE YOUR PERSONAL APPEARANCE?

Send for booklet showing photos of Men with and without the **PERFECT LEG FORMS FOR BOW LEGS and KNOCK-KNEES**. Also **BRACES** for children for **PERMANENT CURE**.

Perfect Sales Co., 140 N. Mayfield Ave., Dept. 8, Chicago, Ill.

AMAZING NEW WASHER!

SELLS LIKE WILDFIRE—Wonderful new invention; does large family washings in 30 minutes. No work or rubbing. Fits in any wash-boiler. No changes necessary. Creates its own power from fire under boiler—shooting 64 jets of hot soapy water through the clothes. Flushes dirt, grime and grease out of them. No electricity—no gas engine or hand power. No rubbing. Costs but a few dollars complete. Solid copper. No mechanical or moving parts. Lasts a lifetime. Write today for free descriptive literature and special selling plan including 30 day trial.

AGENTS WANTED TORRENT WASHER CO.
Dept. 7, 122 S. Michigan Ave., Chicago, Ill.

DIAMONDS

FOR A FEW CENTS
A DAY



\$1.50 a Week
SEND NO MONEY
Looks like
\$350 Solitaire
No. 81
only **\$59.50**
We Trust You

**MONEY
BACK
GUARANTEED**

Million Dollar
Bargain Book

FREE

Send for it today.
It pictures thou-
sands of Bargains.
Address Dept. 1173

FREE

J.M. LYON & CO.
2-4 Maiden Lane N.Y.

FREE Book of Newest Styles just out. Women's, men's, children's clothing on credit and at bargain prices, less than cash prices everywhere. Very latest fashions; best materials. Open a charge account with us. Buy on credit and save money! Dress in newest styles. Send for Style Book absolutely **FREE today!** Elmer Richards Co., Dept. 1773, W. 35th Street, Chicago

Armortred MOCCASIN SHOE
By Mail, Prepaid **\$4.85**
FOR WORK OR OUTDOOR WEAR
DIRECT TO YOU

Choc. elk uppers; two full soles; Armortred sole; full rubber heel; full vamps (nothing to rip). A sturdy shoe for real wear and comfort.
CHARLES KELLERT CO.
116 Bedford St., Dept. 501, Boston, Mass.
(Exclusive territory open to agents)

**THEY
WEAR!**



Big Money for Spare Time Workers

This notice is written to interest the man who wants to earn some money and in return for very liberal pay would be willing to introduce to friends and neighbors the finest C. T. A. clothes selling for \$19.00, \$24.00, \$31.50, \$33.50 per suit. One man in each community can earn one of our best suits and in addition **\$3 to \$12 for each order**, besides extra cash bonuses, and many beautiful presents, including \$1000 in cash, Ford Sedan, Elgin Watch, Diamond Ring, etc. If you would like a fine suit and will be willing to show samples to at least a few men each week, **send me your name and address** and I will be glad to send you full details. **C. A. Milligan, Manager.**
Chicago Tailors Association, Dept. 551, Sta. C, Chicago



FANSTEEL Balkite

PATENTS
APPLIED FOR. *Battery Charger*

Noiseless and Indestructible

A new battery charger for Radio "A" (6 volt) batteries. Entirely noiseless. Has no moving parts, requires no attention or adjustment, and cannot get out of order. No bulbs to break. Simple and unfailing in action. Can be used while the radio set is in operation. A positive economical charger for home use. Can also be used to charge automobile batteries. If your dealer can't supply you, send direct on receipt of price. Money back guarantee.

Price \$18 (\$18.50 West
of Rockies)

Dept. P6 Fansteel Products Co., Inc.
North Chicago, Illinois

FREE Radio Text Book and Catalog

A Post Card Brings It

CONTAINS 75 VACUUM TUBE
HOOK-UPS
300 ILLUS. 500 RADIO ARTICLES

All Armstrong Circuits: These important circuits are explained clearly, all values being given, leaving nothing to puzzle you.

Also 75 full, clear diagrams, explanations and instructions for all important vacuum tube circuits, from the simplest to the most advanced. How to make a wave-trap—how to increase wave length of set—serial data—tube data—battery data—reflex—regeneration—radio amplifiers—audio amplifiers—loud speakers—tables of component parts, and endless other radio subjects covered in simple, understandable way.

The 75 diagrams in book form alone would cost you \$5 to \$6. Get this all FREE. Send for it right away. Offer limited.

RADIO SPECIALTY COMPANY, 98 E. Park Place, N. Y. City





Rings Bells Without Batteries

Avoid the annoyance of having bells out of order. At a nominal cost you can install this little device which will ring electric bells, buzzers, annunciators, electric heat regulators, door-openers, etc., from the same current that lights your home.

ONLY \$2.00
Canada \$3.00

Air-Way

Bell Ringer Transformer

C connects direct to lighting-current, and eliminates forever the use of troublesome dry batteries. Does not use enough current to register on meter. Buy it from any electrical dealer, or we will send it anywhere postpaid upon receipt of price. Your money back if you are not satisfied.

JOBBERS, DEALERS, AGENTS—Write for selling proposition.

AIR-WAY ELECTRIC APPLIANCE CORPORATION
Toledo, Ohio





The
Superior
Tube
for
Radio
Receiving
Sets

Cunningham

RADIO TUBES

CUNNINGHAM RADIO TUBE Type C-299 is a Detector and Amplifier of the high vacuum type, designed especially for dry battery filament current supply. The special filament in this tube draws a current so low that as many as four tubes may be readily operated from a single set of three standard No. 6 dry cells. The ideal tube to use in your set. The care and operation of each model of Receiving Tube is fully explained in our new 40 page "Radio Tube Data Book." Copies may be obtained by sending ten cents in stamps to our San Francisco office.

CUNNINGHAM RADIO TUBES

C-301A—5 Volts 1-4
ampere filament, \$6.50
C-299—3Volts .06 amp.
Dry Battery Det. and
Amp. \$6.50
C-300—5 Volts Gas
Content Detector, \$5.00
C-11—1.1Volts .25amp.
Dry Battery Det. and
Amp. Special Base, \$6.50
C-12—Similar to C-11
with standard base,
.....\$6.50

PATENT NOTICE

Cunningham tubes are covered by patents dated 11-7-05, 1-15-07, 2-18-08, and others issued and pending. Licensed for amateur, experimental and entertainment use in radio communication. Any other use will be an infringement.



E. J. Cunningham Inc.

Home Office: 183 Second Street, San Francisco, Calif.
154 W. Lake Street
Chicago, Ill. 30 Church Street
New York City, N. Y.

*An Easy Way
to Cut Out
Interference*



The Ferbend "Wave Trap" Makes Every Night Silent Night

Get the station you want quickly. Listen in on the distant stations without annoying squawk-k-k-s or irritating whistles. Listen like this St. Louis user—"Heard Havana clearly with three St. Louis stations broadcasting. My receiver works like a new set. The 'Ferbend' is certainly a wonder!"

YOU Can Obtain These Remarkable Results

You can obtain results as satisfactory as this St. Louis user. If you don't, it doesn't cost you a penny, for the "Wave Trap" is sold with a positive guarantee that it will tune out interfering stations. Don't wait. Order now at our risk.

Send No Money You need not send a penny. Pay Postman \$6.00 (plus postage). If you prefer, send \$6.00 with order and "Wave Trap" is mailed postpaid. Money back guarantee either way. You see you take no risk, so order **TODAY**.

Ferbend "Wave Trap" can also be supplied complete for use mounted on formica panel in mahogany finished cabinet 6x5x6 at \$8.50. Complete circular on request.

Ferbend
Electrical Co.
15 E. S.
Water St., Chicago

Send me a Ferbend "Wave Trap". I will pay Postman \$6.00, plus postage. I understand you guarantee "Wave Trap" to tune out interfering stations or refund money.

Name.....

Address.....

FERBEND ELECTRIC CO.

15 E. South Water Street, CHICAGO

FERBEND

Wave Trap

CATALOG E19-100 PAGES FREE

LATEST REFLEX AND NEUTRO DYNE CIRCUITS

One of the largest complete stocks in the world.

DEALERS ALLOVER THE U.S.

Making big profits handling our supplies. 24-hour service. Goods shipped same day order received.

AMERICAN RADIO MFG. CO.
WHOLESALE DISTRIBUTORS
Dept. O, 6 W. 14th St. KANSAS CITY, MO.

The Real Metal Solder in Paste Form

SOLDERALL

Introducing Our New
SOLDERALL BLOW TORCH
of Heavy Solid Brass

Indispensable in the Home, Garage and to the Electrician. For soldering Radio, House Wiring, Jewelry, Ignition, Kitchen Utensils, etc.



SOLDERALL CO. Dept. P Newark, N.J.

YOU DON'T NEED TUBES

to receive concerts from Distant Stations.
You can hear them on

YOUR CRYSTAL SET

If you fix it up the right way. You may already have everything you need and just have it connected up wrong. People using my methods hear programs clearly from stations

400 TO 1000 MILES AWAY

No Tubes, Batteries or Amplifying apparatus required. No Special Crystal Necessary. Changes often cost less than a dollar. Picture of my set and further information free. Write me today.

LEON LAMBERT, 539 So. Volusia St., WICHITA, KANSAS

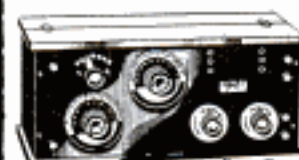

MIRACO
GETS 'EM
FROM
COAST TO
COAST

PRICE ONLY \$29.50

At rock-bottom prices you get the efficiency of sets costing three times as much. Users tell us that Miraco Radio frequency receivers pick up stations from coast to coast. Operate either on dry cells or storage battery. Solid mahogany cabinets—finest workmanship throughout. Order direct or send for bulletin.

Two tube outfit \$29.50
Four tube outfit 54.50

DEALERS—AGENTS—Write for proposition quickly—it's a winner
THE MIDWEST RADIO COMPANY
807 Main Street, Cincinnati, Ohio

WEIGHS
ONLY
8 OZ.



A "200,000" COMPANY
stands squarely back
of the guarantee on
every Scientific headset

SEND NO MONEY!

20,000 TURNS
EQUIVALENT TO
3,000 OHMS

Order TODAY
by Postcard
and Pay
Postman
on arrival

\$2.95
POST-PAID
LOUD
SPEAKER
UNIT '1935

We Guarantee The Scientific Headset to be the greatest value on the market. Try it for five days. If not satisfactory send it back and your money will be refunded immediately. Circular on request. Dealers wanted.

THE SCIENTIFIC ELECTRIC WORKS
26 Brookline Ave. BOSTON, MASS.

Reliable
RADIO
Goods

Results are sure with **RELIABLE** goods

And it's easy to get such goods—anything you want in radio equipment. Big, complete stock—everything guaranteed; quick service; right prices. And you're sure it's reliable when it comes from Andrae. Get our complete catalog—free.

JULIUS ANDRAE & SONS CO., 116 Michigan St., Milwaukee, Wis.

ANDRAE In Business Since 1860

Sears, Roebuck and Co.

The World's Biggest Mail Order House

Radio Fans

Here Is a Winner
Armstrong
Regenerative Set
Receiving
Radius
600 Miles
\$23.25

Order Direct From
This Advertisement.

HERE is a money saving Radio Outfit that will bring the news of the world—concerts, lectures and stock reports—into your home. Sold complete with head set, tube, batteries, aerial and ground wires, for only \$23.25! Connections simple and plainly marked. Easy to tune. Order NOW! Shipping weight, 12 pounds. Shipped from CHICAGO or PHILADELPHIA store.

57 P. M. 9366 \$23.25

Save on All Radio Supplies.

Save money on your radio supplies, and get guaranteed quality! Our big FREE Book shows hundreds of bargains in complete sets and parts. Many new hookups, complete list of broadcasting stations. Contains "How to Build an Aerial." Mail coupon!



Licensed under the Armstrong Patent No. 1113149 for amateur experimental and scientific uses only.

**FREE
Radio
Catalog!**



Sears, Roebuck and Co.
Chicago - Philadelphia

Mail coupon today to store nearest you for Free Radio Catalog.

Send me FREE Radio Catalog No. 80 P02 _____

Name _____

P. O. _____

State _____

Rural Route _____

Box No. _____

Street and No. _____

Swing 4 in.; 11 in. between centers, 17 in. total length. Shipping weight 13 lbs. Bed of lathe is machined. Workmanship first-class. Equipped with wood turning chuck. Can be fitted with 3 in. face plate and drill chuck as special equipment. Order one today.



Price \$6.00 cash with order
Made also in larger sizes.
SYEPHER MFG. CO.
Dept. D TOLEDO, OHIO

THE TRINITY LOUD SPEAKER

The only device of its kind in the radio field.



LAMINATED ADJUSTING SCREW CORE

TYPE B \$12.50

Study the illustration carefully and you will understand why it produces full, clear natural tones with perfect reproduction of all vocal and instrumental music. May be used with phonograph or built into your set.

Type A1, \$25.00
21" Fibre Horn

TRINITY RADIO CORPORATION
446 TREMONT ST.,

BOSTON, MASS.



Howard Micrometer Adjustment Rheostats

Instant adjustment. Made from special heat resisting materials; operates with single knob; positive smooth contact. Micrometer adjustment.

Rheostats, 6 1/2" — 25 or 40 Ohm, Plain, \$1.10; Micrometer, \$1.50

Power Rheostats, \$1.50

Potentiometers, 200 Ohm, \$1.50; 400 Ohm, \$2.00

Ask your dealer or write us. Complete catalog of Howard radio parts and hook-ups free on receipt of 2c for postage. Jobbers write for discounts.

HOWARD RADIO COMPANY 4244 N. Western Avenue CHICAGO

2000
Ohms
\$4.00



3000
Ohms
\$4.50

You can pay more but you can't get better value

THE fine acoustical properties embodied in Murdock Radio Phones permit the user to receive distant signals with great volume and clearness. All parts are firmly embedded in moulded insulation—thus assuring firmness, strength and permanence of adjustment.

Get a Murdock to-day and test it out. They are fully guaranteed.

*A higher price is a luxury
—any less is poor economy.*

WM. J. MURDOCK COMPANY
349 Washington Ave. Chelsea, Mass.

MURDOCK RADIO

Morrison

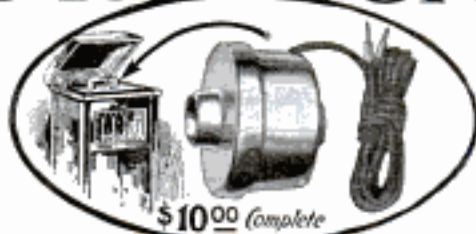

\$10.00 complete

Loud Speaker

Use Your Phonograph for Radio

To really enjoy radio you require a loud speaker that reproduces all broadcasting in full volume with rattle, vibration and distortion eliminated. Your phonograph has a sound-box that cannot be excelled. So attach a Morrison Loud Speaker to the tone-arm of your phonograph and you have a perfect combination—a scientifically developed loud speaking unit reproducing Radio's wonderful concerts through your phonograph's incomparable sound-box. It is the refinement of radio enjoyment.

A little dial on the Morrison enables you to adjust the tone soft or loud, to suit your taste. Further than that, Morrison is fool-proof—requires no technical skill nor constant adjustment to operate. This remarkable loud speaker complete with a 5-foot cord costs only

\$10.00

Nickel Plated Model

Every Morrison Loud Speaker is sold on a satisfaction or money-back guarantee. Our 2 color catalogue describes Morrison fully—we would like to send you one free.

Dealers: Our merchandising plan to help you sell Morrison Loud Speakers assures you a profitable business. Every sale you make brings many more. Let us tell you about this plan.

MORRISON LABORATORIES, Inc.
337 Jefferson Ave., E. DETROIT, MICH.

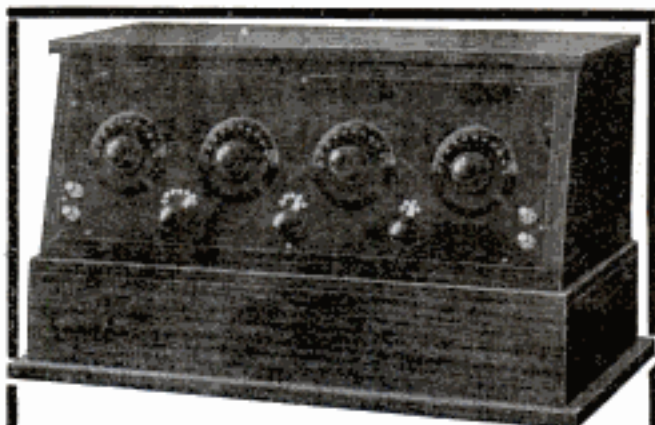

MAKE MONEY—SELL RADIO!

Radio offers the biggest money-making opportunity on earth today. And the Ozarka Plan opens the door to this big opportunity. Look at the picture of this beautiful Radio Receiver. This picture was made from an actual photograph. By the Ozarka Plan that Radio Instrument can be the product of your own making—easily, simply and surely. It will be yours to make, to sell and to reap a rich reward in cash profits.

No experience necessary. You need not have much cash. All you need is spare time, determination and action. If you're that kind of a chap, the Ozarka Plan will start you on a straight line toward a real money-making business of your own. It can be as big and as profitable as you are ambitious to make it. We want good men in every county. Exclusive territory is going fast. Be sure and give us the name of your county. Write today for the Ozarka Plan. A wonderfully interesting book, of facts, particulars and proofs. It is FREE. Act now.

OZARKA, INC.

851 Washington Blvd.

CHICAGO

Accurate Measurements **Interlox**

MASTER SLIDE RULE

Inside or outside, made instantly. Rule slides in and out; no slow folding. Strong; brass-trimmed. Any length, 2 to 8 feet, 20¢ per lineal foot. If not at dealer's, sent post paid.

MASTER RULE MFG. CO., Inc., 641-43 East 116th Street, New York City

Dealers and Agents; request attractive proposition.



**GOLD SEAL
HOMCHARGER**

The World's Most Popular
Butters' Charger

Charges Radio and Auto Batteries at home overnight for a nickel. Your dealer has it. Write for FREE booklet and list of broadcasting stations.

The Automatic Electrical Devices Co.
129 West Third St., Cincinnati, Ohio

Every Home Needs **TURNER BLOTORCH**

Safe as a Candle

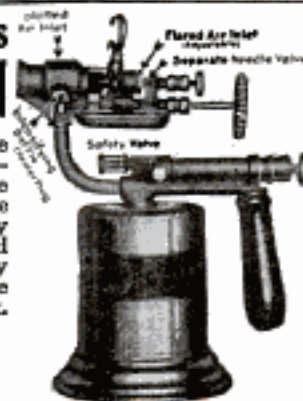

Serves any purpose where intense heat is required—Will burn either gasoline or kerosene—400° more heat than ordinary Torches—Handy men and experts prefer the only torch with a safety valve and one opening in tank.

At Hardware Stores
or Direct

\$8.25

THE TURNER BRASS WORKS
Industry Ave., SYCAMORE, ILL.

Largest exclusive manufacturers of blow torches

It's Easy to Build Your Own Set with a Tunall Unit

It is 80% of an efficient receiving set and can be used with any popular Radio or Audio Frequency Circuit. Stults Design. Entire wave length controlled with dial.

Receives on any wave length from 250 to 600 and permits sharp tuning.

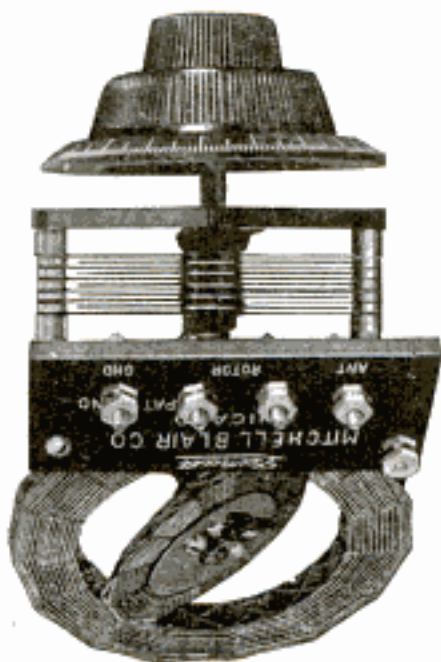

Long distance reception, good volume, excellent selectivity. Practically no resistance or capacity feed back loss.

If your dealer cannot supply, write us.

Price \$8.00

MITCHELL BLAIR CO., 3942 Federal St., CHICAGO, ILL.

FROST-RADIO Catalog and Instruction Book

THIS new booklet on the care and operation of FROST-FONES and FROST-RADIO is now ready. Contains 36 pages of valuable information on radio apparatus. Your copy mailed free on request.

Address Dept. 14F62

Herbert H. Frost, Inc.
154 West Lake Street
CHICAGO, ILLINOIS



FREE!

A post card from you will bring this 40-page catalog.



The LITTLE WONDER
The smallest, yet most efficient Transformer ever made. Maximum reproduction value, minimum distortion, 100% shielded.

PREMIER "HEGEHOG" AUDIO TRANSFORMER

Mounts anywhere—save space in assembly. We guarantee it unconditionally. Try them in your next "hook up." Ratio 1 to 3, 1 to 4, 1 to 5, \$3.50; 1 to 10, \$4.50. Ask your dealer. Write for bulletin No. 92.

Premier Electric Company

3817 Ravenswood Ave.

CHICAGO



Branston D. L. Honeycomb Coils and Ganged Back and Front Panel Mountings BEST for SELECTIVE TUNING

Superior construction and vernier adjustment give better results in your set. Licensed under DeForest Patents. Send 2c for new Radio Manual with 5 Honeycomb Coil "Hook-ups."

CHAS. A. BRANSTON, Inc.
819 Main St. Buffalo, N. Y.
In Canada—Chas. A. Branston, Ltd., Toronto

Vacuum Tubes Repaired

SAVE AT LEAST 1/2 THE COST OF NEW
UV200 and UV201..... \$2.75 each
UV201-A, WD-11 and WD-12..... 3.50 each
GUARANTEED EQUAL TO NEW

Opportunity for boys to make big money by collecting tubes in quantities.

All tubes received and returned parcel post, C. O. D.
HARVARD RADIO LABORATORIES
200 & 204 Old Colony Ave., So. Boston, Mass.



\$300 Profit Monthly with 8 HOUR BATTERY CHARGING



Your Best Winter MONEY-MAKER

HB 8 HOUR Battery Charging Pays Big Monthly Profits

Make \$150 to \$300 monthly charging batteries. Start now to build your own money-making business. No experience needed. Buy an HB 8-Hour Constant Potential Battery Charger on long easy terms, more than paid by big monthly profits. Small cash payment puts HB outfit in your shop, complete ready to connect up and operate. 30 days' free trial on money-back guarantee. You will make big profits, build steady business. Only \$29 monthly pays for your outfit. No repairs, no expensive renewals. No experience needed to operate. More ill outfits in use than any other make. First cost less, monthly profits larger. Write today for information.

HOBART BROS. CO., Box M3, TROY, OHIO

Profits Easily Carry Small Monthly Payments

8 Hour Battery Charging PAYS BIG!



Pays for Itself on Easy Terms

Super-Heterodyne Pinkerton Transformers

4000 Miles Loud Speaker Reception on 24-inch Loop

Radio engineers agree that the Super-Heterodyne is the best circuit. Don't waste your time and money by building other out-of-date circuits. Start now—build a Super-Heterodyne set and have a radio set that for ease of control, selectivity, sensitivity, cannot be surpassed.

Only Super-Heterodyne Transformer on Market

Pink-a-tone engineers, well known in radio, have perfected a transformer that experts nation-wide are using in Super-Heterodyne circuits. Super-Heterodyne sets built by Pinkerton were the first sets to bring in England in recent trans-oceanic tests.

Easily gets all DX Stations

All DX stations are right around the corner with the Super-Heterodyne using Pink-a-tone transformers. Get yours today. Super-Heterodyne hook-up FREE with every order. Mail orders promptly filled on receipt of price. \$25.00 for complete set of 4—or \$27.00 C.O.D. Complete set of parts including set of 4 transformers, drilled panel, etc., \$125.00. Complete plans from which set can be easily constructed, FREE.

PINKERTON ELECTRIC EQUIP. CO.
1834 Broadway, Dept. 100 New York, N. Y.

**GUARANTEE
MONEY
BACK
IF NOT
SATISFIED**

ARLINGTON Receiving Set

COMPLETE
NOTHING ELSE
TO BUY **\$750**

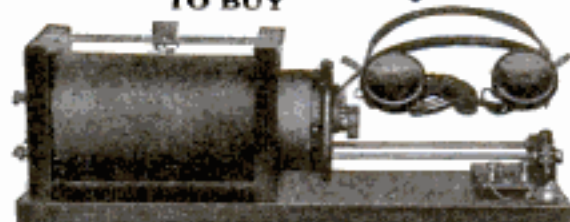

For all wave lengths up to 4000 meters. This is beyond doubt the best crystal set in the market. Ideal for local broadcasting and yet can pick up code on mostly used wave lengths. Everything complete including head-set, antenna and insulators, nothing else to buy.

*Begin with this set, learn radio
—there is a big future for you.*

HECCO ELECTRIC COMPANY
911 Sheridan Road Menominee, Michigan

Please Mention Popular Mechanics

World's Greatest BATTERY BARGAIN

FREE

Written 2-Year Guarantee
Year Proof of Performance

Save 50%

Thousands of Popular Mechanics Readers will profit by this amazing offer. They will buy the famous 2-year guaranteed World Battery at the lowest price ever quoted. They will get their choice of a hydrometer and a "B" Battery or a nickel Auto Spotlite FREE. And they get the best battery built, with 2-year ironclad guarantee.

Compare These Prices

Five Per Cent Discount for Cash with Order

Automobile Prices

6 Volt, 11 Plate \$12.25
Ford, Chev., Mitchell, Hup.,
Grant, Elgin, Vette, Saxon.

6 Volt, 13 Plate \$14.00
Overland, Buick, Reo, Paige,
Hudson, Nash, Stude., Dort.

12 Volt, 7 Plate \$17.00
Maxwell, Dodge, Regal, Frank.,
Hudson and Crow-Elliart.
Give year and model of car.

SEND NO MONEY You need not send a penny. Just clip this ad and mail with your name and address. The battery you specify will be shipped to you the day your order is received. When the battery arrives, inspect it—read our 2-year guarantee before you pay one penny. Convince yourself you are protected from every angle—that the World Battery saves you 50 per cent. Get the "B" Battery and hydrometer, or Auto-Spotlite FREE. Clip the ad, and send your order today.

WORLD BATTERY CO.

Dept. 6, 1219 So. Wabash Ave., Chicago, Ill.



CASH FOR PRACTICAL IDEAS

of some new and useful WAT to utilize Pressed Metal in place of other materials. The undersigned pays cash for every acceptable suggestion approved by our Engineering Advisory Board. Free book gives you the facts.

PRESSED METAL TRADE COUNCIL
27 QUINCY STREET, SUITE 1705, CHICAGO

Audio and Radio
Frequency

Power Amplifying
(Input and Output)

ALL-AMERICAN

AMPLIFYING TRANSFORMERS

Largest Selling Transformers in the World

Over 500,000 in use. Standard on the better sets. Approved by more radio engineers, favored by more fans, recommended by more dealers, than any other transformers.



SPECIAL OFFER!
Write for All-American diagram and circular describing Power Amplification; also Book of Hook-ups containing 22 tested circuits. Enclose 4c in stamps.

RAULAND MFG. CO., 200 N. Jefferson St., Chicago

National Audio Frequency Transformers

The New 6 to 1 Ratio National Transformer is for use on the first stage of amplification. Its greater ratio means increased volume, but the tone qualities that characterize the 3½ to 1 ratio have been fully retained. Price of 6 to 1 ratio \$4.50 postpaid; of the 3½ to 1 ratio, \$4.00 postpaid. Dealers: Write for interesting sales proposition.

National Transformer Mfg. Co.
154 Whiting Street
Dept. 310 Chicago, Ill.

**"Sold 1st Dozen Today!
Rush 18
More"**

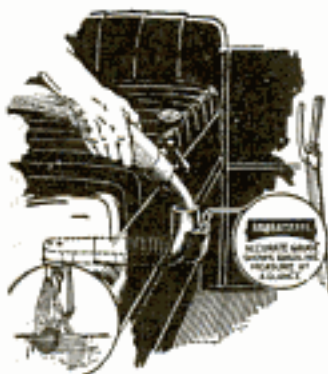

"First dozen received this morning and sold before night. Rush 18 more today. Order for gross follows."—D. C. ORTH, Menlo, Iowa.

You, too, can make quick, easy sales and big profits with the

Kirstin

Fil-O-Meter

A GASOLINE GAUGE AND FILLER COMBINED
Fills Ford Gas Tanks—Shows Gas Measure Without Lifting Cushion

Eliminates bother, dirt, and loss of time in filling Ford (or Chevrolet) gasoline tanks. It is a filler and gauge combined. Automatic Air Vent, allows full flow from pump. Accurate gauge with glass covered dial, always in plain sight. Prevents running out of gas and short measure at filling station. Made of aluminum. Weighs only two pounds. Easy to install—clamps into regular gas tank opening.

SELLS FOR \$5—BIG PROFIT

Retail price \$5.00 (\$5.50 on Pacific Coast). Big profit—Easy Seller. Ford owners now paying \$6.00 for gas gauges alone! KIRSTIN FIL-O-METER at \$5.00 gives visible gauge besides providing the only comfortable, clean, easy way of filling tank. Magnuson made \$48.00 in one day. Laux, as a side line, cleared \$56.00 in 3 days.

Territory Going Fast—Write Today

Get our proposition TODAY. If you wish sample, send \$1.00 deposit and pay balance of Distributor's Price C. O. D.

A. J. KIRSTIN COMPANY

17 First Street

ESCANABA, MICH.

**AUTO SUPPLIES
WHOLESALE
3000 BARGAINS**

**SEND FOR THIS
CATALOG—
it's FREE!**

Everything you need
in Auto Supplies at
Amazingly LOW PRICES.

NEMCO BARGAIN SUPPLY HOUSE

33 to 49 No. Peoria St. Dept. P. CHICAGO, ILL.

Custom-Made Tops Less Than Half Price

EASILY ATTACHED

Full instructions sent. Complete tops with beveled plate glass, tacks, fasteners and welts. Free delivery 1,000 miles. For all cars; special prices on Stars, Overland Fours, Dodges and Chevrolets. Describe your car. Samples and money-saving Bulletins free.

Automobile Trunks for Running Board or Rear Platform.
S-C PRODUCTS CO., 767 Nicholas Bldg., Toledo, O.

SPORT BODIES for FORD and CHEV. 490 at \$34.50

Life-size paper patterns—You can build your own body at small cost.



**\$8 UP
UNDER
SLUNG
PARTS
Per Set
\$6.75**

We are manufacturers and our quantity production enables us to quote exceptional low prices. Our unique shipping methods save you 73% in FREIGHT CHARGES. Send at once for free particulars on Central Bodies. Our Book "HOW TO BUILD A FORD RACER" sent anywhere on receipt of 25c in cash or stamps. **WRITE TODAY!**
Central Auto Supply Co. Dept. 129. Louisville, Ky.

ONLY \$2 DOWN

**FAMOUS 21-JEWELLED
ILLINOIS RAILROAD WATCH
BUNN SPECIAL**

**\$5.50
A Month**



PENN. TERMINAL



GRAND CENTRAL



We guarantee this watch to pass railroad inspection on any railroad in the United States. The requirements for passing railroad inspection are so severe that only the very finest watches can pass them. This watch is adjusted to six positions, although railroad requirements call for only five. A full description of the movement will be given if desired. Better still, order it on trial.

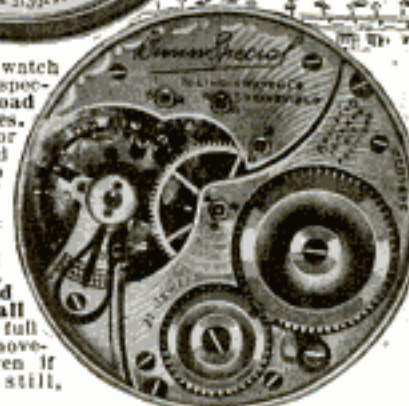

GUARANTEED 25 YEARS

This famous Bunn Special movement is put in a 25 year gold filled case that will wear like solid gold for more than 25 years. We guarantee it against any defect in material or workmanship. These movements are built to give a lifetime of satisfactory service just as the two famous Terminals pictured above were built to last for generations.

30 DAYS' TRIAL: 10 MONTHS TO PAY

You can test this watch in your own pocket for 30 days with the distinct understanding that if you return the watch we will return every penny you paid. Order it now or write for any additional information desired. Get our big catalog.

STERLING DIAMOND & WATCH CO.

Established in 1879

63 Park Row Dept. 1502 NEW YORK

STERLING DIAMOND & WATCH CO.

63 Park Row, Dept. 1502, New York.

Gentlemen: Please send the famous BUNN SPECIAL, 21 jewelled Illinois Watch, as described above, to me on 30 days free trial. I enclose \$2.00 deposit to show my good faith. If I am not satisfied and return the watch within 30 days, you will return my money. If I keep the watch I will pay you \$5.50 every month for ten months until the total price of \$57.50 is paid. Title to this watch remains with you until I have paid you in full. It is understood that you fully guarantee this watch to be as described. Please send your catalog.

**YOUR
NAME**

**LOCAL
ADDRESS**

**CITY &
STATE**

Fired!

Do you work for day wages? Are you working for someone else? If you are, you can more easily appreciate this fellow's misfortune—and you will understand more fully why, at the age when he should be well fixed and in a position to spend the rest of his life in comfort, dependent on no one for support, he is practically penniless—and out of a job, fired because he is too old to work.

Some Facts Straight From the Shoulder

Nearly everyone who works for others tries to save—tries to get enough money together to take care of him and his family when old age overtakes him—but how many are successful in their efforts to accumulate a fair sized savings account?

Government Figures Show

That 82% of the Country's Men, at the Age of 65, Are Dependent on Relatives or Friends for Support! The other 18%, who have money and are independent, are Business Men, Not Fellows Who Have Worked For Others All Their Lives! The workingman can't save. There are too many bills to pay. His pay check comes every so often, but so does the grocery bill, meat bill, light bill, doctor bill, dentist bill, and a hundred and one other incidental expenses. Then sickness often robs him of a couple of weeks pay. No Matter How Hard You Try, It's Practically Impossible to Save Enough Money From Day Wages or a Monthly Salary to Make You Independent in Your Old Age!

Did You Ever Hear of a Retired Workingman?

No, you never did—and what's more—you never will! You hear of retired Business Men. Business men Can Afford to Retire! The fellow who works for someone else (whether he wears a white collar or not) never leaves the job until he is forced to—until fired—replaced by someone younger.



What Are You Going to Be?

A Retired Business Man—or a Fired Workingman? It's up to you. Do your deciding right now! The floor surfacing business will make you and your family independent. The "American Universal," electrically driven, replaces six hand scrapers—and turns out much better work. There's \$25.00 to \$40.00 a day, and more, in it for you as a floor surfacing contractor. Requires a surprisingly small investment—no special training necessary. Beautiful work creates big demand—every floor (old or new) a prospect. Pleasant work—profits unlimited.

Write for Full Particulars at Once

Act Now—don't turn this page until you have written to us for full particulars and testimonials from "American Universal" floor surfacing contractors who are making big money, who are actually enjoying life—and who will continue to enjoy life as long as they live. Don't Wait Until Tomorrow. Write Today—Now!

American Floor Surfacing Machine Co.
523 South St. Clair St. Toledo, Ohio



SEND NO MONEY

5 DAYS FREE TRIAL



"INVINCIBLE" Rebuilt GUARANTEED
STANDARD No. 10 Self Starter Model
REMINGTON

A real bargain. All late improvements—full 84 character key board, standard size type, back spacer, automatic ribbon reverse. Many other standard makes. Time payments if desired. Shipments from nearest of our 29 stores. Order NOW or write for circular. Resident salesmen wanted.

American Writing Machine Co., Est. 1880
Factory, 452-R Central Ave., Newark, N. J.



Saws Logs—Falls Trees—
Buzzes Branches—
Does Belt Work
10-Year Guarantee—Cash or Easy Terms.

One Man
Saws 15 Cords a Day!

—Easy with the OTTAWA Log Saw! Wood selling for \$3 a cord brings owner \$45 a day. Use 4 H. P. Engine for other work. Wheel mounted—easy to move. Saws faster than 10 men. Shipped from factory or nearest of 10 Branch houses. Write for FREE Book—"Wood Encyclopedia"—today.

OTTAWA MANUFACTURING CO.
1741-T Wood Street, Ottawa, Kansas
Room 1741-T Magee Bldg., Pittsburgh, Pa.



RUSSIAN, GERMAN MONEY AUSTRIAN, SOVIET MONEY

Biggest selling proposition of the century! Everybody has. Cheap, popular give-away advertising for Agents, Salesmen, etc. Will boost your sales tremendously. Largest "Dusts," "Right at the market". Have your MONEY on anything. Write

Many bargains and ideas for you in our big FREE circular

HIRSCH EXCHANGE, 70 Wall St., N. Y.



MAKE A MOTOR CYCLE

OUT OF YOUR BICYCLE with a STEFFEY MOTOR ATTACHMENT. RELIABLE—ECONOMICAL—EFFICIENT. Easy to attach. Fits any wheel. Send stamp for circulars.

STEFFEY MFG. CO., Dept. P, 5025 Brown St., Phila., Pa.

\$50 a Week
EASY

AGENTS

Free Sample Offer



You can start a big paying business at once. Don't wait. Get big money. We tell you how—selling the famous E-Z Self-Heating Sad Iron. No experience necessary. Easy to sell. Possibilities great. Every home a prospect. Satisfaction guaranteed. Absolutely safe. Thousands in use. Write today for proposition.

Enterprise Tool & Metal Works, Dept. 33, 2441-9 N. Western Ave., Chicago



No Deposit

Just send your name, address and finger size, and we will send you this beautiful genuine diamond, 14K solid gold ring on approval. Send no money; pay no C. O. D. Merely accept the ring and wear it a week. Then decide—either return the ring and call the deal closed, or keep it and send only \$3.75 a month until our cut price of \$33.75 is paid. (Regular \$50.00 value.)

Genuine Diamonds

Each ring is solid 14K green gold, with 18K white gold top, exquisitely hand engraved and set with a fine, large, extra brilliant, perfectly cut, blue-white genuine diamond. Order now—at once! Send name, address and finger size. Also kindly give your age and occupation and say whether you want ladies' or men's ring. Write today!

200 So. Peoria Street

HAROLD LACHMAN CO., Dept. 1773 Chicago, Illinois



You can have disc wheels, too

You can have steel disc wheels on your coaster wagon, just as Dad has on his car. And with over-sized rubber tires, too — sturdy, fat, solid rubber tires which ride easily and as swiftly as a racer. Substantial steel disc wheels are only one of the many features which make boys proud of

Auto-Wheel

Coasters and Auto-Carts

Besides disc wheels with rubber tires (3 largest have over-size tires) the other features are: steel-tired disc or wood spoke wheels (all wheels interchangeable); self-contained roller bearings, hound brace, hand brake, special hub cap and locking pin, sides mortised and nailed.

Write for catalog of all models of the Auto-Wheel and the Auto-Cart (for little brother or sister). If you send names and addresses of three coaster wagon dealers in your town, telling which sell Auto-Wheel, we give you a year's subscription FREE to the "Auto-Wheel Spokes-man," our magazine.

AUTO-WHEEL COASTER COMPANY, Inc.
NORTH TONAWANDA, N. Y.



This Wonderful Invention!

Converts any stove into a gas stove. OXO-GAS is made from kerosene and air (mostly air). Cheaper, cleaner and more efficient than coal. Eighteen different models for all purposes.

Responsible distributors wanted

GLORIA LIGHT COMPANY 137 N. May Street
CHICAGO, ILL.

AGENTS

Make \$10 to \$20 daily selling Premier Knife and Scissors Sharpeners.



200% PROFIT or more. 9 out of 10 women buy. Produces keen edge quickly. Sells for 50c.

PREMIER MFG. CO.
Dept. 29, DETROIT, MICH.

Send No Money

8-Window Pass Case, Card Case and Billfold

Be up to the minute. Carry all of your passes, lodge receipts, membership cards, loose change, bills, memos, etc., in the best-looking and most practical card case on the market.



A combination Card Case and Bill Fold made of **Genuine High Grade Leather** in a **Winston Grain**. It has eight windows for passes and membership cards, one full-size card pocket, two smaller pockets for stamps, car tickets, etc., one change pocket fastened with snap fastener and one large pocket in back for bills. All pockets are lined. Turned edges, hand tooled. Size closed, 3 1/2 x 5-8 in.

GOLD ENGRAVING FREE

We engrave your name, address (two lines) and Lodge Emblem in 23-carat gold, absolutely free. This work alone is worth \$1.50. The engraving gives the card case a very classy appearance and will be the means of identifying it if lost or stolen.

CHINESE LUCKY RING FREE

We want every one of our customers to have the best of luck and just to live things up a bit we will include with every card case sold one of these **Chinese Good Luck Rings**. A platinum ring with heavy black enameled top and enameled Chinese lettering in white, meaning "Good Luck." This ring is said to be almost infallible in its power to bring "Good Luck," Health, Wealth, and Happiness. Marvelous stories of good fortune are told by its wearers. It's the last word in Novelty Rings. It sells for \$1.50, but we give it to you absolutely free of charge when you purchase a card case.



Eight window combination card case, value \$5.00
Gold stamping, name, town, state, and lodge emblem . . . 1.50
Chinese Lucky Ring (FREE) 1.50

ALL FOR ONLY - - \$2.90
Value \$8.00
SEND NO MONEY If You Act at Once

You surely must have one of these card cases, and also the free Chinese ring. Remember, we do not ask for one penny in advance. Just fill out the coupon and pay the postman \$2.90 plus a few cents for postage when the package is delivered. We guarantee absolute satisfaction or your money refunded without question. You risk nothing. Send the coupon today.

P. M. REDINS MFG. CO., 6046 Superior Ave., Cleveland, Ohio

Send me the **Genuine Leather** combination card case shown above with my name, town, state and lodge emblem in gold engraved absolutely free. Also include a Chinese Lucky Ring free. When the package arrives I will pay the postman \$2.90 plus a few cents to cover postage. If I am not fully satisfied, I will immediately return the case and the ring and you will refund my money.

Name.....
Street No.....
City.....State.....
Emblem Wanted.....
We do not send C.O.D. outside of United States.

Hand Forged
Razor Steel
Blades, No. 57



Direct at Factory Prices

This \$2 KNIFE \$1.18 Postpaid
Hand Forged Razor Steel Blades
Handy shaped Blade makes this knife best for mechanics, sportsmen and farmers; light but strong; re-sharpened easily. Stag handle. German silver finish; blades file tested; hand forged from razor steel and warranted.

Sample \$1.18 3 for \$3.00 Postpaid.

Send for our 100-page List and "HOW TO USE A RAZOR" **FREE**

MAHER & GROSH CO., 106 A St., Toledo, Ohio



GET RID OF THIS

with no
effort at all!

Here is the easiest way in the world to rid yourself of that useless, joke-inviting, health-menacing paunch! Simply fasten on *Dr. Lawton's Automatic Waistline Reducer*—and the flabby flesh will vanish. Absolutely automatically! For men and women.

DR. LAWTON'S AUTOMATIC WAISTLINE REDUCER



Hour by hour, with every breath you take and every step you make, the *Waistline Reducer's* Vacuum Applicator massages away unwanted bulge. Made of soft, pliable, glove-like rubber. Fits snugly and comfortably to the figure. Weighs but few ounces. Flexible as a handkerchief.

SATISFACTION A SURETY

Dr. Lawton's Automatic Waistline Reducer is sold under a guarantee bond of absolute satisfaction.

Your money back if you do not like it when you get it. Write now—this minute—to Dr. Lawton for full description, convincing literature and low price. Mail the inquiry blank below now to

DR. THOMAS LAWTON

Dept. C-61, 19 W. 70th Street, New York City

Dr. Thomas Lawton, Dept. C-61, 19 W. 70th St., New York City

Dear Sir:—Send me complete description of Dr. Lawton's Automatic Waistline Reducer, convincing literature and illustrations, and tell me how low it is priced. This obligates me in no way.

NAME

STREET

TOWN..... STATE.....

VITALIC Bicycle Tires

TRADE MARK REGISTERED
Tougher Than Elephant Hide



This Palatial Florida Home

can be purchased at a very reasonable price. It is the finest estate in a community of 30,000 situated amid 5 acres of orange, grape fruit, sweet bay, palmetto and a large variety of semi-tropical trees and foliage. A water front of 400 feet, with entrance from a Boulevard, affording every modern convenience. House recently completed and never occupied. Has every modern improvement, large sun parlors, sleeping porches and 8 bath rooms. Inexhaustible supply of soft water, steam heat, high, light basement under entire house. Surf bathing all winter within 5 minutes' walk.

For full details, photographs and price address

OWNER,

200 E. Ontario St. CHICAGO, ILL.

Turn Your Ideas Into Profits

On Whether you are interested in light manufacturing, repairing or experimental work; whether you are a mechanic, engineer, amateur or student; whether you work in wood or metal, your ideas can be turned into profits with accuracy, speed and economy on

The Baby Grand Lathe

A sturdy, simple lathe of high quality at low price. Operation same as large lathes. Made of selected materials by skilled machinists who specialize on lathe building. Quantity production explains the low price. Not a toy but a practical machine for all small work. Sold direct from factory to you on positive money-back guarantee.

Write today for illustrated folder giving complete description and prices.



The Watson Mfg. Co.
103 Watson Bldg., Toledo, Ohio, U. S. A.

Get This Book BEFORE BUYING A TYPEWRITER

The Truth About Typewriters

3 DOWN BRINGS ANY TYPEWRITER FOR TEN DAYS TRIAL

We Save You Money

Big Reduction in Prices Our big book tells you how the "Young Process of Re-Manufacturing" saves you money on a Remington, Underwood, Royal, L. C. Smith, Woodstock, Noiseless, Oliver, Monarch, etc. Write for it today—it's FREE.

YOUNG TYPEWRITER CO., 654 W. Randolph St., Dept. 1103, Chicago, Ill.

NO MORE COAL DUST OR WORRY

WRITE TODAY

E. R. KNOTT MACHINE CO., 1 Ellery St., S. BOSTON, MASS.

HEAT YOUR HOUSE OR STORE with the VICTOR Furnace Oil Burner

VICTOR

Furnace Oil Burner

E. R. KNOTT MACHINE CO., 1 Ellery St., S. BOSTON, MASS.

HEAT YOUR HOUSE OR STORE with the VICTOR

Furnace Oil Burner

VICTOR

Furnace Oil Burner

E. R. KNOTT MACHINE CO., 1 Ellery St., S. BOSTON, MASS.

HEAT YOUR HOUSE OR STORE with the VICTOR

Furnace Oil Burner

VICTOR

Furnace Oil Burner

E. R. KNOTT MACHINE CO., 1 Ellery St., S. BOSTON, MASS.

HEAT YOUR HOUSE OR STORE with the VICTOR

Furnace Oil Burner

VICTOR

Furnace Oil Burner

E. R. KNOTT MACHINE CO., 1 Ellery St., S. BOSTON, MASS.

HEAT YOUR HOUSE OR STORE with the VICTOR

Furnace Oil Burner

VICTOR

Furnace Oil Burner

E. R. KNOTT MACHINE CO., 1 Ellery St., S. BOSTON, MASS.

HEAT YOUR HOUSE OR STORE with the VICTOR

Furnace Oil Burner

VICTOR

Furnace Oil Burner

E. R. KNOTT MACHINE CO., 1 Ellery St., S. BOSTON, MASS.

HEAT YOUR HOUSE OR STORE with the VICTOR

Furnace Oil Burner

VICTOR

Furnace Oil Burner

E. R. KNOTT MACHINE CO., 1 Ellery St., S. BOSTON, MASS.

HEAT YOUR HOUSE OR STORE with the VICTOR

Furnace Oil Burner

VICTOR

Furnace Oil Burner

E. R. KNOTT MACHINE CO., 1 Ellery St., S. BOSTON, MASS.

HEAT YOUR HOUSE OR STORE with the VICTOR

Furnace Oil Burner

VICTOR

Furnace Oil Burner

E. R. KNOTT MACHINE CO., 1 Ellery St., S. BOSTON, MASS.

HEAT YOUR HOUSE OR STORE with the VICTOR

Furnace Oil Burner

VICTOR

Furnace Oil Burner

E. R. KNOTT MACHINE CO., 1 Ellery St., S. BOSTON, MASS.

HEAT YOUR HOUSE OR STORE with the VICTOR

Furnace Oil Burner

VICTOR

Furnace Oil Burner

E. R. KNOTT MACHINE CO., 1 Ellery St., S. BOSTON, MASS.

HEAT YOUR HOUSE OR STORE with the VICTOR

Furnace Oil Burner

VICTOR

Furnace Oil Burner

E. R. KNOTT MACHINE CO., 1 Ellery St., S. BOSTON, MASS.

HEAT YOUR HOUSE OR STORE with the VICTOR

Furnace Oil Burner

VICTOR

Furnace Oil Burner

E. R. KNOTT MACHINE CO., 1 Ellery St., S. BOSTON, MASS.

HEAT YOUR HOUSE OR STORE with the VICTOR

Furnace Oil Burner

VICTOR

Furnace Oil Burner

E. R. KNOTT MACHINE CO., 1 Ellery St., S. BOSTON, MASS.

HEAT YOUR HOUSE OR STORE with the VICTOR

Furnace Oil Burner

VICTOR

Furnace Oil Burner

E. R. KNOTT MACHINE CO., 1 Ellery St., S. BOSTON, MASS.

HEAT YOUR HOUSE OR STORE with the VICTOR

Furnace Oil Burner

VICTOR

Furnace Oil Burner

E. R. KNOTT MACHINE CO., 1 Ellery St., S. BOSTON, MASS.

HEAT YOUR HOUSE OR STORE with the VICTOR

Furnace Oil Burner

VICTOR

Furnace Oil Burner

E. R. KNOTT MACHINE CO., 1 Ellery St., S. BOSTON, MASS.

HEAT YOUR HOUSE OR STORE with the VICTOR

Furnace Oil Burner

VICTOR

Furnace Oil Burner

E. R. KNOTT MACHINE CO., 1 Ellery St., S. BOSTON, MASS.

HEAT YOUR HOUSE OR STORE with the VICTOR

Furnace Oil Burner

VICTOR

Furnace Oil Burner

E. R. KNOTT MACHINE CO., 1 Ellery St., S. BOSTON, MASS.

HEAT YOUR HOUSE OR STORE with the VICTOR

Furnace Oil Burner

VICTOR

Furnace Oil Burner

E. R. KNOTT MACHINE CO., 1 Ellery St., S. BOSTON, MASS.

HEAT YOUR HOUSE OR STORE with the VICTOR

Furnace Oil Burner

VICTOR

Furnace Oil Burner

E. R. KNOTT MACHINE CO., 1 Ellery St., S. BOSTON, MASS.

HEAT YOUR HOUSE OR STORE with the VICTOR

Furnace Oil Burner

VICTOR

Furnace Oil Burner

E. R. KNOTT MACHINE CO., 1 Ellery St., S. BOSTON, MASS.

HEAT YOUR HOUSE OR STORE with the VICTOR

Furnace Oil Burner

VICTOR

Furnace Oil Burner

E. R. KNOTT MACHINE CO., 1 Ellery St., S. BOSTON, MASS.

HEAT YOUR HOUSE OR STORE with the VICTOR

Furnace Oil Burner

VICTOR

Furnace Oil Burner

E. R. KNOTT MACHINE CO., 1 Ellery St., S. BOSTON, MASS.

HEAT YOUR HOUSE OR STORE with the VICTOR

Furnace Oil Burner

VICTOR

Furnace Oil Burner

E. R. KNOTT MACHINE CO., 1 Ellery St., S. BOSTON, MASS.

HEAT YOUR HOUSE OR STORE with the VICTOR

Furnace Oil Burner

VICTOR

Furnace Oil Burner

E. R. KNOTT MACHINE CO., 1 Ellery St., S. BOSTON, MASS.

HEAT YOUR HOUSE OR STORE with the VICTOR

Furnace Oil Burner

VICTOR

Furnace Oil Burner

E. R. KNOTT MACHINE CO., 1 Ellery St., S. BOSTON, MASS.

HEAT YOUR HOUSE OR STORE with the VICTOR

Furnace Oil Burner

VICTOR

Furnace Oil Burner

E. R. KNOTT MACHINE CO., 1 Ellery St., S. BOSTON, MASS.

HEAT YOUR HOUSE OR STORE with the VICTOR

Furnace Oil Burner

VICTOR

Furnace Oil Burner

E. R. KNOTT MACHINE CO., 1 Ellery St., S. BOSTON, MASS.

HEAT YOUR HOUSE OR STORE with the VICTOR

Furnace Oil Burner

VICTOR

Furnace Oil Burner

E. R. KNOTT MACHINE CO., 1 Ellery St., S. BOSTON, MASS.

HEAT YOUR HOUSE OR STORE with the VICTOR

Furnace Oil Burner

VICTOR

Furnace Oil Burner

E. R. KNOTT MACHINE CO., 1 Ellery St., S. BOSTON, MASS.

HEAT YOUR HOUSE OR STORE with the VICTOR

Furnace Oil Burner

VICTOR

Furnace Oil Burner

E. R. KNOTT MACHINE CO., 1 Ellery St., S. BOSTON, MASS.

HEAT YOUR HOUSE OR STORE with the VICTOR

Furnace Oil Burner

VICTOR

Furnace Oil Burner

E. R. KNOTT MACHINE CO., 1 Ellery St., S. BOSTON, MASS.

HEAT YOUR HOUSE OR STORE with the VICTOR

Furnace Oil Burner

VICTOR

Furnace Oil Burner

E. R. KNOTT MACHINE CO., 1 Ellery St., S. BOSTON, MASS.

HEAT YOUR HOUSE OR STORE with the VICTOR

Furnace Oil Burner

VICTOR

Furnace Oil Burner

E. R. KNOTT MACHINE CO., 1 Ellery St., S. BOSTON, MASS.

HEAT YOUR HOUSE OR STORE with the VICTOR

Furnace Oil Burner

VICTOR

Furnace Oil Burner

E. R. KNOTT MACHINE CO., 1 Ellery St., S. BOSTON, MASS.

HEAT YOUR HOUSE OR STORE with the VICTOR

Furnace Oil Burner

VICTOR

Furnace Oil Burner

E. R. KNOTT MACHINE CO., 1 Ellery St., S. BOSTON, MASS.

HEAT YOUR HOUSE OR STORE with the VICTOR

Furnace Oil Burner

VICTOR

Furnace Oil Burner

E. R. KNOTT MACHINE CO., 1 Ellery St., S. BOSTON, MASS.

HEAT YOUR HOUSE OR STORE with the VICTOR

Furnace Oil Burner

VICTOR

Furnace Oil Burner

This New Way To Iron Cuts Ironing Time In Half



New Invention Ends Forever Ironing Day Drudgery

Now, once and for all, you can do away with the hardest part of ironing day. No more need you keep a roaring hot fire to do your ironing. No more need you trot back and forth from ironing board to stove. No heavy back-breaking, hot-handled flat irons to carry. No tiring, tedious, drudgery in a sweltering, smothering kitchen, but instead, you can make ironing day delightfully easy, cool and comfortable with the new **Diamond Self-Heating Iron**. You can do your ironing—all of it with one iron—in any room—out on the porch—out-doors in the shade. No wonder housewives are delighted—amazed at its convenience, and pronounce the Diamond Self-Heating Iron the greatest labor-saving invention for housewives of the age.

Beats Electricity or Gas

Cheaper to Operate No home need be without the labor-saving advantage of the Diamond Iron. Gives all the conveniences of the electric or gas iron without the danger or annoyances. Has no hose attachments to break or leak—no cords, tubes nor wires to bother with or replace. Costs only one cent to do the average weekly ironing. Retains its heat—quickly regulated to right heat for any class of ironing. Ready in a minute—simply turn a valve. Absolutely dependable. Lasts a life-time. **Guaranteed.**

What Users Say:

"I am pleased with the Diamond Self-Heating Iron. It surely saves lots of steps, and it is much more pleasant to use."
Mrs. Freeman Crippen, Mich.

"I have used the Diamond Self-Heating Iron for the past eight months, and find it saves steps, does better work in half the time."
Mrs. P. H. Danaker, Conn.

"I bought a Diamond Iron and I will say every woman should have one. I would not sell mine for \$50.00 if I could not get another one."
Mrs. Wm. J. DeShane, Mich.

FREE Trial

Special Advertising Offer

Try this Iron 30 Days FREE, use it for 4 weekly ironings without risk or obligation. See for yourself how easy ironing is done this new way. Send at once for Special Free Offer and descriptive circular—"A New Way To Iron"—tells all about this invention and how it works. Act now and you will be in time to receive special free trial advertising offer. Write today. Your name and address on a postcard will do.

THE AKRON LAMP COMPANY
33 Iron Street AKRON, OHIO, U. S. A.



AGENTS, \$1200 A Day

If you are making less than this, the position I have open in your town will interest you. Moyer, Pa., made \$164 in one week. Wonderful opportunity. New plan. Simply accept orders. Work is pleasant and dignified. No experience nor capital required. If you cannot work full time I will pay you well for your spare time. Outfit Free to workers. Exclusive territory. Address me personally—say, "Send Agent's Free Outfit Offer."
J. C. STEESE, President.

THE TIMEPIECE YOU ARE LOOKING FOR! YOUR SATISFACTION ABOVE ALL!

is guaranteed by Expert Watch Makers actually working at the bench for the past 35 years.



The movement of this watch is the product of the most skillful Swiss manufacturers; it has 15 jewels and is expertly timed and adjusted by us to give you every expected satisfaction. The case is of solid 14 Karat white gold, hand engraved platinum finish, rectangular shape. The grosgrain ribbon is fitted with a solid 14 Karat white gold clasp. The style is the latest. The price is the lowest in the market considering the quality. **only \$22.50**

Send order with remittance to:

PRECISION WATCH CO., 15 Park Row, NEW YORK CITY

WRITE FOR CATALOG OF OTHER STYLES

State Distributors Wanted AMAZING NEW INVENTION

Patented Hand Envelope Sealer. Seals 60 envelopes per minute. Absolutely no competition; retails for \$4.00. Used and endorsed by largest corporations in America. Recent shipment made to U. S. Government. Tremendous demand! Repeat business enormous! Permanent connection. Sales organizers can make \$30,000.00 yearly. Write or wire for free particulars.

CONSOLIDATED CO., Dept. TT, 100 Boylston St., Boston, Mass.

200 Sheets — 100 Envelopes

\$1.00
Postage Prepaid



High grade, clear white bond paper — unusually smooth writing surface. Size 6 x 7 inches with envelopes to match. We give you much superior quality stationery at this low price as we sell this item only. Special handy box keeps paper and envelopes in order and easily reached, preventing waste.

Your Name and Address Printed FREE

on every sheet and envelope, in rich dark blue, up to 4 lines. (Note—our low price does not allow any variation in printing. Top center of sheet and flap of envelope only.) Type is Plute Gothic, designed especially for clearness and good taste. Makes a personal stationery you will be delighted to use. An ideal gift printed with your friend's name. Just send your name and address (write or print clearly) with \$1.00 (west of Denver and outside the U. S. \$1.10) and this generous box of stationery will come to you neatly packed, postage prepaid. Money returned if you are not more than satisfied. Order today!

National Stationery Co. 1773 Lincoln Highway, Batavia, Illinois

OILANSHINE

The finest piece of shoe dressing ever put upon the market. It oils your shoes and shines them too. Oils, waterproofs, softens, preserves and gives a brilliant shine that lasts.

Send for a large trial box containing over 200 shins. Black, Brown, Oxblood or Tan. **PRICE 50c** Postpaid to any address.

The Herriott Polish Co., St. Louis, Missouri

MAKE YOUR FORD INTO THIS SPORT CAR—SAVE \$50 to \$150 WITH

Red-i-Kut Life-Size Patterns **\$6.40**

Famous **Red-i-Kut** life-size patterns and picture-fit instructions show you how you can easily convert your Ford into this Fast, Saucy, Sport Car so thousands have done, with easily obtained materials. No need to lay up this car. **LOOK AT WILFRED END'S PAL**—Evo says, "Fatal material cut with steel and paint for my Pal only \$14.31. It took me just 5 Sundays to build it and I sure am proud to hear them say, 'He built that swappy sport car.' I never cut any steel or did any woodwork before but one can't go wrong with Kuempel patterns." (Overland City, St. Louis, Mo. The "Pal" with pressed metal streamline rear,

life-size patterns for each part of the body so you can't go wrong, picture instructions and **CONICAL DISK WHEEL PATTERNS** Only \$6.40 delivered. Order now while we can make good delivery, and really enjoy these wonderful days in your "Pal," "Kees, Classy, Up-to-the-minute. You can build it. Over 11,000 in use. Don't hesitate. "Swing Lo" Underbody Irons, no frame cutting kind, only \$7.01. Send for our new manual of other distinctive sport body patterns from \$3.00 up — "RRR" Steel "Swing Lo" Irons, "Jiffy" Tops and "Gowen" Windshields. Order Right Now. Kuempel Co., 46 Kuempel Bldg., Guttenberg, Iowa

Easy-to-Understand Instructions and Tail Delivered



36-inch, Easy-riding seat

I PAY \$75⁰⁰ a Week and up
MEN

I pay men \$75.00 a week and up by my plan which I want to send you at once. Be your own boss, work where and when you like. You can do fine even without previous experience. **Biggest values—positively sell on sight.**

Profits in Advance

My plan pays biggest profits and commissions in this line, paid in advance, we attend to delivering orders and collections.

Sell *fine* Tailoring



Astonishing values get orders easy when you show samples of our tailored to order, all wool, suits and overcoats, all one price \$31.50. Our advertising helps you take orders quick.

FREE

This big, fine sample outfit furnished free, contains 100 all wool big samples, all one price \$31.50, fine colored, fashions, stationery, supplies, tape, etc. All in classy fine carrying case. Also complete sales manual, we place you in Big Money class.

\$31⁵⁰ ONE PRICE
W.Z. Gibson

W. Z. GIBSON, Inc., CHICAGO, ILLINOIS
161 West Harrison Street, Dept.

Please send me your plan for \$75 a week and up, also FREE outfit and sales manual.

Name _____

Address _____

City _____

State _____



Wrestling Book FREE

Be an expert wrestler. Learn at home by mail. Wonderful lessons prepared by world's champions Farmer Burns and Frank Gotch. Free book tells you how. Secret holds, blocks and tricks revealed. Don't delay. Be strong, healthy. Handle big men with ease. Write for free book. State your age.
Farmer Burns School, 1773 Railway Bldg., Omaha, Neb.



Tapestry or Velour

17c
a Day
Pays for this
Beautiful
Rocker

Over 1000 other bargains, Furniture, Rugs, Lamps, Silver, China, Blankets, Stoves, etc. Save big money at our Factory-to-Family prices. Pay as little as \$3 down; up to a year and a half to pay balance. Get all your Furnishings at once—pay as you use. Thousands buying this new way.



Big Catalog FREE

New Spring "Larkin Book of Better Homes." Shows everything for parlor, porch, dining-room, bedroom, kitchen. **Bargain Prices** on famous Symphonola Phonographs. Also Symphonola Pianos, Player-Pianos in genuine Mahogany, Walnut, Fumed Oak. Free trial. Up to 4 years to pay. Satisfaction or money back. Check below article interested in.



- Home Furnishings
- Pianos or Players
- Phonographs

Cut out this adv.—write TODAY for FREE Book.

Larkin Co Inc.

Dept. 339 BUFFALO, N. Y.
Peoria, Ill. Chicago, Ill.

MONEY SILVERING MIRRORS

Plating and refinishing autolights, radiators, beds, chandeliers, stoves, tableware. Outfits. Methods free.
CLARENCE SPRINKLE, Dept. 25, Marion, Indiana



FREE
Fine Tone
Musical
Instruments
\$20

We have a wonderful new copyrighted system of teaching note music by mail! To first pupils in each locality we will give free a \$20 superb Violin, Tenor Banjo, Ukulele, Hawaiian-Guitar, Banjo, Mandolin, Banjo-Ukulele, Banjo-Mandolin, Cornet or Banjo-Guitar absolutely free. Also teach Piano and Organ. Very small charge for lessons only. Four lessons will teach you several pieces. Over 100,000 successful players. We guarantee success or no charge. Complete outfit free. Write today, Dept. 167. No obligation.
SLINGERLAND SCHOOL OF MUSIC, 1815 Orchard Street, CHICAGO, ILLINOIS



CAMERAS

Over a Hundred Styles and Sizes
Send for new illustrated catalog showing latest reduced prices. It's Free.
10 days' trial given

SENECA CAMERA MFG. COMPANY
300 Central Avenue Rochester, N. Y.

Sells for \$1.25 — Agent's Sample 65c!



New
Self-Filling
Bamboo
Fountain Pen
with
Stylo Point

Imported from Japan
Hustlers Make \$20 Daily! Money refunded if you don't think it the best pen you ever wrote with. Just Out! Up to 150 per cent Profit. Send for quantity price list and distributing plans.
F. SPORS & COMPANY 332 Main Street Lesueur Center, Minnesota

5-Room \$548

ALADDIN



We Pay the Freight

You can buy all the materials for a complete home direct from the manufacturer and save four profits on the lumber, millwork, hardware and labor.

6-Room \$695

ALADDIN

Living room, dining room, 2 bedrooms, kitchen, bath, 4 other plans, some with pantries, dining alcoves, grade and inside cellar entrances. Get free Aladdin Catalog Today.



4-Room \$414

ALADDIN



Here's your opportunity to avoid high apartment rentals. Build this home yourself. Two men can build it in a week. Instructions explain every step. Five plans shown in Aladdin catalog.

Price includes all lumber cut to fit; highest grade interior woodwork, siding, flooring, windows, doors, glass, paints, hardware, nails, lath, roofing, with complete instructions and drawings. Freight paid to your station. Permanent Homes—NOT PORTABLE. Many styles to choose from. Write nearest mill today for FREE Money-Saving Aladdin Catalog No. 934.

The ALADDIN Co., BAY CITY, MICHIGAN
Wilmington, North Carolina; Portland, Ore.; Toronto, Ont.

No Ugly Wires or Nails Show

Encourage your boy to display pictures properly in his room.

MOORE PUSH-PINS

Glass Heads—Steel Points

Moore Push-less Hangers

"The Hanger with the Twist"

Won't mar the wall paper 10c pkts. Sold everywhere. In Canada 15c

MOORE PUSH-PIN CO., Philadelphia, Pa.

Taxidermy Book FREE



Mount Birds

We teach you by mail to stuff and mount all kinds of Birds, Animals, Game Heads. Also to taxidermy and make rugs. Be your own taxidermist. Decorate your home with your beautiful trophies or increase your income selling specimens and mounting for others. Easily, quickly learned in spare time by men and women. Highest endorsements by thousands of students. Write today for our great free book "How to Mount Birds and Animals" Free—write today. N. W. School of Taxidermy 9773 Elwood Bldg., Omaha, Neb.

Build This Phonograph Yourself

TREMENDOUS SAVING IN COST

Easy, fascinating work with our SIMPLIFIED PLANS. We furnish blue prints, diagrams, motor, cabinet pieces, ready-built horn, etc. You don't need to be a cabinet maker. A few hours assembling and you will have a fine instrument at one-quarter the regular retail price. AGENTS MAKE MONEY making and selling these instruments. Write today for full details and our FREE OFFER. Address

LUPERL PHONO PARTS CO.

2648 W. Chicago Ave. Dept. 11 CHICAGO, ILLINOIS



Sell Shirts

Sell Madison "Better-Made" Shirts, Pajamas, and Nightshirts direct from our factory to wearer. Nationally advertised. Easy to sell. Exclusive patterns. Exceptional values. No experience or capital required. Large steady income assured. Entirely new proposition. WRITE FOR FREE SAMPLES.

MADISON SHIRT CO., 503 B'way, N.Y. City

21 Jewel ~ Extra thin

STUDEBAKER

The Insured Watch



Direct from the Maker

New Model Extra Thin

SENT FOR

\$1.00 DOWN!

Only \$1.00! The balance in easy monthly payments. You get the famous Studebaker 21 Jewel Watch—Insured for a lifetime; a choice of 54 new Art Beauty Cases; 8 adjustments, including heat, cold, isochronism and 5 positions—direct from the maker at lowest prices ever named on equal quality. Write today for FREE BOOK of Advance Watch Styles.

Fine Chain FREE!

For a limited time we are giving away FREE with every Studebaker Watch a beautiful pattern Studebaker Watch Chain. Write now while offer lasts.

Mail Coupon for FREE Book of Advance Watch Styles

Send at once and get a copy of this book—FREE! See the newest, beautiful, advance styles in Studebaker Art Beauty Cases and Dials. Read how you can buy a 21 Jewel Studebaker Insured Watch direct from the maker—save big money—and pay for it on easy monthly payments.

Write! for our free book. It will post you on watch styles and watch values. Send coupon at once. Get Free chain offer today while it lasts.

Studebaker Watch Co.

Dept. 223 South Bend, Ind.



STUDEBAKER WATCH CO.

Dept. 223 South Bend, Indiana

Please send me your Free Book of Advance Watch Styles and particulars of your \$1.00 down offer.

Name

Address

City State

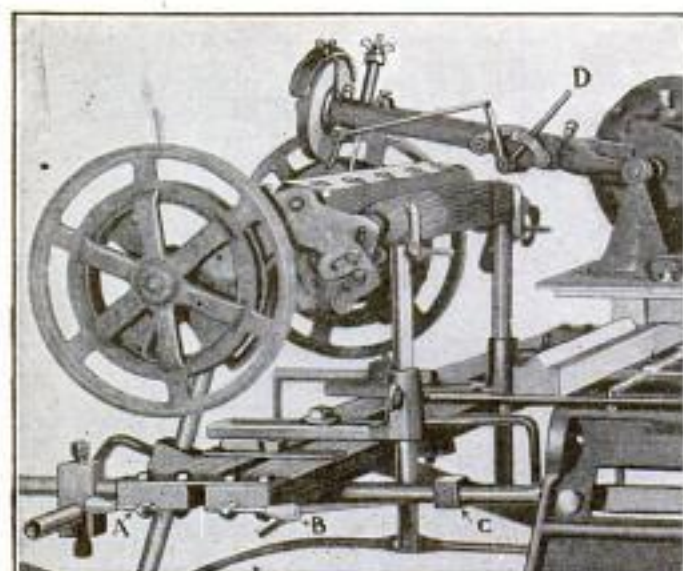

Make \$2000 Own a Business of YOUR OWN A Little Savage Grinder

will make **BIG MONEY** for you grinding Lawn Mowers, making keys, sharpening skates, tools and cutlery.

Amazing invention sharpens quickly, scientifically, accurately. Anyone can operate it. Start in your own home. Soon have a shop of your own. Hundreds have done it. "The Little Savage" handles any size reel. Track bed, 54 in., 1/4 H. P. Motor, 4 or 5 in. emery wheel. Emery wheel runs across blade—cannot groove. Sharpens both ways. No belts or chains.

Write today for our **BIG PROFIT PLAN.**

A. L. BERRY & CO., 68 W. Monroe St., Chicago, Ill.

Made by the Savage Co., Greenville, Tenn. Service Guaranteed.

MOTOR BARGAINS



Every Motor Guaranteed

1/4 H. P. A. C.

\$10.50
and
\$13.50

Every motor guaranteed O.K. If not satisfactory, you can return and your money (less return charges) will be refunded.

	Rebuilt	New
A. C. 110 Volt, 60 cycles	\$10.50	\$13.50
D. C. 110 Volt, 60 cycles	\$12.50	\$16.00



New 1/4 H. P.
110 Volt, 60 Cycles

Buffer and Grinder with base and switch	\$25.00
Without base or switch	\$20.00

NORTHWESTERN ELECTRIC CO. 408 S. Hoyne Av. CHICAGO, ILL.

Big 3-Ft. Telescope Useful and Entertaining (In Five Sections)

See people and objects miles away, on land or sea, as if they were close. Wonder Telescope gives new pleasures to home, farm, camp, travel, sport. See moon and stars as never before. Opens out over 3 feet long; measures 12 inches closed. Brass bound; has powerful lenses. **Thousands pleased!**—"Could tell color of aeroplane 4 miles away."—Mrs. Yarbrough. "Saw Provincetown Light, 23 miles away, as clear as if in front of me."—Clyde Scribner.

SEND NO MONEY

SPECIAL OFFER!
while they last

"I have been watching submarines 5 miles off the coast."—F. Grush. "Can see children playing in school yard 6 miles away."—F. H. Heron. "Read the numbers on freight cars mile away, see mountains on moon."—A. G. Palmer.

Because of a fortunate purchase from a large European manufacturer we can give you a big bargain. Be first in your neighborhood; entertain your friends. **Send no money!** send only name and address for telescope complete by parcel post. On arrival deposit with Postman only \$1.85 plus a few pennies postage. Satisfaction guaranteed or money refunded. Order today while the supply lasts.

FERRY & CO., 75 W. Van Buren St. Dept. 1773 Chicago, Ill.

ALL INSTRUMENTS AT M'AKES BAND 1/3 to 1/2 PRICE!

All famous American and imported instruments for band, orchestra or solo offered at astonishingly low prices. Hundreds of bargains in new list. **New Guarantee. 5 Days' Free Trial** and money back guaranteed.

<p>CONN "C Melody" silver plated Saxophone, gold bell, latest model, new pads, factory rebuilt, guaranteed same as new. Case, reeds, strap, pearl keys. List \$160. \$89.75 Our price.....</p>	<p>HOLTON Silver plated gold bell Cornet; in case, pearl keys. Slightly used, completely rebuilt, guaranteed new condition, perfect. \$90 list. Our price \$35.45</p>
<p>DEAGAN XYLOPHONE \$15 list, 2 1/4 octaves, slightly used, rebuilt guaranteed like new. Our \$8.55 price.....</p>	<p>SPECIAL! Brand new Brass Cornet made by most famous factory in U. S. Low pitch, pearl keys. List \$35. \$12.25</p>

WRITE TODAY! Don't waste time and money. Dixie known for 21 years as bargain headquarters. Send for latest bargain list TODAY.
Dixie Music House, Dept. 201, 320 S. Wabash Ave., Chicago

\$33 UP FARM ENGINES

Saved \$21 ordering direct from your factory says W. Price, Ind. You will save on our reliable engines. Built to do hard, heavy work. Kerosene, gasoline. Easy to start—no cranking. Sizes 1-4 to 25 H.P. 3 Months Trial. Cash, Easy Terms; 10-Year Guarantee. Free Book—"How to Know Better Engines." Write today. **THE OTTAWA MFG. CO.**
531-2 King Street, OTTAWA, KANSAS; Desk 531-2, Magee Bldg., PITTSBURGH, PA.

Ford Owner Stop that ruinous chatter on your cap. **MAKE THIS TEST**—take out your floor boards, pull your emergency brake back and forth. If you notice play at the ball joint, you need Bredar's Ball Shim. Price \$1.10. Ask your Dealer or send money order. We will ship prepaid.

NIC BREDAR'S SON MFG. CO., Rock Island, Ill.

"Wouldn't take \$10 for mine."—L. H. McKee.
"See objects miles away that seem close at hand."—A. W. Stockholder.
"I will always recommend the Wonder. I have two of them."—Anton Berkis.
"Well pleased with Wonder, send my son one for remembrance enclosed."—W. H. Baker.
"More than pleased."—J. S. George.
"Please send telescopes to two of my neighbors and 5 brothers and sisters, names enclosed."—Isaac Ridings.
"More than pleased, better than I expected."—Steve Bile.
"Live a mile from town and have such pleasure seeing things that distance."—Mrs. C. M. Campbell.



GET THIS WONDERFUL RING

IF YOU CAN TELL IT FROM A GENUINE DIAMOND SEND IT BACK
 These Amazingly CORODITE Gems match the scintillating beauty of GENUINE DIAMONDS in every way. They have the same gorgeous blazing flash and dazzling play of living rainbow fire. Standing the terrific Acid Test of direct comparison. Life time experts need all their experience to see any difference. Prove this yourself.

Make this Test Wear a Genuine CORODITE and a Diamond side by side on the same finger. If you and your friends can tell the difference send it back, you won't lose out a penny. That's fair enough. If you keep the ring, price printed here in all your day. Remember CORODITES alone have the same facet cutting as Genuine Stones.

SEND NO MONEY Keep your money right at home. Just send name, address and number of ring wanted and size as shown by slip of paper fitting end to end around finger joint and your ring will come by return mail. Drive amount shown above with postage. You do not risk a penny as our binding legal guarantee to refund your money in full is attached to every ring we sell. **SEND TODAY.**

E. RICHWINE CO., Dept. 995 19 West Jackson Blvd. CHICAGO, ILLINOIS

Sole Importers Genuine Corodite Gems



\$100 a Week

"Wouldn't you like to earn that much, too?"

"I know you would, Bob—think what it would mean to us! It worries me to see you wasting the best years of your life when you could make them count for so much.

"Can't you see it, Bob? Don't you see that the reason men get ahead is because they train themselves to do some one thing just a little better than others?"

"If the International Correspondence Schools can raise the salaries of other men, they can raise yours. If they can help other men to win advancement and more money, they can help you, too. I am sure of it.

"Don't let another year slip by and leave you right where you are to-day. Let's at least find out how the I. C. S. can help you. Let's mark and mail this coupon right now!"

INTERNATIONAL CORRESPONDENCE SCHOOLS

Box 5589-D, Scranton, Penna.

Without cost or obligation, please tell me how I can qualify for the position or in the subject before which I have marked an X:

BUSINESS TRAINING COURSES

- | | |
|---|---|
| <input type="checkbox"/> Business Management | <input type="checkbox"/> Salesmanship |
| <input type="checkbox"/> Industrial Management | <input type="checkbox"/> Advertising |
| <input type="checkbox"/> Personnel Organization | <input type="checkbox"/> Better Letters |
| <input type="checkbox"/> Traffic Management | <input type="checkbox"/> Show Card Lettering |
| <input type="checkbox"/> Business Law | <input type="checkbox"/> Stenography and Typing |
| <input type="checkbox"/> Banking and Banking Law | <input type="checkbox"/> Business English |
| <input type="checkbox"/> Accountancy (including C.P.A.) | <input type="checkbox"/> Civil Service |
| <input type="checkbox"/> Nicholson Cost Accounting | <input type="checkbox"/> Railway Mail Clerk |
| <input type="checkbox"/> Bookkeeping | <input type="checkbox"/> Commercial School Subjects |
| <input type="checkbox"/> Private Secretary | <input type="checkbox"/> High School Subjects |
| <input type="checkbox"/> Spanish | <input type="checkbox"/> Dictating |
| <input type="checkbox"/> French | <input type="checkbox"/> Cartooning |

TECHNICAL AND INDUSTRIAL COURSES

- | | |
|---|--|
| <input type="checkbox"/> Electrical Engineering | <input type="checkbox"/> Architect |
| <input type="checkbox"/> Electric Lighting | <input type="checkbox"/> Blue Print Reading |
| <input type="checkbox"/> Mechanical Engineer | <input type="checkbox"/> Contractor and Builder |
| <input type="checkbox"/> Mechanical Draftsman | <input type="checkbox"/> Architectural Draftsman |
| <input type="checkbox"/> Machine Shop Practice | <input type="checkbox"/> Concrete Builder |
| <input type="checkbox"/> Railroad Positions | <input type="checkbox"/> Structural Engineer |
| <input type="checkbox"/> Gas Engine Operation | <input type="checkbox"/> Chemistry |
| <input type="checkbox"/> Civil Engineer | <input type="checkbox"/> Automobile Work |
| <input type="checkbox"/> Surveying and Mapping | <input type="checkbox"/> Airplane Engines |
| <input type="checkbox"/> Metallurgy | <input type="checkbox"/> Navigation |
| <input type="checkbox"/> Steam Engineering | <input type="checkbox"/> Agriculture and Poultry |
| <input type="checkbox"/> Radio | <input type="checkbox"/> Mathematics |

Name.....
 Street.....
 Address.....
 City..... State.....

Occupation.....
 Persons residing in Canada should send this coupon to the International Correspondence Schools Canadian, Limited, Montreal, Canada.

A Friend and Playmate

Shomont White Collies Love Kiddies
 This one quality alone makes our Scotch Collies rare bargains. They're gentle, fearless, devoted. Have every quality a dog should have—intelligence, courage, strength. Finest shepherds, unsurpassed as watchdog, indefatigable enemies of vermin. They are the "Aces" of all dog-dom. Satisfaction guaranteed. Pairs not akin. Get our special bargain lists now.

SHOMONT KENNELS
 Box 143 Monticello, Iowa

RAISE BELGIAN HARES

New Zealand Reds—Flemish Giants—American Blues
FOR US—BIG PROFITS—WE SUPPLY STOCK AND PAY \$2 TO \$8 EACH. Also other fur bearing animals easily raised anywhere. **FREE!** Big Illustrated Rabbit Book. and copy of our large small stock catalogue 10c.

OUTDOOR ENTERPRISE CO., 1005 O. L. Bldg., Kansas City, Mo.

SQUAB BOOK FREE!

Squabs are selling at highest prices ever known. Greatest market for 20 years. Make money breeding them. No mixing feed, no night labor, no young to attend. Start small, grow big. Start now. Head how our customers sell squabs for \$12 a dozen. We have been established for 25 years. Better look into this. Let us send you, at no cost to you, our big, illustrated free book telling how to make money breeding squabs. Address:

Plymouth Rock Squab Co., 634 HSt., Melrose Highlands, Mass.

Buchstein's Fibre Limb

is soothing to your stump—strong, cool, neat, light. Easy payments. Braces for all deformities.

D. BUCHSTEIN CO.
 610 3rd Ave., So., MINNEAPOLIS, MINN.

PIMPLES

CAN BE CURED. If you suffer from pimples, acne, blackheads, brown spots or eruptions I want to send you my simple home treatment under plain wrapper. It gave me a soft, velvety, smooth and radiant complexion, and cured thousands of men and women, after everything else failed. Simply send name for generous 10 day free trial offer of my secret home treatment.

W. H. WARREN 451 Gray Bldg. KANSAS CITY, MO.



Oh Man! This Is the Life

Zowie! Give me a thousand miles of open road and an Indian Scout Motorcycle! Let me cut the wind to the merry tune of a racing engine! Let me feel the eager response of a powerful motor! Let me fill my lungs with the cool, crisp air of the pine-scented forest! That's real living—the greatest fun of earth—full of action, excitement, thrills!

New Kind of Motorcycle

Light, powerful, perfectly balanced, the Indian Scout is the favorite among red-blooded fellows everywhere. The left-hand throttle control leaves the right hand free for action and the low saddle position and perfect balance make the Indian Scout easily maneuvered at low speed. Gets away quick as a flash! Cheap to operate—goes 60 miles per gallon. Simple yet sturdy in construction—100 pounds lighter than the average motorcycle—and as comfortable as a high-priced automobile.

Your local Indian Dealer will be glad to tell you all about the Indian Scout—the greatest Motorcycle in the world, or write us for free descriptive literature and name of your nearest Indian Dealer.

Indian Motorcycles

INDIAN MOTORCYCLE CO.

Dept. P3

SPRINGFIELD, MASS., U.S.A.



INDIAN SCOUT
The New Kind of Motorcycle

Let Sousa tell You Music Success Secrets FREE

Conn instruments speed your progress—insure success. Used and endorsed by world's great artists. Exclusive features, including the famous hydraulic expansion of tubing, make Conns—easiest to play—beautiful in tone—perfect in scale—reliable in action—slide, valve or key—artistic design and finish.

Free Trial; Easy Payments. Send for your copy of "Success in Music" by Sousa and other famous musicians, and details of trial offer. All exclusive Conn features are yours at no greater cost.

C. G. CONN Ltd., 331 Conn Bldg., Elkhart, Ind.

CONN
BAND
INSTRUMENTS



64BREEDS Most Profitable chickens, ducks, turkeys and geese. Choice, pure-bred northern raised. Fowls, eggs and incubators at low prices. America's great poultry farm. At it 31 years. Valuable 100-page book and catalog free. **R. F. NEUBERT Co.,** Rt. 908, Mankato, Minn.

WEBER'S BEST laying; BEST paying chickens, ducks, geese & turkeys. Fine pure-bred quality. Fowls, Eggs, Incubators at new low prices. 42 years poultry experience, and my 100 page Catalog and Breeders' Guide Free. **W. A. Weber, Box 82, Mankato, Minn.**

GREIDER'S FINE CATALOG of fine bred poultry and incubators and brooders for 1924; choicest breeds illustrated and described; how to make hens lay, grow chicks—all facts. Low price on breeding stock and hatching eggs. 31 years in business. This book only 10c. **B. H. GREIDER, Box 19, Rheems, Pa.**

POULTRY MILLER'S AMERICAN GUIDE

—tells all about chickens—care, feeding and raising for profit. Also describes IDEAL INCUBATORS, Hot Water and Electric—IDEAL BROODERS—Coal and Oil Burning—FREE

J. W. MILLER CO., Box 12, ROCKFORD, ILL.

Raised 1025 Chicks NEVER LOST ONE—

Send Now!

—reports Mrs. N. D. Wildt, after following the simple methods outlined in Prof. T. E. Quisenberry's FREE BOOK, "Dollars and Sense in the Poultry Business". You, too, can get bigger hatches and raise all your chicks the Quisenberry Way. Tells how to feed, brood and raise chicks without loss. Hundreds of new secrets that make poultry raising more profitable than ever. No obligations. Send Today.

FREE BOOK
96 Pages

American Poultry School
Dept. 181 KANSAS CITY, MO.



Your Tires Free and \$300 a month



Agent Users Wanted

SEE how easy it is with the MASTER SALESMAN KIT, which I send Free, to make \$10 to \$25 a day in your spare time showing MELLINGER TIRES at BIG SAVING to car owners. This powerful, hand-made, oversize, non-skid Cord is guaranteed by Bond for mileage half way around the world.

The Mellinger Plan starts you in business, all or part time; no capital or experience needed. Tires shipped prepaid on approval. Lowest wholesale prices in America. **FREE** If you will boost MELLINGER TIRES, I have a surprising offer that will give you a set of tires Free. Also the MASTER SALESMAN KIT with sample sections. Be first to get my free offer, amazing confidential wholesale prices and big free book. Simply send me your name today. S. L. MELLINGER, Pres.

MELLINGER TIRE & RUBBER CO.,
\$500,000 CAPITAL. 1724 Grand Ave., Kansas City, Mo.

Why Burn Coal

or wood when you can burn gas in your stove or heater by installing a Uni-Hete Kerosene Burner (with exclusive 1924 features) in five minutes time. It gasifies common kerosene to the hottest and cheapest fuel known. Does away with dirt and high fuel cost. Heat regulated to any degree by valve. Increases stove efficiency 100%. Has brought joy and economy to thousands. **FREE TRIAL.** Saves its cost in 30 days. Write quick for full particulars and introductory price.



Special Offer to Agents

Today's fuel prices make the Uni-Hete a big money maker for agents. We have made oil heating devices for 25 years. Acorn Brass Mfg. Co., 367 Acorn Bldg., Chicago, Ill.

No Joke To Be Deaf



—Every Deaf Person Knows That

I make myself hear, after being deaf for 25 years, with my Artificial Ear Drums. I wear them day and night. They are perfectly comfortable. No one sees them. They stop head-noises. Write me and I will tell you a true story, how I became deaf and how I make you hear. Address

GEO. P. WAY, Artificial Ear Drum Co. (Inc.)
50 Hoffman Bldg., 2523 Woodward Ave., Detroit, Mich.

Write For Book About the *Elto*

3 H.P. — The Fastest "Light Twin"

Designed and built by Ole Evinrude
Weighs less than 17 lbs. per h. p.

Gives half more power, much more speed, yet easy to carry. Instant starting without spinning. Safe rudder steering. Trouble-proof carburetor. Push button reverse, without danger of tipping boat. The ideal family motor. Fits carrying case without taking apart. Write for catalog.

ELTO OUTBOARD MOTOR COMPANY

Manufacturers' Home Bldg.,
Dept. AA, Milwaukee, Wis.

1/2
More
Power—
Much
More
Speed



EARN Big Profits With HB 8 Hour Battery Service

OWN A MONEY MAKING BUSINESS Make \$1500 to \$3000 Yearly Charging Batteries

HB users everywhere, with no previous experience, are making \$150 to \$300 every month charging batteries. HB 8 Hour Battery Service pays for itself from your increased profits. Saves on current and labor, brings new trade, keeps old customers, makes your shop the leader for real battery service. With an HB you charge batteries in 8 hours that other shops take 2 or 3 days to handle. An HB costs less to operate, handles 1/2 more work than any other outfit of similar rating.

Only \$20 Monthly Pays for Your HB 8-Hour Battery Charger

Small Cash payment puts an HB 8 Hour Battery Charger in your shop, complete, ready to operate, with no extras to buy. Easy \$20 monthly payments let your outfit pay for itself out of your monthly profits with nice surplus besides. Every HB is built complete in our shops. Big production and direct selling let us save you \$35 to \$115 on purchase price alone on an HB over other outfits.

More
HB 8 Hour
Battery Chargers
are in use than
any other
Make

30 Days' FREE Trial On Money-Back Guarantee

No obligation whatever on your part. Order your HB outfit on trial and use it 30 days. If it does not fulfill every claim we make—cut charging costs, bring new business, increase profits, and give more complete satisfaction than any other equipment—you return it, and we will refund every cent you have paid us. Our positive guarantee of satisfaction-or-money-back gives you complete protection. Don't let your opportunity slip. Order your HB outfit NOW, on trial, and prove these facts for yourself. Make your own tests at our risk. Send this coupon with your letterhead or your name and address for full information.

Hobart Bros. Co., Box M 303
Troy, Ohio

Use this Handy COUPON

Hobart Bros. Co., Box M 303, Troy, O.
Send me Bulletin No. 321

Name.....

Address.....

ONLY \$2⁰⁰ DOWN
10 MONTHS TO PAY
\$48⁰⁰ NO RED TAPE
10 DAYS TRIAL



Just send \$2.00 deposit to show your good faith (or pay postman \$2.00 on delivery) and we will send either of these beautiful, latest style diamond rings. If satisfied after trial, pay only \$4.80 a month for only ten months.

SET WITH BLUE SAPPHIRES

Ring A has two deep blue sapphires set in the shanks that attractively set off the blue-white diamond in the center. Ring B (without sapphires) is hand engraved in the latest style basket design. Both rings are 18 Kt. solid white gold and hand pierced. Order one today.

ORDER ON FREE TRIAL

Compare either of these handsome diamond rings with any \$75.00 diamond. We will give you a written guarantee that every penny you paid will be returned, if you are not satisfied and return the ring within the ten days' trial.

Write for BARGAIN CATALOG

It brings our large jewelry store right into your home. Compare our prices! \$1,000,000 Stock. EASY TERMS.

STERLING DIAMOND & WATCH CO.

(Diamond Importers—Established 1879)
 Dept. 1501, 63 PARK ROW, NEW YORK, N. Y.



"A RIVER LANDSCAPE"
 BOUDOIR LAMP
 No. 99-3114

This Beautiful \$4⁹⁵ Boudoir Lamp

Hand painted shade. Base finished in old ivory or bronze.

A LAMP that will add to the distinction and loveliness of your bedroom.

Per Pair \$9.50

Satisfaction Guaranteed

J. M. FLETCHER

66-12th St., Wellsburg, W. Va.

Deformities of the Back

Thousands of Remarkable Cases



An old lady, 72 years of age, who suffered for many years and was absolutely helpless, found relief. A man who was helpless, unable to rise from his chair, was riding horseback and playing tennis within a year. A little child, paralyzed, was playing about the house after wearing a Philo Burt Appliance three weeks. We have successfully

treated more than 50,000 cases in over 20 years.

30 Days' Trial Free

We will prove its value in your own case. There is no reason why you should not accept our offer. The photographs show how light, cool, elastic and easily adjusted the Philo Burt Appliance is—how different from the old torturous plaster, leather or steel jackets.

Every sufferer with a weakened or deformed spine owes it to himself to investigate thoroughly. Price within reach of all.

Send For Our Free Book.

If you will describe the case it will aid us in giving you definite information at once.

PHILO BURT MFG. CO.

53-14 Odd Fellows Temple
 JAMESTOWN, N. Y.



Deafness



Perfect hearing is now being restored in every condition of deafness or defective hearing from causes such as

Relaxed or Sunken Drums, Roaring or Hissing Sounds, Perforated, Partially Destroyed Drums, etc.

Wilson Common Sense Ear Drums

"Little Wireless Phones for the Ears"—require no medicine but effectively replace what is lacking or defective in the natural drums. They are simple devices, which the wearer easily fits into the ears where they are invisible. Soft, safe and comfortable to wear at all times.

Write today for our 168 page FREE book on DEAFNESS giving you full particulars and plenty of testimonials.

WILSON EAR DRUM CO., Incorporated
 729 Inter-Southern Building LOUISVILLE, KY.

NO MORE BALD HEADS



WHEN our VACUUM CAP is used a few minutes daily. We accept no pay until you have tried the Cap 30 days and are satisfied. The Vacuum Cap is an appliance that draws the blood to the Hair Roots and starts a new healthy crop of hair. It stops Dandruff, stops the hair from falling out.

Bought by Doctors and men who know that it is the only reasonable HAIR GROWER known to science. No Drugs Used. Write for application blank, testimonials, and booklet on "HAIR," sent sealed in plain envelope, FREE.

THE MODERN VACUUM CAP CO.

T 559 BARCLAY, DENVER, COLO.

Swear Off Tobacco

Tobacco Habit Banished Let Us Help You

Quick Results

Trying to quit the tobacco habit unaided is often a losing fight against heavy odds, and may mean a serious shock to your nervous system. So don't try it! Make the tobacco habit quit you. It will quit you if you will just take **Tobacco Redeemer** according to directions.

It doesn't make a particle of difference whether you've been a user of tobacco for a single month or 50 years, or how much you use, or in what form you use it. Whether you smoke cigars, cigarettes, pipe, chew plug or fine cut or use snuff—**Tobacco Redeemer** will positively remove all craving for tobacco in any form in a few days. Your tobacco craving will usually begin to decrease after the very first dose—there's no long waiting for results.

Tobacco Redeemer contains no habit-forming drugs of any kind and is marvelously quick, scientific and thoroughly reliable.

Not a Substitute

Tobacco Redeemer is in no sense a substitute for tobacco, but is a radical, efficient treatment. After finishing the treatment you have absolutely no desire to use tobacco again or to continue the use of the remedy. It helps to quiet the nerves, and will make you feel better in every way. If you really want to quit the tobacco habit—get rid of it so completely that when you see others using it, it will not awaken the slightest desire in you—you should at once begin a course of **Tobacco Redeemer** treatment for the habit.

Results Absolutely Guaranteed

A single trial will convince the most skeptical. Our legal, binding, money-back guarantee goes with each full treatment. If **Tobacco Redeemer** fails to banish the tobacco habit when taken according to the plain and easy directions, your money will be cheerfully refunded upon demand.

Let Us Send You Convincing Proof

If you are a slave of the tobacco habit and want to find a sure, quick way of quitting "for keeps" you owe it to yourself and to your family to mail the coupon below or send your name and address on a postal and receive our free booklet on the deadly effect of tobacco on the human system, and positive proof that **Tobacco Redeemer** will quickly free you from the habit.

Newell Pharmacal Company
Dept. 300 St. Louis, Mo.

Free Book Coupon

NEWELL PHARMACAL CO.,
Dept. 300 St. Louis, Mo.

Please send, without obligating me in any way, your free booklet regarding the tobacco habit and proof that **Tobacco Redeemer** will positively free me from the tobacco habit or my money will be refunded.

Name.....

Street and No.....

Town..... State.....



Tobacco Tells on
Nervous System



Tobacco Ruins
Digestion



Tobacco Stunts
Boy's Growth



Tobacco Robs
Man of Vitality



Tobacco Steals
from You the
Pleasures, Com-
forts, Luxuries
of Life





LUMINOUS PAINT

Make Your Watches, Clocks, Etc., Visible by Night

The very latest discovery in the scientific world, hitherto, practically unobtainable except at an exorbitant price, we have at last succeeded in producing this remarkable LUMINOUS PAINT, which, applied to the surface of any article, emits rays of white light, rendering it perfectly visible in the dark. THE DARKER THE NIGHT, THE MORE BRILLIANT IT SHINES. Quite simple to use. Anyone—you can do it. A little applied to the dial of your watch or clock will enable you to tell the time by night. You can coat the push buttons or switch plates of your electric lights, match boxes, and innumerable other articles; make your own Luminous Crucifixes, Luminous Rosaries, etc. Small bottle, price 25c. Larger sizes, 50c and \$1 postpaid.

Serpent's Eggs

Box contains 12 eggs. When lit with a match, each one gradually hatches itself into a snake several feet long, which curls and twists in a most life-like manner. Price per box, 10c postpaid, 3 for 25c.



Potmend

Mends Ironware, crockery, woodware, marble, etc. Comes in powdered form. Just mix with water and apply. HARDENS LIKE IRON. Mends a big hole or a small crack. PRICE 15c, 3 for 40c, postpaid.

stoves, broken china, porcelain, brass-brass, crockery, woodware, marble, etc. Comes in powdered form. Just mix with water and apply. HARDENS LIKE IRON. Mends a big hole or a small crack. PRICE 15c, 3 for 40c, postpaid.

Midget Bible

GREAT CURIOSITY Smallest Bible in the World. Size of a postage stamp. 200 Pages. Said to bring good luck to the owner. A genuine work of art. Must be seen to be appreciated. Make good money selling them to friends, church acquaintances, etc. PRICE 15c each, 3 for 40c, 12 for \$1.35, 100 for \$7.50.



STAGE MONEY

With a bunch of these bills, it is easy for each person of limited means to appear prosperous by flashing a roll of these bills at the proper time and peeling off a genuine bill or two from the outside of the roll, the effect created will be found to be all that can be desired. Prices, postpaid: 15 Bills 10c, 50 Bills 25c, 125 for 50c, or \$3.50 thousand.

Wonderful X-Ray Tube

A wonderful little instrument producing optical illusions both surprising and startling. With it you can see what is apparently the boxes of your fingers, the lead in a lead pencil, the interior opening in a pipe stem, and many other similar illusions. A mystery that no one has been able to satisfactorily explain. Price 10c, 3 for 25c, 1 dozen 75c. Johnson Smith & Co.



Good Luck Ring
Quaint and Novel Design

A VERY striking and uncommon ring. Silver finish, skull and crossbones design, with two brilliant, flashing gems sparkling out of the center. Said by many to bring Good Luck to the wearer, hence its name. Good Luck Ring. Very unique ring that you will take a pride in wearing. ONLY 25 CENTS.

The Dying Pig



The most laughable novelty yet produced. Made of rubber, and you have only to blow it up and stand it on its four feet, when he begins to squeal as he slowly collapses and finally lies down and dies in the most natural manner. You can blow him up as often as desired, and each time he will go through the same performance to the great amusement and delight of your friends. Price, 15 cents; 3 for 40 cents, one dozen \$1.35, mailed.

Popular Watch Charms

ONLY 15c
3 for 40c; \$1.35 doz.

Very pretty little curiosities and decidedly novel. Fitted with Magnifying Lenses that enlarge the pictures to a very surprising degree; in fact, it seems almost incredible that a clear picture could be possible in such a small compass, and how sharp and distinct they show up when you look through. Comes in assorted views—Actresses, views of Panama Canal, Lord's Prayer in type, etc.

Mystic Skeleton

A jointed figure of a skeleton 14 in. in height, will dance to music and perform various gyrations and movements while the operator may be some distance from it. 10c & pd.

NEW BOOK ON ROPE SPLICING

Useful Knots, Hitches, Splices, etc. A most practical handbook giving complete and simple directions for making all the most useful knots, hitches, rigging, splices, etc. Over 100 illustrations. All about wire rope attachments, lashing, blocks, tackles, etc. 37 Illustrations. Illustrated. Of great value to mechanics, riggers, carpenters, boatmen. Price 20c post.

MAGIC FLUTE

Wonderfully Sweet Toned and Musical
The Magic Flute, or Humanator, is a unique and novel musical instrument that is played with nose and mouth combined. There is just a little knack in playing it which, when once acquired after a little practice will enable you to produce very sweet music that somewhat resembles a flute. There is no fingering, and once you have mastered it you can play all kinds of music with facility and ease. When played as an accompaniment to a piano or any other musical instrument, the effect is so charming as it is surprising.

BLANK CARTRIDGE PISTOL

Protection against Burglars, Tramps & Dogs
Prices 50c \$1.00 Post-paid



Well made and effective; modeled on latest type of Revolver; appearance alone is enough to scare a burglar. When loaded it may be as effective as a real revolver without danger to life. It takes standard 22 Cal. Blank Cartridges obtainable everywhere. Price 50c, superior quality \$1.00 post-paid. Blank Cartridges, by express, 50c per 100. Johnson Smith & Co., Dept. 73, Racine, Wis.

DANCING BEAUTIES

Get a Kinetograph and see the picture move. Franco's latest sensation. A great surprise. Is worth twice what they cost. Are made of solid brass, highly nickel and very durable. Satisfactory or your money back. Price..... 50c
Johnson Smith & Co., Dept. 73, Racine, Wis.

BOYS! BOYS! BOYS!

THROW YOUR VOICE

Into a trunk, under the bed or anywhere. Lots of fun fooling the teacher, policeman or friends.

THE VENTRILO

a little instrument, fits in the mouth out of sight, used with above for Bird Calls, etc. Anyone can use it. Never Fails. A 32 page book on ventriloquism, the Ventrillo, ALL FOR 10 CENTS

1000 Silk Remnants

for patching Crazy Quilts, Sofa Cushions, Head Rests, Pin Pads etc. Large pieces, all colors and shades. Sure to delight you. For 10 Cents stamps, we send a large package and Book of quilt designs. 8 packages 25c. 1 pound makes a lovely large quilt. Price 75c postpaid. Our silk is the best. JOHNSON SMITH & CO., Dept. 73, RACINE, WIS.

LOOK 35c LOOK

Wonderful Instrument. Greatest thing yet. Nine separate articles in one. Everybody delighted with it. Odd, curious and interesting. Lots of pleasure as well as very useful. It is a double Microscope for examining the wonders of nature. It is also an Opera Glass, a Stereoscope, a Burning Lens, a Reading Glass, a Telescope, a Compass, a Pocket Mirror, and a Laryngoscope—for examining eye, ear, nose and throat. It is worth all the cost to locate even one painful cinder in the eye. Folds flat and fits the pocket. Something great—you need one. Don't miss it. Sent by mail, with 356 page Novelty Catalog. Only 35c or 3 for \$1.00

Resurrection Plant

One of the most wonderful plants known. Possesses the strange power of turning in a few minutes from an apparently lifeless, dry herb to a beautiful living fernlike plant of a dark green color. Simply place the plant in saucer of water, it will open up and start to grow in 20 minutes. When taken out it will dry up and go to sleep until placed in water again. Fine house plant—summer or winter. 10 cents each or 3 for 25c, post paid. AGENTS WANTED JOHNSON SMITH & CO., Dept. 73, RACINE, WIS.

Address orders for all goods on this page to
JOHNSON SMITH & CO.
Dept. 73 RACINE, WIS.
Our large catalog (356 Pages) of all the newest and best novelties, unobtainable elsewhere, free with every order.

\$100 A WEEK AND MORE with This Amazing Device

Does away with dirty coal and wood. Makes any range a gas stove in 15 minutes. 16 models for furnaces, stoves and ranges. Read what others have done.

IN spare time only, our agents everywhere are cleaning up \$25 a day. There is no limit to what you can make—only one order a day means \$75 a week. All over the country this amazing invention is doing away with old fashioned dirty and expensive methods of heating. Our men say it.

Sells Itself

Think of the appeal you can make in every home. It does away with ashes, soot, dirt and smoke—carrying and lifting coal and wood. It gives more heat than coal and combines a large amount of air with a small quantity of oil. Solves the fuel problem. Cuts house-

work in half. Protects health. Makes any range, heater or furnace a real gas stove—much or little heat when and as you want it by simply turning a valve. Absolutely safe—lasts a lifetime.

15 MINUTES TO DEMONSTRATE

You can slip this wonderful device in any stove, without changes, in 15 minutes. Show any woman what it will do in her own stove and the sale is made. \$12 in 15 minutes.

FREE SAMPLE CASE OFFER

We will show you how to clean up. Start at once, spare or full time. Exclusive territories. Real co-operation. Some Oliver agents make as high as \$1,000 a month. By writing at once you will be entitled to a Free Sample Case Offer.



\$215 IN ONE DAY
F. W. Bentley of Phila. says, "Ye Gods—some relief! I made \$215 today!"

\$60 A MONTH
"Have averaged \$60 profit a month for last six months."—A. M. Russell, Conn.

\$1000 IN 4 WEEKS
"Am making \$1000 per month. I have made big money before, but did not expect so much. Your burner is just the thing."—J. Carnegie, S. Dak.

BUYS A CAR WITH PROFIT

"Have earned enough in one month to buy me a new auto."—S. W. Knapp, Col.

OLIVER OIL-GAS BURNER

Oliver Oil-Gas Burner Company, C-56 Oliver Bldg., St. Louis, Mo.
Canadian Distributors, C-56 Oliver Bldg., Toronto, Ont.

Oldest and Largest Mfrs. of Oil-Gas Burners in the World

OLIVER OIL-GAS BURNER COMPANY

C-56 Oliver Bldg., ST. LOUIS, MO.

Send me immediately complete details of your Free Sample Case and Exclusive Territory Offers. I am not obligated.

Name.....

Address..... Co.....

City..... State.....

Secret Service



This liquid quickly searches out and permanently mends all leaks in auto cooling systems. Kept in the water, it will prevent leaks as soon as they appear. Alcohol in the water does not affect it.

GUARANTEED

not to clog or harm the water system in any way. Will give entire satisfaction or your money back. 50c and 75c, at auto-supply and hardware stores.

Write for "Secret Service," a free booklet.

The Buffalo Specialty Company
357 Ellicott St. BUFFALO, N. Y.

RADIATOR NEVERLEAK

Buffalo Specialty Co. Buffalo, N. Y.

The LIQUID WEAVER People



New! Perfected Headlight Control

Day Comfort for Night Driving

At last a new wonderful invention that gives you ALL the light but NO glare. Lillis Light Shield illumines the highway ahead and the ditch on the right perfectly and with no glare whatsoever.

New, Comfort, Safety, Convenience, Beauty

The shield can be dropped instantly, operates from steering wheel. A remarkable new invention, taking the trade by storm. Every car should have it. One size, adjustable to all cars, installed in a few minutes.

Distributing Agents

Our sales plan opens an unusual big money making opportunity for you no matter what line you are in. You can make from \$100.00 to \$500.00 a week and more with ordinary sales efforts. No competition. Profits 125% to 200%. Sell consumers, dealers and have agents of your own. It sells for \$4.48. Single sample \$2.50 postpaid to prospective agents only. Quick action necessary. Write, wire or phone.

Detroit Lillis Engineering Company
908 P. Kresge Bldg. Detroit, Mich.

**Sell
Style
Arch
Shoes**

\$2.00 Per Hour

Two dollars per hour is little for even an inexperienced Style-Arch salesman to earn—it's so easy to sell Style-Arch shoes direct to wearer. Our salesmen make \$5 to \$25 a day, \$6,000 a year, and more. You too can get into the big money class.

Fast Sellers

Smartest styles and below-retail prices, plus exclusive steel arch support feature, bring immediate and repeat orders. *We supply handsome carrying case and actual shoe samples.*

Get into this big-paying business. Apply quick for selling outfit and particulars.

STYLE-ARCH SHOE COMPANY
Dept. PM-1 Cincinnati, Ohio



ONE-CAR SIZE
FRE-RENT GARAGE
\$106⁰⁰
COMPLETE

SAVE GARAGE RENT

All complete—doors, windows and even paint. All wood. Just bolt together the 10 sections and drive in your car. Easily portable. 11 sizes. Two-car size as pictured above only \$200.00. Write for booklet.

FRE-RENT GARAGE COMPANY
447 Walden Ave. Buffalo, N. Y.

Be Independent!

Own a Grape Fruit and Orange grove—Truck or Poultry Farm. Increase your Income. You can start a grove today under our new plan and have a Home and Income in Sunny Florida on the easiest terms imaginable. Any size Farm. Groves developed for Non-Residents. We raise our own guaranteed Citrus Trees in our own Nurseries. We have the Right Land—in the Right Location—at the Right Price, and on the easiest terms. Write for Book "The Call of the Southland"—It's Free.

NORTH TAMPA LAND CO., 404 Zack St., Dept. 3-24, Tampa, Fla.

TIRES WITH 500 NAIL HOLES LEAK NO AIR

A new puncture-proof inner tube has been invented by a Mr. M. G. Milburn of Chicago. In actual test it was punctured 500 times without the loss of air. This wonderful new tube increases mileage from 10,000 to 12,000 miles, eliminates changing tires, and makes riding a real pleasure. It costs no more than the ordinary tube. Mr. M. G. Milburn, 331 West 47th St., Chicago, wants them introduced everywhere and is making a special offer to agents. Write him today. See our advertisement on page 187 February issue.



10 A DAY Selling Shirts

Yes—it is easy selling Packard Shirts of Quality. Individual patterns and remarkable values. Direct from our own modern factory. Big demand. Steady increasing repeat business. No capital or experience required. We furnish everything, including FREE Sample Case. Be first. Packard Shirt Co. Dept. 116 808 W. North Ave., CHICAGO

PLANS for Poultry Houses

All styles, 150 illustrations, secret of getting winter eggs, and copy of "The Full Egg Basket." Send 25 cents. INLAND POULTRY JOURNAL, Dept. 74 Indianapolis, Ind.

Our BUREAU OF INFORMATION will answer all questions regarding articles appearing in this magazine. Address Bureau of Information, Popular Mechanics Magazine, Chicago.

POPULAR MECHANICS SHOP NOTES BOOK FOR 1924 IS READY

Send for your copy today. Like its predecessors, this volume is packed full of **Easy Ways to Do Hard Things** that are of daily use to every mechanic. The entire collection of 550 Shop Notes articles that appeared in Popular Mechanics Magazine during the past year is now offered to you in this one handy volume, conveniently indexed. **50c Postpaid Bigger and Better than Ever** 248 Pages—455 Illustrations. If you have at hand for quick reference a set of Shop Notes consisting of 15 volumes previously issued, you will seldom, if ever, **GET STUCK ON A JOB.** You cannot afford to be without these helpful books any longer. The several thousand time and labor-saving kinks will save you the price of 50 cents a volume many times over. Make this a red-letter day of preparation for increased efficiency by mailing us your order for a set of the books.

POPULAR MECHANICS BOOK DEPARTMENT, 200 East Ontario Street, CHICAGO



Dhassi Will Tell You FREE

Do You Know Are You Lucky?

Under which zodiac sign you were born? What significance it has in shaping your life?

IN LOVE
MARRIAGE
FRIENDS
INHERITANCE
SUCCESS

Send Birth Date

I have made Astrology my life's work and offer the most interesting astrological interpretations of the Zodiac sign under which you were born. Send exact name, address and exact date of birth in own handwriting and receive your astrological interpretation in plain sealed envelope, post paid. A great surprise awaits you. Enclose 12c to cover cost of this notice and mailing. Address me personally DHASSI.

TARA STUDIO, 1133 Broadway, Desk 44, NEW YORK

Don't forget
your pliers*



Take a pair of Bernards (No. 102) to the office. You will find them of constant use for repairing typewriters, desks, straightening telephone wires, cutting wire and doing the countless little jobs for which fingers are inadequate. Be sure you get

* BERNARD

Standard High-Power Cutting
PLIERS



No. 130—Bernard "Wunaxion" Eyelet Punches

Catalog "P" free
on request from

WM. SCHOLLHORN CO., New Haven, Conn.

Health-Vigor
SUCCESS

By means of Marvelous

VIOLET RAYS

Use it Yourself at Home

This wonderful FREE book describes the marvelous strange new force, simply tells how Violet Rays revitalizes every cell and works apparent miracles in overcoming pain and sickness. Pleasant to use in your home.

Physicians and plain home folks explain how Violet Rays has made them well, strong and happy. 60 pages, illustrated, actual photographs, scientific charts and diagrams. It's FREE.

QUICK RESULTS—No Medicine

Violet Rays work quickly, you feel results at once, it's scientific, goes after the cause. That's why results are quick and permanent. Dr. Duncan, Kewanee, Ill., writes, "Violet Rays is the finest thing I ever used . . . to relieve pain, treatments are so pleasant all my patients like it." Use it yourself at home, save Doctor's bills. See list of ailments Violet Rays treats successfully, and many others, not space to list. Success depends on health, this book shows the way.

Beauty Aid Send For FREE BOOK

Brings natural magnetic beauty of health, no dieting, exercise or drugs.

Earn Cash

Men, women without experience earn liberal profits in spare time showing Violet Rays to neighbors. Proves results first demonstration, sells on sight. Get attractive offer and wholesale prices now.

Explains how Nikola Tesla discovered Violet Rays, how it works, why it heals. Tells what doctors and plain folks accomplish in conquering pain, disease and nervous troubles with Violet Rays.

REVEALS MARVELOUS SCIENTIFIC DISCOVERY

Shows charts of human body, explains where pains start, how to banish them. Offered FREE for a limited time only, to introduce Violet Rays. Send for FREE copy.

VI-REX COMPANY, 211 SO. PEORIA ST. Dept. 23, CHICAGO



Pleasure
and
Profit
With a
"KING"
Saxophone



IT'S so easy to learn to play the famous KING saxophone! A few weeks' practice and you can play popular music—then join a band or orchestra and make good money playing for dances and other entertainments.

"KING" Band Instruments and Saxophones are easiest to play because they are built acoustically correct. Scientific design, finest skilled workmanship, careful supervision at each phase of construction make "KINGS" the most perfect instruments in the world. The tone quality is impossible to duplicate. Leading bands and orchestras insist upon "KINGS." Let us send you one for 10 days' free trial.

Free Trial—Easy Payments

"KING" Band Instruments and Saxophones are fully described in beautifully illustrated circulars. Write today for complete information about our ten days' free trial and our easy payment plan on any instrument. Ask for bargains in rebuilt instruments; old ones taken in trade.

THE H. N. WHITE COMPANY
5211-49 Superior Avenue
Cleveland, Ohio

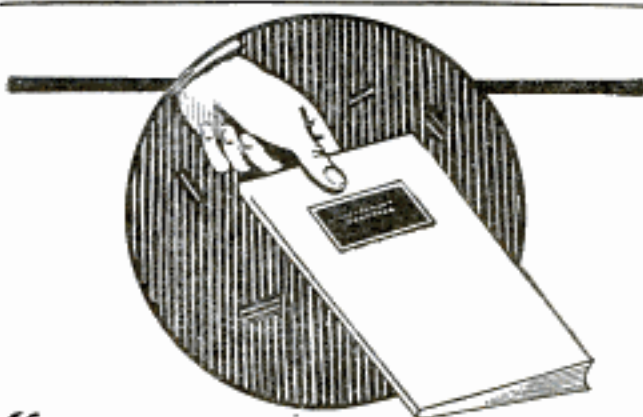

"How to Select Safe Bonds"

A coupon is appended below for the convenience of every interested investor in sending for our booklet, "How To Select Safe Bonds." It tells how you can make your investments pay an attractive yield (ranging as high as 7%) with absolute safety.

COUPON BRINGS YOUR COPY

In every banking circle the name of Geo. M. Forman & Company has always been associated with sound investments. This house has been in business for 39 years without loss to a customer. Mail coupon for your copy of this interesting book.

GEORGE M. FORMAN & COMPANY

Dept. 443 105 West Monroe Street CHICAGO, ILL.
GEORGE M. FORMAN & COMPANY, Dept. 443, 105 West Monroe Street, Chicago, Ill.

GENTLEMEN:—Please send me at once your booklet, "How To Select Safe Bonds."

Name.....

Address.....

JAPANESE ROSE BUSHES

The Wonder of the World

Japanese Rose Bushes bloom all the year round. Just think of it. Six weeks after planting the seed, the plants will be in full bloom. It may not seem possible, but we positively guarantee it to be so. They will bloom every ten weeks, Summer or Winter, and when three years old the bush will be a mass of roses, bearing from five hundred to a thousand roses on each bush. The flowers are in three shades—white, pink, and crimson. The plants will do well both in and out doors. We guarantee at least three bushes to grow from each packet of seed. Price, 10c packet, 3 pkts. for 25c postpaid.

Chinese Fragrant Tree Fern

Just introduced; noted for its rapid growth. An exceptionally pretty ornamental plant. Foliage is rich dark green. Forms grand pyramidal bushes about 5 feet high. Branches very desirable for decorative purposes, wreaths, etc. Seeds 15c pkt., 3 for 40c.

Weather Plant

NATURE'S WEATHER PROPHECY By mysterious changes that take place, this remarkable plant accurately forecasts the weather many hours in advance. Will grow anywhere all the year around. An interesting house plant. Bears large, fragrant, pink, butterfly shape flowers. Seeds, 15c packet, 3 for 40c, postpaid

GROUND ALMONDS

Amazingly Prolific—Easily Grown From Seed The Ground Almond has a flavor that is MOST EXCELLENT, resembling the cocoanut. The meat is snow white, covered with a shell or skin of brown color. It grows close to the surface and anything from 200 to 300 Almonds may be expected from a single nut. There is no trouble whatever in growing anywhere and in any kind of soil. May be planted any time, and in eight or ten weeks from time of planting you will have an ENORMOUS CROP of the MOST DELICIOUS ALMONDS YOU EVER TASTED. Seeds 15c Pkt.



Perfume Plant

Blooms only at night, giving forth the most delightful scented fragrance for quite a distance. Capes much comment. For house or garden. Also valuable because of rare perfume made from it. SEEDS, 10c pkt., 3 for 25c.

SENSITIVE PLANT

Marvel of the Philippines. Leaves curl, fronds droop when touched. Apparently resents interference. A handsome shrub for house or garden; very curious and interesting. Seeds, 15c pkt., 3 for 40c.

Calabash or Pipe Gourds

A luxuriant and rapid growing climber; thrives anywhere. Produces the ornamental gourds from which the famous African calabash pipes are made. Grow this interesting vine and make your own. Seeds, with instructions, 15c pkt., 3 for 40c.

Japanese Nest Egg Gourd

Very curious. Produces fruit same size as a hen's egg and color of nest eggs. Matured fruit does not crack. Will serve for years as a nest egg, stocking dispenser, ornamental purposes, etc. Seeds 15c pkt., 3 pkts. for 40c.

Mammoth Peanuts

Peanuts can be easily cultivated. Their culture is very simple and exceedingly interesting. Mammoth Peanuts grow to an astonishing size. It is a good producer, very prolific, and the giant nuts have a thick, heavily ribbed protecting shell. The plant is very attractive, the leaves being of odd shape and a handsome green shade, tinted through the center with white. You will derive much pleasure cultivating this interesting species. Seeds 15c pkt., 3 pkts. for 40c.

Shoo Fly Plant

A very remarkable botanical curiosity you should have. Though quite odorless, flies will not remain in a room where it is grown. Bears very pretty blossoms; blooms summer and winter. Grows rapidly from seed. SEEDS 15c packet, 3 for 40c, postpaid.

Japanese Climbing Cucumber

Unusually strong and vigorous growing vine. Attains twice the size of ordinary varieties. Grows readily on fences, poles, trellises, etc. One hill will keep an entire family supplied all summer. Seeds 10c, 3 pkts. for 25c.

Gigantic Butter Beans

The New Edible Vegetable Wonder Grows to an astonishing size, the Beans measuring from 3 to 6 feet long, and weighing anything from 10 to 16 lbs. and even more. One Bean is sufficient for a family for several meals. Very palatable and rich in nutritious materials. The delicate Buttery Flavor is much appreciated. The Vines are easily grown, very prolific, and a most welcome and valuable adjunct to your garden. Try them; you will find them the most delicious vegetable you have ever tasted. Imported direct. Unobtainable elsewhere. Sample packets of seeds with full directions for cultivating and cooking. 25c, postpaid.

A Few Other Seed Novelties You Should Cultivate—10c Pkt.

- Japanese Kudzu Vine
 - Jack and Beanstalk
 - Chinese Balloon Flower
 - Purple Feather Grass (Ornamental)
 - Curious Ferns (grown from seed)
 - Bird of Paradise Flower
 - Nitto's Plant & Flower Food
 - Japanese Hop Vine
 - Camellia Plant
 - Ornamental Cotton
 - Job's Tears (Great curiosity)
 - Cathedral Bells
 - "Tiger" Flower
 - Snake Cucumber
 - White Velvet Okra
 - Emerald Isle Kale
 - Passion Flower Vine
 - Pachira
 - Ornamental Gourds
 - Bougainvillea, or Red Cluster
 - Pepper
 - Salsify, or Oyster Plant
 - White Velvet Okra
- White Velvet Okra changes ill-nourished plants into luxuriant beauties, producing masses of blooms that will equal any. Causes plants to bloom early and ahead of others. Friends marvel at success. Brings out New Foliage and Flowers, and causes a Marvelous Transformation. Pkts. 15c 3 for 40c.

THE REMARKABLE FIREFLY PLANT

A Vine that Blooms at Night Fills the Atmosphere with Fragrant Aroma One of the most rapid growing vines known. Under favorable conditions this vine has been known to grow OVER 25 FEET IN A SINGLE WEEK. In a very short space of time indeed the Vine has climbed to a great height, and is covered with IMMENSE FLOWERS, from 5 to 7 inches in diameter. It is, indeed, a great novelty for unlike other plants, the flowers OPEN IN THE EVENING, and remain open until about noon the following day. In dull weather they will remain open all day. It is a most INTERESTING SIGHT to watch the opening and closing of the flowers as the clouds appear and disappear. As the flowers open they give forth the most DELIGHTFUL AROMA and the whole atmosphere around is full of scented fragrance. It is always the object of favorable comment, and much curiosity is aroused by people passing at night time so to the cause of the charming aroma, frequently stopping in an endeavor to satisfy their curiosity. PRICE, 15 CENTS packet, two packets for 35 CENTS, POSTPAID.

The Great Wonderberry

A luscious berry that may be grown and ripened from seed in any soil or climate in 3 to 4 weeks. The flavor is fine and unsurpassed for eating raw, cooked, canned or preserved in any form. The fruit is blue-black in color, and tastes like a luscious, rich blueberry. One bush will produce an enormous amount of fruit, yielding great masses of rich fruit all Summer and Fall. Packet, 10c, 3 pkts. for 25c, postpaid.

Bush Musk Melon

A vineless Musk Melon, grows in bushes, and thus can be cultivated in the smallest garden. The fruit is of the popular "Jenny Lind" type, but larger, averaging 2 inches in diameter. The flesh is very deep, edible almost to the rind and is colored light green, flushed with a salmon toward the center. The quality is most closely sweet and juicy. Packet of seeds, with full directions for culture, 15 cents, 3 packets for 40 cents, p.p.d.

The Great Umbrella Palm

A Graceful House or Conservatory Plant The Japanese Umbrella Palm is a semi-aquatic plant. It is easily grown from seed either in a bowl of water or in very damp soil. Probably the most usual, as well as the most interesting method, is to cultivate the plant in a bowl or jardiniere filled with water, with two or three inches of good garden soil at the bottom. The seeds soon commence to germinate, and the plant shoots up stems two to three feet high and rapidly assumes a most pretty palm-like appearance, as shown in the engraving. The tops of the stems are surmounted by a wheel of umbrella-shaped leaves, of a waxy appearance. We will send a package of this seed, with full instructions for culture, for only 15c or three packets for 40c postpaid.

Butterfly's Own Bush

This plant is a veritable refuge or haven for butterflies, and it attracts all the most beautiful butterflies to the neighborhood. Bees, too, are very fond of it. It is a pretty plant bearing perfectly double flowers, ranging from white to rich crimson, deep red and pink, lilac and other delicate shades. Packet 10 cents, 3 for 25 cents postpaid.

FAMOUS MEXICAN FIREFLY PLANT

Beautiful hedge plant, grows 2 to 2 1/2 feet high and resembles a closely clipped ornamental evergreen. The globe-shaped or pyramidal bushes are close and compact, and of pleasing light green color. May be grown singly or in the form of a hedge or background. In early autumn the whole bush becomes carmine or blood red, hence the name of Mexican Firefly Plant, or Burning Bush, as it is sometimes called. Selected Seeds, 10c

CROWN OF THORNS

A very curious and remarkable window plant, can be trained over any desired form. Bright scarlet flowers. An object of rare and striking beauty, easily grown. It grows wild in Judea, and it is said that it was from this plant that the crown of thorns was made which was worn by our Saviour. Packet 10 cents, 3 packets for 25 cents

Asparagus Sprengeri

The best plant for hanging baskets. Masses of rich, gleaming foliage droop in a very graceful manner. The foliage when cut for decorative purposes will last for weeks in water. The seed pods are very pretty and berries adding to its beauty. Packet, 10c, 3 pkts. for 25c, postpaid

"Wong-Bok" Chinese Cabbage

Novelty from China and should be grown in every garden. Seems to be a cross between Celery and Cos Lettuce. Flavor is more mild than any other cabbage. Can be served on the table and eaten raw or cooked like cabbage, spinach or lettuce or made into salad. Grows very rapidly, easy to cultivate. You can create quite a sensation by cultivating this remarkable novelty. Seeds, 15c packet, 3 pkts. for 40c.

TREE OF HEAVEN

This splendid ornamental tree is a native of China and is called the Tree of Heaven, on account of its great beauty. Very hardy, thrives in any soil, no matter how poor, and grows from 6 to 10 feet high from seed the first summer. The leaves are from 6 to 8 feet in any length, giving it a grand appearance. Nothing out of the tropics can rival it for lawn decoration. Large panicles of bloom, followed in season by great clusters of colored seed pods, make the tree a continual thing of beauty. Packet, 15c, 3 packets

SURPRISE FLOWER GARDEN

Over Hundred Varieties of Mixed Flower Seeds MANY RARE AND CURIOUS NOVELTIES An Abundance of Flowers Assured Throughout the Season A mixture of easily grown annuals that bloom very soon after sowing the seeds; others vary in their time of blooming. Those who cannot give the constant care necessary for finely arranged flower beds will be delighted with the Surprise Wild Flower Garden. Will prove a continual surprise and pleasure, as new varieties and the old garden favorites flower successively throughout the season. There are over a hundred varieties of seeds. Many of the plants may be taken inside as house plants and will bloom during the winter. Fine for children, also teachers for school gardens. Packet, 15 cents, three packets for 40 cents, postpaid. J. S. & CO.

JOHNSON SMITH & CO., Dept. 77, RACINE, WIS.

A Perfect Glareless Headlight At Last



Distributors—Agents and Dealers—Can Make \$3,000 to \$15,000 or More A Year

The Detroit Safety Headlight Devices absolutely solve the greatest menace to automobiling—the headlight glare. This

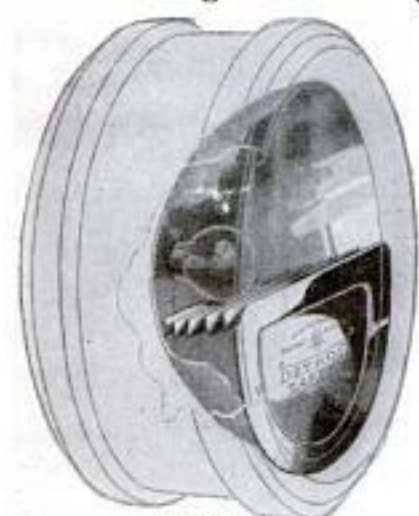

PATENTED

is a new, simple device and fits any model of any car. Installed easily and quickly by anyone.

Used with low priced plain glass lens. It adds style and dignity to any car. It absolutely concentrates the light down on the road, not up in others' eyes. Drive with all the courtesy of the road with bright lights on. The glare is positively eliminated. Will last a lifetime. Will not rust, corrode or deteriorate. Meets every legal requirement. They are the best headlight devices made and stand any test.

Detroit Safety Headlight Devices **Sell On Sight**

They sell on sight—a demonstration sells anyone. Easily demonstrated in store, home or on car. Sold on 30 day trial—never taken out. Appeals to fairness—no one wants to drive others to death in ditch. Owners urge others to buy. Gives longest light on road—lights full width of road. See illustrations as to installation and effect.

Exclusive Territory—Newspaper Advertising—Installed Free

Exclusive territory granted to right men—we run newspaper advertising and arrange for **Free** installation by competent garages. Printed matter and cards also furnished. We want men in every county who can handle men and sales and

make from \$3,000 to \$15,000 or more according to territory.

Hundreds of live wide-awake men have made application for territory—there is still plenty of excellent territory left. Better act NOW.

FREE—One Set. Free Introductory Advertising Offer

One set of Detroit Safety Headlight Devices in a neighborhood makes everyone want them. It's the best kind of advertising for our representatives. Therefore, for a short time we will sell two sets for the price of one (\$2.00) or one set at wholesale price of \$1.00, postage paid. Buy two sets, sell one easily at \$2.00—yours will be free. This offer is open to everyone to advertise the devices. When territory Representatives are appointed offer ceases—so act now. Easily installed by anyone. Get literature—clip **FREE** coupon, fill in, pin \$1 or \$2 bills to coupon—act quickly NOW.

Motor City Syndicate

Sole Manufacturers

Offices: 1217 Book Bldg., Dept. 23

Detroit, Mich., U. S. A.

FREE—One Set Free Coupon

Motor City Syndicate,
Offices: 1217 Book Bldg., Dept. 23,
Detroit, Mich.

Gentlemen: Without obligations, please send literature on Detroit Safety Headlight Devices. Send such offer as I have marked below.

Do you want to sell?.....

What territory?.....

Make of your car..... Model..... Year.....

Make of other car..... Model..... Year.....

Fill in both for \$2.00 offer.

Are you interested in Bonus Offer?.....

Just use Dollar Bills if sending money.

Enclosed \$..... for offer as marked above. These to be mailed postage paid.

Name.....

Address.....

City..... State.....

THE FAMOUS YORK SAX



BRILLIANT
NEW
TRUMPET
SENT TO YOU
ON 6 DAY

For
Jazz
Players

free trial

Here is the easiest instrument to play. Sent to your home on 6 days' free trial. Play on it. Compare the tone, the workmanship, the quality. Note the ease of blowing. Keep it 6 days. If not satisfied in every way send it back and it won't cost you a penny. Easy monthly payments on the balance if you buy. Pay while learning to play. Send for details today. You will be placed under no obligation.

The York Trumpet

Brilliant new small bore trumpet—a York triumph—for the musician who wants a snappy, beautiful tone. Permits jazz player to get the effects he wants. No fatigue in playing. To hear it is to want it.

Take Your Choice

If you would rather have any other band instrument on trial indicate it on the coupon. You may take your choice of Saxophones, Trombones, Clarinets, Cornets, Trumpets, Altos, Basses, Baritones, Drums, etc. All sent on 6 days' free trial for your inspection.

Send Coupon for Details

Simply fill out the coupon below and mail at once and get our beautifully illustrated literature and full details of our great free trial offer.

J. W. YORK & SONS

Dept. 221-C Grand Rapids, Mich.

J. W. York & Sons, Dept. 221-C, Grand Rapids, Mich.
Gentlemen: Kindly mail, without cost to me, your beautifully illustrated literature and details of your Free Trial and Easy Payment Offer.

Name.....

Address.....

Instrument.....

(Mention above the instrument most interested in.)

Orlando is Calling You

Do you want to get away
From the grind of every day—
From the drudgery of things you have to do?
Do you want to settle down
Near a lively, busy town,
Where the joy of living will appeal to you?

Do you want to scent the breeze
Coming through the orange trees?
Do you want to hear the birds call—loud
and clear?

Are you seeking perfect health
That's combined with certain wealth
And an income from an orange grove each
year?

Do you want a piece of land
That will grow to beat the band
All the different garden crops that you
enjoy?

Do you want to make a "Nest,"
And a permanent bequest
For the future welfare of each girl and boy?

Do you want a sunny clime
Where there's fishing all the time?
Where there's ducks and deer and quail
and other game?

Where the summer climate's cool,
And within each lake and pool,
You can swim in January—just the same?

Do you want to buy this land
On an easy-payment plan,
With about your monthly outlay for cigars?
Do you want to read a book
That will make you want to look
On the finest land that lies beneath the stars?

Send a letter right away;
Put it in the mail to-day,
We will send this Booklet absolutely FREE.
After you have read it through,
If a thought occurs to you—
Just address another letter here to me.

We will answer, straight and true,
Questions that occur to you.
We have nothing to evade or to conceal.
On an Orange County Farm
Life will take on added charm,
And you'll never lack a dollar — nor a meal.

Send for our Big, FREE Illustrated Book—
"TWENTY ACRES AND PLENTY." It
tells of almost unbelievable profits made
from trucking and fruit-growing in our part
of FLORIDA. Also about sick-and-out-of-
work Clauses, and other protective features
of our contract. Address Sylvester E.
Wilson, Dept. L-15, Orlando, Florida.

16¢ a rod WIRE FENCE

Hog, Field, Poultry, Lawn
Send for sensational fence
bargains. Save money on every rod. Sold
Direct from our factories to you at
prices that will amaze you. Satisfac-
tion Guaranteed or your money back.
Many styles of fence, gates and posts.
Write today for FREE Fence Book.
OTTAWA MANUFACTURING CO.
Fence Makers for over 20 Years
Box 211-G
Box 211-G
OTTAWA, KANSAS
CHICAGO HEIGHTS, ILL.

FREE Fence Bargain Book

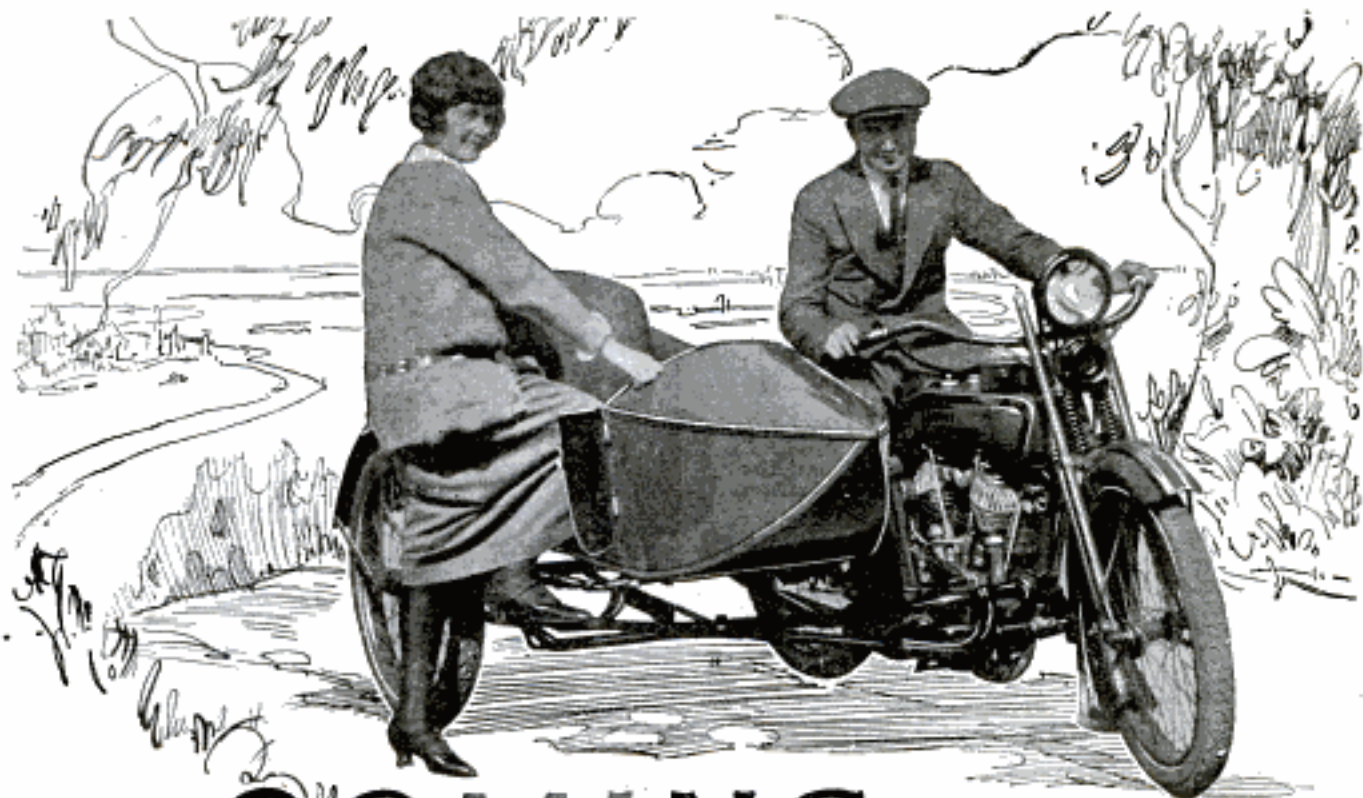

COMING ~ A Wonderful Summer!

JOYOUS, care-free week-ends—long evenings when it's too hot to stay cooped up in town—think now what sport you can have *then* with a Harley-Davidson!

Every day will bring new joys, new thrills to you and your side-car pal. Speedy jaunts to seldom-fished lakes that automobiles never reach—Sunday outings with "the gang"—cool rides to and from work while others pack into street cars. No garage necessary; only a few cents a day for upkeep (Harley-Davidsons average two cents a mile—gas, oil, tires, and all)!

And remember: 1924 Harley-Davidsons are the finest ever built. Lightweight-alloy pistons, Alemite lubrication, full-floating, easy-riding sidecar, olive green finish maroon striped.

Ask your dealer for a free demonstration ride and his Pay-as-You-Ride Plan. And send us the coupon below.

HARLEY-DAVIDSON MOTOR COMPANY
Dept. P, Milwaukee, Wis.

Money-making sales opportunities in open territories. Write for particulars.

Harley-Davidson

The Motorcycle

Harley-Davidson Motor Co., Dept. P, Milwaukee, Wis.
Send me, free, postpaid, new catalog showing 1924 models in actual colors.

Name _____
Address _____

CLEAR RECEPTION ASSURED

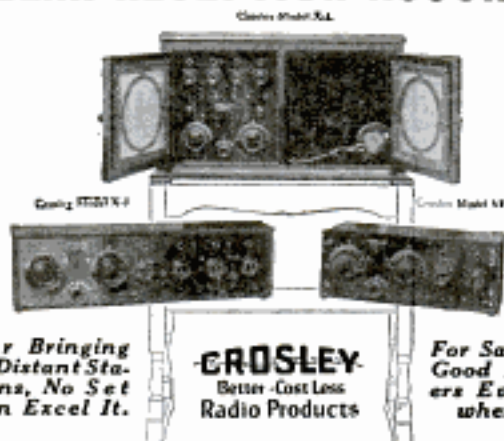

For Bringing
in Distant Sta-
tions, No Set
Can Excel It.

CROSLLEY
Better—Cost Less
Radio Products

For Sale by
Good Deal-
ers Every-
where.

MODEL VI—\$30. A wonderfully efficient two-tube set, one stage of Tuned Radio Frequency Amplification and Detector.

MODEL X-J—\$65. A four-tube radio frequency set combining one stage of Tuned Radio Frequency Amplification, a Detector and two stages of Audio Frequency Amplification. A jack to plug in on three tubes for head phones, the four tubes coupled up for loud speaker.

MODEL X-L—\$140. A duplicate of Model X-J, except the arrangement and mounting into a beautiful cabinet provided for housing the necessary batteries. Special mahogany stand for Model X-L \$25 extra.

Cost of necessary accessories \$40 up.

***** MAIL THIS COUPON TODAY *****
THE CROSLLEY RADIO CORPORATION

POWELL CROSLLEY, Jr., President
Formerly The Precision Equipment Company and Crosley Manufacturing Company
315 Alfred Street Cincinnati, Ohio

Gentlemen: Please mail me free of charge complete catalog of Crosley instruments and parts, together with booklet entitled "The Simplicity of Radio."

Name

Address



PURE-BRED POULTRY Most profitable varieties. Also **EGGS** and **BABY CHICKS**, Incubators, Brooders, Grain Sprouters, Supplies, Garden Seeds. Highest quality. Low cut prices. Illustrated Catalog mailed FREE. Address **Nichol's Poultry Farm, Box 3, Moxmouth, Illinois**



\$2409 BUNGALOW \$1606

\$489
5-ROOM HOUSE



FREE CATALOG
with many other beautiful homes at \$489 to \$4,797—all at big savings. Garages \$73 and up.



ALL materials complete for only \$489! See specifications below. For double walls and floors add \$42.

You receive all lumber cut-to-fit (highest grade only), windows, doors, flooring, shingles, lath, glass, paints, varnish, putty, hardware, nails, molding, cupboards—everything plainly marked and easily assembled according to drawings and directions we furnish. \$1,606 Bungalow includes double walls and floors.

Buying Direct Saves 1/3

LET us ship you direct from our mill all the materials complete for a **Sterling cut-to-fit Home** (not portable) and save you four big profits on lumber, hardware, millwork and labor, besides a 20% saving in waste. **Sterling Homes** are substantially built and lasting. Many thousand satisfied **Sterling Home** owners. Satisfaction guaranteed or money back promptly. **International Mill & Timber Co.** 1972 South Wenona Ave. Bay City, Mich.



MAH JONG SET

Complete with instructions, rules and illustrations, 144 characters, 152 counters, racks, dice and score card. Postpaid, in attractive box, on receipt of \$1.00. (Canada 25c extra.) **ORIENTAL IMPORTING CO., 110 W. 40th St., N. Y.** AGENTS WANTED

\$1

ABSOLUTELY FREE
Thousands of
RADIO BARGAINS

You Can't Equal This Anywhere
SRACO head sets—2,000 Ohms—head bands and cord complete. Extremely sensitive. Write Dept. A for wonderful catalog. **\$2.98**

STANDARD RADIO CORP.
227 WEST MADISON ST. CHICAGO

"Little Wonder" Alcohol Torch

Indispensable to any Tool Kit. Splendid for light wire and Radio work. Powerful soldering flame. Burns any position, stands safely. Best type of small torch made. Sent on 10 days' trial. Price \$2. Money refunded if not pleased.



VAN PRAAG SALES CORP.
19 East 17th St. New York

O. D. Wool Coats \$1.25
Like Cut. New. Sizes 33-34-36-38 only. The coat for any mechanic, lounging, hunting or working. Postage Prepaid. Arms and other goods in catalog. *It's Free.*
W. STOKES KIRK 1627-PM No. 10th Street PHILADELPHIA, PA.

HANES For downright Underwear value

ARTISTS MAKE MORE MONEY
Use our photographic enlargements direct on canvas. This gives you an entirely new field for your efforts and a tremendous opportunity to make enormous profits. We copy and enlarge any picture on a high grade canvas with full detail and strength—any size you may require. For trial size 11x14 send \$1.00 and postage.
CANVASOGRAPH COMPANY
6215 Wentworth Ave. CHICAGO, ILL.

SEE-WELL
Windshield Cloth
Works Like Magic

An absolute protection against rain and snow. Clear vision at all times over entire windshield.
Positive protection for motorists, motormen and engineers. Makes driving safe in stormy weather. Keeps entire windshield absolutely clear. No grease, no oil. Full vision guaranteed. Rain actually bounces off the glass. Simplicity itself. Money back if not satisfied. Guaranteed for one year.
AGENTS WANTED

Here is a life saver that sells on sight once its usefulness has been demonstrated. All you have to do is rub the wet windshield with magic See-Well once and the glass will remain clear and clean in the rain for 24 hours. Send it back if it doesn't work.
Sent prepaid to any address. 50 cents ea. Two for \$1.00. Send for yours now. Write for our agents proposition.

S. & W. MANUFACTURING COMPANY
403 Diamond Ave., S. E. GRAND RAPIDS, MICH. **50c**



Nothing Like a **BUESCHER**

TRUE
TONE **Saxophone**
of Your Own

- To play the newest hits.
- To play with piano accompaniment.
- To play in orchestras.
- To play in bands.
- To put life in every party.
- To make new friends.
- To win a welcome everywhere.
- To make you a leader in church, lodge, fraternity or school circles.

And it is all so easy.



TOM BROWN
Director
Six Brown Brothers
Saxophone Sextet
Victor Records



BENNIE KRUEGER
Director
Bennie Krueger and
His Orchestra
Brunswick Records

Easy To Play - Easy To Pay

Saxophone Book FREE

Every music lover should send for a copy of this interesting book on the history and development of the Saxophone.

It tells which Saxophone takes violin, cello and bass parts, and many other things you would like to know. Also illustrates first lesson. Send coupon for your free copy.

The Buescher Saxophone is so perfected and simplified that it is the easiest of all musical instruments to learn. With the aid of the first three lessons, which are sent free (upon request) with each new saxophone, the scale can be mastered in one hour; in a few weeks you can be playing popular music. Within 90 days you can take your place in a band if you desire.

Try It in Your Own Home

We will send you any Buescher Saxophone, Cornet, Trumpet, Trombone or other orchestra instrument you may select. You can try it six days in your own home without obligation.

Easy terms of payment arranged if desired. Mention the instrument interested in and we shall mail you our complete catalog—free.

Buescher Band Instrument Co.
2567 Buescher Block, Elkhart, Ind.

Gentlemen:
I am interested in the instrument checked below:

Saxophone..... Cornet..... Trombone..... Trumpet.....
(Mention any other instrument interested in)

Name

Street Address.....

Town..... State.....

BUESCHER BAND INSTRUMENT CO.

Makers of Everything in Band and Orchestra Instruments

2567 Buescher Block ELKHART, INDIANA



A real Stevens rifle for only \$4.50

Here's a real honest-to-goodness rifle—at a price that makes you want to cheer.

Made like all the rest of the Stevens line—for straight shooting and long, hard service.

The barrel, for instance, is rifled to less than a thousandth of an inch. That means downright accuracy! And in Stevens rifles strength is their middle name. They simply stand all sorts of hard wear. And all this for only \$4.50.

Whether it's the new *Stevens Junior*, the old *Favorite* or the fast working little *Visible Loader* repeater, you can always bank on a Stevens for bagging game or for knocking over pests. Look over the Stevens line at your dealer's or write us direct for interesting catalog.

J. STEVENS ARMS
COMPANY

Dept. 541

Chicopee Falls, Mass.

Owned and Operated by the
Savage Arms Corporation

Stevens

No. 11 Stevens Junior, 20 inch barrel, round-blued finish — military stock—knife blade front sight—open rear sight. Shoots C.B. Caps .22 short, long or long rifle. Weight — 2 $\frac{3}{4}$ lbs. Price, \$4.50.

SHOES AT WHOLESALE

BUY direct from the wholesaler! Send today for free catalog containing 140 big savings in men's, women's and children's shoes at 99c and up.

EXTRAORDINARY VALUE ALL LEATHER

\$2⁸⁹

Genuine Good-year Welt. Men's latest style Mahogany brown dress Oxford with uppers of handsome, soft, strong, calf-finished leather. Extra wearing quality leather soles and live, springy rubber heel.

SIZES: 5 to 11, Widths, C, D, E. No. 01041. WE PAY POSTAGE, if money or check accompanies order; or you can PAY POSTMAN on delivery plus postage. Simply mention No. 01041, size and width, or all numbers in shoe you now wear.

Money Back Promptly if Not Delighted

Anderson Shoe Co., Inc., Dept. 1 BD
102 Hopkins Place Baltimore, Md.



BEAUTIFUL EMBLEM RINGS SET WITH LUXO DIAMONDS

AT LAST! A genuine LUXO DIAMOND EMBLEM Ring. Only \$3.99. Why spend more? LUXO DIAMONDS defy experts. Same dazzling brilliance and sparkling fire of \$50 Diamonds. Handset only engraved. Genuine 14 K. Gold. Raised emblem with rich enamel filling. Limited supply at an introductory price. Any Emblem desired. Rush order!

(ANY EMBLEM) Just send name, address. Ever size emblem wanted. Pay postman \$3.99 plus postage! Money back guaranteed if not delighted. Any two lodge rings \$7.25; three \$10.00. Splendid gift to fraternal brother. Write today!

HOUSE OF KIER, 443 So. Dearborn St. Dept. H-3 Chicago, Illinois

Send for FREE Catalog

INVENTORS, experimenters, designers, auto repairmen—you should have this catalog which illustrates and describes the various models of MONARCH Lathes which are built up to 30" swing. Illustration herewith shows the MONARCH Jr. 9" engine lathe—accurate, compact and trouble proof. Has semi-quick change gear and automatic safety devices.



\$245 9-in. Lathe—
2 $\frac{1}{2}$ -ft. bed—
with bench legs

Also built with bed lengths up to 5 feet. Made in 11-inch swing size, too, at slightly higher price.

THE MONARCH MACHINE TOOL CO.
400 Oak Street SIDNEY, OHIO

Build Sportsman's Ideal Ford DeLuxe

With
Ford speed
Body—
6 Models

Mount One on
your Ford
\$2900
up



8-16 Overhead Valves Selective Transmissions Sport Fenders Underlung Sport Fenders for Standard Fords

Others the beauty of this body and the wonderful change in the line of a Ford. Ford speed Bodies Offer Class—Quality—Variety—Reasonable Prices. Bodies are completely assembled and finished in most attractive sport colors—all ready to be set on chassis. Twelve complete sport cars on DISPLAY in our showroom.

THIS MONTH'S SPECIALS

Price	Now	Price	Now		
Spiral Gear Maximo Drive	\$20	\$13.95	Speed & Power Camshaft	\$19.00	\$ 9.95
Underlung Fenders	15	9.50	Overhead Valves	57.75	44.75

Satisfaction or Money Back Guarantee. 50% with order, balance on delivery.
W. T. FORD SPEED & POWER EQUIP. MFRS., 250 W. 54th St., New York, 2nd Floor



No. 2692—Eveready two-cell aluminum flashlight complete with battery 75c—anywhere in the U. S. A.



EVEREADY UNIT CELL[®] fit and improve all makes of flashlights. They come in two sizes to fit every tubular case flashlight. Know the Eveready size that fits your case. Then you can buy new Eveready Unit Cells without bothering to take your flashlight along. Eveready Unit Cells mean brighter flashlights and longer battery life.

To locate the trouble —use your flashlight!

LIGHTS out—something wrong! Use your flashlight to locate the trouble. Keep an Eveready at the top of the cellar stairs. Tie a tape around it and hang where it will be instantly convenient. Use it for safe steps in the emergency and all the time. No fire hazard. Don't fumble—keep an Eveready Flashlight in your room. Another in your garage for looking over the car—and use on the road.

Keep all your flashlights loaded with Eveready Unit Cells and you will have plenty of bright, white light when and where you need it.

If you have a flashlight not in use, get it out and reload with Eveready Unit Cells; long-lived cartridges of brilliant light. Buy them from any

electrical or hardware dealer, drug, sporting goods or general store, garage or auto accessory shop.

When you buy new flashlights, be sure they have EVEREADY stamped on the end. EVEREADY means the highest standard of flashlight quality, and Eveready Unit Cells give more light longer.

Prices from 65c to \$4.50 complete with battery—anywhere in U. S. A.

NATIONAL CARBON COMPANY, INC.

New York San Francisco

Canadian National Carbon Co., Limited

Factory and Offices: Toronto, Ontario

EVEREADY
FLASHLIGHTS
& BATTERIES
—they last longer

I Train You to Boss the Job!



Make \$3,000 to \$10,000 a Year as a Cooke-trained Auto Expert!

The world's biggest, most fascinating business needs you! Why slave away at small pay when there are unlimited opportunities as a **Cooke-trained** Auto Expert waiting for you? Mail coupon and I will tell you how I train you **AT HOME** in your spare time for positions paying \$75 to \$200 a week. Let me show you how hundreds of men just like yourself have used my **JOB-WAY** training to make a quick, brilliant success in the Auto business.

I Train You AT HOME



Cooke **JOB-WAY** training will raise you out of the "dub" class **quick!** As Directing Engineer of the great Chicago Auto Shops I know what training you

need to make big money, and **I GIVE YOU THAT TRAINING!** Right in your own home, I make you **MASTER** of every branch of Auto, truck, and tractor work. I train you with **JOB**—not books. I give you complete and practical instruction in every detail of Mechanical and Electrical work, Battery, Ignition, Farm Power Plants, Welding, Brazing, Vulcanizing, etc.

Go into the best-paying business on earth!

When you read that there are now 15 MILLION autos, trucks and tractors—that car owners are paying out SIX THOUSAND MILLION DOLLARS A YEAR for **up-keep** you will realize here is the business to get into! There are so few Experts, there's such an enormous demand for them that every man who takes my **JOB-WAY** training is assured of a successful future!

Earn While You Learn! Go Into Business!

My training also includes Garage management, automobile salesmanship and advertising—how to go into business for yourself and make a success of it. Get my big Auto Book—it's **FREE**—see what others have done after only a few months of my **JOB-WAY** training. In this book I prove to you under a written Money Back Guarantee that you too will find your success as a **Cooke-trained** Auto Expert. Almost at the start I train you to **do actual jobs and make extra money doing it.** 92 out of every 100 of my students report they are doing practical work, many of them are making more money than the entire cost of "**JOB-WAY**" training!

Mighty little capital needed. The big thing is **COOKE JOB-WAY TRAINING.** Rich prizes, big profits await every man who has been trained to give car-owners **EXPERT** service. I give you this training, and I also train you how to start, and run a business of your own.

AUTO BOOK FREE!

I don't care how old or young you are, how much or little education you have, this training will make you a successful Auto Expert. Special inducements and many

EXTRA features **right now.** Easy terms and low cost. Coupon brings free book and complete information. **Mail it today!** Address me personally:

B. W. COOKE
Directing Engineer

Pioneer Automotive Maintenance Engineer and Directing Engineer of the great Chicago Auto Shops.

Mail Coupon Today!

B.W.COOKE,
Directing Engineer
CHICAGO AUTO SHOPS
Dept. 316-A
1553 W. Madison St., Chicago

Send me **FREE** Auto Book and proof that I can become an Auto Expert at home in spare time. Also send your special offers of **FREE** outfit reduced price and easy terms.

BIG OUTFIT FREE!

Mail coupon for my astonishing offer of costly testing and repair outfit free to every student for a limited time. Many students have used this outfit and my special instruction covering practical work to make **EXTRA MONEY** almost from the very start.

B. W. COOKE
Directing Engineer

CHICAGO AUTO SHOPS
316-A, 1553 W. Madison St., CHICAGO

.....Name
.....Address
.....City.....State
.....Occupation.....Age



Amazing *new* farm offer!

PAYMENTS SO SMALL YOU WILL HAVE A SURPLUS FOR COMFORTABLE LIVING

The Canadian Pacific Railway now offers you a Farm Home in Western Canada on a New Long-Term Plan of Easy Payments that is Extraordinary. The plan makes it possible to own a farm home without taking all profits to meet land payments and leaves a surplus for the comforts and enjoyments of life.

PAYMENTS EXTENDED OVER 35 YEARS —FIRST YEAR FREE USE OF LAND

Under this plan all the settler pays down is 7% of the purchase price—One year's free use of the land without any interest chargeable whatsoever. The balance of principal and interest will be amortized on an easy payment plan of 34 equal annual payments which makes the second payment fall due two years after the purchase of the land, which is figured on the basis of 7% (including principal and interest) of the balance of the cost of the land. For example, on a purchase of 160 acres costing say, \$3,000, the down payment will be \$210 and the annual payments, commencing at the end of the second year, will be \$195.30. After 35 years the settler will get clear title to the land—unless, of course, he wishes to pay sooner, which is his privilege.

CANADA'S 1923 CROPS BEAT ALL RECORDS

In 1923 the wheat crop of Canada exceeded the 1922 crop by almost 100,000,000 bushels. In Alberta, the average yield was 26.5 bushels per acre and there were many individual cases where yields of 50, 60, 75 and 80 bushels were returned. Other crops showed a corresponding increase over previous years with equally high yields. These enormous yields on moderate priced land even at average prices for farm products have placed many farmers on the road to success.

NO TAXES ON IMPROVEMENTS

Taxes are moderate and there are no taxes on livestock, buildings, improvements, implements or personal effects. Good markets, modern schools, roads, churches, amusements make farm life in Western Canada desirable and attractive.

IRRIGATED FARM LANDS

In sunny Alberta—a district that is especially adapted to mixed farming and where irrigation has been proved beneficial—a vast irrigation system with an unfailing supply of water administered under the direction of the Government, has been constructed.

Irrigation in Southern Alberta—insures you a crop every year—increases your crops each year—makes you independent of weather conditions—produces great quantities of coarse grains, pastures, alfalfa, roots, etc., thus developing the livestock industry which is safer and ultimately more profitable than wheat farming—tends toward closer development, well-cultivated farms, good neighbors.

These lands are also for sale upon the same amortization terms as our other farm lands. Full details on application.

YOU CANNOT BUY UNTIL YOU INVESTIGATE

You must inspect the land before buying in order to judge of its fertility. Special inspection trips from points

Chicago and West will leave on the first and third Tuesdays each month. Single fare plus \$2.00 for the round trip. Let us arrange details. Send this coupon now. It will give you without obligation complete information on the new and amazing plan. These terms are so easy that you can own your own farm home—instead of renting.

M. E. THORNTON, Supt. of Colonization
Room 433, Canadian Pacific Ry. Bldg.
Calgary, Alberta

M. E. THORNTON

Supt. of Colonization, Room 433
Canadian Pacific Railway Bldg.
Calgary, Alberta, Canada

I am interested in learning more about
Prairie Provinces of Canada
Irrigation Farming in Sunny Alberta
Business and Industrial Opportunities in Western
Canada
Lloydminster and Battleford Districts

My Name.....

Address.....

Town..... State.....

**FREE**

Book on Wood Finishing

Gives complete instructions for finishing all wood—hard or soft—old or new. Explains just what materials to use and how to apply them. This book is the work of experts—illustrated in color. Contains a hundred wood finishing hints.

Tells how inexpensive soft woods may be finished so they are as beautiful as hard wood. Includes color charts—gives covering capacities, etc. Contains many practical suggestions on making your home more artistic, cheery and inviting.

Johnson's Wood Dye

Johnson's Wood Dye is for the artistic coloring of all wood. It is very easy to apply—dries in four hours and will not rub off or smudge—penetrates deeply bringing out the beauty of the grain. Made in fourteen popular shades all of which may be easily lightened, darkened or intermixed.

S. C. JOHNSON & SON, Racine, Wis.
 "The Wood Finishing Authorities"
 (Canadian Factory—Brantford)

S. C. JOHNSON & SON, Dept. PA3, Racine, Wis.

Please send me, free and postpaid, your instruction Book on Wood Finishing and Home Beautifying.

Name.....

Address.....

City & State.....

Dealer's Name.....

MEN WANTED!

I am teaching trades to men who want to get out of white collars and into overalls. Who want to quit being wage slaves whose job a strike or bad business or employer's whim can terminate without warning. Who want a chance to be independent, make real money and own their own business. I refer you to sixty thousand men who found the way to success by sending for my catalog.

Earn \$50 a Week and Up!

If you are looking for work at \$50 a week and up, if you would like to get into something sure and solid that will give you success and independence, and can put in a few weeks this winter in TRAINING write me today.

With over TWELVE MILLION automobiles running the demand for mechanics, demonstrators, chauffeurs, truck drivers, garage men, etc., is greater than ever before. Countless opportunities in cities and towns and even remote places. I estimate there are 20,000 Sweeney trained men owning their own garage or business.

FREE CATALOG AND SPECIAL OFFER

Get my big FREE 64-page catalog. It shows hundreds of actual photographs of men at work in my magnificent new school. Tells all about wages, profits, opportunities in auto and tractor business. Explains step by step how you learn. Interesting letters from graduates telling how they made good. Shows how men come from all over the world to this big school. Makes you want to join the crowd. Tell everything you want to know. I will gladly send you a copy beautifully illustrated. I'll tell you how to get into business for yourself. No colored students accepted.

Send this NOW

E. J. SWEENEY, President

LEARN A TRADE-
Sweeney
AUTOMOTIVE & ELECTRICAL SCHOOL
28-C SWEENEY BLDG. KANSAS CITY, MO.

The white-collar worker contemplating a shift into a manual trade will find, with a little investigation, that the trades themselves are shifting. Yesterday he would have tackled something like carpentering, bricklaying, plastering, painting or typesetting. Today he finds a demand for men who understand automobiles, internal-combustion engines, electricity, and other crafts cutting and welding, and other developments of comparatively recent growth of internal-combustion power and the changed character of building.

—Saturday Evening Post
"The White Collar Shifts Into Overalls"



SWEENEY System of Practical Instruction

is the ONLY way to learn if you want to save time and money and be properly trained. You get this at the famous trade school, the MILLION DOLLAR SWEENEY SCHOOL and you get it nowhere else. I have helped 60,000 men to success. The way to learn is easy. You don't need any experience, age makes no difference. I teach with tools, not books. You learn by actually doing the work. I am making a *Special Thirty Day Offer*. That is why you should not delay. The first step is to send for my big Free Catalog.

EMORY J. SWEENEY, President
Dept. 28-C, Sweeney Building, Kansas City, Mo.

Send me free, without any obligation on my part, your 64-page catalog and Special Offer!

NAME _____

GIVE AGE _____

P. O. _____

STATE _____

RIDE A RANGER



ALL THE YEAR 'ROUND

30 Days' Free Trial

ment and exclusive features. If at the end of thirty days you

Factory-to-Rider

When you buy a Ranger you are dealing direct with the makers at Factory Prices. Your "Ranger" is waiting for you. The breath of Spring is in the air. Write for our catalog to-day. When we get your order your bicycle will leave on a fast express train (all charges prepaid) packed in a waterproof paper bag and enclosed in a strong wooden crate. Safe delivery in perfect condition guaranteed.

See for yourself the values found in Ranger bicycles with their complete equipment of accessories and extras. Send to-day for catalog and select the model you prefer. Ride it thirty days, test its speed, sturdy qualities, de luxe equipment and exclusive features. If at the end of thirty days you want to return it for any reason, send it back and you will not be out one cent.

Pay only \$5 a Month

If not convenient to pay cash for your "Ranger" bicycle, we will ship it to you at once and arrange with you to accept small monthly payments which will enable you to take advantage of our rock-bottom factory-to-rider cash price with only a slight amount added to cover the cost of extra bookkeeping. Parents frequently advance the initial small payment and energetic boys and girls save and earn the later small monthly payments.

There are many styles and sizes in the famous line of RANGER Bicycles a model to suit every taste and any pocket book.

5-Year Guaranty

This means we make good trouble arising from any defect in workmanship or material at no cost to you. Our guaranty is a written contract—we are directly responsible for the satisfaction and general performance of your bicycle because we made it.

Every Mead "Ranger" is warranted for five years.

Tires and Equipment

Our big free catalog illustrates and describes parts, equipment and sundries that our more than a million riders may need. All are carefully selected from the leading parts makers of the world, to Save You Money at Our Factory Prices.



MEAD CYCLE COMPANY
Dept. H-108, Chicago, U. S. A.

Send me the new Ranger Catalogue, factory-to-rider wholesale prices, 30-day Free Trial Offer and Easy Payment Terms.

Name.....
R. F. D. or.....
Street No.....

Town..... State.....

FACTORY DISTRIBUTORS IN 364 CITIES

The nearest city (with a population of 28,000 or more) which I can conveniently visit to select a Mead Ranger is.....

If you have a Special Factory Distributor there, send me letter of introduction to him so I can inspect the Rangers and take delivery from there at Factory prices or on Easy Payment Plan if I prefer.

Get this FREE Catalog



We have a copy all ready

for you and it will be sent as soon as we receive the coupon in the lower corner of this page. If you prefer send a postcard—only write your name and address plainly. Turning the pages of the "Ranger" catalog is like walking down the aisles of the largest and greatest of bicycle stores seeing bargains, new ideas and conveniences that you never saw or heard of before.

Send No Money

Ask for the big catalog and full particulars of our Factory Prices, marvelous offers and Easy Payment terms. Read especially about our extra \$5.00 FREE Premium set which goes with every "Ranger" bicycle

MEAD CYCLE COMPANY

DEPT. H-108

CHICAGO, U. S. A.

Copyrighted material